



3 1761 02170828 4

Digitized by the Internet Archive
in 2008 with funding from
Microsoft Corporation





THE
LIFE, TIMES,
AND
SCIENTIFIC LABOURS
OF THE SECOND
MARQUIS OF WORCESTER.

TO WHICH IS ADDED, A REPRINT OF HIS
CENTURY OF INVENTIONS,
1663,
with a Commentary thereon,

BY
HENRY DIRCKS, ESQ.,
CIVIL ENGINEER, ETC. ETC.

Inventas aut qui vitam excoluere per artes.
Quinque sui memores alios fecere merendo.
VIRGIL.

How few men of genius are there who have not been the victims of
misfortune! SIR EGERTON BRYDGES, BART.

LONDON:
BERNARD QUARITCH, 15 PICCADILLY.
1865.





TO

THE MOST NOBLE

Henry Charles FitzRoy,

DUKE OF BEAUFORT,

MARQUIS AND EARL OF WORCESTER,

EARL OF GLAMORGAN, VISCOUNT GROSMONT,

BARON HERBERT OF CHEPSTOW, RAGLAND, AND GOWER,

BARON BEAUFORT OF CALDECOT CASTLE, AND

BARON DE BATTETCOURT,

ETC. ETC. ETC.

MY LORD DUKE,

THROUGHOUT your Grace's most ancient and regal line of ancestry it would be impossible to name a more truly exalted character than EDWARD SOMERSET, the sixth Earl and second Marquis of Worcester, father of Henry, created first Duke of Beaufort by Charles the Second.

This pre-eminence, due to his high intellectual

gifts in CONSTRUCTIVE INGENUITY, distinguishes him not only amongst the illustrious descendants of Plantagenet, but renders it impossible to name his compeer, either among the highest nobility, or the most eminent scientific celebrities of Europe, during the last two centuries. Indeed, it may be justly said, that ancient lineage, noble descent, illustrious titles, even when crowned with all the glories of martial deeds, or senatorial honours, fade into comparative insignificance before the enduring renown, which it is alone the prerogative of original genius to confer on the memory of men remarkable for their discoveries in arts conducive to the elevation of mankind in the scale of being.

The History of Science from the days of Archimedes presents a vast phalanx of men mighty in genius; but foremost in this intellectual group ranks the Marquis of Worcester, the originality, independence, and grandeur of whose mechanical conceptions have acquired a world-wide celebrity; for he it was who first evoked that Titanic power, which, through successive improvements, consequent on the accumulated ingenuity of two hundred years, has given to the present age the modern Steam-engine.

It may be freely conceded that, *stupendous* as he himself pronounced the parent engine to be, it was, nevertheless, only as the acorn compared to the time-honoured monarch of the forest. Just as the existence of the plant is dependant on that of the seed, so, had the Engine he constructed never existed, we might have been unacquainted even to this day with the mechanical application of steam.

Living at a period when Civil War convulsed this country, and unhappily brought severe suffering on

all who were conspicuous for their loyalty, the Marquis of Worcester, in common with the Royalist party, had to succumb to intolerant rulers. For while Cromwell enjoyed an income of £2,500 per annum, derived from a portion of his Lordship's princely estates, the Protector proudly granted to THE INVENTOR OF THE STEAM ENGINE, a weekly stipend of Three pounds!

Unfortunately, the Restoration of the monarchy contributed but little to ameliorate his Lordship's sad condition; while his enthusiasm led him to sacrifice those personal comforts which his declining years would seem to have absolutely required; rather than jeopardize operations depending on his great invention.

In offering for your Grace's approval this first effort to realize a connected memoir of your Grace's immortal ancestor, it is unnecessary to dwell on the fact of its matter being chiefly derived from very scattered sources, and often from but fragmentary materials, though in every instance the very best available authorities have been consulted; among which, the unique collection of Manuscripts, so freely and obligingly submitted for the present purpose by your Grace, being given entire, forms the most valuable and interesting portion. I sincerely regret my own insufficiency to do complete justice to this comprehensive labour. The result of my researches, however, may gratify your Grace's curiosity, and prove interesting in respect to many early family details. And if my own earnestness of purpose, in prosecuting this attempt, does not mislead me, I may venture to hope, that the Memoir will not only meet with your Grace's favourable reception, but prove, at the same time, acceptable to the general public.

With warm acknowledgments of heart-felt obligation to your Grace, for the exceedingly handsome and liberal manner in which manuscripts and paintings have been placed at my disposal,

I have the honour to be,

My Lord Duke,

Your Grace's most obliged,

And most humble, obedient servant,

HENRY DIRCKS.

BLACKHEATH, KENT,

January, 1865.

P R E F A C E.

THAT a Memoir of the Inventor of the Steam Engine, should appear for the first time two hundred years after his decease, is an occurrence in our literature, which, of itself, might almost be considered sufficient to arouse public inquiry in respect to such a production. But far more solid ground exists for believing that the great country which gave birth to the Inventor, and his Invention of one of man's noblest productions in art, will peruse it with true national pride, when assured of the amount and strength of the evidence now first adduced to establish those claims which, although never entirely doubted, yet have hitherto borne too misty and mythical a character to satisfy common comprehension. The labour encountered in carrying out the required design may be appreciated from the fact, that the present work has been to a great extent the study of thirty years, although literally completed within only the last few years. This field of inquiry has been, consequently, long open to more ambitious pens, and sooner or later would, no doubt, have received, as it demands—the attention of men of letters and of science.

Probably no other country furnishes so singular a fact, as that of being for two centuries without information much better than tradition, and accumulated diversities of opinions freely indulged in, respecting the political and private character, and inventive talent of one of its most remarkable, interesting, and glorious benefactors. And, during so long a period, in consequence

of such defective and conflicting information, producing the most absurd and unreliable statements, even on the most ordinary points of individual history. In the whole range of English biography, within the same period of time, no important memoir has ever been so mythical as that of Edward Somerset, second Marquis of Worcester.

So entirely unacquainted are his countrymen with the history of his life, that a very plausible work might be written to disprove both his authorship of the "Century," and his invention of the steam-engine. Indeed Scotland has already contributed materials for the former, and M. Arago, late Astronomer Royal of France, has all but made out the latter! And such a production would excite little suspicion and probably no hostility of feeling. But this need not cause much surprise when it is mentioned, that it has not yet been the good fortune of any writer, touching on the Life of the Marquis of Worcester, to escape recording a mass of errors, such as occur in no other biography in our language; although the period usually selected seldom exceeds four or five years, out of a life of sixty-six. The reader, therefore, who takes up the present volume, under impressions derived from such dubious sources of information as those indicated, will find little to confirm his preconceived opinions. The histories of men as of nations require facts for their basis, judgment to guide in their arrangement, discretion to direct a wise selection, and a knowledge of the whole to perfect the desired work. The mixed character of the Marquis of Worcester has ever been a stumbling-block to the purely classical scholar, the divine, the politician, and the lawyer; while, on the other hand, the rapid advances in science during the last fifty years, have deprived "The Century" of more than half its interest. Science cannot

hope to be advanced by discussing the automata of the 17th century, its fountains, improvements in fire-arms, bows, keys, stairs, boats, fortifications, and many other promising inventions. But a Life of the Marquis of Worcester, without the "Century," would be a drama without its most important character. It is, therefore, no act of supererogation to give a commentary on that little, but perplexing book; it is something more than a mere amusement, it is a necessary adjunct, and is not wholly useless considered as a matter connected with the history of science. The commentator on the "Century" may hope to render the biography of its noble author interesting from another and most important point of view, which would be wholly lost by its omission, or by treating it as secondary or unimportant. The "Century" is the exponent of the man; the author without his pocket-journal of his life-long labours is reduced to a nonentity, with nothing higher left to him to boast of than his descent from royal blood, the unimpeachable character of his noble line of ancestry, and his own spotless rectitude of character—an amiable, unintellectual man!

The "Century," the only work he is known to have left to posterity, sorely perplexed the fastidious Horace Walpole, was too much of a mechanical production for the astute David Hume, and has thoroughly bewildered the legal acumen of Mr. Muirhead, the biographer of James Watt. It has challenged the skill of critics of every degree, from contributors to the Gentleman's Magazine to those of the Harleian Miscellany, and even in all sketches of the history of the steam-engine, percolating thence through biographies, and popular accounts of Raglan Castle, to the latest and best illustrated works on our castles and abbeys. So many writers, so many minds, whose judgments in a collected form, would afford

a very discordant and uninviting miscellany, a sad satire on the material and style of a certain class of criticism, too much encouraged in our current literature. It is painful to observe its constant want of sympathy with the pains and penalties which unhappily are the too frequent lot of lofty, original, inventive genius. The case might fairly be paralleled by supposing Voltaire and others to have successfully established a clique against Shakespeare, to misrepresent and malign the great dramatist up to the present time; when, suddenly should appear, the *first* work, to settle his literary claims! Of course it is declared impossible; and so it is, with a literary work; but it is not so with Inventions. The fame of the Marquis of Worcester rests less on his book than on his Water-commanding Engine. The book we see and read, but probably not one man in ten thousand knows anything about the Engine. Here is the weak point when the tide turns against the Inventor, against the man, a man politically and religiously proscribed. A great man for his Engine but hated by those politicians who side with the Stuart dynasty, for his luckless association with Charles the First. And misunderstood by the dilettanti Walpole, a connoisseur in paintings and works of *vertu*, but in matters of science more ignorant of the Marquis of Worcester's worth, than Voltaire was of Shakespeare's genius. But we regret there is a third conspicuous offender in the field, and as he is the latest, so we hope he is the last of the clan of vituperative critics.

Our largely gifted historian, Lord Macaulay, never wrote such feeble lines as those in which he attempted to depict the Marquis of Worcester; but the historian is a tower of strength, and his words may here be quoted without a fear of our object being either mistaken, or open to misrepresentation. Depreciation is not

our object, and nothing could be a greater folly than to attempt it on such ground; we give them in evidence, to prove how little really is known, even in well-informed circles, respecting this extraordinary inventor, when so brilliant a writer as Macaulay could be at fault, from no other cause than defective information. Speaking of Charles the Second's reign, he says:—"The Marquess of Worcester had *recently* [?] observed the expansive power of moisture rarified by heat. After *many* experiments he had succeeded in constructing a *rude* steam engine, [?] which he called a fire water-work, and which he pronounced to be an admirable and most forcible *instrument of propulsion*. [?] But the Marquess was suspected to be a *madman* [?] and known to be a Papist. His inventions, *therefore*, found no favourable reception. [?] His fire water-work *might, perhaps*, furnish matter for conversation at a meeting of the Royal Society, [?] but was not applied to *any practical purpose*. [?]" These few lines suggest seven inquiries, but we are satisfied Macaulay could never have written thus upon the life of any great man of that period, much less on this illustrious inventor, had the proper materials been at command. This example is valuable, in as much as it is well known that Lord Macaulay was master of much curious reading, particularly of the class referring to that interesting period of our country's history, and also that he possessed a remarkably retentive memory. But he was here dealing with a shattered monument; its goodly form wholly gone, and its fragments scattered in every direction; here ground to dust, there altogether buried, and so disfigured and dishonoured that he made the most he could of the faint traces within his immediate reach, and unquestionably felt satisfied that, considering the limit of these few lines, he had boldly, graphically, and truthfully portrayed the character

he had designed to delineate. How infinitely superior to this rough draught would have been the sketch, had Macaulay possessed proper documentary evidence. A more striking or satisfactory instance than is here adduced could not be presented for showing the paucity of information hitherto existing in a collected form; and those readers who might otherwise have doubted the fact, will readily gather from what is here brought forward, that the story of this singular man's life has hitherto remained untold.

The life of the Marquis of Worcester affords a tissue of the most violent contrasts, romantic in many incidents, exceeding any that have ever been experienced by any other descendant of our ancient nobility. He was a man of rigid honour and probity, remarkable too for his modesty, virtue, and genius, in an age distinguished for few excellencies, and notorious for many vices. He was the favourite of his Sovereign, although in but little favour at Court, and the very esteem which raises most men was his certain ruin; obliged to flee his country, he returned only to be imprisoned; and on his release, was allowed £156 per annum out of his own princely but confiscated estates! As the subject of Charles the Second, he received back his demolished castle, without the means to re-establish himself; and, steeped in debt, he sought royal patronage in vain, although his genius was perhaps of greater value to the state, than all the revenues of the Crown! Neglected by contemporaries, his memory has been preserved rather traditionally than by any literary effort (beyond fitful glimpses of doubtful praise), to raise a monument to the indisputable inventor of the Steam Engine—that greatest source of our country's commercial and manufacturing greatness; and universal, moral and intellectual progress. Lord Macaulay has tersely and justly

remarked that:—"The chief cause which made the fusion of the different elements of society (in the 17th century) so imperfect, was the extreme difficulty which our ancestors found in passing from place to place. Of all inventions, the alphabet and the printing press alone excepted, those inventions which abridge distance have done most for the civilization of our species." He then adds, speaking of steam, that it has—"in our day, produced an unprecedented revolution in human affairs, which has enabled navies to advance in the face of wind and tide, and battalions, attended by all their baggage and artillery, to traverse kingdoms at a pace equal to that of the fleetest race-horse."

The general reader will be very likely to overlook one important fact, a golden hinge on which more rests than at first appears in the following narrative; and, therefore, a word of remark may not be altogether thrown away, in calling attention to the circumstance. There are very many persons, most intelligent and well informed on other matters, who have yet to learn that all invention is progressive in a regular series. There may be a long series of elementary principles developed without the occurrence of a single practical result, practical as regards any useful application to supply man's wants. Then may arise a series combining these elements, so to speak, and for the first time producing a new instrument, machine, or engine. When a new machine is produced, we do not say, Why it only consists of a number of wheels and cylinders, therefore, surely there is nothing new in it! All the parts may be old, and yet the combination be quite new. To analyse an invention into its several parts, would be equivalent to finding that a poem was only composed of the letters of the alphabet, or the words in a dictionary. But there is another point of view not lightly to be passed

over. Take this instance of the steam engine. We find a talented Scotch writer wondering that Englishmen take the trouble to claim the invention of the steam engine for the Marquis of Worcester, because of the "doubtfulness" existing respecting it, at the same time that he accompanies this statement with a large amount of evidence, but evidence which he does not fully admit. He thus places himself very much in the position of a philosopher, who should adopt as his theory some peculiar notion to the effect that the letter A, or the numeral 1, could be dispensed with, in consequence of some "doubtfulness existing" in respect to its value; and that, indeed, to retain either any longer would only be evidence of a "little national rivalry." Although this may appear too absurd in this light, something very similar has been proposed as a kind of compromise in the contest between England and France, the "little national rivalry" between which countries might be settled, would Englishmen but give up all further advocacy of the Marquis of Worcester's claim. This is not the reason given, but it is the happy result which would follow; and it is urged against the invention, that there is so much "doubtfulness existing" about it, that it is a wonder any one takes further trouble in the matter. So far as we can see, its value is A, or 1, it is the first of a series, it is the golden hinge, or link, on which all hangs; take this away, and we sever the head from the main body. Will any one in future be found to take up and maintain so foolish a line of argument? The Marquis of Worcester was unquestionably the Inventor of the Steam Engine in the first of its three stages, as a fire engine. Previous to the Marquis of Worcester, all that had been done, was solely in the series developing a principle, a mere idea, but still no invention, in the proper sense of such a term, as applied

to works of practical utility. All other early efforts were purely elementary or experimental.

Let us take an illustration from another branch of science. It is not unreasonable to suppose that Electricity, using the term in its most extended sense, will some day or other supersede steam. We probably only require to be able to collect it cheaply and to control it effectually, to employ the artillery of heaven on the wide ocean, on our network of iron rails, and throughout all our manufacturing establishments. A, we will suppose, invents the first efficient Electric Engine, which with fifty horse power is fully at work; and in the course of a few years we sit down to write the history of this engine invented by A. Where shall we start in our history? Did not Faraday years ago produce an electro-magnetic engine; then of course Faraday invented A.'s engine! But we need not stop here; we have the whole history of electricity before us. There is no end of machines and engines; and a patent specification may come to light, the nearest possible thing to A. But we have not done yet, we have to consider France, &c., where we may find some more elementary electrical models before Faraday, and then of course before A. So that, on this system, as hitherto adopted, in attempting to settle a claim for De Caus, and depreciating the claim of the Marquis of Worcester, we may venture to predict an analogous fate for the Electric Engine, *hereafter* to be invented by some inventor, A. Here we must plainly see that all that has hitherto been invented in this electrical line, does *not* go beyond model or elementary apparatus, and that however nearly some of these may approach any plan hereafter to be invented, it would be ridiculous and highly reprehensible to set up claims based on *no* practical value, and only colourably *similar* in *some single particular*, but otherwise of no greater concern than as

amusing, or illustrative scientific toys. De Caus' fountain was one of these pleasing toys, and De Caus himself could never have thought otherwise of it, taking his own large book and his own few lines of description; although it served the purpose of M. Arago to assume for it a pre-eminence over the Marquis of Worcester's invention, merely because the latter came half a century later.

The author is not aware of any portion of his work that is open to controversy, unless it be that relating to a second visit to Ireland, asserted to have been made by the Earl of Glamorgan. However, should it be contended, or proved, that his negotiations refer to a *single* visit there, this circumstance would not affect the main story. The author has, however, had one essential difficulty to deal with, arising from the quantity of correspondence and documentary evidence, which, under the circumstances, he was obliged to introduce, thus materially affecting the text. It certainly was open to him to throw the greater part into the Appendix, but with considerable drawbacks to all readers really interested in such a work. The course adopted has been to introduce documents, of whatever kind, in their order of date, and to modernise the orthography (and that alone) to render them generally readable. The few pieces admitted in their original style will satisfy any one how thoroughly unreadable the work would have become, if largely occupied with such orthography. The prayer (for example) is a strict copy of the original, which appears to be in the handwriting of the Marchioness, with several interlinear corrections made by the Marquis himself, which certify to its genuineness.* Every document is given with its own

* I am happy in being able to afford this testimony, were it only to dissipate the imendoes of Mr. Muirhead.

date, and no deviations occur beyond the modern spelling of words. The "Century," however, being printed matter, has been re-produced verbatim, with scrupulous accuracy.

The general reader will find that the really scientific portion of this memoir, is restricted to the "Century," which has relieved the biographical portion of much technical detail: no more reference to inventions occurring therein than appeared absolutely necessary to preserve uniformity in the narrative.

It was very desirable in such a work as the present to steer clear of a controversial strain, whether in reference to the past or the present. This has been effected in a great measure, as regards the numerous detractors that might be cited, who have given false views, both of the personal character of the Marquis, and the merit of some or most of his inventions, until we find the admiring biographer of the celebrated James Watt, as if blinded by too much light, speaking of the Marquis in the most disparaging terms. And lastly, it was impossible to escape recurring to the charge against Savery; the dates and facts, now for the first time supplied, going far to strengthen the belief, that the engine reputed to be Savery's, is identical with that invented by the Marquis of Worcester.

The materials of the present work are principally derived from original sources with respect to Manuscripts; and from the highest published authorities. All printed materials are scrupulously acknowledged in two catalogues, one historical and literary, the other wholly scientific. Through the kindness and liberality of His Grace the Duke of Beaufort, the entire collection of Manuscripts in his Grace's possession, relative to the Marquis of Worcester, are here given at large. While at Raglan, on visiting Troy, Osmond A. Wyatt, Esq.,

was especially obliging in affording information ; as well as John Cuxson, Esq., of Raglan ; and at Badminton, John Thompson, Esq., materially assisted in procuring the required manuscripts, and affording facilities for copying them, for which kindly aid the author can but insufficiently here express his obligations. The author is likewise greatly indebted generally to the rich stores of the British Museum, and the obliging attentions of its principal officers ; to the State Paper Office, where he was especially assisted through the kindness of Mrs. M. A. E. Green, with the uncalendered papers given at pages 249, 270, 286, and 287, and to John Bruce, Esq. Also to the excellent Libraries of the Royal Society ; the London Institution ; and the particularly valuable scientific collection of the Patent Office. At Oxford, the privilege of consulting works and manuscripts at the Bodleian Library, was freely granted, and every facility afforded. The author would especially notice among other contributions of information, the able assistance of Bennet Woodcroft, Esq., F.R.S., &c. To the Rev. John Webb, of Hay, he is particularly indebted for the papers at pages 64, 88, and 142, to which that gentleman directed his attention, and which he might otherwise have overlooked. He has also received assistance from the collections of Robert Cole, Esq., and of the late Dawson Turner, Esq., which are noted where they occur. When inquiring for the autograph of " Glamorgan," every possible effort to trace it, although unavailing, was kindly employed by the Librarian of St. Cuthbert's College, Durham, and by the Rev. Dr. Grant, the Roman Catholic Bishop of Southwark.

During the author's visit to Dublin, Sir Bernard Burke, Ulster King at Arms, very obligingly searched for any documents referring to the Earl of Glamorgan, that might be in Dublin Castle, but without success ;

and the author is also much indebted for general information most courteously given by the Rev. Dr. Todd, of Trinity College, Dr. R. G. Travers, Marsh's Library, and the Rev. C. P. Meehan; and likewise, through correspondence, by the Rev. James Graves, of Stonyford.

It now only remains for the author to say, that in the event of any of our nobility or gentry, or other collectors, possessing any manuscript whatever, even although only a copy of matter here produced, he would esteem it a very particular favour to be informed of it (through his publisher), and to be permitted to examine any record, bearing either directly or indirectly on this subject.

H. D.



C O N T E N T S.

DEDICATION	Page iii
PREFACE	vii—xxi
1599—1628.	
CHAP. I.—Marriage of Henry Somerset, Lord Herbert of Raglan	1—9
1601—1639.	
CHAP. II.—Birth, home, education, early career, times, and first marriage of Edward Somerset, Lord Herbert	10—29
1639—1642.	
CHAP. III.—Edward, Lord Herbert's second marriage	30—36
1641—1642.	
CHAP. IV.—Henry, Earl of Worcester — created Marquis of Worcester—Raglan Castle	37—54
1642—1644.	
CHAP. V.—Lord Herbert in his military capacity	55—68
1644—1645.	
CHAP. VI.—Lord Herbert created Earl of Glamorgan — Irish affairs	69—94
1640—1645.	
CHAP. VII.—Raglan Castle—Royal visits	95—111
1645—1646.	
CHAP. VIII.—The Earl of Glamorgan's second visit to Ireland	112—139
1646—1647.	
CHAP. IX.—Raglan Castle; its defence and surrender — Death of Henry, Marquis of Worcester	140—156
1645—1647.	
CHAP. X.—The Earl of Glamorgan's transactions in Ireland, concluded	157—185

1646—1650.

- CHAP. XI.—The Marquis of Worcester in exile ; resides in France
Page 186—191

1643—1659.

- CHAP. XII.—Affairs affecting the Marquis of Worcester's family,
in respect to Worcester House and other property in and near Lon-
don 192—200

1651.

- CHAP. XIII.—The Marquis of Worcester's son, and two daughters
201—208

1651—1661.

- CHAP. XIV.—His return to England — Imprisonment, and liberation
—his "*Century*"—pecuniary difficulties—petitions—at Charles the
Second's Coronation—Lord Herbert 209—233

1660—1662.

- CHAP. XV.—His prospects at the period of the Restoration—Pro-
ceedings in Parliament respecting the Patent to create him Duke of
Somerset—Estates restored, &c.—Parliamentary duties . 234—246

1660—1664.

- CHAP. XVI.—His Inventions—further Petitions—publication of his
"*Century*"—Charles II. visits Lord Herbert at Badminton—Wor-
cester House, Strand 247—261

1664—1670.

- CHAP. XVII.—His operations at Vauxhall—Petitions and decease—
Caspar Kaltoff and family—M. Sorbière—Cosmo, Grand Duke of
Tuscany—The Dowager Marchioness of Worcester . 262—308

- CHAP. XVIII.—A brief retrospect of the Marquis of Worcester's
Genealogy, and his private, political, and philosophical character ;
including his own statement of expenditure during the Civil War
309—342

LIST OF ENGRAVINGS.

From Drawings and Sketches made, and Ciphers and Autographs traced, by the author.

The steel engraved Portraits executed by Mr. J. Cochran, and the Wood Engravings by Mr. Stevens, and Mr. J. H. Rimbault; and Coats of Arms by Mr. Layton.

STEEL ENGRAVINGS.

- A Family Group, being Portraits of the MARQUIS OF WORCESTER, with Margaret his second wife, and their infant daughter Mary. From a painting by Hamman. (See pages 30, 31.) TO FACE TITLE PAGE.
- Portrait of ELIZABETH LADY HERBERT, first wife of Edward Lord Herbert, afterwards Marquis of Worcester. From a painting by Vandyke PAGE 16.

WOOD ENGRAVINGS.

PAGE.	PAGE.
Armorial bearings of His Grace the Duke of Beaufort	iii
Plan of the Castle and Citadel of Raglan, Monmouthshire	xxiv
Baynard's Castle, from Newcourt's ancient Map of London, 1658	1
Worcester House, 1658	8
H. Herbert (autograph) Henry, 1st Marquis of Worcester	10
E. Worcester (autograph) Edward, 4th Earl of Worcester	12
Water-works side of the Citadel, Raglan Castle	20
Distant view of Raglan Castle	49
Ed. L. Herbert (autograph) afterwards 2nd Marquis of Worcester	77
The Earl of Glamorgan's writing in the address of a Cipher letter	179
The letter written in his Cipher. [See also page 553.]	180
The Tower, Map of London, 1658. Worcester [autograph, 1665-6, of the Author of the "Century"]	283
St. Cadoens, Raglan Church	296
— east end and plan	297
Arms of the Marquis of Worcester, and his two wives	298
C. Somerset (autograph) Charles Somerset, 1st Earl of Worcester	309
One line of the Marquis of Worcester's cipher writing	333
Portrait of Edward Lord Herbert, afterwards second Marquis of Worcester, from a painting by Vandyke, in the possession of his Grace, the Duke of Beaufort	377
A Cipher Seal	389
A one line Cipher	392
The Marquis's Cipher	398
Ancient Paddle Boat	408
A Balance Water-work	417
A Bucket-fountain	418
A double-drawing Engine	424
A to and fro Lever	426
A most easy level Draught	427
Tobacco-tongs	446
A weighted wheel	454
A water-flowing and ebbing motion	457
A musketeer, 1643	465
De Caus' Fountain	477
A forceer	483
Savery's Engine, 1699	485
Engine to raise weights	532
Porta's steam apparatus	541
A blowing Æolipile	542
A steam blow-pipe	543
A fire-blowing Æolipile	543
A weather glass	546
The Marquis of Worcester's Engine —his Cipher Alphabet	551
Construction of a water-screw	554
Christopher Copley (autograph)	570

REFERENCES TO THE PLAN OF THE CASTLE AND CITADEL OF RAGLAN, MONMOUTHSHIRE.

. *All other portions are named on the plan.*

THE CASTLE.

1. Outer portecullis; 1. A second portecullis within the arched entrance.
2. Gateway.
3. The gate.
- 4, 4. Two barbican towers.
5. A guard room.
6. Parlour or ante-room.
7. Stair-cases; all marked 7.
8. The Closet or Library Tower.
- 9, 10. Sitting Room or Parlour, originally wainscoted with oak, and over which was the Marquis's Dining room.
10. Large bay-window looking towards the moat.
11. Broken porch.
12. Entrance from the courtyard to the vaults.
- 13, 13. Broken entrance to cellars.
14. Remains of a staircase.
15. This part is vaulted.
16. Suite of family apartments.
17. Gateway to the Bowling-green.
18. Bridge.
19. Bowling-green.
- 20, 20. Cellars
21. Steps and door leading to—
22. Way to stable-yard.
23. One sipe of the outer wall of the Paved Court, where the first breach was made by the Parliamentary forces, 1646.
24. Ruined tower.
25. The buildings formerly here completely obliterated, having suffered most during the siege.
26. The bakery and remains of its ovens.
27. Entrance to the Wet Larder.
28. An outside high level walk.
29. Low ground.
30. Pier wall.
31. Deep space.
32. The Kitchen Tower, remarkable for its great strength, and remains of a large fire-place.
33. A draw-well.
34. A long, narrow, vertical gap through former windows and door. The building probably had a corridor at top.
35. Ruins of cellar or dry larder.
36. The uppermost window in this part indicates the situation of the apartment occupied by Charles I.
37. The Buttery.
38. The Minstrels' gallery was probably raised here.
39. Porch leading to—
40. The great Banqueting hall.
41. Spacious fire place, with centre window high above.
42. The large, handsome, and well-preserved bay-window, with a circular opening or ventilator in the roof.
43. The recess.
44. The arms of the Beaufort Family, carved in stone, are inserted centrally in the lofty wall on this side.
45. The Pantry.
46. Ruined entrance to the wine cellar.
47. End of the Picture Gallery, a narrow upper apartment of great length, extending over and beyond the chapel.
48. Supposed to be the Bell tower.
49. The apartments above and below here were the ladies' women's rooms.
50. A through passage.
51. High watch tower.
52. An ancient Arbor Vitæ grows in the Fountain Court at this point.
53. Superior officers' quarters, on the ground and upper floors.
54. Basin of the fountain.

THE CITADEL, OR KEEP,

called

THE MELIN-Y-GWENT, OR YELLOW TOWER OF GWENT.

- A. There was probably a drawbridge here.
- B. B. Two broken bastions.
- C. A temporary wooden bridge.
- D. Site of arched bridge to the Keep.
- E. The Water-works side of the Keep, presenting large grooves cut into the stone work, probably to insert metal pipes, &c.
- F. Stone stair-case to the top, in good preservation.
- G. Outer entrance to F.
- H. I. Ruins of the massy walls varying from 4 to 10 feet high; the upper portion destroyed in 1646, by order of Parliament.
- L. A well.

L I F E

OF

THE MARQUIS OF WORCESTER.

CHAPTER I.

MARRIAGE OF HENRY SOMERSET, LORD HERBERT OF RAGLAN.

TOWARDS the close of the sixteenth century there was a rumour afloat in London, among aristocratic circles, respecting a marriage in high life. At that time Blackfriars was as much the seat of fashion, as St. James's at a later period; and was conveniently situated while Queen Elizabeth held her court at Greenwich.

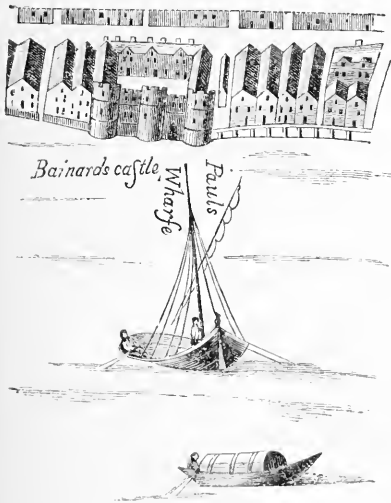

BIRD'S-EYE VIEW FROM MAP OF LONDON, 1658.

A contemporary correspondent, writing in the usual quaint style of the day, states in a letter dated from Baynard's Castle, the 23rd of November, 1599:—"I hear that the Lord Herbert, the Earl of Worcester's son, shall marry Miss Anne Russell, and that it is concluded upon." This announcement relates to no less a person than the future Marquis of Worcester, father of

that Edward, Marquis of Worcester, whose life we shall hereafter have to detail, and whose prowess was severely tested by the evil times of his closing career; it will be interesting, at this early stage of that eminent nobleman's personal history, to follow this same correspondent through his future gossiping epistles touching the proposed matrimonial alliance.

Writing to Sir Robert Sydney on the ensuing 22nd of December, he acquaints him:—"This afternoon your little daughter was christened by Edward, Earl of Worcester, the Lady Nottingham, and the Lady Buckhurst. My Lord of Worcester sent his son, Henry Lord Herbert, because he himself waited on the Queen, who rode abroad to take the air. Among the presents were a very fair bowl and a cover from the Earl."

After a lapse of nearly four months, we have again news from Baynard's Castle, under date the 19th of April, 1600, stating that—"The marriage between Lord Herbert and Mrs. Anne Russell is concluded; for my Lady Russell was at court, to desire the Queen's leave, which is obtained."

But on the 16th of May we are assured—"The marriage between Lord Herbert and Mrs. Anne Russell is at a stay, till it please her Majesty to appoint a day." And further, that—"It will be honourably solemnized; and many take care to do her all the possible honour they can devise. The feast," it is added, "will be in Blackfriars, my Lady Russell making exceeding preparations for it."

Her Majesty appears to have been somewhat deficient in considering either the distraction she was occasioning the lovers, or the disarranged domestic economy of the several attendants, for another month is allowed to glide gloomily away, only to find on the 24th of May that—"My Lord of Bedford is come to town, and his lady to

honour the marriage of Mrs. Anne Russell; but the day is not yet appointed by her Majesty, which troubles many of her friends, that stay in town to do her service."

Some weeks more pass on, when at length we learn from Greenwich, under date the 14th of June:—"Her Majesty is in very good health, and purposes to honour Mrs. Anne Russell's marriage with her presence. It is thought she will stay there (at Blackfriars), Monday and Tuesday. My Lord Cobham prepares his house for her Majesty to lie in, because it is near the Bride-house. There is to be a memorable masque of eight ladies; they have a strange dance newly invented; their attire is this: Each hath a skirt of cloth of silver, a rich waistcoat wrought with silks, and gold and silver, a mantle of carnation taffeta cast under the arm; and their hair loose about their shoulders, curiously knotted and interlaced. These are the masquers. My Lady Doritye, Mrs. Fitton, Mrs. Carey, Mrs. Onslow, Mrs. Southwell, Mrs. Bess Russell, Mrs. Darcy, and my Lady Blanch Somersett. These eight dance to the music Apollo brings; and there is a fine speech that makes mention of a ninth, much to her honour and praise. The preparation for this feast is sumptuous and great; but it is feared, that the house in Blackfriars will be little for such a company. The marriage is upon Monday."

Accordingly on Monday the 16th of June, 1600, her most gracious Majesty Queen Elizabeth, arrived at Blackfriars in all possible state to grace the marriage of the Lord Herbert and his wife. The Bride (the same gossiping authority states) met the Queen at the waterside, where my Lord Cobham had provided a Lectica, [used similar to a sedan chair] made like half a litter, whereon she was carried to my Lady Russell's by six knights. Her Majesty dined there, and at night,

went through Dr. Pudding's house (who gave the Queen a fan), to my Lord Cobham's, where she supped. After supper the masque came in; and delicate it was to see eight ladies so prettily and richly attired. Mrs. Fitton led, and after they had done all their own ceremonies, then eight lady masquers chose eight ladies more to dance the measures.

Mrs. Fitton went to the Queen, and wooed her to dance.

Her Majesty asked her what she was.

"Affection," she said.

"Affection!" said the Queen; "Affection is false."

Yet her Majesty rose and danced. So did my Lady Marquis (of Winchester).

The Bride was led to the Church by the Lord Herbert of Cardiffe, and my Lord Cobham; and from the Church by the Earls of Rutland and Cumberland.

The gifts given that day were valued at one thousand pounds, in plate and jewels, at least.

The entertainment was great and plentiful, and my Lady Russell much commended for it.

Her Majesty, upon Tuesday (following) came back again to the Court. But the solemnities continued till Wednesday night. "And now the Lord Herbert, and his fair lady are at Court," (writes this pleasant correspondent on the 23rd of the same month.)²⁸

The bride's portion, as a younger daughter, was said to be about two thousand pounds in money; one hundred and fifty pounds a year in land; and a reversion of one thousand marks.¹⁰⁶

Thus was celebrated the marriage of Henry the young Lord Herbert, son of Edward, fourth Earl of Worcester, then Master of the Horse, who was eminently distinguished alike for his noble and ancient

²⁸ Collins.

¹⁰⁶ Wiffin, v. ii. p. 56.

lineage and courtly attainments. Greatly was his son's marriage honoured, not only by the presence of royalty in the person of a queen of Elizabeth's high-toned feelings and sentiments, but, if possible, more so by her condescending to participate in the dance on that festive occasion.

The particulars afforded by this domestic incident take us far back to a most interesting period in our country's history. The great Queen's reign was then within three years of its close. The Pope had published his bulls to exclude King James from the throne of England. On the 19th of November following, was born at Dunfermline in Scotland, Prince Charles, whose future reign was destined materially to affect the family and fortunes of the Somersets, Earls of Worcester.

The social habits of the aristocracy, as here briefly pourtrayed, evince a peculiarly primitive character. Three days' feasting shows a singular lustihood of enjoyment in the revels attaching to such occasions of festivity. But, notwithstanding we are treating of the most elevated society, in the most flourishing period of the Augustan Age of our Literature, as it has been not inappropriately styled, a comparative grossness of habit prevailed, occasioning a particular relish for such carousals, during the period that viands and wine were served without stint or stay.

Many of the modern common luxuries of the table were then unknown; asparagus, artichokes, cauliflowers, and other edibles were not introduced; while the finest clothing was costly, being of foreign manufacture. Considerations like these should check the forming of hasty judgments in reference to the manners and customs of olden times.

The lady whom Henry Lord Herbert had thus espoused was Anne, sole daughter and heir of John Lord

Russell, eldest son of Francis Russell, Earl of Bedford. She bore him nine sons, of whom Edward was the eldest son and heir, and four daughters, making in all a family of thirteen children.

Sir John Somerset, the second son, married Mary, daughter of Thomas Arundel, Lord Arundel of Wardour; and, as will appear in the sequel, he resided at Troy House, near Monmouth.

The fifth son, Thomas Somerset, lived at Rome, 1676; and his brother Charles was governor of Raglan Castle in 1646, and afterwards died a Canon at Cambray in Flanders.

Four other sons died in infancy; and another, later in life, died unmarried.

Kennet, the historian, records, in respect of one of the daughters, that King James reprimanded the Earl, her father, for his sending her to Brussels to be made a nun,⁵⁸ in 1620.

But it will be our chief business hereafter to treat especially of the life and labours of the first-named son of this nobleman; only making such allusions to the father, and relating such circumstances affecting him, as serve to throw light on remote particulars of his son's life.

Of the age of Henry Lord Herbert, at the time of his marriage, we are afforded indirect evidence through Wood, who, speaking of him and his elder brother William (who died unmarried during his father's lifetime) being at Magdalen College, Oxford, in 1591, states the brothers to have been of the respective ages of 15 and 14; so that Henry, being then only 14 years of age, would have been born on or about the year 1577, and marrying in the year 1600, he would at that time be in his 23rd year.

⁵⁸ Kennet.

His age has been very variously, and, as it appears, vaguely stated; originating probably with hasty printed statements during the Civil War, when no particular purpose had to be served by accuracy on such a matter. Wood certainly was not likely to be ten years out of truth in recording the ages of youths. It is also more likely that his Lordship in his circumstances, and with his family, had married rather at 23 than at 33 years of age.

We meet with no accounts of the births or baptisms of his children, with the exception of his seventh son, Frederick Somerset, who, according to the Parish Registers of St. Dunstan's in the West,⁷³ London, was baptized on the 26th March, 1613, in the house of Lady Morrison in the Friars, she being related through the Russells to Anne Lady Herbert.

James I. was proclaimed on the 24th of March, 1603. The same month Lord Herbert was summoned to Parliament, being then 26 years of age. A great plague was at that time raging in the metropolis, having destroyed 30,000 of the population, rendering his residence in town very perilous.

His Lordship's father was, in 1604, invested with the Order of the Garter, and on resigning his office of Master of the Horse, on the 1st of January, 1616, having retained it fifteen years, he was, on the 2nd of the same month, made Keeper of the Privy Seal.

In a literary and scientific point of view, this was a period of great historical interest. In December, 1608, Milton was born; while in April, 1616, Shakspeare died. In 1611 the new translation of the Bible was published. Lord Napier, in Scotland, invented his system of logarithms; the great Harvey was propounding his discovery respecting the circulation of the

⁷³ J. B. Nichols, vol. vi. p. 371.

blood; and Sir Hugh Myddleton had completed his great undertaking of forming the New River. Such are a few among the prominent facts that mark the intelligence and enterprise of those times.

It is possible that Henry Lord Herbert's parliamentary duties, his attendance at court, with other circumstances, might occasion prolonged residence at Worcester House, in the Strand, the ancient family town mansion, a locality which was occupied by many noble families above two centuries ago. Nothing transpires to indicate his presence at Raglan Castle at that period.

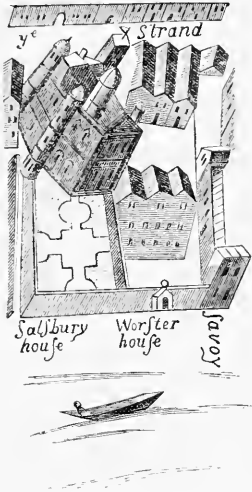

BIRD'S-EYE VIEW FROM MAP
OF LONDON, 1658.

On the 24th of August, 1621, died Elizabeth, daughter of Francis Hastings, Earl of Huntingdon; and on the 3rd of March, 1627, in the 79th year of his age, Edward, fourth Earl of Worcester, the honoured parents of Henry Lord Herbert, who succeeded to his father's dignities and fortune. Their decease happened at their town residence, whence each was conveyed with great funeral solemnity to Raglan, where, being interred in the family vault of Raglan Church, suitable monuments were raised to their memory.

Of Henry, now fifth Earl of Worcester, we have less intelligence as resident in London than as retired to his magnificent Castle of Raglan, in Monmouthshire. On the 13th of March, 1628, he obtained dispensation to be absent from Parliament,* which appears to have

* Calendar of State Papers. Domestic Series. Charles I. 1628-1629. Edited by John Bruce, Esq. 8vo. 1859.

been the commencement of his decreased attention to public business.

He had then been married twenty-eight years, being in the fifty-first year of his age. Of his numerous family he lost five sons and three daughters. Edward, his first born and heir was probably about twenty-six years old; Sir John Somerset, his second son, most likely occupied Troy House, a few miles off, while his next surviving and sixth son, Charles Somerset, he installed as Governor of his Castle.

The noble Earl, inclined to a plethoric constitution, had not uniform good health, being subject to gout, yet was he of a joyous, hearty, kind, benevolent disposition. He was too a man of some learning, without being distinguished for its application, otherwise than in some verbal polemical discussions attributed to him by Dr. Bayly, the last chaplain in his service, who has preserved many of his witty apophthegms, presenting us with indications of his religious and political sentiments.

Although our interest in this memoir concerns us less in reference to the father, than to be informed respecting his son, yet the intelligent reader cannot fail to discover, that Edward, now Lord Herbert, during the early years of his life, was necessarily so intimately associated with all matters of domestic history, affecting the large family then resident at Raglan Castle, that such relations as can be gathered respecting its several branches at that early period, are invested with a degree of interest which they might not under other circumstances possess.

CHAPTER II.

BIRTH, HOME, EDUCATION, EARLY CAREER, TIMES, AND FIRST MARRIAGE OF EDWARD SOMERSET, LORD HERBERT.

As already related, Henry,* fifth Earl of Worcester, married in June, 1600, while yet attached to the Court of Queen Elizabeth, and, therefore, most likely he was resident at Worcester House, in the Strand, a building of some importance from its magnitude and position, as well as from the princely character of the noble possessor of the property.

There, it is reasonable to conclude, was born Edward Somerset early in 1601, the son and heir whose eventful history will hereafter mainly occupy our attention, first as Lord Herbert, afterwards as the Earl of Glamorgan, and lastly, on succeeding to his father's titles, as Earl and Marquis of Worcester.

The birth of this Lord Herbert has never before been attempted to be ascertained, wherefore the present assumed date requires confirmation. On the 14th of July, 1609, when he would thus probably be only eight years of age, we find him associated with his grandfather and father in a lease of lands in the manor of Wondy, Monmouth, and of the fishing, or river of Usk and Carlion, for their lives.†

His preceptor at Raglan Castle was Mr. Adams; but he does not appear, like his father, to have been at any college in England; as, however, he travelled much

* The annexed specimen of his Lordship's autograph, during his father's lifetime, is from a MS. certificate in the British Museum, dated 21st May, 1604.

† Calendar of State Papers, Domestic, 1603—1610. Edited by Mrs. M. A. E. Green. 8vo. 1857, page 529.



on the Continent at an early period of his life, it is possible he also finished his education at some foreign university. In a communication of singular interest, written late in life, hereafter given in full, he specially observes:—"Amongst Almighty God's infinite mercies to me in this world, I account it one of the greatest that his divine goodness vouchsafed me parents as well careful as able to give me virtuous education, and extraordinary breeding at home and abroad, in Germany, France, and Italy, allowing me abundantly in those parts." This summary is sufficiently explicit as regards the circuit of his travels, and the easy, agreeable circumstances under which it was performed, but still leaves it open to doubt whether he had completed his educational course before entering on his continental tour. Wood expressly states, in reference to Lord Herbert's father, that after he had been two or three years at college he was sent to travel in France, Italy, &c., where he presumes he changed his religion for that of Rome.¹⁰⁹

During the reign of James I., and while his grandfather was Keeper of the Privy Seal, no mention occurs of Lord Herbert enjoying any favour at Court, his courtier life commencing only in that of Charles I., according to allusions made in the document before noticed. On the accession of the latter monarch to the throne, Lord Herbert might be 24 years of age. In alluding to his "education and breeding," coupled with his travels, he adds: "And since most plentifully at my master of most happy memory, the late King's Court;" making it almost conclusive that his education was considered as completed shortly prior to the King's decease, in 1625.

In 1627 his grandfather was at Worcester House,

¹⁰⁹ Au. à Wood. Vol. 3, pp. 199—204.

whence he wrote to the Earl of Huntingdon on the 11th of June, informing him of his illness and inability to leave his bedchamber.*

The first year of the reign of Charles I. was an auspicious one, therefore, for the young Lord Herbert. His father, a stalwart, hale man, was in the prime of life, only 48 years of age, lord of one of the finest castles in the kingdom, whether considered for the beauty, strength and importance of its structure and its commanding situation, or the extent of its parks, pastures, plantations, and forests; it was a luxurious place well stored with paintings, furniture, and plate, while it was surrounded with every embellishment of fountains, fishponds, statuary, and gardens that art or wealth could command. Lord Herbert himself was rich in acquired knowledge, and in whatever way his natural genius then displayed itself, such a mind as he possessed must have afforded many evidences of latent talent. One important part of a young nobleman's education in Elizabeth's time, and later, was that of horsemanship, particularly in the tilt-yard, a kind of adjunct to noble residences, supposed by many to have existed even at Raglan Castle, but such an opinion is not even authorised by any tradition. Some interest he might take in tournaments, but we easily suspect without aiming at, or succeeding in that skill in manœuvres so requisite in the fierce and fiery jousts appertaining to such knightly contests, equipped in heavy armour, wielding a ponderous lance, and mimicking all the maddest encounters of the fellest enemies. We doubt if his talent lay that way. His grandfather's horsemanship has been greatly extolled

* Bodleian Library, "Carte Papers—Earl of Huntingdon's Papers, Temp. Eliz. Car. II. 77." No 120. The annexed engraving is a facsimile of his autograph to the letter in question.

by all writers, in alluding to his character. In his youth (it is said) he was remarkable for his athletic acquirements, distinguishing himself by the manly exercises of riding and tilting, in which he was perhaps superior to any of his contemporaries. But we have no reason to extol the grandson for like success in these chivalric exercises.

We conceive he was otherwise disqualified, that he was too light of weight and too short in stature. He appears to have been of slender figure, and rather under than above the middle standard in height. In another point, indirectly perhaps affecting this same matter, he did not possess that easy, boisterous speech which armed assailants may often be called on to assume, to strike terror into a foe, by throwing him off his guard. He himself acknowledges, later in life, to this vocal defect, when, in writing to Charles II. he admits that he takes up the pen, as he says,—“To ease your Majesty of a trouble incident to the prolixity of speech, and a *natural defect of utterance* which I accuse myself of.” “The prolixity of speech” any one may imagine, both from the letter in which this passage occurs, as well as in the noble lord’s general correspondence throughout his life; it seems to be a style in which the close of each sentence, or its matter, suggests the next, to be followed again in like manner, until the main subject becomes so overlaid as to be lost in needless verbose amplification. But he could and did write tersely enough on occasion. No man could then better display the admirable art of compressing large meaning into small compass. If eloquence in speaking “troubled” him, eloquent writing assuredly cost him, it would appear, vastly more trouble in the labour of the pen. We suspect that concentration of thought was natural to him, but its elaboration to produce that

roundness of period assumed necessary for the style of a courtly gentleman, confused and perplexed him. We imagine the prosy writer, being conversationally sententious; perhaps painfully so to the ears of fashionable society, delighting as it does in the trivialities of such conversation as that which would principally characterise the Court of those days; rendered perhaps only the more irksome by his continuance in its fashionable frivolities for three or more years.

A very fair specimen of the mechanical knowledge of the period, when Lord Herbert was finishing his education, is afforded in the work of Henry Peacham, published in 1627, entitled "The Compleat Gentleman." In his ninth chapter, treating of Geometry, he says: "Out of Egypt, Thales brought it into Greece, where it received that perfection we see it now hath. For by means hereof are found out the forms and draughts of all figures, greatness of all bodies, all manner of measures and weights, the cunning working of all tools; with all artificial instruments whatsoever. All engines of war, for many whereof (being antiquated) we have no proper names; as, Exosters, Sambukes, Catapultes, Testudos, Scorpions, &c. Petardes, Grenades, great Ordinance of all sorts.

"By the benefit, likewise, of Geometry, we have our goodly ships, gallies, bridges, mills, chariots and coaches, (which were invented in Hungary, and there called Cotzki), some with two wheels, some with more; pullies and cranes of all sorts. She (Geometry) also with her ingenious hand rears all curious roofs and arches, stately theatres, the columns simple and compounded, pendant galleries, stately windows, turrets, &c. And first brought to light our clocks and curious watches (unknown unto the ancients); lastly, *our kitchen jacks, even the wheel-barrow.* Besides whatsoever hath

artificial motion, either by air, water, wind, sinews or cords, as all manner of musical instruments, water works and the like.

“Yea, moreover, such is the infinite subtilty, and immense depth of this admirable art, that it dares contend even with nature’s self, in infusing life, as it were, into the senseless bodies of wood, stone, or metal. Witness the wooden dove of Archytas, so famous not only by Agellius; but many other authors beyond exception; which by reason of weights equally poised within the body, and a certain proportion of air (as the spirit of life enclosed), flew cheerfully forth, as if it had been a living dove.”

This Cambridge Master of Arts appears much delighted with these and certain minute automata, occupying two pages in describing Scaliger’s ship, to swim and steer itself by means of the pith of rushes, bladder, and little strings of sinews; a wooden eagle “which mounted up into the air, and flew before the Emperour to the gates of Nuremberg;” an iron fly that flew about a table; ants and other insects made of ivory, so small that the “joints of their legs could not be discerned;” a four wheeled coach, which a fly could “cover with her wings;” a ship with all its sails, “which a little bee could overspread;” and, “of later times, Hadrian Junius, tells us that he saw with great delight and admiration, at Mechlin, in Brabant, a cherry-stone cut in the form of a basket, wherein were fifteen pair of dice distinct, each with their spots and number, very easily of a good eye to be discerned;” how “the Ilias of Homer written, was enclosed within a nut;” while, to conclude, Scaliger, relates “of a flea he saw with a long chain of gold about its neck.” The account of these wonders of art, winds up with descriptions of brazen, glass, and silver models, or planetariums illus-

trating the situations and motions of the heavenly bodies.

From this serious discourse, by a grave scholar, and contemporary, relating to the labours of the first mathematicians of a bygone as well as of the existing age, we may form a valuable conception of the state of science, in its popular character, when Edward, Lord Herbert, entered upon his own course of practical philosophical pursuits, affording the ground work of his *Century of Inventions*, the accumulated digest of whatever he had effected during the early, middle, and later years of his life. Viewed from any other point than the period in which he lived, the means of information around him, and the comparatively limited extent of scientific knowledge, the modern reader would form a serious misconception of his singular abilities, his versatile mechanical talent and the fecundity of his inventive ingenuity. There can be little or no doubt but that he was well versed in the mathematical knowledge of his times, and that it principally contributed in aiding him to obtain those mechanical results, to which we consequently find him restricting his attention.

Lord Bacon had died but the year before the publication of Peacham's work. Alchemy still ruled and had its adepts and votaries; and Ashmole made a large collection of alchemical writings, for Chemistry was but just faintly emerging from the mysticisms of its precursor, Alchemy.

In the year 1628 Edward Somerset, Lord Herbert, being then about 27 years of age, married Elizabeth, daughter of Sir William Dormer, eldest son of Robert Lord Dormer of Weng, and sister to Robert Earl of Carnarvon.⁵ She became in 1629 the mother of Henry*

⁵ Atkyns.

* Henry, Duke of Beaufort, died in 1699, at 70 years of age, so that he must have been born in 1629.



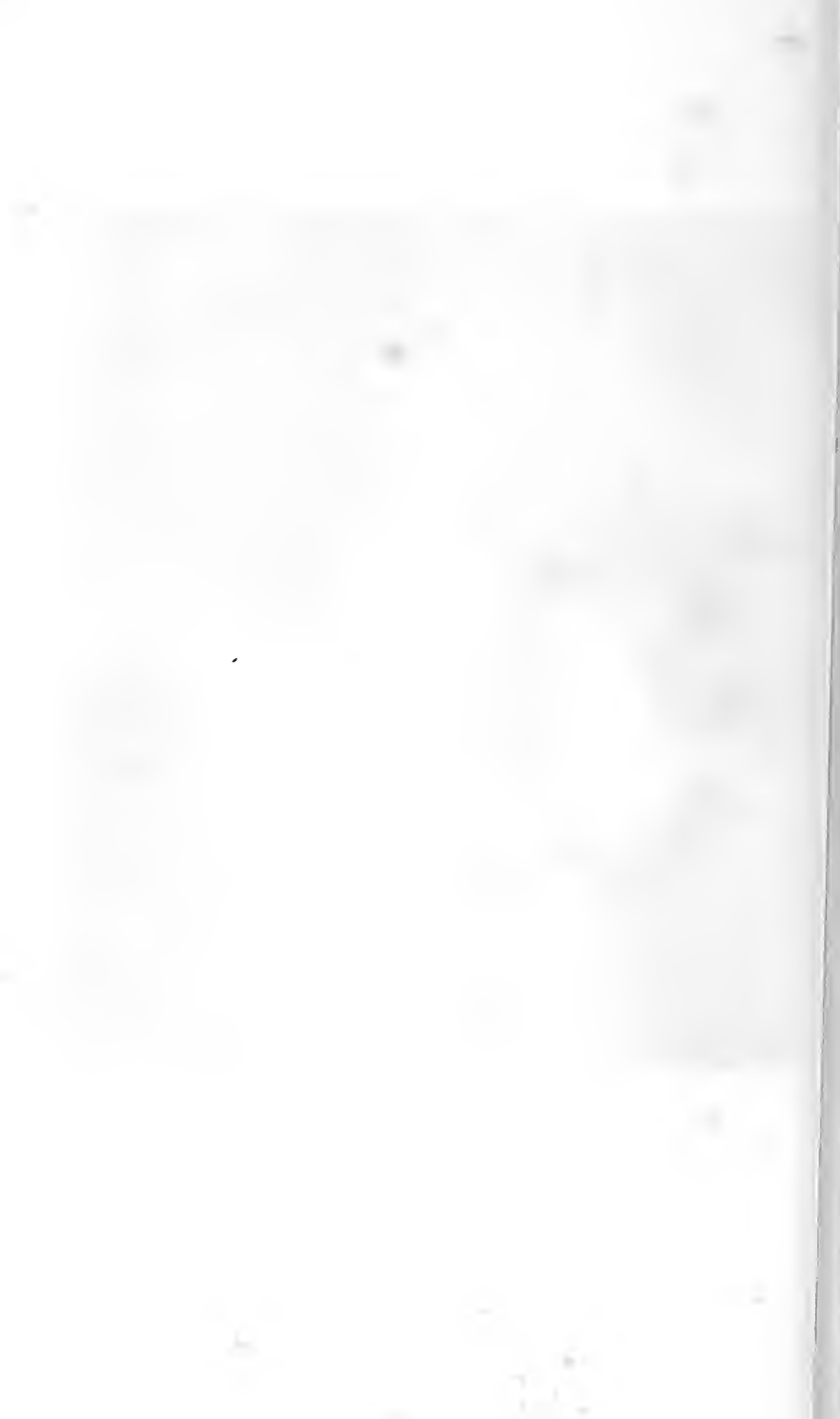

Somerset (afterwards created first Duke of Beaufort); and had besides two daughters, Anne, who married Henry Frederick, third Earl of Arundel of the Howards; and Elizabeth, who married William Herbert, first Marquis of Powis.

No contemporary or other hand has recorded any details of Lord Herbert's marriage, or even any particulars of his early life; in the absence of decisive information, we can only surmise from stray facts the possibility of his having withdrawn from the Court, taken up his abode at Raglan Castle, and there occupied himself in those scientific studies and pursuits which were his special delight at that early period, and which were indeed the solace even of his declining years.

Judging from a statement that occurs in his writings,* it is most likely that in 1628, soon after his marriage, he engaged the services of "the unparalleled workman both for trust and skill, CASPAR KALTOFF," of whom we shall have occasion to speak more at length hereafter, and who, he says, was "as in a school under me employed;" † by which we understand that Kaltoff had the practical management of those mechanical and other inventions which, then commenced, became the principal study and employment of his Lordship's leisure during the remainder of his life. He must have set up a complete laboratory or workshop in which to operate on the many varied ingenious contrivances and experiments, of only part of which he has left us a most interesting catalogue raisonné.

The early genius of Lord Herbert would appear to have exhibited itself in an attachment to mathematical studies, and a singular predilection, in a young nobleman, for mechanical pursuits. He has himself

* Dedication to the "Century."

† *Ibid.*

mentioned two instances which we consider may fairly be referred to his earliest continental tour, accompanied by his tutor. Speaking of a certain contrivance for a fountain, he explicitly declares:—"This I confess, I have seen and learned of the great mathematician Claudius his studies at Rome, he having made a present thereof unto a Cardinal." And when, alluding to a peculiar kind of lever, he pointedly remarks: "This I saw in the arsenal at Venice;"* thus showing how early his mind was impressed with those studies which became the distinguishing feature of his writings; and all the more surprising in him, considering his birth, his times, and the originality and fruitfulness of his inventive talent, which might have found ample scope in some branch of literature, in agriculture, or in military works.

His employment of a foreign mechanic was quite in accordance with the spirit of the age. National and private undertakings, as well as manufacturing and other matters requiring engineering skill, were ordinarily superintended by eminent Italian, Dutch, German, French, Swiss, or other continental engineers.

During a period of seven years, from the time of his marriage, his life appears to have borne an entirely studious and domestic character, spent, most likely, principally at Raglan. To the ample leisure and quiet thus afforded him we may attribute all his lesser inventions, such as the numerous schemes for effecting and conveying secret correspondence, which in early and troubled times were esteemed as highly useful; some of his automata, amusive toys, drawing and other instruments and mechanical devices. He appears to have taken considerable interest in multiplying these comparatively minor inventions almost to exhaustion, as it

* "The Century," articles Nos. 21 and 26.

were, of the several subjects to which they apply. So fertile, indeed, was this inventive faculty in him, that he himself has stated: "The more that you shall be pleased to make use of my inventions, the more inventive shall you ever find me, one invention begetting still another."*

Among his larger works we must rank his water-raising engines, in which his earliest efforts are exhibited in the water-works he erected in connection with the Citadel or Keep of Raglan Castle; which, as will be more minutely explained in a future commentary, belongs to this period. It probably depended for its operation on the influence of heat from burning fuel acting on a suitably constructed boiler containing water, and so arranged as to be able to apply the expansive force of steam to the driving of water through vertical pipes to a considerable elevation, which in this instance is supposed to have been limited to a large cistern on the summit of the Citadel or Donjon, known as the Tower of Gwent. This early work may, in fact, have been the occasion of calling in the aid of Caspar Kaltoff; and once thus employed, his after retention by such a master is readily conceivable. But master, and man, and works have all disappeared, and no printed, written, or drawn record or model remains of the waterworks there set up, to enable us to point distinctly to precise particulars of arrangement. All that the inquisitive and ingenious investigator can find to reward his most prying curiosity, are certain strange mysterious grooves in the external wall of the Citadel, on one side facing the moat and the castle, which point like a hieroglyphic inscription to the precise place where once stood in active operation the first practical application in a primitive form of a means of employing steam as a useful mechanical agent.

* The "Century," Dedication.

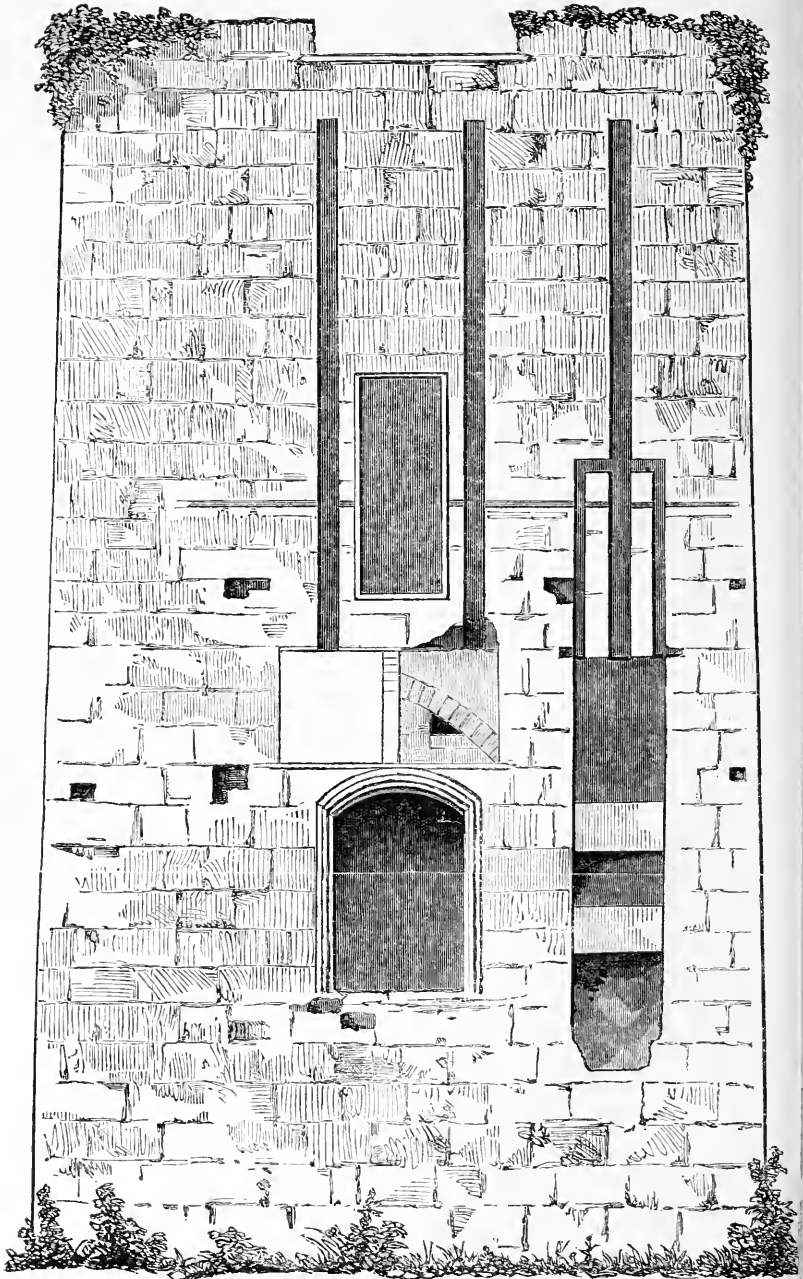

The annexed engraving represents a view of that side of the Citadel which looks across the moat towards the castle; that is, across the place where a bridge once stood, and opposite the Fountain Court. Commencing from below we observe a gothic doorway, which was the entrance to the draw and the permanent bridges. Over the arched interior of this entrance is a chamber or cell, measuring about seven feet by five feet, and better than six feet high in the centre. On the outside front of the cell are seen indications of two square places; and above them, one to each, two upright channels or grooves, each one foot wide and the same in depth. Adjoining is another groove but terminating at bottom in two lesser grooves of four inches and a half in width, connected a little way up with the large groove. This second portion has a distinct cell behind it, less in dimensions than the first. From the summit of the three large vertical channels to the ground measures forty-six feet.

Now it would have been quite possible to work a small steam boiler in each cell, and the pipes from those boilers might have been enclosed in the grooves described, entering inwards at top to discharge their contents into a cistern on the Citadel roof. And the boilers might have been conveniently supplied with water from the moat either by hand pumps, or by forming a vacuum for that purpose. It is here, however, unnecessary to enter upon mechanical details, as the subject will appear at large when describing his matured Invention.

That inimitable portrait painter Vandyck, who was born 1598-9, studied under Rubens, and was an especial favourite with Charles the First, has undoubtedly left us a faithful portraiture of the features of both his Lordship and of Elizabeth his first wife; the former dating pro-

bably between 1621 and 1626, the latter between 1628 and 1635.

The portrait of Lady Herbert, three-quarter size, is to be seen in the dining-room at Badminton House. It displays an intellectual countenance of a serious, dignified and most pleasing cast; her dark auburn hair is combed close from the forehead backwards, but so as still to leave a fringe of small curls in front; her hair braided and knotted behind is entwined with a string of pearls, while a portion of her tresses from behind falls in abundant ringlets about her neck and shoulders. She wears a large plain pearl necklace; with single pearl-drops as ear-rings. Her dress is low-bodied, of white satin, with the usual long tight stomacher, full short sleeves and large white vandyked frills or cuffs; on her arms, near each elbow, are single strings of pearls, like bracelets. Over her shoulders is thrown a light narrow fur tippet with long ends terminating backwards in short tails. The artist has represented her looking slightly aside as she might appear crossing her drawing-room, in the highly graceful and becoming style which Vandyck always so happily selected for the subjects of his magic pencil.

This may have been the period to which his Lordship later in life fondly looked back as his "golden days." He was, however, doomed to suffer his first great bereavement in the decease of his young wife at Worcester House in the Strand, on Sunday the 31st of May, 1635. She was buried at St. Cadocus, the parish church of Raglan, within the family vault beneath the Beaufort Chapel. He was thus left a widower with the charge of his son and heir not above six years of age, and two daughters.

A singular error, as to the date, occurring in all genealogies and biographical accounts that mention the

decease of Lady Herbert, renders it the more important to refer to the following certificate obtained from the Heralds' Office:—

“The right honourable Lady the Lady Elizabeth, late wife of the right honourable Edward Somerset Lord Herbert, son and heir to the right honourable Henry Earl of Worcester, and daughter of Sir William Dormer, Knight, eldest son of Robert Lord Dormer, of Wing, (which Sir William died in the lifetime of his father) and sister to the now Earl of Carnarvon, departed this mortal life at Worcester House in the Strand, near London, on Sunday the last of May, 1635, leaving issue, Mr. Henry Somerset, only son, about six years of age, Mrs. Anne eldest and Mrs. Elizabeth youngest daughter. Her body was honourably conveyed to Ragland, in the County of Monmouth in Wales, there to be interred. This Certificate was taken by George Owen Yorke, herald, the 1st day of June, 1635, to be registered in the Office of Arms, and testified by the right honourable Lord,

“EDWARD HERBERT.”

Among the family papers is a letter bearing date this year, alluding to Lord Herbert, but addressed by Secretary Coke to his Lordship's father:—

“RIGHT HONOURABLE,

“Upon a letter received from your noble son, the Lord Herbert, whereby he signifieth, that the Deputation is now come from the Lord President of Wales, I have according to his Lordship's desire represented his thankfulness to his Majesty, and have order from his Majesty to signify to your Lordship that it is not only in this particular case; But hereafter also he will be graciously

mindful of your good service done heretofore, in the Lieutenancies of Glamorgan and Monmouth, and your willing resigning of them. And he hath also commanded me to tell the Earl of Bridgewater, that he shall proceed therein with your Lordship in the same manner the Earl of Northampton his predecessor did, and not otherwise: which accordingly I have signified to his Lordship. And thus having imparted to your Lordship both his Majesty's gracious favour towards yourself and your son, who in this business hath performed as much respect and duty as can be expected from a worthy son, I humbly take leave and so remain,

“ Your Lordship's humble servant,

“ JOHN COKE.

“ Whitehall, December 3rd. 1635.

To the right honourable THE EARL OF WORCESTER, &c.”

It is not at all unlikely that after the funeral his Lordship returned to Worcester House. London would afford him many advantages for the gratification of his scientific pursuits, not to be obtained in the country. It appears, indeed, pretty evident that about this period he set up in the Tower his large wheel for exhibiting self-motive power, which the learned assume to be a mechanical fallacy, but which no one has yet proved to general comprehension to be an impossibility. In a scientific point of view, but particularly in connection with the life of this remarkable man, a subject of this nature cannot be lightly passed over. It affects his reputation more than appears on the surface, as we shall show in the course of our observations.

It was a machine, consisting of a wheel fourteen feet in diameter, carrying forty weights of fifty pounds each,* and is supposed to have rotated on an axle, sup-

* The “Century,” Article No. 56.

ported on two pillars or upright frames. His Lordship has been very precise in describing all the circumstances under which it was shown. There were present Charles the First, accompanied by two extraordinary Ambassadors, the Duke of Richmond, the Duke of Hamilton, with most of the Court; and Sir William Balfour was at the time Lord Lieutenant of the Tower. Now the latter circumstance would fix the date as not being later than 1641, while other facts make it reasonable to suppose the experiment took place at least two or three years earlier. Up to 1638 Charles the First had reigned for ten years in comparative peace and leisure. May it not have been during this lull in the portending storm of public discontent that royalty deigned to inspect a singular piece of mechanism, supposed to move of itself without any aid from external agency? In 1642, Sir John Byron was made Lord Lieutenant of the Tower; and Sir William Balfour* was in command of the Parliamentary forces at Edge-hill.

This wheel experiment may have been made in 1638-9, prior to the decease of his lady, and during the most peaceable portion of his Majesty's reign; and indeed while his Lordship's own domestic affairs were wearing their most cheerful and agreeable aspect.

His Lordship has been charged with dealing in paradoxes, and none greater than the one under consideration need be sought for. It relates to a problem which for 2000 years has not only perplexed mathematicians, but likewise been a stumbling-block to many ingenious mechanics during at least five centuries. What mathematicians fail to prove and what mechanics fail to produce, every modern philosopher demands

* It is not certain how long Sir William Balfour was Lord Lieutenant of the Tower prior to 1641.

shall be stamped as an impossibility, as absurd as it is impossible. Now the dilemma is, How has the author of the "Century of Inventions" fallen into the common, vulgar error of believing in the possibility of perpetual motion; and not only so, but publicly exhibiting a machine pretending to that character?

We are not disposed to question either his talent, or his veracity, hence the difficulty of offering any simple, direct, satisfactory reply to what otherwise appears to be an easily answered interrogative. Eminent writers of the seventeenth and previous centuries maintained that perpetual motion was possible. Dr. Dee, in his very curious preface to the first translation of Euclid into English, wrote favourably on this very topic; so that, however the modern scientific sceptic may blame his Lordship for want of skill, or, worse, of veracity, his opinion was quite in accordance with the estimation in which the subject was viewed in his day. But he goes a step farther, he speaks of a practical result. Hence he leaves us no alternative but to declare that he propounds either a truth or a falsehood; and if false that he was either himself mistaken, or deceived by others. But either way it is difficult to arrive at a thoroughly satisfactory conclusion, even as to what his Lordship actually intended and performed in this instance, owing to the usual vagueness of his own statements.

At 38 years of age Lord Herbert had enjoyed seven years of matrimonial felicity, and had been during four years a widower. In 1639, his son Henry would be 10 years old, his two daughters much younger, so that as well for their education as for the gratification of his own scientific investigations, he may have continued for some time to reside at Worcester House: the Strand and all that neighbourhood being then in the occupancy of families of title, wealth and high position.

During his father's lifetime, the resident housekeeper was James Redman, Esquire, as we learn from the list of his household.

The private studies and pursuits in which Lord Herbert was indefatigably engaged, must have occupied his attention from an innate love of physical science. The society in which he moved had no tendency that way, while the times in which he lived were far from affording any encouragement for such investigations as those in which he was principally engaged. The metropolis in his day was without coaches until 1625, when they were first used by the gentry, and ten years later hackney coaches were considered to have arrived at such a dangerous increase that their plying was restrained by law; and London streets were either so bad, or the treasury so low, that penalties were levied on all heavy vehicles passing over the highways. It is characteristic of the state of our laws at that period, that Dr. Leighton was for his writings sentenced to barbarous mutilations, as also happened in 1633 to the unfortunate learned Mr. Prynne, and four years later to John Lilburn. The pillory, whipping culprits through the streets, cropping ears and other mutilations and barbarities were ordinary punishments, and in 1636 the plague was raging throughout the metropolis and its suburbs, with all its accustomed terrors.

But not in this view alone do we see little to inspirit him in the ardent pursuit of mechanical employments, another and more serious obstacle arose from his belonging, like his father and ancestors, to the Roman Catholic faith. The laws against Papists were inconsistently stringent in England on religious grounds; and strange to say, in imperial Rome, the very seat of the papacy, absurdly severe denunciations were pronounced against even the free discussion of scientific subjects. On the

memorable 22nd of June, 1633, Galileo, prosecuted by the Inquisition at Rome, was compelled to abjure his astronomical theories and discoveries as heretical! The inquiry with its results must have deeply interested Lord Herbert; but what could he hope to gain even from his own party, as the inventor of a "semi-omnipotent engine?" Thus situated he was surrounded by circumstances nowise calculated to stimulate his mental activity in the peculiar occupations that employed his leisure and his fortune; but the fact offers an invaluable proof of the intense satisfaction an inquiring mind always experiences in the realization of its mental speculations.

There is every reason to believe that his studies were completed, his tastes fixed, his experiments pretty well matured at this period, and that it was, therefore, the occasion of stamping his future character. He was then terminating his "golden days," to enter upon a very different career. While, therefore, most anxious to avoid every appearance of substituting fictions for facts, we feel impelled to indulge in an attempt to account for his long serious devotion to employments so apparently foreign to either his education, his station in life, or the necessities of the times; while, indeed, on the other hand, all operated against him, owing to the darkness, ignorance, persecution and prevailing prejudices of the age.

It appears from his published work that Lord Herbert was better versed in mathematical than in classical literature. His mental activity may have been promoted by physical causes, assuming that from delicacy of constitution he may have been thereby disposed to those studious habits, to which he was ever after so much attached; the Vandyck portrait of him in his youth would indicate that he was not constituted for

undergoing much severity of exercise in the fatiguing sports and pastimes then in vogue.

In 1639, his confidential workman, Caspar Kaltoff, would have expended eleven years in constructing models and machines to establish the practicability of the many novel schemes which his Lordship had, up to that time, developed. Meanwhile, his own reading was no doubt pursued with vigour, and we cannot believe him to have been unpossessed of the celebrated authorities among English and foreign writers. He must have studied with interest Ramelli's very elaborate volume, 1588, on machines, illustrated with one hundred and ninety-five large, finely executed copper-plate engravings; the popular *Spiritualia* of Hero of Alexandria; with even, perhaps, the works of the engineer and architect Solomon De Caus, published in 1615; together with the labours of many kindred writers. Judging, however, from internal evidence, there was one; among many English authors, whose work especially gratified his taste, the "Mysteries of Nature and Art," by John Bate, which went through two editions, dating 1634 and 1635, containing a "Booke of Water-workes," treating of "evaporating water, and rarifying ayre." The peculiarity of such studies was sufficient to separate him from the fashionable society of Courts, and the too frequently frivolous society attendant even at Raglan Castle. If he then made few enemies, his conversation and pursuits were little calculated to enlarge his social acquaintance, and may even have early inspired a belief in his possessing equal eccentricity and enthusiasm. His memory, however, cannot fail to be cherished by posterity as the illustrious possessor of a highly cultivated intellect, displaying a singularly powerful, original, protean inventive genius.

CHAPTER III.

EDWARD, LORD HERBERT'S SECOND MARRIAGE.

IN 1639 Lord Herbert entered a second time into the matrimonial state, a prudential step as he was then situated, at the age of 38, having a young family without any sufficient guardian. He married the Lady Margaret, second daughter and co-heir of Henry O'Brien, Earl of Thomond; by which alliance he obtained some possessions, as well as a connexion with many of the best and most powerful families in Ireland. Of this, as of his first marriage, no particulars have been preserved, not even their date, or where celebrated; yet considering that both occurred during his father's lifetime and greatest prosperity, we can readily believe that they were accompanied with all the usual demonstrations of joy, ceremony and feasting. They had but one daughter, Mary, who died during her infancy. In a family group, painted by Hanneman, a close imitator of Vandyck, Lord Herbert is represented as a Roman general, seated by his lady attired in a modern costume of pale blue satin, with their child standing before her in a reclining position. He has a very aged appearance, although one might presume that the portrait was executed when he was under forty-five. It is a very thinly and sketchily painted performance. His Lordship presents a singular appearance in a toga and tight fitting hose of deep scarlet, an ornamented leathern jerkin, and wearing a wig streaming over his breast and shoulders, sitting in a chair with his right hand resting on a walking stick, while his left hangs negligently over the arm of the chair in proximity with a

mighty sheathed sword. His lady in ample folds of silk, with the usual long, tightly fitting, jewelled stomacher, has her hair in a fringe of small curls over her forehead, combed closely back, where it terminates in a knot from which a few ringlets flow behind; she wears also pearl ear-drops and a pearl necklace, which ornaments are repeated on her child.

The same year, on the 8th of April, he lost his mother, Anne, Countess of Worcester, who was buried at Raglan. It is possible, therefore, that his marriage was deferred during her illness, and not celebrated until some months after her decease.

It was then the 15th year of Charles the First's reign. Before the close of the year following, the Long Parliament commenced its sittings, when Lenthall was chosen Speaker. All projectors and monopolists were denounced as incapable of holding office, several members, therefore, withdrew, whose places were speedily supplied. What must have been his Lordship's impressions under the existing aspect of political affairs may easily be conceived, while as yet "Royalist" and "Round-head" could scarcely be called popular terms of party distinction.

In 1641, that martyr of science, Galileo, died, whose case so far assimilated with the Marquis's own, that they were of the same religious persuasion: the one proscribed at home for the peculiar heretical turn his genius had taken, the other under the ban of suspicion for his papistical persuasion and supposed consequent prejudices.

We now enter on the most critical era in the history of this great and good man. He was then residing in London, where he continued for some length of time, with the politic motive of avoiding as much as possible the suspicion of Parliament; for through his

father's liberality he had already commenced supplying Charles the First with heavy loans.

In the collection of manuscripts at Badminton, is an unpublished letter from Charles the First, dated 3rd of August, 1641, and also copies, in an ancient and probably contemporary hand, of letters, the originals of which, according to Birch, form part of the Harleian collection.* In the first of these, dated 7th of December, 1641,—Charles the First requires Lord Herbert to repair to Whitehall, “not only for *his own particular use*, but *likewise for the good of the kingdom*,” so early had his Majesty taken him into his confidence and council. He had then not long returned from Scotland, and soon after he retreated to Hampton Court. He writes:—

“CHARLES R.

“Right trusty and right well-beloved Cousin, We greet you well,—whereas We have heretofore by many letters and messages signed by us, given you testimony of Our favour and inclination to reward the good service of you and yours: These are further to assure you, that neither the times nor business shall ever make us unmindful of them: Yet upon occasions when Our good intentions therein may be really manifested, We desire to be put in mind that we may readily concur to a speedy performance, of which you may be ever most confident. And being [seeing?] your indisposition of body is such, that before Our intended journey We cannot signify the same to yourself in person, We have thought good to express it by these our Letters, Given at our Palace of Westminster, 3 day of August, In the seventeenth year of Our Reign and 1641.”

[Endorsed in an old handwriting, 1641.]

“To Our Right trusty and right well beloved
Cousin, HENRY EARL OF WORCESTER.”

* Inquiry, 1756, page 349.

Next comes the following:—

“HERBERT,

“Yours of the 1st of December has given me a just reason for your absence but certainly I have juster cause for your attendance, for it is well known how that you are to give me account of matters not only for my particular use, but likewise for the good of the kingdom; wherefore I require your repair hither with all convenient diligence; And the rather that you may find out the authors of these lying and scandalous Pamphlets concerning your father and you, touching [which] I not only promise you protection to your innocency but justice against those offenders, assuring you likewise that I shall be so mindful of you that, if I live, you shall neither be a loser in, nor repent you for the services you have done me. And so I rest

“Your assured friend,

“CHARLES R.

“Whitchall, the 7th December, 1641.¹³

“I send you herein the paper that I could not find when you were with me.”

Harl. Mss. 6988. 66

In his journey towards the north, his Majesty, on arriving at Royston, wrote to Lord Herbert as follows:—

“HERBERT,

“Your services are expressed to me in so noble a way that I cannot but acknowledge to you under my own hand, and that I should think myself very unhappy, if I did not live by real testimonies to express my gratitude to you. And for your sister, Carnarvon, though I cannot punctually answer your expectation therein,

*Orders
The Genl
Walker at
this House
being for
before W
the bodie
Thomas an
also to a
complaine
them for p
and pub
scandalou
against the
of a Bre
peer of
and it is
Ordered that
Wardens
of Station
make dili
search wh
the author
said Pamf
and present
scame to this
Lord's Jour
1641.*

¹³ Birch, gives the date “11th of December, 1641.” p 356.

yet I hope you will be satisfied with the answer you will receive by your cousin Sir John Byron, to whom, referring myself for many things I have not time to write. I rest,

“ Your most assured constant friend,

“ CHARLES R.

“ Royston, 6 March, [1641-2.]”

Hull. MSS. 6988. 67.

And again he addressed him a few lines, shortly before being refused admittance to Hull:—

“ HERBERT,

“ I entrusted your cousin Byron with the particular answers to your letter, reserving only to myself to answer you, that I esteem your services such as my words cannot express them; but by showing myself at all occasions to be

“ Your most assured constant friend,

“ CHARLES R.

“ York, 9 May, 1642.”

Hull. MSS. 6988. 69.

We have here the earliest communications on record between these two remarkable individuals, whose personal histories have alike perplexed all political, polemical, and philosophical writers.

Before setting out for Scotland, the King appears to have desired a personal interview with his Lordship, who seems to have been prevented from complying by some severe indisposition in July, 1641; his Majesty, therefore, conveys to him in writing, his “favour and inclination to reward the good service of you and yours.” His Lordship’s father had already made to the needy monarch some of those munificent advances, which, as long as he could obtain them, he was in the habit of repaying with ample promises and abundant flattery.

In his second letter, he alludes to “lying and scandalous pamphlets concerning” his Lordship’s father, but what these may have been has not transpired; they may only have referred to him as connected with the Roman Catholic party.

In another letter he expresses his “gratitude” for his Lordship’s noble expression of services; and alludes to his sister Carnarvon. And in the last of these letters, he flatteringly informs his Lordship, that,—“I esteem your services such as my words cannot express them;” yet by *words* alone were they ever, as then, expressed, only to be as conveniently repudiated.

Up to forty years of age, Lord Herbert had lived as became a gentleman of ancient nobility, great expectations, and in the enjoyment of the most friendly intercourse with his sovereign. Well educated, travelled, accustomed to courtly life, devoted to learned studies and given to scientific pursuits, he has been hitherto only presented to us, in his domestic relations, as a dutiful son, a husband and father, having few engagements to withdraw him from the management of his estates, or distract him from the enjoyment of country sports and social intercourse. During this period, he had probably nothing more serious on hand than an occasional change of residence, as he passed some portions of the year at Raglan Castle, and occupied at others the ample accommodations of Worcester House.

In a statement* he wrote long after, he incidentally remarks:—“I was not privy, or present with his Majesty at Greenwich [26th February, 1641] when he first took his resolution for the North, and removed, without the Queen, to Theobalds; from which he was pleased to write me a lamentable letter by the hands of Sir

* See Chapter XVIII.

John Byron, averring that he had but £600, and £300 of which was given to defray his horses, which the Marquis of Hamilton, then Master of the Horse, refused to do, fearing to displease the Parliament."

For awhile he was necessitated to act with consummate caution to conceal his true political bias from the Parliamentary party. But the drama of his life has now to change; his "golden days" are gone, and hereafter we view him only in evil times, times so distracted and turbulent, that the materials they afford us of his future life, are but like the fragments of a terrible wreck.

CHAPTER IV.

HENRY, EARL OF WORCESTER.—CREATED MARQUIS OF
WORCESTER.—RAGLAN CASTLE.

THE general aspect of public affairs in 1641, foreshadowed the coming storm. Charles the First had departed from Whitehall; civil war raged through the length and breadth of the land, terminating in fearful consequences to the monarch and all his wealthiest loyal supporters.

On the 2nd of November, 1642,⁸⁸ Henry was created Marquis of Worcester, being the first of his family raised to that dignity. He would then be 65 years of age, but does not appear to have enjoyed uniform good health; he was corpulent in body, possessed a vigorous intellect, and was remarkable for his flow of humour. It is recorded of him, but without reference to any authority for the statement,⁴ that he was singular for the custom of wearing a coat of frieze, a coarse narrow cloth much in use; the term being applied to garments having long wool, then said to be friezed. Sanderson speaks of him as a plain man, especially in his apparel.

His great wealth enabled him to afford Charles the First early important pecuniary assistance, which, together with his great loyalty, although a papist, secured him all that esteem and favour, which the peculiar mental constitution of his royal master, alone best knew

⁸⁸ Sandford.

⁴ Annual Register, 1769.

how to turn to the largest possible amount of personal profit, without being absolutely necessitated to make any adequate return other than his word and honour. If the materials for the personal character of Charles the First had to be drawn solely from his treatment of the first two Marquisses of Worcester—the veteran Lord of Raglan Castle, and his enthusiastic valorous son, the Lord Herbert, sufficient evidence would be found to establish that monarch's perfidious nature, and the utter worthlessness of his plighted word and most solemn protestations.

The Parliament took early notice of the proceedings of both the Earl of Worcester and his son Lord Herbert. The Journals of the House of Commons* inform us that on the 29th of January, 1640-41:—

“ Die Veneris, 29 June, 1640.

“ Mr. Treasurer acquaints this House, that his Majesty's pleasure is, that this House do attend his Majesty this afternoon, at two of [the] clock, in the Banqueting House, and that he had intimated his pleasure likewise to the Lords to attend him at the same time.

“ Ordered, That the consideration of the commission granted to the Earl of Worcester, and his eldest son the Lord Herbert, and the sub-commissions by them granted to others, for the levying of forces in several Counties of England and Wales, and all the circumstances depending thereupon, be referred to the Committee appointed to draw up the charge against the Earl of Stratford, &c.”

And on the 11th of February following, that:—

* 1640. 16 Car. I. vol. ii. p. 75.

“Die Jovis, 11^o Feb. 1640.

“Mr. Reignolds reports from the Committee of the Earl of Worcester, the substance of that business. * * * * (thus printed in Journal.)

“And then it was resolved, upon the question, That the particulars reported by Sir W. Erle, Sir Jo. Clotworthy, and Mr. Reignolds, shall be the heads of the Conference to be desired with the Lords, concerning the disbanding of the new-levied Irish Army, and disarming of the Popish Recusants here in England.”

Later we find a guard set on his residence in London.*

“Die Martis, 16^o Nov. 1641.

“Mr. Wittacre, Sir John Fraucklin, Sir John Hippisley, Mr. Wheler, Mr. G. Long, are appointed to go immediately, and take order to set a good guard upon the house of the Earl of Worcester; and to search for persons suspected of high treason.

“They are to take like care for setting a guard upon, and searching * * * ; and likewise upon such other houses, as they shall be informed; and that they have power to search all such houses at such times as they shall think fit.

“. . . . To acquaint their Lordships, what this House has done for the searching, and setting a guard upon, the Earl of Worcester’s house, and upon what grounds.”

On the 5th of January, 1642, his Majesty addressed the following letter to the Marquis, in which he says—

* Journals of House of Commons, 1641. 17 Car. I. vol. ii. p. 317.

“The large expressions which you and your son have made unto us of your forwardness to a service, shall *never be forgotten.*”

“CHARLES R.

“Right trusty and right entirely beloved Cousin, We greet you well. Your son, the Lord Herbert, hath excused your not writing unto us; but where we find so much royalty, there needs not ceremony, and your last performance of our desires hath crowned the rest. And we would have you confident that the mentioning of leaving few forces at Raglan, was not out of any diminution of our care of you, or meant to lessen any provision fitting thereto: For we well understand that there were never any of the forces raised in the county, applied thereunto more than a private company under servants of your own. But the Ward of Raglan was given as a general ward attributive to the country, as that time we understood it. The large expressions which you and your said son have made unto us of your forwardness to a service, shall never be forgotten. He now commands in chief in the absence of the Lord Marquis [of] Hertford, and besides his dutifulness unto you, our command is, that his power and yours shall [be] the same, as your hearts are to our service. The acceptance whereof we shall not fail to make appear on all occasions, whereof you may rest assured. Given under and signed at our Court at Oxford, the 5th day of January, in the eighteenth year of our reign, 1642.*

“To Our Right trusty and right entirely beloved
Cousin, HENRY, MARQUIS OF WORCESTER.”

The earliest direct intimation we have of money passing from the Marquis to the King occurs in two

* From MSS. Badminton.

letters from Sir John Byron. In his first communication he says:—

“MY LORD,

“The King is so oppressed with [a] multitude of business that he has commanded me to write unto your Lordship this inclosed letter, not having leisure himself to write more than a short postscript to give credit to what I have written. I had thought to have sent some of my own servants to convey the money hither, but Mr. Griffin tells me your Lordship would rather send it by him and some other, whom you should think fit to trust, and then it may be brought so privately to Newstead, where I shall be ready to receive it, that none but such as your Lordship trusteth need to know of it. I humbly desire your Lordship it may be sent with all possible speed, because his Majesty hath allotted it for a service that must immediately be gone in hand with all [speed]. I shall not need to trouble your Lordship any farther, and therefore humbly kissing your hands, rest ever,

“Your Lordship’s most humble Servant,

“JOHN BYRON.*

“York, July 8, 1642.

“To the EARL OF WORCESTER.”

On the 24th of the same month Sir John Byron † wrote a second letter as follows:—

“MY MOST HONOURED LORD,

“Your Lordship hath honoured me with a title which I value above any other that can be given me, and of which I shall ever endeavour to make myself worthy by all real expressions of faithful and humble service. It was my misfortune to be from home when

* From MSS. Badminton.

† Ibid.

Sir John Somerset came, and though I acquainted his Majesty therewith (upon whom I then attended), yet he would not permit me to go to him for a day or two, having some other service to employ me in by reason of his journey to Leicester, where it was thought he would have had some opposition; but upon his Majesty's approach, his enemies fled, Hazelrick,* the chief of them, was said to be lurking hereabouts, whereupon the King commanded me and some other gentlemen, to go out and see if we could apprehend him; but, though we used the best diligence we could, riding both day and night, yet we came short of him.

“This is the cause of the delay in returning your Lordship an answer, for which I hope your Lordship will pardon me; and now, since Sir John Somerset is come hither, having left the £5000 your Lordship sent at Newstead, my house, his Majesty hath commanded me to make use of it for the levying of 500 horse, and withal, in his name, to return your Lordship all possible thanks for your seasonable assistance both now and heretofore, and that he hopes he shall not die in your debt. These are his own words, and desires to be excused for not writing himself, by reason of the little leisure he hath; for my own particular, I humbly beseech your Lordship to believe that, as there lives not any body more deeply engaged for real and noble favours to your Lordship than myself, so no man can be more sensible of them, or more ready upon all occasions to express myself, my Lord,

“Your Lordship's most humble

“and faithful servant,

“JOHN BYRON.

“Leicester Abbey, this Sunday, being
the 24th of July, 1642.”

* Sir Arthur Hazelrigge, Bart.

Still later, and the House of Commons directs its attention to the disarming of the Earl, and the requiring of his son's attendance.*

“Die Sabbati, 20 Augusti, 1642. Post meridiem.

“Message from the Lords by Sir Robt. Riche and Mr. Page;

“That the Lords had sent them with Three Orders: 1. For the disarming of the Earl of Worcester, and all Papists; wherein they desire the concurrence of this House, &c. &c.

“Answer returned by the same messenger (as to two of the Orders); And as to that of disarming the Earl of Worcester, will send an answer by messengers of their own.”

And again on the following month:—

“Die Martis, 30 Septembris, 1642.

“That Mr. Speaker shall write his letter to the Lord Herbert, son of the Earl of Worcester, to appear here, and attend the House.

“Mr. Glyn to prepare this letter.

“That the Lords be moved to send for the Earl of Worcester, to attend the Parliament.”

In August, 1642, had commenced that series of national disasters, which divided shires and even families into either Cavaliers or Roundheads—Royalists or Parliamentarians—Protestants or Puritans, in short, Tories or Whigs. It was then, or perhaps somewhat earlier, previous to his elevation, that the Earl of Worcester garrisoned Raglan Castle, strengthening his position by the raising of extensive earthworks on its most approach-

* Journal, House of Commons, 1642. 17 Car. I. vol. ii.

able side, and maintained there 800 men entirely at his own expense.

In September, 1642, Lord Herbert was in personal communication with his Majesty at Nottingham. He was then, although 41 years of age, a man singularly inexperienced in the ways either of commerce or of courts. His studies, pursuits, domestic habits, were not calculated to foster that spirit of intrigue which a deep designing mind alone knows best how to conjure up and apply with consummate art, and the exercise of which base quality his position would seem to have frequently demanded. We have now to peruse a minute report, drawn up by Lord Herbert, of what passed between himself and the King in regard to a further loan.* The cunning and artfulness of the royal negotiator is mirrored forth in this affair in most unmistakeable characters. But the whole document is a striking example of the arts by which Charles the First could practise on his unsuspecting victims. It is an engrossed copy—not signed—but has been endorsed on the back, “Lord Herbert’s Message from the King to be delivered to his father from Nottingham, Sept. 9th, 1642,” and runs as follows:—

“The effect of the message your Majesty desireth I should deliver to my father for your Majesty at Nottingham, the 9th of September, 1642.

“That your Majesty with many thanks expresseth yourself most sensible of the great expense and charge his Lordship hath been at for your service, far more than any man else, considering what I have had as well as Sir John Byron’s [expenses], that it is most true at this time, much lieth at stake both of your Ma-

* From MSS. at Badminton

jesty's honour and power for want of a little money, since £20,000, with what you have, would further your Majesty's designs to a most hopeful condition ; for want whereof, your Majesty is enforced to dally (though you will never yield), and at this present you offer that which is worth £100,000 for £50,000, besides my Lord Capell, Sir William Savill and others of good estates do offer also theirs for security ;—yet no want nor occasion can make your Majesty to press my Lord, who hath already done so much, but if he and his friends could procure £10,000, your Majesty would suddenly (if it please God to restore you) see it repaid, and would presently in token of thankfulness send my father the Garter, to be put on when he pleased, and also having the Great Seal in your Majesty's own custody you would pass a patent of Marquis of what title my father should desire, and keep it private as long as he thought fitting ; and to show that this proposition is far from urging him to his inconvenience, and so much doth your Majesty acknowledge yourself already beholding to him, as that even without procuring his Majesty this unspeakable advantage, your Majesty is graciously pleased that if he desire either or both these, your Majesty, at my return unto you, will vouchsafe them ; but if this could be possibly performed, then the Crown, which hitherto your Majesty confesseth to stay upon your head by his assistance, will be then confirmed by him, and your Majesty ; and your Majesty esteemeth so much of his understanding, as well as passionate zeal to your service, that if he will send your Majesty his advice (upon the relation of the state of business which your Majesty hath commanded me to make unto him) your Majesty will as soon follow it as any man's, and the power you give, or intend to give me is, as I am subordinate, and most dutiful unto him to whom your

Majesty esteemeth it to be given when it is to me; and your Majesty doth not only faithfully promise on the word of a King but of a Christian, that you will punctually perform your engagements advantageously to him and his, and never forsake either, whilst you breathe, joining his safety with your own, which is, and ever shall be your Majesty's resolution."

We have here a summary of the interview between Charles the First and Lord Herbert at Nottingham. The King was no doubt very gloomy, and the discourse between them most serious. There was on all occasions an imperturbable dignity of manner about his Majesty, although his personal appearance operated against him, his visage being long, with a narrow forehead, large nose, grey eyes, thick lips, and peaked beard. He stammered, too, in his speech, being also somewhat impetuous and hurried amidst all the apparent coolness and calmness of his conduct and conversation. Lord Herbert, on the contrary, in the very prime of life, was a man of cheerful aspect, with small dark full eyes, and smooth, oval, delicately formed features. Both wore the flowing locks in fashion, the one in ample curls, the other in plain long wavy hair. The Marquis fastidiously observed all courtly etiquette; without the accomplishment of fluency in speech, his conversation would be deferential, simple, without any show of boldness other than what conscious integrity of purpose might naturally inspire; unaffected, direct, and straightforward; displaying much suavity without any taint of selfishness, and profound zeal without the slightest hypocrisy.

We almost see and hear again the wily financier, (such is the freshness of the reported conversation) while the meek, unsophisticated Lord Herbert is scru-

pulously noting each suggestion as it is dictated by his suppliant royal master, anxious to give in their integrity the identical honeyed phrases the Sovereign employs in depicting his obligations, his necessities, his securities, with the readiest means for extricating the royal cause and assuredly giving stability to the already tottering crown. His Majesty is gracious to an extreme; he will in very "thankfulness send the Earl the Garter," and having "the Great Seal" in his "own custody," he offers to "pass a patent of what title the Earl should desire;" nay, should he desire unconditionally to have either or both "his Majesty will vouchsafe them." It was by such unworthy arts in diplomacy that Charles the First drew the loyal, warm-hearted, sincerely attached Lord Herbert into his toils, inducing him by unremitting flattery, artfully simulated condescension, and consummate sophistry to become instrumental in the ruin of both himself and his father. There is not the slightest ground to suppose that from the first to the last advance of money made by this family to the King, a single offer in the first instance came direct from either the Earl or his son; but there are abundant proofs that his Majesty held out from time to time every possible inducement he could conceive to sap the wealth of the too-confiding Earl of Worcester. Transparent as the craftiness of the present transaction must appear to the reader, it was not so obvious to the peer whom it interested, for he having once made his election to support the royal cause magnanimously proceeded as he had begun, until he exceeded even the bounds of common prudence.

It will be requisite, as we progress, to notice many particulars which might at first appear irrelevant, as relating more considerably to the father than to the son; but it is important to bear in mind, that Lord Herbert

becomes intimately associated with events then apparently only concerning his father, but which really are those most seriously affecting that turn in events which colour all his future history, whether as regards his early military career or his later cheerless destiny.

Raglan Castle was then in its glory; it was often gay with numerous noble visitors. Lord Herbert resided there with his lady, particularly at that disturbed period; his father too had a numerous family and household. Although rather isolated in position, it must have been a place possessing considerable internal comfort. The good old Marquis was constituted to make all around him as happy as circumstances would permit; with strong religious and moral principles he combined the strictest possible sense of honour, of a gentlemanly and military bearing, with a joyous temperament that refused no source of accidental innocent amusement, turning the very ills of life to sources either of merriment or moral reflection as the case might be: which, with his princely means and liberal spirit, must have largely contributed to the promoting of good feeling and hilarity within the fortress of Raglan.

The Castle crowns one of the many broad low verdant hills occupying a valley of immense extent in Monmouthshire. It is at present so embowered in a forest of ancient lofty trees, as to be all but hid from view within the circuit of a mile radius. There is just one point from which may be seen at the same time towering above the foliage the Tower of Gwent or Citadel on the right, and the Closet Tower on the left. The Citadel, which in reality stands outside the Castle, as being the loftiest object, is visible from the village, the Warrage, and other points of view. In its palmy days there were attached to the Castle an extensive, well-wooded and highly picturesque home-park, with



DISTANT VIEW OF RAGLAN CASTLE, MONMOUTHSHIRE.

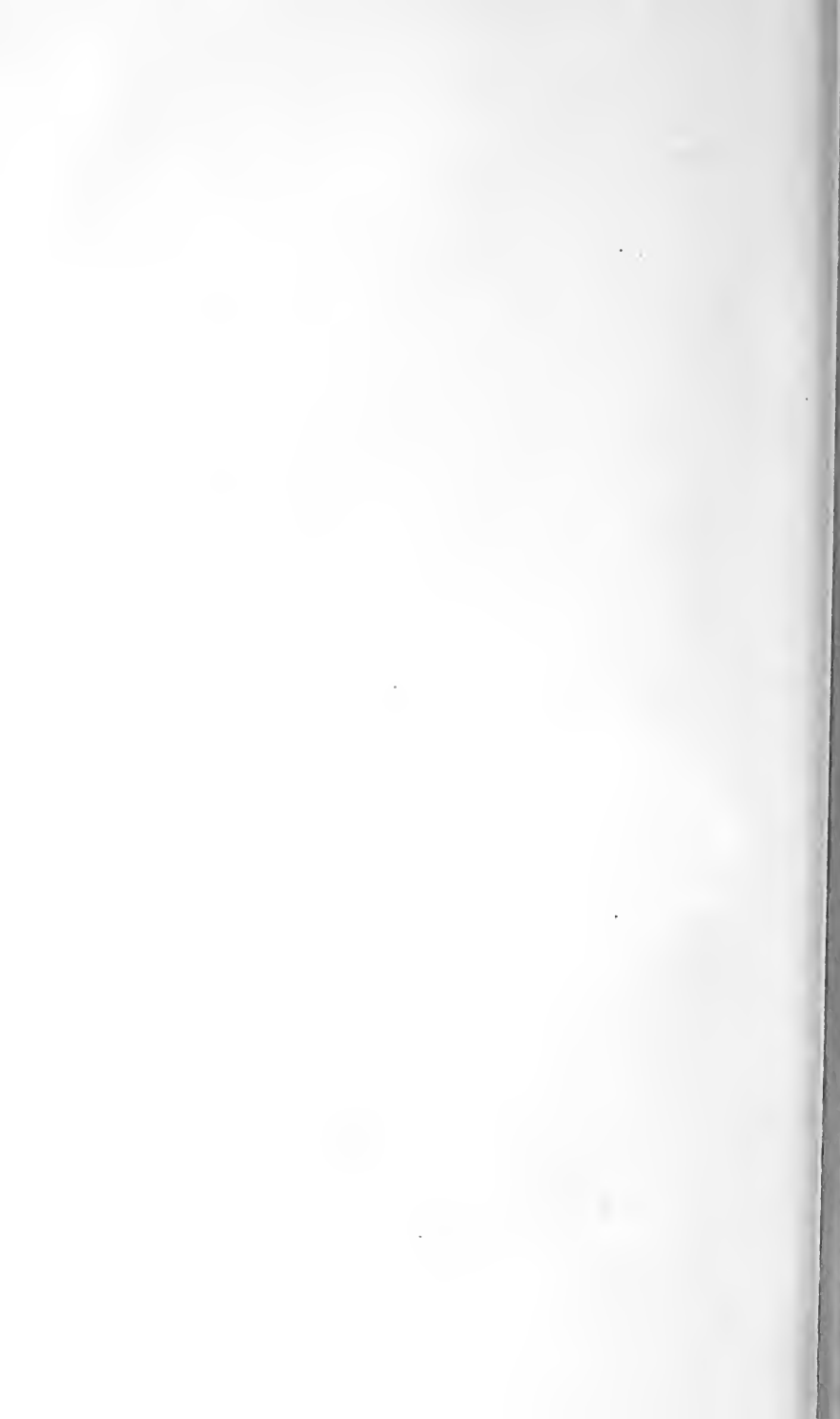

a well-stocked red-deer park; also various gardens, orchards, lawns, pleasure grounds, and fish-ponds artfully constructed, affording islands here, fountains there, and summer houses where they could be most advantageously placed. Thus were the demesnes of Raglan characteristic of its noble possessor's distinguished position.

The most ancient portions of the Castle itself, were probably raised in the reign of Henry V., others are of more recent construction, but not much, if any of it, dates later than that of Elizabeth. Its mixed styles of architecture are very obvious. Among its later improvements were, no doubt, those large windows, which were better suited for an elegant domestic mansion, than for a fortress. The grand entrance was secured by its double porteullis, as likewise by a gate, leading to the paved or pitched court; a porteullis also protected the south-eastern entrance, leading from the fountain court to the pleasaunce or bowling-green, supposed by some to have originally been the tilt-yard; both of which entrances were further guarded by draw-bridges. The tower of Gwent, citadel, or keep, stands before, and a little removed from the castle, surrounded with a broad moat, which it would appear could be crossed by two bridges; one permanent, connected with, and for the special use of the castle, reaching to the walls of the bastions, whence communication was kept up by a draw-bridge with the keep itself; the other a draw-bridge only, in an opposite direction, whereby to pass over the moat to the sunk walk, for ordinary use. The tower is of extraordinary strength, its form hexagonal, its walls ten and a half feet thick, and its summit reached by a stone staircase.

The Castle may be described as presenting two portions, distinguished by two courts and two fortified

arched entrances. The grand entrance between two hexagonal towers leads to the paved court, with the closet tower or library to the right, a withdrawing or ball-room over head, and the banqueting or stately hall to the left, which last attracts much notice from its size, nobleness, and state of preservation. It had a magnificent oak roof lighted by a lantern or cupola window at the top; at one end is a large stone carving of the arms of the Beaufort family, with their celebrated motto, *Mutare vel timere, sperno*; at the opposite end rose the minstrels' gallery. One entire side is occupied with an ample fire-place, having large windows above, and on the right hand side a magnificent bay window; the opposite side of this great apartment is a mere lofty blank wall. Returning to the court we see the kitchen-tower, larders, and other domestic offices. Passing to the second, or Fountain Court, we observe a small chapel, marked only by its foundation stones. Above it, on the same level and of no greater width, ran the picture gallery, which may have been 126 feet long by 13 feet wide. In it were, among others, many family portraits, particularly one of Charles, the first Earl, and another of Henry, the second Earl of Worcester.⁹³ The Marquis's private chamber was probably over the gate; but here, the outer walls excepted and the grand staircase, few remains of the ruin rise above the ground to distinguish their character.

The vaults and cellars are numerous, but not so large as is generally supposed, although sufficiently capacious. Some were undoubtedly used as cells for prisoners, others for various stores, while certain vaults are even reputed to have served the purpose of underground stables.

The Fountain Court, derives its name from formerly

⁹³ Symonds

possessing a handsomely carved fountain which stood in its centre, supposed to have been supplied with water by means of water-works erected by Lord Herbert, in contiguity with the citadel, and sufficiently near for that purpose, as already noticed.

Such then was Raglan Castle in the days of its magnificence, during the life-time of its last munificent lordly resident. But the time had arrived to protect it against the worst consequences of civil war. Its paved court afforded ample scope for the drilling of recruits, and the reviews of the regular soldiery, when the open ground could not be safely taken. A mill was also erected for the home manufacture of gunpowder, in which we imagine the combined skill of Lord Herbert and Caspar Kaltoff was actively exercised. The clang of arms, the beat of drum, the constant firing of artillery, with all the noise, the show, and circumstance of war, soon transformed the once quiet homestead into a most mortifying scene of discomfort, alarm, watchfulness, care, anxiety and activity.

Charles, Lord Somerset, the Marquis's sixth son, officiated as governor of the castle. The garrison, originally amounting to 300 foot,⁹³ was considerably augmented to meet the threatening aspect of public affairs.⁹⁰

Warfare, as at that time conducted, bore but a slight analogy to modern practice. The bow and cross-bow, it is true, were entirely superseded by the use of gunpowder, but that material was comparatively indifferent, and the ordnance and arms employed of the clumsiest possible description. Great guns weighing from $3\frac{1}{2}$ tons to half and less that weight were denominated cannon, demi-cannon, culvering, demi-culvering, saker, minion, drake, &c. Then for small arms, they had the musket, carbine, arquebuse, blunderbuss,

⁹³ Symonds.

⁹⁰ Somers.

pistol, &c. Their weapons were chiefly swords and pikes. Armour was employed to a considerable extent. The curious in such military matters may consult with advantage "The exercise of arms for Calivers, Musketts, and Pikes," in the masterly executed folio engravings by Jacob de Gheyne, printed at the Hague in 1607. The soldiers of the 17th century had to carry immense unwieldy fire-arms, requiring a crutch or rest on which to steady them while taking aim, and had to fire with the ignited end of prepared rope, used as a match for that purpose, and which for security against accidental extinction was usually kept lighted at both ends.

In respect to the Marquis's wealth, a contemporary authority informs us in reference to that period, that,—“His whole estate *ubique* was esteemed 24 thousand pounds per annum.”⁹³ Indeed he was almost an universal landlord in the county.²⁹ He had then altogether raised 1500 foot and near 500 horse, the command of which he gave to his son, Lord Herbert; thus raising the first horse levied by the King.

The writer of a contemporary pamphlet published at Oxford, entitled—“A short view of the late troubles,” states: “Moreover, within few days following, one John Davis discovered [12th Nov.] to the House that the Earl of Worcester had large stables under ground, at Raglan Castle, and a number of light horse in them; likewise arms for a hundred and forty horse, and two thousand men, whereof seven hundred were then in pay, and ammunition proportionate.”⁹⁰

We learn little more personally affecting the Marquis of Worcester for about two years, during which his time must have been both fully and painfully absorbed in superintending the warlike preparations which environed his domicile.

⁹³ Symonds.²⁹ Corbet.⁹⁰ Somers.

CHAPTER V.

LORD HERBERT IN HIS MILITARY CAPACITY.

THE sad necessities of the times and the perilous position in which his tortuous policy had placed him, obliged Charles the First to court the assistance and presence of the wealthiest among the nobility, than whom none then ranked higher than the Marquis of Worcester, who, as we have seen, his Majesty pressingly sues, through his son, Lord Herbert, at Nottingham, for still further monetary supplies.

It is not surprising then to find Lord Herbert, even against his better judgment, considering his tastes, habits and experience, taking an active part in military affairs, and the mailed philosopher actually setting forth as an enthusiastic Cavalier.

In one of the political tracts of the day, published at Oxford in 1642, the writer gives as a reason for the Marquis of Hertford declining the service in which the King had employed him:—"For that the King hath not only given way to the raising of a popish army in the North, but hath granted commission to the Marquis of Worcester, a known papist, to be general of the forces in those parts, where he is; whose army consists of profest papists."⁹⁰

As early as 1640, rumours had been falsely circulated against the Marquis of Worcester, charging him with being concerned in a design to raise a large popish army in Lancashire, as also another in Ireland. In

⁹⁰ Somers' Tracts, vol. iv. p. 459.

1642, however, he did raise a great number of Welsh in support of the royal cause;¹⁰⁵ and the same year Lord Herbert was made General of South Wales.⁹⁵

Thus Lord Herbert, in command of troops raised by his father, being in favour with his sovereign, and generally esteemed both for his high nobility and his wealth, held a most important influential position. Fully to prepare himself for such a post, it appears most likely that he commenced the requisite course of training even previous to his second marriage, for so early as March, 1638, Lady Harley writes to inform her son:—“They say, my Lord of Worcester’s son shall be general of the horse.”⁴⁶

In his first considerable exploit he appeared before Gloucester, then in the Parliamentary interest, stoutly defended by a company of volunteers, who had raised very extensive fortifications. In February, 1642, it was summoned by Prince Rupert, and again later, but without effect. About the middle of the same month, Lord Herbert, with a body of about 1500 foot and 500 horse, well armed, attempted the reduction of the garrison. His eldest brother, Lord John Somerset, commanded the horse, while Sir Jeremiah Brett was general of the foot. A third time the city not only refused to surrender, but received with ridicule the summons from a Welsh brigade; the Welsh troops therefore encamped at Highnam within the distance of one mile and a half, where they lay still in their camp for five weeks in mistaken security, not even attacking the outguards, or attempting any great action, seemingly deluded by expectations of aid from Prince Rupert; who, however, could not leave Bristol. Sir William Waller, crossing the river by means of flat-bottomed boats, advanced on

¹⁰⁵ Whitelock.

⁹⁵ Thomas—also Clarendon.

⁴⁶ Harley.

them with a body of light troops, numbering about 2000. The Welsh, without taking the least advantage arising from their strong position, sounded a parley, and surrendered on conditions which were readily granted; in consequence of which, 1300 foot and three troops of horse were led prisoners into Gloucester, where several were kept for some time under strict confinement. Rushworth states, under date 19th of March, 1642-3, that Lord Herbert lost 500 men killed, and above 1000 taken prisoners. Lord Herbert, we find from his own account, was not present on the occasion of this defeat, for in reference to this disaster he says:—"God forgive those of the King's party, who were the occasion that 1500 gentlemen were surprised, and I not despatched from Oxford until the day after. Yet at 14 days' warning I brought 4000 foot and 800 horse to the siege of Gloucester." But Rushworth and others erroneously speak of his escaping to Oxford.⁸⁷ From first to last the defeat cost his Lordship, according to his own showing, £60,000.⁹⁰ Such was the unpromising result of his earliest enterprise in his new career, offering a very gloomy foreboding of the future. He had been untiring in his exertions to raise those troops throughout Monmouthshire, Herefordshire, and adjacent counties, in which, as also in efforts to obtain sufficient stores for the garrison at Raglan, he appears to have acted with extraordinary energy.||

During the progress of operations against Gloucester, Lady Harley in her correspondence with her son, on the 14th of February, 1642, says:—"Nine days past my Lord Herbert was at Hereford, where he stayed a

⁸⁷ Rushworth.

⁹⁰ Somers' Tracts, vol. v. p. 312.

|| Rapin states that after thus relieving Gloucester, Sir William Waller took first Chepstow, and afterwards Monmouth.

week. There was held a council of war, what was the best way to take Brompton [Castle—her residence]. It was concluded to blow it up, and which counsel pleased them all. The sheriff of Radnorshire, with the trained bands of that county, and some of the Hereford soldiers, were to come against me. My Lord Herbert had appointed a day to come to Preston, that so his presence might persuade them to go out of their county. He had commanded them to bring pay to victuals for 10 days. The soldiers came to Preston, but it pleased God to call my Lord Herbert another way, for those in the Forest of Dean grew so strong, that they were afraid of them.”¹⁰²

We ascertain from his own later statement of expenditure that from February, 1641, to October, 1642, or thereabouts, he was actively engaged in dispensing his father's immense loans in support of the royal cause; he says,—“With as much privacy as might be, keeping good correspondence with the Parliament; remaining in London, to avoid suspicion, being then trusted both by King and Parliament.”

Taking amounts as stated by his Lordship, the dates may be pretty correctly supplied from *Iter Carolinum*.⁹⁰

Between 28th February, and 18th March, 1641, he sent to Theobalds for the “pressing necessities of his dear master,” the sum of . . . £3,000

About the same time to Huntingdon, after the King's departure from Theobalds . . . 3,000

On or after the 19th March, to York . . . 8,000

On or after 21st July, 1642, to Nottingham, “where his Majesty set up his royal standard.”⁹⁰ 4,000

¹⁰² Washbourn.

⁹⁰ *Some's' Tracts*, vol. v. ed. 1811, 4to. page 263.

Officers' expenses to York	1,500
Besides, by his Majesty's command, victual- ling the Tower, Sir John Byron being Lord- Lieutenant, for which purpose, he "sent him in old plate, under pretence of coining it"	2,500
And further, obtaining through some pre- tence, leave of absence, from the Parliament, he proceeded with their pass to York, carry- ing to the King in ready money	15,000
And in bills and assurances	80,500
For these his Majesty giving his "note for ninety-five thousand five hundred pounds," his Lordship returned in two days.	
Raising Sir John Byron's regiment of Horse, the first completed	5,000

Representing a total of £122,500

Annexed to the record of this vast outlay, Lord Herbert has left us a short piece of autobiography. "Things being thus set in order, (he says) between his Majesty and me, I fairly took leave of the Parliament, to go down to my father; where I no sooner arrived but there came directed unto me from his Majesty a Commission of Array; whereof I presently, by a servant of my own, sent word to the Parliament, with a letter to the House of Lords, which I directed to my Lord of Holland, and to the House of Commons, to Mr. Pym; in both which I offered to intercede to his Majesty, and conceived I should prevail to suspend the Commission of Array, if they should make an Act that their Militia should not come into my country. But they with civil compliments and thanks replied that his Majesty's [proceedings] was so illegal, and theirs for the good of the kingdom so just and necessary, that by

no means would they waive the one for the other. At which I declared myself irritated, to see that they durst tell me that anything commanded by my master was illegal, and professed I would obey his Majesty's commands, and let them send at their perils. So immediately, and in eight days' time, I raised six regiments, fortified Monmouth, Chepstow, and Raglan, fetching away the magazine [of powder and ammunition] from the Earl of Pembroke's town, Carlyon, and placed it in Raglan Castle, leaving a garrison in lieu thereof. Garrisoned likewise Cardiff, Brecknock, Hereford, Goodrich Castle and the Forest of Dean, after I had taken them from the enemy."

We have here a striking instance of his unflinching loyalty, of his first public expression of his political sentiments, with a brief sketch of the course he adopted in his first decisive military measures.

In the month of September several horses, the property of Lord Herbert, being seized in Gloucestershire, the same was formally reported, as appears first from the Journals of the House of Commons,* as follows :

“ Diè Martis, 13^o Septembris, 1642.

“ A letter, from the city of Gloucester, from Mr. Perry, &c. concerning the Lord Herbert, son of the Earl of Worcester, seven horses of war stayed there ; and concerning some provisions they desire for the safety of the city ; was this day read : And

“ It is ordered, that Sergeant Wilde do prepare an Order concerning both these particulars.

“ That Mr. Speaker shall write his letter to the Lord Herbert, son of the Earl of Worcester, to appear here, and attend the House.

* Journals of the House of Commons. 18 Car. I. 1642. vol. ii. page 763.

“ Mr Glyn to prepare this letter.

“ That the Lords be moved to send for the Earl of Worcester, to attend the Parliament.”

And further, afterwards, from the particulars afforded by the annexed document :—

“ Die Jovis, 15^o Septembris, 1642.

“ Whereas information hath been given to the Lords and Commons assembled in Parliament, that seven great horses or geldings, of the Lord Herbert, son of the Earl of Worcester, were lately brought to the city of Gloucester, to be by them employed (as is justly suspected) upon some design against the Parliament; and that great endeavours are used by divers commissioners of array, and other ill-affected persons, in the several counties of Hereford, Monmouth, Glamorgan, Carmarthen, Brecknock, and Radnor, to draw the said counties by way of association against the Parliament, and their adherents, and in particular against the said city, as a place the most advantageous for the furtherance of their malignant designs; therefore upon the humble desire of the citizens of the said city of Gloucester, and for the better preservation of the safety of the said city, being a place of great importance, and of the counties and parts adjoining; it is thought fit and ORDERED by the said Lords and Commons, that the Mayor, aldermen, and citizens of the said city, shall have the use and disposal of the said horses, for the defence of the said city and parts adjacent, and the services of the Parliament; and that, for the same purpose, they shall have power to raise one or more troop or troops of horse and men, and to train, exercise, and employ the same, and other forces of the said city, as by the ordinance concerning the militia is appointed; and further, that, for their better encouragement and

assistance in this behalf, some such small pieces of ordnance shall be forthwith sent down to the said city, to be used, ordered, and employed for the uses and purposes aforesaid, as to them shall seem most meet and expedient; and that they and every of them, in so doing, shall be protected and assisted by the power and authority of both Houses of Parliament."

The records of Gloucester frequently allude to these seven great horses, which were afterwards placed under the command of Lieutenant Backhouse, and kept together till the close of the war.

In February, Lord Herbert wrote to Prince Rupert,¹⁰⁰ as follows:—

"MAY IT PLEASE YOUR HIGHNESS [Prince Rupert],

"Your commands came unto me but the last night late, and being now upon making my entry into the Forest [of Dean], I cannot so suddenly execute the same; but as soon as it is any way feasible, there shall be no delay therein. Upon Thursday next, I have given order, that accordingly as I shall receive intelligence from the other side of Severn (which when I have taken order to receive), there shall be men sent over, hoping by that time to master all on this side of Severn. And in what I may I shall ever most readily obey your Highness' commands, and remain, Sir,

"Your Highness' most affectionately
devoted Servant,

"ED. HERBERT.

"Raglan Castle,

"This Tuesday morning, 7th Feb. 1643."

A contemporary, a clergyman,²⁹ has preserved an interesting account of Lord Herbert's operations before

¹⁰⁰ Warburton.

²⁹ Corbet.

Monmouth, on the 1st of April, 1643. Sir William Waller having accepted the invitation of a number of resident gentlemen, when he came near the town of Monmouth, where Lord Herbert had begun to place a garrison, his presence occasioned the precipitate flight of his Lordship's troops. But Waller, although so far victorious, failed in obtaining needful supplies, owing to the devotion of the stream of the people, most of whom were the Marquis's tenantry.

Lord Herbert afterwards united with Sir John Winter, the reputed plague of the Forest of Dean, who had strongly fortified and defended his own residence; he was, too, considered a most active enemy, as well as a chief agent of the popish faction. His Lordship's horse so materially assisted Sir John's operations as to compel the rebels to quit the forest, having made a passage over the Severn, at Newnham.

Soon after this affair, rumours were current that forces were expected from Oxford for Paineswick and Stroud, while the Irish it was believed were to lie on one side of Berkeley, Lord Herbert and Sir John Winter holding the Forest. The same chronicler assures us that the taking of Monmouth gave a fearful alarm to the whole country, the Marquis of Worcester calling in Prince Rupert's horse to their assistance. The result of these preparations was that Sir William Blaxton, with his brigade of horse, joined the country train-bands, with the forces from Raglan and Chepstow, making together about 500 horse and 1200 foot. They fell upon the enemy's horse quarters, where were lodged two troops and ten musketeers; while 150 musketeers speedily came from Monmouth to their assistance. With these and further supplies of foot the Monmouth party routed the cavaliers, of whom many were slain and threescore taken prisoners.

Sir John Winter, despairing of longer subsistence, at length deserted the Forest, after first firing his house at Lidney, and somewhat revenging himself for past disasters by spoiling the Forest itself.²⁹

In June, Charles I. addressed the following letter* to the harassed Marquis of Worcester, conveying promises as usual, after a personal interview with his son:—

“ WORCESTER,

“ I am very sensible of the miseries and dangers which of late you have been in, and do hope the time will come when I shall be able to requite all my good subjects, and none sooner than you; concerning the changing of your title, and other particulars, I leave to your son’s relation, who knows my mind therein, who will ever remain

“ Your most assured constant friend,

“ CHARLES R.”

“ Oxford, 19th, June, 1643.

“ For the Marquis of Worcester.”

Lady Harley, writing on the 13th of June, 1643, observes:—“ My Lord Herbert and Colonel Vavasour, who is to be Governor of Hereford, is gone up into Montgomeryshire to raise soldiers.”⁴⁶

On the 25th of July, 1643, Lord Herbert, having sent a dispatch to Prince Rupert,† in which he found he had omitted some important particulars, afterwards transmitted the same day by letter, dated from Raglan Castle, to the following effect:

“ MAY IT PLEASE YOUR HIGHNESS,

“ Since my dispatch to you this morning there occurs one thing which I then omitted, which I

²⁹ Corbet.

* From MSS. Badminton.

⁴⁶ Harley.

† “ Rupert’s correspondence, No 18,980, vol i.’ Brit. Mus.

thought fit to represent to your Highness; that some Parliament ships now lie in and about Milford Haven, which hath hitherunto so far countenanced the county of Pembroke, that they (dissenting from all Wales besides) have only showed themselves refractory to his Majesty's commands; and could your Highness so dispose, that some of the ships late come in might speedily (before notice be given them there of their professing themselves for the King) surprise them, or draw them to their allegiance that county would be soon reduced to its due obedience, which otherwise by land will not without much difficulty and loss be done. One other thing I likewise forgot in my last; that in case your Highness became master of the city of Bristol, and the castle holding out, your Highness should need pioneers, for undermining the same, which (the situation considered) will easily be effected, upon notice from your Highness I shall procure some of the forest miners, who being very expert at those works shall speedily attend your pleasure. I wish all fortunate success in all your attempts as becomes your Highness'

“Most obedient and humble servant,

“LD. HERBERT.*

“Ragland Castle, 25th July.

“After 10 of the clock in the morning.”

Lord Herbert (probably immediately after the defeat at Gloucester) raised a regiment of foot and ten troops of cavalry, offering, however, according to Sir William Vavasour, to act only under the command of Prince Rupert or the King: the former writes:—†

“Whereas the Right Honourable Henry Marquis of Worcester hath by his care and expenses long saved

* The letter is in a clerk's writing; the autograph in a different ink.

† From MSS. Badminton.

the town and county of Monmouth from the hands of the enemies, and of late regained the said town from them; and in regard likewise that the towns of Monmouth and Chepstow are belonging to him of inheritance, and the interest he hath in the whole county, my desire is, that the Commander-in-chief of the said county and the Governors of both or each of those towns, or of any other garrison within the said county, should be complying with or observing any desires of his, intimated unto them: either concerning his Majesty's service, the good of that county, or the particular safety and interest of him and his (whereof I am very tender). As also the High Sheriff, Commissioners of Array, Justices of the Peace, or other officers of the said county, martial or civil (as they tender my pleasure), and will answer the contrary at their perils. And for their so doing, the sight of these, or a copy hereof, attested by that Right Honourable Henry Marquis of Worcester, shall be their and either of their warrant. Given under my hand at Oxford, the 5th day of January, in the twentieth year of his Majesty's reign.

“RUPERT.” *

The accounts we have of Lord Herbert's military operations are extremely meagre; in a patent hereafter to be noticed, the sieges and battles at which he was present are briefly announced; with what courage and successful conduct he took Goodrich Castle, the Forest of Dean, and the city of Hereford; indeed with what remarkable good fortune, with what unhopèd-for success, he made himself master of the strongly fortified town of Monmouth.

* Endorsed in the same hand—"Prince Rupert, his Warrant." And endorsed by a private hand,—“Prince Rupert's Warrant to the Marquis of Worcester, Oxford, January 5. 1644.”

The achievements, as thus recorded, are sufficiently high sounding, but no contemporary historian seems to have considered them of sufficient importance to put on record. Neither his own letters, nor those of his numerous family and connexions, neither political nor religious partizans nor opponents give us a glimpse of our general's skill, bravery, and final successes; while the few particulars actually recorded leave but a faint impression as regards facts, and a most unfavourable one as regards results. In short, in his military capacity he bears a most mythical character.

We have his own statement* that, through the means supplied by his father and himself, the Marquis of Hertford, after his defeat in the West, was supplied with recruits to attend his Majesty at Oxford, at a cost of £8000. They also raised Sir John Byron's regiment of horse, at an expense of £5000.

He further expressly alludes to having rendered his Majesty's army considerable service before Edge-hill, by the men he furnished. And he was likewise at the charge, if not personally engaged in the reducing of Abergavenny and Carlyon to the service of the Crown.

His own troop of Life Guards, consisted of one hundred and twenty noblemen and gentlemen, whose estates amounted to above sixty thousand pounds per annum, most of whom he supplied with arms and horses. This troop he acknowledges to have raised without consulting his father, who reproving him said: "The consequence would be that the love and power he had in the country would be perspicuous, although he should have thanks from the King, yet others, though his Majesty's well-wishers, through envy, would hate him for it." His Lordship adds:—"which I confess I have found too true, my services having been more

* See Chapter XIX. giving the entire statement.

retarded by those who called themselves the King's friends, than obstructed by his enemies."

It is certain that Lord Herbert acquired no military celebrity. He was bold, determined, and energetic when acting on the defensive, but he was not remarkable for any adventurous or brilliant aggressive successes. His troops were formidable in number, well paid, and abundantly supplied with every requisite; but in all his reputed sieges, in all his encounters with the foe, we seek in vain for any return of the slain, the wounded, the prisoners taken, the disasters surmounted and inflicted, and the splendid store of spoil acquired. The red hand and unpitiful slaughter of war are only shadowed forth to us like shapeless forms, creations of the imagination rather than even faint pictures of reality. His Lordship's naturally studious habits would seem to have incapacitated him from entering ardently into the wanton destruction of human life and the infliction of severe injuries on multitudes, regarded by him more as deluded neighbours than cruel adversaries. Above forty years having passed over his head in the experience only of plenteous, peaceful times, and scholarly pursuits, he was no longer like the pliant sapling, but partook more of the stability of the sturdy oak. In perfect agreement with his own noble and generous spirit, he no doubt expected, as he desired, an early and complete compromise of the political differences which were then spreading their baleful contagion over the land.

Nevertheless, it is rather remarkable that operations on so extensive a scale, prosecuted at a large cost by a single family, should have obtained comparatively so little renown in the annals of the civil war: among which we search in vain for details characterising the martial deeds of Edward Somerset, Lord Herbert of Raglan.

CHAPTER VI.

LORD HERBERT CREATED EARL OF GLAMORGAN.
IRISH AFFAIRS.

ALTHOUGH many successes had early attended the Royalists' arms, the chances of war in 1643 were interminably perplexing to all parties. The royal cause was becoming desperate, and the King, never over-scrupulous, then endeavoured to obtain speedy assistance at all hazards. After taking the sacrament at Oxford, in sacred repudiation of employing papists, yet was he privately urging his generals to engage all who would serve. The fact of the Marquis of Worcester being of the proscribed religion was no obstacle to his maintaining correspondence with him, personally communicating with his son, and constantly draining their fortunes and other resources.

The impoverished monarch was at least liberal in promises and niggardly in fulfilling even those referring to mere dignities in acknowledgment of immense services, so long as farther demands might thereby possibly be the better secured; such was his insincerity in all social relations, and such his intriguing policy in all his acts of sovereign power.

At home the battle of Edge-hill had just been fought, and in Ireland a rebellion had to be suppressed, and troops to be raised to swell the royal army. The King must have been much confounded how best to conciliate friends and enemies, protestants and papists, until he could fearlessly assert his claims in accordance with his own construction of regal rights.

In the early part of the year 1644, the King conferred on Lord Herbert, during his father's lifetime, the dignity of Earl of Glamorgan. "But," says Sir Harris Nicolas,* "great doubt exists whether the patent ever passed the great seal." And Mr. Nichols states that, on reference to the original Docquet Book of grants made by the King at Oxford, commencing in December 1642, and ending in June 1646, nothing of the kind occurs among the numerous grants of Dignities there recorded.⁷⁴ Yet the title was constantly employed by Charles the First in his several letters and commissions, and later in a message to the Houses of Parliament; and the following is a copy of the PATENT he privily granted to his Lordship on the 1st April, 1644.¹³

"Charles, by the Grace of God, King of England, Scotland, France, and Ireland, defender of the faith, &c. to our right trusty and right well-beloved cousin, Edward Somerset, alias Plantagenet, Lord Herbert, Baron Beaufort of Caldicote, Grismond, Chepstow, Ragland, and Gower, Earl of Glamorgan, son and heir apparent of our entirely beloved cousin, Henry Earl and Marquis of Worcester, greeting. Having had good and long experience of your prowess, prudence, and fidelity, do make choice, and by these nominate and appoint you, our right trusty and right well-beloved cousin, Edward Somerset, &c. to be our Generalissimo of three armies, English, Irish, and foreign, and Admiral of a fleet at sea, with power to recommend your lieutenant-general for our approbation, leaving all other officers to your own election and denomination, and accordingly to receive their commission from you; willing and commanding them, and every of them, you

* Synopsis of the Peerage.

⁷⁴ Nichols.

¹³ Birch and others.

to obey, as their general, and you to receive immediate orders from ourself only. And lest through distance of place we may be misinformed, we will and command you to reply unto us, if any of our orders should thwart or hinder any of your designs for our service. And there being necessarily great sums of money to the carrying on so chargeable an employment, which we have not to furnish you withal; we do by these empower you to contract with any of our loving subjects of England, Ireland, and dominion of Wales, for wardships, customs, woods, or any our rights and prerogatives; we by these obliging ourselves, our heirs and successors, to confirm and make good the same accordingly. And for persons of generosity, for whom titles of honour are most desirable, we have intrusted you with several patents under our Great Seal of England, from a Marquis to a Baronet; which we give you full power and authority to date and dispose of, without knowing our further pleasure, so great is our trust and confidence in you, as that, whatsoever you do contract for or promise, we will make good the same accordingly, from the date of this our commission forwards; which for the better satisfaction, we give you leave to give them, or any of them, copies thereof, attested under our hand and seal of arms. And for your encouragement, and in token of our gratitude, we give and allow you henceforward such fees, titles, preheminences, and privileges, as do and may belong unto your place and command above-mentioned, with promise of our dear daughter Elizabeth to your son Plantagenet, in marriage, with three hundred thousand pounds in dower or portion, most part whereof we acknowledge spent and disbursed by your father and you in our service; and the title of Duke of Somerset to you and your heirs male for ever; and

from henceforward to give the Garter to your arms, and at your pleasure to put on the George and blue ribbon. And for your greater honour, and in testimony of our reality, we have with our own hand affixed our Great Seal of England unto these our Commissions and letters, making them patents.

“Witness ourself at Oxford, the first day of April, in the 20th year of our reign, and the year of our Lord, One thousand six hundred and forty-four.”

Under any ordinary circumstances there would appear to be no possibility of obscurity respecting this title, and that any should exist only occasions the more surprise, when considered in reference to a family so eminently in favour with Charles the First. But the subtle Monarch might have his own reasons for favouring any source of possible remote obscurity, until assurance of the Earl of Glamorgan's success in his new enterprise should embolden him to make his title clear; for it has been well observed of him, that he was not only a most unscrupulous but a most unlucky dissembler.⁶⁷

This much disputed title is, however, acknowledged by Charles the Second in a royal warrant, bearing date the 6th of April, 1661, as one, he is informed, “settled by our Royal Father, of blessed memory.”⁷⁴

His Majesty gave the Earl the following instructions:*

“*Oxford, this 2nd of January, 1644. Several heads whereupon you our right trusty and right well-beloved Cousin Edward Earl of Glamorgan may securely proceed in execution of our commands.*”

⁶⁷ Macaulay.

⁷⁴ Nichols.

* From MSS. Badminton.

“First, you may engage your estate, interest and credit, that we will most really and punctually perform any our promises to the Irish, and as it is necessary to conclude a peace suddenly, whatsoever shall be consented unto by our Lieutenant the Marquis of Ormond, We will die a thousand deaths rather than disannul or break it; and if upon necessity anything be to be condescended unto, and yet the Lord Marquis not willing to be seen therein, or not fit for us at the present publicly to own, do you endeavour to supply the same.

“If for the encouragement of the Lord Marquis of Ormond you see it needful to have the Garter sent him, or any further favour demonstrated from us unto him, we will cause the same to be performed.

“If for the advantage of our service you see fit to promise any titles, even to the titles of Earls in either of our kingdoms, upon notice from you we will cause the same to be performed.

“For the maintenance of our army under your commands, we are graciously pleased to allow the delinquents’ estates where you overcome to be disposed by you, as also any our revenues in the said places, customs or other, our profits, woods, and the like, with the contributions.

“Whatever towns or places of importance you shall think fit to possess, you shall place commanders and governors therein at your pleasure.

“Whatever order we shall send you (which you are only to obey) we give you leave to impart the same to your council at war, and if they and you approve not thereof, we give you leave to reply; and so far shall we be from taking it as a disobedience, that we command the same.

“At your return we will accept of some officers

upon your recommendation, to the end no obstacle or delay may be in the execution of your desires in order to our service, and our commands in that behalf.

“At your return you shall have the command of South Wales, Herefordshire, and Gloucestershire of the Welsh side returned to you in as ample manner as before.

“In your absence we will not give credit or countenance to anything which may be prejudicial to your father, you, or yours.

“C. R.”

Next month his Majesty wrote the following letter:*

“GLAMORGAN,

“I herewith send you the rest of my dispatches for Ireland, whither I pray hasten, time being most considerable. I am sensible of the dangers you will undergo, and the great trouble and expenses you must be at, not being able to assist you, who have already spent a million of crowns [£250,000] in my service; neither can I say more than I well remember to have spoke and written to you that already words could not express your merits, nor my gratitude: and that next to my wife and children I was most bound to take care of you, whereof I have, besides others, particularly assured your Cousin Byron, as a person dear unto you.

“What I can further think at this point is to send you the Blue Ribbon, and a Warrant for the Title of Duke of Somerset, both which accept, and make use of at your discretion; and if you should defer the publishing of either for a while to avoid envy, and my

* From MSS. Badminton.

being importuned by others, yet I promise your antiquity for the one, and your Patent for the other shall bear date with the Warrants.

“ And rest assured, if God should cross me with your miscarrying, I will treat your son as my own, and that you labour for a dear friend as well as a thankful master, when time shall afford means to acknowledge, how much I am

“ Your most assured, real, constant

“ and thankful friend,

“ CHARLES R.

“ Oxford, Feb. 12th, 1644.”

The Earl being from some cause detained at home, his Majesty wrote in March, as follows:—*

“ HERBERT,

“ I wonder, you are not yet gone for Ireland ; but since you have stayed all this time, I hope these will overtake you, whereby you will the more see the great trust and confidence I repose in your integrity, of which I have had so long and so good experience ; commanding you to deal with all ingenuity and freedom with our Lieutenant of Ireland the Marquis of Ormond, and on the word of a King and a Christian I will make good anything, which our Lieutenant shall be induced unto upon your persuasion ; and if you find it fitting, you may privately show him these, which I intend not as obligatory to him, but to myself ; and for both your encouragements and warrantise, in whom I repose my chiefest hopes, not having in all my kingdoms two such subjects ; whose endeavours joining, I am confident to be soon drawn out of the mire, I am now

* From MSS. Badminton.

enforced to wallow in; and then shall I show my thankfulness to you both; and as you have never failed me, so shall I never fail you, but in all things show how much I am . . .

“Oxford the 12th of March, 1644.”

The newly created Earl of Glamorgan was now just entering on what afterwards proved to be the most perilous period of his life. He no doubt felt the weighty importance of the duties he was undertaking, and one cannot help imagining that it was under a lively impression of the possible change in his fortune, which, whether for good or for evil, it was past human wisdom to divine, that he addressed the following most reverential letter to his honoured father, in August, 1644.*

“MAY IT PLEASE YOUR LORDSHIP,

“Amongst other memorable expressions which have taken deep root in my heart, I assure your Lordship, that those you were pleased to use towards me on Sunday last, shall never be defaced out of my memory; for you were pleased so to interlace terror and comfort, as that I knew not whether joy or fear possessed me most, or whether you showed more justice or clemency; but at last a tender fatherly affection appeared to steer your words and deeds which shall be, God willing, answered with a filial duty and tenderness, and your unparalleled goodness shall not, with God Almighty’s grace, undo, but strengthen me in my duty to God and your Lordship, with as much zeal and true-hearted devotion as can be witnessed, with the uttermost endeavours of thought, word, and deed, lying in the power and uttermost abilities which I can at any time attain

* From MSS. Badminton.

unto, whose ambition is not greater to anything in this world than really and entirely to appear, my Lord,

“Your Lordship’s most dutifully obedient son,
“and most devoted servant,

A handwritten signature in cursive script, reading "E. Herbert". The signature is written in dark ink on a light background. The letters are fluid and connected, with a prominent loop at the end of the word.

“This 13th of August, 1644.”

His military career in Wales appears to have terminated late in 1644, at which time the Parliament having protested against the cessation made by the Marquis of Ormond with the Irish rebels, by the King’s express orders, his Majesty determined not only on a speedy peace in Ireland, but also on the raising of troops there to be sent over to England. Difficulties, however, arising consequent on the demands made by the Irish Roman Catholics, the King devised the expedient of engaging the services of the Earl of Glamorgan in that hazardous negotiation. Adopting his customary narrow policy, he planned and plotted alike with friends and foes. Ormond was to be flattered and deceived, next Glamorgan, and in succession all his ministers, council and court, yea, the very Parliament and the public were to be hood-winked by a master-stroke of double-dealing. Such a net-work of intrigue had he woven, before the least of his measures could be finally executed, that Charles the First’s course of conduct throughout this affair, has confounded early as well as later and most dispassionate politicians. That the

King was wavering and uncertain, at least in his decisions, is admitted by all, and it is very evident that expediency was with him a sufficient plea for the most perfidious treachery, without distinction of parties. He first wrote to the Marquis of Ormond that well-known letter, in which he says:²⁵

“ORMOND,

“My Lord Herbert having business of his own in Ireland (wherein I desire you to do him all lawful favour and furtherance), I have thought good to use the power I have, both in his affection and duty, to engage him in all possible ways to further the peace there; which he hath promised to do. Wherefore, as you find occasion, you may confidently use and trust him in this, or any other thing he shall propound to you for my service; there being none in whose honesty and zeal to my person and crown I have more confidence. So I rest,

“Your most assured constant friend,

“CHARLES R.

“Oxford, 27 Decemb. 1644.

* “His honesty or affection to my service will not deceive you; but I will not answer for his judgment.”

In this letter we detect the artful arrangement of its matter, making Lord Herbert's real mission secondary to some private business of his own, to the forwarding of which the wily monarch solicits the kind offices of his minister. Yet, secondary as was his mission apparently, he is much lauded for his “honesty and zeal” to the royal person and crown; while the same hand adds a postscript in cipher,—“but I will not answer for his *judgment*.”

²⁵ Carte, Birch and others.

* Several lines of numerals have been deciphered as here given.

Yet he was not so insufficient in “judgment,” but that the royal adept in deception could purpose his eventually superseding the Lord Lieutenant, whom he was thus cajoling meanwhile.

On the 12th of January, 1644, his Lordship received a Commission under the Great Seal from the King, empowering him to levy any number of men in Ireland and elsewhere, with other considerable powers, requiring for their exercise a man of no ordinary “judgment.” So that when the King wrote one thing, he meant another, for his acts reversed his own statement, and offer the best proofs of the want of truth, although he might consider himself obliged to adopt this shallow species of subterfuge, in such an emergency.

The Commission is as follows:—¹³

“CHARLES R.

“Whereas we have had sufficient and ample testimony of your approved wisdom and fidelity, so great is the confidence we repose in you, as that whatsoever you shall perform, as warranted under our sign-manual, pocket signet, or private mark, or even by word of mouth, without further ceremony, we do on the word of a King and a Christian, promise to make good to all intents and purposes, as effectually as if your authority from us had been under the Great Seal of England, with this advantage, that we shall esteem ourself the more obliged to you for your gallantry, in not standing upon such nice terms to do us service, which we shall, God willing, reward. And although you exceed what law can warrant, or any powers of ours reach unto, as not knowing what you have need of; yet it being for our service, we oblige ourself, not only to give you our pardon, but to maintain the same

¹³ Birch and others.

with all our might and power; and though either by accident, or by any other occasion, you shall deem it necessary to deposit any of our warrants, and so want them at your return, we faithfully promise to make them good at your return; and to supply anything wherein they shall be found defective, it not being convenient for us at this time to dispute upon them; for of what we have here set down you may rest confident, if there be faith and trust in men. Proceed, therefore, cheerfully, speedily, and boldly; and for your so doing this shall be your sufficient warrant.

“Given at our Court at Oxford under our sign-manual and private signet, this 12th of January, 1644.”

The Warrant his Lordship received from his Majesty, to treat and conclude with the Irish confederates, dated 12th of March, 1644, proceeds as follows:—¹³

“CHARLES R.

“Charles, by the grace of God, of England, Scotland, France, and Ireland, Defender of the Faith, &c., to our trusty and right well-beloved cousin, Edward Earl of Glamorgan, greeting. We, reposing great and especial trust and confidence in your approved wisdom and fidelity, do by these (as firmly as under our Great Seal, to all intents and purposes) authorise and give you power, to treat and conclude with the confederate Roman Catholics in our kingdom of Ireland, if upon necessity any be to be condescended unto, wherein our Lieutenant cannot so well be seen in, as not fit for us at present publicly to own. Therefore we charge you to proceed according to this our warrant, with all possible secrecy; and for whatsoever you shall engage yourself, upon such valuable considerations as

¹³ Birch and others.

you in your judgment shall deem fit, we promise on the word of a King and a Christian, to ratify and perform the same, that shall be granted by you, and under your hand and seal; the said confederate Catholics having by their supplies testified their zeal to our service. And this shall be in each particular to you a sufficient warrant.

“Given at our Court at Oxford, under our signet and royal signature, the 12th of March, in the twentieth year of our reign, 1644.”

It is generally asserted that the visit of the Earl of Glamorgan to Ireland was of a personal nature, having by his marriage become allied to some of the first Irish families; but no one can doubt that the important commission he had received from the monarch swayed all other considerations. He was then about 43 years of age. His royal master was profuse in the professions of the most sincere attachment to the person of his Lordship; his acts and words being such as were best calculated to ensnare an honourable man quite incapable of insincerity. But the King, after his own fashion, had sound reasons for his conduct; the Marquis of Worcester was still rich, and might continue his liberality; and, as belonging to the Roman Catholic faith, the son might promote his measures in Ireland. He only felt it necessary to flatter without serious meaning, and to promise without feeling the duty of performing, should expediency cause him to change his views.

To Ormond, however, from whom he was not seeking any favour, yet whose suspicion he desired not to awaken, the royal diplomatist made light of this visit to Ireland—“having business of his own” there; spoke sneeringly of the Earl—“I will not answer for his judgment;” and yet employed him on matters of

such vital importance for the success of his own measures, that we at once detect the sophistry of such language.

The Earl of Glamorgan, it would appear, went to Ireland at the end of 1644 or commencement of 1645, as his Majesty addressed the following letters to him in 1645;* the first in February:—

“HERBERT,

“I am confident that this honest trusty bearer will give you good satisfaction why I have not in every thing done as you desired, the want of confidence in you being so far from being the cause thereof that I am every day more and more confirmed in the trust that I have of you, for believe me it is not in the power of any to make you suffer in my opinion by ill offices, but of this and divers other things I have given so full instructions that I will say no more, but that I am

“Your most assured constant friend,

“CHARLES R.

“Oxford, 26th Feb. 1645.” †

The next in June following:—

“GLAMORGAN,

“I am glad to hear that you are gone to Ireland, and assure you that as myself is no wise disheartened by our late misfortune so neither this country; for I could not have expected more from them, than they have now freely undertaken, though I had come hither absolute victorious, which makes me hope well of the neighbouring Shires. So that (by the grace of God) I hope shortly to recover my late loss with advantage, if

* From MSS. Badminton.

† Birch, p. 359, gives the date 28 Feb. 1645.

such succours come to me from that kingdom which I have reason to expect, but the circumstance of time is that of the greatest consequence, being that which is chieffiest and earnestliest recommended you by

“ Your most assured, real constant friend,

“ CHARLES R.

“ Hereford, 23rd June, 1645.”

The Earl wrote the annexed letter to the Marquis of Ormond, dated from Kilkenny in February, 1645 :—*

“ MAY IT PLEASE YOUR EXCELLENCY,

“ I need not give you a relation of the public audience given to the Nuncio yesterday by the Assembly, nor of his addresses thereunto; all which (I am confident) will be at Dublin before this can have the happiness to arrive with your Excellency. Neither need I use many words to persuade your Lordship, that the expectance of a more advantageous peace, wrought by the powerful hand of her Majesty, soon wipes out the clandestine hopes of my endeavours to serve this nation, to which any professions of mine have never been other, and always in order to the King my master’s service, which my duty commands me ever to have before mine eyes. And my zeal unto that transports me beyond all other considerations. Neither was ever anything of vanity in me to be esteemed the person that should contribute to the satisfaction of this kingdom, which I have ever aimed more to do than to seem to do (as the private way of my proceedings may well testify for me). But the saying is, a burnt child dreads the fire; and, therefore, if I be contented to

* Bodleian Library, MS. Vol. “ Carte Papers, 1634-57, Ireland,” No. 159.

withdraw my hands from meddling with concessions, I conceive it is your Excellency's own dictamen, not only as you are so great a public Minister of State, but likewise as your Excellency is pleased in all things to express yourself my noble friend. And sure I am in all things you will find me a devoted servant unto you; and according unto the freedom that your Excellency is pleased to give me in order to his Majesty's service, I must needs deal so plainly with your Excellency, as to put you in mind how absolutely necessary it is not to disgust the Nuncio, since that the supplies out of this kingdom unto the King can be but men. And certainly, before I can put myself into a handsome posture to serve the King my master by sea and land, and in some kind to supply his Majesty's private purse, I think it will stand me in little less than £100,000, within three months; all which whence can I have it but out of Catholic countries; and how cold I shall find Catholics bent to this service, if the Pope be irritated, I humbly submit to your Excellency's better judgment. And here am I constrained, to your friends and mine here, absolutely to profess not to be capable to do the King that service which he expects at my hands, unless the Nuncio here be civilly complied with, and carried along with us in our proceedings. Besides (if there be understanding or reality in me), it is impossible to carry this nation, and make them do any notable service for the King my master, against the hair, and contrary to the Nuncio's satisfaction. And (pardon me to tell you) he is not a friend to your Excellency that will persuade to the contrary, knowing very well that you place your happiness and contentment in serving his Majesty and this kingdom, as far as any great and public Minister of State and real Protestant can attain unto. According to which conditions I confess

it is not fit for your Excellency to appear in it yourself; but if you please to interest myself and some others of your chief assured friends and servants here (even with whom your Excellency must give me leave to vie in reality and zeal to serve you), to deal with the Nuncio, I am most confident in a few days (if not in a few hours), we shall bring him so far to comply in order to his Majesty's service, as may give your Excellency satisfaction. And for the present I alone have dealt with him so efficaciously, as that he hath not only given his consent and approbation for the 3000 men to go for Chester (for the transporting whereof I shall find shipping sufficient ready); and if that will not serve, he means to-morrow or the next day to make it his absolute business. And I beseech your Excellency to take what I have said here into your serious and speedy consideration, as proceeding from me, who am not only transported with zeal to the King my master's service herein, but also to manifest myself how much I am

“Your Excellency's, &c.

“GLAMORGAN.

“Kilkenny, the 8th of February, 1645.”

To which the Marquis replied from Dublin Castle on the 11th of February:—²⁵

“I hope the supplies your Lordship labours for with so much diligence will yet come seasonably for the relief of Chester, notwithstanding the rumours raised here of the taking of it; but of this and the rest of the 10,000 men I can say no more than I lately have done, in a letter commended to Mr. Browne's conveyance.”

²⁵ Carte. vol. vi. p. 353.

And in a letter of the 26th of March, he observes:—

“By intercepted letters of the 16th (Feb.) of this month out of the North, I find it confirmed that Chester held out, and was not delivered on the second, as was confidently written hither out of North Wales by some that desired it should not be relieved; but it will infallibly be lost if the succours be not speedily sent.”

And also writes desiring to be informed when the shipping and men will be in readiness.

Again the Earl addressed the Lord Lieutenant on the 24th:—*

“MAY IT PLEASE YOUR EXCELLENCY,

“I am now setting foot in stirrup for Waterford, having made an embargo of all the shipping there, at Wexford, and all other places of that coast, towards the exportation of six thousand men, and have likewise sent an express to St. Ives and Falmouth for shipping, either to convoy or to help to transport these men. And if your Excellency please to inform yourself what may be done to forward this business out of Dublin, I shall not fail to see performed any agreement your Excellency shall make, whose zeal to the service I know to be such as that it were vanity in me to recommend it unto you. I will, therefore, only desire to know your Excellency's pleasure as soon as may be, and as it is my part, so it is my affection always to obey you, and ever to remain,

“Your Excellency's, &c.

“GLAMORGAN.

“Kilkenny, the 24th Feb. 1645.”

* Bod. Lib. MS. Vol. “Carte Papers, 1634-1657, Ireland, 63,” Nos. 160 and 161.

These letters seem at variance with the statement made by Dr. Birch and others, that "the Earl left Oxford, in March, 1644-5, in company with Sir Brian O'Neile and some Romish Priests, and went to Wales;"*²² unless we suppose he went to Ireland in December or January, and returned to England sometime in February or March, which, although not impossible, yet was a matter not so easily accomplished in those times and under existing circumstances.

It is possible, however, that his own private, and the urgency of public affairs, might induce his setting out early to arrange the one, and to settle preliminaries in the other; for this latter purpose he would certainly require his commissions of the 6th and 12th of January, 1644-5.

Then in March, 1644-5, being returned from Ireland, he waits on his Majesty at Oxford, and receives from him his Warrant of the 12th of March, and on the 1st of April his extraordinary and ever-memorable patent; than which nothing could possibly show more convincingly his Majesty's surpassing confidence in the newly-created Earl, and his determination to "answer for his judgment."

But this last favour had to be sent to him, as we find from his instructions to Edward Bosdon, accompanied by a letter to his Majesty, dated the 21st of March, 1644.

We are here enabled to clear up a mystery which has hitherto hung over this portion of his personal history, through a very humble source, fortunately preserved in the Letter Book of Sir William Brereton, now in the British Museum, wherein is the copy of a letter from John Bythell, apparently the commander of

* Birch's Inquiry, p. 56.

²² Carte.

the "Peter," bound for Dublin. The circumstance is too interesting to epitomise, and might suffer in graphic description by any attempt to curtail its minute particulars intended to interest his father and family.

From this document we learn that the party left Carnarvon for Dublin on the 25th of March, 1645:—

* "John Bythell his letter to his father Rich: Bythell, in Wyre hall. Wherein the much admired Providence of God is to be observed in commanding the seas, &c.

"Loving Father and Mother,—

"My duty remembered unto you, and my love to my brother Peter and my sister. These are to certify you that I am in health, but am very sorry that I have such an occasion as this to write to you of. But I pray you be not dismayed nor discouraged, for I trust that that God that hath preserved me from my childhood, and brought me into these troubles, will in his good time deliver me from them again. For when I went into a place into Wales, called Carnarvon, with a small barque laden with corn, intending to go for Dublin, which [where] it was my fortune to stay some six weeks for a wind; in the interim there came some great men from Oxford, and pressed the barque for the King's service to carry them to Dublin, and said if I did deny they would throw my corn overboard; and they being of that power forced the barque to go out with them. There was the Lord Herbert, and the Lord John Somerset, the Lord Herbert's brother,

* Additional Manuscripts, Brit. Museum, 11,331, Plut. CLXXIII. E, 3 vols. folio. Lettered—"Letter-Book of Sir W. Brereton, 1645." 3 vols. folio. Vol. I. (old page, 13; pencil page, 15.) Indexed—"From John Bythell to his father Richard Bythell in Wyrehall, wherein the providence of God, in commanding the seas, is observable."

and many knights and colonels and captains, all being strangers to me. But as it seemed, and so it fell out, God was not pleased to grant them a passage, for we left Carnarvon upon the 25th day of March, being our Ladyday, with a very fair wind, although north-east, and as fair a day as possibly could be. But when we came over the bar of Carnarvon the wind began to calm, and to come to the south and south-east. And when we had not sailed past three or four leagues, but the wind came to the south-west, and began to blow very hard about two or three of the clock in the next morning, so that we could not possibly get the Holyhead; and it increased more and more still, insomuch that when we came to the Skerries the storm grew to that [remorselessness?] that the barque had much ado to recover for being swallowed up in those great waves. But when we had passed the Skerries the wind grew greater and greater, and with much ado we recovered the shore with the [ship], but could not possibly gain any harbour, but were driven to the main sea. And seeing the danger we were now in, the passengers threw over some of my corn and cheese, so we lay on the sea Tuesday and Wednesday; and on Thursday we could not gain any land but in the North of England, at a place called Pillen; there we came to anchor on Thursday about five of the clock in the afternoon. But Lord Herbert would not go on shore, nor suffer any that was in the barque to land before him. But on the Friday the storm increased more and more, insomuch that no man did expect life, but every man prepared himself for death. But God (out of his great mercy) was pleased to spare our lives for that time most miraculously; for about ten of the clock in the morning, about one hour before full sea, the barque not being able to ride, we were forced to cast our main-

mast overboard, and presently after cut both her cables, and committed ourselves to God's mercy. But it pleased God we run on a part of the sand called Cockram Sand, near to Pillen, but she struck many times before she came near any shore; but at the last we recovered shore, but had neither anchor nor cable to hold her, so she did [lie] all a-dry, and as soon as she did ebb a-dry all the great men went away that were papists, and are got to some garrison under the king's command. But one Mr. Nutterfield and his wife, and one Mr. Argent and his daughter, and one Mr. Collour and his wife, and myself, went to Pillen with some few men more, to comfort ourselves with the fire and to refresh ourselves. And the next morning being Saturday, Mr. Collour and one Mr. Hambleton and myself hired horses from Pillen to go to the governor of that place to make him acquainted with our landing. His name is Colonel George Doddinge, and when we came to him and told him our cause, he said he could not do any less than commit us to Lancaster, where now I am, at a very good place, one Capt. Rippendshoupe's. The Colonel was pleased to remove me out of the Castle to his house, a very good place, where I am well used; but it has pleased the Colonel to seize on all my corn, and to take it from me, so that I cannot tell what course to take; for all our names are sent up to the Parliament, and the Colonel cannot release any till he receives an answer, how we must be disposed of. The best course that you can take to have me released will be to make some friends to Sir Wm. Brereton and Colonel More, and to procure their answer to Colonel Doddinge, and to inform him where I lived, and that I never took up any arms on either side, but have lived in Ireland this ten years. And so I hope that will be answer to procure my en-

largement, for here I am a stranger, and am not known by anybody, so I desire this truly may be certified, and by the hands of Sir Wm. Brereton and Colonel More ; and I hope that will give satisfaction. I desire my brother Peter to use his best endeavour herein for my liberty, and to come to see me. The Colonel hath granted Mr. Collour and me the favour [and me *sic*] to send to his friends, being at Namptwich, and the same messing [messenger?] to come down from thence to you with my letter for fear [if] ours were sent before [they] should miscarry, so we sent letters by the Colonel's directions to Namptwich from hence on Wednesday, being the first of April ; my letters were inclosed in Mr. Collour's letters, and he desired his father-in-law, Lieut.-Col. Jones, Sir Wm. Brereton, Lieut. Coa, that as soon as his letters came to his hands, to send my letters down to you. But for fear these should miscarry, we have sent the bearer to you with this letter. I had all my money taken from me, therefore I pray you to make shift to procure me four or five pounds, for I have not a penny but what I do borrow. I pray you to send a shirt and two or three bands, for I have none left me. I hope my brother Peter will not fail to come and to bring these things along with him, that I have written for ; so desiring you to remember my love to all our friends, especially to Mr. Glegg and Mrs. Gregg, to Capt. Edw. and Capt. John Glegg, and to Capt. Robert, and to Mr. Wm. and Mrs. Elizabeth and Miss Jones, and all the rest ; so desiring a happy meeting, I rest,

“ Your loving and obedient son, till death,

“ JO. BYTHELL.

“ Lancaster, 6 April, 1645.

“ I pray you give the bearer hereof, Mary Goadfine, 2s and 6d, and make much of her. But let her make what haste she can back again to me.”

We have next:—

“A list of their names that were aboard the ‘Peter,’ bound for Dublin and distressed by storms, and cast upon the coast of Lancashire, and [who] afterwards escaped to Skipton Castle.”

(The name of the Prisoners taken at Lancaster, 1st April, 1645.)

The Earl of Glamorgan, the Lord Herbert.

The Lord John his brother.

Sir Brian, uncle of Sir Francis Edmonds.

Sir Charles Hayward, the Duke of Norfolk’s grand-child.

Lieut. Vivian Mouelex, a man who was very decrepid.

Col. Cave, Col. Mitchell (Irish).

Mr. F. Flemmia, a Lancashire man.

Captain Mulbrian, Captain Bacon.

Mr. Peters, the Lord Peters’ brother, Mr. Poynes.

Mr. Hutton, Col. Pristoe, Captain Butler.

“Some two or three more whose names are not known to any passenger, but they were men of ordinary quality.

“The Protestants that are now prisoners at Lancaster, and went of their own voluntary will, and not taken by force, and hired horses.

“Mr. Collham, Mr. Jones, James Hambleton, Jo. Bythell, Mr. Rob. Noterfield, his wife and children and three servants; not siding with the papists, Mr. Argent a gentleman, his daughter, and Boyes, and his maid; Mr. Barker, Mr. Floyde, a minister.

“Two of the Lord Herbert’s men who were taken in their escape after their Lordship; two poor sailors.”

* From additional MSS. Brit. Museum, 11,338—3. “Letter Book of Sir W. Brereton, 1645.” 3 vols. folio, Vol. 1, page 69.

Mr. Carte, in his Life of the Duke of Ormond,²² and Dr. Birch,¹⁹ following the same authority, assert that—"The Earl of Glamorgan, having embarked on board a small vessel, was near being taken by a Parliament ship, which pursued him till he took refuge in a port of Cumberland." This, however, must refer to his second, and not to his first, attempt to set sail from Wales.

We can now understand the occasion of delay previously unaccounted for; thus, Dr. Birch, after informing us through Mr. Trevor's letter of the 9th of April, 1645,* that the Earl has actually "gone into Ireland," proceeds in the next page to quote a passage from Lord Digby's letter, dated Dublin, 8th of May, 1645:—"Though I have no full knowledge of what Lord Herbert was to bring with him; yet by his letter to me out of Wales, I guess his *missing this place* (Dublin) was a great misfortune to the King's service, even in relation to the credit I found the Irish were apt to give to his services and undertakings; and therefore if he be where he can *get once more to the water's edge, and will venture over*, I am very confident the little frigate I now send to stay the return of the bearer, will land him in some safe port of Ireland."

In consequence of this arrangement he at length arrived at Dublin about the end of July or beginning of August,²² 1645, being a space of about six months from the time of his leaving Oxford.

An incident with which the Earl of Glamorgan was connected occurred during his stay in Wales, affords an amusing episode illustrating the prevailing superstition of the age, against which his Lordship was by no

²² Carte.

¹⁹ Birch.

* Birch's Inquiry, p. 58.

means proof. Dr. Bayly states that: "The Earl, accompanied by officers, knights, and gentlemen of high rank, all of the red letter, as they were in their journey for Ireland, quartered in the town of Carnarvon, a sea-port in North Wales, where they were entertained with discourse at their table by some of the gentlemen of the country, who informed them of the fulfilling of an old Welsh prophecy, at that very time and place." The legend related to the building of nests in the crown on the head of King Edward I., over the gate of Carnarvon Castle, and was interpreted as significant of the times. "Dinner being ended, they all went to the castle gate." Thereon the Earl of Glamorgan "commanded the nest to be pulled down, which was done accordingly; and being thrown down, they found the materials of the nest to be such, as wherewith never any bird did build her nest, viz. with white thorn, which, for a memorandum or rarity, every one of them stuck a thorn in his hat-band, and wore it."⁷

But we must now, however, revert to Raglan Castle, to keep in view what had been passing there in the interim.

⁷ Bayly, Ap. XIX.

CHAPTER VII.

RAGLAN CASTLE—ROYAL VISITS.

WHILE the Earl of Glamorgan was zealously prosecuting Charles the First's designs in Ireland, he had left his Countess under his father's protection at Raglan Castle. At the commencement of this period the noble Marquis would be in about the 63rd year of his age, rather feeble, and a martyr to gout, which his fondness for claret may have aggravated; a pleasant story being related by his chaplain, that on the physician recommending abstinence from his favourite beverage, he declared that he would rather incur the attacks of his old enemy than abandon his favourite claret.⁷

Between the years 1640 and 1641 Raglan Castle had been strongly garrisoned, when much activity was evinced in providing and securing stores, arms, and the munitions of war. It must, therefore, have worn a very animated and impressive appearance, occupied as it was by hundreds of soldiers, with a large number of war-horses. The exercising of the troops would most likely take place daily in the extensive paved or pitched court, under full view of the drawing-room windows, a spacious upper apartment, ranging behind the hexagonal towers of the grand entrance, all of which remain to this day.

A contemporary writer⁹³ states that in the hall win-

⁷ Bayly.

⁹³ Symonds.

dows of this princely castle might be seen the ancient arms:—Argent, a lion rampant, sable, within a garter. Thomas Lord Morley, died 1416; and an old carving on the outside walls, representing three lions rampant, impaling, a fess, in chief three martlets.

In the adjoining village of Raglan the old parish church of St. Cadocus had its large pedestal sun-dial perfect, its yew-tree flourishing, and its burial-ground hedged in with trees. Within the sacred edifice, the Worcester chapel possessed its funeral ornaments in varieties of fine marble, sculptured with artistic skill. Against the north wall was the statue of an armed knight, in parliamentary robes, decorated with the Garter, in memory of William Somerset, who died 21st of March, 1589, aged 61 years. Another fair monument consisted of two statues, male and female, under an arch between the chancel and this chapel; he in parliamentary robes, garter, badge, *sans gloire*, an earl's crown, and the privy-seal purse. Edward Somerset died 1627-8.⁹³

Dr. Bayly, in his capacity of chaplain to the then Marquis of Worcester, appears to have resided in the Castle from 1643 to 1646. His collection of the Marquis's sayings and family anecdotes, under the title of "Apophthegms," includes some antecedent matters related on the authority of others. He expressly remarks:—"I have lived in Raglan Castle three years, and in all that time I never saw a man drunk, nor heard an oath amongst any of all his servants; neither did I ever see a better ordered family."

He describes from hearsay, in his usual gossiping strain, the ceremony of a mock wedding, which was conducted as a kind of masque at the Castle some

⁹³ Symonds.

years previously, on the occasion of the marriage of the Marquis's fourth daughter Elizabeth to Francis Brown, Viscount Montagu, the particulars of which graphically illustrate the domestic manners and customs prevailing in those times, affording also a fair example of the Marquis's own peculiar humour, and further offering a scene in which there can be little doubt that the then Lord Herbert fully participated: for he would scarcely have absented himself on so important an occasion as that of his sister's marriage.

Dr. Bayly expresses himself as not being sure whether the mock ceremony happened on the occasion of Lord Herbert's marriage, or on that of his fourth sister Elizabeth.²³ However, it seems that no sooner had the marriage party been seated at the feast provided for the occasion, than, as the chaplain states, "Tom Deputy, an old bachelor, chanced to cast his eye upon a pretty piece of waiting woman, one of the appurtenances of this honourable bride. He, this jovial Tom, having whetted his wits by the sides of the marriage bowl, fixes upon her, being enabled sufficiently thereby to follow any humour, as a fit subject to make their lordships some sport; which happened to be so suitable to the occasion and so well performed, that it soon captivated the ears also." Tom, being informed he may have the lady for asking, makes that request of the fair bride, remarking, "I protest I will marry her, and fancy myself to be a lord, and herself a lady. *My mind to me a kingdom is*, which shall make her a sufficient jointure."

"Tom, Tom," said the Marquis, "such men as you and I, whose joints are enfeebled with the strokes of many years, must not think to win young maids, by promising to make them jointures of the mind,

²³ Bayly, Ap. XX.

but will you make her Deputy of Deputy Hall? and landlady of all the land that is belonging to it? and mistress of all the stock that is upon the land, and goods that are within the house, and then you shall hear what my daughter* and her waiting woman will say unto you."

"With all my heart," said Tom, "and all the hogs and poultry that are about the house to boot, and she shall lie upon six feather-beds the first night."

Matters being arranged after some jocular preliminary promises, Tom telling the bride that they were agreed, the lady drank to him, he promising to marry her after dinner; the only difficulty appearing to arise from the want of wedding clothes. The Marquis, willing to remove that obstacle, told Tom that he thought his clothes would fit him, and bid him go into his wardrobe, and take what he had a mind to.

"Give me your key," said Tom; and receiving it, went up, and equipped himself with the Marquis's beaver hat, satin cloak laid with plush, daubed with a gold and silver lace, suit of the same, silk-stockings, with roses and garters suitable, inside and outside, cap-a-pie, all as brave as if he carried a lordship on his back.

"The lady bride takes her woman aside, and dresses her in one of her richest and newest gowns, with all things answerable thereto, not without some store of slight jewels, and brings her down as glorious as the morn that breaks from the eastern hill, and chases night away.

"Tom acted this scene of mirth in the Hall, which proved to be a thing of that convenience, as if it had been an act of some set policy to keep the crowd out of

* Elizabeth, his fourth daughter.

the parlour, that the Masquers might have room enough to dance in. At last, when the Masque was ended, and Time had brought in supper, the Cushion led the dance out of the Parlour into the Hall,* and saluted the old new-made bridgroom and his lady, leading them into the parlour to a table which was furnished with the same allowance that was allotted for all the nobles; where they were soon forced to sit down," and were bountifully served.

"Supper being ended, the Marquis of Worcester asked the Lady, his daughter, if she had a hundred pounds about her. No, my Lord, she answered, but I can send for as much. I pray do, said the Marquis, but it must be all in gold. She sent for it accordingly, presenting it to her father, who pulled out another purse of a hundred pieces; and put the two hundred pieces in the basin, saying—'Madam, if you do not give earnest, Deputy will tell you in the morning, that he married your woman but in jest.' Whereupon some gave fifty, others forty, some twenty, others ten, the least gave five pieces, who sat at the table, in all seven hundred pounds; the apparel and other gifts amounting to no less value than one thousand pounds, which so transported the old man, that he protested, that now he was in the humour, he would marry all the waiting gentlewomen they had; one every day in the week, as long as the wedding lasted."

Thomas, however, was at that period of the entertainment overcome with the potent effects of the good wine of which he had freely partaken. The Marquis, desirous of making the practical experiment of trying whether Thomas could be persuaded that the past was all a dream; had him carried to his old lodging in the

* The Banqueting Hall. See plan, preceding Chapter I.

Porter's Lodge, and disrobed of his fine clothes, which was done accordingly. Next morning the experiment realized all their expectations; and the Marquis, after many good exhortations to both parties, delivered unto them the money that had been collected.

During the troubles preceding the civil war, a circumstance occurred at the castle which establishes the early attachment of the Earl of Glamorgan to scientific and mechanical pursuits, whilst it affords tolerably conclusive proof of his having actually constructed the identical invention which has immortalized his name.

Dr. Bayly informs us, to quote his own words, that "At the beginning of this Parliament (Nov. 1640), there were certain rustics who came into Raglan Castle to search for arms, his Lordship being a Papist." The Marquis met them at the castle gate, desiring to know whether they came to take away his money, seeing they intended to disarm him. They stated that they made the application merely in consequence of his being a recusant. To which he replied, "he was a peer of the realm, and no convict recusant, therefore the law could not in reason take notice of any such things." Finding some sharp and dubious expressions coming from the Marquis, they were at last willing to take his word; but he, not wishing to part with them on such easy terms, had before resolved to return them one fright for another. With that view he conveyed them up and down the castle, until at length he "brought them over a high bridge that arched over the moat, that was between the castle and the great tower,* wherein the Lord Herbert had newly contrived certain water-works, which, when the several engines and wheels were to be

* The Citadel, or Yellow tower of Gwent. The bridge crossing the moat was a gothic arched bridge, terminating with a drawbridge, leading direct from the tower to the bridge. See Plan of the Castle, preceding Chapter I.

set a-going, much quantity of water, through the hollow conveyances of the aqueducts, was to be let down from the top of the high tower; which, upon the first entrance of these wonderful asinegoes, the Marquis had given order that these cataracts should begin to fall, which made such a fearful and hideous noise, by reason of the hollowness of the tower, and neighbouring echoes of the castle, and the waters that were between, and round about, that there was such a roaring as if the mouth of hell had been wide open, and all the devils conjured up, occasioning the poor silly men to stand so amazed, as if they had been half dead; and yet they saw nothing. At last, as the plot was laid, up came a man staring and running, crying out, *Look to yourselves, my masters, for the lions are got loose.* Whereupon the searchers tumbled so over one another escaping down the stairs, that it was thought one half of them would break their necks, never looking behind them until out of sight of the castle.”²³

It was probably not long after the commencement of the civil war that the occurrence we have next to notice happened at the castle, affecting the then Lord Herbert, which is related by the family chronicler in his 48th Apophthegm thus:—“My Lord Herbert of Raglan (eldest son of the Marquis) came into Raglan Castle, attended with 40 or 50 officers and commanders; and his business with his father being about procuring from the old man more money for the King, the Lord Herbert in his request unto his father (unhappily and unawares) chanced to use the word *must*; which his father (the Marquis) laying hold on, asked him, *Must you? I pray take it*; and threw him the keys of his treasury, out of his pocket; whereat his son was wonderfully out of

²³ Bayly, Ap. LI.

countenance, and abashed (being otherwise ever a dutiful and respectful son to his father) replied: 'Sir, the word was out before I was aware, I do not intend to put it in force; I pray will you put up your key again?'

"To which the Marquis returned his son these words. 'Truly, son, I shall think my keys not safe in my pocket, whilst you have so many swords by your side; nor that I have the command of my house whilst you have so many officers in it; nor that I am at my own disposal, whilst you have so many commanders.'

"My Lord (replied the son), I do not intend that they shall stay in the castle, I mean they shall be gone.

"I pray let them (said the Marquis), and have care that *must* do not stay behind.

"Whereat, after my Lord Herbert was gone out of the room, there were some who, as mannerly as they could, blamed the Marquis for his too much severity to his son, after that he had seen him express so much of sorrow for that over-slip; whereupon the Marquis replied:—'Hark ye, if my son be dejected, I can raise him when I please; but it is a question, if he should once take a head, whether I could bring him lower when I list. Ned was not wont to use such courtship to me, and I believe he intended a better word for his father; but *must* was for the King.'"²³

In August, 1644, Charles the First wrote to the Marquis, in the following gracious and flattering terms:*

"WORCESTER,

"I am sensible of the great affection which you and your son have expressed unto me, by eminent services, and of the means he may have of doing me more in that way wherein he is now engaging himself,

²³ Bayly, Ap. XLVIII

* From MSS. Badminton.

that I cannot choose, before his going, but express unto you, in a very particular manner, the value I have of you both, and to assure you, that if God bless me, I will not be behind-hand with either of you. In the meantime, finding your son so much more desirous that there should be placed upon you some mark of my favour, rather than upon himself, I have thought fit to let you know that as soon as I shall confer the Order of the Garter upon any, you shall receive it as a testimony of my being,

“Your assured constant friend,

“CHARLES R.

“Liskeard, Aug. 2nd, 1644.”

And again, the same month, he further assured and promised him as follows:—*

“WORCESTER,

“Yours and your son’s daily endeavours to serve me, makes me think which way to give you assurance of my gracious acceptance. And, therefore, as a further testimony, I have sent you this enclosed, only known to him and me, and fit, for several reasons of importance to you and me, to be kept private, until I shall esteem the time convenient, when, as God shall enable me, I will show my tender care of you and yours; as, by a match propounded for your grandchild, you will easily judge; the particulars I leave to your son, Glamorgan his relation, which I have commanded him to make to you only; and you may be confident that I so much esteem your merits, and your upholding your son in my service (wherein no subject I have equals either of you), as that I cannot think anything

* From MSS. Badminton.

too much that lies in my power ; though, as yet, some considerations hinder me from doing all I would towards you and yours. But, by your son's endeavours, I make no question but in short time to pass them so over, as that I shall make good the intentions I have, to manifest that I esteem your services such as my words cannot express them ; nor I, but by showing myself at all occasions, and in all things to be,

“ Your assured friend,

“ CHARLES R.

“For the Marquis of Worcester.”

Which communication conveyed the following enclosure, prepared some time previously.*

“ CHARLES R.

“ Our will and pleasure is, that you prepare a bill for our signature, for creating our right trusty and entirely-beloved cousin, Henry, Marquis of Worcester, Duke of Somerset, to him and the heirs male of his body issuing, with all the privileges and immunities thereunto belonging, and with a grant of an annuity of fifty pounds yearly, to be paid to him and them, out of our customs of Swansea, in our county of Glamorgan, for the support of the said dignity, for which this shall be your sufficient warrant. Given at our Court in Oxford, the sixth day of January, in the twentieth year of our reign.

“ To our Attorney or Solicitor-General
“ for the time being.”

After the fatal battle of Naseby, 14th June, 1645, the position of Charles the First becoming desperate, he early sought the repose and security afforded by Raglan Castle, with the equally or more important pur-

* From MSS. Badminton.

pose of stimulating a further drain on the fast diminishing resources of its munificent proprietor. It will be requisite to relate some particulars in reference to these royal visits from their connection with this memoir, incidentally proving the position and prospects of the Earl of Glamorgan; while they account for much of both his father's and his own misplaced confidence in the fickle monarch and false friend, whose obligations to the aged Marquis of Worcester and his noble minded son were equally of personal as well as political importance to him, during the many mischances of his career at that most critical period of his reign.

On Thursday, the 3rd of July, 1645, late in the afternoon, Charles the First arrived at Raglan Castle, where he was received with all possible state and ceremony. We are informed that:—When the King first entered the castle, the Marquis having kissed the King's hand, on rising, he saluted his Majesty with the compliment—*Domine non sum dignus*. The King replied:—"My Lord, I may very well answer you again; I have not found so great faith in Israel; for no man would trust me with so much money as you have done." To which the Marquis rejoined:—"I hope your Majesty will prove a defender of the faith."²³ He was entertained to supper on the occasion, remaining at the castle until Wednesday, the 16th of the same month, when his Majesty left to proceed to Cardiff.

From a Warrant issued on the 5th of July, 1645, we learn the losses sustained by and the situation of the Earl of Glamorgan's regiment of horse. It is a manuscript in the Harleian Collection, as follows:—*

"Whereas the Earl of Glamorgan's regiment of horse being over at least 200, is now by reason of continual

²³ Bayly, Ap. VIII.

* Mus. Brit. Bibl. Harl. 6852. Plut. LXIV. F.

duty, 2 troops taken from it, and 60 : (*sic*) more lost in fight, much weaker, therefore it is desired that the remainder of this horse may be by order secured in Colonel Lingen's regiment; till such time the rest of the money by the said Earl, appointed for the raising of his regiment, may be received."

On Friday, the 18th of July, his Majesty returning to the Castle dined there, continuing his visit until the 22nd, when he set out for a place called The Creek. In the evening, however, he had supper at the Castle, and remained there until Thursday, the 24th. He purposed going to Bristol, but apprehending the approach of the Scots, on arriving at The Creek, he went thence to Newport, Cardiff, Radnor, and Ludlow Castle. After a lapse of six weeks, his Majesty, on Sunday, the 7th of September, paid his third visit to Raglan Castle in time to partake of supper. He staid until Monday, the 15th of September,* when he took a final leave of his bountiful host. During this last visit his Majesty appears, on different occasions, to have gone to Abergavenny on the 8th and 11th, attended with his guards.⁵⁶

Much misapprehension prevails respecting these royal visits, which it is clear were made on three distinct occasions, his Majesty staying the first time thirteen days, on the second six days, and on the last eight days.

A singular instance of the Marquis's freedom in addressing the King occurs in the following statement made by his chaplain:—²³

"The Marquis had a mind to tell the King as handsomely as he could, of some of his (as he thought) faults; and thus he contrived his plot against the time that his Majesty was wont to give his Lordship a visit,

* Symonds in his Diary states that, on "Sunday, 14th [Sep.], About noon his Majesty left Raglan, and marched to Monmouth; thence that night to Hereford.'

⁵⁶ Somers' Tracts,—Iter Carolinum.

²³ Bayly, Ap. XIV.

as commonly he used to do, after dinner. His Lordship had the book of John Gower* lying before him on the table; the King, casting his eye upon the book, told the Marquis that he had never seen it before.

“Oh,” said the Marquis, “it is a book of books, which if your Majesty had been well versed in, it would have made you a King of Kings.”

“Why so, my Lord?” said the King.

“Why,” said the Marquis, “here is set down how Aristotle brought up and instructed Alexander the Great in all his rudiments, and the principles belonging to a prince.”

“And under the persons of Alexander and Aristotle, he read the King such a lesson, that all the standers by were amazed at his boldness; and the King, supposing that he had gone further than his text would have given him leave, asked the Marquis whether he had his lesson by heart, or whether he spoke out of the book.

“Sir,” the Marquis replied, “if you could read my heart, it may be you might find it there; or if your Majesty please to get it by heart, I will lend you my book.”

“Which latter proffer the King accepted, and did borrow it.

“Nay,” said the Marquis, “I will lend it you upon these conditions: 1. That you read it; and 2. That you make use of it.”

“But perceiving how some of the new made Lords fretted and bit their thumbs at certain passages in the Marquis’s discourse, he thought a little to please his Majesty, though he displeased them, the men who were so much displeased already, protesting unto his Majesty

* Gower, the poet.

that no man was so much for the absolute power of a King as Aristotle. Desiring the book out of the King's hand, he told the King he would show him one remarkable passage to that purpose; turning to that place that had this verse, viz. :—

“ A king can kill, a king can save,
A king can make a lord a knave,
And of a knave, a lord also, &c.”

“ Whereupon there were divers new-made Lords who slunk out of the room, which the King observing, told the Marquis—

“ My Lord, at this rate you will drive away all my nobility.”

“ I protest unto your Majesty,” the Marquis replied, “ I am as new a made lord as any of them all, but I was never called knave and rogue so much in all my life, as I have been since I received this last honour; and why should they not bear their shares ?”

An incident is related as occurring during one of the entertainments given to the royal visitor, which is too characteristic to be omitted. A dessert of Welsh grown fruit having been provided, had to be presented to the King. Sir Thomas Somerset, the Marquis's brother, living at Troy House, five miles from Raglan, delighted much in fine gardens and orchards, ordering and replenishing them with all the varieties of choicest fruits. He sent his brother a present of fair, ripe fruit, which the Marquis could not suffer to be presented to the King by any other hands than his own, the particulars of which are circumstantially detailed by Dr. Bayly, who was very likely an eye-witness. He says:—“ In comes the Marquis to the King, at the latter end of the supper, led by the arm, having such a goodly presence with him, that his being led became him, rather like some ceremony of state, than show of impotence; and

his slow pace, occasioned by his infirmity, expressed a Spanish gravity rather than feebleness. Thus, with a silver dish in each hand filled with rarities, and a little basket upon his arm, as a supply in case his Majesty should be over-bountiful of his favours to the ladies that were standers by." Making his third obeisance, he, in his own peculiar mode of pleasantry, presenting the fruit, observed: "I assure your Majesty that this present came from Troy."

The royal reply was no less witty. The King, smiling, said, "Truly, my Lord, I have heard that corn now grows where Troy town stood, but I never thought there had grown any apricots there before." ²³

During his stay at Raglan the King made the tour of neighbouring towns. At the Castle he was sumptuously entertained; the apartment he occupied is still marked by its fine large remaining window, and its proximity to the picture gallery; also the Pleasaunce or Bowling-green, where he sought amusement and exercise.

It was most likely about or soon after the King's last visit that the next circumstance occurred we shall have to record affecting the Earl of Glamorgan, which is related as follows by Dr. Bayly:—²³

"My Lord Herbert, after that he had sufficiently exhausted his father, by all the means he could possibly use, for his Majesty's relief, and had taken up all his father's moneys far and near, where he could either prevail with force or argument, he chanced to hear of a sum of money to the value of £6000, which the Marquis had committed to the Lord John (his son), his care and trusty preservation abroad. This money my Lord Herbert happened to hear of, and acquaints the King therewith, engaging the King in the business, and tells

²³ Bayly, Ap. IX. and Ap. XLIX.

the King, that if he would send for his brother the Lord John, to come unto him, and would say but thus and thus unto him, that he would undertake he might have the £6000. The King's occasions were then urgent (being then before Gloucester, and hard pinched for lack of money); through my Lord Herbert's persuasion, my Lord John was sent for, came, and the business took effect; the King promising to repay it by such a time. When time and suspicion persuaded the Marquis to call in his money, excuses made delays for a time, but at last all excuses being set apart, by importunity, the Marquis wished his son John to go and fetch the money, or else never to see his face any more; part of which injunction the Lord John performed, but never the other. Not long after the Lord Herbert coming to his father, his father received him with wonted, but unexpected, cheerfulness. It so happened that my Lord Herbert began to excuse himself unto his father, concerning this business; on whom the father bestowed this language:—"Son, I pray save yourself the labour, for I do not blame you at all, neither am I angry with you; for I never trusted you with the money. I love no man the worse for following his profession; and you have made it your profession (all along) to deceive your father, to help the King; but I do not love a man that will take away another man's profession from him, and deceive his own father of his money, and his brother of his calling.'"

In 1650, the chronicler of this anecdote dedicated his book to the subject of it, in the following strain:—"The many favours which I received from your noble family, especially from your Lordship, wrought upon a disposition, some-deal a pretender unto gratitude, how it might, in some measure or other, answer the respect and clear the heart, that had lain charged so long with

benefits." Such expressions seem to qualify the sense in which the affair just related should be taken, coming as it does from no unfriendly hand, and certainly could never have been indited in the way of serious censure on the prevailing character of Lord Herbert. While we cannot omit relating so striking a family incident, it evidently should not be too rigidly construed, when the recorder of it dedicates the recital to Lord Herbert himself at a future day, without offering any apology for introducing a narrative, which, to modern ears, reads exceedingly harsh and offensive; but it is clear that the Sub-Dean of Wells, never contemplated any unfavourable construction, relying probably on the generally well known character of his Lordship at the time of publication.

CHAPTER VIII.

THE EARL OF GLAMORGAN'S SECOND VISIT TO IRELAND.

THE Earl of Glamorgan, actuated by private claims and public business visited Ireland early in 1645, as already stated. Returning to England he again set out for Ireland in March of the same year, but being defeated in his intentions, he had to delay his departure until some months later, arriving at length in Dublin either in July or August.

The Marquis of Ormond had been fully apprized of his Lordship's mission through Charles the First's letter from Oxford, dated the 27th of December, 1644, as also by personal communications with his Lordship during his first visit. The powers granted by the Crown to the Earl of Glamorgan and the nature of his patent, dated 1st of April, 1644-5, are matters of history, so remarkable as to have been already made the subject of distinct treatises, and their peculiar features ably discussed by Dr. Birch and others.

The dates of his Lordship's several commissions and powers are:—I. On the 6th of January, 1644-5, a commission, of which a Latin translation is given in the Nuncio's Memoirs.* II. Another commission dated the 12th of January, 1644-5.† III. Another warrant dated the 12th of March, 1644-5. And IV. a patent granting him, as Earl of Glamorgan, most extensive and extraordinary powers, dated the 1st of April, 1644-5.

* Fol. 713. Also Carte, vol. i. p. 557.

† Nuncio's Mem. fol. 715 ; and Carte, vol. i. p. 554.

At this period the Marquis of Ormond addressed a letter to the Earl, as follows :—*

“ MY LORD,

“ Mr. O’Neill hath with him, to be delivered to the Commissioners that treated here, two kinds of dispatches, the one an answer to their paper of the 11th of November, which contains likewise conditional answers to the several requests made upon the propositions that were, for the most part, debated on in your Grace’s presence. This is drawn and sent with the full approbation of the Council ; the other contains some observations of mine, together with undertakings in some points wherein I held it unseasonable to press the Council to a concurrence, considering that, in the paper transmitted by their advice, there is a clear and full obligation, both upon them and me, to transmit as bills whatsoever his Majesty shall hereafter direct for the good of his subjects. In these two I have stretched my authority to the uttermost that, either with safety to the treaty or myself it will endure, which meeting with equal desires of accommodation there, I doubt not will produce the intended effects of seasonable succour to his Majesty ; and therein of safety to his kingdom. Having told your Grace that I am at the highest I will venture on in this great affair, I should beseech your Grace for accomplishment of those noble ends that induced you through so great and apparent dangers to undertake this your journey, now to set all your strength upon bringing it to a good (that is a speedy) conclusion ; but my experience of your judgment and indefatigable industry informs me that such a request is needless.

“ We have here reports (made I believe without ground of truth) of the manner of the Italian Bishop’s reception

* From MSS. Badminton.

at Kilkenny; but though I believe not all here said of his errand, yet I conceive your Grace may observe something, the knowledge whereof might direct me how to govern myself, in the account I take myself obliged to give his Majesty of the coming of so unbidden a guest into his kingdom.

“I have not yet had time to put your commands touching the parties mentioned in your last letter, received by Col. Fitzwilliams, into a way of execution; but I shall not fail to satisfy your Grace, either in doing the things or in giving such reasons why I could not, as shall still manifest my being

“Your Grace’s most faithful Kinsman,

“and humblest servant,

“ORMOND.

“Dub. Cast. 22 of Novem. 1645.”

This communication contains the Marquis’s remarkable expression of confidence in the Earl of Glamorgan, when he says—“my experience of your judgment and indefatigable industry.” Only that courtiers are as little to be put faith in as princes, one might take this as sufficient evidence of the King’s false estimate of his Lordship’s “judgment,” as expressed in his letter to the Marquis.*

His Lordship’s negotiations with the Irish related to the raising of a body of 10,000 men to be transported to England in the royal cause; their first destination being for the relief of Chester, which measure was to be promoted through certain arrangements to conclude a peace with the rebellious party in Ireland: to be mainly effected through important concessions being made to the Irish Roman Catholic Clergy, to afford extended religious liberty to their cause in Ireland.

It had been arranged that the political articles of

* See page 78.

peace, to be made with the Lord Lieutenant, should be published at once; but other articles, affecting the Roman Catholic religion, concluded with the Earl of Glamorgan, were meanwhile to be kept secret, until ratified by his Majesty himself. The Lord Lieutenant was disposed to act liberally; but the Earl of Glamorgan, from his political and religious bias, combined with his warm, enthusiastic disposition, was fully disposed to approve and support demands in which he saw no extravagance, but, on the contrary, anticipated much real benefit to his own party.

All his Lordship's negotiations, treaties, plans, promises, all his well laid schemes, and all the plottings of his party broke down through delays and repeated disasters, further promoted by the pertinacity with which the clergy held out to the last for the entire acceptance and complete settlement of their every demand; indeed the Nuncio went so far as to insist on the necessity of having a Roman Catholic Lord Lieutenant.

On the 24th of December, 1645, the Earl of Glamorgan went from Kilkenny to Dublin to confer with the Marquis of Ormond. On the 25th he was received by the Lord Lieutenant with the greatest possible civility, and every assurance of regard for his Lordship. But on the 27th, the whole course of events had changed, causing his Excellency to adopt a totally different line of conduct; an unexpected circumstance having meanwhile brought to light transactions of which he was not previously cognisant, which naturally aroused his worst suspicions, at so critical a period.

Dr. Birch has very lucidly narrated the particulars. The Popish Archbishop of Tuam, President of Connaught, and one of the Supreme Council at Kilkenny, going into Ulster to visit his diocese, and put into execution an order for arrears of his Bishopric, granted to

him by that Council, met with a body of Irish troops marching to besiege Sligo, and joined with them. When they came near that town, the garrison made a sally on the 17th of October, charged the troops, utterly routed them, killing the Archbishop of Tuam in the encounter; among whose baggage was found an authentic copy, attested and signed by several bishops, of the treaty concluded with them by the Earl of Glamorgan; together with an order from the Supreme Council for the arrears of his Archbishopric; a bull of the Pope; and several letters between the Archbishop and his agents at Rome, Paris, and other places.*

The result of these disclosures was, that when the Council was assembled at Dublin on the 26th of December, 1645, the Lord Digby came to the board, and charging the Earl with suspicion of high treason, moved that his person might be secured. This done, he proceeded to substantiate the charge on most irrefragable evidence; wherefore the Lord Lieutenant and Council gave a warrant for the commitment of the Earl to the custody of the Constable of Dublin Castle, in condition of a close prisoner.¹³

We have uninterruptedly, thus far, followed Lord Herbert, seen him created Earl of Glamorgan, and eventually engaged by Charles the First in an extraordinary and extra-official capacity in Ireland; where he was delegated by the King to act in certain matters intended to promote the royal cause. So secret and so unheard of was this mysterious affair, that it is without a parallel in history. A Protestant monarch and a Roman Catholic nobleman are the sole actors in this strange drama; a monarch whose crown was tottering to its fall consequent on successive losses, opposed to

* Husband's Collection, p. 787, &c. edit. London, 1646, fol. and Rushworth, Part IV. Vol. I. p. 239.

¹³ Birch, p. 94.

surprising successes continually accruing to his enemies ; for the battle fields of Edge-hill and of Naseby were alone sufficiently disheartening to have paralysed even a stouter heart ; yet he finds in addition that, to the surrender of Bristol, he may soon have to add that of the strong city of Chester. His immediate necessities, added to the increasing expenses of the long continued war, were rapidly impoverishing not only his nobles but the country. While his own and the public distress thus gradually lessened every prospect of success, one last ray of hope seemed to present itself to the unhappy monarch. There was still a chance of succour from Ireland, the acceptance of which, however, was fraught with many difficulties. The loyalty of the Irish, it was quite evident, could only be ensured by nothing short of conciliatory measures of a more than ordinary nature, especially if desired to bring over to his service ten thousand of his Irish subjects.

The King had written from Liskeard, in August, 1644, to the enfeebled Marquis of Worcester, respecting himself and his son, of “ the value I have of you both,” assuring him, “ that if God bless me, I will not be behindhand with either of you.”

The most ordinary delays pressed heavily on his Majesty, whose nerves seem to have been completely unstrung by successive misfortunes and the pitiable state of his entire kingdom. In June, 1645, he expressed himself to the Earl of Glamorgan, “ I am *glad* to hear that you are gone to Ireland ;” so keenly alive was he to the importance of the mission on which he had engaged him, and in one short sentence expresses the sincere trust of his heart, when he says—“ So that, by the grace of God, I hope shortly to recover my late loss with advantage, if such succours come to me from that kingdom, which I have reason to expect, *but* the

circumstance of *time* is that of the *greatest consequence*, being that which is *chiefliest and earnestliest* recommended you."

No one better knew than Charles the First himself, that he was incurring great risk, that he was adopting a bold, daring course, which success would scarcely palliate, which nothing but his own ideas of expediency could extenuate, and from the effects of which, at best, he could only hope to escape by artifice or by some strange amplification of his royal prerogative. Whatever might be the issue, the King well knew that the means he had taken would divide the opinions of all classes, and leave the final decision open to endless litigation. Such, indeed, has been the result even of its failure, but the success of the Earl's negotiations would have brought far more important interests to bear on the questions involved in such strange transactions, than has ever yet occupied the pens of historians or biographers.

The plan for realizing this last hopeful event appeared well arranged. The agent employed was unexceptionable, he was eminently loyal, he had laid his fortune in his royal master's lap, and zealously offered to do his bidding to the utmost of his power. The King was not wanting in condescension, affability and every gracious expression in the acknowledgment of the money and means raised by, and the energetic operations throughout, of the Earl of Glamorgan. He and his father were further each offered a dukedom; and a matrimonial alliance was to rivet their future connexion. But the King had his confidence in this singular mission strengthened materially by his intimate knowledge that both as being in accordance with his religious and political sympathies, the Earl was the most fitting instrument he could employ in so delicate an undertaking. In

what respect the Earl of Glamorgan acted inconsistently or over-zealously in this perilous affair does not appear; while, on the contrary, his wonderful tact, patient submission, and judgment throughout make his remarkable discretion in every act conspicuous.

The Earl of Glamorgan, on the 5th of January, 1645-6, was formally examined before the Lord Lieutenant and the Council of Ireland, a copy of which proceeding the Committee forwarded to Secretary Nicholas, the nature of which will be understood from the following copy of interrogations put to him, with his replies annexed:—*

1. “Did your Lordship enter into Articles of Agreement with the Rt. Hon. Richard Lord Viscount Mountgarret, Donogh Lord Viscount Muskerry, Alexander McDonnell, and Nicholas Plunkett, Esq.; Sir Robert Talbott, Bart; Dermott O’Bryen, John Dillon, Patrick Darcy and Geffry Browne, Esqs., for and on the behalf of his Majesty’s Roman Catholic subjects, and the Catholic Clergy of Ireland, or with any of them, and with which of them in the month of August last, or at any time since your Lordship’s coming into Ireland, for or concerning any grants, or commissions, to be made on behalf of his Majesty, his heirs and successors, to his Roman Catholic subjects, or their clergy; or did your Lordship make any articles or agreement with any other person or persons, for or concerning any such grants or commissions?”

Earl of Glamorgan’s Answer. “That being at Kilkenny, he did before Michaelmas last (but knows not the exact time), enter into Articles of agreement with the Lord Viscount Mountgarret, and for and on the behalf, &c.; for and concerning certain grants or

* Bod. Lib. “Carte Papers, 1634-57, Ireland, 63.” No. 150.

concessions made on the behalf of his Majesty, &c.; and he did not make any Articles or agreements with any other person or persons for or concerning any such grants or concessions other than those in this his examination mentioned, for the matter of which he refers himself to the Articles; and that an oath of secrecy was taken by himself and the others to keep the said Articles secret, and conceives he hath done nothing but what he hath warrant for; and done without intention of prejudice to his Majesty's peace and service, or to the Protestant religion, all circumstances considered."

2. "Was there any counterpart of the said Articles delivered by the persons above named, or any of them, or by any other, unto your Lordship? And if so what have you done therewith? Who were the witnesses at the signing, sealing and delivering thereof; and where or in whose custody or keeping are the said Articles or counterpart? And were not John Somerset, Geffry Baron and Robert Barry present at the signing, sealing, and delivering of the said Articles, and subscribed their names?"

Answer. "That there was a counterpart to deliver to him, and it remains among his things at Kilkenny or Bonretty; he remembers not all witnesses, but refers to the counterpart, only he remembers Geffry Baron (who was entrusted to write the Articles), signed as a witness, and so did Lord John Somerset, whom he called to sign, but he did not read the Articles."

3. "What is the substance of the said Articles?"

Answer. "He refers to the Articles for the substance."

4. "Did your Lordship grant, conclude, and agree on the behalf of his Majesty, his heirs, and successors, to and with the persons in the first interrogatory named,

or any of them, or any others, that the Roman Catholic Clergy of the said kingdom should and might from thenceforth for ever hold and enjoy all, and every such lands, tenements, tithes, hereditaments whatsoever by them respectively enjoyed within this kingdom, or by them possessed at any time since the 23rd of October, 1641, and all other such lands, tenements, tithes, and hereditaments belonging to the Clergy within this kingdom, other than such as are now actually enjoyed by all his Majesty's Protestant Clergy; or did your Lordship make any grant, conclusion, or agreement to the like effect."

Answer. "He refers as before, but conceives the Articles are not obligatory to his Majesty (to which he afterwards desired might be added these words, *and yet without any just blemish of my honour, my honesty, or my conscience.*")

5. "Did the said Richard Lord Viscount Mountgarret and the rest of the persons above named, or any of them, or any others agree with your Lordship on the behalf of the Confederate Roman Catholics of Ireland, that two parts in three parts to be divided of all the said lands, tithes, and hereditaments whatsoever mentioned in the precedent question, shall for three years next ensuing the feast of Easter, which shall be A. D. 1646, be disposed of and converted for and to the use of his Majesty's forces, employed or to be employed in his service; and the other third part to the use of the said Clergy respectively; and so the like disposition to be renewed from three years to three years by the said Clergy during the wars? Or, did your Lordship make any agreement to that or the like effect?"

Answer. "Refers to the Counterpart."

6. "Did your Lordship agree for and in the behalf of his Majesty, his heirs and successors, that the Lord

Marquis of Ormond, Lord Lieutenant of Ireland, or any other or others authorised by his Majesty, should not disturb the professors of the Roman Catholic religion in their present possession and continuance of the possession of their churches, lands, tenements, tithes, and hereditaments, jurisdiction, or any other of the matters aforesaid, until his Majesty's pleasure were signified for confirming and publishing the said grants? Or, did your Lordship make any agreement to that or the like effect?"

Answer. "That (for aught he knows), he did not agree for, &c.; but saith that he promised to use his best endeavours therein with the Lord Lieutenant."

(And so on to the 15th Interrogatory.)

16. "Did your Lordship take an oath in these following words, viz.: I, Edward Earl of Glamorgan, do protest and swear faithfully to acquaint the King's most excellent Majesty, with the proceedings of this kingdom, &c."*

Answer. "He remembers something to this effect, but refers to original or copy, which he will produce."

The proceedings involved by this affair, the Earl's examination before the Council, the documents in evidence against him, his own counter-statements, the correspondence between parties, and especially Charles the First, who entirely repudiated and ignored the acts of his duped agent; together with the proceedings in Parliament, and opinions expressed there, with others published in the political tracts of those agitated times, have been handled by every eminent historian, and still afford abundant matter for dispute. Those who take up the cause of the King, censure the Earl of Glamorgan in most unmeasured terms: Hume assails his intel-

* See page 124.

lect, Carte charges him with forgery. While those who see in the whole transaction but another instance of the King's duplicity, of his contempt of every obligation (which a Christian feels bound to respect), so long as he fancies expediency offers him, in his high position, a sufficient excuse for the boldest tergiversation, exonerate the Earl from the charge of having acted on his own responsibility.

Indeed it requires a large amount of credulity to believe that any subject, much less a man of the mild and honourable tone characteristic of the Earl's whole conduct, could have acted as he did, otherwise than with a full and perfect previous understanding with his misguided sovereign, and empowered with sufficient proofs, if even legally insufficient instruments under his hand and seal to warrant his proceedings. That he had such powers is well authenticated, and that he did not abuse them is his highest merit. He did not coin money, or appropriate property, or commit any other extravagance, such as a man deficient in "judgment" possibly would have done, under the grant of similar powers.

We cannot be mistaken as advocates of his acts in the Irish affairs, by merely showing that those acts were in strict conformity with the injunctions of the Royal will; for so long as troops were required, no means were to be spared that were found absolutely requisite to gain the desired end. We rejoice that the warm-hearted Earl did *not* succeed, that all his negotiations failed, and that the exorbitant demands made on him destroyed the measures they were intended to render unbounded and permanent; at the same time, as a Roman Catholic, the Earl of Glamorgan acted honestly, consistently, and by no means extravagantly. The folly and blame and entire shame of the whole affair weighs heavily on the King's memory.

While the death of the Archbishop of Tuam in October, 1645, led to this exposure in Ireland, very different circumstances conveyed the intelligence to England.

Sir Thomas Fairfax, having some dragoons at Padstow in Cornwall, boarded a packet boat from Ireland, and seized Captain Allen, one of the passengers, who threw a parcel and some loose papers overboard; among those recovered were the Earl of Glamorgan's articles of agreement with the Confederate Irish Roman Catholics, and letters from himself. These were published by order of Parliament, the 17th of March, 1645-6⁴³: viz. "Articles of Agreement made and concluded between the Right Honourable Edward Earl of Glamorgan, in pursuance, and by virtue of his Majesty's authority under his signet and royal signature, bearing date at Oxon, the 12th day of March, in the 20th year of his reign, signed, sealed and delivered by the Earl, 25th August, 1645, in the presence of John Somerset, Jeffrey Browne, and Robert Barry."

To this document was appended his declaration as follows:—

"I, Edward Earl of Glamorgan, do protest and swear faithfully to acquaint the King's most excellent Majesty with the proceedings of this kingdom, in order to his service and in the endearment of this nation, and punctual performance of what I have (as authorized by his Majesty) obliged myself to see performed, and in default not to permit the army intrusted to my charge to adventure itself, or any considerable part thereof, until conditions from his Majesty, and by his Majesty, be performed.

"GLAMORGAN.

"Sep. 3. 1645."

⁴³ Glamorgan.

From the same source we have a letter addressed to Lord Culpepper, in which the Earl says:—

“MY LORD,

“Having overpassed many rubs and difficulties, the expected work is at last compassed, which by what means it was retarded, your Lordship, perhaps, before hath learned; and will be more faithfully and amply related by the bearer, Captain Bamber, whom I have employed to his Highness the Prince, to give an account of the state of affairs here, and in what a mist we are for want of intelligence, whereby we might be ascertained of the King’s and Prince’s condition, which one Allen, a merchant of Waterford, proposeth to undertake a course for. And — his Highness desire, which moved for 300 men for the Prince’s Life Guard, which the Irish party is willing should be sent him, by the return of such shipping as I have humbly desired from his Highness, might be sent hither to Waterford for to waft over the men, whereof six thousand are in readiness for the relief of Chester, which yet we hear holds out, and the other four thousand by the first of May are to follow. Your Lordship would extremely further the service by your representing to his Highness the necessity of a course of intelligence, that we might not [be] as we are now, buried in ignorance of his Majesty’s and the Prince’s being and condition: of which I hope your Lordship will vouchsafe me some light, that our motion may be according thereunto; by which likewise to be ascertained of your Lordship’s welfare and happiness would be most welcome news to,

“My Lord,

“Your Lordship’s most affectionate

“and humble servant,

“GLAMORGAN.

Also to Lord Hopton he wrote as follows:—

“ MY NOBLE LORD,

“ If the report of the many difficulties where-with I have struggled in compassing the designs of his Majesty’s service, have not before this reached you, a faithful relation of the whole will be made to you by the bearer hereof, Captain Allen, whom I desire your Lordship to present unto the Prince his Highness as an honest man, and one that proposeth a course of intelligence to pass between this country and his Majesty’s quarters, whereof there is great need. Now (God be thanked) the business is brought to that upshot, that the 10,000 men are designed for his Majesty’s service, 6000 whereof are ready for transportation; the means for which are wanting, unless your Lordship will please to solicit his Highness the Prince for transmitting what shipping those parts are furnished with, that all possible expedition may be used. We hear, God be thanked, that as yet Chester holds out, to relieve which the 6000 men are ready are transportation. This bearer hath intimated the Prince’s desire for having 300 men hence for his Highness’ Life-Guard, which may be transported to his Highness by the return of such shipping as shall be sent hither, for the aforesaid service. By his return I desire to learn from your Lordship, the King’s present state and being, that we may shape our designs accordingly. Thereby I should be most glad to know the Prince’s and your Lordship’s good success and prosperity, for which none can be more solicitous than I who am,

“ My Lord,

“ Your Lordship’s most affectionate

“ humble servant,

“ GLAMORGAN.

In the same publication appears Fairfax's communication to the Parliament, that he had given Captain Moulton of the Lyon, cruising on the Irish Seas, intimation of the enemy's intentions, which resulted in his capturing a barque from Dublin, taking her into Milford Haven, and seizing various letters intrusted to one of the passengers.

Among these are copies of a long undated letter from his Lordship to his Lady, the Countess of Glamorgan, then resident at Raglan Castle. He writes:—⁴³

“MY DEAR HEART,

“I hope these will prevent any news shall come unto you of me, since my commitment to the Castle of Dublin, to which I assure thee I went as cheerfully and as willingly as they could wish, whosoever they were by whose means it was procured; and should as unwillingly go forth, were the gates both of the Castle and Town open unto me, until I were cleared: as they are willing to make me unserviceable to the King, and lay me aside, who have procured for me this restraint; when I consider thee a Woman, as I think I know you are, I fear lest you should be apprehensive. But when I reflect that you are of the House of *Thomond*, and that you were once pleased to say these words unto me, That I should never, in tenderness of you, desist from doing, what in honour I was obliged to do, I grow confident, that in this you will now show your magnanimity, and by it the greatest testimony of affection, that you can possibly afford me; and am also confident, that you know me so well, that I need not tell you how clear I am, and void of fear, the only effect of a good conscience; and that I am guilty of nothing, that may testify one thought of disloyalty to his Majesty, or of what may stain the honour

⁴³ Glamorgan.

of the family I come of, or set a brand upon my future posterity. Courage (my heart), were I amongst the King's enemies you might fear; but being only amongst his friends and faithful subjects, you need doubt nothing, but that this cloud will be soon dissipated, by the sunshine of the King my Master; and did you but know how well and merry I am, you would be as little troubled as myself, who have nothing that can afflict me; but lest your apprehension might hurt you, especially since all the while I could get no opportunity of sending, nor yet by any certain probable means, but by my Cousin *Brereton's*, Master *Mannering's*, our Cousin *Constable* of the Castle, and my Lord Lieutenant's leave: and hope you and I shall live to acknowledge our obligations to them, there being nothing in this world that I desire more, than you should at least hear from me. And believe it (sweet heart), were I before the Parliament in *London*, I could justify both the King and myself in what I have done. And I pray acquaint my father, who I know so cautious, that he would hardly accept a letter from me, but yet I presume most humbly to ask his blessing, and as heartily as I send mine to pretty *Mall*; and I hope this day or to-morrow will set a period to my business, to the shame of those who have been occasioners of it. But I must needs say from my Lord Lieutenant, and the Privy Council here, I have received as much justice, nobleness, and favour, as I could possibly expect. The circumstances of these proceedings are too long to write unto you, but I am confident all will prove to my greater honour. And my Right Honourable accuser, my Lord *George Digby*, will be at last rectified and confirmed in the good¹ which he is pleased to say he ever had of me hitherto, as the greatest affliction that he ever had, did do what his conscience en-

forced him unto; and indeed did wrap up the bitter pill of the impeachment of suspicion of high treason in so good words, as that I swallowed it, with the greatest ease in the world, and it hath hitherto had no other operation than that it hath purged melancholy: for I was not at the present any way dismayed, so have I not since been any way at all disheartened. So I pray let not any of my friends that's there, believe anything, until ye have the perfect relation of it from myself. And this request I chiefly make unto you, to whom I remain a most faithful, and most passionately devoted husband and servant,

“GLAMORGAN.

“Remember my service to my brother, my cousin *Browne*, and the rest of my good friends.”

There is also a letter from her Ladyship's relative in Dublin, Mr. Roger Brereton, probably very near the same date, being the 5th of January, 1645-6.⁴³

“MADAM,

“I presume that some rumours of my Lord of Glamorgan's being confined in the Castle of Dublin for some matters laid to his charge by the Lord George Digby have before this time come to your Ladyship's hearing; I thought fit therefore by these few lines to let you know that my Lord is in perfect health, hearty and very cheerful, not doubting to give a satisfactory answer to what may be laid to his charge, I have so much confidence in your Ladyship's accustomed discretion, that I know there needs no dissuasive arguments to your Ladyship from either grieving or taking any reports you may receive to heart too much, not doubting but his Lordship will ere long see your Ladyship, when you may partake of all things more fully than

⁴³ Glamorgan.

may be by writing. My Lord your uncle is in health at Bunrally, and with him there the Earl of P. my Lord John and my Lady Honora. I wish your honour all health and happiness, and am,

“Your Ladyship’s still faithful servant

“and kinsman,

“ROGER BRERETON.”

Mr. Brereton likewise wrote, as follows, to Colonel Pigot:—

“WORTHY COUSIN,

“I have here enclosed sent two letters to the Countess of Glamorgan at Raglan, her Lord being lately confined here to the Castle of Dublin; and lest her Ladyship may take things too much to heart, these letters are sent to add some comfort. Both my Lord and I shall acknowledge our thankfulness unto you, if you be pleased to use the best and speediest course you may, for conveying them to my Lady. * * *

“Yours, &c,

“ROGER BRERETON.

“Dublin, January 5, 1645-6.”

The King in his message of the 29th of January, 1645-6, to Parliament, as Sir Thomas Fairfax and others believed, and as Vittorio Siri declares,—“thundered against the Earl in his Declaration only in appearance, that he might be thought not to have been privy to the obnoxious concessions made by the Earl in his Majesty’s name to the Irish Roman Catholics.”¹³

The next day the King addressed a *private* letter to the Lord Lieutenant, affording sufficient evidence of the shifts to which he had recourse to uphold his miserable policy, which no experience of ensuing hazards and vexations could induce him to abandon.

¹³ Birch. p. 121, and p. 124-5.

“ORMOND,^{13 25}

“I cannot but add to my long letter, that, upon the word of a Christian, I never intended Glamorgan should treat anything without your approbation, much less without your knowledge. For besides the injury to you, I was always diffident of his judgment (though I could not think him so extremely weak) as now to my cost I have found, which you may easily perceive by the postscript in a letter of mine to you,† that he should have delivered you at his coming into Ireland, which if you have not had, the reason of it will be worth the knowing; for which I have commanded Digby’s service, desiring you to assist him. And albeit I have too just cause, for the clearing of my honour, to command (as I have done) to prosecute Glamorgan in a legal way; yet I will have you suspend the execution of any sentence against him, until you inform me fully of all the proceedings. For I believe it was his misguided zeal, more than any malice, which brought this great misfortune on him and on us all. For your part, you have in this, as in all other actions, given me such satisfaction, that I mean otherwise, more than by words, to express my estimation of you. So I rest

“Your most assured,

“constant, real friend,

“CHARLES R.

“Jan. 30, 1645-6.”

On the 31st of January, 1645, Secretary Nicholas wrote to the Lord Lieutenant and Council of Ireland, as follows:—^{13 25}

“MY LORDS,

“His Majesty having, with the Lords of the Privy Council here, heard and duly weighed your

¹³ Birch, p. 121, and p. 124-5.

† See page 78.

²⁵ Carte, vol. ii. Append. No. xxiii. p. 12.

²⁵ Carte, vol. iii. No. 426, p. 446.

Lordship's [letter] to me of the 5th present, concerning your prudent and grave proceedings, in the business of the Lord Edward Herbert of Raglan, so highly importing his Majesty, hath commanded me to send your Lordships his royal thanks, as well for your affectionate expressions of your tenderness of his honour, as your just resentment, how scandalous and disadvantageous such the said Lord Herbert's proceedings might have been to his Majesty's affairs and service here, and on that side, if the wise course your Lordships have taken to vindicate his Majesty, had been deferred. Your Lordships will, by the King's own letter herewith sent, receive the particulars of all, that his Majesty can call to mind or imagine he may have done or said to the Lord Herbert in that business. And since the Warrant, whereby his Lordship pretends to be authorised to treat with the Roman Catholics there, is not sealed with the signet, as it mentions, nor attested by either of his Majesty's Secretaries, as it ought, nor written in the style that Warrants of that nature used to be; neither refers to any instructions at all; your Lordships cannot but judge it to be, at least, surreptitiously gotten, if not worse; for his Majesty saith, he remembers it not. And as the Warrant is a very strange one, so hath been also the execution of it. For it is manifest, the Lord Herbert did not acquaint the Lord Lieutenant with any part of it, before he concluded with the said Roman Catholics, nor ever advertised his Majesty, the Lord Lieutenant, or any of the Council here or there, what he had done in an affair of so great moment and consequence four months before, till it was discovered by accident. This doth not sound like good meaning; and I am sure is not fair dealing. But his Majesty having, by his letter to your Lordships, left the charge against the Lord Herbert, to be prosecuted by your Lordships, I shall say no more of that unhappy subject."

To the Lord Lieutenant he wrote the same day another and separate letter, viz.—²⁵ ¹³

“We are all here much amazed at the news of the Lord Herbert’s imprudent action (to say no more of it) which hath most extremely prejudiced his Majesty and his affairs here. Your Excellency, and the Council there, will herewith receive a full and particular relation from his Majesty, of all that he can call to mind concerning that business, wherein as the Lord Herbert hath dealt very unworthily with his Majesty, so it is believed, that even the Roman Catholics themselves will condemn him for his imprudent proceeding therein. For if his pretended Warrant had been authentic, yet to do anything thereupon without your Excellency’s privity, was a madness, rather than a folly; and the concealing so long what he had done argues something worse. The King hath commanded me to advertise your Lordship, that the patent for making the said Lord Herbert of Raglan Earl of Glamorgan is not passed the Great Seal here, so as he is no Peer of this kingdom; notwithstanding he styles himself, and hath treated with the rebels in Ireland, by the name of Earl of Glamorgan, which is as vainly taken upon him, as his pretended Warrant (if any such be) was surreptitiously gotten. And I am sure, that honour cannot be conferred upon him under the signet (as firmly as under the Great Seal, to all intents and purposes) as his Lordship’s pretended warrant and power is alleged to be, though there be no signet to it.”

In a letter from the King dated Oxford, March 22nd, 1645-6, addressed to the Queen while in France, he says:—¹⁶

“DEAR HEART,

* * * “I find that Sir Edw. Nicholas his gloss upon

²⁵ Carte, vol. iii. p. 447.

¹³ Birch, p. 133.

¹⁶ Bruce.

Lord Glamorgan's business hath made thee apprehend that I had disavowed my hand, but I assure thee I am very free from that in the understandings of all men here, for it is taken for granted the Lord Glamorgan neither counterfeited my hand, nor that I have blamed him more than for not following his instructions, as Secretary Nicholas will more at large show thee."

On the 3rd of February, 1645, the King addressed the Earl himself, by his title, which we have just seen disputed:—

"GLAMORGAN,

"I must clearly tell you, both you and I have been abused in this business; for you have been drawn to consent to conditions much beyond your instructions, and your treaty hath been divulged to all the world. If you had advised with my Lord Lieutenant (as you promised me), all this had been helped. But we must look forward. Wherefore, in a word, I have commanded as much favour to be shown to you as may possibly stand with my service or safety; and if you will yet trust my advice (which I have commanded Digby to give you freely), I will bring you so off, that you may be still useful to me; and I shall be able to recompense you for your affection. If not, I cannot tell what to say. But I will not doubt of your compliance in this; since it so highly concerns the good of all my Crowns, my own particular, and to make me have still means to show myself

"Your most assured friend,

"CHARLES R.*

"Oxford, 3rd Feb. 1645."

But this letter was no doubt written by the King under some restraint, as it might be read both by

* Harl. libr. 163, c. 3, 147. Birch, p. 356.

Ormond and Digby. Yet no further evidence need be required of Charles the First's consummate duplicity, or how thoroughly he could make a convenience of his subjects to serve his own subtle and deceitful policy.

The tone of these last three letters sufficiently shows the weakness of the cause in which they were interested; if we credit the statements they contain we are required to believe that Lord Herbert presumptuously assumed the title of Earl of Glamorgan; and that his treaty with the Irish Catholic party was without the privity, much less instructions of his sovereign!

Lingard says, "I have in my possession the original warrant itself, with the King's signature and private seal; bearing the arms of the three kingdoms, a crown above, and C. R. on the sides, and endorsed in the same handwriting with the body of the warrant,—'The Earl of Glamorgan's especial warrant for Ireland.'"⁶²

The Earl's imprisonment created great sensation, many insisting on his release by force of arms. The General Assembly of the Confederate Catholics pressed for his being liberated, as absolutely necessary for the relief of Chester, then besieged, and in distress; for which service 3000 men were reported as being ready to embark, waiting only for the ships contracted for by the Earl, for their transport; the expedition being thus delayed through his imprisonment, and likewise the treaty of peace frustrated.

The Earl of Glamorgan was set at liberty on the 21st of January, on giving up to the Lord Lieutenant the Instrument by which the Confederate Catholics obliged themselves to the articles of their treaty; but he would not resign the command of the Irish troops, for England, intended for the King's service; bail being accepted

⁶² Lingard, 5th edition, Vol. vii. p. 627.

in £20,000, on his own recognizance, and the Marquis of Clanricarde, and the Earl of Kildare, for £10,000 each, to appear on thirty days' notice.

Returning to Kilkenny, he zealously endeavoured to obtain from the Confederate Catholics acceptance of the Lord Lieutenant's offer of terms to conclude a peace; but they, persisting in their exorbitant demands, refused to accept the slightest modification of their own views, so that the Earl was at length compelled to abandon his own measures in despair, only to fall under the suspicion of his own party as well as of his opponents. On the 11th of March, he wrote the following letter to the Marquis of Ormond:—*

“MAY IT PLEASE YOUR EXCELLENCY,

“The perfect knowledge I have of your Excellency's desire to perform what may be of most advantage to the King our master's service, makes me confident to lay before you what I humbly conceive may most conduce thereto; my duty and affection obliging me not only to adventure my life and fortune therein, but also plainly to declare my sense thereof; which being made known to your Excellency, I shall ever most willingly and readily submit to your better judgment. I, therefore, take the boldness to acquaint you, that as I intend (God willing) to go into France, without which journey I cannot possibly bring things to that height of advantage to his Majesty's service, either in the business of shipping, ammunition or money, as I have designed to myself, and can (God willing) infallibly perform; yet if, before my own return, and during my abode in any of those places, the Articles of Peace should be proclaimed here, and not appear so really advantageous,

* Bod. Lib. “Carte Papers, 1634-1657, Ireland, 63.”

as is by them in other countries expected. It would not only prove a cooling card to many, whose zeal otherwise would transport them to supply me gallantly in order to his Majesty's service, but also perhaps render me incapable thereof; for which reason of great importance, I should humbly beseech that the cessation should be continued until about the middle of June next; yet so as that the condition of having the residue of the ten thousand men by the first of May next may be enforced by your Excellency, against which time, though I return not myself, yet shipping shall be provided, and that service no way neglected. But with this motion of mine I have not acquainted the Commissioners that are gone to Dublin, nor the Supreme Council, lest in some I might have raised a spirit I could not lay down: who might have taken a rise at this my inclination for the furtherance of his Majesty's service, to countenance their backwardness in preparing the supplies, or in their unwillingness to submit to a perfect peace; than which nothing is more heartily desired or aimed at by me, to the end that, under your Excellency's most judicious and wise conduct, all things may unanimously proceed to the furtherance of the King my master's service, and the happiness and contentment of this kingdom. And to receive your Excellency's commands hereupon I have sent Sir Vivien Molineux, who goes with me into France. And give me leave to tell you that the continuance of the cessation upon the terms above mentioned (without which I cannot resolve to go myself into France), will be likewise advantageous to your Excellency and this kingdom; since during it, the Nuncio (whose mission is only to the Confederate Catholics) will plentifully contribute here to the maintenance of the war against the common enemy. And your Excellency, giving me a power to engage your

word with mine, I will promise you at my return, to bring for the King's service and the good of this kingdom, ten, if not twenty thousand pounds sterling; which, if managed by you, I conceive will be better than £60,000, as hitherto moneys have been disposed. And of this business, if you please, you may acquaint my Lord Digby, to whom I have intimated something thereof in my letter. But your Excellency, nor my Lord Digby, need not be told with what secrecy my intended journey ought to be kept, though I fear not the Parliament, since I have bought a gallant ship at Galway, with 16 pieces of ordnance, and victualled for two months, manned with 34 good seamen, an excellent captain, and good pilots, of 300 tons, English built, and a good sailer. And for my return, I intend (God willing) it shall be with a fleet, which how it is to be left under your Excellency's command, I hope you are already well assured, as you may be of anything within my power, who am,

“Your Excellency's, &c. &c.

“GLAMORGAN.

“Kilkenny, 11th of March, 1645-6.”

Ormond wrote from Dublin Castle, 4th March, 1645, naming “the sad certainty of the loss of Chester,”—the men, long expected, he hopes will arrive “seasonably for some other service;” and says, “there are many reasons against the prolonging of the cessation till the midst of June,” but especially “the inevitable ruin that must in the meantime come upon all his Majesty's true servants,” promising in his next to send the “authority to engage me for such money as you shall be able, upon so small an assurance as mine, to get.”

On the 29th of September, 1645-6, the Earl addressed a letter of explanations to the Lord Lieutenant.

“For to endear myself to some, the better to do his Majesty service, it is true I did declare a promise from the King of the assent that after your Excellency’s time he would make me Lord Lieutenant. But it is no meaning of mine but to keep your Excellency in during your life, and not really to pretend unto it, or anything in discrimination of your Excellency’s honour or profit; or derogating from the true amity and real service which I have professed, and will ever make good towards your Excellency. And my intention was ever to acquaint your honour herewith, and I once intended to do it before my going to Kilkenny, but never to conceal it totally from you, though for some reasons it being hitherto omitted, I think it not necessary for the present but as an obligation upon me thereunto. And in witness of my true intent and meaning, I leave this sealed in your Excellency’s hands this 29th of September, 1645, at Dublin.

“GLAMORGAN.”

The Earl being thus bound to continue his residence in Ireland, notwithstanding the unpromising aspect of affairs, we shall proceed, in order of date, to consider the position of his father, at Raglan Castle.

CHAPTER IX.

RAGLAN CASTLE : ITS DEFENCE AND SURRENDER. DEATH
OF HENRY, MARQUIS OF WORCESTER.

FROM the close of 1645 to the middle of 1646 the military operations within and surrounding the strong fortress of Raglan were conducted with untiring energy. Parties from the castle were continually annoying the enemy, while they on their part pushing their works with vigour at several points caused many disasters, keeping the favourably situated garrison in a state of constant agitation and watchfulness; finding their course of operations gradually limited to acting entirely on the defensive, not being in sufficient force to disperse the stronger besieging army, against whom it is next to a miracle how they maintained their position so long, Raglan Castle having held out longer than any other.

The Marquis of Worcester, the last lord of Raglan Castle, usually occupied, as is supposed, a handsomely carved oak wainscotted parlour or sitting room in the ground floor of the south side of the castle, nearly the whole side of which was a large, handsome window looking over the moat towards the tall, massive tower or citadel. Over that chamber was his dining room, and from his table the various dishes would be conveyed to the grand banqueting hall, the most complete and spacious apartment within the present ruin.

The great state in which the noble Marquis was accustomed to live may be gathered from the following authentic account of the order of his household :—*

At 11 o'clock the Castle gates were shut and the tables laid—two in the Dining Room, three in the Hall,

* From MSS. Badminton.

one in Mrs. Watson's apartment where the Chaplains eat (Sir Toby Mathews being the first), in the House-keeper's room for the Ladies' women.

The Earl came into the Dining Room attended by his gentlemen. As soon as he was seated Sir Ralph Blackstone, Steward of the House retired, the Comptroller, Mr. Holland, attended with his staff, the Sewer, Mr. Blackburn, the Daily Waiters, Mr. Clough, Mr. Selby and Mr. Scudamore, with many gentlemen's sons, from £2. to £700. a year, bred in the castle. My Lady's Gentleman Usher, Mr. Harcourt. My Lord's Gentlemen of the Chamber, Mr. Morgan and Mr. Fox.

At the first table sat the noble family and such of the nobility as came there.

At the second table in the dining room sat Knights and honourable gentlemen attended by footmen.

Sir Ralph Blackstone, Steward.

The Comptroller.

The Secretary.

The Master of the Horse, Mr. Delaware.

The Master of the Fish ponds, Mr. Andrews.

My Lord Herbert's preceptor, Mr. Adams, with such gentlemen as came there under the degree of a knight, attended by footmen and plentifully served with wine.

At the second table in the Hall, served from my Lord's table and with other hot meat—The Sewer, with the gentlemen waiters and pages, to the number of twenty-four or more.

At the third table in the Hall—The Clerk of the Kitchen, with the Yeomen Officers of the House, two Grooms of the Chamber, &c.

Chief Auditor, Mr. Smith.

Clerk of the Accounts, George Wharton.

Surveyor of the Castle, Mr. Salisbury.

Ushers of the Hall, Mr. Moyle and Mr. Cook.

Closet Keeper.

Gentleman of the Chapel, Mr. Davies.

Keeper of the Record.

Master of the Wardrobe. Master of the Armory.

Master Groom of the Stables for the war horses, twelve.

Master of the Hounds. Master Falconer.

Porter and his Men, two Butchers, two Keepers of the Home Park, two Keepers of the Red Deer Park, Footmen, Grooms, and other menial servants to the number of 150. Some of the footmen were butchers and bakers.

Out Officers.

Steward of Raglan, Wm. Jones, Esq. Governor of Chepstow, Sir Mich. Keney, Bart. Housekeeper of Worcester House in London, James Redman, Esq. Bailiffs thirteen; two Counsel for the Bailiffs to have recourse to. Solicitor, Mr. Jos. Smith.

His Lordship appears to have been very indifferently informed respecting his son's operations in Ireland. The conveyance of communications of any kind was difficult, hazardous, and uncertain. Of this a rather romantic instance occurs in the relation given of his adventures, by Allen Boteler, in his documentary evidence entitled:—"A most true account of my business from his Majesty at Oxford, intended for the most honourable the Marquis of Ormond, it being the last of my [engagements in ?] these employments." It is a long, prolix account, but sufficiently interesting from the facts it details to be given in extenso. He states:—

"On Friday night being the 22nd of February, 1646, I was conveyed to Abbingdon by Sir George Lisle, and a party under his command, and from thence near Cisseter, where I parted from them, took a guide and went to Sir William Pooles, from whence by night I was carefully guided to Sir Robert Poyntz's at Acton,

which his Majesty conceived to be the safest way ; there by Sir Robert was I exceedingly welcomed as coming from his Majesty, and in that employment, and for the space of five days I was concealed in Sir Robert's house whilst he did continually employ some of his trusty servants to endeavour a way for my passage over Severn, which both by land and water was very strongly guarded; yet having disguise from him I hired a boat for Black Rock, and passed as a grazier, and a farmer, a friend of his with me, to assist me; but no sooner had we landed but we had, by a grazier, intelligence that in the village, and in all that country of the Moors, were Parliament forces driven by his Majesty's party from Newport and Carlisle. Thereupon the farmer brought me to a church on a rock [a] few yards from the sea side, into which rock I conveyed my dispatches, and myself and horse into the porch, whilst the farmer bought [brought?] me a guide, a man of his acquaintance, well known to the enemy's party but honest to his Majesty's; and after night he conveyed me through their guards by the name of a butcher of Bristol, and on the break of day, three Parliament officers, newly landed at Gouldcliffé from Bristol, seeing me riding fast, charged me in a lane and questioned me who I was for; and I answered that it was then no time to ask impertinences, by my being here you may judge who I am for; I intended for Newport or Carleon in business for the States, but my guide tells me that there is my Lord Charles Somerset with 300 horse, for God's sake tell me how I shall avoid them. Whereupon they being as much affrighted with my word, as I with their summons, hastily pointed me out a way, and ran themselves another way into the Moors. By this means I came to Carleon, from whence the King's party were marched two days before; and being then within four

miles of Raglan I came (as I thought) undiscovered to Colonel Richard Herbert's, and finding the passage full of dangers, by reason of Langibby Castle and many soldiers quartered in the way, I sent to the Lord Charles, desiring a convoy, and acquainting him with what business I was in. His Lordship returned me answer that by one of the clock, the next day, by a windmill on Christ Church hill, a party should meet me punctually; and so there did, but it was of the enemy, who having foot with the horse made me distrust and betake myself to a wood adjoining; and when they were past, no convoy coming, nor intended, as it appeared afterwards, I returned to the Lady Mary Herbert's, who then lay in, and some intelligence being given to the enemy, so soon as it was dark, a party being sent to take me, my Lady Mary secured the despatches in or under her bed, commanded a servant of hers to go with me, called my horse her's; and [I] going on foot all night in most bitter weather and bad way, full of danger, I came to the Castle about the day's dawning, where I presently appeared myself to my Lord Charles, made my relation, and besought him for a present convoy. His answer was that that house was their own, and not as other garrisons, they must look on their own securities, and had done more than they had thanks for, but would bring me to his father, so soon as he was ready. His Lordship did so, and in the first place my Lord asked me whether in my despatches I had any letters from his Majesty to his son Glamorgan. I answered, not that I knew of, but there might be within the Lord Marquis of Ormond's; on that I delivered to his Lordship his Majesty's most gracious and comfortable message concerning my Lord his son, with thanks for their former loyal expressions; unto which my Lord Marquis answered that it was the grief of his heart that, he was

That message I well remember and so will his Majesty, I having set it down so soon as I went out of the bed chamber. inforc'd to say that the King was wavering and fickle, and that at his Majesty's last being there, he lent him a book* to read in his chamber, the beginning of which he knows he read, but if he had ended, it would have showed him what it was to be a fickle prince; for was it not enough, said his Lordship, to suffer him, the Lord Glamorgan to be unjustly imprisoned by the Lord Marquis of Ormond for what he had his Majesty's authority for; but that the King must in print protest against his proceedings and his own allowance, and not yet recall it. But I will pray for him, and that he may be more constant to his friends, saith my Lord; and so soon as my other employments will give leave, you shall have a convoy to fetch securely your despatches; that I daily pressed and expected, sometimes it was delayed with fair language and sometimes with such as was very unwelcome to me, both from the father and the son; it being invectives against his Majesty and the Lord Marquis of Ormond, and after fourteen days delay, † I advised with Colonel Rateliffe Jarrard, Colonel Thomas Butler, Major Hugh Butler, and William Watkins, Receiver General for South Wales, being all Protestants, and of the Council of War, who agreed in opinion that the delay was of purpose, and caused by jealousy, conceiving that if I got over before Captain Bacon who was then attending for a despatch to his Lord the Lord Glamorgan, my despatch might tend to the prejudice of his said Lord. On this I took occasion to wait on my Lady Glamorgan, and remembering her of the King's gracious intentions towards her Lord, I

* See page 107.

† Note opposite sentence commencing "after fourteen days delay."—"After myself, Colonel Butler and the rest were gone, Lord Charles threatened to take from Mr. Watkins £800 which was in the Castle (his Majesty's money) or siding with us, as he now present is ready to testify."

besought her assistance, to which she answered that my going so hastily was not material whatsoever I considered of it, for that there were others gone with duplicates of business to her Ladyship's knowledge, of whom her cousin Will. Winter was one, and he had no relation to the Lord Marquis of Ormond, but was her husband's friend. To which I answered that my Lord was her Lord's very good friend, as I was very much his servant, but if his Majesty's business be done I care not by whose hand it is; but I thank your honour, for now I know wherefore I am stayed here; and from her Ladyship I went to my Lord Charles, and told him that by his neglect his Majesty might be undone, and that to acquit myself I must lay the blame on those that deserved it; but if his Lordship would yet give way Captain Spite would undertake to do the business with twenty horse. His Lordship answered, that he took my importunity ill, but would impart it to the Council of War, and take their advice, which he did indeed, but that caused so general a knowledge, that the country was laid for me and my business, as I had very good intelligence; and thereupon the Protestant party showed themselves to be much discontented, insomuch that Colonel Butler, Major Butler, and others quitted the Castle the next day, being the nineteenth of my stay there. My Lord sent a party, who bringing the despatches, I desired my Lord, in obedience to his Majesty's Warrant to afford me a convoy, or if not, two guides, one to ride before me to discous [discover or discourse?] and the other to direct me in my way, both which he refused because, as he said, I had no letters to his brother. Thereupon I went discontentedly away to Aburgainy [Abergavenny] with Colonel Ratcliffe Jarrard, Colonel Butler, and Major Butler, with whom I advised, and sent with their approbation for a

woman who was continually employed betwixt the Castle of Denby in North Wales and Raglan in South Wales. I agreed with her to go to Denby, Conway, or Harlo Castles, with the letters quilted up in a truss of linen and tied next to her body, and with her my own man disguised to receive them from her, and to go over with them, if I could not make my way to overtake him, but directed him by the Governors to whom I wrote. The man and woman were taken and carried before Howell Gwynn, then High Sheriff; but what became of the despatches, or how the woman concealed or made them away, I know not, nor dare enquire, but she saw the man taken, being a great distance from her, as I had directed them, to keep in sight one of the other, but not to go together; and she was not taken in two or three hours after, so that by all likelihood she conveyed them away, otherwise the Parliament pamphlets would have told us of it as they did not, for with much fear, I expecting it, perused all the diurnals for more than a quarter of a year. This is all I can deliver of it, and the particulars of these will be punctually justified by those several parties formerly meant, some of them being now about the Court, and for the truth of this I am ready to make Oath when I shall there unto be called.

“ALLAN BOTELER.”*

Boteler or Butler's evidence would appear to have been taken during the Marquis of Ormond's temporary sojourn in England, after his leaving Dublin in June, 1647, previous to his shortly after going to Paris for six months, when he returned to Ireland to assume his

* In MS. Index entitled, “No. 145. Boteler's Account of his business at Oxford, 1646 f. 210.” The MS. vol. containing above is lettered at back, “Carte Papers, 1604-1660. 30.”

post of Lord Lieutenant.¹³ The document derives considerable interest from its conveying to us the sentiments of the Marquis of Worcester, in his reflections on the King's conduct affecting himself and his son. It was on no light grounds he charged Charles the First with being "wavering and fickle;" declaring his son to have been "unjustly imprisoned;" and bitterly lamenting that the King should, in print, "protest against his [son's] proceedings;" being no doubt well satisfied through his Majesty's own discourse and his after written instructions, that the Earl of Glamorgan had, in every sense, been most unworthily used from first to last by his royal master. The upright old Marquis, touched in a tender part, was not disposed to overlook the injury done to his family, although coming from so high a quarter, for he must have felt it as nothing short of a gratuitous maligning and blackening of his son's character from the most sordid, selfish motives, reckless of all risks and hazards. No considerations swayed him to conceal his utmost anger at the indignity put on himself and his house, rendered perhaps all the keener by the presence of the unsuspecting messenger from that prince who had so utterly deceived him, and that peer who had aided in his dishonour. The blunt Boteler adds, in a marginal notification, "That message I well remember, and so will his Majesty; I having set it down, as soon as I went out of the bed chamber."*

The Marquis, a shrewd, observant man, appears to have expressed his wrath not only by words but acts; not caring that the messenger should return with any favourable account of his reception or dismissal, for

¹³ Birch, p. 262.

* It is generally believed that this chamber was over the south-west gate.

after having so unequivocally expressed his mind to him, he is left to shift for himself, is long detained, and at length departs at his own expense.

The siege of Raglan Castle was maintained by Colonel Morgan, Major General Laughorne, Sir Trevor Williams, Baronet, and Colonel Robert Kirle, with about 5000 horse and foot.

It became necessary for the besieged, in their extremity, in the pleasant month of May, 1646, to destroy every shelter or advantage the enemy might derive from the houses in the village, or its old church. They, therefore, levelled the goodly tower of the latter, as also the houses near, burning likewise whatever might in any way have been likely to prove available.

Sir Trevor Williams, at the same time, was arranging to blockade Raglan, garrisoning his men in the town of Usk. On the other side, Colonel Kirle, with his force, was stationed within two miles of Raglan; while Laughorne occupied Abergavenny; and Colonel Birch, besieging Gutbridge Castle, left Raglan without hope of relief.

In their skirmishes with the enemy, posted in these positions, the Royalists lost 16 killed, and 20 taken prisoners; while Sir Trevor Williams seized 80 horses grazing under the castle walls. Colonel Morgan, then at Worcester, shortly after, joining the army, made Landenny his head-quarters, within a distance of three miles.

A domestic incident may be here mentioned, not only as showing the discomfort of the place, but as connected with the wife of the subject of this memoir; and also as characteristic of the Marquis's religious sentiments. Dr. Bayly states that:—

“One evening, during the hottest period of the cannonade, there came a musket ball in at the window of

the withdrawing room, where my Lord used to entertain his friends with his pleasant discourses after dinners and suppers, which, glancing upon a little marble pillar of the window, from thence hit the Marquis upon the side of his head, and fell down flattened upon the table, which breaking the pillar in pieces, it made such a noise in the room, that his daughter-in-law, the Countess of Glamorgan, who stood in the same window, ran away as if the house had been falling down upon her head, crying out, 'O Lord! O Lord!' But at length, finding herself more afraid than hurt, she returned back again, no less excusing her—as she was pleased to call it—rudeness to her father, than acknowledging her fears to all the company. To whom the Marquis said, 'Daughter, you had reason to run away, when your father was knocked on the head.' Then pausing some little while, and turning the flattened bullet round with his finger, he further said, 'Gentlemen, those who had a mind to flatter me, were wont to tell me that I had a *good head* in my younger days; but, if I don't flatter myself, I think I have a good head-piece in my old age, or else it would not have been *musket proof*.' "

It shows how closely Raglan Castle was besieged, when on the 26th of May, about 11 o'clock at night, some of the Parliamentary soldiers could be drinking at a public house, but a little distance from the Castle, having alighted from their horses, and sent a scout to reconnoitre: who bringing them favourable news, they refreshed themselves at their ease. Meanwhile, having been observed, 60 or 80 horse were sent from Raglan to surprise them, and they succeeded in seizing three or four of their horses; but some of the Roundheads escaped in a cornfield, while most of their companions quickly mounted; some riding off were lost in the darkness, while the remainder, in a skirmish of half an hour, took

two prisoners and rescued their lost horses. Many fruitless skirmishes appear to have been thus made; often as many as 150 horsemen rushing forth, only to return with the report of bootless labour.⁸³

On the part of the besiegers, Captain Hooper was employed to conduct the mining approaches, which were pushed forward with great vigour.

The garrison of Raglan (estimated when in full force at 800 strong, in horse and foot) made several desperate sallies on Colonel Morgan's forces: their bold commander often personally encountering the hostile party with marked gallantry, losing on one occasion a colour; and a cornet his life. While on the Royalist side a major and a captain were slain, besides many wounded. But when General Fairfax, sending reinforcement from Oxford, had raised Colonel Morgan's regiment of 1500 to 3500 men, such sallies became less frequent.⁹² The General, who had been at Bath to recruit his health, hastening to Raglan, put life into the siege by his presence, and, on the 7th of August, he sent in his summons to the Castle; in consequence of which, numerous messages passed between the Marquis and the General, the Marquis reminding him in one of his replies how well he was known "in Henry, Earl of Huntingdon's time, unto your [the General's] noble grandfather at York;" at the same time inviting some propositions to be made; specially requiring on his own behalf to have any acts of his first approved by the King, through whom, moreover, he was "above £20,000 out of purse." The conditions offered, required, among others, that the Marquis should submit to the mercy of the Parliament; while those affecting the garrison and inmates of the Castle were honourable to all parties. In

⁸³ Raglan Castle.

⁹² Sprigge.

consequence of these negotiations, the Marquis, on the 13th of August, sent out a drum, desiring leave for his Commissioners to meet the next day, to arrange articles of peace; which being approved, the drum was returned with safe-conduct for the Commissioners' coming forth, and orders given for five hours cessation of arms.

The Marquis must have been fully alive to the jeopardy in which he was placed, after ten weeks of close siege, hemmed in on every side, stores fast diminishing, the cannon ball of the enemy knocking down turret and tower, and demolishing the weaker portions of his castle, never originally intended to withstand more than the ravages of time, with the exception of a very limited portion, the Citadel itself. The main work of the enemy's approaches, too, was then within 60 yards of the garrison's works, and a breach already made in the eastern wall, near the library or closet tower; besides which, four mortar pieces had been advantageously planted, capable of carrying grenado shells of 12 inches diameter; also two mortar pieces in another position, capable of delivering similar shells. Captain Hooper, the engineer, expressed his expectation to be in a few days within ten yards of the castle, with trenches, which he was constructing very exact and secure; from these he purposed making galleries, mines, and numerous batteries. The General himself, not only took great interest in these military works, visiting them daily, but at that very time had designed a new approach.

On the 15th of August, final terms were to be concluded; for which purpose the meeting of the Commissioners was appointed to take place at Keventilla House, the residence of Mr. Oates, about a mile and a half from Raglan.⁸⁴

⁸⁴ Raglan Castle.

The terms of peace being concluded on the 17th of August, the Castle was to be surrendered to Sir Thomas Fairfax for the use of the Parliament, the articles of the treaty, among others, stipulating:—That all the officers, soldiers, and gentlemen of the garrison, should march out with horses and arms, colours flying, drums beating, trumpets sounding, matches lighted at both ends, bullets in their mouths; and every soldier with twelve charges of powder and ball; with permission to select any place within 10 miles of the Castle, for the purpose of delivering up their arms to the General in command; after which the soldiers were to be disbanded and set at liberty; and safe-conduct and protection given to all the gentlemen and others who had sought refuge within the walls of Raglan Castle.

Wednesday, the 19th of August, 1646, in conformity with the treaty, the Castle was taken possession of by General Fairfax. The Marquis of Worcester, bordering on 70 years of age, infirm and careworn as he was, accosted Fairfax in a pleasant, jocose mood; yet it must have been but a melancholy cortege by which he was attended, on abandoning that roof which was soon to be destined to irreclaimable ruin. It must have appeared to the bystanders more like a military funeral procession than any other conceivable spectacle, in which, however, the glistening of arms and armour, the rustling of banners, the blast of trumpets, and the roll of drums must have been felt by all alike, as though more in mockery than evincing any cause of exultation.

The Marquis was accompanied by his son, the Lord Charles Somerset, governor of the Castle; the Countess of Glamorgan; Lady Jones and Sir Philip Jones; Dr. Thomas Bayly, the chaplain, who had also acted as one of the Commissioners from the Castle; Commis-

sary Guillian ; together with 4 colonels, 82 captains, 16 lieutenants, 6 cornets, 4 ensigns, 4 quarter-masters, and 52 esquires and gentlemen ; including also his Lordship's numerous visitors, household, and retainers.

The General, having thus secured the last stronghold that had withstood the power of the Parliamentary army, went to Chepstow to take part the same night in a splendid entertainment, returning thence the following day to recruit himself at Bath.

There were found in Raglan Castle, a mill for the manufacture of gunpowder, 20 pieces of ordnance, only 3 barrels of powder, good store of corn and malt, beer, and various wines ; not many horses, and but little hay or oats. The apartments, however, were amply supplied with rich furniture, and well stored with goods. All these the General committed to the charge of Mr. Herbert, the Army Commissioner, and others to be inventoried.

Thus far the articles of capitulation were punctually performed with regard to all matters, except only the Marquis himself. We are not very precisely informed respecting his removal, but only assured that he was in the custody of the Black Rod ; and next hear of him as being in Covent Garden, probably at that official's residence, where he was repeatedly visited by his former chaplain, the loquacious Dr. Bayly.⁷ It was a base violation of the conditions in the treaty, on the part of the Parliament, to keep the Marquis in confinement, and still worse considering his age, corpulency, and bad state of health, aggravated no doubt by the excessive toils and troubles of the last few years, together with the more recent fatigues of his journey from Wales to

⁷ Bayly.

London. Harassed, afflicted, and a prisoner, he died within the space of four months, in the custody of the Parliament's Black Rod, in Covent Garden, on the — of December, 1646.⁸⁸

The House of Commons, on the 20th of December, proposed allowing £500¹⁰⁵ for the funeral, out of the Marquis's estate; the votes being 168 for, and 92 against so much liberality. It was resolved—"That the £500 be raised out of the plate and other goods of the Earl of Worcester, brought up by Mr. Thomas Herbert; and that the disposing of it be referred to his care, to be accountable for it to the House; and especially to take care that the said Earl of Worcester may be buried according to the Directory, and not otherwise."⁵⁷

In dedicating to the son his collection of the father's "Apophthegms," Dr. Bayly observes—"I laid your noble father in his grave, with my own hands." He was interred in the vault of the Chapel of our Lady, now known as the Beaufort Chapel, in St. George's Chapel, Windsor Castle, near his great ancestor, William first Earl of Worcester.

Among the property at Raglan Castle, the most interesting to the biographer was that respecting which an order passed the House of Commons, on the 25th of August 1646, to the effect:—"That Mr. Thomas Herbert be enjoined to deliver all the letters and papers found at Raglan Castle, and remaining in his hands, to the Committee of the Army: Who have hereby further power to send for all such other letters and papers, found at Raglan Castle, which they shall have information of to be in the hands of any other Com-

⁸⁸ Sandford.¹⁰⁵ Whitlock states £1000.⁵⁷ Jo. Ho. of Comm. Vol. V. p. 20.

mittee or persons; and are to report the whole to the House."

The fate of Raglan Castle was decided by an order of the House the same day, when it was resolved:—"That the Castle of Raglan, the works about it, and the house and buildings thereof, be forthwith pulled down and demolished." And further, "That it be referred to the Committee of the county of Monmouth, to take care that the same may be totally demolished, and all the materials thereof sold and disposed of for the best advantage of the state; deducting the charges for pulling it down; and a due account rendered for the same."

Various orders were passed regarding the sale of estates, and disposition of the funds, sometimes to raise money for the service of Ireland, at others for reparation of losses through depriving certain noblemen of the Court of Wards, with other and numerous demands. But we must return to review the closing scene of affairs in Ireland.

CHAPTER X.

THE EARL OF GLAMORGAN'S TRANSACTIONS IN IRELAND—
CONCLUDED.

WE left the Earl at Kilkenny after his enlargement. That his own confidence in his position was not misplaced all his acts clearly prove, and no attempt has been successfully made by his adversaries to show him in any other light than that of being a too ready instrument in the hands of his prince to work out his mystified political schemes.

It requires considerable calmness and consideration on the part of the biographer while undertaking to become the apologist of the Earl's conduct, particularly when wholly differing in political and religious views. But sincerity will always command respect. That he was strictly conscientious in all his conduct there cannot be the shadow of a doubt; nor can he be accused of rather tempting the monarch than being tempted by him, a man open and most anxious to adopt any measures to regain his despotic authority over the people. Charles the First was all things to all men who offered him service; he was a Catholic to the Catholics, and a Protestant to the Protestants; and it was this duality of character, united with unbounded selfishness and a fatal attachment to secrecy, that perplexed his most discreet ministers. No man's life or property was safe in his hands. No engagements were held sacred or inviolable, all being artfully contrived to conceal some mental reservation, which expediency always found it convenient to be shifting to serve some opposite purpose or other. All this subtle

strategy was perfectly consistent with the possession of the most distinguished domestic affections and habits, and tastes most refined for art and literature, which, after all, may have been but the consummation of that all-grasping selfishness which shows but little integrity beyond the confines of self and home. His Majesty united so many inconsistencies of character that he completely deluded not the Earl alone but the entire Roman Catholic party throughout the land. He had succeeded in draining the Marquis of Worcester of his enormous wealth, and had not blushed to degrade his son, the Earl, by a public accusation (which his private conduct repudiated) to give colour to his own sophisms.

A letter written by the Earl to the Nuncio, in February, together with the oath he afterwards took, are not a little remarkable.¹³

“ MOST ILLUSTRIOUS AND MOST REVEREND LORD,

“ There is no occasion for me to employ any further protestations to persuade your Lordship, how sincerely I desire that the whole glory of the advantages, which this nation and we poor Catholics of England may attain, should, as it ought, be ascribed to his Holiness, through your Lordship’s intervention; whom I beseech to consider the authority granted your Lordship by his Holiness, and to recall to your memory the letter written by the King my master to your Lordship, and my powers for treating with your Lordship. These things being laid down as a foundation, let us not sleep over our cause, but finish all the conventions made or to be made between his Holiness and our Queen (though without suffering them to be published), till your Lordship shall have received the original instruments themselves, or till an answer shall be re-

¹³ Birch, p. 175.

turned from the King by means of my brother, who shall be sent to his Majesty in the name of your Lordship and myself. During which interval, though there be only a cessation of arms, yet our peace will be secure, and depend only on such conditions, as shall be acceptable to his Holiness; for it will not be such a peace, as the Pope disapproves of in his letters, but the same which your Lordship desires. But while the articles are agreed upon and concluded between your Lordship and me, and no change is made in the government, or in any other respect, till the peace shall be published, and the ratification transmitted hither by the King from England, no danger will arise either on your Lordship's or my part, since the seven thousand soldiers will not pass over into England, till the peace be concluded and published, nor ever depart, till I shall return from Italy, and there shall be a certainty concerning his Holiness' pleasure."

He proceeds to suggest the conclusion of the peace at the end of three months; the signing of the articles by the Nuncio and himself, on the part of the Pope and the King respectively; thus satisfying the Irish, while affording the King security, the articles not being published; the safety of the kingdom ensured, and the Nuncio at ease in having thus conformed to the Pope's instructions.

He afterwards signed, on the 18th February, 1646, an engagement to the Nuncio; and the next day took the following oath.¹³

"I, Edward Earl of Glamorgan, promise and swear to your most illustrious and most reverend Lordship, that I will adhere to your party, not only against the Marquis of Ormond, and all his relations and favourers,

¹³ Birch, p. 182; Nuncio's Memoirs; and Siri, Mercurio, Vol. viii.

but likewise against all others, who shall oppose the Pope's treaty and your measures for the good of the Catholic Religion, and the service of the King my master, to supply your Lordship with—

200,000 crowns,
 10,000 arms for foot,
 2,000 cases of pistols,
 800 barrels of powder,

and 30 or 40 ships well provided, over which your Lordship shall name an Admiral. For I esteem your cause to be the cause of God, and of the King my master, in whose name I make all the concessions agreed upon between your Lordship and me; and am therefore ready, if your Lordship pleases, to confirm this my resolution before the most holy sacrament. In the mean time I subscribe my name, and affix my seal, this 19th day of February, 1646.

“GLAMORGAN.”

The Earl, in conformity with the power granted him on the 1st of April, by the King, agreed with the Nuncio to create, at his recommendation, one Earl, two Viscounts, and three Barons, hoping thereby to gratify the Irish.

But previously, on his arrival in Waterford, he wrote to the King:⁸⁷ ¹³—

“MAY IT PLEASE YOUR MAJESTY,

“I am now at Waterford, providing shipping immediately to transport 6000 foot; and 4000 more are by May to follow them. I hope these will yet come opportunely to the relief of Chester. What hath been the occasion of so long delays, and yet suffers

⁸⁷ Rushworth, Part IV. vol. I. p. 249.

¹³ Birch, Inq. p. 184.

not your Majesty's service herein to proceed with that advantage it might do, I conceive not so fit to commit to paper; but I will shortly send my brother, who shall fully inform your Majesty with all particulars, and thereby rectify your opinion, and give you true knowledge, who are your faithful servants. I hope long ere this Captain Bacon hath arrived with you since my enlargement; and, therefore, I need only tell your Majesty that, my further services intended for you will, I hope, without further crosses, be suffered to go on; though strange is the industry used by many seeming friends to hinder me therein. But I am confident it shall not lie in their power, your Majesty remaining still constant, as I doubt not but you will, to your favourable opinion, and right interpretation of my poor endeavours; which, if they may take place, will procure you to be a gracious and happy prince, I having no other ends, but to approve myself,

“ Sir, your sacred Majesty's

“ Most dutiful, obedient subject,

“ and passionately devoted servant,

“ GLAMORGAN.

“ Waterford, Feb. 23, 1645-6.”

The same month, however, Chester surrendered to the Parliamentary forces, after a stubborn siege; while in March following news arrived at Kilkenny of his Majesty's message of the 29th of January, addressed to the Parliament, denying any participation in and unreservedly disavowing all knowledge of the Earl's treaty of the 25th of August, 1645. The Roman Catholics were astounded; all their labour and expense, all their negociations at once appeared worse than vain, being only calculated to arouse public indignation.

But the Parliamentary party appeared pretty well satisfied that the Earl's imprisonment was a merely

colourable affair, suspecting that the King was merely sacrificing a devoted friend to clear himself and appease the public wrath.

Notwithstanding this state of affairs in Ireland, the Earl was, on the 4th of March, 1646, created "Duke of Somerset and Beaufort," which title he afterwards resigned, but the original patent, still existing at Badminton, is translated as follows:—

"Charles, by the grace of God of England, France, and Ireland King, Defender of the Faith, &c. To all our Archbishops, Dukes, Marquesses, Earls, Viscounts, Bishops, Barons, Knights, Governors of Towns, Freemen, and all other Officers, Ministers, and subjects to whom these Presents shall come Greeting.

"We esteem the greatness of our Royal Dignity not only to be highly adorned but even to be augmented and enlarged when men eminent for their nobility and virtue, who have deserved well of their country, and by notable achievements and particularly by trophys and other monuments of military valour acquired at home and abroad and distinguished and adorned by any illustrious accession of Honour, Dignity, or Titles.— And Whereas our right trusty and well beloved Cousin Edward Somerset, alias Plantagenet, Knight of the most noble order of the Garter, Earl of our County of Glamorgan, son and heir apparent of our right trusty and well beloved Cousin Henry Earl and Marquess of Worcester, Baron of the Honours of the castles of Raglan, Chepstow, and Gower, a man eminent for the nobleness of his blood, and his approved attachment and fidelity to us, (by always furnishing the most ready supplies out of his own fortune to us in these most calamitous times) Hath in a special manner recommended himself to our favour: as he is rendered illustrious by a long train of noble ancestors, and by the high

nobility transmitted by paternal succession from John of Gaunt Duke of Lancaster, and his son John Plantagenet Duke of Somerset, from the place of his nativity surnamed Beaufort—and by other connections of blood with the Royal Houses of Lancaster and York, to Charles the first Earl of Worcester; All which dignity of birth and accumulated honours he hath himself greatly surpassed by his own personal virtues and inviolable fidelity to Us.

“For with what integrity, with what constancy, with what expense, he did execute the royal command of President of the six counties of South Wales and the places adjoining to the Severn coast? He was present at sieges and battles.—With what courage and successful conduct did he take Goodridge Castle, the Forest of Dean and the city of Hereford? In short, with what remarkable good fortune, with what unhopd for success he made himself master of the strongly fortified town of Monmouth? And not content with the confined limits of one kingdom, go to the most distant places beyond the seas, through the midst of hostile forces and the dangers of shipwreck, yet at his own private expense, regardless of all dangers, at the loss of his own private fortune, that he might raise succours for the support of the tottering crown of his King. These things, &c.”

Endorsed—“1646, 4 March. 21 Charles I. Creation of Edward, Earl of Glamorgan, Duke of Somerset and Beaufort, 4 March, 1646, and 21 C. I.”

This patent, worthless as it proved for confirming the title it was intended to convey, may well serve to seal the duplicity of the monarch who could thus intend to honour one whom he charged with treasonable acts, if not with absolute forgery of warrants in his own name.

In March 1646, the Earl committed to writing the following memorandum:—¹³

¹³ Birch, p. 188.

“Considerations and conclusions concerning the present state of my affairs, 29 March, 1646.

“1. As the King has published such a Declaration, I think myself at present incapable of serving him. Yet I am persuaded, that he has done this unwillingly, and through the violent impulse of others, and on account of the bad situation of his affairs. For which purpose, I am desirous to send express to him a person of rank, and my relation; by whose means I shall propose to his Majesty a method, by which he may enable me, under the authority of the Great Seal, to proceed further, both in promoting the interest of this nation, and his Majesty’s own, in such a manner, that his forced renunciation shall not be openly touched upon, and yet my justification, as far as it shall conduce to the good of this kingdom, so sincerely desired by me, may attain its wished-for effect. The safety even of the lowest person of this nation, is so truly at my heart, that I would not expose the life of one man to danger on my own account, nor press the transportation of the soldiers, till the return of the messenger to be sent to the King.

“2. As I have received such instructions from the King as these, viz. If by any unfortunate accident we should be involved in any counsels, in appearance contrary to the powers given by us to you, you shall make no other account of them, but by putting yourself in a condition to help us, and set us free; I do not find any more expeditious way of relieving his Majesty from his distress, than by taking no notice of anything which he has done through compulsion, and by supporting this nation. But if the Supreme Council will engage to adhere firmly to me, I will likewise oblige myself to employ the ships and money, which I had before designed for England, to the assistance of this nation, and devote my labours and endeavours to the service of this kingdom, till we

can all jointly succour his Majesty in England. I desire, that the most illustrious and most reverend Nuncio of the Apostolic See will first of all subscribe this treaty of ours.

“But in this affair, I require nothing of the Supreme Council, but their private faith, till I shall return, by God’s blessing, with all things necessary. And though I am sensible, how little this concerns my own interest, yet my zeal prompts me to it. But I am extremely desirous, that General Preston should march the troops, designed for me, into Munster, to compose the commotions there, as well as to take care of this kingdom, whose safety is greatly concerned in it, as that when, through God’s blessing, I return with the subsidies, I may find an army ready. I desire, that our mutual engagement may be committed to writing, and signed and sealed, and kept under the most profound secrecy.”

The Earl of Glamorgan had designed a visit to Rome, anticipating important assistance there, as well as the especial favour of the King in that matter. But the Supreme Council, wearied by the expense of keeping a large army, intended for the relief of Chester, finding no vessels were supplied from England for that purpose, and being further discouraged by his Majesty’s recent proceedings, finally resolved against sending any troops out of Ireland. The critical state of affairs had become so acutely distressing to the Earl, that in a letter addressed to Father Robert Nugent at Kilkenny, he expressed the bitterness of his anguish in the most unrestrained language, such as we find no example of in any other portion of his varied correspondence.

To Father Robert Nugent, he thus wrote:—¹³

¹³ Birch, p. 192.

“REVEREND SIR,

“I return you thanks for the messenger sent me on purpose, and your letter; and desire you to signify to the Nuncio, that if all the devils on earth and in hell had not conspired against me, I should not have been reduced to these difficulties and distresses; and that the loss of life itself would have been more tolerable to me, being now tired of it on account of the present difficulty, and I can think of nothing but redeeming myself; assuring you, that the misfortunes of my whole life have not perplexed me so much as this: to remedy which, though I am pressed by letters and most urgent business to go to Limerick, I still continue here. I swear to you, that I have been disappointed of seven thousand pounds sterling, which I thought as entirely my own as if the money had been actually paid to me; and all this since the resolution was published against sending the soldiers to England. I do not think it necessary to remind the Nuncio, that my enemies in Ireland are exasperated against me, because they perceive me so warmly and sincerely affected towards him, and know, that I shall always continue so; and because I should not hesitate to expose my life and fortune to the utmost danger, in order to bring to an issue his commission and business in this kingdom. This seems to me to deserve, that some pity and toleration should be shown towards me, especially in an event unforeseen by me, and forced upon me, and which has given me a vexation, than which I can imagine nothing more severe to me.

“I remain, in great affliction,

“Your affectionate Cousin and Servant,

“GLAMORGAN.

“Waterford, 3 May, 1646.”

His operations in Ireland were virtually terminated,

every measure had signally failed, and he was without hope, after the Parliamentary publications, of regaining confidence with any party. Much as has been written on this subject, and ably as it has been investigated by Dr. Birch and other writers, it must be admitted that we gain little from the mass of evidence accumulated to enlighten us in respect to the personal character of the Earl of Glamorgan, beyond entire satisfaction that he acted solely as his sovereign's agent, at his instigation, and entirely under such authority as he could alone give him under all the circumstances of such an important secret mission. Charles the First's confidence in him was by no means misplaced, and he had no doubt well weighed his character before taking him into his confidence. For this inquiry he had sufficient opportunity while the Earl was at his court, and again while himself a guest at Raglan. He well knew the weak side of the father and the son, the one expectant that his Majesty would be "a defender of *the* faith," the other warm-hearted, and generous, to an extraordinary and enthusiastic degree. Not alone were the Marquis and Lord Herbert deceived by the machinations of the wily monarch, but so likewise were the whole Roman Catholic community. Had it been otherwise we might suspect undue measures would have been adopted, but wherever such were carried into effect they were on the side of the Crown and not of the subject. Charles the First's duality of character in this respect has never been, nor can be, successfully refuted. Embarking, therefore, in his Majesty's cause, in Ireland, we cease to be surprised that the Earl of Glamorgan should, consistently with his faith, be in constant consultation with the Nuncio and conform to proffered oaths. In short, had he adopted any other course than that which he pursued, his negotiations would from the first either have ceased, or merged into the dilatory measures attending the

Lord Lieutenant's previous course, which it was expected by the King that the Earl would be able to out-run and overmatch. But his utmost diplomatic skill was insufficient to grapple with and satisfy the grasping party on his own side; and he was equally unsuccessful placed in opposition to such practised politicians as Ormond, Digby, and others. And above all, a supreme difficulty must have been, the conducting of his entire system to accord with the subtleties and secrecies of the King's personally communicated and private counsels. He was thus placed in many painful straits, but which his ardent, vigorous temperament determined him to overcome. In his position, however, the Earl felt a compulsory necessity to maintain great secrecy; negotiating with many mental reservations. He had to satisfy the King, while he did not wish to disoblige Ormond, and although there was a natural bond of sympathy between himself and the Roman Catholic party, he could neither wholly accede to the Nuncio's measures nor satisfy the Council. To the best of his ability he consistently and conscientiously employed the vast powers delegated to him for the good of his King and his country through his own party; so that no historian, not his most bitter, sarcastic enemies, can point to any single fact that could cast the slightest taint on the rectitude of his conduct throughout the unfortunate and unhappy transactions into which it was his misfortune to be drawn by a too sanguine, hopeful, but helpless monarch.

On the 3rd of April the Earl wrote to the Marquis of Ormond:—*

“MAY IT PLEASE YOUR EXCELLENCY,

“With many thanks for your letter delivered me by Sir Vivien Molineux, give me leave to congratulate

* Bod. Lib. “Carte Papers, 1634-1637, Ireland, 63.” No. 172.

your Excellency's happy escape from the mischievous intentions against you by the wicked enterprise for the taking of the castle of Dublin. And as nobody joys more in your deliverance than I do, so cannot any one wish more heartily than I, that all the warnings which your Excellency hath had might prevail to persuade you, in whom you might totally best confide, and of whom to beware; and then with a stedfast resolution to adhere to your truest and most real friends. Amongst whom, if your Excellency afford me not a place, I dare boldly say that it is not for want of having already endeavoured to deserve the same by serving you, with as great expressions, both public and private, as my wish and will could possibly obtain unto. Neither shall my future actions be inferior to what is past, but shall (God willing) enact those things wherein my good will only can yet be seen: for upon the ground work of my professed reality and affection unto your Excellency, and of your noble and friendly acceptance thereof, have I ever thought to build a fabric of my future services to his Majesty and most real friendship to yourself, whose subsistence I tender as mine own. And if your Excellency's first begotten and expressed confidence in me had not been retarded by some unknown means unto me, though I humbly and thankfully acknowledge you never suffered it to be extinguished; give me leave to aver with truth, that your Excellency ere this should have seen the remarkable effects thereof. But this is so copious a theme, as that I fear already I have been too prolix, I will therefore abridge myself, and not extend unto the latitude, which the truth of this subject prompts me unto.

“ And to the second part of your Excellency's letter, give me leave to thank you for your tenderness in not accepting the £2500 from me; but also your Excellency may know, that it is upon a reliance thereon, that the

Council offered you the £3000, and for the performance thereof I am enforced to this journey, without which against the prefixed time I could not have supplied them with the money. Now to the latter part of your letter, wherein you promise I should at large hear farther from you, as upon Friday last; but yet have received no other your commands, which I expected, before I thought it necessary to answer yours of the 24th of March. But receiving no other your directions, I think it opportune to let your Excellency know, that, of three vessels which I sent for a convoy unto the Prince, Sir Nicholas Crispe, and Mr. Hasendanke, the merchant, I have but one return, Captain Allen being taken and stript. And I hear a packet of your Excellency's, as well as letters, thrown overboard without weight, were taken up; which I look for shortly to have in print.*

“By the sole return which came unto me, I received notice from the Prince and those about him, in how ill a condition he was enforced to retire into the Isle of Scilly, where he now is; and made use of Hasendanke's frigates to transport himself, whereby I was not only disappointed of what I hoped for by the Prince, but also of his.

“Sir Nicholas Crispe indeed offers to send me three, but they were not then with him, and he desires a return from me first, so that only my Lord of Antrim's frigates are come; and a ship with 18 pieces of ordnance, which is hourly expected, and bought by me at Galway. Two Hollanders there are likewise at Waterford, and two frigates likewise of Captain Antonio's, and the Spanish agents, which carry ordnance. These are all of force, and truly I conceive, might, for so short a cut, be a sufficient convoy, were not Chester taken, the Prince in so bad a condition, and some defeat of my

* See page 124.

brother's forces in Glamorganshire spoken of. But upon these considerations, how hazardous it will be to send away a part of the army only. I humbly offer to your Excellency, not speaking anything of a great disheartening and discouragement some take at a pretended declaration of his Majesty against me, though I myself value it so little, as that, could I, without shortening much more advantage to his Majesty's service, go myself in person with 6000 men, I should no ways boggle thereat. And as it now stands, to give testimony that my zeal is not lessened to his service, and that you may have further assurance of my care to your person, I make this offer, that if you please to join, and together with the Supreme Council assure me, that against my return I may have 10,000 men in readiness for his Majesty's service, I will immediately go and bring back with me twenty sail of good shipping at the least, well furnished for men of war; £40,000 ready money; 10,000 musquets, 2,000 case of pistols, 800 barrels of powder, and a gallant train of artillery.* For I shrink not at this instant from pain and expenses out of diminution of zeal to his Majesty's service, as by the present difficulties propounded may perchance be surmised by others, though not by your Excellency, who (I am confident) will make a right construction, and how I only would willingly retire myself from further present charge, as a ram doth to take a greater vease. For I am not so much frightened at the bugbear declaration, but that, if I could go myself with a considerable force

* This statement agrees pretty nearly with that occurring at page 160, and in "The Earl of Glamorgan's instructions to me, to be presented to your Majesty," signed by Edward Bosden, 21st of March, 1644, viz. :—

"That, God willing, by the end of May or beginning of June, he will land with 6000 Irish, &c. &c.

"That to advance these his undertakings, he hath £30,000 ready, 10,000 muskets, 2000 case of pistols, 800 barrels of powder, besides his own artillery; and is ascertained of £30,000 more, which will be ready upon his return." See the "King's Cabinet opened," 4to. 1645. And Birch's Inquiry, 1756, p. 57.

and provisions, it should not any ways deter me, from the confidence I have in his Majesty's justice and goodness. It is true that two days since I have sent to take myself off from paying demurrage, which would have amounted to one hundred or two hundred pounds a day. But the shipping are still under an embargo, and the soldiers designed for England no other ways disposed of, who may in the interim until my return be useful unto this kingdom, assisted by the Nuncio's purse. If therefore your Excellency resolve upon my journey, I pray send me immediate word by this messenger, whom I have sent of purpose, assuring that the shipping I speak of shall also attend this coast. And if (which God forbid) the King should be already joined with the Parliament, and that my services for him there be consequently rejected, I shall endeavour to serve his Majesty at my return in preserving your Excellency and this kingdom for him; and nothing but an extraordinary confidence in your Excellency's goodness, and an infinite zeal unto my master's service, could make me take this resolution; which I humbly submit to your better judgment, and ever remain,

“Your Excellency's, &c.

“GLAMORGAN.

“Waterford, the 3rd of April, 1646.”

The reply made by the Marquis of Ormond,* to this noble offer, only three days after, shows that he did not esteem it as being in any way extravagant or impossible; he writes:—

“MY LORD,

“I receive your congratulations and devices for my future security as evident testimonies of your continued favour to me; and I am much joyed to find, that the accidents fallen out concerning your Lordship have not

* Bod. Lib. “Carte Papers, 1634-1637, Ireland, 63.” No. 175.

left any impression on you, to the prejudice of the real affection you give me to bear you.

“ My Lord, I had, according to my promise, given you a larger account of things here ; but that, at the concluding of the articles, we found ourselves so straitened in time, that many material parts of the agreement were fain to be put in another way than was first thought of ; and at this instant I am so pressed with important despatches from Kilkenny, that I shall be able but shortly and confusedly to give you a return to the main parts of your Lordship’s [letter] of the 3rd of this month, which came to my hands yesterday about noon. Touching the noble and large offer you are pleased to make of shipping, arms, ammunition, and a train of artillery for the King’s service, in case you may receive assurance from those in power among the confederates, and from me, that ten thousand men shall be ready against your return, to be transported to serve the King in England. I return your Lordship this answer, that I shall, and by this letter do, cheerfully oblige myself for as much as shall lie in my power, either in my public or private capacity, to have that number of men in the readiness you expect ; and to compass it, am contented all the remainder of my fortune should stand engaged. If your Lordship can procure as much as this from the other party, I conceive you will proceed in your intended voyage with satisfaction, and return (I hope) with success ; which is earnestly wished by

“ Your Lordship’s, &c.

“ ORMOND.

“ Dublin Castle, the 6th of April, 1646.”

The following letter from the King, dated the 20th of July, 1646,* originally written in cipher, while it

* A Latin copy is in the Nuncio’s Memoirs, and in Italian in Vittorio Liri’s *Mercurio*, Vol. vii. p. 97, 98. Translation in Birel’s *Inquiry*, 8vo. 1756, p. 244.

shows the estimation in which he justly held the Earl of Glamorgan, only throws a darker shade on his own mysterious and inexplicable line of policy. The Earl's zeal and unbounded confidence in his Royal Master (determining rather to die in his service than to break faith with him), served, as they well might to continue him in his favour:—

“GLAMORGAN,

“I am not so strictly guarded, but that if you send to me a prudent and secret person, I can receive a letter, and you may signify to me your mind, I having always loved your person and conversation, which I ardently wish for at present more than ever, if it could be had without prejudice to you, whose safety is as dear to me as my own. If you can raise a large sum of money by pawning my kingdoms* for that purpose, I am content you should do it; and if I recover them, I will fully repay that money. And tell the Nuncio, that if once I can come into his and your hands, which ought to be extremely wished for by you both, as well for the sake of England as Ireland, since all the rest, as I see, despise me, I will do it. And if I do not say this from my heart, or if in any future time I fail you in this, may God never restore me to my kingdoms in this world, nor give me eternal happiness in the next, to which I hope this tribulation will conduct me at last, after I have satisfied my obligations to my friends, to none of whom am I so much obliged as to yourself, whose merits towards me exceed all expressions, that can be used by

“Your constant Friend,

“CHARLES R.

“From Newcastle, July 20th, 1646.”

On receipt of this letter in Ireland, a copy of it was sent to the Pope, who is related to have shed tears, with

* Being empowered by the King's Commission of the 1st April, 1644.

mingled feelings of gratification and sorrow, the King's circumstances being so desperate; while at the same time his determination to favour the Irish and English Roman Catholics in all their demands was, to all appearance, proportionably increased. The Earl of Glamorgan, on his part, sent his suggestions and devised a plan for his Majesty's safe conduct to Ireland; but the scheme either failed or was abandoned.

On the 30th of August, the Earl addressed a long letter to the Lord Lieutenant,* when he must have been unaware of the fate of Raglan Castle:—

“MAY IT PLEASE YOUR EXCELLENCY,

“I have this long time expected your commands, which to receive, having sent two expresses, I verily believed would have come ere this into my hands; trusting likewise to Mr. Walsingham's solicitations; but as yet I have neither heard from him nor your Excellency, one word since his departure, and receiving an earnest desire from the Nuncio to speak with me; as understanding likewise how prejudicial it might be to me, and especially to my brother who is in Italy, if the dean whom he hath sent thither, should depart without satisfaction from me of so pressing an occasion, as was by my Lord Nuncio pretended unto me. I repaired thither on Saturday last, with so much the more contentment as that I persuaded myself that your Excellency would be at Kilkenny, and I so much the nearer to kiss your hands; but I now return to the county of Clare, there to expect your commands. Yet let me not forget to give you an account of the business I was sent for. The rumour being spread that the Concessions (which some call mine) were to be printed and published at

* Bod. Lib. “Carte Papers, 1634 1637. Ireland, 63.” No. 202.

Kilkenny, as I have absolutely disowned any such thing to my Lord Nuncio, and denied to patronise the same; so I think myself bound to acquaint your Excellency, and by your means the Council Table, how mindful I am of the favours I there received, so as not to incur the least censure of yours and theirs by enacting anything, for which I had already a check. And certainly it cannot be imagined that the Supreme Council which was, could expect or desire any such thing at my hands, since they never urged to take off my recognizance, which through innocency I also neglected, and I joy to be disengaged from so perilous a business, protesting before Almighty God, that since that time I have entered into no new engagements unto them; and what hath passed before (conditions not having been held with me), none of the Commissioners themselves can think them obligatory, all other reasons also considered. Besides, when they had first thought to make use of them, it was resolved, that after the completing of conditions with your Excellency, they might bear a true date subsequent thereunto; and how invalid they are without the same is sufficiently evident, abstracting from the King's declaration, which (though enforced upon him), I esteem it yet a warning for further proceedings therein, and fit only for great persons, who can maintain the same, to go contrary to the intimation of his Majesty's pleasure, though never so compulsorily granted. For as I never have, nor will esteem, and be frighted at the contradiction of any others, when the intimation of his Majesty's pleasure continues to me in any particular unrevoked; so, on the contrary, can I never be drawn, for any man's pleasure, to go immediately contrary to what proceedeth from him, deeming it not my part to enter into dispute which way his Majesty is induced, when I see his positive act extant. Let this,

therefore (I beseech your Excellency), give you and the world satisfaction, that I no ways countenance the standing upon any articles heretofore treated of by me, who am no more tied to make anything thereof good, than any man is to deliver up the possession of his lands for which he never received the consideration agreed upon. Besides, in order to the King's subsistence, one man was then more considerable than three now. In fine, having washed my hands of that business, verify I will that proverb that the *Child burned dreads the fire*. And those noble Lords, who stand my bail, may be confident, I shall never deservedly put them in fright, or myself in danger to save them further harmless; or to show such ingratitude to your Excellency and the Council as to own those concessions which they so much endeavoured to prevent. And thus fearing to have been too tedious, I abruptly kiss your Lordship's hands and ever remain

“ Your Excellency's, &c.

“ GLAMORGAN.

“ Waterford, the 30th of August, 1646.”

Ormond replied under date, Dublin Castle, the 2nd of September, 1646, saying—“ I must profess myself exceedingly satisfied with the prudence of your Lordship's carriage at Waterford, and with the wisdom of the resolution you have taken in the particular of those things now endeavoured to be fastened upon you;” and which course he designates “ a thing so much to your Lordship's honour and advantage.”

Under date of 11th of September, the Earl again addressed the Lord Lieutenant:*

* Bod. Lib. “ Carte Papers, 1634-1637. Ireland 63.” No 207.

“MAY IT PLEASE YOUR EXCELLENCY,

“I think myself very happy in that the resolution which appeared in my letter unto you proved so acceptable, as by the noble expressions of your letter and of my Lord Digby’s I find it is, and do humbly acknowledge infinite thanks for your Excellency’s great desire of seeing me; and had the self-same letter informed me of any service I could have done you, I should have been far from taking the resolution which I now have put on, correspondent unto my expressions in my last unto your Excellency, and unto the sense for which the commendations given me by you (I conceive) do proceed: which was to keep myself free from having any part in those most unfortunate and newly occasioned distractions, from which the further I withdraw myself, and the sooner, suits best with my disposition. Besides, my intentions wherewith I came into this kingdom were first to serve his Majesty and it; and next to serve your Excellency above all his subjects, and my own friends, which being now frustrated, that part only remains which can only die with myself, which is *Omnibus viis et modis*, to endeavour to promote his Majesty’s service, finding myself more capable and more probable for to do it elsewhere for this present, than in this kingdom. I hasten towards the seaside, where I am informed some conveniency of shipping will afford; . . . yet I could not omit to send a person of trust and confidence, by whom your Excellency may send unto me before my departure such notions as perhaps you may think not fit to put to paper. And if, either by word of mouth or writing sent by so trusty a person as Mr. Joyner (by whom I have sent you the reasons, that debar me of the happiness to kiss your Excellency’s hands *in transitu*), I find myself thought capable by you to serve his Majesty or

your Excellency longer in these parts, and more advantageously than what I am now going about, you may be confident to receive such a return from me as may best stand with my duty to his Majesty and my affection to your person, to whom my professions have been ever real; and had my ambition and only thoughts taken place, I dare boldly say, I should have vied with the nearest person in blood or affection you have in Ireland, in the reality of being ever,

“Your Excellency’s most really
“affectionate kinsman and
“devoted servant,

“GLAMORGAN.

“Limerick, the 11th of September, 1646.”

Among the Carte MSS. in the Bodleian Library, from which the foregoing letter is taken, there occurs a curious undated letter written in cipher, which it is just possible may be the writing above named “sent by so trusty a person as Mr. Joyner.” The annexed engraving is a facsimile of an endorsement at the back of it

*It is humbly desired that
the Right Ho: the Lord
Marquis of Ormond Lord
Lieutenant of Ireland be
pleased to keepe this until
the Earle of Glamorgan
before his going out of
this Kingdome call for
it*

in the Earl's own hand-writing, affording the only specimen approaching to an autograph exemplifying his use of the title of *Glamorgan** yet made public: every effort to obtain it in any other form having proved unavailing. And on page 180, an exact copy is given of the letter itself, as traced from the original.

The Nuncio wrote from Kilkenny on the 21st of September, 1646, to Cardinal Pamphilio at Rome,† as follows:—

“ Among other patents and commissions signed by the King, and brought by the Earl of Glamorgan from England, there is one, appointing him Lord Lieutenant of Ireland, upon the expiration of the Marquis of Ormond's term of holding that post, or in case the Marquis should, by any fault, deserve to be removed from it. For this reason, I was of opinion, that the Earl, who had designed to go to Rome, should stay for the present in this kingdom, imagining, that a way might perhaps be opened for accomplishing this affair. And in fact the way seems open for us, since the Marquis of Ormond is now publicly negotiating with the Parliamentarians, and consequently making a treaty with the King's enemies. Upon which occasion, the Earl, being desirous of advancing himself to the Marquis's post, has begun to solicit the consent of the kingdom, and believes, that he has the interest of the two Generals, and all the Congregation of the Clergy and the New Council. I have thought it the more proper to promote this affair, since when Dublin shall be taken, it will be immediately necessary for the king-

* The autograph of *Glamorgan* is said by Dr. Lingard to have attested a *copy* of his Warrant of 12th January, 1644; possibly the one originally handed by him to the Marquis of Ormond. It is not, however, among his papers at St. Cuthbert's College, Durham.

† Nuncio's Memoirs, fol 1376-1379. Birch, Inq. p. 253-256.

dom to provide a Lord Lieutenant. And it is a point of no small importance to the present situation of affairs, to begin with appointing to that post a Catholic, so highly beloved by this kingdom and the King himself. Besides it is to be considered, that the King's inclination and pleasure concurs with this design; for though his Majesty has appointed the Earl by his lesser seal only, yet that is sufficient for the Irish, since they have just reason to consider that appointment as legal and valid. Add to this, that as the Confederates of Ireland have it in their view to transport the Holy Faith into England by their arms, no person appears to be more fit for the execution of such a purpose, than the Earl, in whom two characters are united, that of a faithful servant to the King, and a perfect Catholic; and who, the winter before, was ready to carry over to the King from that country ten thousand men for the same purposes. Some, and those but a few, oppose this design, upon this single consideration, that the Earl being both an Englishman and of a very mild temper, will not be favourable enough to Ireland, nor exert the firmness necessary in this case. But I believe no better choice can now possibly be made, and that the appointment of a Catholic Lord Lieutenant, who is in so many respects attached to the Apostolical See, and bound to it by oath and promises, which the Earl has a hundred times repeated to me, is sufficient to weigh down every other doubt."

And about the 28th of the same month the Earl took the following Oath* to the Nuncio:—

"I, Edward Earl of Glamorgan, &c. faithfully promise and swear, that I will do nothing of moment

* See his previous Oath, page 159.

without the consent and approbation of the most illustrious Nuncio; and if I shall happen to do anything imprudently, which shall not be approved by him, I will correct my error upon the first intimation of his pleasure, and obey his commands. If it should be more conducive to the praise and glory of God, the splendour of the Catholic Church, and the happiness of this kingdom, that the post of Lord Lieutenant be conferred upon another person rather than myself; I swear, that I will readily and without reluctance resign it, at the command of the most illustrious Nuncio. And in all things I vow a perfect, voluntary, and religious obedience to his Holiness, saving any secular obligations towards my most serene King. And if I fail in any part of the oath taken by me, I consent, that the said oath be published, and myself exposed; otherwise the said oath shall be communicated only to the Bishop of Fernes, Chancellor of the Congregation, and Father Robert Nugent, Superior of the Jesuits in Ireland. In confirmation of this oath voluntarily taken by me, I have written all this with my own hand, subscribed my name, and affixed my seal, the 28th of September, 1646.

“GLAMORGAN.”

These various letters and documents make us familiar with the Earl of Glamorgan's Irish treaties,* and to a great extent with the cause of their failure: a most happy and provident circumstance for himself, his family, and above all for his country. His conduct throughout, notwithstanding the many temptations in his way, and his own naturally enthusiastic conduct in every enterprise in which he engaged, bears none of the distinguishing traits of intolerant bigotry. The King

* See his own explanations, given in a letter to the Earl of Clarendon, dated 11th June, 1660.

had already sapped the Earl's available property, and was continually tantalising him with the prospect of coming fortune and ample honours. He fawned on the old Marquis and flattered his son; inducing the one to place his wealth, and the other his honour and happiness at his disposal. Perhaps in the whole course of his political scheming he never succeeded so completely, as in this instance, in thoroughly victimising any single noble family.

On the 1st of October, 1646, the House of Lords ordered, That a pass be granted to the Lady Herbert, Countess of Glamorgan, into Ireland, with thirty of her menial servants, etc.*⁷⁴ So that from August, when she left Raglan Castle, with the other inmates, to this period, she must have been a wanderer.

Towards the close of the year 1646, it was decided between the Earl and his own party, to send his brother, the Lord John Somerset, a zealous Catholic, on a mission to the Pope. The Earl's complicity with the clergy in these affairs, which had been conducted with great secrecy, occasioned much suspicion, creating for him many enemies among the Protestant party.

In August, 1647, the Marquis of Ormond, leaving Ireland, waited on Charles the First at Hampton Court: Dublin being besieged, and likely to fall into possession of the English Parliament.

While affairs were in this distracted state the Earl was apprised of his father's decease, in December, 1646; and as Marquis of Worcester, he wrote from Galway to the titular Bishop of Fernes:—²⁶

“MY NOBLE LORD,

“Although the place whither I go be now changed upon serious consideration, and my Lord Nun-

* Lords' Jour. VIII. 507.

⁷⁴ Nichols.

²⁶ Clarendon, vol. ii. p. 380.

cio's concurrence therein, as most advantageous *super totam materiam*, yet are my intentions the same they were when I left your Lordship; and I hope a shorter way contrived to them than I then imagined, having found a probable (I may call it even a certain) way to bring the Queen about to befriend this nation. In the interim, I beseech your Lordship, together with the Lord Bishop of Clogher and Mr. Rochfort, to be mindful of your promises to me, and to be sure that General O'Neile dissent not from the letter which you approved; the contents whereof I have not failed accordingly to recommend to his Majesty: and if I should deceive him therein, I must betake myself unto your Lordship's advice and approbation, given thereupon. The copy of the original letter, together with the Nuncio's recommendation, are to be delivered to General O'Neile by Father Definitor; and I have no more to say than that your Lordships (as I have said before), with Mr. Rochfort are the Triumvirate and the pillars upon whom I build, making no question of the goodness of that foundation; and I hope none of you do of my affection, which is not only devoted to yourselves, but as you shall further apply it to such persons as may be useful to God's service, the King my master's, and the good of this kingdom. And so, with my service to you all, I ever remain,

“My Lord,

“Your Lordship's most humble

“and devoted Servant,

“WORCESTER.

“Galway, 12th Oct. 1647.”

His Lordship ultimately left Ireland in company with Father George Leyburn, a Roman Catholic priest, with whom he went to France in March, 1647-8.⁶¹

⁶¹ Leyburn, p. 61.

CHAPTER XI.

THE MARQUIS OF WORCESTER AN EXILE ; RESIDES IN
FRANCE.

THE Earl of Glamorgan, succeeding to his father's title and honours in December, 1646, while he was yet in Ireland, very soon after, as we have seen, went to France, a voluntary exile. His countrymen had heaped on him (in common with the entire Roman Catholic adherents to the royal cause) all the acrimonious abuse which political and religious intolerance is always too ready to disseminate, with a zealous ardour which defies discrimination. His fate, it is true, was the general fate of hundreds of noble families, condemned in like manner to suffer for their loyalty. While we are prone to praise what is gained by a rebellion, we are apt to overlook whether the civil war entered upon for effecting it, might not have been avoided ; and while lauding times which bring to light some great military and naval spirits or still greater statesmen, we overlook entirely the possibility of altogether destroying the mental energies of men of brighter intellects, doomed to fall in the flower of their age on the field of battle. The blessings of good government all readily admit, but sad indeed is it, when wholesome changes in a state have to be effected through convulsions that paralyse a nation's advance in civilization.

It is clear, on a retrospect, that much has been delayed, much missed, and more possibly lost that other-

wise might have arisen from energies sacrificed, alas! to the sword, and fortunes turned into other and wasteful channels. In this nineteenth century we can calmly look with some wonder and astonishment on the indifference of the seventeenth, in failing to realize at least some of the Marquis of Worcester's remarkable Inventions, of which we shall shortly have to treat more at large.

On the 18th of September, 1646, the House of Commons "Ordered, That the Lady Herbert, wife of the Lord Herbert of Raglan, shall have Mr. Speaker's pass to go into France, only according to the pass given her by Sir Thomas Fairfax." From this it is probable that Henry, Lord Herbert, the Marquis of Worcester's only son, was already in France.

Mr. Carte, ²⁴ in his life of the Duke of Ormond, incidentally alludes to the Marquis of Worcester, as being at Paris a few months before March, 1648; he says:—

"In 1648, the Duke of Ormond considered the Parliament was grown jealous of him, and wanted a pretext to seize his person. He had notice likewise given him, that a warrant was actually issued out for that purpose, though in breach of the articles.* Upon this advertisement, he quitted Acton—ten miles from Bristol, where he was then residing,—and crossing the country to Hastings in Sussex, he took shipping for France, and landed happily at Dieppe in Normandy. From thence he went in the beginning of March [1648] to Paris, there to wait upon the Queen and Prince, and assist with his advice in the present conjuncture of affairs, when matters of the greatest consequence, the most in-

²⁴ Carte, vol. 2. p. 16.

* He had liberty by his articles to stay twelve months in England—but the Parliament was jealous of his doing them a disservice.

tricate nature, and the most embroiled circumstances, were under their consideration, and resolutions to be taken therein for his Majesty's service:"—he having just previously escaped from the Isle of Wight.

"The Earl of Glamorgan* had come to Paris a few months before him, recommended by the Nuncio Rinuccini to Cardinal Mazarine, and to the Pope's Nuncio in that place, on account of his attachment to the Holy See, though unfortunate in all his undertakings, and not endued with that prudence which was necessary to the post he desired. His business there was to solicit the Queen to make him Governor of Ireland, but he met with so ill a reception at Court, that he soon despaired of succeeding. His Lady, to whom the Marquis of Ormond had once made his addresses, (before he had hopes of marrying his cousin, and uniting the estate of his family) resented the neglect shewed of her Lord, and imputed it, as well as his imprisonment at Dublin, to the influence and power of the Marquis. She carried her resentment so far, that when he waited upon her after his arrival at Paris, and offered to salute her, she turned away her face with great disdain. The Marquis thereupon made her a reverence, and with great presence of mind, said, 'Really, Madam, this would have troubled me eighteen years ago;'† and then went to the next, the company present being of his acquaintance, and much pleased with what he had said."

We may here pause to remark that, from the close of the year 1640, when the Long Parliament commenced its memorable sittings, the prominent events affecting the history of art and science in England are comparatively meagre, as might be expected, while the public mind was being perpetually distracted and disturbed

* See Nuncio's Memoirs, fol. 1818. Ireland, iii. 100.

† See her Marriage in 1639, page 30.

not by intestine war alone, but also by plague and pestilence in fearful forms.

Of remarkable events of the period we especially notice the fortifying of London in 1643, and the delivering up of Charles the First to the Parliament by the Scots in January 1647, followed by his execution on the 30th of January 1649, the establishment of the Commonwealth on the 6th of February following, and of the Protectorate under Cromwell in 1654.

Under the new regime, public taste either was greatly changed, or was to be compulsorily directed into new channels, for, in 1647, theatrical performances were prohibited, actors were declared rogues and vagabonds, and all places usually employed for theatrical performances were ordered to be demolished. Such was the narrow-minded and furious puritanical zeal of the then governing power.

Charles the Second held his Court at Paris, where alone the Marquis of Worcester associated with the libertine monarch; at least no circumstance occurs to show that he ever removed with the Court in its several changes to Cologne, Bruges, Brussels, and other continental towns.

Sir Richard Browne, ambassador at Paris, in his correspondence with John Evelyn, when writing from Paris, the 3rd of August, 1648, incidentally observes in a postscript:—"Our Court wants money, and lives very quietly at St. Germain: where no peer appears but my Lord Jermin. The Marquis of Worcester, the Lords Digby and Hatton, though yet in France, yet live for the most part in Paris."³⁷

³⁷ Evelyn. The Editor of the Diary erroneously indexes the Marquis as—"Henry Somerset, &c.," instead of "Edward Somerset, &c."

The Marquis had been little more than a year in France, when he seems to have written to the exiled King, then at Jersey, for some confirmation of his titles; to which request he received the following courtly compliments and vain empty promises :—*

“ MY LORD WORCESTER,

“ I am truly sensible of your great merit and sufferings in the service of the King my father, and I shall never be wanting to reward and encourage as well that kindness to his person as that zeal to his service which you have expressed in all your actions, and which I doubt not but you will still continue to me. I fear that in this conjuncture of time it will not be seasonable for me to grant, nor for you to receive the addition of honour you desire ; neither can I at this time send the order you mention concerning the Garter, but be confident that I will in due time give you such satisfaction in these particulars and in all other things that you can reasonably expect from me, as shall let you see with how much truth and kindness I am

“ Your affectionate friend,

“ CHARLES R.

“ I do not send the letter to Monsieur Monbrun till I understand more particularly from you what the intention of it is, which I do not yet well understand.

“ Jersey, 21/31 of Octob. 1649.

“ For the MARQUIS OF WORCESTER.”

The Marquis was probably for four or five years a refugee in France, intimately associated with the exiled Court; “ Paris and indeed all France (says Evelyn³⁷), being full of loyal fugitives,” in 1650. Many vague surmises have originated with different writers to account for

* From MSS. Badminton.

³⁷ Evelyn.

the manner in which he passed his time abroad, all alike fallacious, being inconsistent with facts. It is certain that his finances were equally straitened with those, not only of the nobility around him, but likewise of the King himself. He could have had but few, if any, opportunities for leisurely engaging in his usual studies, much less for any practical pursuits in experimental natural philosophy. That he was not wholly idle, however, we may well conceive; yet it is more consistent to suppose that it was a period in his life which he would most likely employ to investigate the works of those writers whose labours he most affected, rather than engage himself in productions which might only add to the danger as well as the difficulties of his uncertain journeyings, surrounded as the Court was with political spies.

During the Marquis's absence on the continent, we proceed to trace the progress of events at home.

CHAPTER XII.

AFFAIRS AFFECTING THE MARQUIS OF WORCESTER'S FAMILY,
IN RESPECT OF WORCESTER HOUSE AND OTHER PROPERTY
IN AND NEAR LONDON.

WORCESTER House, in the Strand, was of course early in possession of the Parliament, who used it for the state paper and other public offices. The mansion had gardens to the water-side.* In the reign of Henry VIII. it had belonged to the see of Carlisle; it was afterwards inhabited by the Earls of Bedford, being then known as Bedford and Russell House, from whom it came to the Earls of Worcester, when it assumed their name. It also figured as the temporary residence of the great Earl of Clarendon,³⁷ who is represented to have paid for it a rental of £500² per annum, probably taking it furnished.

On the 21st of April, 1643, the House of Commons had³⁷ ordered, "That the iron seized in Worcester House, be forthwith sold; and the proceeds delivered to the collectors in the county of Middlesex, appointed by the ordinance for seizing the estates of Papists, and notorious malignants; to the end that they may be accountable to the Committee for it: And that no Committee, or other person, do grant out Warrants for seizing the estates of malignants, without the knowledge of that Committee; in regard there is an ordinance settled to

³⁷ Evelyn.

² Allen's London.

³⁷ Jo. H. C. Vol. iii. p. 54.

* See engraved view, page 8.

that purpose, and a Committee armed with power for the execution of the said Ordinance, in all the points and circumstances hereof."

In pursuance of an Ordinance of Parliament,* passed the 11th of September, 1646, contracts were concluded by the Government with various purchasers of houses, stables, sheds and plots of ground, the joint property of the Marquis of Worcester and his brother, Sir John Somerset, some situated in the parish of Clements Danes in the Strand, a part in Drury Lane, and smaller tenements in Fish-Street Hill, Cross Lane, and Coppings Court, in the City; together with a house, farm and land in Stepney, "alias Stebunheath;" also the manor of Acton, with its farm-house, buildings, and 805 acres of land; the whole for the sum of £12,584. 12s.—Nearly half this amount arose from the purchases of "William Penmoyer and Richard Hill of London, merchants," to whom the Government was indebted in the sum of £9,402. 5s.—which was to be paid out of such sales of this property, and any amount remaining was to bear "interest after the rate of £8. *per centum* for a year." And they had further the option of claiming any purchases of the property not paid for within ten days; so that either out of purchases or by forfeitures they were secured for their balance of £3,199. 13s. over and above their own purchases.†

That Worcester House became a depot for the security of treasure seized by the Parliament, we learn from a Resolution passed by the Commons⁵ on the 10th of January, 1650.

"Resolved, That Colonel Berksted be, and is hereby, required to appoint four of his soldiers to lodge every

* See "Ordinances of Parliament," 1641-46, 4to. Brit. Mus. 517, K. 11-36.

⁵⁷ Jo. H. C. Vol. vii. pp. 523, 533.

† See also Miscellaneous MSS Brit. Mus. No. 5501.

night at Worcester House; and four other of his soldiers to lodge every night at Guildhall; for the better securing the treasuries there, from time to time, as the Treasurers at War shall appoint.”

On the 11th of February following, the House,⁵⁷ among other business—

“Ordered, That it be referred to the Council of State, to dispose of Worcester House, and the yards and gardens thereunto belonging, for the best carrying on of the public service of the Commonwealth.”

The Marchioness of Worcester, being deprived of other sources of property, petitioned the Parliament in respect to the only likely means of obtaining pecuniary consideration. A copy of her petition, being a printed folio fly-leaf, probably as then in use for members of the House, preserved in the Library of the British Museum, has upon it the MS. date “October 1654,” but it is more probable that it was not presented to Parliament before the end of 1656 or early in 1657. It is as follows:—

“To the Parliament of the Commonwealth of England, Scotland, and Ireland.

“The humble Petition of Margare[t Somerset] Countess of Worcester.

“Sheweth,

“That your Petitioner having been married to Edward, now Earl of Worcester, in the year 1639, with a considerable portion, to the value of twenty thousand pounds, and not having received out of the whole estate but four hundred pounds these nine neares [years], in lieu of jointure, fifths, or thirds. Notwithstanding her claim and four years’ attendance: and finding now

⁵⁷ J. H. C. Vol. vi. pp. 523, 533.

only *Worcester House* unsold, and in pursuit to discover some other little thing.

“ *Your Petitioner humbly prayeth your Honours, to grant her the benefit of the said House, and such other things as may be discovered.*”

“ And your Petitioner shall ever pray, &c.”

Every circumstance connected with this petition acquires interest from the peculiar position of the times, and of all parties interested. The Marquis of Worcester had rendered himself highly obnoxious to the dominant party, he was beyond their power, a recusant and a papist, and here was his noble Lady petitioning the Cromwellian Parliament in respect to her rights, a papist demanding her fifths at the hands of her husband's bitterest enemies. We need, therefore, offer no apology for tracing rather more particularly than might otherwise seem requisite, the course pursued in this simple affair.

On Monday, the 30th of March, 1657, Mr. Burton²² reports from the Committee, to whom the Petition of Margaret Countess of Worcester was referred ;

“ A Bill for settling the messuage in the Strand, called Worcester House, on Trustees, for the life of Edward, Earl of Worcester, in trust, for Margaret, Countess of Worcester, in lieu and satisfaction of the arrears of her fifths, was this day read the first time ; and, upon the question, ordered to be read the second time, on Thursday morning next.”

On Saturday, the 2nd of May, 1657.

“ The Bill for settling Worcester House upon Margaret Countess of Worcester, and some discoveries, in lieu of the arrears of her fifths, was this day read the second

²² Burton.

time ; and, upon the question, committed to Mr. Nath. Bacon, Mr. Franc. Bacon, Mr. Burton, and 29 other members, to meet on Tuesday next."

On Friday, the 16th of June, 1657, "a Bill for settling of Worcester House upon Christofer Copley, Esquire, and William Hawley, Esquire, during the life of Edward, Earl of Worcester, and also such monies as were due to the said Earl or Margaret his Countess, from Barnaby, Earl of Thomond ; in trust for the said Countess, was this day read the third time.

"The humble petition of Barnaby, Earl of Thomond, was this day read :

"A Proviso was tendered to this Bill, in these words ; viz. 'Provided that this shall not impeach or invalid the sale of the Gate-house of the said Worcester House, by the trustees appointed for the sale thereof.'

"Which was read the first and second time ; and, upon the question, agreed to be part of the Bill.

"And the said Bill, with the Schedule annexed, being put to the question, passed.

"Ordered, That this Bill be tendered to the Lord Protector, for his consent."

After other business, the Speaker, with the whole House, repaired to the Painted Chamber, to present the Bills to his Highness, who gave his assent to this, along with other Bills.⁵⁷

After much delay, from unexplained postponements and references, it was at length, on the 24th of March, 1658-9, resolved, to agree with the Committee's recommendation.²² We, therefore, find on the 14th of April, 1659,⁵⁷ after prayers—

"Mr. Terill reports from the Grand Committee of the

⁵⁷ Jo. H. C. Vol. vii. p. 512, 529, 576.

²² Burton.

House of Grievances, the state of the case, upon the petition of Margaret, Countess of Worcester, concerning her interest in Worcester House in the Strand.

“Resolved, &c. That Margaret, Countess of Worcester, have the actual possession of Worcester House in the Strand delivered up to her on the 25th day of March next: and that, in the meantime, the rent of £300 be paid to her for the said house, for this year, commencing from the 25th day of March last, out of the receipt of the Exchequer, half yearly, by equal portions, if her interest therein shall so long continue.

“Resolved, &c. That the sum of £400 be paid to Margaret, Countess of Worcester, or her assignees, out of the receipt of the Exchequer, in recompense of all demands for the detaining of Worcester House from her since her title thereto, by virtue of the late act of Parliament, until the 25th day of March last.

“Sir George Booth, Sir William Wheeler, Mr. Raleigh, Sir William Doyley, Mr. Annesley, or any three of them, are appointed a Committee to wait on his Highness, the Lord Protector, from this House, to desire his Highness to give direction for a Privy-Seal to be issued for the payment, as well of £400 allowed to the Countess of Worcester, for her recompense of all demands for detaining of Worcester House from her since her title thereunto, by the late act of Parliament; as of the rent of £300 appointed to be paid to her for this present year, for the said house, to end on the 25th of March next.

“Resolved, &c. That it be referred to a Committee, to consider how to remove, and where to place, the conveyances, records, and other writings, now remaining at Worcester House, so as they may be disposed for their safety, and the service of the Commonwealth.

“A Committee accordingly appointed.”

“ Tuesday, the 19th of April, 1659.*

“ Mr. Annesley reports from the Committee appointed to attend his Highness about the payment of £400 to the Countess of Worcester, in satisfaction of all demands due to her, for the use of Worcester House, till the 25th day of March last; and of £300 more for the rent of the said house for this present year, to end the 25th day of March next; that the Committee had attended his Highness, and acquainted him with the Orders of this House in that behalf: that his Highness was pleased to give the Committee this answer, That he assured himself the House had considered of her interest; and that himself was therewith satisfied; and did take notice of the Orders; and would give speedy direction for her satisfaction accordingly.”

“ Saturday, August 20th, 1659.†

“ Ordered, That the sum of £6 by the week shall be paid unto Margaret, Countess of Worcester, or her assigns, so long as Worcester House shall be made use of by the Commonwealth; to be paid to her, or her assigns, out of the contingencies of the Council of State: and the acquittance of the said Margaret, Countess of Worcester, testifying the receipt thereof, shall be a sufficient discharge in that behalf.

“ Ordered, That the Commissioners for removing of obstructions, trustees, contractors, and other officers, at Worcester House, do quit the said house, as soon as they can conveniently, without prejudice to the service of the Commonwealth: and that when the said house shall be quitted, that the same shall be settled upon the Countess of Worcester, or upon trustees to her use, during the life of Edward, Earl of Worcester: And it is

* Page 642.

† Page 763.

“ Ordered, That it be referred to a Committee, to set out some rooms in Worcester House, for the use of the said Countess of Worcester in the meantime: And it is further—

“ Ordered, That the said Committee do also examine whether it is necessary for the Commonwealth to continue to make use of Worcester House for the service of the Commonwealth; or whether it be best to take some other course for the accommodation of the said Commissioners, &c. at Worcester House, &c.”

“ Wednesday, 14th March, 1659. Afternoon.*

“ An act for settling Worcester House in the Strand upon trustees, for the use of Margaret, Countess of Worcester, during the life of Edward, Earl of Worcester; and also such monies as are due to the said Earl or Countess, from Barnaby, Earl of Thomond, was this day read the first time.

“ Ordered, That the pension of six pounds a week formerly ordered to Margaret, Countess of Worcester, be continued until the Parliament take further order; and that the same be forthwith paid, with all arrears thereof, from the time of the granting thereof unto her the said Margaret, Countess of Worcester, or her assigns, out of the contingencies of the Council of State: And that the Council of State be, and are hereby, authorized and required forthwith to pay the same, accordingly: And that the Council of State be repaid the same money out of the public revenue of the Exchequer.

“ Ordered, That the possession of Worcester House in the Strand, in the county of Middlesex, be forthwith delivered up to Margaret, Countess of Worcester: And the Council of State are hereby authorized and required,

to take care, that the possession of the said house be delivered up to her, or her assigns, accordingly."

" Wednesday, 14th March, 1659. Afternoon.*

" A Bill empowering the trustees for sale of lands forfeited to the Commonwealth for treason, to convey Worcester House to trustees in trust for Margaret, Countess of Worcester, was this day read the first and second time; and, upon the question, passed."

Thus it occupied above two years to obtain anything approaching an equitable arrangement of the Countess' very obvious claim, concluding at last with a " pension of six pounds a week,"—a pension in arrear in March, 1659, but to be " continued until the Parliament take further order."

* Page 876.

CHAPTER XIII.

THE MARQUIS OF WORCESTER'S SON, AND TWO
DAUGHTERS.

WITH a view to giving completeness to the preceding domestic narrative (affecting the Marchioness of Worcester, in respect to Worcester House), our remarks have extended to the early part of the year 1659, thus going some years beyond the time of the Marquis of Worcester's flight to and residence in France.

We come next, in the order of family claimants, to consider the several petitions, first of his son, Henry Lord Herbert; and next of his daughters, Ladies Anne and Elizabeth.

On Wednesday, the 23rd of April, 1651, the humble petition of Henry, Lord Herbert, was read in the House of Commons,⁵⁷ when it was—

“Ordered, That it be referred to a Committee, to consider what interest the Petitioner hath in any of the lands, late the Earl of Worcester's, settled by Act of Parliament on the Lord General, and the value thereof, and to report the whole state of the business to the Parliament. And, in case they find the Petitioner hath any good title to any of the said lands, that then they bring in a proviso, for excepting out of sale, by this Act, so much of the lands of the said Earl, now in the power of the Parliament to dispose of, as may be of

⁵⁷ Jo. H. C. Vol. vi. p. 565.

like value ; to be disposed of as the Parliament shall see cause."

After naming a Committee—

"Ordered, That the business of the delinquency of the Lord Herbert of Raglan, as to the matter of fact, be referred to this Committee ; to send to the Commissioners at Goldsmiths' Hall, for what evidence they have against him ; and to report the state of the business touching the delinquency charged on the said Lord Herbert, to the Parliament."

This was succeeded, on Wednesday, the 21st of May, 1651,* by an inquiry into the state of the case of the Lord Herbert of Raglan, reported as follows :—

"Manors and lordships of Tidenham in the county of Gloucester ; Chepstow Barton, and Hardwick Chepstow, Burgus, and Frythwood, in the county of Monmouth ; the seigniory of Gower in the county of Glamorgan ; by force of two several indentures, one of them dated 3^o Junii, 3^o Caroli, the other dated 10^o Novembris, 1631, for good and valuable considerations, in the said indentures mentioned, were settled upon the Earl of Worcester, for and during his life only ; the remainder thereof to the said Lord Herbert, and the heirs male of his body ; with divers remainders over ; which said lordships and manors are, by Act of this present Parliament, settled upon the Lord General Cromwell and his heirs ; and are of the yearly value of one thousand seven hundred and seven pounds, fifteen shillings and two pence.

"And that the manors of Monmouth, Wisham, Pelleny, Purcasseck, Trellocks Grange, the demesnes of Grosmond, Skewfreth, and Monmouth, Bettus, and Per Lloyd, in the county of Monmouth, the manor of Crook-

* Page 577. The same inquiry also supplied an interesting notice of Lord Herbert's early life.

ham in the county of Berks, the manor of Kendall in the county of Westmorland, the manor of Shopden in the county of Hereford, by force of several conveyances thereof made, are settled upon the Earl of Worcester, and the heirs males of his body; with divers remainders over; all which said manors and lands are forfeited, for treason of the said Earl; and are in the power of the Parliament, to settle or dispose of; and are of the yearly value of one thousand seven hundred pounds, twelve shillings and sixpence.

MONMOUTHSHIRE.

	£.	s.	d.
The manors of Monmouth and Wyesham	186	0	10
The manor of Pellenny	38	18	0
The manors of Purcasseek, and Trellecks Grange	443	0	8
The demesnes of Grosmont, Skenseth, and Monmouth	160	0	0
Bettus and Per Lloyd	110	0	0

BERKS.

The manor of Crookham	392	6	10
---------------------------------	-----	---	----

WESTMORELAND.

The manor of Kendal	220	6	6
-------------------------------	-----	---	---

HEREFORD.

The manor of Shobdon	150	0	0
--------------------------------	-----	---	---

Sum	£1700	12	10
-----	-------	----	----

“Lands disposed of by the Parliament to my Lord General Cromwell, and entailed on my Lord Herbert:—

GLOUCESTER.

	£.	s.	d.
The lordship of Tyddenham	356	3	11

MONMOUTHSHIRE.

	£.	s.	d.
The lordships of Chepstow Barton, and Hardwick	510	1	10
Chepstow Burgus	68	13	8
Frithwood, near unto Chepstow, conceived to be equivalent to £100 per annum .	100	0	0

GLAMORGANSHIRE.

The seigniory of Gower	672	15	9
Sum	<u>£1707</u>	<u>15</u>	<u>2</u>

“The question being put, That the House do take into debate the business of delinquency, concerning the Lord Herbert of Raglan.

“It passed with the negative.

“Resolved, That it be sent back to the Commissioners for compounding, to proceed touching the point of delinquency charged on the Lord Herbert of Raglan; and give judgment therein; and to report their judgment, and the grounds of it, to the Parliament, forthwith.”

Again, on Thursday, the 30th of October, 1651.⁵⁷

“The humble Petition of Henry, Lord Herbert, of Raglan, was this day read.

“Ordered, That this Petition be referred to the former Committee, touching the Lord Herbert, to consider of this business; and if they find the Petitioner hath just title to the land, to present some lands to the Parliament for the Petitioner’s satisfaction, in consideration thereof.

“Ordered, That it be referred to the same Committee,

⁵⁷ Jo. H. C. Vol. vii. p. 33.

to consider of the lands settled upon Mr. Peters, to which the Lady Anne Somerset maketh title; and if they find her title thereunto to be just, that then the said Committee do present some other lands to be settled upon the said Lady, in lieu and satisfaction of her title to those lands.”

And on Friday, the 9th of January, 1651-2.*

“Mr. Say reports from the Committee, to whom the business touching the Lord Herbert of Raglan was referred, several resolutions of that Committee, as followeth:—

“Resolved, That the houses and lands conveyed by Act of Parliament unto Mr. Pennoyer and Mr. Hill, were, by indenture, dated 3^o Caroli, conveyed by Edward, then Earl of Worcester, unto the Petitioner and his heirs, after the decease of Edward, now Earl of Worcester, who is but tenant for life thereof.

“Resolved, That the yearly value of the said houses and lands are, and were, before the beginning of these wars, £786.

“Resolved, That it be humbly presented to the Parliament, as the opinion of this Committee, That the several manors and lands, the inheritance whereof is by this present Parliament settled upon the Petitioner and his heirs, and are of the yearly value of £1700; that the present possession thereof be granted unto the Petitioner, he paying to the trustees for sale of delinquents' lands, the sum of £800.

“Resolved, That it be presented to the Parliament, as the opinion of this Committee, that the trustees and contractors for sale of delinquents' lands, do convey the said manors and lands to the said Petitioner, during

the life of Edward, Earl of Worcester; the said Petitioner paying to them therefore the said sum of £800.

“Resolved, by the Parliament, That in satisfaction and discharge of the title and claim of the Lord Herbert of Raglan unto the houses and lands settled by ordinance of Parliament on Mr. Pennoyer and Mr. Hill, the trustees for sale of several lands and estates forfeited to the Commonwealth for treason, be authorized and required to convey unto the said Lord Herbert of Raglan, and his assigns, all the manors and lands, the inheritance whereof is, by this present Parliament, by an Act, intituled, An Act for Sale of several Lands and Estates forfeited to the Commonwealth for Treason, settled on the said Lord Herbert, and his heirs, during the life of Edward, Earl of Worcester; the said Lord Herbert paying for the same, to the Treasurers of the receipt, the sum of £800. And that the present possession of the said manors and lands be thereupon delivered unto the said Lord Herbert: And that the Commissioners for compounding be authorized and required, upon a certificate of the said Treasurers, to take off the sequestration thereof.”

The Marquis's two daughters were, like their mother-in-law, petitioners to Parliament for the restoration of their rights in their proportionate share of their father's property. On the 17th of March, 1647, after other business before the House of Commons, “The humble petition of Anne and Elizabeth, daughters of Edward, Earl of Worcester, was read.” And it was ordered, “That this petition be referred to the consideration of the Committee, where Mr. Wheeler has the chair.”

On the 9th of July, 1649, after a lapse of two years and a quarter, this matter was again before the House, when, “The humble petition of the Ladies Anne and Elizabeth, daughters of the Earl of Worcester, was read:—

“Whereas, according to an order of the Committee of Lords and Commons for sequestrations, of the 17th of March, 1646, the Committees of Monmouth, Brecknock, Glamorgan, Gloucester, and Berks, have sent out, and assigned, unto the Petitioners, a fifth part of their father’s estate in those counties, towards their respective maintenance: It is ordered by the Commons assembled in Parliament, That the Petitioners shall have and receive the profits of the said fifth part, so allotted unto them, from the time of their demand, according to the said order of the Lords and Commons, until this House take further order: And the several Committees of the said counties are hereby authorized and required forthwith to pay the same, or permit the Petitioners to receive the same accordingly.”⁵⁷

The period from the surrender of Raglan Castle in August, 1646, down to the close of 1651, extending over five years, must have been one of the most galling and trying nature to the Marquis of Worcester. From a state of ease and affluence he was suddenly plunged into a condition the most mortifying possible to a noble and independent mind; without any other than the barren consolation that his Prince, the Court, and men of all ranks shared a similar fate. He did not stand alone, a monument of ruin amidst plenty. In September, 1649, Charles the Second had quitted the Continent for Jersey, and the next year he arrived in Scotland; in 1651, his romantic career in England terminated, and in November he was once more in France, without credit, as Clarendon asserts, to borrow twenty pistoles.

The Marquis’s extensive property in Middlesex and in Wales enabled the Government to discharge many heavy claims; but among its claimants, its very good

⁵⁷ Jo. H. C. Vol. v. p. 504; vi. p. 256.

friends, its warmest and most needful supporters had first to be considered ; while charitable acts, and the asserted claims of persons related to recusants, and persons specially proscribed by Parliament, and all who were even remotely related to them would have to submit to long delays and hard wrung submissions, when the object was to obtain the least assistance from an already depressed treasury.

That the Marquis's wife and family received any assistance whatever, through appeals to the Commonwealth Parliament, is significant of the high estimation in which he himself must have been held, simply for his moral worth, and his not overstrained political bias: marking his acts with extreme humanity in war, and good sense in avoiding the risk of launching into any of those extraordinary measures, for which the late King had granted him the ample powers already considered. Indeed the Nuncio,* as early as 1646, had correctly estimated his Lordship's character, designating him "an Englishman of a very mild temper."

* See page 182.

CHAPTER XIV.

HIS RETURN TO ENGLAND—IMPRISONMENT, AND LIBERATION—HIS “CENTURY”—PECUNIARY DIFFICULTIES—PETITIONS—AT CHARLES THE SECOND’S CORONATION—LORD HERBERT.

WE find that in the House of Commons, on the 14th of March, 1648, “The persons reported to be banished, and their estates confiscated, being fourteen in number, were every one particularly put to the question;” when it was resolved, &c. “That Charles Stuart, eldest son of the late King, be one of that number; also James Stuart, his second son;” then follow the Earls of Bristol, and Newcastle, along with Witherington, Digby, Musgrave, Langdale, Greenville, and Dodington. After which it was—

“Resolved, &c. That the Earl of Worcester be one other of that number.” Likewise were added the names of Winter, Culpepper, Byron, the Duke of Buckingham; and finally, “all that have been plotting, designing, or assisting, in the Irish rebellion,” shall be proscribed, as enemies and traitors to the Commonwealth; and shall “die without mercy, wherever they shall be found within the limits of this nation; and their estates employed for the use of the Commonwealth.”⁵⁷

It appears, on the authority of Dr. White Kennet,⁵⁸ the historian, that while Charles the Second was a refugee in the Court of France, the King of France, Louis XIV., was in himself disposed not only to assist,

⁵⁷ Jo. H. C. Vol. vi. p. 165.

⁵⁸ Kennet.

but if possible to restore the royal family of England. His commanding minister, the Cardinal Mazarine, however, was always averse to any such measure; so that all the exiled prince could do was to send abroad his envoys and agents, to solicit for justice and relief, although without effect, as the result proved. He sent to England, says Kennet, "the noble Marquis of Worcester for private intelligence as well as for supplies; but the Marquis was taken up prisoner in London, and committed to the Tower in September [?]; where he was threatened with a speedy trial, and worse punished with a long confinement."

We are brought by this circumstance to an interesting period in the adventurous life of the Marquis of Worcester. His visit to England was every way extraordinary for its boldness or apparent recklessness; as he was a marked man, one who could have no reason for expecting to be able to conciliate the reigning power, which had already stigmatized him as an "enemy and traitor to the Commonwealth," his estates to be confiscated, and himself, wherever taken, doomed to "die without any mercy whatever."

The Marquis's son sat in the Cromwellian Parliament; Cromwell enjoyed the Monmouthshire estates of the Marquis, to the value of £2500 per annum, and allowed Lord Herbert a pretty liberal income. From Edinburgh, Cromwell wrote on the 12th of April, 1651, a letter to his wife:—"My dearest, Beware of my Lord Herbert his resort to your house; if he do so may occasion scandal, as if I were bargaining with him: indeed be wise; you know my meaning."†²³

The Marquis might have some private object in view, equally with that of serving his prince, and might have

been better assured than history determines, that his life, at all events, would be safe. It is stated in the History of the Tower,⁶ in noticing the Marquis of Worcester being added to the number of distinguished persons confined there in 1652, that the wants and distresses to which he had been subjected on the continent had driven him to seek shelter in his own country.

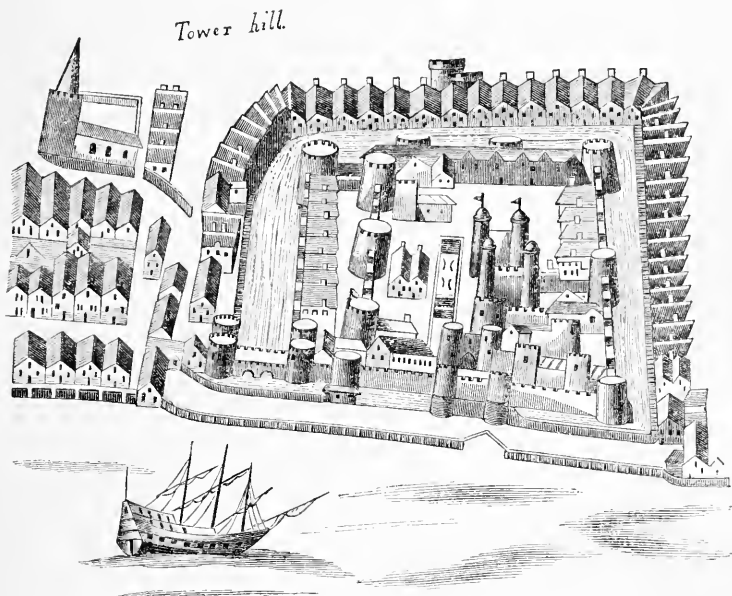

BIRD'S-EYE VIEW FROM MAP OF LONDON, 1658.

On the 28th of July, 1652, the House of Commons, immediately after prayers, “Resolved, That the Earl of Worcester do stand committed to the Tower of London, in order to his trial.” And, “That it be referred to the Council of State to consider, in what way the Earl of Worcester may be tried, and who hath harboured him; and to consider of all circumstances in his business, and to report their opinion thereon to the House, on Friday morning next.”

⁶ Bayley.

A year later, being on the 29th of August, 1653, Colonel Rous reports from the Committee of Petitions, "The most humble Petition of Edward Somerset, Earl of Worcester, now prisoner in the Tower.

"As also, the humble Petition of Margaret, Countess of Worcester ; which were both read."

Followed, on the 3rd of October, by repetitions of the same report, when it was "Resolved that this Petition be laid aside."

While, on the 5th of October, 1654, one year later, after other business, the Earl's petition was again read, and it was thereon "Resolved, That the Earl of Worcester have his liberty for the present upon bail, until the Parliament take further order. And that the Lieutenant of the Tower do take sufficient bail: And that a Warrant do issue under Mr. Speaker's hand, to that purpose." ⁵⁷

In Burton's highly valuable and interesting Diary of Oliver Cromwell's Parliament, when noticing the foregoing business in respect to the Marquis's petition, it is added:—"The Petitioner was alleged to be a papist, in arms in England, who had headed a party in Ireland, making a most dishonourable peace there, and had done many other disservices, for which he was excepted from all mercy and pardon; his whole estate ordered to be sold, and all such to be banished. Yet, it was urged, he was an old man, had lain long in prison, and the small-pox then raging under the same roof where he lay. And he had not, as was said, done any actions of hostility, but only as a soldier; and in that capacity had always shown civilities to the English prisoners and protestants. It was, therefore, ordered, that he should be bailed out of prison."²²

⁵⁷ Jo. H. C. Vol. vii. pp. 309, 373.

²² Burton.

Consequently he was a close prisoner for at least two years and a quarter, assuming that he was then liberated; which is the more likely, as we find that a Warrant was given by Cromwell, dated the 26th of June, 1655, to pay his Lordship the sum of three pounds a week, for his better maintenance.* He would be about or verging on 53 years of age, and must have suffered very seriously from fatigue, disease, and severe mental disquietude, prolonged through at least eight years passed in every diversity of honour and disgrace, wealth and poverty, high hopes and aspirations, terminating in blank disappointment; he thus united in his own person and history the most violent contrasts, enough to have broken down and utterly destroyed any enthusiasm less than is due to the conscious possession of surpassing mental wealth. It would be difficult to find in the voluminous history of scientific biography a parallel case of so much self-reliance on the promptings of a great and noble mind, under anything like such an unmitigated burden of uncontrollable evils, as fell to the share of this extraordinary man in the very decline of life, when tired nature seeks calm, repose, and competence.

It would seem as if, while still a prisoner, he was treating for Vauxhall, where we shall find he was afterwards actively engaged with his Water Engine; for Samuel Hartlib, well known from his acquaintance with Milton, writes to the Honourable Robert Boyle on the 8th of May, 1654, signifying that, the Marquis is buying Vauxhall from Mr. Trenchard.¹⁴

The next incident we meet with, of which any record occurs, after his enlargement, is a melancholy evidence of his extreme necessities and indeed absolute

* Appendix F.

¹⁴ Boyle, Vol. v. p. 264.

poverty. It consists in the following, taken from the original acknowledgment:—*

“Received and borrowed of my Honored friend S^r David Watkins the full somme of Twenty pownds sterling w^{ch} I faythfully promise to repaye at or before the second day of February next ensueing to w^{ch} I oblige myselfe my Hayre Executor Administrator or assign in a dubble somme or forfeiture Witnessse my hand and seale this eight of De: 1655.

“Witnessed by LANCELOT HODSHON.”

“WORCESTER.”

We have thus far traced the career of the Marquis of Worcester from youth to manhood; the scholar, husband, father, general of armies, a wealthy nobleman, an impoverished exile, in danger of his life by war and shipwreck, twice imprisoned, now a freeman, oppressed by pecuniary difficulties and earnestly striving against the pressure of his own misfortunes and the weight of public prejudice, to which his political life and religious persuasion subjected him: sometimes through court intrigue, but mostly from the rooted bigotry of those gloomy times.

Whatever interest the history of the life of the Marquis of Worcester may derive from other sources, the philosopher will dwell alone with delight on that period which divulged the extraordinary inventive mental capabilities of such a singular scholar and early man of science. He now first produced, as he himself states, his remarkable little work, of which the full title runs thus:—“A century of the names and scantlings of such Inventions, as at present I can call to mind to have tried and perfected, which (my former notes being lost)

* Robert Cole, Esq. had the original receipt lithographed in facsimile.

I have, at the instance of a powerful friend, endeavoured now, in the year 1655, to set these down, in such a way as may sufficiently instruct me to put any of them in practice." That small book, then only in manuscript, and not published until eight years afterwards, has sealed his fame; for through all time the "Century" will be regarded as a great curiosity in scientific literature, for its variety of subjects, and its author's versatility of genius in pursuits then but little cultivated.

The first year of his release, appears, therefore, to have been mainly distinguished by this valuable contribution, as he says, "at the instance of a powerful friend." We think that that *friend* was no other than Colonel Christopher Copley, or Copley,* who had served in the Parliamentary army of the North, under the command of General Fairfax; a sufficient reason for the author omitting to particularize him by name. That he and the Marquis were, however, on terms of close friendship, is evident from the annexed letter;⁹⁸ alluding to previous kind offices accorded by his "powerful" now his "dear" and his "honoured friend."

"DEAR FRIEND,

"I know not with what face to desire a courtesy from you, since I have not yet paid you the five pounds, and the main business so long protracted, whereby my reality and kindness should with thankfulness appear; for though the least I intend you is to make up the sum already promised, to a thousand pounds yearly, or a share amounting to far more, which to nominate, before the perfection of the work, were but an *individuum vagum*; and, therefore, I defer it, and upon no

* See Appendix E.

⁹⁸ Walpole. Mr. Bliss' states that he discovered the MS. among the papers of Wm. Wilcox of St. John's College, Oxford.

other score. Yet, in this interim, my disappointments are so great as that I am forced to beg if you could possibly, either to help me with ten pounds to this bearer; or, to make use of the coach, and to go to Mr. Clerke, and if he could this day help me to fifty pounds, then to pay yourself the five pounds I owe you out of them. Either of these will infinitely oblige me. The alderman has taken three days' time to consider of it. Pardon the great troubles I give you, which I doubt not but in time to deserve by really appearing,

“Your most thankful friend,

“WORCESTER.

“28th of March, 1656. To my honoured friend,

“COLONEL CHRISTOPHER COPPLEY.”

This epistle the Colonel endorsed, “My Lord of Worcester's letter about my share in his engine.” What was the result of these negociations remains untold; but eight months later it would seem that, for some reason or other, he entered into a solemn obligation with the Colonel, in the terms following:—*

“I, under written, do confess and acknowledge to have received of Colonel Christopher Copley so great civilities and obligations as that I do take him into so strict bonds of kindness, as that, if at any time the adventure of my life and fortune may bestead him, I do, upon the word of a gentleman, and the faith of a Christian, engage myself not to stick thereat, but cheerfully to run the same fortune with him. And upon the same ties I vow never to deceive or delude him in thought, word, or deed; and to declare the truth at all times unto him, using neither hyperbole nor equivocation concerning my water-work; or any promise made or to be made

* From MS. collection of the late Dawson Turner, Esq., of Yarnmouth.

between us ; which, as I am a gentleman, a Christian, and Roman Catholic, I will even keep inviolable, and that (if I should do any thing to the contrary), I may appear a most dishonest and perjured person ; I have signed these with my hand, and affixed on them my seal at Stems (?), the 18th day of November, 1656,

“ WORCESTER.”

On the 28th of December, 1656, he wrote a short letter to Mr. Secretary Thurloe. Politicians have generally supposed that it had reference to some great state secret, which he was bargaining to disclose ; while, how contrary must have been his views is now transparent, from seeing what really was the one absorbing subject of his daily meditation, arising out of his arduous endeavours to obtain assistance, and to carry out the working of his “ water-commanding engine.” The letter is in every sense remarkable and interesting, both from the mistiness that has for so long a time clouded its meaning, and from the circumstances under which it was dictated. The Marquis writes:—†

“ 28th of December, 1656.

“ RIGHT HONOURABLE,

“ I do confess, that the old saying is, that proffered service is not valued, and in that respect I wonder not to have my endeavours so little set by. In a word, I am very well pleased to acquiesce, if his Highness nor your Honour think me not worthy of one quarter of an hour’s audience ; yet I must needs say, that if esteemed of, I am able to do his Highness more service than any one subject of his three nations ; and though, after a message by Mr. Noell, and a letter of

† Bod. Lib. “ Thurloe’s Papers, Vol. xlv.”—“ Rawl. MS. A. 45.”

mine delivered by my own hands to Mr. Owng, and as he told me, by him to your Honour, I cannot get a time assigned me to wait upon you. I here send you a true copy of Don Alonzo, his answer to me, and do assure you, that I have in readiness a person whom you yourself will confess Don Alonzo cannot except against : so that there only resteth needful your approbation. When your Honour shall have read this, and the copies of the Don's letter, I have entreated and enjoined Mr. Noell to bring them me back, and in his presence I will burn them, and remain silent for the future in anything of this nature, but in all things else, your Honour's most affectionate friend and humble servant,

“ WORCESTER.”*

The noble inventor's proceedings could have been no secret at Court, surrounded by spies of every description to report all his operations ; and his principal object being one of a large and costly character, would be better known for its nature than its construction. It would also become known from the manuscript of his Century, copies of which seem to have been privately circulated, that his inventions extended to improvements in fire-arms, cannon, and general naval and military improvements. Now it is not in the least improbable that some foreign party or parties communicated with him in reference to some particular invention, but particularly his much commended novelty of a “ water-commanding engine,” while the Marquis might feel it a delicate as well as an imprudent act on his part, to make arrangements with foreigners before he had confided his secret and rendered it available in his own

* This letter is dated 28th of December, but might be mistaken for 18th. See Thurloc's Papers.

country. That his object in desiring an interview with Cromwell, or with his haughty Secretary, bore no political cast, is next to self-evident, from their perfect indifference to his communication; while for any political ends, either would have shown some tokens of regard, and not have left the author of the slightest thread of interested intelligence craving for a few minutes' audience. Besides, we have the inferential evidence that the communication referred to scientific inventions, rather than to political intrigues, from the context—"proffered service is not valued, and in that respect (he says) I wonder not to have my endeavours so little set by." And what could those endeavours be, at that particular crisis more than any other, but the possible requirement of patronage from the Protector, and probably also the Parliament, before committing himself to foreigners for that aid which he rightfully considered he would soon merit from his countrymen. But he still further says, "I am able to do his Highness more service than any one subject of his three nations." Will any one pretend to assume that such language had reference to political plottings, of which he possessed the secret knowledge to such an extent of national importance, without being either listened to, or at once seized and consigned to the dreaded chambers of that fortress, from which he had been only three years released? Admit that the language is inflated, it still would be very significant if it bore at all on the state of public affairs at home or abroad. But its true significance may be found in its counterpart in the Dedications appended to the first edition of the "Century," printed in 1663. The promise to burn the returned copies of papers, in the presence of Mr. Noell, would seem merely another way of showing, that, come what might of the matter, he would break off all nego-

ciations with others than his countrymen. The communication can only be read as alluding to one subject, and not as introducing anything forced and irrelevant. It can only be reconciled as being wholly political, or wholly affecting his special scientific engagements. Besides, had it been otherwise, it would not have escaped the historian, or some court spy to record the wonderful discovery of a plot of frightful magnitude, with all particulars. But no plot ever came to light; and the Marquis never did Cromwell or the Commonwealth any service beyond anything accomplished by the humblest citizen. We must, therefore, for ever abandon the opinion of there being any political character attached to this supposed mysterious communication.

The Marquis of Worcester's son and heir, Lord Herbert, married Mary, Lady Beauchamp, on the 17th of August, 1657. The following certificate on a small square piece of parchment is preserved among other family documents at Badminton House:—

“These are to certifie: It being desired by the p'ties concerned, that, Henry Somerset Lord Herbert and Mary Lady Bochampp, both of the parish of St. Clements Danes, Middlesex, were Legally married before me Richard Powell of Clerkenwell, Middle Sq: one of the Justices for the said County, authorized soe to doe by vertue of an Act of Parliamt. bearing date the fflower and twentieth day of August 1653. There then being pre'te Charles Price and Edward Gibbes, dated this Seaven tenth day of August 1657.

“RICHARD POWELL.”

The Marquis of Worcester's private affairs were year by year growing more and more desperate, we continu-

ally find him and the Marchioness petitioning the Parliament for pecuniary assistance out of the confiscated estates. He seems to have been on friendly terms with John Lenthall, Speaker of the House of Commons, from whom we find the following letter:—*

“MY LORD,

“I will ever acknowledge that your Lordship hath dealt most honourably with me, and with all hearti[ness] I will profess that to all; and will endeavour to show my thankfulness to your Lordship, and to your honourable Lady; and do assure you both that, if I may do you any service to my brother speaker, about your business in Parliament, I will endeavour my uttermost to act for you. My wife takes your promise of half a buck exceeding thankfully, and also some great *belles* here. We shall all endeavour to make a requital; and I shall ever acknowledge myself to be

“Your Honour’s most humble Servant,

“JOHN LENTHALL.

“8th July, 1659.

“I have received from your Lordship 20 marks in full of all your Lordship’s fees, which I hereby acknowledge, and acquit your Lordship of that and all other demands at this day.

“To the Right Honourable the
LORD MARQUIS OF WORCESTER—these presents.”

His manuscript of his wonderful “Century” had been four years written, copies passing probably from hand to hand, and himself urging the great and noble of the land to patronise his efforts. In the British Museum is the only MS. of the Century extant, having on the top of its title page the dates “From August y^e 29th to Sep. y^e 21st, 1659,” which may, however, merely refer to the

* From MSS. Badminton.

date of copying, or to a period granted for lending it. The 88th article alludes to a *Coining Engine*, while in the printed edition this is omitted and a *Brazen Head* substituted; there are also some slight verbal differences; only an abbreviated title page; and no dedication.

Among other petitions a rough draft exists of one evidently prepared by the Marchioness herself; whether sent or not cannot now be ascertained, but of its authenticity as a family record of distress there can be no doubt whatever. It is so negligently and imperfectly written, that an entire copy cannot be advantageously given. It runs thus:—

“Master Speaker, I beseech you not to stand so much upon an order of the House as to forget God Almighty’s precepts, to do as you would be done by. Most of the honourable House I conceive have wives, and if any of you would be contented his wife should suffer as I do, then let me still endure; if otherwise, be pleased to consider me, if not according to my sex or quality”—yet, “in consideration of seven years attendance, and millions of court sueings, and my heart almost broken with supplications and vain promises to them, and at last instead of many thousand pounds,” out of the estates, “all now ending in a ruined house, and that but for an uncertain time, not for my own life, rather but this poor pittance for his life, who is near three score.” She also seems to allude to fever, and the breaking up of his health, concluding, “I, therefore, most humbly seek this honourable House to make an end of it.”

We find the Marquis with noble perseverance con-

* Brit. Mus. Harleian MS. No. 2428.

tending against every difficulty, evincing an elasticity of mind that cannot but excite surprise.

Writing to the Earl of Lotherdale,* he says:—

“MY THRICE HONOURABLE LORD,

“The two predominant powers which reign over my soul, and do chiefly guide and govern my actions, are love and gratitude; the one begotten in me towards your Lordship by the knowledge I had in the Tower of the virtues and excellent parts, the other by a certain and most true information of some passages vouchsafed by your Lordship in your servant’s behalf, and even in his absence yesterday, before his Majesty at Hampton Court. The particulars I set not down, because (?) they seemed so obliging to me as that Colonel Charles Groger, telling them me but at nine of the clock this night, yet I could not defer till morning this most humble acknowledgment; but before I go to rest, as a little token of great thankfulness, I promise your Lordship a box, with such conveniences and rarities as that which you saw had, and though it were presumptuous in me to say, I would give a subject a better qualified present than I gave my Sovereign; yet the King must pardon an honour I have, never to be contented to produce any invention the second time without appearing refined; this doth not also content me, but I do likewise engage myself that as soon as with security and satisfaction, by Act of Parliament, I may put in practice the greatest gift of invention for profit that I ever yet heard of vouchsafed to a man, especially so unworthy and ignorant as I am (I mean my water-commanding engine). I offer to your Lordship’s disposal the accruing benefit of five hundred pounds; and that your Lordship may not think it improbable to rise

* From MS. collection of the late Dawson Turner, Esq. of Yarmouth.

thence, I beseech you to vouchsafe to read over, but to keep it to yourself, this enclosed, which shall be made good to a tittle by me,

“ My Lord,

“ Your Lordship’s most really affectionate

“ and ever obliged servant,

“ WORCESTER.

“ Saturday night, 26th of January, 1660,

“ be therefore pleased to pardon the scribbling,

“ and regard but my real meaning.

“ For the RIGHT HON. THE EARL OF LOTHERDALE, &c. these.”

(*Copy of the enclosure.*)

“ The name and the truly significant definition of a most admirable and most stupendous invention, through the providential dispensation of the Almighty God’s infinite mercy and goodness, found out, and perfected by the sole expenses, ingenuity, knowledge, and mathematical insight of the Right Hon. Edward Somerset, Marquis of Worcester, and by his Lordship deservedly termed, and pithily defined to be—

“ An Imperial, or a Water-commanding Engine, boundless for height and quantity, and requiring no external, nor even additional help, or force to be set, or continued in motion, but what intrinsically is afforded from its own operation, nor yet the twentieth part thereof, and the engine consisteth of these following particulars:—

“ 1. A perfect counterpoise for what quantity of water soever.

“ 2. A perfect countervail for what height soever it is to be brought unto.

“ 3. A primum mobile, commanding both height and quantity, regulator-wise.

“ 4. A vice-gerent, or countervail, supplying the place, and performing the full force of man, wind, beast, or mill.

“ 5. A holme, or stern, with bit and reins, wherewith any child may guide, order, and control the whole operation.

“ 6. A particular magazine for water, according to the intended height and quantity.

“ 7. An aqueduct, capable of any intended quantity, or height of water.

“ 8. A place for the original fountain, or even river, to run into, and naturally of its own accord to incorporate itself with the rising water, and at the very bottom of the same aqueduct, though never so big or high.”

This communication affords the earliest distinct reference to the Water-commanding Engine, and renders it reasonable to suppose that similar written copies of the “Definition” were in circulation at the same period, if not earlier.

The letter itself is peculiarly interesting for the insight it gives us into a distinguishing trait in his mental constitution, when he observes:—“a humour I have, never to be contented to produce any invention the *second* time *without appearing refined*.” He seems to have had no idea of cessation in invention. It was in this self-same spirit that he dedicated his “Century” to the Houses of Parliament:—“The more you shall be pleased to make use of my inventions, the more inventive shall you ever find me, one invention begetting still another.”

It is rather remarkable that, with this exception, his inventions are never named either in his own or his family’s correspondence; indeed the latter may have considered the circumstance as more marking his misfortune, than calculated to bring him enduring fame.

The death of Cromwell, the short reign of his son, and the proclamation of Charles the Second on the 8th of May, 1660, followed by his triumphal entry into

the metropolis on his birth-day, the 29th of the same month, must have had their influence on the Marquis in his most distressing condition. He was, no doubt, one among the privileged to congratulate his Majesty in private, at Whitehall, while bonfires blazed, fireworks glared, and cannon roared; what conflicting emotions must have revelled in his own breast, broken down as he was by disasters on every hand, which through more than thirteen years he had borne with magnanimous fortitude.

His son, Lord Herbert, resided at Badminton House, Gloucestershire, but being in London, on his way to Dover, after the proclamation, he wrote to his wife, as follows:—*

“MY DEAR HEART,

“We have this night received our instructions, and to-morrow begin our journey towards the King, whom we are commanded to acquaint with what great joy and acclamation he was here proclaimed; and to let him know that the Parliament hath enjoined all ministers in England and Ireland to pray for him, the Duke of York, and the rest of the Royal progeny; and ordered that the Arms of the Commonwealth, wherever they are standing, be taken down, and that his Majesty’s be set in the place. We are further to beseech his Majesty to return with speed to his dominions and government; and finally, to acquaint him that the Parliament hath given order to the Admiral to obey his commands with the navy, and to desire that he will please to signify to us when and where he will land, and whether he will come from Dover by land, or to London by water; where lodged, and how his pleasure is to be received.

“I hope we shall soon return with him we go for,

* From MSS. Badminton.

and so have nothing wanting for my particular satisfaction (as when he is here, there will not be to the general). I desire you would begin and come this way some time next week, that I may find you here at my return, in order to which I have given order that lodgings, such as can be found, be taken, where you may be till you can choose yourself a house to your mind, for I cannot be anywhere with my contentment without you,

“Your most affectionate husband,

“HERBERT.

“London, the 9th of May.”

Charles the Second had not been many days on the throne, when the Marquis of Worcester wrote a long letter to Lord Clarendon,*²⁶ explanatory of his instructions from his late Majesty, and the powers he granted to him to negotiate with the Irish Roman Catholics. It very fully and lucidly explains the whole of that affair, showing how completely he was in the King's confidence; and it was; no doubt, written to answer all doubts that his Lordship might entertain. It bears internal evidence of coming from a strictly conscientious character, and its truthfulness has never been disproved.

“The Marquis of Worcester (late Earl of Glamorgan), to the Earl of Clarendon.

“MY LORD CHANCELLOR,

“For his Majesty's better information, through your favour, and by the channel of your Lordship's understanding things rightly, give me leave to acquaint you with one chief key, wherewith to open the secret passages between his late Majesty and myself, in order to his service; which was no other than a real exposing of myself to any expense or difficulty, rather than his

*²⁶ Clarendon, Vol. ii. p. 201.

just design should not take place; or, in taking effect, that his honour should suffer. An effect, you may justly say, relishing more of a passionate and blind affection to his Majesty's service, than of discretion and care of myself. This made me take a resolution that he should have seemed angry with me at my return out of Ireland, until I had brought him into a posture and power to own his commands, to make good his instructions, and to reward my faithfulness and zeal therein.

“Your Lordship may well wonder, and the King too, at the amplitude of my commission. But when you have understood the height of his Majesty's design you will soon be satisfied that nothing less could have made me capable to effect it; being that one army of ten thousand men was to have come out of Ireland through North Wales; another, of a like number at least, under my command-in-chief, have expected my return in South Wales, which Sir Henry Gage was to have commanded as Lieutenant-General; and a third should have consisted of a matter of six thousand men, two thousand of which were to have been Liegeois, commanded by Sir Francis Edmonds, two thousand Lorrainers to have been commanded by Colonel Browne, and two thousand of such English, French, Scots, and Irish as could be drawn out of Flanders and Holland. And the six thousand were to have been, by the Prince of Orange's assistance, in the associated counties; and the Governor of Lyne, cousin-german to Major Bacon, major of my own regiment, was to have delivered the town unto them.

“The maintenance of this army of foreigners was to have come from the Pope and such Catholic Princes as he should draw into it, having engaged to afford and procure £30,000 a month; out of which the foreign army was first to be provided for; and the remainder to be divided among other armies. And for this pur-

pose had I power to treat with the Pope and Catholic Princes, with particular advantages promised to Catholics, for the quiet enjoying their religion, without the penalties which the statutes in force had power to inflict upon them. And my instructions for this purpose, and my powers to conclude and treat thereupon, were signed by the King under his pocket signet, with blanks for me to put in the names of Pope or Princes, to the end the King might have a starting hole to deny the having given me such commissions, if excepted against by his own subjects; leaving me as it were at stake, who for his Majesty's sake was willing to undergo it, trusting to his word alone.

“In like manner did I not stick upon having this Commission inrolled or assented unto by his Council, nor indeed the seal to be put upon it in an ordinary manner, but as Mr. Endymion Porter* and I could perform it, with rollers and no screw-press.

“One thing I beseech your Lordship to observe, that though I had power by it to erect a mint any where, and to dispose of his Majesty's revenues and delinquents' estates, yet I never did either to the value of a farthing, notwithstanding my own necessities, acknowledging that the intention of those powers given me, was to make use of them when the armies should be afoot; which design being broken by my commitment in Ireland, I made no use of those powers; and consequently, repaying now whatever was disbursed by any for patents of honour, as now I am contented to do, it will evidently appear that nothing hath stuck to my fingers, in order to benefit or self-interest; which I humbly submit to his Majesty's princely consideration, and the management of my concerns therein to your Lordship's grave judgment, and to the care of me,

* One of the King's attendants, who had formerly accompanied him to Spain. Clayton's Charles II. Vol. i. p. 136. 1859.

which your Lordship was pleased to own was recommended unto you by the late King, my most gracious Master, of glorious memory: And the continuance thereof is most humbly implored and begged by me, who am really and freely at your Lordship's disposal, first, in order to his Majesty's service, and next to the approving myself,

“ My Lord,

“ Your Lordship's most really affectionate,

“ and most humble servant,

“ WORCESTER.

“ June, 11th, 1660.”

Within a fortnight after writing this letter, no doubt encouraged by the Lord Chancellor's reception of it, he petitioned the Crown as follows:—*

“ TO HIS MOST EXCELLENT MAJESTY, &c.

“ The most humble petition of Edward Somerset, Earl and Marquis of Worcester, &c.

“ Sheweth,—That your Petitioner's father and himself, having in ready money expended incomparably more for the service of the Crown than any subject of England, for which your Petitioner is possessed of sundry promises of extraordinary reward and satisfaction, as well under the Great Seal of England, as likewise voluntarily under his late Majesty the King, your Majesty's father of blessed memory, his own handwriting and private signet set down in a most gracious ample and kind manner, it being all that in those necessitous times his Majesty, your Petitioner's most graciously obliging master, could afford or be rationally demanded from him, yet in these perhaps may not be so fit to be ratified, lest they should draw upon your Petitioner the envy of others, and prove prejudicial to your Majesty.

* Cal. of State Papers, Dom. Series, 1660-61. Edited by Mrs. M. A. E. Green, 8vo. 1860.

“Your Petitioner, therefore, most willingly layeth all these grants and promises to his father, or to your Majesty’s Petitioner made (as far as they concern himself) at your Majesty’s feet, without any the least capitulation, expecting no more in his own behalf for his loyalty therein than that your Majesty will be graciously pleased (in consideration of his dutiful zeal thereby manifested) effectually and through your Majesty’s innate and transcending goodness, feelingly to recommend to your Majesty’s most dutiful Houses of Parliament the speedy re-investing of your Petitioner in his due and proper estate, according unto the laws of the land, and so by your Majesty’s most gracious assistance, this his Petition of right (as he humbly conceives) shall be by your Petitioner most really acknowledged as a grant of favour and remunerating grace from your sacred Majesty.

“And he shall ever pray,” &c.

The Marquis, in November, 1660, signed what appears to be a circular note to certain of his creditors, of which the following is one written in an official hand, but concludes, “Your most humble servant, Worcester,” in his own handwriting:—

“MADAME,

“Those Commissioners whom I have appoynted to take care of my affayres are now enquireinge into ye state of my debts, and I have given directions to the bearer to wayte upon you and receive your propositions about what is due unto you from him who is,

“Madame, Your most humble servant,

“WORCESTER.

“November 22, 1660.”

Mr. Secretary Nicholas, writing to Sir Henry Bennet, 3rd of January, 1660, states: “The King joins the Queen

and Princess at Guildford, and in two days they go to Portsmouth. On New Year's day, the ceremony of christening the young Earl of Cambridge—for this is to be his title—was performed at Worcester House; the King and Duke of Albemarle godfathers; the Queen and Marchioness of Ormond godmothers. The Duke and his Duchess then came to Court, and the Queen received them very affectionately. The Coronation is deferred to St. George's day."*

The Lord Bishop of Peterborough,⁷⁹ in his ecclesiastical and civil register and chronicle of the period, records the following particulars in reference to the order of proceedings at the Coronation of Charles the Second, April the 23rd, 1661: "The Marquis of Dorchester, the Marquis of Worcester, in their robes, with their coronets in their hands."

Then as to the homage paid by the nobles; after the oath given by the Archbishop of Canterbury; and other Bishops, saluting the King; among others came up the Marquises of Worcester and Dorchester.

That even at the Restoration the Marquis's religion presented some obstacles to his progress may be inferred from the resolution of the House of Lords, that the indulgence to be granted to the Roman Catholics should not be extended to the Jesuits. Whereupon that Society drew up a paper, entitled, "Reasons why the Jesuits hope that they should partake of the favours shown to other priests, in taking away the sanguinary laws." And it is noticed that, "As for noble persons who lost great estates, and endured much hardship for his Majesty, the late Duchess of Buckingham, the late Marquis of Worcester,† and the late Earl of Shrewsbury were Penitents of the Society, as other prime nobility yet in being."⁷⁹

* Cal. State Papers, Dom. Series, Charles II. 1660-1661, Vol. xxviii. p. 466.

⁷⁹ Peterborough.

† Henry Somerset.

For some reason or other it now became the son's lot to be committed to the Tower, of which, however, he makes very light, as will be seen by his letter to his Lady announcing his position; which, however, has no other immediate interest than as making us acquainted with the last occurrence of the kind affecting this noble family. He writes:—*

“MY DEAR,

“I have now sent according to your desire to let you know of my being safely arrived at London. I was last night examined, and am now in the Tower. I have already so well satisfied you of my innocence that I am sure my being lodged here cannot fright you, neither can I imagine my restraint should be long, for I think I only owe it to my Lordship. I desire you would not resolve upon your journey hither till you hear further from me, for I hope yet you may lie in, in the country, and not have the trouble of any journey to bring us together. If these hopes fail me, and that I see myself like to continue longer than I can yet fancy, I will let you know it, and send the coach down for your women, and (if you think fit) your children to come up in; to whom in the meantime I send my blessing, and remain

“Your most affectionate husband,

“HERBERT.

“Aug. the 20th.

“For my dear wife the Lady Herbert.”

It does not fall within our province to enter particularly into any circumstances relating to Lord Herbert, but it may not be out of place to mention here that, he was then about 23 years of age, and had not long been constituted Lord Lieutenant of Gloucestershire.

* From MSS. Badminton.

CHAPTER XV.

HIS PROSPECTS AT THE PERIOD OF THE RESTORATION—
PROCEEDINGS IN PARLIAMENT RESPECTING THE PATENT
TO CREATE HIM DUKE OF SOMERSET—RECOVERY OF
ESTATES, ETC.—PARLIAMENTARY DUTIES.

CHARLES the Second was only thirty years of age when he ascended the throne, the Marquis was verging on sixty. Charles, gay, lively, accomplished, and fascinating in his manners, well knew from bitter experience the pain of leading a courtly life on straitened means; and the Marquis had been too closely associated with him on the continent, not to be aware of his exact position then, and his now brilliant change of circumstances. The Marquis of Worcester too, was one of those happily constituted men who do not grow misanthropic on every fresh instance of the world's ingratitude. His own nobleness and goodness of heart found a thousand excuses for the cold, callous, calculating society around him; and with his enlarged views, and greatness and purity of mind, he never despaired that the day would arrive, when he should be able to move at least in ease, if not in plenty. As regarded his Majesty, he enjoyed the fullest confidence in his behaving towards him with more than ordinary consideration; he might not be able to be magnificent, but at the very least he dared not to doubt that the word of the King would be realized, who had written to inform him*—"I am truly sensible of your great merit and sufferings in the ser-

* See page 190.

vice of the King my father, and *I never shall be wanting* to reward and encourage as well that kindness to his person as that zeal to his service which you have expressed in all your actions." But he was then only nineteen years of age, unseared by the eleven years of profligacy, the expiration of which found him on the throne of his ancestors.

The Marquis's political position had been unpopular, making him many enemies, which even altered times could not wholly obliterate. It was not merely a question whether he was justified in acting in concert with the late King, but it was manifestly imprudent and unwise, to say the least, his becoming the champion of his church in so dangerous an enterprise as that in which he engaged in Ireland. Consequently he found comparatively few who sincerely sympathised in his sufferings, amidst the crowd of suffering humanity distinguishing those unhappy times.

On the 9th of May, 1660, being the day after the King's proclamation, the House of Lords had before them a petition from the Marchioness of Worcester,* the subject of which was strange enough, being no other than to complain "That Colonel Christopher Copley, doth undermine Worcester House." Wherefore it was ordered, "That stop be made to further proceedings therein."

His Lordship early solicited the kind offices of Lord Clarendon, offering him gratuitously the use of his mansion in the Strand.²⁶ He says:—

"MY LORD CHANCELLOR,

"The world speaks you to be a person of honour, and I know your Lordship to be so, and that if you

* Jo. II. of Lords, Vol. xi. p. 19.

²⁶ Clarendon.

say the word your Lordship will make good the same. My humble suit, therefore, to your Lordship is, but to tell me freely whether you will be my friend in all things honourable, just, and fitting; and when I ask of your Lordship anything contrary to either of these, then do not only deny it me, but spit in my face, having afforded me only patience first to give you my reasons.

“Nothing, I am confident, can set an obstacle to your Lordship’s granting me this reasonable request, but an apprehension of the obnoxiousness of my religion, as for that, such are my abilities to serve not only my Prince but the whole kingdom, that when once known in Parliament, and his Majesty looking but as favourably upon me as the tenth part of my deserts (pardon me if I say so) doth require, I will undertake, within few days, there shall be a vote in the very House of Commons to make me capable of any service whereof I may be thought worthy. Another Remora doth perhaps forcibly lie in the way, which is my son the Lord Herbert’s underhand working by false suggestions; but I shall soon blow them over. In a word, if your Lordship please to accept of me, I am the most real and affectionate servant, and as a little token of it, be pleased to accept of Worcester House to live in, far more commodious for your Lordship than where you now are, though not in so good reparation; but such as it is, without requiring from you one penny rent (yet that only known between your Lordship and me). It is during my life at your service, for I am but a tenant in tail; but were my interest longer, it should be as readily at your Lordship’s command, and I believe I may serve you in some things of ten times the value; yet I never desire word or deed from your Lordship other than according to what I first began

with. Be but pleased to deal plainly with me, and I desire to show your Lordship in the King's presence or if you please, what I intend to produce or say, having had a dearly bought experience what it is to trust to Princes alone. So preventing your Lordship further trouble, and asking pardon for what I have put your Lordship unto, I only desire to receive a verbal answer by this most deserving person, Mr. White, my ancient acquaintance, into whose hands I would deposit the greatest imaginable treasures untold, and intrust the greatest secrets, without other tie than his acceptance of them.

“ My Lord,

“ your Lordship's,

“ Most really affectionate and humble servant,

“ WORCESTER.

“ June 9th, 1660.

“ For the Right Honourable the LORD CHANCELLOR, present these.”*

It is painful to find the Marquis of Worcester compelled by the theological tendencies of that age, to allude in his letter to “the obnoxiousness of his religion.” But it is in just accordance with all that we have seen of his progress through life, his “having had a dearly bought experience what it is to trust to *princes alone*,”—that is, without witnesses or other sufficient legal evidence. This last observation is called forth by his “desire to show” Clarendon, as he states—“what I intend to produce or say.” This might possibly have reference to his long written statement of his losses, amounting to

* The Lord Chancellor was at this time occupying Dorset House, in Salisbury Court, once the residence of the Bishops of Salisbury, one of whom alienated it to the Sackville family.

Notwithstanding this offer (free of rent), it is stated by Lord Clarendon, that he paid for Worcester House a yearly rent of £500. (T. H. Lister's *Life of Edward, first Earl of Clarendon*.)

£918,000, intended for the King's inspection, if not also to form the basis of an address to the House of Lords, as given in the last chapter. If this surmise is correct, it would clearly establish how severely pressing were his pecuniary affairs, the King having then only been eleven days at Whitehall; so early, would it seem, was he a suitor for the royal favour.

The House, on the 20th of June,* upon the reading of the Marquis's Petition, "That he hath been dispossessed of his estate in the late unhappy wars, and hath undergone many pressures in the same,"—ordered, "That he be put into possession of his estate, which is not sold; and a stop and stay of waste, and cutting wood upon his land sold; and the rents to be stayed in the tenants' hands; and to have a view of the writings and evidences which concern him, which are in the custody of the trustees at Drury Lane."

And further, on the 11th of September,† the said order was ratified and confirmed, with the exception that, it was not to "extend to any manors or lands sold unto or enjoyed by Henry Lord Herbert, son and heir apparent of the said Marquis."

But previously, on the 9th of July,‡ the House of Lords, "Upon information given, That Elizabeth Cromwell, widow, the relict of Oliver Cromwell; Richard Cromwell, Esquire; and Henry Lord Herbert, have many deeds, evidences, and writings belonging to the Lord Marquis of Worcester,"—it was ordered that "all such deeds, evidences, conveyances, court-rolls, surveys, patents, fines, recoveries, rentals, plates, papers, memorials, and writings, whatsoever," in their hands, should be delivered up unto his Lordship.

* Jo. II. of Lords, Vol. xi. pages 70 and 302.

† Ibid. Vol. xi.

‡ Ibid. p. 85.

Among other purchasers of his estates under the authority in power, in 1651, was one Ann Tisser, a widow, whose husband had become possessed of the Gatehouse attached to Worcester House. On the 27th of July the House had ordered possession to be given up, but Ann Tisser refusing, another order was issued on the 20th of August, requiring possession within two days, but with no better effect; so, on the 29th, the refractory widow "was brought to the Bar, to hear what she can say, why she does not deliver up the Gatehouse." To which she answered, "She bought it of the trustees that did sell the Marquis of Worcester's lands in 1651." Her plea, however, was only met by the House directing the Lord Chancellor to inform her, "That the House expected that she should deliver up the said Gatehouse forthwith; or else she must expect to undergo the displeasure of the House, for contempt of their Lordships' order." Three days were allowed her to obey this mandate, and as we hear no further account of Ann Tisser, she, like many others in the same pitiable plight, was doubtless speedily ejected.

In August, 1660, the House of Lords* discussed the subject of his Patent creating him Duke of Somerset, declared to be in prejudice to the Peers; and therefore the following particulars will prove interesting, taken in connexion with the copy of this Patent given at page 162.

On the 18th of August, "upon information to the House, by the Marquis of Hertford, that a patent is granted to the Marquis of Worcester, which is a prejudice to the Peers:—

"It is Ordered, That the consideration of the said Patent is referred to the consideration of these Lords following:—

* Jo. H. of Lords, Vol. xi. p. 133.

D. of Gloucester.	Comes Scarsdale.
Marq. of Winton.	Comes Berks.
Marq. of Dorcester.	Comes Rivers.
L. Steward.	Viscount Stafford.
Comes South'ton.	Viscount Paget.
L. Chamberlain.	Viscount Fynch.
L. Great Chamberlain.	Viscount Lucas.
Comes Derby.	Viscount Arundel.
Comes Portland	Viscount Robertes.
Comes Peterborough.	Viscount Seymour.
Comes Bolingbrooke.	Viscount Mohun.
Comes Bristol.	Viscount Wharton.
Comes Devon.	Vis. Howard de Charl't.
Comes Winchilsea.	Viscount Tenham.
Comes Dorset.	

“Their Lordships, or any five, to meet on Monday next, in the afternoon, at 3 of the clock; and to have power to send for such persons as they think fit, to give them information concerning this business; and to send for the Patent.”

On the 20th of August, it was ordered, “That the Lord Chancellor and Mr. Attorney General do attend the Lords Committee, which are to meet this afternoon, to advise them, in point of law, concerning the Marquis of Worcester’s Patent.”* Then on the 23rd of August, the Marquis of Dorchester reports from the Committee, “That the Marquis of Worcester confessed to their Lordships, that a Patent was made, and left in his hands, by the King, to create him Duke of Somerset, upon certain conditions, which never yet were performed; that he made no use of it; that the said Patent is in the hands of his son the Lord Herbert;

* Jo. II. of Lords, Vol. xi. p. 135.

and his Lordship is willing to deliver it up to his Majesty."

A message was sent to the House of Commons, by Justice Tyrrell and Justice Turner :

"To let them know, that the Marquis of Worcester hath acknowledged that the Patent of the Dukedom of Somerset was made to him upon conditions on his part to be performed, which he hath not performed; and that therefore he hath not assumed the place or title, and is willing to submit it to be surrendered, or otherwise disposed, as the King should appoint; but that it is in the hands of his son the Lord Herbert, who is a member of the House of Commons; and therefore to desire that the Lord Herbert may deliver it up to the Marquis of Worcester."* Then it was on the—

1st of September, "Ordered, That the Committee formerly appointed to examine the business concerning the Marquis of Worcester's patent do meet on Monday next, in the afternoon, peremptorily: And these Lords following are added to that Committee:—

Comes Bristol.	Viscount Petre.
Comes Bridgwater.	Viscount Culpepper.
Comes Clare.	Viscount Clifford.
Viscount Montagu.	Viscount Craven.
Viscount Maynard.	

"The Marquis of Worcester is to have notice hereof; and if his Lordship be not present in the House on Monday morning, then witnesses are to be examined upon oath in the business, by the Committee."†

On the 1st of September it was "Ordered, That the said Committee do meet on Monday next in the Prince's lodgings;" but in repeating the names the Earl of Bristol was omitted.

* Jo. H. of Lords, 1660. 12 Car. II.

† Ibid. p. 152.

On the 3rd of September, the Lord Arundel of Warder signified to the House, "That the Marquis of Worcester hath delivered up the patent to his Majesty, for the Dukedom of Somerset." When it was—

"Ordered, That the same Committee prepare a Bill, that all patents and grants obtained since the beginning of the late wars shall be brought within a short time to be limited, or else the same to be vacated."

In consequence of this order, on the 5th of September, Lord Roberts reported the Draught of a Bill for bringing in of grants and patents, which was twice read and committed; and being read a third time on the 6th, it was duly passed.

It is very humiliating to find the Marquis of Worcester stripped, not only of his great wealth, but of even empty titles; and this latter act not by professed enemies, but through his peers conjointly with his very sovereign! There is something so utterly contemptible in the whole proceedings, which deprive without substitution, and sap the wealth of any man without an adequate effort at remedial measures, that we feel perplexed how to account for treatment so heartless and discreditable; whether considered in reference to Charles the First, or his son and successor, or the reformed Parliament. In all the relations of private life the conduct of Charles the First was as commendable as that of his son was reprehensible; and if Charles the Second had viewed the Marquis's case only in respect to his father's private debts, he must have felt bound in honour and in common gratitude to assist and uphold the Marquis of Worcester in every way and by every means consistent with existing circumstances. It is true that his property was restored along with the very deeds held by Cromwell, but his Castle was an untenantable ruin, and his estates denuded of their wood; so that without fortune, and in

debt, his possessions were almost valueless. Besides, the Marquis was remarkably modest and fastidiously considerate in all he urged; yet he sought royal patronage in vain, for the gay monarch was not to be won from his levity by the philosopher's most plausible petitions.

On the 14th of December, 1661, Lord Herbert and other members brought a message to the Lords, with several Bills, one being "An Act for confirming the Marquis of Hertford to the Dukedom of Somerset," which had passed the House of Commons; and on the 17th, having then been read a third time, it also passed the House of Lords.

As Courthope⁷⁰ observes, although the Marquis of Worcester thus resigned his claim on the Dukedom of Somerset he still retained the titles of Earl of Glamorgan and Baron Beaufort, as will be seen hereafter in the copy given of his funeral certificate.

The Marquis seems to have attended the House of Lords for the first time after the Restoration, on the 13th of June, 1660, continuing very regularly for some months. The only others of his rank were the Marquises of Winton, Hertford, Dorchester, and Newcastle, and later, the Marquis of Winchester, seldom more than one or two of these being present on the same occasion. Between this date and the 30th of August, he sat in the House on thirty-seven days. Then after an absence of more than two months he is again present on the 6th of November, from which to the 24th of December he attended twenty-five meetings, the King being in the chair on the last occasion. He was not again in his place until the 29th, when his Majesty in person adjourned the House; which, meeting again on the 8th of May, "his Majesty, being arrayed in his regal robes with his crown

⁷⁰ Nicholas.

on his head, ascended his seat of state, the Peers being in their robes. On the right hand of his Majesty stood the Lord Great Chamberlain of England, the Marquis of Winton, bearing the cap of state, and on his left hand stood the Earl of Brecknock, Lord Steward of his Majesty's household, bearing the sword.

“And the Commons being below the bar, his Majesty made a short speech, declaring the cause and the reasons for his summoning this present Parliament.”

In all this august assembly the Marquis of Worcester, robed as were the other Peers, claims our special notice. He sat there in strange contrast with that gorgeous company, and the formalities which marked every process of action or language. Was it possible for him to be too expectant, seeing what he then saw and hearing what he then heard? Here was one who was no obscure individual, no questionable professor, or undeserved claimant on the patronage and smallest available favours often solicited by him from the crowned monarch in whose presence he then sat.

We again miss his attendance until the 11th of May, and the 8th of June, from which time he attended twenty-nine meetings, the last being on the 30th July, when his Majesty in person adjourned the House, and again recalled it on the 20th November, when the Marquis was present, as before.

He again attended in his place on the 26th of November, 1661, from which time to the 17th of May, when Parliament was prorogued, until the 18th of February, 1662, he attended thirty-two meetings with much irregularity, being on one occasion absent for above a month; and he did not appear on the re-opening of Parliament, when the House being called, he was declared absent; wherefore, it would seem he attended on the next meeting of the House, on the 25th of the same month, when

he was elected one of a Committee to report on Petitions, occasioning his further more regular attendance.

These particulars satisfactorily show his residence in or near London, while they likewise account for the nature of a large share of the employments that then engaged his active mind. But a change in the Government had brought him little if any alleviation in a pecuniary point of view, for on the 2nd of July, 1661, his petition was read in the House of Peers,* showing “That he having contracted many debts in the service of his late Majesty’s wars, and some of his creditors have obtained judgments against his estate, and are now extending his lands, being contrary to the privilege of Parliament, he being a Peer of this Realm.

“It is Ordered, That there shall be no further proceedings, by any of the Marquis of Worcester’s said creditors, against him, during the time of the privilege of this Parliament: And hereof all counsel, attornies, and solicitors herein employed, or to be employed, are to take notice, and yield obedience to this Order, as the contrary will be answered to this House.”

And as affecting his property, on the 7th of August, 1660, he had leave granted him by the House to bring in a Bill,* “for restoring him to his estate, as other Lords have.” Accordingly, on the 13th of that month an Act for the same was read. But in consequence of the petitions of certain creditors, his Lordship had leave granted him on the 28th of February, 1661-2, to withdraw his Bill; and on the 10th of March following he brought forward an amended Bill, entitled—“An Act on the behalf of Edward, Marquis of Worcester, and of the creditors of the said Marquis, for vesting

* Jo. II. of Lords, Vol. xi. p. 296.

† Ibid. pages 119, 125, 149, 150, 348, 386, 393, 395.

and settling upon the feoffees, in trust, certain manors, lands, and tenements, for payment of the debts of the said Marquis." In fact, the estates were heavily encumbered, the petitioners, among others, alleging, that "They have bought lands and houses of the Marquis of Worcester, for which they have as good assurances as the law can give;" and being heard by counsel at the bar of the House, they succeeded in their object, as just stated.

It was in the midst of such distractions as these Parliamentary details serve to illustrate, that this talented inventor and noble benefactor to his species, had to maintain his social position; and at the same time, struggle to convince a bigoted age that he was master of a power of such magnitude for the abridging of human labour, as the mind of man had never before conceived.

CHAPTER XVI.

HIS INVENTIONS—FURTHER PETITIONS—PUBLICATION OF HIS CENTURY—CHARLES II. VISITS HIS SON AT BADMINTON—WORCESTER HOUSE, STRAND.

THE preamble of an Act for awarding £60,000 to poor cavaliers sets forth, that "Whereas there was a loyal party which through all hazard and extremities in the defence of the King's person, crown, and dignity, the rights and privileges of Parliament, the religion, laws, and honour of the English nation, did bear arms by command of his late Majesty of ever blessed memory, according to their duty, and the known laws of this land, and did with an unwearied courage, faith, and constancy, with their lives and fortunes, oppose the barbarous rebellion raised against his most excellent Majesty in the year 1642, &c. &c."* But means so inadequate could really benefit few, particularly so large a claimant as the Marquis of Worcester, who had sacrificed more than fifteen times the whole amount of that fund.

And although he received back a large portion of his estates, the very deeds held by Cromwell being at this day in the family's possession, his own debts had accumulated to a most ruinous extent, less from improvidence on his own part, than from the precarious course of

* Bod. Lib. "Carte Papers. Lord Wharton's Papers, 81."

life his necessities had obliged him to lead, especially during the last ten or twelve years.

But his indomitable spirit rose superior to every calamity, whether public or private, and we find him in the midst of all his personal grievances having a patent sealed on the 15th of November, 1661, for four several inventions; 1. a watch or clock; 2. guns or pistols; 3. an engine applicable for giving security to a coach; and 4. a boat to sail against wind and tide. No description is afforded to guide the mechanic in constructing such inventions, being a mere statement of their nature and properties, as detailed probably in the first written copy of the *Century* in 1655, and still preserved in the printed edition. There is not the slightest connection between these inventions, and their incongruity would rather dishearten than encourage modern enterprise, variety of employments being contrary to the proverbial recommendation of all traders. It may be as well, therefore, to remark that this brief and strange assemblage of inventions in the same inventor, and in his single patent, was customary long before and after this period; so that, considered in this respect alone, the circumstance wore no air of singularity in the 17th century. Nothing occurs to throw the least light on the effect of this first publication of these inventions, we are consequently led to suppose that they proved of but little value to him, as regarded watches or firearms; and in respect to coaches and paddle-boats we should certainly have heard more about them had the one perambulated the streets or the other sailed on the Thames.

He appears, previous to his patent, probably immediately after his release from the Tower, to have circulated a written statement of such of his inventions as

he conceived most likely to attract public notice. In the Library of the British Museum* there is a small quarto half sheet of paper, closely written on both sides in a clerk's hand, bearing the title of "Inventions of y^e Earle of Worcester," enumerating eight subjects, viz. improvements in a watch, vessel, artificial bird, hour ball, coach engine, raising weights, raising water, and to stay motion.†

A matter of slight consequence at the time makes us acquainted with a small matter passing in reference to the recovered estates. Sir Robert Mason writing, on the 10th of November, 1661, to Mr. Secretary Nicholas, states that the person whom he has taken into custody is Edward Herbert, late of the Grange, near Magor, Monmouth, where he was Cromwell's tenant of part of the Marquis of Worcester's estate; but since the Marquis had power to recover it, he retired to Bristol. He further says, that he was Cromwell's right hand, and is an Independent.‡

The Marquis of Worcester must have been very fully occupied at this time, with the various incidents portending a change in his domestic affairs, yet he appears never to have forgotten, or considered it any trouble, to assist and relieve the necessities of others. In this humane spirit we find him addressing two long letters to the Secretary of State, the first in respect to Captain William Foster, a prisoner in the Tower; the other relating to the Captain's servant. They derive a further interest from the allusion he makes to his own former captivity in the same fortress:—§

* Brit. Mus. Birch MSS. No. 4459.

† See Appendix B.

‡ Col. State Papers, 1661-1662; Domestic Series. Edited by Mrs. M. A. E. Green, page 141. 8vo. 1861.

§ Col. State Papers, Dom. Series, 1662. [Nos. 28 and 60. Vols. 63 and 64.]

“ RIGHT HONOURABLE,

“ Though I bear as great a reverence to the Act of Oblivion as any, yet methinks justice also requires it at my hands to make a great difference between those who in their then actings carried a respect and afforded kindness to us their poor prisoners for his Majesty’s cause; I think myself therefore bound in honour and gratitude to give such a testimony in Captain William Foster’s behalf to my own knowledge, and was an eye-witness thereof to the very saving some prisoners of quality and merit [from?] their greatest hazards, who I believe (if they were in town, or present with you) would not deny it: the favour he only begs, and I in his behalf, is, that upon sufficient bail, he may follow his own calling, and provide for many children of his wife’s relict, of one once a soldier for his Majesty; and some little ones of his own, now by her ever a most Lady Cavalier. And if my intercession may be of stead to him, and of value to you, I shall take it for a good obligation upon one who am confident his accusations are of some priest animosities, and will prove so when rightly understood: for before his Majesty’s happy restoration his commission was upon that account taken from him to his damage, and that he should now likewise suffer for his Majesty does seem very hard. But I submit all this to your Honour’s best judgment towards him, and create an obligation from you upon me, though not very personally known to you, yet a great admirer of your great parts and merit; and shall ever approve myself

“ Your Honour’s

“ most affectionate and most humble servant,

“ WORCESTER.

“ November 18th, 1662.

“ For the Right Honourable Sir Henry Bennett,

One of his Majesty’s principal Secretaries of State, these.”

And the month following he wrote:—

“RIGHT HONOURABLE,

“Had not my indisposition hindered my attendance at Court, I should in one of the first places waited upon you to give humble thanks for your extended favour upon my letter, in taking bail for Captain Foster’s servant; and I hope his Honour is now satisfied so well at the sessions, as not to detain him any longer, in whose behalf, had I thought him in the least guilty, I should rather have suffered myself than have appeared for him; but my six years’ experience of him during my imprisonment in the Tower, made me confident, and if you please now to crown your favour to me by his despatch, it shall be, ere long, most thankfully acknowledged by me, who do not long for any one reason more to be at Court, and haste thither, than to be an eye-witness of so bright a star showing there; and that I may have occasion to appear

“Your Honour’s

“most humble and obliged servant,

“WORCESTER.*

“December 13th, 1662.

“For the Right Honourable Sir Henry Bennett,

“One of his Majesty’s principal Secretaries of State, these.”

We learn from the latter communication that he was in attendance at Court, though at the time, through indisposition, obliged to discontinue. His expression—“my six years’ experience of him, during my imprisonment in the Tower,” will bear two or three constructions, unless certain particulars are well noted. He may be considered to have been a state prisoner

* This and the former letter are holographs.

from July 1652, to May 1660. But he may have been confined in the Tower only from July 1652, until 5th of October 1654, when an order passed for his liberation on bail, but yet virtually a prisoner. As we have for the longest period the term of nearly eight years, the preceding "six years" acquaintance may have commenced only shortly before his discharge on bail, which appears to be the most reasonable construction, as he is not speaking of the precise term of his own imprisonment but of that of his "experience of him *during* my imprisonment." From the time of his enlargement to the termination of the Protectorate was five years and seven months, still leaving five months to accomplish the acquaintance within the precincts of the prison, and which he might fairly date to the period of Charles the Second's accession, as the full term of his "imprisonment," whether within or without its precise locality; for he was certainly not at liberty, like any other subject of the Commonwealth, to leave the kingdom. It has generally, however, been supposed that he suffered many years of absolute close confinement, and most romantic fictions have grown out of the interesting fable of a philosopher incarcerated in some dungeon-like chambers within the Tower, experimenting on culinary vessels, led by the explosion of a pot-lid to study the nature of steam, thereon applying his great discovery to practice, and forthwith writing a book, a true picture of science struggling under the most excruciating difficulties. The fable lost nothing of interest by repetition, being of a nature which left much to the imagination whether of readers, writers, or artists, all of whom have exercised almost unlimited indulgence in picturing the Marquis of Worcester, under circumstances purely mythical and absurdly ingenious.

We now approach the great event of the Marquis of Worcester's life, that for which alone, through all time, he will be distinguished, as pre-eminent among the luminaries who have advanced those branches of science which have most contributed to promote and extend the necessaries, conveniences, and comforts of mankind, thereby giving a decided impulse to civilization.

The new reign was marked by highly favourable circumstances connected with the advance of science, giving rise to the institution of the Royal Society, in 1660, for "improving natural knowledge," which was incorporated by Royal Charter two years later.

As early as January 1660-61, the Marquis had intimated his intention to proceed practically to work, so soon, as he expresses himself,—“as with security and satisfaction, by Act of Parliament, I may put in practice the greatest gift of invention for profit, that I ever yet heard of vouchsafed to a man, especially so unworthy and ignorant as I am (I mean my Water-commanding Engine).”*

Two years later the House of Peers, and afterwards the House of Commons, had this subject before them, and therefore, in a matter which has grown to be one of national importance, we shall proceed to afford the fullest particulars of what transpired, to obtain for the Marquis the long contemplated Act.

In the House of Lords, on the 16th of March, 1662-3, the Marquis of Worcester being present, his Bill was read the first time, for—“An Act to enable Edward of Worcester to receive the benefit and profit of a Water-commanding Engine, by him invented; one tenth part whereof is appropriated for the benefit of the King's Majesty, his heirs and successors.”†

* See page 222.

† Jo. II. of Lords. Vol. xi. p. 493, 494.

It was read a second time, and committed on the 19th following, his Lordship again attending, when a Committee of 14 members was appointed.*

“His Lordship was again present on the 28th of March, 1663, when the Bill was reported with amendments and recommitted; and he also attended on the 30th, when the Report was received with a proviso, which was read twice, agreed to, and the Bill ordered to be engrossed. And on the 31st of the same month it was read a third time and passed.”†

On the 2nd of April‡ the House of Lords sent the Bill, with the following message, to the House of Commons, by Sir Thomas Bennett and Sir Justinian Lewyn, Knights:—

“Mr. Speaker, The Lords have sent you down a Bill to enable Edward Marquis of Worcester to receive the benefit and profit of a Water-commanding Engine, by him invented; one tenth part whereof is appropriated for the benefit of the King’s Majesty, his heirs and successors; to which they desire the concurrence of this House.”

After other business, in the House of Commons,§ on the 4th of April, the Bill was read a second time and

* It was “Ordered, That the consideration of this Bill is committed to these Lords following; *videlicet*,

Lord Privy Seal.	Bp. London.	Ds. Pagett.
Marquis of Dorchester.	Bp. Winton.	Ds. Chandos.
Comes Bridgwater.	Bp. Ely.	Ds. Hunsdon.
Comes North’on.	Bp. Sarum.	Ds. Craven.
Comes Bollingbrooke.	Bp. Petriburgh.	Ds. Loughborough.
Comes St. Albans.	Bp. Carlisle.	Ds. Byron.
Viscount Say et Seale.	Ds. Berkeley de B.	Ds. Colepeper.

“Their Lordships, or any other five, to meet on Saturday next, in the afternoon at three of the clock, in the Prince’s Lodgings.”

† Jo. H. of Lords, Vol. xi. p. 499, 501, 502.

‡ Ibid. p. 504.

§ Jo. H. of Com. Vol. viii. p. 464.

committed, and it was recommended to the Committee* to provide, “That after the death of the Lord Marquis, the benefit of the Water-commanding Engine may come to the Lord Herbert his son.”

“And they are to meet on Tuesday next, in the Exchequer Chamber, at two of the clock in the afternoon: And to send for persons, papers and records.”

The Commons' Committee† reported on the 5th of May following, through Mr. Hungerford, “That the Committee had accordingly prepared a proviso for the purpose aforesaid: which he read in his place; and after, delivered the same in at the clerk's table.

“The said proviso being twice read;

“Resolved, &c. That the words ‘raising and’ be inserted in the proviso, after the word ‘the,’ and before the word ‘carriage,’ in the fourth line of the proviso.

“Which was done accordingly.

“The proviso, thus amended, was read the third time.

“Resolved, &c. That the proviso, so amended, be agreed to.

* The following Members were on the Committee :—

Lord St. John,	Sir Tho. Tompkins,	Mr. Gandy,
Sir Geo. Probert,	Mr. John Vaughan,	Mr. Prideaux,
Sir Robert Atkyns,	Sir Rich. Braham,	Sir Tho. Littleton,
Mr. Clifford,	Sir John Birkinhead,	Sir Humphrey Bennet,
Sir John Goodrick,	Mr. Wren,	Colonel Gilby,
Sir Tho. Meres,	Sir Rowland Berkley,	Sir Wm. Fleetwood,
Mr. Wm. Sandis,	Colonel Fletchvile,	Sir Solomon Swale,
Mr. Chicheley,	Sir Geo. Downing,	Mr. Geo. Montague,
Sir Tho. Ingram,	Mr. Westphaling,	Mr. Morice,
Mr. Crouch,	Mr. Waller,	Sir John Low,
Mr. Culleford,	Sir Cha. Harbord,	Sir John Holland,
Serjeant Charlton,	Mr. Wm. Montague,	Sir Roger Bradshaigh,
Lord Herbert,	Colonel Windham,	Sir Nich. Steward,
Lord Bruce,	Mr. Hungerford,	Mr. Whorwood,
Mr. Hen. Coventry,	Mr. Sprye,	Sir John Denham,
Sir Lane. Lake,	Sir Wm. Lewis,	Sir John Norton,
Mr. Birch,	Sir Rich. Onslow,	Mr. Cornwallis.

† Jo. II. of Com. Vol. viii. p. 474, 476.

“ Resolved, &c. That the Bill, with the amendments and proviso, agreed to, be returned to the Lords, for their concurrence.

“ And the Lord Herbert is to carry the same up to the Lords.”

In the House of Lords,* on the 7th of May, “ A message was brought from the House of Commons, by the Lord Herbert and others: To return a Bill formerly sent down, concerning the Lord Marquis of Worcester’s Water Engine; wherein they have made some amendments and alterations, and desire their Lordships’ concurrence therein.”

On the 8th of May, after other business:—“ Next, was read the alterations and proviso brought up from the House of Commons, which are to be added to the Bill concerning the Marquis of Worcester’s Water-commanding Engine; and being thrice read over, and considered of,—

“ The question being put, ‘ Whether this Bill, with the alterations and additions now read, shall pass?’

“ It was resolved in the affirmative.”

On these three last occasions the Marquis was likewise present.

On the 12th of May* their Lordships, in their message,† by Sir William Child and Sir Toby Woolrich, to the House of Commons, acquainted them that they agreed to their alterations; and, on the 3rd of June, the royal assent was given to “ An Act to enable the Marquis of Worcester to receive the benefit and profit of a Water-commanding Engine, by him invented, &c.”—in these words:—

“ *Soit fait come il est desiré.*”

* Jo. II. of Lords, Vol. xi. pages 517 and 519.

† Jo. II. of Lords, Vol. xi. p. 522 and 533; and Jo. II. of Com. Vol. viii. p. 480.

But the Marquis was not in attendance, as on former occasions, to watch the proceedings.

We have thus traced the progress of this remarkable Act through Parliament; from the 16th of March to the day of its receiving the royal assent on the 3rd of June. It will have been remarked that the Marquis was in constant attendance, and that it was his son who was deputed by the Commons, on the 3rd of May, to present the amended Bill to the Peers. It is impossible to imagine what might have been the feelings of the Marquis himself throughout the period of these prolonged proceedings, but he unquestionably had set his mind on this measure as the palladium of his inventive rights and the forerunner of brighter prospects.

In a memorandum relating to various grants, among others, occurs one to the Marquis of Worcester, thus noticed:—"March, 166 $\frac{3}{4}$. That by Act of Parliament his Invention of a Water-commanding Engine, granted him for ninety-nine years, one tenth reserved to the King. The King remitted the tenth to the Marquis upon a surrender of a Warrant dated at Oxford, 5th Jan. 20 Car. I. by which his then Majesty did grant the Marquis lands to the value of £40,000, in consideration of a debt due to the Marquis from his Majesty."*†

The prospect of better days had now fairly set in; he had at least succeeded in securing his invention to himself and to his family after him, as a property in the value of which he felt unbounded confidence, roundly

* See Calendar of State Papers, 1663-1664. Domestic Series, Charles II. edited by Mrs. M. A. E. Green, referring to Vol. 95, and papers between Nos. 101 and 102. The same memorandum, in another form, appears also in Domestic Correspondence, Feb. 1664. Vol. 93, No. 83,—thus:—

"Water Engine Invented. The tenths of the benefit remitted to the Marquis of Worcester, the Inventor, in lieu of lands to the value of £40,000, granted by warrant from his Majesty for that sum disbursed in his service."

† See Appendix F.

estimating it at not less than £400,000. Shortly after the passing of this Act he published his ever memorable and extremely curious and ingenious little work, entitled "A Century of the names and scantlings of Inventions."*

* Mr. Thomas Baker, a talented engineer, and withal a poet, has very gracefully epitomized the character of the *Century* in his poem on "The Steam Engine; or the Powers of Flame," published in 1857. As the work is now extremely scarce, and not likely to be met with by the general reader, the following extract may prove acceptable:—

THE VISION OF THE MARQUIS OF WORCESTER.

WITH hopes now high, now with despair oppress'd,
As Phœbus sunk, he also sunk to rest;
When lo! uprose before his mental view
A HUNDRED ENGINES of devices new!
In slow procession he their forms survey'd;
In each recondite fabric were display'd
Rare works of art, and such as far surpass
Ought erst beheld in iron, steel, or brass;
While gems with gold and silver's polished sheen
Blended their hues in this artistic scene:

* * * * *

Resplendent seals were there in groups arranged,
Which by a touch their rare devices changed,
And secrets in all languages convey'd
From man to man, nor once their trust betray'd.
Such were the seals to Eastern Magi known,
By which of old their wond'rous feats were shown.

Nine engines next in slow succession came,
Explosive from the slightest touch of flame,
Replete with missiles, used in various ways:

* * * * *

A floating garden, gay, with verdant bowers,
And redolent with blooming trees and flowers,
Drew its own moisture, moved its pleasing form,
Spontaneous met the sun, and shunn'd the storm;
Such scenes of fair delight, are wont to smile
From age to age in Hainan's palmy isle!

Nine splendid founts their varied forms display'd.
Whence cooling streams, abstrusely winding, stray'd;
In one, tall jets bright Iris' colours show'd;
In one, the waters ever ebb'd and flow'd:

* * * * *

Next there came forth a vast abstruse machine,
Where motions of ten thousand worlds were seen;
Th' æthereal vault around was wide display'd,
As by bright Phœbus from his car survey'd;

It is dedicated to Charles the Second, and also to both Houses of Parliament; in addressing the latter he expresses himself as being—"by the Act of the Water-commanding Engine (which so cheerfully you have passed) sufficiently rewarded;" and as the work bears date on the title page, 1663, it must have been published after the passing of the Act, in May, that year. This edition, only duodecimo size, consisting of 98 pages, is now very scarce, but it has been frequently reprinted. This small volume was most likely only intended for private distribution, particularly among members of

Here scenic splendour and rich art outshone
All Orreries to modern science known !

A new variety, in number vast,
Of ever-changing forms before him pass'd :
Not Proteus' self could with their antics cope,
Nor modern scenes of gay Kaleidoscope :
Their graceful symmetry and rainbow-hues
A rapt'rous wonder o'er his mind diffuse !

To vary these abstruse artistic scenes,
There pass'd along a group of fresh machines ;
Many there were that in these days impart
Essential aid to various schemes of art :
One was a globe buoy'd by a crystal well,
Which night or day the passing hour could tell,
With the elapsing minutes, seconds too ;
And, like the dial, to the heaven true ;
The famed Clepsydra, in its artifice,
Was but a bauble when compared with this !

Martial designs came next, in size immense,
Adapted for attack, and for defence :

* * * * *

To crown these shows of wonder and delight,
A BEING rose of superhuman might :

* * * * *

At every motion from his nostrils came
A mounting vap'rous breath like subtle flame !
At once it beam'd on Worcester's mental eye,
That STEAM alone might this great power supply :
And lo ! as 'twere this thought to realize,
He saw it, fuming, from vast cauldron rise ;
From whence this prodigy his spirit drew,
Achieving thus what met the wondering view !

Parliament, and persons whose support might be solicited; for it is generally believed that a company was being organised for bringing the invention into public use.

During this state of affairs in London an agreeable episode was being enacted at Badminton House, Gloucestershire, the seat of his son, Lord Herbert. In September, 1663, Charles the Second and his Queen visited Bath, Badminton, Cirencester, and other places, in their progress to Oxford. Mr. Godolphin, writing from Bath on the 18th of September, 1663, to his brother, says:—“We were waiting on the King to Badminton, a house of my Lord Herbert of Raglan, where the King dined, and was handsomely entertained.” From Oxford, he again writes to his brother, on the 28th September, 1663, in which he informs him that, among other matters, he will “receive the account promised of our progress through Bath, hither.” A news-letter, dated “Oxford, 28th” [1663,] which is no doubt the one alluded to, commences:—

“On Tuesday, the 22nd instant, [?] the King and Queen left Bath, and at their entrance into Gloucestershire were met by the High Sheriff; and a little after by the Lord Herbert of Raglan, Lord Lieutenant of that County, with a brave appearance of the gentry of that County, who all conducted their Majesties to the Lord Herbert’s house, at Badminton, where their Majesties were nobly entertained at dinner.”

They went thence to Cirencester, where they supped at Lord Newburgh’s, and lodged that night.

An obvious discrepancy occurs in the two accounts of the dinner, Mr. Godolphin on the 18th writes of it as having taken place, whereas the Oxford news-letter names the 22nd.

From 1660, we find Lord Clarendon making a tem-

porary residence of Worcester House in the Strand, where, in December, the same year, Evelyn paid a visit to the Lord Chancellor's newly married daughter. And four years later he dined there, being afterwards taken in their coach by the Chancellor and his Lady, to see their palace, building at the upper end of St. James's Street.³⁷

The Marquis's own residence never transpires, but it is more than probable he would reside near to, or within easy access of Vauxhall, where we have next to trace his very different, exceedingly arduous, and most trying undertaking.

³⁷ Evelyn.

CHAPTER XVII.

HIS OPERATIONS AT VAUXHALL—PETITIONS AND DECEASE
—CASPAR KALTOFF AND FAMILY—M. SORBIERE—COSMO,
GRAND DUKE OF TUSCANY—THE DOWAGER MARCHIONESS
OF WORCESTER.

IN the second Dedication to his "Century" the Marquis of Worcester expressly alludes to "the experiments extant, and comprised under these several heads, practicable with my directions, by the unparalleled workman both for trust and skill, Caspar Kaltoff's hand, who hath been these five and thirty years as in a school under me employed; and still at my disposal, in a place by my great expenses made fit for public service, yet lately like to be taken from me, and consequently from the service of King and kingdom, without the least regard of above £10,000 expended by me through my zeal to the common good."

We have thus the fact on record, that Kaltoff was employed by him in the execution of his mechanical experiments from 1628 to 1663, commencing with the period of his first marriage, when he was about twenty-seven years of age.

In 1664, M. Samuel Sorbière, historian to the King of France, published in Paris a small work entitled—"Relation d'un voyage en Angleterre, &c." As he appears to have interested himself in scientific matters, as much or more than in any other single subject, no

apology need be offered for quoting his entire remarks; because, although perhaps in one sense they appear irrelevant, yet they acquire interest here, as proving that he was not an incompetent authority in reference to his most important remarks resulting from a visit to Vauxhall. Besides, it is not a little remarkable that Dr. Sprat, a Fellow of the Royal Society, as well as its historian,* in a book of equal extent to that written by this contemporary authority, addressed to Dr. Wren, Professor of Astronomy, under the title of "Observations on M. Sorbière's Voyage into England,"⁹¹ not only passes over these remarks, but ridicules his short experience of only "three months;" and, "that when he declares he came into England to content his curiosity, to see all rare things and men amongst us, yet he scarce mentions the Duke of York!" This last omission, however serious a one it might have been in 1665, the lively Frenchman has amply compensated for, by the substitution of matter that has a far greater interest for posterity. Sorbière says:—

"M. de Monconis showed me his journal, which was so curious, and where he had collected so exactly all that was passing among the learned men of the Royal Society of London, that his industry has made me negligent in collecting afresh for myself the things found there. We shall see some day all that he has said in it, for if he believes me he will lay before the public that, as well as his other journal of Egypt and Jerusalem. He speaks of several new inventions, which would be very difficult to believe, if not tried. One is a self-registering instrument to mark atmospheric changes

* History of the Royal Society of London. By Thomas Sprat, Bishop of Rochester, 4to. 1667.

⁹¹ Sprat.

which happen every 24 hours, effected by a pendulum clock. A thermometer; a compass; a self-registering weather-cock; a means by which Mr. Willis causes a piece of iron by exposure to moderate heat to calcine, without the help of a corrosive, and dissolve on being plunged into water; of a deaf and dumb person at Oxford, who Mr. Willis has taught to read by showing the different inflexions of the voice necessary for articulation; a new manner of exploding ships in the water; a way by which several short beams can be made into a plain flat surface, by placing them one on the top of another without being supported, nailed, or grooved one into another; of a furnace or stove by Dr. Kuffler, in the style of Drebbel's, which I saw some time ago at La Hague, and which was so successful at Arnheim, with self-acting registers; another kind of furnace which, for five sous worth of wood, cooked a large quantity of bread; a way of distilling salt-water to make it drinkable, where for five sous you can distil water enough for 100 persons to drink; an instrument to design and draw every description of object by a person who has never learnt."

He adds:—"One of the most curious things I wished to see was a Hydraulic Machine, which the Marquis of Worcester has invented, and of which he has made an experiment. I went expressly to Vauxhall, the other side of the Thames, a little below Lambeth, which is the Palace of the Archbishop of Canterbury, in sight of London. This machine will raise to the height of 40 feet by the strength of one man, and in the space of one minute of time, four large buckets of water, and that by a pipe or tube of 8 inches. But what will be the most powerful help to the wants of the public is the work which is performed by another ingeniously constructed machine, which can be seen raised on a wooden

tower on the top of Somerset House, which supplies that part of the town with water, but with some difficulty, and a smaller quantity than could be desired. It is somewhat like our Samaritane water-work on the Pont-Neuf; and on the raising pump they have added an impulsion which increases the force; but for what we obtain by the power of the Seine, they employ one or two horses which incessantly turn the machine, as the tide of their river changes its course twice a day, and the spring or wheels which are used for the ebbing tide would not do for the flow."

M. Sorbière's Dedication of his narrative to the King is dated 12th December, 1663, so that it is possible the *Century* had been published previous to the visit he has just described, and it is worthy of notice that he expresses no difficulty in obtaining access to the exhibition of the machine, which gives colour to the belief that it was on public view, for the purpose of establishing a company to carry out the invention on a large scale.

Vauxhall, as it is now called, was variously designated Fox-hall, Faukeshall, Fulke's Hall, corruptions of a derivation from Fulke de Breauté, who built a mansion in the manor of South Lambeth, long known as Fulke's-hall.⁹⁴ In 1652, the Parliament having determined that Vauxhall-house, which had been reserved by a former order, should be sold, it was purchased by John Trenchard of Westminster. After the Restoration it was leased to Henry Lord Moore, afterwards Earl of Drogheda, together with the demesne lands of Kennington for 31 years; with a proviso, that if his Majesty should think fit to make use of the house, or any part thereof, it should be surrendered upon a proper allowance being made for the same. The King, availing

⁹⁴ Tallis.

himself of this proviso the year after the lease was granted, settled Casper Kaltoff, a Dutchman, at Vauxhall, who was employed in making guns and other warlike implements for government service.⁶⁵

By an Act of the House of Commons, 17th of July, 1649, for the sale of the houses, &c. of the late King, Queen, and Prince, it is provided that "it should not extend to the house called Vaux Hall, nor to the grounds, houses, buildings, *models*, utensils, or other necessaries for *practical inventions therein contained*; but that they should remain for the use of the Commonwealth, to be employed and disposed of by the Parliament, as they shall think fit."³ Now the mention of *inventions* and *models*, taken in connection with recent facts, would lead to the inference that the Marquis of Worcester might have been much earlier associated with practical experiments at Vauxhall than at first appears. On this point he was always reserved, even in his *Century* only cautiously alluding to Kaltoff as being "in a place by my great expenses made fit for public service, yet lately like to be taken from me."

Among the manuscripts of the Royal Society is a letter from Samuel Hartlib, the author of works relating to Husbandry, addressed to the Honourable Robert Boyle,¹⁴ dated Amsterdam, May the 18th, 1649, in which he remarks:¹⁰⁴—"Fauxhall is to be set apart for public uses, by which is meant making it a place of resort for artists, mechanics, &c. and a *dépôt* for models and philosophical apparatus." It is further proposed, that "experiments and trials of profitable inventions should be carried on," which, says Hartlib, "will be of great use to the Commonwealth." Adding that the late King (Charles I.) "designed Fauxhall for such an use."

⁶⁵ Lysons.³ Allen.¹⁴ Boyle.¹⁰⁴ Weld.

After a lapse of five years, he writes another letter to Boyle,¹⁴ on the same subject, furnishing us, incidentally, with the following curious and important details:—
“The Earl of Worcester is buying Fauxhall from Mr. Trenchard, to bestow the use of that house upon Gaspar Calehof [Kaltoff] and son [son-in-law], as long as they shall live, for he intends to make it a College of Artisans. Yesterday (he adds) I was invited by the famous Thomas Bushel to Lambeth Marsh, to see part of that foundation.”¹⁰⁴

Hartlib was a generous-hearted man, who projected many schemes for public benefit. Evelyn styles him an “ingenious person, honest and learned;” that he deserved the latter distinction we may infer from the fact of Milton having addressed to him his treatise “Of Education.”

These particulars serve to show a very early connection on the part of the Marquis of Worcester with Vauxhall, making it still more probable that he had established a laboratory or workshop there, years before the Civil War broke out; that from its extent it was proposed to retain it for the benefit of the State; and that on his own release from the Tower he sought to regain possession of the premises, but possibly, for politic reasons, in the name of his faithful workman Caspar Kaltoff.

During 35 years there would be a large accumulation of models for one hundred inventions and several hundreds of experiments, as well as a considerable quantity of tools and machinery. He would certainly choose some place as near as possible to the great mart, where alone he could obtain, within any reasonable time, the numerous articles and materials constantly

¹⁴ Boyle.

¹⁰⁴ Weld.

required in experimental employments; and desiring to be near London, when we find him at Vauxhall in 1663, who can doubt, that he rather continued, than selected for the first time, the locality where we now find the indefatigable noble inventor and his veteran "unparalleled workman," engaged on the first public example of the "Water-commanding Engine."

Pressing as were his personal necessities, he continued untiring in maintaining the practical working of the new engine set up under protection of the Act he had obtained in 1663. But, like all novel enterprises, people were sceptical as to its real value. He appears to have been wholly neglected by the first scientific authorities of his day, who yet could not be otherwise than aware of the remarkable performance of the engine erected by him at Vauxhall. We find him making sufficient allusion to its nature and properties in his *Century*, published in 1663; then, in 1664, Sorbière published his account of his visit to England, further describing what he had seen of the water-works at Vauxhall; while Dr. Sprat, by the severe strictures he wrote on the Royal-Hydrographer's book, in the letter he published, addressed to Dr. Wren, at Oxford, must have spread the intelligence, and served to call attention to Sorbière's statement. What benefit the Marquis of Worcester really received through the intervention of friends or the public, beyond temporary loans of money, does not transpire, and, judging from the following documents, his financial position was reduced to the lowest state possible. The original papers are fortunately preserved at Badminton House. The first is endorsed, "Copy of the letter which was sent by my Lord Duke of Albemarle to the Lord Arlington."

“MY LORD,

“The sad condition of my Lord Marquis of Worcester, after his so great merits from the Crown of England, as few can imagine, but now discovered by sure hands unto me, inclined me to write such a letter to his Majesty, as I find by him that your Lordship hath been acquainted with; but reflecting, that if it should be presented to the King, it might seem against some resolutions of mine, not to importune his Majesty for things of the like nature, as are therein mentioned, I choose rather to desire my Lord Marquis to suspend my endeavours to serve him therein with his Majesty, till I have the honour personally to attend him; yet, in the meantime, if your Lordship find an occasion to incline the King thereunto, I shall not fail to second your Lordship therein, or any other who may be instrumental to get from his Majesty a due consideration of my Lord Marquis, his just pretensions to as much favour and recompense as any subject I know; and I make no question but when your Lordship hath thoroughly known him, you will be of the same opinion, and if that be any value with you, I do profess that in obliging my Lord Marquis of Worcester, you will also exceedingly oblige,

“Your Lordship’s, &c.”

The next is a Draft Petition in the Marquis’s handwriting, written with more care than usually occurs in his letters:—

“DREAD SOVEREIGN,

“Although I know very well that were the wise and politic Cornelius Tacitus living, he durst not whisper unto your Majesty as he did to other Princes, prone to hear him, when he said:—‘Eo usque grata

sunt beneficia quam diu solvi posse videantur ubi semel antevenere pro gratia odium vedditur.' I am, notwithstanding, very loth to trouble your sacred Majesty in order to myself, not but I am sufficiently necessitated to importune you, even as much as any poor subject your Majesty hath; and warranted by as good a title unto it (if, after an opulent and flourishing condition to become an object of pity, through my zeal and services to the crown you wear, may challenge any esteem); but my very nature abhors anything that may seem self-interest, though indeed whatever I have or do ambition, be it of favour or benefit from your Majesty's most gracious self, it hath been, really is, and shall be ever, but to make me able the more eminently to serve your matchless Majesty, whose advantage is my greatest comfort; and, in earnest, my very heart's objectum adæquatum. Think of me whatever others please to suggest, yet such shall your Majesty ever find me, and unless your Majesty command me to speak, I shall still say nothing, but seeing a coldness in your Majesty, I shall continue dumb and speechless:—*Leves loquunter curæ ingentes stujescunt*. Yet, animated by your Majesty's cheerful commands, I shall ingenuously lay before you the truth and nothing but the truth, and (though to mine own confusion) I will as candidly shrive me to your benign self, as to a ghostly father, and I will make your most excellent Majesty my sole judge, as well spiritual as temporal, that is to look into my inward man, as well as my outward actions and deportment."

In November we have another petition in respect to a large claim on his estate, and a report thereon, as follows:—*

* MS. Public Record Office, in course of being calendared by Mrs. M. A. E. Green.

“To the King’s most excellent Majesty, the humble petition of Edward Marquis of Worcester.

“SHEWETH,

“That whereas your Petitioner and his late father did heretofore lend to serve his then late Majesty’s urgent necessities the sum of two hundred thousand pounds and upwards, (ninety-five thousand pounds whereof appears under his late Majesty’s hand and seal, and the rest the Petitioner, if permitted, will make appear), besides other great sums the Petitioner employed in other his Majesty’s service, by which means your Petitioner’s estate was encumbered, and continued encumbered with vast debts, insomuch that to the Petitioner and his family there is left but a small pittance for a mean livelihood; the Petitioner’s estate being charged with the debts so contracted for his late Majesty’s service, and your Majesty’s, as aforesaid.

“That the Petitioner by bond from himself and others (his sureties) in 1643, amongst other engagements, became bound in six thousand pounds to Henry Hall, Esq.; which bond was sued in his Majesty’s Exchequer by John Hall, Esq. administrator of the said Henry (not only against your Petitioner, but also against his sureties, the Lady Lingen, and Charles Price, Esq. whom the Petitioner is bound to save harmless, great sufferers for their loyalty in his Majesty’s service), who thereupon hath obtained judgment against your Petitioner for six thousand pounds, and as particular receiver of some part of your Majesty’s revenue hath assigned the same as debtor unto your Majesty, whereupon an extent is in the sheriff’s hands (by the said Mr. Hall’s prosecution) to extend your Petitioner’s estate for the use of your Majesty, whose prerogative intervening, that extent (as your Petitioner is advised by counsel) will take place (although subsequent in time of all

former encumbrances), by which means not only the Petitioner's other creditors will be defeated of their respective debts, but the small remainder of your Petitioner's (once considerable) now shattered estate will by your Majesty (to pay a debt to your Majesty) be swallowed up, and your Petitioner and his other creditors wholly deprived thereof.

“The Petitioner therefore most humbly prays, that in regard your Majesty's name is made use of against your Petitioner, and since that this debt (being subsequent in time to other encumbrances) could not affect your Petitioner's estate, but by your Majesty's prerogative, your Majesty will be graciously pleased to supersede the said Mr. Hall's prosecution, and order him some other satisfaction; the Petitioner being absolutely disabled by those vast sums in his late Majesty's service expended as aforesaid.

“And your Petitioner shall ever pray.”

“At the Court of Oxford, Nov. 24th, 1665.

“His Majesty is graciously pleased to refer the consideration of this petition to Mr. Attorney, or Mr. Solicitor-General, to consider how far his Majesty may fitly gratify the honourable Petitioner, of whose condition he hath a just sense, but sees not what he can do in this particular for his satisfaction, till he receive Mr. Attorney's or Mr. Solicitor's opinion upon it.

“ARLINGTON.”

Agreeable to the preceding reference the following report was made:—

“MAY IT PLEASE YOUR MAJESTY,

“The Petitioner hath been pleased to show me the sign-manual of your royal father, acknowledging £95,000 to be due to him, for so much advanced by his father and himself in his late Majesty's service.

“The Petitioner doth further allege that the six thousand pounds [£6000] owing by him to Mr. Hall, and for which Mr. Hall hath obtained a judgment against the Petitioner, is part of that very £95,000 advanced in the service of your royal father.

“I find likewise that Mr. Hall hath assigned this judgment to your Majesty, and all the time of that assignment was indebted to your Majesty five or six hundred pounds.

“But I am humbly of opinion, that though your Majesty may by your prerogative release this judgment thus assigned, yet it will not be fit for your Majesty to do it as this case is, because then your Majesty will stand obliged to make good to Mr. Hall so much money as would remain due to him after your Majesty’s debt [is ?] satisfied, which is in effect to put your Majesty in the Petitioner’s place for payment of Mr. Hall’s debt.

“Nevertheless the Petitioner’s case being very worthy of relief, I do humbly consider it fit for your Majesty to reserve the consideration of his satisfaction to some better occasion.

“HENEAGE FINCH.”

Among family documents at Badminton House is the following draft, which may relate to the foregoing petition:—

“The Case of Edward Marquis of Worcester, &c.

“Edward, Marquis of Worcester is indebted £6000 unto John Hall, Esq. the Receiver for the Counties of Gloucester, Monmouth, and Hereford, &c.

“John Hall assigns this judgment to the King, whose prerogative interfering, John Hall’s debt of £6000 will affect the Earl of Worcester’s estate, and obstruct the other creditors from their respective satisfactions, by the former settlement of my Lord of Worcester’s.

“The Lord of Worcester petitions the King in regard he had expended, and lent towards his late Majesty’s service the sum of £92,500, for which and his other very many and considerable losses, to the utter impoverishment of himself and family, he never yet received any compensation or satisfaction. His Majesty would be pleased to take the state of the Petitioner into his gracious consideration, &c.

“His Majesty is graciously pleased to refer this petition unto Mr. Attorney or Mr. Solicitor. Mr. Solicitor reports to his Majesty matter of fact in the petition mentioned to be true, and further adviseth it is not safe for his Majesty either to supersede or discharge the said judgment, but that likewise the Earl doth justly merit his Majesty’s just and favourable consideration, &c.

“Whereupon the Earl of Worcester prayeth, that in regard what he petitioned for, was for the satisfaction merely of creditors, and not to his mediate or immediate advantage, and his fortune totally disposed of to his Majesty’s service, other than what is settled as aforesaid to the payment of his many creditors, which in honour (his only livelihood now left him), he is bound to see satisfied, the which as the present case standeth with my Lord cannot be, without his Majesty extendeth his favour, either by payment of the money, or some other means equivalently satisfactory, &c.

“His Majesty will be graciously pleased to confer the honour of Baron on J. B. being firly qualified, and whose estate suits in proportion with the charge that dignity requireth, by which means his Majesty will not be out of purse and the Petitioner indemnified.”

On Christmas day the Marquis wrote a long epistle (but to whom is unknown) requesting the favour of a letter by means of which he could obtain the services of Lord Arlington and Lady Castlemaine, probably to

obtain some protective influence over his property, then much jeopardized:—*

“HONOURED SIR,

“You have by God’s infinite providence not only befriended my wife and me in Cromwell’s time, but likewise by his great mercy and goodness, I think, reserved to do the like in his now Majesty’s reign; in whose happy memory [he] was pleased to say, even to his Queen, now dowager, that next to his own children and her, he was obliged to take care and recompense me; so can you not do now a greater act of charity, nor loyalty, than to set your concurring hand to procure from her Grace, and her unparalleled deserving husband, the favour of setting their hands each to a letter I shall be bold to present to your perusal first, and then your favour to their Graces; which done, my Lord Arlington and my Lady Castlemaine undertake to perfect my most humble request to his Majesty; so that they shall incur no risk of denial, and yet by the same obliging hand of yours which promotes my most humble suit, I shall present a thousand pieces to the Duchess, to buy her a little jewel to what she deserves to wear every day of the week. And if it please God I live but two years, I will, out of the profits of my Water-commanding Engine, appropriate five hundred pounds yearly, for ever, to her Grace’s, and two hundred pounds yearly, likewise, to your disposal; and in present forty pieces to buy you a Nogge; all which, as I am a gentleman and a christian, shall be faithfully and most thankfully performed, though the benefit I pretend to by my petition, will not amount to what my gratitude obliges; yet the satisfaction which it will be to my mind, and my credit

* From MSS. Badminton.

therein at stake, I value at ten times as much. And this will enable me to place my Water-commanding Engine, where I am a certain [assured ?] an hundred pounds a day profit, without further troubling the King or any body. And that done the greatest of my ambition will be to show my gratitude and pay my debts; confessing not to owe to any person living more real acknowledgment of thankfulness than to her Grace, who hath been pleased, in my absence and my wife's, to be a champion for us, which draws upon herself in part this trouble, with more than confidence to receive from her more than gracious hands and princess-like disposition this further favour, which my wife and I shall never forget, and thankfully to acknowledge to her Grace, and your most worthy self, whose further trouble it is time to prevent in subscribing myself as you shall ever find me,

“ Sir, your most real affectionate friend,

“ and humble servant,

“ WORCESTER.

“ Christmas Day, 25th of Dec. 1665.

“ Because the profit accruing from my Water-commanding Engine may seem uncertain, I humbly offer in lieu thereof and in token of my gratitude, a judgment of ten thousand pounds for the payment of one thousand pounds a year for four years, at the disposal of her Grace, and two hundred pounds per annum at yours; so their Graces be pleased cheerfully to sign the letter, and positively to own them and me to be their perpetual servant, not doubting then to find ways more efficaciously to testify my reality and devotion to them if accepted of, and thus obliged to them and you.

“ WORCESTER.”

Whether the following is the draft of a letter, proposed in the preceding communication, is uncertain; it

is however in a contemporary handwriting, and, therefore, may be the very letter he offered to submit for approval.* It runs thus:—

“MAY IT PLEASE YOUR MAJESTY,

“Upon my Lord of Worcester’s speaking to my husband for his letter to your Majesty, and laying open his sad condition, there comes into my mind a petition from his Lady to the Speaker ready to adjourn the House in Cromwell’s time, without relief to her, but upon her petition, as here enclosed, Worcester House was granted her. God forbid a greater hardness should possess your Majesty’s heart, our most gracious King, than did those regicides to one they took for their enemy; and I do, therefore, with more than confidence in remembrance of my Lady’s former pressures and miseries make myself a party with my Lord Marquis, in his most humble suit to your Majesty, in my Lord Powis his behalf, that he may not be frustrated of what the last King entitled him, of being created Earl, because it came through my Lord Marquis his hands, but further likewise to bestow a Baron’s patent upon a friend of my Lord Marquis, for both which I become a suitor with his Lordship, and beg pardon if I become more importunate to your Majesty in this case, than for myself in anything, who do already acknowledge most thankfully many great favours done to me,

“Your Majesty’s most humble servant.”

The following letter it would appear was addressed to the Duke of Albemarle:—

“MAY IT PLEASE YOUR GRACE,

“The objections you were pleased to make against the owning and subscribing the letter to his

* From MSS. Badminton.

Majesty were as I humbly conceive your Grace's resolution not to trouble the King for money business even in your own behalf, much less in another's; and secondly that as for Creations you had absolutely promised his Majesty you would not importune him again. To the first I answer that this is to save the King's coffers, since certainly if either honour or conscience should take place his Majesty ought to save me harmless from the six thousand pound confessed and proved to be the Crown's debt; so happily now upon his head by your Grace's no less prudent and valorous, than dutiful endeavours, blest by Divine Providence, never intending the ruin of his best deserving subjects, and the only promoting of his rebels, which the child unborn may rue if not timely prevented; and as a wise Privy-Councillor your Grace's part is to mind his Majesty so of, as not totally to dishearten, I will not say disgust his good subjects well deserving, yet that as far as loyalty and religion will give them leave; and I am sorry his Majesty should bid adieu to works of supererogation and love in his subjects, and most certainly they are not his best counsellors who advise him to it; and your Grace will be most commendable in doing the contrary, and at long running the King will love you best for it, so that this objection of your Grace I humbly conceive to be totally solved.

“As for the second, your Grace's promise not to speak for any more Creations, be pleased to understand it rightly, and you are no motioner of this; you do but lay before him my reasonable petition therein, such as my Lord Chancellor was pleased to think so fitting as he once undertook it for me, and I am confident will thank your Grace for reviving of it, and in my conscience so will the King too in granting of it; for I cannot have so mean a thought of his Majesty but that

against the hair he hath been forced to bestow honour to the highest degree upon five member men, and * * * upon earth, as subscribed to his father of happy memory his death, and that he will think much to countenance him who only assisted his late Majesty to fly from their compulsion of him, to agree to such acts as would have left himself our now gracious King the successor of a title of a King of three kingdoms, but to the substance of no one of them. It was I furnished his Majesty with money to go (to) Theobalds to go to York, when the then Marquis of Hambleton refused to pay three hundred pounds for his Majesty at Theobalds only to deliver him to the Parliament, as he had done the Earl of Strafford, and to * * * the * * * Parliament. It was I carried him money to set up his standard at York, and procured my father to give the then Sir John Byron five thousand pounds to raise the first regiment of horse, and kept a table for above twenty officers at York, which I underhand sent thither to keep them from taking conditions from the Parliament, and so were ready to accept his. It was I victualled the Tower of London, and gave five and twenty hundred pounds to the then Lieutenant, Sir John Byron, my cousin-german by my first wife's side. It was I raised most of the men at Edge-hill fight, and after I was betrayed at * * * * * when so many gentlemen of quality were taken, and of twenty-five thousand men first and last by me raised, eight thousand men dispersed by the contrivance of such as called themselves the King's good subjects, and some of them rewarded for it; they were my men weekly paid, without taking a farthing contribution, because the country tottered; who took * * * * * in the forest of Dean, Goodridge Castle, Monmouth, Chepstow, Carlyon, and Cardiff from the Parliamentary forces; in which, and the garrison of Raglan, I can bring proof of

above an hundred and fifty thousand pounds expended ; and in ready money first and last to the King's own purse above as much more ; and of above thirty-five thousand pounds received by my father and me comunely armes, in forty, forty-two, and forty-three, I have not now five and twenty hundred, and that clogged with twenty thousand pounds crying debts, that keep me not only from a competent maintenance, but even from sleep. I speak not here of above three hundred thousand pounds which it hath cost the noblemen, knights, and gentlemen, which rode in my Life-Guard * * for * * * their comorting, they making amongst them above threescore thousand pounds yearly, of land of inheritance ; and I, upon my interest with seven counties, had begun an engagement of above three hundred thousand pounds yearly land of inheritance against my return with men from beyond the sea ; in which endeavours my charges have been vast, besides hazard by sea even of shipwreck, and by land of deadly encounters, I do not trouble your Lordship with, but all this being true to a tittle, as upon my word and honour, dearer to me than my life, I avouch it ; I cannot doubt but your Grace will call for a pen to sign the letter, and if you please send this together with it, and rest assured that if the King refuse my request, I will never importune you more, nor ever set my foot into his Majesty's Court again, unless expressly commanded by him for his service ; otherwise I will only heartily pray for him, but never hereafter shall I or any friend of mine engage for him further, than the simple duty of a loyal subject sitting quietly at home, no ways break the peace, or disobeying the wholesome laws of the land, and God send him better and more able subjects to serve his Majesty than myself ; willinger I am sure he cannot, and I beseech your Grace to pardon me if passion hath a little trans-

ported me beyond good manners, and lay what penance you please upon me, so I tend not to lessen your Grace's belief that I am

“Your Grace's most really devoted friend

“and servant ever to obey you,

“WORCESTER.

“Dec. 29, 1665.”

“My dear Lord, my heart is yet full fraughted, and I can say much more for myself, were I not ashamed of giving your Grace so great a trouble with my scribbling, which I will thus end, promising to smother as long as may be, my deplorable condition, and worse usage, but it will at last fly over the whole world to the disheartening of all zealous and loyal subjects; unless such a true-hearted Englishman and faithful servant as your Grace do awaken his Majesty out of the lethargy my enemies have cast him into, not to be sensible of what I have done or suffered. Cardinal Mazarine presented me to his King with these words, ‘Sire, whosoever hath loyalty or religion in recommendation, must honour this well-born person;’ and the Queen-mother, now Dowager, hath often said to have heard her husband say, that next to her and his children, he was bound to take a care of me, of whom it may be now verified, *qui jacet in terra non habet unde cadet*, I am cast to the ground, I can fall no lower.”

This month the Marquis appears to have obtained the loan of £200, for which a draft receipt* is extant, as follows:—

“I, Edward Somerset, Earl and Marquis of Worcester, do confess and acknowledge to have received and bor-

* From MSS. Badminton.

rowed of * * * * the full sum of two hundred pounds sterling, for the assurance thereof I do constitute him the said * * * to be receiver of two hundred pounds, payable from the Right Honourable the Lord High Chancellor of England, the Earl of Clarendon, at Michaelmas next, which shall be in the year of our Lord 1666, and therewith to repay himself the said two hundred pounds. Witness my hand and seal, this 30th day of Dec. 1665.

“ WORCESTER.

“ Signed, sealed and delivered
“ in presence.”

From 1662 to 1665, the Marquis of Worcester appears to have been pretty regular in his attendance at the House of Peers. But the last we hear of him was on the 31st of October, 1665. When the House met on the 1st of October, 1666, the Marquis was absent, being “excused,” possibly from the state of his health, as he was never present afterwards.*

About the same time we have his Petition for the appointment of a Committee of Inquiry:—†

“To the King’s Most Excellent Majesty.—The most humble Petition of Edward, Marquis of Worcester:—

“ SHEWETH,

“That your Petitioner overwhelmed with the very, very much he hath to say, and fearful too long to detain your sacred Majesty therewith from more serious affairs, humbly prayeth that you will be pleased to refer him to be heard by the Lord High Chancellor of England, the Lord Privy Seal, the Duke of Albemarle, the Earl of Lotherdale, the Lord Arlington, the Lord

* On the 10th of October, 1667, his son occupied his place, as Marquis of Worcester.

† From MSS. Badminton.

Ashley and Mr. Secretary Morrice, or to such of them or other persons as your Majesty shall think fit, and that upon their report your Majesty will vouchsafe to do with your Petitioner, or to your Petitioner, what they in the Petitioner's behalf, and congruous to your service shall find reasonable, and consonant with your Petitioner's merits or demerits; the Petitioner most entirely submitting to your will and pleasure: Casting himself upon your Majesty's goodness, no ways standing upon his deserts, though really found never so many not thought of, or hitherto kept from your Majesty's knowledge, your Petitioner doth not say through envy or malice, since perhaps through ignorance, such ignorance, notwithstanding, as the Divines call *ignorantia crassa*. But whatsoever in quality or number his services were, they were but due to such a gracious King and Master as your Majesty's father, of happy memory, was to your Petitioner, and to your incomparable self; and, therefore, acknowledgeth they fall far short of his true loyalty and devotion to either; and being once rightly made known and presented to your sacred Majesty, your Petitioner promiseth himself no less encouragement for the future from your Majesty, nor less abilities in himself to become as useful as formerly; and as disinterestedly to serve you. Neither shall anything for the future dismay, or in any kind deter your Petitioner from that his resolution, but from the bottom of his heart

“ He shall ever pray, &c.

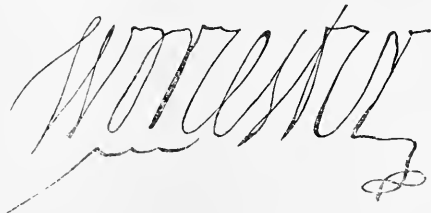
A handwritten signature in cursive script, likely belonging to the Marquis of Worcester, written in dark ink on a light background. The signature is highly stylized and fluid, with a long, sweeping underline that extends to the right.

“ At the Court, at Hampton Court, Jan. 29th, 1665/6.

“ His Majesty is graciously pleased to refer and recommend the Petitioner to be heard by the within named Lords, referees, or to any four or more of them, and they to give their report to his Majesty as soon as conveniently may be.

“ ARLINGTON.”

The next letter is without date or address, but appears both to belong to the present period and to relate to the same business as the foregoing; he says:—*

“ MY NOBLE LORD,

“ I must and ever will most thankfully and humbly acknowledge your Lordship’s civil and obliging language and carriage towards me, your humble servant. But pardon me if I cannot conceive how my Lord Arlington, Principal Secretary of State, and as well of the Bourne [?] as Cabinet Council, and that most deservedly, can, notwithstanding, miss of an opportunity to acquaint and receive his Majesty’s answer to the meanest of his Majesty’s subjects; praying but a reference to the chiefest of his Privy Councillors, and by them only to be heard for the King’s service, as well as his own concerns. His Majesty little thinks what he hath, or doth daily lose for not suffering himself to be disabused of a premeditated opinion concerning me; nor doth your Lordship imagine what services I do intend to your Lordship’s most worthy self, and that the King will have cause to thank you for any service you may please to afford me whose aim (I take God to witness) is in chief more really to the King’s advantage and service than mine own interest, who could not want forty or fifty thousand pounds yearly beyond

* This is a holograph letter, from MSS. Badminton.

seas, and do as good as want bread at home, where I was born to five and thirty thousand pounds, land of inheritance, and two hundred thousand pounds in cash left me by my grandfather, which, for so good a cause as I have lost it for, I joyfully renounce.

“Monsieur La Sual told me that Germany, France, Spain, and Italy censured England very much for so ill requiting my services and sufferings, and being so little sensible of my yet abilities to serve it; and yet those Kings and Princes know not the quarter, and mine own King the least of all, or the least sensible and persuaded, as well not to understand what I can yet perform, as not to reflect upon what is past.

“My dear Lord, look once more upon both my petitions; and if the King thinks me not worthy of common justice to be heard, or you deem them fit, and me, to be laid aside, I will gladly acquiesce, and I will not further trouble the King, nor importune your Lordship, but, fair and far off, ever quietly without more importunity remain,

“My Lord, your Lordship’s

“most faithful and most humble servant,

“WORCESTER.”

In the April of this year, the plague had commenced its appalling ravages in the metropolis, the stagnant air of which was partially purified by means of large bonfires, to promote circulation, the air having, it was supposed, become noxious through unusually prevalent calm sultry weather. The unhealthy state of the town may have had its influence on the Marquis, contributing to weaken a constitution already sufficiently harassed; yet so far from relief of any kind coming to solace him in his afflictions, we next find him compelled to petition

for protection of his public works, which (as noted three years before, in his *Century*), were again being similarly nearly taken from him, “without (as he observes) the least regard of above ten thousand pounds expended by me, and through my zeal to the common good.” His application is endorsed—“10 Jan. 1666. The Marquis of Worcester’s Petition for a Fee and Farm of Works House at Foxe Hall:”*—and is as follows:—

“To the King’s Most Excellent Majesty. The humble Petition of Edward, Lord Marquis of Worcester.

“HUMBLY SHEWETH,

“That the Petitioner (over and above great sums of money lent by him to his late Majesty of blessed memory) did expend in building of a house called Fauxhall, for an operatory for engineers and artists to work public works in, £9000 and upwards, as appears by the bills of the workmen that built the house.

“That the Petitioner hath expended above £50,000 trying experiments and conclusions of arts, in that operatory, which may be useful to his Majesty and his kingdoms.

“That there being a grant made by your Majesty, under the Great Seal of England to the Lord Moore, of the manor of Kennington, (within which manor the said Fauxhall is situated and being) the Petitioner applied himself to your Majesty, and acquainted your Majesty with the Petitioner’s equitable right to the said Fauxhall, that thereupon your Majesty was graciously pleased to recall the said Patent, and to cause an exception to be made therein as to Fauxhall, which was done, whereby your Majesty might gratify the

* Cal. State Papers, Dom. Series. Ch. II. 1667. No. 101.

Petitioner therewith, but the Petitioner hath not hitherto desired the same.

“The Petitioner humbly prayeth that your Majesty will be graciously pleased, in consideration that the Petitioner hath built the said house, at so great a charge, to serve your Majesty,

“That you will be pleased to grant it to the Petitioner at some fee farm rent, as your Majesty shall think fit.

“And the Petitioner shall pray.”

This document divulges at least one important secret in regard to the Marquis of Worcester's personal history, in connection with his practical mechanical pursuits. We now find that he actually built suitable premises as workshops at Vauxhall,* for “engineers and artists to work public works in.” That in that “operatory,” or laboratory, he had “expended above £50,000, trying experiments and conclusions of arts.” And that on the building alone he had laid out above £9000. It is, however, only by bearing in mind the enormous amount that these sums of money represent, considered in reference to the value they bore two hundred years ago, that we become fully alive to the princely expenditure of this great scientific experimentalist, whose patronage and encouragement of experimental philosophy, for practical designs, is without a parallel in any other age or country.

The very next month his Lady was necessitated to petition in the following terms, in regard to Worcester House.†

“To the right Honourable the Lords Spiritual and Temporal, now assembled in Parliament.

* Appendix G.

† Cal. State Papers, Dom. Series, Ch. II. 1667. No. 33.

“The humble Petition of Margaret, Marchioness of Worcester, wife of Edward, now Marquis of Worcester.

“HUMBLY SHEWETH,

“That the said Marquis for his services to his Majesty did expend many vast sums of money, and thereby contracted great debts; that although the said Marquis, since his Majesty’s happy restoration, hath paid above fifty thousand pounds of those debts so contracted, as aforesaid, yet there remains so many great debts, that the said Marquis his estate is all seized on by his creditors upon judgments, statutes, and recognizances, insomuch that the said Marquis is deprived of his whole estate; and nothing left for his and your Petitioner’s support and maintenance.

“That in particular the said Marquis his estate was extended by one Mr. John Hall* in March last, upon a judgment of six thousand pounds for money borrowed by the Petitioner’s husband in 1642, to pay the garrison of Monmouth, then in a mutiny.

“That the said extent is assigned now to the Lord John Somerset, who now threatens (having got most part of the estate) to turn the Petitioner out of Worcester House, so that she will be destitute of an habitation and maintenance.

“The Petitioner humbly prayeth your Lordships’ consideration of the Petitioner’s most necessitous condition, and to find out a way for her relief, and also your Lordships’ recommendation of her case to the Right Honourable the Lords and Commons of England.

“And your Petitioner shall pray.

“WORCESTER.”

“Die Jovis, 7 die Febr. 1666.

“Upon reading the humble Petition of the Lady Marchioness of Worcester, it is ordered by the Lords

* See page 271 and 273.

Spiritual and Temporal in Parliament assembled, that the Duke of Albemarle, the Lord Chamberlain of his Majesty's Household, the Earl of Anglesey, the Lord Arundell of Warder, and the Lord Howard of Charlton, be appointed a Committee to wait on his Majesty and represent unto him the sad condition of the said Marquis and his Lady.

“JO. BROWN,
“Cleric. Parliament.”

From the Marchioness' petition we obtain a further acquaintance with the deplorable situation in which the Marquis was placed, even seven years after the Restoration, when he had recovered his estates, and possessed whatever he may have received as gifts from the Crown; and by the way of loans from friends, from secured money-lenders, and for assigned portions of interest in the profits to arise from working his “Water-commanding Engine.”

In a report made to the Duchy of Cornwall* (although two years later) full particulars are furnished of the nature and extent of the property in which the Marquis was interested, as stated in his preceding petition. The Surveyors General say:—“Foxhall house is parcel of the manor of Kennington and Duchy of Cornwall, and the use thereof was lately allowed by his Majesty unto Mr. Jaspas Calthoff, who was employed in the making of guns and divers engines and works for his Majesty's service, since whose death part thereof hath been granted by his Majesty to Peter Jacobson (the said Jaspas Calthoff's son-in-law) for his life, and the residue is enjoyed by this Petitioner (widow of the said Jaspas) in favour of her said late husband's

* Duchy of Cornwall Office. Report II. 1. 1665-8. (April, 1668.) See Appendix G.

services for his Majesty; containing in the whole within the brick walls, two acres and 28 perches of ground, divided into divers parcels, whereof the furthest part S. contains about 214 feet in length from E. to W. and about 66 feet in breadth at the W. end, nearest the Thames, and about 109 feet in breadth at the end next the highway, leading from Lambeth Church towards Kingston; and hath a dwelling house thereon erected at the S.E. corner thereof, containing about 40 feet in length, and 24 feet in breadth, and several sheds both at the E. and W. ends of the said piece, all which are affirmed to be let together to one John Collins, at £16 per annum.

“And one other part of the said ground next adjoining N. used for a great garden, containeth in length, on the E. side thereof next the said highway, about 238 feet, and on the W. side next the Thames about 213 feet, and in breadth at the S. end about 192 feet.

“And other part of the said ground still more N. used for a yard or garden, containeth in length from the last mentioned great garden to the mansion house of Foxhall, about 144 feet, and in breadth from a range of pales, dividing this and the said Jacobson's part, to the said highway about 98 feet.—On the E. side whereof (next the said way) is erected a long range of building, used for a working house, containing in length about 132 feet, and in breadth (from out to out) about 20 feet, two stories high, besides garrets.

“At the N. end of which working house there is a cross building erected, of the same height, part used for a forging house, and the rest for dwelling; extending from the said highway W. about 46 feet in breadth from out to out.

“Still more W. is the chief mansion house, extending W. from the last mentioned building about 46 feet

more in length, and about 24 feet in breadth, three stories high, besides garrets and cellars, with a staircase built out cross on the N. side thereof about 18 feet square."

The remaining portion of the report concerns property on the north side let to another tenant; to stables, and to outhouses; concluding with an opinion that the whole, when repaired, would render a lease for 31 years worth £100 per annum.

We thus ascertain that the "Working house," as it is here called (the "Operatory" named in the petition), where Caspar Kaltoff and his engineers worked, and in or near which the first great public exhibition of the "Water-commanding Engine" was consummated, occupied a considerable space of crown property. It was no exposition of questionable utility that was there offered to public view. And that it was public is every way certain, and, indeed, there could be no reasonable occasion for its being otherwise, after being fully protected for ninety-nine years by Act of Parliament. Besides, in no other way would it have been possible to obtain a sufficient proprietary, such as was evidently sought by the publication made by the Act itself, and apparently also by the distribution of large posting bills; of which latter a curious specimen still exists in the archives of the British Museum.*

It was the Marquis of Worcester's misfortune, being involved in heavy debt, to be necessitated to seek pecuniary benefit from his great invention. What means were particularly adopted, beyond setting up a practical illustration at Vauxhall, it is impossible to ascertain, but he would most likely engage the services of one or

* It is very similar to the Draft, page 224; and the "Definition" in Appendix C.

more active business agents. That a public company was intended to be carried out by means of several shareholders, is also highly probable, judging from remarks occasionally made by himself, and from the dispersion of placards and similar written statements, headed a "Definition" of the Engine.

Now it is assuredly a matter of surprise that an invention so singular and novel in character, promising unheard of advantages, should not have attracted the general attention of all patrons and promoters of science. The only instance of a passing remark from a scientific source is anything but gratifying. Dr. Hook, writing to the Honourable Robert Boyle about the early part of 1667,¹⁴ reports certain experiments with glass tubes then being carried on at Gresham College, after which he says:—"Sir R. Moray presented the Society with an engine sent them by Prince Rupert; being for raising water, such a one as, I am sure, you have seen and taken notice of in Scottus his mechanics, whose contrivance is, continually to raise water, by turning round a cylinder with a sliding board in it, included in another hollow cylinder, or barrel. The Engine has not been tried, but it will be the next Wednesday. But I find that it goes exceedingly hard with the several grating and sliding motions that it has, so that it is more likely to prove a pretty curiosity than a useful engine. But this gave an occasion for producing the definition or description of the Marquis of Worcester's Water-commanding Engine, which is so purely romantic that it would serve one rarely to fill half a dozen pages in the *History of Fortunatus his Wishing Cup*. A transcript of some of the most observable passages, because I

¹⁴ Boyle, Vol. v. page 532.

could not procure the book itself to send you, I have here enclosed, which if it should chance to perform but the least part of what is therein specified, my Lord Brereton is likely to pay £5 towards the revenue, that is to acerue thereby to the Marquis, he having wagered so much against him. I was since my return to London to see this engine, where I found Caltrop his chief engineer, to laugh at it; and as far as I was able to see it, it seemed one of the perpetual motion fallacies. Of which kind Caltrop himself, and two or three others, that I know, are labouring at this time in vain, to make, but after several ways; and nothing but costly experience will make them desist."

The prejudices created against monopolists in the reign of Queen Elizabeth, were not without foundation, in consequence of the absurd rights conceded to patentees of imaginary inventions; amounting to the legalizing of extortion of the most unquestionable and aggravating kind, without any chance of remedy. Real inventions were few, and impositions were everywhere practised with bold effrontery. There was nothing in the public character of the Marquis of Worcester to bespeak public favour. Who could ever dream that the Earl of Glamorgan was suddenly to assume a new character? The few inventions that were regarded as wonders of art were of ancient origin, slowly perfected, and in 1663 were considered to have reached almost the acmé of perfection. Yet here was a nobleman, unheard of, except for his share in Charles the First's design to punish his rebellious subjects with the aid of an Irish army, suddenly proposing to supersede all ancient approved and improved methods of elevating water; and to perform many other surprising mechanical feats. And not only was he an inventor, but an innovator on old custom and a monopolist, not by

patent alone, but by Act of Parliament for ninety-nine years! Even Dr. Hook could not view the Marquis otherwise than by the common standard of public opinion, acknowledging that he only went to see the wondrous engine at Vauxhall *to laugh at it!*" And he could even condescend to report of his fellow inventor's labour, that,—“as far as I could see it, it *seemed* one of the perpetual motion fallacies.” So that its very regularity and remarkable continuity of operation were alone, considered enough to condemn it! Dr. Robert Hook was deservedly esteemed as a mathematician, and he was also distinguished for his mechanical ingenuity; but he was a man of very peculiar habits and singular disposition, being excessively jealous and cynical. This splenetic philosopher appears to have set out for Lambeth in no disposition to form a dispassionate opinion on the work of a rival inventor. A few lines of description, however meagre, would have been invaluable, whereas his cynical remark leads to the unfavourable supposition that his disingenuous statements had their influence on Boyle and other Fellows of the Royal Society, to check any further inquiry respecting the supposed mechanical marvel.

The Marquis might well allude in his *Century* to “the melancholy which had lately seized upon him;” his sole desire being to pay his debts and possess “a competency to live according to his birth and quality;” yet every way frustrated, month by month, year by year, even after his last ray of hope was realized in the return of the exiled sovereign. He makes slight allusion to enemies, and none to public neglect. The enemies must have existed, Papist as he was, when so late as November 1666, the King had published a declaration to banish all priests and jesuits, on pain of punishment if found in the kingdom after the middle of

the next month; the public neglect, from his aristocratic sympathies, he might not choose to recognise. It is certain he had been abundantly persecuted for his political acts, and was being neglected with a degree of callousness for which it is difficult at this remote period, and in the absence of needful intelligence, to account, so as fairly to reconcile the many incongruities and inconsistencies in the statement of his devotion to Charles the First, the coolness of Charles the Second, the Marquis's own firm clinging to a Court which used him so basely, and the utter oblivion into which his efforts fell among all classes of men esteemed patrons of art, literature and science.

Amidst plague, and intestine troubles, and surrounded with domestic calamities of the most poignant character, this great and good man, this glorious genius deceased on Wednesday, the 3rd of April, 1667. Where he died is nowhere recorded, and no incident of his latter days affords the slightest information. It is not unreasonable to suppose that he had resided at Lambeth, if not indeed at the mansion then called Faux-hall. He was conveyed with funeral solemnity from London to his barony of Raglan, in the county of Monmouth, where he was buried in the family vault within the Parish Church, on Friday the 17th of the same month, near to the body of Edward, Earl of Worcester, Lord Privy Seal, his grandfather, the following inscription being engraved on a brass plate:—

“Depositum Illustrissimi Principis Edwardi Marchionis & Comitis Wigorniae, Comitis de Glamorgan, Baronis Herbert de Raglan, Chepstow, & Gower, nec non Serenissimo nuper Domino Regi Carolo primo, Southwallie Locum-tenentis: Qui obiit apud Lond. tertio die Aprilis, An. Dom. M.DC.LXVII.”

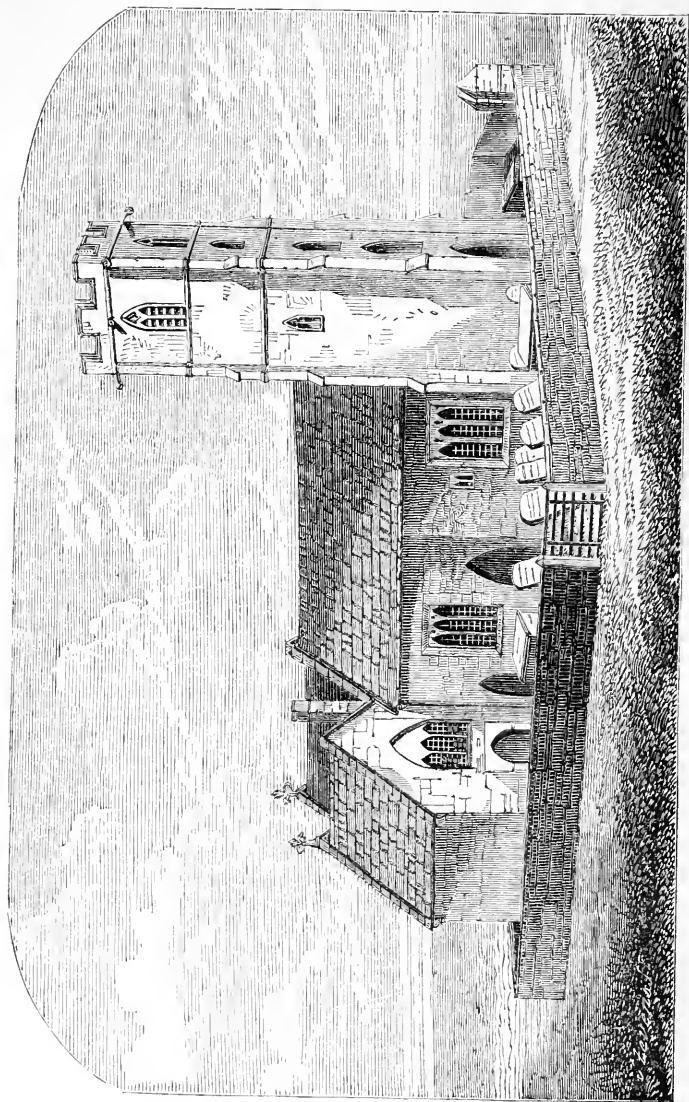

ST. CADOCUS :
THE PARISH CHURCH OF RAGLAN, MONMOUTHSHIRE.

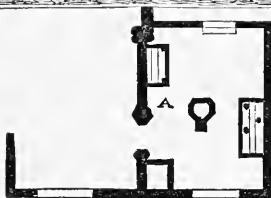
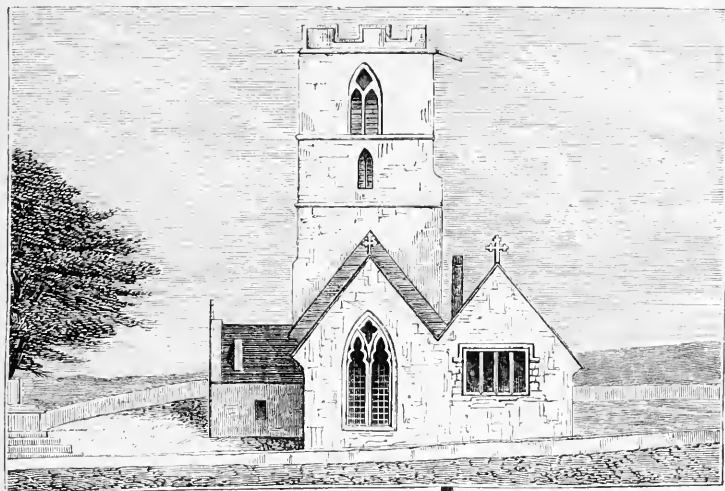

EAST END VIEW AND PLAN OF RAGLAN CHURCH.

In the above view of Raglan Church, a corresponding plan is given, showing, by the letter A, that portion of the chancel beneath which is situated the family vault of the Beaufort family. The flagged area has a font in the centre, pews in one corner and at the sides, with a window at one end, and at the other a door opening to the church-yard.

Although Francis Sandford, Pursuivant at Arms, in noticing heraldic particulars, when alluding to his funeral, adds, "which myself had the honour to attend," he makes no comment of a personal or interesting character, beyond the customary genealogical details. From Sandford's remark one is led to suppose he attended as a personal friend. He was a native of Wicklow, of humble origin and moderate education, long resident

in London. He was therefore a person likely to be intimately acquainted with the Dowager Marchioness of Worcester's Irish connexions, and to take a more than usual interest in the circumstances relating to the death and funeral obsequies of the Marquis.*

On the 24th of the same month the following funeral certificate was attested by his son Henry, Marquis of Worcester, at the Herald's College:—

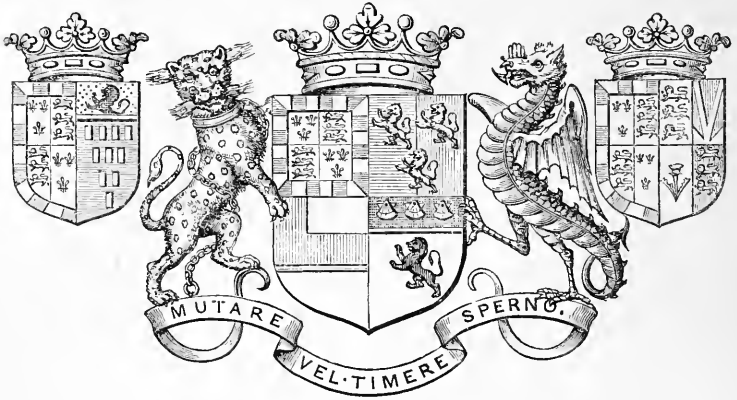

“The Right Hon^{ble} Edward Somerset Marquess and Earle of Worcester, Earle of Glamorgan, and Baron Herbert of Raglan, Chepstow, and Gower departed this mortall life upon Wedensday the third of Aprill 1667, and was conveyed with ffunerall Solemnitie from London to his Barony of Raglan in the County of Monmouth (accompanied with many Gentry of y^e

* I am the more particuilar in naming these facts, as it is singular that there should be any doubt thrown on the place of his sepulture. Yet in a copy of “The Baronage of England, by William Dugdale,” containing his own manuscript corrections, he substitutes for “Ragland,” to read “Windsor, near to the tomb of Charles of Worcester his ancestor.” This copy is in the Bodleian Library, and I have not only examined it very carefully, but also the Register at St. George's Chapel, and the tombs in the Beaufort Chapel, Windsor, without being able to confirm Dugdale's manuscript emendation.—D.

County's of Gloucester and Monmouth aforesaid) and there interred in his Lordships Chappell in the Parish Church, neare to the body of Edward Earle of Worcester Lord Privie Seale, his Grandfather (in a vault arched with stone) on fryday the 19 day of the same month. His Lordship married to his first wife Elizabeth Dormer daughter of Sir William Dormer Knight that dyed in the lifetime of his father, and sister unto Robert Earle of Carnarvon by whom he had issue his only son Henry Lord Herbert, now Marquess of Worcester at the time of the takeinge of this Certificate, who, marrying with Mary daughter of that most loyall Nobleman Arthur, Lord Capell, beheaded by the rebells upon the 9th day of March 1648 (Sister to Arthur Earle of Essex, &c. (and Widdow to Henry Seamour, Lord Beauchampe that dyed in the lifetime of his father, by whom she had issue William now Duke of Somerset aged 15 years and Frances and Mary, dead, and Elizabeth Seamour third daughter now liveing, had by the said Mary also issue Henry Somerset his eldest son dead, and buried at Windsor; Charles Somerset second son and heire, now Lord Herbert about 6 years old; Edward Somerset 3^d son, dead also, and was interred at Raglan; and Henry Somerset the yonger 4 sonne who departed this world about two dayes before his Grandfather and was buried at Raglan; Elizabeth Somerset elder daughter dyed young and was buried at Raglan, and Lady Mary Somerset, younger daughter is now liveing about a yeare and halfe old. Lady Anne Somerset elder daughter to the defunct was married to Henry Howard second sonne of Henry Earle of Arundell, and brother and heire to Thomas Duke of Norfolk, and by him hath issue Henry Howard, Thomas Elizabeth and Frances. Lady Elizabeth Somerset younger daughter to the defunct is the wife of William, Lord Herbert of

Powis and by him hath issue William Herbert his only son and five daughters.

“The said Edward Lord Marquess defunct married to his second wife the Lady Margaret O’ Bryan daughter and coheire of Henry Earle of Thomond, and by her had issue one only daughter named Mary, who dyed an Infant, and was buried at Raglan. This Certificate was taken upon the 24th day of Aprill 1667 by F Francis Sandford, Rouge Dragon, who, served for S^r Edward Walker K^t. Garter Principall King of Armes, and the truth thereof attested by the subscription of the Right Ho^{ble}. Henry Marquesse of Worcester

“Examd. F. R. S. D.

WORCESTER.”

It is, throughout, very observable that the invention of the Water-commanding Engine was no imaginary scheme, no merely ingenious idea, but a realized fact, of the nature and importance of which the late Marquis had been fully sensible. And it affords a striking proof of his high estimation and correct knowledge of the magnitude of his discovery, that he should have bowed himself before his Maker in humble adoration, acknowledging in a simple yet solemnly sublime strain, his sense of obligation to the supreme Source of all intelligence, for permitting him to become instrumental in the development of so great a mystery of nature.

The following is from the original manuscript at Badminton :—

“*The Lord Marquesse of Worcester’s Ejaculatory and extemporary thanksgiveing prayer when first with his corporall eyes, he did see finish’d a perfect tryall of his Water-commanding Engine delightfull and usefull to whomsoever hath in recomendation eyther knowledge, profit, or pleasure.*

“Oh! infinitely omnipotent God whose mercyes are fathomlesse, and whose knowledge is immense and inexhaustible next to my Creation and Redemption I render thee most humble thanks even from the very bottome of my heart and bowells, for thy voutchchafeing me (the meanest in understanding), an insight in soe great a secret of nature beneficial to all mankind as this my Water-commanding Engine. Suffer me not to be puff'd upp, O Lord, by the knowing of it, and many more rare and unheard off, yea unparaleled Inventions, Tryals, and Experiments, but humble my haughty heart, by the true knowledge of myne owne ignorant, weak, and unworthy nature, proane to all euill O most mercifull Father my creator, most compassionatting Some my Redeemer, and Holyest of Spiritts, the sanctifier, three diuine persons and one God! grant me a further concurring grace with fortitude to take hould of thy goodnesse, to the end that whatever I doe, unanimously and courageously to serue my King and Countrey, to disabuse, rectifie, and convert my vndeserved yet wilfully incredulous* enemyes, to reimburse thankfully my creditors, to reimunerate my benefactors, to reinhearten my distressed family, and with complacence to gratifie my suffering and confiding friends may, voyde of vanity or selfe ends, only be directed to thy honour and glory cuerlastingly. Amen.”

With Caspar Kaltoff to superintend the work at Vauxhall, the engine would no doubt be kept in operation, for the benefit alike of the Dowager Marchioness and all interested, most likely including Colonel C. Copley.

* This had been written “wilfully malicious”—but “malicious” has been struck out, and “incredulous” substituted. This with other corrections are in the Marquis's own handwriting.

In the travels of Cosmo de Medici the Third, Grand Duke of Tuscany,³⁰ through England,* among other matters that attracted his attention in the metropolis, it is recorded that on the 23rd of May, 1669:—"His Highness went to see an hydraulic machine upon a wooden tower, in the neighbourhood of Somerset House, † which is used for conveying water of the river to the greater part of the City. It is put in motion by two horses, which are continually going round, it not being possible that it should receive its movement from the current of the river, as in many other places where the rivers never vary in their course; but this is not the case with the Thames, owing to the tide; consequently the wheels, which serve at the ebb, would not be able to do their office when the tide returns."

On the 29th following, his Highness was entertained by the Earl of Devonshire, when a sumptuous banquet was provided.

"His Highness, that he might not lose the day uselessly, went again after dinner to the other side of the city, extending his excursion as far as Vauxhall, beyond the palace of the Archbishop of Canterbury, to see an hydraulic machine, invented by my Lord Somerset, Marquis of Worcester. It raises water more than forty geometrical feet by the power of one man only; and in a very short space of time will draw up four vessels of water through a tube or channel not more than a span in width; on which account it is considered to be of greater service to the public than the other machine near Somerset House."

³⁰ Cosmo.

* Being this portion only of his Travels, derived from two large folio MS. volumes, narrated by the celebrated Count Lorenza Magalotti, preserved in the Laurentian Library, Florence.

† See Sorbière's Account, page 265.

Up to September next year we still find the “Water-commanding Engine,” engaging the attention of the Dowager Marchioness, who was fully alive to the importance of so wonderful an invention; not only as enhancing her late husband’s fame, but also as affecting her own interest, with that of the other parties who had assisted in its promotion. She seems to have acted with a persevering and noble spirit under all the disadvantages of her situation, oppressed as she was in fortune, her heart lacerated by the accumulated wrongs she and her husband had through life endured, and now alone, neglected, and with but this one hope left, of which his prophetic views must have left a lively impression on her heart.

But the Marquis’s surprising invention was doomed to another, and a more novel persecution than could well be conceived possible, one which assuredly might very justly be doubted, had we not the written record before our eyes. Among the other manuscripts at Badminton House is the letter of a Roman Catholic priest, dated 6th of September, 1670, addressed to the Marchioness “at her house in Lincoln’s Inn Fields.”*

As her spiritual adviser, he says:—“Almighty God hath, Madam, put you into a happy and flourishing condition, fit and able to serve God, and to do much good to yourself and others; and your Ladyship makes yourself unhappy, by seeming not to be contented with your condition, but troubling your spirits with many thoughts of attaining to greater dignities and riches.”

He next declares that she is in danger “to lose the right use of her reason,” all arising from disposing herself for great dignity and wealth—“by getting of great

* Her being there 3½ years *after* the decease of the Marquis, makes it probable she had removed from Lambeth, or wherever she had previously resided.

sums of money from the King to pay your deceased Lord's debts, and enriching yourself by the great Machine [the Water-commanding Engine] and the like."

To deter her from proceeding in this course, he points out, as ill effects, "the danger of losing her health and judgment," and "the probability of offending Almighty God." That she is under "great temptation" he considers certain, "yet I confess (he adds) that the devil, to make his suggestion the more prevalent, doth make use of some motives that seem plausible, as of paying your Lord's debts, &c." For her future government he recommends her Ladyship—"To seek after eternal riches and honours, which your age doth assure you are not far off; for which you may dispose yourself, before death comes, by retiring into the country for some time, from the distractions of the Court, where you may have the advice and directions of some learned priest, in whose virtue you may wholly confide, for your internal quiet and security." With this view he recommends a lady's house at Hammer-smith, where, "by Almighty God's blessing, you may recover from that most pernicious distemper of body and mind, into which every one sees you to be very near approaching."*

He claims "the candour of his intentions," as a plea for this extraordinary interference, in a matter of personal and strictly honourable conduct of a wholly private nature.†

We lose after this all intelligence regarding the Vauxhall Water Engine, and it is in vain to enter on mere conjectures as to what may have been its fate. It is certain, however, that great disadvantages in

* See Appendix D.

† She afterwards married Donough O'Kearney, and died 26th July, 1681.

exhibiting, and in manufacturing or repairing, would ensue on the decease of the Marquis's right hand man "both for trust and skill."

In 1670-71, letters patent were granted to the late Marquis's son, Henry, Marquis of Worcester, remitting payment of certain sums due to the Crown at the time of his father's decease.*

And on the 1st of August, 1672, letters patent were obtained, in respect to property at Vauxhall, which state that the same are granted by Charles the Second "from grace and favour towards Jasper Calthoff and Martha Calthoff, *lately deceased*." From the same document we learn in reference to their children, that there were then living, Catherine, married to Claude Denis,
 Jasper Calthoff, and
 Isabel Calthoff.

And we find from letters patent, bearing date 22nd March, 1667-8, that Peter Jacobson (married to another daughter) is named as the "son in law," So that it would appear that, in 1672, four children were living, one son and three daughters. The Peter Jacobson, here named, was a sugar baker, holding a portion of the Vauxhall estate for carrying on his business, at a trifling rental, during the term of his natural life.†

Beyond all question the Marquis of Worcester's prime invention, the *Water-commanding Engine*, was erected and at work from 1663, to the year 1670, during which time it had been made the subject of an Act of Parliament; had been published in the *Century*, in brief outline; also noticed in a separate pamphlet, copies of which are exceedingly rare; and

* Appendix G.

† Duchy of Cornwall Office. See Index to Reports—1660-1684. A. to P. 1. And Report II. 1. 1665-8. And Appendix G.

likewise in large posting bills. Besides which a model was deposited with the Chancellor of the Exchequer as required by the Act. It was also the subject of much correspondence. That it excited the attention of intelligent sight-seeing travellers we ascertain from the Diaries published first by M. Sorbière, and five years later by Cosmo de Medici. And after the noble inventor's decease, his warm-hearted and enthusiastic widow brought herself under priestly censure for her active endeavours "to enrich herself by the great Machine;" on which, alas! both had built reasonable, but such as were at that time considered extravagant, expectations of present fortune and future fame.

With the Marquis of Worcester this invention was no idle fancy, no mere experiment, no amateur work, no casual, doubtful trial, and was not lightly estimated by himself. He had by practice so thoroughly satisfied himself, that, long after 1655, amidst all his troubles, without his notes, and to oblige a friend, he wrote off, *con amore*, three distinct accounts of his invention, under the titles of, "A fire water-work;" "A semi-omnipotent engine;" and lastly, "A stupendous water-work."

How it happens that the Marquis of Worcester should have been wholly unnoticed for his inventions by contemporaries it is difficult to offer anything like a sufficiently reasonable or satisfactory conjecture. But surprise might seem to vanish when such diarists as John Evelyn and Samuel Pepys, with all their curiosity and all their apparent pleasure in recording scientific novelties, although they name the Marquis, notice Worcester House, and mention Vauxhall, never so much as hint at one invention by the Marquis of Worcester. When these gossips had nothing to say, conjecture may well cease to promise a satisfactory solution.

But it must be remembered that the means for giving publicity to any matter were then comparatively limited; and it is possible that the Water-commanding Engine was little known beyond a certain aristocratic circle, who afforded the chief support of the affair pending other arrangements. Even this supposition very indifferently accounts for the dead silence on the subject at home, when it seems apparent that the invention was looked on by foreigners as in striking contrast with a much inferior mode of raising water at Somerset House, performed by machinery worked by two horses. One would suppose that of all inventions an engine of superior capabilities for supplying the city with water, would have excited attention in every quarter. The inventor, and all concerned with him, might see certain difficulties in meeting any demand adequately remunerative, until works and machinery were provided; not so much to make the engines, but to provide certain requisite articles and materials, well understood in modern times, but wholly unknown two centuries ago. The Marquis was in fact creating a demand for iron plates, wrought and cast iron cylinders, metal rods, and all manner of tools and novel kinds of workmanship, so completely was this wonderful man in advance of the age he might have adorned.

Charles the Second, in the midst of all his gaiety and all his poverty, had it in his power to benefit the Marquis by, at least, affording him some countenance. He had every reason to be grateful to him, but his ruling passion gained the sway over all other considerations. What Samuel Pepys relates of him, as happening on the 1st of February, 1663-4, is characteristic of what may have been his utmost estimate of even the Marquis himself. He says:—"I to Whitehall, where, in the Duke's chamber, the King came and

stayed an hour or two, laughing at Sir W. Petty, who was then about his boat; and at Gresham College [the Royal Society] in general, which he mightily laughed at, for spending time only in weighing of air, and doing nothing else since they sat."⁷⁸

Our great historian has given a masterly miniature of the volatile monarch, observing:—"To do him justice his temper was good; his manners agreeable; his natural talents above mediocrity. But he was sensual, frivolous, false and cold-hearted, beyond almost any prince of whom history makes mention."* His neglect of the Marquis of Worcester had the effect of retarding the full development of the Steam Engine in this country for above half a century; and thus he, who had never been known to say a foolish thing, lost the chance of performing a wise one, that would have evinced the existence of at least one redeeming quality in his character.

⁷⁸ Pepys.

* Macaulay's Essays.

CHAPTER XVIII.

A BRIEF RETROSPECT OF THE MARQUIS OF WORCESTER'S GENEALOGY, AND HIS PRIVATE, POLITICAL, AND PHILOSOPHICAL CHARACTER; INCLUDING HIS OWN STATEMENT OF EXPENDITURE DURING THE CIVIL WAR.

THE ancient and honourable family of Somerset is descended from John of Gaunt, Duke of Lancaster, son of Edward the Third.

1. Charles,* the only natural son of Henry Beaufort, third Duke of Somerset, in that line (eldest son of Edmond, Duke of Somerset), assumed the surname of Somerset. He, in consequence of the devastating wars of the Roses, was, on the accession of Henry the Seventh to the throne, the only remaining representative of that monarch's illustrious ancestors, and he, therefore, considerably distinguished him. In addition to his other honours, he was created a Knight of the Garter; and in the succeeding reign elevated to the dignity of Earl of Worcester, on the 1st of February, 1514.

In right of his first marriage with Elizabeth Herbert, only child of William Herbert, Earl of Huntingdon, he bore the titles of Baron Herbert, Lord Herbert of Raglan, Chepstow and Gower. After the decease of

* The annexed autograph of this great ancestor of the Marquis of Worcester, is obtained from a do-

cument in the British Museum. Cotton. MSS. Vesp. F. xiii. fol. 78.

his first wife he was twice married; first, to Elizabeth West, daughter of Thomas, Lord la Warr; and on her decease to Eleanor Sutton, daughter of Edward Sutton, Lord Dudley. He died on the 15th of April, 1526, leaving her a widow.

2. He was succeeded by his eldest son Henry, second Earl of Worcester, who died 26th of November, 1549.

3. And he was succeeded by his eldest son, William, third Earl of Worcester, and a Knight of the Garter, who died the 21st of February, 1589.

4. Being succeeded by his only son, Edward, fourth Earl of Worcester, and a Knight of the Garter, who died 3rd of March, 1628.

5. And was succeeded by his second son, Henry (his eldest son William having died during his father's lifetime). Charles the First created him Marquis of Worcester, by patent dated at Oxford, 2nd of November, 1642 (which dignity was repudiated by the Commonwealth Parliament). He was the fifth Earl and first Marquis of Worcester, and died December, 1646.

6. When he was succeeded in his honours by his eldest son, Edward, the subject of this memoir; but the latter never enjoyed any portion of the vast estates until after a lapse of fourteen years, when, at the Restoration in 1660, he recovered a large portion of his landed property, as already set forth.

He bore the second or family title of Lord Herbert, from March, 1628, to the end of March, 1643; being on the 1st of April following, created Earl of Glamorgan (during his father's lifetime) by Charles the First, he was best known by that title, from the part he took in Irish affairs during the civil commotions from 1644, until the decease of his father in 1646; when, in consequence of the Cromwellian Parliament refusing

to acknowledge any of the King's later creations of Peers, he was uniformly styled *Earl* of Worcester; but at the Restoration in 1660, his proper style of Marquis of Worcester was fully recognized. These latter party distinctions now materially serve to fix or limit the dates of some documents, not otherwise to be approximated.

Until the 27th year of his age we meet with little respecting his education, travels, and pursuits. With his marriage commenced his engagement with that artificer Caspar Kaltoff, whom he employed in promoting his own practical course of studies in a branch of inquiry which had never before, and has never since, been so assiduously examined and tested. The pursuits then commenced and indefatigably pursued, as well for instruction as amusement, combined with a strong natural bias for such occupations, may have served at a later period, under less favourable circumstances, to lighten the tedium of exile and imprisonment.

He enjoyed but seven years of married life, being then left with three children, and remained a widower for three years; when, in 1639, he married a second time, having but one child by his second marriage, who died an infant. In the family group, painted by Hanneman (now first engraved), the artist has drawn him seated beside his wife and child; but when this work was executed is unknown, although it most likely dates between 1639 and 1641.

The breaking out of the Civil War would seriously interfere with the Marquis of Worcester's scientific investigations; he would no longer be able to settle down to the serious study of his favourite authors; his models and mechanical experiments would be in abeyance; and there was no alternative left for him but to unite himself to the cause either of the King or the

Parliament. His loyalty led him to choose the former course, and his association with Charles the First, combined with that unfortunate monarch's unhappy situation and disposition, eventually worked the entire ruin of the Marquis of Worcester. But apart from the ordinary occurrences of the war, it was his misfortune to be selected by the King to act as his emissary in negotiating a peace with the Roman Catholic party in Ireland, on terms contrary to the established religion of the realm and irrespective of the laws. That he should have listened to the urgent demands of his sovereign is, under any circumstances, not very remarkable; and we are the less disposed to be surprised at his being won over by the King's solicitations, considering that he was not a practised statesman, and that the proposed measure was preceded by his being created Earl of Glamorgan, and that it was represented as offering enlarged privileges to his own church and party, as well in Ireland as in England. A more cautious politician might have suspected some ulterior design beneath this promising external appearance, might have questioned the possibility of some extraordinary exercise of the royal prerogative, and at length concluded that no measure was safe, coming from a sovereign who actually seemed to imagine that divine right was delegated to him to annul any obligation whatever, however freely tendered by himself, provided he could satisfy his own conscience that his so acting would be to the advantage of the Crown. But the Marquis was no grovelling worldling; he had left the study for the battle-field, and for awhile abandoned the path of philosophy to become the King's agent in Ireland. It was thus that his loyalty and his zeal, uniting with his religious sentiments and his sovereign's gracious conduct toward him, and seeming sincerity,

combined effectually to plunge himself, his family, and his posterity into a series of disastrous losses in fortune and property.

He had not been many months a refugee in France, when he received a very welcome and highly gratifying acknowledgment of his past services, from the exiled Queen, in a present of valuable jewels, accompanied with a testimonial, empowering him to make what use he might please of the regal gift. The original, written in French and sealed with the royal arms, is translated as follows:—

“HENRIETTA MARIA R.,

“We, Henrietta Maria of Bourbon, Queen of Great Britain, have, by the order of the King our very honoured Lord and Husband, caused to be delivered into the hands of our dear and well beloved cousin, Edward Somerset, Count and Earl of Worcester, a necklace of Rubies, containing ten large Rubies and one hundred and sixty pearls set and strung together in gold; among the said Rubies are likewise two large diamonds called the Sancy and the Portugal, acknowledging that besides the great expenses made by him for the said King our very honoured Lord, he has supplied us with three hundred and seventy thousand Livres Tournois,* exclusive of the very great services at least of equal consequence, which up to the present time, even, he has rendered us, in regard to which we make known that the said necklace and diamonds belong entirely to him, so that he may either sell or engage them without any interference on our part, or that of

* According to the old money system prevalent in France before the Revolution, accounts were kept in Livres Tournois of 20 Sous or Sols.—*Dr. Patrick Kelly's Universal Cambist*, 4to. 1811, page 146.

any other, or seeking after or troubling any person, who may buy them, or lend money on the ten jewels heretofore mentioned, in faith of which we have signed this present and put thereto our Royal Seal in our Court at St. Germain en Laye, this 20th day of May, one thousand six hundred and forty-eight.”

(ROYAL ARMS.)

The lamentable fate that befel Charles the First, effectually terminated all expectation of relief; and therefore, from the year 1647, when the Marquis left Ireland, to 1660 the period of the Restoration, about 13 years, was, if possible, the most unhappy and gloomy of his eventful life. He was about five years in exile, about three years and a quarter a prisoner in the Tower, and nearly five years a state prisoner at large, most likely under strict surveillance.

The year of his Lordship's release from the Tower, 1655, will ever be memorable for his having then written his “*Century of Inventions*,” which was published eight years later.

There is every reason to believe that the Marquis of Worcester pursued his scientific inquiries both in secrecy and seclusion. This might arise from his early domestic habits, particularly during his married life, commencing in 1628, when he first engaged Caspar Kaltoff. We never find him associated with, or mentioned by, men of his time, which, therefore, leads to the supposition that he was naturally of a recluse and retiring disposition. But, on the other hand, we have nothing to guide us in forming an opinion of the origin, the nature, and the progress of his experimental operations. They may have been commenced for the simple gratification of a mind desirous to satisfy itself in every particular of whatever it undertakes. In

his early travels, when at Venice, he had observed in the arsenal there a peculiar employment of the lever; and when at Rome his mathematical studies had led him to a knowledge of a particular kind of fountain. After his return he had undertaken the erection of water works at Raglan Castle, in connection also, no doubt, with the fountain set up in one of its adjacent courts. The young engineer may have been deeply read in Ramelli's elaborate work, and may have determined, with the assistance of Kaltoff, to adopt, what he long after expressed, as "a humour I have, *never to be contented* to produce any invention the second time, without appearing refined."* Once started on an inquiry so peculiarly suitable to his taste, he may have pursued it almost without design, and continued it only because it interfered with no more serious employment. Being drawn into the designing of novel inventions, and further encouraged by his workman's production of excellent models, it seems natural enough that, in the seclusion of Raglan, immersed in the scientific literature then available, and possessing as he did a remarkably inquisitive and inventive genius, he should grow up an inventor almost without taking cognizance of his own progress. It is certain that it was peculiar to him to take nothing on trust, but to reduce everything to the test of absolute experiment. There was perhaps never any contrivance of which he thought or read, that he did not reduce to a model; and his was the experience of a great practical mechanic, whose information was founded on known results; whether of success or failure. It was thus that he required the services of Kaltoff through nearly forty years, together with many assistants employed under him. The great

* See page 225.

ingenuity, perfection, and variety of his Lordship's inventions are traceable to this laborious and expensive practical process.

When at length, in 1655, he commenced in earnest to make known among a select number of persons his determination to bring out his inventions for public advantage, he had a difficult task before him. The recluse philosopher was about to assume a new character, offering to submit for approbation, to an ignorant and prejudiced public, his mechanical marvels, the product of nearly thirty years' study! At fifty-four years of age, without the least practice in trading transactions, bred to no profession, and known only as a high-minded but ruined nobleman, he sues for public patronage!

Among his manuscripts we find a slip of paper which has all the appearance of having passed through many hands,* and suggests the idea that it was one of many similarly written, to enable others to make known among their friends what the Marquis had to offer, seeking their encouragement therein, of what they chose to select. It reads thus:—

1. Intelligence at a distance communicative & not limited to distance, nor by it the time p'long'd.
2. Ffountaines of pleasure, with artificiall snow or haill or thunder, & quantity not limited.
2. Oft suteing [shooting] peerds, controuleable, in one plane, either for number or time.
3. Discourse to be had by a Lamp.
4. A Brass head, capable to Receave at the Eare a Whisper & the mouth thereof to Render Answer in any Language to the Interrogator.

There is a somewhat similar but fuller MS. list of eight

* From MSS. Badminton.

of his inventions, evidently issued between 1655 and 1660, from its being headed, "Inventions of y^e Earl of Worcester,"* as he only bore the title of Earl during the Commonwealth. By these means, a small select circle of friends would become acquainted with the singular mechanical skill of the Marquis; but, with what success for the desired end is problematical. He would unquestionably astonish all, while it is but too likely he would convince very few indeed. Besides, his ultimate views were beyond the scope of the ordinary trader, and could only be effectually realized through government influence; particularly in an age when the common manufacturing resources of the country were but sparingly developed, and when trading enterprise was monopolized by special corporate bodies. Here was a spectacle to behold; one of our country's brightest ornaments, and its unquestionable glory, degraded to this hopeless drudgery; deprived of his princely property, and allowed a pittance of £3 per week!

When, in 1661, Parliament passed "An Act for distribution of £60,000 amongst the truly loyal and indigent commission-officers, &c." the following was the appointment of Commissioners named therein for Monmouth:—"Henry, Lord Herbert† of Raglan, eldest son of

* Appendix A.

† Between the 14th of July, and the 21st of August, 1684, being then Duke of Beaufort, he made his progress through North and South Wales, as Lord President of Wales, and Lord Lieutenant of the counties of Gloucester, Hereford, and Monmouth, accompanied by "T. D. gen." that is "T. Dineley," who left the particulars thereof in a manuscript of some length, containing many interesting anecdotes, inscriptions of arms, and pen sketches of scenery and antiquities, now very curious.

At Worcester, on Wednesday—"After divine service his Grace was attended in great order with drums, trumpets, the city-waites, haut-bois, flutes, and other wind music, together with harps, Welsh and Irish, viols, violins, and other stringed instruments, to the Town Hall." His Grace was numerously and handsomely attended, being himself "in glorious equipage." While at Troy, near Monmouth,

Edward, Lord Marquis of Worcester; Sir Anthony Morgan, Sir George Probert, Knights; William Jones of Lanarth; Thomas Morgan of Lansoan; Miles Morgan; William Morgan, one of his Majesty's household; Charles Hughes; Roger Williams of Kentild, Esquire; James Progers, Esquire."

Also, "For the county of Gloucester, and the city and county of the city of Gloucester, Henry Lord Herbert of Raglan, &c." along with 21 other Commissioners.

The Marquis of Worcester had every reason to expect an agreeable change of fortune on the accession of Charles the Second to the throne. He made a full declaration to Lord Clarendon of the powers under which he had acted for the late King in Ireland. He recovered a large portion of his estates. He had given up all claim to the promised title of Duke of Somerset. He was granted an Act of Parliament for his Water-commanding Engine, in 1663; and immediately after he printed the first edition of his "Century of Inventions." But he was entirely neglected by the frivolous monarch on whose consideration and patronage he had calculated, with his usual confiding sincerity of heart.

Worn out by three years' delay, without any prospect of improvement, he seems to have concluded on an appeal in person to the House of Lords. But his first

on the 20th of August, his Grace viewed the County Militia Regiment; "several of the principal gentry" on the occasion "placing themselves in the front of the stand of pikes. Doublings, countermarches, wheelings, variety of exercise, and good and close firings were made."

He returned to Badminton after nine weeks' absence, "extremely satisfied with the good order in which his Grace found the militia," also "with the reception and entertainments in all places of the progress."

The MS. has been printed for private circulation, under the title of "An account of the progress of his Grace, Henry the First Duke of Beaufort, through Wales, 1684. And Notitia Cambro-Britannica. By T. Dineley. Edited by Charles Baker, Esq. 4to. 1864."

course was to submit a draft of his proposed discourse to his Majesty, agreeable to an understanding at the Hague, when his Majesty was in exile, that he should so act, previous to consulting any of his ministers. The document now at Badminton, is most likely his Lordship's own copy of the one forwarded to the King, who seems either to have discouraged its being brought forward, or to have given it no further attention. It is in every sense a remarkable production, whether as regards its matter, its style, or the extraordinary evidence it affords of his Lordship's unbounded confidence in and devotion to Charles the First. The MS. is endorsed—

“Statement of the Marquis of Worcester's expenses for his King and country ;” and is as follows :—

“MAY IT PLEASE YOUR MOST EXCELLENT MAJESTY.

“SIRE,

“To ease your mind of a trouble incident to the prolixity of speech, and a natural defect of utterance which I accuse myself of, I have presumed here to set down summarily in writing what I desire (if your Majesty approve thereof) to speak in the House of Lords, whereby your Majesty may gather how far (some things being rectified) I am confident of myself to serve you, praying your Majesty's favourable construction of what I shall endeavour candidly to submit unto your Majesty.

“In the first place, according to your most gracious commands laid upon me at the Hague, when I offered to make my Lord Chancellor privy to what I should at any time presume to offer to your Majesty's transcendent judgment, having sufficiently suffered for treating with the late King, of happy memory, alone ; to which request of mine you were pleased to give this most gracious and never-to-be-forgotten reply, that,

notwithstanding you would have me first to acquaint yourself therewith, and then only such as your Majesty should consent unto, and think proper for it: In pursuance whereof I most humbly offer this following discourse, which I shall with a most ready and implicit obedience augment, diminish, or alter, as your Majesty shall think fittest; disputing nothing, much less waiving anything, that your Majesty shall command either as to substance or circumstance.

“MY LORDS,

“Amongst Almighty God’s infinite mercies to me in this world, I account it one of the greatest that his Divine goodness vouchsafed me parents as well careful as able to give me virtuous education, and extraordinary breeding at home and abroad, in Germany, France, and Italy; allowing me abundantly in those parts, and since most plentifully at my master of happy memory, the late King’s Court, by which means, had it not been my own fault, I ought to have become better able and more capable to serve Almighty God, my King and country, which obligatory ends of theirs have I always had in my eyes, as drawing and sucking them thence, it being certainly the greatest and surest portions parents can leave to their children; since breeding and knowledge cannot be taken from them, when as riches and possessions are fading and perishable, witness my own case, my Lords. Yet, by dear-bought experience and their great expenses, for which I honour the happy memory of my most beloved parents, more than for my very life, drawn from them, they giving me by the one but my being, and by the other by *bene esse*. Whereby I find nothing more certain than that the way to make oneself considerably useful to his Prince and nation, is the surest means for him to become

cherished by them, which they then do for their own sake, not his, though he had spent and lost above 7, or £800,000, sterling; and narrowly escaped several times, both by sea and land, imminent dangers, and long and close imprisonment, and a scaffold, threatening death, as I have done, *Experte Crede Roberto*, my Lords; yet happy is this day unto me, wherein I have the honour, sitting amongst your Lordships, to express from my heart that I have not the least repining thought within me, though I had suffered ten times more for so good a cause, and so gracious and obliging a master as the late King, of happy memory, was unto me. And for so majestical and promising a Prince as my new sovereign is, whom God long preserve; and, morally speaking, cannot do amiss, whilst he hearkens to so wise a great Council, and so tender of his good and welfare as your Lordships, assisted by so discreet, experienced, and well-affected persons as sit now in the honourable House of Commons, the whole kingdom's representatives. And may your Lordships be ever as tender of your innate privileges, members, and birthrights, as they of theirs, and both of you equally likewise tender of his Majesty's just and undoubted prerogatives, upon which two hinges, or rather bases (that is, our most gracious King's prerogatives and the birthright of his subjects), this excellent government of King and Parliament outvies and excels all other in the world. Let them, therefore, my Lords, hold together as the surest props of a settled kingdom; his Majesty's power consisting in nothing more than in the greatness of your Lordships, who are, as well by Divine Providence as human policy, allotted to be as it were the medium between the King and the people; that is, to interpose yourselves as mediators if the King's supreme authority should become severe, which cannot be feared from so gracious a Prince; as

also to be curbers of the people's rustic stubbornness, if they should prove insolent, which cannot likewise happen to a nation that hath so lately smarted for such inconveniences, as, had the Lords' former greatness and power been continued in them, could never have happened; for, as I hold with the old saying, *No Bishops, no King*, so may I boldly aver that no power of temporal Lords being extant, there will be neither Bishop nor King. But I am too tedious, my Lords; yet what I further shall presume to say, will need no eloquence, being upon a theme pleasing, as I humbly conceive, to the minds of all your Lordships, there being none of you whose birth brings you unto this place, but so much generosity possesses your hearts, that you conclude and harbour a firm resolution to believe and follow that noble and heroic maxim—*Beatius est dare quam accipere*, since *Beneficium accipere est libertatem vendere*, a thing beneath your Lordships. According, then, to which maxim, as having the honour to be a member of this House, esteeming in the first place the right of Peerage, even before the titles of Earl, Marquis, or Duke; as a Peer, therefore, I say of this House, I shall (with your Lordships' approbation) humbly offer a present unto his most excellent Majesty, our most gracious Sovereign, a present, my Lords, which cannot be done without you, and fit to be owned by a House of Lords, it being no less than to raise an auxiliary troop for his Majesty's Life-guard, of an hundred horse, and commonly called in France an hundred Meistres; that is, each Cavalier to keep a servant with a led horse, as well as his own, and one of them to be worth £100. The whole troop shall amount the first day unto upwards of ten thousand pounds, besides arms and equipage accordingly; nay, my Lords, every one of this troop shall be of that quality and power as to

be capable to raise at his Majesty's command an hundred men in 14 days; and at the entering into the troop, shall furnish into his Majesty's store-house a 100 foot arms, two parts fire-arms, and the third pikes, at his own proper cost and charges, and marked by him, there to be kept till his Majesty's occasions be to raise men accordingly: but God long preserve his Majesty from needing of them; yet if, at any time, then will his Majesty have in readiness at a fortnight's warning 10,000 men, without costing his Majesty or the kingdom sixpence, till they be raised and armed. And that most worthy nobleman, the Earl of Northampton, who, according to the Spanish saying, *So many brothers united so many castles*,* hath approved himself to be such in gallantry and strength for his King and kingdom's defence, is desirous and willing through his zeal to his Majesty's service, to be but lieutenant to the said troop. But the whole troop, consisting of such persons qualified as above-mentioned, volunteers, and not serving for pay or gain, will deservedly require not to be put upon common services, and not to be commanded but by his Majesty, or his most deserving general the Duke of Albemarle; and they themselves not to be tied to daily duties, but to have liberty to substitute some gentleman of quality, or an experienced officer, to serve for him at any time when his Majesty requires not his personal appearance, and that the Captain of the troop gives way unto it. I presume, my Lords, to nominate my Lord of Northampton but as second to me, because his goodness and zeal to his Majesty's service makes his Lordship contented to give me the precedence as Captain, though far less worthy, and shall indeed be but a servant to his Lordship and the rest of the troop,

* The Earl of Northampton, who fell at Hopton Heath, left five sons in arms for the King. The young Earl fought as gallantly as his father for the cause.

in order to his Majesty's command, and the welfare of his tenderly beloved people. The rest of the troop shall be nominated when your Lordships shall approve of the motion, and his Majesty vouchsafe an acceptance thereof. They shall all of them be approved persons in zeal, loyalty, and allowed by you, and do ambition the honour of being called a troop of the House of Lords, and being so termed, and most of them of your members, I dare without vanity affirm that no King in Christendom but may boast of such a troop; and it will not only be a safety to his Majesty's person, but an honour to the whole nation; and an evident testimony of your Lordships' constant loyalty and zeal to both King and kingdom, and will keep up the honour of this House, and not subject [it] again to be thrust out of doors; and I beseech your Lordships that I may be rightly understood, for it is my duty to his Majesty, and the honour I bear to this House, and not the ambition of being Captain of the said troop, that makes me to motion the raising thereof; for as I acknowledge that there are many greater persons in the House, as well titular as real, in merit and power, any of whom, if they please to undertake it, I shall with more joy and readiness serve as a trooper therein, than to have the command thereof.

“ My second humble offer, disposable by your Lordships, is at my own cost and charges, but under your Lordships' name and approbation, and out of the accruing profits of my Water-commanding Engine, to cause to be erected a competent ordinary, affording as well wine as meat, for one meal a day, for forty indigent officers, such as the calamity of the late times has brought to so pressing necessities, as none of your Lordships, I am confident, but is very sensible thereof, especially of such persons who (had not their zeal to their King and country transported them) might have

lived plentifully of their own; yet if your Lordships' commiserating eyes look not speedily upon them, may follow the destiny of some others of quality, yea colonels, and never were under my command; yet I never made distinction when his Majesty's honour or service was interested, or his well-deserving subjects suffered, and were within my power of relief, for whose burials it hath been my good fortune to pay; they not leaving behind them to the value of an angel; and I humbly conceive this act of charity, worthy your Lordships' owning, since your Lordships' cheerfully passing the act of my Water-commanding Engine enableth me thereunto; and I most humbly offer this little testimony of gratitude, to be under your name thus employed. And I intend there shall be so good order given therein, within 6 months, as that there shall be a stipend given to a person to read unto them during their meals, either of military affairs or history, the better to avoid frivolous discourse tending to quarrels and quaffing.

“Thirdly, in favour and benefit of the commonalty as well as your Lordships, and for the general good and honour of this most famous City of London, I most humbly offer, under your Lordships' name and protection, to cause a fair causeway to be made, upon which, without disturbance, two carts may pass one by the other for 2 miles together, at 4 of the greatest avenues to the City, as the Lord Mayor and Aldermen shall best advise; and at the end of each of the four causeways, an Hospital and House of Correction to be erected and endowed, with a perpetuity of £500 a year to each house; and this pious work to begin within two years, and to be finished within seven.

“Fourthly—and, indeed, I should have begun with it, according to the true rule—*a Jove principium*—I do humbly offer, in honour of this House, to cause £1000

a year, for ten years, from Michaelmas come twelve-month, to be allotted towards the building of Paul's, according as his Grace the Lord Archbishop of Canterbury, and the Bishop of London, and now Bishop of Winchester, together with the Dean and Chapter of Paul's shall set forth, and may continue:—a memorable gift from the House of Lords. And thus, I humbly conceive, to have offered an acknowledgment of thankfulness both to his Majesty, and to your Lordships, Spiritual and Temporal, and for the Honourable House of Commons, for passing the Act of my Water-commanding Engine; and to improve this my humble thankfulness, shall be my daily exercise and study, no ways meaning that what here I suffer shall set a period thereunto, so as your Lordships will be pleased to set your helping hands to remove some misconstructions and personal inconveniences, which, if not diverted from my mind, and from a too generally received opinion, though upon false grounds, and not appearing otherwise than false; I beseech your Lordships to be so tender of a member of yours, as to contribute to the vindicating of me therein, whereof no ways doubting but that your Lordships will remove such an absolute remora to all my intended services; and, therefore, I will presume to lay my case openly and cheerfully before you, not doubting but that at your Lordships' intercessions, his most gracious Majesty (having given way that I should speak thus before your Lordships) will vouchsafe a concurrence, and suffer himself to be disabused, and such false and malicious opinions to be eradicated out of his princely mind, as have been endeavoured, by either envy, malice, or ignorance, to be rooted therein, and so certainly have obstructed the natural influence of grace and favour, which could not otherwise but have been the effects of so great a Sun as shines within a throne of so

much goodness and majesty. Now, whether my merits have been considerable, I beg leave here to set down not as a trumpet to proclaim them, but narrative-wise, modestly, yet truly, for your Lordships' better information, accusing myself in some things with the same candour and freedom as to vindicate myself, in others, desiring to stand or fall by your Lordships' just judgment, and his Majesty's gracious proceeding thereon; no further relying even upon his Majesty's most gracious act of general pardon, than in compliance with others, his Majesty's subjects, have taken it out, yet with so great a reluctance, through the clearness of my heart, not to have deserved for it, that the Lord upon the Woolsack was forced to chide me to it, through his tenderness of my good, and, as I humbly conceive, a further apprehension than I could have of a necessity thereof; for which his tender care I acknowledge thankfulness, yet, at the same time, I must humbly ask leave to stand upon my justification, humbly praying to be rightly understood, for I do it not out of pride or vain glory, but purely—*Me defendendo*,—and if any body—*Se defendendo*,—kills another, the law quits him, much more will your Lordships pronounce me not guilty of arrogance, though I should arrogate to myself a praiseworthy desert, and not, through too much modesty, be mealy-mouthed, and not discover what of right appertains to the blessed memory of my dead father, and even my own commendations, crying with Virgil,—*Sic vos non vobis nidificatis aves; sic vos non vobis vellera fertis oves; sic vos non vobis fertis aratra boves; sic vos non vobis mellificatis apes*. Know, then, my noble Lords, that herein I speak not to derogate from the merit of the Roman Catholics from their duty and love to their Sovereign, we having all of us, with an unanimous resolution, *nemine contradicente*, that is

to say, no one gentleman of quality throughout the whole nation, but has stuck to the cause, adventuring his life, and lost his whole fortune therein; yet give me leave to aver it, boldly, that all the Catholics of England assisted not my father, or me, to the value of £5, without real security for it, and such, indeed, as at this time lieth heaviest upon me; and this I aver as in the presence of Almighty God and your Lordships. In the second place, my Lords, how came the then Marquis of Hertford, after his defeat in the west, with recruits to his Majesty at Oxford, but by my father's means and mine. The forces that I sent with him had cost me £8000; and £2000 my father lent him, ready money. How came Sir John Byron's regiment of horse to be first raised, but by £5000 in gold, given him by my father? How came the Forest of Dean to be reduced; Goodrich strong castle to be taken; Monmouth itself, with its garrison, to be surprised; Chepstow, Newport, and Cardiff to be taken, and secured for his Majesty, but by my forces and my father's money? How came Raglan Castle to be first fortified and last rendered, but by £50,000 disbursed therein by my father?

“How came his Majesty's army to be considerable before Edge-hill fight, but by the men I brought, and how was his Majesty recruited at Gloucester side, even after the defeat given by Waller to my men? God forgive those of the King's party, who were the occasion that 1500 were surprised, and I not despatched from Oxford until the day after; yet, my Lords, at 14 days warning I brought 4000 foot and 800 horse to the siege of Gloucester, paying them £6000 down upon the nail at Gloucester, besides my troop of Life-guard, consisting of 6 score noblemen and gentlemen, whose estates amounted to above 3 score thousand pounds a-year, most of whom I furnished with horse and arms,

which of a sudden they could not do themselves; for I was then master of 34 horses in my stable, for the worst of which I have refused £100, and above 40 others lonely worth £50 a horse. I kept a table for the said troop, not only at Gloucester side, but all the way to the west, without so much as making use of free quarter, but all upon the penny; for General Raven complained of me to the King, who graciously and smilingly reprehending me publicly, I desired to know my accuser, and called my Lord-General Raven, afterwards made Earl of Bradford, before his Majesty, who, objecting that it was of ill example and made them to be thought the more burdensome; my humble reply was, that I yielded to his Excellency to be the better soldier, but still to be a soldier of fortune, here to-day and God knows where to-morrow, and therefore he needed not care for the love of the people; but though I were killed myself I should leave my posterity behind me, towards whom I would not leave a grudge in the people, but whilst I could serve his Majesty upon my own purse and credit I would really do it, and afterwards leave it to such as his Lordship.

“I confess I raised this troop without my father’s consent first asked; his Majesty’s peremptory commands and the shortness of time requiring, and I confess his Lordship checked me for it, and said I had undone myself thereby, and [I] replied that 5 or £6,000 would not undo me; the horses being all my own already, and the arms, by accident coming to Bristol afforded a sudden and cheaper means for it. My father answered, that he did allow that 6 nor £16,000 would not undo me, but the consequence would be that the love and power I had in my country would be perspicuous; although I should have thanks from the King, yet others, though his Majesty’s well-wishers, yet, through envy, they would hate me for it: which I

confess I have found too true, and my services have been more retarded by those who called themselves the King's friends than obstructed by his enemies.

“ Pardon me, my Lords, if I detain you a little longer, descending to some particulars as near as I can call to mind; and beginning first to tell your Lordships that I was not privy nor present with his Majesty at Greenwich, when he first took his resolution for the North, and removed without the Queen to Theobalds, from which he was pleased to write me a lamentable letter by the hands of Sir John Byron, averring that he had but £600, and £300 of which was given to defray his horses, which the Marquis of Hamilton, then Master of the Horse, refused to do, fearing to displease the Parliament; but upon such a lamentable complaint, and pressing necessities of my dear master (yet no ways advising him unto the journey), I sent him to Theobalds. £3,000

“ To Huntingdon, after his departing from Theobalds 3,000

“ To Nottingham 4,000

“ To York 8,000

“ And took order for a table, to be kept for several experienced officers, who by this means were kept from taking arms for the Parliament, and were ready for the King's service, and the defraying of their debts here, their journey into York, and their table there, which none of them but 2 knew it came from other hand than the King's privy purse, yet stood me in 1,500

“ And these sums, with as great privacy as may be, keeping good correspondence with the Parliament, and myself present at London, to avoid suspicion, being then trusted both by King and Parliament. For victualling the Tower of London, by his Majesty's command I sent to the

then Lieutenant, Sir John Byron, in old plate,
under pretence of coining it 2,500

“By a feigned pretence getting leave of the
Parliament (the circumstance being too tedious
to relate to your Lordships, but yet notable in
itself), I went with their pass to York, and
carried to his Majesty in ready money 15,000

“In bills and assurances. 80,500

“For both which sums I had his Majesty’s
note, yet extant, for ninety-five thousand 5
hundred pounds. Which done, in two days,
his Majesty’s further commands received, I re-
turned to the Parliament, with a plausible
answer to a message sent from them by me, and
I agreed with Parliament to remove the maga-
zine of powder and [ammunition] for [from?]
Monmouth, which was a town of my own, to
Carlyon, a town of the Earl of Pembroke, a
professed adherent unto them, which they took
kindly at my hands, though done by design by
me, who could not have pretension to take it from
the town of Monmouth had it been still there.

“For the raising of Sir John Byron’s regiment
of horse, being the first completed 5,000

“Things being thus set in order between his
Majesty and me, I fairly took leave of the Par-
liament to go down to my father; where I no
sooner arrived but there came directed unto me
from his Majesty a Commission of Array; where-
of I presently, by a servant of my own, sent
word to the Parliament, with a letter to the
House of Lords, which I directed to my Lord of
Holland, and to the House of Commons, to Mr.
Pym; in both of which I offered to intercede to
his Majesty, and conceived I should prevail to

suspend the Commission of Array, if they should make an Act that their militia should not come into my country; but they, with civil compliments and thanks, replied, that his Majesty's [proceeding?] was so illegal, and theirs for the kingdom so just and necessary, that by no means would they waive the one for the other. At which I declared myself irritated to see that they durst tell me that anything commanded by my master was illegal, and professed I would obey his Majesty's commands, and let them send at their perils. So, immediately, and in 8 days' time, I raised 6 regiments, fortified Monmouth, Chepstow, and Raglan; fetching away the magazine from the Earl of Pembroke's town, Carlyon, and placed it in Raglan Castle, leaving a garrison in lieu thereof. Garrisoned likewise Cardiff, Brecknock, Hereford, Goodrich Castle and the Forest of Dean, after I had taken them from the enemy.

"To the then Lord Marquis of Hereford, in Wales, as many forces as cost me the raising and arming * [8000?]

"Lent him to prosecute that expedition, in [2000?] raising of forces in Wales, first and last, [to the?] number of twelve thousand men, and [maintaining] them, whilst the country was tottering, [also providing?] them weekly for fifteen months: . . . [plainly?] speaking, }
 and it shall be made good. . . . † } [130,500?]
 "Brought to Oxford and delivered }
 [with my?] own hands † }

* See page 328.

† The MS. being defective on this side, the particular sums of money cannot be ascertained.

“ My journey to Ireland with levies and inci-
dent[al expenses?], there as well at sea as at
land.

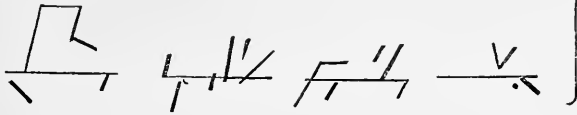

“ The furnishing of troops of 6 score [gentle-
men with?] arms, and most of them with horses,
some of them of an hundred pounds price, and
many of £50; for though the gentlemen betwixt
them made above £60,000 per annum land of
inheritance, yet being unexpectedly raised in 8
days, and could not furnish themselves, which I
did according to their quality, together with
their servants to the number of 200, keeping a
constant table for them the whole journey, all
along from Gloucester into the West; whereat
they never wanted wine, that being carried along
with us, but oftentimes beer; together with
£6,000 in ready money, paid my foot soldiers
at the raising of the siege of Gloucester: which,
all modestly rated, came unto above . . . 25,000

“ The keeping of the garrison of Raglan,
towards which, till the very last cast, there was
never a penny contribution raised or exacted,
amounted to, at the least . . . 40,000

The total £318,000

“ Besides the garrison of Monmouth, both town
and castle, Chepstow, Goodrich with Hinan, and
the Forest of Dean, recovered from the enemy,
all at my charge till Sir William Vavasour came,
who hath had of me 500 twenty shilling pieces at

* The cipher follows on the same line, and agrees in character with the cipher-
writing on page 180. See Comment on Article No. 5, in the “Century.”

a time, to encourage him to go on at Gloucester; besides, likewise, the charge of reducing of Abergavenny, Carlyon, and Newport to his Majesty's obedience.

“Furthermore, for seven years, both in England and Ireland, I allowed twenty pounds each meal, to which all officers and gentlemen were welcome; and I believe the charges in these particulars, not to be inserted or charged on this account, amounts to one-half as much as the former sums. I never received a farthing towards it as General or [otherwise], nor a penny out of my estate in 20 years. These times came unto upwards of *sumebus viis et modis*, which alone amounted unto . 600,000

“These sums added together balance the accounts and make good that I have spent, lent, [and lost?] for my King and country, *revera* £918,000

“My Lords, being conscious of this, and many things forgotten by me to set down, I was become proof against anything the King's enemies could do against me, since by their principles I knew I deserved it; but, since his Majesty's return and happy restoration it hath almost stupified me to have been so laid by as not to have had any promise made good to me, for which I had his Majesty's royal word, hand, or even the Great Seal of England; but, of the contrary, I humbly beseech your Lordship's leave to set down what, with all submission to his Majesty's will and pleasure, flesh and blood cannot but resent, yet so far only as shall stand with the duty of a loyal subject and the unquenchable zeal of my real heart towards my King and country, and a most humble submission to your Lordships' better judgment, casting

myself wholly at your disposal and favourable construction of what I shall set down, according to the old saying, that—*losers may have leave to speak.*”

In this proposed address to the House of Peers, the Marquis of Worcester offers some introductory remarks bearing on his parentage, education, and travels; but the burden of his speech is a detailed account of the severe losses himself and his family sustained, consequent on the Civil War, combined with his father's and his own liberality to Charles the First personally. His proposed plan of laying his case before the House is prefaced with a singular offer on his own part, under four different heads:—

1st. He proposes to raise an auxiliary troop for his Majesty's Life-guard.

2nd. To cause to be erected a complete ordinary for forty indigent officers.

3rd. To cause a fair causeway to be made, for two miles together, at four of the greatest avenues to the city.

And 4th, to cause £1,000 a year, for ten years, to be allowed towards the building of St. Paul's.

Then follow items of the various and vast sums expended in the Royalist cause.

His allusion to the Act obtained for his Engine, in 1663, fixes the date of this document at or soon after that period. The amount expended in the Royal cause by his father and himself was so enormous, that it is difficult to understand on what ground he considered he bettered his claim to some compensation, by burdening his statement with four separate offers, calculated to absorb far more than he could ever expect to obtain through a monarch so needy, extravagant, and dissolute as Charles the Second.

Whatever may have been the Marquis of Worcester's previous private engagements, there is every reason to believe that from the time he was protected by Act of Parliament, he vigorously put forth all his energies to promote the works at Vauxhall, where, aided by Caspar Kaltoff, he soon had one of his "stupendous" engines in operation.

James Rollock, an "ancient servant of his Lordship's" (as he styles himself), who made some pretence to being a poet, wrote "a Latin Elogium and an English Panegirick, both of them composed through duty and gratitude." He informs us that, he "hath for forty years been an eye-witness of his great ingenuity:" adding, "I think it not amiss to give further notice in his Lordship's behalf, that he intends within a moneth or two to erect an Office, and to intrust some very responsible and honourable persons with power to Treat and Conclude with such as desire at a reasonable rate to reap the benefit of the same Water-commanding Engine."* About the same time would also appear to have been issued large posting bills, one rare and curious specimen of which may be seen in the Library of the British Museum,† setting forth a short address to the King, followed with the usual "definition" of "A stupendous or a Water-Commanding Engine, boundless for height or quantity." We have thus very clear evidence that he was employing every possible means at command to impress his claim on public notice.

Then, as regards the Engine itself, it was required by the Act of Parliament, "that a model thereof be delivered to the Lord Treasurer or Commissioners for the Treasury for the time being, at or before the 29th day of September, 1663," and the same to be "put into the

* "An Exact and true Definition, &c." Appendix C.

† Brit. Mus. 12. El. 75. 10.

Exchequer and kept there;" a requirement which he was certain to obey punctiliously, not only to avoid dispute, but because nothing was easier for him to perform, through the agency of Kaltoff.

Another remarkable point referring to his Engine is that he concludes the 98th article of his Century, which alludes to it, by saying:—"I call this a semi-omnipotent Engine, and do intend that *a model thereof be buried with me.*"

And lastly, there was his practical demonstration on a large scale. As early as May 1654, we have an intimation of his being in treaty for works at Vauxhall. Not long afterwards we find his workman Kaltoff settled there, and in one of his Petitions he explicitly mentions having spent "£9,000 on buildings and improvements," and at least "£50,000 in trying experiments and conclusions of art in that Operatory:"* thus actually curtailing his personal comforts to fulfil his engagements with all those persons who confided in his promises to perfect his novel undertaking.

His works and Engine were examined and noticed in 1663, by the French traveller M. Sorbière; in 1666 or 1667 by the eminent mathematician Dr. Robert Hook, whose cynicism unfortunately thwarted his judgment; in 1669, by the Grand Duke, Cosmo de Medici; and we find it still in existence in September, 1670, being then alluded to in a letter written by Walter Travers, a Roman Catholic priest.†

We have, therefore, certain evidence that the Marquis of Worcester's Engine was in full operation for at least seven years, and that one of the conditions of the Act of Parliament obliged him to deposit a model in the Exchequer. His own estimate of its value may

* See page 287.

† Appendix D.

be judged by his gladly giving up for the promised tithe of it to the King, his claim on Charles the First equal to £40,000, in lieu thereof.*

His Lordship's invention was never offered by him as a merely amusing trifle; it was not a curious model which might or might not possess some practical advantage; and it was not of a nature of which he was but partially aware, and which it was left to others to apply. It is even possible that as early as 1628 he had set up his Engine in its most simple form of application; and that, improved upon through thirty-five years of study and experimenting, the Engine of 1663 was a master-piece of workmanship and contrivance for that age. His invention was no longer a secret, he had done all that any inventor could possibly be required to perform to establish his claim to be considered as a true and first inventor. His right did not depend on the vague notice first put forth in his *Century*, but on the actual Engine made, and, for not less than seven years, constantly worked for public inspection at Vauxhall. Any one so disposed could have obtained the same examination of it that was conceded to Sorbière and to Cosmo de Medici. Dr. Hook does not condescend to state what he saw of it; he set out for Lambeth with the intention of going to Vauxhall, but the *laughing* philosopher may have settled the problem in his own mind, to his own entire satisfaction, without taking any trouble on a supposed foolish errand. We speculate in vain whether among the visitors stimulated by curiosity, or invited by intending shareholders, there were such men as Sir Samuel Morland, the King's Master of Mechanics; Rupert, Duke of Cumberland; Dr. Sprat, the historian of the Royal Society; Bishop Wilkins, the author of

* See page 257, and Appendix F.

“Mathematical Magic”; the Honourable Robert Boyle, Sir William Petty, Lord Viscount Brouncker, and other distinguished personages.

Without positive facts to guide us we are ever in danger of misjudging a bygone age, and in the present instance it would be imprudent to hazard an opinion on what is no less true than strange, that the Marquis of Worcester entirely failed to arouse public inquiry into the merits of his invention: being treated throughout with an indifference, which, to modern apprehension, appears wholly inexplicable. Yet, so inconsistent is human nature, that the same age which burned and drowned so-called witches, which believed in the transmutation of base metals into gold, put faith in the curative effect of sympathetic powders, and the King’s touch for bodily distempers, saw portents in meteoric phenomena, and considered astrology a sound science, could yet look with stolid indifference on this germ of the steam-engine, unimpressed by what was publicly exhibited, written, printed, and for at least four years made the subject of its inventor’s daily conversation. Books and pamphlets were constantly being published, filled with mysticism, gravely recording the day-dreams of fanatics and impostors, and letters lent their aid to promulgate such fables; yet here was a new agent at work, of such potent power that its like had never been seen, which nevertheless men saw, heard, and listened to in dumb astonishment, with the infantile simplicity of the poor Indian, ignorant of the value of the gold or diamonds strewn in his path.

The early associated scientific men may have been perplexed on finding an individual coming forth, in the sixty-second year of his age, to propound a new doctrine. The suspicion was natural; the cause appeared evident; his project might be a chimera, or an absolute delusion. No one ever so remotely suspected his

own want of wisdom. Had the Marquis suddenly dropped from the clouds, or sprung from the earth, he could not have been in himself a much greater phenomenon than he appeared to the virtuosi (as the learned were called) of his day. Such a prodigy had never been heard of, and perhaps will never again appear, as that of a secluded scholar, studying all his life, suddenly coming to light with unheard-of knowledge. If true, he was a Leviathan, and compared with him all must have acknowledged a sense of painful inferiority. The Marquis on his part appears to have acted with unsuspecting confidence and modesty, as one quite unconscious of the intellectual disparity between himself and the professors of mechanical science in his day. However, he neither sought nor formed new acquaintances; he seems to have rested satisfied with his early associates, or his own immediate connexions; so that no one was gratified by his condescension, or induced to proffer advice, through any application on his part. Indeed he mainly looked to the Crown for efficient support; but the luxurious and gay monarch sought only youth and beauty, the banquet, the ball-room, or the tennis-court, and was not to be disturbed in his pleasures by aged philosophy propounding mechanical experiments, and smoky steam-engines. The King carried "Hudibras" in his breast, and might perchance have a copy of the "Century" in some remote cabinet. Need we be surprised that his Lordship's confidence in succour from such a source was every way misplaced? His treaties with the business world, it is to be feared, ran counter to all accepted forms, the talented philosopher being no plodding trader; so that act as he might for the best, it nevertheless appears to have been his uniform misfortune neither to acquire friends nor conciliate enemies, a posture of affairs not uncommon to fallen greatness.

It is most unfortunate that he did not survive to complete his intended publication of a larger work than the "Century," presenting his hundred inventions with illustrative engraved plates. But in common candour let it never be overlooked, that we have before us a promise published in 1663, long preceding the devastating plague, which almost depopulated the metropolis in 1665, and the terrible conflagration of 1666, which laid waste the city of London; and that it was in the midst of such accumulated public calamities his health appears to have suddenly given way, aged, harassed, disappointed, and dismayed, when he was prematurely called to his long rest.

Neglected by contemporaries, modern writers have rested satisfied with a detail of some three or four years of his political career in Ireland, and a notice that he possibly possessed some mechanical ability, as giving a sufficiently comprehensive view of his character through a life extending over sixty-six years. This lax course, on the part of his biographers, has favoured the opinion expressed on the Continent, that the invention of the steam-engine is not of English, but of French origin! And this statement has been long colourably supported by means of a forged letter, the subject of which has been graphically represented by the painter, and copied by the lithographer; all attesting the prevailing zealous ardour of France to honour native genius. Thus, as though it were not a sufficient infliction to be ruined, dishonoured, oppressed, and neglected while living, it would almost seem as if events conspired to lessen, if possible, the lustre of his memory by the dark shades of apocryphal history.*

The Marquis of Worcester, considered in his true

* Appendix H.

character, was in every sense a learned, deep-thinking, studious, amiable, and good man. He was a Roman Catholic wholly free from religious prejudices, and a most loyal subject without displaying under an adverse change of circumstances any appearance of undue party zeal. In all his public conduct he was invariably consistent, scrupulously conscientious, and strictly honourable and humane. In scientific acquirements he stood grandly alone, not from pride, but rather as the result of a naturally modest retiring habit, probably constitutional, but certainly confirmed by long continued close study, favoured by his early domestic course of life. When at length he was forced to come before the public, he proved himself one of the most extraordinary mechanical geniuses of the seventeenth, or any preceding century; yet he was neither understood nor appreciated in his own day; his surpassing mental endowments were probably lost for want of earlier and fuller exhibition; while the influence of combined prejudice and ignorance served further to obstruct his rising in public estimation. It is, however, the glorious privilege of genius to leave on all its works the sure impress of mighty intellect. The "Century of Inventions," gradually increasing in public estimation through two hundred years, owes its vitality to its remarkable ingenuity and its concentration of thought; and it cannot fail to happen that each succeeding age will inquire, with increasing interest, into every particular of the singular and touching history of its noble author.

THE
CENTURY OF INVENTIONS,

WRITTEN IN 1655 ;

BY

EDWARD SOMERSET, MARQUIS OF WORCESTER.

BEING

A VERBATIM REPRINT

OF

THE FIRST EDITION, PUBLISHED IN 1663.

“ He was a man, take him for all in all,
We shall not look upon his like again.”

WITH

An Introduction and Commentary

BY HENRY DIRCKS, ESQ.,

CIVIL ENGINEER,

AUTHOR OF “PERPETUUM MOBILE, OR HISTORY OF THE SEARCH AFTER
SELF-MOTIVE POWER;”

“CONTRIBUTION TO THE HISTORY OF ELECTRO-METALLURGY;”

AND “THE LIFE OF SAMUEL HARTLIB;” ALSO

INVENTOR OF THE “DIRCKSIAN PHANTASMAGORIA,” PRODUCING THE OPTICAL
ILLUSIONS POPULARLY CALLED “THE GHOST!”

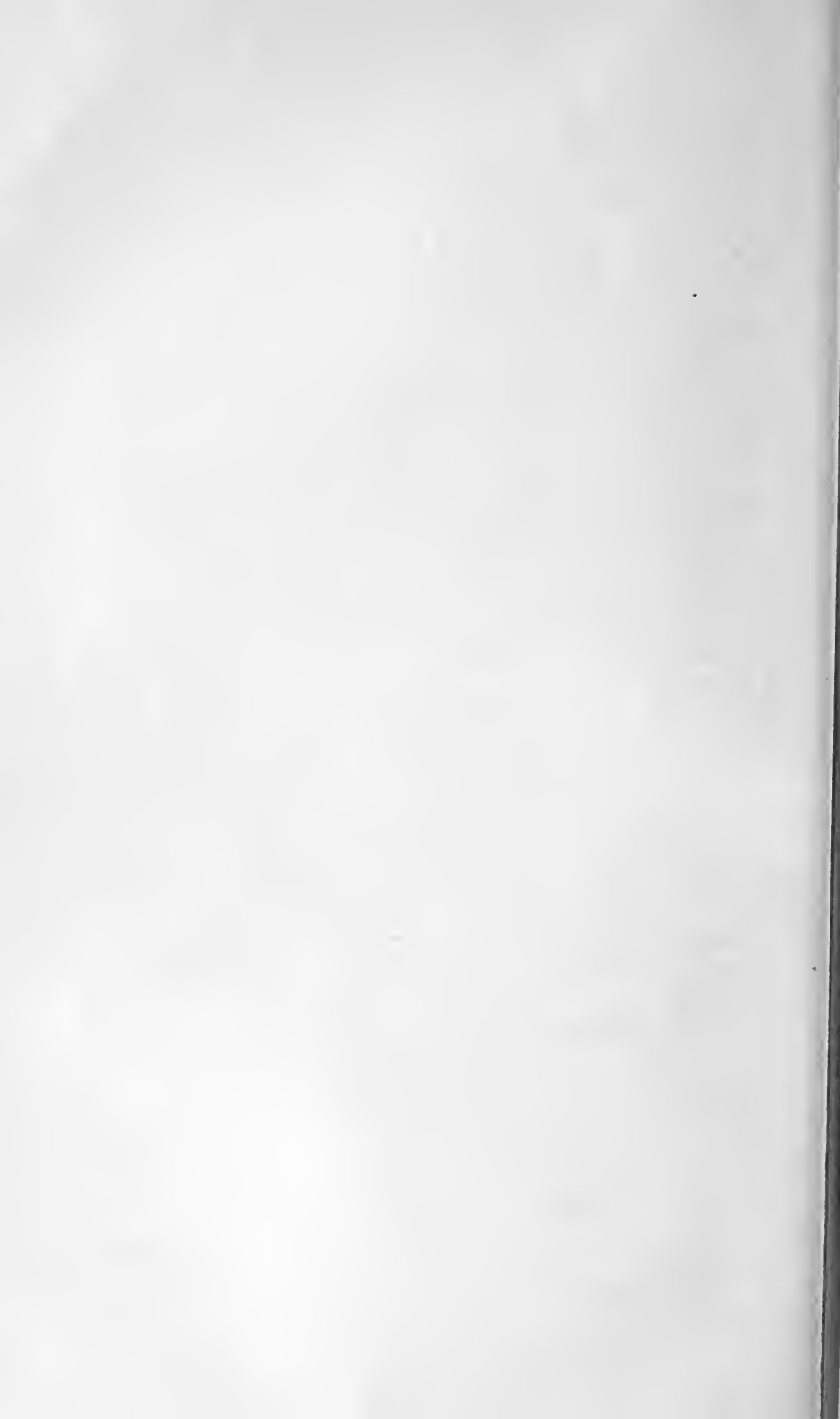

INTRODUCTION.

THE Middle Ages are usually considered to have closed between 1490 and 1500, only one century previous to the birth of that Marquis of Worcester to whom posterity is indebted for his ever memorable publication, the "Century of Inventions," of which a reprint is now before the reader. It records the earliest full, though brief, sketch of a practically working Steam-Engine; an invention which, whether in relation to the age in which it was produced, or the difficulties under which it was wrought out, cannot be considered otherwise than as a marvellous effort of ingenuity. The literature and science of that era, as compared with the progressive stages of improvement distinguishing the two succeeding centuries, were barren and meagre indeed. Hallam justly observes: "Learning, which is held pusillanimous by the soldier, unprofitable by the merchant, and pedantic by the courtier, stands in need of some countenance from the ruling powers before whom all three bow down." But even at that early period Leonardo da Vinci, born 1452, had anticipated Lord Bacon in the universally accepted principle, that experiment and observation must ever be the only sure guides to the forming of just theories in the investigation of nature.

The "Century of Inventions" derives its name rather from the circumstance of the work containing one hundred articles, than the same number of inventions. Its

noble author may have had in mind the *Centuria di Secreti Politici, Cimichi, e Naturali*, by Francesco Scari-
oni of Parma, duodecimo, printed at Venice in 1626,
when he fixed on the quaint title of his own remarkable
production.

Among the Harleian Manuscripts in the British
Museum Library is a manuscript copy of the "Century,"
the title of which omits the words "at the instance of a
powerful friend," also the motto, date, dedications, and
author's name. It also differs in other respects from
the printed edition, by introducing "A stamping En-
gine" as the 88th article, in place of which its author
has printed his account of "A Brazen Head;" the
concluding article likewise varies, especially in closing
with a short notice of "three sorts" of other inventions
"set down in cypher," but which do not appear. The
top of the title page has written on it "From August y^e
29th to Sept. y^e 21st 1659," probably by the copyist, to
notify the time occupied in writing.

The first edition was printed in 1663, during the au-
thor's lifetime, as he died in 1667; and the last edition,
with notes by Mr. C. F. Partington, is dated 1825. This
last edition professes on the title page to be "from the
Original Manuscript"; and, at page 6, alludes to "a
manuscript in the Marquis's handwriting, having been
preserved in the *Harleian* Collection, appended to an
original copy of the Century of Inventions." Now, as
no other manuscript is known to exist, it is important
to state distinctly that the Manuscript Century in ques-
tion is neither original nor yet in the handwriting of
the Marquis; it is evidently no more than one of those
copies, which it was then a common practice to circulate;
and the MS. bound up in the same volume with this in-
teresting document, relating to a method of "Cypher
writing," is *not* in the Marquis's handwriting.

So far, therefore, from "The Century of Inventions of the Marquis of Worcester, from the Original MS." being what it thus distinctly professes, it is an amalgamation of the Harleian MS. copy, and the first printed edition. This obliges the introduction of two Nos. 88; but unfortunately there is neither mark, note, nor observation to guide or guard the reader even as to the editor's numerous emendations; and the result has been such as to render this the most unreliable of all the reprints of the "Century," which will appear more evident by the unauthorised readings, marked P, in the notes.

The "Century" remained in manuscript from 1655, the period of its author's release from the Tower, until 1663, the date of the first printed edition; the title page of which repeats the date of its composition, adding, "my former notes being lost;" as he was, however, the inventor of many ciphers or kinds of short-hand, it is probable his lost notes would be written so as to be unreadable without the key. It was printed soon after the passing of the Act for his "Water-commanding Engine," which is mentioned in the Dedication to the Houses of Parliament.

It has been frequently reprinted singly, as well as produced entire in larger works, of all which publications a list is hereunto annexed.

We subjoin the title pages of the "Century":—

From the Harleian MS. in the British Museum.

"From August ye 29th to Sept. ye 21st, 1659.

From the printed edition of 1663.

"A Century of the names and scantlings of such Inventions as att present I can call to mynde to have tried, and perfected; (my

"A Century of the Names and Scantlings of such Inventions, As at present I can call to mind to have tried and perfected, which

former notes being lost) I have endeavoured to sett these downe in such a way, as may sufficiently instruct me to putt any of them in practice havinge wherewith to doe it."

(my former notes being lost) I have, at the instance of a powerful Friend, endeavoured now in the year 1655, to set them down in such a way as may sufficiently instruct me to put any of them in practice.

"Artis et Naturæ prole."

The peculiar term "Scantlings," here employed, is no doubt derived from *eschantillon*, a pattern or quantity cut for a particular purpose, a certain small quantity serving as a sample of some similar larger piece of work; the "Century" being intended by its author as but the precursor of his proposed ample, finished, descriptive and illustrated production.

No one unacquainted with the state of scientific knowledge between 1601 and 1667, can justly estimate the character and value of the Marquis's labours. Properly to understand him the reader must place himself as much as possible in his actual condition, peruse the books that he might have read, and consider the existing state of society and science. No commentator has yet done this, and consequently a serious difficulty has been thrown in the way of the purely classical scholar, who, though he might fairly estimate the Marquis's character on points of history, learning, or theology, could in no way turn to account his one hundred extraordinary inventions. When Walpole composed his "Catalogue of Royal and Noble Authors," the capricious cynic was sorely perplexed how to treat such a literary production as the "Century." It has been said of the wit that he had so disparaged all things in his own eyes, that nothing appeared to him worthy

of admiration, respect, or emulation; and it is no wonder, therefore, that he should cover his own ignorance on scientific matters by declaring the book he affected to criticise, "an amazing piece of folly;" closing his flippant strictures with the sapient remark, "But perhaps too much has been said on so fantastic a man; no wonder he believed transubstantiation, when he believed that himself could work impossibilities!"

David Hume was equally at fault in comprehending the mechanical skill of the Marquis of Worcester, for we find the eloquent historian, in his *History of England*, in perfect simplicity and ignorance, observing, "That the King judged aright of this nobleman's character, appears from his *Century of arts or scantling of inventions*, which is a ridiculous compound of lies, chimeras and impossibilities, and shows what might be expected from such a man!" That the "Century" shows "what might be expected from such a man," as its author, all must willingly admit; but that Hume's pungent tirade presents any logical sequence, all must as strenuously deny. Never surely did two talented writers, in different departments of our literature, figure so unfortunately and contemptibly as Walpole and Hume in their unseemly efforts thus to misrepresent and malign their country's noblest mechanical genius.

Verstegan, in his "Restitution of decayed Intelligence," printed at Antwerp in 1605, treating in the second chapter of Germany as it was of old, exclaims: "And as touching the knowledge of the people, what learning or skill is there among men that they exceed not in." And proceeds—"Sundry most rare inventions have had their original and birth among them. Whereof the noble art of printing, and the use of Artillery, are of most note." He then goes on to enumerate "the heaven of silver," a piece of exquisite workman-

ship which it took twelve men to carry; and the wonderful flying "eagle made of wood."

We in the 19th century are ever liable to misunderstand the inventions of the 17th century. Either the inventions often appear puerile, or their authors seem perplexed on very small occasions of difficulty. Many have no doubt hastily formed opinions in regard to the automata and other curiosities of the "Century." But such judgments can only emanate from persons not versed in our history and literature from Elizabeth to Charles the Second's reign. A few brief illustrations may be advantageously offered here, to show that within a very short period after the death of the Marquis of Worcester, scientific men, in mechanical matters, not only seldom rose above very slight improvements, but were at the same time delighted with every species of amusing mechanical device.*

The late Marquis's nephew, then Lord Herbert, being on the Continent, writes from Blois, 18th July, 1674:† — "We are again settled here for this summer. In our passage from Aix we saw at Lyons the most curious closets of Monsieur Cervier, which for mathematical Inventions and Machines (all his own handy-work) are the most surprising and astonishing, I believe, in the world. His many pretended Perpetual Motions, Hydraulic Dials, various Clocks and Hour-glasses, his Engines of Sympathy and Antipathy; but above all his device to discover the most predominant quality in every spectator, are past my comprehension and conception. These, and a hundred other things

* See, at page 263, M. Sorbière's enumeration of inventions considered exceedingly curious in 1663.

† A letter from Lord Herbert, to Mon. Grubendol. London. MSS. in the Library of the Royal Society. His Lordship alludes to M. Grollier de Servière's Cabinet, of which a Catalogue was published at Lyon, 1719.

there, might be well worthy a journey in this long vacation for one of your experimentators.”

In the 21st volume of the Royal Society's Transactions, for 1685, Dr. Papin, describes the external appearance, and the performance, of a small hydro-pneumatic fountain, which is represented in an engraving, as being enclosed by a cylindrical glass, under a glass shade. The Doctor states that it might be seen at his house, in operation on his mantel-piece, where Dr. Hook had watched it for half an hour, and other visitors for four hours together. The secret had been communicated to Mr. Boyle, but, with a view to excite the speculations of the ingenious, was not made public; for it was the pleasure of the learned to puzzle each other with such paradoxes.

The Diaries of John Evelyn and of Samuel Pepys offer numerous instances of the possession of similar cabinets of mechanical curiosities.

In the Life of Baron Guilford,* we have a fuller notice of scientific society, about the same period, of which the following extracts will suffice to give a clear idea. It is evident that, except as relates to the most ancient, approved appliances, then in common use in the mechanical arts, all mechanical improvement beyond these was in its non-age; so much indeed was this the case, that no invention was too simple, and scarcely any too outrageous or absurd, to be esteemed unworthy of being submitted to the attention of the learned.

“His Lordship was no concealed virtuoso; for his diffused acquaintance and manner of conversation, made

* The Life of the Rt. Hon. Francis North, Baron of Guilford, Lord Keeper of the Great Seal, under King Charles II, and King James II. By the Hon. Roger North. 2nd ed. 2 vols. 8vo. 1808. Vol. 2, p. 251.

him known and esteemed, as a professor of most polite arts, and given to scientific inquiries. This brought upon him an importunity to be admitted a member of the Royal Society. But his Lordship never countenanced the proposal; and at length, gave his positive denial. He esteemed it a species of vanity for one, as he was, of a grave profession, to list himself of a society which, at that time, was made very free with by the ridiculers of the town: and he could not discover what advantage of knowledge could come to him that way, which he could not arrive at otherwise."

Among his acquaintance were "Sir John Werden—very far gone in the mystery of algebra and mathematics.—

"One Mr. Aubrey of Surrey, a professed virtuoso, and always replete with new discoveries.

"One Mr. Weld, a rich philosopher, lived in Bloomsbury. He was single, and his house a sort of knick-knack-atary. Most of the ingenious persons about town, sometimes visited him; and, among the rest, (his Lordship) did suit and service there.

"His Lordship was once invited to a philosophical meal, at the house of Mr. Evelyn at Deptford. The house was low, but elegantly set off with ornaments and quaint mottos at most turns; but, above all, his garden was exquisite, being all boscoresque.

"He had a great value for Sir Jonas Moor, a capital mathematician, knowing well his worth and honesty, . . . (he) once invited his Lordship to dine with him in the Tower, and, after dinner, presented Mr. Flamstead . . . the star-gazer (who was) invited to come and see him."

He "had another virtuoso acquaintance in the Temple, one Mr. Ball . . . one in the list of his Lordship's ingenious acquaintance."

“ And once, upon an invitation, his Lordship dined with Sir Samuel (Morland) at his house ; and though his entertainment was exquisite, the greatest pleasure was to observe his devices ; for every thing showed art and mechanism, as—1. A fountain in the room.—2. A cistern in his garret—supplying all parts of the house.—3. His coach was most particular.—4. A portable engine, moved by watch-work—it had a fire-place and grate,—cost £30. He took it with him in his own coach, and, at inns, he was his own cook.”

These notices afford a glimpse of the early progress of mechanical science. To return to our remarks on the “ Century ;” two of the articles the Marquis borrowed, No. 21, “ A Bucket fountain,” of which he obtained information at Rome ; and No. 26, “ A to and fro Lever,” which he saw at Venice. A great number refer to Cipher writing and means of holding secret correspondence, many of which contrivances depend on very slight modifications, so that, although only twenty-three are set down, he might very easily have enlarged this one subject tenfold, only to arrive at still more extended conclusions. His engine is noted under the articles Nos. 68, 98, and 100, as, *a fire water-work ; a semi-omnipotent engine ; and a stupendous water-work*. So that discarding 2, and reducing these three to one, will leave 96 inventions emanating from the Marquis. But a further reduction might be made, if we strike out the additions made to the list, thus: No. 9 is “ a ship destroying engine,” but No. 10 is only the means whereby to fasten it ; and No. 11, a mode of preventing the operation of the engine, in the hands of an enemy. Now in strictness the whole can only be considered as *one* invention. So likewise, in his improvements on Fire-arms ; No. 61, is a way for Muskets, No. 62, for Harquebusses, and No. 63, for Sakers, &c. which again

can but be taken as representing *one* invention variously applied. These examples would remove four other inventions from the list, thereby reducing the number of inventions, due to the Marquis of Worcester in the Century, to 92. But this rather explains the plan adopted in indicating the several inventions, and in no way detracts from the value of the work.

The Inventions may be thus classified :

- 3 refer to Seals and Watches.
- 2 . . . Games
- 2 . . . Arithmetic and Perspective.
- 6 . . . Automata.
- 23 . . . Ciphers, Correspondence, and Signals.
- 10 . . . Domestic affairs
- 9 . . . Mechanical appliances.
- 32 . . . Naval and Military affairs.
- 13 . . . Hydraulics and the Water Engine.

100

The very incongruous character of these matters is suggestive of their having occurred to the inventive mind of the Marquis at very different times, at remote intervals, and under varied circumstances; they might occasionally have resulted from his reading, his studies, or his experiments. He evidently availed himself of every suggestion that either reading, accident, experience, or travel threw in his way. His domestic life led to light, amusive, and mechanical exercises; while his military operations drew him to consider improvements in ordnance, fire-arms, and military and naval affairs generally.

All we know regarding the origin of the work itself is derived from the author's title page, wherein he states that it was written in 1655, his "former notes" then "being lost." He consequently sets down "at

the instance of a powerful friend," only those inventions he "can call to mind to have *tried and perfected.*" This explicit language admits of no doubtful construction, yet he has been maligned by the envious as recording dreams and fancies. The Century closes with the remarkable declaration of his "meaning to leave to posterity a book, wherein under each of these heads the means to put in execution and visible trial all and every of these inventions, with the shape and form of all things belonging to them, shall be printed by brass-plates." An intention which his premature decease rendered unavailing, yet sarcastic writers have not been wanting to stigmatize the "Century" as though its author had offered it to public approbation as a complete work; making no allowance for the circumstances under which it was produced, as a mere syllabus of the intellectual treasures he possessed, or the sad occurrence to which alone the non-completion of his promised publication with engravings of his several designs can be attributed.

Some of his inventions he specially notices to signify their practical development. Thus No. 56, he performs at the Tower before Charles I, most of his Court, and the Lieutenant, Sir William Balfour.

No. 64, an improvement on fire-arms, was "tried and approved before the King (Charles I.), and an hundred Lords and Commons."

Nos. 59 to 67, further improvements on fire-arms and cannon, occasion his particularly stating that:—"by several trials and much charge I have perfectly tried all these."

No. 77, his scheme for flying, whatever it might have been, whether a balloon, wings, or a machine, yet even of this he says—"which I have tried with a little boy of ten years old."

Lastly, No. 100, a water-work is spoken of as “by many years experience and labour, advantageously contrived.” And connected with this water-raising subject we may take No. 68, of which he says:—“I have seen the water run like a constant fountain-stream forty feet high.” This is not the language of a speculative theorist. It is experimental, practical, and demonstrative.

Considering the vast sums expended by the Marquis on his experimental and on his practical works, the immense variety of his inventions, and the extreme novelty and singularity of many, it is rather surprising that no account of any of them has come down to our time, through some of the many channels of information then open to receive any accounts of the marvellous. Our next surprise is that none of the many cabinets of the curious seem to have possessed any model or any curious work of his production; not even the indefatigable Tradescant, although his museum was at Lambeth, bought by Ashmole, and given by him to the Bodleian Museum at Oxford. The Marquis did, however, present a peculiarly constructed box to Charles the Second, and he offered an improvement on it to the Earl of Lotherdale,* remarking:—“I promise your Lordship a box, with such conveniences and rarities as that which you saw had,—though it were a presumption in me to say, I would give a subject a better qualified present than I gave my Sovereign.” The invention might refer to the Cabinet mentioned in article No. 79, of the Century, as well as include some of his ingenious escutcheons, keys, and locks.

We cannot but suppose that the Marquis was intimately acquainted with the published works of the

* See page 223.

renowned Roger Bacon, born in 1212, and who died at Oxford in 1292, celebrated for his proficiency in mathematics, mechanics, and chemistry. In his "Discovery of miracles of Art," published 1659, there occurs the following passage:—"A man may easily make an instrument, whereby one man may, in despite of all opposition, draw a thousand men to himself, or any other thing, which is tractable."

The Marquis has left in manuscript a list of nine inventions, due to the "Quint-essence of Motion," by means of which, he says in the 8th section,—“I can stop any other man's motion, and render it null, since from any point of the compass, I can forcibly and effectually cause a counter-buff, or absolute obstruction to such motion, which way I please; all ways being indifferent to me, to work a perfect resistance, and to countermine their intentions, or to force their motions a clear contrary way.”*

What may be the meaning of either statement it is difficult to imagine; or even to decide whether they be really allied to each other, for although in some respects alike, each is very enigmatical.

We have also given in the "Life," at page 216, a copy of a MS. list of heads of some inventions, among which occurs:—"Intelligence at a distance communicative, and not limited to distance, nor by it the time prolonged." The wording of which article as clearly as possible expresses what in modern times has actually been attained by the magnetic and the electric telegraph. The "not limited to distance," and the "time not prolonged" appear conclusive. Wires, tubes, or other mechanical means of communication would necessarily be "limited to distance;" and that which alone we believe to be

* Appendix A.

illimitable through any human agency is *electricity*. Truly the Marquis of Worcester was a man of no ordinary stretch of mind.

The "Century" has but slender claims to our notice as a literary performance. Some persons have even imagined that it would have been fortunate for the character of its noble author had it never been written. This is a mistaken view of the subject. In the absence of his elaborated work, it is fortunate that this precious relic has come down unmutilated to our time. It is but as a sketch compared with the finished picture, but we realize the master-hand in the brief outline, and feel conscious of the intelligence and versatile genius of the mind that could conceive, work out, and minutely register the forming of alphabets, automata, ordnance, and finally "a semi-omnipotent engine." His work has two dedications, one addressed to Charles the Second, the other to both Houses of Parliament, composed in a quaint but courtly style. He mingles classic lore with every-day proverbs. He re-entitles his book as a "summary collection," and a "Century of summary heads of wonderful things," as "experiments extant and comprised under these heads practicable with my directions," and is convinced of "The treasures buried under these heads both for War, Peace and Pleasure being inexhaustible;" concluding that it is a "Century of Experiences perhaps dearly purchased" by him.

He also touches on his pecuniary position, offering, in case he is assisted with the patronage and support sought, "to outgo the £6 or £700,000 already sacrificed;" alludes to "the melancholy which hath lately seized" upon him; and to his work-place at "great expenses made fit for public service," amounting to about £10,000, "yet lately like to be taken" from him.

He assures Parliament that his several inventions are

“practicable with my directions, by the unparalleled workman both for trust and skill, *Caspar Kaltoff*’s hand, who hath been these five and thirty years as in a school under me employed.” So that, dating from 1663, when he made this statement, we are thus carried back to the year 1628, about the period of his first marriage, and the whole comprises a space of time from the 27th to the 62nd year of his age. How had he employed the peaceable portion of those 35 years? It seems to have been peculiar to the noble experimenter to keep his favourite workman fully employed in putting into practice whatever was known, and in that way establish his own improvements. We can find some analogous device in old scientific writings for the greater part of the subjects he investigated; and it is no disparagement of his ingenuity to say that his refinements may often be traced to the crude efforts made by others to attain similar results. Italy, Germany, Holland, and France abounded in authors whose works we may easily imagine formed a favourite portion of his library; Vitruvius, Vegetius, Hero, Ramelli, Branca, De Caus, Fludd, Besson, Van Etten, Schwenter, Porta, Lana, and other similar tomes replete with engraved brass, copper, and wood-engravings. But the English press likewise produced such works, as Bourne’s *Inventions*, 1578; Lucar’s *Lucar-solace*, 1590; Bate’s *Mysteries of Art*, 1634; Wilkins’ *Mathematical Magick*; Porta’s *Natural Magick*, 1658; De Caus’ *New and Rare Inventions*, 1659, &c. Of all these we are disposed to think that *Bate’s Mysteries of Nature and Art* was an early favourite; the second edition appeared in 1635, when the Marquis was 34 years of age. The first portion of the work on “Water-works” opens with the observation: “It hath beene an old saying amongst Philosophers, and experience doth prove it to bee true, *Non*

datur vacuum, that is to say, Nature will not admit of any vacuity or emptinesse. For some or other of the Elements, but especially Ayre and Water, doe insert themselves into all manner of concavities, or hollowneses, in, or upon the earth, whether they are such as are formed either by Art or Nature." Through 82 pages the same subject of Water-works is carefully examined, and at page 57, is a description with engravings of "the Watermill or Engine neare the North end of London Bridge."

In the composition of the "Century," we notice several peculiarities which may sometimes be accounted for by the writer having caught the style of certain English authors. In a letter dated 30th of August, 1646, he quotes the proverb, "a *child* burned dreads the fire," and in the "Century" we find the word "*child*" occurring six times to indicate little power or strength being required. The word "*conceited*" is used three times in the sense of ingeniously contrived. All these modes of expression are also peculiar to Bate, Plat, and the translation of Van Etten. The "*twinkling of an eye*" is an expression used twice. The article No. 15, is "A boat *driving* against wind and tide;" in *Humane Industry*, 1661, appears—"a way to *drive* their ships without oar." The term "*admirable*" is common to Bate and to the Marquis; and so is another, that of the word "*force*," peculiarly used in article No. 68, when he speaks of the "vessels" being "strengthened by the *force* within them:" really meaning no more, as appears, than some kind of pump-force or plunger acting the part of a valve to diminish any superabundant steam pressure; and not, as is perplexingly supposed, that he had some contrivance for making the expansive force of the steam within the boiler act of itself to strengthen the vessel!

When we read in article No. 56, the expression, "A most incredible thing if not seen," and find Dr. Dee, in his preface to Euclid, expressing himself on a kindred subject, that it is—"A thing almost incredible," we cannot refuse to believe from internal evidence that the author was from natural inclination well acquainted with that early English translation. The range of such studies as he delighted in, taken from the reign of Elizabeth to the troubled times of Charles the First, or even later, was very restricted; therefore a course of scientific reading would soon be exhausted by an indefatigable inquirer, who would then probably settle down to being satisfied with a small but chosen collection of his favourite authors. It is not only in traits of language that we see a resemblance in such early authors, but equally do we find a certain agreement in their matter. John Bate, for example, mingles the great with the small, the serious with the ludicrous; he has philosophical experiments, a great water-work, amusive toys, pyrotechny, drawing, and medical recipes arranged in four books; and the several editions appear to have enjoyed an amount of popularity which has made any of them very scarce in a perfect form.

A careful perusal of the "Century" will satisfy the reader that its contents relate principally to the practical and useful, notwithstanding that some appear of doubtful value, and some even paradoxical. The variety of cannon and musquetry is singular, the improvements in ships and fortifications quite surprising, and in various mechanical appliances remarkably ingenious. But, after all, what was the special design of its author; what was he principally seeking to establish through this wide course of investigation? It is evident he sought some mechanical power to supersede ordinary wind, water, and animal power. He tried weights and springs, screws and levers, and

finally he filled a piece of a cannon three-quarters full of water, which, after making a fire under it, "burst and made a great crack." The aim and object of all his laborious experiments was now attained, and from the day when he thus burst the cannon, steam power was realized, its application pursued, various kinds of machines constructed, and the strangeness, novelty, and power of the new engine were such that he declared, as in an ecstasy of delight, "I call this *A Semi-omnipotent Engine*, and do intend that a model thereof be buried with me." Nay, more, he bowed down in adoration before his Maker, rendering him most humble thanks for vouchsafing him "an insight in so great a secret of nature."

It is worth remarking, that the very form of the "Century" was rather due to a custom among scientific inventors than to any whim on the part of its author. In the 13th century, Wilars de Honecort had given a statement of fourteen inventions. In like manner Leonardo da Vinci, of ten various schemes for bridges, ditches, fortifications, and others, military and naval. So again Ralph Rabbards in 1574, Edmund Jentill in 1594, and Henry Marshall in 1595, gave notices of their several discoveries in medical waters, fire-works, and mechanical devices. In 1583, appears a MS. note of twenty "sundry sorts of engynes. In 1596, Lord Napier wrote concerning his four "secret inventions," concluding:—"These inventions, besides devices of sailing under water, with divers other devices and stratagems for harming of the enemies, by the grace of God, and work of expert craftsmen, I hope to perform." In James the First's reign was published a tract entitled, "Cornu-Copia: a miscellanæum of luciferous and most fructiferous experiments, observations, and discoveries, inmethodically distributed; to be really demonstrated and communicated in all sincerity." The suggestions,

amounting to seventeen, are chemical, medicinal, agricultural, and mechanical. In 1632, Thomas Grent patented six inventions, not one of which is otherwise described than after this manner:—"First. An instrument very profitable when common windes doe fail, for a more speedy passage of calmed shippes, or other vessels upon the sea or great rivers, which may be called the wind's mate." In 1636, Sir John C. Van Berg patented eight inventions, specified after this manner:—(First) "Diverse mechanicke instruments and frames operating by waights, soe to bee fitted and ordered that the force and strength of them may bee augmented or diminished either in regard of the instruments themselves, or in respecte of the number of workmen to be employed aboute them accordinge as occasion or necessitie shall require; &c." In 1646, Captain Bulmer gave Emanuel College, Cambridge, a certificate of four hydraulic and mechanical inventions. In 1659, an account of Roger Bacon's "admirable artificial instruments" was published, relating to ships, chariots, flying, scaling ladders, diving bell, &c. So that there was no lack of precedents for the form adopted in treating the multifarious subjects recorded in the "Century." But, indeed, had no other existed, he had a sufficient example in the vague patent specifications that his predecessors, and he himself (in 1661), lodged as sufficient and valid instruments to secure a right in the matters therein specified. And in confirmation of this we have only to place in juxta-position the fore-named patent of 1661, and the "Century," to see at once the close resemblance between the two; thus No. 1, is the 78th article, No. 2, the 58th, No. 3, the 19th, and No. 4, the 15th article of the "Century," copied almost verbatim.* We, therefore,

* See Appendix B.

find that the one hundred articles are as explicit as any of the patent specifications of, and prior to, the reign of Charles the Second. Yet men of unquestionable literary taste, but unacquainted with these simple facts, have charged the Marquis of Worcester with mystifying his statements, by writing too enigmatically, without considering his promise, had he lived, "to leave to posterity a book" containing "the means to put in execution all these inventions;" and without the indulgence of awarding him at least the merit of writing his very syllabus with all the amplification required by law for the enrolment of a Patent Specification.

While the Marquis was struggling to obtain royal and state patronage, he had a powerful rival in Sir Samuel Morland, a gentleman of the Privy Chamber and Master of Mechanics, to Charles the Second. It has never been noticed that, simultaneously with the Marquis, he was projecting plans of novel means for draining mines, and it is very improbable that, while so engaged, he could view disinterestedly the various efforts of the Marquis of Worcester. In the "Calendar of State Papers, Domestic Series for 1661-1662, edited by Mrs. M. A. E. Green," octavo, 1861, we find the following particulars under the respective dates, viz:—

"Dec? 1661. No. 36. Petition of [Sir] Samuel Morland to the King, for a patent for the sole use of his invention of an Engine for raising water out of mines or pits, quicker and better than before practised.

"Dec. 11. Whitehall. Warrant for a grant to Sir Sam. Morland of the sole use for 14 years of his invention for raising water out of pits, &c. to a reasonable height, "by the force of powder and air conjointly."

“Dec. Whitehall. Vol. 46. No. 49. Warrant for a grant to Sir Sam. Morland of the sole making of an Engine invented by him for raising water in mines or pits, draining marshes, or supplying buildings with water.”

The annexed reprinted title page is a facsimile for size and letter-press *within* the gothic frame, employed to enlarge it. The smallness of the work was by no means unusual, indeed the first edition, in the British Museum, is bound in a volume uniform with the discourses of Sir William Petty, and of Dr. Grew, before the Royal Society, in 1674, issued by its own printer. Although more than ten years later the quaint style reminds one of the Dedications to the “Century,” as when Sir William says he was commanded to print his discourse—“Because, as drapers cut patterns of their whole cloth out of an end, not because the end is better than the rest, but because it may be best spared; so (I suppose) the Society are content, that this exercise pass for a sample, *pro tanto*, of what they are doing.” And of his second part he observes that it is “To excite the world to the study of a little Mathematics, by showing the use of Duplicate Proportions in some of the most weighty of human affairs, which notion *a child of 12 years** old may learn in an hour.” Lastly, the Epistle Dedicatory informs us that:—“Falsity, disproportion, and inconsistency cannot be rectified by any sermocinations, though made all of figurate and measured periods, pronounced in tune and cadence, through the most advantageous organs; much less by grandiosonous or euphonical nonsense farded with formality; no more

* The Marquis, in the 19th article of the “Century,” twice alludes to “*a child* ;” and patenting his invention, which applied to Coaches, he introduces the expression in the 3rd article of his patent of 1661 :—“*a child* of six years old may secure from danger all in the coach,” and “the *child* being able” to loosen the horses.

than vicious wines can be remedied with brandy and honey, or ill cookery with enormous proportions of spice and sugar: *Nam Res nolunt malè administrari.*" One example from Dr. Grew's epistle to his discourse will suffice, where he says:—"I know, my Lord, that there are some men, who have just so much understanding, as only to teach them how to be ambitious: the flattering of whom, is somewhat like the tickling of children, till they fall a dancing."

The annexed Commentary has for its object to show the several sources from which it is not less probable than possible that the Marquis derived a certain amount of information for his guidance in endeavouring to advance and refine on the same by his own efforts at improvement. Many intelligent persons, particularly classical scholars, and men of purely literary tastes, whose reading has not embraced the study of the literature of science, have supposed that the whole or greater part of the Marquis of Worcester's inventions emanated solely from his own unguided inventive skill; and not a few may have imagined it would be derogatory to the originality of an inventor to suppose him walking in the steps of others, however much he might outstrip their attainments in the same branch of inquiry. But all invention is progressive—first, laws of nature are discovered, then applications are invented, and last follow divisions and sub-divisions of endless great, small, and minute improvements. The Marquis originated many improvements, but assuredly only one pre-eminent invention, his great "fire water-work." It would have been easy for us to make the commentary consist of essays on modern improvements, more or less traceable to the suggestive character of the "Century." But we stop where the Marquis laid down his pen, preferring rather to show that materials

existed from which he might derive the several classes of subjects therein noted, which many have so far doubted as to believe they originated wholly with himself; as by adopting the other course, we should only satisfy the public of the great use the "Century" has been to others, a matter which has never been doubted.

We thus see that the "Century" is but the epitome of a greater work, designed to have been published with suitable explanatory engravings, which the premature decease of the author alone frustrated. During two hundred years the subjects of the various inventions and improvements in calendars have been long superseded, so that there is not one, perhaps, that would in the least assist the modern engineer, however minutely it could be described. Yet the history of the Steam Engine, of Inventions, and of Inventors would be incomplete indeed without a Memoir of the Marquis of Worcester, and some account of his inimitable "Century of Inventions."

Much might be written on the conflicting opinions expressed by historical, biographical, and scientific writers, regarding the intellectual capacity and ingenuity of the Marquis as well as of their adverse statements on various historical points. But instead of adopting such a thoroughly controversial strain, which after all would only lead to a very doubtful result, another and very different course has been adopted in the present work, by supplying facts in place of conjecture. The writer, who is strongly imbued with political, theological, or scientific views, cannot write otherwise than as directed by the natural effect of such influences. But as a rule the arena of scientific discussion is neutral ground; and the biographer and commentator, in the present instance, does not feel swayed by any party prejudice, and certainly not by any peculiar scientific

views. It has been his wish to associate himself as much as possible with the Marquis and with his times, irrespective of modern taste, changed customs, and enlarged knowledge, as contrasted with a period about the middle of the seventeenth century. Here the critic rises in importance with the information he possesses of a bygone age. But it has been so uniformly the misfortune of the Marquis of Worcester to be examined solely through a modern medium, that it is almost surprising his antiquated costume, and style of writing, should have escaped the generally reckless course of censure bestowed on the precious relics that alone remain to attest his amazing genius.

Every work descriptive of the Steam-engine, gives some historical notice, awarding a certain amount of dubious merit to the Marquis of Worcester, among other early inventors, but it would be impossible to point to a single instance savouring of any national pride in the inquiry. It seems incredible, and might be believed to be so, had we not the fact before our eyes, that the true history of the origin of the Steam-engine is only now emerging into light in the form best calculated to place the fact beyond dispute.

Like all other great inventions, the improvements in the Steam-engine have been progressing from 1663 to the present day. Its history presents three eras:—1st, the period when the parent engine and its immediate successors were called “fire engines;”—2nd, from Newcomen’s time, when that stage of improvement was designated the “atmospheric-engine;” and, 3rdly, its last form, the true “steam-engine” of Watt. We cannot destroy one link in this mystic chain without serious hazard, without deranging the natural consanguinity of these children of the brain. But while we consider it unnecessary to deal singly with each work

contributing an apocryphal history to the origin of the steam-engine, a solitary instance occurs, within the last five years, the publication of which demands special notice.

Nowhere should we less expect to find a want of sympathy with the amiable character and astonishing scientific abilities of the Marquis of Worcester than in the pages recording the life of James Watt; for there we might hope to be supplied, as from a fountain-head, with the pure stream of most authentic information; an elaborate, careful, and comprehensive digest of the best materials that learning and influence could accumulate; at once clearing up many doubts, and for ever dissipating the groundless surmises of a multitude of superficial writers. We should never expect a less careful procedure, or in its absence other than the most respectful allusion to the true inventor of the steam-engine—that engine from which Watt's is lineally descended.

Had the Marquis of Worcester and his "Century," together with his Engine, been unknown, and consequently also his untiring representation and advocacy of its wonderful properties, where would have been the justly-admired models of Savery, Newcomen, and Watt? The inveterate prejudice against the employment of any new engine with which the Marquis had to contend, was not wholly extinct even in the days of Watt's early career; and it was the all-powerful influence of large capital alone that secured for him what Charles the Second blindly withheld from the great engineer's noble predecessor.

We are far from advocating any undue devotion either to a theory or to a hero. But, certainly, if the rhetorical flourishes of M. Arago can justly be summoned to eulogize the hot-water fountain of De Caus, in pre-

ference to producing his own clear, simple description; then, assuredly, in common fairness Mr. Muirhead should have felt bound to a somewhat similar advocacy of the Marquis of Worcester's invention. If M. Arago's example is to be quoted, showing how much could be advanced in favour of De Caus's little metal sphere, then surely Mr. Muirhead should have exerted himself to represent and distinguish the superior properties of the Marquis's Water-commanding Engine, raising four vessels of water, forty feet high, through a tube a span wide.*

But Mr. Muirhead hazards no opinion decidedly favourable to either the Marquis or his inventions; while, on the contrary, his observations suggest unfounded difficulties, and raise unnecessary doubts, contributing to increase the existing confusion found in our current literature, in relation to the great inventor and his projects; an instance is even adduced of the pseudonymous writer, Robert Stuart, who, in his "Anecdotes," and his "History," flatly contradicts himself; and frequently what one compiler only conjectures, another takes up as a fact. But this vicious system of writing is not to be corrected by following in the same track and proposing new speculative views, offered too in a strain seriously derogating from the Marquis's character for honour, integrity, consistency, and consummate ingenuity.

In quoting the "Century" Mr. Muirhead notices that it concludes with the promise of a more finished work, which only elicits the sinister remark: "that he either was unable, or never seriously intended to make such a further publication." This is indeed unjust, and severe enough. And what he quotes from the "Century" about the *Engine*, is only to tell what "posterity

* See page 302.

supposes" about it; and to note that, in respect to it, "there has always prevailed a great diversity of opinion." But here is no attempt made to trace and analyse that "diversity of opinion," or to dissipate the cloud. The Marquis's captivity in the Tower is misstated; and the luckless "pot-lid" story enlarged and improved upon, for it is concluded that hence—"so runs the story—arose the 'Century of Inventions,' with its steam-engine all ready—made and acting;—at least in the mind of its contriver!" This undignified view of the case of the imprisoned, ruined, neglected inventor of the steam-engine, never deserved to be enrolled in the volume devoted to the life of his glorious but remote successor.*

* We meet with the following singular passages recorded by his biographer, as introductory to the Inventions of James Watt, in the second edition of his Life, 1859. At page 145, it is remarked :—

"When we consider the whole of the contrivances invented by Savery, as described by himself in 'The Miner's Friend,' we cannot but accord to him the praise of very great ingenuity, independent of the merit of having made THE FIRST WORKING STEAM ENGINE, (if he was not preceded in that by the Marquis of Worcester); but, at all events, of having been the first who introduced it into use."

We give this passage as printed, and proceed to the next, at page 156, which is not recorded either in the Contents or Index, only distinguishing certain words :—

"We think it right to add that the language used by Savery in his 'Miner's Friend,' in treating of the advantages, whether ascertained or prospective, of his invention, presents a strong contrast, in point of plainness, simplicity, and modesty, to the more high-flown phrases in which the Marquis of Worcester *magnifies* the performances of his 'semi-omnipotent' engine. Savery was evidently a practical man, possessed of great [1] common sense as well as of [2] ingenuity; and although it would *probably* be wrong to deny to Lord Worcester the possession of a good deal of the *second* of those qualities, it may *well be doubted* how far he is entitled to the claim of any very considerable share of the *first*" [common sense]!

We believe that the author of this strange composition is a Scotch Advocate of some standing; now it is far from being the character of the legal profession, as a body, to commit to paper such reckless reproach of even the dead; but assuredly it does not require the caution induced by a knowledge of common law to point out the propriety of treating with respect the memory of a man of high birth and untainted reputation, such as was the Marquis of Worcester. But this is not all, we are introduced to a "FIRST ENGINE," at the risk of a second "first," as declared by the same pen! And without fear of contradiction we say the last should be first, and the first last in this category.

Although, however, we have been presented with a view of De Caus as elevated through the medium of Arago's eloquent Eloge, when endeavouring with true national zeal to claim the honour of the invention of the steam-engine (even on this slender proof) for his own country; this position seems only to have been assigned to him in the present instance, to make his downfall the more signally complete; for Mr. Muirhead most dispassionately observes:—"Considering the uselessness of the contrivance of De Caus, and the doubtfulness existing as to that of the Marquis, it is, perhaps, rather surprising that 'the invention of the steam-engine' should have been attributed to either of them, with such great confidence as both English and French writers have alternately shown." Unfortunately for this anti-thesis, the one invention is not "worthless," and the other is not properly to be charged with "doubtfulness." It may be justly said, in one sense, that all the engines preceding those made in Watt's time are "worthless,"—but we have here a wide range. In 1615 De Caus's invention was not "*worthless*," although its worth was limited to its demonstrating one simple mode of applying an important elementary principle. And the vast amount of accumulated evidence relating to the Marquis of Worcester's Engine indisputably removes all "*doubtfulness*" as to its actual accomplishment and general construction, so far as words, irrespective of absolute models and drawings, can supply information; and the absence of these latter accessories is traceable solely to the lapse of time, combined with the indifference of the public to designs that went beyond general information on such matters, as well as from their exceeding the common manufacturing skill, and not captivating the small commercial enterprize of that age.

We must estimate the Marquis of Worcester by his general character. His natural taste and domestic habits led him into mechanical studies, while his large fortune enabled him to retain a paid mechanic in his service for nearly forty years, expending many thousands of pounds in experimental and practical trials of engines, machines, automata, naval and military works, and great guns and fire-arms. In his private life he was strictly honourable, virtuous, consistent, and free from all narrow or bigoted views, either in politics or religion. So adverse, however, did the course of events prove to him, that his loyalty and his religion combined, can alone be named against him as his greatest misfortune. His "Century" has been preserved to these times, but all his other works which might have thrown a fuller light on his inventions have perished. Whether books and papers belonging to him were procured and burnt, according to the story relating to such an incident, is now past discovery; but it is abundantly evident that the great scarcity of information which exists, has led to the propagation of many unfounded statements, and given undue weight to others purely conjectural. That which cannot be established by producing positive evidence, is too often only complicated by hazarding opinions irrespective of reasonable evidence, or worse, in the face of reasonable grounds for contrary statements. The "Century" stands alone in the languages of the civilized world, the strange monument of a strong mind, seeking its full development in a prejudiced age, striking into new paths which society could not comprehend, and which it therefore would not patronise.

H. D.

EDITIONS OF THE CENTURY.

1663. London: Printed by J. Grismond in the year 1663. small 12mo.
1746. London: Printed in the year 1663. Reprinted and sold by T. Payne, in Round-Court in the Strand, 1746.
1748. No particulars. A copy was sold, according to Lowndes's Bib. Man. with MS. additions.
1763. No particulars. Query—1663.
1767. Glasgow: Printed by R. and A. Foulis, 1767.
1778. Dated "Kyo, near Lanchester [co. Durham], June 18, 1778," with an "Appendix containing an Historical account of the Fire-Engine for raising water."
1778. A reprint agreeing with above, except in having *no name or date*. It repeats the Title of the first edition, 1663, and at the end gives the foregoing "Appendix: containing an Historical Account of the Fire-Engine for raising water." 8vo. In the latter, Dr. Desagulier's Lectures, 1744, are quoted, so that this may possibly be an edition short only of a leaf, bearing the same place and date as the preceding.
1786. Glasgow, Printed. London: Reprinted by W. Bailey, Proprietor of the Speaking Figure, now shewing, by Permission of the Right Hon. the Lord Mayor, at No. 40, within Bishopgate, 1786. Sq. 16mo.
1813. Newcastle; Printed by S. Hodgson, Union Street, 1813. 8vo. pp. 53. Title page:—"The Marquis of Worcester's Century of Inventions, to which is added, An Appendix containing an historical account of the Fire-Engine, for raising Water; which invention originated from the above work. By John Buddle." [The Preface is dated "Kyo, near Lanchester, June 18, 1778,"—in the North West of Durham. See edition 1778. A copy of this reprint is in the Library of the Patent Office.]
1813. The Title page is a reprint of 1663, and on the back appears "Reprinted by J. Adlard, 27, Bartholomew Close, 1813." [London.] Sq. 16mo.

1813. [It would appear from a MS. note by Mr. P. Bliss, in an interleaved edition of "Walpole's Royal and Noble Authors," Brit. Mus. that this year there was another edition of "The Century, &c." viz.]—

London, sold by R. Triphook, 37, St. James's Street; J. Major, West Smithfield; and R. Priestley, 143, High Holborn.

[12mo. price 4s. sewed; 100 copies printed, 1813.]

1825. The Century of Inventions of the Marquis of Worcester. From the Original MS. &c. By Charles F. Partington. London: John Murray, Albemarle Street, 1825. 12mo.

REPRINTED IN THE FOLLOWING WORKS: VIZ.—

1789. The Gentleman's Magazine, Vol. 18. 8vo.

1801. The Philosophical Magazine. By Alexander Tilloch. Vol. 12. 8vo. pp. 43 to 57.

1802. The Repertory of Arts, Manufactures, and Agriculture. Vol. 1. Second Series. 8vo.

1809. The Harleian Miscellany: a collection of scarce Pamphlets and Tracts, &c. By Oldys and Park. Vol. 4. 4to.

1815. A Treatise of Mechanics. By Olinthus Gregory, L.L.D. &c. 3rd edition. Vol. 2. 8vo.

1822. The Mechanic; or, compendium of Practical Inventions. By James Smith. 2 vols. 8vo. p. 403.

1824. The Kaleidoscope. Liverpool. Vol. 5. 4to. No. 212 to No. 219.

1825. The Mechanics' Magazine [London.] Vol. 3. 8vo. p. 18.

1827. One thousand Notable Things. London, T. Tegg; and Glasgow, Griffin and Co. [Appended to this reprint of the original work, 12mo. by "Thomas Lupton," B.L. 1586. 4to.]

1833. Mechanics' Magazine. New York. Vol. 1. 8vo. pp. 82 to 92.

1856. Weale's Quarterly Papers on Engineering. Vol. 5. 4to.

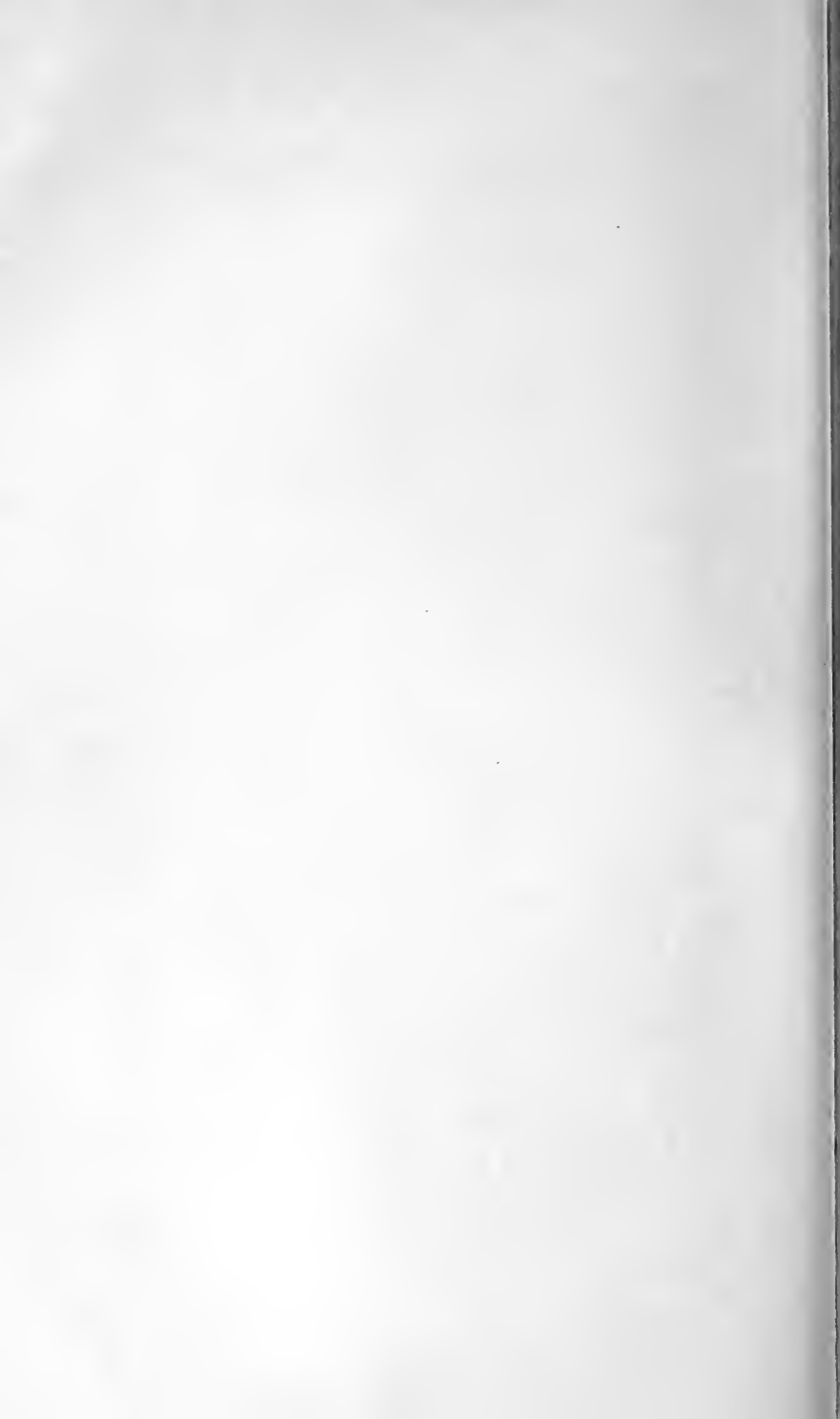

A
CENTURY
OF THE
Names and Scantlings
OF SUCH
INVENTIONS,

As at present I can call to mind to have tried and perfected, which (my former Notes being lost) I have, at the instance of a powerful Friend, endeavoured now in the Year 1655, to set these down in such a way as may sufficiently instruct me to put any of them in practice.

Artis & Naturæ proles.

LONDON :

Printed by *J. Grismond* in the year 1663.



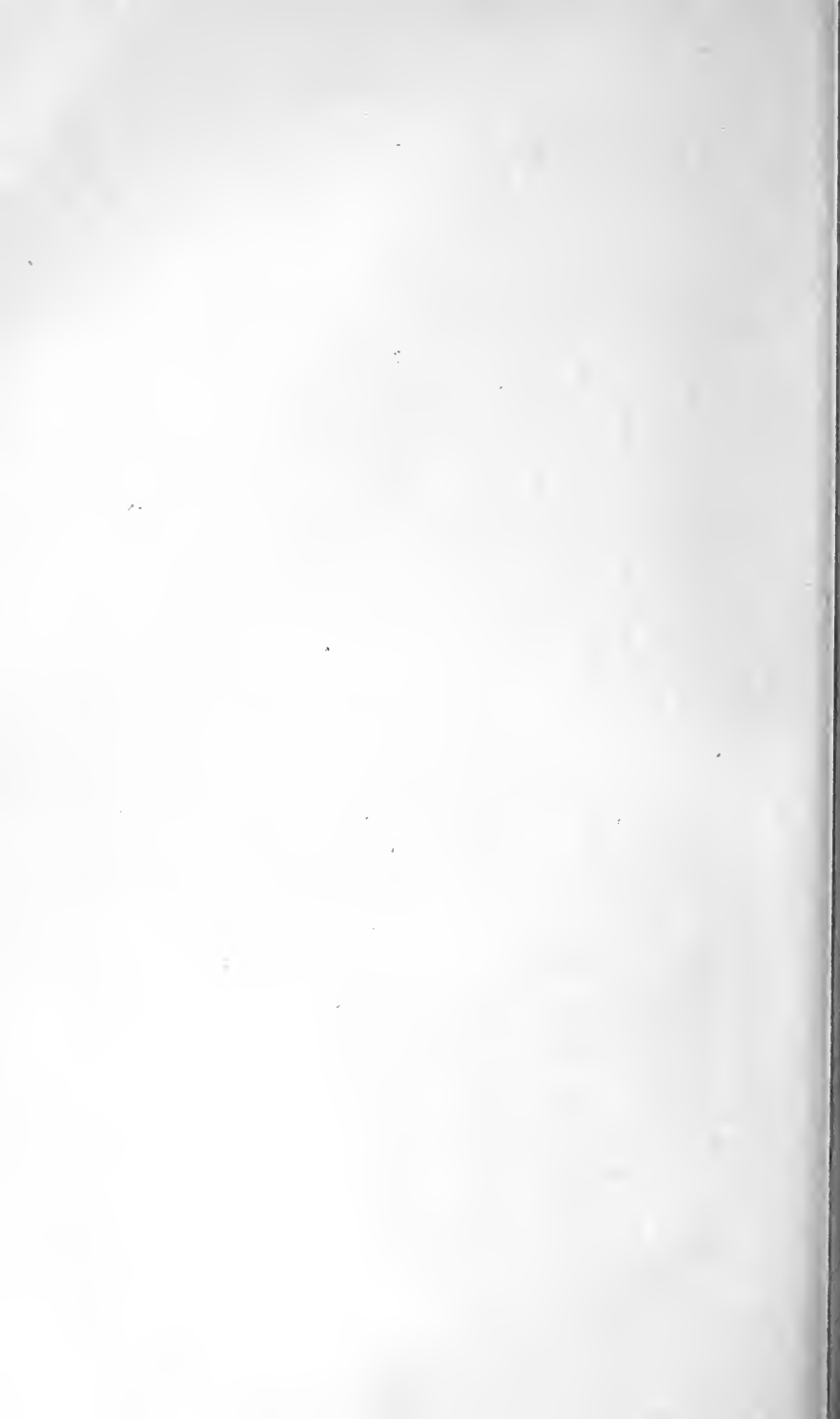

TO THE
KINGS

Most Excellent MAJESTY.

SIR,

SCIRE meum nihil est, nisi me scire hoc sciat alter, saith the Poet, and I most justly in order to Your Majesty, whose satisfaction is my happiness, and whom to serve is my onely aime, placing therein my Summum bonum in this world: Be therefore pleased to cast Your gracious Eye over this Summary Collection, and then to pick and choose. I confess, I made it but for the superficial satisfaction of a friends curiosity, according as it is set downe; and if it might now serve to give aime to Your Majesty how to make use of my poor Endeavours, it would crowne my thoughts, who am neither covetous nor ambitious, but of deserving Your Majesties favour upon my own cost and charges; yet, according to the old English Proverb, It is a poor Dog not worth whistleing after. Let but Your Majesty approve, and I will effectually perform to the height of my Undertaking: Vouchsafe but to command, and with my Life and Fortune I shall chearfully obey, and maugre envy, ignorance and malice, ever appear

YOUR MAJESTY'S

Passionately-devoted, or

otherwise dis-interested

Subject and Servant,

WORCESTER.



To the Right Honourable

THE LORDS SPIRITUAL AND TEMPORAL ;

*And to the KNIGHTS, CITIZENS, AND BURGESSES of the Honourable
House of Commons ; NOW assembled in Parliament.*

My Lords and Gentlemen,

BE not startled if I address to all, and every of you, this Century of Summary Heads of wonderful things, even after the Dedication of them to His most Excellent Majesty, since it is with His most gracious and particular consent, as well as indeed no wayes derogating from my duty to His Sacred Self, but rather in further order unto it, since your Lordships, who are His great Council, and you Gentlemen His whole Kingdoms Representatives (most worthily welcome unto Him) may fitly receive into your wise and serious considerations what doth or may publickly concern both His Majesty and His tenderly-beloved People.

Pardon me if I say (my Lords and Gentlemen) that it is joyntly your parts to digest to His hand these ensuing particulars, fitting them to His palate, and ordering how to reduce them into practice in a way useful and beneficial both to His Majesty and His Kingdom.

Neither do I esteem it less proper for me to present them to you in order to His Majesty's service, then it is to give into the hands of a faithful and provident Steward whatsoever dainties and provisions are intended for the Masters diet; the knowing and faithful Steward being best able to make use thereof to his Masters contentment and

greatest profit, keeping for the morrow whatever should be overplus or needless for the present day, or at least to save something else in lieu thereof. In a word, (my Lords and Gentlemen) I humbly conceive this *Simile* not improper, since you are His Majesty's provident Stewards, into whose hands I commit my self, with all properties fit to obey you; that is to say, with a heart harbouring no ambition, but an endless aim to serve my King and Countrey: And if my endeavours prove effectual, (as I am confident they will) His Majesty shall not onely become rich, but His People likewise, as Treasurers unto Him; and His Pierless Majesty, our King, shall become both belov'd at home, and fear'd abroad; deeming the riches of a King to consist in the plenty enjoyed by His People.

And the way to render him to be feared abroad, is to content his People at home, who then with heart and hand are ready to assist him; and whatsoever God blesseth me with to contribute towards the increase of His Revenues in any considerable way, I desire it may be employed to the use of His People; that is, for the taking off such Taxes or Burthens from them as they chiefly groane under, and by a Temporary necessity onely imposed on them; which being thus supplied will certainly best content the King, and satisfie His People; which, I dare say, is the continual Tend of all your indefatigable pains, and the perfect demonstrations of your Zele to His Majesty, and an evidence that the Kingdoms Trust is justly and deservedly reposed in you. And if ever Parliament acquitted themselves thereof, it is this of yours, composed of most deserving and qualified Persons; qualified, I say, with your affection to your Prince, and with a tenderness to His People; with a bountiful heart towards Him, yet a frugality in their behalfs.

Go on therefore chearfully (my Lords and Gentlemen) and not onely our gracious King, but the King of Kings, will reward you, the Prayers of the People will attend you, and His Majesty will with thankful arms embrace you. And be pleased to make use of me and my endeavours to enrich them, not my self; such being my onely request unto you, spare me not in what your Wisdoms shall find me useful, who do esteem my self not onely by the Act of the Water-commanding Engine (which so chearfully you have past) sufficiently rewarded, but likewise with courage enabled to do ten times more for the future; and my Debts being paid, and a competency to live according to my Birth and Quality settled, the rest shall I dedicate to the service of our King and Countrey by your disposals: and esteem me not the more, or rather any more, by what is past, but what 's to come; professing really from my heart, that my Intentions are to out-go the six or seven hundred thousand pounds already sacrificed, if countenanced and encouraged by you, ingenuously confessing that the melancholy which hath lately seized upon me (the cause whereof none of you but may easily guess) hath, I dare say, retarded more advantages to the public service than modesty will permit me to utter: And now revived by your promising favours, I shall infallibly be enabled thereunto in the Experiments extant, and comprised under these heads practicable with my directions by the unparallel'd Workman both for trust and skill, *Caspar Kaltoff's* hand, who hath been these five-and-thirty years as in a school under me employed, and still at my disposal, in a place by my great expences made fit for publick service, yet lately like to be taken from me, and consequently from the service of King and Kingdom, without the least regard of above ten thousand pounds expended by me,

and through my Zele to the Common good; my Zele, I say, a field large enough for you (my Lords and Gentlemen) to work upon.

The Treasures buried under these heads, both for War, Peace, and Pleasure, being inexhaustible; I beseech you pardon me if I say so; it seems a Vanity, but comprehends a Truth; since no good Spring but becomes the more plentiful by how much more it is drawn, and the Spinner to weave his web is never stinted but further inforc'd. The more then that you shall be pleased to make use of my Inventions, the more Inventive shall you ever find me, one Invention begetting still another, and more and more improving my ability to serve my King and you; and as to my heartiness therein there needs no addition, nor to my readiness a spur. And therefore (my Lords and Gentlemen) be pleased to begin, and desist not from commanding me till I flag in my obedience and endeavours to serve my King and Country.

*For certainly you'l find me breathless, first t' expire,
Before my hands grow weary, or my legs do tire.*

Yet abstracting from any Interest of my own, but as a Fellow-Subject and Compatriot will I ever labour in the Vineyard, most heartily and readily obeying the least summons from you, by putting faithfully in execution, what your Judgments shall think fit to pitch upon amongst this Century of Experiences, perhaps dearly purchased by me, but now frankly and *gratis* offered to you. Since my heart (methinks) cannot be satisfied in serving my King and Country, if it should cost them any thing; As I confess when I had the honour to be neare so obliging a Master as His late Majesty of happy memory, who never refused me his Ear to any reasonable motion: And as for unreasonable ones, or such as were not fitting for him to grant, I would rather to

have dyed a thousand deaths, then ever to have made any one unto him.

Yet whatever I was so happy as to obtain for any deserving Person, my Pains, Breath and Interest imployed therein satisfied me not, unless I likewise satisfied the Fees ; but that was in my Golden Age.

And even now, though my ability and means are shortened, the world knows why my heart remains still the same ; and be you pleased (my Lords and Gentlemen) to rest most assured, that the very complacency that I shall take in the executing your Commands shall be unto me a sufficient and an abundantly-satisfactory reward.

Vouchsafe therefore to dispose freely of me, and whatever lieth in my power to perform ; first, in order to His Majesty's service ; secondly, for the good and advantage of the Kingdom ; thirdly, to all your satisfactions, for particular profit and pleasure to your individual selves, professing that in all and each of the three respects I will ever demean my self as it best becomes,

My Lords and Gentlemen,

*Your most passionately-bent Fellow-Subject in
His Majesty's service, Compatriot for the
publick good and advantage, and a most
humble Servant to all and every of you,*

WORCESTER.

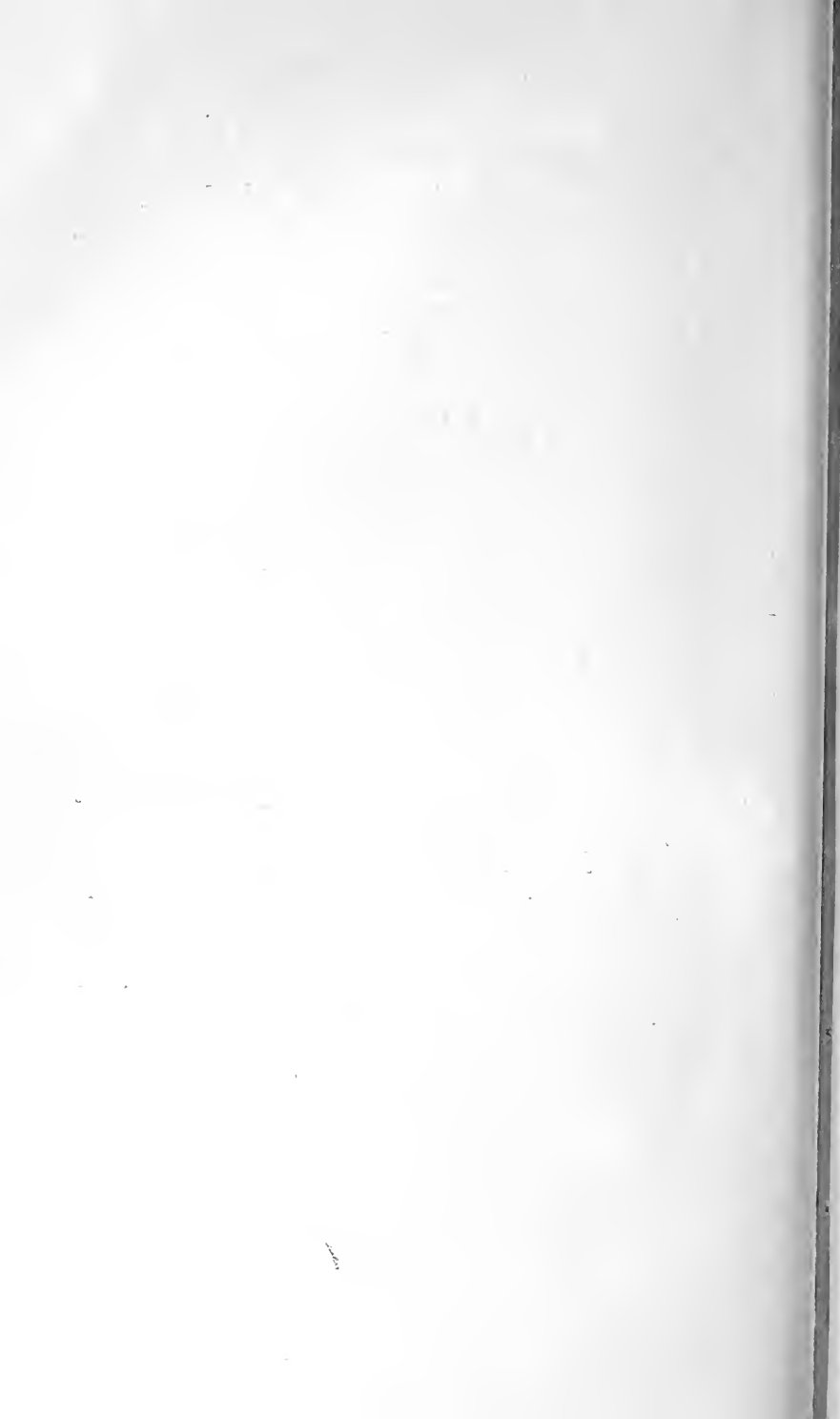

A CENTURY

OF THE

Names and Scantlings of

*Inventions by me already
practised.*

[* * * The numerals refer to variations in the reading, afforded by the *Harleian MS.*; except when marked P, to distinguish the unauthorised and other alterations made by Mr. Partington, in his edition of 1825.]

I.

Several sorts of Seals, some shewing by scrues, others by gages, fastening or unfastening all the marks at once; others by additional points and imaginary places, proportionable to ordinary¹ Escocheons^{2 3} and Seals at Arms, each way palpably and punctually setting down (yet private from all others, but the Owner, and by his assent) the day of the Moneth, the day of the Week, the Moneth of the Year, the Year of our Lord, the names of the Wit-

¹ *Escoccheon* is the old heraldic term. ² *Escuchcons.* MS. ³ *Escutcheons.* P.

nesses, and the individual place where anything was sealed, though in ten thousand several places, together with the very number of lines contained in a Contract, whereby falsification may be discovered, and manifestly proved, being upon good grounds suspected.

Upon any of these Seals a man may keep Accompts of Receipts and disbursements from one Farthing to an hundred millions, punctually shewing each pound, shilling, penny or farthing.

By these seals likewise any Letter, though written but in English, may be read and understood in eight several languages, and in English it self to clean contrary and different sense, unknown to any but the Correspondent, and not to be read or⁴ understood by him neither, if opened before it arrive unto him; so that neither Threats, nor hopes of Reward, can make him reveal the secret, the Letter having been intercepted, and first opened by the Enemy.

⁴ nor to be.

[*Seals abundantly-significant.*] Under this title the present article is referred to in the "Index," given by the Marquis, at the end of the first edition of his "Century," while the articles themselves are only distinguished by consecutive numerals. Therefore, without deranging the original form of the "Century," the designation of the several articles will appear throughout, as above, at the head of each comment.

The author, never having met with any attempt to elucidate the mechanical arrangement here suggested, communicated a plan that occurred to him in 1829, soon after reading the foregoing, which was as follows:—

A Cipher Seal. Amidst the variety of inventions for giving security to property, few improvements have been made in seals or signets. I shall proceed to describe a cipher seal, which, though not, perhaps, so "abundantly significant" as those described by the Marquis of Worcester, might, nevertheless, be applied to very important uses, inasmuch as the face of the seal may be varied at pleasure.

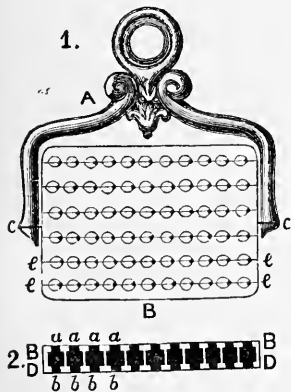

Fig. 1. A, the seal handle; B, the seal made moveable on the pivots at *c c*.

Fig. 2. Is a section of the seal. It consists of two metal plates, B B, and D D, having a number of corresponding holes drilled through them, as at *a a a a*, and *b b b b*, into which the ends of small rollers, *a b, a b*, are made to fit and turn exactly. When

all the holes are supplied with rollers, the plates, B B, D D, are retained at a proper distance by a metal rim, soldered to the edges of the plates. The ends of the rollers being thus exposed, and ground level with the

surface of each plate, are to have a groove cut in each, similar to a screw head; this is to be effected by cutting lines from end to end of the plate, as shown at *ee, ee*, Fig. 1. With a graver a small dot is next to be made, all to the right on one plate, and all to the left on the other; or, *vice versa*, of each line occupying the small circular end of *each* roller. It is now evident that, by using a small chisel-shaped steel instrument, or key, with which to turn the roller, the small dotted line on its end, may be so varied as to form any alphabetical arrangement.

The position of the dotted line admits of sufficient variety to take in 24 letters, distinct enough to the eye, without increasing the size of the seal. In this alphabet only three variations are supposed to be made from the horizontal and perpendicular, one very slight on either side, the other greater, and the third at an angle of 45°. It only requires a transposition of the letters to produce a correspondence which shall be private between two persons. The use of two faces to the seal is obvious, one serving to compose on, and *the other*, being a reverse, to make an impression on the wax. Were this not the case, a sentence would have to be written from right to left. Its use might be multiplied by making each cipher refer to an entire word or sentence; as, if *a*, stood for men; *b*, for horses; *c*, food; *d*, money; and so forth: a mode which it would be next to impossible for any third party to decipher.—See Mechanics' Mag. vol. x.

2.

How ten thousand Persons may use these seals to all and every of the purposes aforefaid, and yet keep

their secrets⁵ from any but whom they please.

⁵ secrets private.

[*Seals private and particular to each owner.*] The present is one of those articles of a nature already noticed in the introduction, which can scarcely be classed as an independent invention; it is in fact little, if any, more than some intricate application of the foregoing, a mere step beyond the more obvious employment of such seals. We may consider the first as the instrument, and No. 2 as an ingenious table, by the aid of which to construct alphabets, words, or sentences.

3.

A Cypher and Character so contrived, that one line, without returns and⁶ circumflexes, stands for each and every of the 24. Letters; and as ready to be made for the one letter as the other.

⁶ or—for and.

[*An one-line Cypher.*] A line to be continuous, and yet capable of signifying a series of letters, must be curved. A method of performing this occurred to the author some years ago, which affords a very simple key, being composed from the Circle and the Ellipsis, and can be, therefore, very readily kept in mind. The first affords only one figure, the second can be varied to one vertical and two inclined figures, and all can be again varied as to size, but for convenience only three gradations are recommended, as four or more would increase the difficulty of writing accurately.

These varieties are shown in the annexed diagram—

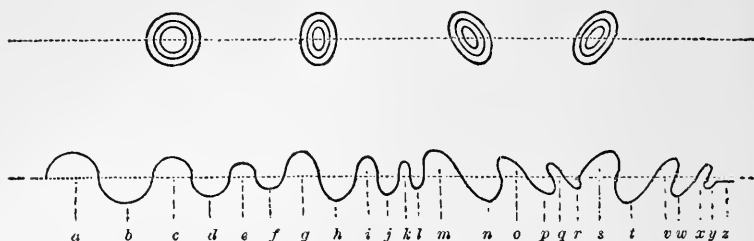

where each is described three-fold, with a horizontal line through the centre. Each figure thus affords three varieties of size above, and three below the line, making six figures each, or twenty-four in all, as curvilinear signs for letters. These taken in rotation, may be extended as above, or in any arbitrary order, and each employed, as in short-hand, to signify letters, syllables, or words. In practice it is only requisite to bear in mind the three gradations of size, so as never to mistake the middle semicircle for the outer ones. This is to be avoided by invariably making the small figure as small as possible, and the greater figure as large as space will permit.

4.

This invention refined, and so abbreviated that a point onely sheweth distinctly and significantly any of the 24. letters; and these very points to be made with two pens, so that no time will be lost, but as one finger riseth the other may make the following letter, never clogging the memory with several

figures for words, and combination⁷ of letters; which with ease, and void of confusion, are thus speedily and punctually, letter for letter, set down by naked and not multiplied points. And nothing can be less than a point, the Mathematical definition of⁸ being *Cujus pars nulla*. And of a motion⁹ no swifter imaginable than¹ *Semiquavers* or *Relesbes*, yet applicable to this manner of writing.

⁷ combinations. P.

⁸ of it. MS. and P.

⁹ motion, equally as swift as *semiquavers*. P.

¹ than what expresseth even.

[*Reduced to a Point.*] A man of the Marquis of Worcester's ingenious cast of mind could readily have made up the entire "Century" out of these systems of alphabets and secret writing. He may have been acquainted with "*Traicté des Chiffres, ou Secretes Manieres d'escrire, par Blaise de Vigenere, Bourbonnois.*" 4to. Paris, 1586—now very scarce; but indeed there were many learned works on the subject, among which Trithemius's "*Libri Polygraphia VI,*" 1600, was conspicuous. The long disuse of such methods of secretly conveying information, has reduced the cleverest of these systems of Cryptographia in public estimation. But, at the same time, these inventions were quite consistent with the early times in which the Marquis flourished. We shall see, in the next article, what probably illustrates this proposed use of a mere point or dot.

5.

A way by a Circular motion, either along a Rule or Ring-wise, to vary any Alphabet, even this of Points, so that the self-same Point individually placed, without the least additional mark or variation of place, shall stand for all the 24. letters, and not for the same letter twice in ten sheets writing; yet as easily and certainly read and known, as if it stood but for one and the self-same letter constantly signified.

[*Varied significantly to all the 24. letters.*] This and the former article may certainly be taken in connection with each other; and the cipher engraved in No. 3, would seem to anticipate the present proposal of "a circular motion along a rule." The "ring-wise" method may have been no more than a substitution for the octagon or any other figure. We fortunately find among the Harleian MSS. in the British Museum, No. 2428, a probable clue to this particular method of writing, which we shall give entire. It forms the first portion of the small oblong folio volume containing the Manuscript Century at the end, with many intervening blank pages between them. It is as follows:—

"An explanation of the most exact and most compendious way of short writing. And an example given by way of Questions, and Resolves upon each significant point, proving how, and why, it stands for such and such a letter, in order Alphabetically placed in every page.

- “ A. Q. How is a point made to signifie an A. Resol. By being placed between the constant center of the square and the right side thereof in a streight line not touching it. [See diagram at the end].

It is proved by drawing a line from the said center towards, and not to touch the right side line, and then you will finde the line placed under an A of the Alphabett in each page.

- “ B. Q. How is a point made to signifie a B. Res. By being placed between the center of the square, towards the right corner upper angle of the Octagon, or square devided in to eight Angles, not touching the line thereof.

It is proved by drawing an oblique line from the center, towards the right corner upper angle, yett not touching the line thereof, and then you will finde it to bee the line placed under a B, in the Alphabett of each page.

In like manner lett there be a Question, and a Prooffe made of all the other Letters in order and you will finde—

- “ C. The C. to bee placed in a streight line from the center upwards, but not arriving to the upper side line of the square.
- “ D. The D. in an oblique line towards the left upper corner line but not touching it.
- “ E. The E. in a streight line between the center of the left side line, butt not touching it.
- “ F. The F. in an oblique line downwards, towards the left angle line, butt not touching it.
- “ G. The G. in a streight line downwards from the center, likewise towards the lower line of the square not touching it.

- “ H. The H. in an oblique line downwards towards the right angle line, butt not touching it.
- “ I. The I. in a streight line from the center to the midle of the right side line.
- “ K. The K. in an oblique line from the center to the right upper angle touching it.
- “ L. The L. in a streight line from the center upwards, and touching the upper line.
- “ M. The M. in an oblique line from the center towards the left upper corner line touching it.
- “ N. The N. in a streight line from the center to the midle of the left side line.
- “ O. The O. in an oblique line from the center downwards, towards the left corner touching the line thereof.
- “ P. The P. in a right line from the center downwards touching the lower side line.
- “ Q. The Q. in an oblique line downwards towards the right corner touching the line thereof.
- “ R. The R. in a streight line from the center to the outside, and furthest line of the right midle and opposite chequer touching it.
- “ S. The S. in an oblique line from the center, and passing the right upper corner line.
- “ T. The T. in a streight line from the center and passing the upper-side line of the square.
- “ V. The V. in an oblique line from the center upwards passing the left upper corner line.
- “ W. The W. in a streight line from the centre to the left outside and furthest line of the left midle and opposite chequer.
- “ X. The X. in an oblique line downwards passing the left lower corner line.
- “ Y. The Y. in a streight line downwards passing the lower side or bottome line.

“Z. The Z. in an oblique line downwards passing the right corner line of the square.

“The Chequers are five in number, which of either outside show the vowels, and each Chequer haveing two corners inwards of each side make tenn, those towards the preceding square may conteyne of the 24 letters, and the opposite corners as many Alphabetically, and the centers of the two upper Chequers square, and of the two lower shew the other 4 letters; The 20 in the Chequers are noted by a separation of a corner in the printed Alphabett, and the 4 by the midde points.

“It is for curiosity and secrecy to bee deservedly observed that whether in squares or chequers single points only stand for letters, and they being varied att pleasure, it is in any ones power to keepe his secrett from me or any other not made acquainted with the denominations by him given to the severall points, and accordingly by him marked in the 24 blank squares, and rowes of chequers placed under the Alphabett in his private explanation easily to be framed by him mutatis mutandis, only that is making the questions and resolves according to his points as they represent the letters to his owne fancy kept private from others without his consent.

“The points are to bee written, and reade as they precede, or as they are the one above the other, unlesse they have a sequell distinction made by takeing the penn of the paper thus ^v without further losse of tyme, and such as are soe marked, must be written and read as the others they being soe made, but for husbanding of paper, the word being soe conteyned in lesse roome, the e at the end of most words prolonging butt the sillable, and all needlesse and unsounding letters are to

bee omitted; I will not trouble you with more rules leaving the rest to practice."

The preceding description is written on small oblong pages, which measure $11\frac{1}{4}$ by $7\frac{1}{4}$ inches, the whole surface of the unwritten portions being covered with an engraved pattern, of which Fig. 1 is but a portion of

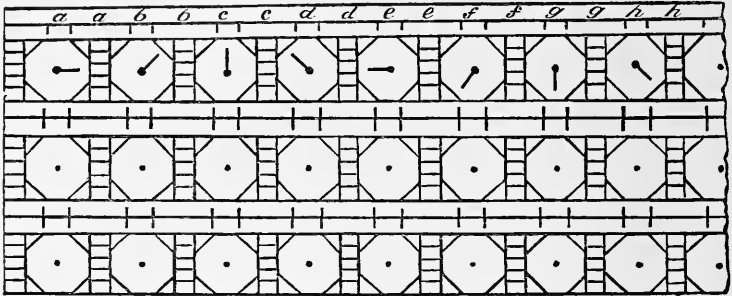

the top left-hand corner, and therefore proceeds no further than letter *h*, which ends the application of that particular figure.



Fig. 2. Gives the next form for 8 other similar situations, commencing at *i*. And—



Fig. 3. Is again 8 more, commencing at *r*; making in all 24 characters or letters.

We thus see how, whether by a dot, or a short line of three gradations in length, an entire alphabet may be obtained.

On page 180 of "The Life of the Marquis of Worcester," is the facsimile of a letter written by his Lordship about 1646-7, apparently adopting this very cipher. It occurs in a volume, entitled "Carte Papers, 1634-57. Ireland, No. 63," in the Bodleian Library.

It is worth remarking here, that the foregoing description, with its accompanying brass-plate engravings, looks exceedingly like an instalment of his promise, conveyed to us in the concluding lines of the 100th Article.

6.

How at a Window, far as Eye can discover² black from white, a man may hold discourse with his Correspondent, without noise made or notice³ taken; being, according to occasion given and means afforded, *Ex re natâ*, and no need of Provision before-hand; though much better if foreseen, and means prepared for it, and a premeditated course taken by mutual consent of parties.

² discern.³ noise—for, notice. P.

7.

A way to do it by night as well as by day, though as dark as Pitch is black.

[*A mute and perfect discourse by colours.*]

[*To hold the same by night.*]

These two may be ranked as the same system, the one used by day, the other illuminated to be conspicuous at night. As early as 1658, John Baptista Porta, in his "Natural Magick," entitled the last chapter of his 16th Book, "By night we may make signs by fire."

We have here a simple system of telegraphy, the only examples afforded by the "Century," of this particular mode of correspondence.

8.

A way how to level and shoot Cannon by night as well as by day, and as directly; without a platform or meafures taken by day, yet by a plain and infallible rule.

[*To Level Cannons by Night.*] In 1587 was published, "*The Arte of shooting in great Ordnance,*" by William Bourne. Among other matters in the table of contents are the following:—

"The 10th Chapter showeth how to mount a mortar piece, for to lay the shot at any distance appointed.

"The 13th Chapter is, how to give level at a mark upon a hill or valley with a quadrant.

"The 24th Chapter is, how for to batter the walls of any town, as well by night as by day.

"The 25th Chapter doth declare how to plant ordnance by night, to batter the walls of any town, or displace any ordnance in any bulwarks, or any such other like, as well by night as by day." And—

"The 26th Chapter doth declare how for to keep a haven, or river, on the sea coast, for to sink a ship, as well by night as by day in all points."

On the subject of levelling great guns, Fludd's "*Historia Macrosmi,*" 1618, would afford abundant suggestions, with three copper-plate engravings, showing the operation of using the quadrant.

9.

An Engine, portable in ones Pocket, which may be carried and fastened on the inside⁴ of the great-

⁴ the side.

est Ship, *Tanquam aliud agens*, and at any appointed minute, though a week after, either of day or night, it shall irrecoverably sink that Ship.

[*A Ship-destroying Engine.*] In 1578, William Bourne, in his "Inventions or Devices," had in the 17th article, suggested, "How for to sink a ship that hath laid you aboard, without shooting of ordnance."

And again in his "Arte of shooting in great ordnance," published in 1587, the 56th Chapter, suggests a mode "to sink a ship."

The whole passage in the "Century" is abundantly obscure. The smallness of the Engine suggests some explosive missile, connected with clock-work, as the only means to insure its being compact and operating on a precise day at a stated point of time. But his inventive faculty once stimulated, even by the notices of Bourne, would speedily lead him to many ingenious contrivances.

10.

A way from a mile off to dive and fasten a like Engine to any Ship, so as it may punctually work the same effect either for time or execution.

[*How to be fastened from aloof and under water.*] The wording of this article so far differs from the title as to allude only to diving, or a kind of submarine navigation, but gives no intimation of the fastening "aloof;" so that this latter may refer to any part of the ship's sides above her water-line.

"Mersennius," observes Bishop Wilkins, "doth largely and pleasantly descant concerning the making

of a ship, wherein men may safely swim under water." He further declares, that "such a contrivance is feasible, and may be effected, is beyond all question, because it hath been already experimented here in England by Cornelius Dreble." He next considers various schemes, and mentions as one of the advantages of such a submarine vessel, that, "It may be of very great advantage against a navy of enemies, who by this means may be undermined in the water and blown up."—Math. Magick, 1648, p. 178.

Among the Sloane MSS. No. 4159, in the British Museum, is one for a means of destroying an entire fleet with one ship. It is endorsed, "A proposition sent to Mr. Augier, from Paris," and the following is a copy:—"A person who makes profession of honour, and saith he hath had the good [fortune?] to have been known of Sir Oliver Flemming during his public employments abroad, doth propound to a friend of yours that by a secret he hath he can, with one ship alone, break what naval army or fleet, &c."

In 1596, the celebrated John Napier, of Merchiston, wrote a statement of four "Secret Inventions," concluding with the remark: "These inventions, besides devices of *sailing under the water*, with divers other devices and stratagems for harming of the enemies, by the grace of God, and work of expert craftsmen, I hope to perform." The original MS. anno 1596, is in the Lambeth Library, No. 658.

There is an article in Tilloch's "Philosophical Magazine," Vol. 18, for 1804, reviewing a Memoir of Lord Napier of Merchiston. On his device for sailing under water, the writer observes:—"The famous Dutch philosopher, Cornelius Drebell, the reputed inventor of the microscope and the thermometer, constructed for James I. a subaqueous vessel, which he tried on the

Thames, and which carried twelve rowers, besides some passengers, for whom the effete air was again rendered respirable by a liquor, the composition of which Drebell never would communicate to more than one person, and that person told Mr. Boyle what it was." The Marquis, might, likewise, even be acquainted with Napier's statement of his secret inventions.

Evelyn, in his Diary, informs us on the 1st of August, 1666, "I went to Dr. Keffler, who married the daughter of the famous chymist, Drebell, inventor of the bodied scarlet." On which his editor, Mr. Bray, remarks, "Cornelius Van Drebell, born at Alkmaar, in Holland, in 1572; but in the reign of Charles I. settled in London, where he died in 1634. He was famous for other discoveries in science—the most important of which was the thermometer. He also made improvements in microscopes and telescopes; and though, like many of his scientific contemporaries, something of an empiric, possessed a considerable knowledge of chemistry, and of different branches of natural philosophy."—Diary, vol. ii. p. 9.

Pepys, in his Diary, under date the 14th of March, 1662, says: "This afternoon came the German, Dr. Knuffler, to discourse with us about his engine to blow up ships. We doubted not the matter of fact, it being tried in Cromwell's time, but the safety of carrying them in ships; but he do tell us, that when he comes to tell the King his secret, for none but the Kings, successively, and their heirs must know it, it will appear to be of no danger at all."—Pepys' Diary, ed. 1858, vol. i. p. 264.

Dr. Robert Hooke, in his "Philosophical Collections," published in 1679, has "an account of Jo. Alphon. Borellius's *De Mo. Animalium*," two volumes quarto, containing, among other things, "A way to make a

submarine vessel, whereby several persons may pass together from place to place under water, accommodated with two ways to move it to and fro, and to make it rise and sink in the water, &c. It is supposed it may be much like that which Mersennus long since published."

The American engineer, Robert Fulton, turned his attention to this subject, and published "Torpedo War, and Sub-marine Explosions," 4to. New York, 1810.

I I.

How to prevent and safeguard any Ship from such an attempt by day or night.

[*How to prevent both.*] Some armour or alarum is probably proposed, which should be either invulnerable, or when struck indicate the presence of the enemy's "portable pocket engine," intended "irrecoverably to sink the ship;" not by merely perforating a single hole, but by a powerful disruptive explosion, rending asunder all the timbers. But the whole passage is so abundantly obscure that all opinion on the matter goes for very little.

I 2.

A way to make a Ship not possible to be sunk though shot⁴ an hundred times betwixt wind and water by Cannon, and should⁵ lose a whole Plank, yet in half an hours time should be made as fit to sail as before.

shot at. P.

⁵ she lose. P.

[*An unsinkable Ship.*] As early as 1583, appeared "A Note of sundry sorts of Engines," without the author's name. The 20th and last of these is:—"To preserve a boat from drowning and the people that be therein." See J. O. Halliwell's *Rara Mathematica*.

Considering the state of ship-building in 1655, the foregoing plan must have been some very primitive scheme; but, rendering vessels unsinkable, has long been a favourite subject with inventors.

13.

How to make such false Decks as in a moment should kill and take prisoners as many as should board the Ship, without blowing the⁶ Decks up, or destroying them from being reducible, and in a quarrer⁷ of an hours time should recover their former shape, and be made fit for any imployment without discovering the secret.

⁶ the real. P.

⁷ read quarter.

[*False destroying Decks.*] William Bourne, in his "Inventions of Devices," 1578, devotes the "Third device" to show—"How to use a plain or open deck hatches, that it is not possible to enter the ship without spoiling of the enemies."

14.

How to bring a force to weigh up an Anchor, or to do any forcible exploit in the narrowest or⁸ lowest

⁸ and—for, or.

room in any Ship, where few hands shall do the work of many; and many hands applicable to the same force, some standing, others sitting, and⁹ by virtue of their several helps a great force augmented in little room, as effectual as if there were sufficient space to go about with an Axle-tree, and work far from the Centre.

⁹ and yet.

[*Multiplied strength in little room.*] We shall have to allude to the ambiguous use of the word "force" in the same sentence, as indicating "strength, power, &c." or, "a pump, or pump plunger," in John Bate's, and other old works on mechanics. Now if we were to read this, "How to bring the force [or plunger of a pump] to weigh up an anchor, &c., and many hands applicable to the same force [or pump], &c." — we should have a statement strongly indicating the modern contrivance of the hydraulic press. The concluding portion of the sentence only serves to strengthen this suggestion. See "force" used in No. 21.

In 1594, Edmund Jentill, writing to Lord Burghley, mentions, as his fourth invention:—"A devise whereby two men may be sufficient to weigh the weightiest anchor in her Majesty's navy, with greater expedition than it is now done with the number now used." Also, "The like device is found for the hoisting of the main-yard with the like expedition."—MS. Lansdown, 113, Art. 4: and, "Letters on Scientific Subjects," edited by J. O. Halliwell, F.R.S. 8vo. 1841.

15.

A way¹ how to make a Boat work it self againſt Wind and Tide, yea both without the help of man or beaſt ; yet² ſo that the Wind or Tide, though directly oppoſite, ſhall force the Ship or Boat againſt it ſelf; and in no point of the Compaſs, but it ſhall be as effectual, as if the wind were in the Pupp,³ or the ſtream actually with the courſe it is to ſteer, according to which the Oars ſhall row, and neceſſary motions work and move towards the deſired Port or point of the Compaſs.

¹ A way—omitted.² but—for yet.³ poop. P.

[*A Boat driving againſt wind and tide.*] The wording of this article is varied as follows in the MS. of certain of his Inventions. See Appendix A. He therein ſtates:—

“By this (his quinteſſence of motion), I can make a veſſel, of as great burden as the river can bear, to go againſt the ſtream; which, the more rapid it is, the faſter it ſhall advance. And the moveable part that works it, may be, by one man, ſtill guided, to take the beſt advantage of the ſtream; and yet to ſteer the boat to any point. And this engine is applicable to any veſſel or boat, whatſoever, without being, therefore, made on purpoſe; and work theſe effects:—It roweth; it draweth; it driveth, if need be, to paſs London bridge againſt the ſtream, at low water. And a boat lying

at anchor, the engine may be used for loading or unloading."

He made this invention one of the four subjects in his Patent of 1661 (see Appendix B), which again varies the reading; but this last plainly indicates the motive power as having been a mill. He proposes in his patent specification:—"To make a boat that roweth, draweth, or setteth even against wind or stream, yea, both, and to any part of the compass which way soever the stream runs or wind blows, and yet the force of the wind or stream causeth its motion, nothing being required but a steersman; and whilst the boat stayeth to be loaded or unloaded, the stream or wind shall perform such work as any water-mill or wind-mill is capable of."

Among the Harleian MSS. in the British Museum, there is an Italian book of sketches on parchment, No. 3281, attributed to the 15th century, entitled, "Delineationes Machinarum;" from one of the pen and ink drawings of which the annexed engraving is a reduced copy. It is a paddle boat of a very primitive form, to be operated by men working at two crank handles. The Marquis seems to have had a very similar idea, only employing the mechanical arrangements of a suitable wind or water-mill.

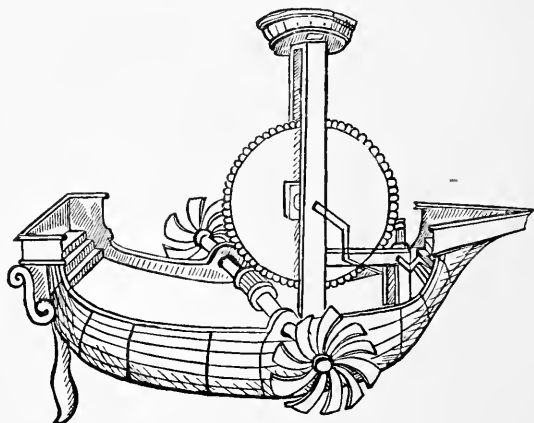

In that fine work, "Vitruvia de Architectura," folio, Como, 1521, there is an engraving of a large vessel propelled by paddles, worked by animal power; therefore, so far as such a mode of propulsion is concerned, paddle-wheels are of very ancient origin. In 1574, Ralph Rabbards* presented to Queen Elizabeth, through the medium of the venerable Lord Burghley, a list of twenty-five inventions. The 24th is:—"The rarest engine that was ever invented for sea service. A vessel in manner of a galley or galliotte to pass upon the seas and rivers without oars or sail, against wind and tide, swifter than any that ever hath been seen; of wonderful effect both for intelligence, and many other admirable exploits, almost beyond the expectation of man."

William Bourne, in his "Inventions or Devices," published in 1578, most of which he claims to be his own projects, yet acknowledging some to have been borrowed, offers the following in the 19th Device without comment:—"And furthermore you may make a boat to go without oars or sayle, by the placing of certain wheels on the outside of the boat, in that sort, that the arms of the wheels may go into the water, and so turning the wheels by some provision, and so the wheels shall make the boat to go."

This is followed by another application, being the 20th Device:—"And also, they make a water-mill in a boat, for when that it rideth at an anchor, the tide or stream will turn the wheels with great force, and these mills are used in France, &c."

In 1583, proposals were made for 20 different inventions, but the author's name does not appear. The

* From the Lansdown MSS. 121. See also Letters Illustrative of Science. Edited by J. O. Halliwell, F.R.S. &c. 8vo. 1841.

19th is :—“To make a boat to go fast on the water without oar or saile;” but this is all we learn of his project. See “*Rara Mathematica*,” edited by J. O. Halliwell, F.R.S. &c. 8vo. 1841.

In 1594, Edmund Jentill addressed to Lord Burghley two communications respecting his inventions. The last he names thus:—“A device wonderful strange is also found out, whereby a vessel of burden may easily and safely be guided both against wind and tide.” MS. Lansdown, 113, Art. 4; and “*Letters on Scientific Subjects*,” edited by J. O. Halliwell, F.R.S. &c. 8vo. 1841.

Cressy Dymock, in his letter published by Hartlib in the “*Legacie; or an enlargement of the Discourse of Husbandry*,” 4to. 1651, describing what he saw at Wicklesen, mentions—“a pretty kind of Pinnace with ordinance, somewhat like a close litter, but flat-bottomed; which rowed with wheeles instead of oares, imployed it seemes formerly with admirable successe, for the taking in of Crowland, and which gave me a prooffe of what I for many years have thought possible, and of very great use and service, and still think it of unknowne value, if it were skilfully indeed framed, and applyed as it might be.” [p. 110.]

Samuel Cotton, on the 28th of January, 1619, obtained a patent for making and erecting mills upon barges or lighters in the river Thames.

David Ramsey and Thomas Wildgoose, on the 17th of January, 1618, patented, among various other inventions, one “to make boats for the carriage of burthens and passengers run upon the water as swift in calms and more safe in storms than boats full sailed in great winds.”

David Ramsey includes in his patent of 21st of January, 1630, his invention “to make boats, ships, and barges to go against the wind and tide.”

And Dr. Thomas Grent, on the 20th of July, 1632, patented a plan “for a more speedy passage of calmed ships.”

In 1640, Edward Ford, patented his invention, whereby he can make all boats, &c. “go faster against wind and tide than now they use to do, with half the men they have formerly used.”

It is stated in “Frier Bacon’s discovery of the Miracles of Art, &c.” published in 12mo. 1659, that—“It is possible to make engines to sail withal, as that either fresh or salt water vessels may be guided by the help of one man, and made sail with a greater swiftnes, than others will which are full of men to help them.” Chap. iv. p. 17.

In “Humane Industry,” 1661, chap. 10, p. 154, it is noticed—“The ancients had a way to drive their ships without oar or sail, so that they could never be wind bound.” And at page 155, it is observed that—“Sealiger doth aver, that he could make a ship that could steer herself.”

Thomas Togood and James Heyes, in 1662, patented their invention for the making of ships to sail without the assistance of wind or tide.

16.

How to make a Sea-castle or Fortification Cannon-proof, and^t capable of a thousand men, yet fail-able at pleasure to defend a passage, or in an hours time to divide it self into three Ships as fit and trimm’d to sail as before : And even whilest

^t and—omitted. P.

it is a Fort or Castle they shall be unanimously steered, and effectually be driven by an indifferent strong wind.

[*A Sea-sailing Fort.*] Vitruvius, Vegetius, and many ancient writers supply a variety of schemes to direct an inventor's ingenuity. The idea of such a construction, to divide into three or more sailing vessels is likewise suggested, in many early designs, although no doubt very different in some details. But the peculiarity hitherto unnoticed, of the present invention, consists in the propelling and steering by means of an artificial current of air. It is very clear that the Marquis had discovered some pneumatic mode of propulsion. There is no inconsistency in the idea of the same means being adapted for both steering and propelling alternately. Even within the last few years extensive experiments have been made, in which air-pumps were used to compress the air beneath an inclined plane under the stern, which in flowing upwards gave motion to the vessel.

17.

How to make upon the *Thames* a floating Garden of pleasure, with Trees, Flowers, Banqueting-Houses, and Fountains, Stews for all kind of fishes, a reserve for Snow to keep Wine in, delicate Bathing-places, and the like; with musick made with⁵ Mills: and all in the

⁵ by—for with. MS. and P.

middest of the stream, where it is most rapid.

[*A pleasant floating Garden.*] There appears to be little more invention here than in the contrivance of so much variety, and the selecting of “the stream where it is most rapid,” to give motion to the water-mills to work the bellows for producing the promised music; as well as to raise water high enough to obtain a pressure of it for making the snow. The whole offers one of those raree-show designs in which our great-grandfathers delighted, and the descriptions of which formed the staple of their scientific discussions in polite society.

18.

An Artificial Fountain, to be turned like an Hour-glass by a child, in the twinkling of an eye, it⁶ holding great quantity⁷ of water, and of force sufficient to make snow, ice and thunder, with a⁸ chirping and singing of birds, and shewing of several shapes and effects usual to Fountains of pleasure.

⁶ yet—for it. MS. and P.

⁷ quantities. P.

⁸ the—for a. MS. and P.

[*An Hour-glasse Fountain.*] In a MS. among the Marquis's papers, the foregoing appears to be the invention indicated under the title:—“Fountains of pleasure, with artificial snow or hail, or thunder, and quantity not limited.” [See p. 316.]

Kircher, Schottus, and others give descriptions, with engravings of fountains, having the external appearance of the hour-glass. The process of turning

may have been facilitated by the machine resting on two central pivots. But it must have been of considerable size to produce an efficient hydraulic pressure engine to give forth snow and ice. The thunder, &c., would depend on plans well understood for producing stage effects, and their introduction here, with the music of birds, &c. [see Article 46.] is similar to other automatic arrangements which were the wonder and delight of that age, and a much later period.

In 1755, an engine of peculiar construction, to raise water from an Hungarian mine, was erected by M. Hoel, at Chemnitz, which generated intense cold as the water and air rushed out together, under great columnar pressure, causing the formation of artificial hail, projected with amazing force; the effect being very analogous to the suggestions offered by the present articles, Nos. 17 and 18.

19.

A little engine within a Coach, whereby a child may stop it, and secure all persons within it, and the Coachman himself, though the horses be never so unruly⁹ in a full career; a child being sufficiently capable to loosen¹ them in what posture soever they should have put themselves, turning never so short; for a child can do it in the twinkling of an eye.

⁹ and running.¹ unloose. P.

[*A Coach-saving Engine.*] We have two other readings of this article; the first is the 5th article in

his list of a portion of his Inventions, (see Appendix A.) as follows:—"By this (his quintessence of motion) I can make a child, in a coach, to stop the horses (running away), and shall be able to secure himself, and those that be in the coach; having a little engine placed therein, which shall not be perceived, in what posture soever the horses draw. A child's force shall be able to disengage them, from overturning the coach, or prejudicing anybody in it."

The second reading is in his patent of 1661, (see Appendix B.) wherein he offers:—"To make an engine applicable to any coach, by which a child of six years old may secure from danger all in the coach, and even the coachman himself, though the horses become never so unruly, the child being able in the twinkling of an eye to loosen them from the coach, in what posture soever they draw or turn, be it ever so short, or to either hand." By means of a T-ended lever, two or four bolts could be simultaneously drawn inwards, and the horses thereby released with the greatest possible ease and certainty.

20.

How to bring up water Balance-wise, so that as little weight or force as will turn a Balance will be onely needful, more then the weight of the water within the Buckets, which counterpoised² empty themselves one into the other, the uppermost yielding its water (how great a quantity soever it holds) at the self³-

² counterpoise, and empty. MS. and P.

³ self—omitted. P.

fame time the lower-moſt taketh it in, though it be an hundred fathom high.

[*A Balance Water-work.*] It is to be regretted that we have nothing at preſent to aid us in offering a deſcription at all approaching the ſingular conſtruction of this hydraulic machine. There are ſome curious deſigns given in the deſcription of M. Grollier de Servièrè's cabinet, 1719, but we have never ſeen any plan fully realizing the effect above indicated.

2 I.

How to raiſe water conſtantly with two Buckets onely day and night, without any other force then its own motion, uſing not ſo much as any force, wheel, or fucker, nor more pullies then one, on which the cord or chain rolleth with a Bucket faſtened at each end. This, I confeſs,⁴ I have ſeen and learned⁵ of the great Mathematician *Claudius*⁶ ⁷ his ſtudies at *Rome*, he having made a Preſent thereof unto a Cardinal; and I deſire not to own any other mens⁸ inventions, but if I ſet down any, to nominate like-wiſe the inventor.

confeſs to have ſeen. ⁵ in the great Mathematician's ſtudy, Clavius at Rome.

⁶ Clavius.

⁷ Clavius's Studies at Rome. P.

⁸ man's. MS. and P.

[*A Bucket-fountain.*] In the present and preceding articles the water is elevated by means of buckets, and it was only while these pages were passing through the press that the author perceived those precise marks of distinction between the two methods of employing the buckets which enables him now to offer the following explanation of each.

As regards No. 20, it seems, at first, absurd to expect to raise water which is to be in a balance and pass from one bucket to the other. But let us suppose an arrangement, as in the subjoined engraving, where A, B, is a strong vertical wooden frame carrying six

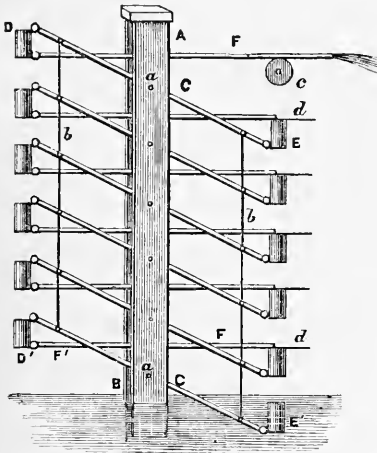

metal or wooden pipes C, C', which can be moved simultaneously up and down on centres, *a, a*, being connected by the iron rods, *b, b*; these pipes are united with the top of six buckets at D, D', and with the bottom of six other buckets at E, E'. The buckets D, D', are also connected at the bottom

with six other pipes F, F', each open at the end F, F', and so arranged that the topmost pipe passes over a pulley *c*, but the other five pipes with guide rods *d, d*, at their ends, enter the top end of the five uppermost buckets on the side E; the pipe F, passing over *c*, delivers the contents of bucket D, while the lowermost bucket E', is being replenished, "thus the uppermost yielding its water at the same time when the lowermost taketh it in." In the present position of the machine the pipes C, C', are inclined, and the pipes F, F', are horizontal, but when the bucket E' is ele-

vated, then these pipes will all reverse their positions, being connected with the buckets by means of flexible leather hose, or suitable jointed metal tubing.

We have next to consider the present article No. 21. The conditions stated require the use of but one pulley, one cord, and two buckets, without any "force" or pump plunger, or "any wheel, or sucker." An arrangement so simple seems only possible to be attained by some such plan as that exhibited in the illustration given below. We have here an endless chain or cord,

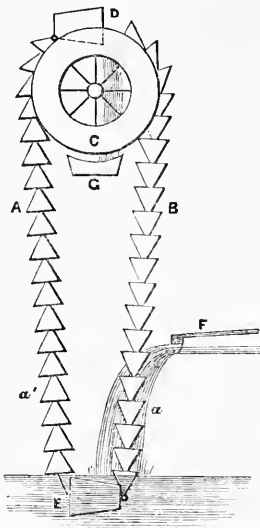

A B, passing over the pulley C, with a bucket D, at the upper end; and another bucket E, at the lower end; the first in the act of discharging its contents into the trough G, the second re-charging with water at the level E. This endless chain is further supplied with a series of conical or other shaped buckets, *a, a'*, set on the endless cord in a reverse direction, so as to receive water conveyed from an upper stream by the spout F, by which means the side B, of the cord will descend,

and the side A, ascend, "without any other force than its own motion," and that "with two buckets only, day and night." On the side *a'*, the conical buckets reverse and empty themselves, thereby lightening the ascending side A, of the endless chain or cord.

22.

To make a River in a Garden to ebbe and flow constantly, though twenty foot over, with a child's force,

in some private room or place out of sight, and a competent distance from it.

[*An ebbing and flowing River.*] In reference to this invention Mr. Partington has quoted Peter Bogaerts' ingenious method of a canal lock, so contrived that, in a model, a weight of seven pounds was made to raise ten hundred weight of water more than four feet in a few seconds.

But still the process of ebbing and flowing is not made out; it does appear, however, that its operation requires the constant services of a boy or other attendant, probably to keep alternately opening and closing certain sluice arrangements, placed somewhere concealed from view; the whole affording a water-work to amuse and surprise, and forming a variety on the usual strange schemes attached to grottos, caves, &c. spouting water in every variety of form.

See further the comments on article No. 57, which very probably includes the principle here employed by the Marquis.

There is no communication in this article of facts requisite to direct an engineer or inventor in the adjustment of any special kind of machinery to obtain the desired ebbing and flowing river; which is a novelty, in this respect, peculiar to the Marquis of Worcester's ingenuity. He was evidently not copying or improving any anterior system of water-work. The next article is but an application of this new system; and it is not until he has taken us through descriptive hints of thirty-three totally different designs or devices, that in No. 57, he offers "A constant water-flowing and ebbing motion." We think the three may be taken together, that is, No. 57, refers to the principle and mechanism, of which Nos. 22 and 23, are mere simple applications.

Thus, referring to what we have stated under No. 57, the purpose named in the present article might be attained by means of two domed or bell-shaped vessels, placed like gasometers, but otherwise immovable, partially immersed in a pond, or other artificial piece of water; which being arranged so that, by admitting a steam pipe into each, the contained air could be driven out thereby, condensation would naturally follow, or might be accelerated; and one vessel immediately filling with water, while the other was emptying, the surface of the pond or river would be kept in a continual state of agitation, and the water might be said to "ebb and flow constantly, though 20 feet over."

No reason is assigned for proposing this modification of water work, no advantage is pointed out, the Marquis doubtless depending on its apparent impossibility for its exciting and stimulating inquiry. He knew how the promulgation of such a wonder would have affected his own mind, and never imagined but that the public would feel equally inquisitive. His incomprehensible truths are, however, often denounced, without investigation, as though they were false.

23.

To set a Clock in⁹ a Castle, the¹ water filling the Trenches about it;² it³ shall shew by ebbing and flowing the Hours, Minutes and Seconds, and all the comprehensible motions of the Heavens, and Counterlibation⁴ of the Earth, according to *Copernicus*.

as within a. MS and P. ¹ and the. ² about it shall show the hours, minutes, and seconds by ebbing. ³ which—for it. P. ⁴ counterlibation.

[*An ebbing and flowing Castle-clock.*] John Bate, in his "Mysteries of Nature and Art," 1635, at p. 45, describes—"A water-clock, or a glasse showing the hour of the day," by three different arrangements.

This article is further noticed in commenting on No. 57.

24.

How to increase the strength of a Spring to such an height,⁵ as to shoot Bumbasses and Bullets of an hundred pound weight a Steeple-height, and a quarter of a mile off and more, Stone-bow-wise, admirable for Fire-works and astonishing of besieged Cities, when without warning given by noise they find themselves so forcibly and dangerously surpris'd.

⁵ degree—for height. P.

[*A Strength-increasing Spring.*] The technical term BUMBASSES, or probably bombasses, here used, has escaped the attention of all compilers of Archaic Dictionaries. By the context we may presume it was applied to the large stones usually fired from bombards, and differing only from bullets in these last being made of lead or iron.

Ancient cannon appear to have consisted of two kinds; a large one for discharging stones, called a *Bombard*, and a lesser one for darts. In 1388, a stone bullet, weighing 195 pounds, is related, according to Meyrick, to have been discharged from a *Bombard*, called the Trevisan. Such stone missiles may have been of the kind called by the Marquis "bumbasses," and would be perhaps more properly named bombasses.

The Stone-bow was the Prodd; probably the Slurbowe was furnished with a barrel through a slit, in which the string slid, when the trigger was pulled. Three kinds are mentioned by Du Cange. See Fosbroke's *Encyclopædia of Antiquities*, 8vo. 1840.

Bishop Wilkins, treating on Catapultæ in his *Mathematicall Magick*, 1648, observes that their usual form was "after the manner of great bows placed on carriages, and wound up by the strength of several persons;" adding: "These were sometimes framed for the discharging of two or three arrows together."

As the Marquis wrote the *Century* in 1655, only seven years after Wilkins' publication, it is not at all unlikely that he seriously contemplated the contriving of a most useful warlike implement; and this appears the more reasonable when we find the worthy and learned prelate advancing, as it appeared to him, cogent reasons in his 19th chapter, in favour of the "Military offensive engines used amongst the ancients," as compared to cannon; gravely summing up his observations with the remark—"that the force of these Engines does rather exceed than come short of our gun-powder inventions." Then again on the ground of expense he shows an advantage in favour of Ballistæ and Catapultæ. Thus: "the price of these gun-powder instruments is extremely expensive." This is proved from "a whole Cannon weighing commonly 8,000 pounds, a half Cannon 5,000, a Culverin 4,500, a Demi-culverin 3,000," which "must needs be very costly," amounting "to several hundred pounds," for which sum "at least 10 of the ancient timber made engines might be purchased"!

Then their transport was a serious matter, for "a whole Cannon does require at the least 90 men, or 16 horses," and so in proportion for others. But the

timber made engines are light, and their “materials to be found everywhere.”

Then the gun-powder is costly; “a whole Cannon requiring for every charge 40 pound of powder, and a bullet of 64 pounds,” and in proportion for lesser cannon; whereas those other engines may be charged only with stones. So that only for the superior force of cannon “those ancient inventions” he conceives to be “much more commodious than these later inventions.”

Among questions propounded and agreed upon, in January, 1660, to be sent to Teneriffe by the Lord Brouncker and Mr. Boyle, the fifth was,—“Try the power of a stone bow, or other spring, both above and below (the hill), and note well the difference.”—Weld’s Hist. Royal Society, Vol. i. p. 98.

25.

How to make a Weight that cannot take up an hundred pound, and yet shall take up two hundred pound, and⁶ at the self-fame distance from the Centre; and so proportionably to millions of pounds.

⁶ and—omitted.

[*A double-drawing Engine for weights.*] The articles Nos. 25, 27, and 29 can only be taken as descriptive of elucidatory models, demonstrative of the applications of a certain principle, the result of condensation. For some unaccountable reason there has been a prevalent opinion that the Marquis was ignorant of condensation. If such an opinion is grounded on his not expressly alluding to it in the “Century,” then by the same rule it might be doubted whether he

understood anything about steam! But as the "Century" was written to remind himself, and not to inform others of the *modus operandi*, it was sufficient for his purpose to particularise only the results. We can usually distinguish where he treads a beaten track, the result of reading, and where his course deviates into his "fire-water-work" experiments. The former generally has its parallel in some old author; but when the same rule is attempted to be applied to measure the others, we find we are dealing either with a new order of things, or else with sheer paradoxes of the most chimerical character. While, on the other hand, follow him in his own new track of experimental research, and we are rewarded at every step with a full and clear exposition of the wonderfully ingenious processes of inquiry by which he attained the perfection ascribed by him to his "Water-commanding Engine."

In the present article it is required that a weight shall take up double its own weight, not by the old rule of leverage, but "at the self-same distance from the

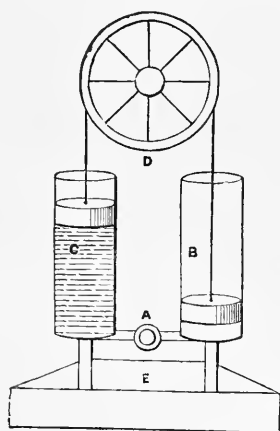

centre." In the subjoined diagram we have two cylinders C, B, connected at the lower end with a steam pipe, supplied with the steam-cock A. A cord passing over the drum wheel D, is connected at its ends with the pistons B, C; and the whole stands in a trough E. Steam having been admitted to B, and then cut off, condensation has ensued, the piston B has descended and C has been raised, and along

with it a quantity of water. Here we may take the two pistons as representing "one hundred pound" each, and although they balance, yet we thus find "how to make

a weight" under such circumstances, nevertheless, take up "two hundred pounds," that is, including the water.

A very similar kind of piston to the one here shown, is suggested by Fludd, Besson, and others, to be worked by a spiral spring, which being drawn to the bottom of a cylindrical vessel, water may be poured in above it, and being then tightly covered, with a lid having either an open jet or a tap in the centre, on releasing the spiral spring, the false bottom rising, and pressing the liquid, causes it to escape in a jet d'eau, gradually diminishing as the spring relaxes. The contrivance is elaborately illustrated in the 18th folio engraving of Besson's "Theatrum Instrumentorum et Machinarum," 1578; the Marquis, therefore, had only to substitute steam for the spiral spring.

26.

To raise weight as⁷ well and as forcibly with the drawing back of the Lever, as with the thrusting it⁸ forwards; and by that means to lose no time in motion or strength. This I saw in the *Arcenal at Venice*.⁹

⁷ so—for as.⁸ of it.⁹ at Venice in the arsenal.

[*A to and fro Lever.*] William Bourne offers the following as his 112th Device, "touching the making of engines to thrust from or pull to you with great force or strength." He says, "And furthermore, you may make an engine to thrust from you or to pull unto you, to lift vp or to presse downe with great force, eyther to goe with wheelles as before is declared, or else to goe with skrewes or to goe with both, as to thrust open huge and strong gates, or else you taking good hold, to pull them open vnto you wards, and will

make but little noyse in the doying thereof, but you must be sure to set the engine fast, if to thrust from, to be strongly and well backed, and to pull to them it must be strongly bolstered before, sufficient to be of force to scrue the turne."

The Venetian arrangement may be described, as shown in the annexed engraving, where A, B, C, is a

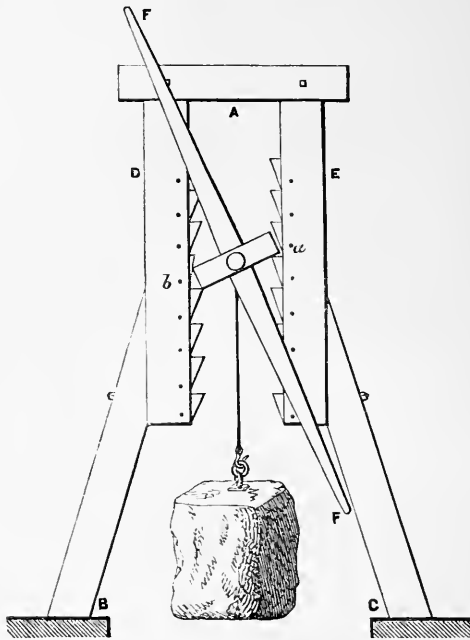

frame, the two upright sides of which D E, are provided with a series of clicks, appearing in the drawing like the serrated edge of a saw, and each is so placed secured by a pin on which it moves, as always to incline to fall outwards. F, F, is a long lever, having a stout short cross bar in the centre, and is represented on the point of taking up on a click at *a*, while it leaves one on the opposite *b*, such being the *to* and *fro* motion required, thereby losing "no time in motion or strength."

27.

A way to remove to and fro huge weights with a most inconsiderable strength from place to place. For example, Ten Tunne with ten pounds, and less; the said ten pounds not to fall lower than it makes the ten Tunne to advance or retreat upon a Level.

[*A most easie level Draught.*] The weight is in this case to be moved “with a most inconsiderable strength.” Ten pounds, or less, are to be capable of moving 22,400 pounds. And the precise conditions are—“the said ten pounds not to *fall lower* than it makes the ten ton to *advance*.” The annexed engraving shows, as in No. 25, two cylinders B, C, with their steam-pipe and

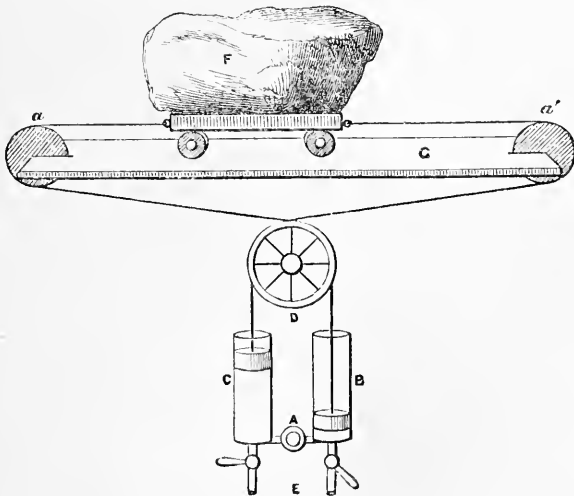

valve at A, having above a platform G, on which is a loaded truck F, attached by a cord *a*, at one end passing over a pulley, and the drum wheel D, to the piston B; and a second cord at the other end passing over a pulley at *a'*, attached in like manner to the other piston C. Steam having been admitted to B, on its condensation the piston descending draws along with it the weighted truck F, while the piston C, ascends, drawing in air at E.

We thus attain the strict letter of the conditions set down, the *full* and the *advance* being equal.

28.

A Bridge portable in¹ a Cart with six horses, which in a few hours time may be placed over a River half a mile broad, whereon with much expedition may² be transported Horse, Foot and Cannon.

¹ upon a. MS. and P.

² there may be.

[*A portable Bridge.*] The great painter, Leonardo da Vinci, born in 1452, and who died at 67 years of age in 1520, was a man of singularly inventive talent. Among his other projects, he declares:—"I have the means of constructing light bridges, easy of carriage, and equally adapted to pursue or escape an enemy, secure from fire; and as easy to remove as to replace; and also the means of destroying those of the enemy." See an interesting Memoir of him by J. W. Brown. 12mo. 1828.

Bourne's 94th Device promises, "How you may make a bridge upon a sudden, that a whole army of men and their carriages may pass over any river or

haven, if that it be of not too great breadth."—See his *Inventions or Devices*, 1578.

Sir Hugh Plat, in his "*Jewel House of Art and Nature*," 1653, shows, in article No. 22, "How to erect or build over any brook, or small river, a cheap and wooden bridge of 40 or 50 feet in length, without fastening any timber work within the water."

29.

A portable Fortification able to contain five hundred fighting men, and yet³ in six hours time may⁴ be set up, and made Cannon-proof, upon the side of a River or Pass, with Cannon mounted upon it, and as complete as a regular Fortification, with Half-moons and Counter-scarps.

³ yet—omitted.

⁴ able to be—for, may be.

[*A moveable Fortification.*] Vegetius, in "*De re militari*," 1535, offers many similar schemes but less ambitious than the present one; which is, after all, little if any more than an extension and improvement on what had previously been more or less practised.

In his "*Naturæ simia seu technica*," dated 1618, Robert Fludd, at page 421, gives a folio engraving of a triangular fort, with six pieces of cannon and three gunners. It appears to be on wheels, and is pushed along by a beam running on three wheels, having four horses yoked to it; literally the cart before the horse.

30.

A way in one nights time to raise a Bulwork twenty or thirty foot high, Cannon-proof, and Cannon mounted upon it, with men to overlook, command and batter a Towne ; for though it contain but four Pieces, they shall be able to discharge two hundred Bullets each hour.

[*A Rising Bulwork.*] Grose, in his "Military Antiquities," Vol. I. page 385, notices a moveable tower, the use of which was revived by the Royalists in their attack on Gloucester, during the Civil War.

In 1644, Edmond Felton, gentleman, published a pamphlet entitled, "Engins invented to save blood and moneys;" the nature of which he "discovered unto the Committee for the fortifications of the City of London." The Honourable Major General Skippon attested in respect of it, that the engine "was of three tiers of ten muskets in a tier, to shoot arrows withal." The inventor satisfied the Committee, "how an engine will secure the foot from the horse, and the soldiers from musket shot, which engine in fair ways two men may manage at pleasure."

He complains of a piracy of his invention, observing, "There was about twenty of the said engines made at Oxford, and from thence carried to Gloucester, to go up to the walls. And had not his Excellency the Earl of Essex so happily arrived to raise the siege as he did, it was reported by some of the army, the city was in great fear to be taken thereby; most of which said engines the besiegers burnt, because they should not be taken."

In the second volume of “*Bibliotheca Gloucestrensis*: a collection of scarce and curious tracts, by John Washbourn, jun. Gloucester. 4to. 1825,” there is a reprint of “*Corbet’s Historicall relation of the Military Government of Gloucester, 1645*,” which contains this passage: “Wherefore besides their mine and battery, they framed great store of those unperfect and troublesome engines to assault the lower parts of the city. Those engines ran upon wheels, with planks musket-proof placed on the axle-tree, with holes for musket-shot and a bridge before it, the end whereof (the wheels falling into the ditch) was to rest upon our breast works.” Page 54.

And in the reprint of “*A briefe and exact diurnall of the siege before Gloucester, by John Dorney, Esquire, 1643*,” we meet with the following:—“Munday, September 4. We understood likewise that the enemy had by the direction of that Jesuitticall Doctor Chillingworth, provided great store of engines after the manner of the *Romane Testudines cum Pluteis*, with which they intended to have assaulted the parts of the city, between the south and west gates. These engines ran upon cart wheelles, with a blinde of planks musquet prooffe, and holes for foure musquetiers to play out of, placed upon the axeltree to defend the musquetiers and those that thrust it forward, and carrying a bridge before it; the wheelles were to fall into the ditch, and the end of the bridge to rest upon our breast-workes, so making severall compleat bridges to enter the city. After the raising of the siege, we tooke all these engines, and brought them into the towne.”—Page 225.

In the first volume of this work there is a note on the two preceding passages, in which the editor observes:—“The plan of these machines was borrowed from the ancients. Various contrivances of this kind were also employed in the middle ages, before and for a con-

siderable time after the invention of fire-arms. Sometimes they used them for undermining the walls. At the siege of Ribadavia in Spain, during the reign of Richard II. similar moveable machines were used. See Froissart, viii. c. 26. Such an engine is also mentioned by the Marquis of Worcester in his *Century of Inventions*."

31.

A way how safely and speedily to make an approach to a Castle or Town-wall, and over the very Ditch at Noon-day.

[*An approaching Blinde.*] Vegetius, in "*De re militari*," 1535, depicts and describes several kinds of these ancient military blinds, screens, and other contrivances and machines for protecting the attacking party. At page 15 he shows a ponderous advancing screen or shield on four wheels, and at two pages further a side view of the same, covering a large body of soldiers. Some have raised, hinged platforms, to be lowered for crossing a ditch.

Grose says:—"The cattus, cat-house, gattus or cat, was a covered shed, occasionally fixed on wheels, and used for covering soldiers employed in filling up the ditch, &c."—*Military Antiquities*, 4to. 1801.

32.

How to compose an universal Character methodical and easie to be written, yet intelligible in any Language; so that if an English-man write it in English, a French-man,⁵ Italian, Spaniard, Irish,⁶ Welsh,⁷

⁵ man—omitted.⁶ Irish and.

or Welchman. P.

being Scholars ; yea, Grecian or Hebritian shall as perfectly understand it in their owne Tongue, as if they were perfect^s English, distinguishing the Verbs from the Nouns, the Numbers, Tenses and Cases as properly expressed in their own Language as it was written in English.

^s perfect—omitted. P.

[*An universall Character.*] In 1668, the Royal Society ordered the printing of “An Essay towards a real Character, and a philosophical language ; by John Wilkins, D. D. Dean of Ripon, and F. R. S.,” folio. It is dedicated to the president, William Lord Viscount Brouncker, and consists of a treatise of 454 pages, to which is appended a dictionary of 155 pages. The very extent of such a work is almost fatal to its acceptance, and we must admit that it is questionable whether, with all its learning and ingenuity, it affords a single hint calculated to promote the intended object.

In relation to this subject, the reader, desirous of enlarged information, could not do better than consult the recently published “Lectures on the Science of Language,” by Professor Max Müller, M. A.

It would be highly interesting to possess any clue whatever to the ideas of the Marquis on this subject. He was so truthful in his statements, that he must have made a considerable advance in the discovery of means for obtaining the end proposed, although he may have over-estimated its application, according to our judgment.

Of early publications on this topic we would especially notice, “Le Caractere universel, par lequel

toutes Nations peuvent comprendre les conceptions l'une de l'autre en lisant par une esriture commune, à toutes leur propre langage maternelle. Par Cave Beck. M. A." London, 1657, 12mo. Also "Joh. J. Becheri Spirensis character, pro Notitia Linguarum Universali." Francfort, 1661. And "Ars signorum, vulgo character universalis et lingua philosophica," by Georgius Dalgarno: a small 12mo. volume in Latin. 1661.

A system of a universal alphabet has been recently proposed for telegraphic purposes, by means of which it is believed all the sounds of the human speech may be recorded and transmitted; mastering all the sounds which the human voice is capable of uttering in any language. The proposed scheme is even said to have been severely tested by many eminent linguists. It is to be hoped that the announced discovery will be found to realize all its promises, and remunerate the ingenious inventor.

33.

To write with a Needle and Thred, white, or any⁹ colour upon white, or¹ any other² colour, so that one stitch shall significantly shew any letter, and as readily and³ as easily shew the one letter as the other, and fit for any Language.

⁹ any other. P. ¹ or upon. ² other—omitted. ³ and as. MS. and P.

[*A Needle-alphabet.*]

34.

To write by a knotted Silk string, so that every knot shall signifie any

letter with Comma, Full point, or Interrogation, and as legible as with Pen and Ink upon white Paper.

[*A knotted String-alphabet.*]

35.

The like, by the fringe of Gloves.

[*A Fringe-alphabet.*]

36.

By stringing of Bracelets.

[*A Bracelet-alphabet.*]

37.

By Pinck'd Gloves.

[*A Pinck'd Glove-alphabet.*]

38.

By holes in the bottom of a Sieve.

[*A Sieve-alphabet.*]

39.

By a Lattin or⁴ Plate Lanthorn.⁵

⁴ or candlestick lantern. P.

⁵ plate candlestick Lanthorn.

[*A Lanthorn-alphabet.*]

40.

By the Smell.

41.

By the Taste.

42.

By the Touch.

By these three Senses as perfectly, distinctly and unconfusedly, yea as readily as by the sight.

[*An alphabet by the—Smell; Taste; Touch.*]

43.

How to vary each of these, so that ten thousand may know them, and yet⁶ keep the understanding part from any but their Correspondent.

⁶ yet—omitted.

[*A variation of all and each of these.*] We have here ten Alphabets, concluding with a variation on each, which, had it been given, would have at least increased the number to twenty, but that was by no means the limit. Cipher Alphabets are the least interesting portion of the "Century;" we imagine we trace in them some of the Marquis's earliest studies, and fancy that later in life they were retained from fond recollections of the past.

These secret methods of corresponding are no longer of any service, and have no interest beyond what may attach to them in connection with the history of shorthand writing, wherein the object is rather dispatch than secrecy. Among early writers on the art of Senigraphy, and Stenography, are Bright, 1588, Bales 1590, Arnold Bostius, Trithemius 1600, Willis 1618, Dix 1633, Wilkins 1641, Cartwright 1652, Rich 1654,

Falconer ("The Art of Secret Information,") 1685, with others.

John Baptista Porta, a Neapolitan of considerable eminence, born 1445, and who died in 1515, wrote "De Occultis Literarum Notis, Libri quinque," Argent. 1608, octavo, in which he gives no less than 180 different methods of secret writing.

The learned and ingenious Bishop Wilkins in 1641, published his "Mercury, or the Secret and Swift Messenger."

Of line alphabets he says—"Who would mistrust any private news or treachery to lie hid in a thread, wherein there was nothing to be discerned, but sundry confused knots or other the like marks?" It is, however, easily effected by each party having like tablets marked at top with the alphabet, and having hooks down each side for the passing and holding of a thread worked backwards and forwards, in which action it is to have a knot made on it for the desired letter above; making altogether words and sentences.

Chapter 6, is on "Secret writing with the common letters, by changing of their places."

In chapter 11, "Of writing by invented characters," he says: "There have been some other inventions of writing by points, or lines, or figures."

Chapter 13 is, "concerning an universal character that may be legible to all nations and languages," concluding with observations on "The benefit and possibility of this."

In chapter 17, we are told "of secret and swift informations by the species of sound." Among others he names "Bells," as a species which "may be a sufficient means, whereby to communicate the thoughts;" and in chapter 18, he treats "concerning a language that may consist only of tunes and musical notes, without

any articulate sound." And lastly, in chapter 20, we have "Of informations by significatory fires and smokes."

Among the "variations" the sense of Seeing may be employed, as proposed by Sir Hugh Plat in his "Jewel House of Art and Nature," 1653, in which he describes "How to speak by signs only without uttering of any word"—using the fingers and motions with them and the hands, which he calls a "conceited alphabet."—Page 41.

Those who are curious in such matters, may see more at large in Dr. W. Hooper's Rational Recreations, ed. 1794, 8vo. different methods of writing in cipher, commencing at p. 143, of 1st Vol.—thus:—

To communicate intelligence by a pack of piquet cards.—The musical dial.—The corresponding spaces.—The musical cipher.—Rules for deciphering.—Example of a cipher written in arbitrary characters, and the words separate from each other.—Visual correspondence; and, Correspondence by bells.

44.

To make a Key of a Chamber door, which to your fight hath its Wards and Rose-pipe but Paper-thick, and yet at pleasure in a minute of an hour shall become a perfect Pistol, capable to shoot through a Brest-plate commonly of Carabine-proof, with Prime, Powder and Firelock, undiscoverable in a strangers hand.

[*A Key-Pistol.*] This mere piece of ingenuity, so pleasing to certain mechanics in working out mechanical trinkets, might be effected by causing the removal of the key handle to expose a sufficiently strong pistol barrel, while the "rose pipe but paper thick" would answer to receive, and perform the office of retaining the key handle securely, by which to hold it while firing this key-pistol. The next part of the contrivance would be, to make the "wards" serve to conceal the pistol pan, cock, &c. The description is well calculated to mislead the reader, under the impression that the barrel itself is "but paper-thick."

45.

How to light a Fire and a Candle at what hour of the night one awaketh, without rising or putting ones hand out of the bed. And the same thing⁷ becomes⁸ a serviceable Pistol at pleasure ; yet by a stranger, not knowing the secret, seemeth but a dexterous Tinder-box.

⁷ to be a. P.⁸ becomes to be.

[*A most conceited Tinder-box.*] The following note from "Humane Industry," 1661, appears highly suggestive of such an instrument, although the Marquis's invention is more elaborate. "Andrew Alciat the great Civilian of France, had a kind of Clock in his chamber, that should awake him at any hour of the night that he determined, and when it struck the determined hour, it struck fire likewise out of a flint, which fell among tinder, to light him a candle: it was the invention of one Caravagio of Sienna in Italy."

46.

How to make an artificial Bird to fly which way and as long as one pleaseth, by or against the wind, sometimes chirping, other times hovering, still tending the way it is designed for.

[*An artificial Bird.*] The third article in his list of a portion of his inventions supplies a different reading, thus: "By this (his 'quint-essence of motion') I can make an artificial bird to fly which way, and as long as I please." [Appendix A.]

The Marquis, not to be behind the curious and ingenious men of ancient times, has here and in article No. 18, emulated John Muller of Nuremberg, better known as Regiomontanus, who was born in 1436. He is celebrated for this species of *rara avis*; a self-moving and flying eagle, and an iron fly have afforded much matter for romantic and no doubt exaggerated accounts of their performances; the one flying a good way in the open air and returning; the other flying from the philosopher round a table and coming back to his hand. He evinced a genius of the first order as a great inventor, and also as a promoter of the advancement of science.

In Ramelli's great work on various machines, folio, 1588, the 187th figure offers a detailed representation of a handsomely furnished apartment, in which a large carved sideboard sustains a gigantic vase containing a flowering shrub, in the branches of which six birds appear in the act of singing. The vase being a sectional drawing, various pipes can be seen, also the performer behind, who is blowing through a single pipe into the body of the vase.

But the highly popular work of Hero of Alexandria promulgated several similar schemes. He shows how to make an artificial bird sing by flowing water, or alternately sing and be silent. See Mr. Woodcroft's handsome edition of Hero's *Pneumatics*, 4to. 1851.

William Bourne, also, in his "Inventions or Devices," 1578, treats of "birds of wood or metal made by art to fly," and of others, "to sing sweetly at certain hours appointed."

Bate, in his "Mysteries of Nature and Art," 1635, treats, at page 24, "How to make that a bird sitting on a basis, shall make a noise, and drink out of a cup of water, being held to the mouth of it;" and further, "Advice whereby several voices of birds chirping may be heard."

So again Isaac De Caus, in his "Rare Inventions of Water Works," folio, 1659, at page 20, gives instructions—"To counterfeit the voice of small birds by means of water and air." And in Plate XIV. "To represent divers birds which shall sing diversly when an owl turns towards them; and when the said owl turns back again they shall cease their singing."

These later examples show that the Marquis was neither altogether original nor singular in attempting improvements in these automatic toys, which from the time of Hero of Alexandria were accounted sufficiently wonderful evidence of mechanical ingenuity to attract the serious attention of even the most talented engineers of the last century. Of such mechanical achievements of the ingenious a full account may be read in Montucla's edition of Ozanam's "Mathematical Recreations."

Volant automata, as he calls them, did not escape the attentive consideration of Bishop Wilkins, and he says enough on this class of mechanical curiosities to

have stimulated the mechanical ingenuity of even a less enthusiastic inventor than the Marquis of Worcester, as of the wooden dove of Archytas, and the wooden eagle and iron fly of Regiomontanus.

The Marquis, if he ever perused the little treatise just quoted, would be keenly alive to the truthfulness of the remark that—"it is none of the meanest discouragements, that any strange inventions are so generally derided by common opinion, being esteemed only as the dreams of a melancholy and distempered fancy; for that saying of Virgil,

"Demens qui nimbos et non imitabile fulmen," &c.

"hath been an old censure applied unto such as ventured upon any strange or incredible attempt."—See *Math. Magick*, 1648, p. 198.

The Rev. Dr. Powell, in the last chapter of his "*Humane Industry*," 1661, treats of various minute automata as—"Certain sports and extravagancies of art," for which he offers an ingenious apology, observing: "As nature hath her *ludicra*, so art hath hers too; that is, some pretty knacks that are made, not so much for use, as to show subtilty of wit, being made *de Gaieté de Cœur*, and for pastime as it were; yet the workmanship and elegancy of these may justly deserve admiration;" concluding—"art, as well as nature, is never more wonderful than in smaller pieces." After describing small chains, locks, chariots, ships, clocks, and insects, he remarks:—"though these knacks are but little useful, and take up more time than needed to be lost, yet they discover a marvellous pregnancy of wit in the artificers; and may be *experimenta lucifera*, if not *frugifera* hints of greater matters."

It will not appear strange to find the inventor of the steam engine engaged toying with an artificial bird, an imprisoning chair, a brazen head, or a riding horse,

when it is remembered that for a hundred years later such automata were highly prized by the nobility and gentry, and proved extremely lucrative to the public exhibitors of such mechanical imitations of life. M. Vaucanson's inventions were of this character, attracting admiring audiences among the learned and the vulgar, on the Continent and in England. A learned society received his communication in Paris, while in London it had the unquestionable honour of being translated by Dr. Desaguliers, who says in his preface, "In giving this paper an English dress, I am still acting in my province, which has been for many years to explain the works of art, as well as the phenomena of nature;" and his translation is given under the following elaborate title:—

"An account of the mechanism of an automaton or image playing on the German Flute: as it was presented in a memoire, to the gentlemen of the Royal Academy of Sciences at Paris. By M. Vaucanson, Inventor and maker of the said machine. Together with a description of an artificial Duck, eating, drinking, macerating the food, &c. As also that of another image, no less wonderful than the first, playing on the tabor and pipe; as he has given an account of them since the memoir was written. Translated out of the French original, by J. T. Desaguliers, LL.D., F.R.S., Chaplain to his Royal Highness the Prince of Wales, 4to. 1742." [24 pages, and an engraved frontispiece.]

47.

To make a Ball of any metal, which thrown into a Pool or Pail of water shall presently rise from the bottom, and constantly shew by

the *superficies* of the water the hour of the day or night, never rising more out of the water than just to the minute it sheweth of each quarter of the hour; and if by force kept under water, yet the time is not lost, but recovered as soon as it is permitted to rise to the *superficies*⁹ of the water.

⁹ surface. P.

[*An Hour Water-ball.*] The 4th article of his selected list of his inventions supplies the following varied reading:—

“By these (his quintessence of Motion) I can make a ball of silver or gold, which thrown into a pail, or poole of water, shall arise again to the perfect hour of any day or night. The superficies of the water shall still show the hour distinctly; even the minutes, if I please.” See Appendix A.

Many curious specimens of these Horologies occur in the description of M. Grollier de Servière’s cabinet, published 1719.

48.

A scrued Ascent, instead of Stairs, with fit landing places to the best Chambers of each Story, with Backstairs within the Noell¹ of it, convenient for Servants to pass up and down to the inward Rooms of them unseen and private.

¹ Noell, in the MS.

[*A scru'd ascent of Stairs.*] This title does not strictly agree with the text, for there is a material difference between "a screwed ascent, *instead* of stairs," and "a screwed ascent of stairs;" the former altogether dispenses with stairs, giving the idea of an inclined ascent without steps, such as is employed in the construction of the Observatory of Copenhagen; the width being sufficient and the ascent so gradual, that a carriage and four may easily be driven up to the top circular gallery.

According to this improvement there are "back-stairs within the *noell*," that is, the Noel, Nowel, Noyau, or Newell, a term applied to the centre round which the stairs of a circular staircase wind, and which may be either a solid column, or an open space. Such stairs are said to be neweled.

The great labour and expense bestowed on some kinds of staircases is well exemplified by Evelyn in his tour of France, who describes going to Blois, in 1664, and seeing there a palace built by Francis the First, the staircase of which, consisting of 274 steps, is mentioned by Palladio; he notices it as a wonderful piece of work, from its construction having occupied 1800 workmen during twelve years. "The stayre-case (he says) is devised with four entries or ascents, which cross one another, so that though four persons meet, they never come in sight, but by small loopholes, till they land." —Memoirs of John Evelyn, 2nd edit. 4to. vol. i. page 59.

49.

A portable Engine, in way of a Tobacco-tongs, whereby a man may get over a wall, or get up again

being come down, finding the coast proving² ³ unsecure unto him.

² proveth insecure for him. P.

³ proveth.

[*A Tobacco-tongs Engine.*] The designation here given, when published in 1663, was doubtless generally understood, but the smallness of the "engine," its very nature, and not less, its long discontinuance of use, now renders the passage obscure. It so happens, however, that a scientific experiment, in which this humble instrument was employed by the Honourable Robert Boyle, has preserved, for our information in this matter, the true figure of the "tobacco-tongs." In the 3rd Volume of Boyle's Works, folio, published in 1744, is recorded his pneumatical experiments on the falling of bodies in vacuo. Treating of "New experiments physico-mechanical, touching the spring of the air," illustrated by the well-known experiment of dropping at the same time a guinea and a feather within an exhausted glass receiver, he says: "We so fastened a small pair of *tobacco-tongs* to the inside of the receiver's brass cover, that by moving a turning key, we might by a string tied to one part of them open the tongs, which else their own spring would keep shut."



In an illustrative engraved plate, accompanying his description, the fourth figure therein is designed to show the tobacco-tongs," which appear in the form of a figure of 8, as in the annexed diagram, where *a*, is the top or hand portion, being the largest oval, while the lower oval *b*, is not above one third its size, at which point this steel spring instrument was cut through, to form the tong or nippers. We imagine that a side view would be like the dotted figure *c*, *d*, where *d*, shows how the ends of these nippers were probably elongated a little, the more readily to take up and part with the tobacco

or other material. The least pressure on the outside of the large oval, will extend the nippers *b*, *d*, which again close when such pressure is removed.

But there may have been another form of such tongs, like the letter X, or two such figures combined; and by increasing the series we should produce the instrument known as the lazy-tongs, which collapse into a very small space, yet will extend to a great distance.

50.

A complete light portable Ladder, which taken out of ones Pocket, may be by himself fastened an hundred foot⁴ high to get up by from the ground.

⁴ feet. P.

[*A Pocket-ladder.*] There are many curious and ingenious designs for portable scaling ladders, offered by Vegetius in "De re militari," 1535, but which would require to be very considerably modified to become pocketable; however, they occur in every variety at page 35, in short pieces, each with a screw at one end, and a socket at the other; at p. 59, as a neat rope ladder; at p. 113, on the principle of the lazy-tongs; and at p. 162, a method of connecting short poles is exhibited.

Robert Fludd, in the second book of his works, published in 1617 and 1618, folio, page 414, gives a large copper-plate engraving of a very ingenious form of ladder. Each step is of wood, and the two sides of rope. The ingenuity of the invention consists in each step having a ferrule at one end, and the opposite end tapered sufficiently to fit into each ferrule of the adjoining step; by this means the whole can be put together like an ordinary fishing rod, and the top step terminat-

ing with a hook, it can easily be attached to any elevated place, and on pulling the pole, each part separates, falling at once into the form of a ladder with rope sides. Bourne's 62nd Device, in his "Inventions, or Devices," 1578, is—"How for to make a sealing ladder."

Van Etten, 1653, gives for his 111th Problem, "To make a Ladder of Cords, which may be carried in ones pocket: by which one may easily mount up a wall, or tree alone." It consists simply of two pulleys, with "a cord of an half inch thick (which may be of silk, because it is for the pocket)," having a staff at one end to sit upon. The author gravely concludes, "This secret is most excellent in warre, and for lovers, its supportableness avoids suspicion." See page 248.

Among Friar Bacon's inventions, the following is recorded in the fourth chapter of his "Discovery of the Miracles of Art, Nature and Magick," 12mo. published in 1659:—"It is possible to invent an Engine of a little bulk, yet of great efficacy, either to the depressing or elevation of the very greatest weight; which would be of much consequence in several accidents; for hereby a man may either ascend or descend any walls, delivering himself or comrades from prison; and this engine is only three fingers high and four broad."

51.

A Rule of Gradation, which with ease and method reduceth all things to a private correspondence, most useful for secret Intelligence.

[*A Rule of Gradation.*] Probably some scheme which appeared to be capable of indefinite multiplication, the object of the secret correspondent always being

to elude the utmost skill of an expert decipherer. Twenty-six lines of 26 letters of the alphabet each, would form a square; and supposing the letters placed in different order on each line, we might produce 26 linear alphabets, and 26 columnar alphabets; or change these by diagonal or other lines. These, and similar variations appear interminable, but it is questionable whether they would not delay rather than defy detection.

52.

How to signifie words and a perfect Discourse by⁵ jangling of⁶ Bells of any Parish-Church, or by any Musical Instrument within hearing, in a seeming way of tuning it; or of an unskilful beginner.

⁵ by the.

⁶ of the.

[*A mysticall jangling of Bells.*] There occurs at page 185, of Van Etten's *Math. Recreat.* 1653, among the several heads of Problem 84, "Of changes in Bells." He inquires: "Is it not an admirable thing to consider how the skill of numbers doth easily furnish us with the knowledge of mysterious hidden things?" He says: "It is often debated—what number of changes there might be made in 5, 6, 7, 8, or more bells;" observing thereon, "that a childe which can but multiply one number by another, may easily resolve it." Not only have we here a kindred subject discussed, but also in language very analogous to that employed by the Marquis, particularly in the use of the words "mysterious," "admirable," and "a child;" the latter being a favourite similitude.

53.

A way how to make hollow and cover a Water-scrue as big and as long as one pleaseth in an easie and cheap way.

[*An hollowing of a Water-scrue.*] This was probably no more than an ingenious piece of carpentry, to obtain an object which was then most likely of considerable importance. Three of his inventions refer to the Archimedian screw, so that the Marquis seems to have given the subject more than ordinary attention.

54.

How to make a Water-scrue tite, and yet transparent, and free from breaking; but so clear, that one may palpably see the water or any heavy thing how and why it is mounted by turning.

[*A transparent Water-scrue.*] This invention does not appear to be offered as one of any other use than for pleasure and instruction, to "see the water or any heavy thing, how and why it mounteth by turning." Was it not by such models that he had early informed his own mind?

If the transparent covering was not to be glass or horn, the Marquis may have used the material proposed by Sir Hugh Plat in his "Jewel House of Art and Nature," 1653, in which is given, at page 72, a recipe: "To make parchment clear and transparent to serve for divers purposes. This I commend, (he says) before

oiled paper, because it is more lasting"—when employed for windows.

55.

A double Water-scrue, the innermost to mount the water, and the outermost for it to descend more in number of threds, and consequently in quantity of water, though much shorter then the innermost scrue, by which the water ascendeth, a most extraordinary help for the turning of the scrue to make the water rise.

[*A double Water-scrue.*] The arrangement of this simple invention is so clearly and amply set forth, that it is a wonder it could ever have been misunderstood; yet it so baffled Mr. Partington, that he classes it among "extraordinary sleight of hand discoveries."

M. Pattu, a French engineer, in 1815, published his account of a double water-screw of this description which he had invented, capable of being applied in three different ways, the construction, however, in all being the same. In one arrangement, the enlarged end of the screw is about one-eighth part that of the entire length of the internal or lesser screw, and it surrounds the "innermost" screw, the spirals winding in a reversed direction. The top of the shorter or "outermost" screw may be on a level with a stream of water "for it to descend" therein, to promote "the turning of the screw" (of greater length and smaller diameter) "to make the water rise," from a lower stream.

In a second application, the long screw may be used to propel the short one, to raise water a moderate height.

Or, thirdly, the enlargement may form the upper end, and be used to propel from above, instead of from below, as at first described.

56.

To provide and make that all the Weights of the descending side of a Wheel shall be perpetually further from the Centre, then those of the mounting side, and yet equal in number and heft to⁷ the one side as the other. A most incredible thing, if not seen, but tried before the late king (of⁸ blessed memory) in the *Tower*, by my directions, two Extraordinary Embassadors accompanying His Majesty, and the Duke of *Richmond* and Duke⁹ *Hamilton*, with¹ most² of the Court, attending Him. The Wheel was 14. Foot³ over, and 40. Weights of 50. pounds apiece. Sir *William Balfore*,^{4*} then Lieutenant of the *Tower*,⁵ can jus-

⁷ of—for to. MS. and P. ⁸ of happy and glorious. MS. and P. ⁹ of, omitted.

¹ and—for with. ² most part. ³ feet P. ⁴ Belford. MS. and P.

⁵ and yet living can.

* Among the Additional Manuscripts in the British Museum occurs No. 6176, a MS. volume, containing at folio 16, *b*, a "Certificate of the Armory in the Tower," signed among others by "W. Balfour," Lieutenant of the Tower, "17th Dec. 1640."

tifie⁶ it, with several others. They all saw, that no sooner these great Weights passed the Diameter-line of the lower⁷ side, but they hung a foot further from the Centre, nor no sooner passed the Diameter-line of the upper⁸ side, but they hung a foot nearer. Be pleased to judge the consequence.

⁶ testify—for justify. P.

⁷ upper—for lower. MS. and P.

⁸ lower—for upper. MS. and P.

[*An advantageous change of Centres.*] This is the most minutely as well as circumstantially noted of all the Marquis's inventions; yet we have no evidence of his ever afterwards recurring to it. The mention of Sir William Balfour makes it probable that the exhibition of this great weighted wheel took place between 1638 and 1641. [See *Life, Times, &c.*, page 25.] Dr. John Dee, in his celebrated preface to Sir Henry Billingsley's first English edition of Euclid, published in folio, 1570, speaks of such a machine, as not only possible, but as having been actually constructed, and "a thing most incredible if not seen;" this, compared with the language used by the Marquis, would lead to the supposition that he had not only read but copied the passage.

It is difficult to reconcile the statement he has here made, with the declaration on the title page, of his inventions having been "tried and perfected." In this single instance, he leaves the reader to "Be pleased to judge the consequence."

Dr. Desaguliers, in a memoir, published by the Royal Society, vol. 31, 1720-21, quoting the foregoing article, ventures the reply: "Now the consequence of this, and such like machines [assuming them to be as above

described,] is nothing less than a perpetual motion." Of course he does not admit even the possibility of such an arrangements of parts, he only allows that if *that* could be executed, the other would follow. But Desaguliers admitted too much, for it may easily be demonstrated that the conditions stated may be mechanically produced, without any resulting motion. Let the annexed diagram represent a wheel of 14 feet in diameter,

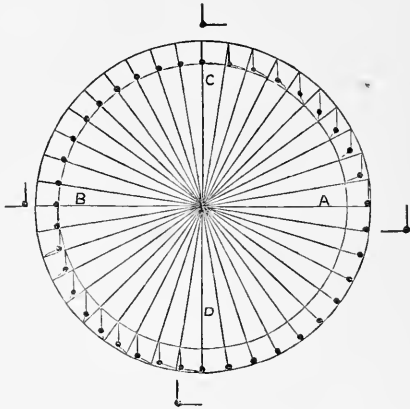

having 40 spokes, seven feet each, and with an inner rim coinciding with the periphery, at one foot distance, all round. Next provide 40 balls or weights, hanging in the centre of cords or chains two feet long. Now fasten one end of this cord at the top of the centre spoke C, and the other end of the cord to the next right hand spoke one foot below the upper end, or on the inner ring; proceed in like manner with every other spoke in succession; and it will be found, that, at A, the cord will have the position shown outside the wheel; while at B, C, and D, it will also take the respective positions, as shown on the outside. The result in this case will be, that, all the weights on the side A, C, D, hang to the great, or outer circle, while on the side B, C, D, all the weights are suspended from the lesser or inner circle.

And if we reverse the motion of the wheel, turning it from the right hand to the left hand, we shall reverse these positions also, (the lower end of the cord sliding in a groove towards a left hand spoke) but without the wheel having any tendency to move of itself.

His notice of this exhibition was not written by the Marquis until 1655, from 14 to 17 years after its occurrence, and he may have then hesitated to say that it was not a success; but he may have persuaded himself that he was at last in possession of the secret that was at first wanting. Besides, we are not to infer that the company described as being present had gone to the Tower purposely to see the Marquis's wheel; it being far more probable that, Charles the First and the foreign ambassadors were there to view that fortress with all its treasures and curiosities.

According to the state of knowledge in 1663, the Marquis of Worcester was not singular in entertaining this subject, and all we can make of the present article is, that he has left it open to doubt whether he himself did not consider that his experiment required confirmation. "Perpetuum Mobile; or a history of the search for self-motive power," 1862, is a work which may be taken as an elaborate note on this article, for it was the perusal of it that led the author, to commence the compilation of that work, more than thirty years ago.

Before the publication of the "Century" Samuel Hartlib had, (on the 10th of August, 1658,) written to Mr. Boyle on the subject of a perpetual motion invented by the ingenious and celebrated John Joachim Becher, an account of which was to be printed at Frankfort. —Boyle's Works, fol. 1744, p. 280.

Charles the Second was favoured with the exhibition of another scheme of this sort, by John Evelyn, a

Fellow of the Royal Society at the time, and therefore not likely to participate in any matter which the scientific world of his day repudiated. But learned men of his time rather approved of all wonder-working automata than otherwise. Evelyn says in his Diary, under the date of 14th July, 1668, that during an interview with the King:—"I showed his Majesty the perpetual motion sent to me by Dr. Stokes from Cologne."—Vol. ii. p. 37, ed. 1859.

57.

An ebbing and flowing Water-work in two Vessels, into either of which the water standing at a level, if a Globe be cast in, instead of rising it presently ebbeth, and so remaineth untill a like Globe be cast into the other Vessel, which the water is no sooner sensible of, but⁹ that¹ Vessel presently ebbeth, and the other floweth, and so continueth ebbing and flowing untill one or both of² the Globes be taken out, working some little effect besides its own motion, without the help of any man within sight or hearing: But if either of the Globes be taken out with ever so swift or easie a motion, at³ the very instant the ebbing and flowing ceaseth; for if during the⁴

⁹ but that the. P.¹ the—for that.² of—omitted. MS. and P.³ at that instant. P.⁴ that—for the.

ebbing you take out the Globe, the water of that Vessel presently returneth to flow, and never ebbeth after, until⁵ the Globe be returned into it, and then the motion beginneth as before.

⁵ unless—for until.

[*A constant Water-flowing and ebbing motion.*] We are very much mistaken if this is not the result of one of the Marquis's early experimental model demonstrations, and a happy illustrative example for the lecture-table of raising water by the condensation of steam.

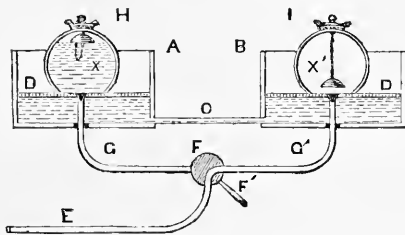

A, B, represents two water tanks or cisterns, permanently connected by the water-pipe C, and having within, D, D, two perforated shelves or false bottoms; E, is a main steam-pipe, with a four-way steam cock at F, branching into the form shown at G, G', and passing through the bottom of each tank, rises vertically to the level of the false bottoms, where each is supplied with a valve at the top end, to prevent the ingress of water. G', is shown receiving steam from E. H, I, are two hollow metal globes, surmounted with a small crown ornament to conceal a spring valve, to which a floating weight is suspended by a chain, as at X'; but floated upwards at X, where it operates to open the spring valve within the crown. In the above

diagram, it is obvious that water placed in A, will flow onward to B, and stand at the same level in both cisterns. The valve in each globe requires to be so arranged, that when forced open its spring will prevent its closing until acted on by a weight, which weight must hang to the inside of the valve by means of a chain, and be able to float on the surface of the water, and it will be requisite to adjust the chain to such a length that when the water is at a certain level it shall have no influence on the float-weight of the valve, which will then close.

With this apparatus, the operator can conceal the connection between the two cisterns, and that between the bottoms to admit steam. The water is now seen at the same level in "two vessels," and with a perforated shelf about an inch below the surface of each. We may now find, "if a globe be cast in," the water "instead of rising, it presently ebbeth, and so remaineth," doing nothing further "until a like globe be cast into the other vessel; which the water is no sooner sensible of, but *that* vessel presently ebbeth, and the other floweth." For it must be observed, the first globe was placed in the centre, over a steam pipe, its nozzle protected with a valve, and on letting in the steam, being otherwise empty and the valve purposely opened for the escape of steam and air, but which its weight closed as soon as permitted to act, and thereon condensation followed, the water flowed into that vessel, but ebbed in the other. We then insert a second globe, in the second cistern, under like conditions; and as soon as the rising water has opened the top valve of the first globe, this second globe will repeat the operation, "and so continueth ebbing and flowing until one or both the globes be taken out." And this ebbing and flowing, this rising, and these

changing heights in the water in the two tanks or cisterns, may easily be adapted for “working some little effect besides its own motion, without the help of any man within sight or hearing,” and of course too far off to be the acting agent in such additional “working of some little effect,” some see-sawing action, to work automata or like “little effects” for the delectation of the ingenious and the delight of all the lovers of the marvellous. And note “if during the ebbing,” when that globe and that cistern is all but empty, “you take out the globe, the water of that vessel presently returneth to flow,” showing that the globe thus removed was quite empty; and therefore would be shown as part of the miracle, the same empty globe had been performing such strange motions in the water. But let “the globe be returned (empty as it was before) into it [the cistern], and then the motion beginneth as before.”

If we are correct in this conjecture, the principle involved would easily account for the inventions couched in the terms of articles No. 22, An ebbing and flowing river; and No. 23, An ebbing and flowing Castle Clock.

The present article, viewed in any other light than as illustrative of the peculiar properties of the great principle with which he was operating, and which he was incessantly investigating, and varying its applications, is altogether incomprehensible. But it was very natural for him to preserve in this simple but striking form the sure signs of greater applications. In the present example, we have no attempt, in this philosophical demonstrative model, to cater to the popular taste, although the fertile genius of the noble inventor could not permit the suggestion to escape his pen that the rise and the fall of the water might be made to operate—shall we say bellows, mills and the like, and

cause birds to chirp, and fountains to play? Thus "working some little effect besides its own motion" of soberly ebbing and flowing. But this is a mere parenthetical, gratuitous offer to dash the concealed purpose, and give colour to the supposition that it had no higher design. There is generally something to serve for amusement, or to answer some practical purpose, observable in all the 100 articles, but who could assign the use of two globes, in two vessels of water, causing the same to flow and ebb? Viewed independent of the object here suggested, it bears a most purposeless character; and in no other way than as illustrative of the results of the condensation of steam, set forth in a merely experimental apparatus, can we conceive it possible of receiving either a scientific or any other reasonable explanation.

For adjusting the apparatus it would be necessary to fill the troughs or cisterns until the water was level with the perforated false bottom, and next to add as much more water as would be equal to the contents of one globe, when the water altogether would cover the false bottoms. The globes should be heavy enough not to overturn either on the admission of the steam, or the expulsion of steam and air from beneath. While steam is entering, the top spring-valve is kept closed by the float-weight, but when condensation commences, the external pressure performs the same duty; so soon, however, as the rising water has elevated the float to the underside of the spring-valve, its pressure against it and the action of the spring, cause it to open, and then the column of water will at once commence descending. As a matter of detail, the float would require a guide rod, or some similar contrivance to direct and keep its course uniformly under the valve, so as to open it.

The whole experiment is one of mere matter of fact

and not of excellence. It is simply to develop a principle and not to carry out any express piece of curious workmanship; there is not, therefore, any statement of its possessing surprising qualities, the utmost proposed is "a constant water-flowing and ebbing motion," without any condition as to degree, quantity, or extent of its effect. This and no more would the apparatus here described demonstrate on its trial.

This article of the "Century" strikingly illustrates how truly the Marquis wrote it as he says—"in a way, as may sufficiently instruct *me* to put any of them in practice;" or, rather to repeat the practice of them, for he has only a line or two before told us, they are such of his inventions as "I can call to mind to have TRIED and PERFECTED;" and what he wrote he meant, let sceptics and superficial critics pervert his words as they may to uphold their own narrow conceits. The reader of articles, Nos. 22 and 23, is informed of effects without the least intimation of a means; he is then amused with springs, weights, levers, portable bridges, fortifications, stenography, keys, automata, stairs, ladders, cochlea, and so forth, to the number of 33 inventions, and then, after losing sight of No. 22, and No. 23, he is invited to examine the machine by which the "ebbing and flowing" effects are produced. All this is perfectly legitimate, but, nevertheless, well worthy of notice, as opening to view the peculiar tact and skill of the writer; and the extreme necessity of exercising cautious judgment in our estimate of "The treasures buried under these heads, both for war, peace, and pleasure."

It is when we refer back to No. 22, that we become convinced, beyond what No. 57 alone might persuade us of, that by no means short of the condensation

of steam could the proposed ebbing and flowing be effected on a river "twenty feet over," and be managed by "a child's force," as in article No. 100.

58.

How to make a Pistol to discharge a dozen times with one loading, and without so much as once new Priming requisite, or to change it out of one hand into the other, or stop ones horse.

[*An often-discharging Pistol.*] About the year 1575, a description was given of the operation and advantages of a certain newly invented engine of war, whereby twenty-four bullets could be discharged from one piece at a time. And it appears that at that period there were in the Tower 200 of the engines and 3000 bullets.—Cal. State Papers, Vol. 106.

About 1580 (?) John the Almain of Walsyngham, recommends one of his countrymen, who had invented an harquebuse, "that shall contain ten balls or pelletes of lead, all the which shall go off, one after another, having once given fire; so that with one harquebuse one may kill ten thieves or other enemies without recharging."—Cal. State Papers, Vol. 146.

Porta, in his "Natural Magick," folio, English edition, 1658, gives an account, in the 12th Book, how "A brass gun once fired, may discharge ten times." He says, "It is a new invention, that a great brass-gun, or hand-gun, may discharge 10 or more bullets one after another without intermission. Make a dark powder, such as I used in the precedent part, and fill it thus:—First, put in a certain measure of gunpowder, that

being put in, may discharge the ball, but a small one, that it may go in loosely, and that the powder put in upon it may come to touch the gunpowder: then pour in this dark powder two or three fingers deep; then put in your gunpowder and your bullet; and thus in order, one after the other, until the gun seems to be full to the very mouth. Lastly pour in some of your dark clammy powder: and when you have levelled your gun to the place appointed, put fire to the mouth of it; for it will cast out the bullets, and then fire for so long time as a man may discharge a hand-gun at divers shoots. And thus with one brass-gun you may discharge many times.”—(p. 293.)

59.

Another way as fast and⁶ effectual, but more proper for Carabines.

⁶ and as.

[*An especial way for Carbines.*] The Carabine or Carbine was a short gun for bullets of twenty-four to the pound.

60.

A way with a Flask appropriated unto it, which will furnish either Piftol or Carabine with a dozen Charges in three minutes time, to do the whole execution of⁷ a dozen fhots, as soon as one pleafeth, proportionably.

⁷ of 12.

[*A Flask-charger.*] His patent of 1661 gives the

following altered reading to his improvements applying to guns, thus:—"To make certain guns or pistols, which in the tenth part of one minute or an hour, may, with a flask contrived to that purpose, be recharged, the fourth part of one turn of the barrel, which remains still fixed, fastening it as forcibly and effectually as a dozen threads of any screw, which in the ordinary and usual way require as many turns."—See Appendix B.

61.

A third way, and⁸ particular⁹ for Musquets, without taking them from their Rests to charge or prime, to a like execution, and as fast as the Flask, the musquet containing but one Charge at a time.

⁸ and—omitted.

⁹ particularly. P.

[*A way for Musquets.*] The heavy firearms of the seventeenth century afforded the Marquis fine scope for the exercise of his versatile ingenuity. Muskets were originally matchlocks; long, heavy, and requiring a tall forked rest to steady them in firing. Eventually their bore was reduced for bullets of eighteen to the pound. It is curious to observe the difference between the drill practice of those times compared with the present. In "The compleat Gentleman," by Henry Peacham, M.A., published in 1627, among his other "Military Observations," he gives the following: "The postures of the Musquet. 1. March with your Musquet and Rest shouldred; 2. Prepare your Rest; 3. Slipp your Musket; 4. Pease your Musket; 5. Joyne your Rest and Musquet; 6. Take out your Match; 7. Blow your Match; 8. Coek your Match; 9. Try your Match;

10. Guard your Pann; 11. Blow your Match; 12. Open your Pann; 13. Present; 14. Give Fire," &c.

Then, "25. Open your Charge; 26. Charge your Musket; 27. Draw out your Scouring Sticke; 28. Shorten your Scouring Sticke; 29. Ram your Powder; 30. Withdraw your Scouring Sticke;" &c.

Thomas Smith, in his "Additions to the Book of Gunnery, both pleasant and profitable," published in quarto, 1643, black letter, mentions "certain short muskets of an inch, or very near an inch bore, out of which you may shoot either chained bullets, or half a score pistol bullets, or half a dozen harquebus bullets at one shot, or you may shoot out of the same fire arrows made with strong shafts, feathered with horn, or with common feathers, glued and bound on with thread. When you are to shoot a fire arrow out of any of these pieces, you must not give the piece her full loading of powder." He further notices that "The string made fast to the end of the fire-work is to keep the arrow straight in his passage."



A graphical sketch of the soldier accompanies these remarks (as in the facsimile annexed), which appears almost a caricature, but it must have been seriously approved as a good illustration, by our author, the "Souldier of Berwick-upon-Tweed."

Mr. Hewett gives the following table in his "Ancient Armour and Weapons," page 715.

	Length of Barrel.	Number of Bullets to the pound.	Nature of lock.
Musquet . .	4 ft.	10	Match
Harquebus .	2½ ft.	17	Wheel
Carbine . .	2½ ft.	24	Flint

62.

A way for a Harquebufs, a Crock, or Ship-musquet, fix upon a Carriage, shooting with such expedition, as¹ without danger one may charge, level, and discharge² them sixty times in a minute of an hour, two or three together.

¹ as that.

² level and discharge—omitted.

[*A way for a Harquebus, a Crock.*] Arquebuse, corrupted to Harquebus—a firearm requiring a forked rest placed in the ground, on which to steady the heavy barrel, which carried a ball of 2 ounces, or for fortresses 3½ ounces.

Arquebuse à croc—a small piece of ordnance placed on a stock or club, fired by a match. We find among the records of the State Paper Office the following notice in the Calendars, viz. :—John the Almain* writes

* Almain engineers seem to have been in much repute.

to Walsyngham, recommending one of his countrymen, who had invented an harquebuse “that shall containe ten balls or pellets of lead, all the which shall goe off, one after another, having once given fire, so that with one harquebuse one may kill ten theeves or other enemies without recharging.”—Cal. State Papers, Dom. Series, 1547-1580. Edited by R. Lemon, F.S.A., 8vo. 1856, p. 696. No. 45.

63.

A sixth way,³ most excellent for Sakers, differing from the other, yet as fwift.

³ way—omitted.

[*For Sakers and Minions.*] Sakers were cannon, 5 to 8 pounders; and Minion, long 4 pounders, or short 3 pounders.

64.

A seventh, tried and approved before the late King (of ever blefled memory) and an hundred Lords and Commons, in a Cannon of 8. inches half quarter,⁴ to shoot Bullets of 64. pounds weight, and 24. pounds of powder, twenty times in fix minutes; so clear from danger, that after all were discharged, a Pound of Butter did not melt being laid upon the Cannon-britch, nor the green

⁴ a quarter. P.

Oile difcoloured that was first anointed⁵ and used between the Barrel thereof, and the Engine, having never in it, nor within six foot, but one charge at a time.

⁵ it and.

[*For the biggest Cannon.*] This article affords a further example of the practical working out of another invention of the Marquis, and possibly at the Tower, previous to 1641.

As early as the 16th century cannon had been undergoing gradual although slight improvements. The Marquis had many opportunities for obtaining the best information, and his active mind must have long been on the alert, both at home and abroad, to ascertain all that was then known on the subject of their manufacture, with their best form and dimensions. We have very early intelligence on the subject of Engines of War among the valuable records of our State Paper Office, from which we have selected the following:—

1575? No. 74. Description of the operation and advantages of a certain newly invented engine of war, whereby twenty-four bullets can be discharged from one piece at a time.

No. 75. Notes by the inventor touching the engines of war, with the expense of making a few at a time. It would require above 100 engines to be employed at once. Desires a yearly pension in consideration of his invention.

No. 76. A note of the effects already performed by the engine of war; of which there are 200 engines and 3000 bullets already delivered into the Tower for service.—Cal. State Papers, Dom. Series, 1547-1580. Edited by R. Lemon, F.S.A., 8vo. 1856, page 513.

In the Bodleian Library there is a folio volume of the MS. papers of General Mountagu, or the Earl of Sandwich, lettered on the back "Carte Papers, 1604-1684. Letters to Earl of Sandwich, &c. 74," in which is the following: "Invention for Cannon to doe extraordinary execution. (No. 123.) Canon that shall slute more then 400 paces, a bulett of four fadem longe to destroy the Riggings of any ship, the which bulett must necessarily goe a twart, and cannot come perpendicularly, as other chayne buletts, and other such like, who by that means may misse the intended effect and passe through the cordage or Riggings."

Among the Sloane MSS. in the British Museum is one, No. 2497, with rude drawings of cannon, &c. viz.: a fauconet; a faucon; a minnion; a saker; a demi-culvering; a culvering; a demi-cannon; a cannon; a cannon-peuterer; a cannon-rial; each with its proper ball, ramrods, &c.

Robert Norton, Engineer and Gunner in "The gunners dialogue with the art of great Artillery," a black letter quarto, accompanying "The Arte of shooting in great ordnance," by William Bourne, 1643, gives the names, &c. of ordnance, thus:—

Cannon of 8	weighing 8,000 lbs.
— of 7	7,000
Demi-Cannon	6,000
Culvering	4,500
Demi-Culvering	2,500
Saker	1,500
Minion	1,200

Among other inquiries in the course of the dialogue occur the following:—"If you were to make a shot in the night, at a mark showed you in the day, how would you prepare for it?" And:—"How would you make a

shot at an enemies light, in a dark night, not having any candle, lanthorn, or other light by you?"

David Papillon, in his "Practical Art of Fortification," 4to. 1645, enumerating the ordnance and ammunition of a garrison, observes:—"for a towne of two English miles circumference, of these sorts, six cannons, six demi-cannons, six long culverins [or double for a sea-port], twentie sacres [or less for a sea-port], and twelve drakes, and one hundred thousand [pounds?] weight of powder."—P. 97.

In "Mathematical Magick," 1648, Bishop Wilkins incidentally remarks—"the greatest cannon in use, does not carry above 64 pound weight," page 126. And in the 19th chapter of the same work he states the charge to be 40 lbs. of powder.

John Greaves, Geometry Professor of Gresham College, who was born in 1602, and died in October, 1652, made experiments for trying the force of great guns, at Woolwich, 18th of March, 1651, which were published in the 15th volume of the Philosophical Transactions, 1685.

The following extracts are given, from their specifying the description, weight, and sometimes the size of the cannon used, with the charge of powder and weight of shot.

The great ordnance tried were:—

1. "An iron demy Canon, of 3500 lbs. weight, and having a cylinder bore, the bullet 32 lb. of iron, the powder 10 lb.

2. "An iron demy Canon, having a taper bore, and being 3600 lbs. in weight, and 4 inches longer than the former, the iron bullet 32 lb.

3. "Experiment with a whole Culverin in brass, of 5300 lbs. in weight, 11 foot one inch in length, with a taper bore, being intended for a chase piece to the

frigate called the *Speaker*; the iron bullet was 18 lbs. in weight, the powder 10 lbs.

4. "A whole Culverin in brass, made at Amsterdam, for the French, with this mark 3580, being 10 foot long, and not very thick in the breech, 18 lb. bullet, and 9 lb. of powder.

5. "An iron Demy Culverin, 9 lbs. iron bullet, and 4 lb. of powder. This half Culverin was shot eight times.

6. "A brass Demy Culverin, the breech $13\frac{5}{8}$ inches, the mouth $9\frac{5}{8}$, 9 lb. iron bullet, 4 lb. of powder."

65.

A way that one man in the Cabin may govern the⁶ whole side of Ship-musquets, to the number (if need require) of 2. or 3000. shots.

⁶ a—for the. MS. and P.

[*For a whole side of Ship-musquets.*] The list of five inventions, which appears in the "Life, Times, &c.," page 316, refers to a similar improvement, viz.: "Oft shooting peards, controlable in one plane, either for number or time."

The 43rd Device, given by Bourne in his "Inventions or Devices," 1578, is entitled, "How to make any piece of Ordnance go off at any hour or time appointed, by itself, and no person there."

Again, in the 44th Device, we have, "How to make a piece go off when you list, and no person there."

66.

A way that against⁷ several Advēnes⁸ to a Fort or Castle, one man

⁷ the. MS. and P.

⁸ avenues. P.

may charge fifty Cannons playing,
and stopping when he pleaseth,
though out of sight of the Cannon.

[*For guarding several advenues to a Town.*] This would appear to be no more than an extended application of the preceding invention. We can imagine that Caspar Kaltoff executed a very beautiful model of this piece of machinery, with its 50 little brass guns, 50 ramrods, &c., all worked simultaneously by a man below, "out of sight of the cannon;" but it is very unlikely that the Marquis would have recommended its adoption; it shows, however, how he persevered in endeavours to abridge human labour.

67.

A rare way likewise for musquettoons fastened to the Pummel of the Saddle, so that a Common Trooper cannot misse to charge them, with twenty or thirty Bullets at a time, even in full career.

*When first I gave my thoughts to
make Guns shoot often, I thought
there had been but one only exquisite
way inventible, yet by several trials
and much charge I have perfectly
tried all these.*

[*For Musquettoons on horseback.*] The remark which forms a postscript to this article, naturally leads to the conclusion that the improvements in guns were among the later inventions of the Marquis, perhaps about or

after 1641, when his own active services promised soon to be required in the field. His improved firearms are chiefly recommended for effecting rapid firing. It may have been one of the results of his experiments, that Caspar Kaltoff became engaged at Vauxhall in such manufactures for the government.

The Marquis would obtain little assistance from Vegetius, although he would find some extraordinary applications of "Mirabilis Machina." We see there the "Tormentum," with its great stone ball, and fire issuing from muzzle and touch-hole, manipulated after an extraordinary fashion, bristling down the sides of an angular frame; whirled round on a circular table like a capstan; eight placed crosswise; or two placed breech to breech, one horizontal, the other vertical, to be fired from behind a goodly target. But the Marquis went far beyond these ancient military weapons, for gunpowder was then beginning to be understood and applied with a degree of effect that startled and surprised the enemy, while it only disgusted the humane portion of our forefathers of that day, who, in case of dire necessity alone, favoured the use of balista, catapulta, bows, and pikes, in the conduct of military and naval engagements.

Musketoons were the same as the blunderbuss, being of large bore to fire with a charge of twenty or more pistol bullets, of from seven to seven and a half ounces of lead, among a multitude, to disperse the crowd.

The arms offensive and defensive of the old militia, described by Grose, in his "Military Antiquities," 1801, as applying to a trooper, with the furniture for his horse, were as follows:—"The defensive armour, a breast, back, and pot (or scull cap without vizor or bever), pistol proof; the offensive arms, a sword, and a case of *pistols*, the barrels not under 14 inches in length; the furniture for the horse, a great saddle, or pad, with

burs and straps for affixing the holsters, a bit and bridle, with a pectoral and crupper: for the foot, a *musketeer* had a *musket*, the barrel, not under three feet in length, and the guage of the bore for 12 bullets to the pound, a collar of bandileers, with a sword." (Vol. 1.)

Abraham Hill, a Fellow of the Royal Society, patented, 3rd of March, 1664, among other inventions, one for guns and pistols, with several devices for the speedier and more effectual discharge of them; also a new kind of powder horn.

We shall close these observations on improvements in firearms with the following miscellaneous illustrations respecting the several kinds then in use.

In "The Exercise of Armes for Calivers, Musketts, and Pikes, after the order of his excellence Maurits Prince of Orange, &c. Sett forth in the figures by Jacob de Gheyn. Printed at the Hage," folio, 1607:—the instructions commence with an engraved illustration of the soldier, showing how he should stand and "carry his caliver, matche, and rapier;" and proceeds to observe, "he shall also hold the match burning or kindled at both the endes, betwixt the two least fingers of the same left hand." He is thus represented, holding a piece of smouldering touch-rope of two or three feet long, lighted at both ends, and has other similar reserve cords at his belt.

In the splendid work on "Ancient Armour and Arms," by Sir S. R. Meyrick, 2 vols. folio, 1830, numerous illustrative plates of firearms occur in the following order:—*Arquebus*, plate 114, figure 5.—*Blunderbuss*, a snaphaunce, from the Dutch donderbus, thunder-gun, p. 119, f. 10.—*Carabine*, a wheel-lock, p. 116, f. 1:—117, and 119, f. 9.—*Carabineers*, p. 43.—*Cross bow*, p. 94; 95; 98.—*Flask for powder*, p. 123; 124.—*Musket*, p. 117; 119.—*Musketeer*, p. 36.

68.

An admirable and most forcible way to drive up water by⁹ fire, not by drawing or sucking it upwards, for that must be as the Philosopher calleth it, *Intra*¹ *sphæram activitatis*, which is but at such a distance. But this way hath no Bounder, if the Vessels be strong enough; for I have taken a piece of a whole Cannon, whereof the end was burst, and filled it three quarters full of water,² stopping and screwing up the³ broken end; as also the Touch-hole; and making a constant fire under it, within 24. hours it burst and made a great crack: So that having a⁴ way to make my Vessels, so that they are strengthened by the force within them, and the one to fill after the other.⁵ I have seen the water run⁶ like a constant Fountaine-stream forty foot⁷ high; one Vessel of water rarified by fire driveth⁸ up forty of cold water. And a man that tends the work is but to turn two Cocks, that one Vessel of wa-

⁹ with—for by. ¹ “Intra”—in printed edition, 1663. But “Infra” in MS. and P.

² of water—omitted. MS. and P.

³ that—for the.

⁴ found a.

⁵ other, have seen. P.

⁶ to run.

⁷ feet. P.

⁸ driving 40 of.

ter being consumed, another begins to force and⁹ re-fill with cold water, and so successively, the fire being tended and kept constant, which the self-same Person may likewise abundantly perform in the interim between the necessity of¹ turning the said Cocks.

⁹ and that to refill.

¹ necessity of—omitted,

[*A Fire Water-work.*] This is that great invention which has popularized and preserved the fame of the Marquis of Worcester in the public mind. Had the whole of the Century been destroyed, with the exception of this 68th article, enough would have remained to satisfy any engineer, that the Marquis had achieved a grand discovery.

We shall proceed to notice what information books and the patent records would afford, to stimulate his inquiries into the possible practical application of the effects, resulting from the action of fire on water in close vessels.

The work which has, from being often quoted, acquired especial notice on this subject is, “*Les Raisons des forces Mouvantes avec diverses Machines. Par Salomon de Caus,*” folio, published at Frankfort, 1615, in which, at page 4, theorem V, under the title, “*L’eau montera par aide du feu, plus haut que son niveau,*” it is illustrated and described as follows:—“*Le troisieme moyen de faire monter, est par l’aide du feu, dont il se peut faire diverses machines, i’en donneray icy la demonstration d’une. Soit une balle de cuiure marquee A. bien soudee tout a lentour, à laquelle il y aura un souspiral marqué D, par ou lon mettra leau, et aussi un tuyau marqué B, C, qui sera soudé en*

haut de la balle, et le bout C, approchera pres du fond, sans y toucher, apres faut emplir ladite balle d'eau par le souspiral, puis le bien reboucher et le mettre sur le feu, alors la chaleur donnant contre ladite balle, fera monter toute leau, par le tuyau B, C." See also Figuiet's "Exposition et Histoire des principales découvertes Scientifiques Modernes." Tome premier. Paris, 1862, p. 25.

The adjoining engraving is exactly traced from the original, of which it is, in every respect, a faithful copy.

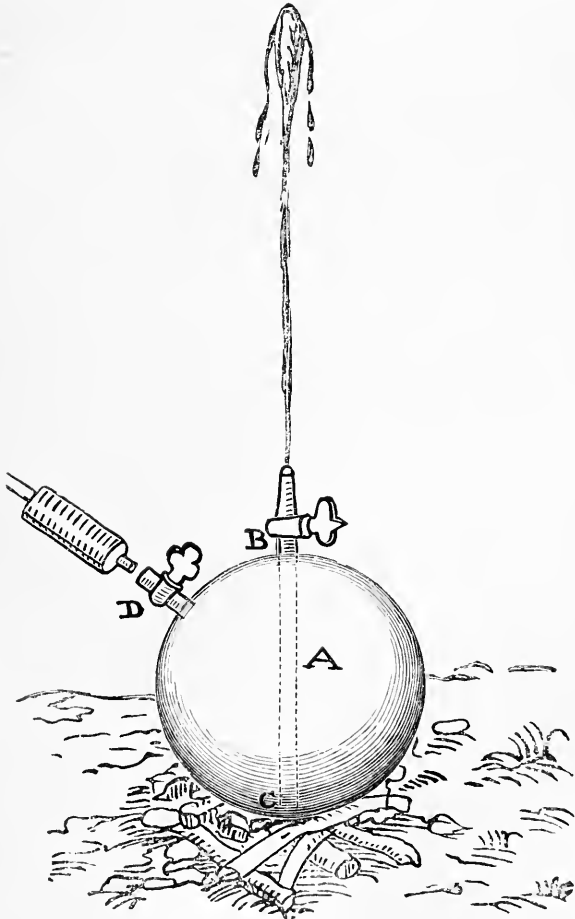

De Caus' Fountain.

It represents a globular metallic vessel A, with a jet and stop-cock at B, and another stop-cock at D, through which water can be injected by means of a syringe. The jet B, is the top end of a pipe C, which nearly touches the bottom of the inside of the hollow sphere. Supposing the globe to be half or two thirds full of water, and placed on a fire, the heat will presently raise a quantity of steam, which, as it increases in quantity, will occupy the upper empty space of the sphere, and by its pressure on the surface of the boiling water, cause the same to rise rapidly up the vertical pipe C, and produce the jet-d'eau above B, the instant the stop-cock is opened. And this operation will continue so long as any water remains for the bottom end of the pipe C, to dip into; after which it can only be renewed by refilling the vessel, and re-boiling the fresh supply of water.

De Caus, in his large folio work, in which varieties of fountains are explained by elaborate copper-plates, and minute descriptions, satisfies himself with the above brief explanation of the simple woodcut figure, which we have here reproduced; from which we infer that he laid no claim to its being his own invention, or at all events that he presented it to his readers as a gratuitous offering, for its curious and amusing results. It is not likely that the author of a considerable work, amidst recondite descriptions and sumptuous engravings of comparatively common affairs would consign his own most valuable contribution to a few lines of bare description and a coarsely engraved diagram. It is obvious, therefore, that De Caus himself, set no great store by this toy fountain; he saw no great scope in its application, and certainly never assumed it to be of greater value than as an amusing experimental fountain. To claim more for an Inventor, than an Inventor claims for himself is mere infatuation. To say that De Caus had

only to add another pipe, and only to make another arrangement or two, and then this petite fontaine would somewhat resemble a steam engine, is neither sound nor admissible. An inventor must be judged by his own aim and object, and the example he offers us, without any additions or subtractions at other hands. What De Caus describes, therefore, is not a continuous but an intermittent fountain; not self-feeding, but to be re-filled by a syringe; not emitting cold, but boiling hot water; and the difficulties and delays in the use of which materially increased in proportion with its dimensions.

But there was shortly afterwards published another highly suggestive work, on a mechanical application of steam, in "Le Machine," by Giovanni Branca, 4to. 1628; in which the 25th figure represents the operation of pounding, the pestles being acted on by pulleys and cog-wheels set in motion by a jet of steam issuing from a pipe against the vanes of a horizontal wheel. The boiler is in the fanciful form of the bust of a negro, with the steam pipe issuing from the mouth.

On the 21st of January, 1630, a patent was granted to David Ramsey, for, among other inventions, one "to raise water from low pits by fire." But unfortunately, like all patents of that period, it is unaccompanied by any description.

John Bate, in his "Mysteries of Art and Nature," 1635, 4to. has "a conceited lamp, for forcing water or air through the figure of a bird." A minute description is given for constructing a small boiler in the form of a crown, surmounted by a bird, and enclosing various perforated pipes and valves, capable of being turned in various directions; the whole is set over a circular lamp, with several cotton wicks. Water being put in the boiler, Bate observes—"Then the water being by little and little converted into ayre, by the heate of the lights

that are underneath, will breathe forth at the mouth of the cock ;” but, on being partially turned, “ then there being no vent for the ayre to breath out at, it will presse the water, and force it to ascend the pipe, and issue out where the air breathed before.” In conclusion he shrewdly remarks:—“ *Other devices and those more strange in their effects, may be contrived from hence.*” (p. 33, 34.)

In the “*Recreation Mathematique*” of H. van Etten, 1629, 12mo. of which there were translations in several editions, as 1633, 1653, and others, the 67th problem is descriptive “*Of the properties of Æolipiles or bowels to blow the fire.*” In the course of the article on this subject it is observed: “*Vitruvius, in his first book of Architecture, cap. 8, approves from these engines, that winde is no other thing than a quantity of vapours and exhalations agitated with the aire by rarefaction and condensation ;*” a remark curious enough, if only for the last word “*condensation.*” The article concludes—“*Now it is cunning and subtiltie to fill one of these Æolipiles with water at so little a hole, and therefore requires the knowledge of a philosopher to finde it out ; and the way is thus:—Heat the Æolipiles being empty, and the aire which is within it will become extreamey rarefied ; then being thus hot throw it into water, and the aire will begin to be condensed: by which meanes it will occupie lesse roome, therefore the water will immediatly enter in at the hole to avoide vacuitie: thus you have some practicall speculation upon the Æolipile.*”

Here we have “*condensation*” a second time adverted to, while the whole experiment proves the folly of attributing to Savery a similar result as a novelty leading for the first time to a knowledge of the property of “*condensation,*” to the disparagement of the

Marquis and his predecessors, assuming their total ignorance of what is here so clearly and graphically described.

Again, Van Etten in the fifth section of Problem LXXXV. treats—"Of a fine fountaine which spouts water very high, and with great violence by turning of a cock." page 193. "Let there be a vessel made close in all its parts, in the middle of which let a pipe open neare the bottome; and then with a squirt squirt in the water (stopped above by the cock or faucet) with as great violence as possible you can, and turne the cock immediately. Now there being an indifferent quantity of water and aire in the vessel, the water keeps itself in the bottom, and the aire which was greatly pressed, seeks for more place, that turning the cock the water issueth forth at the pipe, and flyes very high, *and that especially if the vessell be a little heated.*" The concluding sentence would no doubt afford a mind like that of the Marquis of Worcester's abundant matter for experimental trial, if ever consulted by him, either in the original, or in the translation of 1633.

The following extract from Van Etten's 83rd Problem, "Of Cannons or great Artillery," affords strong presumptive evidence (taken along with other extracts) of the Marquis's acquaintance with the work. The Problem is divided into two parts, of which the first alone need be noticed, namely,—“How to charge a cannon without powder.” It is observed—“This may be done with aire and water, only having thrown cold water into the cannon, which might be squirted forceably in by the closure of the mouth of the piece, that so by this pressure the aire might more condense, then having a round piece of wood very just, and oiled well for the better to slide, and thrust the bullet when it shall be time. This piece of wood may be held fast

with some pole, for feare it be not thrust out before his time: *then let fire be made about the trunnion or hinder part of the piece to heat the aire and water*, and then when one would shoot it let the pole be quickly loosened, for then the aire searching a greater place, and having way now offered, will thrust out the wood and the bullet very quick: the experiment which we have in long trunkes [tubes] shooting out pellets with aire only, sheweth the verity of this Probleme." (page 173.)

The words italicised are a complete description of the Marquis's experiment, although made with a widely different object, but both afford evidence of the force obtainable from a small quantity of heated water, the one in an imperfectly closed, the other in a well closed cannon. It is remarkable how near this experiment comes to the steam-engine cylinder, piston, and safety valve; and we can scarcely believe that such applications would escape the Marquis's observation, when repeated and varied as was his customary course in pursuing his own inquiries.

We have thus, from 1615 to 1653, shown, what sources were open to afford suggestions to the Marquis of Worcester's wakeful and watchful mind, alive and on the alert to seize on every hint promising some enlarged and useful application. We come next to that part of his own statement, where he says: "so that having found a way to make my vessels, so that they are strengthened by the FORCE within them, and the one to fill after the other, &c." "Vessels" may here apply to cisterns, receivers, boilers, &c., in short whatever appliances were used. But it is usually supposed to mean the boiler only, and hence the difficulty to understand how its safety should increase with the increased internal expansive *force* of the steam. But allowance must be made for the general vagueness throughout the

“Century,” and we must bear in mind that its language was not arranged to inform the public in respect to construction, but, as its author explicitly states, the several inventions are “set down in such a way as may *sufficiently* instruct *me* to put any of them in practice.” Now there is good ground for believing that the Marquis had a special meaning for the word “force,” as here applied, a word then used indifferently in its ordinary and in a technical sense, in the same sentence. This is particularly worth illustrating; firstly, because it shows a probability that the Marquis had, before 1655, designed some kind of safety-valve; and secondly, to remove the common supposition of the foregoing invention being utterly paradoxical.

It has already been stated, that there is sufficient evidence to prove, that John Bate’s “Mysteries of Nature and Art,” had attracted the especial notice of the Marquis. He would be about 33 years of age on its first publication, and he wrote his *Century* about 20 years after its appearance, we may, therefore, readily see how likely it would be for him to adopt even its very style and language. John Bate says, at page 11:—



“A forcer is a plug of wood exactly turned and leathered about; the end that goeth into the barrel, is semicircularly concave; p. 57. *Forces* may be made to move either horizontally or perpendicularly, according unto the convenience of the work, or the invention of the artist and engineer; p. 59. (Describing ‘the water mill or engine near the north end of London Bridge.’) These two barrels must be bound fast unto two posts of the frame, with two strong iron bands, as T T; unto each of these must be fitted a *force* well leathered, and in the tops of the *forces* must be set two pieces of wood.”

Then again, at page 66:—"K K, L L, the barrels of the *forces*, which force the water;" p. 67. "E, a barrel of brass or wood fastened in the well, K, a *force* fitted into it." Again, "the *force* must be very heavy;" p. 71. "B, a barrel of iron or brass, fastened in the midst of the cistern, with a *force* fitted unto it;" p. 72. "The *force* is linked, and it is noted with the letter D," (in the engraving.) Again, "F, the barrel of the *force*, fastened within two or three inches of the bottom of the cistern;" p. 73, "C, a *force*, D, the *forces* barrel." Again, "the *force* draweth the water out of the cistern B, into the barrel D;" p. 74, "another strong iron bar as I I, unto each end whereof must be linked a *force*; K K, the two barrels of the aforesaid *forces*."

In the 21st volume of Philosophical Transactions, published in 1700, there is a description, with an engraving,* being, "An account of Mr. Thomas Savery's engine for raising water by the help of fire." It states that Mr. Savery, on the 14th of June, 1699:—"Entertained the Royal Society with shewing a model of his Engine for raising water by the help of fire, which he set to work before them; the experiment succeeded according to expectation, and to their satisfaction. The Engine may be understood by the draughts of it, where Fig. 1 is the front of the Engine for raising water by fire; and Fig. 2, the side prospect of the Engine.

"A, is the furnace; B, the boiler; C, two cocks which convey the steam from the bottom in order to discharge it again at the top; D, the vessels which receive the water from the bottom in order to discharge it again at the top; E, valves; F, cocks which keep up

* The original drawing is preserved in the archives of the Royal Society, coarsely executed on paper, measuring 24 by 27 inches.

the water, while the valves on occasion are cleaned; G, the force pipe; H, the sucking pipe; and I, the water."

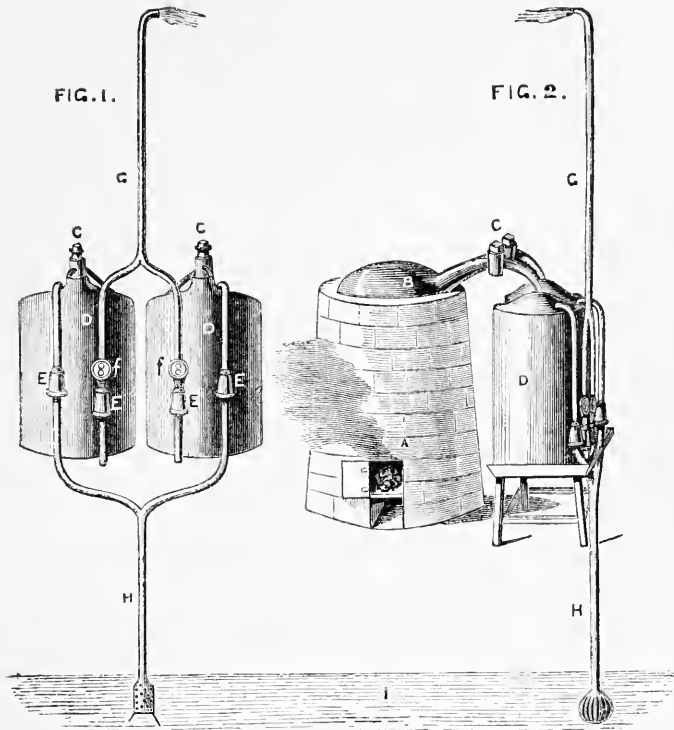

Neither at the time nor afterwards does the invention appear to have attracted any further notice in that quarter. The next account we have of it is afforded by "The Miners Friend, or an Engine to raise Water by Fire," by Thomas Savery, Gent., 1702; in which the invention appears with two furnaces, instead of one, and with other details. In his description he refers to two vessels, marked P, No. 1, and P, No. 2, which correspond with the two receivers above, marked D, D.

Remarking on these, in In the above 68th Article,
 "The Miners Friend," the Marquis of Worces-

Savery says:—"So that P, No. 1, is by the external pressure of the atmosphere, immediately refilled, while P, No. 2, is emptying; which being done, you push the handle of the regulator from you, and throw the force on P, No. 1, pulling the condensing pipe over P, No. 2, causing the steam in that vessel to condense, *so that it fills while the other empties.* The labour of *turning these two parts* of the engine, viz. the regulator and water-cock, and *tending the fire*, being no more than what a *boy's strength* can perform for a day together * * * yet, after all, I would have men. * * * "

ter says:—"A man *that tends the work is but to turn two cocks, that one vessel of water being consumed, another begins to force and refill with cold water*, and so successively, the fire being *tended* and kept constant, which the selfsame person may likewise abundantly perform between the necessity of *turning the said cocks.*"

And in No. 100, he says, "a *child's force* bringeth up an hundred feet high, an incredible quantity of water."

We do not purpose to press any charge against Savery, but simply to relate what is on record respecting the engine he put forward; and to notice here the remarkable coincidence between his description, and that given by the Marquis 32 years before. The Marquis writes in the singular number of "*the fire*," thereby indicating a single furnace; and in Savery's first drawing we find the model represented with one furnace. Then in "The Miners Friend," we have parts

described agreeing precisely with the preceding article, No. 68. And at the particular point just quoted, we have even a closer analogy, in the use of the very same words in reference to the same parts—*turning* and *tending*. And while, in No. 100, the Marquis informs us what “*a child’s force*” can perform; here Savery speaks of “*a boy’s strength*,” which is enlarged on, however, by recommending a man’s services.

The next earliest notice we find of this engine is given by Richard Bradley, F.R.S., in his “*New Improvements of Planting and Gardening*,” 8vo. 1718, who, in the third part, at page 175, supplies an engraving of “the late Mr. Savory, F.R.S.,”* his engine, as set up by him “for that curious gentleman Mr. Balle of Cambden House.” It is represented as a spherical boiler, capable of holding forty gallons, supported on a tripod, with a fire on the ground underneath. It is connected with a bell-shaped receiver of thirteen gallons capacity, supplied below with a pipe sixteen feet long, and above with a pipe to elevate the water, forty-two feet. The steam pressure is stated to be capable of discharging fifty-two gallons per minute, the pipes being of three inches bore; and the original cost of the whole was £50.

In 1729, Stephen Switzer published his “*Introduction to a general system of Hydrostaticks*,” in two volumes quarto. He says:—

“Amongst the several Engines which have been contrived for the raising of water for the supply of houses and gardens, none has been more justly surprising than that of the raising of water by fire; the particular contrivance and sole invention of a gentleman,

* Savery is supposed to have died in 1715, but no particulars are on record respecting his death and burial.

with whom I had the honour long since to be well acquainted; I mean the ingenious Captain Savery, some time since deceased, but then a most noted engineer, and one of the Commissioners of the Sick and Wounded. This gentleman's thoughts (as appears by a preface of his to a little book, entitled, 'The Miners' Friend'), were always employed in Hydrostatics and Hydraulics; and the first hint from which it is said he took his engine, was from a tobacco pipe, which he immersed to wash or cool it, as is sometimes done; he discovered by the rarefaction of the air in the tube by the heat or steam of the water, and the gravitation or impulse of the exterior air, that the water was made to spring through the tube of the pipe in a wonderful surprising manner; though others say, that the learned Marquis of Worcester, in his 'Century of Inventions,' (which book I have not seen), see page 68, gave the first hint for this raising water by fire."—Vol. ii. p. 325.

Thirty-four years later, Dr. J. T. Desaguliers, F.R.S., and Chaplain to His Royal Highness, Frederick, late Prince of Wales, &c., published his "Course of Experimental Philosophy," in two volumes, quarto, 1763. His 13th section is a discourse on the "Fire-engine," as the steam-engine was then designated. And the following lecture treats largely on the Marquis of Worcester's present article in the "Century," which he quotes and then observes:—

"Captain Savery, having read the Marquis of Worcester's book, was the first who put in practice the raising Water by Fire, which he proposed for the draining of mines. His Engine is described in Harris's Lexicon (on the word *Engine*), which being compared with the Marquis of Worcester's description, will easily appear to have been taken from him; though Captain Savery denied it, and the better to conceal the matter,

bought up all the Marquis of Worcester's books that he could purchase in *Pater-Noster-Row*, and elsewhere, and burned them in the presence of the gentleman his friend, who told me this. He said that he found out the power of steam by chance, and invented the following story to persuade people to believe it, viz., that having drank a flask of Florence at a tavern, and thrown the empty flask upon the fire, he called for a bason of water to wash his hands, and perceiving that the little wine left in the flask had filled up the flask with steam, he took the flask by the neck, and plunged the mouth of it under the surface of the water in the bason, and the water of the bason was immediately driven up into the flask by the pressure of the air."

Desaguliers doubts the veracity of this bottle story, and we may well agree with him, when we find that in another version the discovery is attributed to a tobacco-pipe.

He proceeds:—"Captain Savery made a great many experiments to bring this machine to perfection, and did erect several, which raised water very well for gentlemen's seats; but could not succeed for mines, or supplying towns, where the water was to be raised very high, and in great quantities: for then the steam required being boiled up to such a strength, as to be ready to tear all the vessels to pieces. I have known Captain Savery, at York-Buildings, make steam eight or ten times stronger than common air; and then its heat was so great, that it would melt common soft solder; and its strength so great as to blow open several of the joints of his machine: so that he was forced to be at the pains and charge to have all his joints soldered with spelter or hard solder."—Pp. 464-467.

The serious accusation made against Savery of deriv-

ing all his information from the Marquis of Worcester's invention, and destroying all he could procure relating to the Marquis, rests solely on the authority of Desaguliers, to whom it was related by one of Savery's friends! In 1699, the Marquis's Act had yet 63 years unexpired, had the Duke of Beaufort felt disposed to investigate how far Savery's engine interfered with his father's invention; but no such interest was excited, nor had Savery at any time so much success as to induce such an inquiry. But, in 1699, the Marquis had only been dead 32 years, and we have proof that his engine was in existence in 1670, reducing the space of time to 29 years; by no means an unlikely period for Savery to find parts of the large engine, or models of a small one, or drawings, or MS. descriptions, or verbal details from eye-witnesses, from among some of the many visitants to Vauxhall, if, indeed, not directly from descendants of the "incomparable workman," Kaltoff.

Savery's connection with the mining interests of the country would appear to have first drawn his attention to the value of a scheme, proposing to raise vast bodies of water by the aid of a most stupendous power. He might, when a mere youth, have heard enough of the Marquis's invention, however vaguely communicated, to excite his curiosity, and decide him on a course of action whenever an opportunity should occur.

After a lapse of more than a century and a half, Savery's claim is not likely to be materially disturbed; but it will always be a matter of interest to observe the close similarity there is between the simple model he exhibited before the Royal Society, and the Marquis of Worcester's brief summary of the parts and nature of his own engine. And it is not very favourable to a belief in Savery's independence of the Marquis's

invention, that the former should be the sole inventor of a single marvellous production of ingenuity, without producing any novelty either before or afterwards, or displaying any particular inventive ability to improve on this early effort, which he left as at first produced.

“The Miners Friend” is not unlike an imitation of the “Exact and true definition of the most Stupendous Water-commanding Engine;” for example:—

The MARQUIS’s invention is recommended “to every individual, if he either have surrounded Marsh-ground to drain, or dry land to improve.”

“Thus whole cities may be kept clean, delightful, and wholesome.”

“Or, if he have (I further say), Mines wherewith to enrich himself withal.”

“Houses to be served, or gardens to be beautified by pléntiful fountains, with little charge, yet certain in ever so dry a Summer.”

SAVERY recommends the Engine he proposes:—

4. “As for draining fens and marshes,” &c.

3. “Nothing can be more fit for serving cities and towns with water.”

6. “For draining of mines and coal pits, the use of the engine will sufficiently recommend itself in raising water so easy and cheap.”

2. “It may be of great use for palaces, for the nobilities, or gentlemen’s houses; for by a cistern on the top of a house * * * which water in its fall makes you what sorts of fountains you please.”

Savery says:—“And though my thoughts have been long employed about water-works, I should never have

pretended to any invention of that kind, had I not happily found out this new, but yet a much stronger and cheaper force or cause of motion than any before made use of. But finding this of rarefaction by fire, the consideration of the difficulties the miners and colliers labour under by the frequent disorders, cumber-somness, and in general of water-engines, encouraged me to invent engines to work by this new force, that tho' I was obliged to incounter the oddest and almost insuperable difficulties, I spared neither time, pains, nor money till I had absolutely conquer'd them."

Savery is reputed to have died in 1715, therefore he was very probably between 40 and 50 years of age in 1699; and he might have commenced his investigations into the existence of the Marquis's inventions, models, books, papers, drawings, and traditional statements at 25 or 30 years of age, still leaving him from 15 to 20 years to complete his search for information. If he died at 60 years of age, he would be 12 years old when the Marquis died. At all events he had ample leisure, and the period was promising for such an inquiry.

In his time neither writers nor inventors were very scrupulous in their adoption of the labours of others; the wholesale literary plunder then practised by compilers, would not be permitted in modern times, nor would it be attempted by any author of moderate reputation. Invention, on the contrary, has always been a doubtful sort of preserve, the rights of which have been contested with fearless impunity by every poacher down to the present period. In the 16th and 17th centuries particularly, no rights were so ill defined as those of the inventor, even in the face of patents, and Acts of Parliament. But the rights of a deceased inventor were still less sacred in public opinion, and there never has been, at any time, an organized body in-

terested in detecting and exposing unjust assumptions of being a true and first inventor.

Savery claimed perfect independence of the Marquis of Worcester, and promulgated a story to parallel that of the pot-lid, usually related in reference to his predecessor's invention, while (as is pretended) he was a prisoner in the Tower. Let us now compare certain dates and circumstances to see how far they favour Dr. Desaguliers' charge.

On the 25th of July, 1698, Thomas Savery, Gentleman, had granted to him a 14 years' patent for "A new Invention for raising of Water and occasioning motion to all sorts of Mill Work by the impellent force of fire."

Within six months afterwards, on the 21st of January, 1699, died the only son and heir of the Marquis of Worcester, Henry Duke of Beaufort, at 70 years of age.

Within three months after his Grace's decease Savery had a Bill brought into the House of Lords, which, on the 6th of April, was reported to the House of Commons, and passed on the 25th of the same month. This private Act extended the patent privilege over 21 years further, making 35 years.

On the 14th of June following, it is stated in the Royal Society's Transactions, "Mr. Savery entertained the Society with shewing the model of his engine for raising water by the help of fire." (See page 485.)

Dr. Hook was then living, but died on the 3rd of March, 1702. Above 38 years had elapsed since his visit to Kaltoff, to see the engine at Vauxhall; and he could have spoken to the merits of Savery's engine, as compared with what he had earlier seen, had his age and health permitted, or his inclination prompted him so to act.

On the decease of Dr. Hook, there was published "The Miners Friend," (1702), by Thomas Savery,* Gentleman. He there speaks of his model shown to the Royal Society, "June the 14th, 1699," thanking the Society for "your kindness in countenancing this invention IN ITS FIRST APPEARANCE IN THE WORLD;" that is, within six months *after the death of the Duke of Beaufort*.

The Patent of 1698, like all patents of that period, contains no more account of Savery's engine than the mere title, or designation of the nature and intention of the invention; therefore, when the Act of Parliament was applied for and obtained, there had still been no publication indicating the *modus operandi*. It was not until the 14th of June, 1699, that the Invention made *its first appearance in the world*, in the rooms of the Royal Society. And it was not until 1702, that Savery published any account of his invention, and we then expect to learn something interesting in regard to the wonderful discovery. But all he has to say on the matter is in these few lines: "And though my *thoughts* have been *long* employed about water-works, I should never have pretended to any invention of that kind, *had I not happily found out this new, but yet a much stronger and cheaper force or cause of motion than any BEFORE made use of*. But *finding* this of rarefaction by fire, the consideration of the difficulties the miners and colliers labour under by the frequent disorders, cumbersomeness, and in general of water-engines, *encouraged me to invent engines to work by this new force*, that though I was obliged to encounter *the oddest and almost insuperable difficulties*, I spared neither *time, pains, nor money*, till I had absolutely conquered them."

* His address "To the Gentlemen Adventurers in the Mines of England," is dated "London, Sep. 22, 1701."

This stoicism and total absence of the least ray of mental enthusiasm are the first remarkable circumstances to strike our observation. Here, after a lapse of three years, some encouragement, and writing on the matter of a great discovery, the precious jewel is treated as if it were of the nature of the most ordinary pump. "And though my *thoughts* have been long employed about water-works," yet we are to presume that he never heard of the great "Water-commanding Engine" at Vauxhall, 30 years previous. He believes in his having "found out this new, but yet a much stronger and cheaper force than any *before* made use of," yet never, even remotely, declares how or in what way he came by it. "But *finding* this of rarefaction by fire," as he says, we on our part naturally ask, And pray where and how did you *find* it? He names the considerations that "encouraged him to invent engines to work by this new force;" but from the time of producing the model of 1699 to the last improvement of 1702, there was no essential difference; the invention remained the same throughout. The only difficulties in his way were, in his own words, "the oddest and most insuperable," but we are left to guess in what their *oddness* consisted.

He finally states, in his first chapter:—"I may modestly affirm that the adventurer or supervisor of the mine will be freed from that perpetual charge, expence, and trouble of repairs which all other engines ever yet employed in mines for the raising of water are continually liable unto."

In Article No. 100, of the "Century," however, it is shortly but expressly urged, as one important point, that the engine works, "with *little charge*, to drain all sorts of mines, &c."

It appears from documents dated 1664, relating to Vauxhall, that Caspar Kaltoff is named therein

as "lately deceased."* So that in 1699 Thomas Savery was left in full possession of the field he had entered upon. The facts and dates now furnished, are not very favourable to the genuineness of Savery's Invention. For it is not likely that all trace of the "Water-commanding Engine" would have been lost between 1670 and 1699, when Kaltoff's family were still living, as also many persons who had witnessed the performance of the great engine at Vauxhall. It is true that the last we hear of it is not later than 1670, but it was then the property of the Dowager Marchioness, who died in 1681, and her Ladyship would most likely, from respect, as well as from personal interest in the matter, not permit the engine to be sold or destroyed. Then from 1681 to 1699, reduces the probability of its existence up to a period within 18 years, taking the dates to the uttermost limit, although we can easily understand that for the whole or a large portion of those 18 years Savery was in possession of all the facts he would require for coming before the public on the decease of Kaltoff, the Dowager Marchioness of Worcester, and the Duke of Beaufort; the latter being the last party interested in the invention, and likely, during his life, to frustrate such a design.

But what papers could he procure at Paternoster Row for destruction? 1. There was a pamphlet, being the Definition and Act, the latter printed in black letter. 2. There was the "Definition" itself, printed in the form of a posting bill. And, 3, there was the "Century." All these were printed 1663 to 1664, and are editions which are now remarkably scarce. There are only about three copies of the Act, and one of the "Definition," known to exist, while the few copies of

* See Appendix G.

the "Century" of 1663, are rarely indeed to be found in private collections. But, besides these, it was quite possible to 'procure, within 15 or 20 years after his decease, even manuscripts, drawings, and books, the property of the deceased Marquis, more or less referring to his great invention.

Even admitting that Savery was an independent inventor in 1699, notwithstanding so many conflicting circumstances pointing to a different conclusion, he could not have been working many years at York Buildings in the Strand, without hearing of the Engine at Vauxhall, invented by the proprietor of Worcester House in the Strand. This very propinquity alone was sufficient to excite in the mind of some intelligent, inquisitive, and observant visitor the fact, which so singular a coincidence would obviously suggest.

While, however, everybody else is viewing the engine of Savery's reputed invention with astonishment, Savery himself is present to our mind only as a cold calculating man, proud, not of being a Captain over Mines, but of being designated "Gentleman;" and while thus precise to inform the world of his gentility, he leaves us in perfect ignorance of his mental acquirements, or the origin of the marvellous engine. It may appear to some, that his exhibiting of the model before the Royal Society is at once evidence of straightforwardness and uprightness of conduct. But this view is open to the objection, that he had never before shown the model, and he thanks the Royal Society for "countenancing this Invention on its *first appearance in the world.*" From the 25th of July 1698, to the 14th of June 1669, he had been nursing the invention in secret. What doubts could remain in his mind, when all persons likely to be most interested were no longer in existence? Men of science alone remained, who might

possibly disturb his claims, and what means could be found more likely to set this doubt at rest, than a bold appeal to that learned body? And come of it what might, there would still remain to him the question of *improvements*; supposing the grand claim to originality to become a matter of dispute. But to Savery's great satisfaction, if not to his greater surprise, so far from a word of dissent being raised, there was (contrary to all precedent) a certificate given in favour of the invention at Savery's request.

Savery's career may be taken as commencing in 1699, thirty-two years after the decease of the Marquis of Worcester, thirty-six years from the date of the "Century of Inventions," or thirty-nine years after the establishment of the Royal Society, and yet his operations made slight impression on the public, and scarcely any on scientific society. This circumstance removes much of the surprise we might otherwise seriously entertain respecting the occasion of the Marquis of Worcester's own publications and personal labours, during four arduous years of excessive mental and physical activity, leaving little behind to attest the extent of his operations and the precise nature of the difficulties with which he had to contend. Great strides must have been made in arts, manufactures and trade, during the intervening thirty-two years, all in favour of Savery's progress, and yet, with the exception of Dr. Papin, scientific men were not attracted by the remarkable results which Savery prominently placed before the public; and Savery's own exposition before the Royal Society is abridged to a single copper-plate engraving, and the shortest possible printed reference to its several details. Thus was this true mechanical prodigy of the age treated as though it were of little or no interest.

When we compare this long continued apathetic feel-

ing, this absence of forecast to form some strikingly favourable judgment of the value of the novelty thus published, although in its earliest stage, with the superior knowledge on the subject evinced by the writings, labour, and conduct of the Marquis of Worcester, at least thirty-six years before Savery; it is then, and then only, perhaps, that we become fully alive to his almost prescient judgment, that could, as if inspired, prognosticate so truthfully as he did the future benefits of his invention to mankind.

69.

A way how a little triangle² scrued Key, not weighing a Shilling, shall³ be capable and strong enough to bolt and unbolt round about a great Chest an hundred Bolts through fifty Staples, two in each, with a direct contrary motion, and as many more from both sides and ends, and at the self-same time shall fasten it to a place beyond a mans natural strength to take it away: and in one and the same turn both locketh and openeth it.

² triangle and. MS. and P. ³ not weighing a shilling - omitted. MS. and P.

[*A triangle Key.*] This ingenious trifle may be really only one part of another instrument, just as we see in the cutting portion of a centre bit, which, if its operation were attempted to be described after the same fashion, would afford a perplexing and seemingly paradoxical

statement. Yet no doubt the little triangle key was capable to the full of performing the duty here stated.

70.

A Key with a Rose-turning pipe, and two Roses pierced through end-wife⁴ the Bit thereof,⁵ with several handfomly-contriv'd Wards, which may likewise do the same effects.⁶

⁴ endwise ; together with. P.

⁵ together—for thereof.

⁶ effect.

[*A Rose-Key.*]

71.

A key perfectly square, with a Scrue turning within it, and more conceited then any⁷ of the rest,⁸ and no heavier then the triangle-scrued Key, and doth the same effects.

⁷ either—for any. P.

⁸ other—for rest.

[*A square Key with a turning scrue.*] These two contrivances are simply variations on Article No. 69, and may depend for sufficient leverage on some source purposely kept out of view.

72.

An Escocheon⁹ to be placed before any of these Locks with these properties.

1. The owner (though a woman) may with her delicate hand vary the wayes of coming to open the Lock

⁹ A Schuchion. MS. escutcheon. P.

ten millions of times, beyond the knowledge of the Smith that made it, or of me who invented it.

2. If a stranger open it, it setteth an Alarm a-going, which the stranger cannot stop from running out; and besides, though none should be within hearing, yet it catcheth his hand, as a Trap doth a Fox; and though far from maiming him, yet it leaveth such a mark behind it, as will discover him if suspected; the Escoccheon⁹ or¹ Lock plainly shewing what monies² he hath taken out of the Box to a farthing, and how many times opened since the owner hath been in³ it.

⁹ Scuchion. MS. escutcheon. P. ¹ or the. ² money. P.
³ at it. MS. and P.

[*An Escoccheon for all Locks.*] Stow, in his Annals of Queen Elizabeth, has particularly distinguished Mark Scaliot as a clever blacksmith; and Dr. Robert Plot, in his "Natural History of Staffordshire," 1684, especially notices the elaborate, ingenious, and expensive locks made by several eminent Staffordshire locksmiths. He observes:—"The greatest excellency of the blacksmith's profession, that I could hear of in this county, lies in their making locks." He then explains at large a certain kind of locks with a master's key, and inferior keys for the servants; and supposing any servant to trifle with such locks, the master or mistress can "certainly

tell how many times that servant has been in, at any distance of time; or how many times the lock has been shot for a whole year together." He also says: "I was told of a very fine lock made in this town (Stafford) sold for twenty pounds, that had a set of chimes in it, that would go at any hour the owner should think fit."

73.

A transmittible Gallery over any Ditch or Breach in a Town-wall, with a Blinde and Parapit Cannon-proof.

[*A transmittible Gallery.*] The perusal of the elaborately illustrated works of Vegetius, Vitruvius, Fludd, and other writers of the sixteenth and seventeenth centuries, would abundantly furnish the Marquis of Worcester with hints to show what had been done in such warlike machinery, and to stimulate him to make improvements. Such an invention as the present one, with others of a like magnitude, he probably never proved practically beyond satisfying himself by means of well made models, that whatever modifications he proposed to introduce were mechanically practicable.

74.

A Door, whereof the turning of a Key, with the help and motion of the handle, makes the hinges to be of either side, and to open either inward or outward, as one is to enter or to⁴ go out, or to open in half.

⁴ to—omitted.

[*A conceited Door.*] Van Etten, in his *Mathematical Recreations*, offers as Problem XV. "How to make a Door or Gate, which shall open on both sides." It is represented that "All the skill and subtilty of this, rests in the artificieall disposer of four plates of iron." The description, which is very imperfect, concludes—"the gate will open upon one side with the aforesaid plates, or hooks of iron; and by the help of the other two plates, will open upon the other side." [Oughtred's ed. 1653, page 30.] The Marquis may have conceived his own plan to be a most decided improvement upon this primitive design.

75.

How a Tape or Ribbon-weaver⁵ may set down a whole discourse, without knowing a letter, or interweaving any thing suspicious of other secret than a new-fashioned Ribbon.⁶

⁵ riband-weaver. P.⁶ riband. P.

[*A Discourse woven in Tape or Ribbon.*] This article should have followed article No. 43, of which it seems to be one of the "variations" therein contemplated.

76.

How to write in the dark as streight as by day or candle-light.

[*To write in the dark.*] This would appear only to require a box of any form, the top or lid of which being of ground glass, it could be illuminated by means of a small night-light placed below, within the box; when

it would be possible to write on paper laid on the glass, in a totally dark room. Such a device might be useful to an inexpert artist for making a tracing of any drawing.

77.

How to make a man to fly ; which I have tried with a little Boy of ten years old in a Barn, from one end to the other, on a Hay-mow.

[*A flying man.*] One feels disposed to believe, on reading this article, that the Marquis, in multiplying his experiments with fire and water, might have tried in different ways the effects of heating air, and actually gone far to anticipate Montgolfier in producing a balloon.

However, it was confidently believed in the 17th century that flying was possible, provided proper machinery could be invented. There is a curious little work on this subject, "De arte Volandi," by Frid. Hermannus Flayder, small 12mo. 1627.

Milton, in his "History of Britain," 1670, speaking of the prognostications of Elmer, a monk of Malmsbury, during the reign of Harold, mentions that—"He in his youth strangely aspiring, had made and fitted wings to his hands and feet; with these on the top of a tower, spread out to gather air, he flew more than a furlong; but the wind being too high, came fluttering down, to the maiming of all his limbs; yet so conceited of his art, that he attributed the cause of his fall to the want of a tail, as birds have, which he forgot to make to his hinder parts." See also Kennet's History of England, 1st vol. 1706, fol.

In "Friar Bacon's discovery of the miracles of Art,

Nature, &c." published in 12mo. 1659, treating "Of admirable artificial instruments," the following occurs among other inventions: "It is possible to make engines for flying, a man sitting in the midst whereof, by turning only about an instrument, which moves artificial wings made to beat the air, much after the fashion of a bird's flight." Chap. iv. page 17. He states that he has seen all his other named inventions, "excepting only that instrument of flying, which I never saw, or know any who hath seen it, though I am exceedingly acquainted with *a very prudent man, who hath invented the whole artifice.*"

The learned Dr. Robert Hooke, Professor of Geometry at Gresham College, in 1655, made many ineffectual trials to accomplish this object, which he communicated to the celebrated Bishop Wilkins, who considered his plans were very ingenious.

Lord Bacon was not above recommending experimental investigation of means for flying. And Bishop Wilkins suggests, that the most obvious way for effecting the desired purpose is "by wings fastened immediately to the body, this coming nearest to the imitation of nature;" and further, "this is that way which Fredericus Hermannus [Flayder], in his little discourse, *De Arte volandi*, doth only mention and insist upon."

In 1679, Dr. Robert Hooke, while Secretary of the Royal Society, published "*Lectiones Cutlerianæ*, a collection of Lectures made before the Royal Society," 4to. consisting of a series of pamphlets, among which, No. 1 of the "*Philosophical Collections*," contains eleven articles, the fourth being, "An account of the *Sieur Bernier's* way of Flying," as follows:—

"Having lately seen an account from France of a person there, who, with some considerable success, has attempted to raise and sustain himself, and so to move

and fly in the air by the help of mechanical or artificial wings, agitated only by his own strength, without the assistance of any other either animate or inanimate power; I thought it might not be unacceptable to the curious to receive some (though imperfect) account thereof.

“It is, I confess, no new design, since there has hardly been an age wherein some one or other of these Dædalian engineers have not been trying the strength of their invention about it. The story of Dædalus and Icarus might have its ground from the attempts of some persons about this matter, though poetic relations have made it seem romantic. What the performances of Simon Magus were is uncertain; they might have [been] somewhat mechanical. That attempt of one of our English kings is delivered to us for true history: whether so or no, I determine not. But without doubt, it was believed possible, and attempted also in the time of our famous Friar Roger Bacon, who lived about 500 years since. Now, though he was believed a magician or conjuror, and to have performed what was related of him by the help of diabolical magic, yet from the perusal of several of his excellent works yet extant, I esteem him no such person; but I rather find him to have been a good mathematician, a knowing mechanic, a rare chemist, and a most accomplished experimental philosopher, which was a miracle for that dark age. This man affirms the art of flying possible, and that he himself knew how to make an engine,* in which a man sitting, might be able to carry himself through the air like a bird. And affirms that there was then another person who had actually tried it with good success. The stories of Architas his wooden dove, and Regio-

* On the contrary, he expressly declares he had never seen such an engine.—H. D.

montanus his wooden eagle, are not much doubted of. Questionless, those persons did make some kind of engines to perform what was considerable in this art of flying. Busbequius his story of the Turk at Constantinople, that attempted to fly, is not doubted. Nor are other relations of late attempts made in Germany, and elsewhere disbelieved. We have not wanted late instances, even here in England, of several ingenious men who have employed their wits and time about this design. Particularly, I have been credibly informed, that one Mr. Gascoyn did about 40 years since try it with good effect; though he since dying, the thing also died with him. And even now there are not wanting some in England who affirm themselves able to do it, and that they have proved as much by experiment.

“But of all these, we have little or no account of the ways they have taken to effect their designs, and therefore conjectures will be much at random; only we may conclude them defective in somewhat or other, since we do not find them brought into common use, which the desirableness and usefulness of any one that should succeed would certainly cause it to be. I shall desist therefore from inquiry further concerning them, and acquaint you with two ways lately published in print, and more particularly described, which pretended to some considerable performance of this kind.”

The first is inserted in the “*Journal des Scavans*” of the year 1678.

Then follow a letter on the subject, and an account of Lana's flying chariot. The latter is like a boat with wheels and sails; the former was the invention of of *Sieur Besnier*, a smith of *Sable* in the county of *Maine*. The engraving represents a nude figure with two poles held horizontally on each shoulder, about the centre, and having at each end flags or wings, in

form of folio book backs, with the two back ends of the poles attached by strings to the feet; affording altogether a very feeble attempt to obtain the desired object.

The privilege of flight by any mechanical means is denied to man; his figure, weight, muscular constitution, all operate against his imitating the bird, which, admirably proportioned, light in frame, yet concentrating powerful muscular strength in its wings, well adapt it for enduring prolonged aerial flight, although the medium in which it floats is eight-hundred times lighter than water.

If flight in the air is ever to be mechanically attained, it will be by a machine, worked independently of man's power, and which possibly will neither be so safe nor so manageable as the common balloon, with all its hazards and wayward guideless journeyings.

78.

A Watch to go constantly, and yet needs no other winding from the first setting on the Cord or Chain, unless it be broken, requiring no other care from one then to be now and then consulted with concerning the hour of the day or night; and if it be laid by a week together, it will not erre much, but the oftener looked upon, the more exact it sheweth the time of the day or night.

[*A continually-going Watch.*] A watch having the dial enclosed under a metal case, as in hunting watches,

is no doubt to be so contrived that the opening and closing of such case, to ascertain the time, shall act more or less to wind it up. A room door has been thus made to transmit power through attached levers to keep a clock constantly wound little by little, every time on opening and closing the door.

His list of certain of his inventions gives a different reading to this article; as follows:—"I can render an ordinary watch, which, being once wound up, will go constantly during a man's life, being used but once in 24 hours; and, though oftener looked on, it is still the same; and though not looked on for a week, still the same, if not bruised."—See Appendix A.

And in his patent of 1660, we have again a third reading, viz:—"To make a watch or clock without string or chain, or any other kind of winding up but what of necessity must follow, if the owner or keeper of the said watch or clock will know the hour of day or night; and yet if he lay it aside several days or weeks without looking or meddling with it, it shall go very well, and as justly as most watches that ever were made."—See Appendix B.

In "Humane Industry," chapter I, occur the following remarks, "On Dials," page 8:—"The wit of man hath been luxuriant and wanton in the inventions of late years; some have made watches so small and light, that ladies hang them at their ears like pendants and jewels; the smallness and variety of tools that are used about these small engines, seem to me no less admirable than the engines themselves; and there is more art and dexterity in placing so many wheels and axles in so small a compass (for some French watches do not exceed the compass of a farthing) than in making clocks and great machines." It is also stated at page 9, that "In some towns of Germany and Italy, there are

very rare and elaborate clocks to be seen in their Town Halls; wherein a man may read Astronomy, and never look up to the skies." We are next informed: "But the exactest clocks and watches that are, are defective, and want correction; for in watches, the first half hour goes faster than the last half, and the second hour is slower than the first, and the third then the second." Page 12.

79.

A way to lock all the Boxes of a Cabinet, (though never so many) at one time, which were by particular Keys appropriated to each Lock opened severally, and independent⁷ the one of the other, as much as concerneth the opening of them, and by these⁸ means cannot be left opened unawares.

⁷ the—omitted.

⁸ this—for these.

[*A total locking of Cabinet-boxes.*] The fact that by this means no one of the several cabinets can "be left opened unawares," exposes the source of security, namely something like a long key-rod to take hold of each, or a bar extending down one side to overlap, when each cabinet drawer or door is closed.

80.

How to make a Pistol Barrel no thicker than a Shilling, and yet able to endure a Musquet proof of Powder and Bullet.

[*Light Pistol-barrels.*] One might almost suppose the Marquis contemplated a method similar to that recently introduced by Mr. Longridge, of winding the barrel with wire.

See also article No. 44, which may, or not, refer to the same description of barrel.

81.

A Combe-conveyance carrying of⁹ Letters without suspicion, the head being opened with a Needle-scrue drawing a Spring towards them¹; the Comb being made but after an usual form carried in ones Pocket.

⁹ of—omitted.

¹ one—for them. MS. and P.

[*A Comb-conveyance for Letters.*] The entire ingenuity of the kind of conveyance proposed consists in the skill of the workman to provide a receptacle in so small an article, not open to suspicion when handled by a spy.

82.

A Knife, Spoon or Fork in an usual portable Case, may have the like conveyances in their handles.

[*A Knife, Spoon or Fork-conveyance.*] William Bourne's 73rd Device is—"How for to convey letters secretly." One means is to be found in a Dog's collar. Another in a water-tight metal case, to be inserted within a bottle of wine. "Inventions or Devices," 1578.

83.

A Rasping-mill for Harts-horn, whereby a child may do the work of half a dozen men, commonly taken up with that work.

[*A Rasping-mill.*] This description of mill is largely in use for rasping dye-woods, and has undergone a great variety of modifications.

84.

An Instrument whereby persons² ignorant in Arithmetick may perfectly observe Numerations and Substractions³ of all Summes and Fractions.

² a person.

³ numeration and subtraction. MS.

[*An arithmetical Instrument.*] There is in the British Museum a manuscript description, with a large engraving, of the serpentine scale invented by Thomas Browne, of Fenchurch Street, London, in 1631, by means of which "instrument all kinde of questions in Arithmetike, Geometry, &c. are speedily resolved." Brit. Mus. Birch MS. No. 4407.

Sir Samuel Morland, in 1672-3, published a small treatise, being—"The description and use of two arithmetick Instruments;" a second title mentions, "A new and most useful Instrument for Addition and Substraction of pounds, shillings, pence, and farthings," which he "invented and presented to his most excellent Majesty, Charles II. 1666."

85.

A little Ball made in the shape of a Plum or Pear,⁴ being dexterously conveyed or forced into a bodies mouth, shall presently shoot forth such and so many Bolts of each side and at both ends, as⁵ without the owners Key can neither be opened or⁶ filed off, being made of tempered Steel, and as effectually locked as an Iron Chest.

⁴ which being.⁵ as that.⁶ nor. MS. and P.

[*An untoothsome Pear.*] It is difficult to understand the intended use of this proposed instrument, but it is more likely to have been suggested from a feeling of humanity than from any other motive. A desperate and ferocious enemy, thus rendered helpless before being manacled, would assuredly be less dangerous than he could otherwise be considered; and it would not, therefore, be requisite to take his life, for personal safety; once thus secured he would be likely to listen to any terms of mercy.

86.

A Chair made *a-la-mode*, and yet a stranger being perswaded to sit in't, shall have immediately his armes and thighs lock'd up beyond his own power to loosen them.

[*An imprisoning Chair.*] In the "Memoirs, illustrative of the life and Writings of John Evelyn, F.R.S."

&c., edited by William Bray, 2 vols. 4to. 1819, occurs the Diary of his continental travels in 1644. On the 17th Nov., Evelyn being at Rome went to the "Villa Borghese, a house and ample garden on Mons Pincius." In one of the chambers, he says, "are divers sorts of instruments of music; amongst other toys that of a satyr with so artificially expressed a human voice, with the motion of eyes and head, that it might easily affright one who was not prepared for that most extravagant sight. He showed us also a chair which catches any one who sits down in it so as not to be able to stir out, by certain springs concealed in the arms and back thereof, which at sitting down surprises a man on the sudden, locking him in by the arms and thighs, after a true treacherous Italian guise."—Vol. i. p. 106-107.

M. de Blainville, in his travels, 1757, relates, in passing through Italy, and describing the Villa Borghese, raised under the Popedom of Paul V. uncle of Cardinal Scipio Borghese, that, "In the fourth room of the apartment, on the south side, called the room of the Three Graces, there stands a remarkable chair, said to have been formerly used to very evil purposes, by one of the Borghese family. The machine is very artfully contrived, and strangers who are not acquainted with the trick are infallibly caught, as in a trap, when they are prevailed upon to sit in this chair. By this stratagem the housekeeper gets a good many fees, which the enticed people are obliged to pay him for their deliverance out of captivity. In all appearance, these innocent deceits were the only thing intended by this piece of machinery."—Vol. iii. page 34.

87.

A Brass Mold to cast Candles,
in which a man may make 500.

dozen in a day, and adde an Ingredient to the tallow which will make it cheaper, and yet so that the Candles shall look whiter and last longer.

[*A Candle-mold.*] This invention seems to include some recipe to whiten the tallow. When the idea of improving candle-moulds suggested itself, the Marquis had probably been over some manufactory, and on seeing the customary mode of candle-making, the present suggestion may have occurred to him. We have placed it among the few others (only nine in number), in his numerous list, as belonging to the Domestic Class, of which it is the last.

88.*

How to make a Brazen or Stone-head, in the midst of a great Field or Garden, so artificial and natural, that though a man speak never so softly, and even whispers into the ear thereof, it will presently open its mouth, and resolve the Question in French, Latine, Welsh, Irish or English, in good terms uttering it out of his mouth, and then shut it untill the next Question be asked.

[*A Brazen head.*] In a MS. list of five Inventions,

* The Harleian MS. "Century" has for Article No. 88, "A Stamping Engine," in lieu of the "Brazen Head." Mr. Partington alters this to "A Coining Engine."

“Life, Times, &c.” page 316, the present article is briefly stated to be:—“A brass head capable to receive at the ear a whisper, and the mouth thereof to render answer in any language to the interrogator.”

In “The famous History of Frier Bacon,” [1630?] a black letter quarto of 24 leaves unpagged, the fifth article relates, “How Frier Bacon made a brazen head to speak, by the which he would have walled England about with brass.” He and Friar Bungey, it is stated, “with great study and pains so framed a head of brass, that in the inward parts thereof there was all things like as in a natural man’s head.”

The same account may be read at length in the modernised edition of “Early English Prose Romances,” edited by W. J. Thoms, F.S.A., first volume, 12mo. 1858, page 205. The unfortunate head only survived to speak thrice, and then fell to pieces!

See also “Miscellanea Antiqua Anglicana,” London, Printed for Robert Triphook, 1816, 4to. Vol. I.

In the “Inventions or Devices,” by William Bourne, 1578, “The 113th Device is, as touching the making of strange works, as the brazen head that did seem to speak, or birds of wood or metal made by art to fly, and birds made of wood or metal to sing sweetly at certain hours appointed, &c., which the common people doth marvel at.” He then proceeds to say:—

“As touching the making of any strange works that the world hath marvelled at, as the brazen head that did seem to speak: and the serpent of brass for to hiss: or a dove of wood for to fly: or an eagle made by art of wood and other metal to fly; and birds made of brass, tin, or other metal to sing sweetly, and such other like devices, some have thought that it hath been done by enchantment, which is no such thing, but that it hath been done by wheels, as you may see by clocks,

that do keep time, some going with plummets, and some with springs, as those small clocks that be used in tablets to hang about men's necks. And as the brazen head, that seemed for to speak, might be made by such wheel work, to go either by plummets or by springs, and might have time given unto it, that at so many hours' end, then the wheels and other engines should be set to work: and the voice that they did hear may go with bellows in some trunk of brass or other metal, with stops to alter the sound, may be made to seem to speak some words, according unto the fancy of the inventor, so that the simple people will marvel at it. And for to make a bird or fowl, made of wood or metal, with other things made by art, to fly, it is to be done to go with springs, and so to beat the air with the wings, as other birds or fowls do, being of a reasonable lightness, it may fly: and also to make birds of metal to sing very sweetly, and good music, it may be done with wheels, to go at any hour or time appointed by plummets, and then to have pipes of tin or other fine metal, to go with bellows, and the pipes to have stops, and to go with a barrel, or other such like device, and may be made to play or sing what note that the inventor shall think good when he doth make it; and also there may be divers helps to make it to seem pleasant unto the ears of the hearers, by letting the sound or wind of the pipes pass through or into water, for that will make a quavering as birds do, &c. And also you may make a small puppet, either like a man or woman, to seem to go by wheels and springs, and shall turn and go circular, according unto the setting of the wheels and springs, and also the birds made to fly by art, to fly circularly, as it shall please the inventor, by the placing of the wheels and springs, and such other like inventions, which the common people would marvel at,

thinking that it is done by enchantment, and yet is done by no other means but by good arts and lawful."

Thomas Tymme, in 1612, published "A Dialogue Philosophicall," written in the form of a Dialogue between Philadelph and Theophrast. In the third chapter, the former observes:—"I have heard and read of many strange motions artificiall, as were the inventions of Boetius, in whose commendation Cassiodorus writeth thus: you know profound things and shew mervailles, by the disposition of your Art, mettals doe lowe in sundrie formes: Diomedes picture of brasse, doth sound a trumpet loude: a brasen serpent hisseth: birds artificiall, sing sweetly. Very strange also was the moving of the Images of Mercurie: The brasen head which seemed to speake, made by Albertus Magnus: the Dove of wood, which the Mathematician Architas, did make to flie, as Agellius reporteth. Dedalus strange Images, which Plato speaketh of: Vulcans selfe-movers, whereof Homer hath written: the Iron fly, made at Noremberge, which being let out of the Artificers hand, did as it were flie about by the guests that were at the Table, and at the last, as though it were weary, returned to his masters hand againe. In which Citie also an artificiall Eagle was so ordered to flie aloft in the ayre toward the Emperour coming thither, that it did accompanie him a mighty way."—Page 63.

It is mentioned in Evelyn's Memoirs, that when in Italy, in 1644, he visited the Villa Borghese at Rome, where he saw the figure of a satyr, that "artfully expressed a human voice."—See Note, Article 86. And in his Diary, he records:—"13 July, 1654. We all dined at that most obliging and universally curious Dr. Wilkins's, at Wadham College [Oxford]. He had contrived a hollow statue, which gave a voice, and uttered words by a long concealed pipe that went to

its mouth, whilst one speaks through it at a good distance." He also entertained his visitors with "many other artificial, mathematical, and magical curiosities."

Bishop Wilkins, in his "Mathematicall Magick," 1648, observes:—"There have been some inventions also which have been able for the utterance of articulate sounds, as the speaking of certain words. Such are some of the Egyptian idols related to be. Such was the brazen head made by Friar Bacon, and that statue, in the framing of which Albertus Magnus bestowed thirty years, broken by Aquinas, who came to see it, purposely that he might boast, how in one minute he had ruined the labour of so many years." Proceeding further to consider such inventions, he says, "Walchius thinks it possible entirely to preserve the voice, or any words spoken, in a hollow trunk, or pipe."—P. 176, 177.

Dr. W. Hooper, in the second volume of his "Rational Recreations," has an article on "The Conversive Statue," requiring the employment of two concave mirrors, a statue, and an interlocutor. In regard to this arrangement, it is remarked:—"This recreation appears to be taken from the Century of Inventions of the Marquis of Worcester; one of those men of sublime genius, who are able to perform actions infinitely superior to the capacity, or even the comprehension, of the mere scholar or man of business; and though his designs, at the time they were published, were treated with ridicule and neglect, by the great and little vulgar, who, judging by their own abilities, are ever ready to condemn what they cannot comprehend, yet they are now known to be generally, if not universally, practicable."—Edit. 1794, pp. 220—223.

The "Athenæum" of the 6th December, 1862,

announced that—"A very remarkable talking automaton is exciting the curiosity of the Parisians. It has been constructed by M. Faber, late Professor of Mathematics at a German university, and is stated by our contemporary, 'Cosmos,' to be by far the most successful effort that has been yet made to imitate the human voice. The figure, which is that of a woman, is exhibited on the Boulevard Magenta."

We may here add the following comment on—

[*A Stamping Engine.*] "An engine, without y^e least noyse, knock, or use of fyre, to coyne and stamp 100 lb. in an houre, by one man."—See Harleian MS. No. 2428.

In "Humane Industry," published 1661, at page 36, it is observed, that, "At the Mint of Segovia, in Spain, an engine that moves by water, distendeth an ingot of gold."

The Coining Mill, or Press, was first introduced from France into England during Elizabeth's reign, but was shortly after abandoned for the old hammer process of stamping with two dies. The invention of the mill is ascribed to an engraver, who used it in 1553 for coining the French king's counters. The new process of coining was completely established in France in 1645, but not in England until 1662, the year *before* the "Century" was published, which sufficiently accounts for its author not printing the present article.

According to the Rev. Rogers Ruding, in his "Annals of the Coinage," 1840, no improvement was attempted for upwards of a century, the modern coining-mill having been invented by Mr. Boulton, in 1788.

89.

White Silk knotted in the fingers⁸
of a Pair of white Gloves, and so

⁸ finger.

contrived without fuspicion, that playing at *Primero* at Cards, one may without clogging his memory keep reckoning of all Sixes, Sevens and Aces which he hath discarded.⁹

⁹ without foul play. MS. and P.

[*Primero Gloves.*] Although we cannot give a clue to this contrivance for registering reckonings in card-playing, it is worth noticing the old game indicated:—

Primero, according to Dr. Johnson, is derived from the Spanish, which Minsheu, coupling with the Italian, thus explains, “*primum et primum visum*, that is, first, and first seen, because he that can show such an order of cards, wins the game.” He then quotes as examples:—

“I left him at *primero* with the Duke of Suffolk.”—*Henry VIII.*

“The Spaniard is generally given to gaming, and that in excess; their common game at cards is *primera*.”—*Howell's Letters*, i. iii. 32.

“Give me your honest trick, yet, at *primero*, or gleeck.”—*Ben Jonson's Alchemist*.

Mr. S. W. Singer affords some curious information on *Primero*, in his excellent “*Researches into the History of Cards*,” quarto, 1816. It appears to be uncertain whether it is of Italian or Spanish origin. *Primero*, *prime*, and *primavista*, are the same game, differently designated. It was very popular in the reign of Queen Elizabeth; and, as we have seen, is mentioned by Shakespeare; indeed, it is supposed to have been one of the earliest played card games in England.

90.

A most dexterous Dicing Box,
with holes transparent, after the

ufual fafhion, with a Device fo dexterous, that with a knock of it againft the Table the four good Dice are faftened, and it¹ loofeneth four falfe Dice made fit for his² purpofe.

¹ it—omitted.

² this—for his. P.

[*A Dicing-box.*] It would be doing deep injuftice to the Marquis of Worcefter, to judge him in all refpects rigidly by modern fafhions, customs, and habits of thought. The modern critic, in fimple ignorance of the age, might exclaim with juft indignation againft the promulgating an invention *to cheat at dice*. We have many examples to prove, that the Marquis was not fingular in propofing fo questionable an invention, and we can only confider fuch fchemes put forth as marvels in themfelves and warnings to the unwary.

We find, as early as 1594, that Sir Hugh Plat, in his “Jewel Houfe of Art and Nature,” describes “A perfpective ring that will difcover all the cards that are neere him that weareth it on his finger;” an effect produced by a hollow crystal ftone or glafs, with a good foil on the concave part, to act as a mirror. The apology he offers for publishing this fcheme, will well apply alfo in the prefent inftance; he fays:—“I have difcovered this fecret rather to difcourage yong novesses from card-play, who by one experiment may eafily ghette, how mannie sleights and coufenages, are dayly practised in our dicing and gaming houfes, not doubting but that the general publication thereof will make the fame fo familiar with al men, as that I fhall not juftly be charged of anie to have taught old knaves new-fchoole pointes.”

John Bate, in his "Mysteries of Nature and Art," 1634, page 151, or the edition of 1635, page 242, gives directions, "How to make five or six dice of the ordinary bigness of dice, such as you may game withal, and such as would be taken by their looks to be ordinary dice, and yet all of them to weigh not above one grain." To effect this:—"Take a piece of elder, and pith it, lay the pith to dry, and then make thereof with a sharp knife five or six dice, and you shall find it true that I have said."

So far as the deceptive part goes, we have an example in reference to another game, afforded by Van Etten, in his "Mathematical Recreations," Problem XVII. "Of a deceitfull Bowle to play withall." The whole trick consists simply in producing an undue bias by means of a secretly inserted pellet of lead.

Walpole says of the "Century," that—"It is a very small piece—in which he (the Marquis) affirms having, in the presence of Charles the First, performed *many* of the feats mentioned in the Book." As however only *two* are named, No. 56 and No. 64, the foregoing mis-statement requires no stronger refutation. He proceeds:—"The work itself, which is but a table of contents; being a list of one hundred projects, *most of them impossibilities*, but all of which he affirms having discovered the art of performing." Consequently, either the Marquis, or Walpole occupies a most unenviable position: for one or the other, alone speaks the truth. "Some of the easiest (he adds) seem, (among others) how to form an universal character; how to converse by jangling of bells out of tune; how to take towns, or prevent their being taken; how to write in the dark; *how to cheat with dice*; and in short how to fly." He then proceeds to comment on them, observing:—"Of these wonderful inventions (but why wonderful if the easiest?), the last

but one [how to cheat at dice] seems the only one of which his Lordship has left the secret; and, by two others [the universal character, and flying], it appears that the renowned Bishop Wilkins was but the Marquis's disciple. But, perhaps, too much has been said on so fantastic a man." It was by such unmeaning causticity that the accomplished Walpole could degrade his pen, display his own sterility in scientific acquirements, and perpetuate his incapacity to judge aright of the mathematical and mechanical acumen of the Marquis of Worcester.

91.

An artificial Horse, with Saddle and Caparizons fit for running at³ the Ring, on which a man being mounted, with his Lance in his hand, he can at pleasure make him start, and swiftly to run his career, using the decent posture⁴ with *bon grace*, may take the Ring as handsomely, and running as swiftly as if he rode upon a Barbe.

³ at—omitted.

⁴ postures.

[*An artificiall Ring-horse.*] The nearest approach to this automaton was that of a mechanical horse, the invention of Colonel De Hamel, of the Wurtemberg Cavalry. This was, until lately, exhibited at Mason's establishment, Piccadilly, but is now in Germany. It is made of wood, covered with a natural skin, and contains machinery which can be operated by a lever to produce any variety of action, from that of the most gentle to the fiercest of an unruly horse. But the animal

possesses no locomotive power, being restrained to one spot by a strong pillar underneath, working at the centre in a cup-and-ball joint, so that it can fall sideways, backwards, or forwards, unless prevented by equestrian skill; it was, however, more than master of the greater number of many excellent horsemen who subjected themselves to its astonishing gambols.

The Marquis's automaton was possibly intended for a kind of circus, and we may suppose that a strong post being in the centre, a long wooden bar was so placed across it as to revolve—with the horse attached to one end, and a weight or counterpoise on the other extremity, motion being given to the horse's legs by internal machinery, and acting to propel it so long as the rider pleased, or the mechanism permitted.

92.

A scruie made like a Water-scrue,
but the bottom made of Iron-plate
Spade-wife, which at the side of a
Boat emptieth the mud of a Pond,
or raifeth Gravel.

[*A Gravel Engine.*] The principle of the modern dredging machine is to be seen in Besson's "Theatrum Instrumentorum et Machinarum," 1578, where about 25 hampers or buckets are attached to two endless chains passing over two drums, one at the bottom of two strong inclined poles, the other at the top of the same, where a workman turns it by means of an ordinary winch applied to an endless screw; while labourers below are actively filling the ascending vessels. The Marquis may have had in view to make each bucket dig up its own supply of gravel, &c. as indeed is the present practice.

This antiquated dredging machine, in some other

form, had been contemplated in 1558. The Petition of George Cobham, Tomazo Chanata, and others, was presented to Queen Elizabeth, for the sole use of an engine to cleanse and carry away all shelves of sand, banks, &c. out of all rivers, creeks, and havens.—See Cal. State Papers, Dom. Series, 1547-1580. Edited by R. Lemon, F.S.A. 8vo. 1856, page 119, No. 56.

In 1583, an inventor, whose name does not appear, proposed, as one out of twenty inventions:—"An engine for cleansing or taking away of any shelves or shallow places in the river of Thames, or any such river; the same device may serve for cleansing of ditches about cities or towns, ponds, or any such like standing waters."—*Rara Mathematica*, edited by J. O. Halliwell, F.R.S., &c. 8vo. 1841.

John Gilbert obtained a patent, dated 16th July, 1618, for a water plough, for the taking up of sands or banks out of the river Thames or other places. And the same John Gilbert, with James Freese, obtained a patent, dated 8th July, 1631, for engines or instruments, called water ploughs, for the taking up of sands, gravel, shelves, and banks out of the Thames and other havens. Also Symon Hill, on the 30th May, 1633, patented his invention for taking away of beds of sand and gravel from rivers.

93.

An Engine whereby one man may take out of the water a Ship of 500. Tun, so that it may be calked, trimmed and repaired without need of the usual way of stocks, and as easily let it down again.

[*A Ship-raising Engine.*] We find in Besson's admirably illustrated folio work on Instruments and Ma-

chines, 1578, many means delineated for raising vessels; for taking them bodily out of the water; or, for laying them high and dry on shore for repairs, as in plates 55, 56, and 58. All such methods are naturally, however, not only very rude and imperfect, but are at best only applicable for small craft.

In 1636, Sir John Christopher Van Berg, Moravian Knight, dispossessed of all his property "by the devouring wars in Germany," patented eleven inventions; the fifth being—"An assured way how the very greatest ship may be drawn up again, though it be sunk 80 fathoms deep."

94.

A little Engine portable in ones Pocket, which placed to any door, without any noise, but one crack, openeth any door or gate.

[*A Pocket Engine to open any door.*] Doppelmayr gives an account of the screw-jack invented by Leonard Danner in 1550. It must have been well known in the following century, and we can readily understand how the principle of its action may have occurred to the Marquis for application to a pocket instrument that would exactly accord with his statement.

Bishop Wilkins, in his "Mathematical Magick," 1648, treating on the employment of multiplied wheels, refers to Ramelli, Figure 160, observing:—"Hither also should be referred the force of racks, which serve for bending of the strongest bows, as also that little pocket engine wherewith a man may break or wrench open any door, together with divers the like instruments in common use."—Chap. 13, pages 91, 92.

95.

A double Cross-bow, neate, handsome and strong, to shoot two Arrows, either together, or one after the other, so immediately that a Deer cannot run two steps but, if he mis^s of one Arrow, he may be reach'd with the other, whether the Deer run forward, sideward, or start backward.

^s be missed.

[*A double Cross-bow.*] The employment of the cross-bow still lingered when this was first published in 1663. The invention is so obvious that any particular description would be superfluous, the whole effect consisting in either shooting the two arrows singly, or together.

In an article on Cross-bows, in Fosbroke's *Encyclopedia of Antiquities*, 1840, it is stated that—"In a letter remissory, dated 1420, it is said, 'lequel Haquinet a chevauchie tendu *crenequins* et arbalestes a *croc*'—that is, *which Haquinet rode along with crenequins bent, and arbalestes on the hook.* By the *croc* or *crook* is meant the hook, into which the trigger caught; of use both in bending the bow and shooting.

96.

A way to make a Sea-bank so firm and Geometrically-strong, that a stream can have no power over it; excellent likewise to save the Pillar of a Bridge, being far cheaper and stronger than Stone-walls.

[*A way for Sea-banks.*] This article stands alone in the "Century" as an example of a singular divergence from its author's main course of pursuits. It is more than likely that his idea in the present instance was the mere use of loose stones, laid down at such a curvature as to break rather than resist the force of heavy seas and rapid torrents, for such a plan would be decidedly "cheaper and stronger" than any masonry, especially if presenting a vertical surface to the surging sea.

97.

An Instrument whereby an ignorant person may take any thing in Perspective, as justly, and more⁵ than the skilfullest⁶ Painter can do by his eye.

⁵ more so. P.

⁶ most skilful. P.

[*A perspective Instrument.*] John Bate, in his "Mysteries of Nature and Art," 1635, gives, at page 155, "A very easie way to describe a Towne, or Castle: being within the full sight thereof." A vertical square frame is divided by means of a number of threads, crossing each other at equal distances. A vertical pillar opposite, has a spy-hole at the top, through which the town, or other prospect is to be viewed, and to be drawn square by square, on paper placed on the table below, until the whole is completed, as shown in a wood-engraved illustration. No doubt the Marquis had refined on this, or some like invention.

98.

An Engine so contrived, that working the *Primum mobile* forward or backward, upward or downward,⁷

⁷ forwards or backwards, upwards or downwards.

circularly or cornerwise, to and fro, streight, upright or downright, yet the pretended Operation continueth, and advanceth none of the motions above-mentioned, hindering, much less stopping the other; but unanimously, and with harmony agreeing they all augment and contribute strength unto the intended work and operation: And therefore I call this *A Semi-omnipotent Engine*, and do intend that a Model thereof be buried with me.

[*A Semi-omnipotent Engine.*] The Marquis, previous to the publication of this article, had permitted a written notification of a few of this inventions to be circulated, which is given at length, in Appendix A. In the commencement of this MS. we recognize an earlier reading of the foregoing, as follows:—"The quintessence of motion, or a collection of all kinds of movements, to wit; circular, to and fro, perpendicular, upwards and downwards; side-motions, to the right and left; straight motions, forwards and backwards, with a circular vehiculum, to which any of these may be applicable, or moveable to all the points of the compass; at each of which, it will be as powerful as if it were fixed to one place or centre.

"All and every of these, by height of Art, Industry, and Experiment, working the same individual and intrinsic effect, without disturbance one to the other; and yet by these absolutely contrary motions, so performed, most strange and incredible effects may be brought to

pass, to the admiration of even the greatest mathematicians.

“The knowledge of these things rendering all things as feasible to him that is master of this art, as it is to make a circle with a pair of compasses, or a straight line with a square or ruler; they being a direct abstract of arithmetic contrived by me.”

No. 98 may be read as a second notice of his steam engine; No. 68, developing the broad principle of its source of action, while the above indicates the working parts. He may allude to the facility of communicating motion to levers, forces, pistons, or plungers, in any direction, by turning on steam to variously arranged pipes, so that to his mind it appeared as though it were something of super-human origin. While the beauty, novelty, and success of his new design overawed his own mind, it was a matter of infinite surprise to him that he could not immediately impress others with a sense of the immense value and unbounded importance of an invention which superseded animal power: placing at man's disposal a greater and more controllable mechanical agent than even the elements of nature, under the most favourable circumstances, had ever supplied.

He expressed his own solemn impression, on seeing the successful issue of this great work, when he said—
“I call this a semi-omnipotent engine, and *do intend that a model thereof be buried with me.*”

99.

How to make one pound weight
to raise an hundred as high as one
pound falleth, and yet the hundred

pound⁸ descending doth⁹ what nothing less than one hundred pound⁸ can effect.

⁸ pounds. P.

⁹ to do.

[*A most admirable way to raise Weights.*] In his MS. of a select number of his inventions, we have, in No. 6, the following earlier reading of the above:—

“By these (his quintessence of motions) I can make one pound raise an hundred, as high as the pound falls; and the one pound taken off the 112 pounds shall again descend, performing the entire effect of an hundred weight, that is, have the force which nothing less than 112 pounds can have any other way. An incredible effect till seen, but true as strange.”—See Appendix A.

Keeping in view Nos. 25 and 27, we have here a third application of the same principle, by which it is proposed with one pound to raise a hundred “as *high* as one pound *falleth*.” In the engraved figure of this demonstrative

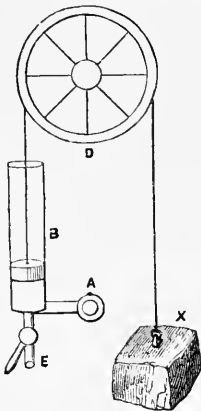

model, one steam cylinder B, is shown, with its steam pipe and valve at A; one end of a cord is attached to the piston B, and passing over the drum wheel D, is attached to the weight X. As condensation ensues, the descent of B, will raise X; and it may be reset for another lift by drawing off the condensed water at E, and re-admitting steam.

Here we are required “to make one pound weight” so that it shall be able to raise 100 times its own weight, always bearing in mind —“as *high* as one *falleth*.” This being no Archimedean experiment would be unintelligible to any man

ignorant of steam, and some mode of applying its property of condensation.

James Rollock,* in his doggerel verses, attempts some description of this principle as applied to raising water, when he says:—

“ Here little David curbs the Giant’s brood,
Small drops of Rain contend with Noah’s flood ;
 One weighs a thousand coming down apace,
 Weighs but himself when he hath run his race.

The Heavens admire, the Centre stands amaz’d,
 To see such Streams by so small Forces rais’d.
 Great is the Work, but greater is the Fame
 Of that great Peer who did invent the same.”

The plain English of Rollock’s feeble lines is, that a stream of water falling like “ *small drops of rain,*” on the steam cylinder, caused the elevation of a hundred or more gallons, which he likens to “ Noah’s flood,” in illustration of the greatness of the result; while the steam “ weighs but itself,” being condensed. “ Here little David,” is no more than the single attendant on the “ Giant’s brood,”—the Water-commanding Engine.

The distribution of the three articles, Nos. 25, 27, and 99, is evidently adopted to conceal their connection; as we have already seen in the instance of Nos. 22, 23, and 58, which, although related to each other, are yet separated, as though they were quite independent.

100.

Upon so potent a help as these two last mentioned Inventions a Waterwork is by many years experience¹ and labour so advantage-

¹ expences—for experience.

* See Appendix C.

ously by me² contrived, that a Child's force bringeth up an hundred foot³ high an incredible quantity of water, even two foot³ Diameter, ⁴so naturally, that the work will not be heard even into the next Room ; and with so great ease and Geometrical Symmetry, that though it work day and night from one end of the year to the other, it will not require forty shillings reparation to the whole Engine, nor hinder ones day-work.⁴ And I may boldly call it *The most stupendious Work in the whole world*: not onely with little charge to drein all forts of Mines, and furnish Cities with water, though never so high seated, as well to keep them sweet, running through several streets, and so performing the work of Scavengers, as well as furnishing the Inhabitants with sufficient water for their private occasions ; but likewise supplying Rivers⁵

² by me—omitted.

³ feet. P.

⁴ The sentence :—“ So naturally, that the work will not be heard even in the next room, and with so great ease and geometrical symmetry, that though it work day and night from one end of the year to the other, it will not require forty shillings reparation to the whole Engine, nor hinder one's day-work”—does not appear in the MS. and is omitted by Partington in his edition.

⁵ the rivers. P.

with sufficient to maintaine and make them portable⁶ from Towne to Towne, and for the bettering of Lands all the way it runs ; with many more advantageous, and yet greater effects of Profit, Admiracion, and Consequence. So that deservedly I deem this Invention to crown my Labours, to reward my Expences, and make my Thoughts acquiesce in way of further Inventions: This making up the whole Century, and preventing any further trouble to the Reader for the present, meaning to leave to Posterity a Book, wherein under each of these Heads the means to put in execution and visible trial all and every of these Inventions, with the shape and form of all things belonging to them, shall be Printed by Brasse-plates.⁷

In Bonum Publicum



*Ad Majorem DEI Gloriam.**

⁶ make navigable—for, make them portable.

⁷ Thus ends No. 100 of the first printed edition ; but Mr. P. continues the paragraph by adding from the MS. what is clearly only a Postscript to the entire "Century." He then concludes with the Latin phrase, thus following neither work entirely.

* The following concluding part of the MS., added as a postscript, does not

[*A stupendious Water-work.*] The present article concludes the Marquis of Worcester's own observations on his Water-commanding Engine. His engagements in hydraulic engineering, as we have already seen, commenced about, or before, 1628; but we have later and more satisfactory evidence of his having had the invention, which is here indicated, absolutely at work, under the management of his engineer Kaltoff, at Vauxhall. Hitherto we have confined our notice of any express date to the period of the passing of the Act in 1663, securing to him the profits in his invention for 99 years. We are, however, now prepared to show that, during the reign of Charles the First, in and before 1647, the Marquis was occupied on the mechanical arrangements of his engine, when one William Lambert, a brass-founder, was engaged under him at Vauxhall, in providing material "founded in brass," expressly for "water-work." This evidence, being afforded under circumstances very different from any attempt to establish the present statement, is all the more trustworthy, coming as a mere evidence of personal employment in the Marquis's service, while soliciting from Charles the Second, after his restoration, to be reinstated at Vauxhall, in accordance with an order from the late king.

We shall now give entire the exceedingly interesting and important petition and royal order, from the original in the State Paper Office:—*

appear in the 1st edition, 1663:—"Besides many omitted, and some of three sorts willingly not set down, as not fit to be divulged, least ill use may be made thereof; but to show that such things are also within my knowledge, I will here in myne owne cypler set down at least one of each, not to be concealed where duty, and affection obligeth me."

* This Petition is calendared under the date "1665?" but probably belongs to 1664.

“TO THE KING’S MOST EXCELLENT MAJESTY,

“The humble Petition of William Lambert.

“Humbly sheweth,

“That your Petitioner was founder to his late Majesty of blessed memory in Ffoxhall under the Marquis of Worcester, for gun and waterwork or any other thing founded in brass; and in the late unhappy war, your Petitioner was dispossessed of his employment, and left to the value of £2,000. and driven to exile by that usurpers authority.

“That your Majesty was graciously pleased at Brussels to grant your petitioner the place of founder for your Majesty’s works at Ffoxhall, upon your Majesty’s happy restoration, whereupon your Pet^r. depended; and deserted the King of Spain’s service; yet, nevertheless, the house was disposed to one Mr. Calthoofe, now deceased.

“Your Petitioner most humbly prayeth, That your sacred Majesty would be graciously pleased to confer upon your Petitioner some part of your Majesty’s house at Ffoxhall, to make a Founding-house for your Majesty’s use and service.

“And your Petitioner (as in duty bound) shall pray, &c.”

The following is the grant above named:—

“CHARLES R.

“Our pleasure is, That WILLIAM LAMBERT, Founder for our Works at Ffoxhall, shall and may, with his family and servants, abide in and possess to our use, our house at Ffoxhall aforesaid, together with the outhousing and appurtenances of the same, and there proceed in the work as formerly he hath done,

without any molestation to him or his, until further express order from us.

“Given at our Court at Oatlands, the 20th day of August, 1647.”*

These documents are highly interesting, as they establish, beyond a doubt, the Marquis's early connection with gunnery and with water-work operations at Vauxhall, and account for the practical character of inventions mentioned in the “Century,” which might reasonably be thought to be beyond the scope of a private individual.

Kaltoff died in, or before, the year 1664, and it is not unlikely, therefore, that the Marquis countenanced Lambert's present application. For more on Vauxhall and Kaltoff, see Appendix G.

The Marquis of Worcester had principally in view, in this invention, raising water for private and public purposes, and the general draining of mines or other inundated property. Its great value was evidently to supply cities and towns with water, and to drain mines of their superfluous quantity. The mineral wealth of this country was drowned treasure, until the steam engine's powerful aid placed it within the power of man to eject the water in greater volume than it entered. Until the 17th century, this apparently obvious application of the steam engine was entirely overlooked, and had Savery done no more than impress on public notice its applicability for that invaluable purpose, he would still deserve the highest commendations of posterity. Many remarkable works were, no doubt, effected even with ordinary appliances, and men do not willingly abandon the experience of generations. We find that

* Cal. State Papers, Dom. Series, 1665-6. Edited by Mary A. E. Green, 8vo. 1664, p. 153. No. 138, and No. 138, i.

in the middle of the 16th century, viz.—July 2, 1565, Wm. Humfrey wrote to Sir William Cecil, concerning the working of copper mines; recommending an Ahnain engineer, who, he represents, can raise water one hundred fathoms high, by a newly invented engine.—Cal. State Papers, Dom. Series, 1547-1580. Edited by R. Lemon, F.S.A., 8vo. 1856, page 254. No. 73.

That the ordinary draining of land had made no material progress in the 17th century, we gather from the correspondence collected in “Samuel Hartlib his Legacie: or an enlargement of the Discourse of Husbandry,” 4to. 1651; where there is a letter written by Cressy Dymock, in which he remarks—“I went into the Isle of Ely, to see one of the Holland-mills, for dreyning; though set up there and kept by certain Frenchmen. The Invention seemed to me but mean and rude, and Mr. Wheeler’s way much more ingenious.” “I saw at Wicklesen the manner of your Holland sluices. The ruines also of a cochlea, for the emptying and dreining of water, of which Ubaldus hath writ a whole treatise.”—Pages 109, 110.

The Act of Parliament, of May, 1663, states in regard to the Marquis’s Invention, that he “hath by long and indefatigable pains and study, and with great and vast expenses, invented and found out a Secret in Nature, never heretofore discovered, being a Water-commanding engine, of greater force and advantage than hitherto hath been known; and being no pump or force now in use, nor working by any suckers, barrels, or bellows heretofore used for the raising and conveying of water; which said Engine will yield very great benefit and advantage to the Commonwealth, by draining of all sorts of Mines, Marish, Oazie, or overflown Grounds, by furnishing of Rivers and Cutts with water to make them Navigable and Portable from Town

to Town; by improving of Lands wanting water; by the supplying and bringing in of water into the City of London, or into any other places; and by divers other ways and means whereby great Encouragement will be given to the People of the Nation, to undertake to work rich Mines, to drain and gain in many Marish, Oazie, and surrounded Grounds, which hitherto they have been deterred to endeavour the improvements of, by reason of the vast sums of money which must be necessarily expended by the draining and conveying away the water out of the same. * * * * * And that a Model thereof be delivered by the said Marquis, or his Assignes, to the Lord Treasurer, or Commissioner for the Treasury, for the time being, at or before the 29th of September, 1663."—See Appendix.

We trace the early use of steam in some of the simple apparatus of various forms, called *Æolipile*, to a period anterior to the Christian era. Greece and Rome, France, Holland, and Germany, have each contributed some instrument or other indicative of a knowledge of the expansive property of steam, pent up in close vessels, to give slight motions to, or force water from small delicately constructed apparatus, designed for amusement, or at most only to occasion a strong blast for blowing a fire, as figured in "*Vitruvio de Architectura*," folio, 1521. Some of these early stages of progress we shall further notice here.

Besson, in his folio work on Instruments and Machines, 1578, among other contrivances shows, in plate XVIII, a cylindrical vessel, containing a coiled spring, above which is a close fitting disc, secured underneath to a cord, which, passing through the coiled spring, passes out at the bottom of the vessel, by which means it can be used to pull down the disc, so as to compress the spring, while the vessel is being filled with water, and

its cover, with a jet in the centre, secured; on releasing the spring, we have here a piston acting from below upwards, to produce a fountain.

John Baptista Porta, in his "Spiritalia," quarto, 1606, gives a rude wood engraving, as here exactly represented, a metal flask-shaped boiler, fitting the top of a small furnace, while its neck proceeds through the bottom of a cistern of water, within which there is a syphon on the right hand side, and an aperture at

the top through which the cistern can be refilled. By this arrangement, the steam presses on the surface of the water, when all is closed, except the syphon, from which the water will rush with increased velocity.

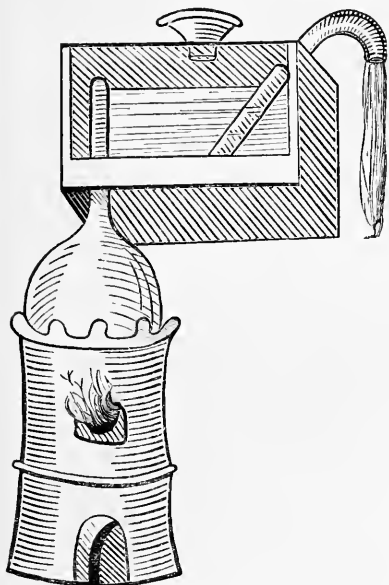

In the 16th century, motive and other Æolipile were well known, and are described and illustrated by Vitruvius, Hero, and other early writers. In 1606, Porta made a slight advance, and John Rovin-

son, patentee of improvements in the manufacture of iron, in his "Treatise of Metallica," 1613, among other necessary parts of his invention, describes the following:—"A new-devised vetible, round and hollow, with a long spout, to be made of some mettall or potter's earth, wherein water being put, and the same placed on a fire, as it heateth, and the *water evaporateth by the spout*, it maketh a *continual blast* to kindle, or increase the fire in furnaces, or fire-workes, *and may be converted to many other excellent uses*: and same may be made in

severall peeces with the top or upper part removeable at pleasure, so as the lower part being made to stand on feet, may serve at pleasure for a posset, skellet or boylatory; and when the top is put on, and when fastened and luted, it may then serve for the ventible to make the blast."

In 1615, De Caus invented, or at all events published an account of a small hot-water fountain; in 1617, Robert Fludd published his voluminous work, "Historia Macrosmi," containing descriptive and engraved illustrations of the effects produced on water heated in close flask-shaped vessels.

In 1629, Branca suggested the rotating of a wheel, acted on by a jet of steam, as a simple kind of stamping or pounding mill. But the author, who seems to have taken a more practical and enlightened view of the subject, and to have considerably contributed to the Marquis's enthusiasm, was John Bate, who, in 1634 and 1635, published editions of his "Mysteries of Nature and Art." His treatise, "The first Booke of Water-workes," contains, as stated at the commencement, "Experiments of drawing water by the crane (syphon), and by engines; of forcing water by ayre compressed, and by engines; of producing sounds by ayre and water; by *evaporation of water by fire*, and by engines; of *motions by evaporating water*, and by rarifying ayre."

Among his "Experiments of producing sounds by evaporation of water by ayer," the following is given:—



"Prepare a round vessell of brasse, or lattin, having a crooked pipe or necke, whereunto fasten a pipe: put this vessell upon a trevet over the fire, and it will make a shrill whistling noyse."—Page 27.

He figures a blow-pipe for glass-working, as in the annexed engraving, which he thus describes:—

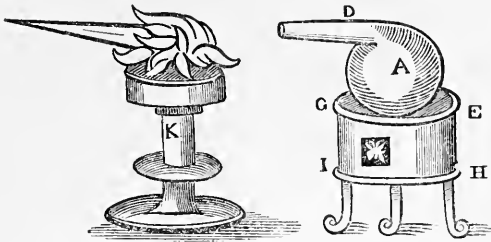

“Let there be a vessell of copper about the bignesse of a common foot-ball, as A; let it have a long pipe at the top as D, which must be made so that you may upon occasion screw on lesser, or bigger vents made for the purpose. Fill this one-third part with water, and set it over a furnace of coals, as E, G, H, I, and when the water beginneth to heat, there will come a strong breath out of the nose of the vessel, that will force the flame of a lampe placed at a convenient distance as K.”
—Page 158.

Sir Hugh Plat, in his “Jewel House of Art and Nature,” 1594, gives an account of the ordinary fire-blowing Æolipile. He says:—“A round ball of copper or lattin, that will blow the fire very strongly, only by the attenuation of water into air; which device will also serve to perfume with. —A round ball of copper or lattin, of the bigness of a small bowl—a round pipe or neck, of 3 or 4 inches in length, less than a goose quill — and an elbow of a less pipe no bigger than a straw, whose

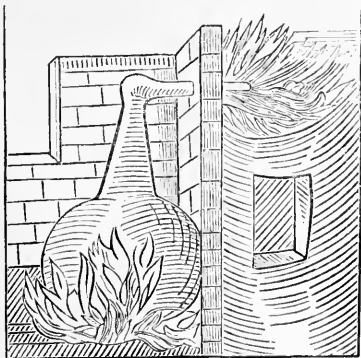

vent in the end must be no bigger than a pinhole." "Heat the same well in the fire, and then put it into a vessel of cold water, and it will suck some of the water into it, you may heat the same so often, till by the peize (poise?) thereof you may be assured that it is more than half full. Then set this ball on a few glowing coals, and you shall find the same to give a very strong blast. . . . I make no question but that the same may be made so large as that they will blow one whole hour together without any intermission."—Page 25.

In the second edition of Dr. French's "Art of Distillation," 1653, page 150, he describes the "Philosophicall Bellowes:" one is to blow a furnace fire; another a candle, serving as a blow-pipe; and the third for a common fire. He notes "that these kind of vessels must be made of copper, and be exceedingly well closed, that they may have no vent but at their noses." He recommends, in preparing them for use, that "you must first heat them very hot, then put the noses thereof (which must have a very small hole in them, no bigger than a pin's head may go in) into a vessel of cold water, and they will presently suck in the water, of which being then full turne the noses thereof towards the candle or fire which you would have blown."

The third figure, instead of being a copper ball is formed like the human face, and is held by a long stick or handle attached to the back. It is represented and described by Schwenterii, in his "Deliciae Physico-Mathematicæ," 1638, along with two tubulated balls for similar use.

Such then were the suggestions the Marquis had before him to excite his experimental inquiries, independent of other sources. But whatever he may have known on the subject of these applications of steam, however much

he may have experimented on them, there are two things, of which no one has yet given him the credit of possessing any knowledge whatever, the one is, condensation; the other, a piston. How the Marquis of Worcester could have been experimenting at the cost of £50,000, and upwards, at Vauxhall, and been occupied in this particular class of experiments during a large portion of thirty-eight years, in perfect ignorance that cold water will condense steam, is past all comprehension. Nay, such ignorance would be a greater matter of surprise, than the exhibition of his utmost ingenuity in the mechanical contrivances connected with his engine. Condensation was no mystery. Every work on distillation spoke on the subject, and supplied the forms of refrigeratory worms, and refrigerating heads for alembics. His very allusion to the strength of his vessels must have had reference, first to internal distension, as well as to collapse from external pressure.

John Bate, in his first book, "Of Water Works," describes a kind of weather glass, which he calls, "the moveable perpendicular glass;" for the construction of which his directions are—"First prepare the glass A, B, fill it almost top full of water, provide also the glass K, L, having a loop at the top of it: divide it into so many equal parts as you would have degrees, and on the mouth thereof fasten a thin board, that will easily slip in and out of the bottom glass; make then a weight of lead or brass somewhat heavier than both the glass and board fastened thereunto; and then tie a little rope to the loop of the glass A, B, and the weight at the other end thereof. *Rarifie* the air contained in the glass L, and reverse it into the glass A, B, filled with water, and hang the plummet over two little pulleys fastened in a frame made for the purpose; and as the glass K, L, *cooleth*, the water will ascend the

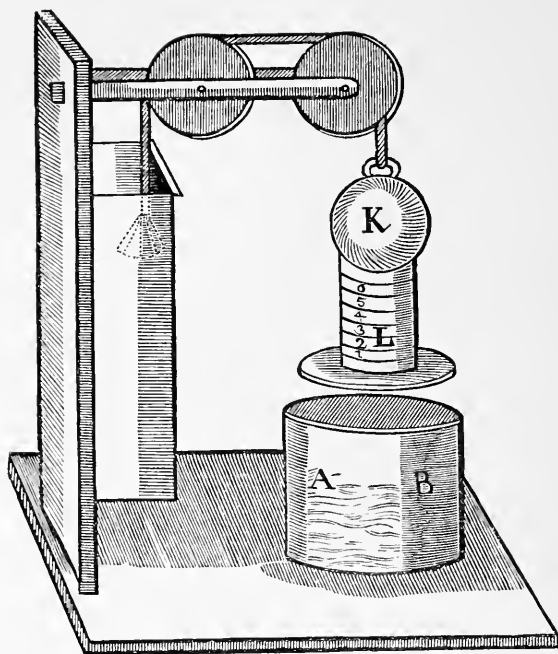

same, and so by the change of the outward both the glass and water will move accordingly.”—Pages 42-43.

From all that has been advanced, an impartial reader must feel satisfied that there existed abundant sources of popular information, highly suggestive to such an inquisitive and inventive mind as the Marquis possessed. Van Etten mentions the filling of a cannon with water, the plugging it up, and exploding it by the action of fire applied to its trunnion. And here John Bate suggests an experimental apparatus on a small scale, which the Marquis would be almost certain to test, and in so doing to vary the construction and application. *Rarefaction* too is here recommended; and the effect of *cooling* or condensation is particularly noted, the stated result being, “*the water will ascend.*” We can readily imagine the Marquis varying such an expe-

riment with infinite delight, and modifying and enlarging it to produce some practical application.

In considering these minuter points, we must never lose sight of the extraordinary perseverance shown by the Marquis throughout a long life, in conducting and varying his experimental inquiries. It was the one pursuit of a studious life-time, the heaviest source of expenditure in his private disbursements. Perhaps we should be very much under the mark in saying that he must have expended above a hundred thousand pounds in experiments alone; which would be represented by nearly ten times that amount in our day. And not only was this outlay very great, but he had for above thirty-five years kept his workman, Caspar Kaltoff, constantly engaged on his models and on practical trials of his variously constructed inventions.

The Act for his Water-commanding Engine received the Royal assent in June, 1663, and the same year he published his "Century of Inventions" (as here reprinted); a pamphlet was next issued, with no other title than the following heading at the top of the first page—"An exact and true definition of the most stupendous Water-commanding Engine, invented by the Right Honourable (and deservedly to be praised and admired) Edward Somerset, Lord Marquess of Worcester, and by his Lordship himself presented to His most Excellent Majesty, Charles the Second, our most gracious Sovereign."—See Appendix C.

This pamphlet appears to have had some connection with means for giving publicity to the formation of a public company for carrying out the great design on a sufficiently large and remunerative scale. The author, or editor, was James Rollock, who here flourishes in a poetical vein, observing, "After the Act of Parliament, there is here set down a Latin Elogium, and an English

Panegirick, both of them composed through duty and gratitude *by an ancient serrant of his Lordship's.*" He afterwards adds: "This ancient servant of his Lordship's, hath for forty years been an eye witness of his great ingenuity, indefatigable pains, and vast expences in perfecting for publique service, not onely this most Stupendious Water-commanding Engine, but likewise several other rare, useful, and never formerly heard of Mathematical conclusions, of which he hath owned a Century, and thereunto I refer you: though this alone were enough to eternalize his Name to all Ages and future times."

The "Definition" given in the pamphlet agrees with that which has already appeared in the "Life, Times, &c.," pages 224, 225, from another source, and is here stated as follows:—

- "The Engine consisteth of the following Particulars;
- " 1. A perfect Counterpoize for what Quantity soever of Water.
 - " 2. A perfect Countervail for what Height soever it is to be brought unto.
 - " 3. A *Primum Mobile* commanding both Height and Quantity Regulator-wise.
 - " 4. A Vicegerent or Countervail supplying the place, and performing the full force of a Man, Wind, Beast, or Mill.
 - " 5. A Helm or Stern, with Bitt and Reins, wherewith any Child may guide, order, and control the whole Operation.
 - " 6. A particular Magazine for Water, according to the intended Quantity or Height of Water.
 - " 7. An Aquaduct capable of any intended Quantity or Height of Water.
 - " 8. A place for the Original Fountain or even river to run into, and naturally of its own accord incor-

porate itself with the rising Water, and at the very bottom of the same Aquaduct, though never so big or high."

We cannot do otherwise than consider that the articles, Nos. 68, 98, and 100, refer to descriptions of the several parts of his remarkable steam engine. In No. 68, we have the two vessels, with two cocks, connected with a furnace, and so arranged that "one vessel of water being consumed, another begins to force and refill with cold water." In No. 98, we have intimation of "the *primum mobile*," forming the 3rd division of the particulars enumerated above; being some portion of the engine capable of every variety of movement. And in No. 100, we have no mechanical suggestions, but in their place a bare enumeration of results, and of advantages to be derived from the employment of such engines.

What then are we to understand by the preceding list of particulars? "1. A perfect *counterpoise*," would suggest that the Marquis had contrived a complete system of pumping; "2. A perfect *countervail*," appears to be only a different kind of counterpoise, as though the one were derived from weight, and the other from the action of the steam; 4. "A vicegerent," may be the force or piston; 5. "A helm or stern, with bit and reins," can hardly be mistaken for any other than levers, acting on valves, and in some positions connected with chains running over guide pulleys; while the parts 6, 7, and 8, refer wholly to reservoirs, cisterns, and other external arrangements. But this statement is simply made to remind the reader that the Marquis's Engine was not so entirely simple in its construction as to consist only of a boiler and receiver, and to depend wholly on the effect of the direct action of steam on a large surface of cold water, as generally intimated. It is usual entirely to set aside this full and clear statement of

details. So indefinitely has the Marquis's claim hitherto been stated, that it is always assumed, that while using this early steam engine, he was quite unacquainted with condensation; or, at least, with any mode of employing it to produce a useful effect. On the other hand, it is not only more rational to suppose that he could not be otherwise than fully acquainted with it, but that, having ascertained its various results, he finally succeeded in employing condensation to produce a vacuum for refilling his vessels, and for giving motion to a force or piston. Indeed, we find in the foregoing statement—"6. A *particular* Magazine for Water, according to the intended *quantity* or *Height* of Water." A *particular* Magazine, one for a special purpose, for which it was particular to have such a supply; and for size, form, and situation, it had reference "to the quantity and height of water," for a small cistern would supply sufficient water for condensation, but a larger cistern would be required in proportion to more extended service. Then, "7. An Aqueduct," might be the vertical main pipe; and "8. A place for the original fountain," peculiarly arranged reservoirs, with suitable valves, floats, &c.

Uniting his several descriptions, we readily make out a construction of apparatus answering many of the conditions he has stated, as shown in the engraving* on the opposite page from a sectional drawing designed by the author.

* DESCRIPTION OF THE ENGRAVING.

A, A' Two cold water vessels, connected by—

B, B'—the steam pipe, with—

C, the Boiler, set in—

D, the furnace. The cold water vessels A A', also are connected with—

E, the vertical water pipe by means of—

F, F', continuations of the same pipe conducted into and nearly touching the bottom of each vessel A, A'.

G, G', are two water supply pipes, with valves *a, a'*, dipping into—

H, the well. It is obvious that by uniting these pipes, and placing the valves in

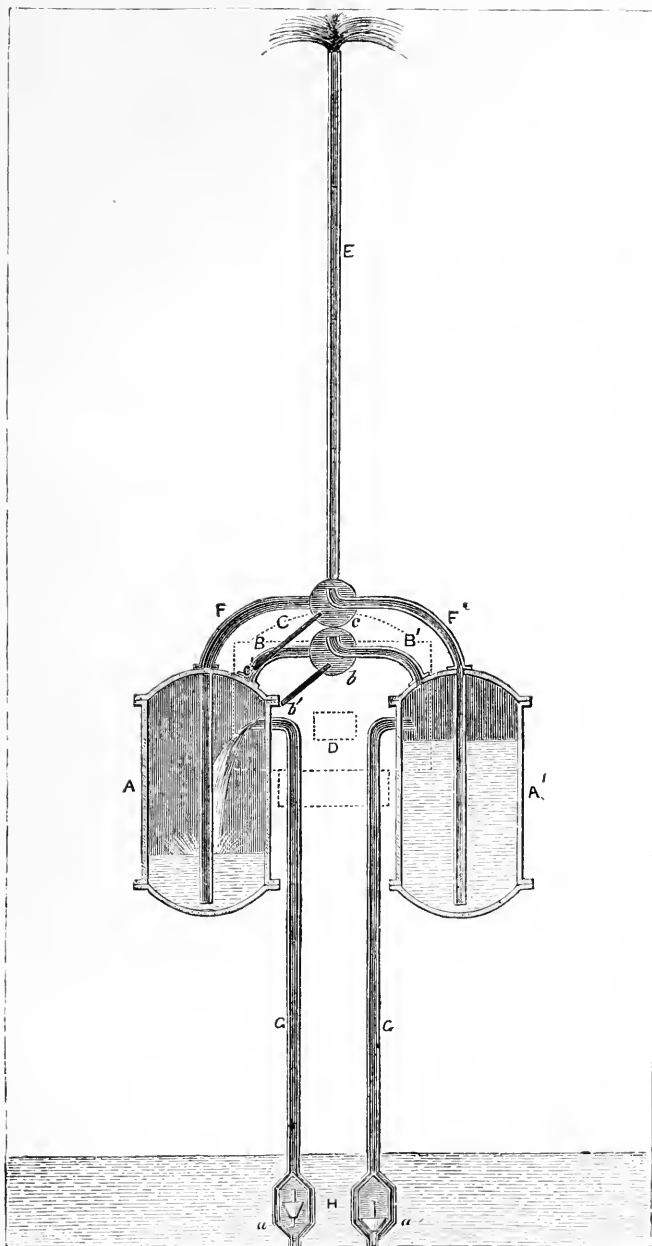

In the "Life, Times, &c.," page 20, we have a view of the deep grooves cut in that side of the Citadel of Raglan Castle, on which the Marquis of Worcester's Water-works were situated. The grooves would admit the insertion of pipes of about one foot external diameter, either round, or square, and they would carry water nearly twenty-five feet high. In the early use of his engine, he may have forced the water direct from the boiler, or by the using of an independent boiler, as employed by Porta, in 1606; but either way, the arrangement of his Raglan works would seem to have been that of employing a main vertical pipe for each boiler or receiver, instead of each receiver being connected with a four-way cock with one vertical pipe, or "aqueduct."

With these observations we close our comments on the various articles of the "Century," after having supplied a mass of most important references to contemporary and earlier scientific authors; as well as offered several entirely new solutions; and reduced the problematical character of this singularly interesting work to one only, being No. 56, which alone remains open to the charge of being a paradox.

the upper bend of each, it would be sufficient for a single pipe to dip into the water to be raised.

On the steam pipe B B' is—

b, a four-way steam cock, operated by—

b', its lever handle; and on the horizontal portion of the water pipe F F', is—

c, a four-way water cock, operated by—

c', its lever handle.

* * The four-way cock is figured and described as early as 1618, by Robert Fludd, in "Historia Macrosmi," folio, page 467.



ADDENDA.

No. 5. *Cipher writing.* At page 398, reference is made to a Cipher letter, engraved in “The Life,” at page 180. It was written by the Marquis, as now appears, at Dublin, the 29th of September, 1645. The author having made out the character, is able to supply the following key, or alphabet.

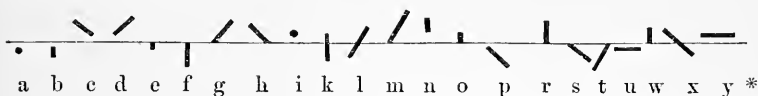

Curiously enough it is the document given at page 139, so that Carte must have obtained a deciphered copy as well. But the words, “the King of the assent,” should be “the King of his assent.” The words, “towards your Excellency” (in the 10th line) are not in the original. Also the words, “And my intention was ever to acquaint your Honour herewith,” should be “and mine intent was ever to acquaint you herewith.” There is no signature to the original, but the written direction shows it was from the Earl of Glamorgan.

We have now authentic proof of the construction and character of at least one Cipher method of writing adopted by the Marquis, eighteen years prior to the publication of the “Century.”

No. 53. *An hollowing of a water-screw.* A slight addition to the comment on this article will be easily understood by reference to the adjoining three figures, and

* No letter q or z.

probably throw some light on what the Marquis may have actually intended. Being desirous to construct a model screw, some years ago, the author designed the following

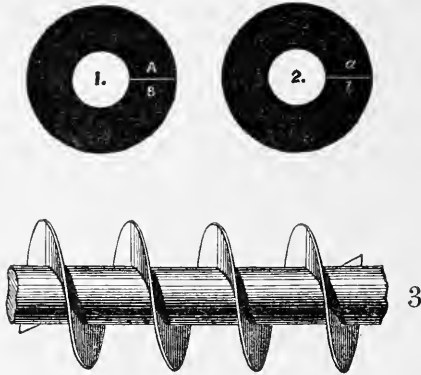

method of making one of tin or zinc, which may be easily shown by cutting out the same in thin paste-board. Form a number of discs of thin metal like No. 1, say three inches diameter, with a hole in the centre one inch diameter, and the metal cut through at A. Rivet, solder, or otherwise fasten them together, commencing by placing No. 2 on No. 1; now secure the cut edge of A, to the similar edge of b, and so on in succession, until a sufficient pile is obtained. They may now be extended to form a screw, as in No. 3, of any desired pitch. The minuter details of construction will be obvious to any clever artizan.

APPENDIX A.

[The following is from Birch's MSS. in the British Museum, No. 4459; and portions have been quoted in the Commentary, under each article of invention named herein.]

INVENTIONS OF YE EARLE OF WORCESTRE

The Quint E'ssence of Motion, or a C'ollection of all kinds of Movements, to wit, C'ircular, to & fro; Perpendicular, upwards & downwards; side motions, to y^e right & left; straight Motions, forwards & backwards with a Circular Vehiculum, to wch any of these, may bee applicable or moveable to all y^e points of y^e C'ompass: At each of wch, it will bee as powerfull as if it were fixt to one place or C'enter.

All & every of these, by hight of Art, Industry, & Experiments working y^e same Individuall & Intrinsicall effect, without disturbance one to y^e other: & yet by these absolutely contrary Motions soe perform'd, most strange & incredible E'ffects may bee brought to passe, to y^e Admiration even of y^e greatest Mathematicians.

The knowledge of these things, rendring all things as feacible to him, y^t is Master of this Art, as it is to make a C'ircle with a paire of C'ompasses, or a straight line, wth a sqvare or Ruler. They being a direct abstraet of Arithmetick, contrived by mee. And by y^e power of those, I have perfected these following Conclusions, wth some hundreds besides all experimented by mee.

(1) I can render an ordinary Watch, wch being once wound up, will goe constantly, during a Mans life, being vsed but once in 24. houres, & (though oftner look't on :) it is still y^e same, & though not look't on for a weeke, still y^e same, if not bruised.

(2) By this I can make a Vessel of as great burthen, as y^e River can beare, to goe ag^t y^e streame, wch y^e more rapid it is, y^e faster it shall advance, & y^e moveable part y^t workes it, may bee by one man still guided, to take y^e best advantage of y^e streame, & yet to steer the boat to any point. And this E'ngine is applicable to any Vessell or Boate, whatsoever; without being therefore made on purpose; And worketh these effects. It roweth, it draweth, it driveth (: if need bee :) to passe London bridge ag^t y^e streame at low water: And a boate lying at Anchor, the E'ngine may be used for loading or vnloading.

(3) By this I can make an Artificiall Bird to fly wch way & as long as I please.

(4) By these I can make a ball of S'ilver or G'old wch throwne into a pale or poole of Water, shall rise againe to y^e perfect houre of any day or night: The superficies of y^e Water shall still show the houre distinctly, even y^e minutes, if I please.

(5) By this I can make a C'hilde in a C'oach, to stop y^e horses (ruñing away) & shall be able to secure him. & those y^t bee in y^e C'oach, having a little E'ngine placed therein, wch shall not bee perceived in what posture soever y^e horses draw: a C'hildes force shall bee able, to disengage them, from overturning y^e C'oach or prejudicing any body in it. .

(6) By these I can make one pound raise an hundred, as high as y^e one pound falls, & y^e one pound taken off y^e 112^{lb} shall againe descend, performing y^e entire effect of an hundred waight (i.e.) have y^t force wch nothing lesse, then 112^{lb} can have any other way. An incredible effect till scene, but true as strange.

(7) By these a C'hilde shall raise as much water 100 foot high (speaking within C'ompasse) as 6. horses can force vp any other way.

(8) By these I can stop any other Mans Motion, & render it Null, since from any point of y^e C'ompasse, I can forceably & effectually cause a counterbuffe or absolute obstruction of such Motion, wch way I please all wayes, beeing indifferent to mee to worke a perfect resistance, & to countermine their Intentions, or to force their Motions a cleane contrary way.

The 9 was left out in y^e Original C'opy. (9)

S'oe here y^a have 9 figures represented, wch in Arithmetick, make all numbers imaginable, soe by y^e helpe of these Motions, noe Manufacture, but may be demonstrated exquisitely & demonstrably & with great ease and facility. And noe Conclusion in y^e Mathematicks or Mechanicks, but may by these bee brought to passe in great perfection & to admiration. Yet as y^e most excellent tooles cannot worke alone; nor any C'ymeter is soe sharp to cut wthout an arme to guide it. S'oe without Knowledge, Art, & Ingenuitic, these are fruitlesse. But being set to worke by one of noe more Knowledge then myselfe, am capable off, they will performe w^t is here asserted & more then I could write, from one end off y^e yeare to y^e other.

(Note.—No. 9 is here stated to be left out, but may not the first named, or “ Quint-essence of Motion,” be No. 1, so making up Nine in all? [See pp. 530, 531.] In the next line the copyist has first written 8 and then altered it to 9, to accord with the sense of the passage.)

APPENDIX B.

[ABRIDGED FROM THE PRINTED SPECIFICATIONS OF THE PATENT
OFFICE.]

MARQUIS OF WORCESTER'S PATENT.—SIGNET BILL.

A.D. 1661. . . . NO. 131.

Clocks, Guns, Carriages, Boats, &c.

CHARLES R.

CHARLES THE SECOND, by the grace of God, &c., to all to whom these pntē shall come greeting.

WHEREAS our right trusty and entirely beloved couzin EDWARD, Marquesse of WORCESTER hath for many yeares applied his thoughtē and studies, and hath beene at very great charges, to contrive and perfect divers rare and new Invenčons, contenting himselfe with the good and advantage which will redound to the publike and to every particuler industrious workman or curious persons who shall make vse of the said Invenčons, the productē of his extraordinary expences and ingenuity: And whereas, amongst other vsefull and new Invenčons of farr greater consequence, the said Marquesse hath found out and experimented these severall new Invenčons herein-after particularly menčoned (that is to say)—

“1. To make a watch or clock without string or chaine, or any other kind of winding up but what of necessity must follow if the owner or keeper of the said watch or clock will know the hour of day or night; and yet if he lay it aside several days and weeks without looking or meddling with it, it shall go very well, and as justly as most watches that ever were made.

2. And also an Invention to make certain guns or pistols, which in the tenth part of one minute of an hour may, with a flaske contrived to that purpose, be recharged, the fourth part of one turne of the barre, which remains still fixt, fastening it as forceably and effectually as a dozen threads of any screw, which in the ordinary and usual way require as many turns.

3. Also an Invention to make an engine applicable to any coach, by which a child of six years old may secure from danger all in the coach, and even the coachman himself, though the horses become never so unruly, the child being able in the twinkleing of an eye to

loosen them from the coach, in what posture soever they draw or turne, be it ever so short, or to either hand.

4. Lastly, an Invention to make a boat that roweth, draweth, or setteth even against wind or stream, yea, both, and to any part of the compass which way soever the streame runs or wind blows, and yet the force of the wind or streame causeth its motion, nothing being required but a steersman, and whilst the boat stayeth to be loaded or unloaded, the streame or wind shall perform such work as any water mill or wind mill is capable of."

All which new Invençons being of publique vse and benefitt if the same were put in practice, and the lawes of England haveing especially provided for the incouragement of such as are the first authors and invento^{rs} of profittable and ingenious Invençons.

KNOW YEE, that wee, of our espeeiall grace, certaine knowledge, and meere moçon doe for vs, our heires and successo^{rs}, give and grant vnto the said Edward, Marquesse of Worcester, his executo^{rs}, administrato^{rs}, assignee, and assignes, full power, licence, liberty, privilege, and authoritye, that hee, they, and every of them, by themselves or his or their deputy and deputics, servant^e, agent^e, and workmen, or any of them, from tyme to tyme, and at all tymes hereafter dureing the terme of yeares hereafter in these p^{nt}e expressed, shall and may vse, exercise, and imploy all and every or any of the aforesaid Invençons, before in and by there p^{nt}e perticularly described, in such manner as to him, them, or any of them, in his and their best judgment^e and discrecçons, shall seeme meete, &c., &c.

May it please yo^r most excellent Majestie.

Yo^r Maj^{tie} is hereby graciously pleased to grant vnto Edward, Marquesse of Worcester the sole vse and exercise of his severall new Invençons concerning watches or clock^e, guns or pistolls, coaches, and boates, for fourteene yeares according to the forme of the Statute in that behalfe made and provided, and with such other clauses as are vsuall in grant^e of like nature.

Signed to be yo^r Majesties pleasure vnder yo^r royall signe manuall.

T. PALMER,

15 Nov. 1661.

[Record mutilated.]

APPENDIX C.

WATER-COMMANDING ENGINE, ACT, Etc.

[From page 559 to 567, is the reprint of a rare quarto tract of 22 pages, of which there is a copy in the library of his Grace the Duke of Beaufort; and another in the British Museum, C. 31. d. 1.]

AN exact and true Definition of the most Stupendious Water-commanding Engine, invented by the Right Honourable (and deservedly to be praised and admired) *Edward Somerset*, Lord Marquess of *Worcester*, and by his Lordship himself presented to his most Excellent Majesty *Charles* the Second, our most gracious Sovereign.

AN Act of Parliament thereupon granted, with great applause of both Houses, being through his Majesties particular favour passed, by special Commission to the Right Honourable the Earl of *Clarendon*, Lord High Chancellour of *England*; the Earl of *Southampton*, Lord High Treasurer; the Lord *Roberts*, Lord Privy Seal, third Officer of the Crown, preceding all Dukes, not of the Blood Royal; the Duke of *Albemarle* his Grace, most deservedly by his transcendent merits never to be forgotten, Lord General of his Majesties Land-forces; the Lord Marquess of *Dorchester*, and the Earl *Lynsey*, Lord High Chamberlain, by his place preceding all Earls, both likewise of the Privy Council: They passed the said Act upon the third of *June*, 1663. For the more expedition, and in Testimony of the great consequence thereof to the King and Kingdom.

His most Excellent Majesty having the tenth part, without deducting of Charges, freely given him by the said Lord Marquess, and there evidently accruing a considerable Profit and Benefit to every individual Subject of the whole Nation, if he either have surrounded Marish-ground to drein, or dry Land to improve; Commodities to sell portable from Town to Town, and through the Countrys to the Towns by Cuts thus fed by water; or if he have (I further say) Mines wherewith to enrich himself withall, Houses to be served, or Gardens to be beautified by plentiful Fountains with little charge, yet certain in ever so dry a Summer: and there being indeed no place but either wanteth water, or is overburdened there-

with, and by this Engine either defect is remediable, that is to say, water necessary to man-kind, furnished with the pleasantness thereof, procured, and the water unnecessary, as easily rejected.

Thus whole Cities may be kept Clean, Delightful and Wholesome, needing no other Scavengery then by means thereof to void their dirt, and avoid noisomness, the Cause of Infection, Sickneses, and Contagion it self, by Stenches commonly ingendring and fomenting the same.

After the Act of Parliament, there is here set down a Latin *Elogium*, & an English *Panegirick*, both of them composed through duty and gratitude by an Antient Servant of his Lordships, presuming to begin the way to the greatest Wits and Poets to dilate upon so plentiful and admirable a Theam, and so deserving a person of King and Kingdom, and of all that ever knew him.

This Antient Servant of his Lordships, hath for forty years been an eye witness of his great ingenuity, indefatigable pains, and vaste expences in perfecting for publique service, not onely this most Stupendious Water commanding Engine, but likewise several other rare, useful, and never formerly heard of Mathematical Conclusions, of which he hath owned a Century, and thereunto I refer you: though this alone were enough to eternalize his Name to all Ages and future times.

I think it not amiss to give further notice in his Lordships behalf, that he intends within a moneth or two to erect an Office, and to intrust some very responsible and honourable persons with power to Treat and Conclude with such as desire at a reasonable rate to reap the benefit of the same Water-commanding Engine, in any of the aforesaid useful and beneficial operations, whereof his Majesty is to reap the first fruit; and then the whole Kingdom in general, before his Lordship is re-imbursed, and his reward beginneth; whose laudable inventions Almighty God prosper with blessings on earth, and reward in heaven.

MOST GRACIOUS SOVEREIGN,

The same individual Definition of my Water-work, which I formerly presumed to put into Your Royal Hands, I again adventure to present to Your Majesty; praying Your Belief of it, as Your Majesty shall find it true by comparing it with the real Effect; which, if found punctually agreeing, Vouchsafe then not to be apt hereafter to lend a believing Ear to such persons, as Malice causeth to detract from, or Ignorance to slight what shall (though never so seemingly strange) be averr'd by me, who will never be convinced of a Falshood in Word or Deed towards Your Sacred Majesty; before whom I shall ever speak as in the presence of Almighty God, whose Vicegerent on Earth I deem You: And to Your Majesties transcendent Judgment I submit all, and will presume to subscribe my self,

SIR,

Your Sacred Majesties

*Faithfully-Devoted and passionately-
Affected, Useful, if cherished,*

Subject and Servant,

WORCESTER.

A Stupendious or a Water-Commanding Engine, boundless for Height, or Quantity, requiring no External, nor even Additional help, or force to be set, or continued in motion, but what intrinscally is afforded from its own Operation, nor yet the twentieth part thereof: And the Engine consisteth of the following Particulars;—

1. A perfect Counterpoize for what Quantity soever of Water.
2. A perfect Countervail for what Height soever it is to be brought unto.
3. A *Primum Mobile* commanding both Height and Quantity Regulator-wise.
4. A Vicegerent or Countervail supplying the place, and performing the full force of a Man, Wind, Beast, or Mill.
5. A Helm or Stern, with Bitt and Reins, wherewith any Child may guide, order, and controul the whole Operation.
6. A particular Magazine for Water, according to the intended Quantity or Height of Water.
7. An Aquaduct capable of any intended Quantity or Height of Water.
8. A place for the Original Fountain or even River to run into, and naturally of its own accord incorporate it self with the rising Water, and at the very bottom of the same Aquaduct, though never so big or high.

By Divine Providence, and Heavenly Inspiration, this is my Stupendous Water-commanding Engine, boundless for Height and Quantity.

Whosoever is Master of Weight,
Is Master of Force ;
Whosoever is Master of Water,
Is Master of both :

And consequently, to him all Forceable Actions and Atchievements are easie, which are in any wise beneficial to or for Mankind.

*Exegi Monumentum ære perennius,
Regalique situ Pyramidum altius ;
Quod non imber edax, non Aquilo impotens,
Possit diruere, aut innumerabilis Horace.
Annorum series, & fuga temporum :
Non omnis moriar, multaque pars mei
Vitabit Libitinam,
 dum stabit Anglia. Capitolium.*

Reader observe, This tells us how to keep
Our morning-Thoughts awake, while others sleep :
'Tis Art and Nature's product, scan'd by some :
Judge of it by th' Effects, then give your doom.

*To God alone be all Praise, Honour and Glory,
for ever and ever. Amen.*

WORCESTER.*

* There is in the British Museum, bound up along with other broadsides, one on which is printed the whole of the foregoing, commencing with the letter, "Most Gracious Sovereign," and ending at this signature. The printed matter covers $14\frac{1}{2}$ by 11 inches of surface, and was originally a sheet of at least 18 by 13 or 14 inches, including the margin, which has been cut off. It is catalogued under "Somerset;" and the reference is, Brit. Mus. No. 12. E 1. 75.

AN ACT to Enable *Edward* Marquess of *Worcester* to Receive the Benefit and Profit of a Water-Commanding Engine by him Invented; One Tenth part whereof is appropriated for the Benefit of the Kings Majesty, His Heirs and Successors.*

WHEREAS The Right Honourable *Edward* Marquess of *Worcester* hath affirmed to the Kings most Excellent Majesty, That he hath by long and indefatigable pains and study, and with great and vast expences, invented and found out a Secret in Nature, never heretofore discovered, being a Water-Commanding Engine, of greater force and advantage then hitherto hath been known; and being no Pump or Force now in use, nor working by any Suckers, Barrels, or Bellows heretofore used for the raising and conveying of Water; which said Engine will yield very great benefit and advantage to the Common-wealth, by draining of all sorts of Mines, Marish, Oazie, or Overflown Grounds; by furnishing of Rivers and Cutts with water to make them Navigable and Portable from Town to Town; by improving of Lands wanting water; by the supplying and bringing in of water into the City of London, or into any other places: and by divers other ways and means whereby great Encouragement will be given to the People of this Nation to undertake to work rich Mines, to drain, and gain in many Marish, Oazie, and surrounded Grounds, which hitherto they have been deterred to endeavour the improvement of, by reason of the vast sums of money which must be necessarily expended by the draining and conveying away the water out of the same. And whereas the said *Edward* Marquess of *Worcester* is willing and contented to settle a tenth part of the accruing benefit thereof upon his Majesty, His Heirs and Successors, for the term of years after in this Act mentioned; To the end therefore that the said *Edward* Marquess of *Worcester* may have and enjoy the full and particular benefit and profit of this his new Invention, with a Prohibition to all others to make use thereof for ninety and nine years: May it therefore please the Kings most Excellent Majesty, That it may be enacted, And Be it Enacted by the Kings most Excellent Majesty, by and with the Advice and Consent of the Lords Spiritual and Temporal, and the Commons, in this present Parliament Assembled, and by the Authority thereof, That it shall and may be lawful to and for the said *Edward* Marquess of *Worcester*, His Executors and Assigns, from time to time, and at all times hereafter, during the said ninety and nine years, to have, receive, take, and enjoy, to his and their own proper use and uses,

* 15 Car. II. cap. xii. 1663.

the Profit, Benefit, and Advantage which shall any ways arise, happen, or accrue by means or reason of the aforesaid Engine and new Invention. And be it also Enacted by the Authority aforesaid, That one full tenth part of the accruing Benefit thereof (without deduction or abatement for or by reason of any Charges or Expences whatsoever) shall be paid and answered, and accounted for by the said Edward Marquess of Worcester, his Executors, Administrators, and Assigns, for His Majesty, His Heirs and Successors, into His Majesties publick receipt of Exchequer yearly, and every year at the Feasts of Saint Michael the Arch-angel and the Annunciation of the Blessed Virgin Mary, during the said Term of Ninety nine years, the first payment to be made at the Feast of Saint Michael the Arch-angel, which shall be in the year of our Lord God, One thousand six hundred sixty and three; And be it further Enacted by the Authority aforesaid, that if any Person or Persons whatsoever within his Majesties Kingdom of England & Dominion of Wales, and Town of Berwick upon Tweed, and the Dominions and Territories thereunto belonging, do, or shall at any time hereafter, during the said term, Counterfeit, Imitate, put in practice, or erect the said Water-commanding Engine (without the consent and License first had and obtained in writing from the said Edward Marquess of Worcester, or his Assignes) That it shall, and may be lawful to and for the said Edward Marquess of Worcester, or his Assignes, with his, or their Agents or Work-men by a Warrant from the Lord Chief Justice, or from any two Justices of Peace within the respective County or Liberty, where such search shall be made, and assisted by the Constable or Constables neer adjacent, to enter into, or upon the said place or places where the said Work or Engine shall be made or erected; And upon discovery of any such Engine, to proceed against the said Person or Persons by Action, Information or Indictment; and after Conviction thereof in due course of Law in any Assizes, or publique Sessions of the Peace, or any of the Courts at Westminster, or any other His Majesties Courts of Record in any City, Burrough, or Town Corporate, or in any Stanary Court, or Jurisdiction of Lead-mines; Then such Engines to be forfeited, and seized to and for the use of the said Edward Marquess of Worcester, his Executors, Administrators and Assignes respectively: And further, that the said Actor or Actors, Contriver or Contrivers thereof, and every of them, shall lose, and forfeit Five pounds of lawful Money of England an Hour for every Hour, he or they shall be Convicted, by one or more credible Witnesses upon Oath, to use the same, after such Conviction without the consent and License of the said Edward Marquess

of Worcester, or his Assignes, first had and obtained in manner as aforesaid; the same to be recovered in the name of the said Edward Marquess of Worcester, his Executors, or Assignes, at the Common Law by any Action or Actions to be grounded upon this Statute; The same Action and Actions to be heard, and determined in any of his Majesties Courts of Record, in which Suit no Essoign, Protection, or Wager of Law shall be allowed; one third part whereof shall be to the Kings most Excellent Majesty, one other third part to the Informer or Discoverer, and the other third part to the said Marquess of Worcester, his Executors and Assignes. Provided always, and it is hereby Declared, That this Act, or any thing therein contained, shall not prejudice any other Water-work or Engine now known and used, nor any Person or Persons, who before the making of this present Act have obtained any Letters Patents from his Majesty, for the sole making and using of any new Engine for the carriage of Water; But that the said other Water-work, and the said Letters Patents shall be and remain of the same force and effect, as if this Act had never been had or made, any thing herein contained to the contrary notwithstanding. Provided always, that nothing in this Act contained shall be construed, or taken to prejudice, or hinder any Person or Persons from making, or using any Engine, Device or Invention, for ther raising and carriage of Water, other then the Engine in this Act mentioned; And that a Model thereof be delivered by the said Marquess, or his Assignes, to the Lord Treasurer or Commissioners for the Treasury for the time being, at or before the Nine and Twentieth day of September, One thousand six hundred sixty three; And be by him or them then put into the Exchequer, and kept there.

Copia vera.

Jo. Brown Cleric.

Parliament.

In admirandam magis quàm imitandam, aut ullis Encomiis satis prædicandam, Illustrissimi Domini Marchionis Vigornie Machinam Hydraulicam, Elogium.

*Barbara Pyramidum silcat miracula Memphis,
Assiduus jactet nec Babylona labor.—HORAT.*

*Siste viator, depone sarcinam, & dum reficis membra
Labore languida, pasce mentem novitatis avidam;
Perpende gyganteam hanc molé, æterni motus æmulam,
Naturæ & Artis compaginem, Cæli Solique stuporem.*

*Pondera ponderibus librata hic Æthera scandunt,
Et redeunt proprias mox subitura vices.
Mens prægnans agitata Deo, nunc præstat in Orbe,
Quæ nec stellifero sunt tribuenda Polo.*

*Taceat Rhodus, facessat Ephesus, et quicquid fabulosa
Prædicat antiquitas; illic laudanda Artificis industria,
Hic admiranda mentis sublimitas celebranda venit.
Cui impares fuere tot seculis retroactis omnes Græci,
Et Romani, humano conatu, id præstitit nostra
Ætate unus Cambrobritannus, Divino afflatu :
Soli Deo Gloria.*

*Martis & Imperii Palmam fert Roma perennem ;
Artis & Ingenii Cambria culmen habet.*

. . . . pauci, quos æquus amavit
Jupiter, aut ardens exivit ad æthera virtus,
Hoc potuere

*Jacobus Rollocus,
Scoto-Belga-Britannus.*

*A Panegyrick to the Right Honourable EDWARD, Lord Marquess of
WORCESTER, Upon his stupendious and never-sufficiently-com-
mended Water-work.*

I know mean subjects need a skilful Pen
To stretch their worth on tenter-hooks, but when
A Theam falls out so pregnant, who can chuse
But strain his vulgar Wit to prove a Muse ?

Come, fainting Pilgrim, lay here down thy Pack,
And, while thou rests thy wearied limbs, look back
Upon this Pageant, th' Emblem of his mind,
Whose Art and skill hath this our Age refin'd.

Here little *David* curbs the Gyant's brood,
Small drops of Rain contend with *Noah's* Flood ;
One weighs a thousand coming down apace,
Weights but himself when he bath run his race.

The Heavens admire, the Centre stands amaz'd,
To see such Streams by so small Forces rais'd.
Great is the Work, but greater is the Fame
Of that great Peer who did invent the same.

What Force or Strength can do is in his reach,
His long Experience, Cost and Charges, teach;
What Greeks, nor Romans e're could do, this day,
Our Noble Britain here hath found the way.

If Ages past had bred you, we had seen
Your Glories current run a bigger stream;
But Art and Envy meeting face to face,
Like *France* and *Spain*, dispute who shall take place.

None but ignoble Minds love to detract
From th' Honour due to such a noble Act:
On then, that after-ages may relate
Your Service done to Country, King and State.

And though that envious Spirits spit their gall,
Your noble Deeds are so well known to all,
As if their malice should take from your praise,
Your own deserts will crown your head with Bays.

By your Lordships
most humble and faithful Servant,
James Rollock.

APPENDIX D.

[Among the Family Papers in the possession of His Grace the Duke of Beaufort is the following:— *Letter from WALTER TRAVERS, a Roman Catholic Priest, to the Dowager Marchioness of Worcester.*]

Jesus + Mia, September 6, 1670.

NOBLE MADAM—

The Grace of the Holy-ghost bee with you.

The greate esteeme and honour w^{ch} I have euer had for your Ladys^p hath allwise made mee prompt, and willing to serue you to the best of my power, without the bias of selfe interest, as your selfe can witnesse; And because I feare that at present, your Honour hath noe one, that in the greate concernes, which you have in hand, will tell you the truth, as it often happens to persons of greate quality: I have thought it the part of my Priestly function and fidelity towards yo^r Ho^r: (haveing first in my poore prayers, humbly commended it to Alm: God) to represent unto you, that w^{ch} all your friends know to bee true, as well as my selfe, and would bee willing that your Ladys^p should know it likewise.

Alm: God hath Madam put you into a happy, and flourishing condition, fitt and able to serue God, and to doe much good to your selfe and others; and your Ladys^p makes your selfe unhappy, by seeming not to bee contented with your condition but troubling your spiritts with many thoughts of attayning to greater dignities and riches.

Madam all those that wish you well, are greeued to see your Ladys^p to bee already soe much disturbed, and weakened in your iudgment and in danger to loose the right use of your reason, if you doe not tymely endeauor to preuent it, by ceasing to goe one with such high designes, as you are vpon, which I declare to you, in the faith of a Priest to bee true: The cause of your present distemper, and of the aforesayed danger, is doubtlesse, that your thoughts and imagination are very much fixed on the title of Plantaginet, and of disposing your selfe for that greate dignity by getting of greate sums of money from the King, to pay your deceased Lords debts, and enriching your selfe by the great Mashine, and the like. Now Madam how vnproper such undertakeings are for your L. and how vnpossible for you to effect them, or any one of them, all your friends can tell you if the please to discover the trueth to you.

The ill effects that flow from hence are many: as the danger of looseing your health and iudgment by such violent application of your fancies in such high designes and ambitious desires; the probability of offending Alm. God and preiudising your owne soule thereby: the advantage you may thereby give to those who desire to make a pray of your fortune, and to rayse themselues by ruening you: the spending greate sums of money in rich and sumptuous things, wh^{ch} are not suteable to the gravity of your Ladys^p and present condition of Widdow-hoode and mourning for your deceased Lord.

Although it bee certine, that it is a greate temptation which you are now vnder, and very dangerous and hurtfull both to your temporall and eternall happynesse; yett I confesse that the Diuel, to make his suggestion the more preualent, doth make vse of some motives that seeme plausible, as of paying your Lords debts, of founding monasteryes, and the like, and that your Ladys^p hath the Kings favour to carry one your designes. But Madam it is certine that the King is offended with your comeing to the Court, and much more with your pretention to the title of Plantaginet; and it is dangerous to provoke him any farther: And for paying of debts, and founding of Monasteryes, wee all know that your L. can neuer bee in a better condition to doe it, then now you are; and as you are not bound to doe such things,

soe they are not expected from you ; but wee all applaud your pious inclinations herein, of w^{ch} you will not loose the merit with Alm: God but our apprehensions are, least you should by your Ladys^{ps} inordinate designes, bring your selfe into such a condition, as not to bee able to helpe your friends nor your selfe.

Bee pleased Madam now to give mee leave to suggest some waie how the approaching dangers may bee prevented, by changing the object of your affections, and insteede of temporall, to seeke after eternall riches, and honors, which your age doth assure you are not far off ; for w^{ch} you may dispose yourselfe, before death comes, by retiring into the countrey for some tyme, from the distractions of the Court, where you may have the advice and directions of some learned Priest, in whose vertue you may wholly confide, and bee guided by him, for your internall quiet and security. Many places may soone be found out, that are fitt for that purpose: At Hammersmith Mr^s. Bedingfield a very vertuous and discreete person, and of your Ladys^{ps} acquaintance, hath lately taken a faire house and garden, & hath but a small family. In some such place your Ho^r might likewise haue the aduice of some well experienced Doctor, for the health of your person, and the benefitt of good ayre and of quietness, would much conduce to your health: And soe by Alm. Gods blessing, you may recover from that most pernicious distemper of bodey and mind, vnto w^{ch} enery one seese you to bee very nere approaching, and may live many yeares with your owne fortune and dignity in greate honour, and happynesse and be the author of many good workes of piety and Charity to the glorey of God and eternall saluation of your owne soule. Thus dear Madam I have ventured to declare a greate trueth to you, w^{ch} was before a secrett only to your selfe ; I know that I run the hazard of incurring your displeasure, if your Ladys^p should not reade the candor of my intentions, w^{ch} in my Letter I intend towards you : but my assurance of haveing herein performed a duty w^{ch} I owe to my God, and the hope I have that you will take it well as I intend it, have encouraged mee to doe it, and to subscribe myselfe

Honored Madam

Your humb. Ser. in C. J.

WALT. TRAVERS.

[*On the back of this letter is the address :*]

For ye Right Hon^{ble}
the Lady markes of wossester,
at her howes in Link[olns]
ins fields.

APPENDIX E.

COLONEL CHRISTOPHER COPLEY.

Sufficient has been said respecting Copley in the "Life, Times, &c.," pages 214, 215, to give interest to any matter that can afford information respecting him.

We here supply his autograph, from MSS. in the British Museum, which may be useful to collectors; and have also to offer the ac-

count he gives of himself and his affairs during the Commonwealth, derived from Cole's MSS. also in the British Museum, No. 5832, volume 31, page 209, as follows:—

- I. (The following Case, wrote on half a sheet of paper, and was the first draught as seems to me, by the alterations and scratchings out of several words, and additions over them. I know not how I came by it.)

Col. Christopher Copley his Case.

Humbly sheweth,

That the said Colonel Copley did, in the year 1642, at his own charge raise a troop, and in 1644, a regiment of Horse, and supplied the Parliament with Bar-iron and Bullets, which with other things due amounted to the value of £1,843, whereof £1,500 was granted unto him as by an order of the 19th of July 1656, may at large appear; but is still unpaid.

That during the greatest part of the years 1644, and 1645, he had the command and care of several regiments of Horse, and by the blessing of God upon his conduct and resolution, several pieces of service were done, and victories obtained, whereby diverse of the counties of England were settled in peace, to the great advantage of the nation.

That the Committees of all ridings of the county of York did, in approbation of his service and fidelity, elect him to be Colonel of the West-riding Regiment of Horse in 1645; and the Parliament, by their letter, under the hand of the R^t. hon^{ble}. Mr. Speaker, did also assure him, that they would be ready upon all occasions to testify their sense of his service; and did after, in 1647, appoint him

to be one of the nine, who by their vote, were to command the nine regiments of Horse then only to be continued for the defence of this nation.

That by reason of the premisses the Earl of Newcastle caused his wife and children to be turned out of doors, and his house, lands, goods, and stock at four Iron Works to be taken from him, to the value of £2,000; for which he never had any recompense.

That Lieut^t.-Gen^l. Cromwell finding the said Colonel Copley would not become subservient to his ambitious ends (which then were under the curtain, but since discovered) caused him to be undeservedly questioned upon articles (which before he had waived), and after he had fully cleared himself, did, notwithstanding his said service, contributions and sufferings, cause him to be put out of the Catalogue presented to be continued in 1647; whereby his regiment was taken from him, and given to Colonel Lambert, contrary to the said vote; the Parliament, as is conceived, not then remembering it, nor their engagement by their letter afore-mentioned.

That though he thus lost his command, yet he did not resist (as others of late) but acquiesced in the pleasure of the house, and submitted shortly after to a Commonwealth Government set up; yet hath been kept out of all employment, both civil and military ever since; to his reproach and the ruin of his estate, contrary to the declaration of the 20th January 1643, while he hath seen many others (who never at all, or not considerably, either served or contributed to, or suffered for the Parliament) from mean conditions, preferred to, and continued in great commands and employments by their compliances with the many changes of this evil age, and the lusts of ambitious men, to the hazard of the ruin of this Commonwealth.

That he did disapprove of the usurpations of the Protectoral, and the longings after the regal power; but when the Parliament was invited to return to the discharge of their trust, and were about the restitution of the commands to such, as by the usurpations were dispossessed, he tendered his service. And after the late interruption, he declared his readiness to raise a regiment, and to run the hazard of his life and fortune, to reduce the army to the Parliament's obedience; and received a Commission to that end.

His humble request, therefore, is, that your Honours will be pleased upon due consideration of the premisses to confer upon him his own regiment of Horse, late under the command of the said Colonel Lambert, and now about 12 years withheld from him, according to the justice of his case above-mentioned,

or some other command or civil employment in England or Ireland, suitable to his former, and to the merit of his fidelity and affections to the Parliament, expressed in the premisses.

This is a true copy of the last :

That since the good Providence hath put the power into your hand, your Ex^{cy}. will be pleased upon due consideration of the Premisses, to confer upon him a command in England or Ireland, suitable to his former, and to the merit of his fidelity and affections to the Parliament expressed in the Premisses.

II. In the 4th Volume of the Journals of the House of Commons for 1644 to 1646, on the 20th October, 1645, is reported—"A letter from * * 18th October, 1645—* * relating the great success of the Parliament's forces (about 1,200), under the command of Colonel Copley, near Ferrybriggs, over near 2,000 of the enemy, under the command of Digby."

And in the 5th Volume, 1646 to 1648, on the 18th May, 1647, was read—"A Certificate from the Earl of Manchester, of the 20th February, 1646, concerning iron belonging to Mr. Copley and his Partners, made use of by the forces under his command."

On referring to the Journals of the House of Lords, we find that on the 8th of July, 1648, there was a message from the House of Commons, and an order desiring their Lordships' concurrence; being among other matters—"An Ordinance for £4,324. 9s.—to Colonel Christopher Copley," which was entered and agreed to. (See Vol. X., 1647 to 1648, pages 369 and 371.)

APPENDIX F.

Copy of Cromwell's WARRANT, and INVENTORY of eight copies of Papers relating to the Marquis of Worcester, in the possession of BENNET WOODCROFT, Esq. F.R.S.

1655. A WARRANT to pay Three pounds a week to Edward Earl of Worcester, for his better maintenance, &c. Given by the Lord Protector, as follows :—[See page 213.]

A WARRANT to pay Three pounds a week to Ye Earl of Worcester.

LORD PROTECTOR, &c. To the Com^{rs} of our Treasury Greetinge our will and pleasure is and wee doe hereby require and

comand you or any Two or more of you That out of such our Treasure as is or shalbe remayninge in the receipt of our Excheq^r you pay or cause to bee paid vnto Edward Earle of Worcester or his Assignes thee weekly allowance of Three pounds (heretofore charged on the Treāry att Goldsmiths Hall) for his better maintenance the said weekly allowance to bee continued vntil wee shall give other order to the contrary And our further will and pleasure is that you also pay or cause to bee paid forthwith vnto the said Earle or his Assignes out of our Treasure remayninge in o^r said receipts the arreares of the said allowance of Three pounds by the weeke from the eight day of January last past vntill which dayes the Treārs of Goldsmiths hall have certified the same to have been satisfied out of the Treāry there And theis presents or the inrollem^t thereof shalbe a sufficient Warrant and discharge aswell to you the said Com^{rs} of our Treāry as to all others our Officers and Ministers of the Receipt of o^r Excheq. to whome it doth or shall any wayes apperteyne for paym^t of the said weekly Allowance and the arreares thereof as aforesaid Witnes the Lord Protector the six and twentieth of June.

[1655 Pat. Roll, part 4, No.30.]

1660. A Pardon granted to Edward Marquesse of Worcester of all such offences, &c. &c. as are expressed in the form of a pardon prepared for that purpose and remaining with His Majesty's Attorney General. Dated August, 1660.
- 1664-5. Grant to Edward Marquesse and Earle of Worcester of all sums of money, jewels, goods, and other matters and things of value concealed or accounted for and arising out of the real and personal estate of the said Edward Earl and Marquesse of Worcester and of his Father Henry late Marquiss of Worcester or belonging to the same and which by the laws of the kingdom are forfeited and belong to the Crown.
- 1664-5. Grant and release to Edward Marquis of Worcester of the tenth part of the benefits accruing from his Water-commanding engine settled upon the Crown, such Grant or release being in consideration of the surrender of the Warrant of Charles I. dated at Oxford, 5th January, 1644, made unto said Edward Marquis of Worcester by the name of Lord Herbert for the grant of lands to the value of £40,000, &c. &c.
- 1670-71. Letters Patent to Henry Marquis of Worcester, remitting

- payment of certain sums due to the Crown at the time of the death of his Father Edward Marquis of Worcester.
1673. Letters Patent relating to constitution of Peverill Court and appointing Henry Marquis of Worcester and Charles Lord Herbert and Arthur Lord Somerset (sons of the Marquis) Chief Seneschals and Simon Degge Seneschal of said Court.
- 1675-6. Letters Patent to Henry Marquis of Worcester, granting to him the Manor of Wondey in the County of Monmouth.
- 1675-6. Letters Patent to Henry Marquis of Worcester conceding the advowson &c. of the Rectory of Sapworth or Sopworth in Wiltshire in exchange for that of Blendworth in the County of Southampton.
- 1678 Commission of Lunacy to inquire whether Margaret Dowager Marchioness of Worcester is a Lunatic, &c.

APPENDIX G.

VAUXHALL WORKS, AND CASPAR KALTOFF.

I.

The Honourable Robert Boyle, corresponding with Samuel Hartlib, the latter, under date "Duke's Place, July 24th, 1649," writes—"As for Vauxhall, there is a proviso put into the Act, that it shall not be sold."

And in another letter, dated "May 8th, 1654," Hartlib says—"The Earl of Worcester is buying Vaux-hall from Mr. Trenchard, to bestow the use of that house upon Gaspar Calehof and his son, as long as they shall live." [Works, fol. 1744, Vol. V., pp. 257 and 264.]

II.

The annexed particulars of the premises at Vauxhall, where the Marquis of Worcester erected one of his Water-commanding Engines, and of Kalthoff and his family, are derived from the Books of the Duchy of Cornwall Office.

1.—*Duchy of Cornwall Office.*

From Index to Reports—1660-1684. A to P. 1.
Kennington* (Surry).

Peter Jacobson.

*Kennington (Foxhall House) 26th Oct., 1666. His Majesty's Warrant directed to Lord Treasurer Southampton and Lord

Ashley, to grant Mr. Jacobson a Lease for his life at a moderate rent, he having expended the sum of £700. on the Premises in making them convenient for the Trade of a Sugar Baker.—

Fo. 218.

Surveyor General's Constat [or Direction] on the Warrant of Lord Ashley, Chancellor of Exchequer, enters minutely into every particular of the premises, showing in what manner the whole has been occupied, and reports the value per annum, and the value for a fine, &c.

Fo. 219.

[** Jacobson married Kaltoff's daughter.]

2.—*Martha Calthoff.*

The Widow of Gaspar Calthoff (a native of Holland, who had settled in this House by his Attorney, and employed in making Guns and divers Engines and works for the King's service). Her Petition and case at large. Here Sir Charles Harbard also enters into a very minute detail of the premises in question.

Fo. 326.

3.—*Duchy of Cornwall Office.*

Report H. 1. 1665-1668.

(Signed) CHARLES R.

Vauxhall, Peter Jacobson.

[By his Petition—has been at a Charge of £700. in repairing and building a part of Vauxhall, which was waste, and made the same convenient for a Sugar Baker, the said J.'s profession—in con. of his charges—and losses by the late fire at London—desires some certainty of the Premises.—Our pleasure to grant a Lease to P. J. of that part of Vauxhall which he hath repaired and built for his trade of a Sugar Baker—for the term of his life—at some moderate Rental. Whitehall, 26th Oct. 1666. 18th year of reign.]

4.—*Duchy of Cornwall Office.*

Report H. 1. 1665-68.

[Report of the Surveyors General C. Harbard and Hugh May, dated 25th and 27th April, 1668, respecting Foxhall House, parcel of the Manor of Kennington and Duchy of Cornwall.]

** This is already quoted in the "Life, Times, &c.," page 239.

5.—*Duchy of Cornwall Office.*

Particulars of a Lease in the form of Letters Patent.

22nd March, 1667-68. Letters Patent whereby the King demised unto Peter Jacobson—

All that part of our Mansion House called Vauxhall or Ffoxhall, part of the Manor of Kennington, in the County of Surrey, extending in length next the River Thames 186 feet, or thereabout, and in width 22 feet, or thereabout; and all that other part of the same Mansion House adjoining the premises, and from thence extending towards the S.E. 47 feet, and in width N.W. $33\frac{1}{2}$ feet, or thereabout, and in other parts $24\frac{1}{2}$ feet, or thereabout; together with all that area or place adjoining and fenced in, extending in length $141\frac{1}{2}$ feet, or thereabout, and in width to the W. end 40 feet, and to the S. end 47 feet, or thereabout, together with free ingress and egress in and through the steps and doors existing at the N. end of the aforesaid house, and through and over the area there, called the Court-yard, appertaining to the aforesaid House, and all that Stable lately built upon part of the said place or area last mentioned, consisting in length $28\frac{1}{2}$ feet, or thereabout, and in width 17 feet, or thereabout; also that shed 26 by 10 feet—premises in or near the Parish of Lambeth, and now in the tenure or occupation of Peter Jacobson * *.

This Lease granted in consideration of the expense incurred in repairing and amending the buildings for and during his natural life, at a Rental of only £5.

6.—*Duchy of Cornwall Office.*

Mem. from various Drafts.

12th January, 1659-60.—Ch. II.

Indenture of Lease between the King's Majesty and Henry Lord Moore.

22nd March, 1667-8.—19th Ch. II.

Letters Patent—The King unto Peter Jacobson. To hold during the natural life of P. J. Rent £5.

1st Aug. 1672.—24th Ch. II.

Letters Patent whereby the King from grace and favour towards Jasper Calthoff and Martha Calthoff lately deceased, and their children, devised unto Herbert Price, Knight and Baronet, James Read, Esq., and John Renny, Gentleman, at the nomination and appointment of Claude Denis and Catherine his wife, one of the daughters of the said Jasper Calthoff and Martha his wife.

Jasper Calthoff and Isabel Calthoff, others of the sons and daughters of the said Jasper and Martha Calthoff.

. Then there would be also Peter Jacobson, the son-in-law, who married a daughter.

7. The following particulars are derived from the Records of the State Paper Office:—

State Papers. Vol. 142, No. 134.

Martha Kalthof and Peter Jacobson's Petition.

To the King's most excellent Majesty.

The Humble Petition of Martha, widow of Caspar Kalthof, and Peter Jacobson, her son-in-law.

Showeth,

That the said Martha is the distressed widow of the said Caspar, your Majesty's and your Royal father's old servant. That he was planted by your Majesty's most gracious father in Vauxhall, and had building therein erected for the exercise of his art and feat as Ingineur [engineer].

That your Majesty upon your happy Restoration resettled him in the said house, after he had been long turned out of doors by the great Traitor and Usurper.

That in this ejection her husband was plundered and bereaved of an estate near £3,000. sterling, and left with 4 children, some whereof were infants.

That being reinstated by your Majesty as aforesaid, he was naked and without means to prefer his daughter grown up, but upon the trust of your Majesty's grace, did dispose of one of his daughters to the Petitioner, Peter Jacobson, but without any other portion than the firm hopes of your Majesty's continued grace and Royal goodness.

That in consideration the Petitioner, Peter Jacobson, did bestow in making the building of that house for his calling of sugar-baking near the sum of £700. sterling.

That now, on the death of his said father-in-law, he is left at your Majesty's mercy for his continuance in this house to the Petitioner Martha's subsistence and her other two daughters preferment, [which] depends wholly upon the said Peter Jacobson his enjoyment of the said house for perfecting his work, and refunding his said great expences. And although your Majesty hath been graciously pleased to design the son of the said Caspar to succeed this office and

service, yet forasmuch as he is held up by the Emperor of Russia, the Petitioners are both under great fears without your Majesty's special grace and clemency.

Their most humble Petition therefore and only hope is that your Majesty will be graciously pleased in contemplation of both their desolate otherwise, and truly sad condition, to grant them such terms of years in the said house, as may in some measure repair the estate of the said widow to provide of the maintenance of herself and preferment of her two orphan daughters, and enable the Petitioner Peter, her son-in-law, by holding the said Sugar-house some certain term of years to have recompense of his said expense of £700. bestowed upon your Majesty's grounds, which he will leave after in good repair to the improvement of your Majesty's interest.

And your Petitioners as in duty bound shall ever with theirs pray, &c.

[See Col. State Papers, Dom. Series, 1665-66, edited by Mrs. M. A. E. Green. Svo. 1864. p. 153, No. 134.]

[Vol. 102, No. 13. Sept. 5. Whitehall. Warrant from Secretary Bennet. (Ent. Book 16, p. 220.)]

It is his Majesty's pleasure that Sir Herbert Price, Sir Paul Neal, and Sir Robert Murray, being attended by Mr. Gervase Price, his Majesty's Serjeant Trumpeter, do visit Foxhall, and there enquire by whom the several rooms in it are possessed, and particularly what belongs to the Marquis of Worcester, what to Gaspar Colthoffe, late deceased, and what their respective interests in the Engines, Tools, &c. remaining in that place are, hearing on the one part the Lord John Somerset; and on the other the widow of the said Colthoff, and his son-in-law, and any persons relating to them, of all which the said persons above mentioned are to give an account to his Majesty in writing. Whitehall, September 5, 1664.

HENRY BENNET.

[See Cal. State Papers, Dom. Series, 1664-65. Edited by Mrs. M. A. E. Green. Svo. 1863. p. 2. No. 13.]

APPENDIX H.

APOCRYPHAL PASSAGES.

Statements that have at various times been published as matters of fact relating to the personal history of the Marquis of Worcester.

1. *The Pot-lid Story.*—No account of the Marquis's great discovery has hitherto been considered complete without relating what is usually offered as a traditional anecdote of its origin. The latest publication, in a popular form, occurs in "A History of Wonderful Inventions," where its interest is enhanced by a neatly executed engraving. It relates that, at the conclusion of the Civil War, the Marquis "hastened over to France, where, after spending some time at the court of the exiled royal family of England, he returned to this country as their secret agent, but being detected, was confined a prisoner in the Tower." It is said that during this imprisonment, "while he was engaged one day in cooking his own dinner, he observed the lid of the pot was continually being forced upwards by the vapour of the boiling water contained in the vessel. Being a man of thoughtful disposition, and having, moreover, a taste for scientific investigation, he began to reflect on the circumstance, when it occurred to him that the same power which was capable of raising the iron cover of the pot might be applied to a variety of useful purposes; and on obtaining his liberty, he set to work to produce a practical exposition of his ideas on the subject in the shape of an acting machine, which he described in his work"—the "Century."

Every writer varies this story in its details. Here the compiler, drawing on his imagination, certifies to the Marquis being his own cook, providing his own dinner, and verifies the pot-lid being of iron. Disraeli and others vaguely state it to have been his meal that was being prepared in his presence, saying nothing whether the pot was brass, copper, or iron. The Tower must have had a large supply of these cooking utensils to meet the wants of its prisoners!

The story reminds one of that of the Three Black Crows related by Addison in *The Spectator*, for like it this "pot-lid" story may after all have originated in some lecture or conversation, in which the speaker indulged his fancy by venturing the statement as what might appear to him a feasible suggestion, and one calculated to render the matter interesting and impressive. Had it happened at all it must have occurred from 1652 to 1654; but the "pot-lid"

of Bacon's Century 2nd ed. 1654
22 " "

story, in another form, was current in 1597, when Lord Bacon, in his *Essays*, alluding to the origin of *Inventions*, remarks:—"It should seem, that hitherto men are rather beholding to a wild goat for surgerie, or to a nightingale for music, or to the ibis for some part of physic, or to the POT-LID that *flew open* for artillery, or generally to chance, or anything else, than to logic for the invention of Arts and Sciences." The third edition of these *Essays* was published at Oxford in 1633, and from so popular a source it was natural for the vulgar to take the suggestive idea of the "pot-lid" to account for the origin of the steam engine, rather than to assign the birth of that gigantic production to a natural process of inductive reasoning.

2. *Unfounded Charge of Forgery*.—Thomas Carte, son of the Rev. Samuel Carte, born in Warwickshire, was baptized there by immersion, 23rd of April, 1686. In 1722, being accused of high treason, he fled to France, but returning in 1728-30, he, in 1735, published the third volume of his "*Life of the Duke of Ormonde*." Among other matters, Nichols, in his "*Literary Anecdotes*," Vol. IX., 1815, observes: "In an unpublished letter to Dr. Z. Grey, dated May 14, 1736, he says—'I suppose you have read that volume [the 3rd], and seen there the letters relating to the Earl of Glamorgan, who certainly forged every commission he pretended to from the King.* I give you his character in the History very justly, but yet too tenderly drawn, because I am naturally unwilling to lay a load on any man's memory, except I am absolutely forced to it. I intimate (so strongly that nobody of common sense can mistake the thing) that he forged letters and commissions without number; and I could have produced the compiler of the Nuncio's memoirs in evidence (who had all those commissions before his eyes, and all the papers signed by Glamorgan to the Nuncio), to prove the commissions and letters he pretended to from King Charles absolutely forged; for he says he was perfectly acquainted with Glamorgan's secretary, and knew his handwriting as well as his own; and all those commissions and letters were wrote in the hand of an Irish priest, who was Glamorgan's secretary.'"

After further remarks to the same effect, he concludes, "In fine, I have not the least doubt but that Glamorgan forged every pretended power or commission he had; and all of them so fully express his vanity, and are so adapted to his present views (which in most cases could not arise till after he was in Ireland), that they could

* See also the Notice in Birch's *Inquiry*, 1756, page 330.

have no other author but himself. I must observe to you that this letter, being directed to the Nuncio, is the only original of the King's writing among his papers (for Glamorgan only gave him copies translated of the others); and whatever commission, or other power, instructions, or letters, Glamorgan pretended to the Nuncio to have from the King, must be in a hand agreeable to that which the Nuncio had as an original."

The Editor properly notes here: "If Glamorgan only gave copies translated of the other commissions, it is no great wonder that they should be written in his secretary's hand."

In the same work is the following inquiry from a correspondent: "I never met with anybody but Mr. Thomas Carte who talked of *Impartiality* and *Mr. Thomas Carte* in the same breath. But, waiving that question, I cannot help asking—If the Irish Rebellion, and all the mischiefs of that period, are to be attributed to commissions and powers forged by the *soi-disant* Earl of Glamorgan, what pretence is there for laying all the load and odium thereof upon the Parliament?"

A thin quarto volume of MSS., in the Bodleian Library, Oxford, entitled "Notes on Carte's History," contains a note from Mr. Birch, dated 2nd February, 1742-3, to Rev. Mr. Thomas Carte; also, "The full answer to the Bystander, compared with the History of the Life of James Duke of Ormonde, written by the same author, September, 1742;" likewise several letters from Rev. J. Boswell, Taunton; and lastly, the following MS. letter:—

"Sir,—I am very much concerned to find by your last letter that you have received such a message from Mrs. Carte. I persuade myself she would think me entitled to the greatest civility from her, if she was apprised of the friendship which subsisted between me and her late husband. I took no small pains for several years to serve poor Mr. Carte, and had the satisfaction of such a valuable correspondence with him as entitled him to every good office that I could do him. In 1748 I laid before him *The Case of the Royal Martyr considered with candour*, and he was so good as to approve of it, and earnestly pressed me to print it. In the course of our correspondence I mentioned some difficulties which I had met with in that work, and particularly in relation to some facts which had been misrepresented in a book entitled *An Enquiry into the share which King Charles, &c.* Mr. Carte, in a series of letters which he favoured

me with on that subject, gave me many valuable Notices, which were of great use to me in clearing up those difficulties, and which I have occasionally availed myself of in many parts of my work. It is likely Mrs. Carte may have found copies of those letters, some of which were very long. But as Mr. Carte first sent them to me professedly with design that I should make what use of them I thought proper, I leave Mrs. Carte to consider, whether her finding such copies of letters in her late husband's own handwriting will give her a claim to any part of my work which you have printed. If Mrs. Carte shall choose to write to me on this affair, I shall be glad to receive a letter from her directed under cover to you.

I am, yours &c.,

The Author of *The Case of the Royal Martyr, &c.*"

July 25th, 1754.

(It has no direction, and the writing is evidently *not* that of the Rev. J. Boswell, of Taunton.)

Dr. Birch was at variance with Mr. Carte on historical points relating to Charles the First and the Earl of Glamorgan; but in his "Inquiry," 1756, he never touches on the subject of this pretended forgery of commissions. The charge is every way discreditable to Carte, being a mere theory of his own to give colour to the King's representations made in public, although well known to have had no effect to alienate old friendship between the King and the Earl.

3. *Fanshawe's story of £8,000. raised in Ireland.* Lady Fanshawe's Memoirs, 1665, written by herself, were printed in London, 1829. In an introductory memoir we are informed:—

"On receiving orders from his Majesty [Charles II.] to deliver the seals to Lord Inchiquin, Mr. Fanshawe proceeded on his mission, and embarked with his wife at Galway, in February, 1650, on board a Dutch ship for Malaga. Their entry into Galway, (which had been devastated by the plague), is deserving of attention, and an anecdote, which is related of the conduct of the Marquis of Worcester to the merchants of that town, if true, reflects equal disgrace on the cause which he espoused and on his memory."

Writing in Ireland, about 1650, as appears from the context, Lady Fanshawe says:—"Our house was very clean, only one maid in it besides the master; we had a very good supper provided and being very weary went early to bed. The owner of this house entertained us with the story of the last Marquis of Worcester, who had been there sometime the year before: he had of his own and other friends' jewels to the value of £8,000, which some merchants had lent upon

them. My Lord appointed a day for receiving the money upon them and delivering the jewels; being met, he shows them all to these persons, then seals them up in a box, and delivered them to one of these merchants, by consent of the rest, to be kept for one year, and upon the payment of the £8,000 by my Lord Marquis to be delivered him.

“After my Lord had received the money, he was entertained at all these persons’ houses, and nobly feasted with them near a month: he went from thence to Franco. When the year was expired, they, by letters into France, pressed the payment of this borrowed money several times, alleging they had great necessity of their money to drive their trade with, to which my Lord Marquis made no answer, which did at last so exasperate these men, that they broke open the seals, and opening the box found nothing but rags and stones for their £8,000, at which they were highly enraged, and in this case I left them.”

The least acquaintance with the character of the Marquis must satisfy any one of the absurdity of this silly story, fastened on a man of stainless honour, by an obscure lodging-house keeper. The man who related it could never have imagined that Lady Fanshawe would place on record the story he was relating for her amusement, as an historical fact, or he might have shown more discretion than her Ladyship, by affording some authority for a statement of so scandalous a character.

4. *Pretended interview between the Marquis of Worcester and De Caus in the Bicêtre, Paris.*—This fiction was long supported by a forged letter, pretended to have been written in February, 1641, by Marion Delorme, addressed to M. de Cinq-Mars. An exposure of this fable is due to M. Figuier, in his “*Principales Découvertes Scientifiques Modernes*,” post octavo, 4 volumes, 1862. After quoting the fabricated document, he says:—“Cette pièce, fabriquée par un mystificateur hardi, eut un succès prodigieux, et l’on ne manqua pas de dire que le marquis de Worcester, à qui ses compatriotes attribuent la découverte de la machine à vapeur, en avait puisé l’idée dans sa conversation avec le fou de Bicêtre. On pouvait cependant élever contre l’authenticité de cet écrit quelques objections qui ne manquent pas de solidité. On pouvait faire remarquer, entre autres choses, que Salomon de Caus, mort en 1630, aurait pu difficilement être enfermé en 1641 dans un hôpital de fous; que Bicêtre était alors une commanderie de Saint-Louis, où l’on donnait asile à d’anciens militaires, et non un hôpital;—que Salomon de Caus n’avait jamais pensé à construire une machine utilisant les

effets mécaniques de la vapeur ;—enfin qu'il n'avait jamais reçu que de bons offices de la part de Richelieu puisque dans la dédicace de son livre, *La pratique et démonstration des horloges* il exprime sa reconnaissance pour les bontés du cardinal. Mais le public n'y regarde pas de si près, et bien de gens ne renoncent pas sans douleur à la bonne fortune historique d'un homme de génie mourant à l'hôpital. Un sujet si bien trouvé revenait de droit aux ouvres de l'imagination et de l'art. On a vu, à l'une des expositions du Louvre, un tableau de l'un de nos peintres, M. Lecurieux, dans lequel Salomon de Caus, enfermé à Bicêtre, est représenté les yeux caves et la barbe hérissée, tendant les mains, à travers les barreaux de sa prison, au couple brillant de Marion Delorme et du marquis. La lithographie et la gravure ont consacré à l'envi ce préjugé historique, le théâtre * et de roman l'ont exploité, de telle sorte que l'architecte normand tient aujourd' hui sa place à côté de Galilée et de Christophe Colomb sur la liste des hommes de génie persécutés et méconnus. Jusques à quand cette légende de fabrication moderne usurpera-t-elle le titre de fait historique ?" [Pages 32, 33.]

5. *A Scotch view of the "Century."* In *Blackwood's Magazine*, Vol. 6, 1820, p. 655, a correspondent, under the signature of J. C., in an article dated Manchester, February 8, 1820, "On Sir Thomas Urquhart's Jewell," declares :—"I have good reason [?] to believe, Sir Thomas was the real author of that singular production, 'A century of names and scantlings of inventions,' the credit or discredit of which was dishonestly [?] assumed by the Marquis of Worcester."

Mr. Hugh Miller, in his "Scenes and Legends of the North of Scotland," 12mo. Edin. 1835, has enlarged on this speculative view with amusing fervour. He says :—"If intrinsic evidence be allowed to weigh anything, either this little tract [the "Century"] was written by Sir Thomas ; or, what is much less probable, the world, nay, the same age and island, have produced two Sir Thomases. Some little weight, too, may be attached to the fact, that many of his manuscripts were lost in the city of Worcester, near which place, *judging from the Title*, it is probable the Marquis resided [!] ; and that the "Century of Names" was not published until 1663, two years after death had disarmed poor Sir Thomas of his sword and his pen, and rendered him insensible to both his country's honour and his own. *If in reality the author of this piece, he must be regarded, it is said, as the prime inventor of the steam engine.*"

* Voir le drame intitulé *Salomon de Caus*, joué à l'Ambigu en 1857.

APPENDIX I.

 PETITION.

[At page 284 of the "Life" is a copy of an undated letter, which may have been one addressed to the Duke of Albemarle. The Marquis speaks of the neglect of two petitions, which may be the one given at page 282, and the present petition, to the matter of both of which the annexed letter from the Duke of Albemarle may refer. It would thus appear that his petitions lay neglected for two months.]

State Papers.

Vol. 152, No. 82. Petition of the Marquis of Worcester.

To the King's most excellent Majesty,
The Petition of Edward Earl and Marquis of Worcester.

That the Petitioner having with great loyalty expended and lost his whole fortune (being very considerable) for the interest of the Crown, and public services whereby he is reduced to that deplorable condition through his debts and wants, that he is not capable to eat bread of his own, or allow himself the freedom of the streets, being deprived hereof through the clamour of his creditors, whose moneys were really borrowed for the use, and on the desire of your Majesty's royal father of blessed memory, your sacred Majesty [sic] and for advancing public services to the general good of the kingdom and security of your Royal person and dignity, of which the Petitioner hath paid above £35,000 since your Majesty's happy restoration, besides many former sums lent and expended, for which it is humbly presumed your sacred Majesty (when rightly informed) will have particular regard to release and to pay such great acts of loyalty as the Petitioner can make appear, as well for justice as an encouragement for all loyal subjects hereafter to expose themselves and fortunes at any rate for your Royal interest, as the Petitioner hath without precedent, truly and really done in many eminent particular services, too tedious to trouble your Majesty with, being more fit to be heard and prepared by some of your Majesty's most

honourable privy Council, who are the most proper advisers in such cases, whose report and advice in this matter to your Majesty may prove a redemption to the Petitioner, a royal exoneration to your Majesty, and a great encouragement to all good subjects for the future, to expose themselves as the Petitioner hath done, for your Majesty's less trouble and better understanding of the premisses, and what shall be made appear concerning the same.

The Petitioner's most humble request is, that your Majesty will be graciously pleased to recommend and refer the Petitioner to be fully heard touching his services, loans, disbursements, losses, and sufferings to the Lord High Chancellor of England, and the Lord Privy Seal, the Duke of Albemarle, the Marquis of Dorchester, the Earl of Anglesey, the Earl of Loutherdale; the Lord Holles, the Lord Ashley, Lord Arlington and Mr. Secretary Morrice, or to such of them, or other, as your Majesty shall think fit. And that your Majesty will be pleased to order the said Lords to refer to reports to your Majesty with all convenient speed the Petitioner's whole case, as they shall find it, with their opinions to your Majesty for such just and speedy satisfaction for the relief of the Petitioner, and encouragement for his long endeavouring for the public good, as shall be thought fit, whereby he may be enabled to stop the mouths of his numerous and clamorous creditors, and live himself without disgrace to nobility, or being further necessitated to importune your Majesty. And that, until the Petitioner's case can be reported, and fitted for your Majesty's royal pleasure, your Majesty will be pleased to order the Petitioner, some small sum out of the privy purse for the present support of his wife and family who exceedingly want the same.

And your Petitioner will ever pray, &c. &c.

[See Cal. State Papers, Dom. Series, 1665-66. Edited by Mrs. M. A. E. Green, 8vo. 1864. P. 330, No. 82.]

State Papers.

Vol. 144, No. 27. Duke of Albemarle to Lord Arlington.

My Lord,—At the request of my Lord Marquis of Worcester I make bold to write to your Lordship in his behalf, you know his Lordship's business so well that I shall not need to state

it to you. I desire your Lordship's assistance to him in the dispatch of his Lordship's concerns before you, whereby your Lordship will oblige my Lord of Worcester, and also him who is,

Your Lordships very humble servant,
ALBEMARLE.

Cockpit, 3 Jan. 1665.

Addressed at the back—"For the Right Honourable Henry Lord Arlington, Principal Secretary of State these, at Oxford."

[*** Calendared under 1666.]

Vol. 142. No. 11, 2. Reference to the Lord Chancellor and others.

[See Cal. State Papers, Dom. Series, 1665-66. Edited by Mrs. M. A. E. Green, 8vo. 1864. P. 189, No. 27.]

State Papers. Vol. 152, No. 10.

Reference to Sir Thomas Ingram—[*Ent. Book* 18, page 200.]

Marquis of Worcester.

Upon the Petition of the Marquis of Worcester, who desiring to be heard in his suit about Mr. Hall, to be referred to the Chancellor of the Dutchy.

March 24, 1665-6.

His Majesty is graciously pleased to refer the suit of the honourable Petitioner unto the Rt. Honble. Sir Thomas Ingram, Knt., and to consider thereof, and to report his opinion thereupon to his Majesty, who will then declare his further pleasure, with a gracious regard to the Petitioner's services and sufferings.

[See Cal. State Papers, Dom. Series, 1665-66. Edited by Mrs. M. A. E. Green, 8vo. 1864. page 316, No. 11. 3.]

State Papers. Vol. 152, No. 82.

[Reference thereon to the Lord Chancellor and others.]

At the Court of Whitehall, March the [March 24, 1665-6.]

His Majesty is graciously pleased to refer this honourable Petitioner, and his suit, to the Right Honourable the Lord High Chancellor of England, and the Lord Privy Seal, the Duke of Albemarle,

the Marquis of Dorchester, the Earl of Anglesey, the Earl of Loutherdale, the Lord Holles, the Lord Ashley, myself, and Mr. Secretary Morrice, or to any three or more of them, who are hereby authorized to take special care to find out the truth of the whole particulars, which will be afforded by the Petitioner, and to report the same to his Majesty, their opinions of the most proper and expeditious way for his Majesty to answer the Petitioner's desires, so far as the same shall be found just, upon whose report his Majesty will take a speedy course for the Petitioner's satisfaction.

[No signature, date, or endorsement. But in Cal. State Papers, 1665-66, reference is made, p. 316, No. 11, to *Ent. Book* 18, p. 18, which supplies the date 24 March, 1665-6.]

[See Cal. State Papers, Dom. Series, 1665-66. Edited by Mrs. M. A. E. Green. Svo. 1864, page 330, No. 82.]

APPENDIX K.

JOHN GOWER.

[In the "Life, Times, &c.," page 108, a quotation is given from the poet Gower, as used by Henry Marquis of Worcester, in addressing Charles I. and is again alluded to at page 145. The author is indebted to a friend for taking the trouble to search the works of the poet, at the London Institution, and supplying, from Chalmers' edition, 1810, page 218, the following reference and extract.

The lines occur in "Confessio Amantis," Book VII. in a dialogue, the subject being: "Of the three, Wine, Women, or the King, which is the strongest?" Harpages says:—]

A kynge maie spille,* a kynge maie saue,
 A kynge maie make a lorde a knaue,
 And of a knaue a lorde also,
 The power of a kynge stont† so:
 That he the lawes ouerpasseth.
 What he will make lesse, he lasseth,
 What he will make more, he moreth.

* *Spille*; to waste, to throw away, to destroy.

† *Stont*; for stondesth (standeth).

CATALOGUE OF EARLY SCIENTIFIC WORKS,

PRINCIPALLY ANTERIOR TO THE PUBLICATION OF THE

CENTURY OF INVENTIONS, IN 1663 ;

WITH A FEW MODERN AUTHORITIES ON MECHANICAL INVENTIONS, AFFORDING
COLLATERAL ILLUSTRATIONS.

-
- ARAGO, FRANÇOIS, Member of the Institute. Biographies of Distinguished Scientific Members. Translated by Admiral Smith, Rev. B. Powell, M.A., and R. Grant, M.A. Svo. 1857. [Life of James Watt.]
- BABINGTON, JOHN, *Pyrotechnia: or, A Discourse of Artificiall Fire-works.* Whereunto is annexed a short treatise of Geometrie. Folio. 1635.
- BACON, ROGER. Frier Bacon his discovery of the miracles of art, nature, and magick. Faithfully translated out of Dr. Dee's own copy, by T. M. and never before in English. London, Printed for Simon Miller, at the Starre in St. Pauls Church-yard. 12mo. 63 pages. 1659.
- BARLOW, PETER, *F.R.S.* &c.—See *Encyclopædia Metropolitana.*
- BATE, JOHN, *The Mysteries of Nature and Art in four severall parts.* The first of water-works: the second of fire-works: the third of drawing, washing, limning, painting, and engraving: the fourth of sundry experiments. 4to. 1634. The second edition. 1635.
- BECHERUS, J. J. *Character, pro Notia Linguarum universali.* Svo. Franc. 1661.
- BEDWELL, WILLIAM.—See Peter Ramus.
- BESSON, JACQUES. *Il Theatro de gl' Instrumenti e Machine; con una brieve dichiaration di tutte le figure di F. Beroaldo.* Folio. Lione, 1582.
- BESSONI, JACOBI, *Delphinatis, Mathematici ingeniosissimi. Theatrum Instrumentorum et Machinarum.* Cum FRANC. BEROALDI figurum declaratione demonstratiua. folio. Lugduni. 1578. [London Institution.]
- BETTINO, Bononiensi, e soc. Jesu. Mario. *Apariari universæ philosophiæ mathematicæ.* Folio. Bononiæ, 1642.

- BILLINGSLEY, HENRY**, Citizen of London. The Elements of Geometric, of the most auncient Philosopher Euclido of Megra. Faithfully (now first) translated into the Englishe toung. With a faithfull Preface made by M. J. Dee. Imprinted at London by John Daye. Folio. 1570. [The date is at the end, vide page 465.]
- BOURNE, WILLIAM**, Inventions or Devices. Very necessary for all generalles and captaines, or leaders of men, as wel by sea as land: Written by — 4to. An. 1578.
- BOYLE, THE HONOURABLE ROBERT**, The Works of. Preface by Thomas Birch. 5 vols. folio. 1744.
- BRADLEY, RICHARD, F.R.S.** New Improvements of Planting and Gardening, both philosophical and practical. 8vo. 1718.
[The 2nd edition in 3 parts, separately paged. See 3rd part, pp. 174—179.]
- BRANCA, GIOVANNI.** Le Machine. Volume nuovo e di molto artificio, da fare effetti maravigliosi tanto Spiritali, &c. 4to. Roma, 1629.
- BROCKLERUM, GEORGIUM ANDREAM.** Theatrum Machinarum novum. Folio. Coloniae Agrippinae, 1662.
- BROWN, J. W.** The Life of Leonardo da Vinci, with a critical account of his works. 12mo. 1828.
- CAUS, ISAAC DE.** New and rare inventions of Water-works, shewing the easiest waies to raise water higher then the spring. By which invention the Perpetual Motion is proposed many hard labours performed And variety of motions and sounds produced. First written in French by Isaak de Caus a late famous engineer: And now translated into English by John Leak. London, Printed by Joseph Moxon. Folio. 1659. [London Institution.]
- CAUS, SALOMON DE.** Les Raisons des forces Mouvantes avec diverses Machines. Folio. Francfort, 1615.
——— Zusatz von allerhand Mühl Wasser und Brotten Werken. [The second part of a volume commencing with, "Heronis Alexandrini Buch von der Luft und Wasser Kunst."] 4to. Frankfurt, 1688.
[Fifty-five quarto copper-plates, Mills, Fountains, and Automata.]
- CHILMEAD, WILLIAM, M. A.**—See James Gaffarel.
- CLARK, DANIEL K., C. E.**—See Encyclopædia Britannica.
- COSMO THE THIRD**, Grand Duke of Tuscany, Travels through England during the reign of Charles II. (1669). Roy. 4to. 1821.
- DESAGULIERS, The Rev. J. T., LL.D., F.R.S. &c.** A Course of Experimental Philosophy. 2 vols. 4to. 1763.
——— Account of the Automaton, by M. Vaucanson, Inventor, translated by. 4to. 1742.
- DIGGES, THOMAS**, A geometrical practical treatize named Pantrometria, divided into three Books. Folio. 1591.
- DIGGES, LEONARD**, Gentleman. A Prognostication cuertaininge Original good effecte, fruitfully augmented by the auctour, &c. augmented by Thomas Digges his sonne. B. L. 4to. 1576.
- DIRCKS, HENRY.** Perpetuum Mobile; or, a history of the search for self-motive power, during the 17th, 18th, and 19th centuries, illustrated from various authentic sources; with an Introductory Essay. Post 8vo. 1861.

- DIRCKS, HENRY. A Biographical Memoir of Samuel Hartlib. Containing a reprint of his publication of Cressy Dymock's account of "An Invention of Engines of Motion." 8vo. 1865.
- DOPPELMAYR, JOHANN GABRIEL. Historische Nachricht von den Nürnbergischen Mathematicis und Künstlern. Folio. Nürnberg, 1730.
- DUDLEY, DUD. Metallum Martis: or, Iron made with Pit-coale, &c. 4to. 1665.
- DYMOCK, CRESSY. An Invention of Engines of Motion lately brought to perfection. [See reprint in H. Dircks' Life of Samuel Hartlib. post octavo. 1864.]
- ENCYCLOPÆDIA BRITANNICA. Vol. 20, 8th edition. 4to. 1860. [Article — Steam and Steam Engine. By Daniel K. Clark, C. E.]
- ENCYCLOPÆDIA METROPOLITANA. 4to. 1845. [Vol. 6, Mixed Sciences. Containing — A Treatise on the Manufactures and Machinery of Great Britain. By Peter Barlow, F.R.S., &c. 1836.]
- ETTEN, HENRY VAN. Mathematicall Recreations. Or a Collection of sundrie *Problemes*, extracted out of the Ancient and Moderne *Philosophers*, as secrets in nature, and experiments in Arithmetick, Geometrie, &c. Most of which were written first in Greeke and Latine, lately compiled in French, by Henry Van Etten, Gent. Small 8vo. 1633.
- Recreacion Mathematique et entretien facetieux de plusieurs plaisants problemes en faict d'arithmetique, geometrie, mechanique, optique, et autres parties de ces belles sciences. 12mo. Pont-a-Mousson, 1629.
- See also Claude Mydorge.
- EVELYN, JOHN, F.R.S. Memoirs illustrative of the Life and Writings of, edited by William Bray, F.S.A. 2 vols. 4to. 1819.
- The Miscellaneous Writings of. By William Upeott. 4to. 1825.
- FALCONER, JOHN. Cryptomenysis Patefacta: or the Art of Secret Information disclosed without a key. Small 8vo. 1685.
[Contains also notices of "Secret Information, mentioned by Trithemius."]
- FAREY, JOHN. A treatise on the Steam Engine. 4to. 1827.
- FELTON, EDMOND. Engines invented to save much blood and moneyes (in these times of warre), and to doe extraordinary good service. [A tract of 8 pages.] 4to. 1644.
- FIGUIER, LOUIS. Exposition et Histoire des Principales Découvertes Scientifiques Modernes. 4 vols. post 8vo. Paris, 1862. [Tome Premier. Machine a vapeur.]
- FLUD, ROBERTO. Utrisque Cosmi majoris scilicet et minoris metaphysica, physica atque technica historia in duo Volumina secundum cosmi differentiam divisa. Folio. Oppenheimii, 1617. [Dedication signed —R. Fludd.]
- FOSBROKE, The Rev. THOMAS D., M.A., &c. Encyclopædia of Antiquities and elements of Archæology. 8vo. 1840.
- FOSTER, SAMUEL. Miscellanies: or, Mathematical Lucubrations. Translated by Dr. John Twysden. Folio. 1659.
- FRENCH, JOHN, Doctor of Physick. The art of distillation, or a treatise of the choicest spagyricall preparations performed by way of distillation; in 6 books. 4to. 1650.

- FRENCH, JOHN. The same. Second edition. To which is added, The London Distiller. 4to. 1653.
[Numerous woodcuts of distillatory apparatus.]
- GAFFAREL, JAMES. Unheard-of Curiosities concerning the Talismanical sculptures of the Persians, &c. Translated by Edmund Chilmead, M.A. small 8vo. 1650.
- GHEYN, JACOB DE. The Exercise of Armes, for Calivers, Muskettes, and Pikes, After the ordre of his Excellence Maurits, Prince of Orange, &c. Sett forth in the figures by Jacob de Gheyne. Printed at the Hage. Folio. 1607.
- GIACINTO, AMATI. Ricerche Storico-Critico-Scientifiche sulle origini, scoperte, invenzioni e perfezionamenti fatti nelle lettere nelle arti e nelle scienze. 5 Tom. 8vo. Milan, 1828. [In Vol. 2, "Stenografia."]
- GLASGOW Meehanics' Magazine, and Annals of Philosophy. 2nd Vol. 8vo. Glasgow, 1825.
- GROLIER DE SERVIÈRE, NICHOLAS. Recueil d'ouvrages curieux de mathématique et de mécanique; ou description du cabinet de M. Grollier de Servièrre. 4to. Lyon, 1719.
- GROSE, FRANCIS. Military Antiquities. 2 vols. 4to. 1801.
- HALLIWELL, J. O., *F.R.S.* &c. A Collection of Letters illustrative of the progress of Science in England from the reign of Q. Elizabeth, to that of Charles II. Edited by. 8vo. 1841.
- Rara Mathematica; or, Collection of Treatises on the Mathematics. Edited by. 1841.
- HARLEIAN MISCELLANY. By Oldys and Park. 4to. 6th Vol. 9th Vol.
- HARSDÖRFFERN, GEORG PHILIPP. Deliciæ Mathematicæ et Physicæ. Z'weyter Theil. 4to. Nürnberg, 1677.
- Dritter Theil. 4to. Nürnberg, 1692. [See M. D. Schwen-terum.]
- HARTLIB, SAMUEL.—See Invention.—See also H. Dircks.
- HERO, Alexandrinus, *Senior*; CTESIBII Ascreni Discipulus.
1. *Spiritium Liber*, à FREDERICO COMMANDINO ex Græco in Latinum conversus; cum figuris. 4to. Urbini, 1575.
 2. *Di Herone Alessandrino de gli Automati, overo Machine se Moventi, Libri due*, Tradotti dal Greco da Bernardino Baldi. 4to. Venetia, 1589.
 3. *Spiritium Liber*: altera editio; cui accesserunt Jo. BAPT. ALEOTTI, quatuor Theoremata Spiritalia, ex Italico in Latinum conversa; cum figuris. 4to. Amsterdam, 1680.
[A 4to. edition also printed at Bologna, 1647.]
 4. *Veterum Mathematicorum—Athenæi, Bitonis, Apollodori, Heronis, Philonis, et Aliorum Opera*; Græce et Latine, pleraque nunc primum edita. Ex Manuscriptis Codicibus Bibliothecæ Regiæ. Folio. Parisiis, 1693.
- HEWETT, JOHN. Ancient Armour and Weapons. 3 vols. 8vo. 1860.
- HOOKE, ROBERT, *F.R.S.* *Lectioes Cutlerianæ*, a Collection of Lectures made before the Royal Society. 4to. 1679.
[See No. 1. of the "Philosophical Collections" therein.]
- HOOPER, DR. WILLIAM. Rational Recreations. 1st and 2d Vol. 8vo. 1794.

HUMANE INDUSTRY: or a History of most manual arts, deducing the original, progress, and improvement of them. Furnished with variety of instances and examples, shewing forth the excellency of Humane Wit. small 8vo. 1661. [By Thomas Powell, *D.D.*; see Ant. 'A. Wood, &c.]

HUTTON, CHARLES, LL.D. and F.R.S. Mathematical Dictionary. 1815.

INVENTION (An) of Engines of Motion lately brought to perfection. Whereby may be dispatched any work now done in England or elsewhere, (especially works that require strength and swiftness) either by wind, water, cattel or men. And that with better accommodation, and more profit then anything hitherto known and used. London, Printed by J. C. for Richard Woodnoth, next door to the Golden heart, in Leaden-hall Street. 16 pages. 4to. 1651.

[Two copies in the British Museum; one as above, the other with "next" corrected to "next." This scarce pamphlet consists of two Letters without signature, addressed to Samuel Hartlib.]

INVENTION.—See Cressy Dymock. Also, Temple Anecdotes.

INVENTIONS.—See Wonderful Inventions.

KIRCHERUS, Athanasius, Germanus, Fuldensis, Soc. Jesu. Romani Collegii Societatus Jesu Musæum celeberrimum. Folio. Amstelodami, 1678.

[Caput IV. *De Horologiis.* Caput V. *De Mobili perpetuo apparente.*]

LANIS; P. Francisci Tertii de. Magisterium Naturæ, et Artis. 3 vol. fol. Brixia, 1684.

LEAK, JOHN.—See Isaac de Caus.

LEYBOURN, WILLIAM, Philomathes. Pleasure with Profit: consisting of recreations of divers kinds, viz., Numerical, Geometrical, Mechanical, &c. folio. 1694.

[The compiler was a schoolmaster, and although largely indebted to Bishop Wilkins and other learned authors, he never names a single authority.]

LUCAR, CYPRIAN, Gent. Three Bookes of Colloquies concerning the art of shooting in great and small peeces of artillerie, variable randges, measure, and waight of leaden, yron, and marble stone pellets, minc-rall saltpeetre, gunpowder of divers sortes, &c. Written in Italian by Nicholas Tartaglia; and now translated into English by, (augmented, and with additions) fol. 1588.

————— A Treatise named Lucarsolace, divided into Fovver Bookes, which in part are collected out of diuerse authors, in diuerse languages. 4to. 1590.

LEUPOLD, JACOB.—1. *Theatrum Machinarum generale; mit figuren, und register.* Folio. Leipzig, 1726.

———— 2. *Hydrotechnicarum.* Folio. 1724.

———— 3. *Machinarum Hydraulicarum; oder. Schau Platz der Wasser-Kunste.* 2 vols. Folio. 1724-25.

———— 4. *Staticum universale.* 1726.

———— 4. *Pontificiale.* Folio. 1726.

———— 6. *Machinarum; oder, Schau-Platz der Heb-Zeuge.* 1725.

———— 7. *Arithmetico-Geometricum* 1726.

MECHANICS' MAGAZINE. Third Vol. 8vo. 1825.

- MEIKLEHAM, ROBERT. Author of several works under the pseudonym of Robert Stuart : which see accordingly.
- MARKHAM, G. The Souldiers Exercise : in three Bookes. 4to. 1639.
- MEYRICK, SIR S. R. Ancient Armour and Arms. 2 vols. Folio. 1830.
- MORVYNG, PETER. The treasure of Evonymus, contayninge the wonderfull hid secretes of nature, touchinge the most apte formes to prepare and destyl Medicines, &c. 4to. 1559.
- MYDORGE, CLAUDE. Examen du Livre des Recreations Mathematiques, et de ses problemes en Geometrie, Mechanique, Optique, and Catoptrique, &c. [And at the end] Notes sur les Recreations Mathematiques. Par D. H. P. E. M. Small 8vo. Paris, 1638.
[See Van Etten's work printed at Pont-a-Mousson, 1629, and later editions ; Mydorge's work is a copy of their matter and engravings. He was an eminent mathematician : born at Paris, 1585.]
- MUIRHEAD, JAMES, P. *M.A.* &c. The Life of James Watt, with selections from his Correspondence. 2nd Edition. 8vo. 1859.
- NOWE, LORD DE LA. The Politicke and Militarie Discourses of. Translated out of the French by E. A. B. Letter. 4to. 1587.
- PANCIROLLUS, GUIDO. The history of many memorable things lost, which were in use among the Ancients, &c. 12mo. 1715.
- PAPILLON, DAVID, Gent. A practieall Abstract of the Arts of Fortification and Assailing. 4to. 1645.
- PARTINGTON, CHARLES F. A course of Lectures on the Steam Engine, delivered at the London Mechanics' Institution, &c. 12mo. 1826.
- PEACHAM, HENRY, *M.A.* The compleat Gentleman. 4to. 1627.
- PERCY ANECDOTES. By S. & R. Percy. 12mo. 1820.
[Articles—Science, Genius, Ingenuity.]
- PHILOSOPHICAL MAGAZINE. Edited by A. Tilloch. 18th Vol. 8vo. 1804.
- PLAT, SIR HUGH, of Lincolne's Inne. The Jewell House of Art and Nature. Printed by Peter Short, on Breadstreet hill, at the signe of the Star. 4to. 1594.
[It contains 4 Books and a last part. The 3 first Books have separate title pages, the first paged 1 to 96, the second 1 to 60, and the third 1 to 48, but also takes in the fourth Book and last part under continuous paging, ending p. 76.
According to the Table of Contents—"The first Booke conteineth divers new and conceited experiments."
The second of "Husbandry;" the third of "Divers Chemicall conclusions concerning the art of Distillation."
The fourth Book the "Art of molding or casting." And the last part "an offer of certain new inventions."]
——— The Jewel House of Art and Nature: containing divers rare and profitable inventions, &c. Another edition. 4to. 1653.
- PLOT, DR. ROBERT. Natural History of Staffordshire. Folio. 1684.
- PORTA, JOHN BAPTISTA. I tre Libri de' Spiritali. 4to. Napoli, 1606.
——— Natural Magick ; in 20 Books. Wherein are set forth all the riches and delights of the Natural Sciences. Folio. 1658.
- POWELL, THOMAS, *D.D.* See Humane Industry.
- RAMELLI, CAPITANO AGOSTINO. Le Diverse et artificiose Machine. Folio. 1588.
[This exceedingly rare and valuable work contains 195 well executed folio plates.]

- RAMUS, PETER. *Via Regia ad Geometriam*. The way to Geometry, being necessary and useful. For Astronomers, Geographers, Landmeeters, Seamen, Enginerees, Architeecks, Carpenters, &c. Written in Latine by Peter Ramus, and now translated by Mr. William Bedwell. 4to. 1636.
- ROVINSON, JOHN. A treatise of Metallica. And containeth a briefe explanation, &c., of the instruments, engins, furnaces, &c. 4to. 1613.
[A copy in the British Museum; also reprinted in two editions, edited by Mr. John N. Bagnall, at Wolverhampton, 1854.]
- SCHOTTUS, GASPAR, Regis Curianus, Soc. Jesu, in Herbipolitano-Franconia Gymnasio Math. Prof.
- *Magia universalis naturæ et artis, sive recondita naturalium et artificialium rerum scientia; cum figuris, et indicibus*. 4 vols. 4to. Bambergæ, 1677.
- *Mechanica Hydraulico-Pneumatica (cum notis musicis)*. Plates. 4to. Herbipoli, 1657-58.
- *Pantometrum Kircherianum, hoc est, Instrumentum Geometricum novum a Kirchero inventum, explicatum et demonstrationibus illustratum*. Plates. 4to. *Ibid.* 1660.
- *Cursus Mathematicus*. Fol. 1661.
- *Mathesis Cæsarea, sive Amussis Ferdinandrea ad Problemata Universæ Matheseos, &c.* Plates. 4to. *Ibid.* 1662.
- *Technica Curiosa, sive Mirabilia Artis*. 2 parts in 1. *Ibid.* 1664.
- SCHWENTERUM, M. DANIELEM. *Deliciæ Physico-Mathematicæ*. 4to. Nurnberg, 1636.
- See also G. F. Harsdörffern.
- SERVIÈRE, GROLLIER DE.—See Grollier de Servière.
- SORBIÈRE, MONS. A Voyage to England, containing many things relating to the state of learning, religion, and other curiosities of that kingdom. 8vo. 1709.
[Also, Observations on the same voyage, by Dr. Thomas Sprat, F.R.S. With a Letter of M. Sorbière.]
- SORBIÈRE, SAMUEL. *Relation d'un Voyage en Angleterre*. Paris, 1664.
[Dedication to the King, dated 12th Dec., 1663.]
- SPRAT, THOMAS, F.R.S. Observations on Monsieur Sorbière's Voyage into England; written to Dr. Wren, Professor of Astronomy. 12mo. 1665. [See M. Sorbière.]
- STATE PAPERS, Calendars of (various). 8vo. 1856-64.
- STEVIN, SIMON, de Bruges. *Les Œuvres Mathématiques. Augmentées par Albert Girard*. Fol. A Leyde, 1634.
- STUART, ROBERT. A descriptive History of the Steam Engine. 8vo. 1824.
——— Historical and Descriptive Anecdotes of Steam Engines and of their Inventors. 2 vols. 32mo. 1829,
- STURTEVANT, SIMON. *Metallica, or the Treatise of Metallica*. [The making of Iron with Sea-cole, &c.] 4to. 1612.
- SWITZER, STEPHEN. An introduction to a general system of hydrostaticks and hydraulics. 2 vols. 4to. 1729.
- TEMPLE ANECDOTES, THE; Invention and Discovery. By R. & C. Temple. Post 8vo. 1864.
- TEYSER, JOHANNIS. *Architecturæ Militaris*. 4to. 1553.
[In 4 Books, with engraved title and plates; pp. 56.]

- TIMBS, JOHN, *F.S.A.* Stories of Inventors and Discoverers. 12mo. 1860.
- TREGOLD, THOMAS, *C.E.* The principles and practice, and explanation of the Machinery used in steam navigation. Compiled by —. 2 vols. 4to. 1851.
- TRITHEMI, JOANNIS. Libri Polygraphiæ VI. Small 8vo. Argentinae, 1600.
[There is also a quarto edition, with diagrams.]
- TYMME, THOMAS. A Dialogue Philosophical, wherein Natures secret closet is opened, and the cause of all motion in nature shewed out of matter and forme, &c. 4to. 1612.
- UBALDI, GUIDI, i machionibus montis in duos Archimedis æqueponderantium libros praphrasis scholiis illustrata. Folio. Pisauri, 1588:
—— è marchionibus montis. Meehanicorum Liber. Pisauri, 1577.
—— Mechanica. Fol. Pisaur. 1577. And Venice, 1615.
—— De Cochlea. Fol. Venice, 1615. pp. 160.
- UPCOTT, WILLIAM.—See John Evelyn, F.R.S.
- VALTURIUS, ROBERTUS, De Re Militari. Folio. Parisiis, 1532.
—— Another edition. Folio. Parisiis, 1534.
[In the Library of the Patent Office. The same volume contains:— Flavius Vegetius de Re Militari.—Sextus Julius Frontinus, Stratagematum.—Ælianus de Instruendis aciebus.—And, Modestus, Libellus de Vocabulis Rei Militaris.]
- VEGETIUS Renatus, Flavius.
—— 1. De re militari Libri IV. Fol. Plato de Benedictis, Bononiae, 1495. *Inter* Scriptores de re militari.
Sextus Julius Frontinus Vit. consularis de re militari.—Flavius Vegetius Vit. Illustris de re militari.—Ælianus de instruendis aciebus.—Modesti, libellus de uocabulis rei militaris. [No engravings.]
—— 2. De re militari Libri IV. : cum picturis bellicis ligno incisis. Fol. Char. Wechelius, Parisiis, 1535.—*Inter* Scriptores de re militari.
[Large engraved figure of a Knight on the back of the title page, and numerous bold, freely executed curious large wood engravings.]
—— 3. VEGEZIO dell' arte militare, nella commune lingua novamente tradotto da TIZZONI GAETANO da Pofi. Small 8vo. Venetia, 1540.
[Wood engraved title page.]
—— 4. Il Modesimo; tradotto da FRANCESCO FERROSI. Small 8vo. Gabriel Giolito, Vinegia, 1551. [No engravings.]
—— 5. De re militari Libri IV. Sexti Julii Frontini viri consularis de stratagematis libri totidem. Fol. Paris, 1553.
—— 6. De re militari Libri IV. [Frontini; Ælianus, Modestus.] G. Stewechio. 8vo. Lugduni Batavorum, 1592.
- VETERUM MATHEMATICORUM, 1693.—See HERO, No. 4.
- VINCI, LEONARDO DA. Life of. See J. W. Brown.
- VITRUVIO de Architectura traducto (da C. Cesariano, Bono Mauro, Benedetto Jovio, Novo Comasco, &c.) e commentato da Cesare Cesariano. Woodcuts. Fol. Como, 1521.
[1st Book, p. 23. Aeolipilarum Figura. Also engraving of a large vessel with paddles. Liber Decimus, p. 174.]
- VITRUVIUS PALLIO, MARCUS. De architectura Libri X. Fol. Romæ, circa 1486.
- [WALLACE, PROFESSOR]. The History of the Steam-Engine from the second century before the Christian era. New edition, illustrated. 12mo. London, *Cassell*, 1860.

- WATT, JAMES.—See J. P. Muirhead,
- WEALE'S QUARTERLY PAPERS.—Vol. V.
- WHITE, JOHN. A rich Cabinet, with variety of Inventions, unlock'd and open'd, for the recreation of ingenious spirits. 12mo. 1684.
- WILKINS, JOHN, M.A. (Bishop of Chester). Mathematicall Magick. Or, The wonders that may be performed by mechanicall geometry. By J. W., M.A. Small Svo. 1648.
- Mercury, or the secret and swift messenger: shewing how a man may with privacy and speed communicate his thoughts to a friend at any distance. By J. W., M.A. Small Svo. 1644.
- WONDERFUL INVENTIONS; A History of. 12mo. 18—.
- ZEISING, HENRICUS. Theatri Machinarum. Thick 4to. Leipzig, 1612.
[Compiled principally from Bessoni and Ramelli's works.]
- ZONCA, VITTORIA, Architect. Novo Teatro di Machine et Edificii. Folio. Podoua, 1656.

CATALOGUE

OF BOOKS EITHER QUOTED OR CONSULTED

IN REFERENCE TO THE

LIFE AND TIMES OF THE MARQUIS OF WORCESTER.

-
- 1 AJAZZI, Cura di G. Nunziata in Irlanda di Monsignor Gio. Batista Rinuccini Arcivescovo di Fermo negli anni 1645 a 1649. 8vo. Firenze, 1844.
- 2 ALLEN, THOMAS. The Historical Antiquities of London, &c.; continued by Thomas Wright. 4 vols. 8vo. 1839.
- 3 ——— History and Antiquities of the Parish of Lambeth. 4to. 1827.
- 4 ANNUAL REGISTER, 1769.
- 4*ANTIQUARIAN REPERTORY. By Francis Grose, F.S.A., &c. and other eminent antiquarians. Vol. IV. 4to. 1809.
- 4**ARCHÆOLOGIA; or Miscellaneous Tracts relating to Antiquity. Vol. 6. 4to. 1782.
- 5 ATKYNS, SIR ROBERT. The ancient and present state of Gloucestershire. Folio. 1712.
- BAKER, CHARLES. See T. D. or T. Dineley.
- 5*BARBER, J. T., F.S.A. A Tour through South Wales and Monmouthshire. 8vo. 1803.
- 5**BARRINGTON, SIR JONAH, Historic Memoirs of Ireland. 2nd edition. 2 vols. 4to. 1833.
- 6 BAYLEY, JOHN, F.R.S., &c. The History and Antiquities of the Tower of London. In 2 parts, royal 4to. 1825.
- 7 BAYLY, THOMAS, (Sub-dean of Bath and Wells). Worcester's Apophthegme: or Witty sayings of the Right Honourable Henry (late) Marquess and Earl of Worcester. By T. B. Small 12mo. 1650.
- 7* ——— Certamen Religiosum: or, a conference between his late Majesty, Charles King of England, and Henry late Marquis and Earl of Worcester, concerning Religion, 1646. 12mo. 1649.
- 8 BEATSON'S Political Index modernised; The Book of Dignities. By Joseph Haydn. 8vo. 1851.
- 9 BEATTIE, WM., M.D. The Castles and Abbeys of England. Royal 8vo. 18—
- 10 BEAUFORT FAMILY, Portraits and Biographical Notices of the. Folio. Salisbury, 1804.
- 11 [BELING, SIR RICHARD.] Vindicarum Catholicarum Hiberniæ. Authore Philopatō Irenæo. Libri duo, quorum. pp. 256. 18mo. Paris, 1650. [He was one of the great movers of the rebellion, but of the moderate party.]
- 12 BETHAM, REV. WILLIAM, The Baronetage of England. 4to. 1803.
- 12*BIBLIOTHECA REGIA; or, The Royal Library, Ch. II. Not extant in the Reliquiæ Carolinæ. In two Books, 12mo. [Brit. Mus.] 1659.

- 13 BIRCH, THOMAS, *D.D.*, Secretary of the Royal Society. An Inquiry into the share which Charles I. had in the transactions of the Earl of Glamorgan. 8vo. 1756.
- BLISS' WALPOLE. See Walpole.
- 14 BOYLE, HONOURABLE ROBERT, *The Works of*. 5 vols. folio. 1744.
- BROOKE, RALPHE. See Augustine Vincent.
- 15 BROOKS, WM. ALEX., Architect. *Select Specimens of the Monastic, Castellated, and Domestic Architecture of Great Britain*. Part 1, Nos. 1 and 2, [all publ.] folio. 1826.
- 16 BRUCE, JOHN, *F.S.A.*, &c. Charles I. in 1646; Letters of Charles the First to Queen Henrietta Maria. Edited by — [Camden Society.] 4to. 1856.
- 17 BRYDGES, SIR EGERTON, Bart. *Memoirs of the Peers of England during the reign of James I.* [all publ.] 8vo. 1802.
- 18 ——— *Restituta; or, Titles and Extracts of Old Books*. 4 vols. 8vo. 1815.
- 19 ——— *Censura Literaria*. 10 vols. 8vo. 1815.
- 20 BURKE, SIR BERNARD. *A Visitation of the Seats and Arms of the Noblemen and Gentlemen of Great Britain*. 2nd edn. 8vo. 1855.
- 21 BUCK'S *Antiquities; or Venerable Remains of above 400 Castles, &c. in England and Wales*. 3 vols. folio. 1774.
- 22 BURTON, THOMAS, M.P. *Diary of the Parliaments of Oliver and Richard Cromwell*. 4 vols. 8vo. 1828.
- BYRNE, W., *F.S.A.* See Thomas Hearne.
- 22* CARLISLE, NICHOLAS, *F.R.S.* &c. *An inquiry into the place and quality of the Gentlemen of His Majesty's honourable Privy Chamber*. 8vo. 1829.
- 23 CARLYLE, THOMAS. *Oliver Cromwell's Letters and Speeches*. 4 vols. 1850.
- 24 CARTE, THOMAS, M.A. *A History of the Life of James Duke of Ormonde*. 1736.
- 25 [CARTE, THOMAS.] *Life of James Duke of Ormond, containing an account of the most remarkable affairs of his time, and particularly of Ireland under his government: with an Appendix and a Collection of Letters*. A new edition. 6 vols. 8vo. Oxford, 1851.
- CHARLES I. *Letters, 1664*. See John Bruce.
- 26 CLARENDON'S *History of the Rebellion*. 7 vols. 8vo. 1849.
- CLARENDON'S *Life, &c.* See T. H. Lister.
- 26* ——— *State Papers collected by*, 3 vols. Folio. Oxford, 1767—1773 and 1786.
- 27 CLAYTON, J. W. *Personal Memoirs of Charles II.* 2 vols. 8vo. 1859.
- 28 COLLINS, ARTHUR. *Letters and Memorials of State*. 2 vols. folio. 1746.
- ——— *Peerage of England*. 9 vols. 8vo. 1812.
- 29 CORBET, JOHN, Preacher of God's Word. *An Historicall relation of the Military Government of Gloucestershire from the beginning of the Civill Warre*. 1645. [Reprinted in "Bibliotheca Gloucestrensis. By John Washbourn, jr. 4to. Gloucester, 1825.]
- 30 COSMO the Third, Grand Duke of Tuscany. *Travels through England during the reign of K. Charles II. (1669)*. Royal 4to. 1821.

- 31 COXE, WM., A.M., &c. An Historical Tour in Monmouthshire, illustrated with views by Sir R. C. Hoare, Bart., &c. 4to. 1801.
- COURTHOPE, WILLIAM. See Sir Harris Nicolas.
- 32 CROKER, T. C. Narratives illustrative of the Contests in Ireland in 1641—1690. Edited by. (Camden Society). 4to. 1841.
- 33 CUNNINGHAM, PETER. Handbook of London. 12mo. 1850.
- 34 [DINELEY, T.] Notitia Cambro-Britannica: A voyage of North and South Wales; being observations in attending his Grace the Duke of Beaufort, in his progress there. 1684. By T. D. *Gen.* Edited from the original MS. by Charles Baker, Esq. London, printed for private circulation. 4to. 1864.
- 35 DISRAELI, ISAAC. Commentaries on the Life and Reign of Charles I. 2 vols. Svo. 1851.
- 36 DODD, CHARLES, [*i.e.* Hugh Tootell]. Church History of England, from the commencement of the 16th Century to the revolution in 1688. With notes and a continuation by the Rev. M. A. Tierney. 5 vols. Svo. 1839-43.
- 36* DUGDALE, WILLIAM, (Norroy King of Arms). The Baronage of England. Folio. 1675.
- 37 EVELYN, JOHN, *F.R.S.* Diary and Correspondence of. Edited by Wm. Bray, *F.A.S.* 1859. Crown Svo. 1859.
- 38 FANSHAWE, LADY. Memoirs of Lady F., wife of the Right Hon. Sir Richard Fanshawe, Bart. Ambassador from Charles the Second to the Court of Madrid in 1665. Written by herself. Svo. 1829.
- 39 FELLOWES, W. D. Historical Sketches of Charles the First. 4to. 1828.
- 40 FOSBROKE, REV. THOMAS DUDLEY, *M.A.* A picturesque and topographical account of Raglan Castle. 12mo. Monmouth, 1831.
- GARDNOR, JOHN. See David Williams.
- 41 GLAMORGAN'S, The Earl of, Negotiations and colourable commitment in Ireland demonstrated, or the Irish Plot for bringing 10,000 men and arms into England, &c. 4to. 1645.
- 42 GREEN, VALENTINE, *F.S.A.* The History and Antiquities of the city and suburbs of Worcester. 2 vols. 4to. 1796.
- GROSE, FRANCIS, *F.S.A.* See Antiquarian Repertory.
- 44 GUIZOT, M. History of Charles I. and the English Revolution. Vol. 2. Svo. 1854.
- 45 HARLEIAN Miscellany. Vol. 2. 1809. Vol. 4. Vol. 7. 8. 4to. 1811.
- 46 HARLEY, Lady Brilliana, Letters of; (Wife of Sir Robert Harley, of Brampton Bryan. K. B. With Introduction and notes by Thos. T. Lewis, A. M. London, (Camden Society.) 4to. 1853.
- HAYDN, JOSEPH. See Beatson.
- 47 HEARNE, THOMAS, *F.S.A.* The Antiquities of Great Britain, illustrated in views of Monasteries, Castles, and Churches. Engraved by W. Byrne, *F.S.A.* from Drawings by Thomas Hearne, *F.S.A.* 2 vols. Oblong folio. 1807.
- 48 HEATH, CHARLES, Printer. Historical and descriptive accounts of the ancient and present state of Raglan Castle. Svo. Monmouth, 1806.
- — — — 10th edition. Svo. Monmouth, 1825.
- 49 HEATH, JAMES. A brief chronicle of the late war in the three kingdoms of England, Scotland, and Ireland. In 4 parts. From 1637 to 1663. By H. J. 2nd edition. 12mo. 1663.

- 50 HOOPER, JACOB. An impartial history of the rebellion and civil wars in England during the reign of King Charles the First. Collected from Clarendon, Bishop Kennet, Echard, Rushworth, &c. Folio. 1738.
- 51 HOUGH, C. (Monmouth.) A companion to Ragland Castle: or, a familiar description of that beautiful and interesting ruin. 4to. 1833.
- 52 HOWEL, JAMES. Londinopolis; an Historicall Discourse of Perlustration of the City of London, &c. Whereunto is added another of the city of Westminster. Folio. 1657.
- 53 HOWITT, William and Mary. Ruined Abbeys and Castles of Great Britain. 4to. 1862.
- 54 HUME, DAVID. The History of England. 8 vols. Svo. 1778.
- 55 HUME AND SMOLLETT. The History of England. With the continuation by the Rev. T. S. Hughes, B. D. Crown Svo. 1854.
- HYDE, E. Earl of Clarendon—See Clarendon, Earl of.
- 56 ITER CAROLINUM. Somers' Tracts, containing 1641 to 1648. Printed in 1660. 4to.
- JOHNSON, GEORGE W. The Fairfax Correspondence. Memoirs of the reign of Charles the First. 4 vols. Svo. 1848-9.
- 57 JOURNALS of the House of Commons. Folio. London.
- 57* JOURNALS of the House of Lords. Folio. London.
- 58 KENNET, DR. WHITE, (Bishop of Peterborough). A complete History of England. 3 vols. folio. 1706.
- 59 ——— A Register and Chronicle, Ecclesiastical and Civil, containing matters of fact, delivered in the words of the most authentic books, papers, and records; digested in exact order of time. Faithfully taken from the MS. collections of the Lord Bishop of Chester. 2 vols. folio. 1728.
- 60 KNIGHT'S Pictorial History of England. Royal Svo. 18—
- 61 LEYBURN, GEORGE, D.D., (Chaplain to Henrietta Maria, Queen of England), Memoirs of, being a Journal of his agency for Prince Charles in Ireland, in the year 1647. 12mo. 1722.
- 62 LINGARD, JOHN, D.D. The History of England. 10 vols. Svo. 5th edition. 1849.
- 63 LISTER, T. H. Life and Administration of Edward, First Earl of Clarendon, with original correspondence. 3 vols. Svo. 1837.
- 64 LODGE, EDMUND, (Norroy King of Arms, F.S.A.) Portraits and Memoirs of the most illustrious personages of British History. Royal Svo. 1831-3.
- 65 LYSONS, REV. D., M.A., &c. The Environs of London. 4to. 1792.
- 66 ——— Supplement to the First Edition of Historical Account of the Environs of London. 4to. 1811.
- 67 MACAULAY, LORD. The History of England. Vol. 1st. Svo. 1857.
- 68 MEEHAN, REV. C. P. The Confederation of Kilkenny. 12mo. Dublin, 1862.
- 68* MEMORIALS of the English Affairs: or an historical account of what passed from the beginning of the reign of King Charles the First, to King Charles the Second his happy restoration. Printed for N. Ponder. Folio. 1682.

- 69 MILTON, JOHN, *The Prose Works of*. By Charles Symonds. 7 vols. 8vo. 1806.
- NEWCOURT'S Map of Ancient London. 1658. And 1863.
[See Worcester House, Baynard's Castle, and The Tower.] From an exact delineation of the Cities of London and Westminster and the S^vbrs thereof, Together with ye Burrough of Southwark and all ye thoroughfares, highwaies, streets, lanes and common allies within the same composed by a Scale, and Iconographically described by Richard Newcourt of Somerton in the Countie of Somerset, Gentleman. Wm. Faithorne, Sculpsit. 1658. [Engraved from the Original by George Jarman, and pubd. by Edward Stanford, Charing Cross, 1863.] Measures 3ft. 5in. by 6ft. 3½in.
- 70 NICOLAS, SIR HARRIS. *Historic Peerage of England*, revised by William Courthope, Esq., Somerset Herald. 8vo. 18—
- 71 NICHOLS, JOHN. *The Progresses, &c., of King James the First*. Vol. 1st. 4to. 1828.
- 72 ——— *Literary Anecdotes of the Eighteenth Century*. 6 vols. 8vo. 1812.
- 72* ——— *Literary Anecdotes*. 8vo. 1814 and 1815.
- 73 NICHOLS (J. B.) & SON. *Collectanea Topographica*. 8vo. 1834.
- 74 ——— *Collectanea Topographica et Genealogica*. 8 vols. 8vo. 1841. [Vol. VII. p. 190.]
- 75 NICHOLS, JOHN GOUGH. *Autographs of Royal, Noble, Learned and Remarkable Personages conspicious in English History*. Folio. 1829.
- 76 NOTES AND QUERIES. *Second Series*. 1st Vol. small 4to. 1856.
- O'DONOVAN, JOHN. *Annals of the Rebellion of Ireland*. 4 vols. 1851.
- ORMOND, JAMES, DUKE OF, *Life of*. See Carte.
- 77 PAMPHLETS, *Collection of*. 1646. 4to. [The gift of George III. to the Brit. Mus. E. 350.]
- 78 PEPYS, SAMUEL, *F.R.S.* *Diary and Correspondence of*. 6th edition, in 4 vols. crown 8vo. 1858.
- 79 PETERBOROUGH, Bishop of. *A Register and Chronicle, Ecclesiastical and Civil; from the Restoration of Charles II. Faithfully taken from the MS. Collections of*. Folio. 1728.
- 80 PLAYFAIR, W. *British Family Antiquity*. 4to. 1809.
- PONDER, N. See *Memorials of the English Affairs*.
- 81 POTE, JOSEPH. *The History and Antiquities of Windsor Castle, and the Royal College, and Chapel of St. George*. 4to. 1749.
- 82 PROUT, JOHN SKINNER. *The Castles and Abbeys of Monmouthshire*. Folio. 1838.
- 83 RAGLAND CASTLE; *The gallant siege of the Parliamentary forces before*. May 30, 1646.
[“Collection of Pamphlets,” 1646. 4to. The gift of George III. to the Brit. Mus.]
- 84 RAGLAND CASTLE; *An exact and true relation of the many several messages that have passed between Sir Thomas Fairfax and the Marquis of Worcester, &c. &c.* 4to. 1646.
[“Collection of Pamphlets,” 1646. 4to. The gift of George III. to the Brit. Mus.]

- 85 RAPIN DE THOYRAS. The History of England. Translated by N. Tindal, M.A. Folio. 1733.
- RINUCCINI, G. B.—See G. Aiazzi.
- ROBERTS, GEORGE.—See Walter Yonge.
- 86 RUDDER, SAMUEL. A new history of Gloucestershire. Folio. 1779.
- 87 RUSHWORTH, JOHN. Historical Collections. Third part, Vol. 2. 1640-1644. Folio. 1692.
- 88 SANDFORD, FRANCIS. A genealogical history of the Kings and Queens of England, and Monarchs of Great Britain, &c., from 1066 to 1707; continued by Samuel Stebbing. Folio. 1707.
- 89 SEWARD'S Anecdotes of some distinguished persons. 12mo. 1796.
- 90 SOMERS, LORD, Tracts. A collection of scarce and valuable tracts, 2nd edition, revised by Sir Walter Scott. Vol. 4. 4to. 1810.
- SOMERS, LORD.—See *Iter Carolinum*.
- SPECTATOR, THE. (Newspaper.) pp. 706 and 733. 1864. Vol.
- 91 SPRAT, THOMAS, F.S.A. Observations on Monsieur Sorbière's Voyage into England; written to Dr. Wren, Professor of Astronomy. 12mo. 1665.
- 92 SPRIGGE, JOHN, M.A. Anglia Rediviva; England's Recovery: being the History of the Motions, Actions, and Successes of the Army, &c. Sir Thomas Fairfax, Kt. Folio. 1647.
- 92* STATE PAPERS, DOMESTIC SERIES, Calendars of: viz.—
- | | | | |
|------------|-------------------------------------|------|-------|
| 1547-1580. | Edited by R. Lemon, F.S.A. | 8vo. | 1856. |
| 1603-1610. | Edited by Mary Anne Everett Green. | „ | 1857. |
| 1611-1618. | „ „ „ | „ | 1858. |
| 1619-1623. | „ „ „ | „ | 1858. |
| 1623-1625. | „ „ „ | „ | 1859. |
| 1625-1626. | Edited by John Bruce, V.P.S.A., &c. | „ | 1858. |
| 1627-1628. | „ „ „ | „ | 1858. |
| 1628-1629. | „ „ „ | „ | 1859. |
| 1629-1631. | „ „ „ | „ | 1860. |
| 1631-1633. | „ „ F.S.A. | „ | 1862. |
| 1633-1634. | „ „ „ | „ | 1863. |
| 1634-1635. | „ „ „ | „ | 1864. |
| 1660-1661. | Edited by Mary Anne Everett Green. | „ | 1860. |
| 1661-1662. | „ „ „ | „ | 1861. |
| 1663-1664. | „ „ „ | „ | 1864. |
| 1664-1665. | „ „ „ | „ | 1863. |
| 1665-1666. | „ „ „ | „ | 1864. |
- 93 SYMONDS, RICHARD. Diary of the marches of the Royal Army during the great Civil War. From the original Manuscript in the British Museum. Edited by C. E. Long. London (Camden Society). 4to. 1859.
- 94 TALLIS'S Illustrated London; with historical and descriptive letter-press by William Gaspey. 2 vols. 12mo. 1851.
- 95 THOMAS, F. S. Historical Notes, 1603-1714. Roy. 8vo. 1856.
- 96 TOONE'S Chronological Historian. 8vo. 1826.
- TIERNEY, REV. M.A.—See Charles Dodd.
- VAUGHAN, ROBERT, D.D. The Protectorate of Oliver Cromwell, and the state of Europe during the early part of the reign of Louis XIV. 2 vols. 8vo. 1838.
- VINCENT, AUGUSTINE. A discoverie of Errours in the Catalogue of Nobility, published by Ralph Brooke, Yorke Herald. Fol. 1622.

- 97 WALPOLE, HORACE, Earl of Orford. A Catalogue of the Royal and Noble Authors of England, &c. Edited by Thomas Park. 8vo. 1806.
- 98 ——— A Catalogue of Royal and Noble Authors, &c. With copious MS. Notes by P. Bliss; containing many cuttings from newspapers, &c. 5 vols. 1806.
[Brit. Museum.]
- 99 ——— Anecdotes of Painting in England. With additions by the Rev. James Dallaway; revised by N. Wornum. 3 vols. 8vo. 1849.
- 100 WARBURTON, ELIOT. Memoirs of Prince Rupert and the Cavaliers. 3 vols. 8vo. 1849.
- 101 WARNER, F., LL.D. The History of the Rebellion and Civil War in Ireland. 2 vols. 4to. 1767.
- 102 WASHBOURN, JOHN, Junr. Bibliotheca Gloucestrensis. 2 vols. 4to. Gloucester, 1825.
- 103 WATKYNs, ROWLAND. Flamma sine Fumo; or Poems without Fictions. By R. W. 16mo. 1662.
- 104 WELD, C. R. A History of the Royal Society. 2 vols. 8vo. 1848.
- 105 WHITELOCKE'S Memorials of the English Affairs; Charles I. and II. Folio. 1732.
- 106 WIFFEN, J. H. Historical Memoirs of the House of Russell. 2 vols. 8vo. 1833.
- 107 WILLEMENT, THOMAS. Facsimile of a contemporary Roll, with the names and the arms of the Sovereign and the Spiritual and Temporal Peers who sat in the Parliament held at Westminster on the 5th of February, in the Sixth year of the reign of King Henry VIII. 1515, in the possession of T. W. Royal 4to. 1829.
- 108 WILLIAMS, DAVID. The History of Monmouthshire, illustrated with Views. By John Gardner, Vicar of Battersea. 4to. 1796.
- 109 WOOD, ANTHONY 'A. Athenæ Oxonienses; continued by Philip Bliss. Vol. 3rd. 4to. 1817.
- 110 YONGE, WALTER, Esq., (Justice of the Peace, and M.P. for Honiton). Diary written at Colyton and Axminster, Co. Devon, from 1604 to 1628. Edited by George Roberts, (Camden Society.) 4to. 1838.

INDEX

TO THE

CENTURY OF INVENTIONS.

ADVANTAGEOUS.

A.

- ADVANTAGEOUS change of centres, 452—456.
 ÆOLIPILE, fire-blowing, 542, 543.
 ALARM for locks, 501.
 ANCHOR, to weigh up, 405, 406.
 ANTIQUITIES, military, 473, 474.
 APPROACHING blind, an, 432.
 ARAGO, M., noticed, 369, 372.
 ARITHMETICAL instrument, 512.
 ARQUEBUSE, 466; à Croc, 466; noticed, 474.
 ARTIFICIAL fountain, 413, 414; river, 419; bird, 440; ring horse, 524.
 ASHMOLE'S Museum at Oxford, 356.
 AUBREY, Mr., "a professed virtuoso," 352.
 AUTHORS, old scientific, enumerated, 359.

B.

- BACON, Lord, notice of, 345.
 BACON, ROGER, his invention, 357.
 BALANCE water-work, 415, 416, 417.
 BALFOUR, SIR WILLIAM, *note*, 452.
 BALL, Mr., "another virtuoso," 352.
 BALL, a hour water, 443, 444.
 BATE, JOHN, his "Mysteries of Nature and Art," a favourite work, 359; his style and the Marquis's compared, 361; raises water, 479, 480; weather glass, 546; on filling Æolipiles, 480; notices "condensation," 480; his use of the technical term "force," 483, 484.
 BELLS, discourse by, 449.
 BIRD, an artificial flying, 440—443, 516.
 BLIND, an approaching, 432.
 BLUNDERBUSS, or Musketoon, 473; noticed, 474.
 BOAT driving against wind and tide, a, 407-411.
 BOATS, patent paddle, 410, 411.
 BOGAERTS, PETER, his canal lock, 419.
 BOURNE, WILLIAM, on "shooting in great ordnance," 400.
 BOYLE, Hon. ROBERT, entrusted with the secret of Papin's fountain, 351.
 BOXES of a cabinet, to lock, 510; dicing box, 521, 522.
 BRACELET alphabet, 435.
 BRADLEY, R., mentions "the late Mr.

CENTURY.

- Savery," 487; account of his engine, 487.
 BRANCA, his steam jet, 479.
 BRAZEN HEAD, 346, a brazen or stone, 515—520.
 BRIDGE, a portable, 428—429.
 BROWNE'S calculating Serpentine scale, 512.
 BUCKETS, to raise water, 415—418; two buckets, 416—418.
 BUCKET-FOUNTAIN, a, 417, 418.
 BULWARK, a rising, 430, 432.
 BUMBASSES and bullets, to shoot, 421.

C.

- CANDLES, a brass mould for, 514, 115.
 CANNON, tried before Charles I., 467, 468; improvements in, 468; extraordinary, 469; various, 469; experiments at Woolwich, 1651, 469; to charge fifty, 472.
 CANNON, "to level by night," 400; Bishop Wilkins' remarks, 422, 423; burst by water, 475; charged with water, 481, 482.
 CARABINES, often discharging, 463; particulars of, 466; noticed, 474.
 CASTLE-CLOCK, 420, 421.
 CAUS, SALOMON de, notice of, 369, 370, 372, 542; his work, 476; fountain and description, 476, 477, 478; comment on, 478, 479.
 CENTURY of Inventions, its name, 345; MS. copy, 346; the MS. and first edition, 347; title pages, 347; why misunderstood, 350; nature of articles therein, 353; as a literary work, 358; its value, 358; variations on its title, 358; verbal peculiarities, 360; its practical tendency, 361; its author's object, 361; its form, 362; similar early statements, 362; its style accords with the legal form in use for patent specifications, 363; agreement between the "Century" and the Marquis's patent, 363, 364; classical scholars have misapprehended the work, 366; its suggestive character, 367; a greater work intended, 367; conflicting opinions, 367; how to be viewed and estimated, 368; the modern steam engine owes its origin to

CENTURY.

- the Marquis and his work, 369; Mr. Muirhead's false estimate of this production and its author's invention, 371; it stands alone, 373; various editions, 374, 375; reprints in other works, 375; fac-simile title page (except the frame work), 377; dedication to Charles I., 379; Dedication to the Houses of Parliament, 381; acknowledges the Act for his engine, 383; mentions the sacrifice of £700,000, 383; Kaltoff, 383; its author's prolific invention, 384; alludes to fees, 385; and his "Golden Age," 385; rarity of the first edition, 497; a postscript, *note*, 535, 536.
- CENTURY, first edition, 346; last edition, 346; its unreliable character, 347.
- CHAIR, an imprisoning, 513.
- CHARACTER, a universal, 433.
- CHARLES II. had a curiously contrived box from the Marquis, 356.
- CIPHER and character, 391; a one-line cipher, 391; the same refined, 392; reduced to a point, 393; varied significantly to all the 24 letters, 394; key to the Marquis's cipher discovered, 552.
- CLAUDIUS, of Rome, his Bucket fountain, 416.
- COACH-SAVING Engine, 414, 415.
- CONCEITED tinder-box, 439.
- CONDENSATION applied to ebbing and flowing, 419—421; applied to drawing weights, 423—425; applied to draught, 427, 428; applied to two globes, 456—462; noticed by J. Bate, 480.
- CONTINUALLY going watch, 508.
- CONVEYANCE, a secret comb, 511; knife, spoon, or fork, 511
- CROCK, 466; Arquebuse à, 466.
- CROSS-BOW, noticed, 474; a double, 528.
- D.
- DARK, to write in the, 503.
- DECKS, false destroying, 405.
- DEE, Dr. JOHN, his preface to Euclid, 361.
- DEFINITION of the Engine, 496, 549, 550.
- DESAGULIERS, Dr., on automata, 443; on perpetual motion, 452, 453; account of Savery's engine, 488—490; charge against Savery, 489.
- DICE, cheating at, 522, 524.
- DICING box, 521, 522, 524.
- DISCOURSE, mute and perfect, by colours, 399; by night, 399.
- DOOR, opening either way, 502; a concealed, 503.
- DOORS, a pocket engine to open, 527.

HARLEIAN.

- DOUBLE drawing engine for weights, 423.
- DOUBLE water-screw, 451; cross-bow, 528.
- DREBELL, CORNELIUS, noticed, 402, 403.
- E.
- EBBING and flowing river, 419; castle-clock, 420, 421; applied to two globes, 456—462.
- ENGINE, portable in one's pocket, 400; ship destroying, 401; to drive and fasten to ships, 401; for cannon, 468; a semi-omnipotent, 529—531.
- ENGINE, a stamping, 520; a gravel, 525; a ship-raising, 526; a pocket, to open doors, 527.
- ENGINES of War, 468, 469.
- ESCUTCHEON for locks, 500.
- ETTEN, VAN, describes a fountain, 481; recommends heat, 481; cannon, 481, 482.
- EVELYN, John, his Diary, 351; his "boscoresque" grounds, 352.
- F.
- FALSE destroying decks, 405.
- FIRE-ARROW, to shoot, 465.
- FLAMSTEAD, John, astronomer, 352.
- FLASK-CHARGER, 463; powder, noticed, 474.
- FLEET, to destroy a, 402.
- FLYING-man, a, 504—508.
- FORCE, as a technical term, explained, 483, 484.
- FOUNTAIN, artificial, 413, 414; De Caus, 477.
- FRINGE-ALPHABET, 435.
- FULTON, Robert, noticed, 404.
- G.
- GARDEN, a floating, 412, 413; a river in, 419.
- GALLERY, a transmittible, 502.
- GLOUCESTER, moveable bulwark at the siege of, 431.
- GLOVE-ALPHABET, pincked, 435; primero gloves, 521.
- GRADATION, rule of, 448, 449.
- GRAVEL engine, 525.
- GREW, Dr., his discourse, 365.
- GUILFORD, Baron, Life of, 351; was "no concealed virtuoso," 351; declines being proposed for the Royal Society, 352; his acquaintances, 352; visits Sir S. Morland, 353.
- GUNS to shoot often, remark on, 472.
- H.
- HALLAM, learning during the Middle Ages, 345.
- HARLEIAN MSS., 346; cipher, 394.

HARQUEBUS.

- HARQUEBUS, particulars of, 466; for expeditious shooting, 466; à crock, 466.
 HEAD, a brazen or stone, 515—520.
 HERBERT, Lord, son of the Duke of Beaufort, his letter, 350.
 HOEL, M., his hydraulic engine, 414.
 HOLLOWING on a water-screw, 450. 553.
 HOOK, Dr., examines Papin's fountain, 351; had seen the Marquis's engine, 493.
 HORSE, artificial ring, 524.
 HOUR-GLASS fountain, 413, 414.
 HOUR water-ball, 444.
 HUME, David, criticises the "Century," 349.

I.

- IMPRISONING chair, 513; one at Rome, 514.
 INSTRUMENT, an arithmetical, 512; for perspective, 529.
 INVENTION, nature and progress of, 366.
 INVENTIONS, estimated number in the "Century," 353, 354; classified, 354; "tried and perfected," 355; short list of, 357; a series of early, 362; early patented, 363; the Marquis's "quintessence of," 555.
 INVENTORS, early, statements of Inventions, 362.

K.

- KALTOFF, Caspar, the Marquis's faithful workman, 359; his death, 1664-5, 537; noticed 538; various notices of him and his family at Vauxhall, 574.
 KNEFLER, or Knuffler, Dr., noticed, 403.
 KNOTTED string alphabet, 435.
 KEY-pistol, 438, 439.
 KEY, a triangle, 499; a rose, 500; a square, 500.

L.

- LADDER, portable sealing, 445—448.
 LAMBERT, William, his petition respecting Vauxhall, 537.
 LANTHORN-ALPHABET, 435.
 LETTERS secretly conveyed in a comb, 511; in a knife, spoon, or fork, 511.
 LEVER, a to and fro, 425, 426.
 LIGHT pistol-barrels, 511.
 LOCKING of Cabinet-boxes, 510.
 LOCKS, an escutcheon for, 500; an alarm for, 501; ingenious and expensive, 501, 502.
 LOTHERDALE, Earl of, the Marquis promises him a curious box, 356.

M.

- MAN, to fly, 504, 505.
 MIDDLE Ages, the, 345.
 MILITARY antiquities, 473, 474.
 MILL, a rasping, 512; a coining, 520.
 MINYONS, minion, cannon, 467.

PORTA.

- MOOR, Sir JONAS, mathematician, 352.
 MORLAND, Sir SAMUEL, his house, coach, and several inventions, 353; his patent for raising water from Mines (1661), 364, 365; his arithmetical instrument, 512.
 MORLD for candles, 514, 515.
 MURHEAD, JAMES P., M.A., his false estimate of the Marquis's character, invention, and "Century," in his "Life of James Watt," 369—372; his treatment of the subject, 370; erroneous opinion of the inventions of De Caus and the Marquis of Worcester, 372.
 MULTIPLIED strength in little room, 406.
 MUSKETOONS, or blunderbuss, 473.
 MUSKETS, often-discharging, 464; short, 465; particulars of, 466; ancient use of, 474.
 MUSQUETOONS, oft-shooting, 472; on horseback, 472.
 MUTE and perfect discourse by colours, 399; by night, 399.
 MYSTICAL jangling of Bells, 449.

N.

- NAPIER, Lord JOHN, his secret inventions, 402.
 NEEDLE-Alphabet, 434.
 NEWCOMEN, noticed, 369.

O.

- OFTEN-discharging Pistol, 462; Peards, 471; Guns, 472.
 ORDNANCE, ancient, 473.

P.

- PAPIN, Dr., his fountain, 361; experiments on steam, 498.
 PATENT for the Marquis's clocks, guns, &c., 557.
 PATTU, M., his water-screw, 451.
 PEAR, an untoothsome, 512.
 PEARDS, oft shooting, 471.
 PEPYS, SAMUEL, his Diary, 351.
 PERPETUAL Motion, 452—456.
 PERPETUAL Motions in M. Servière's cabinet, 350.
 PERSPECTIVE instrument, 529.
 PETTY, Sir WILLIAM, his discourse, 365.
 PINCKED Glove alphabet, 435.
 PISTOL, oft-shooting, 462; ancient use of, 473; improved, 474; light barrels, 511.
 PLEASANT floating garden, 413.
 PNEUMATIC propulsion, 412.
 POCKET Ladder, 447, 448; engine to open doors, 527.
 POINT, a cipher reduced to a, 393.
 PORTABLE "pocket" engine, 400; bridge, 428, 429; fortification, 429; engine, or ladder, 445—448.
 PORTA'S steam apparatus, 541.

POWDER.

POWDER flask, noticed, 474.
PRIMERO gloves, 521.

Q.

QUINT-ESSENCE of motion, by the Marquis of Worcester, noticed, 357: a statement of 9 inventions, 555, 556.

R.

RAMSEY, D., raises water by fire, 479.
RASPING mill, 512.
RIBBON, a discourse woven in, 503.
RISING bulwark, 430—432.
RIVER, in a garden, 418; ebbing and flowing, 419.
ROLLOCK, JOHN, his verses allusive to condensation, 533; his tract containing his panegyric, the Act, &c., 559.
ROME, an invention obtained there, 353; "Claudius his studies at," 416.
ROYAL Society, Transactions, 351; Baron Guilford declines being proposed for, 352; Sir W. Petty, and Dr. Grew, their discourses, 365; Savery exhibits his model, 484; "first appearance in the world" of Savery's engine, 494.
RULE of gradation, 448, 449.

S.

SAKERS, cannon, 467.
SAVERY, THOMAS, noticed, 369; *note*, 371; model engine for raising water, 484, 485; his "Miners Friend," 485; his description and the "Century" compared, 486, 487; Bradley's account, 487; engine at Cambden House, 487; Switzer's account, 487, 488; its discovery attributed to a tobacco-pipe, 488; the same to a Florence flask, 489; noticed by Dr. Desaguliers, 488—490; accused of obtaining and destroying the Marquis's books, 489; this charge examined, 492, &c.; as an independent inventor, 497; his career, 498.
SCANTLING explained, 348.
SCARIONI, FRANCESCO, his Centuria, 346.
SCIENCE, state of, to 1667, 348.
SCREWED ascent of stairs, 445.
SEA-banks, to construct, 528, 529.
SEA-castle, or fortification, 411, 412.
SEA-sailing fort, 412.
SEALS, 387, 388, "abundantly significant," 389; a cipher seal, 389, 390; private and particular to each owner, 391.
SECRET conveyance for letters, in a comb, 511; in a knife, spoon, or fork, 511.
SECRETI, by Scarioni, 346.
SENSES, alphabets by the, varied, 436.
SERPENTINE scale, Browne's calculating, 512.

VAUXHALL.

SERVIERE, M., his cabinet, 350.
SHIP-destroying engine, 401.
SHIP-raising engine, 526.
SHIP, to safeguard any, 404; an unsinkable, 404, 405; false decks, 405; anchor, to weigh up, 406; driving against wind and tide, 407; three ships, or a sea castle, 411; ships' muskets, 471.
SHIP-musquets, to govern a whole side of, 471.
SHORT writing, expeditious way of (supposed to be the Marquis's invention), 349—398; authors on, 436—438.
SIEVE alphabet, 435.
SMELL, alphabet by, 435.
SPRING, strength-increasing, 421.
STAIRS, a screwed ascent of, 444, 445.
STAMPING engine, 346, 520.
STEAM Engine, notice of the first practical, 345; historical notices of and wavering character of opinions respecting the Marquis of Worcester, 368; progressive improvements, 368; false estimate of the Marquis in the "Life of James Watt," 369.
STEAM, its power realized, 362.
STONE bow, 421—423.
STRENGTH-increasing spring, 421.
STRENGTH multiplied in little room, 406.
STRING alphabet, knotted, 435.
STUART, ROBERT, contradicts himself, 370.
SUBMARINE vessel, 402.
SWITZER, S., his account of Savery's engine, 487, 488.

T.

TAPE or ribbon, a discourse woven in, 503.
TASTE, alphabet by, 435.
TELEGRAPH, electric, anticipated, 357.
TELEGRAPHY, systems of, 399.
TINDER-box, a most conceited, 439.
TOBACCO-TONGS engine, 445, 446.
TOUCH, alphabet by, 435.
TOWN, for guarding several avenues to a, 472.
TRADESCANT, his museum, 356.
TRANSPARENT water-screw, 450.
TRITHEMIUS quoted, 393.

U.

UNIVERSAL character, 432—434.
UNTOOTHsome pear, 513.

V.

VACUUM, noticed by John Bate, 360.
VAUXHALL WORKS, expense of, 358; William Lambert's petition in respect to, 537; Marquis of Worcester's engagements there in 1647, and earlier, 537, 538.

VENICE.

- VENICE, an invention obtained there, 353, 425.
 VERSTIGAN, on science in 1605, 349.
 VINCI, Leonardo da, notice of, 345.

W.

- WALPOLE, HORACE, criticises the "Century," 348, 349; groundless censure, 523, 524.
 WATCH, a continually going, 508.
 WATER, to drive up by fire, 475; heated in a cannon, 475; Dr. Ramsay's patent, 479; raised by Bate, 479; Van Etten applies heat, 481; cannon experiment, 481, 482; Savery's model, to raise, 484, 485.
 WATER-SCREW, to make hollow, 450; a transparent, 450; a double, 451; plan of construction, 552, 553.
 WATERWORK, a fire, 476; "the most stupendous work in the whole world," 533—535; a stupendous, 536.
 WATER-WORKS, noticed by John Bate, 360; the Marquis acknowledges the passing of the Act for, 383.
 WATT, JAMES, his engine, 369; indebted to the influence of capital, 369; false estimate of the Marquis in "The Life of," 369—372.
 WEIGHTS, to raise, 531—533.
 WELD, Mr., his "knick-knack-atary," 352.
 WERDEN, Sir JOHN, mathematician, 352.
 WHEEL, great weighted, 452—456.
 WORCESTER, Marquis of, the Harleian MSS. not in his handwriting, 346; his engine in the Century, 353; estimated number of his inventions, 353, 354; classified, 354; his proposed work, 355; special notices of practice, 355, 356; silence of contemporaries, 356; promises a box to the Earl of

WRITE.

- Lotherdale, 356; a mysterious invention, 357; his pecuniary position, 358; expense of his works at Vauxhall, 358; analogous inventions in old authors, 359; enumerated, 359; seems to have been attached to Bate's *Mysteries of Nature and Art*, 359; Waterworks, noticed by Bate, 360; acquainted with Dr. Dee's preface to Euclid, 361; styles of Bate and the Marquis compared, 361; in search of powerful mechanical aids, 361; realizes the power of steam, 362; writes his "Century" similar to patent specifications, 363, 364; his pre-eminent invention, 366; wavering character of historical notices of his invention, 368; false estimate of the Marquis's personal character, his invention, and his "Century," in the "Life of James Watt," 369, 370, 371, 372; his general character, his inventions, and his work, 373; the modern steam engine owes its origin to the Marquis and his work, 369; his engine at work, 370; acknowledges the passing of the Act for his engine, 383; mentions the sacrifice of £700,000, 383; his "Golden Age," 385; his supposed invention of Short Writing, 394; his cipher-written letter, 398; a model of his semi-omnipotent engine to be buried with him, 530; notice of his works at Vauxhall, 1647, 537, 538; statement in his Act of Parliament, 539, 540; construction of his engine, 551; key to his cipher discovered, 553; nine of his inventions, or quintessence of motion, 555; his patent for clocks, &c., 557; Rollock's pamphlet, containing Act, &c., 559.
 WRITE, to, in the dark, 503.

INDEX

TO THE LIFE OF

THE MARQUIS OF WORCESTER.

ACT.

A.

- ACT of Parliament for the Water-commanding Engine, applied for, 253; proceedings in respect to, 254—256; royal assent given, 256; the Act, Appendix C.
- ADAMS, Mr., Lord Herbert's preceptor, 141.
- ALBEMARLE, Duke of, letter from, 268, 269; another letter, 277; names the Crown's debts, 278; statement made to him of expenditure in the late King's service, 278, 280.
- ALCHEMY in vogue, 16.
- ALLEN, Captain, taken at Padstow, with the Earl of Glamorgan's dispatches, 124; promised assistance, 125; bearer of a letter, 126; Glamorgan reports Allen having been taken, 170.
- ALLOWANCE of £3. per week, Cromwell's Warrant for, 213.
- ALONZO, Don, his answer, sent, 218.
- ANNE, Countess of Worcester, her death, 31.
- ANTONIO, Captain, two frigates, 170.
- APOCRYPHAL passages relating to the Marquis of Worcester, Appendix II.
- ARISTOCRACY of the 17th century, social habits, 5; luxuries of the table, and of dress, 5.
- ARLINGTON, Lord, letter to, 269; the Marquis seeks his services, 274.
- ARUNDEL, HENRY FREDERICK, Earl of; marries Anne, daughter of Edward Lord Herbert, 17.

B.

- BACKHOUSE, Lient. has command of war horses taken at Gloucester, 62.
- BACON, Lord, death of, 16.
- BADMINTON HOUSE, Gloucestershire, visited by Charles II. and his Queen, 260.
- BAKER, THOMAS, engineer, his Poem on "The Steam Engine," 258; notice of "The Century," 258, 259.
- BALFOUR, Sir WILLIAM, Lieutenant of the Tower, 25; commanded at Edgell, 25.

BEAUFORT.

- BATE, JOHN, his work, 1634-35, 29; remarks on water-works, 29.
- BAYLY, Dr. THOMAS, noticed, 9; relates a Welsh legend, and occurrence at Carnarvon, 94; chaplain at Raglan Castle, 96; his "Apothegms," 96; Lord Herbert's water-works, 100, 101; his dedication of his book, 110, 111; relates a domestic incident, 149, 150; leaves Raglan Castle, 153; visits the Marquis at Covent Garden, 154; attends the Marquis's funeral, 155.
- BAYNARDS CASTLE, correspondence from, respecting Henry Lord Herbert's marriage, 1, 2, 3, 4.
- BEAUCHAMP, MARY, Lady; married to Lord Herbert, 220; Certificate, 220.
- BEAUFORT, HENRY, Duke of, his mother, 16, 17; his birth, death, and age, (note) 16; at six years of age, 23; ten years of age, 26; "a match propounded for" him, to his grandfather, by Charles I. 103; Petitions the House of Commons, 201; his property, 202, 203, 204; resolutions in regard to value, &c. 205, 206, 207; sat in the Cromwellian parliament, 210; his father's estates in Monmouthshire enjoyed by Cromwell, 210; Cromwell's caution, 210; marriage, 220; resident at Badminton House, 226; going to Dover, 226; letter to his wife, 226; a prisoner in the Tower, 233; letter to his wife, 233; his age, 233; constituted Lord Lieutenant of Gloucestershire, 233; parliamentary clause in respect to his property, 238; ordered by Parliament to give up his father's deeds and writings, 238; delivers a message to the Lords, 243; carries the bill to the Lords for the Water-commanding Engine, 256; visit of Charles II. and his Queen, 260; sits in the House of Peers, (note) 282; attests his father's funeral Certificate, 300; letters patent granted him remitting payments due from his father, 303; a commissioner to distribute fund for poor Cavaliers, 317, 318; his progress through Wales, (note) 317;

BEDFORD.

- return to Badminton, (note) 318; published account of his progress, (note) 318.
- BEDFORD, Lord of, 2.
- BEDFORD, Earl of, Francis Russell, 6.
- BIBLE, new translation published, 7.
- BIRCH'S, Dr. statement about Glamorgan's going to Wales, 87.
- BLACKFRIARS, the seat of fashion, 1; marriage of Lord Herbert there, 2; Queen Elizabeth's stay there, 3; ceremony on arrival, 3; supper there, 4.
- BLACKSTONE, Sir RALPH, named, 141.
- BLAXTON, Sir WILLIAM, assists to retake Monmouth, 63.
- BOSDON, EDWARD, Glamorgan's Instructions to, 87.
- BOTELER, ALLEN, his business from Charles I. to the Marquis of Worcester, at Raglan Castle, 142; his journey, 142; difficulties and dangers, 143; arrives at Raglan, 144; disappointment, 144; stern reception, 144; interview with the Marquis, 144, 145; who plainly declares his sentiments respecting Charles I.'s treatment of his son, 145; neglected, and detained, leaves precipitately, 145, 146; his adventures, and return to Oxford, 146, 147.
- BRICKNOCK garrisoned, 60, 332.
- BRERETON, ROGER, his letter to the Countess of Glamorgan, 129.
- BRERETON, Sir WILLIAM, his letter-book, 87.
- BRETT, Sir JEREMIAH, before Gloucester, 56.
- BRIDGEWATER, Earl of, named, 24.
- BROMPTON CASTLE, council of war to take it, 58.
- BURTON, THOMAS, *M.P.*, reports on the Marchioness of Worcester's Petition, 195; his remarks on the Marquis of Worcester's character, being then a state prisoner, 212; his conduct that of a soldier, and always civil, 212.
- BYRON, Sir JOHN, Lieutenant of the Tower, 23; named, 35, 36; his letters, July, 1642, 41, 42, 59; his regiment, 67; named, 328, 330, 331.
- BYTHELL, JOHN, his letter to his father, about the Earl of Glamorgan and others, 88; escapes shipwreck, his cargo of corn seized, 90; a prisoner, 90, 91; list of passengers and crew, 92.

C.

- CALEHOF, CALTHOFF, CALTROP, COLTHOFF—*see* Kalthoff.
- CARDIFF garrisoned, 60; named, 328, 332.
- CARLYON garrisoned, 60, 332.

CHARLES THE FIRST.

- CARTE and Dr. Birch's erroneous statement about Glamorgan's leaving for Ireland, 93; corrected, 93.
- CARNARVON, ROBERT Earl of, marriage of his sister Elizabeth to Edward Lord Herbert, 16; her death, 23.
- CASTLEMAINE, Lady, undertakes a request to the King, 275.
- CATHOLIC Clergy, Irish Roman, 114, 115, 119; Glamorgan solicits consent for post of Lord Lieutenant, 181; Glamorgan's complicity with, 184; great secrecy observed, 184.
- CATHOLIC Princes, Roman, with the Pope, to supply £30,000, to support an army in England, in the cause of Charles I. 228; Glamorgan's power to treat, 229.
- CATHOLIC, Roman, Lord Lieutenant, 115.
- CATHOLIC, Roman, Religion, Glamorgan's engagement to support measures for the good of, 160.
- CATHOLIC, Roman, countries, support from, 84.
- CATHOLICS, Roman, indulgences granted, 232; Jesuits excepted, 232; the Marquis of Worcester derived no assistance from, 327, 328.
- CATHOLICS, Roman, Irish, inquiry respecting, 122; Charles I. repudiates the concessions made to, 130; his letter to Ormond, 131; negotiations with, repudiated by Secretary Nicholas, 132; the whole party astounded at these abortive results, 161; diminished hopes, Charles I. in custody at Newcastle, 175.
- CATHOLICS, Roman, laws against, 27.
- CAUS, DE SALOMON, his works, 29.
- CAVALIERS, Act providing for poor, 247; fund for, 317.
- CENTURY OF INVENTIONS, a Catalogue raisonné, 17; written, 214; MS. copy in the British Museum, 221; first publication, 258; Poetical notice of, 258, 259.
- CHARLES THE FIRST, his birth, 5; first year of his reign, 12; witnesses the wheel experiment at the Tower, 25; character of his reign, 25; 15th year, 31; the Long Parliament, 31; return from Scotland, 32; retreat to Hampton Court, 32; at Royston, 33; at Hull, 34; flatters the Earl of Worcester, 35; his movements in 1641, 35; Civil War declared, 37; makes a convenience of the Marquis of Worcester for his wealth, 38; his perfidious nature, 38; members of Parliament summoned to attend at the Banqueting House, 16-40, 38; borrows money from the Marquis

CHARLES THE FIRST.

of Worcester, 41; journey to Leicester, 42; £5,000 sent for him to Newstead, 42; "hopes he shall not die in the Marquis's debt," 42; report from the King at Nottingham of his message by Lord Herbert to his father, 44, 45, 46; Charles I. and Lord Herbert portrayed, 46, 47; his tortuous policy, 55; certain early loans from the Marquis of Worcester, 58, 59; at York, 59; commission of Array, 59; attended by the Marquis of Hertford at Oxford, 67; inconsistencies in his conduct, 69; liberal in promises, 69; battle of Edgehill, 69; sends the Earl of Glamorgan the Blue Ribbon, and a warrant for the title of Duke of Somerset, 74; assures Glamorgan "you labour for a dear friend," 75; wonders he has not gone to Ireland, 75; artful letter to Ormond, 78; his deceptive style, 79; profuse in professions of attachment, 81; why selected for this negotiation, 81; reassures Glamorgan of his confidence in him, 82; at Hereford, 83; visits Raglan Castle, 104; the fickle monarch a false friend, 105; reception, 105; returns to the Castle, 106; his third visit, 106; in all 27 days, 106; discourse with the Marquis, 106; presented with a dessert from Troy, 108; deprives the Marquis of £6,000 deposited with his son, 109, 110; his engagement of Glamorgan characterized, 116; disasters in war, 117; looks to Ireland for assistance, 117; his urgent necessities, 117; his plan for realizing his hopes in Ireland, 118; repudiates Glamorgan's proceedings in Ireland, 122; Hume's notice, 122, 123; Carte's charge, 123; the King's duplicity, 123; 6,000 men ready to leave Ireland, 126; his message to Parliament, 130; writes to the Queen about "Glamorgan's business," 134; his letter to "Glamorgan," 134; his consummate duplicity, 135; charged by the Marquis of Worcester with being "wavering and fickle," 145, 148; his character, 157; creates the Earl of Glamorgan, "Duke of Somerset and Beaufort," 162; the patent, 162, 163; his confidence in Glamorgan not misplaced, 167; his perfect acquaintance with the Marquis and his son, 167; writes from Newcastle, 174; not strictly guarded, 174; offers to pawn his kingdoms, 174; a copy sent to the Pope, 174; Glamorgan devises a plan for his escape to Ireland, 175; the King's treatment of the noble family of Somerset, 184; delivered up by the

CHESTER.

Scots, 1647, 189; his execution, 189; the Marquis of Worcester explains his conduct and powers in Ireland, to Lord Clarendon, 227; an immense army was to have been raised, 228; and the Pope and Catholic Princes were to supply £30,000 per month for its maintenance, 228; hence the "amplitude of Glamorgan's commission," 228; the signing and sealing, 229; to Huntingdon, 330; to Nottingham, to York, 330; the Tower, 330; his note of hand, 331; money at Oxford, 332.

CHARLES THE FIRST'S correspondence; his letter, August, 1641, 32; December, 1641, 33; "lying pamphlets," 33; March, 1641-2, 33; May, 1642, 34; January, 1642, 39; June, 1643, 64; his patent granted to the Earl of Glamorgan, 70; his instructions to him, 72; letter, February, 1644, 74; March, 1644, 75; December, 1644, 78; Commission to Glamorgan, March, 1644, 79, 80; February, 1645, 82; June, 1645, 82, 83; August, 1644, 102; August, 1644, 104; January, 1645, 6; March, 1645-6, 133; Feb. 1645, 134; July, 1646, 174.

CHARLES THE SECOND, court at Paris, 189; its changes, 189; its poverty at St. Germain, 189; at Jersey, 207; in Scotland, 207; in France, 207; Louis XIV. of France, favourable to, 209; supposed to have sent the Marquis of Worcester from France to London, 210; the Marquis of Worcester had presented him with an ingeniously contrived box, 223; proclaimed, 225; his return and rejoicings, 226; Marquis of Worcester's petition to have his case investigated by Parliament, 231; the King and Queen's progress, 231, 232; a christening at Worcester House, 232; his coronation, 232; homage of the nobles, 232; sketch of his character, and that of the Marquis, 234; attends the House of Lords, 243; personally prorogues it, 243; ceremony, 244; one-tenth of the Water-commanding engine granted to him, 257; remitted on the Marquis surrendering a warrant granting land to the value of £40,000, 257; the Marquis's petition to, 269; another, 271; draft of a letter to, 277; coolness towards the Marquis, 295; characteristic traits of his majesty, 307, 308; his apathy retards the development of the steam engine, 308.

CHESTER, City of, 3,000 men expected for its relief, 85; rumours of its

CHEPSTOW.

- being taken, 85; men for its relief, 114; Glamorgan writes about relief, 125; 6,000 Irish ready for, 126; 3,000 men reported ready, 135; loss of, 138; Glamorgan's hopes of relief, 160; its surrender, 161.
- CHEPSTOW fortified, 60; belongs to the Marquis of Worcester of inheritance, 66; named, 328, 332.
- CHRISTENING present, a, 2.
- CIVIL WAR, aspect of affairs, 1641, 37; series of national disasters, 43; party distinctions, 43; ancient warfare, 53, 54; perplexing state of the war, 69; the gain and loss by, 186; intellectual losses, incalculable, 186.
- CIPHER, letter written in, 180; a sentence in, 333.
- CLARENDON, Earl of, resided at Worcester House, 192; Marquis of Worcester's letter of explanations to, 227; offer of Worcester House, 235; his residence, (note), 237; at Worcester House, 260, 261; visited by Evelyn, 261.
- COBHAM, Lord, his house at Blackfriars, 3; Queen Elizabeth to stay there, 3; attends the Queen at the water-side, 3; her majesty sups at his house, 4; leads the bride (Miss Russell) to church, 4.
- COKE, JOHN, his letter, 24.
- COPLEY, CHRISTOPHER, named in a Bill for settling Worcester House on the Marchioness of Worcester, 196; may have instigated the writing of the "Century," 215; in the army, 215; letter from the Marquis of Worcester, 215; interested in the engine, 216; obtains a written obligation from the Marquis of Worcester, 216; he "doth undermine Worcester House," 235; named, 301; some account of him, Appendix E.
- CORNWALL, Report of the Duchy of, survey of Vauxhall, 289, 290, 291; other Reports, Appendix G.
- COSMO DE MEDICI the Third, visits Vauxhall to see the Marquis's Engine, 302.
- COUNCIL, the new, of confederate Irish Roman Catholics; Glamorgan solicits consent for the post of Lord Lieutenant, 181.
- COUNCIL, the Supreme, of confederate Irish Roman Catholics, Archbishop of Tuam's death, 115; order for his arrears, 116; disclosures, 116; inquiry respecting, 121; agreement discovered, 124; published, 124; press for Glamorgan's liberation, 135; visited by Glamorgan on his liberation, 136;

EDWARD.

- exorbitant demands, 136; Glamorgan desires its good opinion, 165; wearied of the army expenses, 165; resolve against sending troops over to England, 165.
- CROMWELL, OLIVER, Bill respecting Worcester House to be tendered to him, 196; gives his assent, 196; his directions sought in respect to payment, 197; he is satisfied, 198; enjoyed the Marquis of Worcester's Monmouthshire estates, 210; warns his wife respecting Lord Herbert, 210; his Warrant to allow the Marquis £3. per week, 213; the Marquis seeks an interview with him, 217; his death, and his son's brief career, 225; deeds delivered up, 247; Herbert, his "right-hand" man, 249; his Warrant, Appendix F.
- CROMWELL, RICHARD, ordered to give up deeds and writings, 238.
- CROMWELL, ELIZABETH, letter to her, respecting Lord Herbert, 210; ordered to give up deeds and writings, 238.
- CULPEPPER, Lord, letter from the Earl of Glamorgan, 125.
- CUMBERLAND, Earl of, leads the bride (Lady Herbert) from church, 4.

D.

- DEAN, Forest of, garrisoned, 60; Lord Herbert entering, 62; Sir John Winter "the plague of the forest," 63; the rebels quit, 63; taken by Lord Herbert, 66; named, 328, 332.
- DEE, DR. JOHN, his curious preface to "Euclid," 26.
- DEFINITION of the Water-commanding Engine, 223; published, Appendix C.
- DIGBY, GEORGE, Lord, charges the Earl of Glamorgan with high treason, 116; Glamorgan writes to his wife, mentioning him, 128; named also by R Breton, 129; Charles 1st's commands to, 131; Glamorgan informs him of his business in going to France, 138; approves Glamorgan's resolution, 178.
- DORMER, SIR WILLIAM, marriage of his daughter Elizabeth to Edward, Lord Herbert, 16; her death, 23.
- ROBERT, Lord, of Weng, father of Sir William Dormer, 16; 23.
- DREBBLE, his stove, 264.

E.

- EDGE-HILL, soldiers furnished the King, by the Marquis of Worcester, 67; named, 328.
- EDWARD, Lord Herbert—*see* WORCESTER.

EDWARD.

- EDWARD, fourth Earl of Worcester—*see* SOMERSET, *also* WORCESTER.
- EDWARD, second Marquis of Worcester—*see* SOMERSET, *also* WORCESTER.
- ELIZABETH, Lady Worcester, her death recorded, 8.
- ELIZABETH, Lady Herbert, first wife of Edward Lord Herbert (afterwards sixth Earl of Worcester), 16; mother of Henry, Duke of Beaufort, 16; her two daughters, 17; her portrait, 21, 22; her death, 22; funeral certificate, 23; sister of Robert, Earl of Carnarvon, 299.
- ELIZABETH, Queen, her Court at Greenwich, 1; her leave obtained for Lord Herbert and Miss Russell's marriage, 2; the Queen to appoint the day, 2; promises her presence, 3; arrives at Blackfriars, 3; carried in a Lætica, 3; present at a masque, 4; danced on the occasion, 4; her death, 5.
- ENGINEERING, early, in England, 18.
- ENGINEERS, foreign, usually employed, 18.
- ENGLAND, state of art and science from 1640 noticed, 188.

F.

- FAIRFAX, SIR THOMAS, his dragoons at Padstow, obtains the Earl of Glamorgan's despatches, 124; opinion of Charles I's message to Parliament, 130; sends his summons to the Marquis of Worcester, 151; takes great interest in the mining approaches to Raglan Castle, 152; concludes terms with the Marquis, 152; ratified, 153; Raglan Castle surrendered, 153; entertained at Bath, 154.
- FERNES, the Roman Catholic Bishop of, Chancellor of the Congregation, 183—*see* FATHER NUGENT.
- FINCII, HENEAGE, his report on a Petition, 273.
- FITZWILLIAMS, Col., named, 114.
- FOSTER, Captain WILLIAM, letter in respect to, 249.

G.

- GALILEO prosecuted at Rome, 27, 28; his death, 31.
- GLAMORGAN, Edward Somerset, Earl of, patent privily granted, 70; copy of the patent, 70, 71, 72; was acknowledged by Charles II. 72; his instructions from Charles I., 72, 73, 74; dispatches for Ireland, 74; Charles I. acknowledges £250,000, 74; sends him the Blue Ribbon and Warrant for the title of Duke of So-

GLAMORGAN.

merset, 74; detained at home, 75; his respectful letter to his father, August, 1644, 76, 77; termination of his military career in Wales, 77; Charles I's pretence to doubt his "judgment," 78; his Commission to raise troops in Ireland, 79, 80; visits Ireland, 82; in Ireland, 82; letter to Ormond, 83; estimates his navy and army expenses at £100,000, 84; expects 3000 men from Chester, 85; letter to Ormond, 86; going to Waterford, 86; has laid an embargo on shipping at Wexford, 86; a biographical error corrected, 87; letter of John Bythell, 87; named as "Lord Herbert," in Bythell's letter, 88; at Carnarvon, a Welsh legend, 94; his regiment of horse, 105; second visit to Ireland, 112; his commissions, warrant, and patent, 112; Ormond notes his noble ends and apparent dangers, 113; and his "judgment," 114; secret negotiations, 115; their failure, 115; his treaty found out, 116; charged with high treason, 116; a close prisoner in Dublin Castle, 116; his examination, 119; inquiry respecting his oath, 122; did not unduly use his great powers, 123; deceived by the King, 123; his letters and papers taken at Padstow, 124; publication of his agreement with the Irish Roman Catholics, 124; copy of his oath, 124; has 6000 Irish ready, 126; his letter to his wife, 127; his imprisonment, 127-129; Charles I. repudiates his proceedings to Ormond, 131; Secretary Nicholas writes to Ormond to the same effect, 131; vindicates the King, 132; a second letter, repudiating his powers and patent, 133; Charles I's letter to the Queen on this affair, 134; the King's letter to him, 134; set at liberty, 135; his bail, 136; writes to Ormond that he shall go to France, 136; presses for a continuance of the cessation, 137; withholds his motion from the Supreme Council, 137; Sir V. Molineux will accompany him to France, 137; desires Ormond's co-operation, 138; has informed Lord Digby, 138; his purchase of a ship, ordnance and stores, 138; expects to return with a fleet, 138; learns the loss of Chester, 138; continues in Ireland, 139; his father indifferently informed of his operations there, 142; at Kilkenny, 157; his letter to the Nuncio, 158; a peace proposed to be approved by the Pope, 159; the raising of 7000 men to be

GLAMORGAN.

conditional, 159; his projected visit to Italy, 159; engages a large supply of money, men, arms, and ships, 160; wrote to Charles I. hoping to relieve Chester, 160; seeming friends industriously hinder him, 161; relies on his Majesty's "right interpretation," 161; his imprisonment declared a mere colourable affair, 162; created "Duke of Somerset and Beaufort," 162; the patent, 162, 163; recital of his martial deeds, 162; his remarks on the state of affairs, 164; he apologizes for the King's declaration, 164; the King's instructions, 164; desires the good opinion of the Supreme Council, 165; designed going to Rome, 165; his letter to Father Nugent expressive of bitter disappointment and mental anguish, 166; his operations virtually terminated, 166, 167; perfect consistency of his conduct, 167; had to deal with a grasping party, 168; over-matched by Ormond, Digby, and others, 168; opposition between his own views and those of his party, 168; his spotless rectitude, 168; he wrote to Ormond, 168; reports the taking of Captain Allen, 170; expects his own and other letters to be printed, 170; reports several ships, 170; his offer if joined by Ormond and the Supreme Council, 171; the King's "bugbear declaration," 171; Ormond's approving answer, 172; his brother in Italy, 175; the King's declaration "enforced upon him," 176; the intended articles he pronounces invalid, 177; his bail in no danger, 177; is debarred from calling on Ormond, 178; his handwriting, 179; address of a letter written in cipher, 179, 180; scarcity of his autograph, 181; patent to appoint him Lord Lieutenant of Ireland, 181; his going to Rome, 181; soliciting the post of Lord Lieutenant, 181; "of a very mild temper," 182; "attached to the Apostolic See," 182; and "bound to it by oath and promises," 182; his oath, 182; apprised of his father's decease, 184—*see also* Edward, Earl and 2nd Marquis of WORCESTER.

GLAMORGAN, Countess of, her husband's letter from Dublin Castle, 127; incident relating to her at Raglan Castle, 149, 150; leaves Raglan Castle, 153; a pass granted her to Ireland, 184—*see also* Margaret, Marchioness of WORCESTER.

GLOUCESTER, Lord Herbert before, 56; stoutly defended, 56; summoned by

HERTFORD.

Prince Rupert, 56; its reduction attempted, 56; Lord Herbert's horses seized, 60, 61, 62; named, 328; troops raised against, 333.

GOODRICH Castle garrisoned, 60; taken by Lord Herbert, 328, 332.

GOWER, the Poet, quoted, 108; works mentioned, 145; Appendix K.

GREENWICH, Queen Elizabeth's court at, 1; letter from, 3; the Queen's return to court, 4.

GREENWICH, Charles I. at, 35.

II.

HALL, JOHN, the Marquis's petition in respect of, 271; case, 273; named, 288.

HALL, HENRY, the Marquis's petition in respect of, 271.

HAMILTON, Marquis of, Master of the Horse, 36.

HAMILTON, Duke of, named, 25.

HANNEMAN'S painting of a family group, 30; noticed, 311.

HARLEY, Lady, her Diary, 56, 57, 64.

HARTLIB, Samuel, notice of Vauxhall, 266; states the "Earl of Worcester is buying Vauxhall," 267.

HAZLIRIGGE, Bart., Sir Arthur, named, 42.

HENRIETTA MARIA, Queen, at Paris, her present of jewels to the Marquis of Worcester, 313—*see* QUEEN DOWAGER.

HENRY, Duke of Beaufort—*see* BEAUFORT.

HENRY, 1st Marquis of Worcester—*see* SOMERSET, *also* WORCESTER.

HERBERT, Edward, of the Grange, 249.

HERBERT, Henry, Lord—*see* Henry, Earl and Marquis of Worcester.

HERBERT, ANNE, Lady, her marriage gifts and portion, 4; daughter of John Lord Russell, 5; mother of 13 children, 6; her relative Lady Morrison, 7.

HERBERT, MARGARET, Lady (afterwards Countess of Glamorgan), her marriage, 30; her portrait, in a family group, 30; her infant daughter, Mary, 30; pass granted her to France, 187—*see* WORCESTER, Margaret, Marchioness of.

HERBERT of Cardiff, Lord; leads the bride (Miss Russell) to church, 4.

HEREFORD garrisoned, 60; Governor of, 64; the city taken by Lord Herbert, 66; named, 332.

HERO of Alexandria, his "Spiritalia," 29.

HERTFORD, Marquis of, 40, 55; defeat in the West, 67; supplied with re-

HERVEY.

- recruits, 67; Dukedom of Somerset confirmed to him, 243; named, 328; forces a loan to, 332.
- HERVEY discovers the circulation of the blood, 7.
- HILL, RICHARD, a purchaser of the Marquis of Worcester's estates, 193.
- HOLLAND, Lord, named, 59.
- HOOKE, Dr., ridicules the engine; 292; laughs at it, 294; his character, 294.
- HOOPER, Captain, the engineer, mining at the siege of Raglan Castle, 151; progress of his approaches, 152.
- HOPTON, Lord, letter from the Earl of Glamorgan, 126.
- HUNTINGDON, Charles I. at, 58.
- HUNTINGDON, Francis Hastings, Earl of, death of his daughter, wife of Edward, 4th Earl of Worcester, 8; letter from the Earl of Worcester, 12.

I.

- INVENTIONS, Century of, written, 214; the manuscript, 221; patent for four, 248; list of, 249; state of the knowledge of, 293.
- INVENTIONS of the Earl of Worcester, Appendix A.
- INVENTIONS, the Marquis of Worcester's patent for four, Appendix B.
- IRELAND, visited in 1642 by the Earl of Glamorgan, 82; the King is glad he is there, 82; second visit, 112; Ormond notes the Italian Bishop's reception, 113; to raise 10,000 men, 114; packet boat from, boarded at Padstow, 124; Fairfax's report of this, 127; the Marquis of Worcester expects benefit to Ireland through the Queen, 185; he leaves Ireland, 185; the Marquis's journey, 333.
- IRELAND, rebellion in, 69; Charles I.'s Commission to the Earl of Glamorgan, to raise troops in, 79, 80; Glamorgan's visit to, 81, 112.
- IRISH army, new levied, to disband, 39.
- IRISH Roman Catholics, offer to raise troops, 77; difficulties arise out of their demands, 77; the King's narrow policy, 77; Charles I.'s warrant to Glamorgan to treat and conclude with the confederates, 80, 81.

J.

- JAMES I., the Pope's bulls, 5; reprimands Henry, Earl of Worcester, on his daughter being a nun, 6; the King proclaimed, 7; his reign, 11.
- JESUITS excepted in the indulgence granted to Roman Catholics, 232; the Jesuits represent their case, 232;

MATHEWS.

- Henry, Marquis of Worcester, a Penitent of the Society, 232.
- JONES, Lady, and Sir Philip, leave Raglan Castle, 153.
- JONES, WILLIAM, Steward of Raglan, 142.

K.

- KALTOFF, CASPAR, a practical working engineer or machinist, so engaged, 17; water-works at Raglan Castle, 19; eleven years service, 29; named by the Marquis, 262; stated to be a Dutchman, 266; employed making guns, 266; inventions and models there, 266; visited by Dr. Hooke, 293; superintending works, 301; he and his wife (1672) lately deceased 305; their children, 305; his son-in-law, Peter Jacobson, 305; documents relating to, Appendix G.
- KENEYS, Bart., Sir Michael, Governor of Chepstow, 142.
- KENNET's relation concerning Henry Earl of Worcester's daughter being a nun, 6; remarks on Edward, Marquis of Worcester, his exile and return, 209, 210.
- KIRLE, Colonel, his siege operations, 149.
- KUFFLER, Dr., his furnace, 264.

L.

- LENTHALL, JOHN, letter from, 221; has received a present, and acknowledges his fees, 221.
- LEYBURN, Father George, and the Marquis of Worcester leave Ireland, 185.
- LINGARD, Dr. on Charles I.'s warrant to the Earl of Glamorgan, 135.
- LONDON in 1625-1636, coaches, hackney coaches, streets, pillory, whipping, mutilations, the plague, 27; fortified in 1643, 189; Charles delivered up by the Scots, 1647, 189; and his execution, 189; the Commonwealth established, 189; public taste curtailed, 189; the Plague, 285.
- LOTHERDALE, Earl of, letter to, from the Marquis of Worcester, 223; promises him an ingenious box, 223.
- LOUIS XIV., of France, favourable to Charles II., 209.

M.

- MARRIAGE gifts to Lady Herbert, 4; a mock, at Raglan Castle, 97.
- MASQUE on occasion of Lord Herbert's marriage to Miss Russell, 3; ladies, characters, and dresses, 3; the dance and address to the Queen, 4; her Majesty joined in the dance, 4.
- MATHEWS, Sir TOBY, named, 141.

MAZARINE.

MAZARINE, Cardinal, the Marquis of Worcester recommended to him, 188; opposed to Louis XIV. attempting the restoration of Charles II. 210; presented the Marquis to the King, 281; his gracious remark, 281.

MECHANICAL knowledge in the 17th century, 14.

MILFORD HAVEN, Parliament ships in, 65.

MILTON born, 7.

MOIXNEUX, Sir VIVIAN, will accompany the Earl of Glamorgan to France, 137.

MONCONIS, M. de, named by Sorbière, 263; reports new inventions, 263, 264.

MONMOUTH, fortified, 60; Lord Herbert before, 63; Waller's success, 63; alarm, 63; Marquis of Worcester's efforts, 63; saved by the Marquis, 66; taken by Lord Herbert, 66; named, 328; fortified, 332.

MONMOUTHSHIRE, Cromwell enjoys the Marquis of Worcester's estates in, 210; his letter touching the same, 210.

MONOPOLISTS, prejudices against, 293.

MONTGOMERYSHIRE, raising troops in, 64.

MOORE, Lord JOHN, Kennington, 286.

MORGAN, Colonel, at Worcester, 149; at Landenny, 149; his regiment, 151.

MORLEY, THOMAS, Lord, died 1416, 96.

MORRISON, Lady, in the Friars, 7.

MYDDLETON, Sir HUGH, forms the New River, 8.

N.

NAPIER, Lord, his system of logarithms, 7.

NASEBY, battle of, 104.

NEWPORT, named, 328.

NEWSTEAD, money to be sent privately to, for Charles I. 41.

NICHOLAS, Secretary, letter to Ormond, 131; denounces Lord Herbert's negotiations in Ireland, 132; his second letter, 133.

NORTHAMPTON, Earl of, named, 24.

NOTTINGHAM, Charles I. at, 44, 58.

NUGENT, Father Robert, Superior of the Jesuits in Ireland, the Earl of Glamorgan's letter expressing his distress, 165; named, 183.

O.

O'BRIEN, HENRY, Earl of Thomond, his daughter Margaret's marriage, 30; his petition, 196; named, 300.

O'NEILL, Mr. named, 113.

ORMOND, Marquis of, Lord Lieutenant of Ireland, as respects concluding a peace, the King empowers Glamorgan

PARLIAMENT.

to act, 73, 75, 77; the King's letter to, Dec. 1644, 78; Glamorgan's letter to, 83; recommends to conciliate the Nuncio, 84; about Chester, 85; and 10,000 men, 85; Chester holds out, 86; letter from Glamorgan, 86; letter to, 113; stretch of authority, 113; approves Glamorgan's "judgment," 114; his continued civility to the Earl, 115; his suspicions aroused, 115; his warrant to commit the Earl of Glamorgan to Dublin Castle, 116; letter from Secretary Nicholas, 131; repudiates Lord Herbert's negotiations, 132; second letter, 133; repudiates his powers and patent, 133; letter from Glamorgan, 136; who intends going to France, 136; and presses for a continuance of the cessation, 137; Glamorgan seeks his co-operation, 138; in England, 147; letter from Glamorgan, 168; his large and noble offer, 171; an approving reply, 172, 173; letter from Glamorgan, 175; commends his wisdom, 177; letter from Glamorgan, 178; leaves Dublin, goes to Hampton Court, 184; living at Acton, and goes thence to France, 187; waits on the Queen, 187; meets the Countess of Glamorgan, (Marchioness of Worcester), 188; her ill-timed resentment, 188.

P.

PAPIST, the Marquis charged with being a, 55.

PAPISTS, and notorious malignants, 192; warrants for seizing their estates, 192.

PAPISTS, Parliamentary order for disarming, 43; repudiated, and yet countenanced by Charles I., 69; Charles II.'s declaration to banish, 294.

PARIS, Marquis of Worcester leaves Ireland for, 185; Lady Herbert (Marchioness of Worcester), has a pass to, 187; Ormond flies to, 187; Marchioness of Worcester at, 188; Charles II.'s court at, 189; the Marquis of Worcester at, 189; full of loyal fugitives, 190.

PARLIAMENT, Henry Lord Herbert summoned to, 7; Parliamentary duties, 8; dispensation to be absent, 8; the Long, 31; jealous of Lord Herbert, 36; notice the Marquis of Worcester and Lord Herbert, 38; order to disarm them, 43; Lord Herbert's offer in reference to the Commission of Array, 59; professes his determination, 60; summons Lord Herbert to appear, 60; and his father, 61; ordinance affecting

PARLIAMENT.

Papists, 192 ; contract in pursuance of such ordinance, 193 ; orders the disposal of Worcester House, 194 ; petitioned by the Marchioness of Worcester, 194 ; report on the petition, 195 ; further report, 198 ; order to pay £6. per week to the Marchioness of Worcester, 191 ; reference to Committee, 199 ; order, 199 ; an Act, 199 ; order regarding pension, 199 ; order for possession of Worcester House, 199 ; order on Henry Lord Herbert's petition, 202 ; question on his delinquency, 204 ; petition refused, 204 ; report, 205 ; resolutions, 205 ; persons banished by, and their property confiscated, 209 ; resolutions on, 209 ; orders the imprisonment of the Marquis of Worcester, 211 ; on his petition order for his enlargement, 212 ; sufficient bail to be taken, 212.

PARLIAMENT—at the Restoration.

House of Lords, Marchioness of Worcester's petition about Worcester House, 235 ; restoration of the Marquis's estate ordered, 238 ; discuss the subject of his patent creating him Duke of Somerset, 239 ; referred to Lords named, 240 ; a committee reports, 240 ; message to House of Commons, 241 ; increase of committee, 241 ; the Patent delivered up, 242 ; Bill in respect to Patents and Grants, 242 ; a message from the Commons, 243 ; Marquis of Worcester's attendances, 243, 244 ; prorogued, 244 ; re-opening, 244 ; Act for the Water-commanding engine, 253 ; second reading, 254 ; Lords' committee (note), 254 ; passed, 256 ; attendances, 282.

House of Commons, message from the Lords, 241 ; a message to the Lords, 243 ; report on the Bill for the Water-commanding engine, 255 ; Commons' Committee, 255 ; Bill returned to the Lords, 256 ; passed, 256.

PARLIAMENT, Act of, for the Water commanding engine, Appendix C.

PARLIAMENT ships reported to be in Milford Haven, 65.

PATENT, Marquis of Worcester's, for four inventions, 248 ; Appendix B.

PATENTS and grants, Bill in reference to, 242.

PEACHAM, HENRY, on mechanical knowledge, 14 ; his praise of Geometry, 14, 15 ; automata, 15.

PEMBROKE, Earl of, his town of Carl-yon, 332.

PEMBROKE, Earl of, magazine from, 60.

PENNOYER, WILLIAM, and Richard Hill,

RAGLAN.

large purchasers of the Marquis of Worcester's estates, 193 ; Parliamentary resolutions in respect to the Marquis of Worcester's estates conveyed to them, 205.

"PETER," John Bythell, commander of the, his letter to his father, 88 ; escapes shipwreck, but the cargo of corn seized, 90 ; list of crew and passengers, 92 ; made prisoners, 92.

PETITIONS, &c. dated 1665, Appendix I. PIGOT, Colonel, letter from R. Brereton, 130 ; send him a letter for the Countess of Glamorgan, at Raglan, 180.

POPE, the, his bulls, 5 ; to be conciliated, 84 ; his bull, 116 ; secret negotiations, 158 ; a peace, to his approval, 159 ; his treaty to be pre-eminent, 160 ; a copy of Charles I.'s letter, 174 ; Lord John Somerset to be sent on a mission to, 184 ; with Catholic Princes to supply £30,000 per month to maintain an army in England, 228 ; Glamorgan had power to treat accordingly, 229.

POPE'S Nuncio, the, to be conciliated, 84 ; Glamorgan's letter to, 158 ; secret negotiations proposed by Glamorgan, 158 ; articles on the part of his Holiness and the King, 159 ; Glamorgan's engagement, 159 ; to name an Admiral, 160 ; Glamorgan agrees with him to confer certain titles, 160 ; his letter, 181 ; promoting Glamorgan's solicitations for post of Lord Lieutenant, 181 ; expects Dublin to be taken, 182 ; important to appoint a Catholic so highly approved, 182 ; the King's appointment, 182 ; it is contemplated to transport the Holy Faith into England by arms, 182 ; and by the Earl, a perfect Catholic, 182 ; Glamorgan's oath, 182, 183.

POPISH recusants, order to disband, 39.

POPISH army, rumours of a, 55.

POWIS, WILLIAM HERBERT, Marquis of, marries Elizabeth, second daughter of Edward, Lord Herbert, 17.

PRESENT, a christening, 2.

PROJECTORS and monopolists, 31.

PUDDING, Dr., Queen Elizabeth passing through his house is presented with a fan, 4.

Q.

QUEEN DOWAGER of England, her remark at the Court of France, in respect to the Marquis of Worcester, 281.

R.

RAGLAN Castle, noticed, 8 ; becomes the residence of Henry, Earl of Worcester, 8, 10 ; distinguished as a luxurious

RAGLAN.

residence, 12 ; described, 48 ; distant view of, 49 ; ancient portions, 51, 52, 53 ; garrisoned, 53 ; ancient warfare, 53 ; Lord Herbert obtains troops and stores, 57 ; Countess of Glamorgan there, 95 ; its garrison, 95 ; ancient remains, 95, 95 ; character of the family and servants there, 96 ; a mock wedding and masque, 96 ; visited by Charles I. 104 ; military operations, 140 ; the Marquis's apartments, 140 ; arrival of Allan Boteler with a message from Charles I., his reception, 144, 145 ; detained, and precipitate departure, 146, 147 ; the siege, 149 ; a skirmish, 150, 151 ; mining approaches, 151 ; the garrison makes desperate sallies, 151 ; cessation of arms, 152 ; the castle in jeopardy, 152 ; terms of surrender concluded, 153 ; evacuated and delivered up to General Fairfax, 153 ; departure of the Marquis, his family, friends, and retainers, 153, 154 ; stores, furniture, &c. found there, 154 ; letters and papers ordered to London, 155 ; the castle ordered to be "pulled down and destroyed," 156 ; named, 328, 332 ; expense of garrison, 333.

RAGLAN Church, burial of Edward Marquis of Worcester and his wife Elizabeth, 8 ; "St. Cadoeus," 22 ; Elizabeth, Lady Herbert's funeral, 22 ; described, 96 ; the Marquis of Worcester buried at, 295 ; views of, 296, 297.

RAMELLI's works, 1588, 29.

REDMAN, James, Worcester house, 27.

RESTORATION, the, 226 ; coronation, 232 ; prospects of the Marquis of Worcester at the, 234 ; characters of Charles II. and the Marquis contrasted, 234 ; advance of science, 253.

RICHMOND, Duke of, named, 25.

RINUCCINI, the Pope's Nuncio, gives the Marquis of Worcester an introduction to Cardinal Mazarine, 188.

ROLLOCK, JAMES, "an ancient servant," 336.

ROME, visit to Clandius at, 18 ; Galileo presented at, 27, 28 ; agent's letters from, 116.

ROUNDHEAD party, 31.

ROYAL SOCIETY, established, and incorporated, 253 ; proceedings noticed by M. de Monconis, 263 ; Dr. Hook remedies the Marquis's engine, and may have influenced members unfavourably, 294.

ROYALIST party, 31.

RUPERT, Prince, Gloucester summoned by, 57 ; at Bristol, 57 ; letter from

SOMERSET.

Lord Herbert, 62 ; Lord Herbert's dispatch, 64, 65 ; offered Forest of Dean miners, 65 ; his warrant to the Marquis of Worcester, 65, 66.

RUSSELL, FRANCIS, Earl of Bedford, 6.

RUSSELL, Lord JOHN, named, 5.

RUSSELL, Miss ANNE, report of her marriage to Henry Lord Herbert, 1 ; letters about her marriage, 2 ; her marriage at Blackfriars, 2 ; the feast, 3 ; ceremony and gifts, 4. See ANNE LADY HERBERT.

RUSSELL, Lady, marriage preparations for her daughter, 2 ; Queen Elizabeth carried to her house in a Lectica, 3 ; her great and plentiful entertainment, continued for three days, 4 ; her relative Lady Morrison, 7.

RUTLAND, Earl of, leads the bride (Lady Herbert) from church, 4.

S.

SANDFORD, FRANCIS, Pursuivant at Arms, at the Marquis's funeral, 297 ; account of him, 297, 298 ; takes the Marquis's funeral certificate, 300.

SEVENTEENTH CENTURY, popular superstitions, 339.

SHAKESPERE died, 7.

SIRI, VITTORIO, opinion of Charles I.'s message to Parliament, 130.

SOMERSET, Lord JOHN, to be sent on a mission to the Pope, 184 ; disposal of property by Parliament, 193 ; Patent delivered up, 242 ; named, 288.

SOMERSET, Sir JOHN, second son, 6, 9, 43 ; conveys £5,000 to Newstead, 42 ; levying 500 horse, 42 ; in command before Gloucester, 56 ; named in Bythell's letter, 88 ; his father deposits £6000 with him, 109 ; Charles I. obtains it on promise of repayment, 109 ; subscribes articles, 120.

SOMERSET, THOMAS, named, 6.

SOMERSET, CHARLES, governor of Raglan Castle, 6, 9, 53 ; leaves Raglan Castle, 153.

SOMERSET, FREDERICK, his baptism, 6.

SOMERSET, CHARLES, 1st Marquis of Worcester, his autograph, (note) 309 ; his marriages and death, 309, 310.

SOMERSET, HENRY, Lord Herbert—see BEAUFORT, Duke of.

SOMERSET, WILLIAM, died 1589, 96.

SOMERSET HOUSE, hydraulic work on, 265 and 302.

SOMERSET, EDWARD, died 1628, 96.

SOMERSET, Duke of, patent in respect to the title of, 239 ; Lords' Committee to consider, 240 ; conditions not fulfilled, 240 ; the patent acknowledged

SOMERSET.

- and to be surrendered, 241; committee, 241; Marquis of Hertford, his title of Duke of Somerset confirmed, 243.
- SOMERSET, HENRY, 2nd Marquis of Worcester, 310.
- SOMERSET, WILLIAM, 3rd Marquis of Worcester, 310.
- SOMERSET, EDWARD, 4th Marquis of Worcester, 310.
- SOMERSET, HENRY, 5th and 1st Marquis of Worcester, 310.
- SOMERSET, EDWARD, 6th and 2nd Marquis of Worcester, 310.
- SORBIÈRE, M. SAMUEL, his book, 262; criticised by Dr. Sprat, 263; names M. de Monconis, 263; and new inventions, 264; visits Vauxhall to see the Marquis of Worcester's engine, 264; notices the waterworks at Somerset House, 265.
- SPRAT, DR., criticises Sorbière, 263.
- ST. CADOCUS.—*see* Raglan Church.
- SYDNEY, SIR ROBERT, correspondence, 2.

T.

- THEOBALDS, Charles I to, 35, 58.
- THOMOND, Earl of.—*see* Henry O'Brien, Earl of Thomond.
- THURLOE, Secretary, letter from the Marquis of Worcester, 217.
- TISSER, ANN, a widow, in possession of the Gate-house of Worcester House, resists giving up possession, 239; is charged with contempt and speedily ejected, 293.
- TOWER of London, Marquis of Worcester, his great experiment there before Charles I., 24, 25, 26; committed a prisoner to, 211; enlarged, 212; Lord Herbert, committed a prisoner, 233; his letter from the Tower, 233; Captain William Foster a prisoner, 249; the Marquis's letter, 250; his "six years' experience," 251; period of the Marquis's imprisonment considered, 252.
- TRAVERS, WILLIAM, Roman Catholic Priest, his letter to the Dowager Marchioness of Worcester, Appendix D.
- TROY HOUSE, 6, 9; fruit from, 109.
- TUAM, Roman Catholic Archbishop of, his death, 115; papers found, 116.

V.

- VANDYCK, painter, 21; his portraits, 21, 22.
- Vauxhall, treating for, 213; the Marquis may have resided there, 261; Sorbière's visit, 262; his notice, 264; designation of, 265; notice of

WILLIS.

- by Hartlib, 266; "the Earl of Worcester is buying Vauxhall," 267; Petition respecting, 286; £50,000 expended there in experiments, 286; survey of land and works, 289—291; Dr. Hook's visit, 292; visited by Cosmo de Medici the Third, 302; summary of work there for 7 years, 337; documents relating to, Appendix G.
- VAVASOUR, Colonel, with Lord Herbert, raising troops, 64; Governor of Hereford, 64.
- VAVASOUR, SIR WILLIAM, 65, 333.
- VENICE, visit to the arsenal at, 18.

W.

- WALLER, SIR WILLIAM, defeats Lord Herbert before Gloucester, 56, 57; prisoners taken, 57; before Mounmouth, 63; named, 328.
- WARFARE, ancient, 53, 54.
- WARRANT, Cromwell's, for a weekly allowance of £3 per week to the Marquis, 213, Appendix F.
- WATER-works at Raglan, 19, 20, 21.
- Water-commanding Engine, named in a letter to the Earl of Lotherdale (January 1660), 223; the Marquis alludes to, expecting an Act for it, 223; his "truly significant definition," 224; earliest distinct reference, 225; its progress, 253; application to Parliament, 253; the Act passed, 256; one-tenth granted to Charles II. 257; the same remitted to the Marquis on surrender of a warrant granting him lands to the value of £40,000, 257; (and note), 257; seen by Sorbière, 264; the public prove sceptical, 268; intelligence respecting it, 268; Act, and posting bills respecting, 291; set up at Vauxhall, 291; seen by Dr. Hook, 292; its practical character, 300; seen by Cosmo de Medici the Third, at Vauxhall, 302; mentioned in 1670, in a letter, 303; latest intelligence, 304; the Marquis's principal invention, 305; means taken for publishing it, 305, 306; his three accounts of it, 306; generally unnoticed by contemporaries, 306; its superiority, 307; it was in advance of the age, 307; operations to give it publicity, 336; a model to be deposited, 336; and one to be buried, 337; summary of work at Vauxhall, 337; probable learned and wealthy visitors, 338, 339; Act for, Appendix C.
- WATKINS, SIR DAVID, £20 loan, 214.
- WHEEL, the great, experiment at the Tower, 24, 25, 26.
- WILLIS, MR., his inventions, 264.

WILLIAMS.

WILLIAMS, SIR TREVOR his siege operations, 149; seized 80 horses, 149.

WILLIAM, LORD HERBERT, at Oxford, 6; early decease, 6.

WINTER, SIR JOHN, Forest of Dean, 63; united with Lord Herbert 63; deserts and spoils the Forest, 64.

WOOD, ANT. 'A. his account of William Lord Herbert, and his brother Henry Somerset, at Oxford, 6; their ages, 6, 7; remarks on Henry, Lord Herbert, 11; on his religion, 11.

WOODCROFT, BENNET. *J.R.S.* list of copies of Documents in his possession respecting the Marquis of Worcester, Appendix F.; Cromwell's warrant, *ibid.*

WORCESTER, EDWARD, SOMERSET, 4th Earl of, rumour of his son's intended marriage, 1; christening of Sir Robert Sydney's daughter, 2; waiting on Queen Elizabeth, 2; his christening present, 2; his son Henry Lord Herbert's marriage, 2, 3, 4, 5; invested with Order of the Garter, 7; Keeper of the Privy Seal, 7; his death, 8; his autograph, 12; his horsemanship and athletic acquirements, 13; named, 299.

WORCESTER, EDWARD SOMERSET, 6th Earl and 2nd Marquis of, (Lord Herbert, from 1601 to 1642), notice of, 2; one of 13 children, 6; at Oxford, 6; family associations, 9; probable date of his birth, 10; at eight years of age, 10; his preceptor, Mr. Adams, 10; his education, and on the continent, 11; at Charles the First's court, 11; at 24 years of age, 11; Raglan Castle, a luxurious residence, 12; a young nobleman's education, 12; personal appearance, 13; defect in speech, 13; his style of composition, 13; state of mechanical science, 16; his first marriage, 16; his family of one son and two daughters, 16, 17; Henry created Duke of Beaufort, 17; account of his marriage, 17; engages the mechanic Caspar Kaltoff, 17; a work-shop, 17; predilection for mathematical and mechanical studies, 17; continental tour, 8; at Rome and Venice, 18; domestic and studious habits, 18; early inventions, 18; his inventive faculty, 19; his water-works at Raglan, 19, 20, 21; Vandÿck's portrait, 21; his "golden days," 22; attests his wife's funeral certificate, 23; letter from Secretary Coke, 23; at Worcester House 24; his Wheel at the Tower, 24; described, 25; exhibited to Charles I. 25; paradoxes,

WORCESTER.

25, 26; his married life, 26; a widower, 26; studies and pursuits, 27; studies matured, 28; a mathematician, 28; of delicate frame, 28, 29; his books, 29; second marriage, 30; his Irish connexions, 30; death of his child, Mary, 30; painting of a family group, 30; strange costume, 30, 31; resident in London, 31, 32; letter from Charles I. 33; "lying pamphlets," 33; Charles I. another letter, 33; indisposition, 34; at 40 years of age, 35; his declaration in regard to the King's early movements, 35; fears the Parliament, 36; noticed by Parliament, 38; order to consider his commission, 38; Parliamentary order to disarm him, 43; order for his appearance, 43; at Nottingham, 44; his minute report of Charles I.'s message to his father, 44, 45, 46; Lord Herbert's interview with Charles I. at Nottingham portrayed, 46, 47; residence at Raglan Castle, 48; has the command of 500 horse, 54; in his military capacity, 55; made General of South Wales, 56; General of the horse, 56; before Gloucester, 56; attempts its reduction, 56; defeat and loss, 57; appears to have been at Oxford, 57; at Hereford, 57; called to the Forest of Dean, 58; dispensing his father's loans to Charles I., 58, 59; in fear of Parliament, 58; takes leave of it, 59; retires to Raglan, 59; his offer to Parliament, 59; his declaration to uphold the King's cause, 60; raises six regiments, 60; horses seized at Gloucester, 60, 61; summoned to Parliament, 60; letter to Prince Rupert, 62; entering Forest of Dean, 63; before Monmouth, 63; flight of his troops, 63; unites with Sir John Winter, 63; raising troops in Montgomeryshire, 64; a dispatch to Prince Rupert, 64, 65; reports ships in Milford Haven, 65; offer of Forest of Dean miners for Bristol, 65; recital of his military exploits, 66; no contemporary account of them, 67; reduces Abergavenny and Carlyon, 67; his troop of Life Guards, 67; gained no military celebrity, 68; his character as a commander, 68; created Earl of Glamorgan, 70; his autograph as Edward Lord Herbert, 77; water-works at Raglan, 100, 101; his father's reproof on his demanding money for the king, 101, 101, 102; procures the king £6000, committed to his brother's care, 109; — (*See* Earl of GLAMORGAN,

WORCESTER.

transactions preceding his father's death.)—his letter to the Bishop of Fernes, 184; expects the Queen to befriend Ireland, 185; leaves Ireland for France, 185; in exile, 186; his inventions neglected in his time, 187; styled "Lord Herbert of Raglan," and a pass to France granted to his wife, 187; account of his being in Paris, 188; his introduction to Cardinal Mazarine, 188; seeks to be Lord Lieutenant of Ireland, 188; interview between his wife and Ormond, 188; her ill-timed resentment, 188; at St. Germain's, 189; wrote to Charles II., and his gracious reply, 190; four or five years in France, 190; general poverty, 191; difficulties in the way of study abroad, 191; his family in England, 192; disposal of his property by Parliament, 193; Worcester House, during his life, 195; a Bill for settling the same, 195; his son and two daughters, 201; his property, 202, 203, 204; Parliamentary resolutions in regard to valuation, 205, 206, 207; a trying period of five years, 207; his property assists the Government, 207; treatment of his wife and family significant of his being esteemed, 208; return to England, 209; Parliamentary resolution in regard to him as being banished and his property confiscated, 209; supposed to have been sent to England by Charles II., 210; his visit considered, 210, 211; committed to the Tower, 211; his trial to be considered, 211; his petition, 212; order for his liberation, 212; period of confinement, 213; his age, 213; loan of £20., 214; summary of his history, 214; his "Century" written, 214; writes to Chris. Copley, 215; his solemn obligation to Chris. Copley, 216; names his "water-work," 216; letter to Secretary Thurloe, 217; desires an interview with Cromwell, 218; probable meaning of his letter, 218, 219, 220; letter to the Earl of Lotherdale, 223; promises him an ingeniously contrived box, 223; his humour not to produce an invention a second time, 223; looks for an Act of Parliament, 223; offers his lordship the benefit of 1500 (share), 223; his "definition," 224, 225; earliest distinct reference, 225; his wonderful inventive faculty, 225; his son resident at Badminton, 226; letter of explanations to Lord Clarendon, 227; exposed himself to "any expense or difficulty," 227; object to screen

WORCESTER.

Charles I., 228; the "amplitude of his commission," 228; the "height of his Majesty's design," 228; immense army arrangements, 228; £30,000 from the Pope and Catholic Princes, 228; the signing and sealing, 229; no use made by him of his great powers, 229; his petition in respect to grants and promises made by Charles I., to his father and himself, to recommend the same to the notice of Parliament, 230; circular note to creditors, 231; his prospects at the Restoration, 234; sketch of his character and that of Charles II., 234; political enemies, 235; offer of Worcester House to Lord Clarendon, 235; seeks his friendship, 236; refers to the "obnoxiousness of his religion," 236; intimates his desire to make a secret communication to the King, in his lordship's presence, 237; conjecture as to his meaning, 237, 238; he petitions the House of Lords, 238; restoration of his estates ordered, 238; deeds and writings, his property, ordered to be given up, 238; Ann Tisser's purchase, 239; his Patent, a prejudice to the Peers, 239; Lords' committee to consider, 240; acknowledges a patent to create him Duke of Somerset, 240; delivers up his patent, 242; reflections on the treatment he receives, 242; retained the titles of Earl of Glamorgan and Baron Beaufort, 243; attends the House of Lords, 243; present when the king prorogues parliament, 244; petition in respect to debts, 245; bill to restore his estates, 245; enumerated, 246; petitioners against him, 246; magnitude of his claims, 247; his patent for four inventions, 248; further inventions, 249; his letter in testimony of Captain Foster's character, 250; a second letter, 251; "my six years' experience of him during my imprisonment in the Tower," 251; period of his own imprisonment considered, 252; the pot-lid story exploded, 252; Act for his water-commanding engine, and he attends the House, 253, 254, 256, 256; passed, 256; surrenders a warrant to the value of £40,000, 257; and *note*, 257; may have resided at Vauxhall, 261; noticed by Sorbière, 264; his secrecy in regard to works, 266; reported to be buying Vauxhall, 257; at Vauxhall, 268; Duke of Albe-marle represents his case, 269; his petition to Charles II. 269; another, in respect to Henry and John Hall,

WORCESTER.

271; Finch's report, 273; case as respects John Hall, 273; offers a gratuity of £500 per annum, 275; seeks to set up an engine, 276; offers a judgment in lieu of preceding gratuity, 276; a draft letter, 277; Mazarine's remark, 281; Queen Dowager's saying, 281; borrows £200, 281; petitions for a Committee of Inquiry, 283; his autograph, 283; referred, 284; censures Lord Arlington, 284; could have £50,000 yearly abroad, 284; he does "as good as want bread," 285; his birth-right, 285; foreign censure, 285; speaks of two petitions unnoticed, 285; petition in respect to Vauxhall, 286; £50,000 expended in experiments, 286; survey of land and works at Vauxhall, 289—91; his working-house or Operatory, 291; his Act, and posting bills, 291; his anomalous position as an inventor, 293; alludes to his melancholy, 294; neglected by, yet elings to the court, 295; his death, 295; probably at Lambeth, 295; buried at Raglan, and inscription, 295; his arms and funeral certificate, 298—300; mis statement about his burial, *note*, 298; his prayer on beholding the completion of his engine, 300; brief genealogical retrospect, 309, 310; in his youth, 311; his marriage, 311; the civil war, 311; as Earl of Glamorgan, 312; valuable present from the Queen while he was an exile in France, 313; his "Century," 314; his inventions and experiments, 315; his public appeal, 316; list of five inventions, 316; a further list, 317; Cromwell allows him £3 per week, 317; statement of his expenses and losses through Charles I., 319; spent and lost £800,000, 321; proposes a troop of Life-guards, 322; an ordinary for indigent officers, 324; four causeways, 325; offer of £1000 for repairing St. Paul's, 325, 326; his troop of Life-guards, 328, 329; his father's remark thereon, 329; took leave of the Parliament (1641), 331; writes a sentence in cipher, 333; troops at Gloucester, 333; summary of his proposed address, 335; its date, 335; his estimate of the value of the Engine, 338; made it public, 338; his great acquired knowledge, 340; his promised work, 341; neglected by contemporaries, 341; general estimate of his character and his "Century," 342; early list of his inventions, Appendix A.; his Patent for inventions, Appendix B.; his "De-

WORCESTER.

finition and Act," Appendix C.; apocryphal passages relating to, Appendix H.; Petitions, etc., of 1665, Appendix I.

WORCESTER, HENRY, Earl and 1st Marquis of, his reported marriage, 1; sent to a christening, 2; letters about his marriage, 2; preparations for his marriage at Blackfriars, 2; a memorable masque, 3; feast, 3; ceremony, 3, 4; Lord and Lady Herbert at court, 4; his age, 6; summoned to Parliament, 7; resident in London, 8; his family, 9; his character and constitution, 9; family at Raglan, 9; his autograph, 10; at forty-eight years of age, 12; letter from Secretary Coke, 23; his son and heir, 23; death of his wife, 31; letter from Charles I., 32; munificent advances to the King, 34; created Marquis of Worcester, 37; his age, 37; person, age and wealth, 37; noticed by Parliament, 38; order to consider his commission, 38; guard set on his house, 39; letter from Charles I., 40; sends the King £5,000 to Newstead, 42; the King "hopes he shall not die in his debt," 42; Parliamentary order to disarm him, 43; ordered to appear before the House, 43; Raglan Castle garrisoned, 43; message of Charles I. to him, as reported by Lord Herbert, from Northampton, 44, 45, 46; the Marquis' character, 28; Raglan Castle described, 48, 51, 52, 53; warlike preparations, 53; his wealth, 54; his horses and stables, 54; early rumours against him, 55; Lord Herbert obtains troops and stores, 57; certain loans to Charles I., 58, 59; Lord Herbert leaves London for Raglan, 59; summoned to appear before Parliament, 61; Monmouth mostly the Marquis's tenants, 63; calls in the aid of Prince Rupert to assist Monmouth, 63; letter from Charles I., 1643, 64; promise of title (of Duke), 64; Prince Rupert's warrant, 65, 66; he saves Monmouth, 66; it belongs to him of inheritance, 66; supplies the Marquis of Hertford with recruits, 67; furnishes the King with soldiers at Edge-hill, 67; Charles I. acknowledges £250,000, 74; sixty-three years of age, 95; marriage of his daughter Elizabeth, 97; a masque and mock marriage for entertainment, 97, 98, 99, 100; practical joke on searchers for arms, 100, 101; reproof to Lord Herbert, 101, 102; letter from Charles I., 102; promise of the Garter, 103; another letter, 103; enclosing a war-

WORCESTER.

rant to create him Duke of Somerset, 103; "a match propounded for his grandchild," 103; visited by Charles I. 104; his reception, 105; his free discourse with the King, 106-8; characteristic dinner incident, 108, 109; reproves Lord Herbert for procuring the King £6,000, deposited with his son, Lord John Somerset, 109; apartments at Raglan, 140; his great state, 140; order of his household, 140-142; a message from Charles I. by the hand of Allen Boteler, 142; Boteler's tedious journey, 143; and arrival at Raglan, 144; harsh reception, 144; interview with the Marquis, 144, 145; the Marquis's sharp reply to Boteler, concerning Charles I., 145; the messenger delayed, 145; Boteler's despatches and return, 146, 147; his strong and sincerely expressed feeling on the King's treatment of himself and his son, 148; his angry reception of the King's messenger, 148, 149; the siege of Raglan castle, 149; anecdote during the siege, 150; summons from General Fairfax, 151; numerous messages pass, 151; requires the King's approval, 151; conditions offered, 151; a drum sent out, 152; a cessation of arms, 152; the castle in jeopardy, 152; concludes terms for surrender of his castle, 152, 153; he leaves with his family, friends, retainers, and others, 153, 154; removed to Covent Garden, in charge of the Black Rod, 154; his death four months after, 155; his funeral expenses, 155; Parliamentary order to destroy Raglan Castle, 156; lands of, 201; a Penitent of the Society of Jesuits, 232.

WORCESTER, ANNE, Countess of, her death, 31.

WORCESTER, Countess of—*see* Marchioness of Worcester.

YORK.

WORCESTER, MARGARET, Marchioness of, a pass granted her to France, as "Lady Herbert," 187; meets Ormond in Paris, her ill-timed resentment, 188; petition in respect of Worcester House and property, 194; her peculiar situation politically, 195; report on her Petition, 195; Bill for settling Worcester House, 195; the same, 196; possession to be granted, 197; sum to be paid, 197; referred to a Committee, 197; report, 198; order to pay her £6 per week, 198; has rooms in Worcester House, 199; an Act for settling Worcester House on her, 199; order for payment of her pension, 199; order to give up the house, 199; her petition respecting her husband's imprisonment, 212; draft petition, 222; petitions against undermining Worcester House, 235; petition in respect to, 287, 288; John Hall, 288; petition ordered to be represented, 289; named, 300; residing at Lincoln's Inn Fields, 303; letter from her confessor, 303; Wm. Travers's letter to, Appendix D.

WORCESTER HOUSE, noticed and sketched, 8, 10; death of Lady Herbert there, 22, 23; residence there, 26; guard set on, 39; account of it, 192; iron seized there to be sold, 192; used by the Parliament, 193; soldiery lodged there, 194; its disposal ordered, 194; rooms given to the Marchioness of Worcester, 199; to be examined, 199; an Act for settling, 199; possession ordered, 199; conveyance in trust, 200; christening at, 292; petition in respect to, 287.

Y.

YORK, Charles I. at, 58, 59.

ERRATA.

- Page 38, 17 lines from top, *for* "29 June" *read* "29 Jan."
- 117, 3 lines from top, *for* "Edge-hill" *read* "Marston Moor."
- 120, 16 lines from bottom, *for* "Baron" *read* "Brown."
10 lines from bottom, same correction.
- 145, 2 lines from bottom, *for* "or siding" *read* "for siding."
- 155, 14 lines from bottom, *for* "William" *read* "Charles."
- 168, 172, 175, 177, last line, note, *for* date "1637," *read* "1657," throughout.
- 187, 14 lines from top, *dele* "From" &c., ending "France."
- 210, last line, note, *place* † before "Brit. Mus." &c.
- 222, 3 lines from top, *for* "Coining" *read* "Stamping."
- 249, 4 lines from bottom, *for* "B" *read* "A."
- 253, 5 lines from bottom, *add* "Marquis," *after* "Edward."
- 260, 12 lines from top, *add note* "Cal. State Papers, Dom. Series, 1663-64,
edited by Mrs. M. A. E. Green, 8vo. 1862."
- 314, 15 lines from top, *for* "three" *read* "two."
16 lines from top, *for* "five" *read* "six."
18 lines from top, *for* "of" *read* "following."
- 320, 4 lines from bottom, *for* "other by" *read* "other my."
- 322, 6 lines from bottom, *after* "Meistres," *add* [Reistres?]"
- 347, 15 lines from bottom, *for* "his" *read* "is."
- 462, 15 lines from bottom, *for* "of" *read* "wrote to."
- 484, 6 lines from bottom, *dele* "from the bottom in order to discharge it again
at the top," *and substitute*, "which convey the steam by turns, to
the vessel D."

603.21





Dirks, H.

TJ

L40

The life and time of scientific labours.

.M9

D49

cop.3

