

UC-NRLF



\$B 264 350

THE LIGHTING OF
SCHOOL-ROOMS

STUART H. ROWE

LIBRARY
OF THE
UNIVERSITY OF CALIFORNIA.

Class



**THE LIGHTING OF
SCHOOL-ROOMS**

Digitized by the Internet Archive
in 2007 with funding from
Microsoft Corporation

THE LIGHTING OF SCHOOL-ROOMS

A MANUAL FOR
SCHOOL BOARDS, ARCHITECTS,
SUPERINTENDENTS AND TEACHERS

BY

STUART H. ROWE, PH.D.

SUPERVISING PRINCIPAL OF THE LOVELL SCHOOL DISTRICT, NEW HAVEN,
CONN., AND LECTURER ON PEDAGOGY IN YALE UNIVERSITY
AUTHOR OF "THE PHYSICAL NATURE OF THE
CHILD AND HOW TO STUDY IT"



LONGMANS, GREEN, AND CO.

91 AND 93 FIFTH AVENUE, NEW YORK
LONDON AND BOMBAY

1904

LB3243
R8

GENERAL

COPYRIGHT, 1904, BY
LONGMANS, GREEN, AND CO.

All rights reserved

TROW DIRECTORY
PRINTING AND BOOKBINDING COMPANY
NEW YORK

PREFACE

It has been common report that the principles on which the lighting of a school depended were not known and that the whole subject was still in a chaotic state. My studies had, on the contrary, led me to the conclusion that all the important principles were not only definitely known but were capable of actual demonstration. Accordingly I made it my business to test this conclusion carefully, to ascertain the facts and the reasons underlying them. The result demonstrated quite thoroughly that the main problems of school lighting are solved already, and solved practically.

It must be admitted that one would "never guess it" from an inspection of an average half dozen or half hundred school-houses, but the fact remains that the mechanics of light is adequately known, that, given the data, the lighting value of a window of a certain size at a certain location can be readily ascertained and the effect of obstructions measured, and that the typical shapes possible for a building have all been tried. The problem for the future is simply to get all concerned *to know and respect the requirements*. There is no reason for failure except ignorance, crim-

inal negligence, and misplaced economy—no more excuse for a poorly lighted school-building than there is for an unsafe bridge. Somebody is to blame.

It is the purpose of this book to present as clearly as possible the principles on which the lighting of a school-building depends, and enough of argument to establish them without becoming unnecessarily prolix. If any apology is needed for the dabbling of a pedagogue in this problem of school architecture, let it be found in the historic fact that the architects have left it to the teachers to make demands, which they granted or not, according to their convenience. Practically every great advance in hygiene as applied to school architecture has come as the result of painstaking investigation on the part either of educators or physicians and the scientists whose aid may have been enlisted.

It was only recently that I visited a new school-building connected with a very generously endowed institution. The school itself cost several hundred thousand dollars and was a comparatively small school at that. The plans had undoubtedly been drawn by an expert architect and supervised and studied by an experienced corps of advanced educators. The day was rainy, and the rooms were dark; but the cause was not hard to determine. Neighboring buildings obstructed the light and the upper three square feet of each window (that yielding by far the best light) had been cut off from the window proper, and then, to crown all

stupidity, *curtained off permanently* by tacking shade material around it. When attention was called to it, the blunder was immediately seen and acknowledged. Similar errors in schools and college buildings could be cited almost without end. It is accordingly the design of this book so to free the principles involved from the murkiness of technique that it may prove to be a guide not merely to school-boards, superintendents, inspectors, and architects, but may quicken the teacher's perception of errors where they exist and lead him to a fuller appreciation of the necessity of his co-operation in the plans made for the lighting of his room and his school.

It is all the more necessary that teachers know the requirements of a well-lighted school-room, inasmuch as they almost never work under the direction of the architect, but in their own way make use of the appliances furnished. If it is true (and I believe it is) that the teacher is indirectly responsible for the majority of defective eyes found among pupils enjoying the advantages of well-lighted modern buildings, it is of the highest importance that he know both the requirements and how to make intelligent use of the means given him for living up to them.

No effort has been spared to include every point of vital importance, a thorough search being made through all the standard authorities. These points have been examined critically, and some which were found to rest on false principles or assumptions, and

others which were amply covered by principles already stated, have been omitted for the sake of greater clearness in the essentials. Only such titles have been included in the bibliography as have been actually used by the author or are regarded by him as absolutely essential for any extended study of the subject. For example, I have a list of forty-six titles of contributions made on this and kindred subjects by Dr. Herman Cohn. Of these only two are included.

I wish to acknowledge my indebtedness to Architects C. B. J. Snyder and L. W. Robinson for many courtesies, to Dr. S. D. Risley for his Introduction, to Dr. W. T. Harris for assistance in dealing with lighting problems in soft-coal centres, and to Dr. Charles H. Judd for help with the proof.

TABLE OF CONTENTS

	PAGE
PREFACE	v
INTRODUCTION BY S. D. RISLEY, M.D.	3
PRELIMINARY	8
SECTION I. THE SELECTION OF THE SITE	10
Principles Involved.—Size.—Sunlight.—Application of Principle that Neighboring Buildings must be Distant not less than Twice their Height.—Effect of Corner Lot.—Direction of the Frontage.—Difficulty in Dealing with Too Small a Site.	
SECTION II. THE ARCHITECT'S PART	20
A. <i>In Constructing a New Building</i> : General Sanitary Requirements.—Aim of the Lighting.—The Lighting as Affected by the Type of the Building.—Light should be Put in the Rooms Used for Class-room Purposes.—Amount of Window Space.—Dimensions of the Rooms.—Location of the Light.—Reasons for Unilateral Lighting from the Left.—Bilateral Lighting: (a) from Right and Left, (b) from Left and Rear.—Soft Coal and Left and Rear Lighting.—Overhead Lighting.—Summary Regarding Direction of the Light.—Location of Windows.—Application to a Standard Room.—Adaptation to Cold Climates.—No Arching of Windows Permissible unless on Upper Floors.—Width and Structure of Window.—Securing Unity in the Lighting.—Revolving Sash.—Value of Clear Glass.—Columns, Pillars to be Avoided.—Color of Ceiling and Side Walls.—Curtaining Blackboards.—The Shades.—Unforeseen Obstructions.—The Furnishing of Rooms.—Artificial Distribution of the Light: (a) the Prism, (b) Reflectors, (c) Glass Brick.—How to Reduce the Light.—Artificial Illumination.	

	PAGE
B. <i>In Remodeling an Old Building</i> : How to Discover the Cause of Defective Light.—Application of Devices.—Typical Deficiencies, how Removed: (a) Obstructions, (b) Wasted Light, (c) Too Meagre Window Surface.—Serious Defects.—Extending Window to Ceiling and Use of Small Mullion for Piers.—Light from Wrong Direction.—Similar Methods in all Cases.	
SECTION III. THE TEACHER'S DUTY	67
Charges Made against Teacher.—Heads should be Kept Fifteen Inches from Paper.—Best Arrangement of Shades should be Studied.—Failure to Adjust Desks or make Wisest Disposition of them if not Adjustable.—The Poorly Lighted Desks should be Known.—Condition of Eyes should be Noted.—Hygiene of the Eye ought to be Taught.	
APPENDIX I. A MATHEMATICAL DEMONSTRATION AND ITS COROLLARY	75
APPENDIX II. HOW TO TEST THE LIGHT	78
APPENDIX III. HOW TO TEST THE CHILDREN'S EYES	82
BIBLIOGRAPHY	87
WINDOW MATERIALS	90
INDEX	91

LIST OF ILLUSTRATIONS

FIG.	PAGE
1. Effect of obstructing building	10
2. Effect of hill and obstructing building	11
3. Effect of a hillside with a rise of one foot in every two	12
4. Space needed for 65 × 80 foot school-house	15
5. Increase in the size of a site for practical lighting purposes made by streets about a corner	16
6. L-shaped building	17
7. H-shaped building	18
8, 9. Two forms of half quadrangle buildings. Dotted lines show blind walls	22
10. Perspective of an H-shaped building	<i>Facing</i> 22
11. Second story plan of H-shaped building	23
12. A kindergarten in an H-shaped building	<i>Facing</i> 24
13. Modification of half-quadrangle to meet peculiar conditions	26
14. Perspective of large half-quadrangle building <i>Facing</i>	26
15. Detail of second story plan of building with six- teen rooms and assembly-room on lot 150 feet square, enclosed on three sides	27
16. Plan of building lighted from all sides and having four rooms on each floor	28
17. Plan of small building lighted from two sides only	29

FIG.		PAGE
18.	Diagram to show that left and rear lighting is practically lighting from the left for seats farthest from the window	37
19.	Example of well-lighted high school . . . <i>Facing</i>	38
20.	Sketch of outside wall of school-rooms, showing possible window space	42
21.	Diagram showing light saved by beveled piers and mullions	45
22.	Mullions after patterns by Briggs	46
23a.	The revolving sash. Use	47
23b.	The revolving sash. Detail	48
24a.	Doubled curtain shades. Rolled up	52
24b.	Double curtain shades. Partly drawn	53
25.	Side and front views of four-inch sections of prism glass <i>Facing</i>	54
26.	A prism-glass canopy. A room made fit for school purposes only by use of prism glass <i>Facing</i>	56
27.	Hennig's daylight reflector	56
28.	Glass brick, a block made for use in heavy walls	56
29.	Two old style windows with wide pier between them	66
30.	A class using their rules to measure the distance the eyes must be kept from their work <i>Facing</i>	68
31.	Mr. Straight and Mr. Crooked	69
32.	Figure showing sky-angle visible at farthest desk	76

**THE LIGHTING OF SCHOOL-
ROOMS**

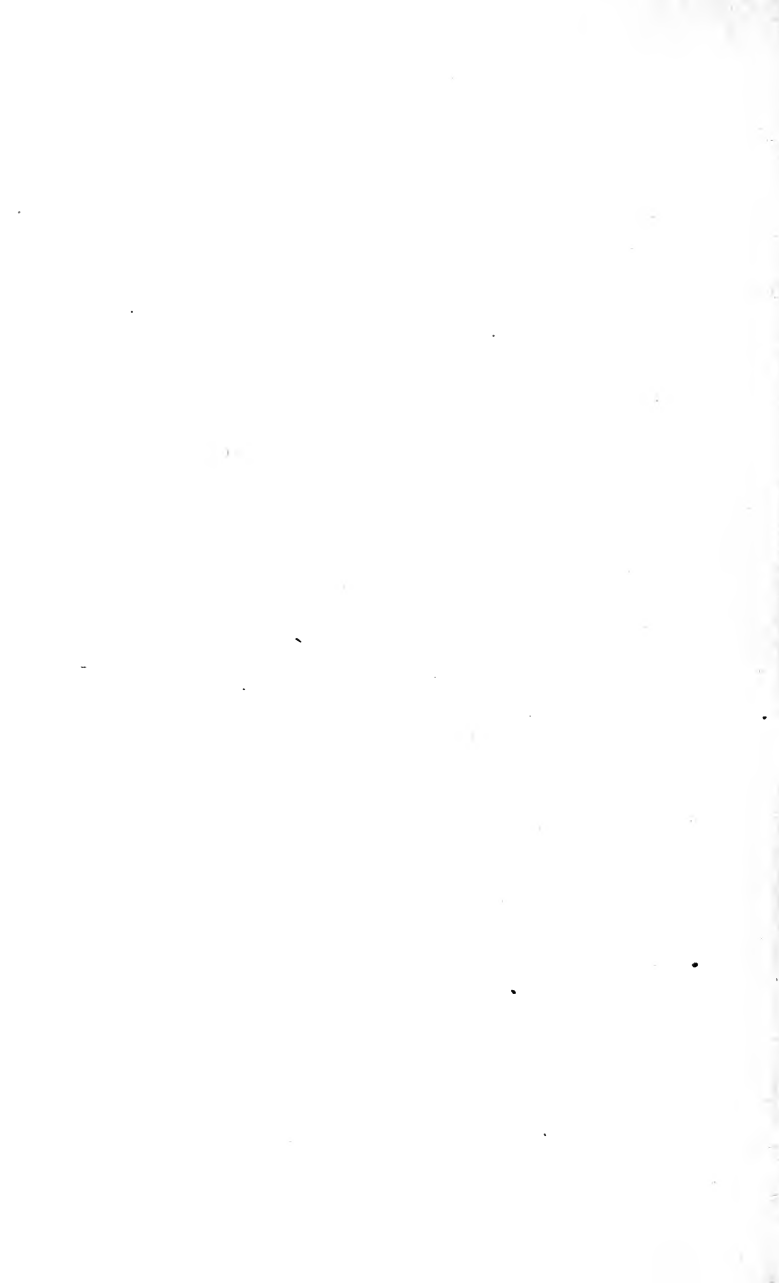



INTRODUCTION

BY S. D. RISLEY, M.D.,
Philadelphia, Pa.

EDUCATIONAL institutions must always furnish a most imposing factor in the social structure of any complex community. In the United States, for example, approximately one-fifth of the entire population is enrolled as pupils in our schools, seminaries, and colleges. It is obvious that these institutions, designed for the training of those to whom the destiny of the nation is to be speedily committed, should be safeguarded at every point; for, not only should the moral and mental education of the rising generation be wisely conducted, but it is essential that the greatest care should be exercised to prevent physical degeneracy during the years devoted to school-life, which are also the most important years for physiological growth and development. It is not unreasonable to expect that some degree of physical deterioration must result when young children are deprived of the careless freedom of the nursery and playground, and for many hours daily subjected to the confinement of the school-room with its tasks and cares; but

careful observation has shown that a considerable percentage of those who enter the schools in apparently good health soon manifest impaired general vigor, acquire distorted spines, become near-sighted, and develop a group of more or less distressing nervous symptoms. It is plain that this deplorable state of affairs must, for the children affected, not only deter their school progress, but plant deeply the seeds for a growth of future ills. The schools, therefore, afford a most important and fruitful field for the application of sanitary science.

The purpose of the present treatise is to teach an important phase of school hygiene, viz., the lighting of school-buildings, a purpose which the author has accomplished in a thorough and satisfactory manner. That such a work is greatly needed will find ample demonstration in a visit to the recitation-rooms of many of our educational institutions, and especially to those of small, so-called private schools, where, too often, no intelligent thought has been given, either to the quantity of light admitted or the relation of the desks to the windows. The student is often compelled to work facing the light or with the point of pen or pencil constantly in the shadow of the hand or body. There is no longer any question as to the harmful influence upon the eyes of school-children of insufficiently or improperly lighted rooms.

During the latter half of the last century great advance was made in our knowledge of school hy-

giene, the result being a marked improvement in the architecture of school-buildings, better paper, and more suitable type for text-books, and a wiser arrangement of seats and desks, both in their relation to the source of light and in their adaptability to the varying size of the children. It is interesting to note that this earnest crusade for the improvement of the general hygienic environment of the student during school hours received its impetus from the careful study of the eyes of school-children. In the early part of the nineteenth century it had been observed in England that there seemed to be some definite relation between near-sight (myopia) and the pursuits of the educated classes in the community. Later extensive and painstaking studies were made in the schools of Europe and this country, until at the present time more than two hundred thousand eyes have been examined. The result fully confirmed the earlier observation, since it revealed a steadily increasing percentage of near-sight as the pupils advanced in age and school progress, until in the German universities approximately sixty per cent. of the pupils had acquired myopic eyes.

The significance of these observations rests in the fact that near-sight is caused by the stretching of the coats of the eyeball, and is associated with and depends upon a congestion and inflammation of the inner or lining membranes. Myopia is, therefore, to be regarded as a disease which impairs the integrity

of the eye. It is very rarely present in young children, but usually begins during the early period of school-life, from the seventh to the twelfth year of age, while the tissues are still tender and yield readily under the protracted strain of school work.

The improvements in the hygiene of the schools were introduced in the hope of arresting the evil. Later examinations of the eyes of children occupying the buildings where all these improvements had been secured were, however, in some measure disappointing as regards the arrest of myopia and led to further research. It was first pointed out in this country as the result of extensive studies made in the schools of Philadelphia, that the eyes which became near-sighted under the strain of school work were congenitally defective, while the normal or model eye remained unchanged and enjoyed throughout school life a higher acuity of vision and comparative freedom from pain and disease. Out of this demonstration grew the suggestion that, not only was it important that the school-room should be sufficiently and suitably lighted, the books well printed on good paper, and the seats properly arranged; but that no child should be permitted to enter upon the coming struggle with books until the eyes had been shown by careful examination to be fitted to undertake safely the strain to be imposed; if found to be defective, the parents were to be apprised of the fact and advised to seek professional advice.

Fortunately, the congenital defects which were shown to be the underlying factor in the breakdown of certain eyes can, in the great majority of cases, be corrected by properly adjusted glasses, and by this means the danger of acquiring near-sight averted.

It is obvious from the foregoing that any measure designed to prevent the occurrence of myopia is to be commended as being in the line of social progress, since impaired vision must in some degree prove a handicap in the career of the individual.

THE LIGHTING OF SCHOOL-ROOMS

PRELIMINARY

MODERN investigation of the eye has made three statements indisputable.

1. A large percentage of the children in our schools have defective eyesight.

2. This percentage increases as the children advance from one school year to the next.

3. The cause has been traced in part to the schools.

These facts have startled the school architects and have led to many and decided reforms in connection with the lighting of school-buildings. They have yet to disturb seriously the equanimity of the buyers of land for schools, and they certainly have not aroused any great wave of reform among teachers generally.

It will be seen that there must be a combination of three requirements for the proper lighting of a school-room. The character of the site must be suitable and large enough to admit of a building which would accommodate the stipulated number of children with a view to effective lighting, the archi-

tectural design of the school-house must be made with the idea of furnishing light enough not only under favorable circumstances but even on dark days, while the teacher's part in the lighting of school-rooms is almost as important as that of the architect, since a failure to co-operate with the architect and follow out his plan for securing and controlling the light, and a failure to see that children avail themselves of it properly, will work most serious results despite the best efforts of the architect. The most sceptical must be convinced by the evidence of their own eyes, if they investigate at all, that not only is this failure of the teacher to do his part a fact, but that it ranks second to the work of the architect in its responsibility for the myopia that is developed in the schools. With the improvement in school architecture now gradually becoming general, the teacher will eventually stand alone in this responsibility unless he, too, learns to work more intelligently. Although these considerations have led to the careful discussion of this subject under the three heads—the selection of the site of the school-building, the requisites of the architecture and equipment, and the teacher's duty, it is important that the teacher bear it in mind that he has an interest and a responsibility in connection with each subdivision. He may have had no hand in the choice of a site or in the planning of a building, but unless he knows the principles involved, how to test the light, and how to test the eyes, he is almost certain to violate

seriously the requirements of school hygiene as applied to the lighting of school-rooms.

THE SELECTION OF THE SITE

Principles Involved.—Aside from the more obvious requirements of the site that it should be at a dis-

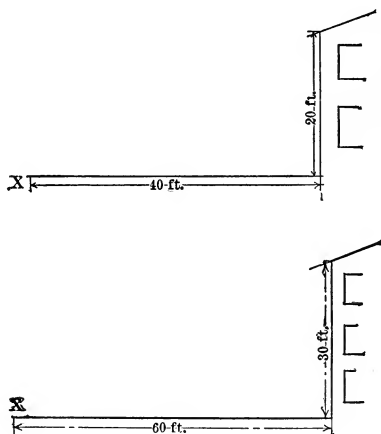

FIG. 1.—The point X is the nearest to the obstructing building that ground-floor windows intended to light school-rooms can approach without violating the first principle of lighting.

tance from swampy ground or stagnant water, that it should be well drained, on a slight elevation if possible, free from disturbing noises and odors, and that the soil should not be “made ground” filled with refuse matter, there is still the question whether

it is large enough to give a building of the proposed size unobstructed light.

It is plain that obstructions will interfere most with ground-floor rooms; but, as these are the most valuable otherwise, it has been assumed in general throughout the book that the ground floor is to be used for school-room purposes. It has also been assumed on hygienic grounds that no basement rooms are to be thus used.

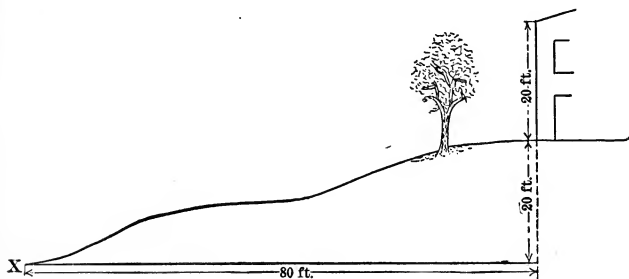

FIG. 2.—Point X is nearest approach to obstruction allowable under the rule.

Aside from the length and breadth of the building, the amount of land necessary to secure unobstructed light depends on the proximity and height of the surrounding buildings erected or to be erected. It has been found that *neighboring buildings should be distant not less than twice their height from a school-building*. (See Fig. 1.) It can be shown mathematically (see Appendix I) that the observance of this rule will make it possible for each child to *see the sky*

from his desk, if the school-building does not depart materially from approved standards. It has been generally accepted on empirical grounds that where the sky can be seen from each desk the light either is or may be sufficient. This rule as to the nearness of an adjacent building may be qualified, however, so as to refer only to the sides of the school-buildings where there are windows; and it is equally obvious that the

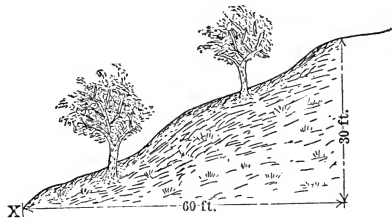

FIG. 3.—Effect of a hillside with a rise of one foot in every two.

total height (see Fig. 2) of the obstructing building, if it is on higher ground than the school plot, must be taken into consideration. A hillside with a rise of one foot in every two would offer the same obstruction as a building half as high as it is distant. (See Fig. 3.)

Trees are the only other obstruction possible, and control of them should be secured with the purchase of the site. If they do not interfere with the lighting of the building they may be allowed to stand. If their effect is doubtful, they may be left until the erection of the building itself determines the matter,

but only provided the possibility of removing any that are actually interfering with the light is secured.

Sunlight.—The value of high ground for the school-site aside from its insurance of good drainage is evident from what has preceded. It not only affords more light by reducing the height of obstructions, but gives a freer play to the sunlight, the influence of which secures immunity from dampness and is supposed to be directly opposed to the culture of disease germs. School-rooms cut off from the sunlight have been found to be less healthful than those located where the sun has full play. Modern systems of building, heating, and ventilation are overcoming dampness and are providing for the rapid removal of disease germs; but the cheeriness of the sun and its actual sanitary aid in buildings too small for economical forced ventilation make it a force worth considering in the selection of the site.

Application of the Principle.—There is every reason for a generous provision of land for the site. Ordinarily it should be assumed that the school-building is to be lighted on all four sides and enough land secured to insure the application of the rule regarding the minimum distance from obstructions.

A building with four rooms on a floor could hardly be less than 80 x 65 feet, leaving out wings for stairways. If this were to be on a lot entirely enclosed by buildings 40 feet high, it is evident that it must keep away from them a distance equal to twice their

height. We should have, then, in accordance with our principle (see Fig. 4):

	Feet
Distance from opposing building on north line...	80
Distance from opposing building on south line...	80
Length of building.....	80

Total length of lot required.....240

In the same way:

Distance from opposing building on east side....	80
Distance from opposing building on west side....	80
Width of building.....	65

Total width of lot required.....225

The total amount in excess of the length and width of the building will be seen, as we should expect, to be four times the height of the building. That is, the minimum dimensions of the lot would be $(80 + 160) \times (65 + 160)$ or 240×225 feet. If the surrounding buildings were only 30 feet high the dimensions of the lot would be $(80 + 120) \times (65 + 120)$ or 200×185 . Similarly, if the building has to have six or eight rooms on a floor, the size of the site can be figured out by adding four times the height of the opposing buildings to each dimension of our proposed building, which should be about 90×100 for six-room building and 95×130 for an eight-room building. These calculations, though approximate and assum-

ing the need of light from all sides, will serve to indicate the amount of land needed in case the opposing buildings stand on the property line. The width of streets bordering the site and the distance away of permanent buildings from the line separating the lot on which they stand from that of the school may be

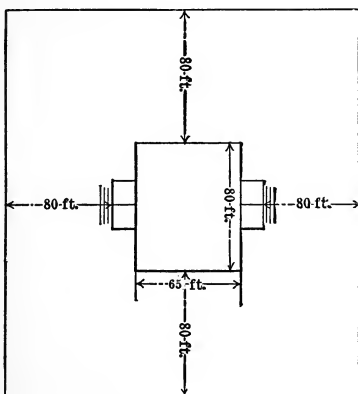

FIG. 4.—Space needed for 65 x 80 foot school-house if lighted on all sides and entirely shut in by buildings 40 feet high. Shows need of another type of building. An H-shaped building (See Fig. 7) would occupy two-thirds of the lot.

credited to the advantage of the school lot. Where the land is very expensive an architect should be consulted before any reduction in these demands is made. He will be able to determine whether by varying the type of building the given amount of land may be made to suffice or not.

Corner lots increase by the width of the streets the



size of the lot for practical lighting purposes (see Fig. 5), but are often noisy and sometimes more expensive than a lot extending through the middle of a block from street to street. This has led in crowded localities to an adaptation in the form of the building. Three types of building are found

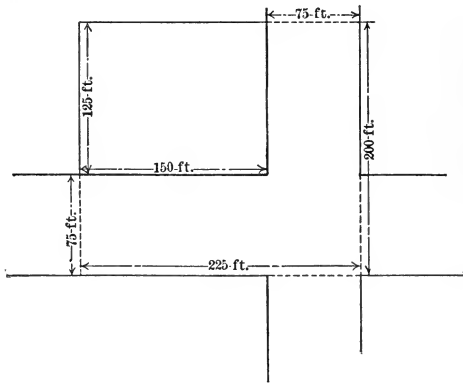

FIG. 5.—Increase in the size of a site for practical lighting purposes made by streets about a corner. If streets are 75 feet wide, lot 125×150 equals lot 200×225 away from streets.

most economical, those shaped like the letter L or H, and the half-quadrangle. These enable the sides indicated by the dotted lines of the accompanying figures to be "blind" walls which may be put directly upon the line of the property. (See Figs. 6 and 7.) These plans are adapted rather to large than to small buildings.

The Direction of the Frontage.—The question how to secure sunlight for all the rooms during some part of the day has led to considerable discussion as to the best direction for a building to face. It is evident that, if the sides of the building coincide with the points of the compass, the north side rooms, if lighted

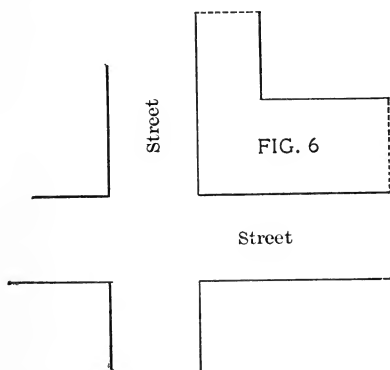

FIG. 6.—Dotted lines indicate that walls may be blind.

on but one side, are cut off from the sun, while south rooms may be over-supplied in warm weather. To avoid this it has been recommended that the buildings face the middle points of the compass. By this arrangement each side receives the sun at some time during the day. A frontage of this sort makes south-east rooms most desirable, southwest next, then the northeast, while the northwest is least to be desired, as it secures the sun late in the day and the beneficial

effects of the sun are felt only after the children are gone.

These distinctions have been carried by the Germans to an unnecessarily fine point and lack practicality; but when such a site can be obtained as readily as another, it should be given the preference. If,

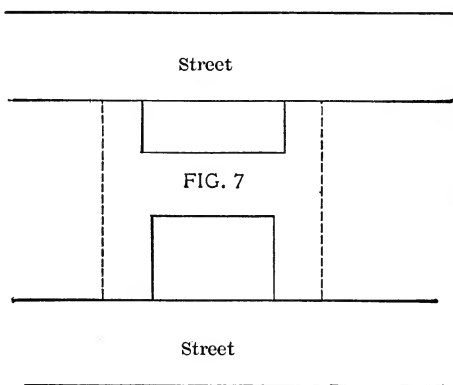

FIG. 7.—Dotted lines indicate that walls may be blind.

however, it seems unadvisable to light a given building from all sides owing to the proximity of obstructions, it should be remembered that a school-building must use the equivalent of one side, at least, for its halls, staircases, office-rooms, etc. These can take the side with the least sun and so cut off little or no light from the children. Where the building is very large with wings, in many cases it is next to impossible to secure the sun for each room. Its absence may

be made up for by increased efficiency in heating and ventilating.

Since the best location for a school-building is more or less dependent upon the size and type of the building, it follows that, if the choosers of the site and the architect work together, better results will be secured than if each works separately.

Too Small a Site.—Very often land is purchased before it is needed in anticipation of a rise in value and is built upon later. Too great economy in the size of the lot will then result in a dilemma if the increase in the population of a section surpasses meagre expectations on the part of the buyers.

If a given site is not large enough to remove all danger of obstructions to the light and sun, only two courses are open unless the authorities are willing to jeopardize for years to come the eyes of children occupying the seats not sufficiently lighted. The first course is to increase the size of the site. That being impossible, the building should be reduced in size and an additional site secured elsewhere, or, as it is the lowest floor only which is usually affected, the structure may sometimes be carried up a story higher and a smaller number of rooms placed on the lower floor. A small site which has been gradually enclosed by tall buildings must be made to meet these special conditions by increased height and the most favorable use of what facilities it has for light. Otherwise it should be abandoned.

THE ARCHITECT'S PART

A. *In Constructing a New Building.*

General Sanitary Requirements.—The trials of the modern school architect are not few. He must ventilate cellar, halls, school-rooms, dressing-rooms, stairways, and even the walls of his building. Each child must have thirty cubic feet of air each minute. There must be no “dead” or unventilated spots, no draughts, and no interference between ingoing and outgoing currents. If possible, to avoid odors, the closets must be removed from the building and furnished with the best sanitary appliances. Moisture must be kept out of the walls by isolating layers. Halls must be large, and stairways made with strong hand-rails, and steps not over eight inches high, seven being preferable. Noises are to be shut out by padded floors, ceilings, etc. Stoves and steam radiators are to be excluded and air heated by furnace or steam pipes and driven by fans must be furnished to the rooms, though radiation from steam-pipes under windows may be used as an aid to a fan system. Again, the floors must be of hard wood free from splinters and cracks, while the cellar should be cemented. The whole must be planned with a view to the requisite number of seats and desks, and these should be separate and adjustable. In the city or town the buildings must be constructed as nearly fireproof as possible,

while in the country the whole school-house must be under-cellared.

The Aim of the Lighting.—As has been seen, all of the above requirements are entirely aside from any thought of the conditions affecting the lighting of the school-building, which is the special topic to be considered in this discussion. The architect's aim in this particular is simply to furnish sufficient and uninterrupted light to each desk even on dark days. The system by which he secures this end depends upon the number of pupils to be accommodated and the extent of the site, for these two factors determine the type of building to be erected. The bearing of the former is evident; that of the latter has been hinted at in so far as it affected the choice of the site, but deserves further consideration as applied to the work of the architect.

The Lighting as Affected by the Type of the Building.—For the same number of children a small site necessitates a higher building than a more generous site would require. If it is long and narrow the building would differ very much from one that could be erected on a square piece of ground. The most common form of building is the square or oblong, which draws its light from all sides and, as a rule, it is the most economical, particularly for from four- to twelve-room buildings. This type may be modified so as to receive light only from two opposite sides, though in case of a very long and narrow building

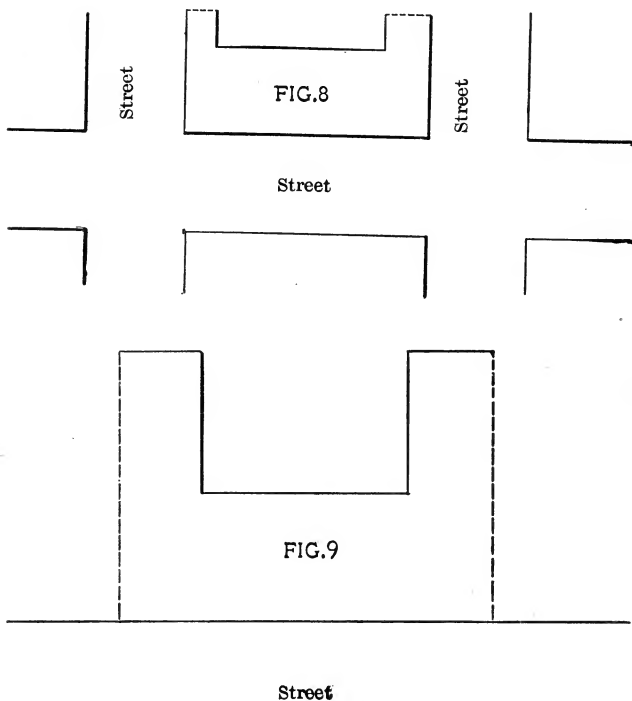

FIGS. 8 and 9.—Two forms of half quadrangle buildings. Dotted lines show blind walls. FIG. 8 is adapted from fifty-room building taking an entire block. FIG. 9 is adapted from a fifteen-room building.

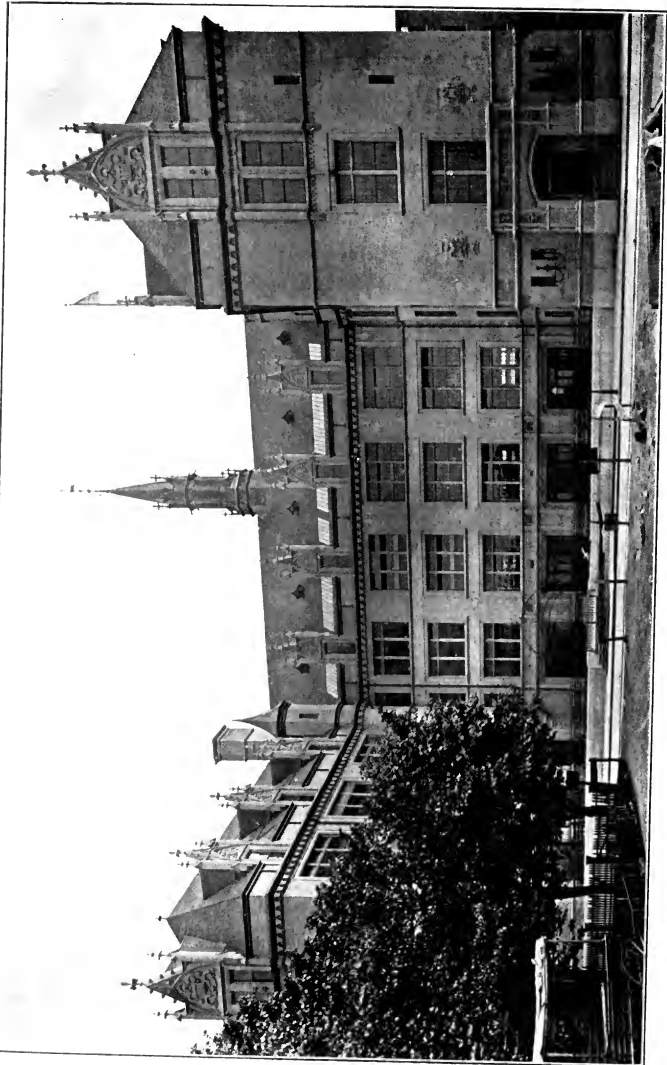
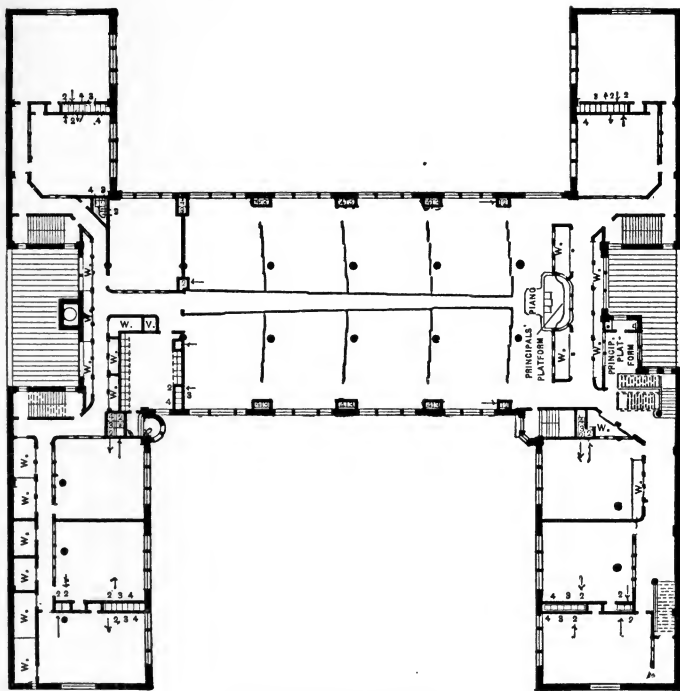

FIG. 10.—Perspective of an H-shaped building. C. B. J. Snyder, architect. Note unity of the lighting.



SECOND STORY PLAN.

FIG. 11.—Spaces in exterior walls between heavy black lines represent windows. Sliding partitions, represented by converging lines, have glass in upper sections. Notice that light enters rooms as a unit.

sufficient light may be obtained even from one side. Aside from these the "L"¹ or "H"² shaped, the half-quadrangle,³ or even the full-quadrangled building represent the ordinary and approved shapes of which all others are modifications or combinations. The square⁴ and oblong⁵ form is best adapted to smaller buildings, while the other shapes will accommodate from eight to twenty rooms on each floor.

From what has already been shown the sides of these buildings from which light is drawn must be at a distance from an opposing building, erected or likely to be erected, equal to twice the height of the obstruction, though a rigid adherence to this principle is less necessary on the south side owing to the greater brightness of the sky in that quarter. A large structure may be suited to varying conditions and be arranged so as to have blind walls on almost any side without interfering seriously with the lighting, provided the light is not shut off from more than two sides. Where light is cut off from one or more sides of a small site for a building containing from four to twelve rooms, less adaptation is possible and the architect must look well to his distances. If in a ten-room school-house costing \$30,000 two rooms are useless because of lack of light, there is a loss of twenty per cent. in the efficiency of the building, or in money \$6,000. The fact that the rooms may be used not-

¹ See Fig. 6. ² See Figs. 7, 10, 11, and 12. ³ See Figs. 8, 9, 13, 14, and 15. ⁴ See Fig. 16. ⁵ See Fig. 17.

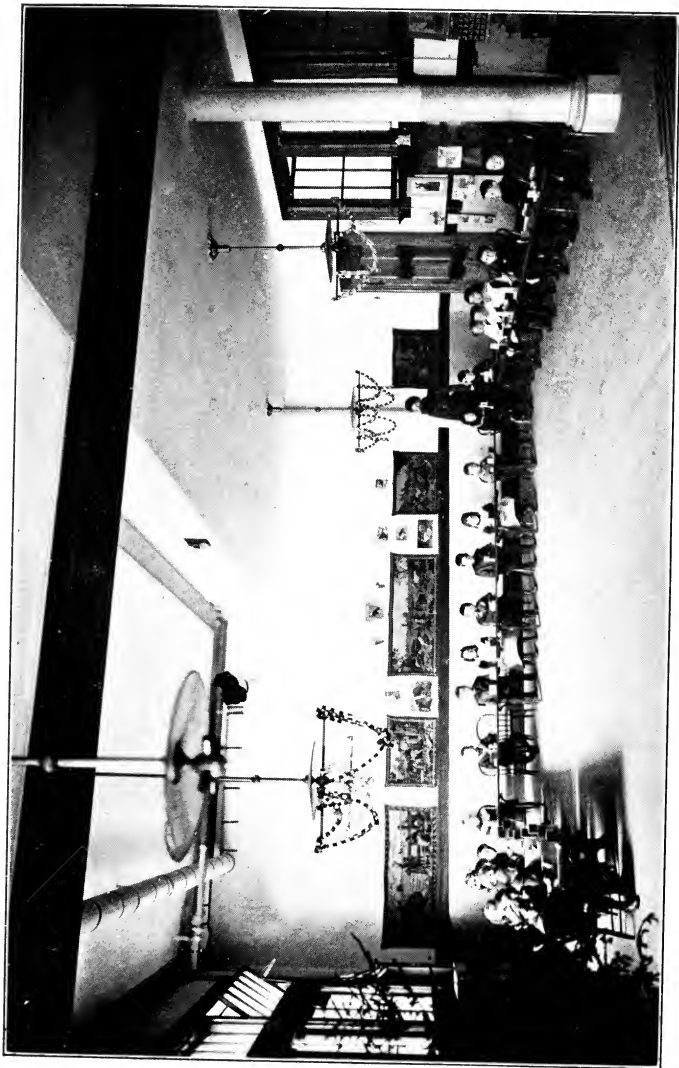
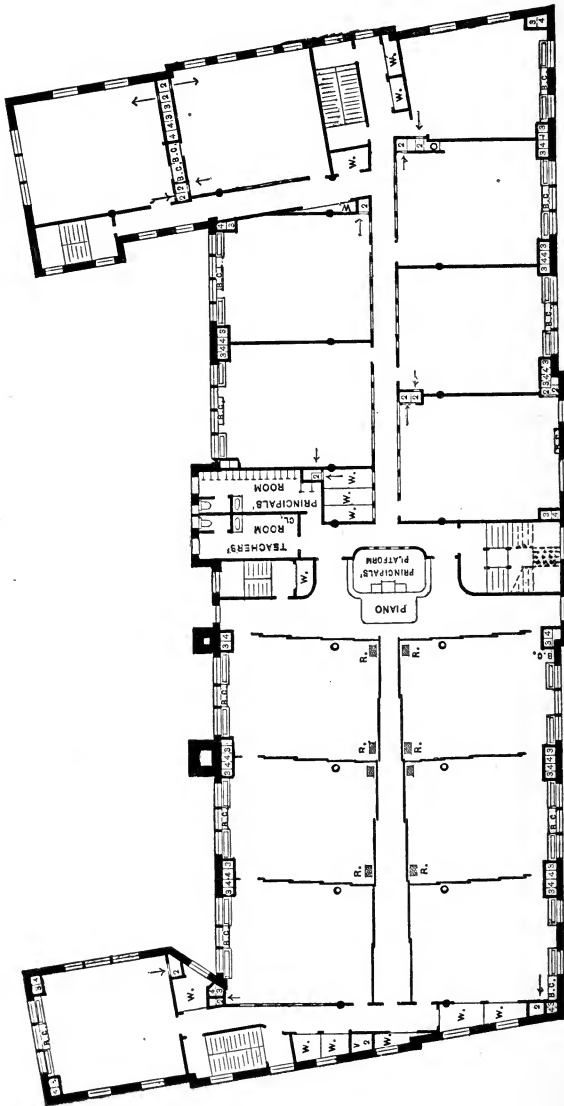

FIG. 12. — Shows light in a kindergarten in one of the side rooms of the ground floor of an H-shaped building.
See Figs. 10 and 11.

withstanding does not wipe out this loss. It is paid for by scores of injured eyes. Again, it would be a waste of good space to put an "H"-shaped building on a corner lot of small size, or to put a large square or oblong building in the middle of a crowded block. The frontage necessary to make a square building conform to the requirements for light would be great compared with that of an "H"-shaped building with two blank walls, as shown in Figs. 4 and 7.

Put the Light in the Rooms Used.—Having determined the general character of the building, its size, exact site, number of floors, staircases, etc., the problems of arrangement and size of rooms are to be considered with a view to the best provision of light. Put the light in the rooms used for the school-work, is the mandate of experience and common-sense, and needs no elaboration as a principle. It involves, however, several considerations not always regarded. For example, assembly-rooms used less than a tenth of the school time are not infrequently on the south side in most favorable positions for light. Dressing-rooms monopolize windows which are needed for light in the class-rooms, while on the side of the building from which the best light is secured are not infrequently found halls or staircases. This means that good light is going to waste.

At other times a room which has been planned for a purpose requiring good light might better have been



PLAN OF SECOND STORY

Fig. 13.—Modification of half-quadrangle to meet peculiar conditions. Compare Figs. 11, 14 and 15.

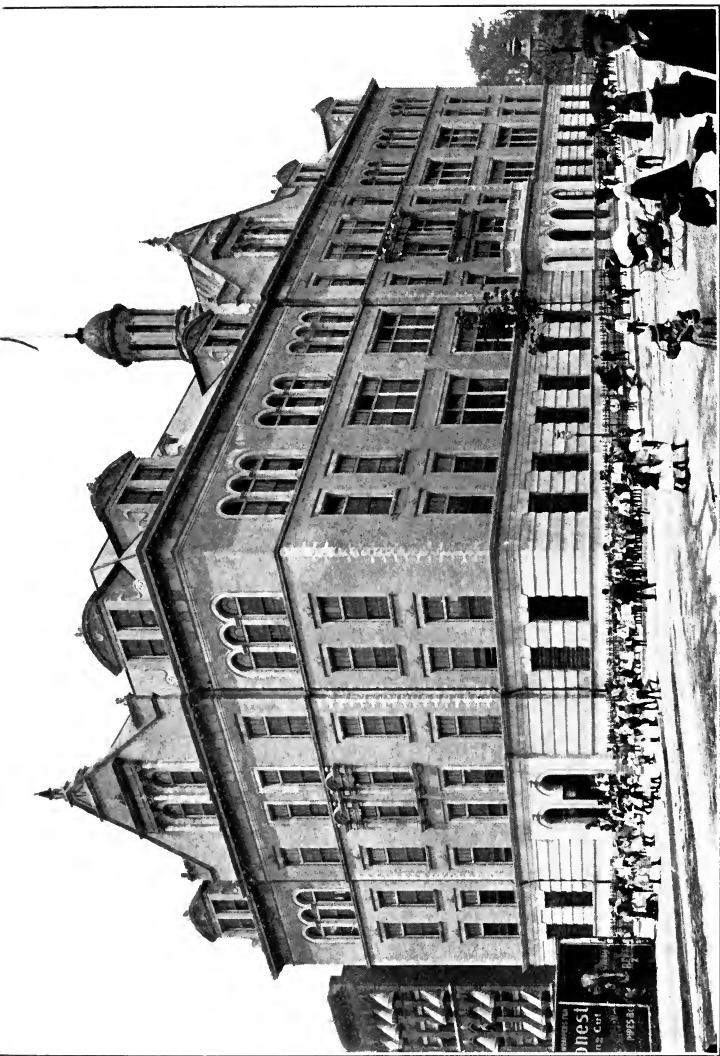

FIG. 14.—Perspective of large half-quadrangle building, C. B. J. Snyder, architect. See FIG. 8.



arranged for another purpose. In one of my schools, for example, just across the hall from a room, the light of which is obstructed by a house built earlier than the school, is a double room used as a kindergarten. If the dark room had been opened into the next room so as to make a double room, it would have been almost as

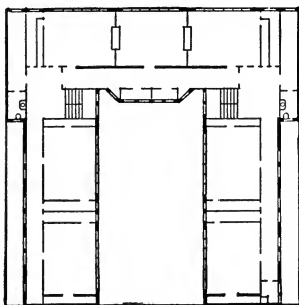

FIG. 15.—Detail of second story plan of building with sixteen rooms and assembly room on lot 150 feet square, enclosed on three sides. Warren R. Briggs, architect.

light as any and would have made a good kindergarten-room, while the room planned for the kindergarten, having no obstruction to the light, could have been divided up into two excellent class-rooms.

Amount of Window Space.¹—It used to be considered sufficient to have about a tenth or even a twelfth as much window space as floor space. But continued experience with bad light, the practical ingenuity of

¹ For an excellent *résumé* of this topic see Dr. Burnham in the *Pedagogical Seminary*, vol. ii., p. 33.

American architects, and, above all, the careful investigations of Dr Cohn, have led to a general acceptance of his standard as the very minimum. According to

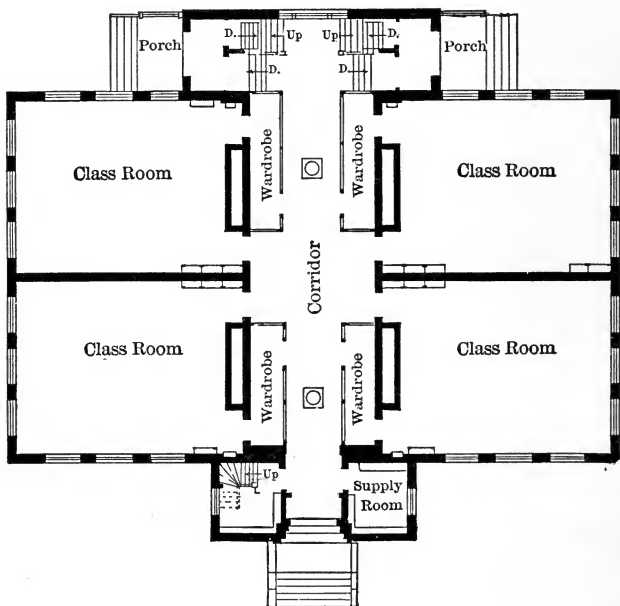

FIG. 16.—Sketch of building lighted from all sides and having four rooms on each floor. L. W. Robinson, architect.

his recommendation, the relation of window space to floor space should be at least one to six. When this amount of window space was provided he found the minimum of defective eyesight. Since then school architecture has demonstrated the practicality of in-

creasing the window surface up to the ratio of one to four, or in corner rooms even one to three. By the use of iron or wooden beams and mullions, glass brick, glass floors, etc., a building for mercantile, manufacturing, or school purposes can be made almost entirely of glass. (See below.) The key to the problem of lighting lies in adhering strictly to the demand for window

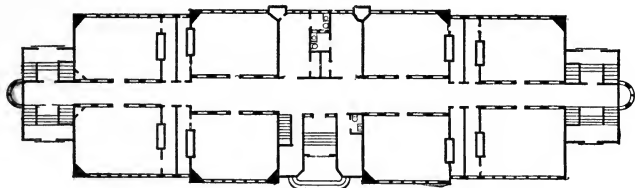

FIG. 17.—Lighted from two sides only. Warren R. Briggs, architect.

space of at least a sixth of the floor space, and more, if the room is unusually deep, so that the farthest seats are quite remote from the windows. The adoption of the one to six ratio is almost entirely the result of actual experiments in the school-room, which showed, where these conditions were not fulfilled, the children in the farthest seats could not read type at the normal distance, and on dark days many others were handicapped.¹ Since Dr. Cohn's investigations many others have been made with similar conclusions,

¹ If architects and school-committee men could test the light as indicated in Appendix II. on the darkest days it certainly would be conducive to better results thereafter.

some investigators even advocating the relation of window-glass to floor surface, one to four, as the minimum. In Switzerland one to four is the rule and one to five the minimum as prescribed by the authorities. This ratio is practical. For, while the light is easily moderated, the task of increasing it is difficult. It has been said that a school-room cannot have too much light. This is in general true except when some of the light comes from the wrong direction or reflections from bright surfaces are thrown into the eyes of the children or teachers. But, if there is too much light, the error can always be corrected easily.¹ If a teacher or pupil has continually to face a bright light, impaired vision is likely to ensue, but there seems to be no reason why with shades, awnings, or proper screening

¹ Burrage quotes Förster's statement, made long ago, that "the curtains are not yet invented that will keep back the direct rays of the sun, and at the same time let the diffuse light of the clear sky pass through." This is either erroneous or absolutely misleading. I have made several tests at various times in rooms lighted unilaterally with less than a sixth as much glass area as floor surface and have found the light passable even with all the shades drawn to cover the windows wholly, it being satisfactory in one case where the ratio was almost one square foot of window to eight square feet of floor surface (but not without a slight glare), and in another where the depth of the room was $27\frac{1}{2}$ feet against $25\frac{1}{2}$ on the window side. In all these cases the light was such that with curtains drawn to the limit one could read without any appreciable loss in accuracy or speed the columns of figures used in connection with Cohn's light-tester in spite of the screen which shuts off four-fifths of the light. The curtains gave no glare except in the case mentioned above, and no poorer conditions for the trial could be found without absolving the shades from any responsibility for their inability to diffuse light enough for the room.

of some kind, any amount of light could not be tempered to the desired degree.

From one-fourth to one-sixth is therefore the desired amount of window space as compared with floor space; and sashes, curtains, and other obstructions to light are not to be included in that amount.

Dimensions of the Rooms.—The floor space for forty pupils is usually, or should be, about seven hundred and fifty square feet, and might advantageously be considerably increased. A standard room for forty pupils would therefore be about $30 \times 25 \times 13\frac{1}{2}$ feet. Such a room would give the minimum air space per pupil, 250 cubic feet, and the air should be changed seven and one-fifth times in the hour to allow each child thirty cubic feet of air per minute. To furnish these same conditions to fifty children the room should be about $32 \times 28 \times 14$ feet.

No court or commission has fixed the dimensions of a standard room. They are determined, however, within narrow limits by the two formulæ (1) that the product of the length, width, and height of the room multiplied by the number of times the air is changed each hour must be equal to or greater than 1,800 multiplied by the number of pupils planned for the room, in which 1,800 represents the number of cubic feet of air needed each hour by each pupil, and (2) the product of the dimensions of the room must be equal to or greater than 250 times the number of pupils planned for the room, in which 250 represents the

minimum air space that can be safely allotted each pupil, applying these formulæ to the above figures, in the room for forty pupils the first would read: $30 \times 25 \times 13\frac{1}{2} \times 7\frac{1}{2}$ must equal or exceed $1,800 \times 40$; and the second: $30 \times 25 \times 13\frac{1}{2}$ must equal or exceed 250×40 . For fifty pupils the first formula would read: $32 \times 28 \times 14 \times 7\frac{1}{2}$ must equal or exceed $1,800 \times 50$; and the second: $32 \times 28 \times 14$ must equal or exceed 250×50 .

So-called standard rooms have failed to meet one or both of these requirements so often that any material departures from these figures should be tested as to their conformity to both of these formulæ. Moreover, if the rooms are made higher than the dimensions given above, the stairs become burdensome, while a more rapid change of the air is likely to produce draughts and it is not wise to count on the aid of "natural" ventilation. If the floor space is much increased in its length there is danger of getting beyond the effective carrying power of the teacher's voice. If the width is increased, care must be taken that desks are not placed where the light of the sky cannot reach them directly. (See Appendix I.) Radical departures from the above proportions cannot, therefore, be safely made. The limitations of the teacher's voice and his inability to handle effectively large numbers must make fifty the very limit for ordinary school-rooms.

Location of the Light.—Knowing the amount of

window space necessary as compared with the floor space and the dimensions of the rooms, our next problem concerns the location of the light.

In this question two considerations are involved. The full light must shine on the children's work, and it must not be faced by pupil or teacher. These conditions are best fulfilled by an adequate lighting from the left or above, as is set forth in the following pages, and in all cases it must be borne in mind that the light from the highest portion of a window is by far the most valuable. That which comes through the lowest portions goes to the floor.

The old contest between the advocates of unilateral and bilateral lighting has been won by the unilateralists, but only so long as they provide *adequate* light and that from the left.

Reasons for Unilateral Lighting from Left.—The reasons for this position of the light are chiefly freedom from shadows. Light from the rear casts shadows from the pupil's body and head upon his book or paper. Light from the right is obstructed by the pupil's hand in using pen or pencil. These are very serious objections to any dependence upon light from either the rear or the right.

Everybody agrees that there should be no light in front of the pupils for them to face, as the strain of facing it is very likely to show itself in weak eyes, particularly when the children are nervously tired or under special strains. For reading, this method

lights the binding of the book instead of lighting the page, and is otherwise objectionable.

The light from the left is therefore the only unobjectionable form of unilateral lighting. It should also be from the long side rather than the short, though this is not essential, provided the requisite amount of light is secured. However, if the room is long and deep, the required amount of light could hardly be supplied from the shorter side, as in such cases there should be at least one-fourth as much window-glass as floor surface to reach the farthest seats.

Bilateral Lighting.—Although we have a general agreement as to the desirability of adequate unilateral lighting from the left, the question as to whether a room may be lighted from more than one side is still in dispute. The objection to the pupil's facing the light is valid, even if this lighting is supplemented from another direction. Therefore any combination by which the children face the light must be avoided. The three combinations left, then, are right and rear light, left and right, and left and rear. It is evident that the first of these is still open to all the objections of light from the right. The hand shades the writing or pencil-work on the right, while the head and body cut off the light from the rear; so that the possible combinations are reduced to two. The school-rooms where right and rear lighting could not be changed either to left and rear or to left alone

(by blocking up certain windows in case of long, narrow rooms) are very rare.

Of the two remaining possible combinations that with windows at the left and right is much to be preferred. This gives abundant light for reading, and if the light at the right is shaded or thrown to the ceiling there will be no shadow of any account on the writing, as the chief source of illumination is then on the left. We see this in the one-room country school, where, if the light is reduced on the right side, a good lighting is secured, unless the piers between the windows cast shadows interfering with some of the children, as they usually do to some extent. This right and left lighting is particularly valuable where two rooms on opposite sides of a building are scantily lighted. By putting in glass in the upper part of the partition walls defects may be greatly reduced or even overcome. Except in the use of glass partitions, this right and left form of lighting has its chief application in rural schools.

Light from the left and rear is generally trying for the teacher, who has hitherto received very slight consideration, as is shown by the fact that perhaps ninety per cent. of the rooms in all but the very largest cities are so lighted. Cases of irritation of the retina as a result must arise, though a great many teachers are strong enough physically to throw off any permanent effects. From the pupil's standpoint alone the left and rear lighting is usually better than that from

right and left; for, as a matter of fact, the children farther away from the windows on their left get from that direction not only the light from windows on that side, but even the light from most of the rear windows comes to them from their left. If there are three windows on the pupils' left and four back of them, the two or three ranges of seats farthest from the windows on the left will get light in general from that direction, not only from the three windows on that side, but from two or three out of the four on the rear side. (See Fig. 18.) The light coming from the remaining rear window will therefore not cast any appreciable shadow in view of the illumination from the other four windows. The other ranges of seats being nearer the left windows will get more light from that side, increasing proportionately as the square of the distance diminishes. This rear light is still better if it comes from a high point, the upper sash being the part of the window most useful, and particularly in supplementing left light. What shadows may be cast then are short and less likely to interfere.

Having light on two sides is also a decided advantage when the sun shines into a room. The shades should be drawn to keep the sun off the desks and books, but when this is done the light is greatly reduced, especially where the ordinary, rather opaque school-curtains are in use, however inexcusably. If at such times light can be added from the rear, the difficulty is removed in great measure, if not entirely.

The shades may be kept drawn in the rear of the room except where the light is needed, and there is then the possibility of having sufficient light even on the darkest days.

It should also be borne in mind in this connection that, as children usually hold their books, the left

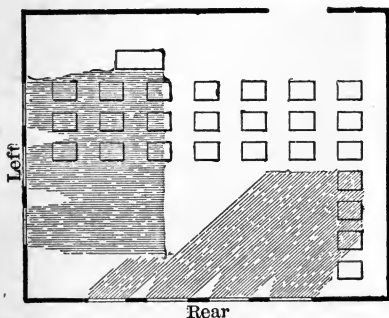

FIG. 18.—Diagram to show that left and rear lighting is practically lighting from the left for seats farthest from the windows.

cover shades the left page in a room lighted from that side alone. If, however, it is lighted also from the top of the rear, the children get a very good light coming in a line almost perpendicular to their books; and they will learn to avoid the shadows cast by their heads under these circumstances. The writing, however, could be seriously shadowed by this style of lighting.

Aside from these advantages it is usually either necessary or desirable from an architectural stand-

point to have the light from two sides in all corner rooms, and these constitute a goodly proportion in almost any except the large buildings where the greater adaptation due to the increased size makes a larger space of "blind" wall possible. Supposing, however, the lighting of these corner rooms on left and rear lacked practical advantages for dark days, sunny rooms, or obstructed light, the architectural difficulties might be overcome, as they frequently are, but, on the whole, few architects seem willing to stake their reputations, considering all the possibilities, on the light that can be gained from one side of a room, if two sides are available. (See Figs. 16 and 19.) It must be remembered, however, that the teacher is likely to suffer under this arrangement. In many cases, particularly where there are trees or buildings opposite the rear windows, this light does not give the teacher any trouble. If, as he looks from his desk toward the window, very little or no sky is visible, this light need not be at all harmful, provided proper precautions are taken.

Soft-coal Smoke and Left and Rear Lighting.—There are some who argue that unilateral lighting cannot afford light enough to a school in a soft-coal burning centre on dark days when the smoke adds its pall to the lead of the sky. I know of no investigations which have attempted to measure the effect of smoke on an otherwise standard well-lighted building, and the question cannot be settled otherwise than by ex-

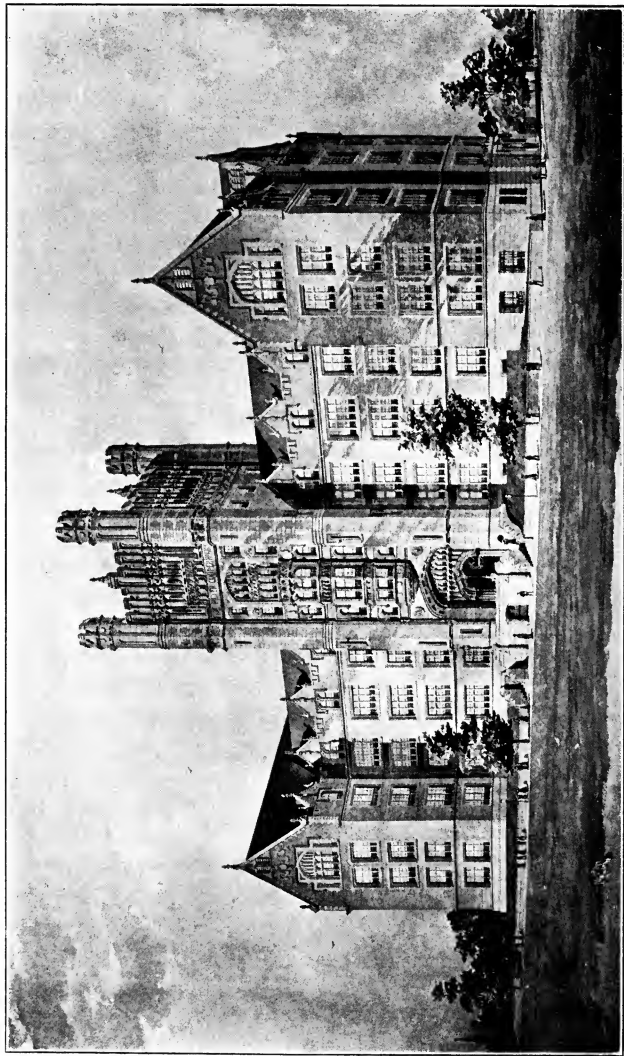

FIG. 19.—Example of a well-lighted High School. Wooden mullions used to secure unity in the lighting.
C. B. J. Snyder, architect.

periments, preferably with a good photometer, or Cohn's light-tester, on the less favorable days of the year, and in each locality separately. (See Appendix II.)

That there must be a loss is evident, and that it must be particularly felt on the dark days when light is most needed is also evident. Perhaps a ratio of one to four in window to floor surface would be sufficient to overcome it in some places, or rooms might be made longer and narrower. In Europe, where such matters have received the attention of investigators, there is no trouble from smoke-laden atmosphere, although the more northern latitude renders the sky light less bright.

This question, however unsettled it may be in its mathematics, leads to a very practical one immediately upon its application to the left and rear lighting. Soft-coal smoke shuts out much of the glaring brightness of the sky even on clear days. It therefore reduces to an almost negligible factor the chief objection to the left and rear lighting in places where the soft-coal smoke is a hindrance to good lighting. The teacher does not face a bright light and the children get the benefit of this additional window surface. Consequently, left and rear lighting, although second ordinarily to the unilateral lighting from the left side, may be preferred to it where the smoke is so dense as to cut off much light.

It might be added that provision should be made

so that windows could be washed more readily where soft coal is burned, as the soot adheres to the glass. The rule there, as anywhere, is simply to keep the windows clean at all times, but where that is made easy by revolving sashes or other devices better results are likely to be attained.

Light from Above.—No serious fault could be found with light from above, but it is only available in one-story buildings, or in the top floor of larger ones where there is no difficulty in providing light, if the other floors are adequately supplied. This method makes a warm room in summer, is expensive, and produces such a prison-cell effect as to make it undesirable, unless it be for art-rooms. The warmth will not be so troublesome a feature if the roof slopes toward the north, so that the sun has little chance to enter. It is a possible method for rural schools, but too expensive and lacking in practical advantages to give it any possibility of general usefulness. Even in rural schools some windows should break the dreariness and cell-like character the room would otherwise have.

Conclusion on the Direction of Light.—In summarizing the direction of the light, it should be said that adequate unilateral lighting from the pupil's left and the long side of the room is the best; that lighting from right and left or left and rear may be advisable under some circumstances. Of these last the advantages of theory are with the right and left illumination,

but practicality, particularly in cities where soft coal is generally used and in corner rooms, demands not infrequently the left and rear lighting, though the evil of this method for the teacher should limit its use to cases either where its effects are nullified by smoke-laden atmosphere, obstructions, and so forth, or where nothing else will do and it can be justified by its advantages for the pupils. Overhead illumination would seem to be thoroughly practical as an aid, but not as a substitute for window-lighting. It is seldom used, however, except in drawing or art rooms.

Location of Windows.—The best light for a school-room comes from the upper part of the windows. On that account the windows should extend as far toward the ceiling as possible. In old buildings it is not unusual to find two or three feet of side-wall above the window, but modern architecture has reduced this to about six inches. On the other hand, a very large percentage of the light coming through the window at or near the level of the pupils' heads goes directly to the floor and consequently is useless or worse than useless, as no light is gained and the children's attention is drawn from their work by the distractions furnished outside. Moreover, they may get reflections from bright objects which intrude themselves upon the children, if their line of vision can reach the ground. Accordingly, windows should be from three to three and one-half feet from the floor and extend to within six inches of the ceiling. Four feet

from the floor seems unnecessarily high for the bottom of the window, except where the conditions are extraordinary.

Application to Standard Room.—Taking the standard minimum room for forty pupils mentioned above, $30 \times 25 \times 13\frac{1}{2}$, it will still be seen that it is a com-

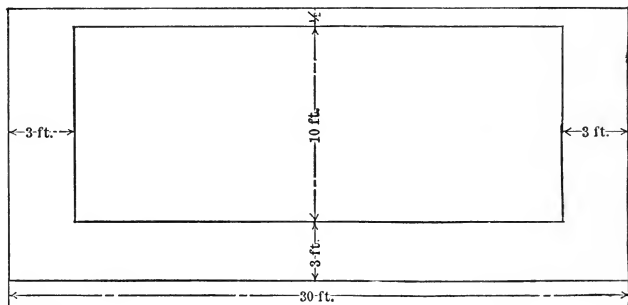

FIG. 20.—Sketch of outside wall of school-rooms, showing possible window space, except for mullions and sashes.

paratively easy matter to furnish from one side only the light called for by the relation even of one square foot of window for four square feet of floor space. Subtracting from the height of the room ($13\frac{1}{2}$ feet) the distance from the floor to the bottom of the window ($3\frac{1}{2}$ feet) plus the distance lost between the top of the window and the ceiling ($\frac{1}{2}$ a foot), we have at least 9 feet available perpendicularly for the window. Multiplying by the long side (30 feet) we find 270 square feet suitable for window space.¹ Deduct-

¹ Compare Fig. 20, where three feet has been taken from each end of the room for wall space.

ing one-third or one-half of this for the amount to be occupied by piers, walls, window sashes and frames and we have still approximately from one-fourth to a little less than one-fifth as much window as floor space. This is a liberal provision for piers, etc., as will be seen by visiting any well and unilaterally lighted school-room and comparing the amount of space above the bottom of windows occupied by piers, walls, etc., with the space taken by the glass. Much better than that can be done, and is done, by the American architect of to-day.

There is one danger to be avoided here, however. Robson quotes Hood to the effect that one square foot of glass will cool 1.279 cubic feet of air as many degrees per minute as the internal air exceeds the external air in temperature. Whether or not this be absolutely true, it is evident that an area of window-glass, for example, 180 square feet, has a temperature equivalent in zero weather to a side-wall of which a surface of 180 square feet was made of ice. For this reason seats should never be placed close to the windows unless they are double windows and the heating and ventilation secures a fairly even distribution of hot and cold air. In northern climates the windows should be double, though some of the outside windows should hang from hinges so that they can easily be swung open to flush out the air where no adequate scheme for forced ventilation is in operation.

It follows also from the fact that the light from the

top is most valuable that there should be no arching or rounded corners to cut that light off. The brickwork may be decorated or sunk in above the windows to complete an arch and the group of windows may be crowned by a large blind but decorated arch above them, but on the principle that a room cannot have too much light it must not intercept light which could otherwise go to the window. This interdiction of the arch applies particularly to the lower-floor windows. Only when it is certain that the architect has more than satisfied the demands of the site, both existing when the building is planned and possible when the surrounding property is built upon, is any arching of the windows on upper floors permissible.

Width and Structure of Window.—Having ascertained the proper height from the floor of the top and bottom of the window, a word may not be amiss regarding the width. The windows should be as wide as is compatible with the strength of the building. It is advisable to have the light enter the room as a unit. (See Figs. 10 and 19.) Then there will be no distinguishable cross-lights, no distinctly outlined shadows; and one intensity of the light will shade into another without any visible lines. To secure this unity of the lighting the windows should be close together, and therefore the piers or mullions between the windows must be small, casting no noticeable shadows a few feet away. Modern architecture has revolutionized the whole problem of window construction. The

use of iron- or steel-framed buildings, and in other structures of iron mullions has made it possible to make the glass surface approach 100 per cent of the available surface. By beveling the window-frames, and especially the lintels and the sides of the mullions and piers—or, in general, the parts enclosing the window—more light is secured where it is needed, as will

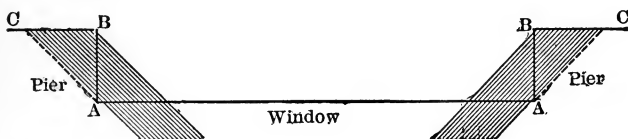

FIG. 21.—Diagram showing light saved by beveled piers and mullions. (Horizontal section.)

be seen from the following figure. By beveling off AB to AC, in Fig. 21, the architect saves all rays of light from BC, forming a goodly percentage of all the light received from that window. This is less necessary where there are no piers of any size.

Piers have been reduced from six feet to as many inches to the great advantage of the lighting. Briggs states that by using iron mullions with window-boxes six windows can be placed in the same space as five with the ordinary sixteen-inch brick piers at practically the same expense. (See Fig. 22 and "Briggs's Modern American School Buildings," page 130.) They contribute greatly to the unity of the lighting. In New York City wooden mullions (see Fig. 19) are

used almost entirely, either with window-boxes or better with spring sash-balances. A series of windows separated by iron mullions with window-boxes would cost from \$3 to \$5 a window (in round numbers) more than wooden mullions with spring sash-balances. The spring in the latter does away with the weights and pulleys, and therefore with win-

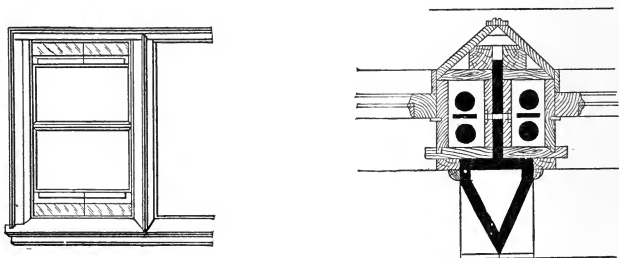

FIG. 22.—Mullions, after patterns by Briggs.

dow-boxes; but, on the other hand, they may more easily get out of order and are not so easily repaired as weights and pulleys.

A revolving sash (see Fig. 23) may be used where screens are not needed. Though of little or no advantage for the lighting, they leave no excuse for dirty windows, as they can be cleaned from the inside, and there is no danger of falling or inconvenience from the cold.

Robson says that in the glazing clear glass should be used. "Rays of light should not be distorted and

rendered harmful by being made to pass through ground-glass, rough-plate, or any other of the numerous devices of a similar kind." His idea is that it

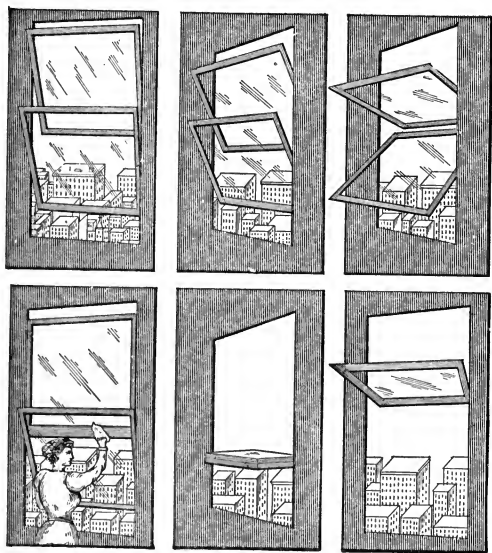

FIG. 23 a.—The revolving sash. (Use.)

“ imprisons vision ” and that our eyes need the long distances for recuperation, just as it has been claimed by Cohn and others on scanty evidence that the reason for greater frequency of myopia in cities than in the country is the more frequent opportunity in the country to rest the eyes in the more natural far vision. For this reason and because of irregular and

dazzling streaks of light as well as the idea of confinement suggested by the inability to see beyond the

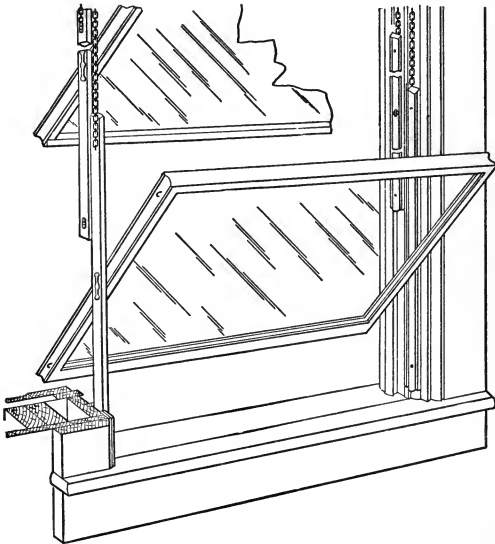

FIG. 23 b.—The revolving sash. (Detail.)

immediate environment, our decision must be in favor of clear glass.

Columns, Pillars, etc.—With the broad piers has also gone the day of columns, pillars, etc., inside the ordinary school-room, though they are still much in evidence in old buildings. Wherever they are to be found their influence on the lighting must be studied, if harmful shadows are to be avoided.

The Ceiling and Side-walls.—The integral parts of the building just considered are of fundamental importance in their relation to adequate lighting. A building may, however, be perfectly constructed but very imperfectly furnished, and still less admirably managed.

The plastering of a building should diffuse the light. It should therefore be tinted some very light color, almost white. A pure white has been objected to on the ground that, like facing a bright light, it irritates the retina. This might be true if its pristine freshness lasted for any length of time; but, as a matter of fact, this vivid white is soon deadened by accumulated dust to a soft color while still retaining considerable diffusive power. It is also objectionable on æsthetic grounds, however. Where no especial dependence upon the diffusion from the ceiling is necessary, very light tints of blue, green, or brown are good. The side-walls, except in rare instances, should be tinted with one of these colors, since the children must face them. Bailey advises, among other good suggestions, the selection of a tint that harmonizes with the finish of the woodwork.

So much of the wall space is taken by blackboards—at least a third of the wall surface which is higher than the pupils' heads—that not only is it important to make the best use of this remaining space, but frequently it is desirable to cover at least a part of the blackboard space with some curtains to reflect the

light. The purpose of these is illustrated by the screens used by photographers to light up this side or that of their victim.

The Shades.—Again, and particularly where a room lighted on one side is exposed to the sunlight, heavy and dark opaque shades will utterly ruin the whole system of lighting. The sun shines in and must be screened off. But when this is done the children are left in semi-darkness. On the other hand, though a light shirting, *écru* or light cream-colored twilling are recommended by some as useful in shutting out the sun, and as not dark enough to shut off the light, I have found that even the *bisque* (a light sage) makes a very satisfactory color, not light enough to annoy or dark enough to exclude the light. This and lighter colors of the Hand-made Tint and the Bancroft Sun-fast Hollands meet all the requirements of Cohn's light-tester.¹ (See Appendix II.)

If the shades are hung at the top of the windows, the roller and the few inches of shade which will almost inevitably hang down from it cut off about four square feet of the very best light coming into the room. This may be obviated by the now common device of fastening a pair of rollers, each with shades, at the centre of the window, and pulling one up and one down to screen the whole window. (See Fig. 24.)

¹ "Bisque" was the color of the shades in most of the rooms tested as noted on page 30. The Hand-made Tint seemed to be preferable to the Bancroft Sun-fast Holland.

The shades should either be wide enough to more than cover the window in order to prevent the sun from shining between the curtain and the side of the window upon the work of some child; or the rollers may be set in with perhaps equally good effect and be neater in appearance. An abundance of curtain cord should be provided for regulating the curtain that covers the upper part of the window.

Venetian and Inside Blinds.—Much better results may be obtained by use of the Venetian blinds than with any other screen for the sun, and demand their use wherever there is difficulty. Their expensiveness, together with a tendency to collect dust and get out of order, will preclude the general use they might otherwise have. I know of no successful inside blind adapted to school uses.

Unforeseen Obstructions.—A school has perhaps been constructed without fire-escapes. Later they are put on and as a result a large fraction of the light is cut off from some room otherwise moderately well lighted. Trees and ivy may so gradually encroach upon the light as to escape notice.

The Furnishing of Rooms.—Through some shortsightedness in furnishing a room with its seats and desks, light intended to come from one side is sometimes made to come from some other. For example, in a room lighted on two adjacent sides the desks may be put in so as to make the lighting from the right and rear instead of from the left and rear,

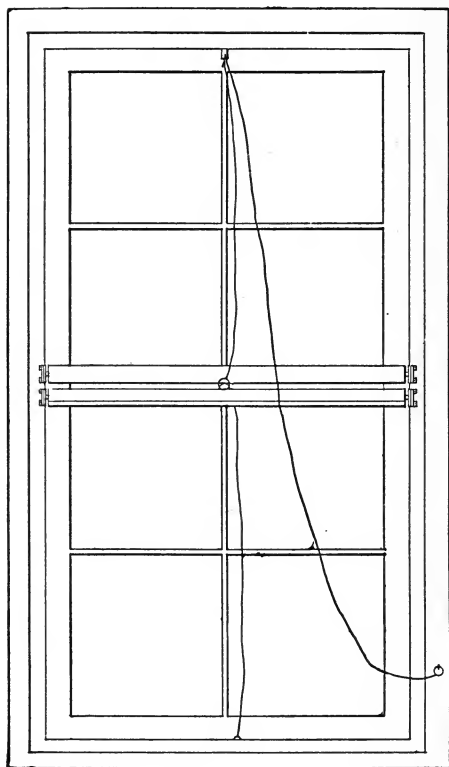

FIG. 24 a.—Double curtain shades. (Rolled up.)

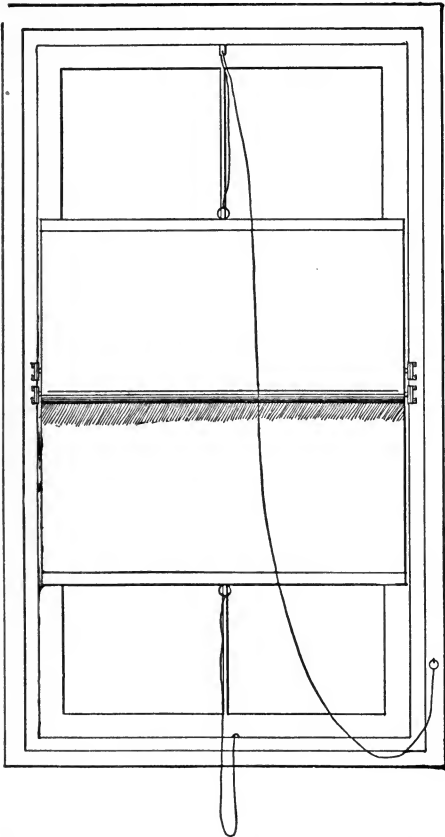

FIG. 24 b.—Double curtain shades. (Partly drawn.)



as was originally intended. The desks may be too high or too low for the pupils, and so the work be brought too near or too far from the eye, and the advantages of having a good building may be again counterbalanced by this mistake in furnishing.

With very few exceptions, of which New York City is the most notable, desks are not furnished American children which give a place for the book while the child reads or studies, it being considered sufficient to furnish a proper writing surface. Much might be said on this point. It cannot be denied that a better position is secured for the book where such provision is made for the child who is reading or studying. On the other hand, the furniture becomes very complicated and the habit of taking an easy natural position with the book is not so readily formed, which, after all, is most to be desired.

Artificial Distribution of the Light.—Modern science has not only found a way to build a well-lighted school-room, but also seeks to control at will the distribution of the light furnished a room. The use of corrugated or ribbed glass has been common for some time as a distributor of light.

(a) **The Prism.**—Now the principle of the prism has been worked out so that by mathematics the whole question of distributing the light can be decided at least within the limits of the possibilities of the prism. The value of ribbed or corrugated glass is a little doubtful owing to its bright lines and the

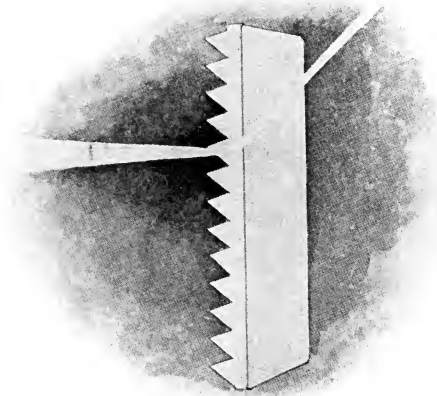

Inside. Outside.



FIG. 25 — Side and front views of four-inch sections of prism glass.

attention called to them by their gleaming, though there is every reason to believe that light is diffused to a greater degree and that there is a more equal distribution of the light than occurs when the light is dropped to the floor through plain glass. The prism glass is, however, more exact and the light can be placed just where it is needed, though not without cutting off some rays that would go to desks near the windows. (See Figs. 25 and 26.) This is not a serious matter, however, inasmuch as the light increases inversely as the square of the distance, much to the advantage of seats near windows. The prism glass is expensive, and it would frequently pay better to remodel than to use it. As dirt may easily accumulate upon the ridges, prism glass needs frequent washing.

(b) **Reflectors.**—Reflectors have also been used very advantageously in German schools, cutting off the sun or sky light and throwing it onto the ceiling. They are described as follows, and are illustrated in the accompanying cut. (See Fig. 27.) “It is composed of a somewhat wavy plate of glass coated with silver and attached to the windows at an angle of about 45° . The corrugation increases the surface of reflection and secures a better distribution of the light. The layer of silver, which increases the intensity of reflection, is given a coat of water-proof varnish to protect it from the weather.”

(c) **Glass Brick.**—In Germany also glass bricks

have been used with good results. (See Fig. 28.) It would hardly seem necessary when so large a proportion of wall space can be given to window space by our best architectural skill, but conditions can very readily be imagined that would be materially bettered by the use of such a device. They are shaped as

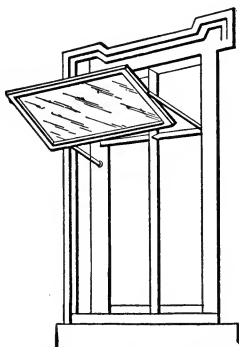
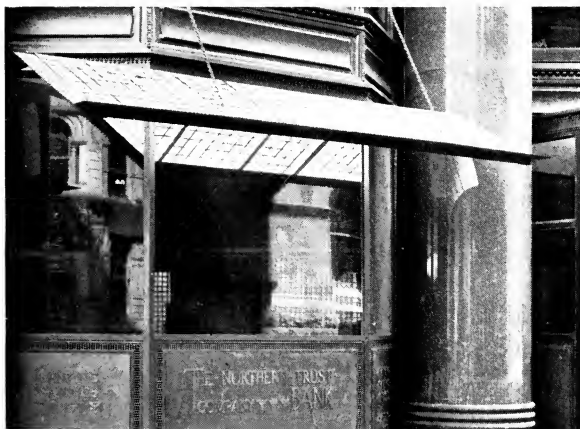

FIG. 27.—Hennig's daylight reflector.



FIG. 28.—Glass brick, a block made for use in heavy walls.

shown in the illustration, and are described by Eulenberg and Bach as .06 of a metre at the top, .14 of a metre wide at the middle, and having a total length or height of .20 metre. It would take from forty-five to sixty bricks, according to the form, to cover a square metre, and they would cost from \$3 to \$4. They are said to be very practical, to be capable of artistic treatment, and to produce a somewhat weird effect. I know of no company manufacturing them in this country.



A prism glass canopy.



FIG. 26.—A room made fit for school purposes only by use of prism glass.

How to Reduce the Light.—To control the light by reducing it, blinds and curtains of various sorts have been used. If some practical combination of the reflector with the Venetian curtain could be devised, it would seem that that would be the ideal form of shade; but I know of no such article, and probably the cheap, light, and not too opaque double curtains fastened at the middle of the window and pulling up and down, are the best practical reducer of the light. To cut off the sun's heat, a blind which slides up and down, in two or three sections, has been advocated. Ordinary awnings seem to be about as desirable, though perhaps not so permanent. They can be raised and lowered to any desired angle and are much cheaper, but there is danger of cutting off too much light both with blinds and awnings.

Artificial Illumination.—A great deal used to be written on artificial illumination. Modern science has reduced that to a word, certainly for all cities, the magic word, electricity. While common gas or kerosene, burnt to give the light of twelve candles equal to 120 grams per hour, consumes from four to six cubic feet of oxygen each hour and produces from three to four cubic feet of carbonic-acid gas in the same time, the incandescent electric lamp burns no oxygen and makes no carbonic-acid gas. Again, common gas and kerosene, under the same conditions, consume from sixteen to twenty-five cubic feet of air and vitiate from fifteen to twenty times that amount, whereas the only

effect of the electric light upon the air is to heat it, and that about one-twentieth as much as the gas or petroleum light. This is not quite so true of the ordinary forms of the arc-light, but its unsteadiness forbids its use in the school-room.

The light should be ranged from some centre of diffusion in the ceiling, or be ranged along the left side and centre of the ceiling, to secure immunity from shadows, the same general principles holding for this light as for the sunlight.

Architect Snyder, Superintendent of School-buildings in New York City, favors the reflection or diffusion of all artificial light from the ceiling. This would cut off all chance of getting the direct glow in the eyes of the children, and therefore remove all danger of retinal irritation. This method is expensive, however, as much more light would be needed, and it is to be hoped that not much work need be done where artificial light must be used.

Next to the electric light, gas with the calcium mantles is certainly second.

The Holophane globe, an adaptation of the principle of the prism to globe-making, will be of assistance in utilizing rays which would otherwise go up to the ceiling and in softening the otherwise too piercing light of the incandescent lamp or the calcium mantle. Reflectors are also used for throwing back the rays from the ceiling.

THE ARCHITECT'S PART

B. *In Remodeling an Old Building.*

It is not the province of this paper merely to consider the principles involved in the lighting as applied to a new building. In the remainder of this section the architect's part in the remodeling of old buildings will be under discussion.

How to Discover the Cause of Defective Light.—By the use of the Jaeger test types¹ on a cloudy day the seriousness of the defect may be detected. What, then, is its source or kind? This will be found to consist in some violation of the principles laid down above. These violations, perhaps necessary under the imposed conditions, or more likely due to the carelessness and ignorance of a contract system, may be discovered by a judicious application of the following test questions:

1. Are all such obstructions as buildings, fire-escapes, or trees, either guarded against or so placed that they will not deprive the children of the direct light from the sky?

2. Is light put where it is wanted without waste?

3. Is the ratio of window-glass to floor surface one to six or better?

¹ Where the diamond type, No. 1, can be read by the normal eye at a distance of twelve inches, the light is satisfactory. See Appendix II and page 71.

4. Are the windows on the left side, or in such combinations as neither cause shadows nor force the children to face the light?

5. Is the top of the window not more than six inches below the ceiling and without arching? Is the bottom of the window at least three or three and a half feet from the floor?

6. Have all large piers between the windows or posts inside the rooms, which obstruct the light for certain seats, been done away with by skilful planning?

These questions will suffice for applying the really fundamental principles and for discovering the nature of the defects.

There are various devices which play a less important rôle in the construction of the building, provided the main principles have been properly regarded, but are indispensable if some of these factors have been disregarded or overlooked.

Devices which May Be Efficacious.—The most important and useful of these devices will appear in the following questions, which will serve both to test the further completeness of the work and to point out, if the defects are not too marked, the best methods of bringing up to the standard old buildings which have been built in opposition to fundamental principles of lighting. It may be said, however, that no device is so generally satisfactory as that of increasing the window surface.

7. Have the lintels, mullions or piers, and frames been beveled?

8. Is the color of the walls or ceiling too dark?

9. Do the blackboards need curtaining to get a greater reflecting surface?

10. Has the best possible arrangement of the rooms with due regard to economy of the light been secured?

11. Have the desks been arranged in accordance with the best possible lighting?

12. Have modern devices, such as prism-glass, reflectors, etc., been made use of where there has been any especial difficulty?

Notice also whether the curtains are so placed as to take the minimum of light when not in use; and in case of artificial illumination, see to it that enough lamps or burners are provided to enable pupils at each desk to read type¹ at the normal distance.

Typical Deficiencies, How Removed.—Having made a test of our building with these points in mind, our next and most important question is what we are going to do if it falls short. This depends upon the principle violated or the nature and extent of this defect.

(a) **Obstructions.**—In case of an obstruction this should be removed, if it is any way possible. If it is a question of putting the fire-escapes in some other place, or of cutting down trees, the difficulty is very

¹ See note on page 59.

easily remedied. If a house or building of some sort has been erected, the light cannot be restored without removing the building. Sometimes painting the building white will make a material difference, while every advantage should be taken of the devices for increasing the light in the room by using more window surface, by securing more and brighter reflecting surface, and by obtaining better distribution of the light. Prism-glass, reflectors, etc., can certainly be used to help toward this end, but may not be sufficient to entirely remove the deficiency. If all fails, the abandonment of the seats farthest from the windows must follow.

(b) **Wasted Light.**—If light is wasted on rooms seldom or never used, the rearrangement of the rooms is highly desirable and can doubtless be effected without very serious expense. This applies to buildings where dressing-rooms take light which should go to the school-room. There may be some expense involved, but it is foolish and criminal not to put a school in good hygienic condition, if by an outlay of a few hundred dollars the eyes of many children might be saved and their general health be greatly improved. By putting, for example, a play-room or kindergarten, which occupies perhaps the space of two ordinary school-rooms, in a light corner room adjoining a room which would be too dark for ordinary school uses unless it were opened into the other and all partitions done away with, both rooms are

well lighted and otherwise waste space is utilized without loss. The displacement of opaque partitions in whole or in part by partitions which will at least allow the surplus light from one room to help that of its less favored neighbor will operate very favorably in lighting many rooms whose adequate illumination would otherwise be quite difficult. Similarly the use of glass even in a door may be all that is necessary to properly light two or three neighboring desks otherwise just lacking the required amount of light.

(c) **Too Little Window Surface.**—If the defect is due to the fact that we have only a tenth as much window-glass as we have floor, it is generally very difficult to remedy, and the only thing that ought in all good reason to be done is to have the window space enlarged. This is in almost all cases possible, although at a considerable expense. Still it is better to make some outlay than to abandon all the poorly lighted seats, which would necessitate greater expense for the erection of a building to hold the children excluded by the poor lighting. If the ratio is almost one to six, it is possible that by beveling and by the use of reflectors, prism-glass, and the other helps to diffusion, that sufficient light may be secured on all but the darkest days, when the character of the school-work should be changed.

Briggs has figured the area of frames, sash, and boxing of five ordinary four-by-eight windows as equal to twenty-two and a third square feet. There-

fore large window-panes (say two to the average window) do away with quite an area of frame, which has a darkening effect.

It should not be forgotten in one-story school-houses that lighting from the roof is both possible, and in some instances, particularly when the side-walls are low, very desirable, nor in most cases is a large area of roof window necessary.

It will very likely be found that the abandonment of the row of seats farthest from the windows is all that is needed; though this is dangerous unless the seats are actually taken out of the room. Every effort should be made to increase the window surface in all cases when it falls below the required ratio.

Light from the Wrong Direction.—No defect can be much more easily overcome than the serious one of the light coming from the wrong side. There are probably in this country very few schools where the light does not come from the left side. Where it does not, the seats and desks should be taken up and put down again, so that the side of the room furnishing the light should be at the left, no matter how inconvenient this new arrangement may appear to be from the standpoint of the use of blackboards, the position of the doors, etc.—all these are minor points and the difficulty is largely imaginary. If there is a platform or anything of the sort in the room which stands in the way of re-arrangement, it should be removed. Froebel condemned the platform in the ordinary

school-room for all time. In all the forbidden combinations, such as the right and rear, or those with front light, the rearrangement of the seats makes it possible to give at least favorable conditions. For example, left and front light, as may be readily seen, can be changed to left and rear. Right and front light can be changed to left and rear. Rear and front light may be changed to left and right. Right and rear may be changed to left and rear. It will thus be seen that light from any one or two sides may, by changing the direction of the desk and seats, be made to come from the left and from one of the two permissible combinations, left and right, or left and rear.

By carrying the windows two or three feet higher many an old building with the top of its windows three or four feet from the ceiling of the room could very easily be brought up to the requirements of good lighting. Where the arching of a window or pair of windows cuts off valuable light, the defect is best remedied by remodeling the windows, if not the building. (See Fig. 29.) The bottom of the windows is seldom too high from the floor, but the minimum of three feet for primary children is frequently reduced several inches with danger of distracting and even harmful reflections. Not less than three feet from the floor for the sill must be our rule, if the pupil's heads are to be kept below the level of the bottom of the window. Nor should the distance from the floor be so great as to cut off needed light.

Great spaces between windows continually shade certain desks, in some cases very seriously. Here, again, the best help is the actual cutting out of the pier, replacing it by window surface, and with one iron mullion to take the place of the former heavy pier.

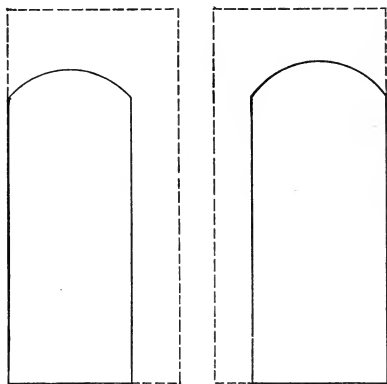

FIG. 29.—Two old style windows with wide pier between them. Dotted lines show additional light obtained by use of mullion and by carrying windows as near the ceiling as possible.

It is in such places that glass brick could also be utilized to bring up the lighting to a normal standard.

It is, of course, impossible practically to remove pillars or posts inside the room supporting the floors above. Where these are used we must be very careful to see to it that any desks shaded by these pillars are abandoned. This cannot be too urgently pressed. The influence of these obstructions is perceptible.

Similar Methods in All Cases.—It is to be conceded that in the foregoing not every possible perversion of the lighting has been considered, but it is believed that the more usual and typical forms of inadequate lighting have been indicated in brief manner, together with the violation of principle responsible for them and the most desirable practical means of overcoming the deficiency. Similar applications of the available devices may be made for any defect according to its nature and extent.

THE TEACHER'S DUTY

The most perfect architectural plans have not and will not rid the school of defective eyes without a more decided co-operation on the part of the teacher and the parent. Only a little experience in the school-room is necessary to show that the following facts are true:

1. Many teachers allow bad positions on the part of the children while they write and read. The eyes are allowed to get too near their work. In writing a stooping posture cuts off light from the paper. The same may be true of the reading, as by the very effort of the children to do well they unconsciously, in straining for a better view, draw the book up too near the eye. Again, they may read with the binding of the book lighted instead of the page, especially if, as they

range around the teacher, some or all of them face the windows.

2. Some teachers do not co-operate with the architect in his designs for lighting the room. This is shown in a careless and ignorant manipulation of the shades (especially in the cutting off of high light), or in a failure to attend to the varying conditions of sun and cloud presenting themselves during the day.

3. Many teachers are ignorant as to what constitutes a well-lighted room, and in case of defective lighting do not know how to determine its extent. They are therefore unable to take steps toward remedying it either by extra care on their own part or by enlisting the aid of others.

4. Most teachers do not watch not test the children's eyes for cases of incipient defect, and so give them an opportunity to protect their eyes, while there is time.

5. The care of the eyes is not taught in any practical or helpful way.

Each of these charges suggests a corresponding duty to the teacher.

(1) The oculists tell us that fifteen inches is the nearest that a child can approach his work without danger to the eye. The observance of this principle must be enforced, be it ever so hard. Children should use their rulers to measure the distance. (See Fig. 30.) They should, if need be while writing, hold the end of the ruler between the thumb and forefinger of the



left hand, leaving the other fingers to hold the paper in place. Then as the ruler points toward their heads, it serves both as a reminder and as a concrete example of the distance to be regarded. Pictures of Mr. Straight and Mr. Crooked (the latter playing the rôle of the sad example) should be placed on the black-

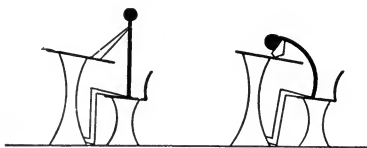

FIG. 31.—Mr. Straight and Mr. Crooked.

board (see Fig. 31), and any other devices which the ingenuity of the teacher may suggest should be used to overcome this most dangerous foe to the eyesight. The battle must be fought at the beginning of the school-year, and the teacher must be unyielding. No excuses are to be accepted. If the children claim they cannot see, test their eyes, and you will soon see that with very few exceptions there is no such defect as to make it impossible to see at a distance of twelve inches from their work. In these, as in other cases of defectiveness, glasses should be worn to bring the eyes up to the normal. Nor is the excuse of the child that he cannot write well to be taken. He might far better write wretchedly than ruin his eyesight, and there is no reason why he cannot both write well and at the

same time take a proper posture. The position of the pen or pencil is a minor point compared with that of the body, neck, and head, but the last is more often neglected.

The Germans have recognized this difficulty and have, with their customary tendency to mould rather than to train, invented a head or face rest which is fastened to the desk and supports the chin, thus keeping the head at the proper distance; while still more ingenious is a contrivance consisting of delicately balanced blinders looking like spectacles, so arranged that if the child bends forward toward his work beyond a certain angle the blinders drop from the frame and he can see nothing until he has restored them to their former position by raising his head.

(2) The teacher should study the best arrangement of the shades in his room for each hour of the day. It is seldom necessary that all the shades be drawn at the same time so as to exclude the sun. When it is cloudy the light should be given every opportunity to enter. Any lighting can be perverted by the teacher's handling of the shades. Light must not be taken from the rear when the architect intended to have it come from the left. But most frequent is the error of leaving the whole or a large part of the upper half of the windows shaded and the attempt to get the light from the lower and therefore much the less valuable part of the window.

The failure of teachers to adjust the desks to short-

waisted or even average children, where this is possible, is only another tangible evidence of the common neglect of the duty to care for the eyesight. If the furniture cannot be fitted to the children, the latter must, as far as possible, be fitted to the furniture.

(3) By the use of Jaeger's test-types, obtainable of any optician at a nominal price, anyone can determine whether the light at a given desk is sufficient or not. If the diamond type, No. 1, can be read by a normal eye with facility at a distance of twelve inches, the light is satisfactory. A better measure of the light, however, is Cohn's light-tester, directions for the use of which will be found in Appendix II together with other suggestions for testing the light. In case neither the Jaeger types nor Cohn's light-tester are accessible, the following poem may be used at a distance not less than twelve inches. It should be read as rapidly at the point where the test is made as in good light.

L A T E

My father brought somebody up
To show us all asleep.
They came as softly up the stairs
As you could creep.

They whispered in the doorway there
And looked at us awhile.
I had my eyes shut up, but I
Could feel him smile.

I shut my eyes up close, and lay
As still as I could keep;
Because I knew he wanted us
To be asleep.

JOSEPHINE PRESTON PEABODY.

Having discovered desks that do not meet the requirements of any one of the above tests a teacher

should abandon them for all fine work, or should in some way secure better light. Every effort should be made to provide adequate light at any cost.

If this cannot be done, the poorly lighted desks must be condemned and removed, while on dark days recreative or blackboard exercises must be substituted for all close work.

If the difficulty is too much light, it can easily be remedied. Reflections from bright surfaces coming to the child's eye can be cut off by shades covering the lower half of the windows, while the direct rays of the sun may be cut off by shades on the upper sash.

(4) This is not the place to give directions for testing the eyes of children. But each teacher should take an inventory of the seeing quality of the eyes entrusted to his care.¹ If weaknesses develop, inflammation, discharge, or any other form of defectiveness, every means should be taken to remove the defect, or at least to prevent its increasing. Many cases of myopia could be cured, if they were only discovered in time. It will take but three or four hours' work to test an entire room of fifty children. Several States in this country make it compulsory to test the eyes of all school-children at certain periods. As a result, hundreds of defective eyes that were previously supposed to be sound have been discovered and submitted to treatment. Many superintendents also require that

¹ See Appendix III. for directions.

each child be tested soon after admission to their schools.

(5) The teacher should impress upon the children, both by precept and practice, the necessity of taking the best care of their eyesight. Common vices, such as reading or working in the twilight, reading by the firelight, while lying down or facing the glare of a lamp, should certainly be made specific topics for study, while staying after school to work on dark days, as well as the use of fine print and too small and indistinct writing on the blackboard, should be avoided. For the good of the eye as well as the general health the very least possible dust should be allowed in a school-room. Reflections from blackboards or maps are frequently troublesome. The effort to see at a distance the names of places on maps also entails a strain. No reading, writing, sewing or fine work of any sort is to be done except in the best light available. If that is not good, such work should not be done at all. Examples of these abuses of the eyesight may be found even in the rooms of expert teachers, while others are discovered in the homes of learned professors.

This brief criticism is written as a result of direct observation in the school-room, while the duties suggested must appeal to anyone interested in the preservation of the eyesight of the children. May our previous neglect point both to the errors of the past and the hopes of the future.

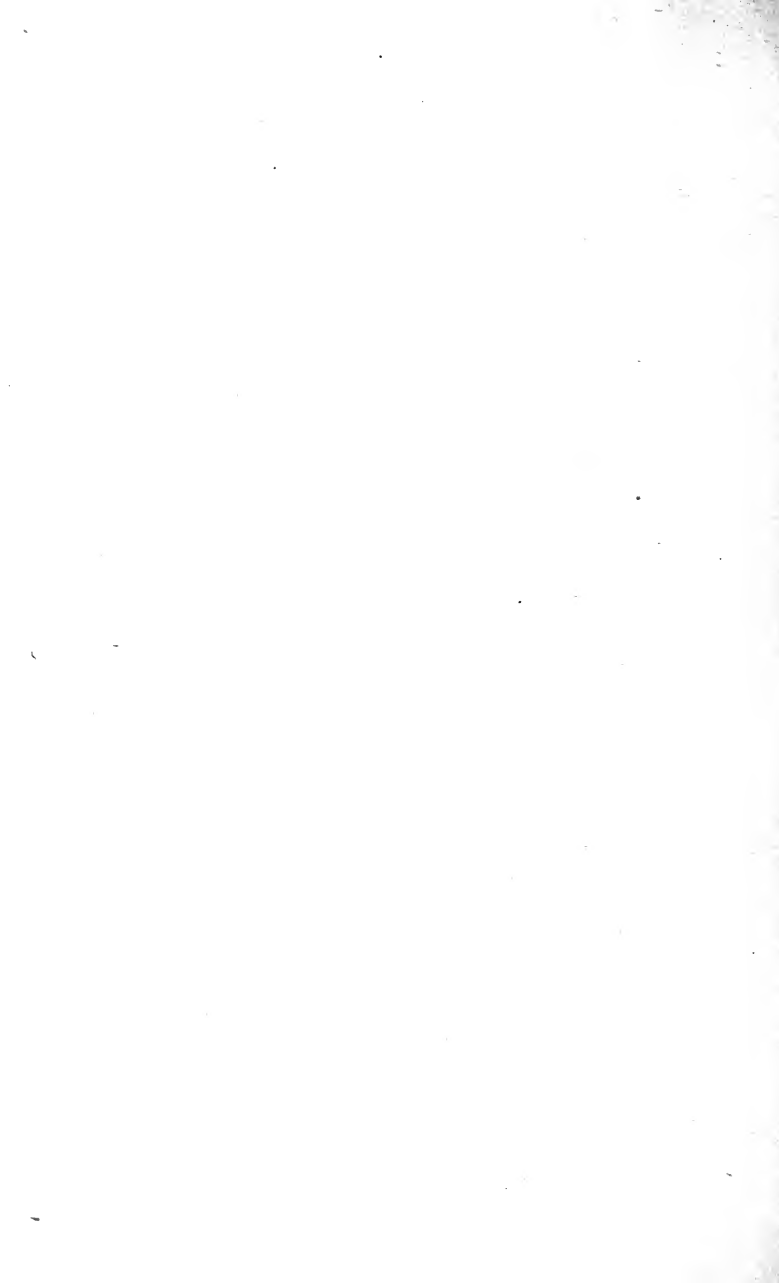



APPENDIX I

A MATHEMATICAL DEMONSTRATION AND ITS COROLLARY

ALTHOUGH it has never to my knowledge been demonstrated, the mathematics of the situation will be evident from the following: Take the dimensions of a standard room for forty pupils, as indicated on page 31, $30 \times 25 \times 13\frac{1}{2}$ in feet. Suppose the desk farthest from the window to be at least three feet away from the wall. It will then be twenty-two feet from the window. The windows can be carried within half a foot of the ceiling, so that, if the desk is two feet high, we need to deduct two and a half feet to get the total height of the top of the window above the top of the desk, which would be in this case, therefore, eleven feet.

The right-angled triangle ABC (see Fig. 32) formed by a point in the desk-top farthest from the window, its projection on the window-wall and a point in the top of the window vertically above this projection, must be similar to the triangle A'B'C' formed in the same vertical plane by the top of a building twice as far away as it is high, by its base and the base of the school, because the sides, including the right angle in each, are proportional. Therefore, the corresponding sides being parallel, the

hypotenuses of these triangles must be parallel, and the eye placed at the surface of the desk, it being higher than the ground, could see as many degrees of sky vertically as are represented by the angle BAB' , formed between the hypotenuse of the small triangle and a line drawn from the desk to the top of

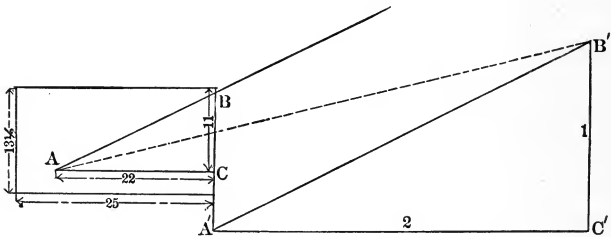

FIG. 32.

the opposite building. By proving that such an angle must inevitably be formed where an obstruction is distant not less than twice its height, we have brought this rule into consonance with that other which requires that the direct light of the sky be visible from each desk.

Conversely, if the triangle made in a vertical plane by the top and base of the opposing building and the base of the school-house has its base less than twice its height, then such allowance must be made in the construction and use of the school-building as to make it possible in all first-floor class-rooms for the triangle made in a vertical plane by the farthest desk-

top, the nearest point on window-wall to it and the top of the window to have the same relation between its height and base as the larger triangle. That is, the ratio of BC to AC must always be equal to or greater than B'C' to A'C', as in the above figure.

In applying these principles to upper-floor rooms, the height of the room above the first floor may be deducted from the height of the obstruction. But, if the first floor is properly lighted, there should be no trouble with the upper floors.

Moreover, if the room is, or is planned to be, deeper than twenty-five feet, either it must be considerably above the ground level, or the desk must be brought nearer the window, or the top of the window carried higher.

APPENDIX II

HOW TO TEST THE LIGHT

IN testing the *light*, the Jaeger test-type No. 1, is far better than the large Snellen types, such as are regularly used in testing the eyes, because they can be used at the exact angles at which the child works, whereas the other must be stood up at some unnatural angle, receiving possibly quite different light from that we wish to test.

Some years ago Dr. Herman Cohn invented a light-tester (Licht-Prüfer). It enables one to cut off approximately 99 per cent., 95 per cent., or 80 per cent. of the light. He claims one should never use light so dim that one could not see as well at 40 ctm. with one fifth of it as he could with the whole of it, since it may easily vary more than that in a few minutes. Dr. Cohn found the daylight at his desk between 12 and 2 o'clock in November, 1898, to vary from 67 to 2,420 meter-candles. Where light is bad, one can determine just how much nearer the object must be brought to the eye in order that a larger retinal image may make up for lack of light, each centimetre counting in the danger to the eye. His light-

tester is a decided improvement over the hit-or-miss use of the Jaeger types. It is eminently practical, fairly accurate, and deserves more notice than it has received, at least in this country both in schools and factories. It may be obtained of Fritz Tiessen, Adalbertstrasse 16, Breslau, Germany, for 15 marks.

In appearance and use it resembles a stereoscope but lacks the glass; and instead of double pictures cards with small printed figures are placed in the holder. This is to be kept 40 ctm. away from the eye unless it is desired to measure how much nearer the numbers must be brought to make up for lack of light. This description will suffice for putting the apparatus together, but for any interested in having directions in English the following digest will be sufficient:

The investigator must first make sure that he can read the numbers with ease in a good light at 40 ctm. without the screens. Next, with the aid of an assistant who times him, he determines how many four-place figures he can read in 30 seconds, errors, if any, being noted by the assistant and the numbers being read down through the columns without using the screens. The figures should be read in pairs, i. e., 2463 would be read twenty-four sixty-three. The element of speed is an important part of the test, as will appear immediately. Place the light-tester in such a position that the print will have the same light ordinarily given the work at the point where the test is made. Place one of the screens between the eye and

the numbers and close the eyes for two minutes to accustom them to the diminished light. With the aid of the assistant note how many figures can be read in 30 seconds. If as many numbers are read and no more errors made than in good light in spite of the screen, which cuts off four-fifths of the light, the light is satisfactory. If not, *daylight*, owing to its variability, must be counted unsatisfactory. If the light meets the requirements of this test, two or even three screens may be used to determine whether it is to be classed as good or excellent. In case of a steady *artificial* light, it will be enough if the numbers can be read at a distance of 40 ctm. without the screens, as in this case there will be no variation in the light to be taken into account. Though the scale makes it very easy to determine the distance the printed numbers must be brought nearer the eye that the increase in the size of the image on the retina may make up for the lack of light, there is little need of it. Every centimeter nearer than 40 means injury to the eye and all unsatisfactory desks or work places should be abandoned until enough additional light has been furnished to bring them up to the standard.

Dr. Cohn's light-tester was made possible by Dr. Weber's much more accurate but complicated photometer, which makes it possible to compare the light of a given place with that of a candle a metre distant. I have discovered no account of any records made with it in this country, though I suspect there have

been such in some instances without being published.¹ In practice the Jaeger test-type is used, though often in a rough and unsatisfactory way, but Weber's photometer is the most scientific measure we have of the light. His stereogoniometer is of much less use, as no measure of the number of square degrees of sky that can be seen from a given point will correspond to the amount of light received at that point. Smoke, point of compass, elevation, obstructions, etc., all necessitate a measure of the actual light itself. (See also page 71.)

¹ A reference to some tests made with his light-tester by myself will be found on page 30. Others are in process to test the results of soft-coal smoke.

APPENDIX III

HOW TO TEST THE EYES OF CHILDREN

SNELLEN'S test-types are ordinarily used for testing the eyes. Excellent copies of these types, with other material mentioned below, well mounted, will be sent on application by the Secretary of the Connecticut State Board of Education, Hartford, Conn., at a nominal price. The following points are adapted from the circular of instructions, to be obtained from the same source, and from my book on the "Physical Nature of the Child."

1. The charts are to be kept out of sight when not in use.

2. When used they are to be hung in a good light, neither in the sun nor in the shadow, nor in range with a window, but receiving a side illumination.

3. Place the child twenty feet from the chart, and as each eye is to be tested separately, cover one eye (though it is to remain open) with a piece of pasteboard so as not to press the eye.

4. Have him read aloud the letters from the top down, and note the lowest line read correctly. Repeat with the other eye. If the line designated as 20 or XX is read, the eye is normal. If most of these,

and some two or three letters in the line designated by 30 or XXX are read incorrectly with either eye, the eye failing should be examined by an oculist. In other cases, where he fails only on three or four of the letters designated for twenty feet, it is on the average as well to consider the case doubtful and watch it for future developments, favoring the child on his light meanwhile.

5. A chart of E's is used where children do not know their letters. The teacher should stand by the chart and point out the different characters, asking which is the open side. It is well to have the child indicate the open side by a gesture of the hand in the direction corresponding to that side. A whole room may be drilled in advance in this exercise by E's put on the blackboard in all sorts of positions.

6. In all charts teachers must be careful not to mark them with lead-pencil as letters are pointed out.

7. If a teacher suspects that answers are being made from memory, a hole about one and a half inches square may be cut in a piece of cardboard, and this may be used to cover the lines, exposing only one or two letters at a time through the hole. By applying this rapidly at various points, this difficulty may be obviated.

8. The five cautions needed are:

a. Hang the card in a good light.

b. Keep it clean, free from finger or lead-pencil marks.

- c. Keep it out of sight when not in use.
- d. Test one eye at a time.
- e. See that the other eye is properly covered.

Experience in schools with various methods of testing have demonstrated, I believe conclusively, the following:

1. Testing children by the method of different distances is very little more accurate and much more difficult than by placing the child at twenty feet and letting him tell what he can see of the test card. If he can see nothing, other distances need be tried only to make sure he understands what he is expected to do or to try to do.

2. The E chart is the most satisfactory for younger children.

3. Parents should be notified wherever children are found to be defective, and urged, if necessary, to consult an oculist. But percentages or fractions indicating the degree of defect result in clashes between the oculist and the teacher, besides giving a halo of accuracy to the latter's results which they should not pretend to possess.

4. Tests of focusing power and astigmatism are absolutely unsatisfactory in teachers' hands and add nothing to the regular test.

5. Tests with a small type may be useful in proving that children can see who claim not to be able to see their writing when proper position is maintained.

6. Either large or small type may be used to ascer-

tain whether the light is sufficient at any given point or not. Whenever there is doubt in case of some seats, whether due to soft-coal smoke, late afternoon hours, or other adverse conditions, tests should be made at those seats. See Appendix II.



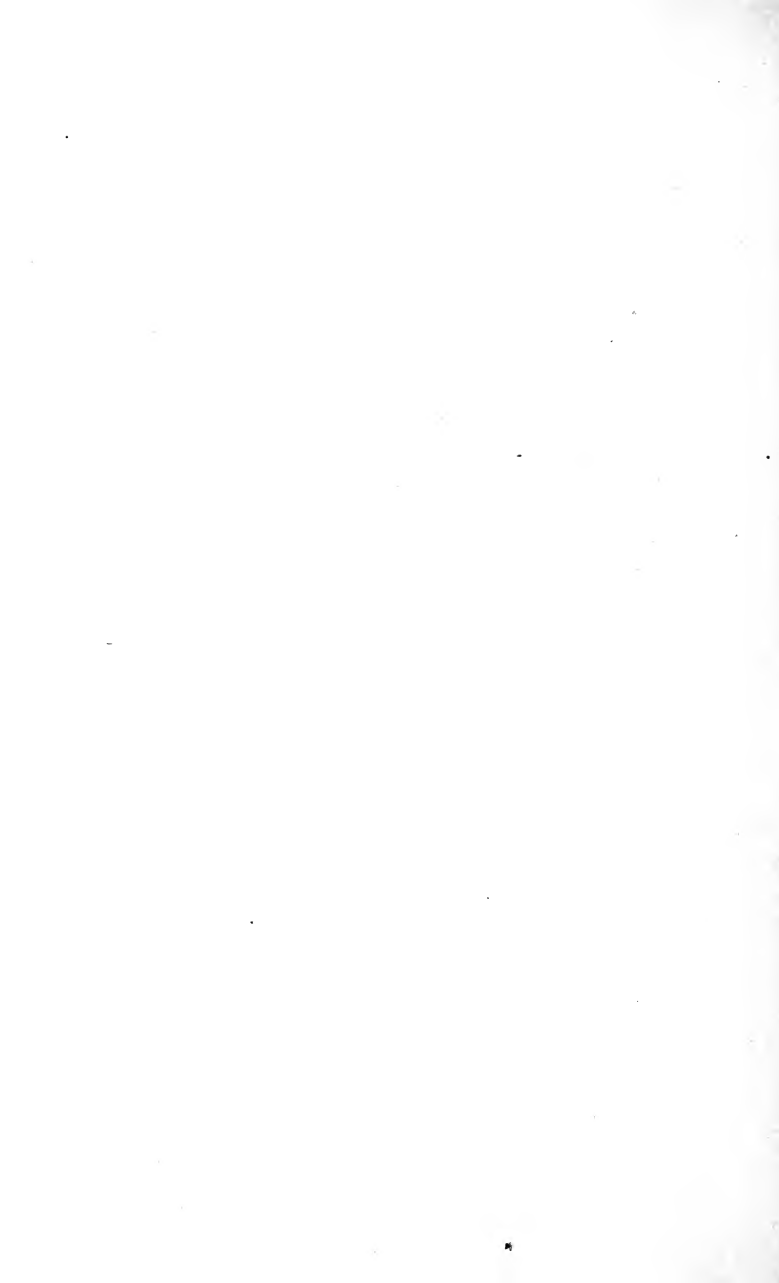

BIBLIOGRAPHY

1. **Municipal Architecture in Boston.** Edited by Francis W. Chandler. Boston, 1898. (Contains a special chapter on school-buildings, with a large number of plates and plans of school-houses drawn by Edmund M. Wheelwright, City Architect 1891 to 1895.)
2. **BRIGGS: Modern American School Buildings.** New York, 1899. (Shows a consistent and successful effort to work out unilateral lighting from the left.)
3. **RISLEY: Chapter on School Hygiene,** in Norris and Oliver's *System of Disease of the Eye.* Lippincott, 1897. (An excellent, practical discussion of lighting of school buildings.)
4. **BURNHAM: Outlines of School Hygiene.** Pedagogical Seminary, Vol. II., No. 1, Worcester, Mass., 1892. (An excellent summary of the investigations on the subject of lighting is to be found here.)
5. **COHN: Hygiene of the Eye.** London, 1886. (Among the first to investigate scientifically the lighting of school-buildings.)
6. **EULENBERG and BACH: Schulgesundheitslehre.** Second edition. Berlin, 1900. (This is the latest and most practical of the three standard German works on School Hygiene.)
7. **BAGINSKY: Handbuch der Schulhygiene.** Third edition. Stuttgart, 1898 (first volume), and 1900 (second volume). (Deals more generally with the principles underlying the form of lighting.)

8. BURGERSTEIN und NETOLITZKY: Handbuch der Schulhygiene. Jena, 1895. (Very good.)
9. JAVAL: Daylight in the Schoolroom. New York. (A good work. Advocates right and left lighting.)
10. KOTELMANN: School Hygiene. Syracuse, N. Y., 1899. (Contains a good but short chapter on lighting, including a description of Weber's Photometer.)
11. ZWEZ: Das Schulhaus und dessen innere Einrichtung. Weimar, 1870. (Discusses at length the question of the most favorable points of compass.)
12. ROBSON: School Architecture. London, 1877. (The most eminent English authority, but out of date.)
13. BARNARD: School Architecture. Hartford, 1854. (Its first publication in the Connecticut Common School Journal in 1842 marked the beginning of attention to this subject in this country.)
14. YOUNG: Annual Report for 1891 of Maine State Board of Health. (Urges northerly lighting for the steadiness of the light.)
15. ROWE: Physical Nature of the Child and How to Study It. New York, 1899. (Gives directions for testing eyesight.)
16. MORRISON: School Architecture and Hygiene. In Education in the United States, edited by Dr. Butler. New York, 1900. (Contains some plates illustrating best forms of school-buildings.)
17. MARBLE: Sanitary Conditions for School-houses. Washington, D. C., 1889. (Touches lighting only briefly.)
18. WOODBRIDGE: Report on the Hygienic Condition of the Public School Buildings of Philadelphia. Philadelphia, 1897. (Shows our common violation of principles of lighting.)
19. Hand-buch der Architectür. Edited by Durm et al. Darmstadt, 1889. (Objects to ribbed or corrugated glass.)

20. COHN: Die Sehleistungen von 50,000 Breslauer Schulkindern. Breslau, 1899. (A valuable piece of work.)
21. WEBER: Band X., Heft I, and Band XI., Heft 1 of the Schriften des naturwissenschaftlichen Vereins für Schleswig-Holstein. (Contains results of his photometric tests for variations in the light.)
22. WHEELWRIGHT: School Architecture. Boston, 1901. (An excellent handbook, but does not treat the subject of lighting at all fully or systematically.)
23. BURRAGE and BAILEY: School Sanitation and Decoration. Boston, 1899. (Contains good suggestions for the color of walls and ceilings, but incomplete on lighting.)

VARIOUS KINDS OF WINDOW MATERIAL, WITH THE MANUFACTURERS OF THE SAME

GLASS: Supplied by local glaziers usually.

SASH: Made generally by local carpenters or builders.

IRON BEAMS FOR MULLIONS: Cambria Steel Manufacturing Co., Pittsburg, Pa. In general any large steel manufacturing company.

IRON MULLIONS (BRIGGS): Yale Safe and Iron Co., New Haven, Conn.

REVOLVING SASH: Bolles' Revolving and Sliding Sash Co., New York.

SASH SPRING BALANCES: Caldwell Spring Balance Co., New York; Pullman Sash Balance Co., Rochester, N. Y.

PRISM GLASS: American Luxfer Prism Co., New York.

REFLECTORS: D. Schuldener, New York.

GLASS BLOCKS (Glasbausteine): Jean Wimmersberg, Cologne, Germany.

VENETIAN BLINDS: James Godfrey Wilson, New York.

SHADES: Any dealer can supply the Standard Hand-made Tint or the Bancroft Sun-fast Holland.

HOLOPHANE GLASS GLOBES OR SHADES: Holophane Glass Co., New York.

LIGHT-TESTER (COHN): Fritz Tiessen, Adalbertstrasse 16, Breslau, Germany.

INDEX

- AIM of the lighting, 21
Air, 31, 43
Air-space, 31, 32
Arching of windows, 44, 60, 65
Architect, vii, 8, 15, 19, 20 ff., 38
Architecture, vi, 5, 8, 41, 44
Arrangement of rooms, 25 ff., 61, 62
Art rooms, 40, 41
Artificial distribution of light, 54
Artificial illumination, 57, 80
Assembly rooms, 25
Astigmatism, 84
Awnings, 57
- BAD positions, 67
Bailey, 49
Bancroft Sun-fast Holland curtain material, 50
Basement rooms, 11
Bevelling, 45 ff., 60, 63
Bilateral lighting, 34 ff., 38, 40
Blackboards, 49, 64
Blinders, 70
Blind walls, 16, 24, 38
Books, 36, 37
- Briggs, 27, 45, 46, 63
Burnham, Dr., 27
Burrage, 30
Buyers of land, 8, 19
- CAUSE of defective lighting, 59
Cautions in testing eyes, 83 ff.
Ceilings, 41, 49 ff.
Class-rooms, 25, 27
Clear glass, 48, 55
Cleaning windows, 40
Cohn, Dr. Hermann, viii, 28, 29, 47, 78
Cold climates, 43
Color of ceiling and side-walls, 49, 61
Columns, 48
Common vices, 73
Constructing a new building, 20 ff.
Corner lots, 15, 16
Corner rooms, 29, 38
Corrugated glass, 54
Country schools. See Rural schools
Cross-lights, 44
Curtaining blackboards, 49, 61
Curtains, vii, 31, 36

- DARK days, 21, 37, 38
 Defective eyesight, 8
 Desks, 20, 21, 36, 55, 61, 63,
 64, 70 ff.
 Devices, 60
 Diffusion of artificial light, 58
 Dimensions of rooms, 31
 Direction of the frontage, 17
 Dirt, 55
 Double curtain shades, 50,
 52, 53, 57
 Double windows, 43
- E-CHARTS, 83, 84
 Electricity, 57
 Eulenberg & Bach, 56
 Eyes, 4 ff., 33, 62, 68, 82 ff.
- FACING the light, 4, 33, 34,
 60
 Floor space, 27, 28, 30, 42, 43
 Förster, 30
 Focusing power, 84
 Frontage, 17, 81
 Full-quadrangle building, 24
 Furnishing rooms, 51
- GAS, 57 ff.
 Germany, 5, 18, 55, 70, 79
 Glass, 29, 30
 Glass brick, 29, 55, 66
 Glasses, 7, 69
 Glass floors, 29
 Ground floor, 11, 76
 Ground glass, 47
- HALF-QUADRANGLE building,
 16, 24, 26
- "Hand-made Tint" curtain
 shades, 50
 Heating, 19
 Hennig's reflector, 56
 Holophane globe, 58
 Hood, 43
 H-shaped building, 15, 18,
 24 ff.
- INSIDE blinds, 50
 Iron beam, 29
 Irritation of retina, 35, 49
- JAEGER test types, 59, 71, 78
- KEROSENE, 57 ff.
- LAND, 8, 13, 15, 19
 Light from wrong direction,
 30, 64
 Light-tester, 30, 39, 50, 71, 78
 Lighting from above, 40, 64
 Lighting from front, 33, 65
 Lighting from left, 33 ff., 36,
 60
 Lighting from left and rear, 34
 ff., 37, 38 ff., 40, 51, 65
 Lighting from rear, 33
 Lighting from right, 33
 Lighting from right and left,
 34 ff., 40, 65
 Lighting from right and rear,
 34, 51
 Lintels, 45
 Location of the light, 32 ff., 60
 Location of the windows, 41
 Lot, 14, 15
 L-shaped building, 17, 24
 Lowest floor, 19

- "MODERN American School Buildings," by Briggs, 45
 Mullions, 29, 44 ff., 66
 Mr. Straight and Mr. Crooked, 69
 Myopia, 5 ff., 47, 72
 NEAR-SIGHT, 4 ff.
 Neighboring buildings, 11
 New York City, 46, 54
 Northeast, 17
 Northwest, 17
 OBLONG building, 24
 Obstructions, vi, 11 ff., 18, 19, 27, 30, 38, 51, 59, 60 ff., 75 ff., 81
 One-floor buildings, 40
 Outside windows, 43
 Overhead lighting, 40, 41, 64
 PAPER, 6
 Partitions, 35, 63
 Philadelphia, 6
 Photometer, 39, 80
 "Physical Nature of the Child," by Rowe, 82
 Piers, 35, 43, 44 ff., 60, 66
 Pillars, 48, 66
 Plastering, 49
 Principles, v, 9, 10, 25, 59, 77
 Prism glass, 54 ff., 58, 61, 63
 Private schools, 4
 READING, 33, 35, 54, 67
 Reducing the light, 30, 50
 Relation of window space to floor space, 27 ff., 34, 39, 42 ff., 59, 64
 Reflectors, 55, 56, 58, 61, 63
 Reflections from bright surfaces, 30, 41, 65, 72, 73
 Remodelling an old building, 59 ff.
 Revolving sash, 40
 Ribbed glass, 54
 Risley, 3 ff.
 Robson, 43
 Rough-plate, 47
 Rural schools, 35, 40
 SANITARY requirements, 20 ff.
 Sanitary science, 4
 Sashes, 31, 43
 School hygiene, 10
 Seats, 6
 Selection of the site, 10
 Sewing, 73
 Shades, vii, 36, 37, 50 ff., 68, 70
 Shadows, 4, 35, 36, 37, 44, 60
 Side-walls, 43, 49 ff.
 Site, 8 ff., 19, 44
 Size of site, 11
 Sky, 11, 12, 24, 30, 39, 55, 76
 Smoke, 38, 39, 81, 85
 Snyder, Architect C. B. J., 26, 58
 Soft-coal, 38, 39, 40, 41, 85
 Soot, 40
 South side, 17, 24, 25
 Southeast rooms, 17
 Southwest rooms, 17
 Square building, 24
 Standard rooms, 31 ff., 42
 Stereogonometer, 81
 Streets, 15, 16

- Structure of window, 44
 Sun, 13, 17, 36, 40, 50, 55, 57, 68
 Sunlight, 13, 17, 50
 Switzerland, 30
- TEACHER, vii, 9, 30, 35, 39, 41,
 67 ff.
- Testing the eye, 9, 68, 72, 82 ff.
 Testing the light, 9, 30, 71 ff.,
 78 ff.
- Too meagre window surface, 63
 Too much light, 30
 Too small a site, 19
 Top floors, 40
 Top of window, 44, 60, 65, 75
 Type of building, 15, 16, 19,
 21 ff.
- Typical deficiencies, 61
- UNFORESEEN obstructions, 51
 Unilateral lighting, 30, 33 ff.,
 38, 40
- Unity of the light, 38, 44
 Upper floors, 44, 77
 Upper part of windows, 41, 43
- VARIATION in daylight, 78, 80
 Venetian blinds, 51, 57
 Ventilating, 19, 20, 32, 43
 Voice of teacher, 32
- WASTED light, 62
 Weber, 80
 Width of window, 44
 Windows, 25, 44 ff.
 Window boxes, 45, 46
 Window space, 27 ff., 42, 43
 Window surface, 39, 63
 Wooden mullions, 29
 Writing, 33, 34, 35, 37, 54, 67,
 73
- ZERO weather, 43



The Ventilation, Heating, and Management of Churches and Public Buildings.

By J. W. THOMAS, F.I.C., F.C.S.

With Diagrams. Crown 8vo. \$1.00.

This is a practical treatise showing the prevailing errors in the ventilation of churches, halls, schools, and other public buildings, and pointing out how the faults can be remedied. The information bearing upon the effects of wind action, and the intermittent air currents in public buildings, was obtained by experiments, or elucidated in the course of the author's practical experience, and these, together with the studies in the physics of ventilation set forth, cannot fail to be of value to architects and builders, as well as to the managers and caretakers of public buildings.

The author has endeavored to compress much practical matter into the smallest compass, and the scientific and technical information regarding the composition of the atmosphere, etc., has been omitted because it can be obtained in any book on physics.

Portions of the treatise have been compiled especially to enable caretakers to make the best use of the ventilating appliances which they have to control, and as there is no book on the subject, and great need for such information, it is hoped the matter provided will prove useful and instructive.

The illustrations are not intended to be complete drawings of the buildings in question, but are only given to show the air currents and other information in reference to the air supply. —AUTHOR'S PREFACE.

LONGMANS, GREEN & CO.

91 and 93 Fifth Avenue,

New York

A History of Architecture.

BY

A. D. F. HAMLIN, A.M.

Adjunct Professor of Architecture in the School of Mines, Columbia College.

With Frontispiece and 229 Illustrations and Diagrams, Bibliographies, Glossary, Index of Architects, and a General Index. Crown 8vo, pp. xxviii-442, \$2.00.

"The text of this book is very valuable because of the singularly intelligent view taken of each separate epoch. . . . The book is extremely well furnished with bibliographies, lists of monuments [which] are excellent. . . . If any reasonable part of the contents of this book can be got into the heads of those who study it, they will have excellent ideas about architecture and the beginnings of a sound knowledge of it."—THE NATION, NEW YORK.

"A manual that will be invaluable to the student, while it will give to the general reader a sufficiently full outline for his purposes of the development of the various schools of architecture. What makes it of special value is the large number of ground plans of typical buildings and the sketches of bits of detail of columns, arches, windows and doorways. Each chapter is prefaced by a list of books recommended, and each ends with a list of monuments. The illustrations are numerous and well executed."

—SAN FRANCISCO CHRONICLE.

"Probably presents more comprehensively and at the same time concisely, the various periods and styles of architecture, with a characterization of the most important works of each period and style, than any other published work. . . . The volume fills a gap in architectural literature which has long existed."—ADVERTISER, BOSTON.

"A neatly published work, adapted to the use either of student or general reader. As a text-book it is a concise and orderly setting forth of the main principles of architecture followed by the different schools. The life history of each period is brief yet thorough. . . . The treatment is broad and not over-critical. The chief facts are so grouped that the student can easily grasp them. The plan-drawings are clear-cut and serve their purpose admirably. The half-tone illustrations are modern in selection and treatment. The style is clear, easy and pleasing. The entire production shows a studious and orderly mind. A new and pleasing characteristic is the absence of all discussion on disputed points. In its unity, clearness and simplicity lie its charm and interest."—NOTRE DAME SCHOLASTIC, NOTRE DAME, IND.

"This is a very thorough and compendious history of the art of architecture from the earliest times down to the present. . . . The work is elaborately illustrated with a great host of examples, pictures, diagrams, etc. It is intended to be used as a school text-book, and is very conveniently arranged for this purpose, with suitable headings in bold-faced type, and a copious index. Teachers and students will find it a capital thing for the purpose."—PICAYUNE, NEW ORLEANS.

LONGMANS, GREEN & CO., Publishers,

91 & 93 Fifth Avenue, NEW YORK.

College Histories of Art.

A HISTORY OF PAINTING.

BY

JOHN C. VAN DYKE, L.H.D.

Professor of the History of Art in Rutgers College, and Author of
"Principles of Art," "Art for Art's Sake," etc.

With Frontispiece and 109 Illustrations in the text, reproduced in half-tone from the most celebrated paintings. Crown 8vo, 307 pages, \$1.50.

" . . . The initial volume of a promising series . . . seems a model of pith, lucidity, and practical convenience; and that it is sound and accurate the author's name is a sufficient guarantee. Essential historical and biographical facts, together with brief critical estimates and characterizations of leading schools and painters, are given in a few well-chosen words; and for students who wish to pursue the subject in detail, a list of selected authorities at the head of each chapter points the way. Serviceable lists are also provided of principal extant works, together with the places where they are to be found. The text is liberally sprinkled with illustrations in half-tone."—DIAL, CHICAGO.

"Prof. Van Dyke has performed his task with great thoroughness and good success. . . . He seems to us singularly happy in his characterization of various artists, and amazingly just in proportion. We have hardly found an instance in which the relative importance accorded a given artist seemed to us manifestly wrong, and hardly one in which the special characteristics of a style were not adequately presented."—NATION, N. Y.

" . . . Gives a good general view of the subject, avoiding as a rule all elaborate theories and disputed points, and aiming to distinguish the various historical schools from one another by their differences of subject and technique . . . we do not know of anybody who has, on the whole, accomplished the task with as much success as has Mr. Van Dyke. The book is modern in spirit and thoroughly up-to-date in point of information."—ART AMATEUR.

"Professor Van Dyke has made a radical departure in one respect, in purposely omitting the biographical details with which text-books on art are usually encumbered, and substituting short critical estimates of artists and of their rank among the painters of their time. This feature of the work is highly to be commended, as it affords means for comparative study that cannot fail to be beneficial. . . . Altogether Professor Van Dyke's text-book is worthy of general adoption, and as a volume of ready reference for the family library, it will have a distinct usefulness. It is compact, comprehensive, and admirably arranged."—BEACON, BOSTON.

LONGMANS, GREEN, & CO.,

91 & 93 Fifth Avenue, NEW YORK.

A History of Sculpture.

BY

ALLAN MARQUAND, Ph.D., L.H.D.

AND

ARTHUR L. FROTHINGHAM, Jr., Ph.D.

Professors of Archæology and the History of Art in Princeton University.

With Frontispiece and 113 Illustrations in half-tone in the text, Bibliographies, Addresses for Photographs and Casts, etc. Crown 8vo, 313 pages, \$1.50.

HENRY W. KENT, *Curator of the Seater Museum, Watkins, N. Y.*

"Like the other works in this series of yours, it is simply invaluable, filling a long-felt want. The bibliographies and lists will be keenly appreciated by all who work with a class of students."

CHARLES H. MOORE, *Harvard University.*

"The illustrations are especially good, avoiding the excessively black background which produce harsh contrasts and injure the outlines of so many half-tone prints."

J. M. HOPPIN, *Yale University.*

"These names are sufficient guarantee for the excellence of the book and its fitness for the object it was designed for. I was especially interested in the chapter on *Renaissance Sculpture in Italy.*"

CRITIC, *New York.*

"This history is a model of condensation. . . . Each period is treated in full, with descriptions of its general characteristics and its individual developments under various conditions, physical, political, religious and the like. . . . A general history of sculpture has never before been written in English—never in any language in convenient textbook form. This publication, then, should meet with an enthusiastic reception among students and amateurs of art, not so much, however, because it is the only book of its kind, as for its intrinsic merit and attractive form."

OUTLOOK, *New York.*

"A concise survey of the history of sculpture is something needed everywhere. . . . A good feature of this book—and one which should be imitated—is the list indicating where casts and photographs may best be obtained. Of course such a volume is amply indexed."

NOTRE DAME SCHOLASTIC, *Notre Dame, Ind.*

"The work is orderly, the style lucid and easy. The illustrations, numbering over a hundred, are sharply cut and well selected. Besides a general bibliography, there is placed at the end of each period of style a special list to which the student may refer, should he wish to pursue more fully any particular school."

LONGMANS, GREEN & CO., Publishers,
91 & 93 Fifth Avenue, NEW YORK.

Longmans, Green, & Co.'s Publications.

AN ENCYCLOPÆDIA OF ARCHITECTURE.

By JOSEPH GWILT, F.S.A. Illustrated with about 1,700 Engravings on Wood. Revised with Alterations and Considerable Additions, by WYATT PAPWORTH. 8vo, 1,459 pages, \$17.50.

This work, first published in 1842, has now passed through eight impressions, those of 1867 and 1876 having received extensive revision and many important additions at the hands of Mr. Wyatt Papworth. In this, the ninth impression, besides many requisite amendments and additions throughout the pages, the chapters entitled "Materials Used in Buildings" and "Use of Materials," which constitute a main portion of the work, have been largely revised, parts rewritten and added to in important particulars, especially in regard to the details of Fire-proof and Sanitary Construction, in order to record the results of later theories and the numerous inventions introduced since the previous revision. The Lives of Eminent Architects have been brought down to date; as are also the Publications, which have been partly rearranged in additional classes; while the Glossary of Terms has been amended where desirable. The Index has been carefully revised to include all new matter.

THE STEPPING-STONE TO ARCHITECTURE:

Explaining in simple language the Principles and Progress of Architecture from the earliest times. By THOMAS MITCHELL. Illustrated by 49 Figures and 22 Plates. 18mo, 83 pages, 50 cents.

BUILDING CONSTRUCTION.

A Manual for Students. By the Author of "Notes on Building Construction." With nearly 400 Illustrations and Index. Crown 8vo, \$1.50.

GEOMETRICAL DRAWING FOR ART STUDENTS.

Embracing Plane Geometry and its Applications, the Use of Scales, and the Plans and Elevations of Solids. With nearly 600 Figures. By I. HAMMOND MORRIS. Crown 8vo, 192 pages, 60 cents.

THE TEACHING OF DRAWING.

By I. H. MORRIS, Art Master. With 675 Illustrations. Crown 8vo, 267 pages, \$1.50.

The book contains about 700 illustrations, which have been specially drawn for the purpose. The Freehand examples . . . may be divided into three sections, viz.: Conventional Ornament, Plant Forms, and Common Objects. They are selected to illustrate definite principles which the teacher may apply to other figures. Considerable space is devoted to Scale Drawing, Model Drawing, and Solid Geometry, as these parts of the subject require the most skillful and intelligent teaching.

Especial attention is directed to the large number of specimen lessons. These are given chiefly with a view of affording assistance to young teachers and those who may not have had much practical acquaintance with the subject.

THE STORY OF MUSIC.

By W. J. HENDERSON. *Fourth Edition.* 12mo, cloth, ornamental, \$1.00.

LONGMANS, GREEN, & CO., 91 and 93 Fifth Ave., New York.



UNIVERSITY OF CALIFORNIA LIBRARY
BERKELEY

Return to desk from which borrowed.

This book is DUE on the last date stamped below.

MAR 10 1948

17 Mar '51 AB

psc and

1B 05312

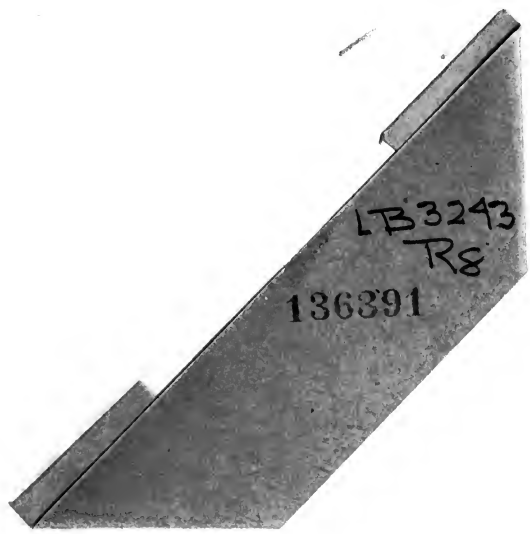

LB3243
R8

136391

