



This is a digital copy of a book that was preserved for generations on library shelves before it was carefully scanned by Google as part of a project to make the world's books discoverable online.

It has survived long enough for the copyright to expire and the book to enter the public domain. A public domain book is one that was never subject to copyright or whose legal copyright term has expired. Whether a book is in the public domain may vary country to country. Public domain books are our gateways to the past, representing a wealth of history, culture and knowledge that's often difficult to discover.

Marks, notations and other marginalia present in the original volume will appear in this file - a reminder of this book's long journey from the publisher to a library and finally to you.

Usage guidelines

Google is proud to partner with libraries to digitize public domain materials and make them widely accessible. Public domain books belong to the public and we are merely their custodians. Nevertheless, this work is expensive, so in order to keep providing this resource, we have taken steps to prevent abuse by commercial parties, including placing technical restrictions on automated querying.

We also ask that you:

- + *Make non-commercial use of the files* We designed Google Book Search for use by individuals, and we request that you use these files for personal, non-commercial purposes.
- + *Refrain from automated querying* Do not send automated queries of any sort to Google's system: If you are conducting research on machine translation, optical character recognition or other areas where access to a large amount of text is helpful, please contact us. We encourage the use of public domain materials for these purposes and may be able to help.
- + *Maintain attribution* The Google "watermark" you see on each file is essential for informing people about this project and helping them find additional materials through Google Book Search. Please do not remove it.
- + *Keep it legal* Whatever your use, remember that you are responsible for ensuring that what you are doing is legal. Do not assume that just because we believe a book is in the public domain for users in the United States, that the work is also in the public domain for users in other countries. Whether a book is still in copyright varies from country to country, and we can't offer guidance on whether any specific use of any specific book is allowed. Please do not assume that a book's appearance in Google Book Search means it can be used in any manner anywhere in the world. Copyright infringement liability can be quite severe.

About Google Book Search

Google's mission is to organize the world's information and to make it universally accessible and useful. Google Book Search helps readers discover the world's books while helping authors and publishers reach new audiences. You can search through the full text of this book on the web at <http://books.google.com/>

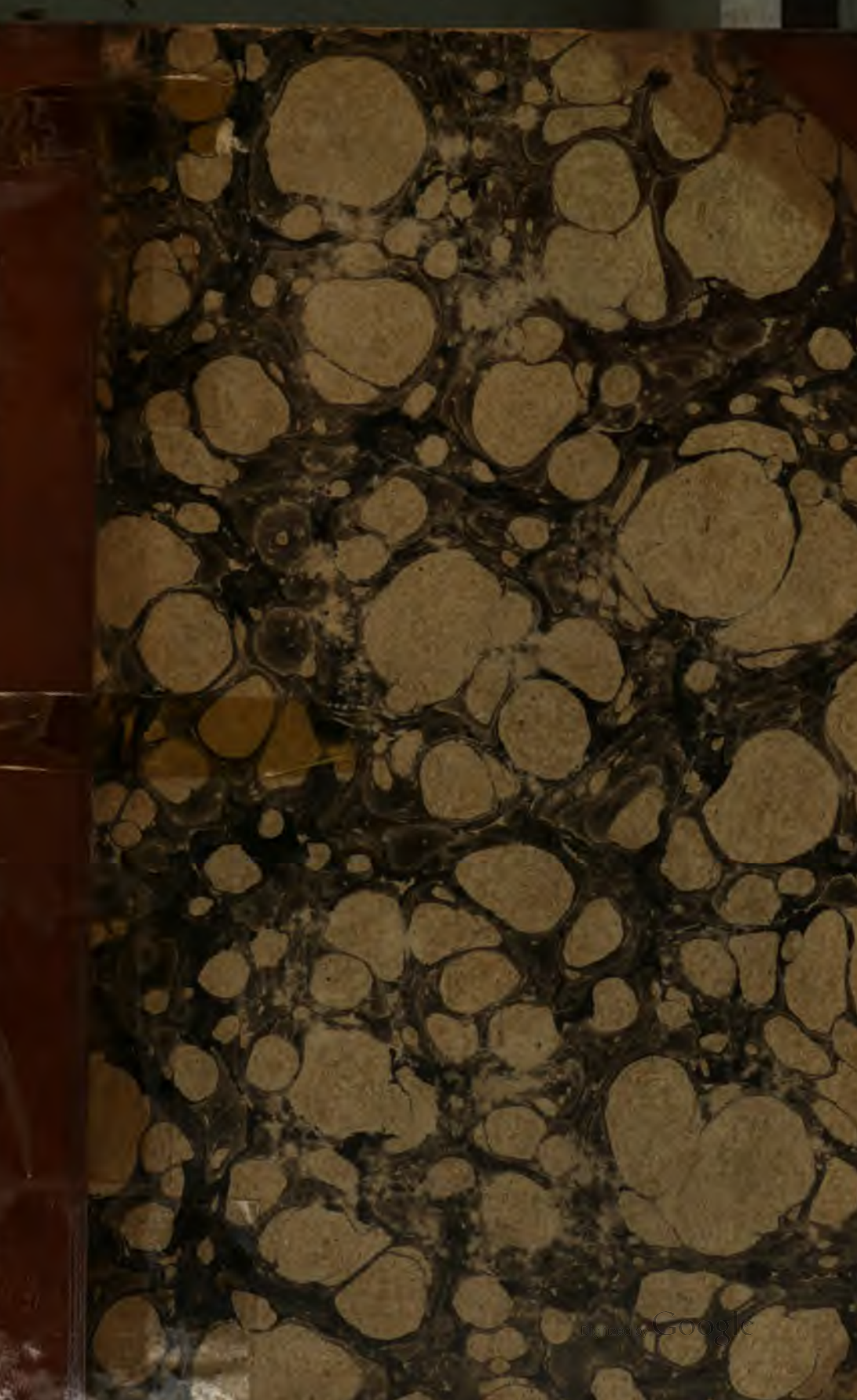

UNIVERSITY OF
University of
Alabama
Library

THE
LONDON ENCYCLOPÆDIA.

VOL. VI.

CLERGY TO CUSTOMS.



J. Hadden, Printer, Castle Street, London.

THE
LONDON ENCYCLOPÆDIA,

OR

UNIVERSAL DICTIONARY

OF

SCIENCE, ART, LITERATURE, AND PRACTICAL MECHANICS,

COMPRISING A

POPULAR VIEW OF THE PRESENT STATE OF KNOWLEDGE.

ILLUSTRATED BY

**NUMEROUS ENGRAVINGS, A GENERAL ATLAS,
AND APPROPRIATE DIAGRAMS.**

Sic oportet ad cibum, præsertim miscellanei generis, legendum accedere lectorem, ut sicut ad convivium contra civile. Convivator amatitur omnibus satisfacere; et tamen si quod apponitur, quod hujus aut illius palato non respondeat, et hic et ille arbore distuliant, et alia fercula probant, ne quid contristant convivatores. Erasmus.

A reader should sit down to a book, especially of the miscellaneous kind, as a well-behaved visitor does to a banquet. The master of the feast exerts himself to satisfy his guests; but if, after all his care and pains, something should appear on the table that does not suit this or that person's taste, they politely pass it over without notice, and commend other dishes, that they may not disgrace a kind host. Translation.

**BY THE ORIGINAL EDITOR OF THE ENCYCLOPÆDIA METROPOLITANA,
ASSISTED BY EMINENT PROFESSIONAL AND OTHER GENTLEMEN.**

IN TWENTY-TWO VOLUMES.

VOL. VI.

LONDON :

PRINTED FOR THOMAS TEGG, 73, CHEAPSIDE;

**SOLD BY N. HAILES, PICCADILLY; E. WILSON, ROYAL EXCHANGE; J. MASON, CITY ROAD;
BOWDERY & KERBY, OXFORD STREET:**

**GRIFFIN & CO. GLASGOW; J. CUMMING, DUBLIN; M. BAUDRY, PARIS; F. FLEISCHER, LEIPZIG;
AND WHIPPLE & LAWRENCE, SALEM, NORTH AMERICA.**

1829.

AE
5
.L85
v.6

Gen lib
11-7-52

THE

LONDON ENCYCLOPÆDIA.

CLERC (John le), a very celebrated writer and critic, was born at Geneva in 1657. At sixteen he could read all the celebrated Latin and Greek authors. After studying at Geneva, he went to France in 1678; returned in 1679, and was ordained a minister of the Genevan church. In 1682 he visited England, preaching in the Wallow and Savoy churches for nearly six months, and then passed over to Holland, and was admitted professor of philosophy, polite literature, and the Hebrew tongue, at Amsterdam. He now published his *Ars Critica*; and in 1686 began, in conjunction with M. de la Crose, his *Bibliothèque Universelle et Historique*, which was continued to the year 1693, in 26 vols. In 1703 he began his *Bibliothèque Choisie*, and continued it to 1714, when he commenced another work on the same plan, called *Bibliothèque Ancienne et Moderne*, which he continued to his death. In 1691 he married the daughter of the copious Italian writer, Gregorio Leti, by whom he had four children, who all died young. Le Clerc is a divine conspicuous among those who have contended for the right of private judgment, and who, at the same time, dogmatise very freely in the use of their own. He evidently leans towards the Socinian school, and treats the Scriptures occasionally with little reverence. His writings, however, are valuable, and, as a whole, should not be neglected by the biblical student. In 1728 he was seized with a palsy and fever; and, after spending the last six years of his life in a state of mental imbecility, died in 1736.

CLERC (John le), called Chevalier, an eminent historical painter, born at Nancy in 1587. He studied in Italy, where he resided twenty years, and was a disciple of Carlo Venetiano, whose style he so effectually imitated, that several of his pictures passed for the work of Venetiano. He was highly esteemed at Venice, and, as a token of public respect, was made a knight of St. Mark. His freedom and lightness of coloring, in which he resembled his master, were the principal beauties of his paintings. He died in 1633.

CLERC (Sebastin le), engraver and designer to the French king, was born at Metz in 1637. In 1672 he was admitted into the royal academy of painting and sculpture; and in 1680 made professor of geometry and perspective. He published, besides a great number of designs and prints: 1. A Treatise on Theoretical and Practical Geometry. 2. A Treatise on Architecture; and other works. He died in 1714.

CLERGY, *n. s.* } Fr. *clergè*; Lat. *clerus*;
CLERGYMAN, *n. s.* } Greek *κληρος*, i. e. sorte deligo, the clergy being regarded as the lot or inheritance of God. See onward. The body of

the Christian ministry. A clergyman is a man in holy orders; set apart for the ministration in the pulpit, and at the altar.

But fame! here as we ride on the way,
Us nedeth net to spoken but of game
And let auctoritees, in Goddes name,
To preaching, and to scole, eke, of *clergis*.

Chaucer. Canterbury Tales.

We hold that God's *clergy* are a state which hath been, and will be as long as there is a church upon earth, necessary, by the plain word of God himself; a state whereunto the rest of God's people must be subject, as touching the things that appertain to their soul's health.

Hooker.

The convocation give a greater sum
Than ever, at one time, the *clergy* yet
Did to his predecessors part withal. *Shakespeare.*

How I have sped among the *clergymen*,
The sums I have collected shall express. *Id.*

Not a few years before the Normans came, the *clergy*, though in Edward the confessor's days, had lost all good literature and religion, scarce able to read and understand their Latin service; he was a miracle to others who knew his grammar.

Milton. History of England.

It seems to be in the power of a reasonable *clergyman* to make the most ignorant man comprehend his duty.

Swift.

CLERGY, as a general name given to the body of ecclesiastics, has been traced to every age of the Christian Church; and some have contended that it is sanctioned by the authority of Scripture. Others conceive that it had its rise at a later period, when the desire of spiritual and secular pre-eminence, and corresponding dominion had perverted the minds of the professors and teachers of Christianity; and the interests of the church became interwoven with that of the state. It is a probable opinion that it was established before the time of Tertullian, towards the close of the second century.

The distinction itself was intended, we are told, to suggest, that the former, that is, the pastors or clergy (for they appropriated the term *κληρος* to themselves), were selected and contradistinguished from the multitude, as being, in the present world, by way of eminence, God's 'peculium,' or special inheritance. In support of this claim they allege, that God is, in the Old Testament, said to be the inheritance of the Levites, because a determinate share of the sacrifices and offerings made to God was, in part, to serve them instead of an estate in land, such as was given to each of the other tribes. But it has been argued, on the other hand, that the tribe of Levi is nowhere called God's inheritance, though that expression is repeatedly used, with respect to the whole nation. Concerning the whole nation of Israel, Moses, who was himself

a Levite, says, in an address to God, Deut. ix. 29, 'They are thy people, and thine inheritance, which thou broughtest out by thy mighty power.' The words in the Septuagint deserve our particular attention. *Ουτοι λαος σου και κληρος σου ως εξηγαγες εκ γης. Αιγυπτου εν τη ισχυι σου τη μεγαλη.* The same persons are, in the same sentence, declared to be both the *λαος* and the *κληρος*. What, says the canonist, at once laymen and clergy? That is certainly absurd; the characters are incompatible; yet it did not then appear so to Moses. Nor would it be thought reasonable or just, that what was allowed to be the privilege and the glory of every Israelite, under the more servile establishment of Moses, should, under the more liberal dispensation of the gospel, be disclaimed by all those disciples of Jesus who have not been admitted into the sacred order, which they, for this reason, have called clerical. As to the use of the term in the New Testament, one passage, as the persons to whom we now refer argue, and only one, occurs, in which it is applied to persons. (See 1 Peter, v. 3). The words in the original are, *μηδ ως κατακυριευοντες των κληρων, αλλα τυσοι γινομενοι τω ποιμνι;* thus rendered in our version, 'Neither as being lords over God's heritage, but being ensamples to the flock.' They are part of a charge given to the presbyters, or pastors, relating to their care of the people committed to them, who are called God's flock, which they are commanded to feed, of which they are to take the oversight, not the mastery, and to which they are to serve as patterns. The same persons, therefore, who, both in this and in the preceding verse are styled *ποιμνιον*, the flock, under the direction of God's ministers, the shepherds, are also called *κληροι*, his inheritance, over whom their pastors are commanded not to domineer. The distinction above mentioned, it is said, stands in direct contradiction both to the letter and to the sense of the unerring standard of Scripture. Some expositors, however, render the term *κληροι*, in this passage, the church's possessions; but this explication, as others say, ill suits the context, and annihilates the contrast between an imperious manner and an engaging pattern, and supposes an awkward ellipsis in the words themselves. Besides, it is asked what were the church's possessions in those days? Was she so early vested with lands and hereditaments, for it is to such only that the term *κληρος*, when denoting property or possession, is applied? In the apostolic times, the church's patrimony consisted chiefly in persecution and calumny, hatred and derision, agreeably to the prediction of her Lord.

The distinction of the whole church into clergy and laity, whensoever it originated, was soon extended much farther than the original intention of those who adopted it. In the time of Cyprian, about the middle of the third century, we find that, in general, all things relating to the government and policy of the church were performed by the joint consent, and administration of the clergy and laity. Thus Cyprian says (Epist. vi. § 5, cited by the author of the Enquiry into the Constitution, &c. of the Primitive Church, p. 106), 'he did nothing without the knowledge and consent of his people.' That the

letters from foreign churches were received and read by the whole church, &c.

The origin of the term laity becomes a curious matter of enquiry in this connexion. The schoolmen will not allow it to be derived from *λαος*, *populus*; they deduce it from *λαας*, *lapis*, a stone. The following specimen of the mode of reasoning adopted by some celebrated doctors, and cited by Altensfaig in his Lexicon Theologicum, is possibly amusing. 'Capitur clericus pro viro docto, scientifico, perito, scientia pleno, repleto et experto. E contra, laicus capitur pro viro indocto, imperito, insipiente, et lapideo. Unde laicus dicitur a *λαας* Græcè, quod est lapis Latine. Et sic omnis clericus, in quantum clericus, est laudabilis; laicus vero, in quantum laicus, est vituperandus. Clerici quoque a toto genere de jure proponuntur, et debent præponi laicis.' Cardinal Bona also delivers his sentiments in relation to the care that ought to be taken by the clergy, that laymen may not be allowed to do themselves harm by studying the profounder parts of Scripture, which their stupidity is utterly incapable of comprehending: and though he does not absolutely prohibit their reading some of the plainer books of Scripture, he indulges them more freely in the use of books containing the histories, lives, and legends of the saints, and holy meditations. See more on this subject in *Campbell's Ecclesiastical History*, vol. i.

In the first century the clergy were distinguished by the title of presbyters or bishops; and some maintain that they are of equal rank and authority. See BISHOP. But towards the close of the second century, a notion prevailing that the ministers of the Christian church succeeded to the character, rights, and privileges of the Jewish priesthood, this produced a subordination of rank among them. The bishops assumed a rank and character similar to those of the Jewish high-priest; the presbyters represented the priests, and the deacons the Levites. This distinction was still farther promoted towards the end of the third century; and a new set of ecclesiastical officers was established, such as subdeacons, acolythi, door-keepers, readers, exorcists, &c. The powers of the clergy were considerably extended under Constantine, and the Romish Church attained its full, and finally intolerable, height.

In that church are two very distinct orders of clergy: one regular, comprehending all the religious of both sexes, as abbots, monks, priors, &c.; the other secular, comprehending all the ecclesiastics that do not make the monastic vows. Among the reformed churches, there are none but those of the latter.

In England the term clergy comprehends all persons in holy orders, and ecclesiastical offices: and, though their almost total exemption from the duties of civil life has been modified since the Reformation, important personal exemptions, essential to their sacred office, are still continued to them. Clergymen cannot be compelled to serve on a jury, nor to appear at a court-leet, which almost every other person may be obliged to do; but if a layman is summoned on a jury, and before the trial takes orders, he shall, not-

standing, appear and be sworn. Neither can be chosen to any temporal office, as bailiff, reeve, constable, or the like; in regard of his own continual attendance on the sacred function. During his attendance on divine service, he is privileged from arrests in civil suits. In cases also of felony, a clerk in orders shall have the benefit of clergy, without being branded in the hand; and may likewise have it more than once; in both which cases he is distinguished from a layman. But, as they have their privileges, so they have also their disabilities, on account of their spiritual avocations. Clergymen are incapable of sitting in the House of Commons; and by statute 21 Hen. VIII. c. 13. are not, in general, allowed to take any lands or tenements to farm, upon pain of £10 per month, and total avoidance of the lease; nor, upon like pain, to keep any tap-house or brew-house; nor engage in any trade, nor sell any merchandise, under forfeiture of the treble value; which prohibition is consonant to the canon law.

CLERGY, BENEFIT OF, an ancient privilege, whereby one in orders claimed to be delivered to his ordinary to purge himself of felony. The old exemptions granted to the church were principally of two kinds: 1. Exemption of places consecrated to religious duties from criminal arrests, which was the foundation of sanctuaries. 2. Exemption of the persons of clergymen from criminal process before the secular judge in a few particular cases, which was the true and original meaning of the *privilegium clericale*. But the clergy increasing in wealth, power, number, and interest, now claimed that which they obtained by the favor of the civil government, as their inherent right, and as a right of the highest nature, indefeasible, and *jure divino*. By their canons, therefore, and constitutions, they endeavoured at, and often obtained a vast extension of those exemptions; as well in regard to the crimes themselves, of which the list became universal, as in regard to the persons exempted; among whom were at length comprehended, not only every subordinate officer belonging to the church or clergy, but even many that were entirely laymen. In England, however, a total exemption of the clergy from secular jurisdiction could never be thoroughly effected. And, in those particular cases in which it was allowed, the custom was for the bishop or ordinary to demand his clerks to be remitted out of the king's courts as soon as they were indicted: concerning the allowance of which demand there was, for many years, a great uncertainty; till at length it was finally settled in the reign of Henry VI. that the prisoner should first be arraigned; and might either then claim his benefit of clergy by way of declinatory plea; or, after conviction, by way of arrest of judgment. This latter way is most usually practised, as it is more to the satisfaction of the court to have the crime previously ascertained by confession, or the verdict of a jury; and more advantageous to the prisoner, who may possibly be acquitted, and so need not the benefit of his clergy. Originally the law was held that no man should be admitted to the benefit of clergy, but such as had the clerical habit and tonsure. But in time a much wider

criterion was established; every one that could read (a great mark of learning in those days of ignorance) being accounted a clerk, or clericus, and allowed the benefit of clerkship, though neither initiated in clerkship, nor trimmed with the holy tonsure. But when learning became more generally disseminated, and reading was no longer a proof of clerkship, or holy orders, it was found that as many laymen as divines were admitted to the *privilegium clericale*; and therefore by statute 4 Henry VII. c. 13, a distinction was once more drawn between mere lay scholars and clerks that were really in orders. The statute directs, that no person, once admitted to the benefit of clergy, shall be admitted thereto a second time, until he produces his orders: and, to distinguish their persons, all laymen who are allowed this privilege, shall be burned with a hot iron in the brawn of the left thumb. This distinction between learned laymen and real clerks in orders was abolished for a time by the statutes 28 Hen. VIII. c. 1, and 32 Hen. VIII. c. 3, but is held to have been virtually restored by statute 1 Edw. VI. c. 12, which enacts, that lords of parliament and peers of the realm may have the benefit of their peerage, equivalent to that of clergy, for the first offence (although they cannot read, and without being burnt in the hand), for all offences then chargeable to commoners, and also for the crimes of house-breaking, highway-robbery, horse-stealing, and robbing of churches. After this burning, the laity, and before it, the real clergy, were discharged from the sentence of the law in the king's court, and delivered over to the ordinary, to be dealt with according to the ecclesiastical canons. Whereupon the ordinary, not satisfied with the proofs adduced in the profane secular court, set himself formally to make a purgation of the offender by a new canonical trial; although he had been previously convicted by his country, or perhaps by his own confession. This trial was held before the bishop in person, or his deputy, and by a jury of twelve clerks. And there, first the party himself was required to make oath of his own innocence: next, there was to be the oath of twelve compurgators, who swore they believed he spoke the truth; then, witnesses were to be examined upon oath, but upon behalf of the prisoner only; and, lastly, the jury were to bring in their verdict upon oath, which usually acquitted the prisoner; otherwise, if a clerk, he was degraded or put to penance.

By this purgation, the party was restored to his credit, his liberty, his lands, and his capacity of purchasing afresh, and was treated as an entirely innocent man. This scandalous prostitution of oaths, and the forms of justice, in the almost constant acquittal of felonious clerks by purgation, was the occasion that, upon very heinous and notorious circumstances of guilt, temporal courts would not trust the ordinary with the trial of the offender, but delivered over to him the convicted clerk, *absque purgatione facienda*: in which situation the clerk convict could not make purgation, but was to be imprisoned for life, and was incapable of acquiring any personal property, or receiving the profits of his lands, unless the king should pardon him.

The statute 18 Eliz. c. 7, enacts, that, for avoiding such perjuries, and abuses, after the offender has been allowed his clergy, he should not be delivered to the ordinary as formerly; but, upon such allowance, and burning of the hand, he shall forthwith be enlarged, and delivered out of prison; with proviso, that the judge may, if he thinks fit, continue the offender in jail for any time not exceeding a year. And thus the law continued unaltered for above a century; except only, that the statute 21 Jac. 1. c. 6, allowed, that women convicted of simple larcenies under the value of 10s. should (not properly have the benefit of the clergy, for they were not called upon to read; but) be burned in the hand, whipped, or stocked, or imprisoned for any time not exceeding a year. All women, all peers, and all male commoners who could read, were therefore discharged in such felonies absolutely, if clerks in orders; and for the first offence upon burning in the hand, if laymen; yet all liable (except peers), if the judge saw occasion, to imprisonment not exceeding a year. And these men who could not read, if under the degree of peerage, were hanged. At last, however, it was considered, that learning was no extenuation of guilt. And thereupon, by statute 5 Anne, c. 6, it was enacted that the benefit of clergy should be granted to all those who were entitled to ask it, without requiring them to read by way of conditional merit. But experience having shown that so universal a lenity was an encouragement to commit the lower degrees of felony; it was enacted that when any person is convicted of any theft or larceny, and burnt in the hand for the same, he shall, at the discretion of the judge, be committed to the house of correction or public work-house, to be there kept to hard labor for any time not less than six months, and not exceeding two years; with a power of inflicting a double confinement in case of the party's escape from the first.

It was also enacted by statute 4 Geo. I. c. 11. and 6 Geo. I. c. 23. that when any person shall be convicted of any larceny, either grand or petit, who by the law shall be entitled to the benefit of clergy, and liable only to the penalties of burning in the hand, or whipping; the court, instead of such burning in the hand, or whipping, may direct such offenders to be transported to America for seven years; and if they return, or are seen at large in this kingdom within that time, it shall be felony without benefit of clergy. In this state does the benefit of clergy at present stand; very considerably different from its original institution; the English legislature having converted, by gradual mutations, what was at first an unjust exemption of popish ecclesiastics, into a merciful mitigation of the general law with respect to capital punishments. All clerks in orders are, without any branding or transportation, to be admitted to this privilege, and immediately discharged, or at most only confined for one year; and this as often as they offend. All lords of parliament, and peers of the realm, by the statute 1 Edw. VI. c. 12. shall be discharged in all clergyable and other felonies provided for by the act without any burning in the hand, in the same manner as real clerks convict: but this

is only for the first offence. All the commons of the realm, not in orders, whether male or female, shall, for the first offence, be discharged of the punishment of felonies, within the benefit of clergy, upon being burnt in the hand, and suffering discretionary imprisonment; or, in case of larceny, upon being transported for seven years. By statute 19 Geo. III. c. 74, burning in the hand is abolished, and instead thereof, except in cases of manslaughter, the court may order the offender to be whipped. Upon the whole, we may observe the following rules: 1. In all felonies, whether new created, or by common law, clergy is now allowable, unless taken away by act of parliament. 2. Where clergy is taken away from the principal, it is not taken away from the accessory, unless he be also particularly included in the words of the statute. 3. When the benefit of clergy is taken away from the offence (as in case of murder, robbery, rape, and burglary, &c.), a principal in the second degree, being present, aiding and abetting the crime, is excluded from his clergy as well as the principal in the first degree: but, 4. Where it is only taken away from the person committing the offence (as in case of stabbing, or committing larceny in a dwelling house,) his aiders and abettors are not excluded, through the tenderness of the law, which had determined that such statutes shall not be taken literally.

CLERK, *n. s.* } Fr. *clerc*; Lat. from *cle-*
 CLE'RICAL, *adj.* } ricus, a clergyman; a lite-
 CLERKSHIP, *n. s.* } rary man; a scribe by pro-
 fession; it received its peculiar application when the clergy were the only peumen. It is now applied to a man employed under another as a writer; a petty writer in public offices; an officer of various kinds. Clerical is applied exclusively to the clergy, except when used in a legal sense to mark the literal errors of clerks and transcribers. Clerkship is the office of a clerk of any kind. It is also used in the sense of apprenticeship by lawyers. A clerk is, according to the usage of the church of England, a reader as well as a writer, one who reads the responses to lead the congregation.

A good man, ther was of religioun,
 That was a poure persone of a town,
 But rich he was of holy thought and werk,
 He was also a lerned man a clerk.

Chaucer's Canterbury Tales.

They might talk of book-learning what they would;
 but, for his part, he never saw more unfeaty fellows
 than great clerks were. *Sidney.*

My lord Bassanio gave his ring away
 Unto the judge; and then the boy, his clerk,
 That took some pains in writing, he begged mine. *Shakespeare.*

In clericals the keys are lined, and in colleges they
 use to line the table-men. *Bacon's Natural History.*

His notions fitted things so well,
 That which was which he could not tell;
 But oftentimes mistook the one
 For the 'other, as great clerks have done. *Hudibras.*

All persons were styled clerks, that served in the
 church of Christ, whether they were bishops, priests,
 or deacons. *Ayliffe.*

Take a just view, how many may remark,
Who's now a lord, his grandsire was a clerk.

Grassville.

The greatest clerks being not always the honestest,
any more than the wisest, men.

South.

He sold the clerkship of his parish, when it became
vacant.

Swift's Miscellanies.

My friend was in doubt whether he could not ex-
ert the justice upon such a vagrant; but not hav-
ing his clerk with him, who is a necessary counsellor, he
let the thought drop.

Addison.

It may seem difficult to make out the bills of fare
for the suppers of Vitellius. I question not but an
expert clerk of a kitchen can do it.

Arbutnot.

Church ladders are not always mounted best

By learned clerks and Latinists professed.

Cowper.

CLERK comes from the Greek κληρος, used
for clergy; but more properly signifies lot or he-
ritage, the lot of clerks or ecclesiastics being to
serve God. Accordingly clerus was at first used
to signify those who had a particular attachment
to the service of God. The origin of the ex-
pression is derived from the Old Testament,
where the tribe of Levi is called the lot, heritage,
κληρος; and God is reciprocally called their por-
tion; that tribe being consecrated to the service
of God, and living on the offerings made to God
without any other settled provision. Thus, Pas-
quier observes, the officers of the counts were
anciently stiled clerks of accounts; and secre-
taries of state were called clerks of the secret.
So clericus domini regis, in the time of Edward I.
was englisbed, the king's secretary, or clerks of
his council. The term was applied indifferently
to all who knew how to manage the pen: though
originally it was appropriated to ecclesiastics.
As the nobility and gentry were usually brought
up to the exercise of arms, none but the clergy
cultivated the sciences.

CLERK COMPTROLLER OF THE KING'S HOUSE-
HOLD, an officer of the king's court, authorised
to examine and pass the charges of pursuivants,
messengers of the green cloth, &c. to inspect and
control all defects of any of the inferior officers;
and to sit in the counting house with the lord
steward and other officers of the household, for
regulating such matters.

CLERK OF THE BAILS, an officer in the court
of King's Bench, who files all bail pieces taken
in that court, where he always attends.

CLERK OF THE CHECK, an officer belonging to
the king's court; who has the check and control-
ment of the yeomen that belong to the king,
queen, or prince. He likewise, by himself or
deputy, sets the watch in the court. There is also
in the navy an officer of the same title, belonging
to the king's yards.

CLERK OF THE CROWN, an officer in the King's
bench, who frames, reads, and records all indict-
ments against offenders there arraigned or indict-
ed, of any public crime. He is likewise termed
clerk of the crown office, in which capacity he
exhibits information by order of the court for
divers offences.

CLERK OF THE CROWN, in chancery, an officer
who constantly attends the lord chancellor ip
person or by deputy; writes, and prepares for the
great seal, special matters of state by commission
both ordinary and extraordinary, viz. commissions

of lieutenancy, of justices of assize, oyer and ter-
miner, gaol-delivery, and of the peace; all
general pardons, granted either at the king's
coronation, or in parliament. The writs of par-
liament with the names of the knights, citizens,
and burgesses, are also returned into his office.
He likewise makes out special pardons and
writs of execution on bonds of statute-staple
forfeited.

CLERK OF THE ORDNANCE, an officer of the
king's tower who has the registers, &c. of the
ordnance.

CLERK OF THE ERRORS, in the court of com-
mon pleas, an officer who transcribes and cer-
tifies into the king's bench, the tenor of the record
of the action on which the writ of error, made
out by the cursitor, is brought there to be deter-
mined. In the king's bench, the clerk of the er-
rors transcribes and certifies records of causes,
by bill, in that court, into the exchequer. And
the clerk of the errors in the exchequer, trans-
cribes the records certified thither out of the
king's bench, and to prepare them for judgment
in the exchequer chamber.

CLERK OF THE ESSOINS, in the court of com-
mon pleas, keeps the essoins roll or enters essoins:
he also provides parchment, cuts it into rolls,
marks the number on them, delivers out the rolls
to the officers, and receives them again when
written. See ESSOIN.

CLERK OF THE ESTREATS, an officer in the
exchequer, who every term receives the estreats
out of the lord-treasurer's remembrancer's office,
and writes them out to be levied for the
crown.

CLERK OF THE HAMPER, or HANAPER, an
officer in chancery, who receives all money due
to the king for the seals of charters, letters patent,
commissions, and writs; also the fees due to the
officers for enrolling and examining them.

CLERK OF THE KING'S SILVER, an officer of
the common pleas, to whom every fine is brought
after it has passed the office of the custos brevium;
and who enters the effect of writs of covenant
into a book kept for that purpose, according to
which all the fines of that term are recorded in
the rolls of the court.

CLERK OF THE MARKET, an officer of the king's
house, who has the charge of the king's measures
and weights, the standard of those that ought
to be used all over England.

CLERK OF THE NICHILS OR NIHILS, an officer
of the exchequer, who makes a roll of all such
sums as are nichilled by the sheriffs upon their
estreats of green wax, and delivers them in to
the remembrancer of the treasury, to have exe-
cution done upon them for the king. See NIHIL.

CLERK OF THE OUTLAWRIES, an officer of the
common pleas, and deputy to the attorney gen-
eral, for making out all writs of capias et legatum
after outlawry, to which there must be the attor-
ney general's name.

CLERK OF THE PAPER OFFICE, an officer be-
longing to the King's Bench, who makes up the
paper books of special pleadings in that court.

CLERK OF THE PEACE, an officer belonging to
the sessions of the peace, who reads indictments,
enrols the proceedings, and draws the process:
he also certifies into the King's Bench, transcripts

of indictments, outlawries, attainders, and convictions before the justices of peace, within the time limited by statute, under a certain penalty. This office is in the gift of the *custos rotulorum*, and may be executed by deputy.

CLERK OF THE PELLIS, an officer in the exchequer, who enters every teller's bill into a parchment roll, called *pellis receptorum*; and makes another roll of payments called *pellis exituum*.

CLERK OF THE PIPE, an officer of the exchequer, who having the accounts of all debts due to the king, delivered out of the remembrancer's office, charges them in a great roll folded up like a pipe. He writes out warrants to sheriffs, to levy the said debts on the goods and chattels of the debtors; and, if they have no goods, then he draws them down to the treasurer's remembrancer to write estreats against their lands.

CLERK OF THE PLEAS, an officer of the exchequer, in whose office all the officers of the court having special privilege, ought to sue or be sued in any action. In his office also actions at law may be prosecuted by other persons, but the plaintiff ought to be tenant or debtor to the king, or some way accountable to him. The under clerks are attorneys in all suits.

CLERK OF THE ROLLS, an officer of the chancery, who makes search after, and copies deeds, offices, &c.

CLERK OF THE TREASURY, an officer belonging to the court of common pleas, who keeps the records of the court, makes out all records of *nisi prius*, and all exemplifications of records in the treasury. He has the fees due for all searches; and has an under keeper, who keeps one key of the treasury door.

CLERK OF THE WARRANTS, an officer of the common pleas, who enters all warrants of attorney for plaintiffs and defendants in suit; and enrolls deeds of bargain and sale that are acknowledged in court, or before a judge. He likewise estreats into the exchequer all issues, fines, estreats, and amercements, due to the crown in that court.

CLERKS OF THE PETTY BAG, three officers of the court of chancery, of whom the master of the rolls is the chief: their business is to record the return of all inquisitions out of every shire; to make out patents of customers, gaugers, comptrollers, &c. liberates upon extent of statutes staple; conge d'elires for bishops; summonses of the nobility, clergy, and burgesses to parliament; and commissions directed to knights and others of every shire, for assessing subsidies and taxes.

CLERKS OF THE PRIVY SEAL, four officers who attend the lord privy seal, for writing and making out all things that are sent by warrant from the signet to the privy seal, and to be passed the great seal; and make out privy seals, upon special occasions of his majesty's affairs, as for loan of money, or the like.

CLERKS OF THE SIGNET, four officers continually attending upon his majesty's principal secretary, who has the custody of the privy signet, for sealing the king's private letters, and the grants which pass the king's hand by bill signed. They have their diet at the secretary's table.

CLERKE (Captain Charles), a celebrated English navigator, bred up to the navy from his youth, and present in several actions during the war of 1745. In that between the *Bellona* and *Courageux*, having been stationed in the mizen top on board the former, the mast was carried overboard by a shot, and he fell into the sea with it; but was taken up unhurt. When commodore Byron made his first voyage round the world, Mr. Clerke served on board his ship as a midshipman; and was afterwards on the American station. In 1768 he sailed round the world a second time in the *Endeavour*, as master's mate; but, during the voyage, succeeded to a lieutenancy. He returned in 1775, and was soon after appointed master and commander. When captain Cook undertook his last voyage, Mr. Clerke was appointed captain of the *Discovery*; and, on the death of captain Cook, succeeded to the supreme command. He did not, however, long enjoy his new dignity, having had symptoms of a consumption before his departure from England; notwithstanding which he persevered in search of a passage between the Asiatic and American continents, until all his officers were of opinion that it was impracticable. He died on the 22d of August, 1778, aged thirty-eight, the ship being then within view of the coast of Kamtschatka.

CLERKE'S ISLANDS, two islands in the North Pacific Ocean, between the coast of Kamtschatka in Asia, and that of North America. They were discovered by captain Cook in his last voyage, and named after captain Clerke. At a distance they appeared to be of a considerable extent, and to have several hills, connected with the low grounds in such a manner as to make them look like a group of islands. The little island lies on the eastern extremity of the large one, and is remarkable for having three elevated rocks upon it. Both islands are uninhabited.

CLERKE'S RIVER, a river of North America, which rises on the western declivity of the Rocky Mountains, and, after a winding course round the mountains, falls into the Columbia about the forty-second degree of north latitude, 500 miles above the mouth of the latter. It was named by captains Lewis and Clarke, who first visited this country in their journey across the American continent to the Pacific.

CLERKE'S ROCKS are a cluster of rocky islets in the South Atlantic, about thirty-seven miles south of the island of Georgia. Lat. 55° S.

CLERKENWELL, one of the most populous of the out-parishes of the city of London, in Osulton hundred, Middlesex. It consists of the united parishes of St. James and St. John. St. James's church stands on the site of an ancient monastery, and is a heavy structure, built partly in the Gothic and partly in the Tuscan order. On the green is the sessions-house for the county. Here also is the New-Prison, built on the Howardian plan, as well as Clerkenwell bridewell. In St. John's Square formerly stood the famous hospital of St. John of Jerusalem, which was destroyed by the rebels under Wat Tyler in the fourteenth century.

CLERMONT, a county of South Carolina, in Cambden district, bounded on the north by Kershaw county, on the east by Salem, on the south by Clarendon, and on the west by the river Wateree, which separates it from Richland county. It is thirty-five miles long and equally broad. The chief town is Statesburg.

CLERMONT, or **CLERMONT FERRAND**, a populous city of France, the capital of the department of Puy de Dome. Before the revolution it was the capital of Auvergne, and the see of a bishop, suffragan of Bourges. From its situation on an eminence at the foot of a lofty mountain, it was originally Clarus Mons. It is now called Clermont Ferrand, from the town of Montferrand being united to it, and forming one of the faubourgs. It is said to contain 16,000 inhabitants, and has a considerable commerce in corn, wine, wool, woollen stuffs, temmies, serges, linen, lace, &c. Here are also manufactures of paper, hats, leather, pottery, and linen and woollen stuffs. There are several fine walks and public squares, but the streets are narrow, and the houses mean; being generally built of stone of a gloomy hue. The cathedral is one of the finest in France, though in an imperfect state; of the five towers which existed in the last century, only one has survived the revolution. The college is a fine edifice, containing a public library; here is also a cabinet of natural history, a botanic garden, a good theatre, and several hospitals. Many Roman antiquities have been found in the neighbourhood; and there are several mineral springs near: the water of a brook which passes through the faubourg of St. Allyre has petrified a wooden Lridge to perfect stone. A council was held here in 1095, to determine on the crusade against the infidels in the Holy Land, during the pontificate of Urban II. It was the birth-place of Paschal; is 233 miles south of Paris, and fifty south of Moulins.

CLERMONT, or **CLERMONT, EN ARGONNE**, a town of France, in the department of the Meuse, and ci-devant territory of Barrois. It is seated on an eminence surrounded with woods and pastures; twelve miles W. S. W. of Verdun, and 137 north-west of Paris.

CLERMONT DE LODEVE, a town of France, in the department of Herault, and ci-devant province of Languedoc. It is the capital of a canton in the district of Lodeve. It has manufactures of cloth and hats, but its chief trade is in wool and cattle. It is twenty miles west of Montpellier.

CLERMONT MANUSCRIPT, Codex Cleromontanus or Regius, a Græco-Latin manuscript of St. Paul's Epistles, found in the monastery of Clermont in France, and used by Beza, together with the Cambridge MS., in preparing his edition of the New Testament. This copy is in the 8vo. form, and is written on fine vellum in uncial, Greek and Latin characters, with some mutilations. Beza supposes that it is of equal antiquity with the Cambridge copy; and it is noted *D* by Wetstein and Griesbach. As it contains the epistle to the Hebrews, which has been however added by a later hand, it is supposed to have been written in the west of Europe. Dr. Mill contended that it was the second part of the

Cambridge MS.; but this opinion has been entirely refuted by a comparison of their form, size, vellum, and more particularly of their abbreviations. The MS. itself was in the possession of Morinus; and, after his death, deposited among the MSS. of the Royal Library at Paris. According to the accounts of Wetstein and Sabatier, thirty-six leaves were cut out of it at the beginning of the last century (by John Aymon, as it is supposed), and sold in England to the earl of Oxford, who however returned them in 1729. The MS. is therefore once more complete, as the covering only is wanting in which the stolen sheets had been enclosed. This is preserved in the British Museum, and filled with the letters that passed on the occasion. The Codex Cleromontanus, together with other Græco-Latin MSS., has been accused of having a Greek text altered from the Latin, but this charge has been entirely refuted by Dr. Semler.

CLERODENDRON, in botany, a genus of plants of didynamia class, and angiospermia order: CAL. five-cleft, campanulate: COR. tube filiform; border, five-parted and equal: STAM. very long, placed between the segments of the corolla: DRUPE four-seeded, bearing a one-celled nut. Species eight; trees and shrubs of the East Indies; the former having scarlet, the latter white flowers.

CLEROMANCY; from *κληρος*, a lot, and *μαντεια*, magic, a kind of divination performed by the throwing of dice, or little bones; and observing the points, or marks, turned up. At Bura, a city of Achaia, was a temple and celebrated oracle of Hercules; where those who consulted the oracle, after praying to the idol, threw four dies, the points whereof being observed by the priest, he drew an answer from them.

CLERVAUT, or **CLERVAUX**, a town of France, in the department of Vienne, and ci-devant province of Champagne, five miles north of Châtelerault, and as far from Bar sur Aube. Its abbey, seated in a valley surrounded with woods and mountains, was formerly the chief of the Cistercian order, and had the famous tun of St. Bernard, which held 800 tuns of wine.

CLERY, a town of France, in the department of Somme, and ci-devant province of Picardy. It is the capital of a canton in the district of Peronne; and lies three miles north-west of Peronne.

CLESIDES, a Greek painter, who lived about A. A. C. 276, under Antiochus I. He revenged the injuries he had received from queen Stratonice, by representing her in the arms of a fisherman; but she was drawn with such personal beauty, that she preserved the piece, and liberally rewarded the artist.

CLETHRA, in botany, a genus of the monogynia order, and decandria class of plants; natural order eighteenth, bicornes: CAL. quinquepartite; the PETALS five; the STIGMA trifold; the CAPSULE trilocular and three-valved. Species four; the most noted is *C. anifolia*, a native of Virginia and Carolina, where it grows in moist places, and near the sides of rivulets, rising nearly six or ten feet high. The leaves are shaped like those of the alder, but longer; and placed alternately

upon the branches: the flowers are produced in close spikes at the extremities of the branches; they are white, composed of five petals, and have ten stamina in each, nearly of the same length with the petals. This plant will bear the open air in Britain, and is one of the most beautiful flowering shrubs. Its season is commonly about the beginning of July; and, if not very hot, the spikes will flourish till the middle of September. It thrives best in moist land, and requires a sheltered situation, where it may be defended from strong winds, which frequently break off the branches where they are too much exposed to their violence. It is propagated by layers, but they are generally two years before they take root. It may also be propagated by suckers, which are sent out from the roots; if these are carefully taken off with fibres in the autumn, and planted in a nursery-bed, they will be strong enough in two years to transplant.

CLEVE, } In composition, at the beginning
CLIF, } or end of the proper name of a
CLIVE, } place, denotes it to be situated on
the side of a rook or hill; as Cleveland, Clifton, Stauchiff.

CLEVELAND, a district of the North Riding of Yorkshire, part of the vale of Stockton. It borders upon Durham, from which it is separated by the Tees; and is remarkably beautiful, fertile, and well cultivated. It contains 70,444 arable acres. Wheat is its staple produce; and no other district in the neighbourhood produces so great a proportionable quantity of equally fine grain.

CLEVELAND (John), an English poet of some eminence, who, during the civil war under Charles I., engaged as a literary champion in the royal cause against the parliamentarians. He died in 1658, and was much extolled by his party. His works, which consist of poems, characters, orations, epistles, &c., were printed in 1677, in 8vo.

CLEVER, *adj.* } Sax. gleawra; proba-
CLEVERLY, *adv.* } bly from $\gamma\lambda\alpha\psi\upsilon\rho\omicron\varsigma$. Dex-
CLEVERNESS, *n. s.* } terous, skilful, just; fit;
proper; intelligent; accomplished; handsome;
commodious.

These would inveigle rats with the scent,
And sometimes catch them with a snap,
As *cleverly* as the ablest trap. *Hudibras.*

A rogue upon the highway may have as strong an
arm, and take off a man's head as *cleverly* as the exe-
cutioner. *South.*

It was the *cleverer* mockery of the two.
L'Estrange.

I read Dyer's letter more for the style than the
news. The man has a *clever* pen, it must be owned.
Addison's Freeholder.

He can't but think 'twould sound more *clever*,
To me, and to my heirs for ever. *Pope.*

She called him gundy-guts, and he called her lousy
Peg, though the girl was a tight *clever* wench as any
was. *Arbutnot.*

CLEVES, a duchy in Westphalia, on the north-west of Germany, near Holland, including an area of 880 square miles, being about forty miles long and ten or twelve in medium breadth. It is situated chiefly on the south bank of the

Rhine, mostly above the point where that river branches out and forms the great stream called the Waal, between 5° 45' and 6° 25' E. long. and 51° 35' and 51° 53' N. lat. It is bounded on the north by the bishopric of Munster, and the province of Overysse, on the west by Brabant and Guelderland, on the south by part of Guelderland, the county of Mark, and the duchy of Berg, and on the east by the county of Reclinghausen and Munster. Since the year 1753 it has been divided into three circles, Cleves, Wesel, and Emmerid; Duisburg, Xanten, and Rees, are also districts of some note. In some parts the country is elevated, and covered with fields, woods and forests, sometimes three or four leagues in extent, on the borders of which are numerous towns and villages. The low grounds, especially on the banks of the Rhine, afford excellent pasturage and a great number of cattle and horses are reared in them. Corn, pulse, fruit, flax, tobacco and various vegetables are cultivated here. Game is abundant, and the rivers furnish salmon, pike, carp, and other fish in great numbers. This duchy contains twenty-four walled towns, the chief of which is

CLEVES, the ancient capital, situated on the river Kermisdale, more than two miles from the west bank of the Rhine. It is one of the neatest towns in the empire, standing in a pleasant situation on the declivity of a hill, and in a valley below it. It is built after the Dutch manner; but, though fortified, it is not very strong. In the upper part stands the castle of Schwandenburg, from which there is a beautiful prospect almost over the whole country. The side of the hill is formed into a number of terraces and alleys, which give it a beautiful appearance. This city is very ancient, having been known to the Romans, the traces of whose works are very evident in the country around. It contains about 5000 people, and is twelve miles south-east of Nimeguen, and seventy from Amsterdam; not far from the frontiers of the united provinces, to which it has a gate directly leading, called the gate of Holland. The duchy of Cleves belongs to the king of Prussia; it was indeed ceded to the French party in 1792, and partly in 1806; and was then included in the department of the Roer. It was afterwards conferred by Buonaparte on general Murat; but, on the restoration of the states of Europe in 1815, it returned to its former possessor. It yields the king of Prussia a revenue of £300,000. The spinning of flax forms an important branch of industry in this country; woollen and linen cloths are also manufactured in several parts, and some silks. Its situation, lying along the Rhine, is extremely favorable for commerce, and the inhabitants are not backward in improving these advantages. The country people are mostly Catholics, while, in the towns, the Protestants form the greater proportion; there are also Jews and Mennonites, liberty of conscience being allowed to all sects. Before the French revolution there were many monasteries here; but they are now almost all suppressed. The air is salubrious, and the climate generally mild. The country is watered by several considerable streams besides the Rhine; as the Maese the Roer the Emeser, the Lippe,

and the Yssel. This duchy forms a part of the grand duchy of the Lower Rhine.

CLEVES, a town of Virginia, in the United States, two miles from Port Royal, in a northerly direction.

CLEW, *n. s.* Saxon, *cljpe*; Dutch, *klousen*. Thread wound upon a bottom: a ball of thread. A guide; a direction; because men direct themselves by a clew of thread in a labyrinth.

*Eftsoons untwisting his deceitful clew,
He gan to weave a web of wicked guile.*

Spenser.

While, guided by some *clew* of heavenly thread,
The perplexed labyrinth we backward tread.

Roscommon.

They see small *clews* draw vastest weights along,
Not in their bulk, but in their order, strong. *Dryden.*

When the only *clew* we have fails us, which is
most reasonable, to stop short or to push forward,
without any *clew* at all into the labyrinth of nature.

Bolingbroke.

This alphabet must be your own *clew* to guide you.

Holder.

Is there no way, no thought, no beam of light?

No *clew* to guide me through this gloomy maze,

To clear my honor, yet preserve my faith? *Smith.*

The reader knows not how to transport his thoughts
over to the next particular, for want of some *clew*, or
connecting idea to lay hold of. *Watts's Logic.*

Clew of the sail of a ship, is the lower corner
of it, which reaches down to that earing where
the tackles and sheets are fastened.

CLEW, *v. a.* From clew, a sea term. To
clew the sails, is to raise them, in order to be
furled; which is done by a rope fastened to the
clew of a sail, called the clew-garnet.

CLIBADIUM, in botany, a genus of plants
of the monœcia class and pentandria order.
Male: CAL. common and imbricated. Female
flowers three or four; SEED an umbellicate drupe:
species but one; a Surinam plant.

CLICK, *v. a.* } Dut. *cliken*; Fr. *cliqueter*;
CLIC'KER, *n. s.* } or perhaps the diminutive of
CLIC'KET, *n. s.* } clack. To make a sharp,
small, successive noise. The substantives are
two low words; one describes the servant of a
salesman who calls to customers; the other, the
knocker of a door.

The solemn death-watch *clicked*, the hour she died;
And shrilling crickets in the chimney cried. *Gay.*

CLIENT, *n. s.* } Lat. *cliens*. One
CLIE'NTED, *part. adv.* } who applies to an ad-
CLIE'NTSHIP, *n. s.* } vocate for counsel and
defence. It may be perhaps sometimes used for
a defendant in a more general sense.

I do think they are your friends and *clients*,
And fearful to disturb you. *Ben Jonson.*

There is due from the judge to the advocate some
commendation, where causes are well handled; for
'tut upholds in the *client* the reputation of his counsel.

Bacon's Essays.

Advocates must deal plainly with their *clients*, and
tell the true state of their case.

Taylor's Rule of Living Holy.

This due occasion of discouragement, the worst
conditioned and least *cliented* petivoguers do yet, un-
der the sweet bait of revenge, convert to a more
pleasful prosecution of actions.

Carew's Survey of Cornwall.

Patronage and *clientship* among the Romans always
descended: the plebeian houses had recourse to the
patrician line which had formerly protected them.

Dryden.

CLIENT, among the Romans, a citizen who
put himself under the protection of some great
man, who in respect of that relation was called
patron. He assisted his client with his protec-
tion, interest, and goods; and the client gave
his vote for his patron, when he sought any office
for himself or friends. The right of patronage
was appointed by Romulus, to unite the rich
and poor together, in such a manner as that one
might live without contempt, and the other with-
out envy; but the condition of a client, in course
of time, became little else but a moderate slavery.

CLIFF, *n. s.* Lat. *clivus*; Sax. *cljpf*, *cljof*. A
steep rock; a rock, according to Skinner, broken
and craggy (*rupes*). The name of a character in
music, properly clef.

This ladie rometh by the *cliffe* to plaie,
With her meine, endlong upon the stonde;
And findeth Jason, and this other stonde,
In speking of this thing, as I you told.

Chaucer. Legend.

The Leucadians did use to precipitate a man from
a high *cliff* into the sea. *Bacon's Nat. Hist.*

Mountaineers, that from Severus came,

And from the craggy *cliffs* of Tetrica. *Dryden.*

Wherever 'tis so found scattered upon the shores,
there is it as constantly found lodged in the *cliffs*
threereabouts. *Woodward.*

CLIFFORD (George), earl of Cumberland, a
nobleman distinguished for his naval enterprises,
was born in Westmoreland, in 1558, and edu-
cated at Peter-house in Cambridge, under Dr.
Whitgift, afterwards archbishop of Canterbury.
He was particularly attentive to the study of the
mathematics. He was also noted for his skill in
the tournament, and all the martial exercises of
his age. Queen Elizabeth, on one occasion,
took off her glove and gave it to him; a mark
of royal favor, which, on public occasions, he
used to wear in his hat, adorned with diamonds.
In 1586 he fitted out a small squadron, with
which he sailed for South America, and, after
taking several vessels from the Portuguese, re-
turned to England. In 1588 he took the com-
mand of a ship, with which he contributed greatly
to the destruction of the Spanish armada; and
was rewarded for his gallant conduct by a grant
from the queen of a commission to make another
voyage to the South Sea. In this, however, he
was unfortunate, for, after proceeding as far as
the Azores, he was obliged by tempestuous wea-
ther to return; nor was he more successful in
1591, in an expedition to the coast of Spain.
Yet he next year attacked the Azores, and took
the town of Santa Cruz and a rich galleon, valued
at £150,000. He sailed again in 1593 and took
several very valuable Spanish prizes. In 1595
he fitted out a ship of 900 tons burden, being
the largest that had ever been launched by an
English subject, but was prevented, by an order
from the queen, from sailing in it himself. In
three years after, however, he sailed with a squa-
dron to the West Indies, where he took the island
of Porto Rico; but in this voyage a great num-
ber of his men were carried off by sickness. This

intrepid nobleman died at Savoy, in 1605, and his remains were interred at Skipton in Yorkshire.

CLIFFORD (Anne), only daughter of the above, born in 1589 at Skepton castle, Craven, and was twice married: first to Richard lord Buckhurst, afterwards earl of Dorset, whose life she wrote, and brought him three sons and two daughters. Her second husband was Philip earl of Pembroke. She built in the course of her life two hospitals, and erected or repaired seven churches. She also erected monuments to the poets Spenser and Daniels, the latter being her tutor. She is particularly celebrated for a spirited reply to Sir Joseph Williamson, secretary of state, after the Restoration. He had presumed to nominate a candidate for *her* borough of Appleyby: 'I have been bullied,' said she, 'by an usurper; I have been neglected by a court; but I will not be dictated to by a subject; your man sha'n't stand.'

CLIFFORTIA, in botany, a genus of the polyandria order, and diœcia class of plants; natural order thirty-eighth, tricocœ: male CAL. triphyllous; cor. none; the stamina near thirty in number: female CAL. triphyllous, superior to the receptacle; styles two; CAPS. bilocular; SEED single: species nineteen, all natives of Africa. Their flowers make no very handsome appearance; but the plants themselves are very ornamental evergreens. They grow to the height of four or five feet, and are propagated by cuttings, which must be young shoots of five or six inches long. If planted in pots in spring or summer, and plunged in a hot-bed, they will readily take root. They must be watered plentifully in summer, but very sparingly in winter.

CLIFT, *n. s.* The same with cliff, now disused.

Down he tumbled, like an aged tree,
High growing on the top of rocky *clift*. *Spenser.*

Lo! where the stripling wrapt in wonder roves,
Beneath the precipice o'erhung with pine;
And sees on high, amidst the encircling groves,
From *clift* to *clift* the foaming torrents shine.

Beattie.

CLIFTON, a parish of Gloucestershire, one mile west from Bristol, and 114 west from London. It stands on a cliff or hill, rising gradually from the river Avon, and has been termed, from the salubrity of its air, the Montpellier of England. Within a few years this beautiful village has been adorned with new and elegant ranges of buildings, shooting out, as a physician phrases it, almost with the rapidity of crystallisation. They are occupied generally by those who seek the aid of the Bristol waters; or very respectable constant residents. It has a most charming prospect of the river, and of the western part of Bristol. The church is handsome and commodious, and on the downs are the remains of Roman military works. Inhabitants about 9000.

CLIMATE, *n. s.* } Gr. *εὐμακτρῶν*. A
CLIMATE'Rick, *adj.* } certain space of time,
CLIMATE'rical, *adj.* } or progression of years,
which is supposed to end in a critical and dangerous time, at the end of which some change is supposed to befall the body.

Elder times, settling their conceits upon *climactors*, differ from one another. *Broune's Vulgar Errors.*

Certain observable years are supposed to be attended with some considerable change in the body; as the seventh year; the twenty-first, made up of three times seven; the forty-ninth, made up seven times seven; the sixty-third, being nine times seven; and the eighty-first, which is nine times nine; which two last are called the grand *climactericks*. *Id.*

The numbers seven and nine, multiplied into themselves, do make up sixty-three, commonly esteemed the great *climacterical* of our lives. *Id.*

Your lordship being now arrived at your great *climacterique*, yet give no proof of the least decay of your excellent judgment and comprehension. *Dryden.*

My mother is something better, though, at her advanced age, every day is a *climacterick*. *Pope.*

CLIMATE, *v. n. & n. s.* } Gr. *κλίμα*. A
CLIMATE'URE, *n. s.* } space upon the surface of the earth, measured from the equator to the polar circles. Also a region, or tract of land, differing from another by the temperature of the air.

The blessed gods

Purge all infection from our air, whilst you
Do *climate* here. *Shakespeare.*

Such harbingers preceding still the fates,
Have heaven and earth together demonstrated
Unto our *climates* and countrymen. *Id.*

Betwixt the extremes, two happier *climates* hold,
The temper that partakes of hot and cold. *Dryden.*

On what new happy *climate* are we thrown. *Id.*
This talent of moving the passions cannot be of
any great use in the northern *climates*. *Swift.*

The subject of *climate* should be studied and attentively observed by the architect; and particularly the effects of the vicissitudes of the seasons upon its materials. *Elmes' Dictionary.*

CLIMATE, in geography, expresses: 1. A portion of the earth's surface contained between two circles parallel to the equator, and of such a breadth, as that the longest day in the parallel nearest the pole exceeds the longest day in that nearest the equator by some certain space of time; and 2. The ordinary state of the atmosphere, with regard to heat and moisture, which prevails in any given portion of the globe. Abulfeda, the great Arabian geographer, gave the names of *real* and *apparent* climates to these two acceptations of the word.

I. In the former the original acceptation of the word is traced, as we see, to the Greek word *κλίμα*, *κλίμῃ*, to incline; and was intended by the ancients to express the obliquity of the sphere with respect to the horizon, the causes of the inequalities of day and night. Ptolemy divided the earth's surface from the equator to the arctic circle into zones calculated to make an increase of a quarter of an hour each in the longest day. These zones would be, of course, nearly of equal breadth near the equatorial line, and become contracted in higher latitudes. It was judged, therefore, sufficient to estimate them in those latitudes by their doubles answering to half an hour's increase of time at Midsummer. The late professor Leslie furnishes, from Ptolemy's geographical work, the following table of the climates as he calculated them.

TABLE OF THE CLIMATES.

Climate, or Parallel.	Latitude.	Length of Midsummer day.	Breadth of zone.	Climate, or Parallel.	Latitude.	Length of Midsummer day.	Breadth of zone.
I.	0° 0	12h. 00m	4° 15'	XIV.	43° 4m	15h. 15'	1° 57'
II.	4 15	12 15	4 10	XV.	45 1	15 30	1 50
III.	8 25	12 30	4 5	XVI.	46 51	15 45	1 41
IV.	12 30	12 45	3 57	XVII.	48 32	16 00	1 32
V.	16 27	13 00	3 47	XVIII.	50 4	16 15	1 36
VI.	20 15	13 15	3 38	XIX.	51 40	16 30	1 10
VII.	23 51	13 30	3 21	XX.	52 50	16 45	1 40
VIII.	27 12	13 45	3 10	XXI.	54 30	17 00	1 30
IX.	30 22	14 00	2 56	XXII.	55 00	17 15	1 00
X.	33 18	14 15	2 42	XXIII.	56 00	17 30	1 00
XI.	36 00	14 30	2 35	XXIV.	57 00	17 45	30
XII.	38 35	14 45	2 21	XXV.	58 00	18 00	
XIII.	40 56	15 00	2 9	XXVI.	59 30	18 30	

Varenius gives us a table of thirty ancient climates ; but without any regard to the refractions. Ricciolus furnishes a more accurate one, wherein the refractions are allowed for ; an abstract of which follows :—

Middle of Climate.	Longest Day.	Lat.	Middle of Climate.	Longest Day.	Lat.	Middle of Climate.	Lat.	Cont. Light.	North Night.	Cont. Light.	South Night.
I.	12th 30	7° 18'	VIII.	16th 0	48° 15'	XV.	66° 53'	31d	27d	30d	28d
II.	13 0	15 36	IX.	17 0	53 46	XVI.	69 30	62	58	60	59
III.	13 30	23 8	X.	18 0	57 44	XVII.	73 0	93	87	89	88
IV.	14 0	29 49	XI.	19 0	60 39	XVIII.	78 6	124	117	120	118
V.	14 30	35 35	XII.	20 0	62 44	XIX.	84 0	156	148	150	149
VI.	15 0	40 32	XIII.	22 0	65 10	XX.	90 0	188	180	178	177
VII.	15 30	44 42	XIV.	24 0	65 54						

More ancient writers speak of seven climates only, confining them to what they imagined the habitable part of the earth. The first they made to pass through Meroe, the second through Sienna, the third through Alexandria, the fourth through Rhodes, the fifth through Rome, the sixth through Pontus, and the seventh through the mouth of Borysthenes.

The beginning of the climate is a parallel circle wherein the day is the shortest. The end of the climate is that wherein the day is the longest ; the climates being reckoned, as we have stated, from the equator to the pole. The first, at its beginning, has its longest day precisely twelve hours long ; at its end twelve hours and a half ; the second, which begins where the first ends, viz. at twelve hours and a half, ends at thirteen hours ; and so of the rest, as far as the polar circles, where, what the geographers call *hour climates* terminate, and *month climates* commence. As an hour climate is a space comprised between two parallels of the equator, in the first of which the longest day exceeds that in the latter by half an hour ; so the month climate is a space terminated between two circles parallel to the polar circles, whose longest day is longer or shorter than that of its contiguous one by a month or thirty days.

The breadth of the respective climates is found

by adding the logarithmic cotangent of the sun's greatest declination to the logarithmic sine of his ascensional difference ; the sum of these logarithms being the logarithmic tangent of the latitude of the circle nearest the pole ; which, being given in each, will determine, of course, the whole operation of forming these circles. Those between the polar circles and the poles are determined by the sun's declination.

The following tables contain the latitude where each climate ends, the length of the longest day at its termination, and its breadth, in degrees and minutes, from Mr. Myer's very complete System of Geography.

FROM THE POLAR CIRCLES TO THE POLES.

Climate.	End of Climate.	Length of Day.	Breadth of Climate.
		Days.	
1	67° 18'	30	0° 46'
2	69 33	60	2 15
3	73 05	90	3 32
4	77 40	120	4 35
5	82 59	150	5 19
6	90 00	180	7 01

FROM THE EQUATOR TO THE POLAR CIRCLES.

Climate.	End of Climate.	Length of Day.	Breadth of Climate.
		Hours.	
1	8° 34'	12½	8° 34'
2	16 44	13	8 10
3	24 12	13½	7 28
4	30 48	14	6 36
5	36 31	14½	5 43
6	41 24	15	4 53
7	45 32	15½	4 08
8	49 02	16	3 30
9	51 59	16½	2 57
10	54 30	17	2 31
11	56 38	17½	2 08
12	58 27	18	1 49
13	59 59	18½	1 32
14	61 18	19	1 19
15	62 26	19½	1 08
16	63 22	20	0 56
17	64 10	20½	0 48
18	64 50	21	0 40
19	65 22	21½	0 32
20	65 48	22	0 26
21	66 05	22½	0 17
22	66 21	23	0 14
23	66 29	23½	0 8
24	66 32	24	0 3

II. Under the second, and more modern acceptation of the word climate, we have to notice the leading features of that great variety of condition and temperature, which pervades the atmosphere of the globe in different regions.

These have been sometimes treated under four very obvious divisions. The cold and humid; cold and dry; warm and humid; hot and dry. 1. A cold and humid climate is such as pervades the eastern shores of Canada, Newfoundland, and Siberia, where the atmosphere, loaded with fogs, yields little encouragement to settlers, and the few vegetable productions only seem to increase the general gloominess of the scene, being confined to a few hardy shrubs. The fenny districts of more temperate regions, as those of some parts of the eastern shores of England, partake of this climate in a modified degree. 2. A cold and dry climate prevails in most of the northern countries of Europe and Asia, in the winters of Upper Canada, &c. and this seems not to be inimical even to delicate human constitutions, while the finest streams of water and abundant vegetation attend it. 3. Warm and humid climates pervade large districts of both the Old and New Worlds; as, Guinea, Demerara, Panama; Hindostan, particularly Bengal, Zanguebar, and Senegal. Here vegetation luxuriates, and is, at the same time, vigorous; the verdant plains are diversified by gigantic trees; and, while the miasmatic vapors render the atmosphere uncongenial to man, the noblest and most ferocious of animals, reptiles of immense size, and beautiful specimens of the feathered creation abound. 4. Hot and dry climates are those of the African and Arabian deserts, where plants, animals, and man, alike languish under burning suns, water is evaporated, and the earth is sand, or 'iron, and the heavens brass.'

These four climates do not, however, as Mr.

Myers observes, always exist according to the full import of the terms by which they are designated. They are subject to various modifications, particularly of two distinct kinds. The one results from the alternation of two different climates in the same region; the other, from the greater or less prevalence of either of the four elements. Thus, when heat, dryness, and humidity are duly combined, they render the climate comparatively temperate. In Egypt, for instance, the combinations of heat and humidity, during the inundation of the Nile, and of heat and dryness during the rest of the year, temper a climate, which, without these alternations, would be insupportable. In Holland the cold humidity of the autumn is succeeded by frost, which increases the salubrity of the climate, that would otherwise not be so healthy. In some places, however, the changes take place so rapidly, or the difference of temperature is so great, that it renders the climate more pernicious to the constitution, than though only one of the kinds existed. The inhabitants of Astrachan and some other cities experience the heats of Africa in summer, and the colds of Siberia in winter. The same constitution of the atmosphere is also agreeably modified, in some instances, by the solar heat; for the dry heat which renders the great desert of Sahara almost inaccessible, becomes a pleasant temperature at either Madrid or Marseilles. The fatal effects of humid heat are less powerful as we advance from the equator; and on the contrary the cold, either dry or humid, is more supportable as we quit the depths of the polar regions and approach towards the tropics. Bergen and Brest have the same winter constitution of the atmosphere, which is rendered humid and varied by the contiguity of the western ocean, but the annual temperatures of the two places are widely different.

The varieties of season connected with this question, we cannot enter into in this place; further than to observe, that in the torrid zone the winter is generally a wet, the summer a dry, season; and that this constitutes the great division of their year: but these are in direct opposition to those seasons, as they would result from the position of the sun in the ecliptic. 'The rain always accompanies the sun, so that, when this luminary is in the northern signs of the zodiac, the countries on that side of the equator have their rainy season. The vertical rays of the sun continually rarify the atmosphere in these regions, the air of colder districts rushes in to restore the equilibrium, the vapors become condensed, and a deluge of rain is the consequence. Those parts of the torrid zone, where there is scarcely any evaporation, have no rain; and in other places the mountains so modify the monsoons as to produce two rainy seasons in the year.' See SEASON.

Professor Leslie insists that all the varieties of climate are reducible to these two causes—distance from the equator,—and height above the level of the sea. 'Latitude and local elevation form, indeed,' says he, 'the great bases of the law of Climate, and any other modifications have only a partial and very limited influence.'

The most obvious effects of latitude appear, in the degree of obliquity given to the solar rays, as

they fall on the surface of the earth, and the quantum of space through which they pass in reaching its surface. Each of these are the immediate results, of course, of the relative height of the sun, and may be illustrated by the following diagram:—

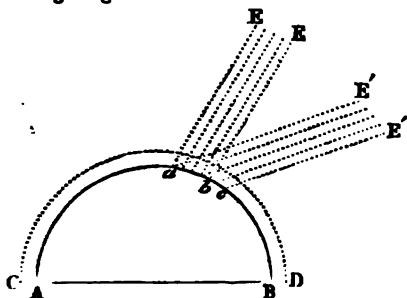

A b B represents the hemisphere, and the dotted semicircle CD the upper limit of the atmosphere; E a and E b are the extreme rays of a pencil of light falling upon the earth at a and b. And E' a and E' c, the extreme rays of an equal pencil, when the sun has a less elevation, as at the winter solstice. It will be evident that the rays reach the surface of the earth in a much more attenuated state in the one case than in the other; and that, as the number of rays in the two pencils is the same, their density will be inversely as the areas of the elliptic spaces they cover. These are as the transverse axes *b, a, c*, since the two conjugate axes are equal. The pencil E' a has also a much greater space to pass through the terrestrial atmosphere, than E a, by which its influence is still further weakened. These causes unite, therefore, in diminishing the solar influence, as the altitude of that luminary decreases; and as this altitude is greatest at the equator, where the sun is vertical, and decreases as the latitude increases, the propriety of the appellations given to the different zones becomes evident, as well as the effects which such a circumstance must have upon the general temperature of the different regions upon which the sun shines.

But, in addition to what we call the height of the sun, the distance of that luminary from the earth must always be taken into consideration in the estimate of different climates. The ratio of these distances at the summer and winter solstices is nearly as 30 to 29; and the number of rays that fall on the same space are inversely as the squares of these distances; and, consequently, in this case, as 900 to 841.—Hence the solar influence in winter is to that in summer, in reference to the distance of the sun only, as 900 to 841, or very nearly as 1.0702 to 1. The length of the day, or the continuation of the sun above the horizon, certainly increases the heat of particular regions, as the shortness of the night also affords less time for a dispersion of the heat accumulated. Refraction and reflection also modify the action of the sun's rays. M. Bouguer has calculated that of 10,000 rays which fall perpendicularly upon the atmosphere, only 8123 reach the surface of the earth; and, if their angle of incidence be 50°, not more than 7624 fall on its surface; but the number was reduced to 2031 when the angle was 7°; and to

5° only when the direction was horizontal. And the earth itself, as absorbing a number of these rays and returning them to the air by reflection, becomes a great source of heat; distance from the earth must therefore be a source of cold; thus we find that, as you ascend in the atmosphere, the cold increases. In the vicinity of Paris, the temperature of the earth being 47°, at the estimated height of 11,084 feet it was found to be 21°, or 11° below congelation, by M. Charles, who ascended in a balloon. And lord Mulgrave, at the bottom of Hackluyt-hill, lat. 80°, found the temperature of the air 50°; but on the top, at the height of 1503 feet, only 42°. Hence we find, that the highest mountains, even under the equator, have their tops continually covered with snow. M. Bouguer found the cold of Pinchina, one of the Cordelieres, immediately under the line, to extend from 7° to 9° below the freezing point every morning before sun-rise; and hence at a certain height, which varies in almost every latitude, it constantly freezes at night all the year round, though in the warm climates it thaws in the same degree the next day. This height M. Bouguer calls the lower term of congelation: between the tropics he places it at the height of 15,577 feet, English measure. And thus while the base of these mountains rests on burning sand, about half way up, in the plains of Quito, we found a temperate zone of the most delightful character. As the hot winds from below ascend the sides of the mountains, they become so cooled by the expansion of the air, that they do not affect the snow on the summits; and the cold winds which sweep over their snowy crests, and descend to the lower regions, are condensed as they proceed, and acquire a temperate warmth before they reach these fertile plains.

A great source of cold is evaporation. The same cause which makes the condensation of vapor a source of heat, makes evaporation the source of cold; as it absorbs the fire in the latter instance, which it gives out in the former: the heat thus absorbed is called latent heat; it producing, in that state, no sensation of warmth. At a certain height above the lower term of congelation it never freezes, not because the cold decreases, but because the vapors do not ascend so high; this height M. Bouguer calls the upper term of congelation, and under the equator he fixes it at the height of 28,000 feet. Kirwan has given us the following mean height of the upper and lower terms of congelation, for the latitude of every 5°, in feet.

Lat.	Alt. lower Term.	Alt. upper Term.	Lat.	Alt. lower Term.	Alt. upper Term.
0°	15,577	28,000	45	7,658	13,730
5	15,457	27,784	50	6,260	11,253
10	15,067	27,084	55	4,912	8,830
15	14,498	26,061	60	3,684	6,546
20	13,719	24,661	65	2,516	4,676
25	13,020	23,423	70	1,557	2,809
30	11,592	20,838	75	748	1,346
35	10,664	19,169	80	120	207
40	9,016	16,207			

Sometimes the temperature of the upper air is higher than that of the lower air, particularly when a large mass of vapors is condensed by electrical agency; for no part of the heat given out by that cause being lost by communication with air much colder, that which surrounds the vapors so condensed, must be heated to a considerable degree. The clouds, by absorbing the sun's rays, are more heated than the clear air would be. These, and other circumstances, render the true height of the terms of congelation, at any time, subject to considerable uncertainty.

Of evaporation, the following facts may be observed: 1. That, in our climates, evaporation is about four times as great from the 21st of March to the 21st of September, as from the 21st of September to the 21st of March. 2. That, other circumstances being the same, it is greater in proportion as the difference between the temperature of the air, and that of the evaporating surface is greater; and so much the smaller, as the difference is smaller; and therefore smallest, when the temperature of the air and evaporating liquor are equal. The former part of this proposition however requires some restriction; for, if air be more than 15° colder than the evaporating surface, there is scarcely any evaporation; but, on the contrary, it deposits its moisture on the surface of the liquor. 3. The degree of cold produced by evaporation is always much greater when the air is warmer than the evaporating surface, than that which is produced when the surface is warmer than the air. Hence, warm winds, as the Sirocco and Harmatan, are more drying than cold winds. 4. Evaporation is more copious when the air is less loaded with vapors, and is therefore greatly promoted by cold winds flowing into warmer countries. 5. Evaporation is greatly increased by a current of air or wind flowing over the evaporating surface, because unsaturated air is constantly brought into contact with it. Hence, calm days are hottest, as has commonly been remarked. 6. Tracts of land covered with trees or vegetables emit more vapor than the same space covered with water. Mr. Williams (*Philadelphia Transactions*) found this quantity to amount to one-third more. Hence, the air about a wood or forest is made colder by evaporation from trees and shrubs, while the plants themselves are kept in a more moderate heat, and secured from the burning heat of the sun, by the vapors perspired from the leaves. Thus, we find the shade of vegetables more effectual to cool us, as well as more agreeable, than the shade from rocks and buildings: and from the same cause the clearing away of woods lessens the vapors, and consequently diminishes the quantity of rain, and increases the temperature. Several parishes in Jamaica which used to produce fine crops of sugar canes, are now dry for nine months in a year, and are turned into cattle-pens through the clearing away of the woods. Hence again, water is most plentiful in those countries where woods abound, and the best springs are there found. Since the woods in the neighbourhood of the American towns have been cut down, many streams have become dry; and others have been reduced so low, as to

cause great interruptions to the miller. It appears probable, that the climates of European countries were more severe in ancient times than they are at present. Cæsar says, that the vine could not be cultivated in Gaul, on account of its winter-cold. The rein-deer, now found only in the zone of Lapland, was then an inhabitant of the Pyrenees. The Tiber was frequently frozen over, and the ground about Rome covered with snow for several weeks together, which very rarely happens in our times. The Rhine and the Danube, in the reign of Augustus, were generally frozen over for several months of winter. The barbarians who overran the Roman empire a few centuries afterwards, transported their armies and waggons across the ice of these rivers.

Drainage of the ground, and removal of forests, however, cannot be reckoned among the sources of the increased warmth of the Italian winters. Chemical writers, says Dr. Ure, have omitted to notice an astronomical cause of the progressive amelioration of the climates of the northern hemisphere. In consequence of the apogee portion of the terrestrial orbit being contained between our vernal and autumnal equinox, our summer half of the year, or the interval which elapses between the sun's crossing the equator in spring, and in autumn, is about seven days longer than our winter half year. Hence also, one reason for the relative coldness of the southern hemisphere.

In the article CLIMATE (Supplement to the Encyclopædia Britannica) the following simple rule is given for determining the change of temperature produced by sudden rarefaction, or condensation of air. Multiply 25 by the difference between the density of air and its reciprocal, the product will be the difference of temperature on the centigrade scale. Thus, if the density be twice, or one half $25 \times (2 - \frac{1}{2}) = 37\frac{1}{2}$ cent. = 67.5° Fahrenheit, indicates the change of temperature by doubling the density or rarity of air. Were it condensed thirty times, then, by this formula, we have 749° for the elevation of temperature, or $25 \times (30 - \frac{1}{30})$. But M. Gay Lussac says, that a condensation of air into one-fifth of its volume is sufficient to ignite tinder; a degree of heat which he states at 300° centigrade = 572 Fahrenheit (*Journal of Science*, vol. vii. p. 177). This experimental result is incompatible with professor Leslie's formula, which gives only 112.5° for the heat produced by a condensation into one-fifth.

The sea exercises an important equalising influence on the temperature of the globe. In the tropical regions a large extent of ocean spreads coolness on every side, and affords a perpetual succession of refreshing breezes. Islands are always, comparatively, of more temperate climates than continents, and those scattered over the expanse of the Pacific, may be said to enjoy almost a perpetual spring. The districts which are surrounded on every side by tracts of continent, experience no mitigation of heat, and are often utterly consumed by the droughts of summer: insular tracts also, and those situated along the sea-coast, experience much less rigorous winters than the interior of continents. The greatest cold in our hemisphere is said to occur

when any country has a wide extent of sea to the south, and of land to the north. Thus Greenland, in lat. 60°, exhibits a more rigorous climate than Lapland, in lat. 72°. From the like cause, the north-east extremity of Asia suffers a cold almost equally intense; and the same combination of circumstances renders the climate of North America, under the same parallel, much colder than that of Europe.

Nor is the influence of winds in general, and the trade-winds in particular, here to be forgotten. Blowing from east to west across the sands of Africa, the latter produce, on its western coast, a most intense heat, much greater than is experienced on the eastern. In passing the Atlantic, they are considerably cooled; and though, in traversing South America, their temperature is again raised, yet, before reaching the opposite coast, they meet the tremendous snow-clad Andes, which stop their progress, and diffuse a wide coolness.

Again, the mountain ranges of the earth not only present and retain on their sides a refreshing coolness; but, by the mighty rivers to which they give rise, diffuse a great amelioration of the temperature through extensive regions. They are particularly of this character, and give rise to the largest rivers in the torrid and burning climes of the earth. In the temperate climates, and those approaching to the poles, mountains are of moderate elevation, are almost always barren, and give rise to few considerable streams.

Professor Mayer, from a comparison of observations, constructed the following empirical rule for finding the relation between the latitude and the mean temperature, in centesimal degrees, at the level of the sea. Multiply the square of the cosine of the latitude by the constant number 29, the product is the temperature. The variation of temperature for each degree of latitude is hence denoted centesimally with very great precision, by half the sine of double the latitude.

Latitude.	Mean temperatures.		Height of curve of congelation in feet.
	Cent.	Fahr.	
0°	29°	84·2	15207
5	28·78	83·8	15095
10	28·13	82·6	14764
15	27·06	80·7	14220
20	25·61	78·1	13478
25	23·82	74·9	12557
30	21·75	71·1	11484
35	19·46	67·	10287
40	17·01	62·6	9001
45	14·50	58·1	7671
50	11·98	53·6	6334
55	9·54	49·2	5034
60	7·25	45·0	3818
65	5·18	41·3	2722
70	3·39	38·1	1778
75	1·94	35·5	1016
80	0·86	33·6	457
85	0·22	32·4	117
90	0·0	32·0	00

As the heat is uniformly greater approaching the equator from the poles, it might be supposed

that the annual accumulation would increase the average temperature of those regions. But this is not the case. The perpetual motion and currents of the atmosphere preserve a maximum temperature, which is but little varied; for, as the air of the equatorial regions becomes warmer, the northern winds have the greater tendency to rush in upon it with rapidity, and check the excess.

‘But within the arctic circle,’ observes an intelligent writer, ‘another powerful agent of nature is constantly tempering the inequality of the seasons. The vast beds of snow, or fields of ice which cover the land and sea in these dreary retreats, absorb, in the act of thawing or passing again into their liquid form, all the surplus heat collected during a nightless summer. The rigor of winter, when darkness resumes her tedious reign, is likewise mitigated by the warmth evolved as congelation spreads over the watery surface.’

Experiments have been made, both at home and abroad, to ascertain the comparative temperature of the earth below its surface, as compared with that of the atmosphere; and they have differed very little.

‘In the caves below the observatory at Paris, in 49° of north latitude, and about eighty-five feet below the surface, Fahrenheit’s thermometer constantly stands between 52° and 54°, and scarcely ever varies 2°; while at the surface the difference of temperature, between summer and winter, sometimes exceeds 90°. In the salt mines at Wieliczka, near 50° of latitude, from the depth of 320 to that of 745 feet, the thermometer stands at about 50°. At Cairo, in Egypt, latitude 30°, at the bottom of Joseph’s well, the depth of which exceeds 210 feet, the thermometer stands at 70°. In the mines of Mexico, at 20° of latitude, the temperature at the depth of 1650 feet, was 74°; thus it augments in approaching the equator.’—*Lacroix’s Geo. Physique.*

Mr. Leslie reports some very interesting experiments on this subject, made in the garden of his friend, Robert Ferguson, esq. of Abbots-hall, in a gravelly soil, lat. 56° 10', and proving how slow is the transmission of heat through the body of the earth. The thermometers were sunk to the depth of one, two, four, and eight feet, and the transmission from the surface appears to have been about an inch per day. The first of these thermometers never sunk lower than 33°, and indicated a mean temperature of 45°·5, which shows that the frost seldom penetrates to that depth. The nature of the soil, however, and external circumstances, must have a great influence on this penetration, as has been proved by experiment. In the same paper it is stated that, ‘in the neighbourhood of Edinburgh, after a long continuance of rigorous weather, the frost was found to have penetrated thirteen inches into the ground in a ploughed field, but only eight inches in one piece of pasture ground, and four inches in another. But, in some of the streets of that city, the frost had descended even below two feet, so as to begin to affect the water-pipes. The greater density and solidity of the pavement had no doubt conducted the frigorific impressions more copiously downwards, while

the loose and spongy blades of grass had mostly scattered and wasted these impressions in the open field. This consideration, it is obvious, might lead to very important practical results. The mean temperatures indicated by the thermometers, at the depth of four and eight feet, were $46\frac{1}{2}^{\circ}$ and $46\frac{1}{4}^{\circ}$; and the mean annual ranges of

the four, in their order from the surface, were, 25° , 20° , 15° , and $9\frac{1}{2}^{\circ}$. The smaller annual temperature of the upper thermometers, the writer thinks, is satisfactorily accounted for by the coldness of the summers of 1816 and 1817, especially the former. The result of the whole number of experiments was as follows:—

	1816.				1817.			
	1 foot.	2 feet.	3 feet.	4 feet.	1 foot.	2 feet.	3 feet.	4 feet.
January, .	33°	36·3°	40·7°	43°	35·6°	38·7°	40·5°	45·1
February, .	33·7	36	39·0	42	37·0	40·0	41·6	42·7
March, .	35	36·7	39·6	42·3	39·4	40·2	41·7	42·5
April, .	39·7	38·4	41·4	43·8	45·0	42·4	42·6	42·6
May . .	44·0	43·3	43·4	44·0	46·8	44·7	44·6	44·2
June . .	51·6	50·0	47·1	45·8	51·1	49·4	47·6	47·8
July . .	54·0	52·5	55·4	47·7	55·2	55·0	51·4	49·6
August . .	50·0	52·5	50·6	49·4	53·4	53·9	52·0	50·0
September .	51·6	51·3	51·8	50·0	53·0	52·7	52·0	50·7
October . .	47·0	49·3	49·7	49·6	45·7	49·4	49·4	49·8
November .	40·8	43·8	46·3	45·6	41·0	44·7	47·0	47·6
December .	35·7	40·0	43·0	46·0	37·9	40·8	44·9	46·4
Mean of whole year.	43·8	44·1	45·1	46	44·9	45·9	46·2	46·6

On this subject, Mr. Leslie remarks, that, 'If the thermometer had been sunk considerably deeper, they would, no doubt, have indicated a mean temperature of $47\cdot7^{\circ}$. Such is the permanent temperature of a copious spring which flows at a short distance, and about the same elevation, from the side of a basaltic, or green-stone rock. Profuse fountains and deep wells, which are fed by percolation through the crevices of the strata, furnish the surest and easiest mensuration of the temperature of the earth's crust. The body of water which bursts from the caverns of Vaucluse, and forms almost immediately a respectable and translucent river, has been observed not to vary in its temperature, by the tenth part of a degree (centigrade) through all the seasons of the year. It is therefore an object highly important for scientific travellers, to notice the precise heat of springs in favorable situations, as they issue from their rocky beds. Such choice observations would accurately fix the medium temperature of the climate. It is only requisite to exclude the superficial and the thermal springs, which are not difficult to distinguish.' See the article CLIMATE. *Supplement to the Encyclopædia Britannica.*

The mean temperature of the air, near the surface of the earth, has also been ascertained at various places. At Paris and Cairo it was found to correspond nearly with the numbers before stated. At St. Petersburg in lat. 60° the mean temperature is about 39° . At Wadso, in Lapland, in 70° of latitude, it was found to be about 36° ; and in the island of Mageröe, near the North Cape, the mean temperature of the year is stated, by M. Von Buch, to be nearly 32° ; the mean for every month in the same situation, is inserted at page 312 of this volume. According

to M. Humboldt, the hottest places are on the southern shores of the Caribbean sea, and the gulf of Guayaquil, in the great equinoxial ocean, between two and three degrees of south latitude. There the mean heat is $81\cdot5^{\circ}$; and the thermometer sometimes rises to 106° . At Belbeis, in Egypt, the thermometer has risen to more than 125° in the shade; but this was occasioned by the hot wind, denominated Sirocco. At St. Petersburg, on the contrary, the cold is sometimes so intense as to congeal mercury. It has also been observed, at the same place, to rise above 90° .

In the first number of the Edinburgh Philosophical Journal, some facts are stated by Mr. Bald apparently incompatible with the idea of the interior temperature of the earth being deducible from the latitude of the place, or the mean temperature at the surface.

The following table presents at one view the temperature of air and water in the deepest coal-mines in Great Britain.

Whitehaven Colliery, county of Cumberland.

	Degrees Fah.
Air at the surface	55
A spring at the surface	49
Water at the depth of 480 feet	60
Air at the same depth	63
Air at depth of 600 feet	66
Difference between water at surface and at 480 feet	11

Workington Colliery, county of Cumberland.

Air at the surface	56
A spring at the surface	48
Water 180 feet down	50

	Degrees Fah.
Water 504 feet under the level of the ocean, and immediately beneath the Irish Sea	60
Difference between water at surface and bottom	12
<i>Team Colliery, county of Durham.</i>	
Air at pit bottom, 444 feet deep	68
Water at same depth	61
Difference between the mean temperature of water at surface = 49°, and 444 feet down	12
<i>Percy Main Colliery, county of Northumberland.</i>	
Air at the surface	42
Water about 900 feet deeper than the level of the sea, and under the bed of the river Tyne	68
Air at the same depth	70
At this depth Leslie's hygrometer indicated dryness = 83°.	
Difference between mean temperature of water at surface = 49°, and at 900 feet down	19
<i>Jarrow Colliery, county of Durham.</i>	
Air at the surface	49
Water 882 feet down	68
Air at same depth	70
Air at pit bottom	64
Difference between the mean temperature of water at surface = 49°, and 882 feet down	19
The engine pit of Jarrow is the deepest perpendicular shaft in Great Britain, being 900 feet to the foot of the pumps.	
<i>Killingworth Colliery, county of Northumberland.</i>	
Air at the surface	48
Air at bottom of pit, 790 feet down	51
Air at depth of 900 feet from the surface, after having traversed a mile and a half from the bottom of the downcast pit	70
Water at the most distant forehead or mine, and at the great depth of 1200 feet from the surface	74
Air at the same depth	77
Difference between the mean temperature of the water at the surface = 49°, and water at the depth of 1200 feet	25
Distilled water boils at this depth at	213
Do. do. at surface	210½

presents an immense excavation, 200 or 300 feet deep, was observed, at a period when the working was stopped, to have great blocks of ice lying at the bottom of it. The bottom of the main shaft of the silver mine of Kongsberg in Norway, about 300 feet deep, is covered with perpetual snow. Hence, likewise, in the deep crevices of *Ætna* and the Pyrenees, the snows are preserved all the year round. It is only, however, in such confined situations that the lower strata of air are thus permanently cold. In a free atmosphere the gradation of temperature is reversed, or the upper regions are colder, in consequence of the increased capacity for heat of the air, by the diminution of the density. In the milder climates it will be sufficiently accurate, in moderate elevations, to reckon an ascent of 540 feet for each centesimal degree, or 100 yards for each degree on Fahrenheit's scale of diminished temperature. Dr. Francis Buchanan found a spring at Chitlong, in the lesser valley of Nepal, in Upper India, which indicated the temperature of 14·7 centesimal degrees, which is 8·1° below the standard for its parallel of latitude, 27° 38'. Whence, $8·1 \times 540 = 4374$ feet is the elevation of that valley. At the height of a mile this rule would give about thirty-three feet too much. The decrements of temperature augment in an accelerated progression as we ascend.

Ben Nevis, the highest mountain in Great Britain, stands in latitude 57°, where the curve of congelation reaches to 4534 feet. But the altitude of the summit of the mountain is no more than 4380 feet; and therefore, during two or three weeks in July, the snow disappears. The curve of congelation must evidently rise higher in summer, and sink lower in winter, producing a zone of fluctuating ice, in which the glaciers are formed.

Baron Humboldt has stated, that the temperature of the silver mine of Valenciana in New Spain is 11° above the mean temperature of Jamaica and Pondicherry, and that this temperature is not owing to the miners and their lights, but to local and geological causes. To the same local and geological causes we must ascribe the extraordinary elevation of temperature observed by Mr. Bald. He further remarks that the deeper we descend, the drier we find the strata; so that the roads through the mines require to be watered, in order to prevent the horse-drivers from being annoyed by the dust. This fact is adverse to the hypothesis of the heat proceeding from the chemical action of water on the strata of coal. As for the pyrites intermixed with these strata, it does not seem to be ever decomposed, while it is in situ. The perpetual circulation of air for the respiration of the miners must prevent the lights from having any considerable influence on the temperature of the mines.

M. Humboldt has also published an admirable systematic view of the mean temperatures of different places, in the third volume of the *Memoirs of the Society of Arcueil*. His paper is entitled, *Of Isothermal Lines* (lines of the same temperature), and the distribution of Heat over the Globe. By comparing a great number of observations made between 46° and 48° N. lat., he

found, that at the hour of sun-set the temperature is, very nearly, the mean of that at sun-rise and two hours after noon. Upon the whole, however, he thinks that the two observations of the extreme temperatures will give us more correct results.

The difference which we observe in cultivated plants, depends less upon mean temperature, than upon direct light, and the serenity of the atmosphere; but wheat will not ripen if the mean temperature descend to 47°6'.

Europe may be regarded, according to this distinguished traveller, as the western part of a great continent, and subject to all those influences which make the western sides of all the continents warmer than the eastern. The same difference that we observe on the two sides of the Atlantic, exists on the two sides of the Pacific. In the north of China the extremes of the seasons are much more felt than in the same latitudes in New California, and at the mouth of the Columbia. On the eastern side of North America, we have the same extremes as in China;

New York has the summer of Rome, and the winter of Copenhagen; Quebec has the summer of Paris, and the winter of Petersburg. And in the same way in Peking, which has the mean temperature of Britain, the heats of summer are greater than those at Cairo, and the cold of winter as severe as that at Upsal. This analogy between the eastern coasts of Asia and of America sufficiently proves, that the inequalities of the seasons depend upon the prolongation and enlargement of the continents towards the pole, and upon the frequency of north-west winds, and not upon the proximity of any elevated tracts of country.

Ireland, according to Humboldt, presents one of the most remarkable examples of the combination of very mild winters with cold summers; the mean temperature in Hungary for the month of August is 71°6'; while in Dublin it is only 60°8'. In Belgium, and Scotland, the winters are milder than at Milan. The above admirable paper furnishes us with the following

TABLE OF THE ISOTHERMAL BANDS, AND DISTRIBUTION OF HEAT OVER THE GLOBE.

Isothermal bands.	Names of the places.	Position in			Mean temperature of the year.	Distribution of Heat in the different Seasons.					Maximum and Minimum.	
		Latitude.	Longitude.	Ht. in feet.		Mean temp. of Winter.	Mean temp. of Spring.	Mean temp. of Summer.	Mean temp. of Autumn.	Mean temp. of warmest month.	Mean temp. of coldest month.	
Isothermal band from 32° to 41°	Nain	deg. min.	deg. min.		deg.	deg.	deg.	deg.	deg.	deg.	deg.	deg.
	*Enontekies	68 30	18 27 W	1356	27.0	0.4	23.7	48.4	33.4	51.8	—	—11.2
	Hospice de St. Gothard	46 30	6 3 E	6390	30.4	18.4	26.4	45.0	31.8	46.2	15.0	—
	North Cape	71 0	23 30 E		32.0	23.8	29.4	43.2	32.2	50.2	22.1	—
	*Ulea	65 3	23 6 E		33.0	11.8	27.2	57.8	36.0	61.6	7.7	—
	*Umea	63 50	17 56 E		33.2	13.0	33.8	54.8	33.4	62.6	11.4	—
	*Petersburgh	59 56	27 59 E		38.8	17.0	38.2	62.0	38.6	65.6	8.6	—
	Drontheim	63 24	8 2 E		40.0	23.8	35.2	61.4	40.1	65.0	19.8	—
	Moscow	55 45	35 12 E	970	40.2	10.8	44.0	67.1	38.3	70.6	6.0	—
	Abo	60 27	19 58 E		40.4	20.8	38.3	61.8	40.6	—	—	—
Isothermal band from 41° to 50°.	*Upsal	59 51	15 18 E		42.0	25.0	40.0	60.2	42.8	62.4	22.4	—
	*Stockholm	59 20	15 43 E		42.2	25.6	38.3	61.8	43.2	64.0	22.8	—
	Quebec	46 47	73 30 W		41.8	14.2	38.9	68.0	46.0	73.4	13.8	—
	Christiana	59 55	8 28 E		42.8	28.8	40.1	62.6	41.2	66.8	28.8	—
	*Convent of Peysenburg	47 47	8 14 E	3066	43.0	28.6	42.0	58.4	43.0	59.4	30.2	—
	*Copenhagen	55 41	10 15 E		45.6	30.8	41.2	62.6	48.4	65.0	27.2	—
	*Kendal	54 17	5 6 W		46.2	36.8	45.2	56.8	46.2	58.1	34.8	—
	Malouin Islands	51 25	62 19 W		47.0	39.6	46.6	53.0	48.4	55.8	37.4	—
	*Prague	50 5	12 4 E		49.4	31.4	47.6	68.9	50.2	—	—	—
	Gottingen	51 32	7 33 E	456	47.0	30.4	44.2	64.8	48.6	66.4	33.2	—
	*Zurich	47 22	6 12 E	1350	47.8	29.6	48.2	64.0	48.8	65.7	26.8	—
	*Edinburgh	55 57	5 30 W		47.8	38.6	46.4	58.2	48.4	59.4	38.3	—
	Warsaw	52 14	18 42 E		48.6	27.8	47.4	69.0	49.4	70.4	27.2	—
	*Coire	46 50	7 10 E	1876	49.0	32.4	55.4	63.4	50.4	64.6	29.6	—
	Dublin	53 21	8 39 W		49.2	39.2	47.3	59.6	50.0	61.0	35.4	—
Berne	46 5	5 6 E	1650	49.3	32.0	49.0	66.6	49.8	67.2	30.6	—	
*Geneva	46 12	3 48 E	1080	49.3	34.9	47.6	65.0	50.0	66.6	34.2	—	
*Manheim	49 29	6 8 E	432	50.2	33.8	49.6	67.1	49.8	68.8	33.4	—	
Vienna	48 12	14 2	420	50.6	32.8	51.2	69.2	50.6	70.6	26.6	—	

TABLE OF THE ISOTHERMAL BANDS, &c.—Continued.

Isothermal bands.	Names of the Places.	Position in			Mean temperature of the year.	Distribution of Heat in the different Seasons.				Maximum and Minimum.	
		Latitude.	Longitude.	Ht. in feet.		Mean temp. of Winter.	Mean temp. of Spring.	Mean temp. of Summer.	Mean temp. of Autumn.	Mean temp. of warmest month.	Mean temp. of coldest month.
		deg. min.	deg. min.		deg.	deg.	deg.	deg.	deg.	deg.	
Isothermal band from 50° to 59°.	*Clermont . . .	45 46	0 45	1260	50·0	—34·7	50·6	64·4	51·2	66·2	—23·0
	*Buda	47 29	16 41	494	51·0	31·0	51·0	63·2	52·4	71·6	27·6
	Cambridge, (U. S.)	42 25	73 23 W	0	50·4	34·0	47·6	64·4	49·8	72·8	29·8
	*Paris . . .	48 50	0 0	222	51·0	38·6	49·2	64·6	51·4	65·3	36·0
	*London . . .	51 30	2 25 W	0	50·4	39·6	48·6	63·2	50·2	64·4	37·8
	Dunkirk . . .	51 2	0 2 E	0	50·6	38·4	48·6	63·8	50·9	64·8	37·8
	Amsterdam . . .	52 22	2 30 E	0	51·6	36·8	51·6	65·8	51·6	67·0	35·4
	Brussels . . .	50 50	2 2 E	0	51·8	36·6	53·2	66·2	51·0	67·4	35·6
	*Franeker . . .	52 36	4 2 E	0	51·8	36·6	51·0	67·2	54·4	69·0	32·9
	Philadelphia . . .	39 56	77 36 W	0	53·4	32·2	51·4	74·0	56·6	77·0	39·7
	New York . . .	40 40	76 18 W	0	53·8	29·8	51·2	79·2	54·6	80·6	25·4
	*Cincinnati . . .	39 6	85 0 W	510	53·8	32·9	54·4	72·8	54·4	74·3	30·2
	St. Malo . . .	48 39	4 21 W	0	54·4	42·2	52·2	66·0	55·8	67·0	41·8
	Nantes . . .	47 13	3 52 W	0	55·0	40·4	54·5	68·6	55·6	70·6	38·0
Pekin . . .	39 54	114 7 E	0	55·2	26·8	56·3	82·6	54·2	84·4	39·4	
*Milan . . .	45 28	6 51 E	390	55·8	36·4	56·1	73·0	56·8	74·6	36·2	
Bourdeaux . . .	44 50	2 54 W	0	56·4	42·0	56·8	70·8	56·3	72·8	41·0	
Isothermal band from 59° to 68°.	Marseilles . . .	43 17	3 2 E	0	59·0	45·5	57·6	72·5	60·0	74·6	44·4
	Montpellier . . .	43 36	1 32 E	0	59·4	44·0	57·0	75·8	61·0	78·2	42·0
	*Rome . . .	41 53	10 7 E	0	60·4	45·8	57·8	75·2	62·8	77·0	42·2
	Toulon . . .	43 7	3 30 E	0	62·0	48·4	60·8	74·8	64·4	77·0	46·4
	Nangasachi . . .	32 45	127 35 E	0	60·8	39·4	57·6	83·0	64·2	86·9	37·4
	*Natchez . . .	31 28	93 50 W	180	64·8	48·6	65·4	79·2	65·8	79·7	47·0
Isothermal band from 68° to 77°.	*Funchal . . .	32 37	19 16 W	0	68·6	64·8	65·8	72·5	72·4	75·6	64·2
	Algiers . . .	36 48	0 41 E	0	70·0	61·4	65·6	80·2	72·5	82·8	60·0
Isothermal band above 77°.	*Cairo . . .	30 2	28 58 E	0	72·4	58·4	73·6	85·1	70·5	85·8	55·8
	*Vera-cruz . . .	19 11	98 21 W	0	77·8	72·0	77·9	81·5	78·6	81·5	71·0
	*Havannah . . .	23 10	84 33 W	0	78·2	71·2	79·0	83·3	79·0	84·0	70·0
	*Cumana . . .	10 27	67 35 W	0	81·8	80·2	83·6	82·0	79·6	84·4	79·2

••• The temperatures are expressed in degrees of Fahrenheit's thermometer; the longitudes are counted from east to west, from the first meridian of the observatory of Paris. The mean temperature of the seasons has been calculated, so that the months of December, January, and February, form the mean temperature of the winter. The mark * is prefixed to those places, the mean temperatures of which have been determined with the most precision, generally, by a mean of 8000 observations. The isothermal curves having a concave summit in Europe, and two convex summits in Asia and Eastern America, the climate is denoted to which the individual places belong.

Comparing the northern half of the globe with the southern, our author observes, the southern hemisphere differs considerably from the northern; but the degree of this difference has been variously stated; the coldness of the southern hemisphere, has generally been attributed to the circumstance of the sun being a shorter time on the south, than on the north side of the equator. But it probably depends more upon the greater proportion of ocean, which gives to the southern temperate zone a climate more approaching to that of a collection of islands. There is, there-

fore, a less accumulation of heat during the summer, and a less radiation from the land, in proportion to its less extent; and there is consequently a less current of warm air flowing from the equator towards the south pole, which permits the ice to accumulate more around it. Near the equator, and indeed through the whole of the torrid zone, the temperature of the two hemispheres appears to be the same; but the difference begins to be felt in the Atlantic about 22° of latitude; and there is a considerable difference between the mean temperature of Rio Janeiro and Havanah,

though they are equally distant from the equator, that of the former being $74^{\circ} 5'$ and of the latter $76^{\circ} 4'$. The southern climates generally differ from the northern with respect to the distribution of temperature through the different parts of the year. In the southern hemisphere, under the isothermal lines of 45° and 50° , we find summers, which, in our hemisphere, belong to the lines

$35^{\circ} 5'$ and 41° . We are not accurately acquainted with the mean temperature of any place beyond 50° of south latitude; but there is every reason to suppose that it differs considerably from the same degree of north latitude. We extract from his Personal Narrative, the following tabular comparison on this subject, in Fahrenheit's degrees.

Latitude.	Corresponding Months.	Mean temp. of the months.		Latitude.	Corresponding Months.	Mean temp. of the months.	
		Southern Hemisphere.	Northern Hemisphere.			Southern Hemisphere.	Northern Hemisphere.
$0-15^{\circ}$	December June	$82^{\circ} \cdot 4$	$83^{\circ} \cdot 3$		February August	$62^{\circ} \cdot 24$	$62^{\circ} \cdot 6$
18	October April	81·5	79·3	43°	July January	59·36	64·76
22—26	January July	72·5	66·74	48	June December	44·6	63·86
	September March	69·44	68·9	58	July January	43·16	56·3
34	December June	56·84	59·72				

The observations employed in constructing this table were all made at sea, except those from which the mean temperature at thirty-four degrees was deduced, which were made at the Cape of Good Hope.

The influence of climate on the character and habits of *man* has, naturally, attracted the attention of various modern philosophers and travellers. Humboldt observes, in his *Researches*, 'Although the manners of a people, the display of their intellectual faculties, the peculiar character stamped on their works, depend upon a great number of causes which are not merely local; it is nevertheless true, that the climate, the nature of the soil, the physiognomy of the plants, the view of beautiful or savage nature, have great influence on the progress of the arts, and on the style which distinguishes their productions. This influence becomes the more perceptible, the farther man is removed from civilisation. What a contrast between the architecture of a tribe that has dwelt in vast and gloomy caverns, and that of the hordes whose bold monuments recal, in the shafts of their columns, the towering trunks of the palm-trees of the desert! An accurate knowledge of the arts can be acquired only from studying the nature of the site where they arose. The only American tribes among whom we find remarkable monuments, are the inhabitants of the mountains. Isolated in the regions of the clouds, on the most elevated plains on the globe, surrounded by volcanoes, the craters of which are encircled by eternal snows, they appear to have admired, in the solitude of their deserts, those objects only which strike the imagination by the greatness of their masses; and their productions bear the stamp of the savage nature of the Cordilleras.

'What a striking spectacle does human genius

present, when we survey the immense disparity that separates the tombs of Tinian and the statues of Easter Island, from the monument of the Mexican temple at Mitla; and compare the shapeless idols of this temple with the masterpieces of the chisel of Praxitelles and Lysippus! But we shall cease to wonder at the rude style, or incorrect expression, of the monuments of the American nations, when we reflect, that, cut off from the rest of mankind, wanderers in a country where man must have long struggled against nature in her most savage and disordered aspect, these tribes, with no resources but in their own energy, could only emerge with tardy progress from their native barbarism.'

A recent contributor to the *Classical Journal* has, in his essay on the Causes of the diversity in Human Character, investigated the influence of climate on our species with considerable research and ingenuity. Extreme heat clearly darkens the skin, swells the flesh, and produces that general chubbiness of appearance which is so remarkable in the torrid zone. The intermediate degrees of temperature produce proportional effects; and persons born in temperate climates become gradually assimilated to the characters of the warmer ones in case of their migration thither. The original Portuguese and French settlers on the coast of Africa would scarcely recognise the kindred of their descendants, who, retaining a snattering of their original language, are closely assimilated to the native tribes, both in their complexion and in the woolly hair that covers their heads.

'One of the most striking illustrations of the

assimilating powers of climate,' says the writer alluded to, 'is afforded in the case of the Jews. This tribe is scattered over the whole face of the earth, and, though naturalised in every soil, it is still preserved distinct from the rest of mankind. The Jews, on account of the prejudices of religion, and other causes, never intermarry with any but their own sect. If, therefore, they are assimilated to the people among whom they reside, this 'cannot be ascribed to a mixture of races. Yet it is found that the English Jew is white, the Portuguese brown, the American olive, and the Egyptian swarthy; so that there are, in fact, as many different species of Jews, as there are countries in which they reside, a diversity which can scarcely be accounted for from any other cause than the influence of climate. And climate,' as this writer further observes, 'has a direct influence in regulating the strength, or weakness of the human constitution; in consequence of which it materially affects the character. The inhabitants of a hot climate are never so robust as those of a more temperate region; extreme heat relaxes the muscular fibre, deranges the natural secretions, and enervates the whole corporeal system. This imbecility of body necessarily has a great effect on the mind; and among such people we have reason to expect timidity and cowardice rather than valor and a capacity to endure hardship. In a climate where moderate cold occasionally prevails, the animal fibre is braced, and all the bodily functions are allowed free play. Here, therefore, we have reason to expect a strong and hardy race, equally qualified to endure the fatigues of the field, and to brave the dangers of war.' In confirmation of this reasoning he cites the imbecile character of the Chinese, the Persians, and the Hindoos, for successive ages.

With indolence we also find the love of luxury and effeminate pleasures prevail in warm climates: together with a remarkable degradation of the female sex. Hence polygamy destroys domestic rule and domestic happiness: woman is the slave altogether of the sexual desires of the master-sex. She is jealously secluded for the sake of her transient charms; and the object of warm passion, at the best, rather than of generous and tender friendship or esteem. Some writers have, indeed, contended, that these climates are favorable to the early stages of science and the arts; and remind us that the 'fertile plains of the south of Asia, are universally respected as the cradle of arts, and of genius.' Soon, however, have they migrated from these regions. 'There has been a continual progress northward from happier climes to those less favored by nature,' observe the same parties; and we conclude, with the writer in the Classical Journal before adverted to, that it is in the temperate regions of the earth therefore, that we are to look for an advanced state of the arts, and there that we are to expect examples of heroic valor, transcendent genius, incorruptible patriotism, and unshaken virtue. And it will not be denied, that historical evidence affords the most direct confirmation of the truth of this doctrine.

CLIMAX, *n. s.* Gr. κλιμαξ. Gradation; ascent; a figure in rhetoric, by which the sentence

rises gradually, as, Cicero says to Catiline, Thou doest nothing, movest nothing, thinkest nothing; but I hear it, I see it, and perfectly understand it.

Choice between one excellency and another is difficult; and yet the conclusion, by a due climax, is evermore the best. Dryden. *Juv. Dedicat.*

Rome radiant Richmond every age has graced,
Still rising in a climax, till the last,
Surpassing all, is not to be surpast. Granville.

CLIMB, *v. n. & v. a.* } Sax. cli-
CLIMBER, *n. s.* } man; Dut.
CLIMBER (from clamber), *v. n.* } klimmen. To
ascend up any place; to mount by means of some hold or footing. It implies labor and difficulty, and successive efforts.

And on the Monday, when it drew to night,
He shette his dore withoute candele light,
And shortly up they clomben alle three.

Chaucer. *Canterbury Tales.*

In scaling the youngest to plucke off his becke,
Beware how ye climber for breaking your neck.

Tusser.

Lowliness is young Ambition's ladder,
Whereto the climber upward turns his face.

Shakespeare.

When shall I come to the top of that same hill?—
—You do climb up it now. Look, how we labour.

Id.

Is't not enough to break into my garden,
Climbing my walls, in spite of me the owner? Id.
As a thief,

Into the window climbs, or o'er the tiles,
So clomb the first grand thief into God's fold.

Milton.

Thou sun! of this great world both eye and soul,
Acknowledge Him thy greater; sound his praise
In thy eternal course, both when thou climbst,
And when high noon has gained, and when thou fallest.

Id. *Paradise Lost.*

Here unto Latmos top I climb,
How far below thine orb sublime. Marvell.

Here I survey the purple vintage grow,
Climb round the poles and graceful row.

Gay.

The path that leads where hung sublime,
And seen afar, youth's trophies bright
In Fancy's rainbow-ray invite
His wingy nerves to climb. Beattie.

Ah! who can tell how hard it is to climb
The steep where Fame's proud temple shines afar,
Ah! who can tell how many a soul sublime
Has felt the influence of malignant star,
And waged with Fortune an eternal war. Id.

What is the end of fame? 'Tis but to fill
A certain portion of uncertain paper;
Some liken it to climbing up a hill,
Whose summit, like all hills, is lost in vapour.

Byron.

CLIMBER, a plant that creeps upon other supports; the name of a particular herb.

Ivy, briony, honey-suckles, and other climbers, must be dug up. Mortimer.

CLIME, *n. s.* contracted from climate, and therefore properly poetical. Climate; region; tract of earth.

He can spread thy name o'er land and seas,
Whatever clime the sun's bright circle warms.

Milton.

They apply the celestial description of other climes
unto their own. Browne's *Vulgar Errors.*

Of beanty sing, her shining progress view,
From *clime* to *clime* the dazzling light pursue.

Granville.

We shall meet

In happier *climes* and on a safer shore. *Addison.*

Health to vigorous bodies, or fruitful seasons in
temperate *climes*, are common and familiar blessings.

Atterbury.

Heart on her lips, and soul within her eyes,
Soft as her *clime* and sunny as her skies. *Byron.*

CLINCH, *v. a. & n. s.* } Sax. *clyniga*, to
CLINCHER, *n. s.* } knock. To hold in
the hand with the fingers bent over it; to bend
the point of a nail in the other side; to confirm;
to fix, as to clinch an argument, to contract or
double the fingers. That part of a cable which
is fastened to the ring of the anchor. A cramp;
a holdfast; a piece of iron bent down to fasten
planks.

Such as they are I hope they will prove, without a
clinch, luciferous; searching after the nature of light.

Boyle.

Pure *clinch*es the suburban muse affords,
And Panton waging harmless war with words.

Dryden.

Simois rolls the bodies and the shields
Of heroes, whose dismembered hands yet bear
That dart aloft, and *clinch* the pointed spear. *Id.*
Here one poor word a hundred *clinch*es make.

Pope.

The wimbles for the work Calypso found;
With those he pierced 'em, and with *clinch*ers bound.

Id.

Their tallest trees are about seven feet high, the
tops whereof I could but just reach with my fist
*clinch*ed.

Swift.

CLINCH, a navigable river of the United
States, in the Tennessee government; which
rises in the Cumberland mountains, Virginia,
and running south-west, crosses the divisional
line; thence meandering south-west by west
for about 200 miles, unites with the Tennessee,
fifteen miles below the Holstein.

CLINCHING, in sea language, a kind of slight
caulking used at sea, in anticipation of foul weather,
about the posts: it consists in driving a
little oakum into their seams, to prevent the
water coming in at them.

CLING, *v. n.* } Dan. *klynger*. To hang
CLINGY, *adj.* } upon by twining round; to
stick to; to hold fast upon. To adhere, as fol-
lowers or friends. To dry up; to consume; to
waste; to pine away, Leclunzen *треоп*, a with-
ered tree.

The broil long doubtful stood;
As twospent swimmers that do *cling* together,
And choke their art. *Shakspeare.*

If thou speakest false,

Upon the next tree shalt thou hang alive,
Fill famine *cling* thee. *Id. Macbeth.*

Most popular consul he is grown, methinks:
How the rout *cling* to him! *Ben Jonson's Cataline.*

The fontanel in his neck was described by the *cling*-
ing of his hair to the plaster. *Wiseman's Surgery.*

When they united and together *clung*,
When undistinguished in one heap they hung.

Blackmore.

See in the circle next Eliza placed,
Two babes of love close *clinging* to her waist.

Pope.

That they may the closer *cling*,
Take your blue ribbon for a string. *Swift.*

CLINICAL, *adj.* } Gr. *κλινω*, to lie down.
CLINICK. } Those that keep their beds;
those that are sick, past hopes of recovery. A
clinical lecture is a discourse upon a disease,
made by the bed of the patient. A clinical con-
vert, one that is converted on his death-bed.
This word occurs often in the works of Taylor.

CLINK, *v. a., v. n. & n. s.* perhaps softened
from clank, or corrupted from click. To strike
so as to make a small sharp noise; to utter a
small, sharp, interrupted, noise. A sharp, suc-
cessive noise; a knocking. It seems in Spen-
ser to have some unusual sense. I believe the
knocker of a door.

Though creeping clove, behind the wicket's *clink*,
Privily he peeped out through a chink. *Spenser.*

I heard the *clink* and fall of swords.

Shakspeare.

Five years, a long lease for the *clinking* of pewter.

Id.

The severed bars

Submissive *clink* against your brazen portals.

Prior.

Underneath the umbrella's oily shed,
Safe through the wet on *clinking* pattens tread.

Gay's Trivia.

CLINOMETER, an instrument for measuring
the dip of mineral strata. It was originally in-
vented by R. Griffith, Esq. professor of Geology to
the Dublin Society, and subsequently modifi-
ed by Mr. Jardine and lord Webb Seymour.

CLINOPODIUM, field-basil, a genus of
the gymnospermia order, didynamia class of
plants; natural order forty-first, asperifoliae.
The involucre consists of many small bristles
under the verticillus or whirl of flowers: *cal.*
two lipped: *cor.* upper lip, flat and inversely
heart-shaped. There are three species, herbace-
ous plants, growing from one to two feet high.
They are remarkable only for their strong
odor, being somewhat between marjorum and
basil.

CLINQUANT, *adj.* Fr. Dressed in em-
broidery, in spangles, false glitter, tinsel finery.

To-day the French

All *clinquant*, all in gold, like heathen gods,
Shone down the English. *Shakspeare.*

CLINTON (Sir Henry), an eminent English
general, and knight of the bath, was the grand-
son of Francis earl of Lincoln. He became a
captain of the guards in 1758, and in July 1766
we find him a lieutenant-general in America. He
took an active part during the unfortunate war
with that country; but some misunderstanding
having taken place betwixt Sir Henry and Lord
Cornwallis, the general, after his return to Eng-
land, published a narrative of his conduct, which
was replied to by his lordship, and vindicated
by the general. In 1784 he published a farther
defence of his conduct; and in 1795 he was ap-
pointed governor of Gibraltar, but died soon
after.

CLINTON, a county of New York, in the
north-east corner, bounded on the east by lake
Champlain, on the north by Canada, on the west
by Harkemer, and on the south by Washington.
It is divided into five townships; viz. Platts-

burg, the capital, Crown-point, Williamborough, Peru, and Champlain. Its form is a parallelogram. It is ninety-six miles long from north to south, and thirty-seven broad from east to west. In 1799 Essex county was erected from the southern part of Clinton county; and, in 1808, Franklin county from the western part. Clinton county is now bounded, north by Canada, east by lake Champlain, or the state of Vermont, south by Essex county, west by Franklin county. Its greatest length north and south is forty miles and a half; greatest width thirty-one miles; and the area is about 1064 square miles, including the waters of the lake, or 680,000 acres.

CLINTON, a large and populous township of New York, in Dutchess county. According to the census of 1810, the inhabitants amounted to 5949, of whom 437 were senatorial electors.

CLIO, from κλειος, glory, in pagan mythology, the first of the muses, daughter of Jupiter and Mnemosyne. She presided over history. She is represented as crowned with laurels, holding in one hand a trumpet, and in the other a book. She sometimes holds a plectrum or quill with a lute. Her name implies honor and reputation, and it was her office faithfully to record the actions of brave and illustrious heroes.

CLIO, in zoology, a genus of insects belonging to the order of vermes mollusca. The body is oblong and fitted for swimming; and it has two membranaceous wings placed opposite to each other; tentacles three and two in the mouth. The species are six, principally distinguished by the shape of their vagina, and all natives of the ocean.

CLIP, *v. a. & n.* } Ang. Sax. *clippan*; Scot. *clippan*, *n. s.* } *clip*. Thus derived, it signifies to embrace, to confine, to fold in the arms. But there is a very different meaning ascribed to it when it is traced to the Goth, *klippa*, and Sax. *clepan* then it signifies to cut, shear, divide.

A merry child he was, so God me save!
—Wel could he leten blod, and *clippe* and shave.

Chaucer. Canterbury Tales.

He kisseth hire, and *clippeth* hire full oft. *Id.*

Your sheers come too late to *clip* the birds' wings,
that already is flown away. *Sidney.*

He that before shunned her, to shun such harms,
Now runs and takes her in his *clipping* arms. *Id.*

Here I *clip*

The anvil of my sword, and do contest
Hotly and nobly with thy love. *Shakespeare.*

O nation that thou couldst remove
That Neptune's arms, who *clippeth* thee about. *Id.*

It is no English treason to cut
French crowns, and to-morrow the king
Himself will be a *clipper*. *Id.*

All my reports go with the modest truth;
Nor more, nor *clipt*, but so. *Id.*

But love had *clipped* his wings and cut him short,
Confin'd within the purlieus of his court.

Dryden's Fables.

This design of new coinage, is just of the nature of
clipping *Locke.*

We should then have as much feeling upon the
clipping off a hair, as the cutting off a nerve.

Bantley's Sermon.

He spent every day ten hours *clipping* papers, or darned his stockings. *Swift.*

By this lock, this sacred lock, I swear,
Which never more shall join its parted hair,
Clipped from the lovely head where late it grew *Pope.*

But in man's dwellings he became a thing,
Restless and worn, and starn and wearisome,
Drooped as a wild-born falcon with *clipped* wing
To whom the boundless air alone were home *Byron.*

CLIPEUS, in natural history, a name given to the flat depressed conteria, from their resembling a shield.

CLISSA, a fort of Dalmatia, seated on a craggy mountain, near which there is a narrow valley, between two steep rocks, through which the road lies from Turkey to Dalmatia. It is six miles north of Spalatia. Long. 17° 31' E., lat. 44° 10' N.

CLISTHENES, a celebrated Athenian magistrate, the author of the mode of banishing ambitious citizens by Ostracism.

CLITHEROE, a borough in Lancashire, at the foot of Pendil hill, thirty miles north of Manchester, 217 N. N. W. of London. It has an ancient castle built by the Laceys, now in ruins. Clitheroe is a borough by prescription, and sends two members to parliament, whose electors are the freeholders and lifeholders. It is governed by two bailiffs, who act together, and are the returning officers. Within these few years, several extensive manufactories of cotton have been established here, which, together with lime-burning, form the chief trade of the town.

CLITORIA, in botany, a genus of the decandria order, and diadelphia class of plants; natural order 320, papilionacea. The cor. supine, or reversed with the verillum or flag petal very large, patent, and almost covering the alae or wing-petals. There are six species, all herbaceous perennials, or annuals, of the kidney-bean kind, growing naturally in both the Indies. The stalk is climbing, slender, and of the height of a man. The leaves are winged, placed alternately, and consist of two, three, or five pair of lobes, terminated by an odd one. The flowers, which are elegant, stand singly, each on its proper foot-stalk. They are very large, and generally of a deep blue, but sometimes of a white color. From the fruit of this plant is distilled an eye-water. The beans reduced to powder, and taken in broth, to the quantity of two drachms, prove a gentle purge; and Grimmius' remarks, in his Labor Ceyl. that the powder of the dried beans, mixed with the milk of the cocoa nut, or with broth, and administered in quantity from one to three drachms, not only mitigates colic pains, but is very useful, and much used in Ceylon, in all disorders of the stomach and bowels. These plants are propagated by seeds; and in this country, must be kept continually in a stove.

CLITORIS, in anatomy, is a part of the external pudenda, situated at the angle which the nymphæ form with each other. Like the penis it has an erection. It is of different sizes in different women; out in general it is small,

and covered with the labia. The preternaturally enlarged clitoris is supposed to constitute an hermaphrodite. When too large, it may be so extirpated as to remove the unnecessary part; but this requires much care, to prevent subjecting the patient to an involuntary discharge of urine. See ANATOMY.

CLITUMNO, a river of Italy, which passes by Spoleto, and joins the Topino, between Spoleto and Perugia.

CLITUMNUS, in ancient geography, a river of Umbria, on this side the Apennine. According to Pliny, it was a fountain consisting of several veins, situated between Hispellum and Spoletium; which soon after swelled into a large and navigable river, running from east to west into the Tinea, and both together into the Tiber. Virgil says, it was famous for its milk-white flocks and herds.

CLITUS, in ancient history, the foster brother and intimate friend of Alexander the great. At the passage of the Granicus, Alexander was attacked by Rhæsaces and Spithridates, two Persian officers of distinction; his helmet was cut through by the battle axe of the latter, and the next stroke would, inevitably, have killed him, had not Clitus, at that instant, rushed to his assistance, and thrust Spithridates through the body with his spear. But Clitus being, some time after, at a feast where some verses in ridicule of the Macedonian officers were introduced by Alexander, angrily expressed his resentment. Being warmed with drinking, he violently retorted on Alexander, and so provoked him that he left the room for his sword. On this the friends of Clitus forced him away, but he soon returned, repeating some insolent verses from Euripides: on which Alexander snatched a spear from one of his guards and ran him through the body. His death however so afflicted Alexander, that he attempted his own life, and for some time shut himself up, and would see no one. See ALEXANDER THE GREAT.

CLIVE (Robert), lord Clive, son of Richard Clive esq. of Styche, in Salop, was born in 1725. Towards the close of the war in 1741, he was sent as a writer in the East India service to Madras; but, being fonder of the camp than the counting-house, he soon exchanged his clerk's place for a pair of colors. He first distinguished himself at the siege of Pondicherry in 1748; and acted under major Laurence at the taking of Devi Cotta, at Tanjore, who spoke of his military talents so highly, that he was made commissary-general. When he came over to England in 1753, he was presented, by the court of directors, with a rich sword set with diamonds, as an acknowledgment of his services, at the siege and in the taking of Arcot. Captain Clive returned to India in 1755, as governor of fort St. David, with the rank of lieutenant colonel; when, in conjunction with admiral Watson, he subdued the pirate Angria, and became master of Geria, his capital, with all his accumulated treasure. Surajah Dowla's perfidy soon produced fresh hostilities, which ended in his ruin; he being totally defeated by colonel Clive at Plassey. The conqueror next day entered Muxadabad in triumph; and placed Jassier Ally Cawn, one of the principal generals, on the throne; the depo-

sed soubah being soon after taken, was put to death by Jaffier's son. Mr. Clive was now honored, by the Mogul, with the dignity of an Omrah of the empire; and was rewarded by the new soubah with a jaghire, or grant of lands, producing £27,000 a year. In 1760 he returned to England, where he received the unanimous thanks of the Company, was elected M.P. for Shrewsbury, and raised to an Irish peerage by the title of lord Clive, baron of Plassey. In 1764 fresh and serious disturbances occurring in various parts of Bengal, lord Clive was again appointed to that presidency, and advanced to the rank of major-general in the army. When he arrived in India he exceeded the most sanguine expectation, by restoring tranquillity to the province without striking a blow. He returned home in 1767; and in 1769 was made knight of the bath; but in 1773 a motion was made in the house of commons that 'in the acquisition of his wealth, lord Clive had abused the powers with which he was entrusted.' He defended himself with great ability; enumerating his services for his country, and quoting various letters from the directors of the East India Company, containing the fullest and most ample commendation and approbation of all his proceedings, as well as the congratulation of the direction, in a full court, on his last return home. He was honorably acquitted; the house resolving that lord Clive had rendered great and meritorious services to his country.' Lord Clive was, however, a striking instance of the inefficacy of external honors, and of great wealth, to confer happiness. After his return to England, though in possession of a splendid fortune, and of many advantages, he often discovered great uneasiness of mind and could not endure to be alone. His friends represented this as the result of a depression of spirits occasioned by a nervous fever; but it was attributed by others to causes of a different nature. At last on the 22d of November 1774, he put an end to his own life when not quite fifty years of age; and his remains were interred at Moreton-Say, the parish in which he was born. He left two sons and three daughters; his eldest son, Edward, succeeding him in his title and estate. Lord Clive is said to have given away a great deal of money in acts of benevolence; and he at one time made a present of £70,000 to the invalids in the East India Company's service. Lord Chatham called him a heaven-born general, who, without experience, surpassed all the officers of his time.

CLIVE (Catharine), a celebrated comic actress, the daughter of a Mr. Raftor, was born in the north of Ireland in 1711. She was married, when young, to Mr. Richard Clive, a barrister; but, a separation taking place, she adopted the comic line of a theatrical profession, and was ever sure to fascinate her audience. Her native wit and playful humor are exemplified by the following anecdote:—She performed at Drury-lane under the management of Garrick, and one night, while playing the lady in *Lethe*, Mrs. Clive, turning her head towards the stage-box, chanced to encounter the eye of Charles Townshend. That celebrated wit pointed instantly to an old belle on his left, a caricature of the ridiculous dame she was portraying. The actress paused for a moment, and burst into laughter; until the

galleries caught the jest, and joined boisterously in the mirth. Garrick, chagrined by the indecorum of the incident, hastened to the Green-room, to meet Mrs. Clive, 'Madam,' said he, 'your smiles are always despotick; it was those of Mrs. Clive which called down that burst of merriment just now; to-morrow night I hope it will be excited by those of the character she may intend to personate.' She comprehended his meaning, and sportively shutting her eyes, she tapped them with her fan, exclaiming—'I whip the truants that brought me into the scrape; they never again shall so betray their mistress.' Mrs. Clive at length retired to pass the latter part of her life at Little Strawberry Hill, where many persons of rank and eminence courted her society. Her death occurred in 1785.

CLIVER, *n. s.* Teut. & Belg. *stein, cliver*; stone clover. The plant melilote, more properly written cleaver. It grows wild, the seeds sticking to the clothes of such as pass by them. It is sometimes used in medicine.

CLOACÆ, in antiquity, the common sewers of Rome, to carry off the soil of the city into the Tiber; justly reckoned among the greatest works of the Romans. The first, called Cloaca Maxima, was built by Tarquin I. of huge blocks of stone joined together without any cement, in the manner of the edifices of those early times; consisting of three rows of arches one above another, which at length conjoin and unite together; measuring, in the clear, eighteen palms in height, and as many in width. Under these arches they rowed in boats, which gave occasion to the remark of Pliny that the city was suspended in air, and

that they sailed beneath the houses. Under these arches also were ways through which carts loaded with hay could pass with ease. It began in the Forum Romanum; measured 300 paces in length; and emptied between the temple of Vesta and the Pons Senatorius. There were as many principal sewers as there were hills. Pliny concludes their firmness and strength from their standing for so many ages the shocks of earthquakes, the fall of houses, and the vast loads and weights moved over them.

CLOACINA, the goddess of common sewers.

CLOAK, *n. s.* & *v. a.* } Barb. Lat. *cloca*,
CLOAK-BAG, *n. s.* } Sax. *lach*. The primary sense is, a garment; its secondary, a covering that conceals. A cloak-bag is a bag which receives or conceals wearing apparel.

Not using your liberty for a *cloak* of maliciousness.
Peter.

Most heavenly fair, in deed and view,
She by creation was, till she did fall;
Thenceforth she sought for helps to *cloak* her crimes
withal.
Spenser.

Why dost thou converse with that trunk of humours,
that stuffed *cloakbag* of guts?
Shakespeare.

I have already fit
(Tis in my *cloakbag*) doublet, hat, hose, all
That answer to them. *Id.*

You may bear it
Under a *cloak* that is of any length. *Id.*

We will not line his thin bestained *cloak* with our
sore honours. *Id.*

Their *clothes* were cloth of silver, mixed with gold.
Dryden.

C L O C K S.

CLOCK, *n. s.* } Goth. *klocka*; and Sax.
CLOCK-MAKER, *n. s.* } clecuan, to strike, to
CLOCK-WORK, *n. s.* } sound. The instrument
which, by a series of mechanical movements,
tells the hour by a stroke upon a bell.

Wel sikener was his crowing in his loge,
Than is a *clock*, or any abbey or loge.
Chaucer. Cant. Tales.

If a man be in sickness or pain, the time will seem
longer without a *clock* or hour-glass than with it.
Bacon.

The picture of Jerome usually described at his study,
is with a *clock* hanging by. *Browne's Vulgar Errors.*

I told the *clocks* and watched the wasting light.
Dryden.

Resolve by sines and tangents straight,
If bread or butter wanted weight,
And wisely tell what hour of the day
The *clock* does strike by Algebra. *Hudibras.*

This inequality has been diligently observed by several
of our ingenious *clockmakers*, and equations been
made and used by them. *Derham.*

So if unprejudiced you scan,
The goings of this *clock-work* man;
You find a hundred movements made
By fine devices in his head;
But 'tis the stomach's solid stroke,
That tells this being what's o'clock. *Prior.*

Within this hollow was Vulcan's shop, full of fire
and *clockwork*. *Addison.*
You look like a puppet moved by *clockwork*.
Arbutnot.

Fate seemed to wind him up for fourscore years,
Yet freshly ran he on ten winters more,
Till like a *clock* worn out with eating time,
The wheels of weary life at last stood still.
Lee's Obitus.

CLOCK, in horology, is a machine so regulated,
by the uniform action of a pendulum, as to measure
time by a series of vibrations in the oscillating
body. Under this head, therefore, we propose to
treat of the structure and internal mechanism of
those machines which owe their property of keeping
time to the continued operation of a pendulum,
leaving the portable chronometer, or WATCH, to
its appropriate place in our alphabetical arrangement.

The earliest complete clock, of which there is
any certain record, was contrived in the thirteenth
century. It was constructed by a Saracen mechanic,
who received about £2000 for his ingenuity. This
clock is stated to have kept time very accurately,
and it was afterwards presented to the emperor
Frederic II. by the Sultan of Egypt, under whose
direction it was made. Some time after this period,
a clock was placed in a small building, erected for
the purpose, in the

city of Westminster, the expense of which was defrayed by a fine imposed on one of the judges for malversation in his office. In the fourteenth century an artist, named James Dondi, a Venetian, constructed a clock for the city of Padua, which was long considered as the wonder of that period. Besides indicating the hours, it represented the motion of the sun, moon, and planets, and also pointed out the different festivals of the year. On this account Dondi obtained the surname of *Horologio*, which became that of his posterity. About the same period William Zelandier constructed, for the same city, a clock still more complex, which was repaired in the sixteenth century by Janellus Turrianus, the mechanist of Charles V.

About the year 1560 Tycho Brahe was in possession of four clocks, which indicated hours, minutes, and seconds, the largest of which had only three wheels, one of which was three feet in diameter, and had 1200 teeth in it, a proof that clock-work was then in a very imperfect state. Tycho, however, observed, that there was an irregularity in the going of his clocks, which depended upon the changes in the atmosphere; but he does not appear to have known how such effect was produced. In the year 1577 Moestlin had a clock so constructed as to make just 2528 beats in an hour, 146 of which were counted during the sun's passage over a meridian or azimuth line, and determined his diameter to be $34^{\circ} 13'$, so that the science of astronomy began thus early to be promoted by the assistance of clock-work; and, as clocks first promoted the study of astronomy, it will be seen by and bye, that astronomy, in its turn, gave rise to some of the most essential improvements in clock-work; and that, as the arts and sciences became more and more cultivated, improvements in clock-work kept pace with them, and employed the talents of the most ingenious men of each succeeding age.

As the construction of every modern horological machine must depend, mainly, on a judicious combination of wheel-work, it may be desirable to examine, first, the principle of a common wheel and pinion, and then to show its application to the movement of a clock.

In the wheel and axis A, B, fig. 1. plate I. of *Horology*, two cords of similar length are made to support weights, attached to their lower extremity; the weights being placed in equipoise, although the one is twice as heavy as the other. This apparently paradoxical effect is produced, by giving a mechanical advantage to the cord B, which is twice as far from the centre, or fulcrum, as the one that supports the larger weight: the velocity of the two weights are effected also in an equal ratio. So that if the wheel be made to revolve upon its axis, the weight marked 1 will descend two feet, while the opposite side will only be raised one foot. Here then the gain in power is compensated for by a loss of time, and vice versa; and upon this circumstance depends the advantageous use of a wheel and pinion.

In fig. 2, the pinion D. is supported by a separate axis, round which it is made to revolve; and the wheel B B, being three times as large as

the pinion, the latter will make three revolutions to one of the former, or about one revolution for the portion of a circle shown in the diagram. If we consider the weight C as the maintaining power, it will be evident, that, for every revolution made by its axis, there will be three revolutions of the next wheel in succession.

If we combine a series of wheels and pinions, a still greater increase in speed will result. This is shown at fig. 3; and it will be seen that there are four revolutions of the pinion *c* for one of the wheel that drives it; and as the wheel *d* is attached to the same axis, the pinion *e* will make sixteen revolutions to one of the prime mover.

A reference to this simple mode of increasing velocity in wheel-work, will readily explain why a clock, which makes but twelve revolutions at the barrel, is enabled to beat half and quarter seconds, and even to go as many days as there are turns at the prime mover.

Having determined upon the kind of clock to be made, the first thing to be done, and that in which the clock-maker is generally deficient, is, to calculate the movement, or proper number of teeth in the wheels, and of leaves in the pinions of the going part of the mechanism. Dr. Derham, in his *Artificial Clock-maker*, has treated this subject at considerable length; and has laid down rules which have tended more to puzzle than to assist the workman in the choice of his numbers. He proposes to take at random, a certain number of vibrations per hour for a pendulum of an assumed length, to represent his train, and then to find the factors or numbers, which, used as multipliers, shall give the regular product, or nearly so; after which each factor is represented by a ratio of two optional numbers, to constitute a wheel and its pinion. We will not here follow the Doctor through his processes, but merely observe, that, by calculating his whole movement at one operation from an assumed number of vibrations, he has introduced a variety of such trains into portable clocks and watches, as make a vibration of the short pendulum, and an oscillation of the balance, no exact fraction of a second; in short, he has begun at the wrong end of the business; has first fixed on the length of his pendulum, in inches, without considering exactly the number of vibrations it would make, and then calculated a train that would so nearly suit it, that the adjustment for time, by the bob, would compensate the defect of the numbers; the consequence has been, that the exact value of a vibration in a portable clock, and of an oscillation in an ordinary watch, has hitherto been disregarded in the construction. On the contrary, we recommend to the clock-maker, first to fix upon his number of vibrations per second, and then to calculate the true length of his pendulum, and exact value of his train, agreeably to the number of vibrations per second that he previously determined. The most simple way of calculating the numbers proper for the movement of any clock, intended to show seconds, is, by dividing it into three portions, and then by calculating the wheels and pinions for each separate portion, by a separate calculation, beginning at the bottom of the train; thus, we first fix upon the pinion of the hour arbor to be, suppose eight,

CLOCK MAKING.

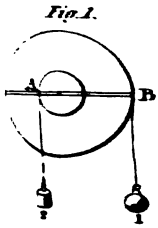

Fig. 1.

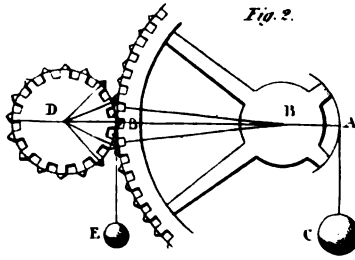

Fig. 2.

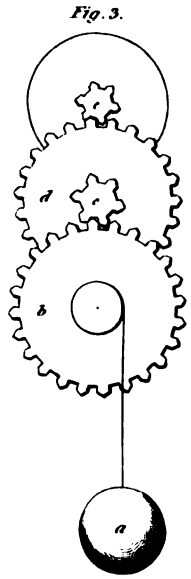

Fig. 3.

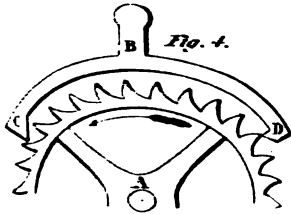

Fig. 4.

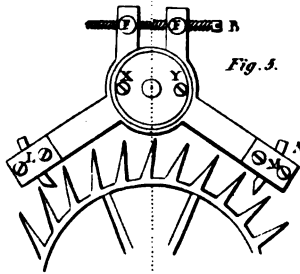

Fig. 5.

Fig. 6.

Fig. 7.

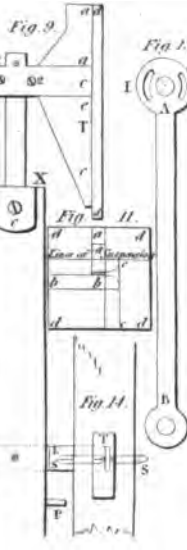
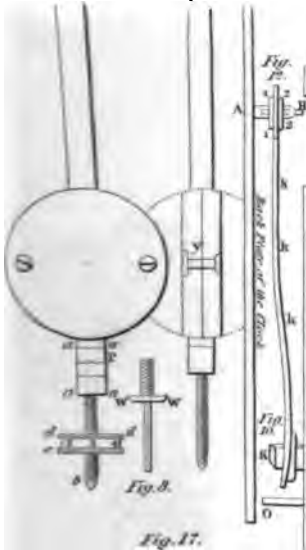

Fig. 15.

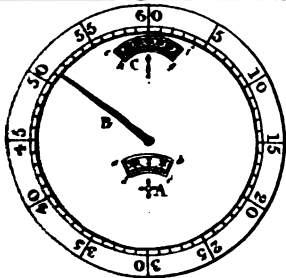
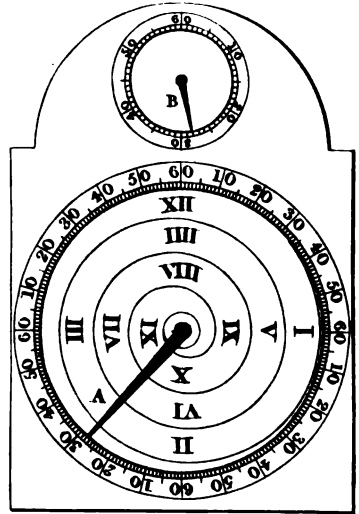
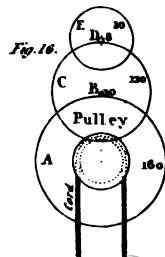

Fig. 17.

Fig. 18.



Fig. 16.



which is a good, practical number; and as our piece is to go eight days, we will make the fusee to revolve in twelve hours, which construction will require the great wheel on its arbor to be $8 + 12$, or 96, because the pinion of 8 revolves with the minute-hand on its projecting pivot, in one hour; hence if we divide 192, the number of hours in eight days, by 12, the time of one revolution of the great wheel, the quotient 16 will be the number of effective spiral grooves necessary to be cut on the circumference of the fusee, in order that the piece may go just eight days. This portion of the movement is not, however, called a part of the train, but only determines, as has been said, the time that the clock shall continue to go, after each winding up of the maintaining power; and it is easy to conceive, that if a fusee or a barrel, with twenty-four turns of the catgut or chain, were placed on the hour arbor, the clock would go a natural day without the large wheel, and, also, that if an intermediate wheel and pinion were placed on the arbor between the hour arbor and the great wheel, the time of going might be prolonged to ten, twelve, or even twenty times eight days, but then the maintaining power must be proportionably increased, which circumstance renders such a construction by no means desirable in a regulator, particularly as the auxiliary spring, now in use, will keep the piece in motion during the act of winding up.

The remaining portion of the movement is properly called the *train*, including those wheels and pinions only which are used for counting the vibrations made in an hour; the train is most easily ascertained by two calculations, one for the two wheels and two pinions which multiply the minutes into seconds, and the other for that wheel and pinion, or those wheels and pinions, which subdivide the seconds into vibrations; the former of these two portions of the train, like the first portion of the movement, or portion for the period of continuance, is the same for all clocks, let the time of vibration be what it may: a circumstance not usually considered. The ratios of velocity to be gained by the pinion on the arbor of the seconds' hand, compared with the wheel on the arbor of the minutes' hand, is required to be 60 : 1; which effect might be produced by one wheel of 300 teeth and a pinion of five leaves, as is done in some of the ornamental French pieces; but the size of the wheel is cumbersome, therefore a pair of wheels, with a pair of pinions, one constituting a ratio or vulgar fraction equal in value to $\frac{8}{60}$, and the other equal to $\frac{7}{12}$, making $8 \times \frac{7}{12} = 60$, or any other two numbers making a similar product will produce the same effect with fewer teeth; for, if the pinions be each 8, the wheels, in this case, will be respectively 64 and 60, the compound ratio, $\frac{64}{8} \times \frac{60}{8}$, being equal to the simple $\frac{60}{8}$; and by the same process, if pinions of 10 had been chosen, the wheels would have been $8 \times 10 = 80$, and $10 \times \frac{7}{12} = 75$, which numbers would, indeed, have less friction than the preceding ones by reason of their teeth acting at less depth, the diameters of the wheels remaining the same, and would, moreover, be capable of acting more behind than before the line joining the centres of the wheel and pinion; in like

manner pinions of 6 would require wheels of 48 and 45, and pinions of 12, wheels of 96 and 90.

The last portion of the movement, or second portion of the train, for a half-seconds' pendulum, will require only one wheel of sixty teeth on the seconds' arbor, properly shaped for the escapement; for, as one tooth in the dead-beat and common anchor escapements escapes completely at two vibrations of the pendulum, sixty teeth will escape, that is a whole revolution of the seconds' hand will be made, in 120 vibrations; if, however, the pendulum had been required to vibrate seconds, the wheel in question, usually called the swing wheel in opposition to the crown wheel which requires another escapement, would have demanded only thirty teeth for that purpose; and, if three vibrations had been fixed upon, the number to correspond must have been ninety, otherwise there must have been a wheel and pinion of the value of three, like $\frac{3}{1}$ or $\frac{3}{3}$, an addition to the usual swing wheel of thirty, or, which is the same thing, a wheel and pinion of the value of six, like $\frac{6}{1}$ or $\frac{6}{6}$, must have been introduced between the seconds' arbor and a pallet, or a swing wheel of 15. Thus all the variety in the calculation of trains, where seconds are indicated, is confined as we have intimated to the last portion of the movement, and the calculation itself so simple, that the mere altering of the numbers of the pallet-wheel will convert a clock with a seconds' pendulum into one with half-seconds, and vice versa.

The calculation of numbers suitable for an eight-days' clock, with a half-seconds' pendulum, being thus readily obtained by three simple operations, which may be had by mere inspection of the three tables which we shall presently subjoin, the whole may be represented, and its value estimated again, by a compound fraction,

thus: viz. $\frac{8}{96} \text{ of } \left(\frac{8}{64} \times \frac{8}{60} \right) \text{ of } \frac{1}{60 \times 2}$ of twelve hours, or, which is the same thing in effect, thus $\frac{8}{96} \times \frac{8}{64} \times \frac{8}{60} \times \frac{1}{60 \times 2} = \frac{512}{44236800} = \frac{1}{64800}$ of twelve hours, or 86400 vibrations in twelve hours, which is the time of a revolution of the fusee, and great wheel, 96, on its arbor, and therefore $\frac{86400}{12}$, or 7200 vibrations, each of half a second in duration, in one hour, constitute the value of this train.

This mode of notation gives the value better than any other, perhaps, that has been adopted; but the position of the wheels and pinions will be better understood from the ordinary mechanical method of writing them down thus:—

Great wheel 96

Pin 8—64 hour wheel

Pin 8—60 second wheel

Pin 8—60 swing wheel
2 pallets.

Indeed it is difficult to write down the movement by any one notation that shall express, at the same time, both the value and position of the wheel-work, on which account we recommend the workman to write down his numbers by both

forms, taking care, in the method by compound ratios, to put all the drivers under the line of division, and all the driven ones above; so that, when an ascending movement is represented, the wheels may be the denominators, and, when a descending one, the pinions.

The arrangements for calculating a train, and, as such, of forming a clock movement having been examined, it may now be advisable to revert to the mode of regulating the wheel-work by what is called an *escapement*. The term is derived from the French *eschappement*, and it is employed to illustrate the action of the pallets in connexion with the last wheel in the train, the teeth of which may be said to escape at each oscillation of the pendulum.

The earliest mode of forming a pair of pallets, or verge, being exactly similar to that employed in the regulation of a common watch, will be fully examined in another department of our work, and it may be enough to say, that its application to the best constructed horological machines has been long since abandoned.

The swing or scape-wheel, represented at fig. 4. plate I. HOROLOGY, is furnished with a pair of pallets, C, D. The wheel passing in the direction of the arrow resting on the pallet C, and as the pallet's arbor, B, is connected with the pendulum by a rod or crutch, the pendulum must oscillate in the same direction. Passing down the inclined plane the tooth is now found to escape, still turning in the same direction. The wheel then rests on the pallet D, and, being aided in its operation by the tendency of gravity to bring back the pendulum, soon passes to the pallet on the opposite side, and the process is repeated as long as the train continues its impulse.

Having thus briefly examined the action of a common anchor escapement; which, from its great simplicity, has been placed first in the order of arrangement, it may now be advisable to direct the reader's attention to the pallets without recoil, invented by the late Mr. George Graham. In this escapement the seconds' hand stands still after each drop of the pallets, and hence the term *dead-beat*, whereas the hand of a clock regulated by the recoiling escapement is always in motion, oscillating backwards and forwards.

Mr. Vulliamy's improved mode of constructing an escapement without recoil, is represented fig. 5, in which the pallets AA are allowed to expand or contract, by the motion of a double screw, B; and this escapement differs from all the others in the accuracy with which the acting parts are formed, nearly the whole of the pallets with their frame being executed in the lathe.

To form the pallets a ring of steel is, in the first instance, prepared of the required size, and the arms, L, M, turned with a circular groove to receive it. The ring may then be cut in short lengths, and inclined planes formed at the proper angle. The two arms of the pallet frame are held together by the collet and screws Y, Y, and the regulation is performed by the larger end of the screw B, being furnished with a coarser thread than its other extremity, so that the dispo-

portion between them is capable of producing the most delicate adjustment.

The great advantages in this mode of construction are, 1. That the rests of the pallets are correct portions of circles; the centre of which circles is the centre of motion of the axis of the verge, and the pallets move in the same circles, and, consequently, there will not be any recoil in the escapement. 2. That the pallets must be of equal thickness, and consequently the drop the same on both. 3. That the pallets may be made perfectly hard, if properly treated, without risk of altering their shape: and should a pallet be spoiled by an accident in hardening, or a flaw or imperfection of any kind be discovered, another exactly similar is easily made to replace it out of the original ring. When the pallets are made out of the same piece of steel as the arms of the frame, it is difficult to preserve their shape correctly in hardening, and to retain the acting part of the pallet perfectly hard. To obviate this difficulty, the pallet has sometimes been made a separate piece, with a short arm, by which it is fixed with two screws to the arm of the frame; but this is only to exchange one evil for another, as, independent of other disadvantages, which it is unnecessary to enumerate, it is very uncertain, with the pallets fixed in this manner, whether or not the rests of the pallets are concentric with the centre of the axis of the verge. The slightest deviation from its original direction in the arm of the pallet, by hardening or any other cause, has the effect of removing the centre of the circle, forming the rest of the pallets, from the centre of the axis of the verge to some other place, the consequence of which is to render the escapement a recoil escapement. 4. That the mode here recommended of constructing the pallets, offers a great facility for making the inclined planes of the pallets equal to one another, or of altering them, as may be required; and consequently the angle which the pendulum is led by one pallet, will be equal to the angle led by the other.

To a person unacquainted with the mechanism of a clock, the pendulum appears but as an appendage to a very complicated machine; whereas, the fact is, that the series of wheels and maintaining power we have now been describing, are, in reality, but appendages to the pendulum, every part of the machine being constructed in subservience to its motion. From this then it will be seen, that it is the pendulum which is the efficient measurer of time, whilst the office of the wheels is to record the divisions marked by its oscillations; so far, indeed, are the wheels from contributing towards the regularity of the pendulum, that they are mostly found to disturb it. The office then of the wheels is to prevent the pendulum coming to a state of rest, which it effects by repeated impulses, at stated periods.

The honor of first applying a pendulous body to regulate the time in horological machines, has been claimed by mechanics in almost every part of Europe: indeed the Arabians, as far back as the time of caliph Haroun Alraschid, state their claims to the invention, although it is

more than probable, that, if the use of the pendulum were known in the east prior to the seventeenth century, it was employed without the accompanying train of wheels which constitute a modern clock.

If the resistance arising from the friction at the moving parts, and from the motion communicated to the air, were always the same, and the clock were urged by a weight, the action of the swing-wheel on the pallets would be always the same at a given place, in consequence of which, the figure of all the parts being supposed invariable, the arc of vibration would be constantly of the same magnitude; namely, such as, that the motion lost by the resistances opposed to the pendulum should be accurately equal to the motion communicated by the pallets, and the times would be equal; that is to say, the clock would be perfect, and would measure time accurately. But these conditions are not easily obtained. It is not found, however, that the variation in the resistance of the air, arising from its change of density, occasions any sensible irregularity in clocks. The most considerable irregularities in the movement arise from the tenacity of the oil applied to the moving parts. For the oil is less fluid in cold than in hot weather; and when it is less fluid, a greater quantity of the maintaining power must be lost in overcoming its rigidity; whence it must happen, that the teeth of the crown-wheel will, in that case, act forcibly on the pallets, and the vibration will be less. If the pendulum be suspended on an axis, this cause, together with the constant wear, is very injurious to the performance of the machine, but this defect is remedied by suspending it by a straight flexible spring, as is shown in fig. 6 to 14 of plate I. HOROLOGY.

The rod of the above pendulum should be made of straight grained yellow deal, which may be procured from the lath-maker's, it should be split down both ways; neither the sort which is white and spongy, nor that which is of a strong grain, and full of turpentine. The rod is a cylinder of about five-eighths of an inch diameter, and forty-two inches long; it should be dried and gilt, and if varnished it would be less subject to changes from moist weather. The rod being first roughed out, a brass ferrule (*a*, fig. 6 above), must be driven on its lower end, previously turned to receive it, the rod is then to be put into the lathe, the ferrule turned true, and a few other places in the rod may likewise be made round; the whole is afterwards to be planed straight, round, and smooth; a hole is then to be drilled at the bottom of the rod, to receive the wire *b* along the axis. This wire should be steel, and the part which goes into the rod a little taper, and rather larger than the hole in the end of the rod, the rest of the wire cylindrical, and the end conical; a screw must be cut upon the cylindrical part with stocks; the wire must be forced into the hole at the bottom of the rod, and then cross-pinned through both ferrule and rod, as at *P*. The top of the rod, fig. 9, is slit along the grain with a fine spring saw, to receive the spring at *X*, by which the pendulum is suspended; the two parts are

drawn together by a screw, and made to pinch the spring; this screw passes through the quarter part of a brass ferrule, and is tapped into the opposite quarter part; the head of the screw, with the first quarter, appears at *c*, fig. 9. The spring is a piece of strong watch-spring, which has not been coiled up; the upper part has two cylindrical buttons rivetted to it, opposite to each other, one of these appears at *Z*; these bear the weight of the pendulum during the time of adjusting its suspension, before the screws are drawn tight. The ball of the pendulum is made of lead, and consists of two parts screwed together upon the rod, so as to pinch it. Fig. 7 is the ball as it appears edgewise, and shows the section down the axis of the rod where the two parts join. The shape of the ball, when the two parts are screwed together, is the middle frustum of a globe, as is seen by the figure. These two parts should be moulded from a neat turned pattern of wood, where the hole should be left to receive the rod; they may be cast so near their true form, as to give but little trouble in turning down in the lathe and finishing; if the pattern be made true, the axis of the rod will pass through the centre of gravity of both. Fig. 6 is the pendulum seen flatwise; two pieces of brass are soldered to the back part of the bow, and tapped to receive the screws which fasten the two parts together; one of these pieces appears at *y*, fig. 12. The place of the ball upon the rod being found, it is then to be screwed fast to the rod, and not to be removed to regulate the clock. On the screw part of the wire, at the bottom of the pendulum-rod, is a cylinder of brass in two parts, the screw passing through the centre of both parts. The upper part, *d, d*, fig. 6, consists of a milled torus, and a plain cylindrical part, both in one piece; the cylinder has numerical figures engraven on it, in the order they are represented in the plate, the lower part consists of a milled torus only, as at *e, e*. When the upper part is screwed to its proper place, it must be held fast, and the lower part screwed against it, so as to pinch the screw-wire, and secure it against any accidental turning. Whenever there is occasion to move the upper part (in order to regulate) the under part must first be detached till the adjustment be made, and then screwed close again, as before. This part may be called the regulator, and will perform that office with a much greater degree of correctness than where the whole ball of the pendulum is moved.

Having thus described the pendulum-rod with its ball, we may now describe the proper method of suspending it, which is by a projecting cock made of brass, and is composed of three distinct pieces, fixed together with rivets and screws. It is difficult to give the exact form without giving many views of it; but the general principle may be easily explained. Strength and steadiness are particularly sought in its formation, and the side view, fig. 9, will make it appear how these are attained in the vertical line, by the part marked *a, a*, above the line of suspension, and that marked *c, c*, below the line, as these serve as strong brackets each

way; but the part which serves as its principal support in the horizontal line does not appear in the side view, but may be seen in fig. 11. The form of the part from *b* to *b*, is the same as that seen in the side view from the dotted line *e* to *c*. The screw marked at *Z*, fig. 9, appears sideways in the plan; this screw goes through the two parts, which project forward to hang the pendulum upon. The right angled part *d, d, b, b*, fig. 11, is fixed to the flat brass plate by three rivets, as large as their thickness will admit, one at the angle near the lower *b*, and one at each extremity of the piece; the parts are put together by rivetting, that, when separate, they may be hammer-hardened. This cock is firmly fixed to a strong piece of wainscot, which is placed against the back of the clock-case, and the whole firmly attached to the wall. The mode of suspension should be such, that none of the lateral motion of the pendulum, as it vibrates, can be communicated to the other parts of the apparatus, nor should the whole be liable to be disturbed by foreign causes. The two planes of the cock at *Z*, which are to receive the string between them, should be filed flat when the plate *T* is taken off, and thus the spring may be pinched firm between them; so also should the cheeks of the slit at the upper end of the rod, so that the spring should not have the least play at either of its terminations; otherwise, its force will be very unequal. In placing the cock, care should be taken that the place where the spring bends, fig. 9, should be adjusted to the level of the verge or arbor of the pallets at *A H*.

When the pendulum is to be suspended upon the cock, take out the screw in fig. 9, and release the opposite one at 2, and hang the pendulum-spring between the two planes at *Z*, fig. 9, putting the cylindrical buttons, which are rivetted at the top of the spring, into the hollow made to receive them at *Z*, then return the screw into its place, but do not tighten it; then tighten the screw *c*, at the top of the pendulum-rod, and afterwards the two screws, *H Q*, which will secure it in its place; and from its having hung freely, before these screws were tightened, the several parts will have been drawn into the true perpendicular line; the clock is afterwards put to it. We may now explain the contrivance by which the pendulum receives its impulses from the wheel-work. *A*, fig. 12, is the verge or arbor, on which the pallets are fixed; *1 1*, is a round piece of brass rivetted to the collet; *k k k* is the stem of the crutch, seen edgewise, and in fig. 13, it appears flatways. In the centre of the upper part is a round hole, *A*, made to fit the verge; and at 1, 2, are two circular slits. In fig. 12, at 2, 2, is another round piece of brass, fitted rather loose on the verge; the screw at *A*, and another on the opposite side, go through the fixed plate marked 1 1, and also through the curved slits on fig. 13, marked 1, 2, and are tapped into the plate, marked 2 2, fig. 12, so that the crutch has a considerable motion round the centre of the verge, and may be fixed in any position by these screws, one of which only can appear in this view, and is opposite to *A*, fig. 12. At the other end of the stem of the crutch, fig. 13, is a hole to receive the screw-

shank of the steel piece seen edgewise, fig. 8, and, when screwed up, appears at *K, L*. The sides of this piece must be filed flat, and polished, or at least a fine grain given to it; its thickness should be about $\frac{1}{8}$ of an inch; the end of the flat part is seen at fig. 14. The shoulder marked *w*, at fig. 8, should be turned flat, and when the screwed shank is put through the hole *B* of the crutch, in order to fix it, a collet of brass should be interposed between the nut and the face of the crutch; this collet or brass plate should be turned hollow towards the crutch, and somewhat round towards the nut, which will make the fitting more effectual. The flat faces of the steel plate must be set parallel to the line *A B*, fig. 13. An oblong hole is pierced through the wooden rod, fig. 14, in the direction of the axis of the rod; two fine steel screws *s s*, are tapped through the sides of this hole. These screws pinch the flat part of the steel piece between them; the ends of the screws which bear against the plate are somewhat rounded off; the ends of these screws, and the flat part they bear against, must be made as hard as possible. The holes for the screws must be made at right angles to the flat sides of the faces of the steel piece, and must pass through the axis of the rod. These screws are $\frac{1}{8}$ of an inch in diameter, and have eighty threads in an inch. They must be forced in so as to cut their own threads in the wood, after which they must never be turned quite out. After having properly suspended the pendulum, and come to set up the clock, draw back the screws *s, s*, fig. 14, so as to leave room for the flat of the steel part, *T*, to enter clearly between them. To put the clock in beat, release the screws at *A*, fig. 12, and its opposite screw, (which is hidden in this view,) so as just to let the verge move stiff in the hole of the crutch. The frame containing the wheel-work must then be set into its place, carefully directing the flat of the crutch between the screws, which pass through the sides of the rod. After having screwed down the frame of the work to the rising board as usual, the crutch must be held fast while the pallets and verge are turned so as to bring the clock into beat. The screw at *A*, fig. 12, and its opposite must then be tightened, so as to set the pallets and verge fast to the crutch. The back frame must be cut so as to get at the heads of these screws with a key from the front of the clock. These screws have square heads, not slits, and are turned with a key, to prevent the thrusting forwards which is necessary when a turn-screw is used. The clock may be adjusted into beat with the greatest nicety, by releasing one of the screws, *s, s*, fig. 14, and screwing up the other; taking care not to overturn these screws so as to strip the threads in the wood. The rule to be observed is this: the artist must always hear the flat, *T*, strike against the screws, and if it be but heard, they cannot be too close; these parts should be oiled. *O, P*, fig. 10, is a piece of steel wire, which passes through the axis of the rod in order to catch it, by means of two slips of wood properly cut and fastened to the rising board, so that this wire just keeps clear of it, in the vibrations of the pendulum. The ingenious clock-maker will easily perceive, that if the above work be carefully ex-

ected, according to the directions given, the impulses will be given in the axis of the pendulum-rod, and thence conveyed to the centre of gravity of the ball: two circumstances absolutely necessary to produce a steady and regular motion of the pendulum.

Dr. Franklin contrived a clock, represented at fig. 15, to show the hours, minutes, and seconds, with only three wheels and two pinions in the whole movement. The dial-plate, it will be seen, has the hours engraved upon it in spiral spaces, along two diameters of a circle, containing four times sixty minutes. The index *A* goes round in four hours, and counts the minutes from any hour which it has passed to the next following hour. The time, therefore, in the position of the index shown in the figure, is either thirty minutes past XII, IV, or VIII; and so in every other quarter of the circle it points to the number of minutes after the hours which the index last left in its motion. The small hand *B*, in the arch at top, goes round once in a minute, and shows the seconds. The wheel-work of this clock may be seen at fig. 16. *A* is the first or great wheel, containing 160 teeth, and going round in four hours, with the index-hand connected by a hole through its axis. This wheel turns a pinion of ten leaves, which, therefore, goes round in a quarter of an hour. On the axis of this pinion is the wheel *C*, of 120 teeth, which goes round in the same time, and turns a pinion *D* of eight leaves round in a minute, with the seconds' hand *B* fixed on its axis, and also the common wheel *E* of thirty teeth, for moving a pendulum, by pallets, that vibrates seconds, as in a common clock.

This clock is wound up by a cord going over a pulley on the axis of the great wheel, like a common thirty-hours' clock. Many of these admirably simple machines have been constructed, which measure time exceedingly well. It is subject, however, to the inconvenience of requiring frequent winding by drawing up the weight, and likewise to some uncertainty as to the particular hour shown by the index *A*. Mr. Ferguson has proposed to remedy these inconveniences by the following construction: in the dial-plate of the clock, fig. 17, there is an opening, *a, b, c, d*, below the centre, through which appears part of a flat plate: on this the twelve hours, with their divisions into quarters, are engraved. This plate turns round in twelve hours: and the index *A* points out the true hour, &c. *B* is the minutes'-hand, which goes round the large circle of sixty minutes whilst the plate *a, b, c, d*, shifts its place one hour under the fixed index *A*. There is another opening, *e, f, g, h*, through which the seconds are seen on a flat moveable ring, at the extremity of a fleur-de-lis, engraved on the dial-plate. The great wheel of this clock, containing 120 teeth, and turning round in twelve hours. The axis of this wheel bears the plate of hours, which may be moved by a pin passing through the small holes drilled in the plate, without affecting the wheel-work. The great wheel *A*, fig. 18, turns a pinion, *B*, of ten leaves, round in an hour, and carries the minutes'-hand *B* on its axis, round the dial-plate in the same time. On this axis is a wheel, *C*, of 120 teeth, turning round a pinion, *D*, of six leaves,

in three minutes; on the axis of which there is a wheel, *E*, of ninety teeth, that keeps a pendulum in motion, vibrating seconds by pallets, as in a common clock, when the pendulum-wheel has only thirty teeth, and goes round in a minute. In order to show the seconds by this clock, a thin plate must be divided into three times sixty, or 180 equal parts, and numbered, 10, 20, 30, 40, 50, 60, three times successively, and fixed on the same axis with the wheel of ninety teeth, so as to turn round near the back of the dial-plate; and these divisions will show the seconds through the opening, *e, f, g, h*, in the dial-plate. This clock will go a week without winding, and always show the precise hour; but this clock, as Mr. Ferguson candidly acknowledges, has two disadvantages, from which Dr. Franklin's clock is free. When the minutes'-hand, *B*, is adjusted, the hour-plate must also be set right by means of a pin; and the smallness of the teeth in the swing wheel will cause the pendulum-ball to describe but small arcs in its vibrations: and, therefore, the momentum of the ball will be less, and the times of the vibrations will be more affected by any unequal impulse of the pendulum-wheel on the pallets. Besides, the weight of the flat ring on which the seconds are engraved will load the pivots of the axis of the pendulum-wheel with a great deal of friction, which ought, by all possible means, to be avoided. This inconvenience might, however, very easily be remedied by omitting the second plate.

The term clock, which is usually applied indiscriminately to all horological machines, belongs in reality to those instruments alone which indicate the hour by means of a bell, and, although we have already shown that striking clocks are of considerable antiquity, the striking portion certainly belongs to a period long subsequent to the first invention of those highly useful machines.

It may now be advisable to examine what is termed the *striking part*, and for its better illustration we have separated that part of the train from the rest of the movement. In the annexed diagram *A* represents the barrel-wheel, furnished with a ratchet and click to prevent the return of the barrel. The wheel *A* turns a pinion of eight teeth, on the same arbor with which pinion is the wheel *i*, turning a similar pinion on the arbor of the wheel *k*. The wheel *k* turns another pinion of eight on the same arbor with the wheel *t* of 48, and this last wheel turns a pinion of six, on the axis of which is a broad flat piece of metal called the fly, seen edgeways at

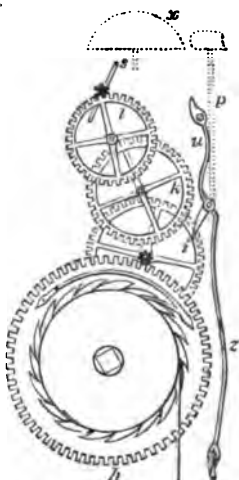

The wheel *i* has eight pins projecting from it, and these, in succession, raise the tail of the hammer as the rotation of the wheel brings them to it. When the hammer is discharged, or frees itself from the pin, it is carried against the bell by the spring *s*; *u* is called the counter-spring, and is employed to prevent the hammer jarring against the bell.

We have now to examine the connexion between the going or watch part, and that which is employed in regulating the hammer-work.

Let *A* be a piece of brass cut down in twelve spiral steps in form of a snail, (from whence it takes its name) as in the figure; let this be fixed on the socket of the hour wheel; and *B* *G* *L* *F* the rack, with 14 teeth, turning on its centre *L*, having a spring *H* to force the end *F* upon the steps of the snail, *A*, when at liberty. The pin at *I* in the motion-wheel takes hold of the lifting-piece *D* *M* *K*; and the end *K* in rising, lifts up the hook *C*

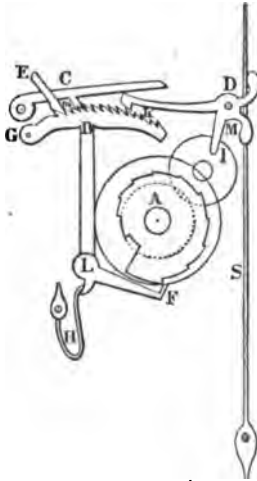

which lies in the teeth of the rack, and rises until the teeth are disengaged from it; the end *F* then falls down, and stops against the steps of the snail *A*, which in the figure is at two o'clock.

The arbor of the third or gathering wheel *k*, shown in the preceding diagram, comes through the plate on which the pallet *E* *m* is fixed; a turn of which answering to one stroke of the hammer, gathers the rack up one tooth: 12 steps of the snail answer 12 teeth in the rack; and, when the gathering pallet *E* *m* has taken as many teeth in the rack as the number of the hour, the end *E* of the pallet stops against a pin in the rack at *G*, and is there at rest until the hook *C* is again lifted out of the teeth by the lifting-piece, as before.

When the hook *C* is lifted out of the teeth of the rack, the clock would strike continually, as the hook, being out of the teeth, prevents the rack being gathered up; but that the end *K* of the lifting-piece has a small arm which goes through the plate, and a pin in the wheel *t*, which stops against it in such a manner, that when the lifting-piece is suffered to fall by the pin *I* having gone past the pin in the rim of the wheel *t*, it is clear of the arm at the end of the lifting piece *K*; the wheel being then at liberty, the clock strikes until the gathering pallet *E* stops against the pin of the rack at *G*, as before. By putting a small string to the top-end of the spring *S*, or lifting-piece *M*, to come through the case, it may be made to strike the last hour at any time, except when on the warning.

A more simple contrivance for dividing the hours in a striking clock may now be examined;

it may, however, be proper to state, that this apparatus is seldom resorted to in the construction of a modern English clock, although the foreign mechanics still consider it well adapted for its intended purpose

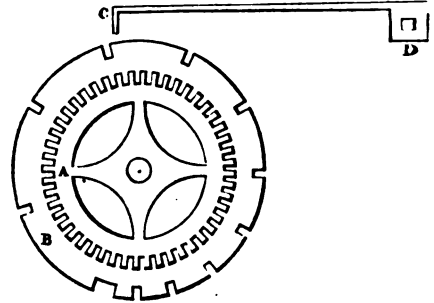

The wheel *A* is in this case united to the barrel arbor, and as such revolves with it, bearing the locking-plate *B*. The arm *C* is attached to the detent *D*, so that when the extremity *C* drops into the notches in the plate, the striking train is stopped, by another arm on the detent *D* intercepting a pin in the warning wheel. A reference to the locking-plate will show that its divisions correspond with the hours of the day: the arm *C* indicating nine o'clock. In clocks of this description the rack and its appendages are of course dispensed with.

In the year 1803, the Society for the Encouragement of Arts, &c. presented to Mr. John Prior of Nessfield, Yorkshire, a reward of thirty guineas on account of his contrivance for the striking part of an eight-days' clock. As this invention is likely to be useful, we shall describe it here. It consists of a wheel and fly, with six turns of a spiral line, cut upon the wheel, for the purpose of counting the hours. The pins below this spiral elevate the hammer, and those above are for the use of the detent. This single wheel serves the purpose of count-wheel, pin-wheel, detent-wheel, and the fly-wheel, and has six revolutions in striking the twelve hours. If we suppose a train of wheels and pinions used in other striking parts to be made without error, and that the wheels and pinions would turn each other without shake or play, then, allowing the above supposition to be true (though every mechanic knows it is not), Mr. Prior's striking part would be found six times superior to others, in striking the hours 1, 2, 5, 7, 10, and 11; twelve times superior in striking 4, 6, and 8; and eighteen times in striking 3, 9, and 12. In striking 2, the inventor purposely made an imperfection equal to the space of three teeth of the wheel; and, in striking 3, an imperfection of nine or ten teeth; and yet both these hours are struck perfectly correct. The flies in clocks turn round, at a mean, about sixty times for every knock of the hammer, but this turns round only three times for the same purpose: and suppose the pivots were of equal diameters, the influence of oil on them would be as the number of revolutions in each. It would be better for clocks if they gave no warning at all, but the snail piece to raise a

Fig. 1.

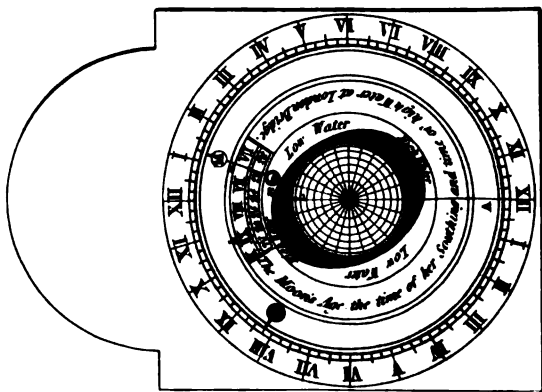

Fig. 2.

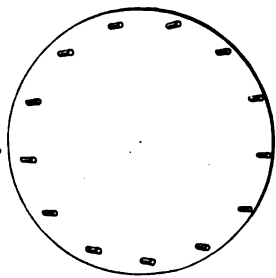
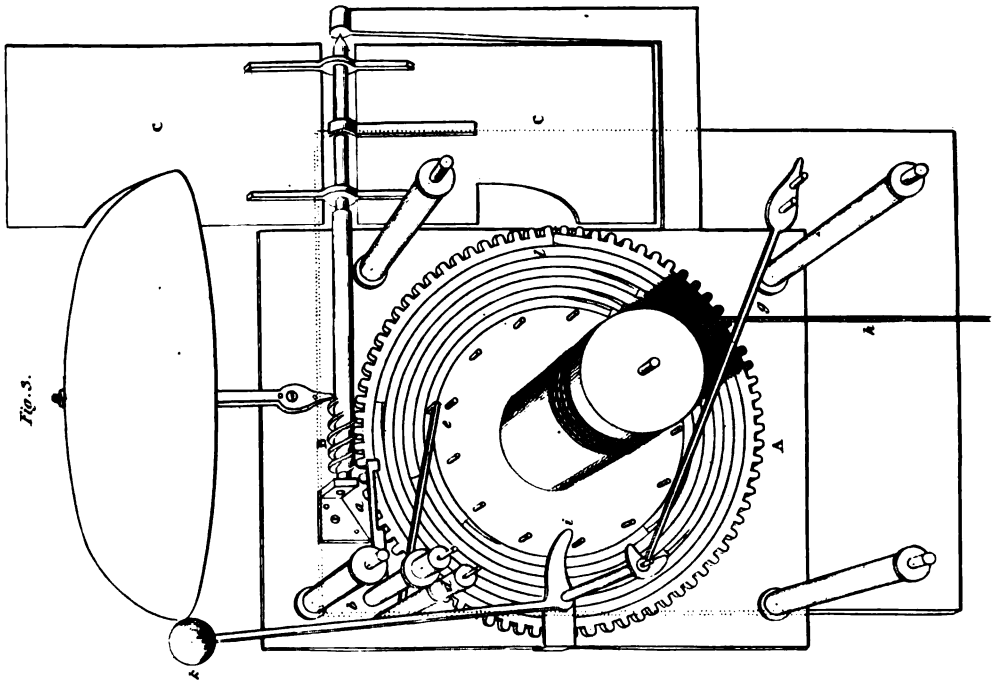

Fig. 3.



Fig. 4.



weight somewhat similar to the model Mr. Prior sent for the inspection of the Society for the Encouragement of Arts, &c.

The striking part of this clock is represented at fig. 3: plate 2, of *HOROLOGY*.

A, the large wheel, on the face of which are sunk or cut the six turns of a spiral.

B, the single worm screw, which acts on the above wheel, and moves the fly C.

D, the spiral work of the wheel A. The black spots show the grooves into which the dents drop on striking the hour.

E, the groove into which the locking piece F drops when it strikes one, and from which place it proceeds to the outward parts of the spiral in the progressive hours, being thrown out by a lifting piece H at each hour; the upper detent G being pumped off with the locking piece F, from the pins on the wheel A.

In striking the hour of 12, the locking piece, having arrived at the outer spiral at H, rises up an inclined plane, and drops by its own weight into the inner circle, in which the hour 1 is to be struck, and proceeds on in a progressive motion through the different hours till it comes again to 12.

I, the hammer-work made in the common way, which is worked by thirteen pins on the face of the spiral.

Fig. 4. K, the thirteen pins on the face of the spiral, which work the hammer-work.

L, the outer pins which lock the detent

M, the pump spring to the detent.

It may now be proper to notice the late James Ferguson's machinery for exhibiting the apparent daily motions of the sun and moon, and state of the tides, &c. The dial plate of this clock is represented at fig. 1, of plate 2, of *HOROLOGY*. It contains all the twenty-four hours of the day and night. S is the sun, which serves as an hour index, by going down the dial-plate in twenty-four hours; and M is the moon, which goes round in twenty-four hours, fifty minutes and a half, from any point in the hour circle to the same point again, which is equal to the time of the moon's going round in the heavens, from the meridian of any place to the same meridian again. The sun is fixed to a circular plate, as at fig. 2, and carried round by the motion of the plate, on which the twenty-four hours are engraven, and within them is a circle divided into twenty-nine and a half equal parts, for the days of the moon's age, accounted from the time of any new moon to the next after; and each day stands directly under the time (in the twenty-four hour circle), of the moon's coming to the meridian, the twelve under the sun standing for mid-day, and the opposite twelve for mid-night. Thus, when the moon is eight days old, she comes to the meridian at half an hour past six in the afternoon; and, when she is sixteen days old, she comes to the meridian at one o'clock in the morning. The moon M, fig. 1, is fixed to another circular plate of the same diameter with that which carries the sun; and this moon-plate turns round in twenty-four hours, fifty minutes and a half. It is cut open, so as to show some of the hours and days of the moon's age; on the plate below it that carries the sun, and across this opening at *a* and *b* are

two short pieces of small wire in the moon-plate. The wire *a* shows the day of the moon's age, and time of her coming to the meridian, on the plate below it that carries the sun; and the wire *b* shows the time of high water for that day on the same plate. These wires must be placed as far from one another, as the time of the moon's coming to the meridian differs from the time of high-water at the place where the clock is intended to serve. At London bridge it is high-water when the moon is two hours and a half past the meridian.

Above this plate that carries the moon, there is a fixed plate N, supported by a wire A, the upper end of which is fixed to the plate, and the lower end is bent to a right angle, and fixed into the dial-plate at the lowermost or mid-night twelve. This plate may represent the earth, and the dot at L, London, or any other place at which the clock is designed to show the times of high and low water.

Around this plate is an elliptical shade upon the plate that carries the moon M: the highest points of this shade are marked high-water, and the lowest points low-water; as this plate turns round below the fixed plate N, the high and low-water points come successively even with L, and stand just over it at the times when it is high or low water at the given place; which times are pointed out by the sun, S, among the twenty-fours on the dial-plate: and, in the arch of this plate, above twelve at noon, is a plate, H, that rises and falls as the tide does at the given place. Thus, when it is high-water (suppose at London), one of the highest points of the elliptical shade stands just over L, and the tide place, H, is at its greatest height: and, when it is low water at London, one of the lowest points of the elliptical shade stands over L, and the tide place H is quite down, so as to disappear beyond the dial-plate. As the sun S goes round the dial-plate in twenty-four hours, and the moon M, goes round it in twenty-four hours, fifty minutes and a half, the moon goes round so much slower than the sun, as only to make twenty-eight and a half revolutions in the time the sun makes twenty-nine and a half; and therefore the moon's distance from the sun is continually changing; so that at whatever time the sun and moon are together, or in conjunction, in twenty-nine and a half days afterwards they will be in conjunction again. Consequently the plate that carries the moon moves so much slower than the plate that carries the sun, as always to make the wire *a* shift over one day of the moon's age on the sun's plate in twenty-four hours.

In the plate that carries the moon, there is a round hole *m*, through which the phase or appearance of the moon, is seen on the sun's plate, for every day of the moon's age from change to change. When the sun and moon are in conjunction, the whole space seen through the hole *m* is black; when the moon is opposite the sun (or full) all that space is white; when she is in either of her quarters the same space is half black and half white; and different in all other positions, so as the white part may resemble the visible or enlightened part of the moon for every day of her age.

To show these various appearances of the moon, there is a black shaded space *N f*, *F l*, on the plate that carries the sun. When the sun and moon are in conjunction, the whole space seen through the round hole is black, as at *N*; when the moon is full, opposite to the sun, all the space seen through the round hole is white, as at *F*; when the moon is in her first quarter, as at *f*, or in her last quarter, as at *l*, the hole is only half shaded; and more or less accordingly for each position of the moon, with regard to her age.

Having seen that all clocks owe their motion either to a main spring, or the gravitating influence of some ponderous body, it will be evident that the moment the power is withdrawn, as in the act of winding, the wheels will cease to advance. To remedy the irregularity and variation in the time which this must of necessity produce, the annexed simple contrivance is occasionally resorted to:—

The small peg at the extremity of the lever is seen in the one case to rest upon the tooth of the wheel, while the dotted line represents it in its usual position. When the clock is wound the lever is raised, and, during the absence of its proper maintaining power, the pressure of a spring acting on the lever produces an equable motion in the train. There are a variety of other contrivances for this purpose; but the great simplicity of the one we have now described, although not entirely free from defects, fits it for general adoption.

As the period of winding a clock propelled by weights must of necessity depend on the length of the cord to which the weight is attached, it will be evident that any contrivance by which the line may be lengthened without increasing the fall must be advantageous to the machine. This desideratum is usually effected in a common clock, by introducing a pulley, represented at *B*, and, by means of this simple contrivance, the time of the clock is doubled. It may, however, be proper to add, that the weight must be increased in an equal ratio, as ten pounds attached to the pulley *B*, can only furnish a maintaining power of five pounds, or half that weight at *A*, so that a clock which is usually furnished with a weight of about fourteen pounds, in reality only requires seven to give motion to the train.

In all pendulum clocks, but more especially those that are employed for astronomical purposes, the greatest attention should be paid to the stability of the case or frame to which they are attached. The necessity of employing care in this respect may be best shown by reference to a curious fact furnished by the late Mr. Ellicott. It occurs in the Transactions of the Royal Society;

and he states, that a very excellent regulator was repeatedly stopped by the motion of a pendulum attached to another clock in the same apartment. At other times its rate was materially affected, and yet no apparent motion of the clock-case was observable. On this account it is, that the best regulators are usually attached to a firm support, altogether independent of the walls of the building in which they may be placed. A very ingenious apparatus has been suggested by Mr. Hardy, and rewarded by the Society for the Encouragement of Arts and Manufactures, which appears admirably adapted to detect the slightest oscillation that may occur. It consists of an inverted pendulum, and may be readily constructed by supporting a perpendicular wire by a slight steel spring, a movable weight being attached to a tube sliding on the wire. Should any vibration occur, the pendulum is immediately put in motion: and a graduated arc is sometimes attached to the upper part of the frame, which serves to mark the amount of oscillation.

The setting a clock into beat is usually effected by bending the crutch till the vibrations on each side are equal. To know when this is the case, it is merely necessary to mark the exact point occupied by the lower extremity of the pendulum when the ball is at rest. If it be then moved till the pallet escape, or, in plainer terms, till the clock is heard to tick, its extreme distance at that side will then be known. This must also be marked correctly; and if, on moving it in the opposite direction, it be found to describe a similar portion of a circle, it may then be considered as accurately in beat. If this should not be the case, the crutch must then be bent; or, in more complete machines, an alteration made by screws. It is also an essential condition, that the centre of suspension of the pendulum shall be exactly in the same vertical plane with the centre of the verge; for, if the pendulum spring happen not to coincide with a perpendicular line passing through the pivot-hole of the pallet's arbor, one half the arc of vibration will be greater than the other, even after the crutch is properly adjusted. An error of this kind must however be very obvious, and may be remedied by the eye.

In the early stages of the art clocks, as well as watches, were of very simple construction, and every artist was compelled from necessity to complete the machine he attempted to construct; but, in the present state of the business, it is divided into a great number of branches, and each, by devoting himself exclusively to that department, attains a greater degree of expertness and accuracy than he could possibly effect without such a division of labor.

The invention of pendulum clocks has been claimed, more especially, by Galileo and Huygens, neither of whom published their discoveries prior to 1649; and it will be found, by reference to the following extract, that it is to an English mechanic that we are really indebted for this valuable appendage of a modern clock:

'The clock fixed in the turret of the said church, was the first long pendulum clock in Europe, invented and made by Richard Harris of London, A. D. 1641; although the honor of the invention was assumed by Vincenzo Galileo,

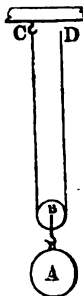
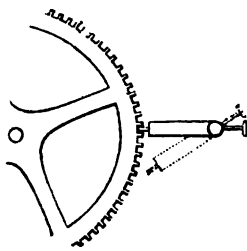

A. D. 1649, and also by Huygens in 1657. This plate is here affixed by Thomas Grignon, of this parish (Covent Garden), the son of the above Thomas Grignon, as a true memorial of praise

to those two skilful mechanicians, his father and Richard Harris, who to the honor of England, embodied their ideas in substantial forms that are most useful to mankind.'

CLOCK, *n. s.* Sax. *galukan*, to close; the gusset or ornamented work of a stocking.

His stockings with silver clocks were ravished from him. *Swift.*

CLOD, *n. s. & v.* } Goth. *klode*; Swed. **CLODDY**, *adj.* } *klot*. A lump of earth; the ground; any thing concreted together in a cluster, as particles of earth cleave to each other. Any thing vile, base, and earthy, as the body of a man compared to his soul. The adjective is applied to whatever is muddy, miry, mean, gross, base, and stupid. To clod is to coagulate together into concretions; and, when used in the active sense, to pelt with clods, or to cover with clods.

The glorious sun,
Turning with splendour of his precious eye,
The meagre cloddy earth to glittering gold.

Shakespeare.

The earth that casteth up from the plough a great clod, is not so good as that which casteth up a smaller clod. *Bacon.*

I'll cut up, as plows
Do barren lands, and strike together flints
And clods, the ungrateful senate and the people.

Ben Jonson.

The spirit of man,
Which God inspired, cannot together perish
With this corporeal clod. *Milton's Paradise Lost.*

Let us go find the body, and from the stream,
With lavers pure, add cleansing herbe, wash off
The cloddied gore. *Id.*

Fishermen who make holes in the ice to dip up fish with their nets, light on swallows congealed in clods of a slimy substance; and carrying them home to their stoves, the warmth restoreth them to life and fight. *Carew.*

The vulgar! a scarce animated clod,
Ne'er pleased with ought above'em. *Dryden.*

Byzantians boast, that on the clod,
Where once their sultan's horse has trod.
Grows neither grass, nor shrub, nor tree. *Swift.*

CLODIUS (Publius), a Roman of an illustrious family, but infamous for his licentiousness, avarice, and ambition. He committed incest with his three sisters, and introduced himself in woman's clothes into the house of Julius Cæsar, whilst Pompeia, Cæsar's wife, of whom he was enamoured, was celebrating the mysteries of Ceres, at which no man was permitted to appear. He was accused of this violation of human and divine laws; but, being made tribune, he thus screened himself from justice. Being the enemy of Cato, he procured him to be sent with prætorian powers, in an expedition against Ptolemy king of Cyprus, that by the difficulty of the campaign he might ruin his reputation, and destroy

his interest at Rome during his absence; but Cato, by his success, frustrated these attempts. He was also the inveterate enemy of Cicero, and by his influence obtained his banishment from Rome. He then wreaked his vengeance upon Cicero's house, which he burnt, and set his goods to sale; which, however, to his great mortification, no one offered to buy. He was some time after murdered by Milo.

CLODPATE, *n. s.* clod and pate. A stupid fellow; a dolt; a thickskull.

CLODPATED, *adj.* from clodpate. Stupid, dull, doltish, thoughtless.

My clodpated relations spoiled the greatest genius in the world, when they bred me a mechanick.

Arbutnot.

CLODPOLL, *n. s.* from clod and poll. A thickskull; a dolt; a blockhead.

This letter being so excellently ignorant, he will find that it comes from a clodpoll. *Shakespeare.*

CLOG, *n. s. & v. n.* } Probably from log,
CLOGGINESS, *n. s.* } a load or hindrance,
CLOGGY, *adj.* } A wooden shoe, which

clogs or hinders in walking, while it protects the under shoe and the feet from wet. The idea of the verb is to impede motion by weight; to encumber with shackles; thence, to embarrass. It is occasionally used in the sense of coalesce, and to adhere; but improperly, as in such cases it is only a corruption of clod or clot.

But as he sought his loggery, he happed oppon a whelp

That lay under a stayer, a grete walsh dog,
That bare about his neck a grete huge clog,
Because that he was spetouse and wold sone bite;
The clog was hongit about his nek for men shuld not wite,

Nothing, the dogges maister if he did eny harm,
So for to excuse them both it was a wyly charm.

Chaucer. Canterbury Tales.

Alone he rode, without his paragone,
For having filcht her bells, her up he cast
To the wide world, and let her fly alone,
He nould be clogged, so had he served many one.

Spenser.

Weariness of the flesh is an heavy clog to the will. *Hooker.*

They're our clogs, not their own; if a man be
Chained to a galley, yet the galley's free. *Donne.*

Since thou hast far to go, bear not along
The clogging burthen of a guilty soul.

Shakespeare.

You'll rue the time,

That clogs me with this answer. *Id.*

If you find so much blood in his liver as will clog
The foot of a flea, I'll eat the rest of the anatomy. *Id.*

I'm glad at soul I have no other child
For thy escape would teach me tyranny,
To hang *clogs* on them. *Id.*

His majesty's ships were over-pestered, and *clogged*
with great ordnance, whereof there is superfluity. *Raleigh.*

I did but prompt the age to quit their *clogs*,
By the known rules of ancient liberty. *Milton's Paradise Regained.*

As a dog committed close
For some offence, by chance breaks loose,
And quits his *clog*, but all in vain,
He still draws after him his chain. *Hudibras.*

By additaments of some such nature, some grosser
and *cloggy* parts are retained; or else much subtilized
and otherwise altered. *Boyle's History of Firmness.*

In France the peasantry goes barefoot; and the
middle sort, throughout all that kingdom, makes use
of wooden *clogs*. *Harvey on Consumptions.*

Gums and pomatums shall his flight restrain,
While *clogged* he beats his silken wings in vain. *Pope.*

CLOGHER, a city and bishop's see of Ireland,
in the county of Tyrone, and province of Ulster.
In a very early age an abbey of regular canons,
dedicated to the Virgin Mary, was founded here.
St. Patrick is said to have presided over the
church of Clogher; and, having appointed his
successor, he resigned this government, and went
to Armagh, where he founded his celebrated
abbey. On the 20th of April, 1396, a dreadful
fire burnt to the ground the church, the two cha-
pels, the abbey, the court of the bishops, and
thirty-two other buildings. In 1610 king James
I. annexed this abbey and its revenues to the see
of Clogher. Clogher is seventy miles from Dub-
lin, and twenty west of Armagh.

CLOISTER, *n. s.* & *v. a.* } Welsh, *clás*; Sax.
CLOISTERAL, *adj.* } clauſter; Germ.
CLOISTERED, *part. adj.* } cloister; French,
cloistre; Lat. *claus-trum*. A religious retirement;
a monastery; an annery. A peristyle; a piazza.
To shut up in a religious house; to confine; to
immure; to shut up from the world.

Yeve me than of thy gold to make our *cloistre*;
Quod he, for many a muscle and many an oistre,
Whan other men han ben ful wel at ese,
Hath been our food, our *cloistre* for to rese. *Chaucer. Canterbury Tales.*

Cloister thee in some religious house. *Shakespeare.*

Ere the bat hath flown
His *cloistered* flight, there shall be done
A deed of dreadful note. *Id. Macbeth.*

They have by commandment, though in form of
courtesey, *cloistered* us within these walls for three
days. *Bacon.*

It was of the king's first act to *cloister* the queen
dowager in the nunnery of Bermondsey. *Id.*

Upon this ground many *cloisteral* men, of great
learning and devotion, prefer contemplation before
action. *Walton's Angler.*

Near to this gloomy *cloister's* gates,
There dwelt the blooming virgin Thwates,
Faire beyond measure, and an heir
Which might deformity make fair. *Marvel.*

Nor in a secret *cloister* doth he keep
These virgin spirits until their marriage day. *Davies.*

Some solitary *cloister* will I choose,
And there with holy virgins live immured. *Dryden.*

How could he have the leisure and retiredness
the *cloister*, to perform those acts of devotion. *Atterbury.*

The Greeks and Romans had commonly two *clois-
tered* open courts, one serving for the women's sick
and the other for the men. *Wotton's Architec.*

CLOISTER, in a more restrained sense, is used
for the principal part of a regular monastery,
consisting of a square, built around; ordinarily
between the church, the chapter-house, and the
refectory; and over which is the dormitory. The
cloisters served for several purposes in the ancient
monasteries. Peter of Blois observes, that it was
here the monks held their lectures: the lecture of
morality at the north side, next the church; the
school on the west, and the chapter on the east;
spiritual meditation, &c., being reserved for the
church. Lanfranc says, that the proper use of the
cloister was for the monks to meet in, and con-
verse together, at certain hours of the day. The
form of the cloister was square; and it had its
name *claustrum* from *claudo*, to close; as being
enclosed on its four sides with buildings. Hence,
in architecture, a building is still said to be in
form of a cloister when there are buildings on
each of the four sides of the court.

CLOISTRESS, *n. s.* from cloister. A nun;
a lady who has vowed religious retirement.

Like a *cloistress* she will veiled walk,
And water once a day her chamber round
With eye-offending brine. *Shakespeare.*

CLOKE, *n. s.* See **CLOAK**
CLOMB, *pret. of* to climb.

The sonne, he said, is *clomben* upon heven
Twenty degrees. *Chaucer. Com. Tales.*
Ask to what end they *clomb* that tedious height. *Spenser.*

So *clomb* this first grand thief into God's fold. *Milton's Paradise Lost.*

CLONAKILTY, a sea-port town in the
county of Cork, Ireland, situated in a bay of this
name. It is built in the form of a cross;
the church, a plain structure, standing on an
eminence. The bay is not convenient, and, in-
deed hardly safe. It is twenty miles south-west
of Cork, and has a good market for yarn.

CLONES, a town in the county of Monaghan,
Ireland. Here was formerly the abbey of St.
Tegernach, of royal blood, who removed to this
place the episcopal seat of Clogher. In 1207 the
town and abbey were destroyed by Hugh de
Lacie; but five years afterwards they were rebuilt.
In 1504 the bishopric was restored. It is ten
miles south-west of Monaghan.

CLONFERT, a city or village of Ireland, in
the county of Galway. An abbey was erected
here in the year 553; the church was also a ca-
thedral at that time, and constituted a bishop's
see. During the middle ages the abbey and town
were frequently plundered by the leaders of fac-
tions, as well as by the Danes. It is thirty-six
miles east of Galway.

CLONMELL, a borough in Ireland, in the
county of Tipperary, situated on the river Suir.
It is the assize town, has a barrack for two troops
of horse, and is governed by a mayor, recorder,

baillifs, and town clerk; sending one member to parliament. The Suir is navigable from this town to Carrick and Waterford; and some trade is carried on in the woollen branch, particularly by the quakers, who are very numerous in this neighbourhood. There is a spring here of Spa water, that issues out of the side of a rising ground, which, however, is overlooked by a pretty steep hill, on that side of the Suir which is in the county of Waterford. In this town the celebrated Laurence Sterne was born. It consists of four cross streets, and has a spacious bridge of twenty arches over the Suir; the market-house is strong and well built; and there is a charter-school for children. A Dominican friary was founded at Clonmell in 1269, when Otho de Grandison also erected a Franciscan friary, the church of which was esteemed one of the most magnificent in Ireland. This town is very ancient, being built before the Danish invasion: it was formerly defended by a square wall. Oliver Cromwell, who found more resistance from this place than any other in the kingdom, demolished the castles and fortifications, of which now only the ruins remain. The Gothic church is still kept in good repair. Clonmell is nineteen miles south-east of Tipperary, and twenty-two W.N.W. of Waterford.

To CLOOM, *v. a.* corrupted from *cleam*. Sax. *claman*, which is still used in some provinces. To close or shut with glutinous or viscous matter.

Rear the hive enough to let them in, and cloom up the skirts, all but the door. *Mortimer's Husbandry.*

CLOSE, *n. s.*, *v. a.*, *adj.* & *adv.* } Fr. *clos*;
CLOSE'LY, *adv.* } Teut. *klose*,
CLOSE'NESS, *n. s.* } from Lat.

classus. Any thing shut, as an enclosed field; also a termination, or that which shuts or encloses; a coming together; consolidation; a shutting up. The adjective conveys all the shades of meaning applicable to the other derivatives, we shall therefore furnish the definitions and illustrations of this, in addition to a few that establish the primary sense, as abundantly sufficient to explain both the literal and metaphorical applications of the entire word.

Certes I have now lived too long,
Sith I may not this closer kepe.
Al quick I would be dolven depe,
Yf any man shal more repayre
To this gardin for foul or fayre.

Chaucer. Romaunt of the Rose.

Ne left he nought,
But through the verger he hath sought
If he might finden hole, or trace
Wherethrough that me [I] mote forth by pace
Or any gap he did it close. *Id.*

I have a tree, which grows here in my close,
That mine own use invites me to cut down,
And shortly must I fell it. *Shakespeare.*

The admirable effects of this distillation in close,
which is like the wombs and matrices of living creatures. *Bacon.*

The king went of purpose into the north, laying an open side unto Pekin, to make him come to the close, and so to trip up his heels, having made sure in Kent beforehand. *Id.*

The air, such pleasure loth to lose
With thousand echoes still prolongs each heavenly
close. *Milton.*

Speedy death,
The close of all my miseries and the balm. *Id.*
At every close she made, the attending throng
Replied, and bore the burden of the song.

Dryden's Fables.

Through Syria, Persia, Greece, she goes;
And takes the Romans in the close. *Prior.*

So in the Roman forum Carteus brave,
Gallop'ing down, closed up the gaping cave. *Marvell.*

Behold the picture! Is it like? Like whom?
The things that mount the rostrum with a skip,
And then skip down again. Pronounce a text,
Cry hem, and reading, what they never wrote,
Just fifteen minutes huddle up their work,
And with a well-bred whisper close the scene. *Cropper.*

Sweet as the downy-pinioned gale that roves,
To gather fragrance in Arabian groves;
Mild as the melodies at close of day,
That heard remote along the vale decay. *Beattie.*

In vain she seeks to close her weary eyes,
Those eyes still swim incessantly in tears,
Hope in her cheerless bosom fading dies,
Distracted by a thousand cruel fears,
While banished from his love for ever she appears. *Mrs. Tighes' Psyche.*

Close to the glimmering gate he dragged his chain,
And hoped that peril might not prove in vain. *Byron.*

What deep wounds ever closed without a scar,
The hearts bleed longest, and but heal to wear
That which disfigures it; and they who war,
With their own hopes, and have been vanquished,
bear
Silence, but not submission. *Id.*

The adjective is thus exhibited by Johnson.
We have supplied a few illustrations. Shut
fast, so as to leave no part open; as, a close box,
a close house.

We suppose this bag to be tied close about, towards
the window. *Wilkins.*

Having no vent; without inlet; secret; private;
not to be seen through.

Nor could his acts too close a vizard wear,
To escape their eyes whom guilt had taught to fear. *Dryden.*

Confined; stagnant; without ventilation.

If the rooms be low roofed, or full of windows
and doors, the one maketh the air close, and not
fresh; and the other maketh it exceedingly unequal. *Bacon's Natural History.*

Compact; solid; dense; without interstices or
vacuities.

The inward substance of the earth is of itself an
uniform mass, close and compact. *Burnet's Theory.*

The golden globe being put into a press, which was
driven by the extreme force of screws, the water made
itself way through the pores of that very close metal. *Loche.*

Viscous; glutinous; not volatile.

This oil, which nourishes the lamp, is supposed of
so close and tenacious a substance, that it may slowly
evaporate. *Wilkins.*

Concise ; brief ; compressed ; without exuberance or digression.

You lay your thoughts so *close* together, that were they *closer* they would be crowded, and even a due connection would be wanting. *Dryden's Juvenal.*

Where the original is *close*, no version can reach it in the same compass. *Dryden.*

Read these instructive leaves, in which conspire *Frenoy's close art*, and *Dryden's native fire.* *Pope.*

Joined without any intervening distance or space, whether of time or place.

But yot the cause and root of all his ill,

Inward corruption and infected sin,

Not purged nor healed, behind remained still,

And festering sore did rankle yet within,

Close creeping twixt the marrow and the skin.

Spenser.

Was I a man bred great as Rome herself,

Equal to all her titles, that could stand

Close up with Atlas, and sustain her name

As strong as he doth heaven. *Ben Jonson.*

We must lay aside that lazy and fallacious method of censuring by the lump, and must bring things *close* to the test of true or false. *Burton's Theory.*

Approaching nearly ; joined one to another.

Now we sit *close* about this taper here,

And call in question our necessities.

Shakespeare.

Nature so herself does use

To lay by her wonted state,

Lest the world should separate,

Sudden parting *closer* glews.

Marvell.

And as a child, when scaring sounds molest,

Clings *close* and *closer* to the mother's breast ;

So the loud torrent and the whirlwind's roar,

But bind him to his native mountain more.

Goldsmith.

Admitting small distance.

Short crooked swords in *closer* fight they wear.

Dryden.

Undiscovered ; without any token by which one may be found.

Close observe him for the sake of mockery.

Close, in the name of jesting ! like you there.

Shakespeare.

Hidden ; secret ; not revealed.

A *close* intent at last to shew me grace. *Spenser.*

The spagyrista, that keep their best things *close*, will do more to vindicate their art, or oppose their antagonists, than to gratify the curious or benefit mankind. *Boyle.*

Having the quality of secrecy ; trusty.

Constant you are,

But yet a woman ; and for secrecy,

No lady *closer.*

Shakespeare.

Having an appearance of concealment ; cloudy ; sly.

That *close* aspect of his

Does show the mood of a much-troubled breast.

Shakespeare.

Without wandering ; without deviation ; attentive.

I discovered no way to keep our thoughts *close* to their business, but by frequent attention, getting the habit of attention. *Locke.*

Full to the point ; home.

I am engaging in a large dispute, where the arguments are not likely to reach *close* on either side.

Dryden.

Retired ; solitary.

He kept himself *close* because of Saul. *Chronicles.*

Secluded from communication ; as, a *close* prisoner. Applied to the weather, dark ; cloudy ; not clear. Applied to the mind, it signifies, to be reserved, impenetrable, covetous. The verb is sometimes used with an addition, as *to close upon* ; to agree upon, to join in.

The jealousy of such a design in us would induce France and Holland *to close upon* some measures between them to our disadvantage. *Temple.*

To close with ; *to close in with.* To come to an agreement with ; to comply with ; to unite with.

Intire cowardice makes thee wrong this virtuous gentlewoman, *to close with* us.

Shakespeare. Henry IV.

It would become me better than *to close,*

In terms of friendship *with* thine enemies.

Id. Julius Cæsar.

There was no such defect in man's understanding, but that it would *close with* the evidence. *South.*

He took the time when Richard was deposed,

And high and low *with* happy Harry *closed.*

Dryden.

Pride is so unsociable a vice, that there is no *closing with* it. *Collier on Friendship.*

This spirit, poured upon iron, lets go the water ; the acid spirit is more attracted by the fixed body ; and lets go the water *to close with* the fixed body.

Newton's Opticks.

Such a proof as would have been *closed with* certainly at the first, shall be set aside easily afterwards.

Atterbury.

These governours bent all their thoughts and applications *to close in with* the people, now the stronger party. *Swift.*

To close with. To grapple with in wrestling.

CLOSE-BANDED, *adj.* In close order ; thick ranged ; or secretly leagued, which seems rather the meaning in this passage.

Nor in the house which chamber ambushes

Close-banded, durst attack me.

Milton.

CLOSE-BODIED, *adj.* Made to fit the body exactly.

If any clergy shall appear in any *close-bodied* coat, they shall be suspended. *Ayliffe's Pereragon.*

CLOSE-HANDED, *adj.* Covetous.

Galba was very *close-handed.* I have not read much of his liberalities. *Arbuthnot on Coins.*

CLOSE-HAULED, in navigation, the general arrangement or trim of a ship's sails when she endeavours to make progress, in the nearest direction possible, towards that point of the compass from which the wind blows. In this manner of sailing, the keel commonly makes an angle of six points with the line of the wind ; but sloops and some other small vessels are said to sail almost a point nearer. All vessels, however, are supposed to make nearly a point of lee way when close-hauled, even when they have the advantage of a good sailing breeze and smooth water. The angle of lee way, however, increases in proportion to the increase of the wind and sea. In this disposition of the sails, they are all extended sideways on the ship, so that the wind, as it crosses the ship obliquely toward the stern from forwards, may fill their cavities. But, as the current of

winds also enters the sails in an oblique direction, the effort of it to make the ship advance is considerably diminished: she will therefore make the least progress when sailing in this manner. The ship is said to be close-hauled, because at this time her tacks, or lower corners of the principal sails, are drawn close down to her side to windward, the sheets hauled close aft, and all the bow lines drawn to their greatest extension to keep the sails steady.

CLOSE-PENT, *adj.* Shut close; without vent.

Then in some *close-pent* room it crept along,
And smouldering as it went, in silence fed.

Dryden.

CLOSE QUARTERS, strong barriers of wood stretching across a merchant ship in several places; used as a place of retreat when a ship is boarded by her adversary; they are therefore fitted with loop-holes, through which to fire the small arms; they are likewise furnished with caissons, or powder-chests, fixed upon the deck, and filled with powder, old nails, &c., which may be fired at any time from the close quarters, upon the boards.

CLOSE-STOOL, *n. s.* close and stool. A chamber implement.

A pebble for his truncheon, led the van;
And his high helmet was a *close-stool* pan. *Garth.*

CLOSET, *n. s. & v. a.* from close. A small room of privacy and retirement; a private repository of curiosities and valuable things. To shut up, or conceal, in a closet; to take into a closet for a secret interview.

Chamber and *closet* clenest of chastitie,
And named her brough of the deitie. *Chaucer.*
Deepe, in the *closet* of my parts entyre,
Her worth is written with a golden quill,
That me with heavenly fury doth inspire,
And my glad mouth with her sweet prayses fill.

Spenser's Sonnets.

The taper burneth in your *closet*. *Shakspeare.*
He would make a step into his *closet*, and after a short prayer he was gone. *Wotton.*

The heat
Of thy great love once spread, as in an urn,
Doth *closet* up itself. *Herbert.*

So where the neatest badger most abides;
Deep in the earth she forms her pretty cell,
Which into halls and *closets* divides;
But when the crafty fox with loathsome smell
Infects her pleasant cave the cleanly beast,
So hates her inmate and rank smelling guest,
That far away she flies, and leaves her loathed nest.

Fletcher's Purple Island.

He knew the seat of paradise,
Could tell in what degree it lies;
And as he was disposed could prove it
Below the moon or else above it,
What Adam dreamt of when his bride
Came from her *closet* in his side. *Hudibras.*

He should have made himself a key, wherewith to
open the *closet* of Minerva, where those fair treasures
are to be found in all abundance.

Dryden's Dufrenoy.

He furnishes her *closet* first, and fills
The crowded shelves with rarities of shells.
Dryden's Fables.

CLOSTER SEVEN, a town of Germany, in the circle of Lower Saxony, and duchy of Bremen, memorable for a convention entered into by the duke of Cumberland and the duke of Richelieu, commander of the French armies in 1758, by which 38,000 Hanoverians laid down their arms, and were dispersed. It is nineteen miles south of Stade, and twenty-four N. N. E. of Bremen.

CLOSURE, *n. s.* from close.

The act of shutting up.

The chink was carefully closed up: upon which
closure there appeared not any change.

Boyle's Spring of the Air.

That by which any thing is closed or shut.

I admire your sending your last to me quite open,
without a seal, wafer, or any *closure* whatever.

Pope to Swift.

The parts enclosing; enclosure.

O thou bloody prison!

Within the guilty *closure* of thy walls
Richard the Second here was hacked to death.

Shakspeare.

Conclusion; end. Not in use.

We'll hand in hand all headlong cast us down,
And make a mutual *closure* of our house. *Id.*

CLOT, *n. s. & v. n.* } Fr. *caillet*; from Lat.
CLOTTER, *v. n.* } *coagulation*. Probably,
CLOTTY, *adj.* } at first, the same with
clod, but now applied to different uses. Con-

cretion; coagulation; grume. To form clots or clods, to hang together, to concrete, to coagulate; as clotted cream; clotted blood. Johnson says to become gross, but gives no proof or illustration.

The *clotterd* blood, for any leche-craft,
Corrumpeth, and in his bouke ylaft,—
That neyther veine-blood, ne ventousing,
Ne drinke of herbes, may ben his helping.

Chaucer.

The white of an egg, with spirit of wine, doth bake
the egg into *clots*, as if it began to poch. *Bacon.*

The opening itself was stopt with a *clot* of grumous
blood. *Wiseman's Surgeon.*

He dragged the trembling sire,
Sliddering thro' *clotterd* blood and holy mire.

Dryden's Æneid.

Where land is *clotty*, and a shower of rain soaks
through, you may make use of a rool to break it.

Mortimer.

Huge unwieldy bones, lasting remains
Of that gigantick race; which, as he breaks
The *clotted* glebe, the plowman haply finds. *Philips.*

CLOTAIRE I., king of France, was the son of Clovis and Clotilda. He began to reign in 511, and died at Compiègne in 561, aged forty-four. See FRANCE, HISTORY OF.

CLOTAIRE II., son and successor of Chilperic I. His father dying in his infancy, his mother maintained the kingdom for him, with great spirit and success, against the efforts of Childebert. After her death Theodebert and Thiuri defeated him; but he afterwards re-united the different kingdoms of France under himself. He died in 628.

CLOTAIRE, III. king of Burgundy, after the death of Clovis II. his father, who left him a minor. His mother Batilda, governed during his minority with great wisdom. He died in 670.

CLOTH, WOOLLEN.

CLOTH, *n. s.*
 CLOTHES, *plural.*
 CLOTHE, *v. a. & n.*
 CLOTHIER, *n. s.*
 CLOTHING, *n. s.*
 CLOTH-SHEARER, *n. s.*
 CLOTH-PRESSING, *n. s.*
 CLOTH-WORKER, *n. s.*

Ang.-Sax. clad, cloth. That which is woven, and now applied to any woven texture of whatever substance. The singular is applied to denominate the article as it comes out of the hands of the manufacturer. The plural is usually applied to the same article made into garments; and to garments in general: hence to whatever is used for covering and protection from outward injuries and unsightly nakedness. The different agents whose cognomen we have given are employed in the primary process of manufacturing and preparing the material; but not in the after process of forming it into apparel. To clothe is to invest, to adorn with dress, to furnish, provide with clothes, to cover.

Better it is to cast away thin here, than to cast away the sweetness of our Lord Jesu Crist, and therefore sayth Saint Poule, *clothe* you—as they that ben chosen of God in herte, of misericorde debonairee, and swiche maner of *clothing* of which Jesu Crist is more plesed than with the heres or habergeons. *Chaucer. The Persones Tale.*

The third had of their wardrobe custody, In which were not rich tyres, nor garments gay, The plumes of pride and winges of vanity, But *clothes* meet to keep keene cold away, And naked nature seemely to aray; With which bare wretched wights he daily clad, The images of God in earthly clay; And, if that no spare *clothes* to give he had, His owne cote he would cut, and it distribute glad.

Spenser.

He with him brought Preyne, rich arrayed
 In Claribellae's *clothes*. *Id.*

Take up these *clothes* here quickly; carry them to the laundress in Datchet mead. *Shakespeare.*

I answer you right painted *cloth*, from whence you have studied your questions. *Id.*

Who fears a sentence, or an old man's saw,
 Shall by a painted *cloth* be kept in awe. *Id.*
 Care no more to *clothe* and eat. *Id. Cymbeline.*

The *clothiers* all, not able to maintain
 The many to them longing, have put off
 The spinsters, carders, fullers, weavers.

Id. Henry VIII.

My father is a poor man, and by his occupation a *cloth-shearer*. *Hakewill on Providence.*

The king stood up under his *cloth* of state, took the sword from the protector, and dubbed the Lord Mayor of London knight. *Sir John Hayward.*

I'll make the very green *cloth* to look blue.

Ben Jonson.

If thou beest he; but O how fallen! how changed
 From him, who in the happy realms of light,
 Clothed with transcendent brightness, did'st outshine
 Myriads though bright! *Milton.*

At length by wonderful impulse of fate
 The people call him home to help the state,
 And, what is more, they send him money too,
 And *cloath* him from head to foot anew. *Marvell.*

A costly *cloth* of gold.

Drayton.

The Spaniards buy their linen *cloths* in that kingdom. *Swift.*

Your bread and *clothing*, and every necessary of life, entirely depen upon it. *Id.*

They leave the shady realms of night,
 And *clothed* in bodies, breathe your upper light. *Dryden.*

Gazing on her midnight foes,
 She turned each way her frighted head,

Then sunk it deep beneath the *clothes*. *Prior.*

Let both use the clearest language in which they can *clothe* their thoughts. *Watts on the Mind.*

Nor let, like Nævius, every error pass;
 The musty winc, foul *cloth*, or greasy glass. *Pope.*

Embroidered purple *clothes* the golden beds. *Pope's Statius.*

True Witney broad-*cloth* with its shag unshorn,
 Unpierced, is in the lasting tempest worn. *Gay.*

With superior boon may your rich soil
 Exuberant nature's better blessings pour
 O'er every land, the naked nations *clothe*,
 And be the exhaustless granary of a world.

Thomson.

Who toils for nations may be poor indeed,
 But free, who sweats for monarchs is no more
 Than the gilt chamberlain, who *clothed* and fee'd.
 Stands sleek and slavish, bowing at his door. *Byron.*

CLOTH is a cotton, linen, or woollen manufacture. That, indeed, which, among the inhabitants of Otaheite, and other barbarous people, is made of the barks of trees, has been sometimes treated under this term; but it has already engaged our attention sufficiently under the word BARK, which see. On the other hand, hair, silk; and the ductile and precious metals of silver and gold have been, in highly civilised countries, wrought into cloth.

But the three divisions of this extensive species of manufacture, which we have named, will embrace its principal and more common application. For HAIR-CLOTH, see that article; for cloth made of silk, see SILK MANUFACTURE; and for cloth of gold and silver, see TISSUE.

Cotton, linen, and woollen cloths, alike undergo three common processes from the raw material, to the complete and finished piece of goods. 1. They are prepared in various ways until they form yarn. 2. They are woven into cloth; and 3. They are bleached, dyed, printed, glazed, &c. to various stages of beauty and perfection. Under the names of the respective materials, COTTON, FLAX, and SILK, will the very distinct methods of preparing those materials be treated. Our attention in this article will be directed to the different operations by which our staple manufacture of woollen cloth is conducted after the sorting of the wool, for which see WOOL; and, with the exception of WEAVING, (an operation sufficiently important to require a distinct article) this finally receiving the name of *cloth*, in distinction from linen, cotton, and silk goods.

Cloths are of various qualities, fine and coarse. The following general criteria of the goodness of cloth, have been often given, viz. 1. That the

wool be of a good quality, and well dressed. 2. It must be equally spun, carefully observing that the thread of the warp be finer and better twisted than that of the woof. 3. The cloth must be well wrought, and beaten on the loom, so as to be everywhere equally compact. 4. The wool must not be finer at one end of the piece than the rest. 5. The lists must be sufficiently strong, of the same length with the stuff, and must consist of good wool, hair or ostrich feathers; or, what is still better, of Danish dog's hair. 6. The cloth must be free from knots and other imperfections. 7. It must be well scoured with fullers' earth, well filled with the best white soap, and afterwards washed in clear water. 8. The hair or nap must be well drawn out with the feazel, without being too much opened. 9. It must be shorn close without making it thread-bare. 10. It must be well dried. 11. It must be tenter-stretched to force it to its just dimensions. 12. It must be pressed cold, not hot-pressed, the latter being very injurious to fine woollen cloth.

This manufacture we shall now more particularly consider in its processes. 1. Of preparing the wool, after it has been sorted for the weaver. 2. Of finishing the cloth after it is taken from the loom.

1. *Of preparing the wool after it has been sorted.*—The best wools for the manufacturing of white cloth, intended for dyeing, are those of England and Spain. Spanish wool, as it arrives in this country, has generally some part of the marking pitch still adhering to it in the bale, which must be carefully cut or picked off; and it is frequently so hardly pressed together in the bag, that it requires to be opened out by beating. Until recently it was the practice to beat the wool with rods, in order to shake out the dust and open the staples; but this is now principally done by an opening machine with long coarse teeth, called a devil, or wool-mill, described farther onward. English wool is generally cleaned from pitch marks or other extraneous substances by the wool-sorter, and left by him in a proper condition to commence the process of cloth-making.

In Hampshire, and the west of England, it is now most commonly scoured, by putting it into a furnace containing a liquor composed of three parts of water and one of urine; and after it has been well stirred therein, and the grease it contains dissolved, it is taken out, drained, and washed in running water. In Yorkshire this excellent practice is said to be omitted in regard to wools intended for white cloths; and manufacturers who dye their own wool frequently put it into the dyeing-vat unscoured; a process which, while it enables him to make a greater weight of cloth from his wool, injures the brightness of the colors. It also makes it needful that the oil afterwards used should be increased one-third at least; and gives a general want of cleanliness and comfort to the whole manufacture.

Berthollet states that in this operation, properly conducted, one-fourth of the previous weight of the wool is taken off; and he attributes to the ammonia of the putrefied urine its detergent quality. Vauquelin having analysed

the grease, or yolk, as it sometimes is called, thus discharged, found it to consist of

1. A soap, with a basis of potash, which formed its chief parts.
2. Carbonate of potash, in small quantity.
3. A notable quantity of acetate of potash.
4. Lime.
5. A little muriate of potash.
6. An animal matter, which yields its odor.

He thinks the ammonia contained in the putrefied urine not to be conducive to its action, and advises the use of ordinary soap as better fitted to procure the desired whiteness to wools.

When wool is dyed in the fleece, or without being spun, it is now ready to be committed to the dye-furnace; and this is principally the case when it is to be employed for forming cloths of mixed colors; otherwise it is dyed after being spun. But it is most commonly dyed in the form of cloth.

In the making of superfine cloths, in Hampshire, the wool, after dyeing, is again washed, well dried and beaten with rods on wooden hurdles, to free it from the dye-stuff, which still hangs about it; or this effect is produced by putting it into a wool-mill, formed of a four-flapped vane or fan thinly set with iron spikes, and swiftly revolving within a hollow cylinder of small wooden rods or staves; sufficiently wide apart to suffer the dust to fall through, as the wool becomes separated by the motion of the fans. It is now once more carefully picked, in order to take out the locks which are unevenly dyed, and also the lint, and other filth with which wool in this state abounds. In the manufacture of mixed cloths, wool of the different colors, being weighed out in their requisite proportions, are first shaken well together; they are then further mixed, by being well turned in the wool-mill, and, by being afterwards twice passed through the scribbling engine instead of once, they are generally found to be sufficiently intermixed.

The nature of wool, as a species of hair, has been well illustrated by M. Monge in his *Observations sur le Mécanisme du Fétrage*, Ann. de Chimie, tom. vi. 'The surface of all these objects,' he observes, 'is formed of rigid plates, superposed or tiled from the root to the point, permitting progressive movement towards the root, and resisting a similar movement towards the point. This conformation is the main cause of the tendency to felting, which the hairs of all animals in general possess.'

But this conformation, it is clear, must be an obstacle to the spinning of wool, and the fabrication of cloth. Their fibres, therefore, are now coated with oil, which, by filling up the cavities, renders their asperity less perceptible in these operations, just as a film of oil is put upon a smooth file when we wish to render it still smoother. For fine cloths, Gallipoli, or olive oil, is principally used: and rape oil for coarse cloths. In still coarser goods, and where color is not an object, fish-oil is sometimes employed; but if the latter remain in the wool or cloth, it is subject to a fermentation injurious to the cloth, and turns it brown. Combustion has even sometimes been known to take place from

it. Some of the Yorkshire manufacturers make use of a mixture of soap and water with oil, which answers, in moist weather, and, if the wool be immediately carded and spun, very well; but the mixture evaporates, if it remain some time unwashed, or the weather become hot.

In oiling, the wool must be sprinkled as evenly as possible. They spread it, for this purpose, on a floor, in Hampshire, beating it in with heavy rods, and use, for superfine cloth, about three pounds of olive oil to twenty pounds of wool. In Yorkshire they reckon six gallons, or a peck, as the proper quantity for fine cloths, and use the wool-mill to assist in its more equal distribution.

This machine consists of a species of cylindrical drum, from three feet, to three feet and a half long, and two and a half to three feet diameter, enclosed with its rollers in a close box or case, in which is a door let down by a hinge. Its circumference being furnished with teeth or spikes, immediately above are five small rollers, furnished with similar teeth: and the machine is made, it is said, to revolve 300 times in a minute. The teeth of the rollers and those of the drum intersect each other, as they all turn round; and the teeth of the five small rollers also intersect each other. The door being opened, or turned down into a horizontal position, about a pound weight of wool is laid upon it at once, and is brought, by its being closed, within reach of the teeth of the cylinder, which take and carry it upwards, so as to work it between the teeth of the cylinder, and those of the five rollers. This opens and separates the matted fibres. Close below, and fitted to the cylinder, is a grating of wooden rods, through which the dust and dirt are carried off. When the door is re-opened, the cylinder throws out the wool in an instant; but sometimes two doors are placed on opposite sides of the machine; one to receive the raw wool, and the other to discharge it when the operation is finished. Coarse goods are passed through this mill; to break the mats of the raw wool and render it light; a second time after it is dyed; a third time, to mix the different sorts together; and lastly, after they are oiled, to spread the effects as we have stated.

The *scribbler*, a kind of rough carding machine, is now resorted to, to break down the longer fibres, and to lay them straight and parallel. It is the same in principle with the carding machine, hereafter described; and, like the above, consists, 1. Of a large cylindrical drum; but covered on the surface with sheets of leather stuck full of projecting wire-teeth, or card-wires, which, as the cylinder is turned, feed themselves with the wool: 2. Of several other smaller cylinders, called workers and clearers, fixed around the great cylinder in pairs. The wool is taken by the teeth of the workers from the great cylinder, and given to the clearers, which return it again to the great cylinder. It is then transferred to another worker, and by its clearer given back again to the great cylinder, and so on. While the teeth of the different cylinders do not actually touch each other, they revolve so near, that the fibres of the wool which the teeth of one card contains are caught by the teeth of the other

card, and drawn out a very few at a time, which renders the wool light and open. 3. When it has passed between three or four pairs of workers and clearers, it is taken up by the *doffer*, a small cylinder, which turns round very slowly. 4. From it the wool is stripped off by a steel comb, which is placed parallel to its axis, and moved rapidly up and down by a crank. The comb, in ascending, does not touch the doffer; but only as it falls down. The successive portions thus combed off, finally hang together in a thin fleece or web; received in a basket from the machine. Scribbling is repeated twice or three times before the wool is completely disentangled and fit for carding, which, as we have stated, is only an improved operation of the same kind.

But great attention has been bestowed on the *carding* engine. We shall best illustrate it by the accompanying plate. M, M, M, M is the frame work of the machine which is of wood or cast-iron, the arched part receiving the screws, which support the cylinders or workers and clearers fixed round it. The workers A are larger, and turn slower, than the clearers B; but all work against the cards of the great cylinder, and each is worked upon its clearer. C is the large cylinder turned by an endless strap applied upon a pulley at one end of its axis. It performs 100 revolutions per minute, and is from thirty to thirty-six inches in diameter. D is a roller-bowl, as it is called, or a cylinder of wood, fluted shallow, and moved by a pulley E, connected with another endless strap moving round a second pulley F, on the cogged wheel G. The lower hemisphere of this roller-bowl is circumscribed with a fluted shell, to catch the wool that falls from the doffer on the left of it. H is a cog-wheel receiving motion from the pinion of a pulley I, turned by an endless band moving on the central pulley of G. This wheel is connected at top with a pinion fixed on the axis of the large cylinder.

The wool having been scribbled is spread upon the feeding-cloth K, an endless sheet stretched over two rollers, on the axis of one of which moves the wheel H. It is taken off the sheet, between a pair of feeding-rollers about two inches and a half diameter within the frame, and clothed with cards laid on in spiral fillets. They are moved by toothed pinions, on the axis of the cloth-roller, rather quicker than the feeding-cloth, and, in the most complete view of the machine we can give, are concealed by other parts of it. These rollers deliver the wool to the cylinder L, about nine inches in diameter, which works against and communicates it to the great cylinder. It is now conveyed to the five workers, and clearers, embraced by the chain N passing under a wheel fixed in G, shown under the frame work, but this chain only moves the three workers A, which revolve once in about four revolutions of the great cylinder.

The clearers both card the wool on the workers, as well as that on the cylinder, and are moved by the band O passing over a wheel eight inches and a half in diameter fixed on the extremity of each of their axes, and communicating with a wheel twenty-two inches in diameter, fixed on that of the great cylinder. The cylinder turns about

CARDING ENGINE

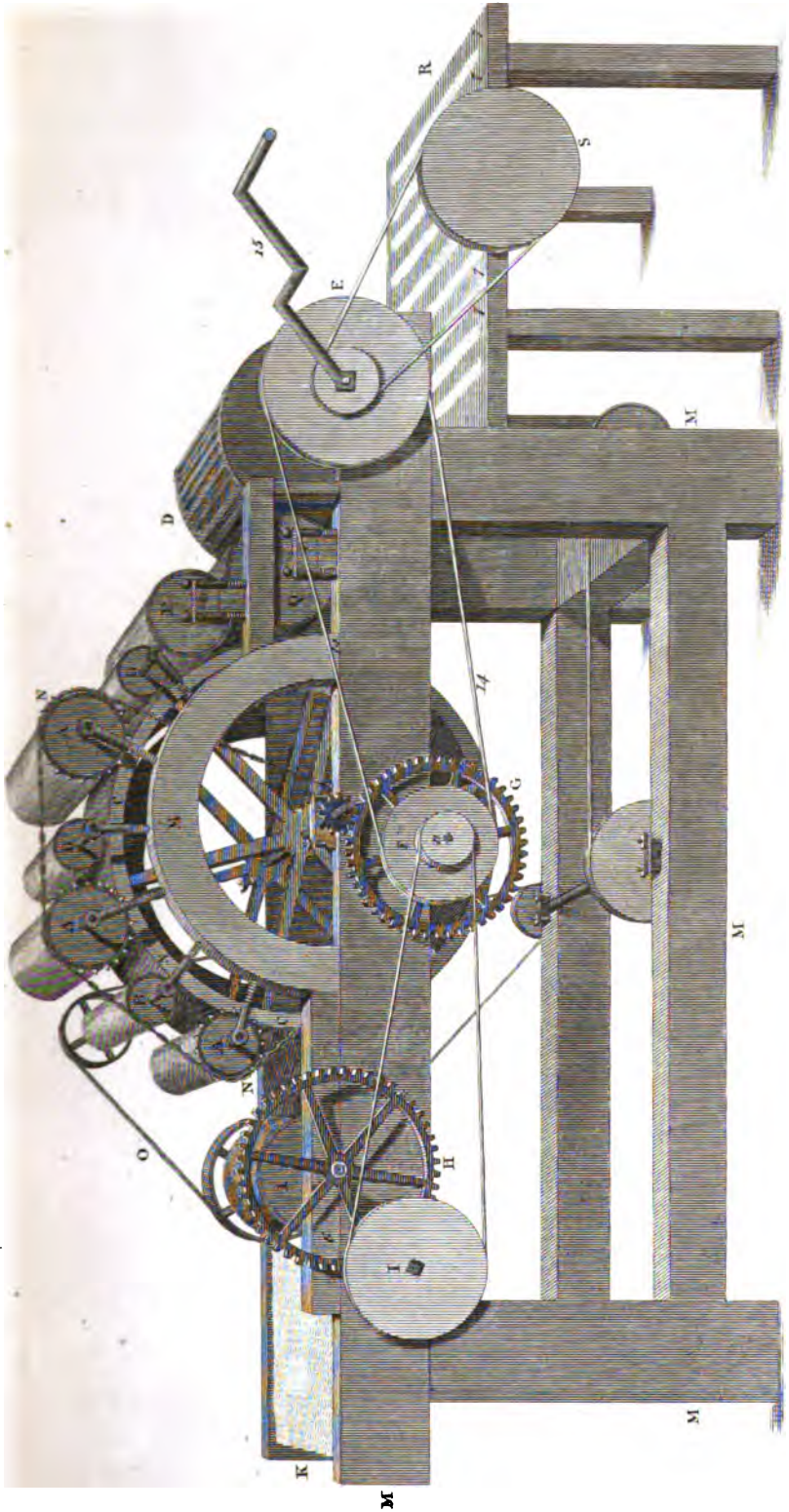

London, Published by Thomas Agnew & Sons, Chancery Lane, April 14th 1877.

J. Shury Sculp.

CLOTH WOOLLEN.

SPINNING JENNY.

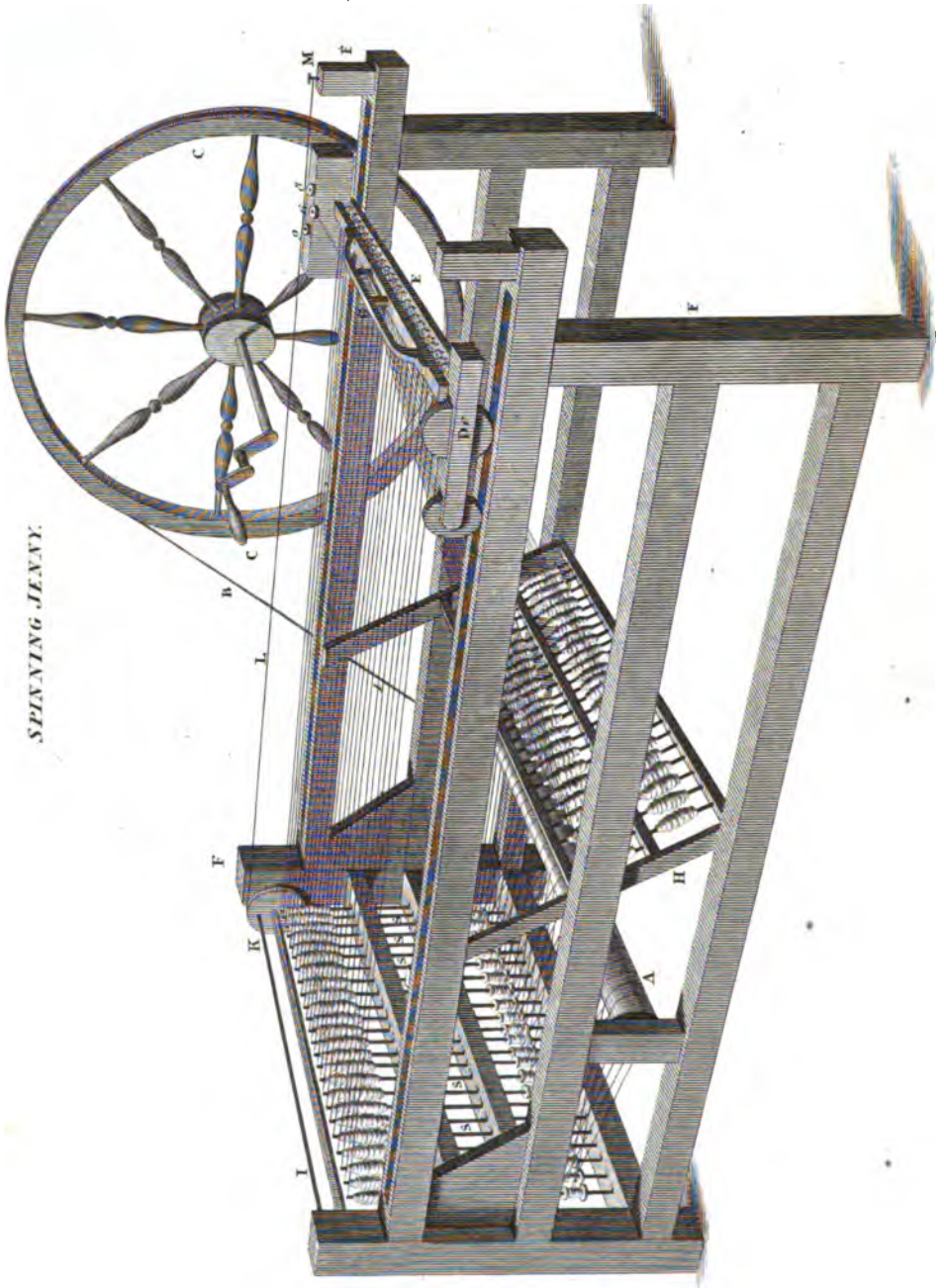

three times and a half as fast as they: this same strap moves the currier L. It also turns the fly P, moving the same way as the surface of the great cylinder, but about half as fast again. This fly is designed to raise and lighten the wool on the surface of the cylinder (not to take it off), so that the doffer, which we have already mentioned, Q, may act upon it the more effectually. This is a cylinder of about fourteen inches diameter, covered with cards about four inches wide, and moving round at the slow rate of about one-thirtieth of the pace of the great cylinder: it is turned by a band connected with the axis of the roller-bowl: a comb which works against these cards cannot be seen. It is supported by rods screwed to it at each end, guided by two horizontal levers. The lower ends are jointed on small cranks formed on an horizontal axis at the lower part of the frame, and put into very quick motion by a strap, from a pulley at the bottom. Each revolution of the cranks causes the comb to rise and fall about two inches; when it descends, its edge-teeth act on the surface of the doffer cards, so as to take out the wool and drop it slowly into the shell of the roller-bowl. The revolutions of this bowl within its shell rolls the wool between them into a straight cylindrical shape, called a carding; these cardings are yielded from between the roller-bowl and its shell, upon a flat table R, in portions there exhibited. An endless cloth covers this table. It is stretched over horizontal rollers, and carries the cardings away to the slubbing machine or biley, by means of the motion it receives from the pulley S, which is fixed on the axis of one of the rollers.

The *slubbing machine* is a species of spinning engine performing the preparatory operations of reducing and cleansing the cardings, and giving them a slight twist. They are then called rovings or slubbings. This was once accomplished by hand on the common hand spinning-wheel, then machines were invented, by means of which a number of slubbings could be drawn out together; but the aid of hands being required for joining the rolls or cardings of wool, they were found of little service, and have universally given way to the modern machine, which we shall now endeavour to describe.

It is a wooden frame, within which passes to and fro a moveable carriage, containing a number of perpendicular spindles, put into rapid motion by a long cylinder, and a band from a pulley affixed to each spindle. These spindles are placed perpendicularly, in a frame at about four inches from each other; their lower extremities are pointed, and turning in sockets; and the upper half projecting above the frame. On the lower part a small pulley or whirl is fixed, to receive the band from the horizontal cylinder (about six inches in diameter), and a little longer than the row of spindles: it is placed before them with its centre at a lower position than the row of whirls. The cylinder receives motion by a pulley at one end, with an endless band from a wheel, made like the large wheel used in spinning wool by the hand. This wheel is situated at the outside of the frame of the machine, and its axis supported by upright standards erected from the

carriage; the wheel is turned by the left-hand of the spinner, applied to a winch, and gives motion to the cylinder, which turns all the spindles at once. The operations of the spinning jenny are so very similar, that our plate of that machine will fully enable the reader to comprehend this. The discretion of the spinner regulates the degree of twists given to the slubbings, which depends both on the rapidity with which the wheel is turned, and the corresponding quickness with which the carriage is drawn out, as well as on the fineness of the wool and the length of its fibre.

For fine shawl yarns, a machine called the mule, similar to the cotton mule, is often employed, see COTTON MANUFACTURE, the slubbing passing through rollers which assist in drawing out the thread smaller and more regularly.

In the *spinning jenny* the slubbings are again spun and prepared for the loom. Its parts are similar to those of the preceding machine, only differently placed. Our plate II. CLOTH, WOOLLEN, contains a view of this important modern invention. F, F, F, is the frame work, at the end of which the spindles *s, s, s*, are placed, about four inches apart. As in the slubbing machine their lower ends turn in caps or sockets of the cross-rail, and near the middle they are held up by brass collars fixed on another rail. Towards the lower end they receive an endless strap round their respective pulleys, communicating with the great roller A, which is generally made of tin plate, and receives its motion from the band B, which passes the great wheel C C. The moveable cross-rail D is morticed into blocks of wood, and runs on the general frame by means of small wheels or castors. It can be moved to and fro from six to seven feet. The underside is furnished with narrow notches for the slubbings to pass through, opposed to the projecting pieces, of a parallel cross-rail E, so as to form a clasp which confines the slubbings in the notches when the lower rail is raised up. They can however pass freely through the notches when the lower rail is down. This rail is limited in its movements up and down a small space by staples, which project downwards from the upper rail. Its rising and falling is effected by small cords fastened to it at about every three feet, and conducted over small pulleys in the substance of the upper rail, which are all attached to a handle, situated over the middle of the upper rail, beneath an arched bar G. This the spinner holds in her left hand, while the right is employed in turning the wheel; and by the fingers of her left hand she raises up the lower rail, and draws it close to the upper. In this position it is returned at pleasure by a small spring-catch, and clasps the slubbings in the notches, through which they pass; when the spring-catch is pushed back the lower rail falls, and releases the slubbings. An inclined frame H, receives the cops of the slubbings to be spun. They are rolled on iron wires, placed in two rows, each containing half as many cops as there are spindles. Each slubbing is conducted through a notch in the clasp, and thence it now proceeds nearly in a horizontal position to the spindles *s, s, s*. The yarns having been drawn out and twisted are wound on the spindles in balls.

I is a wire used for bearing down the thread from the points of the spindles, and attached to a horizontal rail, which is supported on pivots at its ends, close to the row of spindles. A pulley K receives one end of this rail, and a short lever at the other is hid by part of the framing. Between the pulley K and the lever the wire is extended, and by turning round the rail the wire receives a perpendicular motion. This the spinner can communicate when at her business by the cord L, the end being made fast to a pin at M, and the pressure of her finger on a small trigger in the handle G. A counterweight to bring it back to its first position is suspended from the pulley K.

The spinning jenny is worked by a female (generally) standing within the frame and turning the wheel with her right hand, while the cross-rail D is managed by her left. We have described the manner in which the slubbings are drawn between the upper and lower rails of this part of the machine; they are drawn off the balls at H, when the clasp retires from the spindles, until a certain length of each is extended nearly in an horizontal position between the spindles and the clasp. The motion of the wheel then twists those parts of the slubbings which are extended, and first in a contrary direction to the twist of the slubbing. They are now wound up upon the spindles, previously to drawing out a fresh portion of each slubbing, in order to spin it in the same manner. For this purpose they are pushed down upon their respective spindles, by pressing the trigger which moves the wire L; and the motion of the wheel is applied while the carriage and clasp are pushed home towards the spindles. Arrived there, the thread is finished and wound up.

The art of using the jenny consists in drawing out the carriage with a movement correspondent to the rapidity with which the spindles give the twist, or rather untwist, to the slubbing; for the principal extension of the thread is effected whilst this is going forward: as also in giving an equal degree of twist to the whole thread. The yarn that is intended for the warp, we should add, requires that the spindles be turned for a time after the thread is extended to its full length; but for the yarn which is to be used as weft, it is different: the whole of the twist is given during the extension of the thread, and none afterwards; this renders the weft softer than the warp, because in the cloth the weft appears more on the surfaces than the warp, and it is principally the felting and interlacing of the fibres of the weft that will form the surface of the cloth.

Warping, which is our next process, is performed by mounting the yarn on wires in a frame, and drawing it off the coppings, so as to combine a number of them together. The warping-mill, which is now generally used, is a large reel, with an horizontal axis; the ends of the threads in fact are made fast to the reel, which is turned round, and it draws off the threads upon its own circumference. To prevent them overlaying one another, they are guided through an eye or ring affixed to a slider, moved along a wooden rail, in a direction parallel to the axis of the reel, by a cord that winds round one end of the axis.

After this process the warp is *scoured* with urine to cleanse it from the unctuous matters adhering, and sized in a cauldron, about a dozen yards at a time: it is then dried and stretched in the open air: and when dry it is transferred from the field to the loom. The weft-yarn is wound off the jenny-cops on the quills or bobbins which are afterwards used by the weaver.

For the loom employed, and its most recent improvements, we refer the reader to the article *WEAVING*. It will be sufficient here to observe that the width of the cloth returned from that process is expected to correspond with the number of the yarns, so that 3000 common threads will make a piece of coarse cloth 103½ inches wide; and 100 yards of fine cloth is expected to be produced from about 2960 threads: the weft averages about one pound per yard: and sixty-two yards of cloth is considered a fair return for sixty-five yards of yarn.

The cloth must now be scoured in the piece, preparatory to felting: and for this purpose it is taken to the fulling-mill, which ordinarily consists of a pair of stocks in wooden hammers, suspended in an inclined position, and the heads lifted up and down by cogs or tappets, fixed on the axis of a water-wheel. When the cogs are removed by its revolutions from under the hammers, they fall by their own weight, and strike the piece of cloth, which is contained in a wooden cistern or trough. This both causes a continual circulation or turning round of the piece of cloth in the trough, and effects the scouring or washing it by continually bending or folding it in a fresh direction. It is now extended on the well known tenter-hooks, fixed in horizontal rails, attached to vertical posts, one line of the rails being fixed and the other moveable, by means of pins and holes.

Milling is another operation performed by the action of the hammer of the fulling-mill. To a piece of cloth thirty-one yards long, three pounds of soap are allowed at this stage, and it is worked in the mill about two hours, then soaped anew twice, and returned to the mill for about the same time, so that it undergoes the operation three times.

'The operation of fulling woollen stuffs, has so close a relation with felting,' says M. Monge, a writer we have before quoted, 'that we cannot dispense with entering into some details on this subject. The roughness with which the fibres of wool are bristled at their surface, and the disposition which the fibres have to take a progressive movement in the direction of the root, is an obstacle to the spinning of wool and to the fabrication of stuffs. In order to spin the wool, and afterwards weave it, we are obliged to coat all the fibres with a film of oil. When the piece of stuff is manufactured it must be deprived of this oil which gives it a disagreeable color, and constitutes a kind of filthiness which would be an obstacle to dyeing. For this purpose it is carried to the fulling-mills, where it is beaten with mallets in a trough filled with water, through which clay (fuller's earth) has been diffused. The clay combines with the oil, which it renders soluble in water; both are carried off by the fresh water which the machine itself brings

Fig Machine

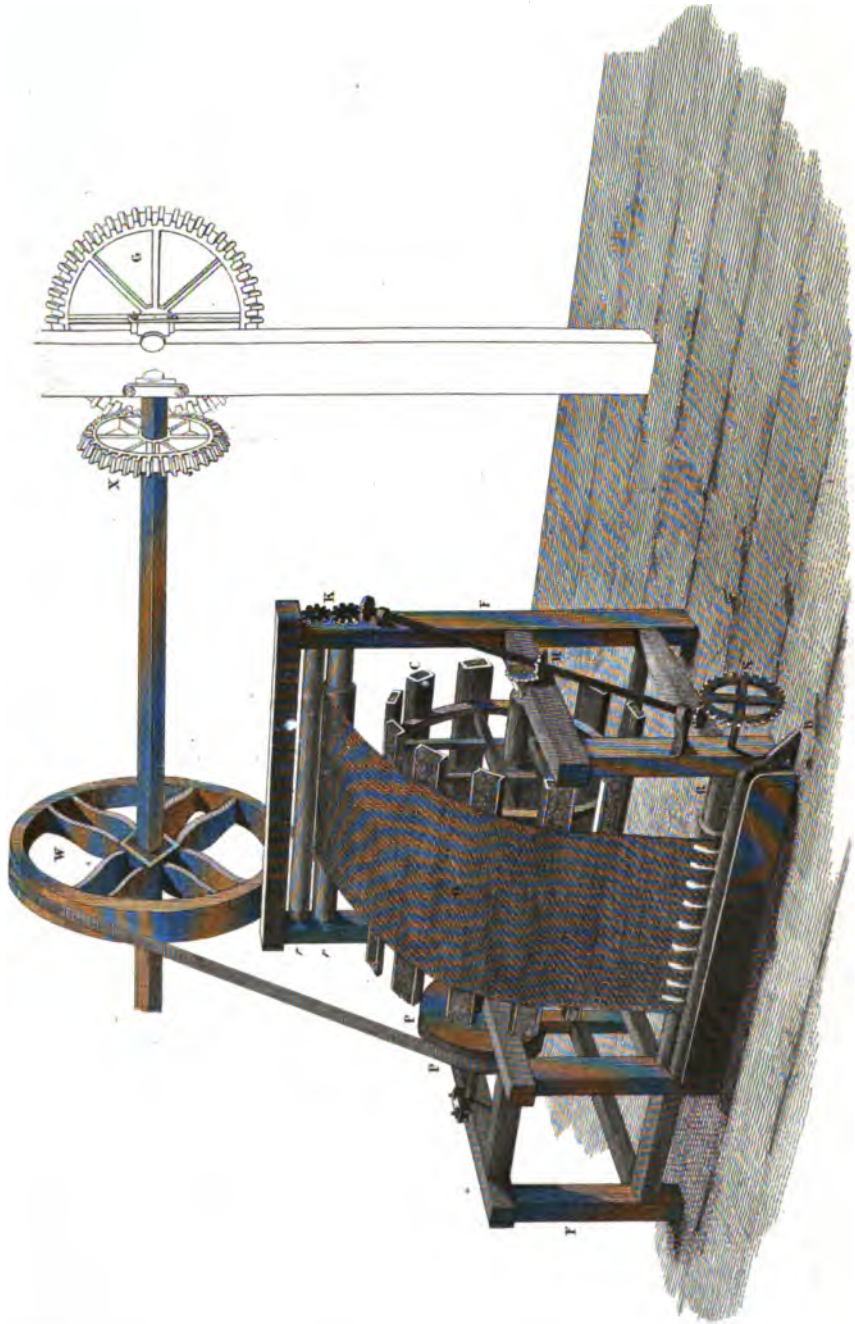

upon it; and at the end of a certain time the stuff is scoured.

But scouring is not the only object of the fuling. The alternate compressions which the beetles exert on the piece of stuff, especially when the scouring is well advanced, produce an effect analogous to that of the hand-pressure of the bather. The fibres of wool which compose one of the threads of the woof, or of the warp, take a progressive movement, get introduced into one of the neighbouring threads, then into those which follow, and soon all the threads both of the woof and warp are felted together. The stuff, after having suffered a narrowing in its two dimensions, partakes of the nature both of web and felt; it may be cut without being liable to open out its threads, and there is no necessity for hemming the different pieces which enter into the composition of a garment. If it be ordinary knit wool, the stitch is no longer apt to run when it happens to escape. Lastly, the threads of the woof and the warp being no longer so well defined, or so distinct from each other, the stuff, which in other respects is thickened, forms a warmer clothing.

After milling the piece is again stretched on the tenter-hooks, and only now awaits the finishing operation that forms its surface. To effect this it is generally first dressed with teasels, a species of thistle; the part used is the ball, or ear, which contains the seed of the *dipsacus fullonum*. Scales project from this ball, with elastic points turned downward. They are fixed in a small frame which is provided with a handle eight or ten inches long, having a small stick, about eight inches long, passed through it at one end. This stick is split into two at each end nearly all its length. Near the middle there is another similar stick which is passed through the handle; the two split sticks being parallel to each other. The space between them is filled with teasels, jammed in very fast, as also in their split parts, where they are secured by strings extended between the ends, and twisted until they draw the sticks and bind the teasels forcibly together. The whole forms a tool resembling the curry-comb, and which is used in a similar manner, to draw out, by scratching, all loose ends of the fibres of the wool. Two men hold the teasel-frame and work the cloth as it hangs up in a vertical position, drawing it down in portions as they proceed. The first time the cloth is thus dressed it is wetted, and worked three times over in that state by strokes, in the direction of its length, then it is worked again three times in the other direction. But more scientific modes of accomplishing this part of the manufacture have of late been adopted in Yorkshire. Plate III. CLOTH, WOOLLEN, represents a gig-mill, very commonly used in the manufactories. On F, a wooden frame is erected, a cylindrical engine C, over which the cloth is conducted, and which revolves with the pulleys PP, receiving an endless band from the upper wheel W. The pulleys are, one fixed and one loose for the straps to turn upon freely, that the machine may be the more readily put in motion or stopped. W, communicates with a barbed wheel X, by means of a strong iron shaft, and is moved by the great wheel G, connected with any convenient first

mover. Round the cylinder, C, are teasels secured in boxes or frames. One end of the piece of cloth is wound over the roller R, at the bottom of the frame, and the other end of the piece is wound on the rollers r, r. The roller below is moved by a bevelled wheel s, and fixed on the extremity of the axis of the cylinder, having a pinion at each end. The upper rollers r, r are both turned by a large spur-wheel which works in a smaller wheel, on the end of the cylinder; one roller is mounted over the other, like the two rollers of a flattening-mill, and pressed together by screws with sufficient force to draw the cloth between them. The piece of cloth, when brought to the machine, is laid down on a board on the ground before the machine, and one end is passed under the roller R, which is merely to guide it; then it is carried over the cylinder, as at O, and introduced between the pair of rollers at top, which draw it slowly forwards; from these it turns upwards, and is extended horizontally over two other rollers suspended from the ceiling. Quitting these it descends perpendicularly, and is gathered on the ground in folds on a board or bench. To make the piece pass a second time, or as many times as is required, through the machine, the two ends of it have only to be sewed together, and it will circulate continually over the machine. B is a perforated pipe which conveys water to the machine for wetting the cloth. The teasels are picked in the course of these operations and cleaned by children. Various substitutes of metallic teeth &c. have been suggested, but none seem to have answered on a considerable scale.

The wool of the cloth is raised by the preceding process, so as to stand up all over its surface in a loose fur: the last operation is shearing, or cropping this fur. The clothiers' shears, for performing this, by hand, consist of two very large flat steel blades, united together by a stem, which is bent into a circular bow, and sufficiently flexible to allow one of the blades to be moved upon the other, but not in parallel planes like scissors, for when the one blade is laid flat upon the cloth the plane of the other will be inclined to it at about an angle of forty-five degrees. The spring of the bow, however, is so set as to press the two edges into contact. The edges of the two blades are not parallel to each other, but inclined, so that the edge of the upper blade crosses the edge of the lower blade, and bears upon the flat surface of that blade, at the end nearest to the bow, whilst the other end of the edge of the upper blade is removed over the edge of the lower blade, thus leaving an interval between the two edges when the shears are open. In this state, the shears being open, if the lower blade is laid flat upon the surface of the cloth, the nap or wool, which is to be removed by the cropping, will stand up above the edge of the lower blade, in the interval between the two edges; then, if the blades be forced together, the edge of the upper blade will pass or cross over that of the lower, and cut away all the wool which projects above the edge of the lower blade. The contact of the cutting-edges begins at the end nearest to the bow, and proceeds regularly to the other, because, as before mentioned, the edges are not parallel. The blades open or re-

turn to their former position by the elasticity of the bow, but in order to make the cut they are closed by means of a handle or lever, which is fitted or lodged on a round part of the stem of the bow, so as to play thereupon as upon a centre. A double cord is made fast to the lever or handle near to this centre, and the other end of the cord is fastened to a block of wood, which is screwed to the flat of the lower blade, and rises up to a proper height. By depressing this handle the shears are closed, and make their cut with the greatest facility, the elasticity of the bow returning the handle. The manner of cropping is:—Let the piece of cloth be laid down in folds upon a plank, or low bench, placed on the ground, and the end drawn across a table or bench, which is covered with cloth and stuffed. The cloth is stretched out flat upon the surface of the table, and is retained by hooks and weights. Two workmen are now employed who place the lower blades of their shears flat on the surface of the cloth, with the line of the edge in the direction of the length of the piece; one of the shears is laid on the edge or list of the cloth, and the other exactly in the middle of the breadth of the cloth. The bows and stems of the shears project over the edge of the table where the workmen place themselves. Each man guides the shears with his left hand, and makes the cut with his right. To hold the shears a short staff is lashed to the bow of the shears, and secured by a stay to the lower blade; its direction is nearly parallel to the back edge of the upper blade. The workman puts his arm through the bow as far as the elbow-joint, then lays the fore-arm flat against the staff, which he grasps with the hand; and in this way he has a great command of the shears, leaving the right hand at liberty to work the handle which closes them. This is moved backwards and forwards with great rapidity to make cuts or clips on the cloth, and between every cut the lower blade is moved forward on the cloth. The art consists in moving the shears with proper regularity. To assist this weights are laid on the flat of the lower blade, which press it down into the cushion on which the operation is performed. Common cloth is cut wet the first time, then dressed with teasels, dried, and cut three times in a dry state. The most common shearing-frames used in the manufactories are only intended to give the difficult motion used for cropping by the hand.

We copy the specification of a patent granted to Mr. Harmor, of Sheffield, for a machine for raising a shag on all sorts of woollen cloths, and cropping or shearing them; which, together, come under the description of dressing woollen cloths, and also for cropping or shearing of fustians. This was until a late period very generally used in Yorkshire; it is said to have been since simplified. See plate IV. CLOTH, WOOLLEN.

Fig. 1. exhibits a side and end view of shearing cloth from list to list. A is the frame, with its pillars, legs, and rails. B is the cushion or shear-board over which the cloth is extended. C, the cropper's shears in their situation for working, with their bobs or levers. D, the harness or breeches fitted to each end of the riding

blade of C; at the near end is hollowed the bow of C, and at both ends fastened with screws passing through the blade, or else is grooved to admit the blade, and is fastened with wedges. It is composed of two strong pieces of plank, with holes to admit screws through to nut-screws fastened to their upper surface, and square holes through which pass small pillars; other two pieces of plank are frames for wheels turning on pins (as in drawing), situated under the pieces fastened to the riding blade; here the lower ends of screws are rivetted to plates, but so as to turn, which plates are screwed to the wheel-frames; also, in these lower pieces, small pillars are fixed, which, passing through the upper pieces, steady the harness; those screws turned to right or left bring the edges of C to the angle of B, for the work of shearing. E, the inclined planes down which the wheels of D roll when the machine is working. F is the working axle, with its rods or rails; the gudgeons of this axle rest on the cross rails of A; the axle has the inclination of B and E, as in drawing. Its rods, fixed to the sides of it by projecting pieces, are about four inches from its centre, and the thimbles of G ride down them to keep pace with C in its progress. G is the line communicating at the lower end by a thimble with the rods of F, and at the upper end with the bob or lever of C, as in drawing. H is an axle-tree, with its handle, cog-wheel, and stop, fixed by stops, on which it turns, to the pillars of A. I, the lines communicating with the extremities of K at one end, and the other with H. K, levers, turning on their pins, and, by the action of K and I, work against E, to raise C from B, for all necessary purposes. L, pulleys in their frames, to give a proper direction to I, that the turning of H may have the effect before named. M is a crank attached to the lower gudgeon of F; the crank handle has an eye in it, through which a square leg passes, against which works the lower end of a screw, the nut of which is one side of the said eye. This screw, turned to right or left, loosens or fastens the leg in the eye at pleasure. The said leg at the other extremity has a handle where the near end of the catch N is fitted on. Now, as the leg is shifted by means of its eye and screw in that end where the handle is further from the centre of F, N works O with more speed. N is the catch that works O. O is the cog-wheel of N, with its screw pinion on its axle. P is an iron axle, with pulleys near both ends, with a cog-wheel. R is a small sword, fitted into the mortise of the projection on the lower extremity of F, and pinned, and the other end is fitted to the crank handle of S. S is the crank axle and pulley that carries the band which goes to the power that works the machine. The situation for R, as to that end that sits on the crank of S, is directly behind the lower end of F, and under the further extremity of B, where the crank end of S rides on a stop fixed to the further rail of A; the pulley end, where the stop is, rides on X. Now the crank S being put in motion, gives R the necessary vibration, and R works F, which alternately raising or falling its rods or rails by G, C works; and, to effect the progression of C, F being in a working state, M works N, and O works P, and C is carried forwards by T, and to

Fig. 1.

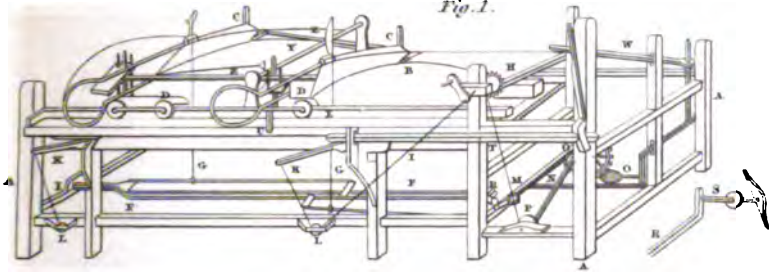

Fig. 2.

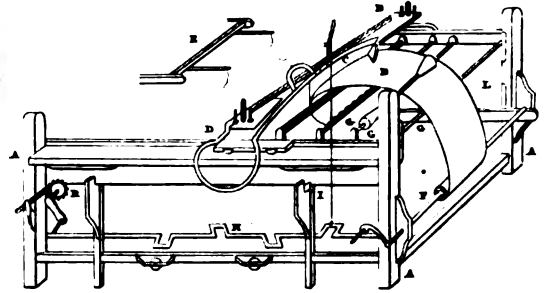

Fig. 3.

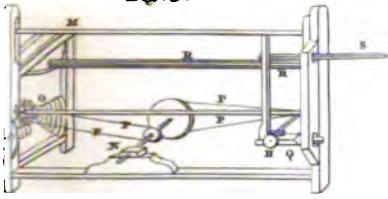

Fig. 4.

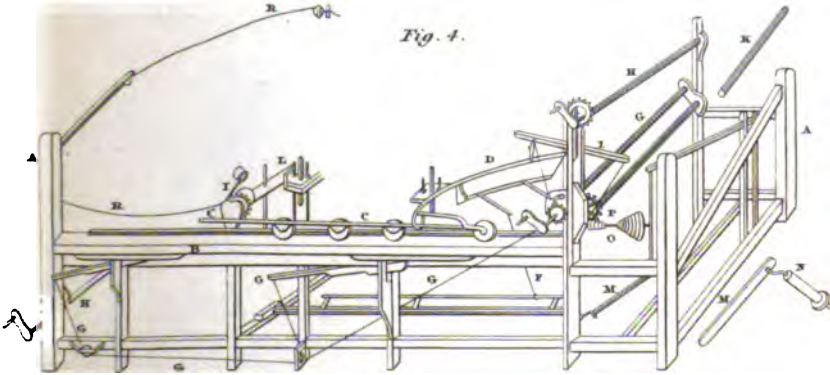
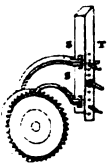
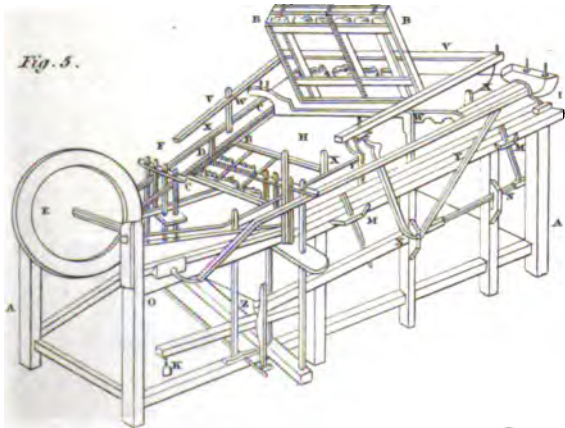

Fig. 5.



carry C forwards faster or slower, as necessary. For the due performance of shearing cloth, the handle of the leg of M, where N is fitted on, must be brought nearer to the centre of F for slacking, and more distant from the said centre to increase the speed, as then N will take more or less teeth in O.

Or the progression in this frame may be effected by the method described in the progression of fig. 3, under the letters M, N, O, P. T, the lines for carrying forwards C by P. U is a projection fastened to D, and works against U when C is about to stop. V is a rail and small sword passing through a mortise fixed to one of the legs of A, at nearly one end, and by a working joint, goes up to near the extremity of W. W is a lever, passing through its fulcrum, and pinned to the upper end of X; and near the other end rests on a small notch, sunk in the inside of the upper end of one of the pillars of A, and weighted in the extremity with lead or iron. X is the step of the pulley end of S, and, by a small sword, goes up to W, on the near side of one of the pillars of A, through which X goes, and moves on a pin, and is the step of one end of O; and the further side of the said pillar, where the letter X stands, is the step of the pulley end of S. Now when U or D works against U or V, W is thrown from its notch, and W sinking raises X, and slackens the band on the pulley of S; then the machine stops, and X, raising the step of S on the further side of the pillar of A, or the near side of it sinks the step of O, and the screw-pinion is thrown out of the large cog-wheel of P. Y is a small axle on steps, fastened to D, with its handle and bands going too near the extremity of Z. Z, two small rails, with catches at their extremities, which fall into notches in D to fasten both the shears of C together. Now when the machine stops, by the means already described, the pressure of the handle of Y raises the catches of Z, from their notches in D, and the shears of C are at liberty, and may be driven by the hand to the necessary situation for shifting the cloth, first turning H to the right, to clear them from B. The cloth being shifted, bring the said shears of C to their proper situation, and the catches of Z will fasten them; then turn H to the left, throw back its catch, and the shears of C are brought to their work; when lift up to its notch, the extremity of W, and the band on S is tightened, and the machine works.

Fig. 2 is a side and the two end views of shearing the length-way of the cloth. A, the frame, with its pillars, legs, and rails. B, a circular cushion, or shear-board, formed to the angle of the cropper's shears, and at each end resting on steps fixed to the top rail of A, to be moved round, as occasion shall require. C, the cropper's shears in its harness, or working position. D, the harness, attached to both ends of the ledger blade of the shears C, as particularly described in fig. 1, under the letter D; but this mode of shearing requires that the strong pieces, attached by screws to the ends of C, should be framed together near the back of the said ledger blade, to take the weight of the ends of the shears. When the whole width of a narrow cloth is shorn, the second shear of C is placed behind

that in drawing, and has another, B, for it to work upon, and I, to be worked by. And that part of D attached to the heel of C and letter E, are lengthened as described, fig. 3, under the letter C; so in like manner the shears are situated behind each other in taking the width of a broad cloth. Here it must be noted, as in this mode of shearing the cloth having the progression, the wheels of D are omitted, and pieces of wood, half rounded, supply their place. E is a small frame in its steps, with its arms and lines. The situation of E is seen under letter D, fig. 3; it is attached to the heel part of the harness, as there seen by the drawing. One of the lines of E goes down to the working-rail of E, in the aforesaid, fig. 3; and the other line communicates with the lever or bob of D. F, the roller, with its handle, on which the cloth to be shorn is wound. G, the small rollers, to guide the cloth to B; the middle one which swells riding on it, lighteneth the lists of the cloth as it rides forwards: the swells are moveable, for the purpose of suiting cloths more or less longlisted. H, the rod, cranked on every side, with the pulley for the progression, and that also which carries a band to the working power situated at the upper end of K, near Q. I is the thimble fitted on the crank, with the line going up to near the extremity of the bob working C. K, and axle, with its cog-wheel and stop, as particularly described, fig. 1, under the letters H, I, K, L, and produce a like effect, and must be fixed to this figure the same as in that. L, the cheek to F, fastened by a pin at the near end, and passing under F, being hollowed to it, the further extremity (being carried under C and B) having a weight suspended on it. M, the roller, with a cog-wheel, to which the end of the cloth is attached; and, being tightened by the handle of F, the weight on L keeps it in that tight state as it is carried through the work. N, an iron axletree, carrying a large pulley with one groove, and a five-groove pulley with its steps, that out of sight lies under A on a cross rail. O, an iron axletree, carrying a five-groove pulley and screw pinion on steps, as in drawing. P, bands going from the small pulley of H to the large pulley of N; and from the five-groove pulley of N to the five-groove pulley of O.

Now these five-grooved pulleys gradually descend in their dimensions from fourteen inches to three inches in one, and the other may be the same dimensions, or very considerably smaller; or it may be reduced to a pulley of three inches diameter with one groove. These five-grooved pulleys stand, in respect to each other, in contrary directions. Now when the crank by a band on the pulley on its upper extremity is set to work, the band B, from the other pulley, puts O and P in motion, and carries forward M. That M may have different speed, the band of the five-groove pulleys must be shifted for that purpose to the different grooves, which give them more or less speed. *The Stop-Frame*—Q, the step where rides the upper end of H, which step at one end is tenoned into the pillar of A, and pinned. R is a small sword, at the lower end tenoned into the extremity of Q, and pinned; and at the upper end is mortised, so as to admit the further end of S. S is the lever, tenoned

into the mortise of H, and pinned, and passing through a mortise in the pillar of A. Now to stop the machine, the near extremity of the lever S must be pressed down, and that slackens the band communicating from the acting power to the pulley of H. When set a-going, the said extremity of S must be lifted up, and pinned there. To work this machine, put the cloth to work as directed under letter M; then throw back the stop of G, and the shears are brought to their work; then raise the extremity of S, and the machine works. Fig. 3 shows a second mode of shearing cloth the length way, a side and end view. A is the frame, with its pillars, legs, and side and end rails. B, the inclined planes, as fig. 1, under E, C, the shear boards, over which the cloth is stretched from H to I; every shear has its board, and is placed by the side of each other, so as to take the width of the cloth; and the shears, situated for the like purpose on them, the harness H, and small working frame E, fig. 2, are lengthened accordingly. D, the cropper's shears in its harness, and bob or working lever, with E, fig. 2, in its proper situations, attached by the steps to the harness of D. E, the axle, with the line communicating with the bob at one end, and at the other with one of the axle rods, by a thimble, described under F and G, fig. 1. F, the line and thimble before named.

G, is a small axle, with its lines, levers, pulleys, &c. particularly described under letters, H, I, K, L, fig. 1. H, rollers for the cloth, and their cog-wheels and stops. I, a lever, with its catch and stop to the wheel of H, which is on the other side of the pillar of A, near the middle of it, and falls into the cog-wheel of H, which line communicates with the lower end of the catches on H and L, and passes through small pulleys, fixed under the catches, on the inside of the frame A, that, by the pressure of the upper extremity of the said lever, the catches are raised out of the cogs of their wheels, to give liberty for winding the cloth when shorn on the roller of H, situated near to I. K, a roller to guide the cloth, when wound forwards, that it may keep its situation on the surface of C: it is placed near the axle G, on steps, in the same direction fixed to the pillars of A. L, an axle, with its handles, cog-wheel, and stop, resting on B, with its near stop. This axle has an aperture through the middle of it lengthwise, to admit the cloth through. Now when the cloth is stretched from one of the rollers of H to the other, by turning L to the right, more regular tightness is given to the cloth, and better fits it for the action of shearing. For effecting the progression in shearing and working the shears, M is a small sword, fitted on the handle of the projection of E at one end, and at the other on the crank handle of N. N, a crank, with its pulley with one groove, and a small five-groove pulley. Or this may be reduced to a small one-groove pulley, of about three inches diameter. The larger one-groove pulley carries a band to the power that drives the machine. The situation of this crank is nearly the same as S, fig. 1, and produces the like effect. O is an axle, with a large five-groove pulley and screw pinion. These pulleys of N and O have their bands, and descend in

their dimensions, as particularly described under letter P, fig. 2. P, a roller, with its cog-wheel on which the bands wind that carry forward D, with all the other shears, more or less, fastened together by a rail, at their proper distances from each other (as in drawing), that each may take its proper share of cloth, being situated as described under letter C. Bands from P to D carry forward the shears of D. For stopping this frame the stop part of fig. 1, under letters U, V, W, X must be put to it, fixed to the rails and pillars of A. Q is a projection attached to D, and will stop this frame when the parts above directed are fixed to it in the manner directed fig. 1. R is a line attached to the shears of D and, passing through a small pulley fixed in the back rail of A, runs through another pulley fixed in a convenient situation over the frame of this said fig. 3, and by pulling its extremity draw back the shears of D when they have cut their board of cloth. For working this machine, the cloth is wound on the upper roller of H, and round a small roller at the upper end of A, and extended down C, and under K, and to the other roller of H, where it is attached; the stop of the upper roller falling into its wheel, the cloth is tightened by the lower roller and the handles of the roller. L, their respective catches falling into the cogs of their wheels, which keep the cloth in a tight state, then throwing back the catch of G, the shears of D are let down to their work, when, by means of R, they are brought to their proper situation on B. Then lift up the lever of the stop-frame into its notch, as directed under letter S, fig. 2, and the machine works. When the machine stops, as before directed, and particularly described, fig. 1, under X, to shift the cloth for cutting another length press down the near extremity of I of this third figure, and wind the cloth that is cut on H. When, lifting up the said extremity of I, the cloth may be tightened as above described, and the shears of D shifted to continue their work.

Fig. 4, for raising a shag on cloth preparatory to shearing. A, the side and end rails, leg and pillars, with its teasele frames, and cotters B, the frames, one open and the other shut which turn on hinges, and, when shut ready for work, are fastened by buttons screwed loosely to C. C is a frame mortised, to fit four sides of B, when shut; and by projections, or sides fixed to its four corners, rides in the groove of a third frame, fixed to the rails of F. D, a third frame in the inner grooves, or two sides of it; C ride this frame, is attached to F, its projection slide through the gutters or flutes of L, when working E, the double crank, with its large pulley, which by a band goes to the working power. These cranks stand in contrary directions, on the same axle, that the frame may work alternately. F working rails, fitted on the crank handles, and fastened on by screws. These rails have a working joint near the side of G, and on the further side of G are attached, by screws, to each end of D; and as E works the frames of D, which carry C and B, works round L, and so raise the shag G, the pulleys, fixed in their frames, over which F rides. H, the board for raising, in its inclined posture, with the cloth passing over it from on

roller of I to the other. I, the rollers, situated before and behind H, and attached to the legs of A, by screws, the gudgeons rising on steps; and at the upper end of H is a small roller, to guide the cloth round the end of H, which swells for both lists of the cloth, after the manner of fig. 2, under the letter G. K, the check to the fore roller I, which at one end is attached to one of the legs of A, and near that end lies over the same roller, and hollowed to fit it, and at the other end carries a weight, as in drawing. L, two pieces of plank, situated on both sides H, at the upper termination of M. The inside of the said planks are fluted or guttered to the angles of L, which stands at the foot of A. The small projection at the top of L is a pattern of the slides fixed to the sides of D, which pass through the aforesaid angle when the frames are working, which raise them to and from the cloth. To effect the revolution of the slides that carry C, the top piece of L is fastened to the side of its plank, at or near the upper end, by a screw, on which it moves, and at or near the bottom end it is fastened to its plank, but with the liberty to play.

When D, by its slides, has passed through the gutter, the lower end of the top piece of L falls, and forms a bridge, to carry the slides of L to the top of the gutter, for the making of another revolution. M are small swords, terminating in L, and fastened with pins, and passing through sockets fixed to the rail of A, and mortised at the lower extremity into N, where they move on pins. N, a strong rail, extending along the side of A, having a joint in it, and turning on pins in a mortise fixed to the pillars of A. O, an axle, with small projections at its ends, in steps, lying on the lower rail of A, extending from one side of the machine to the other. P, small swords, one tenoned into the projection of O, and the other admitting the near extremity of N, through a mortise where it moves upon a pin. Q, an upright leg, fastened at the lower end to the axle of O, near the lower rail of A. Now by turning this leg to right or left, it moves O, and O by its projection raises and lowers the near extremity of N, and N raises and sinks L, which has a like effect on B, C, D; so that, by these mediums, B is brought into contact with H in all necessary degrees. R is a cog-wheel; its situation is on the further extremity of the back roller of I. S, two catches, for carrying forwards R, attached to I at one end in mortises, and moving on pins, and the other working the cogs of C. T, the working leg, fixed to the further pillar of A by a screw, as in drawing. The upper extremity of the said leg goes through a socket, fixed to the further rail of F, near the upper part of it. Now, by the vibration of this extremity of T, in its socket, by E working F, S carries round R, and by varying the pins of S nearer to, or more distant from, the centre of its motion, the said R is carried forwards either faster or slower. For shifting B and C to right and left of H, for the purpose of raising more regularly U, a cog-wheel and stop of the under side, with a handle near the periphery of the said cog-wheel, to act as a crank on the top-side. F, three rails. The rail that crosses the top of H is tenoned into the

extremities of those that form or lie to the right and left of it. W, the steps on which V right with pins to keep the rails of V in their place. X, bands fastened at one end to C, and the other extremity passing through nuts fixed to V, where they are fastened by the end, screws working through the side of their nuts against them. Y, two legs, fastened together at the lower end by a working joint at the upper ends. The further is attached to the near rail of F, and that nearer works upon a pin, a little short of its extremity, with a catch falling into the teeth of W; and, as it works U round, there is another catch on the same side, which prevents the said U from working back. Now F works Y, and Y works U, and U works by its crank V, and X shifts C from right to left by turns in the degree necessary, by tightening and slacking the band X. Z is the near step of E, screwed to a short rail at one end, tenoned into the near pillar at A, near which the step of A is situated. The other extremity of the said rail is fixed under a pin, on a short upright leg, which at the lower is screwed to the inside of the near rail of A, near which the step of A is situated. Now to set this machine to work, or to stop it when working; for the latter, move the said rail from under its pin, and by raising it, the band on E slackens, and the machine stops; and having extended the cloth from the near roller I, on which it is wound, to that behind H, and fixed the handles in B, with its cutters, and buttoned them down, you must then bring the extremity of Z under its said pin, and the machine works.

A perpetual shearing machine is used in the west of England, and is well adapted for narrow cloths. The shears lay crossways on the piece, which is drawn beneath them regularly in the direction of its length without interruption, and hence its name.

A complete rotary shearing machine, for cropping cloth of any breadth, was invented by Mr. Price, of Gloucestershire, in 1815, and is described with plates in the *Repertory of Arts*, vol. xxxix. This machine crops the cloth across the breadth, beginning at one end of the piece and continuing regularly to the other. The cloth for this purpose, is conducted through it by the motion of rollers, and is drawn over a bed or support which lies beneath the stationary or fixed blade of the shears or croppers (which answers to what is called the ledger-blade in the common shears), so that the cloth passes between the bed and the stationary blade. The moving blades of the shears are fixed on the circumference of a cylinder situated above the fixed blade, with its axis exactly parallel to it, and capable of revolving by the power of machinery, so that the edges of the moving blades will be carried against and passed over the edge of the fixed blade, in order to cut away all the wool of the cloth which rises above the edge of the fixed blade. Several such moving blades are fixed upon the same cylinder, to act in succession against the fixed blade; and these moving blades are placed obliquely to the axis of the cylinder, or in such a manner as to form portions of spirals; but, as all parts of the cutting edges are equidistant from the axis of the cylinder, it is

manifest that, in the revolution of the cylinder, every part of each spiral edge is brought in succession into contact with the fixed blade, so that in its revolution it crops off all the wool, which by the progressive motion of the cloth over its bed, is raised up against the fixed edge. The edges of the moving blades are placed at such a degree of obliquity to the axis of the cylinder, that at the same instant the end of one ceases to cut against the edge of the fixed blade, the following revolving blade will begin its action at the other end of the cylinder; therefore, by the time that any one of the revolving edges has passed over and made its cut against the whole length of the fixed blade, and is ready to quit it, the succeeding revolving edge is brought into action, and, when this has passed, the next in succession begins, so as to keep up a continued action. The cloth is stretched in width by a contrivance which he calls stretching-bands, to prevent it getting into folds or wrinkles, which would be injured by the shears, or make irregularities in the shearing.

These stretching-bands are endless straps or bands, each of which is extended over two wheels. The bands have sharp pins projecting from them to prick into the lists at the edges of the cloth; and the bands being so situated that one of them lies exactly beneath each list, they will be caused to circulate round their respective wheels by the motion of the cloth. The stretching of the cloth is effected by the position of the wheels on which the bands circulate, the direction of the bands being slightly oblique to the lengthways of the cloth. The endless straps are so fitted into grooves or troughs, that they are firmly retained to move straight forwards in their oblique direction; and the direction of the obliquity is such, that the bands are nearest together at that end where their pins take hold of the lists of the cloth; but as the bands move forwards with the cloth, they recede from each other, and extend the cloth in breadth in consequence of their obliquity, which may be increased or diminished as is found necessary. The actual width between the two bands can also be regulated according to the width of the piece of cloth. It is not usual to crop the lists of the cloth, and indeed, as the lists are usually of thicker substance than the other parts of the cloth, they would bear up the fixed blade too high from the cloth to cut the nap quite close.

The bed or support on which the cloth is cut is so constructed, that it can be adapted in length to the breadth of the piece of cloth between the lists, in order that the cloth only may be supported or borne up to the edge of the fixed blade; whilst the lists, being depressed or borne down below the level of the bed, by thin slips of metal called guards, will escape the action of cropping, and thereby remain with the long wool upon their surfaces. The bed by which the cloth is borne whilst it is cut is only a narrow ridge of metal, over which it passes, so as to be bent with a sudden curvature, and in this way the nap can be cut more close and even than upon a flat bed or soft cushion. The operation of cutting is facilitated by a row of pieces of metal

screwed to a strong bar, to form a straight edge, very similar to the cutting edge of the fixed blade, but thin and elastic. This edge is placed close to the elevated ridge of the bed, and presses the cloth gently down upon the bed, immediately before it comes to the edge of the fixed blade, against which the nap is to be cut off; this elastic edge being placed on one side of the ridge, and the cutting edge of the lower blade on the other side, the cloth is only exposed for a very narrow space just where it comes to the cutting edge. By this means the cloth can with safety be brought nearer to a level with the upper surface of the fixed blade, so as to shear it closer than could otherwise be done without endangering the cloth. The ends of the ridge part of the bed are composed of a number of narrow plates of metal, accurately fitted together, and placed side by side in a mortise made in the end of the solid bed; their upper ends project out of the mortise so as to line with the elevated ridge, and form a continuation of it; but there is a sliding piece in the bottom of the mortise on which they all bear, and the point of it is of a wedge form. By removing this wedge any number of the moveable pieces may be let down, so as to diminish the length of the elevated part of the bed at pleasure, according to the breadth of the cloth. The whole seems well contrived to effect the desired object.

The cloth, having been shorn for the last time, is brushed over and pressed. The former operation is now generally performed by two cylindrical machine brushes, over which a system of rollers passes the piece, brushing both the sides at the same time. Pressing gives it the final smooth coat and polish: preparatory to which it is doubled and laid in even folds, a leaf or sheet of glazed pasteboard being inserted between each fold or plait of the cloth. It is then covered with thin wooden boards or fences in the press, on which are laid iron plates properly heated, and on the whole, by means of a lever turning a screw, the top of the press is brought down with the degree of force judged necessary to give the gloss. A very high finish however is found objectionable, because the slightest shower of rain marks the cloth. Coarser cloths are glossed with a large hot iron in a hollow box, suspended by tackle from the ceiling, and which two men work backwards and forwards over the surface of the cloth.

By stat. 28 Geo. III. c. 38, all the former statutes respecting the exportation of wool and sheep are repealed; and an infinite variety of regulations and restrictions upon the subject is consolidated into that statute. It is given almost at length in 4 Burn's J. title Woollen Manufacturer. The principal prohibitions are, that if any person shall send or receive any sheep on board a ship or vessel, to be carried out of the kingdom, the sheep and vessel are both forfeited; and the person so offending shall forfeit £3 for every sheep, and suffer solitary imprisonment for three months. But wether sheep, by a licence from the collector of the customs, may be taken on board for the use of the ship's company. And every person who shall export out of the kingdom any wool

or woollen articles, slightly made up, so as easily to be reduced to wool again; or any fullers' earth, or tobacco-pipe clay; and every carrier, ship-owner, commander, mariner, or other person, who shall knowingly assist in exporting or in attempting to export these articles, shall forfeit 3s. for every pound weight, or the sum of £50 in the whole, at the election of the prosecutor, and shall also suffer solitary imprisonment for three months. But wool may be carried coastwise upon being duly entered, and security being given according to the direction of the statute, to the officer of the port from whence the same shall be conveyed. And the owners of sheep, which are shorn within five miles of the sea, and ten miles in Kent and Sussex, cannot remove the wool, without giving notice to the officer of the nearest port as directed by the statute. Much contest having arisen as to the

policy, in the present times, of several acts heretofore made for the regulation of the woollen manufactories; these acts were by 43 Geo. III. c. 136 (a temporary act continued by several subsequent acts), suspended with a view to the framing of a new law on the subject. At length by stat. 49 Geo. III. c. 109. several acts, and parts of acts (nearly forty in number), on this subject from the 2 of Edw. III. to 5 Geo. III. are repealed: and persons having served apprenticeship to any branch of the woollen manufactories, and their wives and families, are allowed to set up and exercise that trade, or any other, in any part of Great Britain, notwithstanding the restrictions in stat. 5 Eliz. c. 4. There are other miscellaneous woollen goods of considerable importance; and we propose, in a history of the WOOLLEN MANUFACTURE of Great Britain, to give a summary of those of each of its branches.

CLOTH, INCOMBUSTIBLE. See ASBESTOS.

CLOTH, LINEN. See LINEN.

CLOTHO, from *κλωθεω*, to spin, the first of the three Parcae, or Fates, daughter of Jupiter and Themis. She was supposed to preside over the time of birth. She held the distaff in her hand and spun the thread of life. She was represented wearing a crown with seven stars, and covered with a variegated robe.

CLOTPOLL, *n. s.* from clot and poll. Thick-skull; blockhead.

What says the fellow, there? call the clotpoll back. *Shakespeare.*

Head, in scorn.

I have sent Cloten's clotpoll down the stream, In embassy to his mother. *Shakespeare. Cymbeline.*

CLOUD, *n. s., v. s. & v. s.*

CLO'UDLY, *adv.*

CLO'UDINESS, *n. s.*

CLO'UDLESS, *adj.*

CLO'UDY, *adj.*

The derivation is not known. Minshew derives it from *cloudo* to shut; Somner from *clod*;

Casaubon from *αχλος*, darkness; Skinner from *kloude*, Dutch, a spot. The embodied vapors of the atmosphere; obscurity; a stain; a multitude of people; an host; Goth. *lyd*; Sax. *leod*; Teut. *liud*; Sax. *ploth*; a crowd, a troop; anything that spreads, variegates, obscures; fills the air with gloom, the mind with confusion, the heart with sadness. It sometimes is applied to a den in the mountains; a rock, a cliff. Goth. *kleit*; Sax. *clud*, *pleoth*, *plith*.

The 'darkness of death,' ben the sinnes that the wretched man hath don, which that distroublen him to see the face of God; right as a derke cloud, between us and the sonne. *Chaucer. The Persones Tale.*

O stars of steres, with thy stremes clere,
Sere of the se, to shippman light and gide!
O lustie, living, moste pleasant to appere,
Whose bright-beames the cloudes maie not hide!
O Weie of life to hem that go or ride;
Haven after tempest, surest to rive
On me have mercie for thy joyes five.

Id.

Their captaine there they cruelly found kild,
And in his armes the dreary dying mayd,

Like a sweet angell twist two cloudes uphild,
Her lovely light was dimmed and decayed
With cloud of death upon her eyes displayed;
Yet did the cloud make even that dimmed light
Seeme much more lovely in that darkness laid,
And twist the twinkling of her eye-lids bright,
To sparke out little beames, like starres in foggie night. *Id.*

Some had rather have good discipline delivered plainly, by way of precepts, than cloudily enwrapped in allegories. *Id.*

So my storm-beaten heart likewise is cheered
With that sun-shine, when cloudy looks are cleared. *Spenser.*

Witness my son, now in the shade of death,
Whose bright outshining beams thy cloudy wrath
Hath in eternal darkness folded up. *Shakespeare.*

Now are the clouds, that lowered upon our house,
In the deep bosom of the ocean buried. *Id. Richard III.*

You have such a February face.
So full of frost, of storm, and cloudiness. *Id.*

For shedding round about his sparkling light,
He clears their dusky shades, and cloudy night,
Producing like himself their shapes all shining bright. *Fletcher's Purple Island.*

Be not disheartened then, nor cloud those looks,
That wont to be more cheerful and serene. *Milton.*

Tho' poets may of inspiration boast,
Their rage, ill governed, in the clouds is lost. *Waller.*

Clouds are the greatest and most considerable of all the meteors, as furnishing water and plenty to the earth. They consist of very small drops of water, and are elevated a good distance above the surface of the earth; for a cloud is nothing but a mist flying high in the air, as a mist is nothing but a cloud here below. *Locke.*

As a mist is a multitude of small but solid globules, which therefore descend; so a vapour, and therefore a watery cloud, is nothing else but a congeries of very small and concave globules, which therefore ascend to that height in which they are of equal weight with the air, where they remain suspended, till, by some motion in the air, being broken, they descend in solid drops; either small, as in a mist; or bigger, when many of them run together, as in rain. *Grew's Cosmologia.*

I saw a *cloudy* Hungarian diamond made clearer by lying in a cold liquor; wherein, he affirmed, that upon keeping it longer, the stone would lose more of its cloudiness.

If men would not exhale vapours to cloud and darken the clearest truths, no man could miss his way to heaven for want of light.

How can I see the brave and young
Fall in the *cloud* of war, and fall unsung?

The objection comes to no more than this, that, amongst a *cloud* of witnesses, there was one of no very good reputation.

This Partridge soon shall view in *cloudless* skies,
When next he looks thro' Galileo's eyes.

The handle smooth and plain,
Made of the *clouded* olive's gasy grain.

The purple *clouds* their amber linings show,
And edged with flame rolls every wave below.

If you content yourself frequently with words instead of ideas, or with *cloudy* and confused notions of things, how impenetrable will that darkness be!

Now beamed the evening star,
And from embattled *clouds* emerging slow,
Cynthia came riding on her silver car,
And hoary mountain cliffs shone faintly from afar.

The gusts of appetite, the *clouds* of care,
The storms of disappointments all o'ercrest,
Henceforth no earthly hope with Heaven shall share

This heart, where peace serenely shines at last.

Lone as a solitary *cloud*,
A single *cloud* on a sunny day,
While all the rest of heaven is clear,
A frown upon the atmosphere,
That hath no business to appear
When skies are blue, and earth is gay.

CLOUDS. That clouds are formed from the aqueous vapors, which before were so closely united with the atmosphere as to be invisible, is universally allowed: but it is no easy matter to account for the long continuance of some very opaque clouds without dissolving; or, to give a reason why the vapors, when they have once begun to condense, do not continue to do so till they at last fall to the ground in the form of rain or snow, &c. A general cause of the formation of clouds has been often suggested; namely, a separation of the latent heat from the water of which the vapor is composed. The consequence of this separation, as is proved by Dr. Black, must be the condensation of that vapor, in some degree at least. In such case, it will first appear as a smoke, mist, or fog; which, if interposed betwixt the sun and earth, will form a cloud; and, the same causes continuing to act, the cloud will produce rain or snow. But though the separation of this latent heat, in a certain degree, is the immediate cause of the formation of clouds, the remote cause, or the changes produced in the atmosphere, whereby such a preparation may be induced, are much more difficult to be discovered. Common observation shows that vapor is most powerfully condensed by cold substances, such as metals, water, &c. But cold alone cannot in all cases cause the condensation of the atmospherical vapors, otherwise the nights would be always foggy or cloudy, owing to the vapors

of the day being condensed by the superior coldness of the night. Great rains will happen in very warm weather, when the union of the vapors with the atmosphere ought rather to be promoted than dissolved, if cold was the only agent in their condensation. The serenity of the atmosphere, also, in the most severe frosts, abundantly shows that some other cause besides mere heat or cold is concerned in the formation of clouds, and condensation of the atmospherical vapors.

The electric fluid is now generally admitted a one agent in all these great operations of nature. It has been even assigned by Beccaria as the cause of the formation of all clouds whatsoever whether of thunder, rain, hail, or snow. But though it is certain that all clouds, or even fog and rain, are electrified in some degree, it still remains a question, whether any clouds are formed in consequence of the vapor of which they are composed being first electrified, or whether they become electrified in consequence of its being first separated from the atmosphere and in some measure condensed. Electricity is known to be in many cases a promoter of evaporation; but no experiments have yet been brought to prove that electrified air parts with its moisture more readily than such as is not electrified so that, till the properties of electrified air are farther investigated, it is difficult to lay down any rational theory of the formation of clouds upon this principle. Instances of the descent of very highly electrified clouds have not been uncommon. Brydone, in his Tour through Malta, mentions a remarkable one which appeared on the 29th of October, 1757. About three quarters of an hour after midnight, there was seen to the south-west of the city of Melita, a great black cloud, which, as it approached, changed its color till at last it became like a flame of fire mixed with black smoke. A dreadful noise was heard on its approach, which alarmed the whole city. It passed over the port, and came first on an English ship, which in an instant was torn in pieces, and nothing left but the hull; part of the masts, sails, and cordage, were carried to a considerable distance along with the cloud. The small boats and felloques that fell in its way were all broken to pieces and sunk. The noise increased and became more frightful. A sentinel terrified at its approach, ran into his box; but both he and it were lifted up and carried into the sea, where he perished. It then traversed a considerable part of the city, and laid in ruins almost every thing that stood in its way. Several houses were laid level with the ground, and it did not leave one steeple in its passage. The bells of some of them, together with the spires, were carried to a considerable distance; the roofs of the churches demolished and beat down, &c. I went off at the north-east point of the city, and demolishing the light-house, is said to have mounted up into the air with a frightful noise and passed over the sea to Sicily, where it tore up some trees, and did other damage; but nothing considerable, as its fury had been mostly spent at Malta. The number of killed and wounded amounted to nearly 200; and the loss of shipping, &c., was very considerable.

The effects of thunder-storms, and the vast quantity of electricity collected in the clouds which produce these storms, are so well known, that it is superfluous to mention them. It appears, however, that even these clouds are not so highly electrified as to produce their fatal effects on those who are immersed in them. It is only the discharge of part of their electricity upon such bodies as are either not electrified at all, or not so highly electrified as the cloud that produces the mischief. Professor Saussure, and young Mr. Jalabert, when travelling over one of the high Alps, supply a singular instance of being caught among clouds of this kind; to their astonishment they found their bodies so full of electrical fire, that spontaneous flashes darted from their fingers with a crackling noise, and they had the same kind of sensation as when strongly electrified by art.

The height of clouds in general is not great; the summits of very high mountains being commonly quite free from them. But those which are most electrified descend lowest, their height being often not above 700 or 800 yards above the ground; may, sometimes thunder clouds appear actually to touch the ground with one of their edges. But the generality of clouds are suspended at the height of a mile, or little more, above the earth. Some, however, have imagined them to arise to a most incredible and extravagant height.

The motions of the clouds are not always directed by the wind; they seem to move very slowly when we have considerable gales, and often to be absolutely stationary for a time. The reason of this probably is, that they are impelled by opposite streams of air of equal strength; by which means their velocity is retarded. In such cases both the aerial currents seem to ascend to a very considerable height; for Messrs. Charles and Roberts, when endeavouring to avoid a thunder cloud in one of their aerial voyages, could find no alteration in the course of the current, though they ascended to the height of 4000 feet from the surface of the earth. In some cases the motions of the clouds evidently depend on their electricity, independent of any current of air. Professor Leslie, in his very able article on Meteorology, in the Supplement to the Encyclopædia Britannica, contends that Dr. James Hutton first suggested the true theory of clouds, in his paper upon the subject of Rain, in the Transactions of the Edinburgh Royal Society, 1787. He thus endeavours to define and complete it:—

‘Air, in cooling, becomes ready to part with its moisture. But how is it cooled in the free atmosphere, unless by the contact or commixture of a colder portion of the same fluid? Now, the portion of the air which is chilled, must in an equal degree warm the other. If, in consequence of this mutual change of condition, the former be disposed to resign its moisture, the latter is more inclined to retain it; and, consequently, if such opposite effects were balanced, there could, on the whole, be no precipitation of humidity whatever. The separation of moisture, on the mixing of two masses of damp air at different temperatures, would therefore prove, that the dissolving power of air suffers more diminution from losing

part of the combined heat, than it acquires augmentation from gaining an equal measure of it; and, consequently, this power must, under equal accessions of heat, increase more slowly at first than it does afterwards, thus advancing always with accumulated celerity.

‘The quantity of moisture which air can hold thus increases in a much faster ratio than its temperature. This great principle in the economy of nature was traced by Dr. Hutton from indirect experience. It is the simplest of the accelerating kind, and perfectly agrees with the law of solution, which the hygrometer has established. Suppose equal bulks of air in a state of saturation, and at the different temperatures of 15 and 45 centesimal degrees, were intermixed, the compound arising from such union will evidently have the mean temperature of 30°. But since, at these temperatures, the one portion held 200 parts of humidity, and the other 800, the aggregate must contain 1000 parts, or either half of it 500; at the mean or resulting temperature, however, this portion could only suspend 400 parts of humidity, and consequently, the difference, or 100 parts, amounting to the 200th part of the whole weight of air, must be precipitated from the compound mass. As another illustration, let air of 15° be mixed with air at the temperature of 35°, in three different proportions, all at the point of saturation; one part being combined with three parts, two with two, and three with one. The temperatures arising from the commixture would be 20°, 25°, and 30°; the corresponding parts of moisture precipitated from the mass being derived from the intermediate proportions of 200 and 504, are 352—317·5, or 34·5, 276—252 or 24, 352—317·5 or 34·5, and 428—400 or 28.

‘In these examples we have assumed the portions of differently heated air to be quite charged with moisture before mixing; but it is only required that they should approach to the point of humidity. The effect, however, of simple commixture would, in most cases, be very small. To explain the actual phenomena, we must have recourse to the mutual operation of a chill and of a warm current, driving swiftly in opposite directions, and continually mixing and changing their continuous surfaces. By this rapidity, a larger volume of the fluid is brought into contact in a given time. Suppose, for instance, the one current to have a temperature of 50°, and the other that of 70°, by Fahrenheit’s scale; the blending surfaces will therefore assume the mean temperature of 60°. Consequently, the two streams throw together 200 and 234·2 parts of moisture, making 567·1 parts for the compound, which, at its actual temperature, can hold only 258·6 parts; the difference, or 8·6 parts, forms the measure of precipitation, corresponding to the 2325th of the whole weight of the commixed air. It would thus require a column of air thirty miles in length to furnish, over a given spot, and in the space of an hour, a deposit of moisture equal to the height of an inch. If the sum of the opposite velocities amounted to sixty miles an hour, and the intermingling influence extended but to a quarter of an inch at the grazing surfaces, there would still, on this supposition,

be produced in the same time a fall of rain reaching to half an inch in altitude.

These quantities come within the limits of probability, and agree sufficiently with experience and observation. But in the higher temperatures, though the difference of the heat between the opposite strata of air should remain the same, the measure of aqueous precipitation is greatly increased. Thus, while the mixing of equal masses of air, at the temperatures of 40° and 60°, is only 6·6, that from a like mixture at 80° and 100° amounts to 19°. This result is entirely conformable to observation; for showers are most copious during hot weather, and in the tropical climates. The quantity of moisture precipitated from the atmosphere thus depends on a variety of circumstances: on the previous dampness of the commixed portions of the fluid; their difference of heat; the elevation of their mean temperature; and the extent of the combination which takes place. When this deposition is slow, the very minute aqueous globules remain suspended, and form clouds; but if it be rapid and copious, those particles conglomerate, and produce, according to the state of the medium with regard to heat, rain, hail, or snow.

But Mr. Luke Howard of London has furnished the most complete classification and exposition of these phenomena, in his *Nomenclature and Observations on Clouds*, published in the 16th and 17th vols. *Philosophical Magazine*.

The simple modifications are thus defined: 1. *Cirrus*. Parallel, flexuous, or diverging fibres, extensible in any or in all directions. 2. *Cumulus*. Convex or conical heaps, increasing upwards from a horizontal base. 3. *Stratus*. A widely extended, continuous, horizontal sheet, increasing from below.

The intermediate modifications which require to be noticed are, 4. *Cirro-cumulus*. Small well-defined roundish masses, in close horizontal arrangement. 5. *Cirro-stratus*. Horizontal, or slightly inclined masses, attenuated towards a part or the whole of their circumference, bent downward or undulated, separate or in groups, consisting of small clouds having these characters.

The compound modifications are, 6. *Cumulo-stratus*. The cirro-stratus, blended with the cumulus, and either appearing intermixed with the heaps of the latter, or superadding a wide-spread structure to its base.

7. *Cumulo-cirro-stratus, vel nimbus*, is the rain cloud. A cloud or system of clouds from which rain is falling. It is a horizontal sheet, above which the cirrus spreads, while the cumulus enters it laterally and from beneath.

The cirrus appears, according to this author, to have the least density, the greatest elevation, the greatest variety of extent and direction, and to appear earliest in serene weather, being indicated by a few threads pencilled on the sky. Before storms they appear lower and denser, and usually in the quarter opposite to that from which the storm arises. Steady high winds are also preceded and attended by cirrus streaks, running quite across the sky in the direction they blow in.

The cumulus has the densest structure, is formed in the lower atmosphere, and moves

along with the current next the earth. A small irregular spot first appears, and is, as it were, the nucleus on which they increase. The lower surface continues irregularly plane, while the upper rises into conical or hemispherical heaps; which may afterwards continue long nearly of the same bulk, or rapidly rise into mountains. They will begin, in fair weather, to form some hours after sunrise, arrive at their maximum in the hottest part of the afternoon, then go on diminishing and totally disperse about sunset. Previous to rain, the cumulus increases rapidly, appears lower in the atmosphere, and with its surface full of loose fleeces or protuberances. The formation of large cumuli to leeward in a strong wind, indicates the approach of a calm with rain. When they do not disappear or subside about sunset, but continue to rise, thunder is to be expected in the night. The *stratus* has a mean degree of density, and is the lowest of clouds, its inferior surface commonly resting on the earth or water. This is properly the cloud of night appearing about sunset. It comprehends all those creeping mists, which in calm weather ascend in spreading sheets, like an inundation of water, from the bottom of valleys, and the surfaces of lakes and rivers. On the return of the sun, the level surface of this cloud begins to put on the appearance of cumulus, the whole at the same time separating from the ground. The continuity is next destroyed, and the cloud ascends, and evaporates, or passes off with the appearance of the nascent cumulus. This has long been experienced as a prognostic of fair weather.

The cirrus having continued for some time increasing or stationary, usually passes either to the cirro-cumulus or the cirro-stratus, at the same time descending to a lower station in the atmosphere. This modification forms a very beautiful sky; is frequent in summer, an attendant on warm and dry weather. The cirro-stratus, when seen in the distance, frequently gives the idea of shoals of fish. It precedes wind and rain; is seen in the intervals of storms; and sometimes alternates with the cirro-cumulus in the same cloud, when the different evolutions form a curious spectacle. A judgment may be formed of the weather likely to ensue by observing which modification prevails at last. The solar and lunar *haloes*, as well as the *parhelion* and *paraselene* (mock sun and mock moon), prognostics of foul weather, are occasioned by this cloud. The cumulo-stratus precedes, and the nimbus accompanies rain. Mr. Howard gives a view of the origin of clouds, which will be found worth consulting. The uses of the clouds are obvious; from them proceeds the rain which refreshes the earth, without which according to the present system of nature, the whole of its surface would be a mere desert. They are likewise of great use as a screen, interposed between the earth and the scorching rays of the sun, which are often so powerful as to destroy the grass and other tender vegetables. In the more secret operations of nature also, where the electrical fluid is concerned, the clouds bear a principal share; and serve as a medium for conveying that fluid from the atmosphere into the earth, and from the earth into the atmosphere.

CLOUDS.

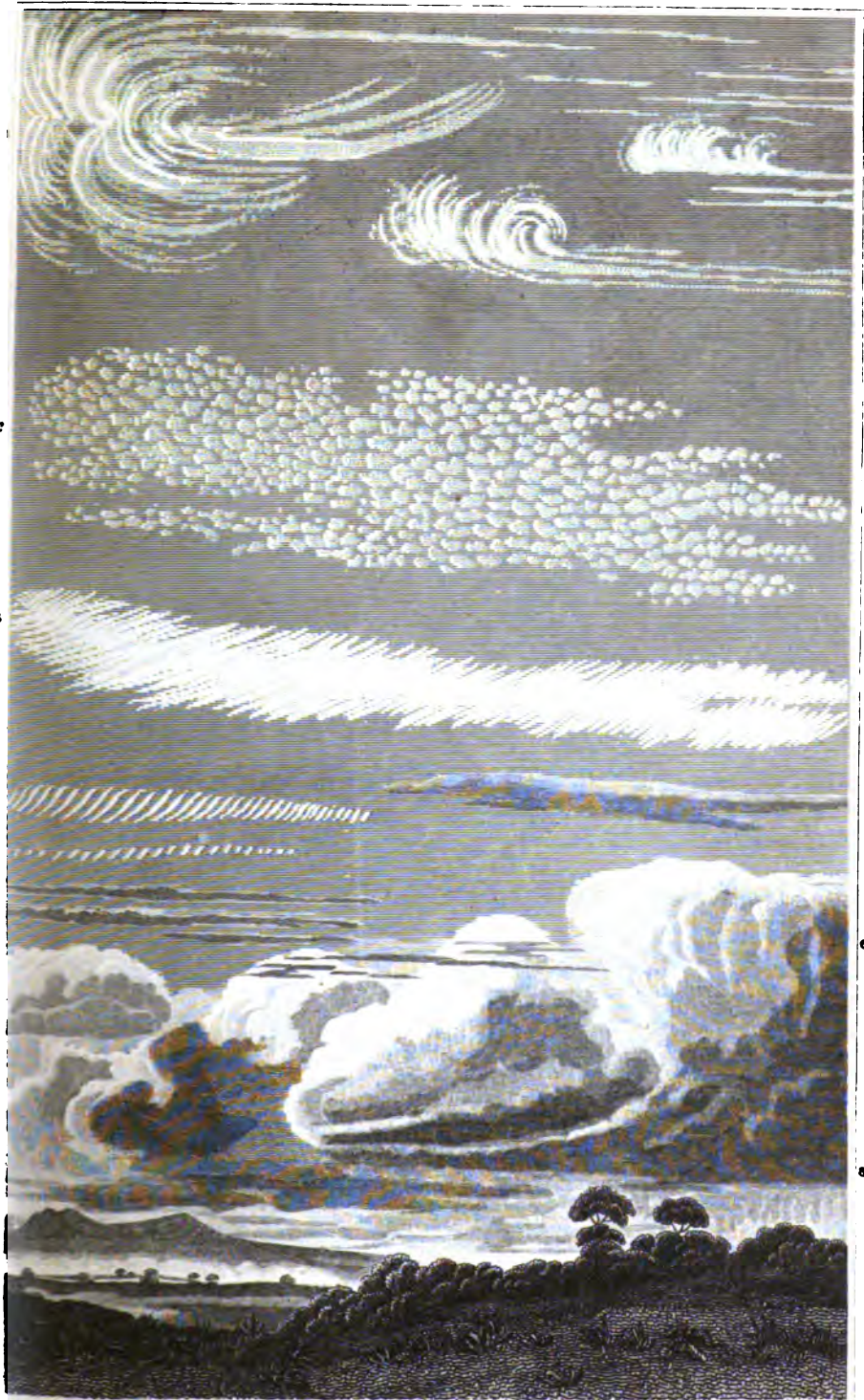

1. Cirrus or Curlcloud - 2. Cirrocumulus or Sandercloud - 3. 4. 5. Cirrostratus or Wanecloud - 6. Cumulostratus or Traincloud - 7. Cumulus or Stakecloud - 8. Nimbns or Raincloud - 9. Stratum or Fallecloud.

CLOUD (St.), a town and palace of France, in the province of the Isle of France, situated on the Seine. The palace, though not the largest, is one of the most pleasantly situated, and beautiful, of any in the neighbourhood of Paris. It contains several beautiful specimens of the fine arts, has a park, gardens, and cascades. The great cascade is 108 feet in width, and the same in height. The terrace affords an extensive view of Paris. Henry III. was assassinated here in 1580, and here Napoleon principally resided. It has a fine manufacture of porcelain; five miles west of Paris.

CLOUDBERRY, *n. s.* from cloud and berry, *chamomorus*. The name of a plant, called also knoberry.

CLOUDCAPT, *adj.* from cloud and cap. Topped with clouds; touching the clouds.

The *cloudcapt* towers, the gorgeous palaces,
The solemn temples, the great globe itself,
Yea, all which it inherits, shall dissolve. *Shakespeare.*

CLOUDCOMPELLING, *adj.* A word formed in imitation of *νεφελήγερης*, ill understood. An epithet of Jupiter, by whom clouds were supposed to be collected.

Health to both kings, attended with a roar
Of cannons, echo'd from the affrighted shore;
With loud resemblance of his thunder prove
Bacchus the seed of *cloudcompelling* Jove. *Waller.*

Supplicating move
Thy just complaint to *cloudcompelling* Jove. *Dryden.*

CLOVE, *n. s.* the preterite of cleave. See **TO CLEAVE**.

Gyon's angry blade so fierce did play
On the' other's helmet, which as Titan shone,
That quite it *cleve* his plumed crest in tway.
Faerie Queene.

CLOVE, *n. s.* Fr. *clou*, a nail, from the similitude of a clove to a nail. A valuable spice brought from Ternate in the East Indies. It is the fruit or seed of a very large tree.

Cloves seems to be the rudiment or beginning of a fruit growing upon *clow-trees*.

Browne's Vulgar Errors.
Some of the parts into which garlick separates,
when the outer skin is torn off. In this sense it is derived from clove, the preterite of cleave.

'Tis mortal sin an onion to devour;
Each *clow* of garlick is a sacred power.
Tate's Juvenal.

CLOVE JULY-FLOWER. See **DIANTHUS**.

CLOVE-TREE. See **CARYOPHYLLUS**.

CLOVEN, *part. pret.* from cleave. See **TO CLEAVE**.

There is Aufidius, list you what work he makes
Among your *cloven* army. *Shakespeare.*

Now heaped high
The *cloven* oaks and lofty pines do lie. *Waller.*

A chap-fallen beaver, loosely hanging by
The *cloven* helm, and arch of victory. *Dryden.*

CLOVEN-FOOTED, *adj.* } Cloven and foot, or
CLOVEN-HOOFED, } hoof. Having the foot
divided into two parts: not a round hoof; bisul-

cous.
There are the bisulcous or *cloven-hoofed*; as camels
and beavers. *Browne's Vulgar Errors.*
The *cloven-footed* fiend is banished from us.
Dryden.

Great variety of water fowl, both whole and *cloven-*
footed, frequent the waters. *Ray on the Creation.*

Whether the serpent at the fall
Had *cloven* feet, or none at all. *Hudibras.*

And for his aspect, look upon the fountain,
And then on me, and judge which of us twain
Look likest what the boors believe to be
Their *cloven-footed* terror.

Byron. Deformed Transformed.

CLOVER, *n. s.* } Dutch *kliver*; Sax.
CLOVER-GRASS, *n. s.* } *clæfer*; from its cleft
CLOVERED, *adj.* } leaves, a species of tre-
foil; a rich provision for cattle; and so great a
luxury, that when an individual has all the
comforts of life in abundance, he is said to live
in clover.

The even mead, that erst brought sweetly forth
The freckled cowslip, burnet, and green *clover*.
Shakespeare.

Nature shall provide
Green grass and fattening *clover* for their fare.

Dryden.
Clover improves land, by the great quantity of cattle
it maintains. *Mortimer's Husbandry.*

My Blouseinda is the blithest lass,
Than primrose sweeter, or the *clover* grass. *Gay.*

Flocks thick nibbling thro' the *clovered* vale.
Thomson.

Well, Laureat, was the night in *clover* spent. *Ogle.*

CLOVER, in botany. See **TRIFOLIUM**, and
AGRICULTURE.

CLOUGH, *n. s.* Sax. clough. The cleft of a
hill; a vale between cliffs.

CLOUGH, *n. s.* in commerce, an allowance of
two pounds in every hundred weight for the turn
of the scale, that the commodity may hold out
weight when sold by retail.

CLOVIO (George Julius), a celebrated histo-
rical and portrait painter, was born at Sclavonia
in 1498. At eighteen years of age he went to
Rome, where he spent three years, devoting him-
self entirely to painting in miniature. His know-
ledge of coloring was established by the instruc-
tions of Julius Romano, and his taste of compo-
sition and design was founded on the works of
Michael Angelo. He thus acquired so great a
degree of excellence in portrait, as well as in
historical painting, that in the former he was
considered equal to Titian, and in the latter not
inferior to Buonaroti. He died in 1578. His
works are exceedingly valuable, and are still
numbered among the curiosities of Rome.

CLOVIS I. the real founder of the French
monarchy, was born in 467, and succeeded his
father Childeric in 481. His first exploit was
the defeat of Syagrius, the Roman governor of
Gaul, after which he took Soissons, and made it
his capital. His wife Clotilda prepared him for
the reception of Christianity, which, however, he
did not embrace till after a victory obtained over
the Germans, which he attributed to the effect of
his prayer to the God of the Christians before
the battle. He was soon after publicly baptised
with 3000 of his subjects, by St. Reni, archbi-
shop of Rheims, and his fitness for the ceremony
may be judged of from his declaration on hear-
ing of the sufferings of Christ. 'Had I been
there,' said he, 'with my valiant Goths, how I
would have avenged him!' He was a warlike
prince, and conquered the several provinces of

Gaul, possessed before his time by the Romans, Germans, and Goths. These he united to the then scanty dominions of France, removed the seat of government from Soissons to Paris, and made this the capital of his new kingdom. Under the pretext of zeal for the conversion of the Visigoths in Gaul, he invaded their territory, and killed Alaric their prince with his own hand. The Visigoths were afterwards assisted by Theodoric, king of Italy, and Clovis was obliged to retreat with great loss, from the siege of Arles. These tribes were finally allowed by treaty to retain the country of Septimania, comprising the sea-coast from the Rhone to the Pyrenees, while the country thence to the Loire was given up to Clovis. He was soon honored by the emperor Anastasius with the Roman titles of patrician, consul, and Augustus. In his advanced age, he founded several churches and monasteries, in expiation of his sins, and was very zealous for the Catholic faith. After being acknowledged king of all the Franks in Gaul, he died at Paris in 511, in the forty-fifth year of his age, after a reign of thirty years. He left four sons, for whom he founded four kingdoms. See FRANCE, HISTORY OF.

CLOUT, *n. s. & v. a.* Sax. *clut*; Swed. *ClouTET*, *part. adj.* } *klut*. A fragment or
CLOUTERLY, *adj.* } small piece of cloth;
a patch; a mean fellow; a clown; a booby;
a cuff; a blow with the hand. To clout is to
patch, to mend coarsely; to cover with a cloth;
to join awkwardly, or coarsely together.
Clouted is sometimes corruptly used for clotted.
Clouterly is louterly, that is clumsy, awkward.
Anciently the mark of white cloth, at which
archers shot was called a clout.

And when she of this bill hath taken hede,
She sent it all to cloutes. *Chaucer. Canterbury Tales.*

Many sentences of one meaning clouted up together.
Ascham.

His garment nought but many ragged clouts,
With thorns together pinned, and patched was.

A clout upon that head,
Where late the diadem stood. *Shakespeare.*

Milk some unhappy ewe,
Whose clouted leg her hurt doth shew. *Spenser.*

He drew a good bow; he shot a fine shoot; he
would have clapt in the clout at twelve score.
Shakespeare.

I thought he slept and put
My clouted brogues from off my feet, whose rudeness
Answered my steps too loud. *Id.*

His clothes all patched with more than honest thrift,
And clouted shoes were nailed for fear of wasting:

Fasting he praised, but sparing was his drift,
And, when he eats, his food is worse than fasting.
Fletcher's Purple Island.

The dull swain
Treads on it daily with his clouted shoon. *Milton.*
The single wheel plough is a very clouterly sort.
Mortimer's Husbandry.

I've seen her skim the clouted cream,
And press from spongy curds the milky stream. *Gay.*

CLOWES (William), an eminent surgeon in
the English navy, in the reign of queen Elizabeth,
settled about 1573 in London, and became
surgeon to Christ's and St. Bartholomew's Hos-

pitals. He went to the Netherlands in 1586, to
superintend the care of the wounded in the army
of the earl of Leicester. He died some time
before 1631; and was the author of treatises On
Syphilis, and On the Cure of Wounds.

CLOWN, *n. s.* } From Lat. *clonus*,
CLOWNERY, *n. s.* } according to Junius; or
CLOW'NISH, *adj.* } *loon*, a hired servant; a
CLOW'NISHLY, *adv.* } peasant; an ill bred
CLOW'NISHNESS, *n. s.* } man; the cognomen for
all that is churlish, rude, uncivil, and brutal.

He came with all his clowns, horsed upon cart-jades.
Sidney.

But with his clownish hands their tender wings
He brusheth oft. *Spenser's Faerie Queene.*

What if we essayed to steal
The clownish fool out of your father's court?
Shakespeare.

Height with a certain grace does bend,
But low things clownishly ascend. *Marvell.*
The fool's conceit had both clownery and ill-nature.
L'Estrange.

The clowns, a boisterous, rude, ungoverned crew,
With furious haste to the loud summons flew.
Dryden.

Young Silvia beats her breast, and cries aloud,
For succour from the clownish neighbourhood. *Id.*
Even his Doric dialect has an incomparable sweet-
ness in his clownishness. *Id.*

If the boy should not make legs very gracefully, a
dancing master will cure that defect, and wipe off that
plainness which the à-la-mode people call clownishness.
Locke.

With a grave look, in this odd equipage,
The clownish mimic traverses the stage. *Prior.*

In youth a coxcomb, and in age a clown. *Spectator.*

A country squire, represented with no other vice
but that of being a clown, and having the provincial
accent. *Swift.*

Touched by thy rod, from Power's majestic brow,
Drops the gay plume, he pines a lowly clown,
And on the cold earth stretched the son of Woe,
Quaffs Pleasure's draughts, and wears a fancied crown.
Beattie.

CLOWN'S MUSTARD, *n. s.* An herb.
CLOY, *v. a.* } Fr. *clouer*, from clou;
CLOY'LESS, *adj.* } Lat. *clavis*. To stop up, to
CLOY'MENT, *n. s.* } fill at once, to spike guns,
to drive a nail into the touch hole. Cloyment is
repletion; cloyless is that of which too much
cannot be had; that which cannot cause satiety.

The length of those speeches had not cloyed Py-
rocles, though he were very impatient of long delibe-
rations. *Sidney.*

The very creed of Athanasius, and that sacred hymn
of glory, are reckoned as superfluities, which we must
in any case pare away, lest we cloy God with too
much service. *Hooker.*

Who can cloy the hungry edge of appetite
By bare imagination of a feast? *Shakespeare.*

Alas! their love may be called appetite:
No motion of the liver, but the palate,
That suffers surfeit, cloyment, and revolt. *Id.*

Epicurean cooks
Sharpen with cloyless sauce his appetite. *Id.*

Wealth which all other's avarice might cloy;
But yet in them caused as much fear as joy. *Marvell.*

Settle, cloyed with custard and with praise,
Is gathered to the dull of ancient days. *Pope.*

He caried not, he never thought of kings,
Nor from those appetites sustained annoy,
That chance may frustrate, or indulgence cloy.

Beattie.

CLOYNE, a town of Ireland, in Cork, Munster, one mile from the sea-coast. A church was built in it, and a bishopric erected by St. Colman, in the end of the sixteenth century; and in 707 an abbey was founded. In 1430 the bishopric was united to that of Cork; and the union continued till the 11th of November 1638; since which time this see has been governed by its own prelates. The cathedral is a decent Gothic building. Cloyne lies ten miles west of Young-hall, and 125 south-west of Dublin.

CLUB, *n. s.* } Swed. *klubba*; Dan.

CLUB-HEADED, *adj.* } *klub*; Teut. *klopfse*; Wel.

CLUB-LAW, *n. s.* } *cluppa*; Lat. *clava*. A

heavy stick, a mace, a staff intended for offence. Club-headed is a thick, clumsy, oaken sort of head, like the ponderous end of a club. Club-law is the law of force, a suit of cards marked with a club, or rather with a clover leaf, bears this name.

When I bete my knives,

She bringeth me the great *clubbed* staves,
And crieth; see the dogges everich on,
And brek hem both bak and every bon.

Chaucer's Canterbury Tales.

Next Hercules his like ensample shewed,
Who all the west with equal conquest wonne,
And monstrous tyrants with his *club* subdued,
The *club* of justice dread, with kingly power endowed.

Spenser.

He strove his combed *club* to quit

Out of the earth.

Id. Faerie Queene.

They are in the very wrath of love, and they will together, *clubs* cannot part them.

Shakespeare.

As he pulled off his helmet, a butcher slew him with the stroke of a *club*.

Hayward.

Small *club-headed* anternae.

Detham.

Armed with a knotty *club* another came.

Dryden.

The enemies of our happy establishment seem to have recourse to the laudable method of *clubbing*, when they find all other means for enforcing the absurdity of their own opinions to be ineffectual.

Addison's Freshwater.

The *clubs* black tyrant first her victim died,
Spite of his haughty mein and barbarous pride.

Pope.

CLUB, *n. s., v. n. & v. a.* } Goth. *kluff*; Swed.

CLUB-ROOM, *n. s.* } *klubb*; Belgic *kloof*;

Teut. *klub*; Teut. *clurben*, *kloeben*. A portion or apportioning, a division, a society paying equally. An assembly, meeting under certain conditions; a voluntary association generally for purposes of conviviality; sometimes for mutual benefit, by contributing each to the common stock; concurrence, contribution, joint charge; to contribute separate powers to one end; to pay to a common reckoning. Club-room needs no explanation.

A faddling couple sold ale: their humour was to drink drunk, upon their own liquor: they laid down their *club*, and this they called forcing a trade.

L'Extrango.

What right has any man to meet in factious *clubs* to vilify the government.

Dryden. Modul. Ded.

Till grosser atoms, tumbling in the stream
Of fancy, madly met, and *clubbed* into a dream.

Dryden.

He's bound to vouch them for his own,
Though' got by' implicate generation,
And general *club* of all the nation.

Hudibras.

The owl, the raven, and the bat,
Clubbed for a feather to his hat.

Swift.

I shall reserve for another time the history of such *club* or *clubs*, of which I am now a talkative, but unworthy member.

Spectator.

These ladies resolved to give the pictures of their deceased husbands to the *club-room*.

Addison's Spectator.

Plumbs and directors, Shylock and his wife,
Will *club* their testers now to take your life.

Pope.

CLUCK, *v. n.* Welsh, *cloccian*; Armorick, *clochat*; Sax. *cloccan*; Dutch, *kloeken*. To call chickens, as a hen.

She, poor hen, fond of no second brood,
Has *clucked* thee to the wars.

Shakespeare's Coriolanus.

Ducklings, though hatched by a hen, if she brings them to a river, in they go, though the hen *clucks* and calls to keep them out.

Ray on the Creation.

CLUE, the lower corner of a sail.

CLUE GARNETS, a sort of tackles fastened to the clues, or lower corners of the main sail or fore sail, to truss them up to the yard, which is usually termed *cluing* up the sails.

CLUE LINES are for the same purpose as *clue garnets*, only that the latter are confined to the courses, whereas the former are common to all the square sails.

CLUMP, *n. s.* formed from lump, a shapeless piece of wood or other matter, nearly equal in its dimensions. A cluster of trees; a tuft of trees or shrubs: anciently a plump.

CLUMPS, *n. s.* a numskull.

CLUMSY, *adj.*

CLUMSILY, *adv.*

CLUMSINESS, *n. s.*

This word omitted in the other etymologists, is rightly derived by Bailey from Dutch, *lompach*, stupid. In English, lump, clump, lumpish, clumpish, clumpishly, clumsily, clumsy. Awkward; heavy; artless; unhandy; without dexterity, readiness, or grace. It is used either of persons, or actions, or things.

This lofty humour is *clumsily* and inartificially managed, when affected.

Collier on Pride.

The drudging part of life is chiefly owing to *clumsiness* and ignorance, which either wants proper tools, or skill to use them.

Id. on Fame.

The matter ductile and sequacious, apt to be moulded into such shapes and machines, even by *clumsy* fingers.

Ray.

He walks very *clumsily* and ridiculously.

Id. on the Creation.

But thou in *clumsy* verse, unlicked, unpointed,
Hast shamefully defy'd.

Dryden.

That *clumsy* outside of a porter,

How could it thus conceal a courtier?

Swift.

CLUNG. The preterite and participle of *cling*.

CLUNG, *adj.* Sax. *clungu*, wasted with leanness; shrunk up with cold.

CLUNG, *v. n.* Sax. *clungan*, to dry as wood does, when it is laid up after it is cut. See *To CLING*.

CLUNIA, in ancient geography, a principal town of Hither Spain, a Roman colony, with a conventus juridicus, on the Durius, to the west of Numantia, now called Corunna del Conde.

CLUNIE, a beautiful lake in Perthshire, with an island in the centre, in which stands an ancient castle, built about A. D. 1500, by George, bishop of Dunkeld, and now a summer residence of the family of Airly. Its walls are nine feet thick at the surface of the ground.

CLUNY, a town of France, in the department of Saone and Loire, and ci-devant province of Maçonnais, seated on the Grone. Before the revolution, it was famous for its Benedictine abbey, founded by William duke of Berry and Aquitain; or, as others say, by the abbot Bern, supported by that duke, A. D. 910. This abbey was so very spacious and magnificent, that in 1245, after holding the first council of Lyons, Pope Innocent IV. went to Cluny, accompanied with the two patriarchs of Antioch and Constantinople, twelve cardinals, three archbishops, fifteen bishops, and a great number of abbots; who were all entertained, without one of the monks being put out of their places: though St. Lewis the king, queen Blanche his mother, the duke of Artois, and his sister, the emperor of Constantinople, the princes of Arragon and a great number of lords, with all their retinues, were there at the same time. Cluny at its first erection, was put under the immediate protection of the apostolic see. It became the head of a very numerous and extensive congregation; and was the first congregation of various monasteries united under one chief; so as only to constitute one body, or, as they call it, one order. This order of monks was brought into England by William earl of Warren, son-in-law to William the Conqueror, who built a house for them at Lewes in Sussex, about the year 1077. There were twenty-seven priories and cells of this order in England, which were governed by foreigners, afterwards made denizens. Cluny lies ten miles north-west of Maçon, and forty-six N. N. W. of Lyons. Population 4200.

CLUPEA, the herring, in ichthyology, a genus belonging to the order of abdominales. The upper jaw is furnished with a serrated mystache; the branchiostege membrane has eight rays; a scaly serrated line runs along the belly from the head to the tail; and the belly-fins have frequently nine rays. There are fifteen species; the most noted are,

1. *C. alosa*, the shad, has a forked snout, and black spots on the sides. In Great Britain the Severn affords this fish in higher perfection than any other river. It makes its first appearance there in May, but in very warm seasons in April; for its arrival sooner or later depends much on the temper of the air. It continues in the river about two months, and then is succeeded by the variety called the twaite. The old fish come from the sea into the river in full roe. In July and August multitudes of bleak frequent the river near Gloucester; some of them are as big as a small herring, and these the fishermen suppose to be the fry of the shad. Numbers of these are taken near Gloucester, in those months only, but none of the emaciated shad are ever caught in their returns. The Thames shad does not frequent that river till the end of May or beginning of June, and is esteemed a very coarse and insipid fish.

2. *C. encrasicolus*, the anchovy, has its upper

jaw longer than the under one, and is about three inches long. They are taken in vast quantities in the Mediterranean, and are brought over to Britain pickled. The great fishery is at Georgia, a small isle west of Leghorn. See FISHERY.

3. *C. herengus*, the common herring, has no spots, and the under jaw is longer than the upper one. A herring dies immediately after it is taken out of the water; whence the proverb, As dead as a herring. This fish is everywhere in great esteem, being rich, soft and delicate. Herrings are found from the highest northern latitudes, as low as the northern coast of France. They are met with in vast shoals on the coast of America, as low as Carolina. In Chesapeake Bay there is an annual inundation of these fish, which cover the shore in such quantities as to become a nuisance. We find them again in the seas of Kamtschatka, and probably they reach Japan; Kempter mentions, in his account of the fish of that country, some that are congenerous. The great winter rendezvous of the herring is within the arctic circle: there they continue for many months to recruit themselves after the fatigue of spawning; the seas within that space swarming with insect food in a far greater degree than those of our warmer latitudes. This mighty army begins to put itself in motion in the spring: we distinguish this vast body by that name; for the word herring comes from the German heer, an army, to express their numbers. They begin to appear off the Shetland Isles in April and May; these are only the forerunners of the grand shoal which comes in June; and their appearance is marked by certain signs, by the number of birds, such as gannets and others, which follow to prey on them; but when the main body approaches, its breadth and depth is such as to alter the appearance of the very ocean. It is divided into distinct columns of five or six miles in length, and three or four in breadth, and they drive the water before them with a kind of rippling. The first check this army meets in its march southward is from the Shetland Isles, which divide it into two parts; one wing takes to the east, the other to the western shores of Great Britain, and fill every bay and creek with their numbers; others pass on towards Yarmouth, the great and ancient mart of herrings; they then pass through the British Channel, and after that in a manner disappear. Those which take towards the west, after passing the Hebrides, where the great stationary fishery is, proceed to the north of Ireland, where they meet with a second interruption, and are obliged to make a second division: the one takes to the western side, and is scarce perceived, being soon lost in the immensity of the Atlantic; but the other, which passes into the Irish sea, feeds the inhabitants of most of the coasts that border on it. These migrations are made in order to deposit their spawn in warmer seas, which mature and vivify it more certainly than those of the frozen zone. It is not from defect of food that they set themselves in motion, for they come to us full of fat, and, on their return, are almost universally observed to be lean and miserable. What their food is near the Pole we are not yet informed: but in our seas they feed much on the oniscus marinus, a crustaceous

inset, and sometimes on their own fry. The young herrings begin to approach the shores in July and August, and are then from half an inch to two inches long; those in Yorkshire are called herring file. Some of the old herrings continue on our coasts the whole year: the Scarborough fishermen never put down their nets but they catch a few, but the number that remain are not worth comparison with those that return. See FISHERIES. The Dutch are most extravagantly fond of these fish when pickled. A premium is given to the first buss that arrives in Holland with a lading of this their ambrosia, and a vast price given for each keg. Flanders had the honor of inventing the art of pickling herrings. One William Beaulken of Biverlet, near Sluys, hit on this useful expedient; from him was derived the name pickle, which we borrow from the Dutch and German.

4. *C. sprattus* has thirteen rays in the back fin. It is a native of the European seas, and has a great resemblance to the herring, only it is of a less size. They come into the river Thames below bridge in the beginning of November, and leave it in March; and are, during that season, a great relief to the poor of the capital. At Gravesend, and at Yarmouth, they are cured like red herrings: they are sometimes pickled.

5. *C. pilcardus*, the pilchard. Nose turned up; dorsal in the centre of gravity; scales firm. Appears periodically in vast shoals, on the Cornish coast, about July; body thicker and rounder than the herring; smaller; the back more elevated, and the belly not so sharp nor so serrate; is more full of oil.

CLUSIA, the balsam tree, a genus of the monogynia order and polygamia class of plants: CAL. tetraphyllous or hexaphyllous, leaflet opposite and imbricated: COR. tetrapetalous or hexapetalous: the STAM. numerous. Nectarium of anthers or glandules coalited, including the germs. The capsule is quinquelocular, quinquevalved, and full of pulp. There are six species, all natives of America. The most remarkable is the *C. flava*. It is pretty common in the British American islands, where the trees grow to the height of twenty feet, and shoot out many branches on every side, furnished with thick, round, succulent leaves, placed opposite. The flowers are produced at the ends of the branches, each having a thick succulent cover. They are succeeded by oval fruit. From every part of these trees there exudes a kind of turpentine, which is called in the West Indies hog gum; because they say, that, when any of the wild hogs are wounded, they repair to these trees and rub their wounded parts against the stem till they have anointed themselves with this turpentine, which heals all wounds. The plants are very tender, and, in this country, must be kept constantly in a stove and sparingly watered, especially in winter; for they naturally grow in those parts of the islands where it seldom rains, and consequently cannot bear much moisture. They may be propagated from cuttings, which must be laid to dry for a fortnight or three weeks, that the wounded parts may be healed over, otherwise they will rot. The best time for planting their cuttings is in July that they may be

well rooted before the cold weather comes on in autumn.

CLUSINA PALUS, in ancient geography, a lake of Tuscany, extending north-west between Clusium and Arretium, and communicating with the Arnus and Clanis. It is now called Chiana Palude.

CLUSINI FONTES, baths in Tuscany, in the territory of Clusium, between Clusium on the north and Acula on the south, eight miles from each; now called Bagni di S. Casciana.

CLUSIUM, or CAMARS, in ancient geography, a town of Tuscany, at the south end of the Palus Clusina, where it forms the Clanis; the royal residence of Porsenna, three days' journey north from Rome. It is now called Chiusi.

CLUSIUM NOVUM, in ancient geography, a town of Tuscany, near the springs of the Tiber, in the territory of Arretium, where lies the Ager Clusinus; now called Casentino.

CLUSTER, *n. s. v. n. & v. a.* } Sax. *clýster*,
 CLUSTERY, *adj.* } Dutch, *klister*.

A bunch; a number of things of the same kind, growing or joined together, as grapes on the vine; any number of creatures adhering together, as bees before they hive; applied to numbers congregated, whether stars or human beings. The idea is union and connexion, by whatever attraction, of multitudes, constituting a body. To cluster, therefore, is to grow, or to collect together; to congregate.

Grapes will continue fresh and moist all winter, if you hang them *cluster* by *cluster* in the roof of a warm room. Bacon.

His armour green might seem a fruitful vine;
 The *clusters* prisoned in the close-set leaves;
 Yet oft between the bloody grape did shine,
 And peeping forth, his jailer's spite deceives.

Fletcher's Purple Island.

Forth flourished thick the *clustering* vine, forth crept
 The smelling gourd, up stood the corny rood
 Embattled in her field. Milton.

As bees

Pour forth their populous youth about the hive
 In *clusters*. Id. *Paradise Lost*.

The luscious *clusters* of the vine
 Upon my mouth do crush their wine. Marvell.

There with their clasping feet together clung,
 And a long *cluster* from the laurel hung. Dryden.

An elm was near, to whose embraces led,
 The curling vine her swelling *clusters* spread. Pope.

My friend took his station among a *cluster* of mob,
 who were making themselves merry with their betters. Addison.

Or from the forest falls the *clustered* snow
 Myriads of gems. Thomson's *Seasons*

The flowering glade fell level where they moved,
 O'er arching high the *clustering* roses hung;
 And gales from heaven on balmy pinion roved,
 And hill and dale with gradulation rang. Beattie

Her glossy hair was *clustered* o'er a brow
 Bright with intelligence, and fair and smooth. Byron.

CLUSTER-GRAPE, *n. s.*, from cluster and grape.

The small black grape is by some called the currant, or *cluster-grape*; which I reckon the forwardest of the black sort. Mortimer's *Husbandry*.

CLUTCH, *v. a. & n. s.* Of uncertain etymology. To hold in the hand; to gripe; to grasp; to comprise; to contract; to double the hand

so as to seize and hold fast. The plural substantive is generally applied to paws and talons, and to hands in a sense of rapacity and cruelty.

Is this a dagger I see before me,
The handle toward my hand? Come, let me clutch thee.
Shakespeare.

Not that I have the power to clutch my hand,
When his fair angels would salute my palm.
Id. King John.

They
Like moles within us, heave and cast about;
And, till they foot and clutch their prey,
They never cool.
Herbert.

It was the hard fortune of a cock to fall into the
clutches of a cat.
L'Esrange.

A man may set the poles together in his head, and
clutch the whole globe at one intellectual grasp.
Collier on Thought.

Your greedy slaving to devour,
Before 'twas in your clutches power.
Hudibras.

Set up the covenant on crutches,
'Gainst those who have us in their clutches. *Id.*

I must have great leisure, and little care of myself,
if I ever more come near the clutches of such a
giant.
Stillingfleet.

When suddenly (for such the will of Jove)
A fowl enormous sousing from above
The gallant chieftain clutched, and soaring high
(Sad chance of battle) bore him up the sky. *Beattie.*

Her glance how wildly beautiful! how much
Hath Phœbus wooed in vain to spoil her cheek,
Which grows yet smoother from his amorous clutch!
Who round the north for paler dames would seek?
How poor their forms appear! how languid, wan,
and weak!
Byron.

CLUTIA, in botany, a genus of the gynandria order and dioecia class of plants; natural order thirty-eighth, tricocceæ: male CAL. pentaphyllous: COR. pentapetalous: STYLES three: CAPS. trilocular, with a single seed. There are ten species, all natives of warm climates. They are ever-green shrubby plants, rising six or eight feet, garnished with simple leaves and greenish-white quinquepetalous flowers. They are propagated by cuttings in spring or summer, planting them in pots of light earth, plunged in hot-heds. The plants must always be kept in a stove. The chief is *C. eleatheria*. Dr. Wright, in his account of the medicinal plants of Jamaica, says that this species is the same as the cascarilla and eleatheria of the shops. Other medical writers have supposed them to be distinct barks, and they are sold in the shops as different productions. Linnæus's croton cascarilla, Dr. Wright observes, is the wild rosemary shrub of Jamaica, the bark of which has none of the sensible qualities of the cascarilla.

CLUTTER, *n. s. & v. n.* See CLATTER. A noise; a bustle; a busy tumult; a hurry; a clamor. A low word.

He saw what a clutter there was with huge, overgrown pots, pans, and spits.
L'Esrange.

The favourite child, that just begins to prattle,
Is very humorous and makes great clutter,
Till he has windows on his bread and butter.
King.

Prithce, Tim, why all this clutter?
Why ever in these raging fits.
Swift.

CLUVIER, or CLUVERIUS (Philip), a celebrated geographer, born at Dantzic in 1589. He travelled into Poland, Germany, and the Netherlands, to study law; but being at Leyden, Joseph Scaliger persuaded him to cultivate his taste for geography. Cluvier followed his advice, and for this purpose visited the greatest part of the European states. He was well versed in many languages: and wherever he went obtained illustrious friends and protectors. At his return to Leyden he taught with great applause; and died in 1623, aged forty-three. He wrote 1. *De tribus Rheni Alveis*; 2. *Germania Antiqua*; 3. *Sicilia Antiqua*; 4. *Italia Antiqua*; 5. *Introductio in Universam Geographiam*. The first was written at Oxford.

CLWYD, a beautiful valley of North Wales, in Denbighshire, enclosed by high mountains, through which there are numerous gaps, and extending from the sea inwards above twenty miles, and varying in breadth from five miles to eight. This delightful vale is in high cultivation, even far up the sides of the hills; and is full of towns, villages, and gentlemen's seats. The climate is excellent, and the natives retain their vivacity to a very late period of life.

CLWYD, a river of North Wales, which rises in the middle of Denbighshire, runs through the vale of the same name, takes a compass to the south-east, then turns north-west, and, having entered Flintshire, falls into the Irish Sea.

CLYDE, a river in Scotland, which rises in Annandale, and running north-west through Clydesdale, by Lanark, Hamilton and Glasgow, falls into the sea a few miles below Greenock, over against the Isle of Bute. Next to the Tay, it is the largest river in Scotland; and is navigable for small craft up to Glasgow. The canal, which joins the Forth, falls into it a little below that city. The cataract called the Falls of the Clyde, opposite to Lanark, is a great natural curiosity, and the grandest scene of the kind in Great Britain. This tremendous sheet of water, for about a mile, falls from rock to rock. At Stonebyers the first fall is about sixty feet; the last, at Corra Lynn, is over solid rock, not less than 100 feet high. At both these places the great body of water exhibits a grander and more interesting spectacle than imagination can conceive. 'This great body of water,' says a traveller, 'rushing with horrid fury, seems to threaten destruction to the solid rocks. The horrid and incessant din, with which this is accompanied, unnerves and overcomes the heart. At the distance of about a mile from this place you see a thick mist, like smoke, ascending to heaven, over the stately woods. As you advance you hear a sul len noise, which soon after almost stuns your ears. Doubling as you proceed towards a tuft of wood, you are struck at once with the awful scene which suddenly bursts upon your astonished sight. Your organs of perception are hurried along, and partake of the turbulence of the roaring water. The powers of recollection remain suspended by this sudden shock; and it is not till after a considerable time, that you are enabled to contemplate the sublime horrors of this majestic scene.' The water-fall at Corehouse called Corra Lynn, is no less remarkable. The

banks of this river are adorned on both sides with woods, orchards, and elegant villas. In March 1787, and in the night between the 11th, and 12th of January 1797, a temporary subsiding or obstruction of the waters of this river took place, which occasioned no small speculation respecting the cause; some ascribing it to a subterraneous passage, by which the waters had run off. The phenomenon, however, was found to have been occasioned solely by the sudden freezing of a considerable part of the water, at the Shallows, between Bonniton Lynn, and the Haughs opposite to the lands of Carstairs, where the river forms a vast extent of still-running water which is apt to be frozen when a very sudden and severe frost sets in, and to remain in that obstructed state for some hours, till the water above the shallows rise to such a height as to break through, and carry down these temporary dams of ice.

CLYDESDALE, a wild district of Scotland, in the south of Lanarkshire, famous for its lead mines, which lie mostly north and east, and afford also a considerable quantity of silver.

CLYMENE, in fabulous history, the daughter of Oceanus: and the mother of Phaeton, Lampæia, Egle, and Phœbe, by Apollo. See **PHÆTOUS**.

CLYPEOLA, treacle-mustard: a genus of the silicosa order, and tetradynamia class of plants; natural order thirty-ninth, siliquose. The silicula is emarginated, orbiculated, compressed, plane, and deciduous. Species, one only, a native of France, Italy, and the warm parts of Europe, but hardy enough to bear the winters in this country.

CLYPEUS, in antiquity, a species of shield, of a round shape, usually formed of ox-hides, and smaller than the scutum. See **BUCKLER**, and the article **ARMOUR**.

CLYSSUS, in ancient pharmacy, an extract prepared from several bodies mixed. Among the moderns the term is applied to several extracts prepared from the same body, and then mixed together.

CLYSTER, *n. s.* *χλυστηρ*, an injection into the anus.

I have found, saith he [Hercules de Saxonis], by experience, that many hypocondriacall melancholy men have been cured by the sole use of *clysters*.

Burton's Anatomy of Melancholy.

If nature relieves by a diarrhœa, without sinking the strength of the patient, it is not to be stoppt but promoted gently by emollient *clysters*. *Arbuthnot.*

CLYSTERS, injections into the anus, usually administered by the bladder of a hog, sheep, or ox, perforated at each end, and having, at one of the apertures, an ivory pipe fastened with pack-thread. But the French sometimes use a pewter syringe, by which the liquor may be drawn in with more ease and expedition than in the bladder, and likewise more forcibly expelled into the large intestines. This remedy should never be administered either too hot or too cold, but tepid; for either of the former will be injurious to the bowels. Clysters are sometimes used to nourish and support a patient who can swallow little or no aliment, by reason of some impediment in the organs of deglutition. A kind of clyster,

made of the smoke of tobacco, appears to be of considerable efficacy when other clysters prove ineffectual, and particularly in the iliac passion, in the hernia incarcerata, and for the recovery of drowned persons. See **ENEMA**.

CLYTEMNESTRA, in ancient history, the daughter of Jupiter and Leda. She married Agamemnon king of Argos, who, when he went to the Trojan war, left his cousin Ægysthus to take care of his wife, his family, and domestic affairs. In the absence of Agamemnon, Ægysthus made his court to Clytemnestra, and so completely succeeded that they lived publicly together. The infidelity of Clytemnestra reached the ears of Agamemnon before the walls of Troy and he determined to take full revenge on the adulterers on his return. The execution of his schemes, however, were frustrated; Clytemnestra, with her adulterer, murdered him on his arrival, as he came out of the bath, or, as others say, as he sat down to a feast to celebrate his happy return. Cassandra, whom Agamemnon had brought from Troy, shared his fate; and Orestes would also have been deprived of his life if his sister, Electra, had not removed him from the reach of his mother. Having thus freed themselves of Agamemnon, they were publicly married, and Ægysthus ascended the throne of Argos. Orestes, after an absence of seven years, returned to Mycenæ, determined to avenge the murder of his father. He concealed himself in the house of his sister Electra, who had been married by the adulterers to a person of mean extraction and low circumstances. His death was publicly announced; and when Ægysthus and Clytemnestra repaired to the temple of Apollo, to return thanks to the gods for the death of the only surviving son of Agamemnon, Orestes who, with his faithful friend Pylades, had concealed himself in the temple, rushed upon the adulterers, and killed them with his own hands. They were buried without the walls of the city, as their remains were deemed unworthy to be laid in the sepulchre of Agamemnon. According to Æschylus, Orestes introduced himself with his friend Pylades at the court of Mycenæ, pretending to bring the news of the death of Orestes, and, when Ægysthus enquired of the particulars, he murdered him, and soon after Clytemnestra.

CLYTIA, or **CLYTE**, daughter of Oceanus and Tethys, beloved by Apollo. She was deserted by her lover, who paid his addresses to Leucothoe; and this so irritated her, that she discovered the whole intrigue to her rival's father. She at length pined away, and was changed into a flower, commonly called a sun-flower, which still turns its head towards the sun in its course, in token of her love.

CNEORUM, in botany. See **CONVOLVULUS** and **DAPHNE**.

CNESTIS, in botany, a genus of the decandria class, and pentagynia order: *CAL.* five-parted; petals five: *CAPS.* five, and bivalved: *SEED* single. Species four, natives of Sierra Leone and the west of Africa.

CNICUS, blessed thistle: a genus of the polygamia æqualis order, and syngenesia class of plants; natural order forty-ninth, composite:

CAL. ovate, imbricated with spinous branched scales, and enriched with bractæe: FLORETS, equal. Species fifty-four, of which the only remarkable one is that used in medicine under the name of *carduus benedictus*. This is an annual plant, cultivated in gardens. It flowers in June and July, and perfects its seed in autumn. For medical purposes it should be gathered when in flower, dried in the shade, and kept in a very dry airy place, to prevent its rotting or growing mouldy, which it is very apt to do. The leaves have a penetrating bitter taste, not very strong or durable, accompanied with an ungrateful flavor, from which they are in a great measure freed by keeping. Water extracts in a little time, even without heat, the lighter and more grateful parts of this plant; if the digestion be continued for some hours the disagreeable parts are taken up; a strong decoction is very nauseous and offensive to the stomach. Rectified spirit extracts a very pleasant bitter taste, which remains uninjured by time. The virtues of this plant are little known in the present practice. The nauseous decoction is sometimes used to provoke vomiting; and a strong infusion to promote the operation of other emetics. A stronger infusion, made in cold or warm water, if drank freely, and the patient kept warm, occasions a plentiful perspiration and promotes the secretions. The seeds of the plant are also considerably bitter, and have sometimes been used with the same intention as the leaves.

CNIDIA VENUS, a principal divinity of the Cnidians. Her statue was executed by Praxitelles; and was esteemed one of the finest productions of his genius.

CNIDUS, in ancient geography, a Greek town of Caria; situated on a promontory of a peninsula. It had in front a double port, and an island lying before it in form of a theatre, which, being joined to the continent by moles, made Cnidus a diopolis or double town. Eudoxus, the astronomer, had an observatory in Cnidus.

CNOSSUS, or **CNOSUS**, anciently called *Cæratos*, a city of Crete, twenty-three miles east of Gortina. Here stood the sepulchre of Jupiter, the famous labyrinth, and the palace of king Minos: its port, *Heracleum*, lay on the east side of the island.

COACERVATE, *v. a.* } Lat. *coacervo* To
COACERVA'TION, *n. s.* } heap together. The
 act of heaping; or state of being heaped, together.

The collocation of the spirits in bodies, whether the spirits be *coacervate* or diffused.

Bacon's Natural History.

The fixing of it is the equal spreading of the tangible parts, and the close *coacervation* of them. *Id.*

COACH, *n. s. & v. a.* } Fr. *coche*; Ital. *coc-*
COACH-BOX, *n. s.* } *chio, kotazy*; among
COACH-HIRE, *n. s.* } the Hungarians, a
COACH-HOUSE, *n. s.* } large covered carriage.
COACH-MAKER, *n. s.* } The French *coche* sig-
COACH-MAN, *n. s.* } nifies also a passage-
 boat on a river. Bel. *koetze*, is a coach as well as a carriage. *Koatche* is said to signify with the Huns a high waggon. With us coach is a carriage of pleasure or state, distinguished

from a chariot, which is but half a coach. Stage-coaches are vehicles of a similar construction, for the use of the public, having their fixed periods of travelling, specific roads and distances, and certain fares agreed upon by the proprietors and their employers. Hackney coaches are vehicles let out for hire, whose sphere of operation is the metropolis and places within the bills of mortality; they are subject to strict and salutary regulations; it is imperative upon them to accept every fare that offers, and in case of dispute to yield to the first applicant.

COACH, or **COUCH**, is also a sort of chamber in a large ship of war near the stern. The floor of it is formed by the aftmost part of the quarter-deck, and the roof by the poop: it is generally the habitation of the captain.

Sudden upriseth from her stately place
 The roiall dame and for he coache doth call. *Spenser.*

So forth she comes, and to her coache does clyme,
 Adorned all with gold and girlands gay,
 That seemed as fresh as Flora in her prime;
 And strove to match, in roiall rich array,
 Great Junoes golden chayre; & which they say
 The gods stand gazing on when she does ride
 To levs's high house through heaven's brass-paved
 way
 Drawne of faire peacocks, that excell in pride,
 And full of Argus' eyes their tayles dispredden wide.
Id.

Basilius attended for her in a coach, to carry her
 abroad to see some sports. *Sidney.*

Her chariot in an empty hazel-nut,
 Made by the joyner Squirrel, or old Grub,
 Time out of mind the fairies coach-makers. *Shakespeare.*

Take care of your wheels: get a new set brought,
 and probably the coach-maker will consider you. *Swift.*

Let him lie in the stable or the coach-house. *Id.*
 Suppose that last week my coach was within an
 inch of overturning in a smooth even way, and drawn
 by very gentle horses. *Id.*

Thy nags, the leanest things alive,
 So very hard thou lovest to drive;
 I heard thy anxious coachman say,
 It costs thee more in whips than hay. *Prior.*

A better would you fix?
 Then give humility a coach and six. *Pope.*

The needy poet sticks to all he meets,
Coached, carted, trod upon; now loose, now fast,
 And carried off in some dog's tail at last. *Id.*

My expences in coach-hire make no small article.
Spectator.

Her father had two coachmen, when one was in
 the coach-box, if the coach swung but the least to one
 side, she used to shriek.

Arbutnot's History of John Bull.

Another simile we mean to breach—
 A new one too!—the stage is a *stage-coach*—
 A *stage-coach*! Why!—I'll tell you if you ask it—
 Here some take place—and some mount the basket.
Garrick.

Your late old coachman, though oft splashed by
 dirt,
 And out in many a storm remains unhurt;
 Enjoys your kind reward for all his pains,
 And now to other hands resigns the reins. *Id.*

London! right well thou knowest the hour of
 prayer;
 Then thy spruce citizen, washed artisan

And snug apprentices gulp their weekly air;
 Thy coach of Hackney, whistkey, one-horse chair,
 And blumest gig through sundry suburbs whirl
 To Hampstead, Brentford, Harrow.

Byron. Childs Harold.

COACHES are suspended on leather, and moved on wheels. In Britain, and throughout Europe, they are drawn by horses, except in Spain, where they use mules. In a part of the east, especially in the dominions of the great Mogul, coaches were very lately drawn by oxen. In Denmark they sometimes yoke rein-deer in their coaches; though rather for curiosity than use. About the beginning of the sixteenth century, according to professor Beckmann, coaches of some kind were known; but their use was confined to women of the first rank; it being at that period considered disgraceful for men to ride in them. Thus the electors and princes of the empire, when they did not incline to attend the meetings of the states, made this their excuse to the emperor, that their health would not permit them to travel on horseback, and it was reckoned unbecoming to ride in carriages like women. It appears pretty evident however that about the end of the fifteenth century, the emperor, kings, and some princes, travelled in covered carriages; and likewise used them on particular public occasions. The nuptial carriage of the emperor Leopold's first wife, a Spanish princess, cost 38,000 florins, including harness. The coaches used by that emperor himself were covered over with red cloth and black nails; the harness was black, and no gold was to be seen in the whole work. The pannels were glass. On festival days the harness was ornamented with fringes of silk. All the distinction betwixt the imperial coaches, and those of the ladies in the emperor's suite, was, that the former had traces made of leather, and the latter of ropes.

Carriages were early introduced into France. A statute of Philip the Fair, issued in 1294, for the suppression of luxury, prohibits the wives of citizens from the use of them. In England the oldest coaches used by the ladies were called whirlicotes, a name now sunk into oblivion. Richard II. towards the end of the fourteenth century, when obliged to fly before his rebellious subjects, travelled with all his attendants on horseback; his mother alone, who was indisposed, riding in a coach. And even this afterwards became unfashionable, the daughter of Charles VI. showing the ladies of England, with what ease she could ride on a side-saddle. Coaches first came into use in England, according to Stow, about the middle of the sixteenth century, being introduced from Germany by the earl of Arandel. In 1598 the English plenipotentiary went to Scotland in a coach; and about 1605 they were generally used. Plenipotentiaries first appeared in coaches at the imperial commission held at Erfurt, in 1613; and in 1681 no fewer than fifty gilt coaches were to be seen at the court of Ernest Augustus of Hanover. They have since been gradually brought to perfection. Louis XIV. of France made several sumptuary laws for restraining the excessive richness of coaches, prohibiting the use of gold, silver, &c. therein.

A coach has been defined, a convenient carriage suspended on springs, and moving on four wheels

intended originally for the conveyance of persons in the upper circles of society, but now become very common among other classes, in almost all civilised countries. In London, upwards of a 1000 hackney coaches are daily employed for the conveyance of its citizens and residents from one place to another; and in Bristol, Liverpool, and Birmingham, coaches of the same kind are used.

The fashion with regard to the form and ornament of coaches and other carriages for pleasure, is perpetually changing; the chief kinds now in use, are the close coach, the landau, which can lower its roof, and part of its sides, like the head of a phaeton; the barouche, or open summer carriage, made on the lightest construction; the chariot, which is intended only for two or three persons; the landaulet, or chariot, whose head unfolds back; the phaeton and caravan, which have only a head and no windows, with a leather apron, arising from the foot-board to the waist. These all run upon four wheels.

Of the two-wheeled vehicles, there is the curricule drawn by two horses, each bearing, on a narrow saddle, the end of a sliding bar or yoke that upholds a central pole; the gig, chaise, or wiskey that have each only one horse, which moves between a pair of shafts, borne nearly horizontally, by means of a leathern sling passing over the saddle tree. When a gig, &c. has two horses, one preceding the other in harness, the machine and its horses taken together are denominated a tandem, a latin word signifying, at length. This is always a very questionable sort of vehicle for safety, especially in crowded streets or ways; but the management of it is not to be compared, certainly with another effort of noble daring which the great and scientific supplement to the Encyclopædia Britannica records. 'We have seen a vehicle, says a writer in that work, called a suicide, from the extreme danger of driving it; and there are some aspiring youths, who have far eclipsed all their competitors, by driving through the most crowded streets in very high carriages, drawn by two horses, the one before the other, supported on one narrow wheel!'

COACHES, MAIL, are stage coaches of a particular construction, carrying his Majesty's mails, which are protected by a guard, and subject to the regulations of the post-office. Until the year 1784, letters were conveyed from the metropolis to distant parts of the kingdom, and vice versa, by carts with a single horse to each, or by boys on horseback; in consequence of which many robberies were committed, delays occasioned, and losses sustained. At this period John Palmer, esq. afterwards comptroller general of the post-office, devised a new plan, which he recommended to government, as calculated to increase the revenue, accommodate the public, and be highly advantageous to all parties. It was to provide a certain number of coaches of light construction; each to be adapted to carry the various bags or packets of letters, which were destined for a particular part of the country, or line of road. All the coaches, drawn by four horses, were to leave London precisely at eight o'clock in the evening, to travel at the rate of eight miles an hour, including the time allowed for change of horses, &c. and to arrive at and leave certain post-towns at

specific times. Each coach is provided with a coachman, a guard with fire-arms, an excellent time-piece set by the Post-office clock, and allowed to carry four passengers inside and two outside. The systematic regularity, punctuality, superior safety, and expedition of the mail-coaches of England render them superior to any other public conveyance in Europe. Every coach on its arrival in town is sent to the contractor's yard for inspection, as to its condition, so that no one returns to its business liable to those accidents through want of examination that frequently occur to other coaches. The property and profits of the post, or the conveyance of letters, are vested in government, which contracts with the proprietors of coaches for the carriage of the mail; but these proprietors derive their chief profit from the fare of passengers, and carriage of small packets. The mail coaches are said to run above 13,000 miles daily. There is a similar establishment in Ireland. By 50 Geo. III. c. 48; if the coachman, or any other person having the care of the mail coach or any other carriage, shall permit any other person, without the consent of a proprietor, or against the consent of the passengers, to drive the same, or quit the box without reasonable occasion, or for a longer space of time than such occasion may require (though the reins be left for the time in the hands of the passenger on the box); or, if the coachman, or person having the care of the coach, shall by furious driving, or any negligence or misconduct, overturn the carriage, or in any manner endanger the persons or property of the passengers, or the property of the owners or proprietors of such carriage (unavoidable accidents excepted) every such coachman or person so offending, shall for every such offence forfeit not exceeding £10, nor less than £5. If the guard of a mail coach or other carriage shall fire off his arms, except for self-defence, he shall forfeit £5.

COACHES, STAGE, in Great Britain, as undertaking the conveyance of persons and parcels from one place to another, have been made the subject of various legal injunctions and provisions. Under the Commissioners of Stamps they are subject to certain mileage duties, 55 Geo. III. c. 185.

As carriers, stage-coachmen (but not Hackney coachmen of London), come under the general law of 'all persons carrying goods for hire;' and are chargeable in a limited way, with all the faults and mis-carriages of their servants. But, 1. A price must be paid, or contracted to be paid. In an action against a master of a stage-coach, the plaintiff set forth, that he took a place in the coach for such a town, and that in the journey the defendant, by negligence, lost the plaintiff's trunk; upon not-guilty pleading, the evidence was, that the plaintiff gave the trunk to the man who drove the coach, who promised to take care of it, but lost it; and the question was, whether the master was chargeable; and adjudged that he was not, unless the master takes a price for the carriage of the goods as well as for the carriage of the person, and then he is within the custom as a carrier; that a master is not chargeable for the acts of his servants, but when they are done in execution of the authority given by the master, then the act of the servant

is the act of the master, 1 Salk. 282. And 2. By the custom and usage of stages, every passenger pays for the carriage of goods above a certain weight; and there the coachman shall be charged for the loss of goods beyond such weight. 1 Com. Rep. 25. 3. In order to charge a stage-coach proprietor or carrier with the loss of goods, regard must be had to any special notice or understanding between the parties. A person delivered to a carrier's book-keeper two bags of money sealed up, to be carried from London to Exeter, and told him that it was £200, and took his receipt for the same, with promise of delivery for 10s. per cent. carriage and risk: though it be proved that there was £400 in the bags, if the carrier be robbed he shall answer only for £200, because there was a particular undertaking for the carriage of that sum and no more, and his reward, which makes him answerable, extends no farther. Carth. 486. Or, A sends goods to B who says, he will warrant they shall go safe; he is liable for any damage sustained by them, notwithstanding A sends one of his own servants in B's cart to look after them. 2 B. and P. 416.

And where the owner of a stage-coach puts out an advertisement 'that he would not be answerable for money, plate, or jewels above the value of £5, unless he had notice, and was paid accordingly;' all goods received by that coach are under that special acceptance; and if money or plate be sent by it without notice, and being paid for it, if lost, the coach owner is not liable; Gibbon v. Paynton, 4 Burr. 2298. *Izett v. Mountain*, 4 East, 371. *Nicholson v. Willan*, 5 East, 507. Not even to the extent of the £5, or the sum paid for booking, *Clay v. Willan*, H. Black. Rep. 298.—In these cases a personal communication is not necessary to constitute a special acceptance.—Advertisements, notices in the warehouse, and hand-bills, which it is probable the plaintiff saw, or which he might have seen, are sufficient.

For the protection of persons travelling by stage-coaches, the salutary provisions of 50 Geo. III. c. 48, are, That a carriage with four or more wheels, and drawn by four or more horses, shall be allowed to carry ten outside passengers and no more, exclusive of the coachman, but including the guard; and one passenger only shall be allowed to sit upon the box with the coachman, three on the front of the roof, and the remaining six behind, on any part, except on the luggage, or that part of the roof allotted for the same. Carriages drawn by two or three horses shall be allowed no more than five outside passengers, exclusive of the coachman; and all stage coaches, called long coaches, or double-bodied coaches, shall carry no more than eight outside passengers, exclusive of the coachman, but including the guard, if there be any, under such fines and penalties as are imposed by the act; provided that no child in the lap, or under seven years, shall be accounted one of this number, unless there be more than one; and if more, two such children shall be accounted equal to one grown person, and so on in the same proportion; and that no person paying as an outside passenger shall be permitted to sit as an inside passenger, unless

with the consent of one at least of the inside passengers, next to whom he shall be placed; provided also, that when the construction is peculiarly wide or commodious, and being so found shall be duly licensed for that purpose, four outside passengers shall be allowed to sit on the front of such carriage; but outside passengers shall never exceed ten in all.

No proprietor or driver of any such carriage, travelling for hire, shall permit any luggage to be carried on the roof, or any person to go as outside passenger on or about the outside of any such carriage, the top of which shall be more than eight feet nine inches from the ground, or the bearing of which on the ground shall be less than four feet six inches from the centre of the track of the right or off wheel, to that of the track of the left or near wheel, under the penalty of £5 for each offence. No luggage whatever, exceeding two feet in height, shall be conveyed on the roof of any carriage, if drawn by four or more horses; and, when drawn by two or three horses, such luggage shall not exceed eighteen inches above the roof, under the penalty of forfeiting £5 for every inch above two feet or eighteen inches respectively; if the driver so offending shall be the owner, he shall forfeit £10 for every inch above the measure above assigned, and, in default of payment, the person or persons so offending shall be committed to the common gaol or house of correction of the county, &c. where the offence was committed, for two months, unless such penalties be sooner paid; provided always, that all packages be so placed on the roof, that no passenger shall sit on them, under the penalty of 50s. for each offence, to be paid by each such passenger; and the division or space on the top allotted for luggage, shall be distinctly separated from the other part of the top, by some railing or otherwise. However, luggage may be carried of a greater height than two feet, if not more than ten feet nine inches from the ground.

The number of passengers permitted to be carried, shall be specified in the licence, and painted on the doors of the coach in legible characters; and commissioners for granting licences may order a cross plate on the side of each coach, with the owner's name, &c. instead of the above inscription; the penalty for defacing, &c. such inscription is a forfeiture of £5, and every person offending against the provisions of this act, by not having a licence, by omitting the inscription, or carrying more outside passengers than are specified in the licence and in the inscription, as above, shall for every offence forfeit £10 for each outside passenger beyond the number allowed, and double that sum if the driver or coachman be owner or part-owner. The owners of stage-coaches shall be liable to penalties if drivers cannot be found, provided that the owners cannot prove to the satisfaction of the magistrates before whom the information is laid, by sufficient evidence independent of his own testimony, that the offence was committed by the driver without his knowledge, and without any profit accruing to himself; and the driver, when found, shall pay the penalty, or be committed to the common gaol or

house of correction, for not less than three, and not more than six months.

The penalty on a driver for using abusive or insulting language to any passenger, or exacting more than his fare, is a forfeiture of not less than 5s. nor more than 40s., or a commitment for any time not exceeding one month, nor less than three days, at the discretion of the magistrate. Passengers are empowered to require toll-collectors to count the number of passengers, and to measure the height of the luggage; and the driver refusing to stop for this purpose, shall forfeit £5 for every such refusal, and if more passengers are carried than the act allows, or the luggage exceed the height assigned by it, he shall forfeit double the penalty imposed by this act for such offence, one-half to the collector for his trouble and the other half to the passenger; and if the toll-collector, upon being required by such passenger, shall refuse to make such examination, he shall forfeit £5 for every such offence; and if any person shall endeavour to evade such examination, by descending from such carriage previously to its reaching any turnpike gate, and re-ascending after it has passed such gate, he shall forfeit £10. But stage-coaches carrying no parcels or luggage inside, or in the boots, or under their beds, having obtained special licence, may carry two extra passengers.

All prosecutions must be commenced in fourteen days; persons aggrieved may appeal to the sessions. This act is a public act. And quoted in the clause respecting mail and other coaches above.

COACH-MAKING. Coach-making is an art which has, within the last fifty or sixty years, been carried to a very high degree of perfection. Coach and coach-harness makers, though of different professions, in some respects, are privileged by each other to follow either or both trades. The coach-maker is generally understood to be the principal in the business, being the person who makes the wood-work. There are, however, but very few professions in which a greater number of artisans are necessarily employed, such as wheelwrights, smiths, painters, carvers and gilders, curriers, lace-makers, woolen cloth manufacturers, and many others. We shall therefore follow this art through its various branches with some particularity of detail.

It is a first and obvious rule, that carriages of every kind should be adapted, not only to the different uses, but also to the different places for which they are intended. The best possible carriage for the paved streets of London, and other large towns, is not the most proper for country use, and one that is adapted to the excellent roads of England, would be unsuitable for the traveller on the Continent. The construction of every carriage should be as *light* as the nature of the place it is destined for, and its necessary work will admit; superior strength can only be effected by addition in the weight of materials, which a regard to the horses will make a person very careful not unnecessarily to increase. The great art then consists in building as light as possible, yet so as sufficiently to secure the carriage from danger. What a light carriage may lose by wearing a shorter time than one much

heavier, is more than compensated by the preservation of the horses.

The general form of structure in a carriage depends much on fancy, while the size must be proportioned to the intention, and regulated by the width of the seat, and the height of the roof. The timbers of the body should be of dry ash, and formed with great exactness; the pannels are made of soft straight-grained mahogany, smoothed to a fine surface, and fitted or fixed in prepared grooves, or bradded on the surfaces of the framing; the insides are to be well secured by gluing, blocking, and canvas, to the pannels; the roof and lining, or inner parts, are made of deal boards. As no parts of the framing of the body, if well executed, are likely to fail by use, a reparation in consequence of accidents is all that is to be expected.

The *pannels* generally suffer most injury, either from excessive heat, or from the bad quality of the timber: of course great attention is required in selecting good boards for this article, which, i. not dry and well-seasoned, are sure to fail by drawing from the grooves, bulging, or cracking: Even though the timbers are good, if the carriage is exposed to any excess of hot weather, it is a great chance but they will fly: but no discredit ought to attach to the builder from that circumstance. The first summer a carriage is used will prove the sufficiency of the pannels. So soon as they begin to start from the grooves, as they mostly will, in some degree, the builder should examine and relieve them where confined, to prevent cracking. A little drawing from the grooves is to be expected, and is of no material consequence; but, if they crack, it will be a disagreeable object to the eye.

As sufficient room in the carriage makes the *seats* comfortable, its capacity should be the first object, and the width of the body ought to be in proportion to the number it is meant to accommodate. Open bodies have this advantage, that three can sit with tolerable ease on the same length of seat, as would accommodate two in a confined one. A full-sized seat for a close body to contain three persons, is about four feet one or two inches; that of an open body, three feet five or six inches. This latter size is sufficient for two persons in a close carriage, but a seat of from two feet seven inches, to two feet eight or ten inches, is sufficient in the open bodies. The width across the seats is never regular, but is adapted to the shape of the body. The usual width is from fourteen to eighteen inches. The height of the seat from the bottom is in general fourteen inches, and from the seat upward to the roof, from three feet six inches to three feet nine inches, without the cushion. It frequently has been found convenient to make the seat moveable, to give freedom to certain head-dresses. Few people rise above three feet from the seat, so that, allowing two inches for the cushions, there is left in the clear, without the head-dress, from four to seven inches.

The *bodies* of a post-chaise and chariot do not differ from each other, but the purposes for which they are intended alter their name. The chariot is distinguished from the post-chaise, by the addition of a coach-box to the carriage part. The

post-chaise being intended for road work, and the chariot generally for town use. The materials of carriages meant for post work only, are somewhat lighter than those of a town carriage but, when alternately used, the strength must be sufficient for either. The framings are not required to be so strong for one or two, as for three persons. If a carriage is generally used for three, the length of the seat should be from four feet to four feet one or two inches; but if only for a third person, occasionally, three feet eight inches will be sufficient, with a seat to draw out from the centre. A greater width is usually allowed at the front, than at the back of the seat to render it more commodious for the elbows. The door-lights or windows are frequently contracted on the seat-side, that the passengers may be more secure from outward observation, while at the same time there is a sufficient view from within. The following is a description of a body complete in all its parts, as given by Mr. Felton in his excellent work on this subject.

The upper parts, except the roofs, are generally called upper quarters, that is side and back quarters. The usual mode of finishing these is by filling the vacancy with deal boardings, firmly battened on the inside, and covering the surface with leather, tightly strained on, and nailed at the inside edges; over which a moulding goes and is sewed at the outside edges, making a welt or is nailed in a prepared rabbet, and covered also with mouldings. Other quarters have the vacancy, the pillars, and rails covered with a pannel or mahogany board, finely smoothed on the outside. The leathered surface is the most secure; the pannel surface looks the best; but the brads with which they are confined, and the other nailings of the head-plates, mouldings, &c occasion them frequently to split.

The sword-case is prepared in the same manner as the quarters, either with a leather or mahogany surface.

The lower side pannels are put in an improved rounded form. It adds considerably to the fullness of the side, and exhibits the painting thereon to a much greater advantage; this is done by the door and standing pillars being left full on the outsides, and reduced by rounding them towards the bottom.

The inside work, where the glasses are contained in the front and doors, is only lined or cased with the boardings, and nailed in rabbets on those pillars which form the lights or windows; the other inside work is battening, blocking, and gluing of canvas along the edges, and across the grain of the pannels, which gluing very much preserves and strengthens them. The blocking is also a material assistance to the strength, which is done by a half-square, cut across or angle-ways, cutting it also in short lengths, and gluing the square sides against the pannel and its framing.

The tattens are long thin pieces of board placed across the grain of the wood, bradded or secured by blocks or canvas, in order to strengthen or support those parts to which they are applied.

The inside work, after being thus finished should be immediately painted all over, except

the seats, and, in particular, the door and front panels, before the lining-boards are fixed in, so as to expose no timber to the air uncovered with paint, as the air materially affects it, particularly the wide boards or pannels. They swell in wet, and shrink in dry seasons; a proper attention, in this particular, is indispensably necessary.

It may here be observed that the coach has no fore pillar like the chariot, because it has no windows in front. The bodies of the landau and landalet differ nothing in shape from those already mentioned. The landau is of the coach, the landalet of the chariot form. The weight of these is so much greater than that of the carriages in their simple structure, that they are now but seldom used. The difference, however, excepting additional strength of timber, is only from the middle rails upward, to which height the doors open. It is usual to add a spring-bolt on that side of the door which shuts, to prevent its being opened when either the glass or shutter is up.

In open carriages, as phaetons, curricles, &c. there is so great a variety of forms, that no general rule can be observed in building them, but they are mostly fashioned according to the fancy of their owner. Those intended for single horses are for the most part light, the length of the seat is generally adapted for two persons only, those for two horses are made of stronger timbers, and are more roomy. The method of hanging the bodies depends also on fancy, or a conception of ease: and some bodies are not hung at all, but fixed on the shaft of the carriage, depending entirely for their ease on the springs which are fixed underneath, and which support the shafts on the axletree. The heads to some open bodies are permanently fixed, and others are made to take off, but the addition of their weight, and their great expense, frequently render their use objectionable. The gig body is principally used in a curricle, or handsome chaise carriage. The hind loops, which suspend the weight, are fixed through the corner pillars. The method of hanging at the fore-part varies according to the taste and judgment of the builder, or the situation of the body. The side pannels may fill the space between the two pillars, but, in conformity to the present mode of building, the side is divided at the standing pillar by a door, or an imitation thereof, preserving the same shape. In either case, whether a sham or real door, it projects above the surface of the pannels. The size of the body varies according to the purposes for which it is intended, but in general the measure is from two feet ten inches to three feet two inches on the seat.

Though the word *four-wheeled* carriage usually implies a carriage complete, yet it is distinguished among builders as the under part only, or frame with the wheels, on which the body is placed. It is the carriage which bears the stress of the whole machine, and, of course, every thing depends on its strength. It should be well proportioned, according to the weight it is meant to support, always allowing rather an over than under proportion, to avoid the risk of accidents. A proper application of the iron work to support the pressure is a thing materially to be attended

to, and great care should be taken that there are no flaws in it. The timbers, which are of ash, should be of young trees, of the strongest kind, free from knots, and perfectly seasoned before they are used; as many parts of the framing are obliged to be curved, it is best to select such timbers as are grown as nearly as possible to the shape. The workmanship must be strong and firm, and not partially strained in any of its parts, as it is liable to much racking. The timbers throughout are lessened or reduced, for the sake of external appearance, which appearance is assisted also with moulding edges and carving.

All four-wheel carriages are divided into two parts; the upper and under carriage. The upper is the main one on which the body is hung, the under carriage is the conductor, and turns by means of a lever, called the pole, acting on a centre pin, called the perch bolt. The hind wheels belong to the upper part, the fore wheels to the under.

Of four-wheel carriages there are two sorts, the perch and crane-neck, in which there is a material difference in the building and properties, but this does not affect the bodies, as they will hang equally well on either. The perch carriage is of the most simple construction, and lighter than the crane-neck; and, as the width of the streets in London gives every advantage to their use in turning, they are the most general. The crane-neck carriage has by much the superiority for convenience and elegance, and every grand or state equipage is of this construction; but the weight of the cranes, and the additional strength of materials necessary for the support, make carriages of this sort considerably heavier than the other.

The track in which the wheels of every carriage are to run is generally the same, except when intended for particular roads, in which waggons and other heavy carriages are principally used: these leave deep ruts, in which light carriages must likewise go, or be liable to accident. All four-wheel carriages should have the hind and fore wheels to roll in the same track; the ordinary width of the wheels is four feet eight or ten inches, that of waggons or carts generally measure more than five feet, to which chaise wheels (being principally intended for the country) are adapted. It is immaterial to what width wheels are set, if used for running upon stones, but upon soft and marshy roads, if exactness is not attended to, the draught is considerably increased. The different heights of the hind and fore wheels make also a difference in the length of their axletrees, agreeably to the proportion they bear to each other, the fore wheel has the longest axletree by one or two inches between the shoulders.

The length of the carriage is regulated by the size or length of the body which it is intended to carry; but it always takes its measure from the centres of the hind and fore axletrees. In general, a perch-formed carriage measures nine feet two inches for a chariot, and nine feet eight inches for a coach; but in a crane-necked carriage, on account of the bow for the wheels to pass under the measure, in a chariot is nine feet six inches, in a coach ten feet.

We shall now give a more particular account of the perch described by Mr. Felton; and afterwards explain the nature of Mr. Edward Stracey's invention for an improved method of hanging the bodies, and of constructing the perches of four-wheeled carriages; by which, he says, such carriages are less liable to be overturned, and for which invention he obtained, some years since, his majesty's letters patent.

The perch is the main timber of the carriage, which extends through the hind and fore spring, transom, or bars. By it the principal part of the upper carriage is supported. The hind part is supported, and united to it, by means of hooping two extended timbers, called wings, on the side. The fore end is fixed or united to the perch by means of a strong piece hooped at the top, and framed through the fore transom, called a hooping piece; but some carriages have a horizontal wheel in the front, the same as the crane-neck carriages; and these have no hooping piece to the perch, but are secured by means of side-plates. Those on the general principle have, at the bottom in front, a flat piece, left extended, called a tongue, which goes through a large mortise in the fore axletree bed, and through which the perch-bolt passes; its use is to keep the fore axletree bed steady in its place.

Sometimes the perch is made of a bent form, called a compass perch, for the purpose of admitting the body to hang low, or to form a more agreeable line to the shape thereof; those perches are of a very ancient form, but are now revived with considerable improvement from their original shape, and are become the prevailing fashion. When the carriage is intended for a whole or horizontal wheel, the perch has no hooping-piece, but is bolted by the plates at each end to the inside of the transoms.

Plating with iron the sides of perches is a great improvement, and is now most generally done, and always must be, to those compass perches, if required to be light in their appearance, as the size of the timber is so much reduced by cutting them to this shape. To the straight or compass perch, iron plating on the sides is a great addition, as it will admit the timbers to be so much reduced, that a sufficient strength is preserved, though but half the usual size; the plates, as fixed edge-ways to the sides of the perch, will support ten times more weight than if flat-ways at the bottom, which is the method of plating a perch in the plain or common way; and many of those carriages which are made up for sale, have even the bottom plate omitted; but the certain consequence of this superficial method is, the sinking or settling of the perch, whereby the carriage is contracted quite out of its form, to the great injury of it, both for use and appearance, and there is no remedy but by a new one.

Mr. Stracey's invention embraces four objects, 1. The constructing of the perch of a four-wheeled carriage, in such a manner, that either of the axletrees may have a vertical motion independent of the other; so that the axletrees may be in different planes at the same time. 2. The hanging of the body on the springs of such a carriage, in such a manner as will tend not only to diminish the liability of its being overturned,

but add also to the ease of its motion. 3. The forming a collar-brace, which shall almost immediately bring the body to an equilibrium, should the centre of gravity be moved. 4. The forming a perch-bolt, by the use of which the carriage may be more easily turned to the right or left, and the friction that now takes place, by the use of the common perch-bolts between the wheel plates, the transom bed, and the fore axletree bed, reduced almost to nothing.

The principal variation of this invention, from the common method of hanging the body on its springs, consists in the body-loops, which must be so extended, that the ends of them may come nearly under the shackles of their respective springs, and each of them so formed, as to end in a cylindrical axis of one to two inches or more in length, and of sufficient strength to support the body; and on each of these body-loop axes, a shackle, for the reception of one of the main braces, should be fitted, ending in a cylindrical box or rocket, made so as to work and turn on the axis of the body-loop, and secured to it by a nut and pin; and the connexion between these shackles and their respective boxes should be by means of a strong joint, working towards the front and hind part of the carriage in the direction of the perch. The body is to be hung by the main braces, attached to these shackles on the springs, in the same manner as other carriage-bodies are usually hung. When the body is thus hung, the action is as follows: should either of the hind or fore wheels descend into a low spot in the road, or ascend a raised surface, the boxes or sockets on the body-loops will turn on their axes, and keep the whole on a proper equilibrium, so as not to be overturned.

Another part of the invention is the application of a cylinder to the collar-braces of carriages, by means of which, should the centre of gravity of the body of the carriage be moved by any inequalities in the road or otherwise, either to the right or left, the equilibrium will be almost immediately restored by the motion of the cylinder, or roller on its axis, and the consequent lapping and unlapping of the straps; for to whichever side the body is impelled, on that side will the collar-brace be lengthened, and of course the opposite collar-brace proportionally shortened; one side is made to operate as a check upon the other, in order to bring the body to its true centre. The last part of the invention is the perch-bolt, which being properly placed, the fore axletree bed may be turned either to the right or the left, with much greater ease than if the common perch bolt were made use of, the usual friction between the beds and wheel-plates, being almost wholly removed from their being gradually separated by the lifting of the screw, in the act of turning.—See *Repertory, New Series*, vol. xiv.

The timbers of the crane neck carriage, are of the same description as those of the last, excepting the perch and hooping timbers, which are not used. The hind and fore ends are fixed to the cranes, which makes the bearings more steady than those of a perch carriage. The whole will be better understood by the following description:—

COUCH MAKING,

Fig. 1.

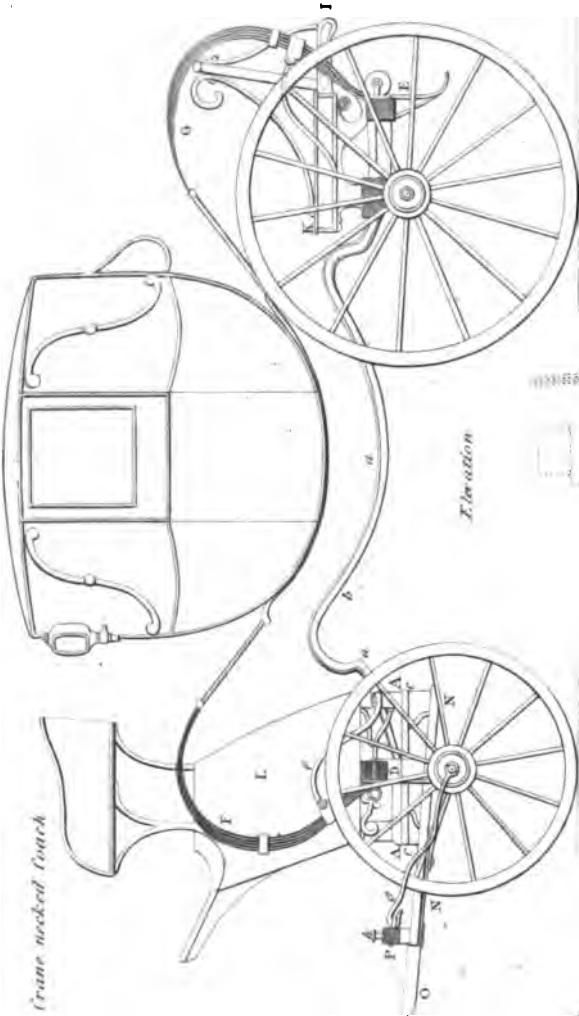

Crane necked coach

Elvation

Fig. 2.

Front view

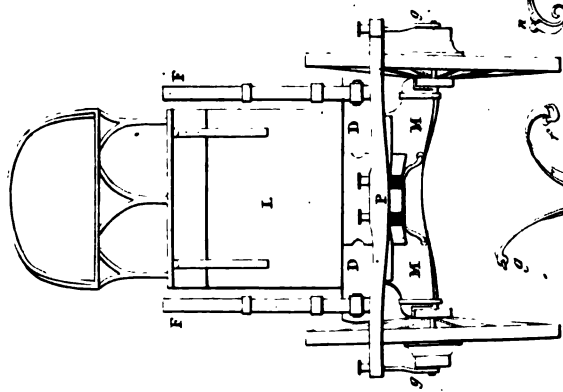

Fig. 4.



Fig. 6.



Fig. 7.

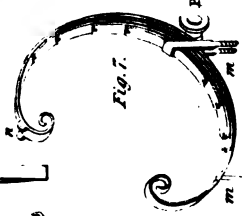
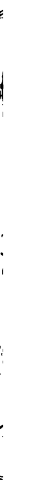

Fig. 3.



Fig. 5.



Plan

Fig. 3.

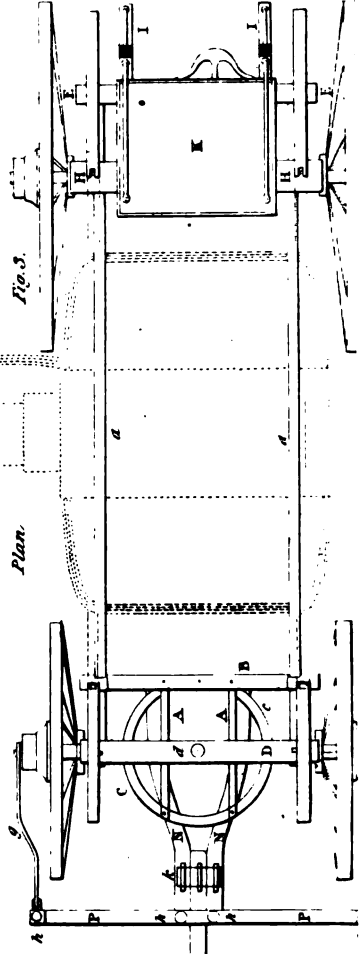

Fig. 1, plate COACH-MAKING, is an elevation of a crane-necked coach complete; fig. 2 is a front view of it, showing the fore wheels and under carriage; and fig. 3 is the horizontal plan of the same, many parts of this are too evident and universally known to require any reference, as the wheels, the body, the coach-box, the boot, the springs, &c. *a, a*, are the two cranes which are made of iron, and answer in their use to the wooden perch of the common carriage, which is the main timber of the carriage, extending and connecting the hind and fore-spring transom *D D*, and *E E*, or cross-bars which support the springs *F F* and *G G*, and thus forming one frame called the upper carriage, in which the body is suspended. The two iron cranes *a, a*, form the same connexion, but in a more complete manner, and they have a bend or neck at *b*, which admits the fore wheels to pass under them when the carriage is turned short about; the cranes are united to the fore carriage, by being screwed fast into the fore spring transom *D*, and they are farther screwed by clipping them down to a cross timber near *A*, in fig. 1, and marked *B* in fig. 3, it is called the budget bar, from the circumstance of its bearing the boot or budget, and it has two pieces *A, A*, called nunters, framed into it, which connect it with the fore transom, *D*, these pieces make a platform or frame, on which the budget immediately rests; the springs, *F*, are bolted to the transom, at the lower end, and have an iron brace *F*, fig. 1, called the spring stay.

The fore transom, or fore spring bar *D*, is the most essential part of the cross framing, it is a strong timber to which the cranes are fixed, by passing through it as before mentioned, therefore, an under carriage is attached thereto, by means of a large, round, iron pin *d*, fig. 3, which passes through its centre; on the bottom is a thick flat plate, made flush to the edges, called the transom plate, on the ends the springs are fixed, and on the top the boot, or the blocks that support it, are rested. *E* is the hind transom, or hind spring bar, something similar in its use to the fore transom, but not required to be of such strength; to this the ends of the cranes are fastened, and the timbers called nunters, which run parallel with them, are framed into it, and unite it with the hind axle bed *H*, on the ends the springs *G, G*, are fixed; the blocks or pump-handles, *I I*, are placed on the top to support the foot board *K*, or platform, and the footman's step-piece bolted on the outside. *H* is the hind axletree bed, it is a strong timber which receives the axletree, the cranes, *a a*, as before mentioned, are securely fastened to it, and it is connected by two pieces called nunters, as before mentioned, with the bend transom *E*; the bottom is grooved to receive the axletree, which groove is called the bedding of the axletree, but is usually bedded at the ends only. At the two ends of these timbers are left projections called cuttoos, which cover the top or back ends of the wheels, to shelter the axletree arms from the dirt, which would otherwise get in behind the wheels, and clog them. *I, I*, are the hind blocks, which are called pump-handles; when further extended than what is here represented, they are frequently

called raisers, as their use is only to heighten the platform from the hind framings, that the appearance may be light, and that the footman may be sufficiently raised, according to the height of the body; they are bolted on the axletree bed and spring bar *E*, and, to prevent the too heavy appearance, they are often neatly ornamented with carving.

The footboard or platform *K*, on which the cushion for the servant stands, is a flat thick elm board, bolted on with blocks, to which it is also screwed. *L*, the boot, a large box made of strong elm board, nailed and screwed together, having a door in the front, which door should be made framed and boarded, and confined by a bolt and thumb nut; the surface of this boot should always be covered with a russet, or japanning leather; it is bolted across the transom *D*, the boot or budget bar *B*, and fore blocks as shown in fig. 1; and is sometimes raised on side blocks, to lighten the appearance of the fore end of the carriage. The parts marked *M N O P*, including the fore wheels, are called the fore or under carriage, united to the upper carriage by the perch bolt. *M*, the fore axletree bed, which is required to be a strong piece of timber, in which the fore axletree is bedded; on this the upper carriage rests. In this timber the futchels, *NN*, are fixed; it is also cutloved on the end, the same as the hind bed. *NN*, the futchels, are two light timbers, fixed through the fore axletree bed, contracted in the front, to receive the pole *O*, which part of the futchels is called the chaps; but they widen towards the hind end, on the top of which the horizontal circle *PC* is placed, with proper blocks to raise it.

Across the fore ends of the chips of *NN*, the splinter board *P* is fixed; the futchels are framed in a slant direction, to give a proper height to the pole; they have iron braces beneath; but sometimes the futchels are framed in a horizontal direction, and are made to rise in a cant from the front of the horizontal wheel, otherwise the pole must be compressed to raise it to a proper height. *P*, the splinter bar, is a long timber to which the horses' traces are attached; on the ends are sockets, with eyes, on which the wheel-irons *g* are placed, and extend from thence to the ends of the axletree arms, holding the splinter-bar tightly back to oppose the strain of the draught, which is taken from the axletrees at the ends by the wheel-irons, and at the middle from the futchels, proper roller bolts, *h h*, being fixed at these situations to receive the traces by which the horses draw.

c c, The horizontal circle called a whole wheel front; it consists of two equal circles, one of which is attached to the under carriage, by bedding it on the fore axle bed *M*, and the other is fixed beneath the fore transom *D*, the flat surfaces of these circles apply to each other, and the perch bolt, *d*, is in the centre of both; their use is to preserve a steady bearing for the upper carriage to work upon while turning round, so that, in whatever direction the fore carriage may be, the steadiness is always preserved. *O*, the pole, is a long timber, which occasionally is placed in the futchel chaps *NN*, being nicely fitted therein, and is confined by two plates, the one bolted to

them at the bottom in front, and the other at the top, at the back end of the chaps; the security is also assisted by a wooden pin *k*, called a gib, which is placed across the futchels, and in a staple which is in the pole; and an iron pin also goes through the futchels and the poles at the free end; on each side of the pole the horses are stationed, and strapped to a loop at the fore end, called a pole ring; its use is to conduct the fore carriage, and may probably be called a carriage lever. *k*, The pole gib, made flat at the bottom, and rounding at the top, to fit the staple in the pole, which it keeps from using up at the fore end; it is nailed on by a loose strap to the futchels, and kept in its place by another strap nailed on the opposite side, which is hitched on a brass or plated button.

We now come to the *iron work* of carriages, of which the articles are extremely numerous, and are manufactured by many different mechanics, such as spring and tyre-smiths, &c. The whole requires to be made of particularly tough metal, and to be fitted with extreme exactness, taking care that each gives its proper support without straining or twisting, and that its substance be adequate to the weight it is meant to carry. The iron-work forms the principal part of the carriage, both for value and use; of course its properties cannot be too much attended to, we shall begin with the springs.

The *springs*, by which riding is made comfortable, require the greatest attention to their properties, otherwise their effect is materially injured. They should be all manufactured of well-tempered steel; the greater the number of plates confined within the hoop the better; and the longer the spring, the more easy and elastic its motion. Those that are the least erect, and of course that incline most to the weight which they carry, and that are also the longest, from the bearing, or stays, have superior advantages. Their forms are various, according to the purpose for which they are designed; and they take their names according to their shape, such as the S, the C, the French horn, the scroll, the worm, the single and double elbow, or grasshopper, spring. The springs support the weight at their extremities, by means of hoops and shackles; and their elasticity is from the hoops, at which parts the plates are all made thickest, gradually tapering thinner toward the extremities, and shortening about four inches in each plate, from the hoop where the bearing for the spring is fixed. Those that are placed in an erect form are supported with iron stays, which clip the spring at the hoop. Those that are placed horizontally, are supported from the middle, and play the whole length; and those that are circular, have frequently no stays, but are well secured to the bearings; short light springs that contain few plates, have frequently no hoops, but the plates are confined with a small rivet, and the bolts with which the spring is confined to its bearings. The principle of springs has been thus stated:—To produce motion when the load is fixed to the carriage, it is evident that the whole mass of the load and carriage together must be simultaneously moved; because, where all the particles of the mass are fixed, one particle cannot move till the whole

move. It is well known how much a horse is obliged to strain himself in putting a heavy load in motion; and the violent shocks he has to sustain from the jolting of the carriage, arising from the unbroken impulse of the whole mass coming upon him, are equally notorious. These disadvantages never occur, at least to the hundredth part of the amount, when the load is supported on springs; because, at the first impulse of the animal, the springs partly yield, and that part of the load which they sustain is momentarily left behind, while the carriage moves forward. When his load is therefore suspended in such a way as to allow of its vibrating freely backwards and forwards in the direction of the road, and the horse begins to pull, he has, in the first instance, only to move a part of his load, as the other part is for an instant left behind, and then gradually brought into motion. Hence, it is just in so far as springs allow the load to vibrate, that any advantage is obtained for them in drawing. A considerable advantage would, it is said, be obtained by inserting spiral springs in the traces and harness: but, to return,

Figs. 6, 7, and 8, represent some of the varieties of springs in use for carriages. Fig. 6, called a double spring, is used for a coach or chariot, and has united to it, at the back plate, an additional spring, which turns the reverse way, to carry separate things, such as the budget, or hind platform; it has a double shackle at *g*, one link of which carries the body, and the other the boot, or platform. The reverse spring has only to carry the hind part of the same boot, or platform. The stays and loops marked *a*, *b*, *c*, *d*, *e*, *f*, are for the following purpose; the stay *a* is rivetted within the hoop *b*, and clips at bottom the fore or hind transom, and is there fixed by this bolt *c*, and is supported at the hoop by a stay *d*, which rests on the hind axletree bed, or budget bar; stay *e*, also clips or bolts through the spring at bottom, and clips or unites in a cap with the other; to oppose the pressure, it has a shackle *f*, bolted loosely on the top, for the weight to hang by, and *g* is the shackle for the other spring. Fig. 7 is the scroll spring; this is a peculiar form of spring for ease, and is used to various kinds of carriages; it rests, and is fixed on a long block for phaetons, or on the two bars only for coaches, &c., at the bearings *m m*; the bottom is sometimes turned up in a scroll form, for ornament only, in imitation of the upper part; the brace is hung by a shackle, or placed round the spring, and, passing through a loop *n*, is fixed in a jack P at the bottom, which is a little roller, to take up the length of the brace at pleasure, by which the body hangs. Fig. 8 is a spring used to light whiskeys or chairs; it is fixed on the axletree, by a Jew's harp staple, at *o*, which staple is united with the spring hoop and bolts through the axletree; it supports the weight at each end by one or two loops, *p p*, which are fixed at the bottom of the shafts; it is mostly fixed at one end, but has room to play at the other. These springs most generally have only one loop at the hind end, in which it is fixed, and the other end bears on a thin plate, fixed to the bottom of the shafts; sometimes two such springs are combined together for a gib, in a manner as shown in fig. 4.

The *axletrees* of the carriage on which the wheel revolves, are of two sorts, the one is made flat, and called a bedded axletree, it being sunk in the timbers; the other is of an octagon form, flat only at the ends, which are bedded. The arms that pass through the wheels should be made perfectly round, and stronger at the shoulder than at the end, which is screwed to receive a nut; through this and the axletree the linch-pin passes to keep all tight. The nuts are made with a collar at the face, and a temporary collar or washer is driven on to the back of the arms, which forms two shoulders for the wheel to wear against, and helps to preserve the grease from running out. The axletrees, being the principal or only support of the carriage, the greatest attention and care should be given in the selection of good iron, and in the manufacture of the material; taking care that it is well wrought, and of sufficient strength; making it rather stronger than necessary, to avoid risking the life of the passenger by the oversetting of the carriage, which mostly happens when an axletree breaks. By the bend of the axletrees the wheels are regulated to any width at bottom, to suit the bracks of the roads in which they are to run, and are confined in the carriage by means of clips, hoops, and bolts. The shape of the axletree between the shoulders, varies according to its situation, or the form of the timber with which it is united; those axletrees are the most firm that are flat bedded in the timber. The axletree-boxes, frequently called wheel-boxes, are long casings fitted close to the arms of the axletree, and securely fixed in the wheel stocks or naves; they are usually made of wrought sheet iron, of a substance proportioned to the weight of the carriage. Their use is to contain a supply of grease, and to prevent the effects of friction, whereby the wheels are much assisted in their motion. There are many sorts of axletrees and boxes, either for the purpose of containing a longer supply of grease or oil; or to be more durable, or to secure the wheels, and lessen the draught. These are all great advantages, and, though the expense is great, their utility must be more than adequate to it. The common axletree and box are of a conical figure, being strongest at the back or shoulder, and regularly tapering to the end, through which the linch-pin is fitted; a nut is screwed on the end of the axle to keep the wheel on; the linch-pin passes through this nut to prevent it from turning round and coming off. This axle and box is most generally used, being simple and cheap in comparison with the others; the box is the only part which wears, and is frequently obliged to be refitted to the arms, otherwise they give the wheel an unsteady motion, and soon exhaust the supply of grease.

Mr. Collinge, of Westminster-road, has for many years past manufactured a patent cylindrical axletree and box, which has very great advantages over the common sort. They have been a considerable time in use, and their advantages have also been fully proved, which principally lie, first, in the length of time they wear; second, in the silent and steady motion they preserve to the wheels; third, the retaining the oil to prosecute a journey of 2000 miles without being once

replenished; and, fourth, they are very durable, and but little subject to be out of order. They have gone through some considerable improvements since their origin, and have met with such encouragement that it has induced other persons to copy them closely.

Fig. 5 is a section of this axletree and box, in which I is the axletree arm, made as perfectly cylindrical as possible, and of a peculiarly hard surface; the middle reduced to contain the oil necessary to feed the axletrees at the two bearings *b b*, having a shoulder *c*, against which the wheel-box, *K K*, takes its bearings; the adjoining collar is grooved for a washer to preserve the oil, and prevent noise in its use, with a rim *e e*, on the collar of the axletree, to answer the use of the cuttoo. The end *f* is double screwed, to receive two nuts for securing the wheel; the one screw turns the way of the wheel, the other the reverse, and is meant as an additional security. *K K* is the wheel-box cut through the middle, which is made of a very hard metal, nicely polished, and fitted to the arms, having a recess at the back part for containing a supply of oil. It has two shoulders *c*, the back one fits close to the rim of the collar, which it covers, the fore one projects without the surface of the wheel stock, and is screwed on the inside to receive the screw of the cap *L*, which covers the nut and receives the waste of oil, is mostly made of brass and screwed on, or in the box against the front of the wheel stock. This form of the cap is used to all but the common axletree.

The *wheels* to four-wheel carriages should be formed as nearly of a height as the appearance and construction will permit, and if not required for heavy work, or bad roads, the lighter they are the better. The fixtures from whence the draught is taken, should be placed rather above the centre of the largest wheel, for advantage of draught. The members of a wheel are of three descriptions, viz. the nave, the spokes, and the fellies; the nave is the stock, made of elm, in which all the spokes are fixed, and in which the axletree or wheel-box is confined to receive the axle-arms. The spokes are straight, made of oak, firmly tenoned in the nave; these are the support of the fellies or wheel rim. The fellies, made of ash or beech, form the rim of the wheel, and are divided into short lengths, in the proportion of one to every two spokes; these are fixed on the spokes, and on them iron strakes are nailed. The height of the wheels regulates the number of spokes and fellies that they are to contain; the larger the circumference of the wheel is, the greater number of spokes is required; they should not be more to any wheel than fifteen inches distance on the fellies. The usual height of wheels extends to five feet eight inches, and are divided in four proportions, to contain from eight to fourteen spokes, and half that number of fellies; these are denominated eights, tens, twelves, or fourteens, which are the numbers of spokes in a wheel, or fellies in a pair. The height which regulates the number for an eight-spoked wheel, should not exceed three feet two inches; for a ten, four feet six inches; for a twelve, five feet four inches; for a fourteen, five feet eight inches: these are the greatest heights for the different numbers of

spokes to each wheel. As the fore wheels of a four-wheel carriage receive more stress than the hind ones, the rule is, when the hind wheels are of that height to require fourteen spokes, the fore ones, if under the necessary height before stated, should have twelve, never allowing the fore wheels to have more than two spokes less than what is needful for the hind ones.

The patent, or bent timber wheel, has the rim of one piece bent to the circle, instead of being put together in short lengths, or fellies, which are hewn to the shape; the strength of the bent timber is preserved, while the other is destroyed; besides, it is hooped with one piece of iron, instead of being shod with strakes, and will often last twice the time in wear that the others will, and has a much lighter and neater appearance, on which account it is often preferred. The mock patent, or hooped wheel, comes very near the others in appearance and use, particularly if made with ash fellies; as the preservation of both lies chiefly in the hoops that the wheels are rimmed with. It is composed partly on the patent plan, and partly on common method, having the timber the same as the strake, and the iron as the patent wheel. The common sort of wheels are preferred by many, on account of their being more easily repaired than the hooped or patent wheel; but, though the repairing of them is more difficult, yet they are much less subject to need it.

Boots and budgets are mostly understood as one article, though so differently called; they are intended for one purpose, which is that of carrying luggage, and are usually fixed on the fore part of the carriage, between the springs; the principal difference lies in this; one is made with a loose cover, and is properly the budget, being made convenient for trunks; these sort of budgets, for travelling carriages, or common post-chaises, are, by far, the most useful, the others are boots, of a trunk form, made more square, and adapted to town carriages, but can be of no other advantage than that of carrying loose hay, horse-cloths, &c. From one or other of these boots, conveniences are sometimes made for the substitute of a coach-box, to save labor to the horse when the carriage is used for post-work, or to preserve an uninterrupted view from within. Boots are frequently used at the fore end of phaetons, and then mostly have the fore springs fixed thereto, by means of carved blocks, which are bolted to their sides; these usually have the step for the entrance to the body fixed or hung. Boots or budgets are sometimes used to the hind part of travelling carriages, but more frequently to the hind parts of phaetons, gigs, or curricles, and are of two sizes less than what are used to coaches or chariots. Platforms, raisers, or blocks, are added to a carriage, either as matter of necessity or appearance: their use is to elevate and support the budget, boot, hind foot-board, and springs; they are generally placed on the side of the carriage, and relieve the inside framings from being obscured by the platforms, as they are lightened and moulded, and give the carriage a more airy appearance.

A handsome *coach-box* is a great ornament to a carriage. Of these there are various sorts now

introduced, to save unnecessary burden to the horse, and fatigue to the driver, which are two very material objects. The objection by many persons to a coach-box, is the obstruction it gives to the view; but they may be so adapted as not materially to affect the sight; and any convenience, however simple, is better than fatiguing both man and horse; but, to carriages used in town, a substantial coach-box is indispensably necessary, as it affords so material an advantage to the driver. The standard coach-box is the most general and simple in use, as it is light, and convenient to remove; it is preferred for those carriages that are alternately used for town and country; these kind of boxes are simply fixed by means of plates, which clip the transom, and are stayed on the hind or boot bar, and fixed with collar-bolts.

The Salisbury boot, though bulky and of a heavy appearance, is by far the most convenient and fashionable coach-box in use; it is boot and coach-box together: and, although it be apparently heavy, it is not more so than the common box or boot, together, as the inside is all a cavity, which is peculiarly convenient for luggage, having a large, flat bottom, which, resting on the framings or blocks, makes it more steady than coach-boxes on the common principles. This sort, however, is not so convenient to remove, and, when taken off, the vacant space must be filled by another kind of budget, such as is usually put on to post-chaises.

We have only room to notice that Mr. Birch, of Great Queen-street, London, obtained, in the year 1807, a patent for an improvement in the construction of the roofs and upper quarters of landaus, barouches, and other carriages, the upper parts of which are made to fall down: which improvement is thus described.

'Frame and fix in the top quarter rails to the tops of the standing pillars and slats, and fix the slats to the neck plates; rabbet the under parts of the standing pillars, the top quarter rails and the slats, and board them with thin deals, or any other proper material. Let the crown-pieces or cornice rails be long enough to bevel or mitre into the corners of the top of the standing pillars; and let in the hinges and thimble catches on the top of the crown-pieces and top of the quarter rails. Fix on the hoops-ticks and back and front rails, and board them all up, except the two hoop-sticks which are nearest to the hinges, which may be placed as close as possible, to admit of the head sticking conveniently low. Conceal or let in one or more boxed locks to the centre hoop-sticks, or at least the hoops-ticks which unite the thimble catches, and fix them so as that they may be opened by a key on the inside of the carriage. Stretch strong canvas, or other fit material, and nail it, or otherwise fasten it, both on the inside and the outside of the slats and elbows, and stuff it between with flocks or tow, or other fit material. Likewise stretch and nail on or fasten canvas, or any other proper material, to the top hoop-sticks, on the roof which are nearest the hinges before you put on the leather covering.'

The patentee says, that, in travelling, a carriage built upon this construction, will carry one or more

imperials on its roof, without interfering with the regular process of opening it, and, when in that situation, will remain without doing the least injury to its upper part. Another advantage is mentioned, viz. that the spring curtains to the landaus remain without being removed, whereas those on the old plan were obliged to be taken down before there was a possibility of opening it.

The practical workman, previously to making the body of a carriage, receives a drawing made on a square canvas; by this the workman makes his patterns, marks out his timber, and saws it according to those patterns. The bottom which is the essential or main timber of the whole, as all the rest principally depend upon it, is of a circular form, four feet long, compassed six inches from the centre, two inches deep, five inches and a half wide in the centre, reduced at the ends to two inches. From the front of the bottom side, at the distant of two feet nine inches, close to the outer circle are framed the standing pillars, the length two feet six inches, one inch and three quarters thick, and two inches and three quarters deep, sweeping outward at the bottom three inches to make the side of the body of a circular form. The front pillars are two feet six inches long, and nine inches wide at the bottom, reduced by an easy sweep to two inches and three quarters at the top, and the whole is two inches and three quarters thick, framed into the front of the bottom side two inches from the point on the outer circle. The corner pillar (two feet six inches long, two inches square, compassed at the bottom five inches, to make a continuation of the sweep of the bottom side, and form a circular quarter), is let into the extreme hind point of the bottom side on the outer circle. To the inside of the bottom side, is framed the front bar three feet long, two inches and a half square, at the distance of two inches from the point, the hind bar three feet four inches long, two inches and a half square, framed in the same manner three inches from the point. On the bottom of the bottom side, is fitted a wooden rocker, which continues from end to end, three inches wide, and four deep, in the centre, reduced to a point at the ends, fixed on with iron bolts, level with the inside of the bottom side. To the rocker the bottom, consisting of deal boards grooved in each other, is nailed and strengthened with iron plates, extending from back to front; the outside elbow is then framed, the length two feet one inch and a quarter thick, and three inches wide, in the middle reduced to an inch and a half at the ends, and turns up at the back part two inches, in an easy sweep, is fixed on the standing pillar nineteen inches from the bottom side. In the hind pillar is framed the rail, three feet five inches long, one inch thick, four inches deep, twelve inches from the bottom side, over which, at the distance of five inches, is framed the sword case rail of the same length, one inch and a half square, compassed one inch, between the standing pillars framed the seat rail, four feet long, two inches square, at the distance of six inches from the bottom side, square with that to the inside of the corner pillars, is screwed the back seat rail. The front latten rail, three feet seven

inches long, three quarters of an inch thick, and one inch and three quarters deep, is framed in the front pillars, distant from the bottom point one foot four inches. The fence rail of the same dimensions ten inches higher. The doors are made with two upright pillars, both of the same dimensions and sweep as the standing pillars, one of which is called the hinge pillar, the other the shutting pillar, in which is framed a batten and fence rail, of the same dimensions and distance as the front two feet long, each compassed one inch on the outside, making a regular sweep with the elbow. In the bottom is framed the door bottom, two feet long, two inches and a half thick, and three inches and a half deep in the centre, compassed to the top of the bottom side.

The body, being now framed, is grooved out to receive the pannels and rounded off for carving: when carved the panneling commences, which is of dry mahogany, planed thin to the grooves, the hind pannel is then cut to the size between the corner pillars; the lower back rail and bottom bar being then compassed by heat to the sweep of the pillar, and fixed to the bottom sides with the pillars, through which two iron bolts are driven and screwed on the inside. The same process is observed with the front quarters, and doors; previous to which, battens are fixed to force the pannels on the sides to a circular form; the pannels are then strengthened on the inside by small pieces of wood an inch and a half square and a quarter of an inch thick, fixed all over them with glue, which is called blocking. The sword case is then fixed in the hind part, by screwing two solid pieces of ash to the corner pillar projecting in the centre eight inches, round which is turned, by means of heat, a thin deal board strengthened inside with glue and canvas; the doors are then hung with brass hinges, fixed in the fore pillars, and fastened, when shut, with a spring lock and dovetail catch to the standing pillars; round the bottom, and upright edges, are screwed brass rabbet plates, to give a good finish, and hide the joints. The pillars are then prepared for the head. In the standing pillar is fixed a strong iron joint, to which is fitted the top pillar, of two feet long and three inches square; in the top of it is fixed the top door case with a joint and hinge, three inches from the standing pillar, full length three feet six inches by three inches in the centre, reduced at both ends to two inches and a quarter; the front pillar of one foot ten inches in length, and two inches and three quarters square, fastened with a double hinge joint, the front of the door case fitted at bottom, on the top of the front pillar, and fixed to that with a strong dovetail lock; the front top rail three feet seven inches long, and two inches and a quarter square, compassed one inch, and the top and bottom is fixed to the front part of the door cases. In the centre of the fore end is fixed the middle front pillar, length four feet, two inches and three quarters wide, and an inch and a quarter thick, in the centre of which pillar, is a hock joint, the upper part fastening with a dovetail plate and bolt. The whole of the pillars are then grooved out for the glasses and blinds; the doors and front outside being now finished, the inside is boarded up with thin deal to receive

the lining and preserve the glasses. The seat is then finished, by fixing boards on the seat rails, from the back pannel one foot eight inches. The hind upper quarter is formed by two compass slats, fixed to a neck-plate in the standing pillar joint, two feet eight inches long, two inches at top, reduced to one inch at bottom and an inch thick; on the top of the hind slat is fixed the back rail, three feet five inches long, by two inches square; swept to correspond with the front rail, on the top of the other slat is fixed a hoop-stick of the same, sweep three feet ten inches by one inch thick and two inches wide. On the top of the door case are fixed three more hoop-sticks of the same dimensions, at the distance of two inches from each other. On the back of the elbow and to the corner pillar is fixed a strong iron prop, which projects six inches from the body; secured inside by an iron stay, as also one on the top of the standing pillar projecting an inch and a quarter, in the ends of which props the main joint is fixed; the lower slat and top rail is then fixed up eighteen inches from the back rail; and the upper slat and hoop-stick fixed ten inches from it; on the elbows made to the sweep are fixed two strong iron plates five inches deep. The steps are then fixed in the centre of the door way in the bottom sides with bolts, width eleven inches, depth, if treble, eleven inches, if single, sixteen inches, cased round with deal to conceal them, when the body is tumbled; the body loops are fixed on the bottom of the rockers, with bolts and nut headed screws, the hind body loops thirteen inches compressed to fancy; the front body loop to the head eighteen inches, from which proceeds a horn six inches long, joined at top to a split stay, which takes the foot board at eighteen inches distance; the other part extending upwards to the bottom of the barouch seat eighteen inches; there is also an iron stay fixed in a socket at the top part in front of the fore pillar, which fastens to the bottom of the seat at the distance of sixteen inches from the body; the width of the seat fifteen inches, and length thirty-one inches, rounded at the hind corners, made of solid board, on the top of which an iron is fixed twelve inches high, level with the outside; the foot board thirty-one inches long, seventeen inches deep, and from the seat to the centre eighteen inches, which finishes the body from the coach-makers' bench.

The body being completed from the coach-makers, it is usual next to cover the sword case with a piece of fine neat's leather prepared for that purpose, and put on wet with paste or white lead to keep it from rising in the hollow part. A very great improvement has lately taken place in covering the top part of coaches, and chariots, by putting the leather on whole, so as to prevent the possibility of wet penetrating, as was frequently the case when put on in separate pieces, and joined on each other by nails, &c. The pannels of the body are painted three or four times with oil color, and several times after with a composition of ground white lead, spruce or brown ochre, turpentine and varnish, and when hard, rubbed to a smooth surface with pumice stones and water. The color, whatever it may be, is laid a sufficient number of times to be solid,

and varnished twice, previous to arms, if any, being put on, afterwards varnished as often as required, being various according to color, &c. &c. The process of painting the carriage is, by giving it a sufficient number of coats to fill up the grain of the wood, rubbing it between each coat with fine sand paper, till it becomes smooth, then ornament it by picking out, and varnish it as often as the nature of the color requires, which never exceeds four times. The inside of the body is then trimmed, the art of which consists in fitting a lining in it composed of cloth, leather lace, &c. in the most ornamental and comfortable manner. The roof, the doors, front, bottom quarters, seat-fall, and the bottom part of the cushions are usually cloth, the upper quarters, top and bottom back, elbows, and top of the cushions morocco. The process is this; first cut out the roof and all the larger parts of the lining; fit the pockets and falls on the front and doors, the pockets and falls are usually bound with broad lace. The morocco part of the lining, with the exception of the cushions and elbows, are made with canvas backs, and bound with narrow lace, stuffed full with curled hair, and tufted with silk or worsted. When the lining is cut out and made up, proceed to line the inside of the sword case with serge, or shalloon of the color of the lining, paste up slips of cloth round the lights, and paste cloth on the recess of the door left to contain the step; nail lace all round the lights, and finish round the same with narrow lace, called parting, fix in the elbows, the bottom, back, bottom quarters, top back, and top quarters, fixing up the roof which is fastened to the hoop-sticks by narrow slips of list nailed to them, and screwed to the roof. The pillars are lined with slips of cloth, bound on each side with lace, through which the hand holders' pass, and are nailed firm to the standing pillars, fix in the front, finishing the sides with the line of lace, which forms part of the front light, fix on the door lining, finishing the edges with a row of parting lace all round. The steps are mostly now very handsomely finished, one side being morocco, and lined with cloth or velvet, welted all round, and the front bound with broad lace. The treads are usually carpet; and, besides a carpet fitted in the bottom, most carriages have spring curtains made of silk, on barrels with silvered ends, the cutting out and fixing up of which, forms a part of the inside trimming. The outside upper part is covered with oiled linen, previous to being covered with very strong-grained neat's leather, which is closed and welted together to fit the roof quarters and back, and, when fixed on, completes the trimmings of the body, the seat; the top iron is usually platted with neat's leather, and japanned, round it a squab or cushion is fitted, the back part of strong leather, the front or inside cloth puckered in full, and welted all round, stuffed and tufted, and fixed in the top iron with straps made up with buckles. Inside the iron the cushion for the seat is fitted, and a fall is fixed along the front part, a deep valance all round the seat of very strong leather, and a leather from the foot board to the front of the seat, which is called a heel leather. Bodies are, in a greater or less degree, ornamented with bending, of which there are three sorts, plated, brass, and

queen's metal; by the quality of which, buckles, handles, crests, and other ornaments are guided. On the front upper pillars are fixed the lamps, which have been much improved of late years, and are usually made to burn candles; the body and carriage thus prepared are fixed together, by suspending the body loops to the springs of the carriage, by leather braces made of several strips, strongly sewed together with buckles fixed in them; there are also cheek and collar braces, fixed to the upper and lower part of the body, to prevent any violent motion which it would otherwise have.

By law, the wares of coachmakers shall be searched, by persons appointed by the sadler's company. Stat. 1 Jac. I. c. 22. And makers of coaches, chariots, chaises, &c. must take out annual licences from the excise office, and pay a duty for every carriage built by them for sale.

COACHMAN. The driver of a coach, is ordinarily placed on a seat raised before the body. A curious circumstance, connected with this subject, is mentioned in Spanish history. The duke d'Olivarez, having found that a very important secret, mentioned in his coach had been overheard and revealed by his coachman, ordered that the place of the Spanish coachman should be the same with that of the French stage-coachman and our postillion, viz. on the first horse on the left. When lord Macartney presented to one of the Chinese mandarins a very handsome English state-coach for the emperor, the mandarin supposed the elevated coach-box in front was intended for the seat of his majesty, and when it was explained that it was for the driver of the horses, he angrily said, 'that it must be altered, for that the son of heaven would never allow any one to sit above him.'

COACT, v. n. } From *con* and act. Lat.

COACTION, n. s. } *coactus*. To act together;

COACTIVE, adj. } to act in concert. Not used.

Compulsion; force, either restraining or impelling. Having the force of restraining or impelling; compulsory; restrictive.

But if I tell how these two did *coact*,
Shall I not lye in publishing a truth. *Shakespeare.*

The Levitical priests, in the old law, never arrogated unto themselves any temporal or *coactive* power.
Raleigh.

It had the passions in perfect subjection; and, though its command over them was persuasive and political, yet it had the force of *coaction* and despotical.
South

COADJUMENT, n. s. from Lat. *con* and *adjumentum*. Mutual assistance.

COADJUTANT, n. s. from Lat. *con* and *adjuto*. Helping; operating.

Thracius *coadjutant*, and the roar
Of fierce Euroclydon. *Philips.*

COADJUTOR, n. s. from Lat. *con* and *adjutor*. A fellow-helper; an assistant; an associate; one engaged in the assistance of another.

I should not succeed in a project whereof I have had no hint from my predecessors, the poets, or their seconds or *coadjutors*, the critics.
Dryden.

Away the friendly *coadjutor* flies. *Garth's Disp.*

A gowman of a different make,
Thom Pallas, once Vanessa's tutor,
Had fixed on for her *coadjutor*. *Swift.*

In the canon law, one who is empowered or appointed to perform the duties of another.

A bishop that is unprofitable to his diocese ought to be deposed and no *coadjutor* assigned him. *Ayliffe.*

COADJUVANCY, n. s. from Lat. *con* and *adjuvo*. Help; concurrent help; contribution of help; co-operation.

Crystal is a mineral body, in the difference of stones, made of a lentous percolation of earth, drawn from the most pure and limpid juice thereof, owing to the coldness of the earth some concurrence and *co-adjuvancy*, but not immediate determination and efficiency.
Brown's Vulgar Errors.

COADUNATÆ, in botany, an order of plants in the fragmenta methodi naturalis of Linnæus. See **BOTANY.**

COADUNITION, n. s. from Lat. *con, ad, unio*. The conjunction of different substances into one mass.

Bodies seem to have an intrinsic principle of, or corruption from, the *coadunion* of particles endowed with contrary qualities. *Hale's Origin of Mankind.*

COAGMENT, v. a. } From Lat. *con* and
COAGMENTATION, n. s. } *agmen*. To congregate or heap together. I have only found the participle in use. Collection, or coacervation, into one mass; union; conjunction.

The third part rests in the well-joining, cementing, and *coagmentation* of words, when it is smooth, gentle, and sweet. *Ben Jonson.*

Had the word been *coagmented* from that supposed fortuitous jumble, this hypothesis had been tolerable.
Glanville.

COAGULATE, v. a. & v. n. } Lat. *coagulo*.
COAGULABLE, adj. } To force into
COAGULATION, n. s. } concretions; as
COAGULATIVE, adj. } by affusions of
COAGULATOR, n. s. } some other substance; to turn milk; that which is capable of concretion; to run into concretions, or congelations. The remaining derivatives have the same application, according to their respective parts of speech.

Sal tartre, alcaly, and salt preparat,
And combust materes, and *coagulat*.

Chaucer. Canterbury Tales.
Roasted in wrath and fire,
And thus oversized with *coagulate* gore. *Shakespeare.*

Vivification ever consisteth in spirits attenuate,
which the cold doth congeal and *coagulate*.
Bacon's Natural History.

Spirit of wine commixed with milk, a third part spirit of wine, and two parts milk, *coagulateth* little, but minglcth; and the spirit swims not above. *Bacon.*

Stones that are rich in vitriol, being often drenched with rain-water, the liquor will then extract a fine and transparent substance, *coagulable* into vitriol.
Boyle.

About the third part of the oil olive, which was driven over into the receiver, did there *coagulate* into a whitish body, almost like butter. *Id.*

To manifest the *coagulative* power, we have sometimes in a minute arrested the fluidity of new milk, and turned it into a curdled substance, only by dexterously mingling with it a few drops of good oil of vitriol. *Id.*

As the substance of *coagulations* is not merely saline, nothing dissolves them but what penetrates and relaxes at the same time. *Arbuthnot*

COAGULATION, in chemistry, the act of rendering a fluid body, in some degree, solid, by exposure to cold, or by the addition of some agent by which it is decomposed. Thus the white of eggs, the serum of the blood, &c. are coagulated by the addition of alcohol; milk by mixture with acids; the serum of the blood by exposure to heat, &c. Some writers have called crystallisation by the same name. See **ALBUMEN**.

COAK, a kind of charred fossile coal. For the exciting intense heats, as for the smelting of iron ore, and for operations where the acid and oily particles would be detrimental, as the drying of malt, coals are previously charred, or reduced to coak; that is, they undergo an operation similar to that by which charcoal is made. By this operation coals are deprived of their phlegm, their acid liquor, and part of their fluid oil. Coak, therefore, consists of the two most fixed constituents parts, the heavy oil and the earth, together with the acid concrete salt, which, though volatile, is dissolved by the oil and the earth. It is used in metallurgic works all over Britain, and gives most intense heat. See below.

COAL, *n. s.* & *v. a.* } Sax. col; Lat. *calor*;
COAL-BLACK, *adj.* } heat. A peculiar mineral
COAL-BOX, *n. s.* } fossil fuel; any
COAL-MINE, *n. s.* } thing inflamed or ignited.
COAL-PIT, *n. s.* } Black, of the
COAL-STONE, *n. s.* } darkest species, is the
COAL-WORN; *n. s.* } color of the fossil-coal.
CO'ALERY, *n. s.* } Writing on a light surface,
CO'ALY, *adj.* } with a piece of
 coal, Camden calls coaling; 'he coaled out rhimes upon the wall.' To coal, is to burn, or to convert into coal any substance capable of such transformation by fire.

Sered pokettes, sal peter, and vitriole;
 And divers fires made of wode and cole.

Chaucer's Canterbury Tales.

Instede of cote-armure,—on his harnais,—
 With mayles yelive and bright as any gold,—
 He hadde a beres-skin, *cole-blake* for old. *Id.*

As burning *Ætna*, from his boiling stew,
 Doth belch out flames, and rocks in pieces broke,
 And ragged ribs of mountains molten new,
 Enwraup in *coal-black* clouds and filthy smoke.

Færie Queene.

You are no surer, no,
 Than is the coal of fire upon the ice,
 Or hailstones in the sun. *Shakespeare.*

You have blown this coal betwixt my lord and me. *Id.*

Whatsoever doth so alter a body, as it returneth not again to that it was, may be called alteratio major; as when cheese is made of curds, or coals of wood, or bricks of earth. *Bacon.*

Charcoal of roots, *coaled* into great pieces, lasts longer than ordinary charcoal. *Id.*

Or *coaly* Tyne, or ancient hallowed Dee. *Milton.*

Coal-black his color, but like jet it shone;
 His legs and flowing tail were white alone.

Dryden.

Leave a pail of dirty water, a *coal-box*, a bottle, a broom, and such other unsightly things. *Swift.*

Coal-stone flames easily, and burns freely; but solds and endures the fire much longer than coal.

Woodward.

Two fine stalactites were found hanging from a black stone, at a deserted vault in Benwell *coalery*. *Id.*

A leaf of the polyphy kind, found in the sinking of a *coal-pit*. *Id.*

There is a vast treasure in the old English, from whence authors may draw constant supplies; as our officers make their surest remits from the *coal-works* and the mines. *Felton.*

Springs injure land, that flow from *coal-mines*. *Mortimer.*

Henry III. granted a charter to the town of Newcastle, in which he gave the inhabitants a license to dig *coal*. This is the first mention of *coal* in England.

Hume's History of England.

COAL, among chemists, is synonymous with charcoal, and in the new nomenclature is styled carbon. See **CHARCOAL** and **CHEMISTRY**, **INDEX**. In the burning of charcoal one part of it exhales without decomposition, and forms a vapor, or an invisible gas, called fixed air or carbonic acid. This vapor is found to be very pernicious, and to affect the animal system in such a manner as to occasion death in a very short time. For this reason it is dangerous to remain in a close place where charcoal, or any other sort of coal, is burnt. Persons struck by this vapor are stunned, faint, suffer a violent head-ache, and fall down senseless and motionless. The best method of recovering them is by exposure to the open air, and by making them swallow or breathe the steam of vinegar.

COAL, in mineralogy, a kind of solid inflammable substance, supposed to be of a bituminous nature, and commonly used for fuel. Of this substance there are various species, viz.

COAL, BOVEY, XYLANTHRAX, of a brown or brownish-black color, and of a yellow laminar texture. According to the German chemists its ashes contain a little fixed alkali; but Mr. Mills disputes this. It is found in almost all the countries of Europe. See **XYLANTHRAX**.

COAL, CANNEL, AMPELITES, of a dull black color. It breaks easily in all directions; and, if broken transversely, presents a smooth conchoidal surface. It burns with a bright lively flame, but is very apt to fly in pieces in the fire; however, it is said to be entirely deprived of this property by immersion in water for some flours previous to its being used. It contains a considerable quantity of petrol in a less condensed state than other coals. Its specific gravity is about 1270. See **AMPELITES**.

COAL, CULM, called kolm by the Swedes, has a greater portion of argillaceous earth and vitriolic acid, with a moderate proportion of petrol. It has the same appearance which the lithanthrax, though its texture is more dull: it burns with a flame, without being consumed, but leaves behind it a slag of the same bulk with the original volume of the coal. Kirwan thus describes it in the Memoirs of the Stockholm Academy: 'its fracture has a rougher section than the *cannel coal*; its specific gravity is from 1300 to 1370. The best kind affords by distillation, at first, fixed air; then, an acid liquor; afterwards, inflammable air, and light oil of the nature of petrol; then, a volatile alkali, and, lastly, pitch oil. The residuum is nearly three-

fourths of the whole; and being slowly burnt, affords thirteen per cent. of ashes, which consists mostly of argillaceous earth; and about 300th parts of them are magnetic. It is found in England and among some alluminous ores in Sweden.'

COAL, KILKENNY, is the lightest of any; its specific gravity being only about 1400. It contains the largest quantity of asphaltum; burns with less smoke and flame, and more intensely, though more slowly, than the cannel coal. The quantity of earth it contains does not exceed one-twentieth part of its weight; but this kind of coal is frequently mixed with pyrites. It is found in Kilkenny, Ireland. Its quality of burning without smoke, is proverbially used as an encomium on the country.

COAL, PIT. Pit coal is a black, solid, compact, brittle mass, of moderate hardness, lamellated structure, more or less shining, but seldom capable of a good polish; and does not melt when heated. According to Kirwan, it consists of petrol or asphaltum, intimately mixed with a small portion of earth chiefly argillaceous; seldom calcareous; and frequently mixed with pyrites. A red tincture is extracted from it by a spirit of wine, but caustic alkali attacks the bituminous part. 'The varieties of this coal,' says Mr. Magellan, 'are very numerous, according to the different substances with which it is mixed.' See **COAL-MINE**, sect. VIII. 'But in regard to their economical uses, only two kinds are taken notice of by the British legislature, viz. culm, and caking coals. The caking coals, in burning, show an incipient fusion, so that their smallest pieces unite in the fire into one mass; by which means the smallest pieces, and even the mere dust of this kind, are almost equally valuable with the largest pieces. The culm does not fuse or unite in the fiercest fire; so that the small coal, being unfit for domestic purposes, can only be used in burning limestone.' See **CULM**, and **LITHANTHRAK**.

COAL, SLATE, contains such a quantity of argillaceous earth, that it looks like common slate; however it burns by itself with a flame. M. Magellan is of opinion that this is the bituminous schistus, already described under **CLAY**. This schistus is of a dark, bluish, rusty color; when thrown on the fire it burns with a lively flame, and almost as readily as the oily wood of dry olive tree, or lignum vitæ; emitting the very disagreeable smell of petrol. Such large quarries of it are found near Purbeck in Dorsetshire, that the poorer part of the inhabitants are thence supplied with fuel. From the appearance of this slaty coal, Cronstadt had been induced to suppose that the earth of all kinds of coal is argillaceous, though it is not so easy to distinguish it after being burnt. The pit coals, he says, contain more or less of the vitriolic acid; for which reason the smoke arising from them attacks silver in the same manner as sulphur does, let the coals be ever so free from marcasite, which however, is often imbedded or mixed with them.

COAL, SULPHUREOUS, consists of the former kinds mixed with a very considerable portion of pyrites; whence it is apt to moulder and break when exposed to the air, after which water will

act upon it. It contains yellow spots that look like metal; burns with a sulphureous smell, leaving behind it either slag or sulphureous ashes, or both. Its specific gravity is 1500 or more.

The above are the most considerable varieties of coal commonly known; but we must not imagine that each of them is to be met with in a homogeneous state. On the contrary, the different qualities and proportions of their ingredients make a vast number of other varieties, fit for different purposes, according to the quality and quantity of those they contain. Some of the finer sorts generally run like veins between those of a coarser kind. M. Magellan observed in the fine coal employed in a curious button manufactory at Birmingham, that it produced a much clearer flame than he had ever observed from common coal; yet, on enquiry, he found that the former was picked out from the common coal of the country, through which it ran in veins, and was easily distinguished by the manufacturers. Fourcroy remarks, that this fossil bitumen, when heated in contact with a body in combustion, provided it has a free access of air, kindles the more slowly and with the greater difficulty, in proportion as it is more weighty and compact. When once kindled, it emits a strong and durable heat, and burns for a long time before it is consumed. The matter that is burned, and produces the flame appears very dense, and seems united to some other substance which retards its destruction. On burning it emits a peculiar and strong smell, which is not at all sulphureous when the coal contains no pyrites. When the combustible, oily, and other volatile parts of the coal are dissipated, if the combustion be then stopped, the remainder is reduced to a true charred state, and is called coak. It is well known, says M. Magellan, that the English method of burning pit coal into coak has been a most profitable and happy acquisition for the smelting our ores, and for many other metallurgical and chemical processes in this island. But the ingenious and extensive undertaking of lord Dundonald, by which he turns to very valuable purposes the mines of coal in his and other estates, building ovens of a proper construction for burning pit-coal into coak, and at the same time for collecting, in separate receptacles, the volatile alkali, oil, tar, and pitch, which were generally lost by the usual method, deserves to be noticed, as it affords a very remarkable instance of the great losses to mankind, for want of carefully attending to every result from great processes of art when made on a large scale. These ovens are so contrived, as to admit an under supply of air; and the coals, after being kindled, decompose themselves by a slow but incomplete combustion, which does not destroy the ingredients. The residuum left in the oven proves to be most excellent cinders or coaks, whilst the volatile parts which otherwise would be dissipated in the air, are separated and condensed in reservoirs or receptacles of capacious size, placed at proper distances beyond the reach of fire. M. Faujas de St. Fond, who visited these works in a trip he made to Scotland, undertook to erect a similar kind of oven in France. On subjecting

pit coal of any kind to distillation in close vessels, it first yields a phlegm or watery liquor; then an ethereal or volatile oil; afterwards a volatile alkali; and lastly, a thick and greasy oil; but it is remarkable, that, by rectifying this last oil, a transparent thin and light oil of a straw color is produced, which, being exposed to the air, becomes black like animal oils. From these and similar observations, Messrs. Magellan, Chattal, and others, have inferred, that pit coal is originally a vegetable substance.

COAL, SMALL, is a term sometimes used for a sort of charcoal prepared from the spray and brushwood stripped off from the branches of coppice wood, sometimes bound in barns for that purpose, and sometimes charred without binding, in which case it is called coming together.

Kirwan divides carbonaceous substances into four species, of which the first two contain almost all the varieties of coal. i. Native mineral carbon, the *blende kohle* of Werner, of which the coal found near Kilkenny and the culm of Wales is a species. The former he thus characterises:—Its color is black, and when fresh broken some parts of it generally display a violet color. Its lustre, 4. Metallic. Transparency, 0. Fracture foliated, and the course of the lamellæ variously and confusedly directed. Its fragments, from 2 to 3, often coated with whitish illunitions. Hardness, 7. Specific gravity, 1.526. Will not burn till wholly ignited, and then slowly consumes, without caking, or emitting flame or smoke.

ii. Mineral carbon, impregnated with bitumen, which he subdivides into three families, and thus describes:—

First Family.—Mineral carbon, impregnated with maltha; cannel coal.—First variety.—Compact. This is found chiefly in Lancashire, its proper name is candle-coal, as it burns like a candle; but candles in that shire are called cannels. Its color is black. Lustre, common. Transparency, 0. Cross fracture, conchoidal. Fragments, from 2 to 3. Hardness, from 7 to 8. Specific gravity, 1.273 per Watson, or 1.232 by my trials. Does not stain the fingers; easily kindles, and burns with a large bright flame, but of short duration, and then leaves a sooty residuum that difficultly burns; does not cake; 240 grains of it heated until all the coaly part was consumed, left 7.5 of reddish-brown ashes, mostly argillaceous and siliceous; 100 parts of it contain by my analysis 75 carbon, 21.7 maltha, and 312 of ashes.

Second Variety.—Slaty.—This coal comes to us from Scotland, where it is called splent-coal. Its color is grayish-black. Lustre, 2, common. Transparency, 0. Fracture, partly slaty and partly imperfectly conchoidal. Fragments, 3. Hardness, from 5 to 8. Brittle. Specific gravity, 1.426, by my trials; burns as the former variety, but soon ceases to flame; does not cake, and leaves a stony residuum; 240 grains of it, treated as the former, left 50 grains of reddish-gray ashes; 100 parts of it contain by my analysis 47.6 carbon, 31.6 maltha, and 20.8 of ashes. 'I even doubt,' says this mineralogist 'whether it contains so much carbon,

for the best specimens discovered by the smell, when inflamed, a proportion of sulphur.'

Second Family.—Mineral carbon, impregnated with asphalt and maltha, in various proportions. Peckhole, Schiefer, kohle of Werner.—Its color is more or less perfectly black, sometimes presenting bright reddish-yellow illunitions, sometimes variegated. Lustre, from 2 to 4, seldom common, mostly greasy or metallic. Transparency 0. Fracture various, mostly foliated, plain, or curved, large or small granularly foliated, sometimes in layers of contrary directions, sometimes promiscuously directed, sometimes presenting small conchoidal distinct concretions, sometimes striated; often in the gross; slaty. Its fragments, 2, often oblong parallelipeds. Hardness, from 4 to 6. Specific gravity, from 1.25 to 1.37, stains the fingers, if moist, or disintegrating, otherwise not. Inflames more slowly, but burns longer than the former family, and cakes more or less, according to the proportion of asphalt. It is often contaminated with lumps, or veins of martial pyrites, sometimes with alum, or intersected with veins of spar. Of this family there are numerous varieties.

First Variety.—From Whitehaven.—Black. Lustre 3, greasy. Fracture plane foliated. Fragments 2. Hardness 6, very brittle. Specific gravity 1.257; 240 grains of it exposed to a heat of 27° for five hours, after flaming a considerable time, caked, and at last left fourteen grains of reddish ashes; 100 parts of it contain by my analysis 56.8 carbon, and 43 of a mixture of asphalt and maltha, in which the asphalt predominates.

Second Variety.—From Wigan.—Black. Lustre 3, greasy, often with bright yellowish illunitions. Fracture foliated, some laminae uniformly, some promiscuously directed, in the gross slaty. Fragments 2. Hardness 6. Specific gravity 1.268, burns more quickly than the former; 382 grains of it exposed in an open crucible, like the former, to a heat of 27°, for four hours, left a residuum of 5.13 grains of reddish-brown ashes.

Third Variety.—From Swansea.—Black. Lustre, 2. Fracture, foliated, but from a contrary direction of the lamellæ seems in part fibrous. Fragments 2. Hardness 5, very brittle. Specific gravity 1.357, burns more slowly than the former varieties; 240 grains of it, treated as above, left eight grains of yellowish-red ashes. One hundred parts of it contain 73.53 of carbon, 23.16 of a mixture of asphalt and maltha, in which the former appears to predominate, and 5.21 of gray ashes.

Fourth Variety.—From Leitrim.—Black. Lustre 3. Fracture, foliated. Fragments, 2. Hardness, 6, very brittle. Specific gravity, 1.351; 240 grains of it exposed to heat, as before, left in three hours a residuum of 12.5 of reddish-gray ashes; one hundred parts of it contain 71.42 of carbon, 23.37 of a mixture of asphalt and maltha, in which the latter appears to predominate, and 5.21 of gray ashes.

Fifth Variety.—From Irvine, in Scotland.—Black. Presents layers in contrary directions, hence often called ribband-coal. Lustre of the alternate layers 3, 2. Fracture small grained

and coarse grained curved foliated. Hardness from 4 to 5. Specific gravity 1.259. Its composition I have not examined. The specific gravity of good bituminous coal never exceeds 1.4, except it contains some quantity of interspersed pyrites.

Third Family.—Carbon bituminated, impregnated with a notable proportion of stony matter. Spurious Coal.—I call the proportion of stony matter notable when it exceeds 25 per cent. Its color is grayish-black. Lustre 0.1. Fracture slaty or earthy. Fragments quadrangular, 3. Hardness from 7 to 8. Specific gravity from 1.500 to 1.600. It commonly explodes and bursts when heated; generally found amidst strata of genuine coal. Buffon tells us that the coal of Alaies is mixed with such a quantity of limestone, that it is often burned for the sole purpose of obtaining lime from it.—2 *Buffon Mineralog.* 8vo. p. 189.

Macquer remarked long ago that nitre detonates with no oily or inflammable matter, until such matter is reduced to coal, and then only in proportion to the carbonaceous matter it contains. Hence it occurred to Mr. Kirwan that, as coals appear in distillation to be for the most part merely compounds of carbon and bitumen, it should follow that, by the decomposition of nitre, the quantity of carbon in a given quantity of every species of coal may be discovered, and the proportion of bitumen inferred. This celebrated chemist accordingly projected on a certain portion of nitre in a state of fusion, successive fragments of various kinds of coal, till the deflagration ceased. Coal, when in fine powder, was thrown out of the crucible. The experiments seem to have been judiciously performed, and the results are therefore entitled to as much confidence as the method permits. Lavoisier and Kirwan state, that about thirteen parts of dry wood charcoal decompose 100 of nitre.

100 parts	Char-coal.	Bitumen.	Earth.	Sp.gr
Kilkenny coal	97.3	0	3.7	1.526
Coamp. cannel	75.2	21.68 maltha	3.1	1.232
Swansen	73.53	23.14 mixt.	3.33	1.357
Leitrim	71.43	23.37 do.	5.20	1.351
Wigan	61.73	36.7 do.	1.57	1.268
Newcastle	58.00	40.0 do.	—	1.271
Whitehaven	57.0	41.3	1.7	1.257
Slaty cannel	47.62	32.52 mal.	20.0	1.426
Asphalt	31.0	68.0 bitumen	—	1.117
Maltha	8.0	—	—	2.07

100 parts of the best English coal give, of coal, . . . 63 by Mr. Jars.
 100 do. 73 Hielm.
 100 do. Newcastle do. 58 Dr. Watson.
 Kirwan says he copied the result, for Newcastle coal, from Dr. Watson.

Werner, without including the beds of coal found on a sandstone or limestone basis, has ascertained three distinct coal formations.

The first, or oldest formation, he calls the independent coal formation, because the individual depositions of which it is composed, are inde-

pendent of each other, and are not connected. The second is that which occurs in the newest floetz-trap formation; and the third occurs in alluvial land. Werner observes, that a fourth formation might be added, which would comprehend peat and other similar substances; so that we should have a beautiful and uninterrupted series, from the oldest formation to the peat, which is daily forming under the eye. The independent formation contains exclusively coarse coal, foliated coal, cannel coal, slate coal, a kind of pitch coal, and slaty glance coal. The latter was first found in this formation in Arran, Dumfries-shire, Ayrshire and at Westcraigs, by Professor Jameson. The formation in the newest floetz-trap contains distinct pitch coal, columnar coal, and conchoidal glance coal. The alluvial formation contains almost exclusively earth coal and bituminous wood. The first formation, besides coal, contains three rocks which are peculiar to it; these are a conglomerate, which is more or less coarse-grained; a friable sandstone, which is always micaceous; and lastly, slate-clay. But besides these, there occur also beds of harder sandstone, marl, limestone, porphyritic stone, bituminous shale, clay-ironstone; and, as discovered by Professor Jameson, greenstone, amygdaloid, and graphite. The slate-clay is well characterised, by the great variety of vegetable impressions of such plants as flourish in marshes and woods. The smaller plants and reeds occur in casts or impressions always laid in the direction of the strata; but the larger arborescent plants often stand erect, and their stems are filled with the substance of the superincumbent strata, which seems to show that these stems are in their original position. The leaves and stems resemble those of palms and feras. The central, northern, and western coal-mines of England; the river coal districts of the Forth and the Clyde, and the Ayrshire, and in part the Dumfries-shire coals, belong to this formation, as well as the coals in the northern and western parts of France.

The most valuable and extensive beds of coal which have been found and wrought, are in Great Britain. The general form of our great independent coal-beds, is semi-circular, or semi-elliptical, being the segment of a great basin. The strata have a dip or declination to the horizon of from 1 in 5, to 1 in 20. They are rarely vertical, and seldom perfectly horizontal to any considerable extent. Slips and dislocations of the strata, however, derange more or less the general form.

Professor Jameson has divided this most useful mineral into the following species and sub-species:—

Species 1. Brown coal.

Species 2. Black coal, of which there are four sub-species; slate coal, cannel coal, foliated coal, and coarse coal.

1. Slate coal. Its color is intermediate between velvet-black, and dark grayish-black. It has sometimes a peacock-tail tarnish. It occurs massive, and in columnar and egg-shaped concretions. It has a resinous lustre. Principal fracture slaty; cross fracture imperfect, conchoidal. Harder than gypsum, but softer than calcareous spar. Brittle. Sp. gr. 1.26 to 1.38. It burns longer than cannel coal; cakes more or

less, and leaves a slag. The constituents of the slate coal of Whitehaven, by Kirwan, are 56·8 carbon, with 43·2 mixture of asphalt and maltha, in which the former predominates. This coal is found in vast quantities at Newcastle; in the coal formation which stretches from Bolton, by Altonby and Workington, to Whitehaven. In Scotland, in the river district of Forth and Clyde; at Cannoby, Sanguhar, and Kirconnel, in Dumfries-shire; in Thuringia, Saxony, and many other countries of Germany. It sometimes passes into cannel and foliated coal.

2. Cannel coal. Color between velvet and grayish-black. Massive. Resinous lustre. Fracture flat-conchoidal, or even. Fragments trapezoidal. Hardness as in the preceding sub-species. Brittle. Sp. gr. 1·23 to 1·27. It occurs along with the preceding. It is found near Whitehaven, at Wigan, in Lancashire, Brosely, in Shropshire, near Sheffield; in Scotland, at Gilmerton and Muirkirk, where it is called parret coal. It has been worked on the lathe into drinking vessels, snuff boxes, &c.

3. Foliated coal. Its color is velvet-black, sometimes with iridescent tarnish. Massive, and in lamellar concretions. Resinous or splendid lustre; uneven fracture; fragments approaching to trapezoidal. Softer than cannel coal; between brittle and sectile. Easily broken. Sp. gr. 1·34 to 1·4. The Whitehaven variety consists, by Kirwan, of 57 carbon, 41·3 bitumen, and 1·7 ashes. It occurs in the coal formations of this and other countries. It is distinguished by its lamellar concretions, splendid lustre, and easy frangibility.

4. Coarse coal. Color dark grayish-black, inclining to brownish-black. Massive, and in granular concretions. Glistening lustre. Fracture imperfect, scaly. Fragments indeterminate, angular. Hardness as above. Easily frangible. Sp. gr. 1·454. It occurs in the German coal formations. To the above, Professor Jameson has added soot-coal; which has a dark grayish-black color; is massive; with a dull semi-metallic lustre. Fracture uneven; sometimes earthy. Shining streak; soils; is soft, light, and easily frangible. It burns with a bituminous smell, cakes, and leaves a small quantity of ashes. It occurs along with slate-coal in West-Lothian and the Forth district; in Saxony and Silesia.

Species 3. Glance-coal, of which the Professor gives two sub-species, pitch-coal and glance-coal.

1. Pitch-coal. Color velvet-black. Massive, or in plates and botroidal branches, with a woody texture. Splendent and resinous. Fracture, large perfect conchoidal. Fragments sharp-edged and indeterminate angular; opaque; soft; streak brown-colored. Brittle. Does not soil. Sp. gr. 1·3. It burns with a greenish flame. It occurs along with brown coal in beds, in floetz, trap, and limestone rocks, and in bituminous shale. It is found in the Isles of Sky and Faroe, in Hessa, Bavaria, Bohemia, and Stiria. It is used for fuel, and for making vessels and snuff-boxes. It is called black amber in Prussia, and is cut into rosaries and necklaces. It is distinguished by its splendid lustre and conchoidal fracture. It was formerly called jet, from the river Gaga in Lesser Asia.

2. Glance-coal; of which we have four kinds,

conchoidal, slaty, columnar, and fibrous. The conchoidal has an iron-black color, inclining to brown, with sometimes a tempered steel tarnish. Massive and vesicular. Splendent, shining and imperfect metallic lustre. Fracture flat conchoidal; fragments sharp-edged. Hardness as above. Brittle, and easily frangible. In thin pieces it yields a ringing sound. It burns without flame or smell, and leaves a white-colored ash. Its constituents are 96·66 inflammable matter, 2 alumina, and 1·38 silica and iron. It occurs in beds in clay-slate, gray-wacke, and alum-slate; but it is more abundant in secondary rocks, as in coal and trap formations. It occurs in beds in the coal formations of Ayrshire, near Cumnock and Kilmarnock; in the coal district of the Forth; and in Staffordshire. It appears to pass into slaty glance-coal.

Slaty glance-coal. Color iron-black. Massive. Lustre shining, and imperfect metallic. Principal fracture slaty; coarse fracture imperfect conchoidal. Fragments trapezoidal. Softer than conchoidal glance-coal. Easily frangible; between sectile and brittle. Sp. gr. 1·50. It burns without flame or odor. It consists, by Dolomieu, of 72·05 carbon, 13·19 silica, 3·29 alumina, 3·47 oxide of iron, and 8 loss. It occurs in beds or veins of different rocks. In Spain in gneiss; in Switzerland in mica-slate and clay-slate; in the trap rock of the Calton-hill, Edinburgh; in the coal formations of the Forth district. It is found also in the floetz districts of Westcraigs, in West Lothian, Dunfermline, Cumnock, Kilmarnock, and Arran; in Brecknock, Caermarthenshire, and Pembrokeshire, in England; and at Kilkenny, Ireland; and abundantly in the United States. In this country it is called blind coal.

Columnar glance-coal. Color velvet-black and grayish-black. Massive, disseminated, and in prismatic concretions. Lustre glistening, and imperfect metallic. Fracture conchoidal. Fragments sharp-edged. Opaque. Brittle. Sp. gr. 1·4. It burns without flame or smoke. It forms a bed several feet thick in the coal-field of Sanguhar, in Dumfries-shire; at Saltcoats, in Ayrshire, it occurs in beds and in green-stone; in basaltic columnar rows near Cumnock in Ayrshire.

Fibrous coal. Color dark grayish-black. Massive, in thin layers, and in fibrous concretions. Lustre glimmering, or pearly. It soils strongly. It is soft, passing into friable. It burns without flame; but some varieties scarcely yield to the most intense heat. It is met with in the different coal-fields of Great Britain. Its fibrous concretions and silky lustre distinguish it from all the other kinds of coal.

It is not certain that this mineral is wood mineralised. Several of the varieties may be original carbonaceous matter, crystallised in fibrous concretions.

Parts	Charcoal.	Earth.
100 Kilkenny coal, he says, contain	97·3	3·7
Anthracite	90·0	10·0
Ditto	72·0	20·0
Ditto	97·25	2·7
Coal of Notre Dame de Vaux,	78·5	20·

We add, from the Philosophical Magazine, Mr. Mushet's general table of the analyses of different kinds of pit-coal, in carbonisation.

	Volatile Matter.	Carbon.	Ashes.	Specific Gravity of the Coal.	Specific Gravity of the Coke.
Welsh furnace coal	8·5	88·068	3·432	1·337	1·
Alfreton ditto	45·5	52·456	2·044	1·235	less than water
Butterly ditto	42·830	52·882	4·288	1·264	1·100
Welsh stone coal	8·	89·700	2·300	1·368	1·3934
Welsh slaty coal	9·100	84·175	6·725	1·409	
Derbyshire cannel coal	47·000	48·362	4·638	1·278	
Kilkenny coal	4·250	92·877	2·873	1·602	1·6568
Stone coal found under basalt	16·660	69·740	13·600		
Kilkenny slaty coal	13·000	80·475	6·525	1·445	
Scotch cannel coal	56·570	39·430	4·000		
Boolavoooneen ditto	13·800	82·960	3·240	1·436	1·596
Corgee ditto	9·100	87·491	3·409	1·403	1·6560
Queen's county, No. 39 } Irish	10·300	86·560	3·140	1·403	1·6218
Stone wood, Giants' Causeway	33·370	54·697	11·933	1·150	
Oak wood	80·000	19·500	·500		

COAL-MINES, BRITISH. It is, generally agreed, that our cannel coal is the lapis ampetites of the Romans; though it seems to have been used by them only for making toys, bracelets, &c. But of that common fuel which we denominate coals, the native Romans were entirely ignorant. It is certain that they are not, as some have imagined, the lapis obsidianus of Piny, about which there have been great disputes, and of which four statues of elephants were made, and placed in the temple of Concord by Augustus: nor the gagates, or jet, which others, again, have taken for the lapis obsidianus; though the lightness and texture show plainly that it is not either stone or coal. In fact there are no beds of it in the compass of Italy. The great line of that fuel seems to sweep away round the globe, from north-east to south-west, not ranging at a distance even from the south-east parts of our island, as is generally imagined, but actually visiting Brabant and France, and yet avoiding Italy. The primeval Britons appear to have used it; and in the precincts of Manchester particularly, which are furnished with an inexhaustible abundance of it, they could not have long remained unapprised of the useful combustible around them. The currents there frequently bring down fragments of coal from the mountains; and in the long and winding course of them through the parish the Britons would soon mark the shining stones in the channels; and by the aid of accident, or the force of reflection, find out the utility of them. But we can advance still nearer to a certainty. Several pieces of coal were discovered some years ago in the sand under the Roman way to Ribchester, when both were dug up at the construction of a house in Quay-street. The number of pieces, several of them as large as eggs, was not less than forty; and a quantity of slack was dug up with them. These circumstances show the coals to have been lodged on the spot, before the road of the Romans covered it. That ground being in the neighbourhood of Mancunion, the Britons had there deposited a quantity of coals, probably for the use of the garrison, and many of the smaller frag-

ments, and some of the slack, were buried in the sand upon which they were laid. And that the Britons, in general, were acquainted with this fuel, is evident from its appellation amongst us at present, which is not Saxon, but British; and subsists among the Irish in their O-gual, and among the Cornish in their kolan, to this day. The extensive coal-mines, therefore, with which the kingdom of England and the precincts of Manchester are so happily stored, were first noticed by the skill, and first opened by the labor, of the Britons; and some time before the arrival of the Romans among us. And the nearer quarries in the confines of Bradford, Newton, and Manchester, would naturally attract the notice, and invite the enquiries of the Britons, before any others. The current of the Medlock, which washes the sides of them, would bring down specimens of the riches within, lodge many of them about the Castlefield, and allure the Britons successively to a collection of the one and a search after the other. But, for two ages after the discovery, wood continued to compose the general firing of the nation. In 852 a grant was made of some lands by the abbey of Peterborough, under the reservation of certain boons and payments in kind to the monastery; as, one night's entertainment; ten vessels of Welsh, and two of common ale; sixty cart-loads of wood, and twelve of pit coal; where we see the quantity of coal was only one cart-load to five of wood. The latter naturally continued the principal article of our fuel, as long as the forests and thickets presented themselves so readily to the hand: and such it continued till a very late period. The first public notice of the former is mentioned by Mr. Hume to have been in the time of Henry III. who, in the year 1272, granted a charter to the town of Newcastle, giving the inhabitants a licence to dig coals, and the first statute relating to this article was in the 9 Henry V. c. 10; ordering all keels in the port of Newcastle to be measured by commissioners, before carriage of coals, on pain of forfeiture. They were not brought into common use till the reign of Charles I., and were then sold for about 17s. a chaldron.

In some years after the Restoration, there were about 200,000 chaldrons burnt in London; in 1670 about 270,000 chaldrons; and at the Revolution, upwards of 300,000 chaldrons; and at present, above 1,000,000 are annually consumed here. In Scotland there are coals sufficient to supply the consumption, and also to export; but a considerable quantity of English coals are imported, because they are found of a stronger heat, and otherwise better adapted to several manufactures. In Ireland, though they have coal, yet they take annually to the value of £40,000 from England, and £20,000 from Scotland. Maliciously setting fire to coal mines is felony, by stat. 20 Geo. II. c. 32. sect. 6.

COAL-MINES, FOREIGN. There are several other countries in Europe, which possess considerable coal-mines; as France, Liege, Germany, and Sweden: also on the other side of the Atlantic Ocean; in Newfoundland, Cape-Breton, Canada, and some of the states of New England. But in all these countries the coal is of a quality much inferior to the British, and entirely unfit to be used in many manufactures; so that they are obliged to import great quantities from Britain for the use of their manufactures of iron, &c.

The INLAND COAL TRADE, that is, carrying coals from Newcastle, Sunderland, Blith, and other adjacent places in the north of England, as also from the Frith of Forth to London, and the port-towns on the coast all the way, as well as on this side of Newcastle, south, as up the channel as high as Portsmouth west, is an important branch of commerce, and employs abundance of shipping and seamen; in so much that, in a time of urgent necessity, the coalery navigation alone has been able to supply the government with a body of seamen for the royal navy, able to man a considerable fleet at a very short warning, and that without difficulty. The Whitehaven coaleries in Cumberland, belonging to lord Lonsdale, which furnish several counties in Ireland with coals, constantly employ upwards of 2000 seamen; and are a noble nursery for the navy of this kingdom. And not only do the pit coals sufficiently supply all the ports, but, by those ports and the navigable rivers, all the adjacent counties very far inland. In short, coals, though not an exclusive, yet may, with propriety, be styled a peculiar blessing to Britain from their great plenty, their acknowledged excellence, and their being found in such places as are conveniently situated for exportation. Nor is there any danger of the export trade being lessened even by the several duties that have been laid upon them; for the foreign consumption being founded in necessity, with regard to manufactures, and in economy, where they are used for convenience (wood and turf being dearer than coals with the duty), we need be in no fear of the markets declining. There is as little room to be alarmed from an apprehension of their being exhausted, as the present works are capable of supplying us for a long series of years, and there are many other mines ready to be opened when these shall fail. Besides, there are known to be coals in many parts of the three kingdoms, which hitherto there has been no encouragement to work. Besides the value of this com-

modity as a conveniency of life, as an article of commerce, and as giving rise to a nursery of seamen for the increase of the marine, other important advantages deserve to be noticed. Coals are, in many respects, and in a very high degree, useful to the landed interest; not only by raising exceedingly the real value, and of course the purchase, of those lands in which they are found, and those through which it is necessary to pass from the works to the places where they are embarked (which are styled way-leaves, and are set at as high rents as any lands in Britain); but from the general improvements they have occasioned. Very few counties are now better cultivated than Northumberland, and the same effects have been produced, in a greater or less degree, in other places. Thousands of laborious people are employed in and about the mines; thousands more in conveying them to the ports, and on board the ships; to say nothing of those that draw their subsistence from the carriage of them by land to supply families, &c. Great numbers also live in a superior station; as stewards, directors, factors, agents, book-keepers, &c. To these we may add the extraordinary encouragement given to ingenious artists who have invented, and the numerous workmen continually employed about those several curious and costly machines, which, for a variety of purposes in this business, are in continual use, and of course in continual wear: we may join to these the multitudes that obtain their living from the manufactures in which they are employed, and which could not be carried on but by the help and cheapness of coals. Lastly, the produce of coals exported, which amounts to a very considerable sum, besides being profitable to the owners, merchants, and mariners, is so much clear gain to the nation. It might be expected, that a trade so beneficial to individuals, and to the nation in general, and which has been gradually increasing for several centuries past, would have been advanced by this time to very great perfection, and reduced to a regular system. But, in one very essential respect, it is found to be quite otherwise. The art of working coal-mines in the most profitable manner is indeed highly improved, but the principles of the art, that of searching for and discovering coal in any district of country, where it has not yet been found, has never, that we know of, been treated in so systematic a manner, as in the *Encyclopædia Britannica*. We shall lay, therefore, before our readers, the following citation from that useful work:—"The terrestrial matters which compose the solid parts of the earth (in coal mines) are disposed in strata, beds, or layers, the under surface of one bearing against or lying upon the upper surface of that below it, which last bears or lies on the next below in the same manner. These strata consist of very different kinds of matters, such as free-stone, lime-stone, metal-stone, whin-stone, coal, &c. as will be particularly specified in the sequel. Some of these strata are of a considerable thickness, being often found from 100 to 200 feet or upwards, nearly of the same kind of matter from the superior to the inferior surface; and others are found of the least thickness imaginable, one inch or less. All these

COAL MINES.

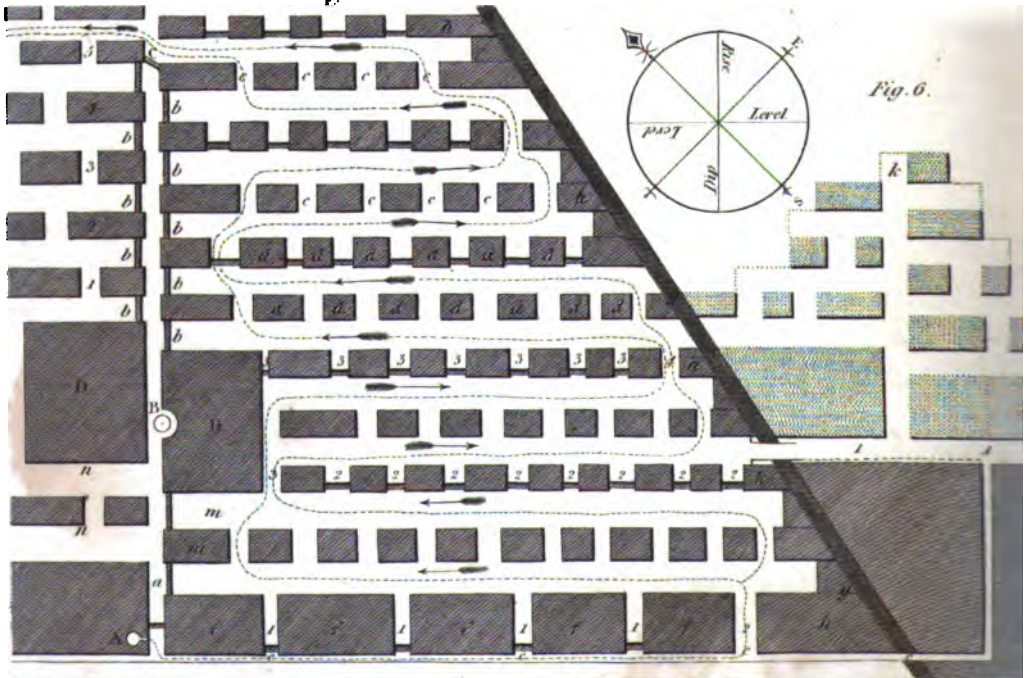
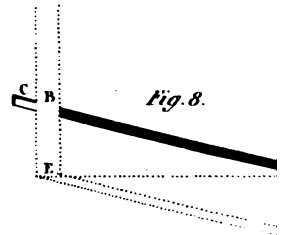
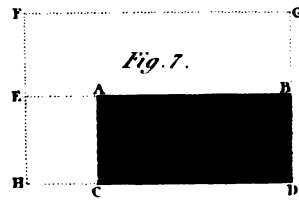
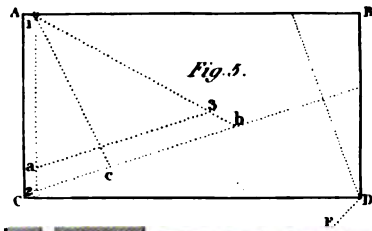
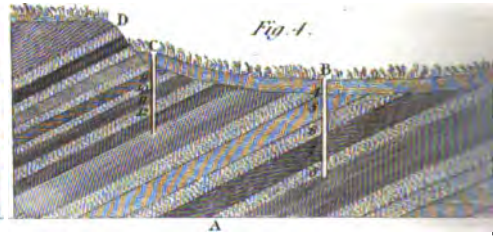
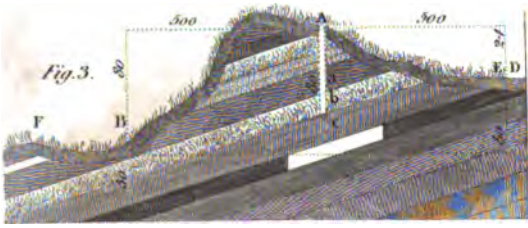
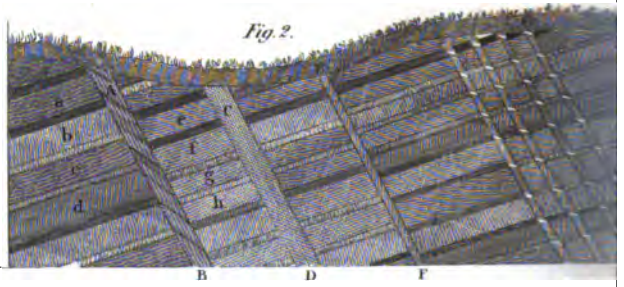
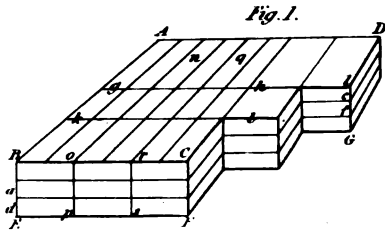

strata are divided or parted from each other laterally, either by their even, smooth, polished surfaces, with very thin lamina of soft or dusty matter betwixt them, called the parting, which renders them easy to separate; or else only by the surfaces closely conjoined to each other, without any visible matter interposed betwixt them; yet the different substance of each stratum is not the least intermixed, though sometimes they adhere so strongly together, that it is very difficult to part or disjoin them: in this last case they are said to have a bad parting. Besides this principal division or parting laterally, there are, in some strata, secondary divisions or parting also laterally, separating or approaching towards a separation of the same stratum, into parts of different thicknesses, nearly parallel to each other; in the same manner as the principal partings divide the different strata from each other; but these secondary ones are not so strong or visible, nor make so effectual a parting, as the principal ones do; and are only met with in such strata as are not of an uniform hardness, texture, or color, from the upper to the under surface. There are other divisions or partings called backs, in almost every stratum, which cross the former lateral ones longitudinally, and cut the whole stratum through its two surfaces into long rhomboidal figures. These again are crossed by others called cutters, running either in an oblique or perpendicular direction to the last mentioned backs, and also cut the stratum through its two surfaces. Both these backs and cutters generally extend from the upper or superior stratum down through several of the lower ones, so that these backs and cutters, together with the lateral partings before-mentioned divide every stratum into innumerable cubic, prismatic, and rhomboidal figures, according to the thickness of the stratum, and the position and number of the backs and cutters. They sometimes have a kind of thin partition of dusty or soft matter in them, and sometimes none, like the first mentioned partings; but the softer kind of strata generally have more backs and cutters than the harder kind, and do not extend through the others.'

Let A, B, C, D, E, F, G, plate COAL-MINES, fig. 1, represent the principal partings, or the upper and under surfaces of any stratum; then a, b, c, d, e, f, will represent the secondary lateral partings nearly parallel to the principal ones: g, h, i, k, l, m, the longitudinal partings called backs; n, o, p, q, r, s, the cross partings called cutters, crossing the last mentioned ones either obliquely or perpendicular. In all places where the strata lie regular, they are divided and subdivided in the manner above mentioned; and sometimes in this manner extend through a pretty large district of country: though it is often otherwise; for their regularity is frequently interrupted, and the strata broken and disordered, by sundry chasms, breaches or fissures, which are differently denominated according to their various dimensions, and the matters with which they are filled, viz. dikes, hitches, and troubles.

I. *Dikes* are the largest kinds of fissures. They seem to be nothing but a crack or breach of the solid strata, occasioned by one part of them being broken away and fallen from the other.

They generally run in a straight line for a considerable length, and penetrate from the surface to the greatest depth ever yet tried, in a direction sometimes perpendicular to the horizon, and sometimes obliquely: the same kind of strata are found lying upon each other in the same order, but the whole of them as greatly elevated or depressed on the one side of the dike as on the other. These fissures are sometimes two or three feet wide, and sometimes many fathoms. If the fissure or dike be of any considerable width, it is generally filled with heterogeneous matter, different from that of the solid earth on each side of it. It is sometimes found filled with clay, gravel, or sand; sometimes with a confused mass of different kinds of stone lying edgeways; and at other times with a solid body of free-stone, or even whin-stone. When the fissure is of no great width, as suppose two or three feet only, it is then usually found filled with a confused mixture of the different matters which compose the adjoining strata, consolidated into one mass. If the dike run or stretch north and south, and the same kind of strata are found on the east side of the dike, in a situation with respect to the horizon ten or twenty fathoms lower than on the other side, it is then said to be a dip-dike, or downcast dike of ten or twenty fathoms to the eastward;—or counting from the east, it is then said to be a rise dike or up-cast of so many fathoms westward. If the strata on one side are not much higher or lower with respect to the horizontal line, than those on the other, but only broken off and removed to a certain distance, it is then said to be a dike of so many fathoms thick; and, from the matter contained between the two sides of the fissure or dike, it is denominated a clay-dike, stone-dike, &c.

II. A *hitch* is only a dike or fissure of a smaller degree, by which the strata on one side are not elevated or separated from those on the other side above one fathom. The hitches are denominated in the same manner as dikes, according to the number of feet they elevate or depress the strata. There are dikes (though they are not often met with in the coal countries) whose cavities are filled with spar, the ores of iron, lead, vitriol, or other metallic or mineral matters; and it is pretty well known, that all metallic veins are nothing else than what in the coal countries are called dikes. The strata are generally found lying upon each other in the same order on one side of the dike as on the other, as mentioned above, and nearly of the same thicknesses, appearing to have been originally a continuation of the same regular strata, and the dike only a breach by some later accident, perpendicularly or obliquely down through them, by which one part is removed to a small distance, and depressed to a lower situation than the other. But this is not the only alteration made in the strata by dikes; for generally to a considerable distance on each side of the dike, all the strata are in a kind of shattered condition, very tender, easily pervious to water, and debased greatly in their quality, and their inclination to the horizon often altered.

III. *Troubles* may be denominated dikes of the smallest degree; for they are not a real breach, but only an approach towards it which has not

taken a full effect. The strata are generally altered by a trouble from their regular site to a different position. When the regular course of the strata is nearly level, a trouble will cause a sudden and considerable ascent or descent: where they have, in their regular situation, a certain degree of ascent or descent, a trouble either increases it or alters it to a contrary position: and a trouble has these effects upon the strata in common with dikes, that it greatly debases them from their original quality; the partings are separated; the backs and cutters disjointed, and their regularity disordered; the original cubic and prismatic figures, of which the strata were composed, are broken, and the dislocation filled with heterogeneous matter; and the whole strata are reduced to a softer and more friable state. The strata are seldom, or never, found to lie in a true horizontal situation; but generally have an inclination or descent, called the dip, to some particular part of the horizon. If this inclination be to the eastward, it is called an east dip, and a west rise; and according to the point of the compass to which the dip inclines, it is denominated, and the ascent or rise is to the contrary point. This inclination or dip of the strata is found to hold everywhere. In some places it varies very little from the level; in others very considerably; and in some so much, as to be nearly in a perpendicular direction: but whatever degree of inclination the strata have to the horizon, if not interrupted by dikes, hitches, or troubles, they are always found to lie in the first regular manner mentioned. They generally continue upon one uniform dip until they are broken or disordered by a dike, hitch, or trouble, by which the dip is often altered, sometimes to a different part of the horizon, and often to an opposite point; so that on one side of a dike, hitch, or trouble, if the strata have an east dip, on the other side they may have an east rise, which is a west dip; and, in general, any considerable alteration in the dip is never met with, but what is occasioned by the circumstances last mentioned.

To illustrate what has been said, see fig. 2, where *a b c d*, &c. represents a course of strata lying upon each other having a certain inclination to the horizon. *A B* is a downcast dike, which depresses the strata obliquely to *e f g h*, &c. lying upon each other in the same order, but altered in their inclination to the horizon. *C D* represents a clay or free-stone dike, where the strata are neither elevated nor depressed, but only broken off and removed to a certain distance. *E F* represents a hitch, which breaks off and depresses the strata only a little, but alters their inclination to the horizon. *G H* represents a trouble, where the strata on one side are not entirely broken off from those on the other, but only in a crushed and irregular situation. As some particular strata are found at some times to increase, and at other times to diminish, in their thicknesses, while others remain the same, consequently they cannot be all parallel; yet this increase and diminution in their thicknesses come on very gradually. The strata are not found disposed in the earth according to their specific gravities: for we often find strata of very dense matter near the surface; and perhaps at

fifty or even 100 fathoms beneath, we meet with strata of not half the specific gravity of the first. A stratum of iron ore is very often found above one of coal, though the former has twice the gravity of the latter; and, in short, there is such an absolute uncertainty in forming any judgment of the disposition of the strata from their specific gravities, that it cannot in the least be relied upon.

From the foregoing sources we next give an account of the several strata of coal, and of stone and other matters, which are usually connected with coal, and are found to have a particular affinity with it: and shall arrange them into six principal classes, which include all the varieties of strata that occur in all those districts of country both in Scotland and England where coal abounds.

I. The strata of *whin-stone* are the hardest of all others; the angular pieces of it will cut glass; it is of a very coarse texture, and, when broke across the grain, exhibits the appearance of large grains of sand half vitrified; it can scarcely be wrought or broke in pieces by common tools, without the assistance of gunpowder; each stratum is commonly homogeneous in substance and color, and cracked in the rock to a great depth. The most common colors of these strata are black, dark-blue, ash-colored and light-brown. Their thickness in all the coal countries is inconsiderable, from five or six feet to a few inches; and it is only in a few places they are met with of these thicknesses. In the air it decays a little, leaving a brown powder; and in the fire it cracks, and turns reddish-brown. Limestone, especially what is called bastard limestone, is sometimes, though rarely, met with in coaleries. It is well known, but, from its resemblance in hardness and color, is often mistaken for a kind of whin. Sometimes, particularly in hilly countries, the solid matter next the surface is a kind of soft or rotten whin;—but it may be noted, that this is only a mass of heterogeneous matter disposed upon the regular strata; and that beneath this all the strata are generally found in as regular an order as where the heterogeneous matter does not occur.

II. *Post-stone* is a free-stone of the hardest kind, and next to the lime-stone with respect to hardness and solidity. It is of a very fine texture; and, when broken, appears as if composed of the finest sand. It is commonly found in a homogeneous mass, though variegated in color; and, from its hardness, is not liable to injury from being exposed to the weather. Of this kind of stone there are four varieties; the most common is white post, which, in appearance, is like Portland stone, but considerably harder; it is sometimes variegated with streaks or spots of brown, red, or black. Gray post is also very common; it appears like a mixture of fine black and white sand; it is often variegated with brown and black streaks; the last mentioned appear like small clouds composed of particles of coal. Brown or yellow post is often met with of different degrees of color; most commonly of the color of light ochre or yellow sand; it is as hard as the rest, and sometimes variegated with white and black streaks. Red post is generally

of a dull red color; this is but rarely met with; it is often streaked with white or black. All these lie in strata of different thicknesses: but commonly thicker than any other strata whatever: they are separated from each other, and from other kinds of strata, by partings of coal, sand, or soft matter of different colors which are very distinguishable.

III. *Sand-stone* is a free-stone of a coarser texture than *post*, and not so hard; is so lax as to be easily pervious to water; when broke, is apparently of a coarse sandy substance; is friable and moulders to sand when exposed to the wind and rain; has frequently white shining spangles in it, and pebbles or other small stones enclosed in its mass. Of this there are two kinds commonly met with, distinguished by their colors, gray and brown, which are of different shades, lighter or darker in proportion to the mixture of white in them. It is, most generally, found in strata of considerable thickness, without many secondary partings; and sometimes, though rarely, it is subdivided into layers as thin as the common gray slate. It has generally sandy or soft partings.

IV. *Metal stone* is a stratum, in point of hardness, next to sand-stone; generally solid, compact, of considerable weight, and of an argillaceous substance, containing many nodules of iron ore, and yellow or white pyrite; its partings, or the surfaces of its strata, are hard, polished, and smooth as glass. The most usual color of this stone is black; but there are several other lighter colors, down to a light brown or gray. It lies in strata of various thicknesses, though seldom so thick as the two last mentioned kinds of stone.

V. *Shiver* is a stratum more frequently met with in coaleries than any other. There are many varieties of it, both in hardness and color. The black color is most common; it is called by the miners black shiver, black metal, or bleas. It is softer than metal stone, and in the mine is rather a tough than a hard substance, is not of a solid or compact matter, being easily separable, by the multitude of its partings, &c. into very small parts, and readily absorbing water. The substance of this stratum is an indurated bole, commonly divided into thin laminæ of unequal thicknesses, which break into long small pieces when struck with force; and, on examination, they appear to be small irregular rhomboids: each of these small pieces has a polished glassy surface; and, when broke across the grain, appears of a dry leafy, or laminated texture, like exceeding fine clay: it is very friable; feels to the touch like an unctuous substance; and dissolves in air or water to a fine pinguid black clay. There are almost constantly found enclosed in its strata lumps or nodules of iron ore; often real beds of the same. Besides black, the brown or dun shiver is frequently met with. Gray shiver is also very common. It lies in strata sometimes of considerable thickness, at other times not exceeding a few feet; they are commonly parted from each other by laminæ or spar, coal, or soft matter.

VI. *Coal*. Referring the reader, for the scientific division of coals, to *AMPELITES*, Li-

THANTRAX, and the preceding articles, we shall here consider them as distinguishable into three kinds, according to their degrees of inflammability. 1. The least inflammable kinds are Welsh coal, Kilkenny coal in Ireland; and blind or deaf coal, which last is found in many parts of Scotland and England. This coal takes a considerable degree of heat to kindle it, but, when once thoroughly ignited, will burn a long time; it remains in the fire in separate pieces without caking; it produces neither flame nor smoke, and makes no cinder, but burns to a white stony flagg; it makes a hot glowing fire like charcoal or cinders, and emits effluvia of a suffocating nature, which renders it unfit for burning in dwelling-houses, its chief use being among malsters, dyers, &c. for drying their commodities. 2. Open burning coal soon kindles, making a hot pleasant fire, but is soon consumed: it produces both smoke and flame in abundance; but lies open in the fire, and does not cake together so as to form cinders, its surface being burned to ashes before it is thoroughly calcined in the midst; from this it has its name of an open burning coal: it burns to white or brown ashes very light. Of this kind is cannel coal, jet, parrot, splint, and most of the coals in Scotland. 3. Close burning coal kindles very quickly, makes a very hot fire, melts and runs together like bitumen, the very smallest culm making the finest cinders, which, being thoroughly burnt, are porous and light as a pumice stone, and when broke are of a shining lead color; it makes a more durable fire than any other coal, and, finally, burns to brown or reddish colored heavy ashes. Of this kind are the Newcastle and several other of the English coals, and the smithy coals of Scotland. The open burning and the close burning coal mixed together, make a more profitable fire for domestic uses than either of them separate. In all those districts where coal is found there are generally several strata of it: perhaps all the different kinds above mentioned will be found in some, and only one of the kinds in others; yet this one kind may be divided into many different seams or strata, by beds of shiver or other kinds of matter interposing, so as to give it the appearance of so many separate strata. All these strata, with their several varieties, do not lie upon each other in the order in which they are described, nor in any certain or invariable order. Though there be found the same kind of strata in one coalery as in another, yet they may be of very different thicknesses. In some places there are most of the hard kinds, in others most of the softer; and in any one district it rarely happens that all the various kinds are found; for some kinds occur only once or twice, whilst others occur ten or twenty times before we reach the principal stratum of coal.

To explain this, suppose the strata in the pit at A, fig. 3, lie in the order *a, b, c, d*, &c. they may be so much altered in their thicknesses by reason of some of them increasing and others diminishing, at the distance of B, that they may be found there of very different thicknesses; or if they are examined in a pit at D, by reason of its lower situation, and the strata there not being a continuation of those

in the other places, they may be very different both in their order and thicknesses, and yet of the same kinds. Though they be thus found very different in one coalery, or district, from what they are found to be in another, with respect to their thicknesses, and the order in which they lie upon each other, yet we never meet with a stratum of any kind of matter but what belongs to some of those above described. To illustrate how the various strata lie in some places, and how often the same stratum may oc-

cur betwixt the surface and the coal, we shall give the following example. The numbers in the left-hand column refer to the classes of strata before described, to which each belongs. The second column contains the names of the strata; and the four numerical columns to the right hand, express the thickness of each stratum in fathoms, yards, feet, and inches. In the following instance the species of sand-stone only occurs twice, and that of post five times, whilst the shiver occurs no less than nine times.

No.	EXAMPLE.	F.	Y.	Ft.	I.
	Soil and gravel	0	1	1	0
	Clay, mixed with loose stones	1	1	0	0
3	Coarse brown sand-stone, with soft partings	3	0	2	6
2	White post, with shivery partings	1	1	0	5
5	Black shiver or bleas, with iron-stone balls	2	0	2	0
6	Coarse splint coal,	0	0	2	6
5	Soft gray shiver	0	1	0	7
2	Brown and gray post, streaked with black	1	0	2	0
5	Black shiver, with beds and balls of iron-stone	0	1	2	6
4	Gray and black metal-stone	0	1	1	9
2	White and brown post	1	1	0	0
5	Black and gray shiver, streaked with white	0	1	0	6
3	Soft gray sand-stone, with shivery partings	0	1	1	0
2	Yellow and white post, with sandy partings	1	0	2	0
5	Black and dun shiver, with iron-stone balls	0	1	2	6
2	White post streaked with black, and black partings	1	0	0	6
5	Gray shiver, with iron-stone balls	0	1	0	9
4	Brown and black metal stone	1	1	2	6
5	Hard slaty black shiver	1	1	0	0
6	Coal, hard and fine splint	0	0	3	6
5	Soft black shiver	0	0	0	3
6	Coal, fine and clear	0	0	3	3
5	Hard black shiver	0	0	1	0
	Total fathoms	25	0	0	0

‘ To apply the foregoing observations to practice: suppose it be required to examine whether there be coal in a piece of ground adjoining to, or in the neighbourhood of, other coaleries. It is proper to be informed, at some of the adjacent coaleries, of the number and kinds of strata; the order in which they lie upon each other; to what point of the horizon, and in what quantity, they dip; if any dikes, ditches, or troubles, and the course they stretch. Having learned these circumstances, search in the ground under examination, where the strata are exposed to examination, and compare these with the other. If they be of the same kinds, and nearly correspond in order and thickness, and by lying in a regular manner, and agree by computation with the dip and rise, it may be safely concluded that coal is there; and the depth of it may be judged from the depth of the coal in the other coalery, below any particular stratum which is visible in this.

II. If the solid strata are not exposed to view, either in the hills or valleys of the ground under examination, then search in the adjoining grounds; and if the same kinds of strata are found there as in the adjacent coalery, and there is reason from the dip and other circumstances, to believe that they stretch through the ground to be ex-

mined, it may be concluded that the coal is there, as well as these other strata. Suppose a coalery is on the side of a hill at A, fig. 3, and you would search for coal at B, on the other side of the hill, but in a much lower situation; by observing the several strata lying above the coal at A, and the point towards which they dip, which is directly towards B (if clear of dikes), you may expect to find the same kind of strata on the other side of the hill, but much lower down. Accordingly if some of the strata are visible in the face of the precipice C, they may be compared with some of those in the pit at A. Or, if they are not to be seen there, by searching in the opposite hill, they may perhaps be discovered in the place F; where, if they be found in the manner before mentioned, and there be reason to believe they extend regularly from the first place to this, it is more than probable the coal, as well as these strata, will be found in the intermediate ground.

III. If the ground to be examined lie more to the rise of the coal, as at E, which being supposed to be on a flat, perhaps the solid strata there may be wholly covered by the gravel, clay, &c. of the outward surface lying upon them: in this case, by measuring the horizontal distance and the descent of ground from A to F and computing the

quantity of ascent or rise of the coal in that distance: by comparing these together, it may be judged at what depth the coal will be found there, allowing that it lie regular. Thus, suppose the coal at A eighty yards deep, the distance from A to E 500 yards, and that the coal rises one yard in ten yards of horizontal distance:—

	Yds.
Then, from the depth of the pit	80
Deduct the descent of ground from A to E, suppose	24
	—
This remainder would be the depth, if the coal was level	56
But as the coal rises one in ten feet, then deduct what it rises in 500 yards, which is	50
	—
And the remainder is the depth of the coal at E	6

IV. Suppose that the place at B is 500 yards the contrary way, or to the full dip of the coal at A; if a view of the solid strata cannot be obtained, then, by proceeding in the same manner as before, the depth of the coal at that place may be computed. Thus,

	Yds.
To the depth of the coal at the pit A	80
Add the descent or inclination of the coal in 500 yards, which, as before, is	50
	—
This sum would be the depth, if the ground was level	130
But as the ground descends towards B, deduct the quantity of that, which suppose	80
	—
Remains the depth of coal at B	50

If the place to be examined be neither to the full dip nor full rise, but in some proportion towards either, the same method may be pursued, computing how much the coal rises or dips in a certain distance in that direction. If there is known to be a dike in the workings of the pit at A, which elevates or depresses the strata towards the place under examination, then the quantity of the elevation or depression must be accordingly added to, or deducted from, the computed depth of the coal at that place. Suppose there is an upcast dike of ten fathoms or twenty yards towards B, then deduct twenty from fifty, the depth before computed, there will remain thirty yards or fifteen fathoms for the depth of the coal at B. But it often happens that coal is to be searched for, in a part of the country, at such a distance from all other coaleries, that by reason of the intervention of hills, valleys, unknown dikes, &c., the connexion or relation of the strata with those of any other coalery cannot be traced by the methods last mentioned; in which case a more extensive view must be taken of all circumstances than was necessary in the former; and a few general rules founded on the foregoing observations, and on conclusions drawn from them, will greatly assist in determining sometimes with a great degree of probability, and sometimes with absolute certainty, whether coal be in any particular district of country or not.

V. The proper step to be taken in such a case, is to take a general view of that district of country intended to be searched, in order to judge from the outward appearance or face of the country, which particular part, out of the whole, is the most likely to contain those kinds of strata favorable to the production of coal; and consequently the particular part thus found, is the most advisable to be begun with, in the examination. Though the appearance of the outer surface give no infallible rule to judge of the kinds of strata lying beneath, yet it gives a probable one; for it is generally found, that a chain of mountains or hills rising to a great height, and very steep on the sides, are commonly composed of strata much harder and of different kinds from those before described wherein coal is found to lie, and therefore unfavorable to the production of coal; and these mountainous situations are also more subject to dikes and troubles than the lower grounds: so that if the solid strata composing them gave even favorable symptoms of coal, yet the last circumstance would render the quality bad, and the quantity precarious. And, on the whole, it may be observed, that the mountainous situations are found more favorable to the production of metals than of coal. It is likewise generally found that those districts abounding with valleys, moderately rising hills, and interspersed with plains, sometimes of considerable extent, do more commonly contain coal, and those kinds of strata favorable to its production, than either the mountainous or champaign countries; and a country so situated as this last described, especially if at some considerable distance from the mountains, ought to be the first part appointed for particular examination. Plains and level grounds of great extent, generally situated by the sides of rivers, or betwixt such moderately rising grounds as last described, are also very favorable to the production of coal, if the solid strata, and other circumstances in the higher grounds adjoining, be conformable; for it will scarcely be found, in such a situation, that the strata are favorable in the rising grounds, on both sides of the plain, and not so in the space betwixt them. Though plains be so favorable, in such circumstances, to the production of coal, yet it is often more difficult to be discovered in such a situation, than in that before described; because the clay, soil, and other lax matter, brought off the higher grounds by rains and other accidents, have generally covered the surfaces of such plains to a considerable depth, which prevents the exploration of the solid strata there, unless they be exposed to view by digging, quarrying, or some such operation. That part of the district being fixed upon which abounds with moderate hills and valleys as most suitable for the proposed examination, the first step to be taken is to examine all places where the solid strata are exposed to view (which are called the crops of the strata) as in precipices, hollows, &c. tracing them as accurately and gradually as the circumstances will allow, from the uppermost stratum or highest part of the ground to the very undermost; and, if they appear to be of the kinds before described, it will be proper to note in a memorandum book their different thicknesses; the order in which they lie

upon each other, the point of the horizon to which they dip or incline, and the quantity of that inclination, and whether they lie in a regular state. This should be done in every part of the ground where they can be seen, observing at the same time, that if a stratum can be found in one place which has a connexion with some other in a second place, and if this other has a connexion with another in a third place; &c., then, from these separate connexions, the joint correspondence of the whole may be traced and the strata, which in some places are covered, may be known by their correspondence with those which are exposed to view. If by these means the crops of all the strata cannot be seen (which is often the case), and if no coal be discovered by its crop appearing at the surface; yet if the strata that have been viewed consist of those kinds before described, and are found lying in a regular order, it is sufficiently probable that coal may be in that part of the district, although it be concealed from sight by the surface of earth or other matter.

VI. Therefore, at the same time that the crops of the strata are under examination, it will be proper to take notice of all such springs of water as seem to be of a mineral nature, particularly those known by the name of iron water, which bear a mud or sediment of the color of rust of iron, having a strong astringent taste. Springs of this kind proceed originally from those strata which contain beds or balls of iron ore; but, by reason of the tenacity of the matter of those strata, the water only disengages itself slowly from them, descending into some more porous or open stratum below, where, gathering in a body, it runs out to the surface in small streams or rills. The stratum of coal is the most general reservoir of this water; for the iron-stone being lodged in different kinds of shiver, and the coal commonly connected with some of them, it therefore descends into the coal, where it finds a ready passage through the open backs and cutters. Sometimes, indeed, it finds some other stratum than coal to collect and transmit it to the surface; but the difference is easily distinguishable: for the ochrey matter in the water, when it comes from a stratum of coal, is of a darker rusty color than when it proceeds from any other, and often brings with it particles and small pieces of coal; therefore, wherever these two circumstances concur in a number of these kinds of springs, situated in a direction from each other answerable to the stretch or to the inclination of the strata, it may be certain the water comes off coal, and that the coal lies in a somewhat higher situation than the apertures of the springs. There are other springs also which come off coal, and are not distinguishable from common water, otherwise than by their astringency, and their having a blue scum on an oily or glutinous nature swimming upon the surface of the water. These, in common with the others, bring out particles of coal, more especially in the rainy seasons, when the springs flow with rapidity. When a number of these kinds are situated from each other in the direction of the strata, as above described; or if the water does not run forth as in springs, but only forms a swamp, or an extension of stagnant water be-

neath the turf; in either case, it may be depended upon that this water proceeds from a stratum of coal.

VII. If the stratum of coal is not exposed to view, or cannot be discovered by the first method of searching for the crop, although the appearance of the other strata be very favorable, and afford a strong probability of coal being there; and if the last mentioned method of judging of the particular place where the crop of the coal may lie, by the springs of water issuing from it, should, from the deficiency of those springs or other circumstances, be thought equivocal, and not give a satisfactory indication of the coal; then a further search may be made in all places where the outward surface, or the stratum of clay or earth, is turned up by ploughing, ditching, or digging, particularly in the lower grounds, in hollows, and by the sides of streams. These places should be strictly examined, to see if any pieces of coal be intermixed with the substance of the superior lax strata; if any such be found, and if they be pretty numerous and in detached pieces, of a firm substance, the angles perfect or not much worn, and the texture of the coal distinguishable, it may be concluded, that the stratum of coal to which they originally did belong is at no great distance, but in a situation higher with respect to the horizon; and if there be also found along with the pieces of coal other mineral matter, such as pieces of shiver or freestone, this is a concurrent proof, that it has come only from a small distance. Though the two fore-mentioned methods should only have produced a strong probability, yet if this last mentioned place, where the pieces of coal, &c. are found in the clay, be in a situation lower than the springs; when this circumstance is joined to the other two, it amounts to little less than a moral certainty of the stratum of coal being a very little above the level of the springs. But if, on the contrary, these pieces of coal are found more sparingly interspersed in the superior stratum, and if the angles are much fretted or worn off, and very little of other kinds of mineral matter connected with them; it may then be concluded that they have come from a stratum of coal situated at a greater distance than in the former case; and by a strict search, and an accurate comparison of other circumstances, that particular place may be discovered with as much certainty as the other. After the place is discovered, where the stratum of coal is expected to lie concealed, the next proper step to be taken, is to begin digging a pit or hole there perpendicularly down to find the coal. If the coal has no solid strata above and beneath it, but be found only embodied in the clay or other lax matter, it will not be there of its full thickness, nor so hard and pure as in its perfect state when enclosed betwixt two solid strata, the uppermost called the roof, and the undermost the pavement, of the coal: in such situation therefore it becomes necessary, either to dig a new pit, or to work a mine forward until the stratum of coal be found included betwixt a solid roof and pavement, after which it need not be expected to increase much in its thickness: yet as it goes deeper or farther to the dip, it most likely will improve in its quality; for that part

of the stratum of coal which lies near the surface, or only at a small depth, is often debased by a mixture of earth and sundry other impurities, washed down from the surface, through the banks and cutters, by the rains; whilst the other part of the stratum which lies at a greater depth is preserved pure, by the other solid strata above it intercepting all the mud washed from the surface. The above methods of investigation admit of many different cases, according to the greater or less number of favorable circumstances attending each of the modes of enquiry; and the result accordingly admits every degree of probability, from the most distant, even up to absolute certainty. In some situations, the coal will be discovered by one method alone; in others, by a comparison of certain circumstances attending each method; whilst, in some others, all the circumstances that can be collected only lead to a certain degree of probability. In the last case, where the evidence is only probable, it will be more advisable to proceed in the search by boring a hole through the solid strata, than by digging or sinking a pit, it being both cheaper and more expeditious; and in every case which does not amount to an absolute certainty, this operation is necessary, to ascertain the real existence of the coal in that place. We shall now suppose, that having examined a certain district, situated within a few miles of the sea or some navigable river, that all the circumstances which offer only amount to a probability of the coal being there, and that boring is necessary to ascertain it; we shall therefore describe the operation of boring to the coal. Suppose that the ground A, B, C, D, fig. 4, has been examined, and from the appearance of the strata where they are visible (as at the precipice D, and several other places) they are found to be of those kinds usually connected with coal, and that the point to which they rise is directly west towards A, but the ground being flat and covered to a considerable depth with earth, &c. the strata cannot be viewed in the low grounds; therefore, in this, and all similar situations, the first hole that is bored for a trial for coal should be on the west side of the ground, or to the full rise of the strata as at A, where, boring down through the strata 1, 2, 3, suppose ten fathoms, and not finding coal, it will be better to bore a new hole than to proceed to a great depth in that: therefore, proceeding so far to the eastward as B, where the stratum 1, of the first hole, is computed to be ten or twelve fathoms deep, a second hole may be bored, where boring down through the strata 4, 5, 6, 7, 8, the stratum 1 is met with, but no coal; it would be of no use to bore farther in this hole, as the same strata would be found which were in the hole A: therefore, proceeding again so far to the eastward, as it may be computed the stratum 4 of the second hole will be met with at the depth of ten or twelve fathoms, a new hole may be bored at C; where, boring through the strata 9, 10, 11, 12, the coal is met with at 13, before the hole proceed so deep as the stratum 4, of the former. It is evident, that, by this method of procedure, neither the coal nor any other of the strata can be passed over, as the last hole is bored to that stratum which was nearest the surface in the former hole.

‘The purposes for which boring is used are numerous, and some of them of the utmost importance in coaleries. In coaleries of great extent, although the coal be known to extend through the whole grounds, yet accidental turns, and other alterations in the dip, to which the coal is liable, render the boring of three or more holes necessary, to determine exactly to what point of the horizon it dips or inclines, before any capital operation for the winning of it can be undertaken; because a very small error in this may occasion the loss of a great part of the coal, or at least incur a double expense in recovering it. Suppose A, B, C, D, fig. 5, to be part of an extensive field of coal intended to be won or laid dry by a fire engine; according to the course of the dip in adjoining coaleries, the point C is the place at which the engine should be erected, because the coal dips in direction of the line AC, consequently the level line would be in the direction CD; but this ought not to be trusted to. Admit two holes, 1, 2, be bored to the coal in the direction of the supposed dip, at 200 yards distance from each other, and a third hole, 3, at 200 yards distance from each of them: suppose the coal is found, at the hole 1, to be twenty fathoms deep; at the hole 2 ten fathoms deeper; but at the hole 3 only eight fathoms deeper than at 1. Then to find the true level line and dip of the coal, say, As ten fathoms, the dip from 1 to 2, is to 200 yards the distance, so is eight fathoms, the dip from 1 to 3, to 160 yards, the difference from one, on the line 1 2, to a, the point upon a level with the hole 3. Again say, As eight fathoms the dip from 1 to 3, is to 200 yards the distance, so is ten fathoms, the dip from 1, in direction of the line 1, 3, to b, the point upon a level with the hole 2. Then let fall the perpendicular 1, c, which will be the true direction of the dip of the coal, instead of the supposed line AC, and by drawing ED and DF, parallel to the other lines, the angle D, and no other place, is the deepest part of the coal, and the place where the engine should be erected. If it had been erected at the angle C, the level line would have gone in the direction ch, by which means about one-third part of the field of coal would have been below the level of the engine, and perhaps lost, without another engine was erected at D. Boring not only shows the depth at which the coal lies, but its exact thickness; its hardness; its quality, whether close burning or open burning, and whether any foul mixture is in it or not; also the thickness, hardness, and other circumstances, of all the strata bored through; and, from the quantity of water met with in the boring, some judgment may be formed of the size of an engine capable of drawing it, where an engine is necessary. When holes are to be bored for these purposes, they may be fixed (as near as can be guessed) in such a situation from each other, as to suit the places where pits are afterwards to be sunk; by which means most of the expense may be saved, as these pits would otherwise require to be bored, when sinking, to discharge their water into the mine below. There are many other uses to which boring is applied. It is generally practised in England, and is brought

to great perfection; and as the operation is generally entrusted to a man of integrity, who makes it his profession, the accounts given by him of the thickness and other circumstances of the strata, are the most accurate imaginable, and are trusted to with the greatest confidence; for as very few gentlemen choose to take a lease of a new coalery which has not been sufficiently explored by boring, it is necessary the accounts should be faithful, being the only guide to rule the landlord in letting his coal, and the tenant in taking it. The instruments used in boring are very simple. The boring rods are made of iron, from three to four feet long and about one inch and a half square, with a screw at each end by which they are screwed together, and other rods, added as the hole increases in depth. The chisel is about eighteen inches long, and two and a half broad at the end, which being screwed on the lower end of the rods, and a piece of timber put through an eye at the upper end, they are prepared for work. The operation is performed by lifting them up a little, and letting them fall again, at the same time turning them a little round; by a continuance of which motions, a round hole is fretted or worn through the hardest strata. When the chisel is blunt it is taken out, and a scooped instrument called a wimble put on in its stead; by which the dust or pulverised matter, which was worn off the stratum in the last operation, is brought up. By this substance, the borers know exactly the nature of the stratum they are boring in; and by any alteration in the working of the rods (which they are sensible of by handling them) they perceive the least variation of the strata. The principal part of the art depends upon keeping the hole clean, and observing every variation of the strata with care and attention. Having, by one or other of the methods above described, ascertained the existence of the coal mine, the next object of consideration is the method of working it.

The most remarkable coal work that we have ever had in this island, was that wrought at Borrowstownness, under the sea. The veins of coal were found to continue under the bed of the sea in this place, and the colliers had the courage to work the vein nearly half way over: there being a mote half a mile from the shore, where there was an entry that went down into the coal-pit, under the sea. This was made into a kind of round key or mote as they call it, built so as to keep out the sea, which flowed there twelve feet. Here the coals were laid, and a ship of that draught of water could lay her side to the mote, and take in the coal. This famous coalery belonged to the earl of Kincardine's family. The fresh water, which sprung from the bottom and sides of the coal-pit, was always drawn out upon the shore by an engine moved by water, that drew it forty fathoms. The coal-pit continued to be wrought many years to the great profit of the owners, and the wonder of all that saw it; but, at last, an unexpected high tide drowned the whole at once; the laborers not having time to escape perished in it.

It is exceedingly uncommon to meet with a stratum of coal which is naturally dry, or whose

subterranean springs or feeders of water are so very small, as to require no other means than the labor of men to draw off or conduct them away; for it most commonly happens that the stratum of coal, and the other strata adjacent, abound so much in feeders of water, that, before access can be had to the coal, some other methods must be pursued to drain or conduct away these feeders: therefore, after the deepest part of the coal is discovered, the next consideration is of the best method of draining it, or, in the miner's language, of *winning the coal*. If the coal lie in such an elevated situation, that a part of it can be drained by a level brought up from the lower grounds, then that will be the most natural method; but whether it be the most proper or not, depends upon certain circumstances. If the situation of the ground be such that the level would be of a great length, or have to come through very hard strata, and the quantity of coal it would drain, or the profits expected to be produced by that coal, should be inadequate to the expense of carrying it up; in such case some other method of winning might be more proper. Or suppose, in another case, it be found, that a level can be had to a coalery, which will cost £2000, and require five years to bring it up to the coal, and that it will drain thirty acres of coal when completed; yet if it be found that a fire engine, or some other machine, can be erected on that coalery for the same sum of money, in one year, which will drain fifty acres of the same coal, then this last would be a more proper method than the level; because four years' profit would be received by this method before any could come in by the other: and after the thirty acres drained by the level is all wrought, a machine of some kind would nevertheless be necessary to drain the remaining twenty acres: so that erecting a machine at first would be on all accounts the most advisable. Where a level can be driven, in a reasonable time, and at an adequate expense, to drain a sufficient tract of coal, it is then the most eligible method of winning; because the charge of upholding it is generally less than that of upholding fire-engines or other machines. If a level is judged most proper, after every consideration of every necessary circumstance, it may be begun at the place appointed in the manner of an open ditch, about three feet wide, and carried forward until it be about six or seven feet deep from the surface, taking care to secure the bottom and sides by timber-work or building; after which it may be continued in the manner of a mine about three feet wide, and three feet and a half high, through the solid strata, taking care all along to keep the bottom upon a level, and to secure the roof, sides, and bottom, by timber or building, in all places where the strata are not strong enough to support the incumbent weight, or where they are liable to decay by their exposure to the fresh air. If the mine have to go a long way before it reach the coal, it may be necessary to sink a small pit, for the convenience of taking out the stones and rubbish produced in working the mine, as well as to supply fresh air to the workmen; and if the air should afterwards turn damp, then square wooden pipes made of deals closely join-

ted, commonly called air boxes, may be fixed in the upper part of the the mine, from the pit-bottom all the way to the end of the mine, which will cause a sufficient circulation of fresh air for the workmen. Perhaps in a great length it will be found proper to sink another or more pits upon the mine, and by proceeding in this manner it may be carried forward until it arrive at the coal; and, after driving a mine in the coal a few yards to one side, the first coal pit may be sunk. If a level is found impracticable, or for particular reasons unadvisable, then a fire engine, or some other machine, will be necessary, which should be fixed on the deepest part of the coal, or at least so far towards the dip as will drain a sufficient extent of coal, to continue for the time intended to work the coalery. See *STREAM ENGINE*. Whether a fire engine, or any other machine is used, it will be of great advantage to have a partial level brought up to the engine-pit, if the situation of the ground will admit it at a small charge, in order to receive and convey away the water without drawing it so high as to the surface; for if the pit is thirty fathoms deep to the coal, and if there is a partial level, which received the water five fathoms only below the surface the engine by this means would be enabled to draw one-sixth part more water than without it; and if there were any feeders of water in the pit above this level, they might be conveyed into it, where they would be discharged without being drawn by the engine. The engine pit may be from seven to nine feet wide; and whether it be circular, oval, or of any other form, is not very material, provided it be sufficiently strong, though a circular form is most generally approved. If any feeders of water are met within a few fathoms from the surface, it will be proper to make a circular or spiral cutting about one foot deep, and a little hollowed in the bottom round the circumference of the pit, to receive and conduct the water down, without flying over the pit and incommoding the workmen. If the strata are of so tender or friable a nature as not to bear this operation, or if the water leaks through them, then it will be necessary to insert in the forementioned cutting a circular piece of timber called a crib, hollowed in the same manner, to collect the water, and a second may be inserted two or three yards below the first, with a sloping notch down the wall or side of the pit, to convey the water from the former into it; proceeding by some of these methods until the pit is sunk fifteen or twenty fathoms; at which place it will be proper to fix a cistern or reservoir, for the first or upper set of pumps to stand in; for if the pit be thirty fathoms, as supposed, it would be too great a length for the pumps to be all in one set from the bottom to top; therefore if any extraordinary feeders are met with, betwixt fifteen and twenty fathoms deep, it would be best to fix the cistern where it may receive them, and prevent their descending to the bottom; observing that the upper set of pumps be so much larger than the lower one, as the additional feeders may require; or, if there are no additional feeders, it ought then to be a little smaller. After the upper cistern is fixed, the operation may be pursued by the other

set of pumps in much the same manner as has been described, until the pit is sunk to the coal; which being done, it would be proper to sink it six or eight feet deeper, and to work some coal out from the dip side of the pit, to make room for a large quantity of water to collect, without incommoding the coal-pits when the engine is not working.

It would exceed the proper bounds of this article to enumerate all the *accidents* to which engine pits are liable in sinking; we shall therefore only recite a few which seem important. If a quicksand happen to lie above the solid strata, next the surface, it may be got through by digging the pit of such a wideness at the top (allowing for the natural slope or running of the sand), as to have the proper size of the pit on the uppermost solid stratum; where fixing a wooden frame or tube, as the timber work of the pit, and covering it round on the outside with wrought clay up to the top, the sand may again be thrown into the excavation round the tube and levelled with the surface. If the quicksand should happen to lie at a considerable depth betwixt the clay and solid strata, then a strong tube of timber closely jointed and shod with iron, of such a diameter as the pit will admit, may be let down into it; and by fixing a great weight upon the top, and by working out the sand, it may be made to sink gradually, until it come to the rock or other solid stratum below; and when all the sand is got out, if it be lightly caulked and secured it will be sufficient. It sometimes happens that a stratum of soft matter, lying betwixt two hard solid ones, produces so large a quantity of water as greatly to incommodate the operations. In such a case a frame work of plank, strengthened with cribs and closely caulked, will stop back the whole or the greatest part of it, provided the two strata which include it are of a close texture; or let an excavation of about two feet be made in the soft stratum, quite round the circumference of the pit; and let that be filled close up betwixt the hard strata, with pieces of dry fir about ten inches square inserted endways, and afterwards as many wooden wedges driven into them as they can be made to receive; if this be well finished, little or no water will find a passage through it. There is an accident of a very dangerous nature to which all coaleries are liable, and which has ruined several, called a crush, or a fit. When the pillars of coal are left so small as to yield under the weight of the superior strata; or when the pavement of the coal is so soft as to permit the pillars to sink into it, by the great weight that lies upon them, the solid stratum above the coal breaks and falls in, crushes the pillar to pieces, and closes up a great extent of the workings, or probably the whole coalery. As such an accident seldom comes on suddenly, if it be perceived in the beginning, it may sometimes be stopped by building large pillars of stone amongst the coal pillars: but if it has already made some progress, then the best method is to work away as many of the coal pillars adjoining to the crust as may be sufficient to let the roof fall freely down; and if it makes a breach of the solid strata from the coal up to the surface, it will very

probably prevent the crush from proceeding any farther in that part of the coalery. If the crush begin in the rise part of the coalery, it is more difficult to stop it from proceeding to the dip, than it is to stop it from going to the rise when it begins in a contrary part. It rarely happens that any suffocating damp or foul air is met with in an engine pit; the falling of water, and the working of the pumps, generally causing a sufficient circulation of fresh air. But that kind of combustible vapor, or inflammable air, which will catch fire at the candle is often met with. It proceeds from the partings, backs, and cutters of the solid strata, exhaling from some in an insensible manner, whilst from others it blows with as great impetuosity as a pair of bellows. When this inflammable air is permitted to accumulate, it becomes dangerous by taking fire, and burning or destroying the workmen, and sometimes by its explosion will blow the timber out of the pit, and do considerable damage. If a considerable supply of fresh air is forced down the pit by air boxes and a ventilator, or by dividing the pit into two by a close partition of deals from top to bottom, or by any other means, it will be driven out, or so weakened, that it will be of no dangerous consequence; or, when the inflammable air is very strong, it may be safely carried off by making a close sheathing or lining of thin deals quite round the circumference of the pit, from the top of the solid strata to the bottom, and lengthening it as the pit is sunk, leaving a small vacancy behind the sheathing; when the combustible matter, which exhales from the strata, being confined behind these deals, may be vented by one or two small leaden pipes carried from the sheathing to the surface; so that very little of it can transpire into the area of the pit. If a candle be applied to the orifice of the pipe at the surface, the inflammable air will instantly take fire, and continue burning like an oil lamp until it be extinguished by some external cause. Upon the whole, every method should be used to make the pit as strong in every part, and to keep it as dry as possible, and, whenever any accident happens, it should be as expeditiously and thoroughly repaired as possible, before any other operation be proceeded in, lest an additional one follow, which would more than double the difficulty of repairing it.

Among the most splendid, because most useful, of the modern contributions of science to the business of life, is Sir Humphry Davy's safety lamp, designed to obviate these accidents. Previous to the year 1815 no secure preventative had in fact been invented. The steel wheel striking sparks from flint (called a steel-mill) had been introduced in Cumberland, to light the miners at their work; but this attempt singularly and unfortunately terminated in the destruction of the projector. In the course of his experiments on carburated hydrogen gas, Sir Humphry found that wire gauze of a certain degree of fineness, interposed between two explosive gases, prevented the kindling of the one from communicating to the other; and hence concluded, that a lamp thus surrounded would not expose the external air to combustion. The result has

been completely successful. We exhibit a diagram of it.

C is the oil cistern; B, a brass rim, around which the wire gauze cylinder is fastened at bottom by a screw; F is the feeder through which the oil is supplied to the lamp; T, the trimmer, a wire which passes through a safe tube, for the purpose of raising and trimming the wick; G, the wire gauze cylinder. The gauze cylinder G is closed at the top by a circular piece of wire gauze; above which is placed a second top, H, fitting on the cylinder as a cap. The circular top of this wire gauze cap is three-fourths of an inch above the top of the wire gauze cylinder; W, W, are thick wires surrounding the cylinder, to preserve it from being crushed or bent; R is a ring to hang up the lamp, or to hold it by. The suture, where the two edges of the piece of wire gauze that forms the cylinder meet, must be well doubled and fastened with wire. If the cylinder be of twilled wire gauze, the wire should be of iron or copper, at least of the thickness of one-fortieth of an inch; if of plain wire gauze, the diameter should not be less than one-sixtieth of an inch. The apertures in a square inch should not be less than 784.

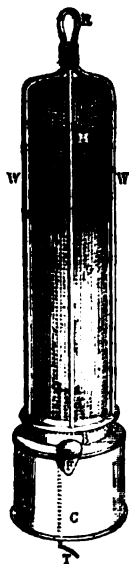

The entire merit of this useful invention is Sir Humphry Davy's; and he has devoted all the powers of his great mind to render it complete. The general size of the lamp is a span, that is, from eight to ten inches high, the wire gauze cylinder being two to two and a half inches in diameter. When choked with coal-dust the wire must be cleaned by means of a brush. Sometimes a lens of glass, or a piece of tin is placed before the light, as a reflector. The light without a reflector is about equal to that of a common miner's candle. Gunpowder, phosphorus, sulphur, and pyrites, applied to the outside of the wire gauze, would produce explosion; but sulphur, to produce this effect, must be applied in a considerable quantity, and blown upon by a current of air. There is clearly little danger of these substances being accidentally applied to the safety-lamp in mines. Should the lamp be placed in a current of explosive gas, and great heat be produced, the radiating or cooling surfaces should be increased, and twilled gauze, or a double or triple fold of wire gauze on one side of the lamp, answers this purpose. But the iron wire gauze receives a strong welding heat, a circumstance which is almost impossible in a coalery, then the iron wire would burn, and the lamp become no longer safe to use.

We copy, in confirmation of Sir H. Davy's claim to this invention, 'Resolutions of a meeting held for considering the fact relative to the discovery of the Lamp of Safety.' The names at-

tached are at once decisive of the fact of the question, as well as of its general importance.

'*Soho Square, Nov. 20th, 1817.*

'3rd.—That Sir. H. Davy not only discovered, independently of all others, and without any knowledge of the unpublished experiments of the late Mr. Tennant on Flame, the principle of the non-communication of explosions through small apertures, but that he has also the sole merit of having first applied it to the very important purpose of a safety-lamp, which has evidently been imitated in the latest lamps of Mr. George Stephenson.

(Signed) Joseph Banks, P.R.S.
William J. Brande.
Charles Hatchett.
William Hyde Wollaston.
Thomas Young.'

See the whole document in *Tilloch's Magazine* vol. 50. p. 387.

The first operations, after sinking the engine pit, are the working or *driving* a mine in the coal, and sinking the first coal-pit. The situation of this should be a little to the rise of the engine-pit, that the water which collects there may not obstruct the working of the coals every time the engine stops; and it should not exceed the distance of twenty, thirty, or forty yards; because, when the first mine has to be driven a long way, it becomes both difficult and expensive. If there be not sufficient circulation of fresh air in the mine, it may be supplied by the before described air boxes and a ventilator, until it arrive below the intended coal-pit, when the pit may be bored and sunk to the coal, in the manner before mentioned. After the pit is thus got down to the coal, the next consideration should be of the best method of working it. The most general practice in Scotland is to excavate and take away a part only of the stratum of coal in the first working of the pit, leaving the other part as pillars for supporting the roof: and after the coal is wrought in this manner, to such a distance from the pit as is intended, then these pillars, or so many of them as can be got, are taken out by a second working, and the roof and other solid strata above permitted to fall down and fill up the excavation. The quantity of coal wrought away, and the size of the pillars left in the first working, is proportioned to the hardness and strength of the coal and other strata adjacent, compared with the incumbent weight of the superior strata. The same mode of working is pursued in most parts of England, differing only as the circumstances of the coalery may require: for the English coal, particularly in the northern counties, being of a fine tender texture, and of the close-burning kind, and also the roof and pavement of the coal in general not so strong as in Scotland, they are obliged to leave a larger proportion of coal in the pillars for supporting the roof, during the first time of working; and, in the second working, as many of these pillars are wrought away as can be got with safety. The Scots coal in general being very hard, and of the open burning kind, it is necessary to work

it in such a manner as to produce as many great coals as possible, which is best effected by taking away as high a proportion of the coal as circumstances will allow in the first working; on the contrary, the English coal being very tender cannot possibly be wrought large, nor is it of much importance how small they are, being of so rich a quality; so that a larger proportion may be left in pillars in this coal than could with propriety be done in the other; and, when all circumstances are considered, each method seems well adapted to the different purposes intended. The ancient method of working was, to work away as much of the coal as could be got with safety at one working only; by which means the pillars were left so small as to be crushed by the weight of the superior strata, and entirely lost. As great quantities of coals were lost by this method, it is now generally exploded, and the other adopted in its place; by which a much larger quantity of coal is obtained from the same extent of ground, and at a much less expense in the end. The exact proportion of coal proper to be wrought away, and to be left in pillars at the first working, may be judged of by a comparison of the circumstances before mentioned. If the roof and pavement are both strong, as well as the coal, and the pit about thirty fathoms deep, then two-thirds, or probably three-fourths, may be taken away at the first working, and one-third or one-fourth left in pillars. If both roof and pavement be soft or tender, then a larger proportion must be left in pillars, probably one-third or nearly one-half; and in all cases the hardness or strength of the coal must be considered. The next proper step is to fix upon such dimensions of the pillars to be left, and of the excavations from which the coal is to be taken away, as may produce that proportion.

To form a just idea of which, see a plan of part of a pit's working, fig. 6, supposed to be at the depth of thirty fathoms, and the coal having a moderate rise. A represents the engine-pit; B, the coal-pit; A a B, the mine from the former to the latter; B C, the first working or excavation made from the coal-pit, commonly called the winning mine or winning headway, nine feet wide; *bbbb*, &c. the workings called rooms, turned off at right angles from the others, of the width of twelve feet; *cccc*, &c. the workings called throughers or thirlings, nine feet wide, wrought through at right angles from one room to another; *ddd*, &c. the pillars of coal left at the first working for supporting the roof, eighteen feet long and twelve feet broad; D D, two large pillars of coal near the pit bottom, fifteen or twenty yards long, and ten or fifteen broad, to support the pit, and prevent its being damaged by the roof falling in; *ee*, the level mine wrought in the coal from the engine-pit bottom, four or five feet wide; *ff*, &c. large pillars of coal left next the level, to secure it from any damage by the roof falling in; *gg*, a dike which depresses the coal, one fathom; *hh*, &c. large pillars and barriers of coal left unwrought, adjoining to the dike where the roof is tender, to prevent its falling down. The coal taken out by the first working in this pit is supposed to be one-third

of the whole; and allowing the rooms twelve feet wide, and the thirlings nine feet wide, then the pillars will require to be twelve feet wide, and eighteen feet long; for, if one pillar be in a certain proportion to its adjoining room and thirling, the whole number of pillars will be in the same proportion to the whole number of rooms and thirlings in the pit.

Suppose *A B C D*, fig. 7, to be a pillar of coal eighteen feet long and twelve feet broad, its area will be 216 square feet; *A C H E*, the adjoining thirling, twelve feet by nine feet, and its area 108 square feet; *B A E F G*, the adjoining room, twenty-seven feet long and twelve feet broad, and its area 324 square feet; which added to 108 gives 432 square feet, or two-thirds wrought, and 216 square feet left, or one third of the whole area *F G H D*. In the prosecution of the workings, the rooms to the right of the winning headway should be opposite to the pillars on the left; and the first, third, and fifth pillar, or the second, fourth, and sixth, adjoining to the said headway, should be of such a length as to overlay the adjoining thirlings; as, in the plan, the pillar 2 overlays the thirlings 1 and 3; and the pillar 4, overlays the thirlings 3 and 5; this will effectually support the roof of the main road *B C*, and will bring the other pillars into their regular order, by which means each pillar will be opposite to two thirlings. Also a large portion of coal should be left in all places which are intended to be kept open after the second working; such as the pit-bottoms, air courses, roads, and water courses, or where the roof is tender, as it generally is near dikes, hitches, and troubles; and if the roof should continue tender for a considerable space, it will perhaps be found proper to leave a few inches of coal adhering to the roof, which, together with a few props of timber fixed under it, may support it effectually for a long time. The level mine *e e*, and the winning headway *B C*, should be wrought forward a considerable length before the other rooms, in order to be drove through any dike that might interpose; otherwise the progress of the workings might probably be stopped a considerable time, waiting until a course of new rooms were procured on the other side of the dike. Suppose the dike *g g*, fig. 6, to depress the coal six feet, or one fathom, and that it rises in the same manner on the under side of the dike as it rises on the upper side; in such a case, the only remedy would be to work or drive a level mine through the strata of stone from the engine level at *e*, over the dike, until it intersect the coal at *i*; and from thence to drive a new level mine in the coal at *i i*, and a new winning headway *i k*. To gain a new set of rooms, and to supply fresh air to this new operation, a small mine might be drove from the room *h*, and a hole sunk down upon the level room *i i*; therefore, if the level mine *e e* was not drove so far forward as to have all these operations completed before the rooms and other workings were intercepted by the dike, the working of the pit might cease until these new places were ready. If there be two or three seams of coal in the same pit, having only a stratum of a few feet thick lying between them,

it is then material to observe that every pillar in the second seam be placed immediately below one in the first, and every pillar in the third seam below one in the second; and in such a situation the upper stratum of coal ought to be first wrought, or else all the three together; for it would be unsafe to work the lower one first, lest the roof should break, and damage those lying above. It sometimes becomes necessary to work the coal lying to the dip of the engine or the level; which coal is, consequently, drowned with water, and must, therefore, be drained by some means before it can be wrought. If the quantity of water proceeding from it be inconsiderable, it may then be drained by small pumps laid upon the pavement of the coal, and wrought by men or horses, to raise the water up to the level of the engine-pit bottom: or if the feeders of water be more considerable, and the situation be suitable, the working rod of these pumps might be connected with those in the engine-pit; by which means the water would be raised up to the level: but if the quantity of water be very great; or if, from other circumstances, these methods may not be applicable, then the engine-pit may be sunk as deep below the coal as may be necessary, and a level stone-mine driven from its bottom to the dip of the strata, until it intersects the stratum of coal, from whence a new level mine might be worked, which would effectually drain it.

Suppose *A B*, fig. 8, to be a section of the engine-pit; *B C*, the coal drained by the engine; *B D*, the coal to the dip of the engine intended to be drained; then, if the engine-pit be sunk deeper to *E*, a stone mine may be wrought in the direction *E D*, until it intersect the coal at *D*, by which the water will have a free passage to the engine, and the coal will be drained. If there be another stratum of coal, lying at such a depth below the first as the engine-pit is intended to be sunk to, the upper steam may in some situations be conveniently drained by driving a mine in the lower seam of coal, from *E* to *F*, and another in the upper one from *B* to *D*: and, by boring a hole from *D* to *F*, the water will descend to *F*, and, filling the mine *E F*, rise up to the engine-pit bottom at *E*, which is upon a level with *D*.

When it is judged necessary to work the pillars, regard must be had to the nature of the roof. If the roof be tender, a narrow room may be wrought, through the pillar, from one end to the other, leaving only a shelf of coal on each side for supporting the roof the time of working. Suppose *A B C D*, fig. 7, to be a pillar of coal eighteen feet long and twelve feet broad; if the roof is not strong, the room 1, 2, 3, 4, of eight feet wide, may be wrought up through that pillar, leaving a shelf of two feet thick on each side; and, if it can be safely done, a part of these shells may be also wrought away, by working two places through them as at 5 and 6. Thus very little of the coal will be lost; for two-thirds of the whole being obtained by the first working, and above two-thirds of the pillar by the second working, the loss upon the whole would not exceed one-tenth. But some pillars will not produce so great a proportion, and others cannot be wrought

at all; so that, upon the whole, there may be about one-eighth, one-seventh, or, in some situations, one-sixth part of the coal lost. If the roof be hard and strong, as much coal may be wrought off each side and each end of the pillar as can be done with safety, leaving only a small piece standing in the middle; and, when very strong, several pillars may be taken entirely out without any loss of coal. In all cases it is proper to begin working those pillars first, which lie farthest from the pit bottom, and to proceed working them regularly away towards the pit; but if there be a great number of pillars to the dip of the pit, it is the safest to work these out, before those to the rise of the pit are begun with.

We shall next advert to some of the various methods of bringing the coals from the rooms and other workings to the pit bottom. Where the stratum of coal is of a sufficient thickness, and has a moderate rise and dip, the coals are most advantageously brought out by horses, who draw out the coals in a tub or basket placed upon a sledge; a horse will thus bring out from 400 to 800 cwt. of coals at one, according to the quantity of the ascent or descent. In some coaleries they have access to the workings by a mine made for them, sloping down from the surface of the earth to the coal; and, where that convenience is wanting, they are bound into a net, and lowered down the pit. If the coal be not of such a height as to admit horses, and has a moderate rise, men are employed to bring out the coals: they usually draw a basket of 400 or 500 cwt. of coals fixed upon a small four-wheeled carriage. There are some situations in which neither horses nor men can be properly used; particularly where the coal has a great degree of descent or where many dikes occur: in such cases the coals are best brought out by women called bearers, who carry them in a kind of basket upon their backs, usually a hundred, or a hundred weight and a half at once. When the coals are brought to the pit bottom, the baskets are then hooked to a chain, and drawn up the pit by a rope to the surface, which is best effected by a machine called a gin, wrought by horses. After the coals are got to the surface they are drawn a small distance from the pit, and laid in separate heaps; the larger coals in one heap, the smaller pieces called chews in another, and the culm or pancal in a separate place.

Foal air is very often troublesome in coaleries. Of this there are two kinds; the black damp or styh, which is of a suffocating nature; and the inflammable or combustible damp. In whatever part of any coalery a constant supply or a circulation of fresh air is wanting, there some of these damps exist, accumulate, and become noxious or fatal; and, wherever there is a good circulation of fresh air, they cannot accumulate, being carried away by the stream of air as fast as they exhale from the strata. Upon these principles are founded the several methods of ventilating a coalery.

Suppose the workings of the pits A and B. fig. 6, to be obnoxious to the inflammable damps; if the communication were open betwixt the two pits, the air which went down the pit A would proceed immediately along the mine *a*, and ascend

out of the pit B; for it naturally takes the nearest direction: so that the air in all the workings would be stagnant, and they would be utterly inaccessible from the accumulation of the combustible damp. To expel this, the air must be made to circulate through all the different rooms by collateral air courses made in this manner: The passage *a* must be closed up by a partition of deals, or by a wall built with bricks or stones to prevent the air passing that way. This building is called a stopping. There must also be stoppings made in the thirlings I I I, &c. betwixt the pillars *f f*, &c. which will direct the air up the mine *e e*, until it arrive at the innermost thirling 2, which is to be left open for its passage. There must also be stoppings made at the side of the mine *a* at *m m*, and on both sides of the main headway BC at *b b*, &c. then, returning to the innermost thirling 2, proceed to the third row of pillars, and build up the thirlings 2 2, &c. leaving open the thirling 3 for a passage for the air; and, proceeding on to the fifth row of pillars, build up in the same manner the stoppings 3 3, &c. leaving open 4 for an air course: and, by proceeding in this manner to stop up the thirlings or passages in every other row of pillars, the current of fresh air will circulate through and ventilate the whole workings, in the direction pointed to by the small arrows in the plan, clearing away all the damps and noxious vapors that may generate. When it is arrived at C, it is conducted across the main headway, and carried through the other part of the pit's workings in the same manner, until it return through *n n* to the pit B, where it ascends; and, as the rooms advance farther, other stoppings are regularly made. In some of these stoppings, on the sides of the main headway, there must be doors to admit the passage for the bringing out coals from the rooms to the pit, as at 5 5: these doors must be constantly shut except at the time of passing through them. If at any time the circulation of the fresh air is not brisk enough, a large lamp of fire may be placed at the bottom of the pit B, which, by rarefying the air there, will make a quicker circulation.

Most of the large coaleries send their coals to the ships for the coasting trade or exportation; and, as the quantity is generally very large, it would take a greater number of carts than could conveniently be obtained at all times to carry them; besides the considerable expense of that manner of carriage; they therefore generally use waggons, for carrying them along waggon-ways, laid with timber; by which means one horse will draw from two to three tons at a time, when in a cart not above half a ton could be drawn. The first thing to be done in making a *waggon-way* is to level the ground in such a manner as to take off all sudden ascents and descents: to effect which, it is sometimes necessary to cut through hills, and to raise an embankment to carry the road through hollows. The road should be formed about twelve feet wide; and no part should have a greater descent than of one yard perpendicular in ten of a horizontal line, nor a greater ascent than one yard in thirty. After the road is formed pieces of timber, about six feet long, and six inches diameter, called sleepers, are laid

across it, being eighteen or twenty-four inches distant from each other. Upon these sleepers other pieces of timber called rails, of four or five inches square, are laid in a lateral direction four feet distant from each other, for the waggon wheels to run upon; which being firmly pinned to the sleepers, the road may then be filled with gravel and finished. The waggons have four wheels, either made of solid wood, or of cast iron. The body of the carriage is longer and wider at the top than at the bottom; and usually has a kind of trap door at the bottom, which, being loosed, permits the coals to run out without any trouble. The size of a waggon to carry 50 cwt. of coals is as follows: length of the top seven feet, nine inches; breadth five feet; length of the bottom five feet; breadth two feet six inches; perpendicular height four feet three inches. Where the pits are situated at a considerable distance from the harbour, it is necessary to have a store-house near the shipping place, where the coals may be lodged, until the ships are ready to take them in. The waggon-way should be made into the store-house, at such a height from the ground as to permit the coals to run from the waggons down a spout into the vessels; or else to fall down into the store-house. This kind of store-house is well adapted for despatch, and saving expense; for a waggon load of coals may be delivered either into the store-house or vessels instantly with very little trouble: and if the coals were exposed to the effects of the sun and rain, they would doubtless be very greatly injured in their quality.

There is no great difference in the weight of different kinds of coals, the lightest being about 74 lbs. avoirdupois, and the heaviest about 79 lbs. the cubic foot; but the most usual weight is 75 lbs. the foot, which is 18 cwt. and 9 lbs. the cubic yard. If one coal measuring exactly a cubic yard, nearly equal to five bolls, be broken into pieces of a moderate size, it will measure seven coal bolls and a half. If broken very small it will measure nine bolls; which shows, that the proportion of the weight to the measure depends upon the size of the coals; therefore it is evident that accounting by weight is the most equitable method.

We have particular personal knowledge of the general merit of the above observations. But some modern improvements in the draining and working of coal-pits may be added.

A careful survey of the real contents of a supposed field of coal, previous to the commencement of any operations, is a precaution that cannot be too strongly recommended. Situations for a clay-level drift have been presumed upon, long leases taken, and works often erected in utter defiance of common prudence, for want of a little careful use of the methods already described for exploring the ground.

Winning or draining the field is effected by a clay-level drift (where suitable) in the following manner.

Let 1, 2, 3, 4, be the borings of the field designed to be won from the ravine at 4 to the crop of the seams at *a*. A clay-level drift is now constructed, from the ravine, until it enters the seam *S*, by which the strata from 3 to 5 is drained.

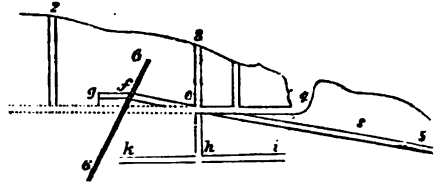

A pit is then sunk upon 3, *e*, which works the contents of *S* with great ease to the surface. But in the progress of the work a down-throw slip-dike 6, 6, may occur, and depress the seam *S*, as at *f*. The nature and extent of this depression is ascertained by carrying forward a horizontal stone-drift, as to *g*, and dropping a bore-hole; the clay-level drift being then continued until it meet the bore-hole 2. When an up-throw slip-dike is met with, the boring is directed upwards from a horizontal drift, and the clay-level drift continued, in a similar manner.

Coals below the level of the clay-drift are won by a shaft sunk at *e*, and worked as at *h*, *i*, and *k*, by a steam engine, which lifts the water to the clay-level drift, and it works off with its water by the ravine.

This mode of operation, it will be seen, requires a particular situation in the field: when it is nearly horizontal, as it often is, such a plan cannot be pursued: and no small obstacles are sometimes found in sinking the pits through the springs and quicksands that are penetrated at from thirty to fifty fathoms: in one shaft, a feeder of water has been found to yield 4000 gallons a minute. In such cases, the assistance of the steam engine has been incalculable; but there are obstacles of this kind which even that powerful agent cannot, at least without an extravagant outlay, be made to overcome. The water is in these instances stopped, or dammed back, by what is called tubbing and wedging, accomplished by fixing water-tight cylinders of wood, or cast-iron, within the circumference of the shaft. Such proceedings being attended with great labor and cost, as much use as possible is made of each shaft, and they have been made from nine to sixteen feet in diameter.

Working is accomplished by what is called the narrow and the broad way: the former is that described in the foregoing article. But Mr. Buddle, of Walls' End, has recently brought an improvement of it into such great perfection, that we must here briefly advert to it. It is particularly described by Mr. Griffith, in his *Report on the Leinster District*.

By this mode of working, the mine is divided into a convenient number of portions, or districts, each of which is wrought in its turn, and the roof then suffered to fall in: this, however, is proposed for a measure, and the effect of it qualified by leaving in the abandoned part certain great protecting pillars of coal. In fact, this method is a mechanical calculation on the strength of the roof, judiciously and by degrees applied; but the issue is, that this mode of working will withdraw safely seven-eighths of the contents of a coal field, whereas, ten years ago, not above a half, and sometimes not above a third, could be taken.

By the broad way of working no pillars are left, but the coal is wrought out sometimes for 150 yards of surface at once: this mode is only adapted, however, to pits in which it lies near the surface.

As we are going to press, we find the following return has been made to the Corporation Coal and Corn Committee of the quantities of coal, culm, and cinders, imported into the port of London during the year 1825. It is the first return of the kind ever made, and will give the reader some impression of the quantity of fuel consumed in the metropolis.

QUANTITIES OF COAL IMPORTED IN EACH MONTH OF THE YEAR 1825.

Months.	Ships.	Chaldrons.	Vats.
January	359	79,750	—
February	480	110,136	1
March	606	136,573	3
April	445	100,198	—
May	490	106,332	1
June	494	103,397	1
July	578	124,896	3
August	764	97,119	2
September	754	158,583	—
October	615	135,611	—
November	639	150,673	2
December	640	146,448	2
Total	6,564	1,449,619	3
Imported under the description of ashes, without certificate		65,542	2
Total	6,564	1,456,162	1

TOTAL IMPORT, SPECIFYING EACH SORT.

	Ships.	Chaldrons.	Vats.
Newcastle coal	2,182	534,015	—
Do. called Wall's end	1,849	436,902	2
Sunderland coal	1,009	184,546	3
Do. called Wall's end	997	198,600	2
Blythe, Scotch, Welsh, &c.	429	76,368	2
Coals, as ashes		6,542	1
Nut and Bean coal	20	2,939	1
Screened small coal	85	16,247	1
Total	6,571	1,456,162	1

COALESCE, *v. n.* } Lat. *coalesco*. To unite
 COALESCENCE, *n. s.* } in masses by a spon-
 COALITION, *n. s.* } taneous approximation
 to each other. To grow together; to join;
 union in one mass or body; conjunction of separate parts in one whole.

The world's a mass of heterogeneous consistencies, and every part thereof a coalition of distinguishable varieties. *Granville.*

In the first coalition of a people, their prospect is not great: they provide laws for their present exigence. *Hale.*

'Tis necessary that these squandered atoms should convene and unite into great masses; without such a coalition the chaos must have reigned to all eternity. *Bentley.*

When vapours are raised, they hinder not the transparency of the air, being divided into parts too small to cause any reflection in their superficies; but when they begin to coalesce, and constitute globules, these globules become of a convenient size to reflect some colors. *Newton.*

COANE, among the Greeks, a name given to a peculiar species of tutia or tutty, which was always found in a tubular form. It had its name from *κωνη*, a word used to express a kind of cylindrical tube, into which the melted brass was received from the furnace, and in which it was suffered to cool. In cooling, it always deposited a sort of recement on the sides of the vessel or tube, which was the tutty called coane.

COANGO, a river of Africa, on the west coast, which, after running through the kingdom of Congo, changes its name to Zaire, and falls into the ocean between Sagno and Ango.

COANZA, a large, deep, and rapid river of Africa, which rises far in the interior, and, crossing the kingdom of Angola, falls into the Atlantic Ocean, about lat. 9° 20' S., thirty-six miles south of Loanda the capital of that kingdom. It is navigable for 150 miles, and abounds with a variety of fish. It forms several islands, has some cataracts, and one in particular which bears its name. As for its source, and the length of ground it crosses from east to west before it comes to the Portuguese settlement, they are absolutely unknown, as well as the countries through which it runs. It falls into the Atlantic Ocean, thirty miles north-east of Cape Ledo.

COAPTATION, *n. s.* From *con* and *apto*, Lat. The adjustment of parts to each other.

In a clock the hand is moved upon the dial, the bell is struck, and the other actions belonging to the engine are performed by virtue of the size, shape, bigness, and coaptation of the several parts. *Boyle.*

The same method makes both prose and verse beautiful, which consists in the judicious coaptation and ranging of the words. *Broom.*

COARCT, *v. a.* } Latin, *coarcto*. To
 COARCTATE, *v. a.* } straiten, to confine into
 COARCTATION, *n. s.* } a narrow compass; to contract power; to restrain; restraint to a narrow space; restraint of liberty.

The wind finding the room in the form of a trunk, and coarctated therein, forced the stones of the window, like pellets, clean through it. *Bacon.*

If a man coarctis himself to the extremity of an act, he must blame and impute it to himself, that he has thus coarcted or straitened himself so far. *Ayliffe.*

Election is opposed not only to coaction, but also to coarctation, or determination to one. *Bramhall.*

Straiten the artery never so much, provided the sides of it do not meet, the vessel will continue to beat, below or beyond the coarctation. *Roy.*

COARSE, *adj.* } Lat. *crassus*. Gross; not
 COARSELY, *adv.* } separated from impurities
 COARSENESS, *n. s.* } or baser parts; not delicate; rough; inelegant; unpolished; unfinished

by art or education; not nicely expert; rude; uncivil; harsh in manners; mean; vile; repulsive from a too common vulgarity of address; whatever is uncultivated.

First know the materials whereof the glass is made; then consider what the reason is of the *coarseness* or dearness.

Bacon's Essays.

I feel

Of what *coarse* metal ye are moulded.

Shakespeare.

Ill consort, and a *coarse* perfume

Disgrace the delicacy of a feast. *Roscommon.*

A *coarse* and useless dunghill weed,

Fixed to one spot, to rot just as it grows. *Otway.*

From this *coarse* mixture of terrestrial parts,
Desire and fear by turns possess their hearts.

Dryden.

The good cannot be too much honored, nor the bad too *coarsely* used. *Id.*

Praise of Virgil is against myself, for presuming to copy, in my *coarse* English, his beautiful expressions. *Id.*

Be pleased to accept the rudiments of Virgil's poetry, *coarsely* translated, but which yet retains some beauties of the author. *Id.*

Friends (pardon the *coarseness* of the illustration) as dogs in couples, should be of the same size. *L'Esrange.*

A base wild olive he remains;

The shrub the *coarseness* of the clown retains. *Garth.*

Consider the penuriousness of the Hollanders, the *coarseness* of their food and raiment, and their little indulgences of pleasure. *Addison on the War.*

Practical rules may be useful to such as are remote from advice, and to *coarse* practitioners, which they are obliged to make use of. *Arbuthnot.*

'Tis not the *coarser* tye of human law

That binds their peace. *Thomson.*

COAST, *n. s., v. n. & v. a.* } *Lát. costa; Fr*
CO'ASTER, *n. s.* } *coste.* The margin

of the land next the sea; the shore. It is not used for the banks of less waters. To coast is, to sail within sight of land; to sail near the shore. A coaster is one who thus sails, and who does so from timidity, or apprehension of danger. Thus, the coast is clear, is a proverbial expression, denoting that the danger is over, or that there is not anything to fear, and the coaster may therefore take leave of the shore.

Stere onys into the *coastes* as well as thou can,
When our shippes be ycom, that we may pass in fere;
Lace on a bonnet or tweyn, that we mave saile nere,
And when they wer the *coastes* nygh, was noon of them all

That wist what lond it was. *Chaucer's Canterbury Tales.*

Ne did it then deserve a name to have,
Till that the venturous mariner that way
Learning his ships from those white rocks to save,
Which all along the southerne *sea-coast* lay,
Threatening unheedy wrecke and rash decay,
For safety that same his sea-marke made,
And named it Albion; but later day
Finding in it fit ports for fisher's trade,
Gan more the same frequent, and further to invade. *Spenser.*

The south-east is found to be better for ripening of trees than the south-west; though the south-west be the hottest *coast*. *Bacon.*

Going out, and seeing that the *coast* was clear, *Zel-*
mane dismissed *Musidorus*. *Sidney.*

Nearchus, the admiral of *Alexander*, not known the compass, was fain to *coast* that shore.

Browne's Vulgar Error

He sees in English ships the *Holland coast*. *Dryde*

In our small skiff we must not launch too far;

We here but *coasters*, not discoverers, are.

But steer my vessel with a steady hand,

And *coast* along the shore in sight of land. *Id. Virg*

The royal spy, when now the *coast* was clear,
Sought not the garden, but retired unseen. *I*

Some kind of virtue, lodged in some sides of the crystal, inclines and bends the rays towards the *coast* of unusual refraction; otherwise the rays would not be refracted towards that *coast* rather than any other *coast*, both at their incidence and at their emergence so as to emerge by a contrary situation of the *coast*. *Newton's Optick*

The greatest entertainment we found in *coasting* is the several prospects of woods, vineyards, meadows, and corn-fields, which lie on the borders of it. *Addison on Ital*

The ancients *coasted* only in their navigation, being dom taking the open sea. *Arbuthnot on Coin*

Cold as the crags upon his native *coast*,
His mind as barren, and his heart as hard,

Is he whose head conceived, whose hand prepared
Aught to displace *Athena's* poor remains. *Byron's Child Harold*

COAST, CAPE, OF COAST CASTLE, CAPE, the chief British settlement on the gold coast of Guinea in Africa. The name is a corruption of Cabo Corso, the ancient Portuguese appellation. This cape is formed by an angular point *east* on the south and east by the sea, on which stand the English fort. Here the Portuguese settled in 1610, and built the citadel upon a large rock that projects into the sea. A few years afterwards they were dislodged by the Dutch, to whom this place is principally indebted for its strength. In 1661 it was demolished by Admiral Holmes, and in 1665 the famous Dutch Admiral De Ruyter was ordered by the States to revenge the insults of the English. With a squadron of thirteen men of war, he attacked the English settlements along the coast, ruined the factories, and took, burnt, and sunk, all the shipping of the English Company: however after all his efforts, he was baffled in his attempt on Cape Coast. By the treaty of Breda it was confirmed to the English, and the king granted a new charter in 1672; on which the Company applied all their attention to the fortifying and rendering it commodious. The fort is considerably strengthened with high and thick walls especially on the land side, flanked with fortifications and ten pieces of cannon; but it is close near the town, and even commanded by some of the houses. There are apartments in it for the governor, besides a chapel, and accommodation for different workmen and artificers. The houses in the town are built in a square form, mostly of clay, but the whole appearance very irregular and dirty. It is supposed to contain about 800 people. The surrounding country was formerly very woody, but some improvement has taken place by the opening of roads, the laying out and planting of private grounds, the erection of mansions, &c. With all the workmen connected with this establishment, the garrison could hardly be raised to 100 men, a force very inadequate to

the importance of the place. It is situated in about 3° W. long., and 5° 15' N. lat.

COASTING, in navigation, the act of making a progress along the sea coast of any country. The principal requisites for this part of navigation are, the knowledge of the time and direction of the tide; of the reigning winds; of the roads and havens; and of the different depths of water, and qualities of the ground.

COASTING PILOT, a pilot who by long experience has become sufficiently acquainted with the nature of any particular coast, and of the requisites mentioned above, to conduct a ship or fleet from one part of it to another.

COAT, *n. s.* & *v. a.* *χιτών*; *Fr. cotte.* An upper garment, belonging generally to the male sex; the outside covering of animals; but extending to any integument, tunic, or covering; to whatever is placed in the exterior to preserve it either from decay or from cold, from accident and from injury. To coat is not merely to put on the outward garment, but it is to cover, to invest, to overspread. That, on which armorial ensigns are portrayed, is called a coat, probably because these ensigns were originally affixed to the coat, or outward apparel. Coat likewise is used to distinguish the habit or vesture, as demonstrative of office.

He was armed with a coat of mail, and the weight of the coat was five thousand shekels of brass.

1 Samuel.

The coat of many colors they brought to their father, and said, this have we found: know now whether it be thy son's coat or no.

Genesis.

A white cote, and a blew hode, wered he.

Chaucer's Canterbury Tales.

Ther maist thou see devising of harnais
So uncooth and so riche, and wrought so welle
Of goldsmithery, of bronning, and of stele:
The sheldes brighte testeres and trappures,
Gold-hewen helmes, hauberkes, cote-amures. *Id.*

The herald of love's mighty king,
In whose coat armour richly are displayed
All sorts of flowers the which on earth do spring.

Spenser.

Cropped are the flower-de-luces in your arms;
Of England's coat one half is cut away.

Shakespeare. Henry VI.

He clad

Their nakedness with skins of beasts; or slain,
Or, as the snake, with youthful coat repaid;
And thought not much to clothe his enemies.

Milton

Men of his coat should be minding their prayers,
And not among ladies, to give themselves airs. *Swift.*
The eye is defended with four coats, or skins.

Peachum.

The optick nerves have their medullary parts, terminating in the brain, their teguments terminating in the coats of the eye.

Derham's Physico-Theology.

At each trumpet was a banner bound,
Which, waving in the wind, displayed at large
Their master's coat of arms and knightly charge.

Dryden.

Amber is a nodule, invested with a coat, called rock-amber.

Woodward on Fossils.

The sunny brood their wonted haunts forsake,
Fleet in the sun, and skim along the lake,
With frequent leap they range the shallow streams,
Their silver coats reflect the dazzling beams. *Gay.*

How his eyes languish! how his thoughts adore
That painted coat which Joseph never wore.

Young's Love of Fame.

You have given us milk

In luscious streams, and lent us your own coat
Against the winter's cold. *Thomson's Spring.*

COAT OF ARMS, in heraldry, a habit worn by the ancient knights over their arms both in war and tournaments, and still borne by heralds at arms. It was a kind of fur coat, reaching as low as the navel, open at the sides, with short sleeves, sometimes furred with ermine and hair, upon which were applied the armories of the knights embroidered in gold and silver, and enamelled with beaten tin, colored black, green, red, and blue; whence the rule never to apply color on color, nor metal on metal.

We insert a wood-cut of the coat of the earl of Chatham, as borne at his funeral.



The coats of arms were frequently open, and diversified with bands and fillets of several colors, alternately placed, as we still see cloths scarleted, watered, &c. Hence they were called devises, as being divided, and composed of several pieces sewed together; whence the words false, pale, chevron, bend, cross, saltier, lozenge, &c. which have since become honorable pieces, or ordinaries of the shield. Coats of arms and banners were never allowed to be worn by any but knights and ancient nobles.

COAT OF MAIL, a kind of armour made in the form of a shirt; consisting of iron rings woven together netways. See **MAIL**.

COATING OF PHIALS, PANES OF GLASS, &c., among electricians, is usually performed by covering the outside of the phial with tinfoil, brass or gold leaf, &c. and filling its inside with loose pieces of brass leaf, by which means it becomes capable of being charged. See **ELECTRICITY**.

COATZACUALCO, a navigable river of North America, in Mexico, which falls into the Gulf of Mexico near Onoqualco.

COAX, *v. a.* } *Teut. kosen.* To wheedle,
COAXER, *n. s.* } to flatter, to humor; to seduce
or low arts.

The nurse had changed her note; she was muzzling
and coaxing the child; that's a good dear says she.

L'Estrange.

I coax! I wheedle! I'm above it.

Farquhar's Recruiting Officer.

CO'BALT, *n. s.* A marcasite frequent in Saxony.

Cobalt is plentifully impregnated with arsenick; contains copper and some silver. Being sublimed, the flores are of a blue color: these, German mineralogists call zaffir

Woodward.

Cobalt is a dense, compact, and ponderous mineral, very bright and shining, and much resembling some of the antimonial ores. It is found in Germany, Saxony, Bohemia, and England; but ours is a poor kind. From *cobalt* are produced the three sorts of arsenick, white, yellow, and red; as also zaffre and smalt.

Hill on Fossils.

H 2

COBALT, a mineral of a gray color, classed with the semi-metals. It nearly resembles fine hardened steel, and its specific gravity is above 8. It is as difficult of fusion as copper, and, when purified, scarcely yields to iron itself in this respect. It is susceptible of magnetism, but in a weaker degree than either steel or nickel. Cobalt, when calcined along with the calx of arsenic in a gentle heat, assumes a red color. The same is naturally produced, by way of efflorescence, and is then called the bloom or flowers of cobalt. It does not mix with mercury by any means hitherto known, nor will it form any union with bismuth without the addition of some medium. It is easily soluble in spirit of nitre, and the solution, either in this or any other acid, is of a red color; and it is observable that the color of the acid solutions of this substance, instead of fading by dilution with water, become more vivid. Cronstadt makes mention of native cobalt; but other mineralogists assure us that it has never been found perfectly pure in the bowels of the earth. That called the gray cobalt ore approaches nearest to the purity of the native metal, but always contains some quantity of arsenic and iron. It is found in Sweden, Saxony, Norway, and England, particularly in the Mendip hills in Somersetshire and in Cornwall, where it has been dug up in large quantities. Here it is sometimes found in conjunction with bismuth and sometimes without it, resembling very much in appearance the Saxon ores of Schauberg in misnia. An arsenicated gray cobalt ore has also been found at Chatelaudren in France. This kind of ore is solid, heavy, and compact, sometimes dull and sometimes of a bright appearance, crystallised frequently in a tessular and sometimes in a dendritical form; being generally hard enough to strike fire with steel, when an arsenical smell is perceived. The most common ore of cobalt is that called the black or vitreous ore, and kobalt mulm or schlaken kobalt by the Germans. It is found in a loose powdery form, sometimes resembling lamp-black, sometimes of a gray color, in which state it is called cobalt ochre; but when in scoriform half-vitrified masses it obtains the name of vitreous or glossy ore. It is frequently embodied in stones or sands of a black color; sometimes it is contained in argillaceous earths of a blue or green color. Talc, chalk, and gypsum, impregnated with it, are called by the same name; and, by some, spiegel cobalt. Cobalt, mineralised by the arsenical acid, is found either loose and pure, or mixed with chalk or gypsum, or indurated and crystallised in tetrahedral crystals. It is also found in a stalactitical form. It melts easily, and then becomes blue. It frequently invests other cobaltic ores; and is found sometimes in stone and sand. From the experiments of Bergman it appears that the arsenical acid, and not the calx of arsenic, enters into this combination; for cobalt is never red but when united to an acid. Flowers of cobalt mineralised by arsenic without any silver, and intermixed with galena, have also been discovered in France. They are often found of a red color, like other earths, spread very thin on the cobalt ores; and, when of a pale color, are erroneously called

flowers of bismuth. The indurated flowers of cobalt are commonly crystallised in form of deep red semitransparent rays. It is found at Schnuberg in Saxony. Cobalt, mineralised by sulphureted iron, is of a color nearly resembling tin or silver. It is sometimes found in large masses, sometimes in grains crystallised of a dull white color, and frequently has the appearance of mispickel. It has no mixture of arsenic. By calcination it becomes black and not red, which distinguishes it from the pyrites; and it contains so little sulphur that none can be extracted from it. When dissolved in aqua regia the solution is yellow, but becomes green when boiling; which alteration, according to Kirwin, is peculiar to marine cobalt. A coarse grained kind of this ore, found in Sweden, becomes slimy in the fire, and sticks to the iron rods employed in stirring it while calcining. The slaggy kind contains a large quantity of iron, and affords a very beautiful color as well as the former. Cobalt mineralised by sulphur, arsenic, and iron, has a great resemblance to the harder kinds of gray cobalt ore; but it is never hard enough to strike fire with steel, and sometimes may even be scraped with a knife. The most shining kind of this and the former species are called kobalt glantz. The great consumption of cobalt is for the permanent blue color which it communicates to glasses and enamels, either upon metals, porcelains, or earthen wares of any kind; and for the making of smalt powder blue &c. But although cobalt is applied to few other purposes, the quantities consumed in this way afford insufficient profit to those who have cobalt mines in their possession. Ores of cobalt are met with, in the greatest quantities, near Schnuberg in Saxony, and at St. Andreasberg in Upper Hartz. Formerly an iron ore only was found in this place; but about the beginning of the fourteenth century, on sinking deeper, it was succeeded by a very rich ore of silver; which, also, being at length exhausted, gave place to cobalt ores. Some pieces, however, are still found in these mines that contain silver and gold. It is supposed that the Chinese, and particularly the Japanese, had formerly mines of excellent cobalt, with which the fine blues of their ancient porcelains were painted; but it appears that these mines are now exhausted, and that the inferior blues of their present wares are painted with the Saxon zaffre, imported to them by the Dutch. See CHEMISTRY.

COBALT, a name applied in Germany, and Saxony, to the damps and arsenical vapors, and their effects on the miners; which has induced the vulgar to apply it to an evil spirit, whom they suppose to dwell in the mines.

COBB (Samuel), an English poet, was educated at Christ's Hospital, whence he proceeded to Trinity College, Cambridge, and took his degree of A. M. in 1702. He afterwards became master of the grammar school at Christ's Hospital, but died in 1713, in the prime of life. He wrote 1. Observations on Virgil; 2. a collection of Poems, with a discourse on Criticism and the liberty of Writing, 8vo.; 3. The Miller's Tale, from Chaucer; 4. a Translation of the Muscipula; 5. The Oak and the Briar, a tale; 6. The Female Reign, an Ode.

Cobb (James), a dramatic writer, was born in 1756, and became secretary to the East-India Company, which office he discharged with great credit till his death in 1818. He wrote the *Humorist*, an opera; *Love in the East*; the *Haunted Tower*; the *Siege of Belgrade*; and several minor pieces, all of which obtained considerable notice.

COBBE, the principal town of the central country of Darfur, Africa. It is situated in the middle of the province, on the great road which penetrates it from north to south, and is said to be more than two miles in length, but very narrow; each house occupying within its enclosure a considerable space of ground, and being separated by a vacant space from the one nearest it. Here reside the principal merchants who conduct the central trade of Africa. In the town appear in great numbers the palm, the delab tree, &c. and two species, called the heglig and the nebbek, which give it an agreeable appearance. The water here, which is drawn from wells filled by the torrents which descend here in the rainy season, though not unwholesome, is turbid, and of an unpleasant taste; in the dry season it often fails. A market is held twice a week for meat and other provisions. Near the town, on the east, is a high mountain of this name abounding with the African tiger and jackal. Long. 28° 8' E. lat. 14° 11' N.

COBBESECONTE, or **COPSECOOK**, a small river of the United States, district of Maine, which rises from ponds in Winthrop, and falls into the Kennebeck within three miles of Nahunkeag, and fifteen from Moose Island. The name, in the Indian language, signifies the place where sturgeon are taken.

COBBING, a punishment sometimes inflicted at sea. It is performed by striking the offender a certain number of times on the breech with a flat piece of wood, called the cobbing board. It is chiefly used as a punishment to those who quit their station during the period of the night watch. Nor are school-boys unacquainted with it as a diversion.

COBBLE, *v. a.* } Fr. *cobler*; Lat. *copulo*.
COBSLER, *n. s.* } To mend a thing coarsely;
 Usually applied to the mending of shoes; hence,
 to a clumsy workman in general; a mean and
 low occupation.

If you be out, Sir, I can mend you.—Why, Sir,
 mend you. *Shakspeare. Julius Cæsar.*

What trade are you?—

Truly, Sir, in respect of a fine workman, I am
 But, as you would say, a *cobbler*. *Id.*

They'll sit by the fire, and presume to know
 What's done i' the capital; making parties strong,
 And feeble such as stand not in their liking
 Below their *cobbled* shoes. *Id. Coriolanus.*

Reject the nauseous praises of the times;
 Give thy base poets back their *cobbled* rhimes. *Dryden*

Think you the great prerogative to enjoy
 Of doing ill by virtue of that race?
 As if what we esteem in *cobblers* base
 Would the high family of Brutus grace. *Id. Juvenal.*

Not many years ago it happened that a *cobbler* had
 the casting vote for the life of a criminal.

Addison on Italy.

COBDEN (Edward), an ingenious divine and poet, born in 1684. He became rector of St. Austin in London, and of Acton in Middlesex, prebendary of St. Paul's, and archdeacon of London. Dr. Cobden was likewise chaplain in ordinary to George II., but resigned that situation some years before his death, which happened in 1764. He published a volume of poems for the benefit of his curate's widow; and, in 1757, a volume of sermons also.

COBEQUIT, or **COLCHESTER**, a river of Nova Scotia, which rises within twenty miles of Tatamogouche, on the north-east coast; thence runs south, then south-west and west, into the east end of the basin of Minas. There is a short bank at its mouth; but it has a good channel on each side, whereby vessels of sixty tons may pass, and go forty miles up the river.

COBHAM, a town of the United States in Virginia, on the south bank of James River, opposite to James town; eleven miles north-west of Smithfield; twenty north-west by north of Suffolk; nine south-west of Williamsburgh; fifty-four east by south of Petersburg; and forty-five south-east of Richmond.

COBI, a desert of Tartary, called Chamo by the Chinese; bounded on the north by the country of the Kalkas; on the east by the Moguls and Chinese Tartary; on the south by China; and on the west by Kalmuc Tartary.

CO'BIRONS, *n. s.* Cob and iron. Irons with a knob at the upper end.

The implements of the kitchen; as spits, ranges, *cobirons*, and pots. *Bacon's Physical Remains.*

CO'BISHOP, *n. s.* Con and bishop. A coadjutant bishop.

Valerius, advanced in years, and a Grecian by birth, not qualified to preach in the Latin tongue, made use of Austin as a *cobishop*, for the benefit of the church of Hippo. *Ayliffe.*

COBITIS, the loache, in ichthyology, a genus of fishes belonging to the order of abdominales. The eyes are in the upper part of the head; the branchiostege membrane has from four to five rays; and the body is nearly of an equal thickness throughout. There are six species, of which three are natives of Europe. The loache is found in several of our small rivers, at the bottom on the gravel; and is, on that account, in some places called the groundling: it is common in the stream near Amesbury in Wiltshire, where sportsmen sometimes, in frolic, swallow it alive in a glass of white wine.

COBLE, a boat used in the turbot fishery, twenty feet six inches long, and five feet broad. It is about one ton burden, rowed with three pairs of oars, and admirably constructed for encountering a mountainous sea.

COBLENTZ, an ancient city in the grand duchy of the Lower Rhine, in Germany, in long. 7° 30' E., lat. 50° 23' N., about thirty-six miles north-west of Mentz, forty-eight south-east of Cologne, and fifty-four north-east of Treves. Formerly it was included in the electorate of Treves, afterwards it was made a part of the French republic, and the capital of the department of the Eiffel, and, finally, became subject to Prussia. It stands opposite the fortress of

Ehrenbreitstein, in a rich and fertile country, the mountains of which are covered with vineyards, at the confluence of the rivers Rhine and Moselle. It has a bridge of free-stone over the latter river, but the former is crossed by one constructed of boats. The city is handsome and well built, the streets regularly laid out, the houses of stone, and the public buildings very elegant. The elector of Treves was accustomed to reside here; and, at the beginning of the French revolution, the emigrant princes and nobles made it their principal resort. The palace of the elector is a magnificent building on the bank of the Rhine, on the opposite side of which the old castle stands on the top of a height, with a small collection of houses round it. A ferry machine erected on two boats, in the form of a square gallery, surrounded with balustrades, passes from one side of the river to the other for the convenience of passengers; it is moved by pulling a rope fixed to a standard on each bank. The castle completely commands the city, and seems almost inaccessible; the French, however, under general Marceau, took it after a siege of two hours on the 23rd of October, 1794. Formerly there were two collegiate churches within the city, besides an archiepiscopal seminary, a Jesuit college, and several convents; but the French suppressed most of them. Its population has been differently stated, some making it 12,000 or 13,000, and others under 11,000, which is the most probable calculation, even including the suburbs of Moselweis and Newendorf. This place is very favorably situated for trade, directly communicating with Germany and Switzerland by the Rhine, and with France by means of the Moselle. Great quantities of the best Moselle wine are made here, and exported to Frankfort and Holland; and through this place the Dutch have much of their timber and iron. Wool, linen, and leather, constitute the chief articles of manufacture, but on a small scale. Two yearly fairs, of a fortnight each, are held here.

Coblentz has been celebrated in antiquity. It was known to the Romans, who called it *Confluentes*, or *Confluentia*, from its situation; in the year 800 a great ecclesiastical council was held in it; and it was counted a free town for a long time before it passed into the possession of the electors of Treves. In 1249 it was fortified with walls, but, during the thirty years' war, it passed successively into the hands of the Swedes, French, Imperialists, and German Protestants. It was besieged by the French in 1688, and almost laid in ashes by a bombardment that it suffered from the castle Ehrenbreitstein; but it did not surrender. It is remarkable for having been made by the Prussians their head quarters, when they were about to invade France; and here the prince of Condé fixed the rendezvous of the emigrants that formed his army. The mineral waters of Tinstein, near this place, are noted, and the baths of Ems, in the neighbourhood of which pumice stone is found in great abundance. There are two interesting objects near this city, a Carthusian monastery, almost in ruins, and the tomb and fort of general Marceau, who fell in the year 1796.

COB'NUT, *n. s.* cob and nut. A boy's game; the conquering nut.

COBOOSE, in sea language, a sort of box, resembling a sentry-box, used to cover the chimneys of some merchant ships. It generally stands against the barricade, on the fore part of the quarter-deck. It is called in the West Indies *Cobre Vega*.

COBOURG, a principality in Germany, situated in the northern part of the circle of Franconia, but dependent on that of Upper Saxony. It is included between 9° 50' and 12° 20' E. long., and 50° 15' and 51° 15' N. lat., and is bounded on the south by Franconia, on the north and east by Upper Saxony, and on the west by the principality of Hesse. Formerly it belonged to the house of Henneburg, but passed by marriage to that of Saxony, and has been divided into four branches, viz. Saxe-Cobourg, of Saxe-Cobourg Saalfeld, Saxe-Meiningen, Saxe-Gotha, and Saxe-Heilburghausen. The principality of Saxe-Cobourg, properly so called, is the most southerly of the four divisions above mentioned; the mountainous ridge, that passes through them, forming its northern boundary, and Franconia being its boundary on every other side; it lies between 10° 35' and 11° 20' E. long., and 50° 15' and 50° 34' N. lat. It comprehend about 580 square miles, and a population of 80,000 persons. It is generally a mountainous district, especially through the middle part, including a great part of the Thuringian forest there are, however, extensive plains, which are very fertile in corn, flax, hops, and fruit, and large pastures for cattle. The inhabitants export corn, wool, cattle, tiles, wood, pitch, and potash which last article constitutes their chief manufacture; they also make glass, leather, and gunpowder, both for home consumption and exportation. It is watered by several streams, the chief of which are the Itz, or Itach, and the Saale, both running into the Maine, and the Werra, afterwards known by the name of the Weser. Amongst its mineral and fossil productions, may be enumerated iron, copper, coals, marble, alur gypsum, and chalk. It is under an hereditary government; and the greater part of the people are Lutherans; free toleration, however, is enjoyed here. It supports an army of 800 men and yields £52,000 revenue.

COBORO, the capital, lies in a pleasant valley through which the Itz flows. It is generally well built, and has a handsome square market place, containing the town-hall and government offices, and a castle, where the prince usually resides. On a hill near the town stands the fort a place of some strength. Various articles are made here of the petrified wood found in the neighbourhood. Six annual fairs are held, and a great trade carried on in wool. There are about 7000 people in this town, many of whom work in the quarries adjacent. Saalfeld, on the Saale, is the second city, and was formerly place of great consequence. It once possessed the mint for Upper Saxony; it has yet some public institutions, and silk and cloth manufactures. Not far from it, on an eminence, stands Saalfeld Abbey, a monastery of Benedictines, the abbot c

which was always a German prince, who had a seat in the Diet.

COBSWAN, *n. s.* Cob head, and swan. The head, or leading swan.

I am not taken

With a *cobswan*, or a high-mounting Jull,
As foolish Leda and Europa were.

Ben Jonson's Cataline.

COBWEB, *n. s.* Dutch, *kopweb*. The web or net of a spider; from cob, a spider. Any snare or trap; implying insidiousness and weakness.

The luckless Clarion,

With violent swift flight, forth carried
Into the cursed *cobweb*, which his foot
Had framed for his final overthrow. *Spenser.*

Is supper ready, the house trimmed, rushes strewed,
and *cobwebs* swept?

Shakespeare. Taming of the Shrew.

The spider, in the house of a burgher, fell presently
to her net-work of drawing *cobwebs* up and down.
L'Estrange.

For he a rope of sand could twist
As tough as learned Sorbonist;
And weave fine *cobwebs* fit for scull
That's empty when the moon is full. *Hudibras.*

Chronology at best is but a *cobweb* law, and he
tote through it with his weight. *Dryden.*

Laws are like *cobwebs*, which may catch small flies,
but let wasps and hornets break through. *Swift.*

Drawn by a fraudulent nymph, he gazed, he sighed,
Unmindful of his home and distant bride;
She leads the willing victim to his doom,
Through winding alleys to her *cobweb* room. *Gay.*

Laws, as we read in ancient sages
Have been like *cobwebs* in all ages.
Cobwebs for little flies are spread,
And laws for little folks are made. *Beattie.*

COCA, a town of Spain in Old Castile, seated on the Eresma, among the mountains, near a strong castle, which is used as a state prison. It is twenty-four miles E. S. E. of Valladolid, and twenty-two north-west of Segovia. Long. 3° 28' W. lat. 41° 29' N.

COCCIEUS (John), a celebrated Dutch divine, born at Bremen in 1608. When only twenty-seven years of age, he was appointed Hebrew professor in his native city; but afterwards removed to Franeker, and lastly to Leyden, where he filled the theological chair. He distinguished himself by his commentaries on the Old Testament history, which he considered as a mirror, holding forth an accurate view of the transactions and events that were to happen in the church under the New Testament dispensation, and unto the end of the world. The apocalypse was his favorite study; and he maintained the notion of a visible reign of Christ in this world, after a general conversion of the Jews, and other people to the Christian faith. His opinions were warmly controverted; but they had many adherents, who obtained the name of Cocceians. He died at Leyden in 1669. His writings make ten vols. folio.

COCCIEUS (Henry), a German civilian, born at Bremen in 1644. He was educated at Leyden, and afterwards became professor of the law of nature and nations at Heidelberg; on the taking of which place he removed to Utrecht, and lastly

to Frankfort on the Oder. He was created a baron of the empire in 1713, and died in 1719. He published *Juris Publici Prudentia Compendiose exhibitâ; Prodrromus Justitiæ Gentium; Deductiones, Consilia, &c.*; Theses, four vols. 4to; and also an improved edition of Grotius on War and Campaigns.

COCCIFEROUS, *adj.* From *κοκκός*, and *fero*, Lat. All plants or trees are so called that have berries.

COCCINELLA, in zoology, the lady-bird, a genus of insects of the order of coleoptera. The antennæ are subclavated; the palpi are longer than the antennæ, the last articulation heart-shaped; the body is hemispheric; the thorax and elytra are marginated; the abdomen is flat.

This genus is divided into sections, from the color of the elytra, and of the spots with which they are adorned. The females, impregnated by the males, deposit their eggs, which turn to small larvæ, slow in their progress, and inveterate enemies to the plant-louse. Those larvæ are frequently found upon leaves of trees covered with plant-lice. On the point of being metamorphosed, they settle on a leaf by the hinder part of the body, then bend and swell themselves, forming a kind of hook. The skin extends, grows hard, and in a fortnight's time the chrysalis opens along the back. The insect in its perfect state receives the impressions of the air, that gives its elytra a greater degree of consistence. It seldom flies, and cannot keep long on the wing. Of all the different larvæ of the coccinella, the most curious is the white hedge-hog, a name given it by de Reaumur, on account of the singularity of its figure, and the tufts of hair which render it remarkable. It seeks its food on the leaves of trees. After a fortnight it settles on one spot, and, without parting with its fur, turns to a chrysalis; three weeks after which it becomes a coccinella. The slough appears nowise impaired by its transformation. M. de Reaumur has observed it on a plum tree. It is likewise found upon the rose tree. When the coccinellæ first arrives at the state of perfection, the colors of their elytra are very pale, nearly bordering upon white or cream color; and the elytra are very soft and tender, but soon grow hard, and change to very lively brilliant colors. Their eggs are of an oblong form, and of the color of amber.

COCCOCYPSILUM, in botany, a genus of plants of the tetrandria class and monogynia order: CAL. four parted superior: COR. funnel-shaped: SEED an inflated, bilocular berry: STYLE semibifid: SPECIES three, shrubs; native of the West Indies.

COCCOLOBA, in botany, a genus of the trigynia order and octandria class of plants; natural order twelfth, holoracæ: CAL. quinquepartite and colored: COR. none: SEED a berry, formed of the calyx, and monospermous. There are thirteen species, of which the principal is the *C. uvifera*, or sea-side grape. It grows upon the sandy shores of most of the West India islands, where it sends up many woody stems, eight or ten feet high, covered with brown smooth bark, and furnished with thick, veined shining, orbicular leaves, five or six inches diameter, standing

upon short foot-stalks. The flowers come out at the wings of the stalks, in racemi of five or six inches long; they are whitish, have no petals, but each is composed of a monophyllous calyx, cut at the brim into five oblong obtuse segments, which spread open, continue, and surround seven or eight awl-shaped stamina, and three short styles, crowned with simple stigmata. The germen is oval, and becomes a fleshy fruit, wrapped round by the calyx, and includes an oval nut or stone.

COCULUS INDICUS, the name of a poisonous berry, too frequently mixed with malt liquors to make them intoxicating, though expressly forbidden by act of parliament. It is the fruit of the menispermum cocculus. Fishermen have a way of mixing it with paste: this the fish swallow greedily, and are thereby rendered intoxicated for a time, and float on the water.

COCCLUS, in zoology, a genus of insects belonging to the order of hemiptera. The rostrum proceeds from the breast; the belly is bristly behind; the wings of the male are erect; and the female has no wings. The species are forty-six in number, denominated principally from the plants they frequent. The most remarkable species are: 1. *C. cacti*, a native of the warmer parts of America, the famous cochineal animal, so highly valued in every part of the world for the incomparable beauty of its scarlet color, which it readily communicates to wool and silk, out with much more difficulty to linen and cotton. This insect is of two sexes, but exceedingly dissimilar in their appearance. The female, which alone is valuable for its color, is ill-shaped and tardy: its eyes, mouth, and antennæ, are fixed so deep, and are so concealed in the folds of the skin, that it is impossible to distinguish them without a microscope. The male is very scarce; active, small, and slender, in comparison with the female; its neck is narrower than the head, and still narrower than the rest of the body. The male is of a bright red; the female of a deeper color. The cochineal was formerly imagined to be a fruit or seed of some particular plant; an error which probably arose from an ignorance of the manner in which it is propagated. The juice of the nopal leaves on which these insects breed, is their sole nourishment. The plant is in May or June in its most vigorous state, and at this favorable season the eggs are deposited among the leaves. In the short space of two months, from an animalcule, the insect grows up to the size above-mentioned; but its infant state is exposed to a variety of dangers; the violent blasts of the north wind sweep away the eggs from the foliage of the plant; and showers, fogs, and frosts often destroy the leaves, leaving the careful cultivator this only resource, to make fires at certain distances, and fill the air with smoke, which frequently preserves them from the fatal effects of the inclemency of the weather. When the insects are at their full growth, they are gathered and put into pots of earthenware. When they have been confined some time in these pots, they are killed and put in bags. The Indians have three different methods of killing these insects; one by hot water, another by fire, and a third by the rays of the

sun; and to these are owing the several gradations of the color, which in some is dark, and in others bright; but all require a certain degree of heat; and, it must be owned, that among the several ways made use of to destroy this valuable creature, that of the rays of the sun seems to perform it in the most perfect manner. The cochineal insect may, in some circumstances, be compared to the silk-worm, particularly in the manner of depositing its eggs. The insects destined for this purpose are taken at a proper time of their growth, and put into a box well closed, and lined with a coarse cloth that none of them be lost; and in this confinement they lay their eggs and die. The box is kept close shut till the time of placing the eggs on the nopal, when, if any motion is perceived, it is a sufficient indication that the animalcule has life, though the egg is so minute as hardly to be perceived; and this seed is placed on the foliage of the nopal; the quantity contained in the shell of a hen's egg, is sufficient for covering a whole plant. It is remarkable that this insect does not, at least in any visible manner, injure the plant, but extracts its nourishment from the most succulent juice, which it sucks by its proboscis through the fine teguments of the leaves. The principal countries where the cochineal insects are bred are New Spain and Peru; but it is only in Oaxaca, in the former country, that they are gathered in large quantities. Though the cochineal belongs to the animal kingdom, of all others the most liable to corruption, yet it never spoils. Without any other care than merely that of keeping in a box, it has been preserved for ages. In drying it loses about two-thirds of its weight. When dried, it is sorted into large entire grains, and small or broken ones: the first are called by the Spaniards *grana*, the latter *granilla*. This insect is said, by Dr. John, to consist of

Cochenilin	50·0
Jelly	10·5
Waxy fat	10·0
Gelatinous mucus	14·0
Shining matter	14·0
Salts	1·5

100·0

In medicine, cochineal has been strongly recommended as a sudorific, cardiac, and alexipharmic; but practitioners have never observed any considerable effects from it. Its principal consumption is among dyers. See **DYEING**. *C. hesperidum*, or the green-house bug, is oval, oblong, and of a brownish color, covered with a kind of varnish: it has six legs, with a notch and four bristles at the tail. It infests orange trees and other similar plants in green-houses. When young, it runs upon the trees; but afterwards fixes on some leaf, where it hatches a great number of eggs, and dies. The male is a very small fly. *C. ilicis*, the insect that forms the kermes grains, inhabits the quercus coccifera of the southern parts of Europe. Both ancients and moderns seem to have had very confused notions concerning the origin and nature of the kermes; some considering it as a fruit, without a just knowledge of the tree which produced it;

others taking it for an excrescence formed by the puncture of a particular fly, the same as the common gall observed upon oaks. The kermes, however, is in reality nothing but the body of an insect transformed into the figure of a grain, berry, or husk, according to the course of nature. At the beginning of March an animalcule, no larger than a grain of millet, scarce able to crawl, is perceived sticking to the branches of the tree, where it fixes itself, and soon becomes immoveable; at this period it grows the most, appears to swell and thrive with the sustenance it draws by degrees. This state of rest seems to have deceived the curious observer, it then resembling an excrescence of the bark; during this period of its growth it appears to be covered with a down, extending over its whole frame like a net, and adhering to the bark: its figure is convex, like a small sloe; in such parts as are not quite hidden by this soft garment, many bright specks are perceived of a gold color, as well as stripes running across the body from one space to another. In April its growth is completed; its shape is then round, and about the size of a pea: it has then acquired more strength, and its down is changed into dust, and seems to be nothing but a husk or capsule, full of a reddish juice not unlike discolored blood. Towards the end of May, sooner or later, according to the warmth of the climate, the husk appears replete with small eggs, less than the seed of a poppy. After this it soon dies, though it still adheres to its position, rendering a further service to its progeny, and shielding them from the inclemency of the weather, or the hostile attacks of an enemy. In a good season they multiply exceedingly, having from 1800 to 2000 eggs, which produce the same number of animalcules. When observed with the microscope, in July or August, we find that what appeared as dust, are so many eggs or open capsules, as white as snow, out of each of which issues a gold colored animalcule, of the shape of a cock roach, with two horns, six feet, and a forked tail. In the civerant province of Languedoc and Provence, the poor are employed to gather the kermes, the women letting their nails grow for that purpose, to pick them off with greater facility. See *KERMES*.

C. lacca, the gum-lac animal, is a native of the East Indies. The head and trunk form one uniform, oval compressed, red body, of the shape and magnitude of a very small louse, consisting of twelve transverse rings. The back is caranite; the belly flat; the antennæ half the length of the body, sending off two, often three, delicate, diverging, hairs, longer than the antennæ. The tail is a little white point, sending off two horizontal hairs as long as the body. It has three pair of limbs half the length of the insect. This is its description in that state in which it sallies forth from the womb of the parent, in the months of November and December. They traverse the branches of the trees upon which they were produced for some time, and then fix themselves upon the succulent extremities of the young twigs. By the middle of January they are all fixed in their proper situations; they appear as plump as before, but show no other marks of life. The limbs, antennæ, and feet of the tail, are no longer to be

seen. Around their edges they are environed with a spissid subpellucid liquid, which seems to glue them to the branch. The gradual accumulation of this liquid forms a complete cell for each insect, and is what is called gum lacca. About the middle of March the cells are completely formed, and the insect is in appearance an oval, smooth, red bag, without life, about the size of a small cucuchanical insect, emarginated at the obtuse end, full of a beautiful red liquid. In October and November we find about twenty or thirty oval eggs, or rather young grubs, within the red fluid of the mother. When this fluid is all expended, the young insects pierce a hole through the back of their mother, and walk off one by one, leaving their exuvie behind, which is that white membranous substance found in the empty cells of the stick lac.

C. polonicus, or the scarlet grain of Poland, an insect which may properly enough be called the cochineal of the northern part of the world. As the cochineal loves only the hot climates, this creature affects only the cold ones. It is collected for the use of dyers: but the crops of it are much smaller, more difficult to be obtained, and the drug itself greatly inferior to the true cochineal. It is gathered in the greatest abundance in Poland, but is also met with in many of the northern countries. It is found affixed to the root of a species of polygonum, of the mouse-ear, rupture-wort, pimpernel, and pellitory of the wall. Towards the end of June the coccus is in a fit state for being gathered. Every one of the creatures is then nearly of a spherical form, of a fine violet color, and full of purple juice. Some of them, however, are not larger than poppy seeds, and others of the size of a pepper corn; and each of them is lodged, either in part or entirely, in a sort of cup like that of an acorn. More than half the surface of the body of the animal is covered by this cup. The outside of the covering is rough, and of a blackish-brown; but the inside is smooth, polished, and shining. On some plants they find only one or two of these, and on others more than forty; and they are sometimes placed near the origin of the stalks of the plant. Each of these produce a six-legged worm, with two antennæ. Several of them have been kept a fortnight, and showed no inclination to eat any thing. They ran about very swiftly for some time; but then began to be more quiet, drew up their bodies shorter, and ceased to run about any longer. They were now of a purple color; but in this state, though they did not walk about, they were subject to various contortions. At length, when wholly motionless, their bodies became covered with a fine white down: this formed a perfect covering, which was sometimes of a spherical, and sometimes of an irregular figure: it was always, however, very elegant; and the downy matter, plainly enough, transpired out of the animal's body. The creatures remained in this state of rest, and covered with this down, for five or six days; but, at the end of that time, every one of them laid more than 150 eggs and died. A sort of very small flies, with two white wings bordered with red, produced from several of these cocci, are supposed to be the males. These flies are plainly of the same kind with the male

gall insects. Those who gather these insects, have a hollow spade with a short handle; then, taking hold of the plant with one hand, they raised it out of the ground with the tool held in the other; after which they very quickly and dexterously detach the insects, and replace the plant in the ground where it again takes root. The coccus is then separated from the earth by a sieve; and, to prevent them from turning into worms, they sprinkle them with very cold water, or vinegar. Lastly, they are killed by exposure to the sun, or by keeping them for some time in a warm place; but this must be done with caution, as too hasty drying would spoil the color. Sometimes they separate the insects from the vesicles with their fingers, and form them into balls; but by this operation their price is greatly increased. It is more expensive than cochineal, as not yielding one-fifth part of the color. Hence this drug is almost entirely fallen into disuse, being scarcely known in any European cities remarkable for having good dyers.

COCCYGIS Os, in anatomy, so called from its resemblance to the bill of a cuckoo; the rump bone. This bone is a small appendage to the point of the sacrum, terminating in an acute point, and differently found according to the different age of the subject. In the child we find but a mere cartilage; in youth jointed bones; in the full grown subject we find one conical bone, though in females the last joint is often loose till the age of sixty. See ANATOMY.

COCHABAMBA, a province of Upper Peru, bounded on the north by the Andes, south-east by the province of Misque, south by that of Charcas, south-west by Oruro, west and north-west by Cicasica. It is 120 miles in length from north to south, and thirty-two wide. This province has been called the granary of Peru. Its western boundary being the Cordilleras of the coast of the Pacific, while it extends to the vast plains of Chiquitos East, sloping off toward it in an inclined plane, whose highest altitude is the summit of the Cordillera, and its base a level track which stretches across the Paraguay and Parenos towards the Atlantic; it may be said to contain every variety of climate and soil. In the mountains is great abundance of mineral wealth, but the gold mines of the provinces have been neglected. On their sides are bred considerable quantities of large and small cattle. The climate is generally mild; it is watered by several small rivers, which fertilise the valleys, and among them are some magnificent and well cultivated estates. Tobacco is cultivated successfully in the district of Valle Grande, in this province. Peruvian bark, indigo, and cocoa, are also among its products. It contains many valuable sugar plantations; and is inhabited by a hardy, sober, and brave race, who have risen of late years, with their country, into a considerable state of prosperity in the manufacture of glass, cotton, &c. with which, during the late European wars, it supplied a vast portion of the interior; 1,000,000 pounds of cotton are said to be annually consumed in its manufactures. Salts and all the common minerals abound; and its forests teem with dyeing woods and roots. The inhabitants are principally mestizos and cholos, and said to

be both taller and fairer than any of the neighbouring provinces. They have taken a very active part in the late revolutions, and joined the independent government of Buenos Ayres in September 1810. Population about 70,000.

COCHAMBA, or **OROPESA**, the capital of the above province, with a beautiful town situated in a plain on the river Scacabo. Orchards and well cultivated gardens surround it: and avenues of lofty trees skirt the roads, 'resembling,' says an American writer, 'the great avenues of Versailles.'

COCHE, a low and barren island of the Atlantic, between that of Margarita and the coast of Cumana. It is nine miles in circumference, and was formerly celebrated for the pearl fishery. It is twelve miles east of Cubagua. Long. 64° 0' W. lat. 10° 45' N.

COCHECO, a river of the United States, in New Hampshire, which rises in the Blue hills in Stafford county, and after running S.S.E. joins the Piscataqua, five miles above Hilton's Point.

COCHIN, a small province of Hindostan, on the Malabar coast, crossed by the tenth degree of north latitude. It is bounded on the north by the district of Calicut, on the east by part of the southern ridge of the Ghauts, which separates it from Dindigull, on the south by Travancore, and on the west by the Indian Ocean. It is situated between 9° 50' and 10° 45' N. lat. and between 76° 4' and 77° 10' E. long. being about sixty-five miles broad, and seventy-four long. The principal places in this province are, Angicaimal, Arsbamichery, Cenotta, Ceavare, Condanada, Mullaventurutti, Naharica, Pallicare, Perimanoor, Pucotta, Putteuchera, and Udiampar. Northwards it consists of narrow valleys, running from the foot of the Ghauts, well watered by constantly flowing streams, and yielding two crops of rice in the year. The natives construct their houses in the thickest parts of the groves, where they are buried amidst palms, mangoes, jacks, and plantains, at the bottom of little eminences crowned with very fine forest-trees, especially the teak-tree, and a species of black wood, called the viti. Little care, however, is taken to encourage the growth of large trees, and check the luxuriance of useless timber. The hills in the neighbourhood of Cadadu are not so lofty, and most of them are covered with grass; but though the soil is good, and the land excellent for pasture, a very small part of it is cultivated. The chief products of this country are rice, pepper, cocoa-nuts, and teak-timber. The Paniany River skirts the northern frontier, and several smaller streams water its central and southern parts; but none of them are of any considerable importance. The principal port, and the capital of the province, is Cochin, said to have originated in a fort, which Albuquerque obtained permission to erect, when the Portuguese landed here in 1503. It was taken by the Dutch in 1663, who, it is said, made a warehouse of the cathedral; it, however, became a place of great trade, and flourished much under their dominion, Jews, Hindoos, and Mahomedans resorting to it, and taking up their residence in it for the purposes of commerce, there being a free toleration of all religious opinions.

Many of the Arab ships used to make two voyages yearly. It still carries on an extensive commerce with Surat, Bombay, the Malabar coast, Canara, Arabia, China, and many of the eastern islands, exporting pepper, cardamoms, teak and sandal wood, cocoa-nuts, coir cordage, cassia, and fish maws; and importing chiefly almonds, dates, pearls, gum arabic, cotton, opium, benzoin, camphor, cinnamon, spices, sugar-candy, tea, china, silks, shawls, and piece-goods. On the north-east side of this town, at the junction of the river with the sea, there is safe anchorage for vessels, and ships can be built here on very advantageous terms; the cost, when coppered and thoroughly equipped for sea, not exceeding, in the year 1800, £14 per ton. It is called by the natives Cacha Bunder, or harbour. It stands on an island at the mouth of the Cali Coylang, is nearly a semicircle, and about a mile and a-half in circumference. It is regularly fortified, both on the land and water sides, with bastions, a wall, and a ravelin; a wet ditch surrounds it, and a glacis and covered way extend beyond this, so that it could withstand any sudden attack, though it could not abide a regular siege. The streets are wide, and it has three gates; among its buildings, may be particularly specified the church, the house of the governor, the barracks, and a public hotel. The Roman Catholic bishop formerly had his residence here, but when the Dutch took possession of the place he removed to Coilan; his jurisdiction was very extensive, including the whole southern peninsula and the island of Ceylon, comprising more than 100 churches. The English took it in the year 1795, and under their power it still continues. It is governed by a president, under whom is a civil establishment of a judge and other officers, and it has a strong military garrison. Lat. $9^{\circ} 57' N.$, long. $76^{\circ} 8' E.$

The Jews are numerous in this province; but Mattacherry is their principal residence, being almost entirely inhabited by them. There are two classes, the Jerusalem, or White Jews, and the ancient, or Black Jews; the latter, though they have a synagogue in Cochin, chiefly live in the interior, and differ very little in appearance from the Hindoos. They are considered as an inferior race by the White Jews.

The rajah of Cochin preserved his independence much longer than most of the other Hindoo chiefs. Tippoo first exacted a tribute of him, which he paid for some years; but on January 6, 1791, the East India Company entered into a treaty with him, by which he was enabled to throw off his subjection to that prince, to recover some districts of which he had been deprived, and to transfer his allegiance to them, which he accordingly did, agreeing to pay them one lac of rupees annually. A treaty of perpetual friendship was concluded on the 6th May, 1809, by colonel Macaulay on the part of the British government, by which the friends and enemies of either party were to be considered and treated as such by both, and the British engaged to defend the rajah's country from all attacks; the rajah engaging to pay an additional annual sum of 176,087 rupees, in order to support a battalion of native infantry, to give the British free access to his

forts and towns, and to exclude from his dominions and service all Europeans not approved of by the English government, to which was to be transferred the management of all his external political concerns.

COCHIN (Charles Nicholas), an excellent artist, and a man of considerable literary abilities, was born in 1715. He was made keeper of the designs in the Louvre, chevalier of the order of St. Michael, and secretary to the academy of painting. He published Letters on the Pictures of Herculaneum; Dissertation on the Effect of Light and Shade; Travels in Italy, or a Collection of Observations on Works of Architecture, Sculpture, and Painting; Letters on the Lives of Slodz and Ceshays, &c. He died in 1790.

COCHIN (Henry), an eminent French lawyer, born at Paris in 1687. At twenty years of age he was admitted advocate, and two years after pleaded his first cause before the great council. It is said that at the bar, he equalled Bourdaloue in the pulpit. He died in 1747; and his works, consisting of memorials, pleadings, &c. were published at Paris in six volumes quarto, in 1751.

COCHIN-CHINA, or WESTERN CHINA, a name given to this country by the early Portuguese navigators, who discovered it. According to the most accurate calculations, it lies between $8^{\circ} 40'$ and $17^{\circ} N.$ lat., and between $106^{\circ} 40'$ and $109^{\circ} 10' E.$ long. It is very narrow in proportion to its length, extending along the coast not less than 500 miles; and being bounded on the north by Tunquin, on the west by Siam, Cambodia, and Siampa, and on the other sides by the China Sea. These were its original limits, but by conquest they have been much extended, as they now include Tunquin, Cambodia, and Siampa. It is mostly a long narrow plain, enclosed within the sea on one side, and on the other by a long range of mountains separating it from the countries on the west, in few places being more than seventy miles broad, and in some not more than twenty. The breezes, that regularly blow from the sea, so temper the extreme heat of the summer, that the climate is very salubrious. During the months of September, October, and November, the rains set in, and the low grounds are overflowed by torrents that come down from the mountains, and for three or four days every fortnight, deluge the country. Cold northerly winds, followed by rain, prevail during December, January, and February, and distinguish the winters of this country from that of all other eastern regions. The inundations experienced here render the soil remarkably fruitful; in many parts, the land yields three harvests in the year, but generally two, one of which is reaped in April, the other in October. Every tropical production is found here, particularly rice and sugar; the fruits of India, and many of those of China, arrive at the greatest state of perfection. Besides the rice that commonly grows in the plain, there is a particular sort that flourishes on the mountains, called mountain rice. Vast woods of mulberry trees are found here, which grow amazingly fast. There are also many forests of remarkably fine timber, particularly the incorruptible tree, which never rots, and is hard enough for anchors; besides a great quantity of aromatic woods. On

the coast, the sharks'-fins, an animal substance of a gelatinous nature, abound; it is often called *beech de mer*: and here, also, are found a kind of birds'-nests, which are much in request in China, where they are counted a great delicacy, and used in seasoning ragouts. Here, likewise, a species of cinnamon is cultivated, which, by the Chinese, is esteemed preferable to that of Ceylon. Agula and Japan wood and ivory furnish articles of advantageous commerce. Gold, in great quantities, is brought from the mountains, in dust, and almost pure, or collected in the beds of the rivers among the sand; and silver has lately been abundant. The great men have their arms frequently ornamented with the former article. Among the domestic animals of this country may be enumerated bullocks, goats, swine, horses, buffaloes, elephants, and camels; while the woods abound with the wild boar, tiger, rhinoceros, and large herds of deer: they have also fine poultry, and the fish that is caught in abundance on the coast, is highly delicious. The Cochín-Chinese consider the elephant's flesh a great dainty; but, though they use bullocks for food, they do not attend much to the breeding of them, and, they have not the least idea of milking their cattle. The birds'-nests, mentioned above, are found in four islands near the coast, and in five other smaller ones there are prodigious numbers of turtles, the flesh of which is very delicate.

Cochin-China consists of twelve provinces, all bordering on the coast, and extending to the mountainous ridge on the west. In these mountains numerous rivers take their rise, and disembogue their waters in the Eastern Ocean, and, though they are not sufficiently large for vessels of any magnitude to navigate, their importance as to the fertility of the country and its internal commerce can hardly be overrated. The estuaries formed by their mouths and other inlets on the coast furnish very convenient harbours and ports. Turon, or Hansan Bay, in the northern part, is surpassed by none in the eastern world, for its convenience and security, and the promontory overlooking it, forming a peninsula similar to that of Gibraltar on the south of Spain, is not only impregnable, but forms a shelter for ships at every season of the year; while multitudes of rivulets of clear fresh water fertilise the valleys that border the shore. Faifoo, an ancient mart for foreign commerce, sometimes regarded as the capital of the country, lies on the banks of a river about ten miles up from this bay. Here is also a considerable port on a river navigable for large ships, but it has a sand bank at the entrance. The bay and harbour of Chin-chew, in the middle division of Chang, is spacious and sheltered, but large vessels can only enter it at high water: at the head of the bay is the city of Quim-nong. Saigong, in the south, has been considered by Mr. Barrow, as situated in Cochín-China, but it is more properly in Cambodia; the largest ships soil up to it, and it has an extensive arsenal for the navy. There is no lake mentioned in this country, but a vast sandy desert seems to stretch along the western limit of it towards Cambodia, for about 250 miles, from the twelfth to the sixteenth degree of latitude. There is no country in

the world on which the sea has made more visible and rapid advances than this; it has been calculated that from 1744 to 1749 it had encroached sixty yards. Some parts of the southern shores are perpendicular, and consist of granite rock, close to which no soundings can be obtained; where the sandy beach is found, there is a gradual descent of sand, mud and shells. In some places the shore consists of ridges of round pebbles, and the bottom is rocky. There is a great irregularity in the tides on the coast; high water continuing in some parts for twelve hours. In summer the tides are lowest, and in winter they rise to the highest degree.

The Cochín Chinese are short in stature, of an olive complexion, and have similar features with the Chinese, so that there can be no doubt of their being of the same origin; but, in some points, they differ widely as to their manners and customs. They are an intelligent, active, and lively people. In their entertainments, superstitions, and ceremonies, they are much like the Chinese; but, with regard to their treatment of women, they are very different. They consider women best suited to conduct the principal concerns of the family; they are, therefore, entrusted with them; and they are generally as free and unrestrained as the men. The lower classes of them are, however, condemned to the most servile labor, while the men are smoking and chewing opium or betel. Mr. Barrow says, 'we observed them day after day, from morning till night, standing in the midst of pools up to their knees occupied in the transplanting of rice. In fact all the labors of tillage, and the various employments connected with agriculture, seem to fall to the share of the female peasantry; while those in Turon add to these the superintendance of all the details of commerce. They even assist in constructing and keeping in repair their mud cottages, conduct the manufacture of coarse earthen vessels, manage the boats on the rivers, and in the harbours; and do everything in the cotton manufacture from the drawing of the wool from the pod, to the making of it up into dresses for themselves and their families.' Unlike the Chinese females, however, they have full liberty and the use of their limbs; but they are licentious, and far from being generally modest. They conduct almost all the commercial business, and, on the arrival of a stranger, it is not difficult for him to procure a female partner, who will be devoted to his service by night and day. In Cochín China a man is not limited to any number of wives or concubines; but the first wife always has the preference, and the chief part of the domestic management. The breaking of a pair of chopsticks, in the presence of witnesses, is sufficient to divorce them. The women are generally dressed in a loose frock of brown or blue cotton, and a pair of black trowsers. They wear neither shoes nor stockings; the higher classes sometimes use sandals. Their hair is long and black, hanging down their shoulders, or fixed in a knot on the top of the head. When in full dress, on occasions of ceremony, they have several gowns one over the other; but differing in length so that the lower parts of all are visible. The men are dressed nearly in the same manner with a

jackel and white short trowsers, and a handkerchief twisted like a turban round the head; hats are sometimes worn of different shapes.

The religion of Cochin China is a form of Buddhism, but more simple, and less mysterious than the rites used in the worship of Fo in China. Like the ancient Jews they offer the first fruits of their ground, and the firstlings of everything else to the image of their protecting deity, as an acknowledgment of his goodness. Their images are generally placed in small wooden boxes, and fixed among the branches of trees in the woods, and here the artless worshipper ascends, deposits his offering, and leaves it to be removed by the priest at his leisure. The people speak a language originally derived from the Chinese; but so much altered, that the natives of the two countries cannot understand each other. It is common to them with the people of Tonquin and the neighbouring countries, and is called the Anam. The written language is in character like the Chinese, and thus an intercourse is readily kept up between them; and, as the government is modelled after the pattern of China, literature is indispensable for office, and of course is widely diffused.

The trade of these people is mostly with the Chinese, to whom they export a great quantity of sugar, particularly sugar-candy, said to be the best in the world, woods, canes, spices, drugs and gold. They also export gum lac, zambore, indigo, and raw silk in large quantities. The chief article shipped to India is sugar. The French, of all European nations, are treated with most favor, probably on account of the assistance given to the king by a French missionary of the name of Adran; in the European improvements he has been making in his dominions. The Cochin Chinese carry on a considerable trade also with Siam, Cambodia, Tonquin, the coast of Malacca, the Philippine and Molucca islands and Borneo, with which there is a ready communication by the China Sea. Every sort of import into this country pays a duty of twelve per cent, and presents also must be made to the king. Low-priced cutlery and piece-goods find a ready market; but European commodities have not hitherto been much in demand. Tutenaque is said to be in request, dollars are much sought after, and amber and coral, if of a good quality, are saleable in this country.

The government is absolute, as in China; but the police is not so perpetually on the watch, though it is formed upon the same model. The laws likewise are the same in character, and similar in the administration. The Cochin-Chinese are a military people, every third man, of certain ages, being exposed to be called to active service. The army and navy have been much improved during the late period of war. The former consisted of 113,000 men in the year 1800, 40,000 of whom are formed into regiments, and disciplined after the European manner. The effects of this improvement have been witnessed in the late conquest of Tonquin. A great alteration for the better has also taken place in the navy; formerly this consisted entirely of junks similar to those of the Chinese; but under the direction of the French the reigning prince

has, in the course of two years, built 309 gun-boats, a lugger, and a frigate.

The history of this kingdom is little known. M. Le Poivre, a French traveller, informs us that about half a century before the French first arrived in these distant regions, a prince of Tonquin, as he fled from his sovereign, by whom he was pursued as a rebel, had, with his soldiers and adherents, crossed the river, which serves as a barrier between Tonquin and Cochin-China. The fugitives, who were warlike and civilised men, soon expelled the scattered inhabitants, who wandered about without any form of government, and founded a new kingdom, which soon grew rich and populous. During the reigns of the first six kings, no nation could be happier than the Cochin-Chinese. Their monarchs governed them as a father does his family, establishing no laws but those of nature, to which they themselves were the first to pay obedience. They honored and encouraged agriculture, as the most useful employment of mankind; and required from their subjects only a small annual free gift to defray the expense of their defensive war against the Tonquinese, who were their enemies. This imposition was regulated by way of poll-tax, with the greatest equity. Every man, able to till the ground, paid in to the prince a small sum proportioned to the strength of his constitution, and the vigor of his arm; and nothing more. Cochin-China continued happy under these princes for more than a century; but the discovery of gold-mines interrupted their felicity. Luxury immediately took place. The prince began to despise the simple habitation of his ancestors, and caused a superb palace to be built a league in circumference, surrounded with a wall of brick in the model of that Peking, and defended by 1600 pieces of cannon. Not content with this, he would have three other palaces, for summer, autumn, and winter. The old taxes were by no means sufficient to defray these expenses; new ones were devised; and oppression and tyranny everywhere took place. His courtiers, to flatter their prince, gave him the title of the king of heaven, which he still continues to assume. When speaking of his subjects, he styled them his children, but by no means behaved as if he was their father: for our author informs us, that he has seen whole villages newly abandoned by their inhabitants, who were harassed with toil and insupportable exactions; the consequence of which was that their lands returned to their former uncultivated state.

In 1774 three brothers, one a merchant, the second an officer, and the third a priest, expelled the reigning prince from the capital. At this time the young prince Caung Shung with his family, assisted by a French missionary of the name of Adran, fled into the forest, where they concealed themselves for some time; after unsuccessfully endeavouring to make head against the usurpers, they took refuge at Pulowai, a desert island in the gulf of Siam, while Adran went to France to procure assistance, taking with him the prince's eldest son. The prince after enduring various hardships in the above island, landed on his native dominions, expelled the successors of the usurpers, and subsequently

conquered Tonquin. In 1797 and 1798, by the aid of Adran, who had now returned, he effected a number of improvements, opening roads, encouraging cultivation, introducing European discipline into his army and navy, &c. Adran died in 1800, and was buried with great pomp.

CO'CHINEAL, *n. s.* Span. *cochinilla*. A wood-louse. An insect gathered upon the opuntia, and dried: from which a beautiful red color is extracted.

COCHINEAL, or **COCHENEEL**. See **COCCUS-CACTI**.

COCHLEA. See **ANATOMY**.

COCHLEA, in zoology. See **HELIX**.

COCHLEARIA, scurvy-grass: a genus of the siliculosa order, and tetradynamia class of plants; natural order thirty-ninth, siliquosae. The silicula is emarginated, turgid, and scabrous; with the valves gibbous and obtuse. There are nine species; the most remarkable of which are, 1. *C. angelica*, or garden scurvy-grass, growing naturally on the sea shore, in the north of England and in Holland; but cultivated for use in the gardens near London. It has a fibrous root, from which arise many round succulent leaves, hollowed like a spoon; the stalks rise from six inches to a foot high, and are brittle, and garnished with leaves which are oblong and sinuated. The flowers are produced in clusters at the end of the branches, consisting of four small white petals placed in the form of a cross; and succeeded by short, roundish, swelling seed-vessels, having two cells divided by a thin partition. In each of these are lodged four or five roundish seeds. This plant is propagated by seeds, which should be sown in July, in a moist spot of ground, and in spring they will be fit for use: those that are left will run up to seed in May, and perfect their seeds in June. Scurvy-grass is a pungent stimulating medicine; capable of dissolving viscid juices, opening obstructions of the viscera and the more distant glands, and promoting the more fluid secretions. It is particularly celebrated in scurvies, being the principal herb employed in these disorders in the northern countries. 2. *C. armoracia*, or horse-radish, a plant too well known to need any description. It is propagated by cuttings or buds from the sides of old roots. The best season for this is in October or February; the former for the dry lands, the latter for moist. The root has a quick pungent smell, and penetrating acrid taste; it nevertheless sometimes exudes on the surface. By drying it loses all its acrimony, becoming first sweetish and then almost insipid: but if kept in a cool place, in sand, it retains its qualities for a considerable time. Its culinary use as a stimulant needs no description: the medical effects of it are to stimulate the solids, attenuate the juices, and promote the fluid secretions: it seems to extend its action through the whole habit, and to affect the minutest glands. It has frequently been of service in some kinds of scurvy, and other chronic disorders proceeding from a viscidosity of the juices, or obstructions of the excretory ducts. Sydenham recommends it likewise in dropsies, particularly those which follow intermittent fevers. Both water and rectified spirit extracts the virtues of this root by infusion,

and elevate them in distillations: along with the aqueous fluid an essential oil rises, possessing the whole taste and pungency of the horse-radish.

COCHLEARY, *adj.* } From *cochlea*, Lat. a
CO'CHLEATED, *adj.* } screw. Screw-form;
in the form of a screw.

That at St. Dennis, near Paris, hath wreathy spires, and *cochleary* turnings about it, which agreeth with the description of the unicorn's horn in *Eliau*.

Brown's Vulgar Errors.

Two pieces of stone, struck forth of the cavity, of the umbilici of shells, of the same sort with the foregoing: they are of a *cochleated* figure.

Woodward on Fossils.

COCHLEUS (John), a catholic divine who early and most vigorously opposed the Reformation. He was born at Nuremberg, in 1479, and wrote with great acrimony against Luther, Calvin, Melancthon, &c. especially the former, in a work entitled *De Actis et Scriptis Lutheri*. He also had a controversy with the English divines on the subject of Henry VIII's marriage with Anne Boleyn, and published a curious history of the Hussites, folio. He died at Breslaw, January 10th, 1552.

COCHRANE, POINT, the west point of a bay in Prince William Sound, on the west coast of North America. The bay is about a league and a half wide, and three miles deep, terminated by a boundary of ice and frozen snow, reaching from a compact body of lofty frozen mountains to the water's edge. Long. 212° 16' E., lat. 60° 46' N.

COCK, *n. s.* } Ang-Sax. *coce*; Fr. *coq*;
CO'CK-CROWING, } Gr. *κικκος*; alluding to the
call or crowing of a cock, as Lat. *gallus*. A male to the hen, or indeed a male of any species of bird. It is also used to designate superiority, courage, and conquest; whatever is first and best. Cock-crowing is not only the note of the bird, but the note of time.

This gentill *cock* had in his governance
Seven hennes, for to donne his plesance,
Which were his susters and his paramoures,
And wonder like to him as of coloures;
Of which the fairest-hewed in the throate
Was cleped faire Damoselle Pertelote.

Chaucer's Canterbury Tales.

And now the crowing *cocks*, and now the owle
Lowde shrieking, him afflicted to the very sowle.

Spenser.

We were carousing till the second *cock*.

Shakspeare.

He begins at curfew, and goes till the first *cock*. *Id.*

————— Might we but hear
The folded flocks penned in their wattled *cotes*,
Or sound of pastoral reed, with oaten *steps*,
Or whistle from the lodge or village *cock*,
Count the night-watches to his feathery *dames*,
'Twould be some solace, yet some little cheering
In this close dungeon of innumerable *boughs*. *Milton.*

Cocks have great combs and spurs; hens, little or none.

Racon's Natural History.

'True *cocks* o' the game,
That never ask for what or whom they fight;
But turn 'em out, and show 'em but a foe,
Cry liberty, and that's a cause of quarrel.

Dryden.

Calves and philosophers, tygers and statesmen, cock-sparrows and coquets, exactly resemble one another in the formation of the pineal gland.

Arbutnot and Pope.

Sir Andrew is the cock of the club since he left us.

Addison.

My schoolmaster called me a dunce and a fool;
But at cuffs I was always the cock of the school.

Swift.

The careful hen

Calls all her chirping family around,
Fed and defended by the fearless cock.

Thomson's Spring.

Cock, *n. s.* Ital. *gallo*. A weather-cock, gnomon of a dial, &c. from the general figure. Things, says Johnson, that were contrived to turn, seem anciently to have had that form, whatever was the reason.

You cataracts and hurricanes, spout
Till you have drenched our steeples, drowned the
cocks!

Shakespeare.

When every room

Hath blazed with lights, and brayed with minstrelsy,
I have retired me to a wasteful cock,
And set mine eyes at flow.

Id.

It were good there were a little cock made in the
belly of the upper glass.

Bacon's Natural History.

Thus the small jett, which hasty hands unlock,
Spirts in the gardener's eyes who turns the cock.

Pope.

Cock, *n. s.* Ital. *cocca*; Fr. *coche*; from Lat. *caso*. The part of a lock of a gun that strikes with a flint; perhaps from the action like that of a cock pecking: but it was, I think, so called, says Dr. Johnson, when it had not its present form. The Ital. *cocca* signifies the notch of an arrow; and thus cock is sometimes applied in English.

With hasty rage he snatched
His gunshot, that in holsters watched;
And bending cock, he levelled fall
Against the outside of Talgol's skull.

Hudibras.

A seven-shot gun carries powder and bullets for seven charges and discharges. Under the breech of the barrel is one box for the powder; a little before the lock another for the bullets; behind the cock a charger, which carries the powder from the box to a funnel at the further end of the lock.

Greav.

Cock, *n. s.* Goth. *kog*; Per. *kak*. Small; diminutive; hence cock-boat, a little boat.

But thou, good man, sith far in seawe bee,
And the great waters gin apace to swell,
That thou no more we can the mayn-land see,
Have care, I pray, to guide the cock-bots well,
Least worse on sea then us on land befell.

Spenser.

This messenger adoune him gan to hie,
And found Jason and Hercules also,
That in a cogge to londe weren i'go,
Him to refreshen and to take the aire.

Chaucer.

The fishermen that walk upon the beach,
Appear like mice; and you tall anchoring bark
Diminished to her cock; her cock, a buoy,
Almost too small for sight.

Shakespeare.

They take view of all sized cocks, barges, and fisher-boats hovering on the coast.

Carew's Survey of Cornwall.

This invincible armada, which having not fired a charge of ours at land, nor taken a cock-boat of ours at sea, wandered through the wilderness of the northern sea.

Bacon.

Did they think it less dishonor to God to be like a brute, or a plant, or a cock-beast, than to be like a man?
Stillingfleet.

Cock, *n. s.* *κόκκος*; Lat. *coctus*. A red color.

Cock, *n. s.* & *v. a.* The top or head of a

COCKADE, *n. s.* } thing; a hat set up with

COCKAPOOF, *ad.* } pertness or presumption;

probably from the appearance of a cock's comb, and his mode of exhibiting it. It is used therefore to express exultation and triumph; hence, too, when the brim of a hat is raised to a point, it is called a cocked hat; and a small heap of hay is for the same reason denominated a cock.

Now I am a frisker, all men on me look;
What should I do but set cock on the hoop?

Camden's Remains.

You'll make a mutiny among my guests!

You will set cock-a-hoop!

Shakespeare.

As soon as the dew is off the ground, spread the hay again, and turn it, that it may wither on the other side: then handle it, and if you find it dry, make it up into cocks.

Mortimer.

For Hudibras, who thought he' had won

The field, as certain as a gun,
And having routed the whole troop,
With victory was cock a hoop.

Hudibras.

You see many a smart rhetorician turning his hat in his hand, moulding it into several different cocks.

Addison.

Cock, *v. a.* & *v. n.* From the noun. To set erect; to hold bolt upright as a cock holds his head; to look big and menacing; to raise any thing into a point, or into a round heap; to fix the cock of a gun ready for discharge. It is also used in the sense of training cocks, or using them for fighting.

Sike mirth in May is meekest for to make,
Or summer shade, under the cocked hay.

Spenser's Pastorals.

Cries out 'gainst cocking, since he cannot bet.

Ben Jonson.

Some of them holding up their pistols, cocked, near the door of the house, which they kept open.

Dryden's Dedication, Æneid.

Sir Fopling is a fool so nicely writ;
The ladies would mistake him for a wit;
And when he sings, talks loud, and cocks would cry,
I vow, methinks, he's pretty company.

Dryden.

This is that muscle which performs the motion so often mentioned by the Latin poets, when they talk of a man's cocking his noise or playing the rhinoceros.

Addison.

Every one cocks and struts upon it, and pretends to overlook us.

Id. Guardian.

An alert young fellow cocked his hat upon a friend of his who entered.

Id. Spectator.

Dick would cock his nose in scorn,
But Tom was kind and loving.

Swift.

Dick, who thus long had passive sat,
Here stroked his chin and cocked his hat.

Prior.

But when the bully, with assuming grace,
Cocks his broad hat, edged round with tarnished lace,
Yield not the way; defy his strutting pride,
And thrust him to the muddy keanel's side.

Guy.

Our Lightfoot barks, and cocks his ears;
O'er yonder stile see Lubberkin appears.

Id. Pastorals.

Cock, in zoology. See PHASIANUS.

COCKATRICE, *n. s.* From cock, and Sax. *atrop*, a serpent. A serpent supposed to rise from a cock's egg.

They will kill one another by the look, like *cochatrices*. *Shakespeare.*

This was the end of this little *cochatrice* of a king, that was able to destroy those that did not espy him first. *Bacon.*

This *cochatrice* is soonest crushed in the shell; but, if it grows, it turns to a serpent and a dragon. *Taylor.*

My wife! 'tis she, the very *cochatrice*! *Congreve.*

COCK-BROTH, *n. s.* Broth made by boiling a cock.

Lessius enjoyns so much at supper; not a little more, nor a little less, of such meat, and at such hours, a dyet drink in the morning, *cock-broth*, china broth, at dinner plumb broth, a chicken, a rabbit, rib of a rack of mutton, wing of a capon, merry-thought of a hen, &c. *Burton's Anatomy of Melancholy.*

Diet upon spoon-meats; as veal or *cock-broths* prepared with French barley. *Harvey on Consumptions.*

COCKBURN ISLANDS, a group of small islands near the north-east coast of New Holland, in long. 217° 18' W, lat. 11° 52' S.

COCKBURN LAW, a hill of the county of Berwick, Scotland, about the middle of which, on the north side, are the ruins of a military station, called Edgar's Hall. Height 900 feet.

COCKBURN (Mrs.), daughter of captain Trotter, of the Royal Navy, was born in 1679. At an early age she abjured protestantism for popery; and produced, at the age of seventeen, *Agnes de Castro*, a tragedy, performed with considerable applause. Two years after she wrote the *Fatal Friendship*, a tragedy, which is considered her best piece. She also applied herself early in life to metaphysical pursuits, and wrote, in her twenty-second year, a *Defence of Locke's Essay on the Human Understanding*. Having re-examined the controversy between popery and protestantism, she returned, in 1707, to the established church. In 1708 she married Rev. Mr. Cockburn, a clergyman of that church. His father was a Jacobite, and, in consequence of his own refusal to take the oath of abjuration at the accession of George I., he lost all his preferments in the church, and was obliged to support his family as the usher of a small school. His erudite lady, in 1726, again defended Mr. Locke in a Letter to Dr. Holdsworth on the resurrection of the body; and, in 1727, wrote a further Vindication of Mr. Locke, which was printed after her death. She had previously commemorated the victories of the duke of Marlborough in her poems, and written her last tragedy, entitled, the *Revolution of Sweden*. In 1732 her husband, having overcome his scruples, was presented to the living of Long Horseley. Mrs. Cockburn now produced Remarks upon some Writers in the Controversy concerning the Foundation of Moral Duty and Moral Obligation, printed in the History of the Works of the Learned, in 1743; and in 1747 Remarks upon the Principles and Reasonings in Dr. Rutherford's Essay on the Nature and Obligations of Virtue, in Vindication of the contrary Principles and Reasonings enforced in the Writings of the late Dr. Samuel Clarke. A plan was now formed of publishing

her works by subscription, but the death of her husband threw her into a painful disease, and she died at Long Horseley in 1749, before her works could be prepared for the press.

COCKER, *v. a.* Fr. *coquelin*. To cade; to fondle; to indulge.

Most children's constitutions are spoiled by *cockering* and tenderness. *Locke on Education.*

He that will give his son sugar-plums to make him learn, does but authorize his love of pleasure, and *cock* up that propensity which he ought to subdue. *Id.*

Bred a fondling and an heirsch,
Dressed like any lady mayoress,
Cockered by the servants round,
Was too good to touch the ground. *Swift.*

COCKER, *n. s.* From cock. One who follows the sport of cock-fighting.

COCKER (Edward), a celebrated penman and writer on arithmetic in the seventeenth century. He was a native of London, where he was born in 1631, and died in 1677. To his fame we seem to owe the occasional proverb of speech 'According to Cocker,' and Mr. Evelyn celebrates his skill in calligraphy. He published fourteen Copy-books, engraved from his own writing: *Decimal Arithmetic*, and *Vulgar Arithmetic*, of the last of which, it is said, forty editions were sold.

COCKEREL, *n. s.* From cock. A young cock.

Which of them first begins to crow?—
The old cock?—The *cockerel*. *Shakespeare.*

What wilt thou be, young *cockerel*, when thy spurs
Are grown to sharpness. *Dryden.*

COCKERMOUTH, a large town of Cumberland, irregularly built, with broad streets. It is washed by the Derwent on the west, and divided by the Cocker into two parts, which are connected by a stone bridge of one single arch. The town, in general, is irregularly built; but there are several modern and well-built streets, particularly the one ascending to the castle-gate, which is very steep; and in that which leads to Derwent-bridge, some of the houses are handsomely built of red free-stone. The manufactures are shal-loons, worsted stockings, and hats. It is a bo-rough town, and sends two members to parliament. The right of voting is vested by burgess tenure in certain houses: the county elections are also held here. It has a castle seated on an artificial mount on a bank above the Derwent. It is a square building, and strengthened with several square towers: on each side of the inner gate are two deep dungeons capable of holding fifty persons each; they are vaulted at top, and have only a small opening to let down the prisoners. On the outside of each is a narrow slit with a slope, down which were dropt their provisions. This castle was founded by Waldof, first lord of Allerdale, and son of Gospatrick earl of Northumberland, contemporary with William the Conqueror. Waldof resided first at Pap-castle, which he afterwards demolished, and with the materials built that of Cocker-mouth, where he and his family long resided. Several arms over the gateway, Camden says, are those of the Multons, Humfravilles, Lucies, and Piercies. In 1658 it was garrisoned for the king; and

being besieged and taken by the rebels, was burnt and never afterwards repaired. Cocker-mouth is now in the possession of the Lowther family, who have here a great property in coal-works. Markets on Monday and Saturday. It is forty-four miles north-west by north of Kendal, and 305 N. N. W. of London.

COCKET, *n. s.* Of uncertain derivation. A seal belonging to the king's custom-house: likewise a scroll of parchment, sealed and delivered by the officers of the custom-house to merchants, as a warrant that their merchandize is entered.

The greatest profit did arise by the *cocket* of hides; for wool and wool-fells were ever of little value in this kingdom. *Davies.*

COCK-FIGHT, *n. s.* Cock and fight. A battle, or match of cocks.

In *cock-fights*, to make one cock more hardy, and the other more cowardly. *Bacon's Natural History.*

At the seasons of foot-ball and *cock-fighting*, these little republicks reassume their national hatred to each other. *Addison.*

COCK-FIGHTING is a cruel and inhuman mode of diversion, consisting in setting cocks of a particular kind, hence called game-cocks, to fight with steel spurs, till one or the other is beaten, and can fight no longer. Among the ancients, the islanders of Delos were great lovers of cock-fighting; and Tanagra, a city of Bœotia, the isle of Rhodes, Chalcis in Eubœa, and the country of Media, were famous for their generous race of cocks. From Persia this kind of poultry was first brought into Greece; and, if one may judge of the rest from the fowls of Rhodes and Media, the excellency of the broods, at that time, consisted of their weight and largeness, as the fowls of those countries were heavy and bulky, and of the nature of what our sportsmen call shakebags or turnpokes. At first, cock-fighting was partly a religious and partly a political institution at Athens; and was continued for improving the seeds of valor in the minds of their youth, but was afterwards perverted both there and in the other parts of Greece to a common pastime, without any political or religious intention. The Romans were prone to imitate the Greeks, but did not, as may be gathered from Columella, adopt this practice very early. It is not known when this game was first introduced into England, but it was probably brought hither by the Romans. It has by some been called a royal diversion, and the cock-pit at Whitehall was erected by Charles II. for the more magnificent celebration of it. The birds are generally dieted for about a fortnight or three weeks by regular feeders, who receive for their trouble, in general, the admission-money to the cock-pit. Cocks of a middle size are found the best fighters: the match-weights being from three pounds six ounces to four pounds eight ounces. The place appropriated to fighting is called the pit, and consists, generally, of a mound of earth covered with sod, and surrounded by seats in circular tiers. The battle is conducted by two setters, as they are called, who place the cocks beak to beak.

When once the cocks are pitted, neither of the

setters-to can touch his cock, so long as they continue to fight, unless their weapons are entangled. But if they have left off fighting, while the umpire or law-teller can count forty, each setter-to instantly handles his cock, bringing them beak to beak in the middle of the pit, and the cock who made the last fight, with either heel or beak, is said to have the first law in his favor. When brought beak to beak, and set on their legs, if the cock who did not fight while the forty was telling, still continues to decline fighting, the umpire proceeds to tell ten; which being done, they are again brought beak to beak; if the same cock continue still unwilling or unable to fight, the ceremony of telling ten, and bringing beak to beak, at the conclusion of every ten, takes place, till it has been repeated ten different times, when the cock so refusing to fight has lost his battle. But should he fight during the enforcement of any part of the law, what has been told is of no effect, and the first ten must be begun again, whenever a fight is renewed.

If a cock, having the law in his favor, dies before the long law is told out, his adversary wins the battle, although he did not fight within the law; for there cannot be a greater criterion of victory than having killed his opponent.

The following fact is recorded as authentic, in the obituary of the Gentleman's Magazine for April 1789, and as a melancholy instance of the brutalising effects of these cruel sports: 'Died, April 4th, at Tottenham, John Ardesoif, esq. a young man of large fortune, and in the splendor of his carriages and horses rivalled by few country gentlemen. His table was that of hospitality, where it may be said he sacrificed too much to conviviality. Mr. Ardesoif was very fond of cock-fighting, and had a favorite cock upon which he had won many profitable matches. The last bet he laid upon this cock he lost, which so enraged him, that he had the bird tied to a spit and roasted alive before a large fire. The screams of the miserable animal were so affecting, that some gentlemen who were present attempted to interfere, which so enraged Mr. Ardesoif, that he seized a poker, and, with the most furious vehemence, declared that he would kill the first man who interposed; but, in the midst of his passionate asseverations, he fell down dead upon the spot.'

COCK-HORSE, *adj.* Cock and horse. On horseback; triumphant; exulting.

Alma, they strenuously maintain,
Sits *cock-horse* on her throne the brain. *Prior.*

COCKLE, *n. s.* Fr. *coquille*. A small testaceous fish.

It is a *cockle* or a walnut-shell. *Shakespeare.*

We may, I think, from the make of an oyster, or *cockle*, reasonably conclude, that it has not so many, nor so quick, senses as a man. *Locke.*

Three common *cockle*-shells out of gravel-pits.

Woodward.

COCKLE, *n. s.* Sax. *coccel*; Lat. *lolium sisania*; a weed that grows in corn, the same with cornrose; a species of poppy.

He shal no gospel glosen, here ne teach
 We leven all in the gret God, quod he:
 He wold sowen some difficultee,
 Or springen *cockle* in our clene corn,
 And therefore, Host, I warn thee beforene,
 My jolly body shal a tale tell,
 And I shal clinken you so mery a bell
 That I shall waken all this campagnie

Chaucer's Canterbury Tales.

In soothing them, we nourish 'gainst our senate
 The *cockles* of rebellion, insolence, sedition.

Shakespeare.

Good seed degenerates, and oft obeys
 The soil's disease, and into *cockle* strays.

Donne.

COCKLE, *v. a.* From cockle. To contract
 into wrinkles, like the shell of a cockle.

Showers soon drenched the camblet's *cockled* grain.
Gay.

COCKLED, *adj.* From cockle, Shelled;
 or perhaps cochleate, turbinated.

Love's feeling is more soft and sensible
 Than are the tender horns of *cockled* snails.

Shakespeare.

COCKLE-STAIRS, *n. s.* winding or spiral
 stairs.

COCK-LOFT, *n. s.* Cock and loft. The
 room over the garret, in which fowls are sup-
 posed to roost; unless it be rather corrupted
 from coploft, the cop or top of the house.

If the lower floors already burn,
Cock-lofts and garrets soon will take their turn.

Dryden's Juvenal.

My garrets, or rather my *cock-lofts* indeed, are very
 indifferently furnished; but they are rooms to lay
 lumber in.

Swift.

COCK-MASTER, *n. s.* Cock and master.
 One that breeds game-cocks.

A *cock-master* bought a partridge, and turned it
 among the fighting cocks.

L'Étrange.

COCK-MATCH, *n. s.* Cock and match.
 Cockfight for a prize.

At the same time that the heads of parties preserve
 towards one another an outward shew of good breed-
 ing, their tools will not so much as mingle at a *cock-
 match*.

Addison.

Though quail-fighting is what is most taken notice
 of, they had doubtless *cock-matches* also.

Arbutnot and Pope.

COCKNEY, *n. s.* A word of which the
 original is much controverted. The French use
 an expression *pais de coccagne*, for a country of
 dainties:—

Paris est pour un riche un pais de coccagne.

Boileau.

Of this word they are not able to settle the
 original. It appears, whatever was its first
 ground, to be very ancient, being mentioned in
 an old Normanno Saxon poem:—

Far in see by west Spaying,
 Is a lond yhoce cocayng.

One of the writers of the glossary to Chaucer
 has the following note, explanatory of the word.
 That this is a term of contempt, borrowed origi-
 nally from the kitchen, is very probable. A
 cook, in the base Latinity, was called *coquinator*,

and *coquinarius*, from either of which *cokeney*
 might easily be derived. In. p. p. fol. 35, 36.

And yet I say, by my soule, I have no salt bacon,
 Ne no *cokeney* (by Christe) coloppes to make.

It seems to signify a cook. And so, perhaps,
 in the Turnament of Tottenham. Anc. Poet, t.
 ii. p. 24.

At that feast, where they served in rich array,
 Every five and five had a *cokeney*.

That is, I suppose, a cook or scullion to at-
 tend them.—In those rhymes ascribed to Hugh
 Bigot, which Camden has published, Brit.
 Col. 451 (upon what authority I know not)—

Where I in my castle of Bungey

Upon the river of Wavesey,

I would ne care for the king of *Cokeney*.

The author, in calling London Cokeney, might
 possibly allude to that imaginary country of
 idleness and luxury which was anciently known
 by the names of Coccagne or Cocagne, a name
 which Hickes has shown to be derived from
 coquina. Gn. A. S. p. 231. He has there pub-
 lished an excellent description of the country of
 Cokaigne, in old English verse but probably
 translated from the French; at least the French
 have had the same fable among them, for Boileau
 plainly alludes to it, sat. vi: in the words already
 cited.

The festival of La Coccagne, at Naples, de-
 scribed by Keyster, v. ii. p. 369, appears to
 have the same foundation. It probably com-
 menced under the Norman government. There is
 a mock heroic poem, in the Sicilian dialect, en-
 titled, La Cuccagna Conquistata, by Gio Baptista
 Basili, Palermo, 1674, in which the description
 of Palma citta di Cuccagna begins thus,—

*Sedi cuccagna una montagna
 Di furnaggiu grattatu, et havi in cima
 Di maccami una caudara magna*

I lie as a drap-sak in my bedde;
 And when this jape is told another day
 I shal be halden a daffy or a *cokeney*:
 I wol arise and auntra it by my fay:
 Undhardy is unsely—thus men say.

Chaucer's Canterbury Tales.

So the *cockney* did the eels when she put them in
 the pastry alive.

Shakespeare. King Lear.

I am afraid this great lubber, the world, will prove
 a *cockney*.

Id. Twelfth Night.

Some again are in the other extrem, and draw
 this mischief on their heads by too ceremonious and
 strict diet, being over precise, *cockney*-like, and curious
 in their observation of meats.

Burton's Anatomy of Melancholy.

For who is such a *cockney* in his heart,
 Proud of the plenty of the southern part,
 To scorn that union, by which we may
 Boast 'twas his countryman that wrote this play.

Dorset.

The *cockney*, travelling into the country, is surprised
 at many common practices of rural affairs.

Watts.

COCKNEY, KING OF, a title used for the king
 of London, in an ancient poem, ascribed to Hugh
 Bagot, earl of Norfolk, in the time of king Henry
 II. And 'king of the cockney' occurs among
 the regulations for the sports and shows formerly
 held in the Middle Temple on Childermas Day,

where he had his officers; a marshal, constable, butler, &c. See *Dugdale's Origines Juridicales*, p. 247.

COCK-PIT, *n. s.* Cock and pit. The area where cocks fight.

Can this *cock-pit* hold
The vasty field of France. *Shakespeare.*

And now I have gained the *cock-pit* of the western world, and academy of arms for many years.

Howell's Vocal Forest.

COCK-PIT, in maritime affairs, a place on the lower deck of a man of war, appropriated to the use of the surgeon and his mates, being the place where the wounded men are dressed in time of battle, or otherwise.

COCK-ROACH. See **BLATTA**.

COCK-COMB, *n. s.* Cock and comb. A plant.

COCK'S-HEAD, *n. s.* A plant, named also saifoin.

COCK-SHUT, *n. s.* From cock and shut. The close of the evening, at which time poultry go to roost.

Surrey and himself,
Nech about *cock-shut* time, from troop to troop
Went through the army. *Shakespeare.*

COCKSPUR, *n. s.* Cock and spur. Virginian hawthorn. A species of medlar.

COCKSURE, *adv.* From cock and sure. Confidently certain; without fear or diffidence. A word of contempt.

We steal, as in a castle, *cocksure*. *Shakespeare.*
I thought myself *cocksure* of his horse, which he readily promised me. *Pope's Letters.*

COCKSWAIN, *n. s.* Sax. *coggsþaine*. The officer who has the command of the cockboat. Corruptly, *coxon*, he sits in the stern of the boat and steers; and has a whistle to call his men.

COCKWEED, *n. s.* From cock and weed. The name of a plant, called also dittander, or pepperwort.

COCLÉS (Publius Horatius), a celebrated Roman, who alone opposed the whole army of Porsena, king of the Etruscans, at the head of a bridge, while his companions were cutting off the communication with the shore behind him. When the bridge was destroyed, Cocles, though wounded by the darts of the enemy, leapt into the Tiber, and swam across it with his arms. A brazen statue was erected to him in the temple of Vulcan, by the consul Publicola, for his eminent services.

COCOA, *n. s.* Span. *cacaotal*; and therefore more properly written *cacao*. See **CACAO**.

The *cacao* or chocolate nut is a fruit of an oblong figure; is composed of a thin but hard and woody rind or skin, of a dark blackish colour, and of a dry kernel, filling up its whole cavity, fleshy, dry, firm, and fastid to the touch, of a dusky colour, an agreeable smell, and a pleasant and peculiar taste. It was unknown to us till the discovery of America. The tree is of the thickness of a man's leg, and but a few feet in height; its bark rough, and full of tubercles, and its leaves six or eight inches long, half as much in breadth and pointed at the ends. The flowers are succeeded by the fruit, which is large and oblong, resembling a cucumber, five, six, or eight inches in length, and three or four in thick-

ness; when fully ripe of a purple colour. Within the cavity of this fruit are lodged the *cocoa* nuts usually about thirty in number. *Hill's Materia Medica.*

Amid those orchards of the sun,
Give me to drain the *cocoa's* milky bowl,
And from the palm to draw its fresh'ning wine. *Thomson.*

CocOA, in botany. See **Cocos**.

COCOA ISLAND, a small island, part of the group of the Pogy Islands, near the west coast of Sumatra. Long. 100° 30' E., lat. 2° 29' S.

COCOA-NUT BAY, a bay of the Pacific, on the west coast of Roberts's Island. Safe anchorage and regular soundings are found from eighteen to five fathoms water; the bottom a fine clear sand; excellent fresh water discharges itself into the bay, near a grove of *cocoa*-nut trees. Long. 219° 48' E., lat. 7° 35' S.

COCOA-NUT ISLAND, a small island near the west coast of Sumatra. Long. 95° 35' E., lat. 4° 38' N. Also a small island at the entrance of Carteret's harbour, on the south-east coast of New Ireland.

COCOA-NUT KEY, a small island in the Spanish main, near the Mosquito shore. Long. 82° 20' W., lat. 15° 52' N.

COCOA-NUT POINT, a cape forming the southern extremity of the island of Gilolo. Long. 128° 26' E., lat. 0° 44' S.

COCONATO, a town of Piedmont, famous for being the birth-place of Christopher Colon, or Columbus. It is four miles south of Crescentino, and twenty east of Turin. Long. 8° 9' E., lat. 45° 5' N.

COCOS, in ootany, a genus of the class monœcia, order hexandria; natural order palmæ. Male, *cal.* tripartite: *cor.* tripetalous, with six stamina: female, *cal.* quinquepartite: *cor.* tripetalous: the stigmata three, and the plum coriaceous. Species five, the chief, *C. nucifera*, the *cocoa*-nut tree, is supposed to have been a native of the Maldives and some desert islands in the East Indies: and from thence to have been transported to all the warm parts of America: for it is not found in any of the inland parts, nor anywhere far distant from settlements. It frequently rises sixty feet high. The body of the trunk, which generally leans to one side, occasioned by the great weight of nuts it sustains when young, is of an equal thickness at top and at bottom, but somewhat smaller in the middle; its color is of a pale brown throughout, and the bark smooth. The leaves or branches are often fourteen or fifteen feet long, about twenty-eight in number, winged of a yellow color, straight and tapering. The pinnae are green, often three feet long next the trunk, but diminishing in length toward the extremity of the branches; which are fastened at top by brown stringy threads that grow out of them, of the size of ordinary pack-thread, and are interwoven like a web. The nuts hang at the top of the trunk, in clusters of a dozen in each. Each nut, next the stem, has three holes closely stopped, one being wider and more easily penetrated than the rest. When the kernel begins to grow, it incrusts the inside of the nut in a bluish, jelly-like substance; as this grows harder, the enclosed liquid, distilled

into the nut from the roots, become somewhat acid; and the kernel, as the nut ripens, becomes still more solid; and at length lines the whole inside of the nut for above a quarter of an inch thick, being as white as snow, and of the flavor of an almond. The quantity of liquor in a full grown nut is frequently a pint and upwards. The husky tegument of the nut consists of strong, tough, stringy filaments, which, when removed from the fruit, resemble coarse oakum. The leaves are wrought into brooms, hammocks in form of nets, mats, sacks, and other useful utensils. The tree is propagated by planting the nuts, which, in six or eight weeks, will come up, provided they are fresh and thoroughly ripe; but this is what few of them are when brought into this country; for they are always gathered before they are ripe, that they may keep during the passage. The best way, therefore, would be to gather such nuts as are thoroughly ripe in their native country, and plant them in a tub of dry sand, to keep them from the vermin during the passage. Here they will frequently sprout, which will be an advantage, as they may then be immediately planted in pots of earth, and plunged in the bark-stove. 2. *C. butyracea*. Palm-oil-tree. A native also of South America; unarmed: fronds pinnate: leaflets simple. It is from this species that we obtain the palm-oil of the dispensatories. For a farther account of which see PALM-OIL.

COCOS ISLAND, an island in the Pacific Ocean, abounding, according to captain Vancouver, in fish, and having a fruitful soil. It is about twelve miles in circumference, say those who examined it, lying in a north-east and south-west direction, and about four miles long and two broad, with detached rocks and islets scattered about its shores. Those lying off its south-west part extend to the greatest distance, which is nearly two miles, but they cannot be considered as dangerous, because they are sufficiently high to be seen and avoided. Water abounds in every part of the island, of excellent quality, and is to be easily procured at the stations to which vessels can resort. The soil in the immediate neighbourhood of the streams that fall into each of the bays, is of a poor, loose, sandy nature; but, at a little distance, behind the beach and in the fissures of the rocks, a rich black mould was observed, apparently capable of affording much vegetable nourishment. All its vegetable productions appeared to grow luxuriantly, and covered the island in one entire wilderness. On the rocky cliffs, near the sea side, whose uneven surface admitted the growth of vegetables, a coarse kind of grass is produced, that afforded an excellent retreat for the different kinds of sea-fowl which resort thither to roost and build their nests, or, more properly speaking, to lay their eggs, as they are at little pains to form a nest of any description.

About these cliffs grow a very particular kind of trees, something like the cloth-plant of the South Sea Islands, but much larger; some of these grow to the height of about thirty feet, are of a lightish colored bark, free from branches to the top, which is somewhat bushy. Many of the trees that composed the forest, especially in

the interior and elevated parts of the island, seemed to be of a considerable size. The cocconut trees, which grow not only on the sea-shore, but high up on the sides of the hills, were the only trees we saw that bore any fruit, although in one of the rivulets an unripe guava was picked up, which most probably had come from the interior country; in addition to these, we noticed an abundance of different sorts of ferns, some of which produced a stem nearly six inches in diameter, and grew to the height of nearly twenty feet; these, as well as I recollect, were exactly of the same description as those commonly found in New Zealand. Such were the most general vegetable productions of this island that fell under our observation; to which we further added the seeds of apples, peaches, melons, pumpkins, with beans, pease, &c. Fish were in great abundance, and sharks of large size; no turtles were seen; but the shores abounded with rats and land-crabs. All the sea-birds common to tropical regions were found here. In a bay on the western shore Vancouver's men found a bottle, stating, that the ship *Ratler*, South Sea whaler, of London, had arrived here 26th of July, 1793, and after procuring wood, water, and refreshments, had left a breed of hogs and goats on the island. None of these articles were, however, to be found. Long. 273° 6' E., lat. 5° 35' N.

COC'TILE, *adj.* Lat. *coctilis*. Made by baking, as a brick.

COCTION, *n. s.* Lat. *coctio*. The act of boiling.

The disease is sometimes attended with expectoration from the lungs, and that is taken off by a coction and resolution of the feverish matter, and terminates in suppuration or a gangrene. *Arbutus* not on *Diet*.

COCYTUS, from *κωκυτος*, to weep; one of the rivers of hell, according to the mythology of the poets. It was a branch of the river Styx; and flowed, says Horace, with a dull and languid stream.

COD, *n. s.* } Lat. *capite*; [Ital. *cavallau*;
COD-FISH. } Belg. *kabljauer*, from *кѣпѣ*;
Scot. *headock*, a sea-fish with a large head.

O! squander not thy grief, whose tears command
To weep upon our cod in Newfoundland,
The plenteous pickle shall preserve the fish,
And Europe taste thy sorrows in a dish. *Gay*.

COD, *n. s.* Sax. *codde*. Any case or husk in which seeds are lodged.

Thy corn thou there mayest safely sow,
Where in full cods last year rich pease did grow. *May*.

They let pease lie in small heaps as they are
reaped, till they find the hawm and cod dry.
Mortimer's Husbandry.

COD, *v. n.* From the noun. To enclose in a cod.

All codded grains being a destroyer of weeds, an improver of land, and a preparer of it for other crops. *Mortimer*.

COD, in ichthyology. See GADUS.

COD FISHERY. See FISHERY.

COD, CAPE, a promontory of the United States, on the south side of Boston Bay, in Massachusetts, near the entrance of Boston harbour. It was discovered, and thus named, by Bartholo-

new Gosnold, in 1602. Long. 70° 10' W., lat. 42° 4' N.

COD, CAPE, a peninsula of Massachusetts, so named from the above cape, which lies on its coast, extending sixty-five miles in length, from the isthmus between Barnstable and Buzzard's Bay to Race Point, and in breadth, for thirty miles, not above three, and above half the remainder from six to nine miles. It is surrounded by water on all sides except the west, where it is bounded by Plymouth county.

CODDERS, *n. s.* From cod. Gatherers of pease.

CODE, *n. s.* Lat. *codex*. A book. A book of the civil law.

We find in the Theodosian and Justinian code the interest of trade very well provided for.

Arbutnot on Coins.

Indentures, covenants, articles they draw, Large as the fields themselves; and larger far Than civil codes with all their glosses are.

Pope's Satires.

CODE, in jurisprudence, is a name given by way of eminence to a collection of the laws and constitutions of the Roman emperors, made by order of Justinian. It is accounted the second volume of the civil law, and contains twelve books; the matter of which is nearly the same with that of the digests, especially the first eight books; but the style is neither so pure, nor the method so accurate; and it determines matters of daily use, whereas the digests discuss the more abstruse and subtle questions of the law, giving the various opinions of the ancient lawyers. Although Justinian's code is thus distinguished by the appellation of code, yet there were codes before his time, such as Gregorian code, and Hermogenean code: collections of the Roman laws made by two celebrated lawyers, Gregorius and Hermogenes, which included the constitutions of the emperors from Adrian to Dioclesian and Maximinus. The Theodosian code, comprised in sixteen books, formed out of the constitutions of the emperors from Constantine the Great to Theodosius II., was observed almost over all the west, till it was abrogated by the Justinian code. There are several later codes, particularly the ancient Gothic, and those of the French kings, as the code of Euridic Louis, and Henry, code Marchande, code des Eaux, &c., and latterly we have had the code de Napoleon. See **NAPOLEON**.

CODE, a considerable river of Panama, South America, on which a large contraband trade being carried on formerly into the Pacific, a tower was built at its mouth. Long. 80° 25' W., lat. 9° 5' N., and taken by the English 1746.

CODEX, in antiquity, a book, or tables on which the ancients wrote, so called à codicibus, or caudicibus arborum, the trunks of trees; the bark of which, being stripped off, served the ancients to write their books on. Codex also denoted a kind of punishment by means of a clog or block of wood, to which slaves who had offended were tied fast, and obliged to drag it along with them; and sometimes they sat on it closely bound.

CODIA, among botanists, signifies the head of

any plant, but more particularly a poppy head; whence its syrup is called diacodium.

CODIA, in botany, a genus of the digynia order, and octandria class of plants: *cal.* tetraphyllous, with small oblong horizontal leaves: *cor.* consists of four very small linear petals: *stam.* eight filaments, twice as long as the calyx; anthers roundish. Species, one only, a native of New Caledonia.

CODICIL, *n. s.* Lat. *codicillus*. An appendage to a will.

The man suspects his lady's crying,

Was but to gain him to appoint her,

By codicil a larger jointure.

Prior.

CODICIL, in law, a supplement to a will which it resembles, except that it makes no mention of an heir or executor, and is not written with the formalities prescribed for a testament: so that a codicil is a less solemn will, of one that dies either testate or intestate, without the appointment of an heir; testate, when he that hath made his codicil hath either before or afterwards made his testament, on which that codicil depends, or to which it refers: intestate, when one leaves behind him only a codicil without a testament, wherein he gives legacies to be paid only by the heir at law.

CODILLE, *n. s.* Fr. *codille*; Span. *codillo*. A term at ombre, when the game is won.

She sees, and trembles at the' approaching ill;

Just in the jaws of ruin and codille.

Pope's Rape of the Lock.

To **CODLE**, *v. a.* Lat. *coquo, coctulo*. To parboil; to soften by the heat of water.

CODLING, *n. s.* From To codle. An apple generally codled to be mixed with milk.

In July come gilliflowers of all varieties, early pears and plums in fruit, gennittings and codlings.

Bacon's Essays.

Their entertainment at the height,

In cream and codlings revelling with delight.

King's Cookery.

He let it lie all winter in a gravel walk, south of a codling hedge.

Mortimer's Husbandry.

A codling, ere it went his lip in,

Would straight become a golden-pippin.

Swift.

CODOGNO, a town of Italy, in the ci-devant duchy of Milan, situated in the department of Adda, near the confluence of the Adda and the Po. It was the head-quarters of the French general Laharpe, when he was shot by the Austrians, in May, 1796, though the French were victorious. It was also the scene of a defeat of the Austrians, fifty years before, in 1746. It lies thirty-three miles east of Pavia, and ten S. E. of Udina. Lon. 10° 59' E., lat. 45° 6' N.

CODON, *κωδων*, in antiquity, a cymbal, or rather little brass bell, resembling the head of a poppy. They were fastened to the trappings and bridles of horses.

CODON, in botany, a genus of the monogynia order, and decandria class of plants: *cal.* decempartite, with the segments alternately long and short: *cor.* campanulated, with the limb decempartite and equal; the nectarium decemlocular, of ten scales inserted into the heels of the stamina; the seed-case bilocular; the seeds hairy, roundish, in a dry colored pulp. Species eight, one only a Cype plant.

CODRINGTON (Christopher), a celebrated English officer, born at Barbadoes in 1668, and educated at Oxford; after which he betook himself to the army; and, by his merit and courage, soon recommending himself to the favor of king William, was made a captain in the first regiment of foot guards. He was at the siege of Namur in 1695; and, upon the peace of Ryswick, was made governor in chief of the Leeward and Caribbee islands. In 1701, however, several articles were exhibited against him before the House of Commons; to which he published a distinct and particular answer, and was honorably acquitted. In 1703, he showed great bravery at the attack of Guadaloupe; but at last he lived a studious and retired life. He died at Barbadoes April 7th, 1710, and was buried there; but his body was afterwards brought over to England, and interred, in 1716, at Oxford. By his last will, he bequeathed his plantations in Barbadoes, and part of the island of Barbuda, to the Society for Propagating the Gospel in Foreign parts; and left a noble legacy to All Souls College, of which he had been a fellow. This legacy consisted of his library, which was valued at £6000, and £10,000 to be laid out; £6000 in building a library, and £4000 in furnishing it with books. He wrote some of the poems in the *Musæ Anglicanæ*, printed at London in 1741.

COD ROY, a river of Newfoundland, which runs into the sea between cape Ray and cape Anguille.

CODRUS, the seventeenth and last king of Athens, son of Melanthus. When the Heraclidæ made war against Athens, the oracle foretold that the victory would be granted to that nation whose king was killed in battle. The Heraclidæ upon this gave strict orders to spare the life of Codrus; but the patriotic king disguised himself and attacked one of the enemy, by whom he was killed. The Athenians obtained the victory, and Codrus was deservedly called the father of his country. He reigned twenty-one years, about A. A. C. 1071. To pay the more honor to his memory, the Athenians enacted, that no man after Codrus should reign in Athens, under the name of king. See *ATTICA*.

COD'S HEAD, a cape on the south-west coast of Ireland. Long. 9° 59' W., lat 51° 36' N.

COECK (Peter), called also Peter Van Aelst, was a Flemish painter of the school of Bernard of Brussels. In 1531 he went to Constantinople, and made some admirable drawings of the Turkish costume, which he afterwards cut in wood. His historical pictures, as well as portraits, were more much admired. He was painter to Charles V. and died at Antwerp in 1550.

CÆCUM, in anatomy, the blind gut; so called as it has but one opening, being the first portion of the large intestine in which the small intestine ends. See *ANATOMY* and *INTESTINES*.

COEFFICACY, *n. s.* Lat. *con* and *efficacia*. The power of several things acting together to produce an effect.

We cannot in general infer the efficacy of those stars, or *coefficientary* particular in medications

Lavoigne's Vulgar Errors.

COEFFICIENCY, *n. s.*; *con* and *efficio*.

Lat. *co-operation*; the state of acting together to some single end.

The managing and carrying on of this work by the spirits instrumental *coefficienty*, requires that they be kept together without distinction or dissipation.

Glanville's Scœpis.

COEFFICIENTS. See *ALGEBRA*.

COEFFICIENT. *n. s.* Lat. *con* and *efficiens*. 1. That which unites its action with the action of another. 2. In algebra; such numbers, or given quantities, that are put before letters, or unknown quantities, into which letters they are supposed to be multiplied, and so do make a rectangle or product, with the letters; as 4 *a*, *b* *x*, *c* *x* *x*; where 4 is the coefficient of 4 *a*, *b* of *b* *x*, and *c* of *c* *x* *x*.

The *coefficient* of any generating term in fluxions, is the quantity arising by the division of that term, by the generated quantity. *Chambers.*

CELIAC ARTERY. See *ANATOMY*. *Index.*

CELIAC PASSION. Κοιλια the belly. A diarrhœa, or flux, that arises from the indigestion or putrefaction of food in the stomach and bowels, whereby the aliment comes away little altered from what it was when eaten, or changed like corrupted stinking flesh.

CELIAC VEIN, in anatomy, that which runs through the intestinum rectum, along with the cœliac artery.

CELIMONTANA PORTA, one of the gates of Rome, situated at the mouth of mount Cœlius, and hence its name: thought to be the ancient Asinaria by some. By this gate Alaric, with his Goths, is said to have entered and plundered Rome.

CELIOBRIGA, in ancient geography, a town of the Bracari in the Hither Spain, south of Bracara Augusta, north of the Durus, and not far from the Atlantic. It was a municipium, and is now thought to be Barcelona.

COELIUS MONS, one of the seven hills of Rome; so called from Coeles, a Tuscan captain, who came to the assistance of Romulus against the Sabines, according to Dionysius Halicarnassus. It was called also Querculanus, or Quercetulanus, from the oaks growing on it; and Augustus by Tiberius. To the east it had the city walls, on the south the Coeliolus, to the west the Palatine, and on the north the Esquiline.

CÆLOS PORTUS, a town of the Chersonesus, near Sestos; where the Athenians erected a trophy, after a sea victory over the Lacedæmonians.

COEMPTION, *n. s.* Lat. *coemptio*. The act of buying up the whole quantity of anything.

Monopolies and *coemption* of wares for resale, where they are not restrained, are great means to enrich. *Bacon's Essays.*

COEMPTIONALES, among the Romans, an appellation given to old slaves, who were sold in a lot with others, because they could not be alone.

COEN (John Paterson), governor of the Dutch settlements in the East Indies, and founder of the city of Batavia, was born at Hoom in 1587. He was educated in Italy for a commercial life and afterwards went to India, where he introduced the Italian mode of book-keeping. He suc-

ceeded to the governorship of Bantam in 1617, but two years after he removed the factory to Batavia, which city he planned and built. In 1623 he returned to Europe, but in 1627 he went back to Batavia, which he defended with great bravery against the emperor Java, who lost such a great number of men before the place, that the dead carcases produced a pestilence, of which Coen died in 1629.

CENOBITE, from *κοινος*, common, and *βίος*, life, a religious who lives in a convent, or in community, under a certain rule; in opposition to a hermit, who lives in solitude. Cassian makes this difference between a convent and monastery, that the latter may be applied to the residence of a single religious or recluse; whereas the convent implies cœnobites, or numbers of religious living in common. Fleury speaks of three kinds of monks in Egypt: anachorets, who live in solitude; cœnobites, who continue to live in community; and sarabaites, who are a kind of monks errant, that stroll from place to place. He refers the institution of cœnobites to the times of the apostles, and makes it a kind of imitation of the ordinary lives of the faithful at Jerusalem; though St. Pachomiurs is ordinarily allowed to have been the institutor of the cœnobite life; as being the first who gave a rule to any community.

CœNOBIUM, *κοινωβιον*, the state of living in a society, or community, where all things are common. Pythagoras is thought to be the author or institutor of this kind of life; his disciples, though some hundreds in number, being obliged to give up all their private estates, to be annexed to the joint stock of the whole. The Essenians among the Jews and Platonists are said to have lived in the same manner. Many Christians also have thought this the most perfect kind of society, as being that in which Christ and his apostles chose to live.

COEQUAL, *adj.* } From Lat. *con* and
COEQUALITY, *n. s.* } *equalis*, equal; being of the same rank and dignity, with another.

Henry the fifth did sometimes prophesy,
If once he came to be a cardinal,
He'll make his cap *coequal* with the crown.

Shakspeare. Henry IV.

COERCE, *v. a.* } Lat. *coerceo*; to restrain;
COERCIBLE, *adj.* } to keep in order by force;
COERCION, *n. s.* } penal restraint; check.
COERCIVE, *adj.* } That which has the power and authority of restraining by punishment.

For ministers to seek that themselves might have *coercive* power over the church, would have been hardly construed.
Hooker's Preface.

The *coercion* or execution of the sentence in ecclesiastical courts, is only by excommunication of the person contumacious.
Hale's Common Law.

The virtues of a general, or a king, are prudence, counsel, active fortitude, *coercive* power, awful command, and the exercise of magnanimity, as well as justice.
Dryden.

Government has *coercion* and animadversion upon such as neglect their duty; without which *coercive* power, all government is toothless and precarious.
South.

COESSENTIAL, *adj.* } Lat. *con* and *essen-*
COESSENTIALITY, *n. s.* } *tia*. Participating of the same essence.

The Lord our God is but one God, in which indivisible unity we adore the Father, as being altogether of himself; we glorify that consubstantial Word, which is the Son; we bless and magnify that *coessential* Spirit eternally proceeding from both, which is the Holy Ghost.
Hooker.

COETA'NEOUS, *adj.* Lat. *con* and *etas*. Of the same age with another: with to.

Eve was old as Adam, and Cain their son *coetaneous* unto both.
Brown's Vulgar Errors.

Every fault hath penal effects, *coetaneous* to the act.
Gov.

Through the body every member sustains another; and all are *coetaneous*, because none can subsist alone.
Bentley's Sermons.

COETER'NAL, *adj.* } Lat. *con* and *eternus*.
COETER'NALLY, *adv.* } Having existence from
COETER'NITY, *n. s.* } eternity. In a state of equal eternity with another.

Arius had dishonored his *coeternally* begotten Son.
Hooker.

The eternity of the Son's generation, and his *coeternity* and consubstantiality with the Father, when he came down from heaven, and was incarnate.
Hammond's Fundamentals.

Hail! holy Light! offspring of Heaven first-born,
Or of the Eternal *coeternal* beam,
May I express thee, unblamed: since God is light,
And never but in unapproach'd light
Dwelt from eternity, dwelt then in thee,
Bright effluence of bright essence increate.
Milton.

COE'VAL, *adj. & n. s.* } Lat. *coævus*. The
COE'VOUS, *adj.* } same in age; a contemporary; but properly one not only living at the same time, but of the same time of life.

This religion cannot pretend to be *coeval* with man.
Hale.

Although we had no monuments of religion ancients than idolatry, we have no reason to conclude that idolatrous religion was *coeval* to mankind.
Id. Origin of Mankind.

The monthly revolutions of the moon, or the diurnal of the earth upon its own axis, by the very hypothesis, are *coeval* with the former.
Bentley.

Then it should not have been the first, as supposing some other thing *coævous* to it.
South.

Even his teeth and white, like a young sock,
Coeval, and new-shorn, from the clear brook
Recent.
Prior.

As it were not enough to have outdone all your *coevals* in wit, you will excel them in good nature.
Pope.

Silence, *coeval* with eternity!
Thou wert, ere nature first began to be,
'Twas one vast nothing all, and all slept fast in thee!
Id.

O my *coevals*! remnants of yourselves!
Poor human ruins tottering o'er the grave!
Shall we, shall aged men, like aged trees,
Strike deeper their vile root, and closer cling
Still more enamoured of this wretched soil?
Young's Night Thoughts.

Describe the man of whom
His own *coevals* took but little note,
And paint his person, character, and views
As they had known him from his mother's womb.
Cowper's Task.

COEVARDEU, or **KOEVARDE**, a fortified town, the capital of the district of Drenthe, in the Netherlands, situated on the river Aa. It has been regarded as the chef d'œuvre of the celebrated Coehorn, and one of the strongest fortresses of Holland, forming the key to Groningen, Overijssel, and Friesland. Its form is that of a regular pentagon, with high and thick ramparts, seven large bastions, seven half moons, and seven ravelins. It is farther strengthened by a fort surrounded with five other bastions, and surrounded by marshes. It was besieged in 1672 by Bernard Von Galen, the warlike bishop of Munster, and betrayed by the governor; but shortly after retaken by the Dutch. In 1795 it surrendered to the French. It is thirty miles south of Groningen, thirty-six north-east of Deventer, and sixty north-east of Arnheim.

COEUR (James), an opulent French merchant of the fifteenth century. He is said to have had 300 agents in the Levant, and lent 200,000 crowns of gold to Charles VII. which enabled him to conquer Normandy. He was, in return, tried upon some false charges, and condemned to the loss of his estates, and the payment of an enormous fine. He himself only escaped through the management of one of his clerks, and died in the isle of Chio in 1456.

COEXIST, *v. n.* } Lat. *con* and *existo*.
COEXISTENCE, *n. s.* } To exist at the same time
COEXISTENT, *adj.* } with another. Existence together; equal in time and duration.

The three stars that *coexist* in heavenly constellations, are a multitude of stars.

Hale's Origin of Mankind.

Of substances no one has any clear idea, farther than of certain simple ideas *coexisting* together. *Locke.*

It is sufficient that we have the idea of the length of any regular periodical appearances, which we can in our minds apply to duration, with which the motion or appearance never *coexisted*. *Id.*

The measuring of any duration, by some motion, depends not on the real *coexistence* of that thing to that motion, or any other periods of revolution. *Id.*

To the measuring the duration of anything by time, it is not requisite that that thing should be *coexistent* to the motion we measure by, or any other periodical revolution. *Id.*

All that one point is either future or past, and no parts are *coexistent* or contemporary with it. *Bentley.*

We can demonstrate the being of God's eternal ideas, and their *coexistence* with him.

Grew's Cosmologia.

COEXTEND, *v. a.* } Lat. *con* and *extendo*.
COEXTENSION, *n. s.* } To extend to the same space or duration with another.

Though it be a spirit, I find it is no inconvenience to have some analogy, at least of *coextension* with my body. *Hale.*

Every motion is, in some sort *coextended* with the body moved. *Grew's Cosmologia.*

COFFEA, the coffee-tree, a genus of the monogynia order, and pentandria class of plants; natural order forty-seventh, stellate: cor. funnel-shaped; the stamina above the tube: SEED, a berry inferior, dispersuous, and arillated. There are ten species, but our limits confine us to the description of one only, the *C. Arabica*.

It seldom rises more than sixteen or eighteen feet in height; the main stem grows upright, and is covered with a light brown bark; the branches are produced horizontally and opposite, crossing each other at every joint; so that every side of the tree is fully garnished with them, and they form a sort of pyramid. The leaves also stand opposite; and when fully grown are about four or five inches long, and two broad in the middle, decreasing towards each end; the borders are waved, and the surface of a lucid green. The flowers are produced in clusters at the root of the leaves, close to the branches; they are tubulous, and spread open at the top, where they are divided into five parts; are of a pure white, and have a very grateful odor, but are of short duration. The fruit, which is the only useful part, resembles a cherry. It grows in clusters, and is ranged along the branches under the axillæ of the leaves, of the same green as the laurel, but something longer. When it comes to be of a deep red, it is gathered for the mill, in order to be manufactured into coffee beans. The coffee-tree is cultivated in Arabia, Persia, the East Indies, the Isle of Bourbon, and several parts of America. It is also raised in botanic gardens in several parts of Europe. Prince Eugene's garden at Vienna produced more coffee than was sufficient for his own consumption. It delights particularly in hills and mountains, where its root is almost always dry, and its head frequently watered with gentle showers. It prefers a western aspect, and ploughed ground without any appearance of grass. The plants should be placed eight feet distant from each other, in holes twelve or fifteen inches deep. They should rise to the height of sixteen or eighteen feet, but they are generally stunted to five, for the conveniency of gathering their fruit with the greater ease. Thus dwarfed, they extend their branches so, that they cover the whole spot round them. They begin to yield fruit the third year, but are not in full bearing till the fifth. They are in danger of being destroyed by worms, or by the scorching rays of the sun. The hills where the coffee trees are found have, generally, a gravelly or chalky bottom. In the last it languishes for some time, and then dies: in the former its roots, which seldom fail of striking between stones, obtain nourishment, and keep the tree alive and fruitful for thirty years. This is nearly the period for plants of the coffee tree. The proprietor, at the end of this period, not only finds himself without trees, but has his land reduced, that it is not fit for any kind of culture; and unless he is so situated, that he can break up a spot of virgin land, to make himself amends for that which is totally exhausted by the coffee trees, his loss is irreparable. The coffee produced in Arabia is found so greatly to excel that raised in the American plantations or elsewhere, that the cultivation of the tree is now but seldom practised in any of the British colonies. Large plantations of this kind were formerly made in some of them; and it was proposed to the parliament to give a proper encouragement for cultivating this commodity there, so as to enable the planters to undersell the importers from Arabia. Accordingly there was an abatement of the duty pay-

able on all coffee imported from our colonies in America, which was then supposed to be sufficient encouragement for this kind of commerce; but the inferiority of the American coffee to the Arabian, almost ruined the project. The coffee berry is very apt to imbibe moisture, or the flavor of anything placed near it. Some years ago a coffee ship from India had a few bags of pepper put on board, the flavor of which was imbibed by the coffee, and the whole cargo spoiled. The coffee tree, when cultivated in Europe, requires a stove. It makes a fine appearance at all seasons of the year (being an evergreen), but especially when in flower, and when the berries are red, which is generally in the winter, as they continue long in that state. It is propagated from the berries; but they must be planted immediately when gathered from the tree, for they lose their vegetative quality in a very short time; when sent abroad by the post, they have constantly failed when they have been a fortnight on their journey; so that where these trees are desired, the young plants must be sent, if it be at any distance from the place where they grow. The fresh berries may be planted in small pots, and plunged into a hot-bed of tanner's bark. The most proper soil for them is that of a kitchen garden, which is naturally loose, and not subject to bind, especially if it has constantly been well wrought and dunged.

The mill for dressing the coffee beans is composed of two wooden rollers furnished with iron plates, eighteen inches long, and ten or twelve in diameter. These movable rollers are made to approach a third, which is fixed, and called the chops. Above the rollers is a hopper, in which the coffee is put, from whence it falls between the rollers and the chops, where it is stripped of its first skin, and divided into two parts, as may be seen by the form of it, after it has undergone this operation; being flat on one side and round on the other. From this machine it falls into a brass sieve, where the skin drops between the wires, while the fruit slides over them into baskets placed ready to receive it; it is then thrown into a vessel full of water, where it soaks for one night, and is afterwards thoroughly washed. When the whole is finished, and well dried, it is put into another machine called the peeling mill. This is a wooden grinder, turned vertically upon its treadle by a mule or horse. In passing over the coffee it takes off the parchment, which is nothing but a thin skin that detaches itself from the berry in proportion as it grows dry. The parchment being removed it is taken out of this mill to be put into another, which is called the winnowing mill. This machine is provided with four pieces of tin fixed upon an axle, which is turned by a slave with considerable force: and the wind that is made by the motion of these plates clears the coffee from all the pellicles that are mixed with it. It is afterwards put upon a table, where the broken berries, and any filth that may remain among them, are separated by negroes, after which the coffee is fit for sale.

It is prepared by roasting, or giving it a just degree of torrefaction on an earthen or metal-lic plate, till it has acquired a brownish hue, equally deep on all sides. As much is then

ground in a mill, as serves the present occasion. A proper quantity of water is then boiled, and the ground coffee put into it. After it has just boiled it is taken from the fire, and the decoction having stood awhile to settle, it is poured into dishes. The ordinary method of roasting coffee among us is in a tin cylindrical box full of holes, through the middle whereof runs a spit. Under this is a semicircular hearth, whereon is a larg charcoal fire: by the help of a jack the spit turns swift, and so roasts the berry, being now and then taken up to be shaken. When the oil rises, and it is grown of a dark brown color, it is emptied into two receivers made with hoops, whose bottoms are iron plates; there the coffee is shaken, and left till almost cold, and if it look bright and oily it is a sign it is well done.

COFFEE, *n. s.* } From the Arab. *cahuk*;
COFFEE-POT, *n. s.* } *caffè*. The tree is a species of Arabic jessamine; used also for the berry, and the beverage made from it.

They have in Turkey a drink called *coffee*, made of a berry of the same name, as black as soot, and of a strong scent, but not aromatical; which they take, beaten into powder, in water, as hot as they can drink it. This drink comforteth the brain and heart, and helpeth digestion. *Bacon.*

To part her time 'twixt reading and bohea,

Or o'er cold *coffee* tribe with the spoon. *Pope.*

It is found to succeed as well in the Caribbee islands as in its native place of growth; but whether the *coffee* produced in the West Indies will prove as good as that from Mocha in Arabia Felix, time will discover.

Miller.

Coffee denotes a drink prepared from the berries, very familiar in Europe for these eighty years, and among the Turks for 150. Thevenot, the traveller, was the first who brought it into France; and a Greek servant, called Pasqua, brought into England by Mr. Daniel Edwards, a Turkey merchant, in 1652, to make his *coffee*, first set up the profession of *coffee*-man, and introduced the drink among us. *Chambers.*

COFFEE, the well-known beverage prepared from the berry of this tree, has now been familiar in Europe for upwards of 200 years. Its origin is not well known. Some ascribe it to the prior of a monastery; who, being informed by a goatherd that his cattle, sometimes browsing on the tree, would wake and caper all night, became curious to prove its virtue. Accordingly he first tried it on his monks, to prevent their sleeping at matins. Others refer the invention of coffee to the Persians; from whom it was received, we are told, in the fifteenth century by Gemaleddin, a mufti of Aden, who, having tried its virtues himself, and found that it dissipated the fumes which oppressed the head, and prevented sleep, recommended it first to his dervises, with whom he used to spend the night in prayer. Hence it passed to Mecca, where first the devotees, and afterwards the rest of the people, took it. From Arabia Felix it passed to Cairo. It 1511 Kahie Beg prohibited it, from a persuasion that it inebriated; but Sultan Causon immediately after took off the prohibition, and coffee advanced from Egypt to Syria and Constantinople. The dervises declaimed against it from the Alcoran, which declares, that coal is not of the number of things created by God for food. Accordingly, the mufti ordered the coffee houses to be shut;

but his successor declaring coffee not to be coal, they were again open. During the war in Candia, these assemblies furnishing opportunities for the discussion of politics, the grand vizier Kiu Prili suppressed the coffee-houses at Constantinople; which suppression, however, did not prevent the public use of the liquor there. The word coffee is originally Arabic; the Turks pronounce it it caheuh, and the Arabians caluah; which some authors maintain to be a general name for anything that takes away the appetite; others, for anything that promotes appetite; and others again, for anything that gives strength and vigor. The Mahomedans, it is observed, distinguish three kinds of caluah. The first is wine, or any liquor that inebriates; the second is made of the pods that contain the coffee berry; this they call the sultan's coffee, from their having first introduced, on account of its heating less than the berry, as well as its keeping the bowels open; the third is that made with the berry itself, which alone is used in Europe, the pods being found improper for transportation.

With respect to the medicinal properties of coffee, it is, in general, excitant and stimulating; though we doubt whether it relaxes the animal fibres, as has by some authors been supposed. Its more or less wholesome effect greatly depends on the climate, as well as the age, constitution, and other peculiarities, of the individual. Hence it cannot be recommended to children, or persons of a hot choleric, nervous, or phthisical habit; nor will it be so safe and useful in warm as in cold and temperate climates; but to the phlegmatic and sedentary, a cup of coffee one or two hours after a meal, or, which is still better, one hour before it, may be of service to promote digestion, and prevent or remove a propensity to sleep. In cases of spasmodic asthma, hypochondriasis, scrofula, diarrhœa, agues, and particularly against narcotic poisons, such as opium, hemlock, &c. coffee often produces the best effects: nor is there a domestic remedy better adapted to relieve periodical headaches which proceed from want of tone, or from debility of the stomach.

COFFEE-HOUSE, } A tavern or subscription
COFFEE-MAN. } meeting where refreshments are sold. A house of public entertainment; a tavern. Coffee-man is the obsolete term for tavern-keeper, or one that keeps a coffee-house.

The Turks have a drink called coffa (for they use no wine), so named of a berry as black as soot, and as bitter (like that black drink which was in use amongst the Lacedæmonians, and perhaps the same), which they sip still of, and sup as warm as they can suffer; they spend much time in these *coffa-houses*, which are somewhat like our ale-houses or taverns; and there they sit chatting and drinking, to drive away the time, and to be merry together, because they find by experience that kind of drink so used helpeth digestion, and procureth alacrity. *Burton's Anat. Mel.*

At ten, from *coffee-house* or play
Returning, finishes the day. *Prior.*

It is a point they do not concern themselves about, farther than perhaps as a subject in a *coffee-house*.

Swift.

Consider your enemies the Lacedæmonians · did

ever you hear that they professed a *coffee-man* to Agasilans? *Adams.*

COFFEE TREE, in botany. See **COFFEA**.
COFFER, *n. s. & v. a.* Sax. *cofe*; Fr. *cof* *fr.* A chest; a depository for treasure; and, by a metonymy, treasure itself.

And had this sergeant that he prively
Shulde this child, ful softe, wind and wrappe,
With all circumstances tendrely,
And carry it in a *cofre*, or in a lappe.

Chaucer's Canterbury Tales.

Treasure, as a war might draw forth, so a peace succeeding, might *offer* up. *Bacon's Henry VII.*

He would discharge it without any burthen to the queen's *coffers*, for honor's sake.

Id. Advice to Villiers

Two iron *coffers* hung on either side,
With precious metal full as they could hold.

Færie Queene.

The lining of his *coffers* shall make coals
To deck our soldiers for those Irish wars.

Shakspeare's Richard II

If you destroy your governour that is wealthy, you must chuse another, who will fill his *coffers* out of what is left. *L'Estrange.*

COFFER, in architecture, a square depresso in each interval between the modillions of the Corinthian cornice, usually filled with some enrichment.

COFFER, in fortification, a hollow lodgment across a dry moat, from six to seven feet deep, and from sixteen to eighteen broad; the upper part being made of pieces of timber, raised two feet above the level of the moat; which little elevation has hurdles laden with earth for its covering, and serves as a parapet, with embasures.

COFFER, in fortification, is nearly the same with the caponiere, excepting that this last is sometimes made beyond the counterscarp on the glacis; and the coffer always in the moat taking up its whole breadth, which the caponiere does not. It differs from the travers and gallery in that these are made by the besiegers, and the coffer by the besieged. The besieged generally make use of coffers to repulse the besiegers when they endeavour to pass the ditch. To save themselves from the fire of these coffers, the besiegers throw up the earth on that side towards the coffer.

COFFER DAM, in architecture, an enclosure used in laying the foundation of the piers of bridges. It is generally constructed by driving piles in double rows, and ramming clay and rubbish between them. The water being pumped out, leaves a dry foundation for the working of the pier.

COFFERER OF THE KING'S HOUSEHOLD, was a white staff officer, and always a member of the privy council. This officer is now suppressed, and the business of his office is transacted by the lord steward, and paymaster of the household.

COFFIN, *n. s. & n. a.* } Fr. *coffin*; from
COFFIN-MAKER, *n. s.* } Lat. *cavus*. A chest for dead bodies. Technically used in farriery.

Would'st thou have laughed had I come *coffined* home,

That weepeth to see me triumph.

Shakspeare's Coriolanus.

Not a flower sweet
On my black coffin let there be sown.

Id. Twelfth Night.

Let me lie
In prison, and here be *coffined* when I die. *Donne.*
He went as if he had been the *coffin* that carried
himself to his sepulchre. *Sidney.*

One fate they have,
The ship their *coffin*, and the sea their grave. *Wall.*
The joiner is fitting screws to your *coffin*. *Swift.*

Coffin of a horse, is the whole hoof of the foot above
the coronet, including the *coffin* bone. The *coffin*
bone is a small spongy bone, inclosed in the midst of
the hoof and possessing the whole form of the foot.

Farrier's Dictionary.

Where will be your sextons, *coffin-makers*, and
plumbers. *Tatler.*

COFFIN. The sepulchral honors paid to departed friends in ancient times, are curious and worthy of attention. Their being put into a coffin was considered as a mark of the highest distinction; though with us the poorest people have their coffins. At this day, in the east, they are not at all made use of, either by Turks or Christians. The ancient Jews seem to have buried their dead in the same manner: neither was the body of our Lord, it should seem, put into a coffin; nor that of Elisha, 2 Kings, xiii. 21, whose bones were touched by the corpse that was let down a little after into the sepulchre. That coffins, however, were anciently made use of in Egypt, all agree; and antique coffins of stone, and sycamore wood, are still to be seen in that country; not to mention those said to be of a kind of pasteboard, formed by folding or gluing cloth together a great many times, curiously plastered, and then painted with hieroglyphics. Its being an ancient Egyptian custom, and not practised in the neighbouring countries, was, doubtless, the cause that the sacred historian expressly observes of Joseph, that he was not only embalmed, but also put into a coffin, Gen. l. 26, both being customs peculiar to the Egyptians. Maillet apprehends that all were not enclosed in coffins who were laid in the Egyptian repositories of the dead; but that it was an honor appropriated to persons of rank.

COG, *v. a., v. n. & n. s.* } Bar. Lat. *coga*.
CO'GGER, *n. s.* } A wedge; the
tooth of a wheel. The verb is applied to the
employment of a wedge, or to the fixing the
teeth in a wheel. As a corruption of cocker it
means to flatter; to deceive. To cog a die is
to give a bias to dice; to play unfairly. It generally signifies to obtrude by falsehood; to lie; to wheedle.

I'll mountbank their loves,
Cog their hearts from them, and come home beloved
Of all the trades in Rome. *Shakespeare. Coriolanus.*

Mrs. Ford, I cannot cog; I cannot prate, Mrs.
Ford: now shall I sin in my wish.

Id. Merry Wives of Windsor.

But then my study was to cog the dice,
And dexterously to throw the lucky sice.

Dryden's Per. Satires.

For guineas in other men's breeches,
Your gamesters will palm and will cog. *Swift.*

Ye gallants of Newgate, whose fingers are nice
In diving in pockets, or cogging of dice. *Id.*

as outcry is, that I abuse his demonstration by
a falsification, by *cogging* in the word.

Tillotson. Preface.

I have *cogged* in the word to serve my turn.

Stillingfleet.

Fustian tragedies, or insipid comedies, have, by
concerted applauses, been *cogged* upon the town for
masterpieces. *Dennis.*

Or more expert in pilfering vice,
They burn and itch to cog the dice. *Gay.*

COGAN (Thomas, M. D.), was born in 1736,
at Rowell, in Northamptonshire. Educated at
Kibworth under Dr. Aikin, he was intended for
the dissenting ministry, and officiated for some
time to a Presbyterian congregation at Amsterdam,
where he married a lady of fortune. He
now studied physic, and in 1767 took his doctor's
degree at Leydon. Some time after we
find him in London, uniting with the late Dr.
Hawes in instituting the Royal Humane Society.
He returned, however, to Holland, till the French
revolution obliged him once more to come to
England, where he published, in 1794, *The*
Rhine, or a Journey from Utrecht to Frankfort;
and, in 1795, the works of Camper. His other
works are, 1. Philosophical Treatise on the Passions;
2. Ethical Questions, or Speculations in Moral
Philosophy; 3. Theological Disquisitions,
5 vols. 8vo. He was also the author of *the*
Life and Opinions of John Bunce, jun.; and *Letters*
on the Doctrine of Hereditary Depravity. He
died February 2nd, 1818.

CO'GENT, *adj.* } Lat. *cogens*. Forcible; re-
CO'GENCY, *n. s.* } sistless; convincing; power-
CO'GENTLY, *adv.* } ful; having the power to
compel; conviction.

Maxims and axioms, principles of science, because
they are self evident, have been supposed innate;
although nobody ever shewed the foundation of their
clearness and *cogency*. *Locke.*

They forbid us to hearken to those proofs, as weak
or fallacious, which our own existence, and the sensible
parts of the universe, offer so clearly and *cogently*
to our thoughts. *Id.*

Such is the *cogent* force of nature. *Prior.*

They have contrived methods of deceit, one repugnant
to another, to evade, if possible, this most *cogent*
proof of a Deity. *Bentley.*

CO'GGLESTONE, *n. s.* Ital. *cuogolo*. A
little stone; a small pebble.

CO'GITATE, *v. n.* } Lat. *cogito*. To think;
CO'GITABLE, *adj.* } to purpose; to medi-
COGITA'TION, *n. s.* } tate; to reflect; to in-
CO'GITATIVE, *adj.* } dulge mental speculation.

Having their *cogitations* darkened, and being strangers
from the life of God, from the ignorance which is
in them. *Hooker.*

The king, perceiving that his desires were intemperate,
and his *cogitations* vast and irregular, began
not to brook him well. *Bacon's Henry VII.*

On some great charge employed
He seemed, or fixt in *cogitation* deep.

Milton's Paradise Lost.

The earl had the closer and more reserved countenance,
being by nature more *cogitative*. *Wotton.*

If these powers of cogitation and sensation are
neither inherent in matter, nor acquirable to matter,
they proceed from some *cogitative* substance,
which we call spirit and soul. *Bersée.*

COGNAC, COGNIAC, or COIGNAC, a town of France, in the department of the Charente, and ci-devant province of Angoumois, with a castle, where Francis I. was born. It is seated on the river Charente, in a very pleasant country, abounding in wine and remarkable for its excellent brandy: it trades largely in it with all the chief cities of Europe. It is 100 miles south-west of Paris.

COGNAC, a town of France, in the department of Upper Vienne, and ci-devant province of Limosin, twenty miles south-east of Consolent.

COGNATION, *n. s.* *Lat. cognatio.* Kindred; descent from the same original. Relation; participation of the same nature.

He induceth us to ascribe effects unto causes of no *cognition.* *Brown's Vulg. Errors.*

Two vices I hall mention, as being of near *cognition* to ingratitude; pride, and hard-heartedness, or want of compassion. *South.*

Let the critics tell me what certain sense they could put upon either of these four words, by their mere *cognition* with each other. *Watts on the Mind.*

COGNISEE', *n. s.* In law. He to whom a fine in lands or tenements is acknowledged.

COGNISOUR, *n. s.* In law. Is he that passeth or acknowledgeth a fine in lands or tenements to another.

COGNITION, *n. s.* } *Lat. cognitio.* Know-
COGNITIVE, *adj.* } ledge; complete conviction. Having the power of knowing.

I will not be myself, nor have *cognition*

Of what I feel; I am all patience.

Shakespeare. Troilus and Cressida.

God, as he created all things, so is he beyond and in them all; not only in power, as under his subjection; or in his presence, as in his *cognition*; but in their very essence, as in the soul of their casualities.

Brown's Vulgar Errors.

Unless the understanding employ and exercise its *cognitive* or apprehensive power about these terms, there can be no actual apprehension of them.

South's Sermons.

COGNITIONIS CAUSA, in Scots law. When a creditor charges the heir of his debtor to enter, in order to constitute the debt against him, and the heir renounces the succession, the creditor can obtain no decret of constitution of that debt against the heir; but only a decret subjecting the hæreditas jacens, or the estate which belonged to the debtor, to his diligence: and this is called a decret cognitionis causa.

COGNIZABLE, *adj.* } *Fr. cognosable, con-*
COGNIZANCE, *n. s.* } *noissance.* That falls under judicial notice; liable to be tried, judged, or examined. Judicial notice; trial; judicial authority; a badge, by which any one is known.

And at the king's going away the earl's servants stood, in a seemly manner, in their livery coats, with *cognisances*, ranged on both sides, and made the king a bow. *Bacon's Henry VII.*

These were the proper *cognisances* and coat-arms of the tribes. *Brown's Vulgar Errors.*

Some are merely of ecclesiastical *cognizance*; others of a mixed nature, such as are *cognisable* both in the ecclesiastical and secular courts. *Ayliffe's Parergon.*

It is worth the while, however, to consider how we may discountenance and prevent those evils which the law can take no *cognisance* of. *L'Étrange.*

Happiness or misery, in converse with others, depends upon things which human laws can take no *cognisance* of. *South.*

The moral crime is completed, there are only circumstances wanting to work it up for the *cognisance* of the law. *Addison.*

COGNIZANCE OF PLEAS is an authority to call a cause or plea out of another court, which no person can do but the king, except he can show a charter for it. This *cognizance* is a privilege granted to a city or a town to hold plea of all contracts, &c. within the liberty; and if any one is implicated for such matters in the courts at Westminster, the mayor, &c. of such franchise may demand *cognizance* of the plea, and that it may be determined before them,

COGNOMEN, in Roman antiquity, a family surname, such as Scipio, Cæsar, Antoninus, &c., in addition to the nomen, or family name, Cornelius, Julius, Aurelius, &c., and differing from the agnomen, such as Africanus, &c. in being heritable. See **AGNOMEN**.

COGNOMINAL, *adj.* } *Lat. cognomen.*
COGNOMINATION, *n. s.* } Having the same name; a surname; the name of a family; a name added from any accident or quality.

Nor do those animals more resemble the creatures on earth, than they on earth the constellations, which pass under animal names in heaven; nor the dog-fish at sea much more make out the dog of the land, than this *cognominal* or namesake in the heavens.

Brown's Vulgar Errors.

Pompey deserved the name Great; Alexander, of the same *cognomination*, was generalissimo of Greece. *Brown.*

COGNO'SANCE, *n. s.* } *Lat. cognosco.*
COGNO'SCIBLE, *adj.* } Knowledge; the state or act of knowing. That may be known; being the object of knowledge.

The same that is said for the redundancy of matters intelligible and *cognoscible* in things natural, may be applied to things artificial.

Hale's Origin of Mankind.

COHA'BIT, *v. a.* } *Lat. cohabito.* To
COHA'BITANT, *n. s.* } dwell with another in
COHABITATION, *n. s.* } the same place. To live together as husband and wife.

Which defect, though it could not evacuate a marriage after *cohabitation*, and actual consummation, yet it was not enough to make void a contract.

Bacon's Henry VII.

The Philistines were worsted by the captivated ark, which foraged their country more than a conquering army; they were not able to *cohabit* with that holy thing. *South.*

The oppressed Indians protest against that heaven where the Spaniards are to be their *cohabitants*.

Decay of Piety.

He knew her not to be his own wife, and yet had a design to *cohabit* with her as such.

Fiddes's Sermons.

Monsieur Brumars, at one hundred and two years, died for love of his wife, who was ninety-two at her death, after seventy years *cohabitation*. *Tatler.*

COHABITATION, in law, denotes the state of a man and woman who live together as if married. By the common law of Scotland *cohabitation*, for a year and a day, or a complete twelve-month, is deemed equivalent to matrimony.

COHANZY, or CÆSARIA, a small river of New Jersey, which rises in Salem county, and, after running south-east for a few miles through Cumberland county, and afterwards S. S. W., falls into the Delaware, opposite to the upper end of Bombay Hook. It is about thirty miles long, and navigable, for vessels of 100 tons, twenty miles from its mouth.

COHASSET, a township of Massachusetts, in Norfolk county, which was incorporated in 1770, and contains 817 inhabitants, 126 houses, and a congregational church. It is twenty-five miles south-east of Boston, but not thirteen in a direct line.

COHASSET ROCKS, dangerous rocks about three miles from the coast of Cohasset, which have proved fatal to many vessels.

COHEIR, *n. s.* } Lat. *cohares*. One of
COHEIRSS, *n. s.* } several among whom an inheritance is divided: when the shares are equal. The difference of termination marks the sex.

Married persons, and widows, and virgins, are all *coheirs* in the inheritance of Jesus, if they live within the laws of their estate. *Taylor's Holy Liv.*

COHERE, *v. n.* } Lat. *cohereo*, To stick
COHERENCE, *n. s.* } together; to hold fast
COHERENCY, *n. s.* } one to another, as parts
COHERENT, *adj.* } of the same mass. To
COHESION, *n. s.* } be well connected; to
COHESIVE, *adv.* } follow regularly in the
COHESIVENESS, *n. s.* } order of discourse; to
sue; to fit; to be fitted to.

It shall be no trouble to find each controversy's resting-place, and the *coherency* it hath with things, either on which it dependeth, or which depend on it. *Hooker's Preface.*

Had time *cohesed* with place, or place with wishing. *Shakespeare.*

Instruct my daughter,
That time and place, with this deceit so lawful,
May prove *coherent*.

Shakespeare. All's Well that Ends Well.
In their tender years, ideas that have no natural cohesion, come to be united in their heads. *Locke.*

The mind proceeds from the knowledge it stands possessed of already, to that which lies next, and is *coherent* to it, and so on to what it aims at. *Id.*

Coherency of discourse, and a direct tendency of all the parts of it to the argument in hand, are most eminently to be found in him. *Id. Preface to St. Paul's Epistles.*

The pressure of the air will not explain, nor can be a cause of, the *coherency* of the particles of air themselves. *Id.*

Matter is either fluid or solid; words that may comprehend the middle degrees between extreme fixeness and *coherency*, and the most rapid intestine motion. *Bentley.*

None want a place; for all their centre found,
Hung to the goddess, and *cohered* around;
Not closer, orb in orb conglobed, are seen
The buzzing bees about their dusky queen. *Pope's Dunciad.*

Two pieces of marble, having their surface exactly plain, polite, and applied to each other in such a manner as to intercept the air, do *cohere* firmly together as one. *Woodward.*

By coagulating and diluting, that is, making their parts more or less *coherent*. *Arbushnot on Aliments.*

Solids and fluids differ in the degree of *cohesion*, which, being increased, turns a fluid into a solid. *Id.*

What cause of their *cohesion* can you find?
What props support, what chains the fabrick bind?
Blackmore.

A *coherent* thinker, and a strict reasoner, is not to be made at once by a set of rules. *Watts's Logic.*

COHESION, in natural philosophy, is that property by which the parts of bodies adhere together. This power was first considered by Sir Isaac Newton as one of the properties essential to all matter, and the cause of that variety which we observe in the texture of different terrestrial bodies. He did not, however, absolutely determine that the power of cohesion was an immaterial one; but thought it might possibly arise, as well as that of gravitation, from the action of an ether. His account of the original constitution of matter is as follows:—It seems probable, that God in the beginning formed matter in solid, massy, impenetrable, movable particles; of such sizes, figures, and other properties, and in such proportion to space as most conduced to the end for which he formed them: and that these primitive principles, being solid, are incomparably harder than any porous bodies composed of them; even so very hard as never to wear or break in pieces; no ordinary power being able to divide what God himself made at the first creation. While the particles continue entire they may compose bodies of one and the same nature and texture in all ages; but should they wear away, or break in pieces, the nature of all things depending on them would be changed. Water and earth, composed of old worn particles and fragments of particles, would not now be of the same texture with water and earth composed of entire particles in the beginning; and therefore, that nature may be lasting, the changes of corporeal things are to be placed in the various separations and new associations and motions of these permanent particles: compound bodies being apt to break, not in the midst of solid particles, but where these particles are laid together, and touch in a few points. It seems farther, that these particles have not only a vis inertiae, accompanied with such passive laws of motion as naturally result from that force, but also that they are moved by certain active principles, such as that of gravity, and that which causes fermentation and the cohesion of bodies. These principles are to be considered not as occult qualities, supposed to result from the specific forms of things, but as general laws of nature by which the things themselves are formed; their truth appearing to us by phenomena, though their cause is not yet discovered. The general law of nature, by which all the different bodies in the universe are composed, according to Sir Isaac Newton, is that of attraction: i. e. 'Every particle of matter has attractive force, or a tendency to every other particle; which power is strongest in the point of contact, and suddenly decreases, insomuch that it acts no more at the least sensible distance, and, at a greater distance, is converted into a repellent force, whereby the parts fly from each other.

'On this principle of attraction may we account for the cohesion of bodies, otherwise inexplic-

able. The smallest particles may cohere by the strongest attractions, and compose bigger particles of weaker virtue; and many of these may cohere, and compose bigger particles, whose virtue is still less; and so on for divers successions, until the progression end in the biggest particles, on which the operations in chemistry, and the colors of natural bodies, depend; and which, by cohering, compose bodies of a sensible magnitude. If the body is compact, and bends or yields inward to pressure without any sliding of its parts, it is hard and elastic; returning to its figure with a force arising from the mutual attraction of its parts. If the parts slide from one another, the body is malleable or soft. If they slip easily, and are of a fit size to be agitated by heat, and the heat is great enough to keep them in agitation, the body is fluid; and, if it be apt to stick to things, it is humid; and the drops of every fluid affect a round figure by the mutual attractions of their parts, as the globe of the earth and sea affects a round figure from the mutual attraction and gravity of its parts. Since metals dissolved in acids attract but a small quantity of the acid, their attractive force reaches but to a small distance. Now, as in algebra, where affirmative quantities cease, their negative ones begin; so in mechanics, where attraction ceases, there a repulsive virtue must succeed. That there really is such a virtue seems to follow from the reflections and inflections of the rays of light; the rays being repelled by bodies in both these cases without the immediate contact of the reflecting or inflecting body. The same thing seems also to follow from the emission of light; a ray, as soon as shaken off from a body by the vibrating motion of the parts of the body and got beyond the reach of attraction, being driven away with exceeding great velocity: for that force which is sufficient to turn it back in reflection, may be sufficient to emit it. From the same repelling power it seems to be that flies walk upon the water without wetting their feet; that the object-glasses of long telescopes lie upon one another without touching; and that dry powders are difficultly made to touch one another so as to stick together, without melting them or wetting them with water, which, by exhaling may bring them together. The particles of all hard, homogeneous bodies which touch one another, cohere with a great force: to account for which, some philosophers have recourse to a kind of hooked atoms, which in effect is nothing else but to beg the question. Others imagine, that the particles of bodies are connected by rest, i. e. in effect by nothing at all; and others, by conspiring motions, i. e. by a relative rest among themselves. For myself, it rather appears to me that the particles of bodies cohere by an attractive force, whereby they tend mutually to each other.

From the above account of the formation an l constitution of bodies, we can conclude nothing, except that they are composed of an infinite number of little particles, kept together by a force or power; but of what nature that power is, whether material or immaterial, we must remain ignorant till farther experiments are made. Some of the Newtonian philosophers, however,

have positively determined these powers to be immaterial. In consequence of this supposition, they have so refined upon attractions and repulsions, that their systems seem not far from downright scepticism, or denying the existence of matter altogether. A system of this kind we find adopted by Dr. Priestley, in his History of Vision, vol. i. p. 392, from Messrs. Boscovich and Mitchell, in order to solve some difficulties concerning the Newtonian doctrine of light. 'The easiest method,' says he, 'of solving all difficulties, is to adopt the hypothesis of Mr. Boscovich, who supposes that matter is not impenetrable, as has been perhaps universally taken for granted: but that it consists of physical points only, endued with powers of attraction and repulsion in the same manner as solid matter is generally supposed to be: provided therefore that any body move with a sufficient degree of velocity, or have a sufficient momentum to overcome any powers of repulsion that it may meet with, it will find no difficulty in making its way through any body whatever; for nothing else will penetrate one another but powers, such as we know do in fact exist in the same place, and counterbalance or over-rule one another. The most obvious difficulty, and indeed almost the only one that attends this hypothesis, as it supposes the mutual penetrability of matter arises from the idea of the nature of matter, and the difficulty we meet with in attempting to force two bodies into the same place. But it is demonstrable that the first obstruction arises from no actual contact of matter, but from mere powers of repulsion. This difficulty we can overcome; and, having got within one sphere of repulsion, we fancy that we are now impeded by the solid matter itself. But the very same is the opinion of the generality of mankind, with respect to the first obstruction. Why, therefore, may not the next be only another sphere of repulsion, which may only require a greater force than we can apply to overcome it, without disordering the arrangement of the constituent particles; but which may be overcome by a body moving with the amazing velocity of light. This scheme of the immateriality of matter, as it may be called, or rather the mutual penetration of matter, first occurred to Mr. Mitchell on reading Baxter on the Immateriality of the Soul. He found that this author's idea of matter was, that it consisted as it were of bricks cemented together with immaterial mortar. These bricks, if he would be consistent with his own reasoning, were again composed of less bricks, cemented likewise by an immaterial mortar; and so on, ad infinitum. This putting Mr. Mitchell upon the consideration of the several appearances of nature, he began to perceive that the bricks were so covered with this immaterial mortar, that if they had any existence at all, it could not possibly be perceived; every effect being produced, in nine instances of ten certainly, and probably in the tenth also, by this immaterial, spiritual, and penetrable mortar. Instead, therefore, of placing the world upon the giant, the giant upon the tortoise, and the tortoise upon he could not tell what, he placed the world at once upon itself.'

Other philosophers have supposed the powers both of gravitation and cohesion to be material; and to be only different actions of the ethereal fluid, or elementary fire. In support of this it is urged, that before we have recourse to a spiritual and immaterial power as the cause of any natural phenomenon, we ought to be well assured that there is no material substance with which we are acquainted, that is capable of producing such effects. In the present case, we are so far from having such assurance, that the contrary is manifest to our senses. One instance of this is in the experiment with the Magdeburg hemispheres. These are two hollow hemispheres of brass, exactly fitted to one another, so as to form one globe when joined together, without admitting any air at the joining. In this state, if the air within them is exhausted by a pump, they will cohere with such force, if they are five or six inches diameter, as to require a weight of some hundreds of pounds to separate them. The pressure of the atmosphere, we see, is in this case capable of producing a very strong cohesion; and if there is in nature any fluid more penetrating, as well as more powerful in its effects, than the air we breathe, it is possible that what is called the attraction of cohesion may somehow or other be an effect of the action of that fluid. Such a fluid as this is the element of fire. Its activity is such as to penetrate all bodies whatever; and, in the state in which it is commonly called fire, it acts according to the quantity of solid matter contained in the body. In this state it is capable of dissolving the strongest cohesions observed in nature: but whatever is capable of dissolving any cohesion must, necessarily, be endued with greater power than that by which the cohesion is caused. Fire, therefore, being able to dissolve cohesions, must also be capable of causing them, provided its power is exerted for that purpose. Nor will it seem at all strange that this fluid should act in two such opposite ways, when we consider the different appearances which it assumes. These are three, viz. fire or heat, in which it consumes, destroys, or dissolves: light, in which it seems deprived of all destructive or dissolvent power, and to be the most mild, quiet, and placid being in nature. The third is, when it becomes what is called the electric fluid; and then it attracts, repels, and moves bodies, in a vast variety of ways, without either burning or rendering them visible by its light. In this state it is not less powerful than in either of the other two; for a violent shock of electricity will displace and tear in pieces the most heavy and solid bodies. The seeming capricious nature of this fluid, however, probably renders it less suspected as the cause of cohesion, than it otherwise would be, were the attractions regular and permanent, which we observe it to occasion. But here we must observe, that the fluid has an existence in all bodies before the experiments are tried which makes its effects visible to us, and was acting in them according to its established laws. While acting in this manner it was perfectly invisible; and all we can do is to produce some little infringement of these regular laws, according to which it commonly acts. In some cases, however, the electrical attractions produced by art are found to be pretty perma-

nent and strong. Thus, Mr. Symmer, in some experiments with silk stockings, found their attraction so strong, that it required upwards of fifteen pounds weight to separate them from each other; and this attraction would continue for more than an hour. In plates of glass, too, he observed a remarkable cohesion when electrified. In the Philosophical Transactions for 1777 we find this hypothesis taken notice of, and, in some measure, adopted, by Mr. Henley. 'Some gentlemen,' says he, 'have supposed that the electric matter is the cause of the cohesion of the particles of bodies. If the electric matter be, as I suspect, a real elementary fire, inherent in all bodies, that opinion may probably be well founded; and perhaps the soldering of metals, and the cementation of iron, by fire, may be considered as strong proofs of the truth of their hypothesis.' On this hypothesis we must observe, that if the electric, or any other fluid, is supposed to be the cause of the attraction of cohesion universally, the particles of that fluid must be destitute of all cohesion between themselves; otherwise we should be at as great a loss to account for the cohesion of these particles, as for that of terrestrial matter. Philosophers, indeed, do not suppose any cohesion between the particles of the electric fluid themselves; it is generally believed that the particles of this fluid are repulsive of one another, though attracted by all other matter. If this is fact, we cannot suppose the electric fluid to be the cause of cohesion. The probability or improbability of this hypothesis, therefore, must greatly depend on its being ascertained whether the particles of the electric fluid do really repel one another, and attract all other kinds of matter, or not; but for this we must refer to the article ELECTRICITY.

COH'BIT, *v. a.* Lat. *cohibeo*. To restrain; to hinder.

COHOBATE, *v. a.* } To pour the distilled
СОЮВА'ТИМ, *n. s.* } liquor upon the remain-
ing matter, and distil it again. A returning any
distilled liquor again upon what it was drawn
from, or upon fresh ingredients of the same kind, to
have it the more impregnated with their virtues.

Cohobation is the pouring the liquor distilled from anything back upon the remaining matter, and distilling it again.

Lochs.
The juices of an animal body are, as it were, *co-*
hobated, being excreted, and admitted again into the
blood with the fresh aliment. *Arbuthnot on Aliments.*

COHOBATION, in chemistry, the returning the distilled liquor on the substance from which it was drawn. It is one of those operations which the ancient chemists practised with great patience and zeal, and which are now neglected. To make this operation easier, and to prevent the trouble of frequently changing the vessels, a particular kind of alembic was constructed, called a pelican, see diagram. This vessel was made in the form of a cucurbit, with an alembic head, but had two spouts communicating with the body. As the vapor rose up into the head, it was gradually condensed, and ran down the spouts into the body of the pelican, whence it was again distilled.



COHOEZ, or the falls of the Mohawk River, in New York, are a great natural curiosity. They are ten miles north of Albany, and about two and a-half above its mouth. The river, above the falls, is about 300 yards wide, and approaches them from the north-west, in a rapid current between high banks, and pours the whole body of its waters over a perpendicular rock of above forty feet high, which extends like a mill dam quite across the river. The banks immediately below the falls are 100 feet high. See **MOHAWK**.

COHORN (Memnon), a celebrated Dutch general and engineer, one of the most skilful writers on fortification that Europe ever produced. He fortified Bergen-op-Zoom, which is considered a masterpiece in the art. In 1692 he commanded Namur, the defences of which he constructed with the assistance of his celebrated rival, Vauban. He died at the Hague, in the seventy-fourth year of his age, July 1704.

COHORT, *n. s.* Lat. *cohors*. A troop of soldiers in the Roman armies, containing about 500 foot. In poetical language, a body of warriors.

The Romans levied as many *cohorts*, companies, and ensigus, from hence, as from any of their provinces. *Camden*.

The arch-angelic power prepared
For swift descent; with him the cohort bright
Of watchful cherubim. *Milton's Paradise Lost*.
Here, Churchill, not so prompt
To vaunt as fight, his hardy cohorts joined
With Eugene. *Philip's Blenheim*.

COHORT, in Roman antiquity, a part of a Roman legion, containing about 600 men. There were ten cohorts in a legion, the first of which exceeded all the rest in dignity. When the army was ranged in order of battle, the first cohort took up the right of the first line; the third was in the centre of the first line of the legion, and the fifth on the left; the second between the first and third; and the fourth between the third and fifth; the five remaining cohorts formed a second division in their natural order.

COHORTATION, *n. s.* Lat. *cohortatio*. Encouragement by words; incitement.

COIF, *n. s.* Fr. *ceiffe*; Arab. *kuehf*.
CO'IFED, *adj.* } a head-dress generally, ap-
CO'IFFURE, *n. s.* } plied especially to the ser-
geant's cap.

The judges of the four circuits in Wales, although they are not of the first magnitude, nor need be of the degree of the *coif*, yet are they considerable.

Bacon's Advice to Villiers.

No less a man than a brother of the *coif* began his suit, before he had been a twelvemonth at the Temple. *Addison's Spectator*.

I am pleased with the *coiffure* now in fashion, and think it shows the good sense of the valuable part of the sex. *Id.*

COIGNE, *n. s.* An Irish term as it seems.

Fitz-Thomas de Desmond began that extortion of *coigne* and livery, and pay; that is, he and his army took horse-meat and man's-meat, and money, at pleasure, *Davies on Ireland*.

COIGNE, *n. s.* *Γωνία*; Lat. *cuneus*; Fr. *coigne*. A corner; a wedge used by printers; a die; a stamp used in coining money.

No jutting frieze,
Butress, nor *coigne* of 'vantage, but this birt
Hath made his pendant bed.

Shakespeare's Macbeth.

See you yond' *coim* o' th' capitol, yond' corner
stone? *Id.*

COIL, *v. a. & n. s.* Fr. *cueiller*; Lat. *colli-
gere*; from Gr. *κυλλω*. To wind up a rope in
circles; to fold round in a ring, as a snake gathers
up itself, and forms a compact circle of several
folds. The substantive is used in a very differ-
ent sense, and is derived by Dr. Johnson from
the Germ. *kollerren*; which signifies tumult; tur-
moil; bustle; stir; hurry; confusion. It has
also the primary sense of the verb.

Who was so firm, so constant, that this *coil*
Would not infect his reason.

Shakespeare's Tempest.

You, mistress, all this *coil* is 'long of you.
Shakespeare.

In that sleep of death, what dreams may come,
When we have shuffled off this mortal *coil*,
Must give us pause. *Id. Hamlet*.

The lurking particles of air, so expanding them-
selves, must necessarily plump out the sides of the
bladder, and so keep them turgid, until the pressure
of the air, that at first *coiled* them, be re-admitted to
do the same thing again. *Boyle*.

From thy own smile I snatched a snake,
For there it *coiled* as in a brake. *Byron*.

COILING, on shipboard, implies a sort of
serpentine winding of a cable or other rope, that
it may occupy a small place in the ship. Each
of the windings of this sort is called a *fake*; and
one range of *fakes* upon the same are called a
tier. There are generally from five to seven
fakes in a tier; and three or four tiers in the
whole length of a cable. This, however, depends
upon the extent of the *fakes*. The smaller ropes
employed about the sails are coiled upon cleats
at sea, to prevent their being entangled amongst
one another in traversing, contracting, or ex-
tending the sails.

COIMBETTORE, or **COIMBETOOR**, **COIAMA-
TURA**, a small country in the south part of
Hindustan, lying between 10° and 12° of N.
lat. It is bounded on the north by Mysore, on
the east by Kistnagherry and Salem, on the south
by the district of Dindigul, and on the west by
Cochin and part of Calicut. It has two divi-
sions, North and South Coimbetoor; the latter
suffered much in the late war, through the de-
struction of the reservoirs and aqueducts; but
the former is well supplied with water, and in a
high state of cultivation. On the north-west and
south-west it borders on the lofty chain of the
Ghauts, while directly westward it extends to the
more level regions round Palicaudebery, which
is the only break in the continuous line of those
extensive mountains. Through this opening the
river Paniany, the largest stream in this district,
flows, on its way to the ocean. There are three
principal towns in this country, Coimbetoor,
Erroad, and Carnour; the capital, which gives
name to the province, is situated on the river
Noyel, at the foot of the western Ghauts, in
77° 10' E. long., and 10° 55' N. lat. It is de-
fended by a small citadel, and contains about
2,000 houses, with barracks for a regiment of

horse. Tippoo Saib built a handsome mosque in it, and sometimes resided here. In 1783 it was taken by the British, but restored the year following; in 1790 the British again took possession of it, after which its garrison under lieutenant Chalmers repulsed Tippoo in an attempt he made to storm it. It surrendered some time after to his general, Cammer ud Deen Khan, who treacherously made the garrison prisoners, and detained them till a general peace was concluded in 1792. Seven years after, it was added to the British dominions, together with the province.

Near the town of Coimbetoor the soil of the country is good, and generally free from rocks. Soil of every variety is cultivated for gardens, and the rent varies accordingly; but the price is greatly regulated by the depth at which water is found, being in some places eight cubits, and in others so low as eighteen. It is common, in many parts of the north, to water the gardens by machines, called *capily* and *yalam*, and thus a small portion of ground will support many persons, and yield a high rent to the land-holder, the crop is also less likely to fail for want of rain. The wet cultivation in this province may be about three per cent. of the whole cultivated surface. In the south the rice grounds on the banks of the Amaravati river are in full cultivation, and very extensive; but beyond that region the soil is rocky and poor, and very little enclosed. Muriac and other salts, with nitrates, impregnate the earth throughout the whole province, and common salt and salt-petre are occasionally made. Nitre, indeed, seems to be ready formed, no addition of potash being necessary. The well water has, in many places, a flavor of these salts. Iron has been discovered in some parts of the country.

The inhabitants of Coimbetoor seem to rank very low in the scale of intellect, and the knowledge of the arts. The only one of these that has been carried to any perfection is that of

weaving. The Vaylalar, a numerous body of the Tamul race, are counted of the pure Sudra caste. In ancient times this district was called Kanjiam; it was subjected to the rajahs of Mysore about 160 years since; but it now forms a collectorship under the presidency of Madras. It contains much uncultivated ground, and yields no permanent revenue.

COIMBRA, a large, handsome, and celebrated town of Portugal, anciently called Colimbria, standing on a hill, near the Mondego. It is the capital of the province of Beira, a bishop's see, and has a famous university, founded in 1290, and amply endowed. The cathedral and the fountains are magnificent, and the country around very pleasant, abounding in vineyards, olive-trees, and fruits. Its population is about 12,000. The Mondego is here crossed by an elegant stone bridge, with a double row of arches, but the town is, in the interior, narrow, crowded, ill-paved, and dirty, and in some places the streets are very steep. The university is now the only establishment of the kind in Portugal. It consists of eighteen colleges, with very ample funds. The course of study is divided into six branches, viz. theology, taught by eight professors; canon law, by nine; civil law, by eight; medicine, by six; mathematics, by four; and philosophy, by four. The session commences in October, and closes in May; and the average number of students is 800. Coimbra is of great antiquity, and was formerly the residence of the kings of Portugal, several of whose tombs it contains. It was fortified at an early period, and has sustained many sieges. The ancient walls and towers still remain. It suffered considerable damage from the earthquake which destroyed Lisbon in 1755, and a number of French soldiers, belonging to the rear of Massena's army, were made prisoners here by lord Wellington in October 1810, after the action of Busaco. Sixty miles S. S. E. of Oporto, and N. N. E. of Lisbon.

C O I N S.

COIN, *n. s. & v. a.* } See COIGNE. Money
COINAGE, *n. s.* } legally made. Payment
COINER, *n. s.* } of any kind. The verb
is derived from the noun, but has a greater variety of applications. To mint or stamp metals for money is its primary sense. But it likewise signifies to invent; to forge in a bad sense; to produce; to give existence to; to impress with an image relating to the mind.

But if that they were put to swiche assays,
The gold of hem hath now so bad allayes,
With bras, that though the coine be faire at eye,
It wolde rather brast atwo than plie.

Chaucer's Canterbury Tales.

Dyonisius, a Greek coiner of etymologies, is commended by Athenæus. *Camden's Remains.*
They cannot touch me for coining: I am the king.

Shakspeare.

My father was I know not where
When I was stamp't: some coiner with his tools
Made me a counterfeit. *Id. Cymbeline.*

VOL. VI.

My lungs

Coin words till their decay, against those measles,
Which we disdain should tetter us. *Id. Coriolanus.*

This is the coinage of your brain;
This bodiless creation ecstasy

Id. Hamlet.

Is very cunning in.
You have made your holy hat to be stamped on the king's coin. *Id. Henry VIII.*

He gave Dametas a good sum of gold in ready coin,
which Menalcas had bequeathed. *Sidney.*

And truly to support that charge,
He had supplies as vast and large,
For he could coin or counterfeit,
New words with little or no wit. *Hudibras.*

Never coin a formal lye on't,
To make the knight o'ercome the giant. *Id.*
These motives induced Virgil to coin his fable.

Dryden.

Unnecessary coinage as well as unnecessary revival of words, runs into affectation; a fault to be avoided on either hand. *Id. Juvenal. Dedication.*

K

This is conceived to be a *coinage of some Jews*, in derision of Christians, who first began that portrait.

Broune.

The loss of present advantage to flesh and blood, is repaid in a nobler coin. *Hammond's Fundamentals.*

I cannot tell how the poets will succeed in the explanation of coins, to which they are generally very great strangers. *Addison.*

It is easy to find designs that never entered into the thoughts of the sculptor or the coiner. *Id. on Medals.*

She now contracts her vast design,

And all her triumphs shrink into a coin. *Pope.*

The care of the *coinage* was committed to the inferior magistrates, and I don't find that they had a public trial, as we solemnly practise in this country.

Arbuthnot.

COIN, in commerce, is a metallic species of money. The barter of one species of goods, or produce, for another, was doubtless the first step in commerce; but Aristotle (*Pol. lib. i. c. 6.*) very well explains the early introduction of a valuable medium of exchange. 'All useful things,' says he, 'could not, without great difficulty, be carried about from place to place, it was resolved, therefore, by common consent, that in bartering commodities, they should reciprocally give and receive some substance, which, being in its nature applicable to the purposes of life, might, at the same time, be easily transported. Cattle was an early medium of this kind: hence some have derived the Latin word pecunia from pecus a herd; and in Homer we find Glaucus's armour valued at 100 oxen, and that of Diomedes at ten.' The patriarch Abraham's purchase of his family burying place is the earliest commercial transaction on record, and this he requests to buy for 'as much money as it is worth,' and he is said to have paid or 'weighed' for it '400 shekels of silver, current with the merchant.' This was, no doubt silver in convenient pieces for עָבָר לְסוּר passing to, or with the traveller. 'We have an order of Lycurgus' on record that iron money only should be used in Sparta; iron bars quenched in vinegar are mentioned as the Lacedæmonian money on other occasions; and the ancient Britons were found at the period of the Roman invasion using this metal as well as tin for the same purpose, in the shape of plates and rings. Seneca speaks of an ancient stamped money of leather, corium forma publica impressum, an expedient used by Frederic II. at the siege of Milan; and, according to some traditions among ourselves, in the time of the barons' wars. In 1360 king John of France, having agreed to pay our Edward III. for the ransom of his person 300,000 of gold crowns, was reduced to the necessity of paying for the necessities of his household in leather money, in the middle of which was a little nail of silver. Pasteboard was coined by the Hollanders in great quantities in the year 1574. Numa Pompilius circulated money of wood and leather, and during the whole period of their early monarchy the Romans do not appear to have used any stamped metallic currency. Wherever commerce obtained the metals uniformly seem to have been adopted as money for their portability, neatness, durability, and universality: there is reason to believe that they were very early used in Egypt,

and, as we have seen, in Asia; that thence they were introduced into Carthage and Greece, and brought from Greece to Rome. Pliny states that silver was first coined at Rome, A. U. C. 480, and gold about the year 640. The first valuation of Roman money was by the 'libra gravis æris,' or pound of heavy brass.

Mr. Turner (*History of the Anglo-Saxons, v. ii.*) has a curious chapter on the coins of our Saxon ancestors. He ascertains that they often reckoned the whole amount of their money by pennies, as the French now do theirs by livres; and that there were larger pennies (*mæra peninga*), five of which made one shilling; and smaller of twelve to the shilling. The mancus, frequently mentioned, was thirty large pennies, or six shillings. The mark, ten shillings.

The money first mentioned, in any legal document extant, consists of shillings and scotta, yceat, part or division, by which our author thinks that a definite piece of metal in an uncoined state is meant; and regards these two as the general names of the Saxon money before the Roman and French ecclesiastics taught them the art of coinage. Various charters mention pennies, mancusa (of thirty pennies, the larger ones, each), pounds, shillings, and sicli, which last is sometimes said to be of gold, and sometimes of silver: on some occasions the term seems to be used as synonymous with scillinga. The pound was an imaginary value of money, or a mode of computing it, and not a coin.

'As no Anglo-Saxon gold coins have reached modern times,' says this able writer, 'though of their silver coinage we have numerous specimens, it is presumed by antiquaries that none were ever made, yet it is certain that they had plenty of gold, and it perpetually formed the medium of their purchases and gifts. My belief is, that gold was used in the concerns of life, in an uncoined state, and to such a species of gold money I would refer such passages as these fifty 'manussa asodenes gold,' 'sexies viginti marcarum auripondo, appensuram novem librarum purissimi auri juxta magnum pondus Normanorum,' 'eighty mancussa auri purissimi et sex pondus electi argenti, 'duo uncias auri.' I think that silver also was sometimes passed in an uncoined state, from such intimations as these 'twa pund mere hwites seolfres,' and the above-mentioned 'sex pondus electi argenti.' The expressions that prevade Domesday-book imply, in my apprehension, these two species of money, the coined and the uncoined. Seventy libras pensatas, like two uncias auri, are obviously money by weight. But money ad numerum, or arsuram, interpret to be coined money; also the pund be getale. The phrases, sex libras ad pensum et arsuram et triginti libras arsas et pensatas, appear to me express the indicated weight of coined money. The words arsas and arsuram I understand to allude to the assay of coin in the mint.'

He is inclined to think, also, that the monies was like the pund, a weight rather than a coin; and says in a note that he is assured on high antiquarian authority, that even the scyllinga was a nominal coin; as no silver coin of that value has been found which can be traced to Saxon times.'

Coined money appears soon after the Anglo-

Scandinavian invasion of England, and throughout the octarchy; but none can be traced in their history before that event. From the laws of Ethelstan, it appears that the places at which public mints were established were (Wilkin's *Leg. Anglo-Saxons* p. 59) 'at Canterbury seven mynteras,' four belonging to the king, two to the bishop, and one to the abbot. At Rochester three, two of the king's, and one the bishop's. At London eight, at Winchester six, at Lewis two, at Hastings one, at Chichester one, and two at Hampton; Wareham, Exeter, and Shaftesbury, respectively. From Domesday-book, they also appear to have been distributed throughout all the large towns. It need hardly be added that these were evidently the small hammer mints first used, and not establishments quite of equal magnitude with that over which Mr. Pole now so ably presides.

William the Conqueror seems to have adopted the plan of his coinage from France and the establishments of Charlemagne; he retained the Saxon pound weight or Moneger's pound as it was now called, and which is ascertained to have been a sixteenth, or 5400 grains less than the troy pound; and coined from it twenty shillings which made twenty-one one-third pounds troy. It was not until the reign of Henry VIII. (1526) that the troy-pound was used at the royal mint. This we see was an increase of the Moneger's pound, and it continued to be increased in successive reigns until the eighteenth of Charles II., when it was fixed at sixty-two shillings, and so continued until the recent alterations in 1816, which made it sixty-six shillings.

The word sterling was originally applied both to the silver penny, and to the penny-weight, which was minted with a deep cross. When this was broken across it was called the *half-penny*, and when into four parts, the *fourth-thing*, or farthing. Silver four-pennies were also coined, and called *greats* or groats. There were also distinct silver half-pence and farthings, but no shillings coined, according to Dr. Kelly, until the year 1504, in Henry VII. reign; and no copper money until 1665, in the reign of Charles II.

The first gold coins on record were struck by Henry III. in the year 1257, and were called *gold-pennies*, weighing as much as two silver pence, and passing for twenty pence. Snelling says, this coinage took place through the king's 'necessity,' and that the city of London remonstrated against the measure. Our next gold coinage was that of the *florin* (from Florence, where a similar piece seems to have been first struck,) in 1354, called also abroad the *guelder*, or golden piece, and containing twenty-three carats, three grains and a half of fine gold, with half a grain of alloy. This was called the old standard, and continued until the minting of crown pieces in 1527, when the new standard, called at first crown gold, was introduced.

It was enacted in 1266, 3 Edw. 51, 'that an English penny, called a sterling, round and without clippers, shall weigh thirty-two wheat corns from the midst of the ear, and twenty pence to make one ounce, and twelve ounces one pound;' 'eight pounds, it is added, do make one gallon of wine, and eight gallons of wine do make a

London bushel, which is the eighth part of a quarter.

Of the old gold standard, the principal coins were *nobles*, of 6s. 8d. value; *half* and *quarter* or farthing nobles, as they were also called; *marks*, of 13s. 4d. value; *angels* of 10s. and *sovereigns* of 20s. each. The last were first minted in Henry VII. reign, and frequently altered afterwards, until that of James I., by whom they were fixed at twenty-two carats, fine. The sovereigns of this reign were at first called *scutes*, and thirty-three pieces and a half were struck from the troy.

Charles II. first minted *guineas* (so called from that part of Africa from which the gold used happened at this time to be brought), and forty-four pieces and a half were yielded from a pound troy. This coin varied in current value from twenty to thirty shillings, until the mint was placed under the care of Sir Isaac Newton; who in 1717 induced the government to fix it at twenty-one shillings. In 1816 took place the new gold coinage of sovereigns at the proper proportion to this guinea, i. e. of 46 $\frac{2}{3}$ pieces to the pound troy.

Seignorage was irregularly charged at the royal mint for both gold and silver coins, until the year 1666, when it was enacted, that all persons bringing in either of the previous metals to be coined, should receive back the full value free of expense: a law still in force as to gold, but the silver coinage is now wholly managed by government; and since 1816, gold has become the sole standard measure of value without any limitation as to the amount that may be legally tendered, but silver coin is only a legal tender to the amount of forty shillings.

Queen Elizabeth seems to have contemplated some reform in our coinage; she ordered the avoirdupois pound to be placed in the exchequer as a standard, and that a copy of the troy pound of goldsmith's hall should be accurately made and deposited in the exchequer, but no practical measure resulted from this.

In the reign of George II., 1758, the first important enquiry of modern times respecting our coinage, was instituted by government. Mr. Bird, a distinguished optician and instrument maker, and Mr. Harris, the king's assay master of the mint, were examined, with several other able mechanics, by a committee of the House of Commons, as to the standards of English weights and measures. Their report demonstrates the great care and ability employed in the proceedings. Speaking of the relative claims of the pound troy and the pound avoirdupois, as a standard weight, they prefer the former 'Because' as the report states, 'it is the weight best known to our law; that which has been longest in use; that by which our coins are measured; that which is best known to the rest of the world; that to which our learned countrymen have referred, and compared ancient and modern weights; the weight which hath been subdivided into the smallest parts. On the other hand, the avoirdupois weight is of doubtful authority; and, though unfit to be made a standard, yet the frequent use of it renders it necessary to ascertain and declare how many ounces, pennyweights,

and grains, troy, the pound avoirdupois ought to weigh.'

This committee caused the inaccurate divisions of the mint standard to be corrected: the following is their account of this important operation: 'Your committee thought it necessary, in the first place, to obtain, with the utmost possible exactness, standard weights of the several parts of the pound troy, in order that from thence such other combinations, or proportions, of weight might be formed, as the business or necessities of the subject should require. And Mr. Harris was employed to make these several parts, who accordingly did so, with great skill and attention, by a very curious and accurate apparatus contrived by Mr. Bird. It was adapted to five different beams, which ascertained the weights from twelve ounces, or one pound, down to a grain inclusive; and that with so great exactness, as to discern any error in the pound weight to the 230,400th part of the weight, and to the 2000th part of a single grain. By these beams, the several parts of the standard pound were examined and adjusted by Mr. Harris, in the presence of your committee, and were found to be what their denominations import. These several parts were tried in every progressive combination necessary to discover their proportions to each other; and appeared so exact, that no greater degree of correctness could, in the nature of the thing, be expected.'

An authentic copy of this standard pound was delivered to the house of commons, and another to the king's assay master of the mint, in whose office it is still carefully preserved, with Mr. Bird's weighing apparatus. With this apparatus, the late comparisons of foreign standards have been made at the mint; but, it should be observed, that certain standards, which were too heavy for this beam, were weighed by a new hydrostatic balance of great accuracy, invented by John Barton, esq. deputy-comptroller of the mint. Before the general comparison was begun, it was deemed proper to compare the parliamentary pound with the exchequer standard; and, for this purpose, the latter was taken to the mint, by an order from the chancellor of the exchequer, where it was found to be one grain and a-half lighter than the parliamentary pound; and its divisions proved to be still more inaccurate. It should be observed, that lord Carysfort's committee intended to correct this standard, as appears by their report; but in 1760, before their plans were completed, parliament was dissolved, and thus ended their useful labors. Since that period no alteration has been made in the standards, though much attention has been paid to the subject, both in and out of parliament, especially since the adoption of the metrical system in France.

The comparison alluded to between the English standard weights took place in the latter part of the year 1818, in the presence of the principal officers of the mint and the chamberlain of the exchequer. In the same year, at the suggestion of Dr. Kelly, of Finsbury-square, the lords of his majesty's privy council for coins, recommended the following letter to be despatched,

through the foreign office, to his majesty's consuls abroad:—

COPY OF LORD CASTLEREAGH'S CIRCULAR TO THE BRITISH CONSULS ABROAD.

'Foreign Office, March 10th, 1818.

'SIR,

'His majesty's government, being desirous of obtaining every information as to the standards in use, for the various weights and measures in foreign countries, with a view to ascertain their relative bearings to those in use here, for the benefit of the commercial interests of this country:

'I am to desire, that you will use your endeavour to procure, with as little delay as may be, two sets of models, being counterparts in every respect, of the standard pound or mark used at your place of residence for weighing gold and silver, and also of other lesser weights used for that purpose.

'If, in any place within your consulate, the standard pound or mark, with its lesser weights, used for weighing gold or silver, should differ from those in use at your place of residence, you will procure also two sets of the weights so differing.

'You will have the accuracy of all these weights regularly attested by the proper authorities.

'You will pack up carefully, and separately, these two sets of weights complete: and you will send them to me by separate conveyances, accompanying each set by an explanatory letter, written in duplicate. In that letter you will give a list and description of the weights sent.

'You will state the difference and proportion between the pound which is used for weighing gold and silver, and that pound used for ordinary articles, which is generally known by the name of the commercial pound.

'You will state the contents of the principal measure, used at your place of residence, and at other places within your consulate, for the measure of corn, and of the principal measure for wine, and also of their lesser measures.

'You will be so good as to describe the contents of these measures, by stating how many cubic inches of the place they contain, or how many English gallons, or how many French litres.

'You will add in your letter such other information as you can collect, or may be in possession of, for throwing light upon the general subject of this instruction.

'You will keep an account of the expense to which you may be subjected in the execution of this instruction, and you will send such account, made out in duplicate, in a letter marked separate, which letter and account may accompany the weights, and the dispatch explanatory of the subject.

'CASTLEREAGH.

'To —, his majesty's consul at —.'

These orders were, in due time, executed in a very correct and satisfactory manner, and the packages transmitted, contained, besides the re-

quired standards, very ample specifications of the divisions of weights and measures. They were first delivered at the foreign office, and thence sent by Joseph Planta, esq. under secretary of state, to the royal mint, through the medium of the board of trade. In the beginning of the year 1820 the intended comparisons were carried into effect. These experiments were made by Robert Bingley, esq. who had assayed the coins, as before stated, and who, on every occasion, evinced the most zealous attention to scientific accuracy.

Dr. Kelly attended this course of experiments at the mint; and, having registered the results, obtained permission to remove the standards to his house, with a view of having the comparisons repeated; and, as a farther means of verification, to compare the subordinate weights or divisions,

the *units* only having been compared at the mint. This second course of experiments was made with a fine balance, recently constructed by Mr. Troughton for the London institution, and with attested standards, both French and English. These comparisons, which were repeated by several competent persons, proved highly satisfactory as corresponding with the mint experiments.

Dr. Kelly has constructed, from the experiments, the various tables of coins which we shall now offer to the reader; and for the use of which the proprietor of this work has been very happy to transmit to that gentleman a considerable remuneration. We have had the pleasure of inspecting some of those contributions of our consuls, and of a liberal and powerful government, to the pursuits of science, in Finsbury-square

TABLE I.

AN HISTORICAL TABLE OF ENGLISH COINS,

Shewing the alterations they have undergone from the reign of William the Conqueror to that of George IV., with respect both to their weight and fineness. Also, a statement of the comparative value of gold and silver, at different periods.

Date.	Reign.	SILVER.		GOLD.		Comparative Value of fine Gold & Silver.	
		Fineness of Silver Coins.	Pound Troy of such Silver coined into	Fineness of Gold Coins.	Pound Troy of such Gold coined into	Gold.	Silver.
1066	William I. . .	Oz. Dwt.	£. s. d.	Car. Gr.	£. s. d.	Gold.	Silver.
1280	8 Edward I.	11 2	1 1 4
1344	18 Edward III.	— —	1 1 6	23 3½	14 0 10	1 to 12,584	
1349	23 ———	— —	1 3 0	— —	14 18 8	1 — 11,571	
1356	30 ———	— —	1 6 8	— —	16 0 0	1 — 11,158	
1421	9 Henry V. . .	— —	1 12 0	— —	17 16 0	1 — 10,331	
1464	4 Edward IV.	— —	2 0 0	— —	22 4 6	1 — 10,331	
1465	5 ———	— —	2 0 0	— —	24 0 0	1 — 11,158	
1470	49 Henry VI. .	— —	2 0 0	— —	24 0 0	1 — 11,158	
1482	22 Edward IV.	— —	2 0 0	— —	24 0 0	1 — 11,158	
1509	1 Henry VIII.	— —	2 0 0	24 0 0	1 — 11,158	
1527	18 ———	— —	2 2 8	22 0	24 0 0	1 — 11,268	
1543	34 ———	10 0	2 8 0	23 0	28 16 0	1 — 10,434	
1545	36 ———	6 0	2 8 0	22 0	30 0 0	1 — 6,818	
1546	37 ———	4 0	2 8 0	20 0	30 0 0	1 — 5,000	
1547	1 Edward VI.	4 0	2 8 0	20 0	30 0 0	1 — 5,000	
1549	3 ———	6 0	3 12 0	22 0	34 0 0	1 — 5,151	
1551	5 ———	5 0	3 12 0	23 3½	34 0 0	1 — 11,000	
1552	6 ———	11 1	3 0 0	22 0	36 0 0	1 — 11,050	
1553	1 Mary	11 0	3 0 0	23 3½	36 0 0	1 — 11,057	
1560	2 Elizabeth .	11 2	3 0 0	22 0	36 0 0	1 — 11,100	
1600	43 ———	— —	3 2 0	23 3½	36 10 0	1 — 10,904	
1604	2 James I. . .	— —	3 2 0	22 0	33 10 0	1 — 12,109	
1626	2 Charles I. .	— —	3 2 0	— —	41 0 0	1 — 13,346	
1666	18 Charles II.	— —	3 2 0	— —	44 10 0	1 — 14,485	
1717	3 George I. . .	— —	3 2 0	— —	46 14 6	1 — 15,209	
1816	56 George III.	— —	3 6 0	— —	46 14 6	1 — 14,287	
1821	2 George IV.	— —	3 6 0	— —	46 14 6	1 — 14,287	

By the above table, it appears, that silver coins have been diminished in value, during the last 500 years in the ratio of ninety-nine to thirty-two, and gold coins nearly as three and a-half to one. It may be remarked that, within the same period, the silver coins of France and Spain have been debased in the ratio of about seventeen to one.

TABLE II.—NEW TABLE OF GOLD COINS.

Containing the ASSAYS, WEIGHTS, and VALUES of the principal GOLD COINS of all Countries, computed according to the Mint Price of Gold in England, and from Assays made both at London and Paris, which have been found to verify each other.

The London Assays have been made by Robert Bingley, Esq. F.R.S. the King's Assay Master of the Mint, and those at Paris by Pierre Frederic Bonneville, Essayeur du Commerce, as published in his elaborate work on the Coins of all Nations.

		Assay.	Weight.		Standard weight.	Conts. in pure gold.	Value in Sterling.	
		cor. gr.	dist. gr.	dist. gr. mi.	grains.	s.	d.	
<i>America</i>	(See Portugal, Spain, and United States).							
<i>Augsburg</i>	Ducat	B. 1 1½	2 5½	2 8 8	52, 1	9	2, 64	
<i>Austrian</i>	Souverain	W. 0 0½	3 14	3 13 15	78, 6	13	10, 92	
<i>Domin.</i>	Double ducat	B. 1 2½	4 12	4 20 5	106, 4	18	9, 97	
	Ducat	B. 1 2½	2 6	2 10 2	53, 2	9	4, 98	
	Ducat Kremnitz, or Hungarian	B. 1 3	2 5½	2 10 3	53, 3	9	5, 91	
<i>Baden</i>	Ducat	B. 1 2½	1 23½	2 3 2	46, 9	8	3, 60	
<i>Basil</i>	Ducat	Stand.	2 4½	2 4 10	48, 1	8	6, 14	
	Pistole	W. 0 2½	4 22	4 18 13	105, 1	18	7, 20	
<i>Bavaria</i>	Carolin	W. 3 2	6 5½	5 5 10	115, 0	20	4, 23	
	Max d'or, or Maximilian	W. 3 2½	4 4	3 14 0	77, 0	13	7, 44	
	Ducat	B. 1 2½	2 5½	2 19 11	52, 8	9	4, 12	
	Pistole (See Manheim).							
<i>Bern</i>	Ducat (double, &c. in proportion)	B. 1 1½	1 23	2 2 1	45, 9	8	1, 48	
	Pistole	W. 0 1½	4 21	4 19 0	105, 5	18	7, 86	
<i>Bologna</i>	(See Rome).							
<i>Brunswick</i>	Pistole (double in proportion)	W. 0 1½	4 21½	4 19 5	105, 7	18	8, 48	
	Carl d'or, before 1802 (double in prop.)	W. 0 1½	4 6½	4 4 15	92, 5	16	4, 44	
	Carl d'or, since 1802 (double in prop.)	W. 0 2½	4 6½	4 3 11	92, 16	16	3, 38	
	Ducat	B. 1 0½	2 5½	2 8 9	51, 8	9	2,	
<i>Cologne</i>	Ducat	B. 1 2	2 5½	2 9 8	52, 6	9	3, 70	
<i>Constantinople</i>	(See Turkey).							
<i>Denmark</i>	Ducat current	W. 0 3½	2 0	1 21 19	42, 2	7	5, 62	
	Ducat specie	B. 1 2	2 5½	2 9 8	52, 6	9	3, 70	
	Christian d'or	W. 0 1	4 7	4 5 16	93, 3	16	6, 14	
<i>England</i>	Guinea	Stand.	5 9½	5 9 10	118, 7	21	0,	
	Half guinea	Stand.	2 16½	2 16 15	59, 3	10	6,	
	Seven Shilling piece	Stand.	1 19	1 19 0	39, 6	7	0	
	Sovereign	Stand.	5 3½	5 3 5	113, 1	20	0	
<i>Flanders</i>	(See Austrian Dominions).							
<i>Florence</i>	(See Tuscany).							
<i>France</i>	Double Louis (coined before 1786)	W. 0 2	10 11	10 5 6	224, 9	39	9, 64	
	Louis	W. 0 2	5 5½	5 2 12	112, 4	19	10, 71	
	Demi Louis	W. 0 2	2 14½	2 13 6	56, 2	9	11, 38	
	Double Louis (coined since 1786)	W. 0 1½	9 20	9 15 19	212, 6	37	7, 53	
	Louis	W. 0 1½	4 22	4 19 19	106, 3	18	9, 75	
	Double Napoleon, or piece of 40 francs	W. 0 1½	8 7	8 3 0	179,	31	8, 36	
	Napoleon, or piece of twenty francs	W. 0 1½	4 3½	4 1 10	89, 7	15	10, 5	
	New Louis (double, &c.) the same as the Napoleon.							
<i>Francfort on the Maine</i>	Ducat	B. 1 2½	2 5½	2 9 14	52, 9	9	4, 34	
<i>Geneva</i>	Pistole, old	W. 0 2	4 7½	4 4 18	92, 5	16	4, 45	
	Pistole, new	W. 0 0½	3 15½	3 15 4	80,	14	1, 9	
<i>Genoa</i>	Doppia, or pistole (pieces of 2, 4, &c. in proportion)	W. 0 1½	4 7½	4 5 14	93, 4	16	6, 36	
	Sequin	B. 1 3½	2 5½	2 10 6	53, 4	9	5, 41	
	Genovina of 100 lire (½, &c. in prop.)	W. 0 1	18 3	17 22 0	394, 2	69	9, 20	
	New Genovina, of 96 lire or 4 pistole, piece of the Ligurian republic	W. 0 0½	16 4	16 1 15	357, 7	63	3, 68	
	Ditto of 48 lire (pieces of 24 and 12 in proportion)	W. 0 0½	8 2	8 0 18	178, 9	31	7, 95	
<i>Hamburgh</i>	Ducat (double in proportion)	B. 1 2½	2 5½	2 9 14	52, 9	9	4, 35	
<i>Hanover</i>	George d'or	W. 0 1½	4 6½	4 5 3	92, 6	16	4, 66	

		Assay.	Weight.	Standard Weight.	Conts. in pure gold.	Value in Sterling.	
		car. gr.	dst. gr.	dst. gr. ms.	grains.	s. d.	
<i>Hanover</i>	Ducat	B. 1 3½	2 5½	2 10 3	53, 3	9 5, 19	
	Gold florin (double in proportion)	W. 3 0½	2 2	1 18 6	39,	6 10, 83	
<i>Hesse Cassel</i>	Pistole	W. 0 2½	4 7½	4 4 8	92,	16 3, 39	
	William d'or of 1815	W. 0 1½	4 6½	4 4 9	92, 1	16 3, 6	
<i>Hesse Darmstadt</i>	Carolin	W. 3 2	3 3	2 15 0	58,	10 3, 18	
	Ducat	B. 1 3	2 5½	2 10 0	53, 2	9 4, 98	
<i>Holland</i>	Double ryder	Stand.	12 21	12 21 0	283, 2	50 1, 46	
	Ryder	Stand.	6 9	6 9 0	140, 2	24 9, 75	
	Half ryder	Stand.	3 4½	3 4 10	70, 1	12 4, 87	
	Ducat	B. 1 2½	2 5½	2 9 12	52, 8	9 4, 13	
<i>Hungary</i>	(See Austrian Dominions).						
<i>Leghorn</i>	(See Tuscany).						
<i>Leipsic</i>	(See Saxony).						
<i>Liege</i>	Ducat	B. 1 1½	2 5½	2 8 16	52, 3	9 3, 07	
<i>Lorraine</i>	Leopold	W. 0 1	7 5½	7 3 15	157, 4	27 10, 28	
	Francis	W. 0 1	4 7½	4 6 1	93, 6	16 6, 78	
	Pistole	W. 0 0½	3 13½	3 13 0	77, 9	13 9, 44	
<i>Lucca</i>	Pistole	W. 1 3½	10 16	9 18 18	215, 3	38 1, 25	
<i>Malta</i>	Double Louis	W. 1 3	5 8	4 21 16	108,	19 1, 37	
	Louis	W. 1 2½	2 16	2 11 3	54, 5	9 7, 75	
	Demi Louis	W. 3 2	6 4½	5 4 16	114, 4	20 2, 96	
<i>Manheim</i>	Carolin (½ and ¼ in proportion)	W. 0 1½	4 6½	4 4 16	92, 3	16 4, 02	
	Pistole	B. 1 2½	2 5½	2 9 10	52, 8	9 4, 13	
	Ducat	B. 1 2½	2 5½	2 9 12	52, 9	9 4, 34	
<i>Mentz</i>	Ducat	B. 1 3	2 5½	2 10 0	53, 2	9 4, 98	
<i>Milar</i>	Sequin	W. 0 1	4 1½	4 0 8	88, 4	15 7, 74	
	Doppia, or pistole	W. 0 1½	8 8	8 4 0	179, 7	31 9, 64	
<i>Naples</i>	Forty lire piece of 1808	W. 1 0½	5 16	5 9 8	118, 7	21 0, 09	
	Six ducat piece of 1752	W. 1 2½	5 18	5 7 14	116, 8	20 8, 06	
	Six ducat piece of 1767 and 1772	W. 0 2½	5 16	5 12 18	121, 9	21 6, 89	
	Six ducat piece of 1783	W. 1 0½	3 18½	3 14 6	79, 2	14 0, 20	
	Four ducat piece, or pistole, of 1752	W. 1 2½	3 18½	3 11 6	76, 8	13 7, 10	
	Four ducat piece of 1767 and 1770	W. 1 2½	1 20½	1 16 6	37, 4	6 7, 42	
	Two ducat piece, or sequin, of 1762	B. 1 3½	2 10½	2 15 1	58, 1	10 3, 40	
	Three ducat piece, or onsetta of 1818	Stand.	5 7½	5 7 16	117, 1	20 8, 69	
<i>Netherlands</i>	Souverain. (See Austrian Dominions)						
	Gold lion, or 14 florin piece	W. 0 1½	4 7½	4 5 15	93, 2	16 5, 93	
	Ten florin piece (1820)	B. 1 2	2 5½	2 9 5	52, 6	9 3, 71	
<i>Nuremberg</i>	Ducat (double, &c. in proportion)	W. 1 0	18 9	17 12 18	386,	68 3, 78	
<i>Parma</i>	Quadruple pistole (double in proportion)	W. 0 3	4 14	4 10 4	97, 4	17 2, 85	
	Pistole or doppia of 1787	W. 1 0½	4 14	4 8 14	95, 9	16 11, 67	
	Ditto of 1796	W. 0 1½	4 3½	4 1 10	89, 7	15 10, 5	
<i>Piedmont</i>	Maria Theresa (1818)	W. 0 1½	6 4½	6 2 8	184, 2	23 9, 01	
	Pistole or doppia (1741 to 1785)	W. 0 1½	5 20	5 17 0	125, 6	22 2, 75	
	Pistole, coined since 1785 (½, &c. in prop.)	B. 1 2½	2 5½	2 9 12	52, 9	9 4, 34	
	Sequin (½ in proportion)	W. 0 1½	31 0½	30 11 14	670, 8	118 8, 64	
	Carlino, coined before 1785	W. 0 1½	29 6	28 20 0	634, 4	112 3, 33	
	Carlino, coined since 1785 (½ &c. in prop.)	W. 2 0	4 3½	3 18 4	89, 7	14 7, 63	
<i>Poland</i>	Piece of 20 francs, called Marengo	B. 1 2½	2 5½	2 9 12	52, 9	9 4, 34	
<i>Portugal</i>	Ducat	Stand.	34 12	34 12 0	759,	134 3, 96	
	Dobraon of 24,000 rees	Stand.	17 6	17 6 0	379, 5	67 1, 98	
	Meio Dobraon of 12,000 rees	Stand.	18 6	18 6 0	401, 5	71 0, 70	
	Dobra of 12,800 rees	W. 0 0½	9 6½	9 5 16	203, 4	35 11, 98	
	Joannese of 6400 rees	W. 0 0½	4 15	4 14 12	101, 5	17 11, 56	
	Half Joannese of 3200 rees	Stand.	6 22	6 22 0	152, 2	26 11, 24	
	Moidore or Lisbonnine (½, &c. in prop.)	W. 0 0½	2 6	2 5 14	49, 3	8 8, 70	
	Piece of 16 testoons, or 1600 rees	W. 0 0½	1 16½	1 16 0	36, 7	6 5, 94	
	Piece of 12 testoons, or 1200 rees	W. 0 0½	1 4½	1 4 6	26,	4 7, 21	
	Piece of 8 testoons	W. 0 0½	0 15	0 14 18	13, 6	2 4, 88	
	Old crusado of 400 rees	W. 0 0½	0 16½	0 16 2	14, 8	2 7, 43	
	New crusado of 480 rees	Stand.	0 19½	0 19 15	18, 1	3 2, 44	
	Milree, (coined for the African colonies; 1755)	B. 1 2½	2 5½	2 9 14	52, 9	9 4, 34	
	<i>Prussia</i>	Ducat of 1748					

		Assay.	Weight.		Standard weight.		Conts. in pure gold.	Value in sterling.					
		car. gr.	dot.	gr.	dot.	gr. mi.	grains.	s.	d.				
<i>Prussia</i>	Ducat of 1787	B.	1	2	2	5½	2	9	6	52, 6	9	3, 71	
	Frederick (double) of 1769	W.	0	1½	8	14	8	9	18	185, 32	8, 90		
	Frederick (single) of 1778	W.	0	1½	4	7	4	5	4	92, 8	16	5, 08	
	Frederick (double) of 1800	W.	0	2	8	14	8	9	6	184, 5	32	7, 84	
	Frederick (single) of 1800	W.	0	2	4	7	4	4	13	92, 2	16	3, 42	
<i>Ratisbon</i>	Four ducat piece	B.	1	2	8	21	9	11	0	77, 2	36	90, 81	
<i>Rome</i>	Doppia, or pistole, of Pius VI.	W.	0	0½	3	13	3	12	5	77, 2	13	7, 59	
	Ditto, of Pius VII. 1802 (¼ &c. in prop.)	W.	0	1½	3	13	3	11	12	76, 6	13	6, 68	
	Zecchino, or sequin, (coined before 1760)	B.	1	2	2	4½	2	8	0	51, 4	9	1, 16	
	Sequin (coined since 1760)	B.	1	3½	2	4½	2	9	0	52, 2	9	2, 86	
	Scudo of the Republic	W.	0	1½	17	0½	16	16	6	367, 7	64	11, 43	
<i>Russia</i>	Ducat of 1751	B.	1	1½	2	5	2	8	4	51, 5	9	1, 37	
	Double ducat of St. Andrew of 1756	B.	1	2½	4	10	4	17	16	104, 4	18	5, 72	
	Ducat of 1796	B.	1	2½	2	6	2	10	0	53, 2	9	4, 98	
	Ducat of 1763	B.	1	2	2	5½	2	9	8	52, 6	9	3, 71	
	Half ducat of 1785	W.	0	0½	1	14½	1	14	6	35, 1	6	2, 54	
	Gold ruble of 1756	Stand.	1	0½	1	0	10	22, 5	3	11, 78	3	11, 78	
	Ditto, of 1799	W.	0	0½	0	18½	0	18	14	17, 1	3	0, 31	
	Gold poltina of 1777	Stand.	0	9	0	9	0	8, 2	1	5, 41	1	5, 41	
	Imperial (coined before 1768)	Stand.	10	16	10	16	0	234, 7	41	6, 45	41	6, 45	
	Imperial of 1763	Stand.	8	9½	8	9	10	184, 7	32	8, 06	32	8, 06	
	Imperial of 1772	W.	0	0½	8	11	8	10	8	185, 5	32	9, 96	
	Half Imperial of 1780	W.	0	0½	4	2½	4	2	4	90, 15	15	11, 14	
	Imperial of 1801	B.	1	2½	7	17½	8	6	8	181, 9	32	2, 31	
	Half Imperial of 1801	B.	1	2½	3	20½	4	3	4	90, 9	16	1, 05	
	Ditto, of 1818	B.	0	0½	4	3½	4	3	12	91, 3	16	1, 98	
<i>St. Gall</i>	Ducat	B.	0	3	21	20½	22	15	2	497, 9	88	1, 44	
<i>Salzburg</i>	Ducat	B.	1	2	2	5½	2	9	8	52, 6	9	3, 71	
<i>Sardinia</i>	Carlino (¼ in proportion)	W.	0	2½	10	7½	9	23	16	219, 8	38	10, 81	
	Doppietta	W.	0	2½	2	1½	1	23	13	43, 7	7	8, 81	
<i>Saxony</i>	Ducat of 1784	B.	1	2	2	5½	2	9	8	52, 6	9	3, 71	
	Ducat of 1797	B.	1	2½	2	5½	2	9	14	52, 9	9	4, 34	
	Augustus of 1754	W.	0	2½	4	6½	4	3	8	91, 2	16	1, 69	
	Augustus of 1784	W.	0	1½	4	6½	4	4	12	92, 2	16	3, 81	
<i>Sicily</i>	Ounce of 1734	W.	0	2½	2	20½	2	18	14	61, 2	10	9, 97	
	Ounce of 1741	W.	0	3	2	20½	2	18	4	60, 7	10	8, 91	
	Ounce of 1751	W.	1	2½	2	20½	2	15	8	58, 2	10	3, 60	
	Double ounce of 1758	W.	1	2	5	17	5	7	14	117, 20	8, 48		
<i>Spain</i>	Quadruple pistole, or doubloon (coined before 1772)	W.	0	1½	17	8½	17	1	8	373, 3	66	5, 06	
	Double pistole (before 1772, single and half in proportion)	W.	0	1½	8	16½	8	12	14	187, 7	33	2, 63	
	Quarter pistole, or gold dollar (before 1772)	W.	0	2	1	3	1	2	8	24, 2	4	3, 39	
	Doubloon of 1772 (double and single in proportion)	W.	0	2½	17	8½	16	21	16	372, 65	10, 05		
	Half pistole of 1772	W.	0	2½	2	4	2	2	10	46, 3	8	2, 33	
	Quarter pistole of 1772	W.	0	3	1	3	1	2	2	23, 9	4	2, 75	
	Quadruple pistole of 1801	W.	1	1	17	9½	16	9	6	360, 5	63	9, 62	
	Double pistole of 1801	W.	1	1	8	16½	8	4	13	180, 3	31	10, 92	
Pistole of 1801	W.	1	1	4	8½	4	2	6	90, 1	15	11, 35		
Coronilla, gold doll. or vintem of 1801	W.	1	2½	1	3	1	0	18	22, 8	4	0, 42		
<i>Sweden</i>	Ducat	B.	1	2	2	5	2	8	12	51, 9	9	2, 22	
	Ducat of Lucerne	B.	1	2	2	5½	2	9	8	52, 6	9	3, 71	
<i>Switzerland</i>	Double ducat of Lucerne	W.	1	0	4	11½	4	6	12	94, 1	16	7, 84	
	Piece of five ducats of Lucerne	W.	0	1	11	3	10	23	18	241, 9	42	9, 74	
	Ducat of Schwitz	B.	0	2	2	5	2	6	4	49, 7	8	9, 55	
	Ducat of St. Gall	B.	0	3	2	5½	2	7	12	51, 7	9	0, 31	
	Ducat of Uri	B.	1	1	2	5	2	8	0	51, 4	9	1, 16	
	Pistole of Lucerne	W.	0	1½	4	21½	4	19	9	105, 9	18	8, 91	
	Pistole of Soleure	W.	0	1½	4	22	4	19	12	106, 18	9, 12		
	Pistole of the Helvetic Republic of 1800	W.	0	1½	4	21½	4	19	9	105, 9	18	8, 91	
		(See also Basil, Bern, Geneva, St. Gall, and Zurich.)											
	<i>Treves</i>	Ducat	B.	1	2	2	5½	2	9	8	52, 6	9	3, 71

	Assay.	Weight.		Standard weight.	Cont. in pure gold.		Value in sterling.	
		car. gr.	dent. gr.		dent. gr. mi.	grains.	s.	d.
<i>Turkey</i>								
Sequin fonducli of Constantinople of 1773	W.	2 2½	2 5½	1 23 6	43, 3	7	7,94	
Sequin fonducli of 1789	W.	2 3½	2 5½	1 22 16	42, 9	7	7,11	
Double sequin mahbub of 1773	B.	1 0	3 4½	3 7 14	73, 1	12	11,26	
Sequin mahbub of 1789	W.	2 3	1 12	1 7 10	28, 9	5	1,37	
Sequin of Cairo of 1773	W.	3 0½	1 15½	1 9 16	31,	5	5,83	
Sequin of Cairo of 1789	W.	5 2½	1 15½	1 5 6	26, 9	4	9,13	
Half misseir (1818)	W.	5 3½	0 18½	0 13 5	12,16	2	1,82	
Sequin fonducli	W.	2 3	2 5	1 22 7	42, 5	7	6,26	
Rubieh	W.	2 3½	0 12½	0 10 18	9, 9	1	9	
Yermeebeshlek	B.	0 3½	3 1½	3 4 13	70, 3	12	5,30	
<i>Turkey</i>								
Ruspone	B.	1 3½	6 17½	7 7 8	160, 8	28	5,50	
Zecchino, or sequin	B.	1 3½	2 5½	2 10 14	53, 6	9	5,83	
Ruspone of the kingdom of Etruria	B.	1 3½	6 17½	7 7 13	161,	28	5,93	
<i>Lat. States</i> Eagle (½ and ¼ in proportion)	W.	0 0¼	11 6	11 4 8	246, 1	43	6,66	
<i>France</i>								
Zecchino, or sequin (½ and ¼ in prop.)	B.	1 3½	2 6	2 10 10	53, 6	9	5,83	
Doppia, or pistole	W.	0 1	4 8	4 7 0	94, 4	16	8,48	
Scudo d'oro, or gold crown	B.	1 3½	26 23	29 6 2	643, 6	113	10,87	
Ducato d'oro, or gold ducat	B.	1 3½	1 9½	1 12 6	33, 3	5	10,72	
Osella d'oro	B.	1 3½	8 23½	9 17 18	214, 5	37	11,55	
<i>Württemberg</i>								
Caroln	W.	3 2	6 3½	5 4 0	113, 7	20	1,47	
Ducat	B.	1 2	2 5	2 8 12	51, 9	9	2,22	
<i>Württemberg</i>								
Ducat	B.	1 2	2 5½	2 9 8	52, 6	9	3,71	
<i>Vienna</i>								
Ducat (double and ¼ ducat in proportion)	B.	1 2	2 5½	2 9 8	52, 6	9	3,71	

EAST INDIES.

<i>East Indies</i>							
Mohur of Shah Allum (1770)	B.	1 2½	7 22½	8 11 15	186, 8	33	0,72
Mohur of the same	B.	1 2½	7 23	8 13 13	188, 5	33	4,33
Mohur, half, (1787) ½ in proportion	B.	1 2½	3 23½	4 6 10	94,	16	7,64
Mohur sicca of Bengal, dated 19th sun.	B.	1 3½	7 23	8 15 0	189, 8	33	7,09
Mohur of Bombay, old, still in circulation	B.	0 3½	7 10½	7 17 8	170,	30	1,04
Mohur of the Dutch East India Com- pany (1783)	W.	3 3½	10 2	8 8 0	183, 4	32	5,50
Mohur of ditto (1797)	W.	4 1	9 20	7 22 8	174, 5	30	10,60
Mohur, half ditto (1801)	W.	3 1½	5 3½	4 18 18	96, 2	17	0,30
Rupee, Tippoo's	W.	1 2	8 20½	8 6 0	181, 5	32	1,46
Rupee, zodiac	B.	1 3½	7 0	7 14 16	167, 6	29	7,9
Rupee, Bombay (1818)	B.	0 0½	7 11	7 11 13	164, 7	29	1,78
Rupee of Madras (1818)	Stand.		7 12	7 12 0	165,	29	2,42
Pagoda, star	W.	3 0	2 4½	1 21 11	41, 8	7	4,77
Pagoda, with a crescent and three figures	W.	1 3½	2 5½	2 0 18	44, 8	7	11,14
Pagoda, with a crescent and one figure	W.	2 1½	2 4	1 22 5	42, 4	7	6,04
Pagoda, Arcot, old	W.	3 2	2 4½	1 20 4	40, 5	7	2,01
Pagoda, Arcot, new	W.	7 1	2 4½	1 11 4	32, 4	5	8,59
Pagoda, Onore	W.	1 3½	2 4½	2 0 4	44, 2	7	9,87
Pagoda, Mangalore	W.	1 2½	2 4½	2 0 12	44, 6	7	10,72
Pagoda, Pondicherry	W.	5 0	2 4½	1 16 6	37, 2	6	7
Pagoda, Hyderee Hoon	W.	2 1½	2 4½	1 23 4	43, 3	7	7,96
Pagoda, Sultane Hoon	W.	0 3½	2 4½	2 2 16	46, 6	8	2,97
Saik Sai, a Mahratta coin	W.	1 3½	6 22½	6 7 16	139, 2	24	7,63
Tippoo's faruki	W.	1 2	2 4½	2 0 18	44, 8	7	11,14
Japan copang, old	W.	1 2	11 9	10 14 8	233, 2	41	3,27
Japan copang, new	W.	6 0	8 9½	6 2 14	134, 5	23	9,66

* This value of the American Eagle is taken from average assays of the coins of twelve years.

TABLE III.—NEW TABLE OF SILVER COINS.

Containing the ASSAYS, WEIGHTS, and VALUES of the principal SILVER COINS of all Countries, computed at the rate of 5s. 2d. per ounce standard, from ASSAYS made both at the London and Paris Mints, as stated in page 157.

	Assay.	Weight.		Standard weight.	Conts. in pure silver.		Value in Sterling.	
		car. gr.	dwt. gr.		dwt. gr. md.	grains.	s.	d.
<i>As-la-Chapelle</i> . Rathspräsentger	W. 4 2	4 1½	2 13 9	56, 9	0	7, 94		
Double ditto	W. 2 15	6 23½	5 5 16	116, 3	1	4, 24		
<i>America</i> . (See <i>Portugal, Spain, and United States</i>).								
<i>Austria</i> . Rixdollar, constitution, before 1753	W. 0 11	18 11½	17 13 10	390,	4	6, 45		
Rixdollar, convention, coined since 1753	W. 1 6	18 1	15 22 4	353, 7	4	1, 39		
Rixdollar, ditto, of Francis II. 1800	W. 1 5	18 1	16 0 4	355, 5	4	1, 64		
Rixdollar of the kingdom of Hungary	W. 1 2	18 1	16 6 1	360, 9	4	2, 39		
Half rixdollar, or florin, convention	W. 1 3	9 0½	8 2 1	179, 6	2	1, 07		
Copfstueck, or 20 Creutzer piece	W. 4 3	4 6½	2 16 3	59, 4	0	8, 29		
'17 Creutzer piece	W. 4 8	4 0	2 9 18	53, 5	0	7, 47		
Halbe Copf, or 10 Creutzer piece	W. 5 5	2 11	1 7 1	28, 8	0	4, 0.		
<i>Baden</i> . . Rixdollar	W. 1 4	18 2	16 3 1	358, 1	4	2		
<i>Basil</i> . . Patagon, or Ecu, old	W. 0 14	18 4	17 0 10	377, 9	4	4, 76		
Thaler, or Rixdollar, of 1763	W. 1 2	14 22	13 10 10	298, 4	3	5, 66		
Patagon, or Ecu, of 1795 (double, &c. } in proportion)	W. 1 0½	16 14	15 1 5	334, 3	3	10, 68		
Piece of 10 batzen	W. 2 2	5 13½	4 12 4	100, 1	1	1, 97		
<i>Bavaria</i> . Rixdollar, convention of 1780	W. 1 6	18 1	15 22 4	358, 7	4	1, 39		
Rixdollar of 1800 (½ in proportion)	W. 1 4½	17 12	15 13 13	345, 6	4	0, 25		
Copstueck	W. 4 3	4 6½	2 16 3	59, 4	0	8, 29		
<i>Bern</i> . . Patagon, or Crown (½ in proportion)	W. 0 7	18 22	18 7 14	406, 7	4	8, 79		
Piece of 10 batzen	W. 1 2	5 3	4 14 17	102, 5	1	2, 31		
Piece of 5 batzen	W. 2 2	2 15	2 3 2	47, 2	0	6, 59		
<i>Bologna</i> . (See <i>Rome</i>).								
<i>Brandenburg</i> (See <i>Prussia</i>).								
<i>Bremen</i> . Piece of 48 grotes	W. 2 2	11 0	8 22 1	198,	2	3, 64		
<i>Brunswick</i> Rixdollar, convention	W. 1 3	18 1	16 4 4	359, 2	4	2, 15		
Half rixdollar	W. 1 3	9 0½	8 2 1	179, 6	2	1, 07		
Gulden, or piece of ⅓, fine, of 1764	B. 0 16	8 10½	9 1 1	200, 8	2	4, 03		
Gulden, common, of 1764	W. 1 2	9 0	8 2 10	180,	2	1, 13		
Gulden, ditto, of 1795	W. 2 2	11 1½	8 23 7	199, 1	2	3, 80		
Half gulden, or piece of ½, of 1764	W. 1 2	4 12	4 1 5	90,	1	0, 56		
<i>Cassel</i> . (See <i>Hesse Cassel</i>).								
<i>Cologne</i> . Rixdollar old	W. 0 15½	18 1	16 18 15	372, 5	4	4, 01		
Rixdollar, constitution	W. 0 7	18 19	18 4 14	404,	4	8, 41		
Rixdollar, convention	W. 1 6	18 1	15 22 4	353, 7	4	1, 39		
<i>Constantinople</i> (See <i>Turkey</i>).								
<i>Denmark</i> . Ryksdaler, old, of 6 marks Danish	W. 1 2	17 5½	15 12 5	344, 4	4	0, 92		
Crone, or old piece of 4 marks	W. 3 1	14 1	10 4 7	226,	3	7, 55		
Crone, or crown, of 1747	W. 1 2	11 15½	10 10 16	232, 9	2	8, 52		
Ryksdaler, specie, of 1798	W. 0 13	18 14	17 11 17	388, 4	4	6, 23		
New piece of 4 marks	W. 0 12	12 9	11 16 14	259, 8	3	0, 27		
Half Ryksdaler	W. 0 13	9 7	8 17 8	194, 2	2	3, 11		
Mark, specie, or ½ Ryksdaler	W. 3 1	4 0	2 21 12	64, 4	0	7, 59		
Rixdaler, specie of Sleswig and Hol- } stein (pieces of ⅓ and ½ in prop.) }	W. 0 12	18 13	17 12 6	389, 4	4	6, 37		
Piece of 24 skillings	W. 4 7	5 2½	3 2 10	68, 9	0	9, 62		
<i>East Indies</i> (See p. 144).								
<i>England</i> . Crown (old)	Stand.	19 8½	19 8 10	429, 7	5	0		
Half-crown	Stand.	9 16½	9 16 5	214, 8	2	6		
Shilling	Stand.	3 21	3 21 0	85, 9	1	0		
Sixpence	Stand.	1 22½	1 22 10	42, 9	0	6		
Crown, (new)	Stand.	18 4½	18 4 7	403, 6	4	8, 36		
Half-crown	Stand.	9 2	9 2 4	201, 8	2	4, 18		
Shilling	Stand.	3 15½	3 15 6	80, 7	0	11, 27		
Sixpence	Stand.	1 19½	1 19 14	40, 3	0	5, 63		
<i>Florence</i> . (See <i>Tuscany</i>).								

		Assay.	Weight.	Standard Weight.	Conts. in pure Silver.	Value in Sterling.	
		<i>en. dent.</i>	<i>dent. gr.</i>	<i>dent. gr. mi.</i>	<i>grains.</i>	<i>s. d.</i>	
France	Ecu of 6 livres	W. 0 7	18 18	18 7 16	403, 1	4 8,28	
	Demi ecu	W. 0 7	9 9	9 1 18	201, 5	2 4,13	
	Piece of 24 sous (divisions in prop.)	W. 0 7	3 20	3 16 19	83, 4	0 11,64	
	Piece of 30 sous (¼ in proportion)	W. 3 8	6 12	4 12 4	100, 2	1 1,99	
	Piece of 5 francs of the convention	W. 0 10½	16 0	15 5 14	338, 3	3 11,24	
	Piece of 5 francs (Napoleon) of 1808	W. 0 7	16 1	15 12 4	344, 9	4 0,16	
	Piece of 2 francs of 1808	W. 0 7	6 11	6 6 2	138, 8	1 7,38	
	Franc of 1809	W. 0 7	3 5½	3 3 1	69, 4	0 9,69	
	Demi franc	W. 0 8½	1 15	4 13 6	34, 7	0 4,84	
	Franc (Louis) of 1818, same as franc of 1809						
Frankfort on the Maine.	Rixdollar, Convention of 1772	W. 1 0½	18 1	16 8 16	363, 5	4 2,75	
	Rixdollar, ditto of 1796	W. 1 2	18 1	16 6 0	360, 8	4 2,38	
Geneva	Patagon	W. 1 0	17 9	15 19 8	351, 1	4 1,03	
	Piece of 21 sous	W. 2 3½	3 1½	2 11 5	54, 8	0 7,65	
	Piece of 12 florins 9 sous, called Genevoise, or Gros Ecu (1794)	W. 0 13	19 8	18 4 16	404, 4	4 8,41	
	Ditto of 1796 (¼ in proportion)	W. 0 14	19 15	18 9 6	408, 2	4 9	
	Piece of 15 sous of 1794	W. 2 6	2 1½	1 15 1	36, 1	0 5,04	
Genoa	Scudo della croce	B. 0 7	24 16½	25 14 8	565, 5	6 6,96	
	Scudo di S. Giambattista, of 5 Lire	W. 0 2	13 8½	13 5 12	293, 8	3 5,02	
	Double Madonnina (single and half in proportion)	W. 1 2	5 19½	5 5 12	116, 2	1 4,22	
	Scudo, of 8 lire, of 1796 (¼, ½, &c. in proportion)	W. 0 8	21 9	20 14 10	457, 4	5 3,87	
	Scudo of the Ligurian Republic	W. 0 9½	21 9	20 11 2	454, 3	5 3,43	
Hamburg	Rixdollar specie	W. 0 10	18 18	17 21 12	397, 5	4 7,49	
	Double mark, or 32 Schillings piece (single in proportion)	W. 2 3	11 18	9 11 8	210, 3	2 5,36	
	Piece of 8 schillings	W. 3 12	3 8½	2 6 4	50, 1	0 6,99	
	Piece of 4 schillings	W. 4 6	2 2	1 6 12	28, 3	0 3,95	
Hannover	Rixdollar, Constitution	W. 0 9	18 19	18 0 14	400, 3	4 7,99	
	Florin, or piece of ½, fine	B. 0 16	8 10	9 0 10	200, 3	2 3,96	
	Half florin, or piece of ¼, ditto	B. 0 16	4 4	4 11 4	99, 2	1 1,85	
	Quarter, or piece of 6 good Groschen, do.	B. 0 16	2 1	2 4 10	48, 6	0 6,78	
	Florin, or piece of ½, base	W. 2 1	11 0½	8 23 15	199, 6	2 3,87	
Hesse Cassel	Rixdollar, Convention	W. 1 6	18 1	15 22 6	353, 4	4 1,39	
	Florin, or piece of ½ (¼ in proportion)	W. 1 6	9 0½	7 23 3	176, 8	2 0,68	
	Thaler, or Rixdollar of account of 1778	W. 2 3	15 2½	12 4 3	270, 3	3 1,74	
	Thaler of 1789	W. 0 10½	12 7½	11 17 5	259, 7	3 0,26	
	Ecu, Convention (1815)	W. 1 6	17 23½	15 21 2	349, 3	4 0,77	
	Six bon gros	W. 4 10	8 0	2 23 0	65, 1	0 9,90	
	Bon gros	W. 6 14	1 4	0 11 5	10, 3	0 1,43	
Holland	Ducatoon	B. 0 3	20 22	21 4 15	471, 6	5 5,85	
	Piece of 3 florins	W. 0 2	20 7	20 2 12	446, 4	5 2,33	
	Piece of 3 florins of Batavia	W. 0 5½	20 3	19 15 0	435, 7	5 0,84	
	Rixdollar (the assay varies)	W. 0 16	18 6	16 20 8	375, 9	4 4,99	
	Daalder, or 30 stiver piece	W. 0 10	10 6	9 18 18	217, 3	2 6,34	
	Half Rixdollar	W. 0 16	9 0	8 8 8	185, 4	2 1,89	
	Florin, or guilder (¼ in proportion)	W. 0 4½	6 18	6 14 14	146, 8	1 8,49	
	12 Stiver piece	W. 0 16½	4 12	4 3 18	92, 4	1 0,90	
	Sesthalf, or 5½ stiver piece	W. 4 15	3 0	1 17 4	38, 1	0 5,32	
	8 Stiver piece	W. 0 17	3 0	2 18 8	61, 5	0 8,58	
	Florin of Batavia	W. 0 5½	6 13	6 9 2	141, 6	1 7,77	
	Rixdollar, or 50 stiver piece of the kingdom of Holland	W. 0 5½	17 0	16 13 18	367, 9	4 3,37	
	Hungary	(See Austria).					
	Japan	(See East Indies, p. 144).					
	Leghorn	(See Tuscany).					
Leipzig	(See Saxony).						
Lisbon	Ducatoon of 1671	B. 0 2	20 18½	20 22 18	465, 3	5 4,97	
	Patagon, old	W. 0 14	17 20½	16 17 14	371, 6	4 3,89	
	Patagon of 1792	W. 0 17	17 15	16 6 11	361, 3	4 2,45	
	Escalin of 1771	W. 3 17	3 3½	2 1 6	45, 6	0 6,36	
	Escalin of 1792	W 4 2	3 1	1 22 0	42, 6	0 5,94	

	Assay.		Weight.		Standard Weight.		Conts. in pure silver.		Value in Sterling.	
	os.	dwt.	dwt.	gr.	dwt.	gr.	mi.	grains.	s.	d.
<i>Lorraine</i>	<i>Ecu, called Leopold (1704)</i>									
	W. 0	3	17	11	17	5	6	382, 3	4	5, 38
	W. 0	4	19	14 $\frac{1}{2}$	19	5	10	426, 9	4	11, 61
<i>Lubeck</i>	<i>Rixdollar, specie</i>									
	W. 0	13	18	18	17	15	12	391, 9	4	6, 72
	W. 2	3	11	18	9	11	8	210, 3	2	5, 36
	W. 2	3	5	21	4	17	14	105, 1	1	2, 67
<i>Lucca</i>	<i>Scudo</i>									
	W. 0	3	17	0	16	18	10	372, 3	4	3, 98
	W. 0	3	8	3	8	0	7	177, 9	2	0, 84
	W. 0	3	5	19	5	17	2	126, 8	1	5, 70
	W. 0	3	3	5	3	3	19	70, 3	0	9, 81
	W. 3	3	1	20 $\frac{1}{2}$	1	7	14	29, 3	0	4, 09
<i>Luneburg</i>	<i>(See Hanover.)</i>									
<i>Malta</i>	<i>Ounce of 30 tari of Emmanuel Pinto</i>									
	W. 2	5	19	1 $\frac{1}{2}$	15	4	14	337, 4	3	11, 11
	W. 1	3	19	1 $\frac{1}{2}$	17	2	2	379, 3	4	4, 96
	W. 2	5	7	19	6	5	0	137, 9	1	7, 25
	W. 1	2	19	1 $\frac{1}{2}$	17	4	3	381, 3	4	5, 24
	W. 2	19	1	2	0	19	2	17, 7	0	2, 47
<i>Manheim</i>	<i>Rixdollar, fine</i>									
	B. 0	16	16	16	17	20	6	396, 7	4	7, 39
	B. 0	16	8	8	8	22	8	198, 3	2	3, 69
	W. 1	3	18	1	16	4	3	359, 0	4	2, 13
	W. 2	2	11	1 $\frac{1}{2}$	8	23	5	199, 1	2	3, 80
<i>Mecklenburg</i>	<i>Florin, or piece of $\frac{3}{4}$</i>									
<i>Mentz</i>	<i>Rixdollar</i>									
	W. 1	2	18	1	16	6	0	360, 8	4	2, 38
	W. 4	2	4	6 $\frac{1}{2}$	2	16	13	59, 8	0	8, 35
<i>Milan</i>	<i>Scudo of 6 lire ($\frac{1}{3}$ in proportion)</i>									
	W. 0	7	14	20 $\frac{1}{2}$	14	9	10	319, 6	3	8, 62
	W. 4	10	4	0	2	9	0	52, 8	0	7, 37
	W. 0	3	2	10	2	9	4	52, 9	0	7, 38
	W. 2	18	4	17	3	11	8	77, 2	0	10, 78
	W. 0	7	14	21 $\frac{1}{2}$	14	10	4	320, 2	3	8, 71
	W. 2	18	4	17	3	11	8	77, 2	0	10, 78
<i>Modena</i>	<i>Scudo of 15 lire, 1739 (double, &c in pro.)</i>									
	W. 0	14	18	12 $\frac{1}{2}$	17	8	9	385, 2	4	5, 78
	W. 0	3	5	19	5	17	2	126, 8	1	5, 70
	W. 3	3	18	1 $\frac{1}{2}$	12	22	12	287, 4	3	4, 13
<i>Naples</i>	<i>Ducat, old ($\frac{1}{3}$ in proportion)</i>									
	W. 0	4	14	0	13	17	18	305, 2	3	6, 61
	W. 0	7	16	7	15	18	12	350, 3	4	0, 91
	W. 1	0	14	15	13	7	8	295, 4	3	5, 24
	W. 1	0	17	15	16	0	18	356, 4	4	1, 71
	W. 1	2	17	16 $\frac{1}{2}$	15	22	12	353, 9	4	1, 41
	W. 1	2	17	16 $\frac{1}{2}$	15	22	12	353, 9	4	1, 41
	W. 1	2	17	18 $\frac{1}{2}$	15	23	18	355, 2	4	1, 60
	W. 1	2	14	18	13	7	0	295, 1	3	5, 20
<i>Netherlands</i>	<i>Ducatoon, old</i>									
	B. 0	4	21	0	21	9	0	474, 6	5	6, 27
	W. 0	14	21	10	20	1	12	445, 5	5	2, 20
	W. 0	14	19	0	17	19	4	395, 2	4	7, 18
	W. 4	4	3	4 $\frac{1}{2}$	1	23	8	43, 8	0	6, 11
	W. 5	8	1	18	0	21	12	20, 0	0	2, 79
	W. 6	3	3	4	1	9	18	31, 3	0	4, 37
	W. 0	13	21	3	19	21	6	441, 5	5	1, 65
	W. 0	14	5	23 $\frac{1}{2}$	5	14	9	124, 3	1	5, 35
	W. 0	16	3	0	2	18	6	61, 8	0	8, 62
	W. 0	7 $\frac{1}{2}$	6	22	6	16	6	148, 4	1	8, 72
	W. 4	5 $\frac{1}{2}$	5	11	3	9	2	75, 0	0	10, 46
<i>Neufchatel</i>	<i>Piece of 21 batzen</i>									
	W. 1	11	9	20	8	11	0	187, 8	2	2, 22
	W. 1	11	4	22	4	5	10	93, 9	1	1, 11
<i>Nuremberg</i>	<i>Rixdollar, Constitution</i>									
	W. 0	8	18	19	18	2	15	402, 2	4	8, 16
	W. 1	3	18	1	16	4	2	359, 0	4	2, 13
	W. 4	2	4	6 $\frac{1}{2}$	2	16	13	59, 8	0	8, 35
<i>Parma</i>	<i>Ducat of 1784</i>									
	W. 0	9	16	11	15	18	18	350, 6	4	0, 95
	W. 0	5 $\frac{1}{2}$	16	12 $\frac{1}{2}$	16	2	18	357, 9	4	1, 97
	W. 1	4	4	14	4	2	2	90, 7	1	0, 66
<i>Persia</i>	<i>(See East Indies.)</i>									
<i>Piedmont</i>	<i>Scudo (1690)</i>									
	W. 0	3	17	9 $\frac{1}{2}$	17	3	12	380, 7	4	5, 16
	W. 0	3	19	3	18	20	16	418, 8	4	10, 48
	W. 0	5 $\frac{1}{2}$	22	14	22	0	10	488, 9	5	8, 26
	W. 0	5	22	14	22	1	16	490, 0	5	8, 42
	W. 0	4 $\frac{1}{2}$	7	20 $\frac{1}{2}$	7	16	13	170, 8	1	11, 85
	W. 0	8	16	1 $\frac{1}{2}$	15	11	12	343, 7	3	11, 99

		Assay.		Weight.		Standard weight.		Conts. in pure silver.		Value in sterling.		
		oz.	dr.	dr.	gr.	dr.	gr.	mi.	grains.	s.	d.	
<i>Poland</i>	Rixdollar, old	W.	1 2	18	1	16	6	0	360,	8	4 2,38	
	Rixdollar, new (1794)	W.	2 17	15	10½	11	11	6	254,	3	2 11,51	
	Florin, or gulden	W.	4 2	6	0.	3	18	16	84,		0 11,72	
<i>Portugal</i>	New crusado (1690)	W.	0 4	11	0	10	19	0	239,	2	2 9,40	
	Ditto (1718)	W.	0 6½	9	8	9	1	0	200,	2	2 3,95	
	Ditto (1795)	W.	0 7	9	9	9	1	18	201,	6	2 4,15	
	Dose vintems, or piece of 240 rees (1799)	W.	0 7	4	16	4	12	10	100,	4	1 2,01	
	Testoon (1799)	W.	0 7	2	0½	1	22	18	43,	4	0 6,06	
	New crusado (1802)	W.	0 9	9	9	9	8	23	16	199,	7	2 3,88
	Ditto (1809)	W.	0 4	9	3	8	23	0	198,	2	2 4,67	
<i>Portuguese Colonies</i>	Seis vintems, or piece of 120 rees (1802)	W.	0 9	2	4½	2	2	8	46,	6	0 6,50	
	Testoon (1802)	W.	0 9	2	0	1	22	0	42,	5	0 5,93	
	Tres vintems, or piece of 60 rees (1802)	W.	0 9	1	2½	1	1	4	23,	3	0 3,25	
	Half testoon (1802)	W.	0 9	0	23	0	22	0	20,	4	0 2,84	
	Pataca of Brazil, old, of 640 rees	W.	0 2	12	4½	12	2	2	268,	3	3 1,46	
	Ditto of 600 rees (1755)	W.	0 4	11	7½	11	2	12	246,	6	2 10,43	
	Ditto of 640 rees (1768)	W.	0 4½	11	9½	11	8	14	252,	3	2 11,23	
	Ditto of 640 rees (1801)½ and ¼ in prop.	W.	0 7	12	4½	11	19	10	262,	2	3 0,61	
	Piece of 12 macutas, of Portuguese Africa	W.	0 7	11	7½	10	22	18	243,	2	2 9,96	
	Ditto of 8 ditto	W.	0 9	7	12	7	4	14	159,	8	1 10,31	
	Ditto of 6 ditto	W.	0 9	5	13	5	7	12	118,		1 4,47	
	Ditto of 4 ditto	W.	0 9	3	16	3	12	8	78,	1	0 10,90	
	<i>Prussia</i>	Florin, old, of the Elector of Brandenburg	W.	2 2	11	9½	9	5	11	204,	9	2 4,61
Rixdollar, Prussian currency (½ in prop.)		W.	2 5	14	6½	11	9	0	252,	6	2 11,27	
Rixdollar, Convention		W.	1 3	18	1	16	4	2	359,	4	2 11,27	
Florin, or piece of ½		W.	2 3	11	2	8	22	8	198,	4	2 3,70	
Florin, of Silesia		W.	2 2	9	11	7	16	0	170,	3	1 11,78	
Drittel, or piece of 8 good groschen		W.	3 3	5	8½	3	20	4	85,	3	0 11,91	
Piece of 4 groschen		W.	5 0	3	9	1	20	10	41,	2	0 5,75	
Piece of 6 groschen		W.	2 8	3	14	2	19	6	62,	3	0 8,69	
Rixdollar, old, of Bareuth		W.	2 4	12	13	10	1	6	223,	3	2 7,18	
Piece of ½ ditto		W.	2 4	7	15½	6	2	18	135,	9	1 6,97	
Piece of 30 creutzers ditto		W.	2 2	4	2½	3	7	16	73,	8	0 10,30	
Rixdollar, old, of Anspach		W.	2 3	14	0	11	6	18	250,	6	2 10,99	
Piece of ½ ditto		W.	2 4	8	21	7	2	14	158,	1	1 10,06	
Rixdollar of Anspach and Bareuth, Convention		W.	1 3	18	1	16	4	2	359,	4	2 2,22	
<i>Ragusa</i>	Tallaro, or Ragusina (1759)	W.	4 2	18	7½	11	13	2	256,	4	2 11,80	
	Ditto (1774)	W.	4 4	18	8½	11	9	16	253,	3	2 11,37	
	Ditto (1794)	W.	3 19	18	17½	12	1	6	267,	7	3 1,38	
	Ducat (1797)	W.	5 11	8	17½	4	8	16	97,		1 1,54	
<i>Ratisbon</i>	Rixdollar, specie (½, &c. in prop.)	W.	1 3	18	1	16	4	2	359,	2	4 1,58	
	Scudo, or crown, (before 1753)	W.	0 4	20	11	20	2	2	446,	5	2 2,27	
<i>Rome</i>	Testone, old	W.	0 4½	5	21	5	18	2	127,	8	1 5,84	
	Paolo, old	W.	0 4½	1	22½	1	21	16	42,	4	0 5,92	
	Scudo, or crown (coined since 1753)	W.	0 4	17	1	16	17	13	371,	5	4 3,87	
	Mezzo scudo, or half crown	W.	0 4	8	12½	8	8	16	185,	7	2 1,93	
	Testone (1770)	W.	0 3½	5	2	5	0	0	111,	1	1 3,51	
	Ditto (1785)	W.	0 5	5	2	4	23	4	110,	3	1 3,40	
	Paolo (1785)	W.	0 4	1	17	1	16	4	37,	2	0 5,19	
	Grosso, or half paulo (1785)	W.	0 5	0	20½	0	20	0	18,	5	0 2,58	
	Papetto (1775)	W.	0 4½	3	8½	3	6	12	72,	7	0 10,15	
	Scudo of the Roman Republic (1799)	W.	0 6	17	1	16	13	18	368,	1	4 3,40	
	Scudo of Bologna (Pius VI.)	W.	0 3	17	1	16	19	8	373,	2	4 4,11	
	Testone ditto	W.	0 3	5	2	5	0	6	111,	5	1 3,56	
	Scudo of the City of Bologna	W.	1 0	19	0	17	6	18	383,	9	4 5,60	
	Ditto of Pius VII. (1800)	W.	0 1	17	0½	16	21	4	371,	5	4 3,78	
	Ruble of Peter the Great	W.	2 7	18	1	14	1	8	312,	1	3 7,58	
Ditto of Catherine I. (1725)	W.	2 4½	17	11	13	23	0	309,	9	3 7,27		
Ditto of Peter II. (1727)	W.	2 12	18	5½	13	23	4	310,		3 7,28		
Ditto of Anne (1734)	W.	1 11	16	14½	14	6	16	317,	2	3 8,29		
Ditto of Elizabeth (1750)	W.	1 7	16	12	14	11	16	321,	8	3 8,93		
Ditto of Peter III. (1762)	W.	2 2	15	10	12	12	0	277,	5	3 2,75		
Ditto of Catherine II. (1780)	W.	2 4	15	12	12	10	6	275,	9	3 2,52		

		Assay.	Weight.	Standard weight.	Conts. in pure silver.	Value in Sterling.	
		<i>or. dst.</i>	<i>dst. gr.</i>	<i>dst. gr. ms.</i>	<i>grains.</i>	<i>s. d.</i>	
<i>Russia</i>	Ruble of Paul (1799)	W. 0 14	13 12	12 15 10	280, 8	3 3,21	
	Ditto of Alexander (1802)	W. 0 13	13 12	17 7 2	273, 3	3 2,12	
	Ditto of ditto (1805)	W. 0 16	13 12	12 12 12	278, 1	3 2,83	
	Poltin, or $\frac{1}{4}$ ruble of Anne	W. 1 10	7 21	6 19 8	151, 2	1 9,11	
	Ditto of Elizabeth	W. 1 8	8 2	7 1 10	156, 8	1 9,89	
	Ditto of Catherine II.	W. 2 4	7 18	6 5 2	137, 9	1 7,25	
	Ditto of Paul	W. 0 15	6 18	6 7 2	139, 7	1 7,50	
	Ditto of Alexander (1804)	W. 0 14	6 13 $\frac{1}{2}$	6 3 10	136, 5	1 7,06	
	Polpoltin, or $\frac{1}{4}$ ruble, old	W. 2 6	4 1	3 4 18	71, 1	0 9,92	
	Ditto of Paul	W. 0 18 $\frac{1}{2}$	3 7	3 0 8	67, 0	0 9,35	
	Ditto of Alexander (1802)	W. 0 13 $\frac{1}{2}$	3 9 $\frac{1}{2}$	3 4 10	70, 8	0 9,88	
	20 Copeck piece (1767)	W. 2 2	3 10 $\frac{1}{2}$	2 19 0	62, 6	0 8,74	
	Ditto (1784)	W. 2 2	3 3	2 12 18	56, 2	0 7,84	
	15 Copeck piece (1778)	W. 2 2	2 6	1 19 18	40, 5	0 5,65	
	10 Copeck piece	W. 2 6	2 1	1 14 16	35, 9	0 5,11	
	Ditto (1798)	W. 0 14 $\frac{1}{2}$	1 9	1 6 16	28, 5	0 3,97	
	Ditto (1802)	W. 0 13	1 8 $\frac{1}{2}$	1 6 11	28, 3	0 3,95	
	5 Copeck piece (1801)	W. 0 13 $\frac{1}{2}$	0 16 $\frac{1}{2}$	0 15 10	15, 3	0 2,13	
	<i>St. Gall</i>	Rixdollar ($\frac{1}{3}$ in proportion)	W. 1 4	18 1	16 2 4	357, 3	4 1,98
		24 Creutzer piece	W. 4 2	4 7 $\frac{1}{2}$	2 17 2	60, 2	0 8,40
<i>Salzburg</i>	Rixdollar, <i>Convention</i>	W. 1 2	18 1	16 6 0	360, 8	4 2,38	
	24 Creutzer piece	W. 4 3	4 6 $\frac{1}{2}$	2 16 4	59, 4	0 8,29	
<i>Sardinia</i>	Scudo or crown, ($\frac{1}{3}$ and $\frac{1}{4}$ in prop.)	W. 0 7	15 2 $\frac{1}{2}$	14 15 0	324, 7	3 9,34	
<i>Saxony</i>	Rixdollar, <i>Convention</i> , ($\frac{1}{3}$ and $\frac{1}{4}$ in prop.)	W. 1 3	18 0	16 3 4	358, 2	4 2,01	
	Old Rixdollar of Dresden	W. 0 9 $\frac{1}{2}$	18 19	17 23 14	399, 3	4 7,75	
	Ditto of Leipsic	W. 2 0	18 19	15 9 16	342, 3	3 11,75	
	Piece of 16 groschen of Leipsic	W. 2 2	9 9 $\frac{1}{2}$	7 14 16	169, 1	1 11,61	
	Piece of 8 groschen	W. 2 5	4 20	3 20 8	85, 6	0 11,95	
	Rixdollar current of Saxe Gotha	W. 4 4 $\frac{1}{2}$	18 1	11 4 2	248, 1	2 10,64	
	Thaler of 1804	W. 4 11	3 11	2 0 19	45, 3	0 6,32	
	Ditto of 1808	W. 4 11 $\frac{1}{2}$	3 5 $\frac{1}{2}$	1 21 8	42, 1	0 5,87	
	Ditto of Jerome Buonaparte of 1809	W. 5 4	3 17	1 23 6	43, 7	0 6,10	
	<i>Sicily</i>	Scudo ($\frac{1}{3}$ in proportion)	W. 1 4	17 14	15 16 6	348, 2	4 0,62
Piece of 40 grains		W. 1 2	5 21	5 7 2	117, 5	1 4,40	
Ditto of 20 grains		W. 1 5	3 0	2 15 18	59, 1	0 8,25	
<i>Sierra Leone Company</i>	Piece of 10 macutas	W. 1 6	16 21	14 21 12	330, 8	3 10,19	
	Ditto of 5 macutas	W. 1 6	8 13	7 12 18	167, 4	1 11,37	
	Ditto of 2 macutas	W. 1 6	3 7 $\frac{1}{2}$	2 22 6	65, 0	0 9,07	
	Ditto of 1 macuta	W. 1 6	1 16	1 11 8	32, 5	0 4,53	
<i>Spain</i>	Dollar, old Mexican square (1747)	W. 0 4 $\frac{1}{2}$	17 7	16 22 10	376, 1	4 4,51	
	Half ditto	W. 0 4 $\frac{1}{2}$	8 15 $\frac{1}{2}$	8 11 5	188, 2	2 1,25	
	Dollar, old, called Sevillau (1731)	W. 0 4 $\frac{1}{2}$	17 7	16 22 10	376, 1	4 4,51	
	Old Mexican peceta of two Mexican reals (1736)	W. 0 4 $\frac{1}{2}$	4 7 $\frac{1}{2}$	4 5 2	93, 6	1 1,07	
	Real of Mexican plate (1746)	W. 0 4 $\frac{1}{2}$	2 3 $\frac{1}{2}$	2 2 11	46, 8	0 6,53	
	Dollar, Mexican, with globes and pillars (1765)	W. 0 4 $\frac{1}{2}$	17 8 $\frac{1}{2}$	17 0 0	377, 4	4 4,79	
	Peceta of two reals of plate (1721)	W. 1 7	3 16 $\frac{1}{2}$	3 5 14	71, 9	0 10,04	
	Real of plate (1721)	W. 1 7	1 20 $\frac{1}{2}$	1 14 19	35, 9	0 5,01	
	Dollar, of late coinage, and circulated under the name of the Spanish dollar	W. 0 8	17 8	16 17 0	370, 9	4 3,79	
	Half dollar, ditto	W. 0 8	8 16	8 8 10	185, 4	2 1,88	
	Mexican peceta (1774)	W. 0 8	4 7 $\frac{1}{2}$	4 3 16	92, 3	1 0,88	
	Real of Mexican plate (1775)	W. 0 8	2 3 $\frac{1}{2}$	2 1 20	46, 1	0 6,43	
	Peceta provincial of 2 reals of new plate (1775)	W. 1 9 $\frac{1}{2}$	3 18	3 6 0	72, 2	0 10,08	
	Real of new plate (1795)	W. 1 9 $\frac{1}{2}$	1 21	1 15 0	36, 1	0 5,04	
	<i>Sweden</i>	Rixdollar (1762)	W. 0 12	18 20	17 19 10	395, 5	4 7,22
Rixdollar of late coinage		W. 0 14 $\frac{1}{2}$	18 17	17 12 0	388, 5	4 6,28	
Double pott, or piece of $\frac{1}{2}$		W. 0 14 $\frac{1}{2}$	12 12	11 16 15	259, 6	3 0,25	
Single pott, or piece of $\frac{1}{4}$		W. 0 14 $\frac{1}{2}$	6 6	5 20 6	129, 8	1 6,12	
Piece of 8 skillings		W. 2 18	3 21 $\frac{1}{2}$	2 21 2	63, 8	0 8,90	
Ditto of 4 skillings	W. 5 2	2 15	1 14 0	31, 5	0 4,95		
<i>Switzerland</i>	Ecu, or rixdollar of Lucerne, $\frac{1}{3}$ &c. in proportion (1715)	W. 0 14 $\frac{1}{2}$	17 8 $\frac{1}{2}$	16 5 8	360, 1	4 2,28	

		Assay.	Weight.	Standard Weight.	Conts. in pure Silver.	Value in Sterling.	
		oz. dwt.	dwt. gr.	dwt. gr. mi.	grains.	s. d.	
Switzerland	Old gulden, or florin of Lucerne (1714)	W. 1 19	8 14½	7 2 8	157, 5	1 9,99	
	Ecu of 40 batzen of Lucerne (1796)	W. 0 5	19 0	18 13 14	412, 3	4 9,57	
	Half ditto	W. 1 2	9 20	8 20 12	196, 7	2 3,46	
	Florin, or piece of 40 schillings of Lucerne (1793)	W. 1 5	4 22	4 8 14	96, 8	1 1,51	
	Half florin of Lucerne	W. 2 2	2 15	2 3 0	47, 3	0 6,60	
	Piece of 10 batzen (1782)	W. 1 12	4 20½	4 3 14	92, 2	1 0,68	
	Quarter rixdollar of Friburg	W. 2 19	6 20½	5 0 18	111, 9	1 3,62	
	Piece of ¼ rixdollar of ditto	W. 3 0	3 7½	2 10 0	53, 6	0 7,48	
	Piece of 20 batzen of Soleure	W. 1 2	9 20	8 20 12	196, 7	2 3,46	
	Ditto of 10 batzen of ditto	W. 1 2	5 1	4 13 0	101, 5	1 2,17	
	Ecu of 40 batzen of the Helvetic Republic (1798), ½ in proportion	W. 0 6	18 23	18 10 14	409, 5	4 9,18	
	Piece of 10 batzen	W. 1 4	5 3	4 13 17	100, 5	1 2,03	
	Ditto of 5 batzen	W. 3 2	3 2	2 5 8	49, 3	0 6,88	
	Ecu of 4 franken (1801)	W. 0 7	18 23	18 8 12	407, 6	4 9,18	
	<i>(See also Basil, Berne, Geneva, Neuchâtel, St. Gall, and Zurich.)</i>						
Taxes	Rixdollar, specie	W. 1 3	18 1	16 4 2	359,	4 2,13	
	Altmetric of 60 paras (1757)	W. 4 2	18 12	11 16 0	259,	3 0,16	
	Piastre of Mustapha III (1757)	W. 4 11	12 7	7 6 0	0,161,	1 10,48	
	Altmetric of 1773	W. 4 9½	17 5½	10 6 12	228, 1	2 7,85	
	Piastre of Abdul-hamed (1773)	W. 5 2	12 7	6 15 8	147, 5	1 8,59	
	Another of the same period	W. 4 9	12 0	7 4 10	159, 6	1 10,28	
	Piece of 100 paras of Selim (1789)	W. 5 9	20 7½	10 8 4	229, 7	2 8,07	
	Double piastre of ditto	W. 5 12	16 22½	8 9 10	186, 4	2 2,03	
	Piastre of Selim of 1801	W. 5 6	8 6	4 7 8	95, 7	1 1,36	
	Half piastre	W. 6 13	4 1	1 14 16	35, 9	0 5,01	
	Piastre of Crim Tartary (1778)	W. 6 13	10 5	4 2 4	90, 9	1 0,69	
	Piastre of Tunis (1787)	W. 6 5½	10 0	4 8 6	96, 5	1 1,47	
	Piastre (1818)	W. 5 14	6 6½	3 1 4	67, 7	0 9,45	
	Beshlie	W. 2 6	15 16½	12 10 8	276,	3 2,54	
	Turkey	Piece of ten paras	W. 5 14	0 16½	8 14 0	7, 5	0 1,04
Ducatone (1676)		B. 0 7	20 2	20 17 4	460,	5 4,23	
Livornina (1723)		W. 0 3	17 10½	17 4 13	381, 7	4 5,30	
Pezza della rosa (1726)		W. 0 2	16 17½	16 14 2	368, 2	4 3,41	
Francescone (1738) ½ in proportion		W. 0 2	17 13½	17 9 14	386, 4	4 5,95	
Leopoldone (1790)		W. 0 4	17 15	17 7 8	384, 3	4 5,66	
Piece of 10 paoli of the kingdom of Etruria (1801)		W. 0 4	17 13½	17 5 18	238, 9	4 5,46	
Scudo Pisa of ditto (1803)		W. 0 2	17 12	17 8 4	385, 0	4 5,76	
Piece of 10 lire of ditto (1803)		B. 0 7	25 6½	26 1 12	578, 7	6 8,80	
Ditto of 5 lire ditto (1803)		B. 0 7	12 15½	13 0 18	289, 4	3 4,41	
Lira (1803)		B. 0 7	2 8	2 9 16	53, 4	0 7,45	
United States		Dollar (1795) ½ &c. in proportion	W. 0 6½	17 8	16 19 16	373, 5	4 4,15
		Dollar (1798)	W. 0 7	17 10½	16 21 6	374, 9	4 4,35
		Dollar (1802)	W. 0 10½	17 10	16 14 0	368, 3	4 3,42
		Dollar, an average of eight years	W. 0 8½	17 8	16 16 0	370, 1	4 3,68
	Dime, or 1/10 dollar (1796)	W. 0 4	1 19½	1 18 14	39, 5	0 5,71	
	Half dime (1796)	W. 0 7	0 21½	0 21 0	19, 5	0 2,72	
	Venice	Scudo della croce	B. 0 5	20 4½	20 15 8	458, 2	5 3,98
		Giustina, or ducatone	B. 0 5½	17 12	17 22 8	398, 1	4 6,47
		Ducato	W. 1 5	14 6	12 15 8	280, 8	3 3,21
		Lirazza, or piece of 30 soldi	W. 6 8	4 18½	2 0 10	44, 9	0 6,26
		Tallaro (½ &c. in proportion)	W. 1 3	18 10½	16 12 16	367, 1	4 3,26
		Osella	B. 0 4½	6 6½	6 9 16	142, 3	1 7,87
		Scudo of 10 lire (1797)	W. 1 4	18 10½	16 10 16	365, 2	4 2,99
		Piece of 2 lire, or 24 creutzers (1800)	W. 8 4½	5 19½	1 12 2	33, 4	0 4,66
		Ditto of 1 lire	W. 8 3	2 21	0 18 7	16, 9	0 2,35
Ditto of 2 lire, called moneta provinciale (1808)		W. 8 3	5 13½	1 11 8	32, 8	0 4,58	
Ditto of 1 lire		W. 8 5	3 1½	0 18 8	17, 5	0 2,44	
Ditto of 2 lire (1802) ½ and ¼ in proportion		W. 8 4	5 6½	1 8 19	30 5	0 4,25	

		Assay.	Weight.	Standard Weight.	Conts. in pure silver.	Value in Sterling.
		as. dwt.	dwt. gr.	dwt. gr. m.	grains.	s. d.
<i>Wurtemberg</i>	Rixdollar, specie	W. 1 3	18 1	16 14	2359, 1	4 2, 14
	Copstuck	W. 4 2	4 6½	2 16 12	59, 8	0 8, 35
<i>Wurtzburg</i>	Rixdollar, specie	W. 1 3	18 1½	16 4 16	359, 7	4 2, 22
	Copstuck	W. 4 3	4 6½	2 16 6	59, 3	0 8, 28
<i>Zurich</i>	Rixdollar, or ecu (1753)	W. 0 14½	18 1½	16 21 8	375, 5	4 4, 36
	Half rixdollar (1753)	W. 0 19½	8 23½	8 4 12	181, 8	2 1, 38
	Ecu (1761)	W. 1 5	17 23½	15 22 14	354, 4	4 1, 43
	Half ecu (1761)	W. 1 5	8 21½	7 21 4	175, 2	2 0, 43
	Ecu (1773)	W. 0 19	17 2	15 14 18	346, 8	4 0, 42
	Half ecu (1773)	W. 0 19	8 13	7 19 9	173, 4	2 0, 21
	Ecu (1794)	W. 0 19½	16 6½	14 19 18	329, 3	3 9, 98
	Half ecu (1786)	W. 1 0½	8 4½	7 10 10	165, 2	1 11, 06
	Piece of 20 schillings (1798)	W. 3 9½	3 18½	2 14 6	57, 6	0 8, 04
	Rupee of Mohammed Shah	B. 0 6½	7 9½	7 14 9	168, 7	1 11, 55
	Rupee of Ahmed Shah	B. 0 12	7 9½	7 18 16	172, 8	2 0, 12
	Rupee of Allum Gbir (1759)	B. 0 13	7 11½	7 22 0	175, 8	2 0, 54
Rupee of Shah Allum (1772)	B. 0 14	7 10	7 21 4	175, 2	2 0, 43	
Rupee of the same (Benares 1774)	B. 0 8	7 6½	7 13 0	167, 5	1 11, 38	
Rupee of the same (1779)	B. 0 14½	7 11½	7 23 8	176, 8	2 0, 68	
Rupee Benares (1818)	B. 0 1½	7 7	7 14 5	168, 9	1 11, 58	
Rupee, sicca, coined by the East India Company at Calcutta	B. 0 13	7 11½	7 22 0	175, 8	2 0, 54	
Rupee, Calcutta (1818)	Stand.	8 0	8 0 0	175, 9	2 0, 56	
Rupee, Arcot (1759)	B. 0 7	7 9½	7 14 16	169, 1	1 11, 61	
Rupee, ditto (1782)	B. 0 8	7 6	7 12 4	166, 8	1 11, 29	
Rupee, ditto (1788)	B. 0 8	7 9½	7 15 12	169, 8	1 11, 71	
Rupee, ditto, of the latest coinages	B. 0 4½	7 8½	7 12 2	166, 5	1 11, 25	
Rupee, Bombay, old	B. 0 13	7 10½	7 21 4	174, 9	2 0, 42	
Rupee, Bombay, new, or Surat (1818)	W. 0 0½	7 11	7 10 4	164, 7	1 11, 01	
Rupee, Lucknow	B. 0 8½	7 5½	7 12 2	166, 5	1 11, 25	
Rupee, Sultanny	B. 0 3½	7 9	7 12 0	166, 3	1 11, 22	
Rupee, Madepoor, or Nowsee	W. 0 5	7 5½	7 1 16	157, 1	1 9, 93	
Rupee, Madras Rajapoor	B. 0 4	7 7	7 10 4	164, 8	1 11, 01	
Rupee, Jeypoor	B. 0 12	7 7	7 16 8	170, 6	1 11, 82	
Rupee, Furruckabad (1818)	B. 0 1½	7 5	7 10 14	165, 3	1 11, 07	
Rupee, Chanderry	W. 0 0½	7 5	7 4 8	159, 5	1 10, 27	
Rupee, Oukery	W. 1 0½	7 7	6 14 0	146, 9	1 8, 51	
Rupee, Shree sicca of Poona	W. 0 1½	7 4½	7 3 6	158, 5	1 10, 13	
Rupee, Halee sicca	B. 0 12½	7 7½	7 17 2	217, 2	1 11, 90	
Rupee, Ougein	B. 0 5	7 6½	7 10 4	164, 8	1 11, 01	
Rupee, Maisore, or new Holkar	B. 0 7	7 5	7 10 8	165, 1	1 11, 05	
Rupee, Indore Holkar	B. 0 4½	7 5	7 8 6	163, 1	1 10, 77	
Rupee, Chinsouree	B. 0 2	7 4½	7 6 6	161, 2	1 10, 50	
Rupee, Broach, old	W. 0 0½	7 10	7 0 10	164, 3	1 10, 94	
Rupee, Broach, new	W. 0 10	7 10	7 1 18	157, 2	1 9, 95	
Rupee, Brodera, old	W. 0 4½	7 10½	7 6 17	161, 8	1 10, 59	
Rupee, Brodera, new	W. 0 10½	7 10½	7 2 2	157, 3	1 9, 96	
Rupee, Ana Sai, coined at Cairra	W. 0 10½	7 8½	6 23 14	155, 1	1 9, 65	
Rupee, Ana Sai, coined at Pitlad	W. 0 17½	7 9½	6 19 4	151, 1	1 9, 08	
Rupee, Amedabad sicca	W. 0 7½	7 10	7 3 18	159, 1	1 10, 21	
Rupee, Mungull Sai	W. 0 10½	7 10½	7 2 4	157, 4	1 9, 97	
Rupee, Mumo Sai	W. 0 8½	7 9½	7 2 14	157, 9	1 10, 04	
Rupee, Seea Sai (coined in Futty Sing's time)	W. 0 9½	7 7½	7 0 4	155, 6	1 9, 72	
Rupee, Cambay	W. 0 18½	7 10	6 19 2	150, 9	1 9, 07	
Rupee, Persian (1745)	B. 0 13	7 9½	7 19 10	173, 5	2 0, 22	
Rupee, ditto (1789)	B. 0 12½	7 10	7 20 0	173, 9	2 0, 28	
Rupee, Madras (1818)	Gold Sta.	7 12	7 12 0	165, 0	1 11, 04	
Fanam, Cananore	W. 0 1½	1 11½	1 11 10	32, 9	0 4, 5	
Fanam, Bombay, old	B. 0 13	1 11½	1 13 16	35, 0	0 4, 88	
Fanam, Pondicherry	B. 0 5½	1 0½	1 1 2	22, 8	0 3, 18	
Fanam, ditto, double	W. 0 3	1 18½	1 18 2	39, 0	0 5, 44	
Larin	B. 0 10½	3 2½	3 6 0	72, 1	0 10, 06	
Bussorah Crux	W. 6 0½	11 16	5 7 14	118, 1	1 4, 49	
Gulden of the Dutch E. I. Comp. (1820)	W. 0 7½	6 22	6 16 6	148, 4	1 8, 72	

In order to show the principles on which the foregoing tables are calculated, it may be proper first to explain the manner by which the value of any coin may be determined when its weight and fineness are known. For this purpose the quantity of standard gold and silver contained in it must be first found; and then its sterling value may be ascertained from the Mint-price of the standard ounce.

GOLD COINS—What is the sterling value of a French Double Louis d'or, the Report (per table, page 131,) being as follows:—weight 9 dwt. 20 gr. Assay W. $1\frac{1}{2}$ gr. that is, 0 car. $1\frac{1}{2}$ gr. worse than English standard?

			car.	gr.				
			From 22	0	the fineness of standard gold,			
			Subtract 0	$1\frac{1}{2}$				
			—————					
			21	$2\frac{1}{2}$				
	car.	car.	gr.	dwt.	gr.	wt.	gr.	
Then, as	22	:	21	$2\frac{1}{2}$::	9	20	: 9 16 the standard gold contained in the piece
	4		4			24		
	—		—			—		
	88		$86\frac{1}{2}$			236		
						86,5		
						(24		
						88)20414,0(232 grains nearly.		
						176	216	
						—————		

281 &c. 9 dwt. 16 gr.

	oz.	£	s.	d.	dwt.	gr.	£	s.	d.
Again, as	1	:	3	17	$10\frac{1}{2}$::	9	16	:: 1 17 $7\frac{1}{2}$ the value of the piece in sterling.
	20.		20			24			
	—		—			—			
	20		77			232			
	24		12			$934\frac{1}{2}$			
	—		—			—			
	480		$934\frac{1}{2}$			(12			
						48,0)21680,4(4516			
						192			
						—	2,0)37	$7\frac{1}{2}$	
						248 &c.	—————		
						4	£1	17s.	$7\frac{1}{2}$ d.
						—————			

&c.

The foregoing calculations may be considerably abridged by using a constant decimal as a multiplier. The following is a general rule for gold coins.

Multiply the carat grains in the fineness by the troy grains in the weight, and again multiply this product by 92182; cut off nine decimals, which will give the answer in pounds and decimals of a pound sterling.

Thus, in the foregoing question of the Louis d'or,

$$86,5 \times 236 = 20414$$

$$92182$$

$$1,881803348$$

$$20$$

$$17,636$$

$$12$$

&c.

Answer. £1. 17s. $7\frac{1}{2}$ d.

To find the contents of pure gold in the above coin, say,

	car.	car.	gr.	dwt.	gr.
As	24	:	21	$2\frac{1}{2}$:: 9 20 : 212,6

Or, the contents in pure gold may be found by multiplying the standard weight by 11, and dividing by 12; and standard gold may be reduced to pure by reversing this operation.

SILVER COINS—What is the value of a Spanish Dollar, the Report (per table, page 133,) being as follows:—weight, 17 dwt. 8 gr. Assay W. 8 dwt. that is, 0 oz. 8 dwt. worse than English standard?

	oz.	dwt.	
From	11	2	the fineness of standard silver,
Subtract	0	8	
	—————		
	0	1	

	oz. dwt.	oz. dwt.	dwt. gr.	dwt. gr.	
Then, as	11 2	: 10 14	:: 17 6	: 16 17	the standard silver contained in the Dollar.
	20	20	24		
	—	—	—		
	222	214	416		
			214		
			—(24		
			222)89024(401		
			888		
			—	16 dwt. 17 gr.	
			224	&c.	

	oz. gr.	s. d.	dwt. gr.	s. d.	
Again, as	1 or 480	: 5 2	:: 16 17	: 4 3¼	the value of the Dollar in sterling.
		12	24		
		—	—		
		62	401		
			62		
			—(12		
			48,0)2486,2)51,8		
			2400		
			—	4s. 3¼d.	
			86	&c.	

The foregoing operation may be thus abridged :—

RULE FOR SILVER COINS—Multiply the carat grains in the fineness by the troy grains in the weight, and again multiply this product by 3818; cut of seven decimals, which will give the answer in pence and decimals of a penny sterling.

Thus, in the foregoing question of the Spanish Dollar,

$$\begin{array}{r}
 214 \times 416 = 89024 \\
 \quad \quad \quad 5818 \\
 \hline
 51,7941632 \\
 \quad \quad \quad 4 \\
 \hline
 3,1766528 \\
 \text{Answer. } 4s. 3\frac{1}{4}d.
 \end{array}$$

To find the contents of the Spanish Dollar in pure silver, say—

$$\text{As } 12 : 10 \ 14 :: 17 \ 8 : 3 \ 0,9$$

Or the contents in pure silver may be found by multiplying the standard weight by 37, and dividing by 40; and, on the contrary, multiplying the contents in pure silver by 40, and dividing by 37, will give the standard weight.

The precious metals in England are mostly bought and sold at so much per ounce standard. It therefore becomes necessary to determine the standard weight; and this must be calculated from the Assay Master's Report of weight and fineness.

But it may be useful first to explain the characters which are generally used in these Reports.

ASSAYER'S MARKS.

1	is	1 Dwt. and occasionally as 1 oz.
4	—	2 —
2	—	5 —
E	—	10 —
E2	—	15 —
E211j	—	18 —
Ej	—	19 —
ob	—	Obulus) ¼ —

The common method of finding the value of small quantities of gold and silver is by alloying, from the Assay Master's Report, at the rate of 4s. per carat, better or worse, in every ounce weight of gold; and at the rate of 6d. per ounce, better or worse, in every ounce weight of silver. But when silver is more than 10 dwt. worse, an allowance of 2d. per ounce must be made for refining.

THE FOLLOWING ARE THE SCALES OF ALLOWANCE.

Scale for Gold.	Scale for Silver.
1 car. (4s.)	1 oz. (6d.)
1 gr. (1s.)	15 dwt. (4½d.)
½ gr. (6d.)	10 dwt. (3d.)
¼ gr. (3d.)	5 dwt. 1½d.
	2½ dwt. (¾d.)

Thus, to find the value of 2 oz. of gold B. 1 car. 1 gr. at £4. per oz.—To £8. (for 2 oz.) add 10s. for better, which gives the value £8. 10s.—And to find the value of 12 oz. of silver, W. 10 dwts. at 5s. 6d. per oz. From £3. 6s. (for 12 oz.) subtract 3s. for worse, which gives the value £3. 3s. We submit finally

I.—RULES FOR STANDARDING GOLD.

As 22 carats are to the Assay, or Report of fineness, so is the gross weight to the quantity that is to be added or subtracted from this gross weight, according as the report is better or worse. If better, the additional quantity is called (by the trade) Betterness, and if worse, the subtractional quantity is called Worseness.

Example—How much standard gold is there in an ingot of the following Report, B. 1 car 3½ grains. Weight, 67 oz. 15 dwt. 8 gr. ?

As 22	:	1 3½	::	oz. dwt. gr.	67 15 8	Or thus, as 22 : 23 3½ ::	oz. dwt. gr.	67 15 8	:	oz. dwt. gr.	73 10 20
4		4			20						
88		7			1355						
4		4			24						
352		30			32528						

$\times 30 \div 352 = 2772 \text{ gr.} = 5 \text{ oz. } 15 \text{ dwt. } 12 \text{ gr.}$

oz. dwt. gr.
To 67 15 8 Gross Weight
Add 5 15 12 Betterness
73 10 20 Standard.

The following method for standarding gold may be generally used with advantage:—

oz. dwt. gr.	
67 15 8 Gross Weight B. or W. 1 car. 3½ gr	
2 gr. = ¼ 33 17 16	
1 = ½ 16 18 20	
½ = ¾ 8 9 10	
2)127 1 6	} Divided by 22
11)63 10 15	
5 15 12 Betterness or Worseness, as above.	

II. RULES FOR STANDARDING SILVER.

As 11 oz. 2 dwt. to the assay, so is the gross weight to the quantity which is to be added or subtracted, according as the report is B. or W.

Example—In 287 oz. of silver, W. 12½ dwt., how much standard?

oz. dwt. dwt. oz.	:	12½ :: 287	Or thus, as 11 2 :	oz. dwt.	10 9½ ::	oz. dwt. gr.	287 : 270 16 20
20		20					
222		2840					
		12½					
		222)71750					
		(323 dwt. 4 gr. = 16 oz. 3 dwt. 4 gr.					
		oz. dwt. gr.					
		From 287 0 0 Gross Weight					
		Subtract 16 3 4 Worseness					
		270 16 20 Standard.					

From the last example, the reason of the following rule for standarding silver is obvious: *Multiply half the weight in ounces by the assay in pennyweights, and divide the product by 111, the quotient will be the betterness or worseness in ounces.*

Example—How much standard silver in 160 ounces of B. 18½ dwt.?

<table style="width: 100%; border-collapse: collapse;"> <tr> <td style="width: 50%; text-align: right;">Half weight 80</td> <td style="width: 50%;"></td> </tr> <tr> <td style="text-align: right;">18½</td> <td></td> </tr> <tr> <td style="border-top: 1px solid black; text-align: right;">1480</td> <td style="text-align: center;">oz. dwt. gr.</td> </tr> <tr> <td style="text-align: right;">111</td> <td style="text-align: right;">13 6 16</td> </tr> <tr> <td style="border-top: 1px solid black; text-align: right;">370</td> <td style="text-align: right;">&c.</td> </tr> </table>	Half weight 80		18½		1480	oz. dwt. gr.	111	13 6 16	370	&c.	<table style="width: 100%; border-collapse: collapse;"> <tr> <td style="width: 50%;"></td> <td style="width: 50%; text-align: right;">oz. dwt. gr.</td> </tr> <tr> <td style="text-align: right;">160 0 0</td> <td style="text-align: right;">Gross</td> </tr> <tr> <td style="text-align: right;">Add 13 6 16</td> <td style="text-align: right;">Betterness</td> </tr> <tr> <td style="border-top: 1px solid black; text-align: right;">173 6 16</td> <td style="text-align: right;">Standard</td> </tr> </table>		oz. dwt. gr.	160 0 0	Gross	Add 13 6 16	Betterness	173 6 16	Standard
Half weight 80																			
18½																			
1480	oz. dwt. gr.																		
111	13 6 16																		
370	&c.																		
	oz. dwt. gr.																		
160 0 0	Gross																		
Add 13 6 16	Betterness																		
173 6 16	Standard																		

It should be observed that there are tables constructed, and sometimes used, for standarding gold and silver, as may be seen in Postlethwayt's Dictionary of Commerce, vol. 1, page 388 to 398; but, from the simplicity and conciseness of the foregoing examples, it is manifest that such tables cannot much shorten the operation, though they may serve to check or prove the calculation.

III. RULES FOR CONVERTING THE FOREGOING TABLES OF COINS INTO FRENCH DENOMINATIONS.

To reduce English gold coin into Francs, and the contrary.

RULE—Multiply the number of Pence by ,105: and the number of Francs by ,9525.

Example—How many Francs in a Sovereign?

Here 240d. × ,105 = 25 Francs 20 Centimes.
And again, 25 Francs 20 Centimes × ,9525 = 240 Pence.

To reduce English sterling silver into Francs, and the contrary.

RULE—Multiply the number of Pence by ,103: and the number of Francs by ,9709.

Example—How many Francs in 240 Pence, silver value?

240 × ,103 = 24 Francs 72 Centimes;
And this number × ,9709 = 240 Pence.

The foregoing results are the Pars, very nearly, in gold and silver value.

To bring English grains into Grammes, and the contrary.

RULE—Multiply the number of Grains by ,064792; and the number of Grammes by 15,434.

Example—How many Grammes in a Sovereign, weighing 113,1 English grains of pure gold?

Answer, 7 Grammes 328 Decigrammes, nearly; and this number, multiplied by 15,434, equals 113,1 grains.

By the application of the above rules, all the foregoing Tables of Coins may be converted into French denominations, except the first column, which contains the Assay, and which is thus reduced:—

RULE FOR GOLD COINS—Make the Assay Report the numerator, and 24 the denominator, and this vulgar fraction, reduced to three places of decimals, will give the Milliemes, according to the French expression.

Example—To convert English standard gold into Milliemes.

Thus, $\frac{82}{24} = 916$ Milliemes. If the gold be 1 carat 2 grains worse than standard.

car. gr.	
22 0	
1 2	
20 2	24
4	4
—	—
Carat grains 82	96

then $\frac{82}{24} = 854$ Milliemes.

Milliemes are reduced to carats by multiplying by 24 and cutting off three decimals.

FOR SILVER COINS—To reduce English Assay Reports of silver into French Reports, or Milliemes.

RULE—Make the number of pennyweights in the Assay Report the numerator, and 240 the denominator, and this reduced to a decimal fraction of three places gives the Milliemes.

Example—To reduce English standard silver into Milliemes.

dwt. gr.
11 2
20
222
— = $\frac{112}{20} = 925$ Milliemes.
240

To reduce Milliemes into English Assay Reports of silver.

RULE—Multiply by 240, and cut off three decimals. Thus, 891 Milliemes × 240 = 214 = 10 dwt 14 gr., and this subtracted from 11 dwt. 2 gr. gives 8 dwt. worse than English standard.

Dr. Kelly's Explication of the Coins of France presents a singular picture of the modern changes of that country. We subjoin it for this, its curious political bearing. He gives a very able and detailed explanation of the same kind respecting all the modern coins of the world, in his *Cambist* 2 vols. 4to. London, 1826.

FRANCE.

GOLD COINS.

The **LOUIS**—Head of the reigning King, with its name and title: thus,

LUD. XVI. D. G. FR. ET NAV. REX.

that is, *Ludovicus XVI. Dei Gratia, Franciæ et Navaræ Rex,*

Louis XVI. by the Grace of God, King of France and Navarre.

Reverse, the arms of France and Navarre, with a crown over them. On the Pieces coined before 1786 there are two distinct shields; and, on those coined since 1786, a double shield; legend,

CHRS. REGN. VINC. IMPER.

that is, *Christus regnat, vincit, imperat,*
Christ reigns, conquers, governs;
under the arms is a letter, by which the mint where the piece was coined is known. The Double and Half Louis bear the same impressions.

The Pieces struck in the year 1791 have on the obverse the head of the King, with the title,

LOUIS XVI. ROI DES FRANCOIS.

Louis XVI. King of the French.

and, on the reverse, the Genius of France writing the Constitution on a tablet resting on a pillar, with a cock on one side, and on the other the fasces and cap of Liberty, with the legend,

REGNE DE LA LOI,
Reign of the Law;

and at the bottom,

L'AN 4 DE LA LIBERTE,
The year 4 of Liberty.

The Piece of 1793 has, instead of the head, a crown of oak-leaves, containing the words 24 LIVRES; legend,

REPUBLIQUE FRANÇOISE L'AN II.
French Republic, the year 2.

Reverse, as on the Louis of 1791, except that the date is in figures only.

The Piece of 40 FRANCS, 1802—Head of Bonaparte; legend,

BONAPARTE PREMIER CONSUL.
Bonaparte, first Consul.

Reverse, a wreath of laurel, containing the words 40 FRANCS; legend,

REPUBLIQUE FRANÇOISE AN. XI.
and, round the edge of the piece,
DIEU PROTEGE LA FRANCE,
God protect France.

In 1804, on Bonaparte's being declared Emperor, the words round the head were altered to NAPOLEON EMPEREUR. The Piece of 20 Francs bears the same impressions, except the figures that mark its value

The Piece of 40 FRANCS, 1818—Head of the King, with name and title, thus:

LOUIS XVIII. ROI DE FRANCE.

Reverse, arms of France, and 40 F. within two branches of laurel. Round the edge of the piece,

DOMINE SALVUM FAC REGEM.

O Lord, save the King

SILVER COINS.

The Ecu of 6 LIVRES—Head of the reigning King, with name and title, as on the Louis. Reverse, the arms of France, between two laurel branches; legend,

SIT NOMEN DOMINI BENEDICTUM,
Blessed be the name of the Lord.

and a letter denoting the place where the piece was coined. Round the edge are the words

DOMINE SALVUM FAC REGEM,
as on the 40 Franc Piece. The Ecu of three Livres, the Pieces of 24, 12, and 6 Sous, all bear the same impressions, except that the three last mentioned coins have no motto round the edge.

The Ecu of 1791—Head of the King; legend,

LOUIS XVI. ROI DES FRANCOIS.

Reverse, the Genius of France, &c. as on the Louis of the same period. Round the edge,

LA NATION LA LOI ET LE ROI,
The nation, the law, and the King.

The Pieces of 15 and 30 Sols, coined at the same period, bear the same impressions, except that, instead of the fasces and cock, their value is marked, and that the motto round the edge is omitted.

The 6 LIVRE Piece of the Republic—The Genius of France, &c. as above. Reverse, a wreath of oak, containing the words SIX LIVRES; legend,

REPUBLIQUE FRANCOISE L'AN II.
and round the edge,

LIBERTE, EGALITE,
Liberty, equality.

The 5 FRANC Piece of the Republic—Three figures, representing Hercules and two young women, joining their hands; legend,

UNION ET FORCE,
Union and strength.

Reverse, a wreath of laurel and oak, containing the words 5 FRANCS L'AN 7; legend,

REPUBLIQUE FRANCOISE;
and round the edge,

GARANTIE NATIONALE,
National guarantee.

The 5 FRANC Piece of 1803—Head of Bonaparte; legend as on the 40 Franc Piece. Reverse, a wreath of laurel, containing the value, 5 FRANCS; legend,

REPUBLIQUE FRANCOISE,
but, on pieces coined in 1809,
EMPIRE FRANCOIS.

Round the edge, the words
DIEU PROTEGE LA FRANCE,

as before.
The FRANC of Louis XVIII. bears the same impressions as the 40 Franc Piece of the same period; except the mark of the value.

COIN, in architecture, a kind of dia cut diagonal-wise, after the manner of a flight of a stair-case, serving at bottom to support columns in a level, and at the top to correct the inclination of an entablature supporting a vault. Coin is also used for a solid angle composed of two surfaces inclined towards each other, whether that angle be exterior as the coin of a wall, a tree, &c. or interior, as the coin of a chamber or chimney.

COINAGE, as an art, has been carried to the greatest perfection in our own country, and in very modern times. From the establishment of the mint by act of parliament, in the reign of Edward II., to the year 1815, it is surprising how small were the alterations introduced by successive masters: but at this period an entirely new constitution of the mint was projected and accomplished. The history, therefore, of the British Mint and its operations, will embrace everything valuable in this art. See **MINT**.

For **COINS**, considered as medals, see **NUMISMATICS**.

COINCIDE, *v. n.* } Lat. *coincido*. To fall
COINCIDENCE, *n. s.* } upon the same point, to
COINCIDENT, *adj.* } meet in the same point; to concur, to agree. The state of several bodies or lines falling upon the same point; tendency of many things to the same end. Occurrence of many things at the same time, without previous arrangement or forethought in their agents.

The very occurrence and *coincidence* of so many evidences that contribute to the proof, carry a great weight. *Hils.*

Christianity teacheth nothing but what is perfectly suitable to, and *coincident* with, the ruling principles of a virtuous and well-inclined man. *South.*

If the equator and ecliptick had *coincided*, it would have rendered the annual revolution of the earth useless. *Chayne.*

These circles I viewed through a prism; and, as I went from them, they came nearer and nearer together, and at length became *coincident*.

Newton's Opticks.

An universal equilibrium, arising from the *coincidences* of infinite centres, can never be naturally acquired. *Bentley.*

The rules of right judgment, and of good ratiocination, often *coincide* with each other. *Watts's Logic.*

I venerate the man whose heart is warm.
 Whose hands are pure, whose doctrine and whose life
Coincident, exhibit lucid proof
 That he is honest in the sacred cause. *Cowper.*

COINDICATION, *n. s.* From *con* and *indicō*, Lat. Many symptoms betokening the same cause.

COJOIN, *v. n.* Lat. *conjungo*. To join with another in the same office.

Thou mayest *cojoin* with something, and thou dost, And that beyond commission.

Shakespeare's Twelfth Night.

COIRE, a large and handsome town of Switzerland, capital of the League of God's House, and of the canton of the Grisons, is seated in a valley at the foot of the Alps, abounding in vineyards and game; and said to have been founded by the emperor Constantius. It is divided into two parts: the upper principally

inhabited by Catholics, and the lower by Protestants. The former contains the cathedral built in the eighth century, the bishop's residence, and the town-house, containing the archives of the Canton: the diet of which meets here every three years. The principal support of the inhabitants is the trade carried on along the Rhine to Loudon and Zurich. It was formerly a city of Germany, and was governed by counts, but became a bishopric in the ninth century, and a part of the Grison's Republic in 1526. The government being partly aristocratic, partly democratic. In 1799 it was taken by the French under general Massena, and annexed to the Helvetic Republic. It is thirty-two miles north of Chiavenna, and twenty-two E.S.E. of Glacis.

COISTRIL, *n. s.* Corrupted from *kestrel*. It signifies a mean fellow; a runaway.

He's a coward and a *costril*, that will not drink to my niece. *Shakespeare's Twelfth Night.*

COIT, *n. s.* Dut. *kote*; a die. A thing thrown at a certain mark. See **QVOIT**.

The time they wear out at *coits*, kayles, or the like idle exercises. *Carew's Survey of Cornwall.*

COITION, *n. s.* Lat. *coitio*. The act by which two bodies come together. Copulation.

By Gilbertus this motion is termed *coition*, not made by any faculty attractive of one, but a syndrome and concurrence of each. *Brown's Vulgar Errors.*

I cannot but admire that philosophers should imagine frogs to fall from the clouds, considering how openly they act their *coition*, produce spawn, tadpoles, and frogs. *Ray on the Creation.*

He is not made productive of his kind, but by *coition* with a female. *Grew's Cosmologia.*

COIX, Job's-tears, a genus of the triandria order, and monœcia class of plants; natural order fourth, gramina. Male, flowers in remote spikes: CAL. a biflorous, beardless glume. Female CAL. biflorous glume: COR. a beardless glume; the style bipartite: SEED covered with the calyx, ossified. Of this there are three species, natives of the East and West Indies. The chief is *C. lachryma Jobi*, an annual plant, rising two feet from a fibrous root, with two or three jointed stalks, and single, long, narrow leaves at each joint, resembling those of the reed. At the base of the leaves come out the spikes of flowers standing on short foot-stalks; the seeds greatly resemble those of gromwell; whence the plant has by some writers been called lithosperma. It may be propagated in this country by seeds brought from Portugal, and sown on a hot-bed; after which the young plants should be removed into a warm border, and planted two feet from each other. They require only to be kept free from weeds. In Spain and Portugal the poor grind the seeds of this plant in times of scarcity, and make a coarse kind of bread of them. The seeds are enclosed in small capsules about the bigness of an English pea, and of different colors. These are strung upon silk, and used instead of bracelets by some of the poorer sort in the West Indies, particularly by the negroes.

COKALAHISKIT, a river of North America, which takes its source in the Rocky Mountains, and, after a course of about 300 miles,

enters Clark's River, a branch of the Columbia, in long. 113° W., lat. 47° N. It is deep and rapid, and its average width about sixty yards. In one part of its course it approaches within sixty miles of Dearborn's Creek, a branch of the Missouri.

COKE, *n. s.* Lat. *lignum coctam*. Fuel made by burning pit-coal under earth, and quenching the cinders; as charcoal is made with wood. It is frequently used in drying melt.

COKE, or **COAK**, charred pit-coal, much used for smelting iron ore in malt-houses, and other places where smoke is to be avoided. It is usually prepared by putting screened coal into cylindrical ovens of brick or stone, generally about six feet by seven, and eight feet in height, and there burning it. When it is red-hot the apertures are all closed, and it is left to cool; it is then drawn out with long iron rakes, and the mass is found to have assumed an arrangement not much unlike starch. An improvement has been adopted by lord Dundonald, by means of which he receives, in a separate chamber, the coal tar. Baron Von Haak, at Newcastle, distilled the coal in cast-iron chambers, but he withdrew the soot for lamp black before the rise of the gray ashes; but the coak thus formed is not so well fitted for the iron smelting.

COKE (Thomas), LL. D. a respectable divine among the Wesleyan methodists, was born September 9th, 1747, at Brecon, in South Wales, where his father was a surgeon and a magistrate. Receiving a classical education, in the public school of that place, he went, as a gentleman commoner, to Jesus College, Oxford. In 1770 he took the degree of master of arts, and in 1775 that of doctor in civil law; became, in the interim, a member of the corporation, and mayor of his native place. Soon after this he became acquainted with Mr. Wesley, and, entering into orders, obtained the curacy of South Petherton, in Somersetshire. He was soon dismissed from his curacy, when he preached at the church-door, which occasioned a riot; and on this he timely left Petherton to become an assistant of Mr. Wesley. In 1784 the latter is said to have consecrated him as a bishop for the purpose of superintending the methodistical societies in America. The doctor now, therefore, made several voyages to the United States and the West Indies, establishing meeting-houses, organising congregations, and ordaining ministers. He also visited Ireland, where he held and presided over several conferences. About the commencement of the French revolution, he attempted a mission in that country, but failed in his object. He next turned his attention to the Wesleyan cause in Wales, which he lived to see very flourishing. He now formed an establishment at Gibraltar; and on the 21st of February, 1814, sailed with some preachers for Ceylon; but on the 3d of May was found dead in the cabin of the vessel, having fallen on the floor in an apoplectic fit. He published a Commentary on the Bible; a History of the West Indies; and some Sermons and Tracts.

COKE (Sir Edward), lord chief justice of the king's bench in the reign of James I. was descended from an ancient family in Norfolk, and

born at Milcham in 1549. When a student, in the Inner Temple, he distinguished himself by stating the case of a cock belonging to the Temple so exactly, that all the house admired him, and the whole bench took notice of him. After his marriage with a lady of good fortune, preferments flowed upon him. The cities of Norwich and Coventry chose him for their recorder; the county of Norfolk for one of their knights in parliament; and the house of commons for their speaker, in the thirty-fifth year of queen Elizabeth. The queen appointed him solicitor-general in 1592, and attorney-general in 1593. In 1603 he was knighted by king James I.; and the same year, upon the trial of Sir Walter Raleigh, at Winchester, he treated that gentleman with a scurrility of language hardly to be paralleled. On June 27th he was appointed lord chief justice of the common pleas, and in 1613 lord chief justice of the king's bench, and one of the privy council. In 1615 he was very vigorous in the discovery and prosecution of the persons employed in poisoning Sir Thomas Overbury in the Tower in 1612. His contest not long after with the lord chancellor Egerton, with some other cases, hastened the ruin of his interest at court: so that he was sequestered from the council table, and the office of lord chief justice. In 1621 he vigorously maintained, in the house of commons, that no proclamation is of any force against the parliament. The same year, being looked upon as one of the great incendiaries in the house of commons, he was removed from the council of state with disgrace; the king saying that 'he was the fittest instrument for a tyrant that ever was in England:' he was also committed to the Tower, and his papers were seized. Upon the calling of a new parliament, in 1625, the court party, to prevent his being elected a member, got him appointed sheriff of Buckinghamshire. To avoid the office he drew up exceptions against the oath of a sheriff, but was obliged to undertake the office. In 1628 he spoke vigorously upon grievances; and made a speech, in which he affirmed, that 'the duke of Buckingham was the cause of all our miseries.' While he lay upon his death-bed his papers and last will were seized by an order of council. He died in 1634. He published many works; the most remarkable are his Institutes of the Laws of England; the first part of which is a translation and comment of Sir Thomas Littleton, one of the chief justices of the common pleas in the reign of Edward IV.

COKESBURY COLLEGE, a college in the State of Maryland, in Abington, Harford county, founded by the Methodists in 1783, and takes its name from Thomas Coke, and Francis Asbury, the American bishops of the Methodist Episcopal church. The edifice is of brick, handsomely built, on a healthy spot, enjoying a fine air, and a very extensive prospect. The college was erected, and is wholly supported by subscriptions and voluntary donations. The students, who are to consist of the sons of travelling preachers, annual subscribers, members of the society, and orphans, are instructed in English, Latin, Greek, logic, rhetoric, history, geography, natural philosophy, and astronomy,

and they are taught the Hebrew, French, and German languages.

COL, one of the western islands of Scotland, about thirteen miles long and three broad; containing above 800 inhabitants. It abounds in corn, pasture, salmon, eels and cod. It lies on the coast of Argyllshire, nine miles from Arduamurchan, and eleven north-west of the Isle of Mull. Lon. 7° 15' W., lat. 57° 0' N.

COL D'AGNELLO, a passage from France, into Italy from Guillièrre to Chateau Dauphin.

COL D'AREZ, a passage of the Pyrenees from Prats de Molo in France, to Campredon in Spain.

COL D'ARGENTIÈRE, a passage from France into Italy between Saluce and Nice.

COL DE LIMON, a passage over the Alps, from Sospello to Coni.

COL DE PARACOLS, a passage of the Pyrenees, from Ceret in France, to Ampardan in Spain.

COL DE PERTUIS, a passage of the Pyrenees, between Boulou and Junquera.

COL DE TENDA, a well-known passage of the Alps, between Piedmont and Nice, over the mountains of Tenda, and 500 feet above the level of the sea.

COLAN, a town of South American Indians, in Peru, within the jurisdiction of Piura. The inhabitants are very industrious; they raise much grain, and feed great numbers of cattle; and they make large rafts of wood, with which they make voyages to Panama. Their cargoes consist of wine, oil, sugar, soap, dressed goat skins, and Quito cloth. Their grain and cattle are disposed of at Payta and the adjacent towns. Colan is nine miles north from Payta.

COLANDER, *n. s.* Lat. *colo*; to strain. A sieve either of hair, twigs, or metal, through which a mixture to be separated is poured, and which retains the thicker parts; a strainer.

Take a thick woven oser *colander*,
Through which the pressed wines are strained clear.

May.

All the viscera of the body are but as so many *colanders* to separate several juices from the blood.

Ray on the Creation.

The brains from nose and mouth, and either ear,
Came issuing forth, as through a *colander*
The curdled milk.

Dryden.

COLAPIS, or COLOPS, in ancient geography, a river of Liburnia, which, after a winding north-east course, falls into the Savus at the Insula Segestica. It is now called Colupe.

COLAPOOR, or CALAPUR, a small independent Mahratta state, on the sea coast of Bejapoor, Hindostan, sometimes called Bonsolo in the maps. It is the only one entirely independent of the British, and bounded to the south by the Portuguese territory of Goa; to the eastward, and northward by the Peishwa's dominions, and to the west by the sea. Its chief towns are Colapoor, Virgorlat, and Raree, the two latter being considerable ports. The rajah gained a great accession of country by conquest, during the confusion in the Mahratta Peishwa's dominions, after the death of Sewai Madhooor, particularly from the Putwurdun family.

COLAR, a district in the eastern extremity of

the Mysore territories, between the thirteenth and fourteenth degrees of north latitude, consisting, for the greater part, of rocky mountains. Those towards the capital are very extensive. The road leading to it being flanked by high hills. The remainder of the district is largely covered with copse wood. But the mango, tamarind, and robinia matis, flourish in particular spots, and salt is made in the lower parts. The natives also plant aloes in the hedges, and use the leaves for cordage. Gold dust is said to be found in considerable quantity.

This district is very fruitful in rice, being well watered; but the enmity of its different tribes to each other has been often exemplified. Aurungzebe overran this country, and burnt down Vingorla in 1684, a few years after it had been taken by the celebrated Sevajee from the king of Bejapore. More recently, when the father of the rajah was taken in war by Appa Saheb, one of the Putwurdun family, although he was a Brahmin, and much wounded, the barbarian captor ordered him to be cut in pieces before his face.

In 1804, when a British squadron had blockaded the ports of the rajah, in consequence of the numerous piracies committed by his subjects, that prince also gave shelter to two of his relations, whom lord Wellington had found at the head of banditti. The British general, therefore, wrote to him, stating 'that he was perfectly aware of the family connexion between the rajah and those brothers, and that it was not the custom of the British government, nor his own wish, to perpetuate enmities, or deprive those of an asylum who were inclined to live in peace; for which reason he did not call on the rajah to give up the brothers, but notified to him, that, as he had given them an asylum, the British government would consider him responsible for their conduct; and if they again assembled troops, which could only be intended to disturb the peace of other powers, he (the rajah) would be called upon to answer for the injuries they might do.' The intimation had the desired effect, and the neighbourhood is said to have enjoyed an extraordinary tranquillity in consequence of this interference.

COLAR, the capital of the above district, has extensive mud fortifications: but in the centre is a cavalier of stone, and it is defended by a deep ditch. This place was taken by the English in the year 1768, and shortly after retaken by Hyder Ali. His father Futeh Mahomed resided here, and began a mosque and mausoleum, which Hyder finished. The establishment is still supported at the expense of the British.

COLARBASIANS, or COLORBASIANS, a sect of Christians in the second century; so called from their leader Colarbasus, a disciple of Valentinus; who, with Marcus, another disciple of the same master, maintained the whole plentitude and perfection of truth and religion to be contained in the Greek alphabet; and that it was upon this account that Jesus Christ was called the alpha and omega. This sect was a branch of the Valentinians.

COLATION, *n. s.* From *colo*, Lat. The art of filtering or straining.

COLATURE, *n. s.* From *colo*, Lat. The act of straining; filtration; the matter strained.

COLBERG, a strong handsome sea-port town of Prussia, in Farther Pomerania. It is remarkable for its salt-works, and is seated at the mouth of the river Persante, on the Baltic sea. The chief edifices are the town-house and the cathedral, a large and beautiful structure. The aqueduct also which supplies the town with water is a well contrived and strong building. Colberg is a fortress of some importance; it was three times besieged by the Russians during the seven years' war, twice without success. It is sixty miles north-east of Stetin, and thirty of Camin.

COLBERT (John Baptist), marquis of Segneval, one of the greatest statesmen of France, was born at Paris in 1619; and descended from a family in Rheims, no way considerable for its splendor or antiquity. His grandfather and father were merchants; and young Colbert was bred up to the same profession; and afterwards became a clerk to a notary. In 1648 his relation, John Baptist Colbert, lord of S. Pouange, preferred him to the service of Michael Le Tellier, secretary of state, whose sister he had married. Le Zellier afterwards recommended him to the service of cardinal Mazarine, and by him he was sent to Rome, to negotiate the reconciliation of cardinal de Rets, and other important business. So high an opinion had Mazarine of Colbert's abilities and faithful services, that, at his death, in 1661, he recommended him to Louis XIV. as the most eligible person to regulate the finances, which at that time stood in much need of reformation; and Louis, in consequence, made Colbert intendant of the finances. This minister established the trade with the East and West Indies, from which France reaped innumerable advantages. In 1664 he became superintendent of the buildings; and applied himself so earnestly to the enlarging and adorning of the royal edifices, that they became master-pieces of architecture; as the palace of the Thuilleries, the Louvre, St. Germain, Fontainebleau, and Chombord attest: and he raised Versailles from the ground. It was formerly a dog-kennel, where Louis XIII. kept his hunting furniture; he made it a palace fit for the greatest monarch. He established the Academy for Painting and Sculpture, and the Academy of Sciences, as well as the Royal Observatory at Paris. France also owes to him all the advantages she receives by the union of the two seas; a prodigious work, begun in 1666, and finished in 1680. In 1672 he was made prime minister, and died of the stone September 6th, 1683, in his sixty-fifth year, leaving behind him six sons and three daughters. His mien was low and dejected, his air gloomy, and his aspect stern. Colbert was a lover of learning, though he never applied to it himself; and conferred donations and pensions upon scholars in other countries, while he established and protected academies in his own. He invited into France eminent artists of all kinds; thus giving new life to the sciences, and making them flourish exceedingly. Upon the whole, he was a wise, active, public-spirited minister; ever attentive to the interests of his master, the happiness of the people, the pro-

gress of arts and manufactures, and every thing that could advance the credit and interest of his country. He was a pattern for all ministers of state; and every nation may wish to be blessed with a Colbert.

COLBERTINE, *n. s.* A kind of lace worn by women.

Go, hang out an old frisoner gorget, with a yard of yellow *colbertine* again.

Congreve's Way of the World.

Difference rose between
Mechlin, the queen of lace, and *Colbertine*.

Young.

COLCHESTER, a town of England, the capital of the county of Essex, pleasantly extended on the brow of a hill, on the south side of the river Colne. It is said to be the ancient Colonia Cameloduni, and that both town and river derive their names from the word Colonia. It was called by the Saxons Colneceaster. There seems indeed ample proof that it flourished under the Romans, several buildings full of their bricks, and great quantities of coin, having been dug up in the town and its vicinity. A curious tessellated or mosaic pavement, three feet under the surface of the earth, was discovered in a garden in 1763.

Colchester is said to have been the birth-place of Constantine the Great, his mother Helen being daughter of a governor of the district under the Romans; and that, from Helen finding out the cross of Christ at Jerusalem, the arms of the town are a cross regulee between three ducal coronets, two in chief and one in base; the coronet in chief passing through the cross. The walls of the town were in general about nine feet thick; and on the south-east and west sides considerable remains of them appear.

Colchester, at the period of compiling the Doomsday Survey, had no less than 276 burgesses. It was besieged during the commotions in the reign of John, by Saher de Quincy, earl of Winchester, at the head of an army of foreigners, but was relieved by the approach of the barons, who were assembled in London, and from whom the earl retreated to Bury St. Edmunds. Saher, however, or some of his party, shortly after obtained possession of and plundered the town, leaving a garrison in the castle; but of this they were not long possessed, for, being soon besieged by king John, they were forced to surrender. In the year 1218 it fell into the hands of the troops of Louis, son to Philip II. of France, who visited England with the professed intention of supporting the demands of the barons; but really, as it would seem from their conduct, to make conquests for themselves. The castle was not long disgraced, however, by the display of the French flag, for the submission of the barons to Henry III. soon enabled that prince to expel the faithless Louis.

During the reign of Edward III. the inhabitants were much harassed by the aggressions of Lionel de Bradenham, who, enraged at being foiled in his endeavours at obtaining the exclusive fishery of the Colne, which had been granted to the burgesses by Richard I. beset the approaches to the town for three months, with a

band of daring villains, and proceeded even to an attempt at destroying it by fire.

This town warmly espoused the cause of Mary at the period of the attempt being made to place the unfortunate lady Jane Grey upon the throne. It was honored in consequence with a visit by Mary, shortly after her establishment on the throne. Here, however, she suffered the torch of bigotry to blaze. Upon the accession of Elizabeth, a different scene presented itself. A colony of Flemmings, fugitives from the persecutions of the duke of Alva, were admitted to settle here, and establish the baize manufacture, for which the town was long celebrated.

In 1648, towards the end of the civil war, this town sustained a siege of ten weeks; and, making a very gallant defence, the siege was changed into a blockade, wherein the garrison and inhabitants suffered extremely for want of provisions. They were at last obliged to surrender at discretion, when their two gallant chief officers, Sir Charles Lucas and Sir George Lisle, were shot under the walls in cold blood. Colchester was made the see of a suffragan bishop by a statute of Henry VIII.

The castle commands, from the porth of the High street, a magnificent view to the north and east; the outer walls are nearly perfect, they are built of an admixture of silicious and calcareous stones and Roman brick. By Norden the erection of this fortress is ascribed to Edward the elder; but the Saxon chronicle refers it to Eudo Dapifer, sewer or steward to William the Conqueror, and its testimony receives no small confirmation from the circumstance of its general structure being Norman; while the immense quantity of Roman bricks, not single but united into masses, would indicate it to have been erected upon the site of a more ancient Roman fortress.

The plan of the castle is a parallelogram, measuring upon its east and west sides 140 feet, and upon the north and south 102 feet; with projecting square towers to the north-east and north-west angles: at the south side on the west face there is another square tower; and a semicircular tower, having a radius of twenty feet, upon the east face. The thickness of the foundations is thirty feet; that of the lower part of the walls twelve, and of the upper nearly eleven feet. The chief entrance is beneath a strong semicircular arch, with three-quarter columns, situated near the south-west tower, here the capitals are of the Norman order of architecture. A portcullis formerly defended this entrance, within which, upon the right, the guard or janitor was stationed, in a niche: not far hence is a square room, having, at its further end, a flight of stairs leading to the vaults, of which that which is situated immediately at the foot of them measures twenty-six feet in length and twenty-one in breadth; the narrow passage at its extremity is bricked up, to prevent the accidents which might arise from the ruinous condition of the arch of the next vault into which it leads. Upon the right of this first vault, a passage has been broken through the wall into an adjacent one, from which the light is wholly excluded, and whose dimensions are similar: hence, through a

chasm at its extremity, a passage leads to a third vault of the same breadth as the others, but much longer. When first discovered, about 100 years since, these vaults were found full of sand; the original descent to them is still undiscovered.

Beyond the stairs is an entrance into a large area formerly roofed, and divided by a wall running north and south. Within this space, upon its different floors, were the principal apartments of the castle: and also a gallery that runs between the wall which crosses the area, and that which is demolished.

At the extremity of a wall which separates this area from a second, is a door above and below, which led into the apartments which filled the space between the east wall of the castle and gallery. At the south end of this space, in the south-east tower, on the ground floor is a strong arched room, with walls of an astonishing thickness. In the south-west tower is the grand staircase, which is circular, arched above and built of stone; this leads to a modern room, used as a subscription library. An arcade of modern workmanship, which runs along the north wall of the library, leads to the ancient chapel, which is a venerable piece of architecture, the beauty of whose proportions strike the eye, notwithstanding the massiveness of its construction. The roof is strongly arched, and the light is admitted through five windows, of which two have been enlarged, while the rest continue nearly in their original state. This building is forty-seven feet long, nearly forty broad, and proportionably high. Prisoners are confined in the arched vault beneath it.

In the north-east and north-west towers, upon the same floor with the chapel, are various small rooms or recesses, and in the latter is also a staircase, which descends from the upper part of the tower, and terminates at the first floor. At the foot of the stairs, in the north wall of the castle, is a sally-port, now closed up, which opened upon an abutment of the north-west tower. This sally-port, which is nine feet wide, and the great gateway in the south wall, are the only original entrances into the castle. From the principal staircase, in the north-east tower, another flight of steps leads to what was the second floor; the walls of this story, of which but a very small part now remains, were nine feet thick. The dome which covers the staircase, the passage formed upon the west and north wall of the castle, and the small room upon the summit of the north-east tower, are all of modern construction. The great doorway in the north wall, and the small port in the east wall, are likewise modern, and have been formed with great labor, by the enlargement of a narrow window in each place. Several of the windows have also been, with no less labor, enlarged; in their original state but a very scanty portion of light could have found entrance into the interior apartments. The peculiar construction of these windows, so entirely different from any in modern buildings, is worthy of observation. An arched niche, about three feet deep, formed the inner opening of the window; in the back of which niche, another of less di-

mensions, gradually decreasing in breadth, penetrated about seven feet further, at the extremity of which a narrow aperture, only eight inches wide, lined with hewn stone, was made through the remaining thickness of the wall. From the floor of the rooms an ascent was made to the narrow aperture of the window by a flight of small steps. The outside of the building is surrounded on every part with several horizontal bands or fillets of Roman brick, which are disposed in perpendicular and oblique layers.

Colchester castle was granted by the empress Maud to Almeric de Vere, ancestor of the Veres, earls of Oxford; Almeric does not however appear ever to have had possession of it. Stephen Haregood next obtained a grant of it during pleasure. In 1256 it was given by Henry III. to Guido de la Rupe Ford, or Rochford, who was, however, in consequence of disgrace, deprived of this along with his other estates two years afterwards. From this period it has repeatedly changed masters, one of whom, of the name of Wheeley, made an attempt at dilapidating it in the year 1683; the solidity of the building, however, proved its security, as the expense attending the demolition of a very small part was so enormous as to deter its owner from proceeding further.

There are twelve parishes in the town and suburbs of Colchester, of which eight are within and four without the walls; several of the churches are, however, destroyed; but some that remain there are handsome structures. The ruins of St John's Abbey in particular merit attention: this building was founded by Eudo Dapifer in 1097, and appears to have been a very magnificent structure. It was dedicated to St. John the Baptist, and occupies the site of a wooden church, dedicated to St. John the Evangelist, which was famous for miracles. When completed, about the beginning of 1104, it was consecrated by Maurice, bishop of London; at which time also its endowment was liberally augmented by its original founder Eudo, and other pious persons. This foundation flourished till the period of the dissolution, its privileges being the same with those of the abbey of St. Peter's, Westminster, and its abbot possessing a seat in parliament. At the time of the dissolution its revenues were estimated at £523. 17s. 10d. Deche, the last abbot, was hung for refusing to acknowledge the king's supremacy. The gateway which remains appears more modern than the other parts of the abbey, and is built of hewn stone and flint; the garden walls enclose an area of little less than fourteen acres.

St. Giles's church, of which only the chancel, which is employed for the celebration of divine worship, is preserved from ruin, stands near the north-west corner of St. John's garden, and was the burying place of the Lucas family; here are interred the remains of the gallant Sir Charles Lucas, and his no less gallant, though equally unfortunate fellow sufferer, Sir George Leslie, whose melancholy fate is recorded upon their common tomb.

St. Botolph's priory, which stands at a short distance north-east of St. John's. Its foundation is commonly, though not improbably with-

out sufficient justice, ascribed to a monk of the name of Eyrnulph, or Ernulph, early in the twelfth century: some of the ruins seem, however, to speak a much more remote origin. The revenues were, at the dissolution, £134. 13s. 4d. per annum; but few traces of the monastic buildings can be now discovered. Previously to the siege, the priory church continued perfect; it was then however almost totally destroyed, each of the contending parties accusing the other of the deed. The curious specimens of brick ornaments and interlaced arches, which they present, furnish the admirer of architectural relics with much interesting contemplation. As it stood, originally, the dimensions of this church were, within the walls, 108 feet long, and, including the nave and aisles, forty-four feet broad. Its west front was richly ornamented, and contained the grand entrance, which still remains. The door-way is formed by a fine semicircular retiring arch, with various mouldings, formed with alternate rows of small thin brick, and hewn stone.

On the south-west side of the town was formerly a monastery of Crouched Friars, established at the first arrival of that order in this country, about the year 1244. The fabric underwent many changes, and became in 1407 the seat of the wealthy Guild of St. Helen, along with whose possessions not less than four chantries, founded here, and in the church of St. Nicholas, were incorporated. Its revenues came, soon after the dissolution, into the hands of lord chancellor Sir Thomas Audley; and the building was; in 1637 converted into a dwelling-house.

The principal church within the walls is St. James's; the rest are All Saints, St. Nicholas partly in ruins; the chapel of St. Helen; Trinity church; St. Runwald's, St. Martin's, St. Peter's, and St. Mary's. The moot hall, for holding the court in, and transacting the public business, was founded by Eudo Dapifer, already mentioned: the town gaol adjoins, and is partly situated under this building, and the theatre behind it. There are several charitable institutions here for the instruction as well as relief of the poor; and this town is one of those included in the gift of the late Sir Thomas Whichcote.

The first charter of incorporation was granted to this town by Richard I. in the year 1198, when many valuable privileges, especially the exclusive fishery of the Colne between the north bridge and west bridge, were conferred upon the burgesses. Their charter has received repeated confirmations and extensions, from succeeding monarchs; the last, by which at present the government of the corporation is regulated, having been granted by his late majesty George III. in the year 1763.

The corporation now consists of a mayor, recorder, town-clerk, twelve alderman, eighteen assistants, eighteen common-councilmen, and inferior servants; it returns two members to parliament; the right of election being vested in the corporation and the burgesses who do not receive alms; the number of electors is estimated at 1400. It seems to have sent burgesses to parliament from the reign of Edward I.

Colchester enjoys an excellent market on Wednesday and Saturday, and, besides the manufacture of haize, furnishes employment to many of its inhabitants in the oyster fishery; the best of which are distinguished by the name of *pyesfeet*.

The following is said to be the method of managing them. In May the oysters cast their spawn, which the dredgers call spat; this resembles a drop of candle grease, and equals the size of a halfpenny; it cleaves to stones, old oyster shells, &c. at the bottom of the sea, which they call culch. It is conjectured, with some appearance of probability, that a shell begins to form upon the spat in twenty-four hours. In May the dredgers are permitted by the admiralty court to take oysters of every size. When they have taken them they raise the small breed from the culch with a knife, and then throw in the culch again to preserve the ground for the future, unless they are so newly spat that they cannot with safety be raised from the culch: they are in such cases permitted to take the stone or shell, &c. upon which the spat is, one shell having frequently twenty spats. It is felony to carry away the culch after May, and punishable to take any oysters of a size less than an half-crown piece, or of such a size as to admit of a shilling fairly rattling between the shells when closed.

Among modern improvements here are a new theatre in Queen-street, and a new market. To these may be added the erection of the new bridge over the Colne, called East Bridge; the levelling of St. John's Green, and the widening the road by St. Giles's church. There is a fine quay on the river, which has been rendered navigable, and the water flows from five to seven feet at neap, and from nine to ten feet at spring tides. Vessels of 100 tons or more can come up to it; and Colchester is considered a port, though eight or nine miles from the nearest sea. Distant fifty-one miles north-east from London, and eighteen S. S. W. of Ipswich.

COLCHESTER, a post town of Virginia, in Fairfax county, situated on the north-east bank of Occoquum creek, three or four miles from its confluence with the Potowmack; where it is about 100 yards wide, and navigable for boats. It lies sixteen miles south-west of Alexandria, 106 north by east of Richmond, and 172 from Philadelphia.

COLCHESTER, the chief town in Chittenden county, Vermont, on the east bank of lake Champlain, at the mouth of Onion River, and north of Burlington, on Colchester Bay, which spreads north of the town.

COLCHI, in ancient geography, a town of the Hither India, mentioned by Ptolemy and Arrian; supposed to be Cochin, on the coast of Malabar.

COLCHICUM, meadow saffron, a genus of the trigynia order, and hexandria class of plants, natural order ninth, sythaceæ: cor. sexpartite, with its tube radicated, or having its root in the ground: caps. three, connected and inflated. There are three species, all bulbous-rooted, low, perennials, and peculiar in that their leaves appear at one time, and their flowers at another;

the former rising long and narrow at the root in spring, and decaying in June; the flowers, which are monopetalous, long, tubular, erect, and six-parted, rise naked from the root in autumn, not more than four or five inches high. The root of this plant is poisonous. When young and full of sap, its taste is very acrid; but when old, mealy and faint.

COLCHIS, a country of Asia, at the south of Asiatic Sarmatia, east of the Euxine Sea, north of Armenia, and west of Iberia. It is famous for the expedition of the Argonauts, and as the birth-place of Medea. It was fruitful in poisonous herbs, and produced excellent flax. The inhabitants were originally Egyptians, who settled there when Sesostris king of Egypt extended his conquests in the north. It is now called Mingrelia, and belongs to the Turks.

COYLCOthAR, *n. s.* A term in chemistry. See VITRIOL.

Colcothar is the dry substance which remains after distillation, but commonly the caput mortuum of vitriol.

Colcothar, or vitriol burnt, though unto a redness, containing the fixed salt, will make good ink. *Quincy.*

COLD, *adj. & n. s.* } Sax. geliel. Wanting, }
CO'LDLY, *adv.* } or without heat; cold; }
CO'LDNESS, *n. s.* } frigid; applied intellectually, morally, and physically. The last application embraces whatever is chilling to the sense; the second to the obscure of all passionate excitement; the desititution of kindness and affection. In a good sense to chastity, and the frigid virtues; the principles that subdue the appetites and desires. The first describes an indifferent, inactive, unconcerned state of the mind; a mind without imagination; addicted to philosophy rather than poetry; clear, but gelid.

He knew the cause of every maladie,
 Were it of cold, or hote, or moist, or drie,
 And wher engendered, and of what humour:
 He was a veray parfitte practisous.

Chaucer. Canterbury Tales.

Upon the morve when that it was day,
 To Bretagne token they the righte way,—
 Aurelie, and this magicien him beside,—
 And ben descended ther they wold abide:
 And this was the bookes me remember,
 The colde frosty seson of December. *Id.*

So downe he tooke his lady in distresse,
 And layd her underneath a bush to sleepe,
 Covered with cold, and wrapt in wretchednesse;
 Whiles he himselfe all night did nought but weepe,
 And wayre watch about her for her safeguard keepe. *Spenser.*

There sprung up one kind of men, with whose zeal and forwardness the rest, being compared, were thought to be marvellous cold and dull.

Hooker's Preface.

Infinite shall be made cold in religion, by your example, that never were hurt by reading books.

Ascham.

Heat and cold are nature's two hands, whereby she chiefly worketh: and heat we have in readiness, in respect of the fire; but, for cold, we must stay till it cometh, or seek it in deep caves, or high mountains: and, when all is done, we cannot obtain it in any great degree. *Bacon's Natural History.*

Cold plants have a quicker perception of the heat of the sun than the hot herbs; as a cold hand will sooner find a little warmth than an hot. *Id.*

Smell this business with a sense as cold
As is a dead man's nose.

Shakespeare. Winter's Tale.

You may
Convey your pleasures in a spacious plenty,
And yet seem cold, the time you may so hoodwink;
We're willing dames enough. *Id. Macbeth.*

She made it good
At the edge corner, in the coldest fault. *Id.*

O noble English, that could entertain,
With half their forces, the full power of France;
And let another half stand laughing by,
All out of work, and cold for action. *Id. Henry V.*

New dated letters these,
Their cold intent, tenor, and substance thus;
Here doth he wish his person, and his power,
The which he could not levy. *Id. Henry IV.*

We should not, when the blood was cold, have
threatened our prisoners with the sword.

Id. Cymbeline.

My master's suit will be but cold,
Since she respects my mistress' love.

Id. Two Gentlemen of Verona.

What a deal of cold business doth a man mispend
the better part of life in? In scattering compliments,
tendering visits, following feasts and plays.

Ben Jonson.

The aggregated ail
Death, with his mace petrified, cold, and dry,
As with a trident smote. *Milton.*

Bids us seek

Some better shroud, some better warmth, to cherish
Our limbs benumbed, ere this diurnal star
Leave cold the night, how we his gathered beams
Relected, may with matter sero foment. *Id.*

Such was the discord, which did first disperse
Form, order, beauty, through the universe;
While dryness moisture, coldness heat resists,
All that we have, and that we are, subsists.

Denham.

Come little infant love me now,
While thy unsuspected years
Clear thy aged father's brow
From cold, jealousy, and fears. *Marvell.*

Love wisely had of long foreseen
That he must once grow old;
And therefore stored a magazine
To save him from the cold. *Id.*

When she saw her lord prepared to part,
A deadly cold ran shivering to her heart.

Dryden's Fables.

To see a world in flames, and an host of angels in
the clouds, one must be much of a stoic to be a cold
and unconcerned spectator.

Burnet's Preface to the Theory of the Earth.

Unhappy youth! how will thy coldness raise
Tempests and storms in his afflicted bosom.

Addison's Cato.

Let every tongue its various censures chuse,
Absolve with coldness, or with spite accuse. *Prior.*

Swift seemed to wonder what he meant,
Nor would believe my lord had sent;
So never offered once to stir,
But coldly said, Your servant, Sir. *Swift.*

The silver stream her virgin coldness keeps,
For ever murmurs, and for ever weeps.

Pope's Windsor Forest.

The diet in the state of manhood ought to be solid;
and their chief drink water cold, because in such a state
it has its own natural spirit. *Arbuthnot on Aliments.*

Cold the soft hand that soothed woe's weary head!
And quenched the eye, the pitying tear that shed!
And mute the voice whose pleasing accents stole
Infusing balm into the rankled soul. *Beattie.*

Restore those tranquil days that saw me still
Well pleased with all, but meet with human kind,
When Fancy roamed through nature's works at will,
Unchecked by cold distrust, and uninformed of ill. *Id.*

Coldness or anger, even disdain or hate
Are masks it often wears, and still too late.

Byron.

COLD, *n. s.* A disease induced by exposure
to the atmosphere in a too gelid state; or in a
state unsuited to the body at the time.

What disease hast thou?

A whoreson cold, Sir; a cough.

Shakespeare. Henry IV.

COLD, in fariery. See FARRIERY, Index.

COLD, in medicine. See MEDICINE, Index.

COLD, in natural philosophy, signifies, in a re-
lative sense, the sensation which accompanies a
transition of the fine vessels of the human body
from an expanded to a more contracted state. In
an absolute sense, it signifies the cause of this
transition; or, in general, the cause of the con-
traction of every substance, whether solid or fluid,
in nature. Great discussion has been excited in
modern times as to the nature of cold, whether
it be a positive or a negative quality.

Cold tends to make bodies electric which are
not so naturally, and to increase the electric pro-
perties of those which are. All bodies do not
transmit cold equally well; but the best conduc-
tors of electricity, viz. metals, are likewise the
best conductors of cold. When the cold has
been carried to such an extremity as to render
any body electric, it then ceases to conduct the
cold as well as formerly. This is exemplified in
the practice of the Laplanders and Siberians,
where the cold in winter is extremely severe.
In order to exclude it from their habitations the
more effectually, they cut pieces of ice, which in
the winter time must always be electric in these
countries, and put them into their windows;
which they find to be much more effectual in
keeping out the cold than any other substance.

Cold, as well as heat, may be produced arti-
ficially, though we have no method of making
cold increase itself as heat will do. The reason
of this is obvious; for, if it consist in a partial
cessation of motion in the elementary fluid, it is
plain, that though we may partly put an end to
this motion in a very small part of it, yet that
of the surrounding atmosphere, extending for an
immense way farther than we can extend our in-
fluence, will quickly counteract our operations,
and reduce the bodies to the same temperature
they were of before. Though there are therefore
some liquids which by mixture will produce con-
siderable degrees of cold, yet, by being left to
the action of the surrounding warm atmosphere,
the heat is quickly communicated from it to
them, and the effect of the mixture ceases. The
case is very different with heat; for this fluid, of
itself naturally very much inclined to motion, no
sooner finds an opportunity of exerting its ac-
tion, than vast quantities of what was for-
merly at rest rush from all quarters to the place
where the action has commenced, and continue

it until the equilibrium is restored. The power of producing cold belongs particularly to bodies of the saline class. In the Philosophical Transactions, No. 274, Mr. Geoffroy gives an account of some remarkable experiments with regard to the production of cold. Four ounces of sal ammoniac, dissolved in a pint of water, made his thermometer descend two inches and three-quarters in less than fifteen minutes. An ounce of the same salt put into four or five ounces of distilled water, made the thermometer descend two inches and a quarter. Half an ounce of sal ammoniac, mixed with three ounces of spirit of nitre, made the thermometer descend two inches and five lines; but on using spirit of vitriol, instead of nitre, it sunk two inches and six lines. In this last experiment it was remarked, that the vapors raised from the mixture had a considerable degree of heat, though the liquid itself was so extremely cold. Four ounces of saltpetre mixed with a pint of water, sunk the thermometer one inch three lines; but a little quantity of sea-salt sunk it only two lines. Acids always produced heat, even common salt with its own spirit. Volatile alkaline salts produced cold in proportion to their purity, but fixed alkalis heat. The greatest degree of cold produced by the mixture of salts and aqueous fluids was that shown by M. Homberg; who gives the following receipt for making the experiment: 'Take a pound of corrosive sublimate, and as much sal ammoniac; powder them separately, and mix the powders very exactly; put the mixture into a phial, pouring upon it a pint and a half of distilled vinegar, shaking all well together.' This composition grows so cold, that a man can scarce hold it in his hands in summer; and it happened, as M. Homberg was making the experiment, that the subject froze. The same thing once happened to M. Geoffroy in making an experiment with sal ammoniac and water, but it never was in his power to make it succeed a second time. If, instead of fluid water, we take it in its congealed state of ice, or rather snow, degrees of cold will be produced vastly superior to any yet mentioned. A mixture of snow and common salt sinks Fahrenheit's thermometer to 0; potashes and powdered ice sink it 8° farther; two affusions of spirit of salt on pounded ice sunk it 14½° below 0; but by repeated affusions of spirit of nitre Mr. Fahrenheit sunk it 40° below 0. This is the ultimate degree of cold which the mercurial thermometer will measure; because the mercury itself begins then to congeal; and therefore we must afterwards have recourse to spirit of wine, naphtha, or some other fluid which will not congeal. The greatest degree of cold hitherto producible by artificial means has been 80° below 0; which was done at Hudson's Bay by means of snow and vitriolic acid, the thermometer standing naturally at 20° below 0. Greater degrees of cold than this have indeed been supposed. Mr. Martin, in his Treatise on Heat, relates that at Kirenga in Siberia, the mercurial thermometer sunk to 118° below 0; and professor Brown at Petersburg, when he made the first experiment of congealing quicksilver, fixed the point of congelation at 350° below 0; but Dr. Black, as soon as the experiment was made

known in this country, observed, that in all probability the point of congelation was far above this. His reasons for supposing this were that the mercury descended regularly only to a certain point, after which it would descend suddenly and by starts 100° at a time. This, he conjectured, might proceed from the irregular contraction of the metal after it was congealed and he observed that there was one thermometer employed in the experiment which was not frozen and which did not descend so low by a great many degrees. Experience has since verified his conjecture; and it is now generally known, that 40° below 0 is the freezing point of quicksilver. Since the discovery of the possibility of producing cold by artificial means, various experiments have been made on the efficacy of saline substances in this way; all of which, when properly applied, are found to have a considerable degree of power. Dr. Boerhaave found that both sal ammoniac and nitre, when well dried in a crucible and reduced to fine powder, will produce a greater degree of cold than if they had not been treated in this manner. His experiments were repeated by Mr. Walker, apothecary to the Radcliffe Infirmary in Oxford, with the same result: but he found, that his thermometer sunk 32° by means of a solution of sal ammoniac; when Boerhaave's, with the same, fell only 28°. Nitre sunk it 19°. On mixing the two salts together, he found that the power of producing cold was considerably increased. By equal parts of these salts, he cooled some water to 22°, the thermometer standing at 47° in the open air. Adding to this some powder of the same kind, and immersing two small phials in the mixture, one containing boiled and the other unboiled water, he soon found them both frozen, the unboiled water freezing first. Having observed that Glauber's salt, when it retains the water of crystallisation, produces cold during its solutions, he tried its power when mixed with the other salts, and thus sunk the thermometer from 65° to 19°; and thus he was able to freeze water when the thermometer stood as high as 70°. And lastly, by first cooling the salts in water in one mixture, and then making another of the cooled thermometers, he was able to sink the thermometer 64°. Thus he froze a mixture of spirit of wine and water in the proportion of seven of the latter to one of the former; and by adding a quantity of cooled materials to the mixture in which this was frozen, the thermometer sunk to -4, or 69°. Spirit of nitre diluted with water reduced the thermometer to -3; and, by the addition of sal ammoniac, to 15. but the cold was not augmented by the addition of sal ammoniac or nitre.

The most remarkable experiment was with spirit of nitre poured on Glauber's salt, the effect of which was found to be similar to that of the same spirit poured on ice or snow; and the addition of sal ammoniac rendered the cold still more intense. The proportion of these ingredients, recommended by Mr. Walker, are concentrated nitrous acid two parts by weight, water one part; of this mixture cooled to the temperature of the atmosphere eighteen ounces, of Glauber's salt a pound and a half avoirdupois, and of sal ammoniac twelve ounces. On adding the

Glauber's salt to the nitrous acid, the thermometer fell from 50° to -1° , or fifty-two degrees; and, on the addition of the sal ammoniac, to -9° . Thus Mr. Walker was able to freeze quicksilver without either ice or snow, when the thermometer stood at 45° . For the experiment four pans were procured of different sizes, so that one might be put within the other. The largest of these pans was placed in a vessel still larger, in which the materials for the second frigorific mixture were thinly spread in order to be cooled; the second pan, containing the liquor, viz. the vitriolic acid properly diluted, was placed in the largest pan; the third pan, containing the salts for the third mixture, was immersed in the second pan likewise, and floated round the third pan: and the liquor for the third mixture was put into wide-mouthed phials, which were immersed in the second pan likewise, and floated round the third pan; the fourth pan, which was the smallest of all, containing its cooling materials, was placed in the midst of the salts of the third pan. The materials for the first and second mixtures consisted of diluted vitriolic acid and Glauber's salt; the third and fourth of diluted nitrous acid, Glauber's salt, and sal ammoniac, in the proportions above mentioned. The pans being adjusted, the materials of the first and largest pan were mixed: this reduced the thermometer to 10° , and cooled the liquor in the second pan to 20° ; and the salts for the second mixture which were placed underneath in the large vessel nearly as much. The second mixture was then made with the materials thus cooled, and the thermometer was reduced to 3° . The ingredients of the second mixture by immersion in this, were cooled to 10° , and, when mixed, reduced the thermometer to -15° . The materials for the fourth mixture were cooled by immersion in this third mixture to about -12° . On mixture they sunk the mercury very rapidly, and seemingly below -40° , though the froth occasioned by the ebullition of the materials prevented any accurate observation. The reason why this last mixture reduced the thermometer more than the third, though both were of the same materials, and the latter of a lower temperature, was supposed to have been, partly, because the fourth pan had not another immersed in it, to give it heat, and partly because the materials were reduced to a finer powder. The experiments were repeated with many variations; but only one mixture appeared to Dr. Beddoes, by whom the account was communicated to the Royal Society, to be applicable to any useful purpose. This is oil of vitriol diluted with about an equal quantity of water; which, by dissolving Glauber's salt, produces about 46° of cold, and by the addition of sal ammoniac becomes more intense by a few degrees. At one time, when Mr. Walker was trying a mixture of two parts of oil of vitriol and one of water, he perceived, that at the temperature of 35° the mixture coagulated as if frozen, and the thermometer became stationary; but on adding more Glauber's salt, it fell again in a short time: but less cold was produced than when this circumstance did not occur, and when the acid was weaker. The same appearance of coagulation took place with other proportions of acid and water, and

with other temperatures. The effect of Glauber's salt in producing cold took place only when it was possessed of its water of crystallisation; and thus the mineral alkali also augmented the cold of some of the mixtures: but, when the water of crystallisation was dissipated, neither of them had any effect of this kind. 'This circumstance,' says Dr. Beddoes, 'leads us to some measure of the theory of the phenomenon. Water undoubtedly exists in a solid state in crystals; it must, therefore, in other cases absorb a determinate quantity of fire before it can return to its liquid state. On this depends the difference between Glauber's salt and mineral alkali, in its different states of crystallisation and efflorescence. The same circumstance, too, enables us to understand the great effect of Glauber's salt; which, as far as I understand, has the greatest quantity of water of crystallisation.' On this the reviewers remark, that 'if in summer the water brought from a deep well is at 52° , in this cheap and easy way it might be reduced to 12° ; and wine placed in it would be chilled.' These excessive degrees of cold occur naturally in many parts of the globe in the winter. It is true, we are very much unacquainted with them in this country: yet in the winter of 1780, Mr. Wilson of Glasgow observed, that a thermometer laid on the snow sunk to 25° below 0; but this was only for a short time; and in general our atmosphere does not admit of very great degrees of cold for any length of time. Mr. Derham however, in 1708, observed in England, that the mercury stood within one-tenth of an inch of its station when plunged into a mixture of snow and salt. In 1732 the thermometer at Petersburg stood at 28° below 0; and in 1737, when the French academicians wintered at the north polar circle, or near it, the thermometer sunk to 33° below 0; and, in the Asiatic and American continents, still greater degrees of cold are very common.

By extreme degrees of cold, trees are burst, rocks rent, and rivers and lakes frozen several feet deep: metallic substances blister the skin like red hot iron: the air, when drawn in by respiration, hurts the lungs, and excites a cough; even the effects of fire in a great measure seem to cease; and metals, though kept for a considerable time before a strong fire, will still freeze water when thrown upon them. When the French mathematicians wintered at Tornea in Lapland, the external air, when suddenly admitted into their rooms, converted the moisture of the air into whirls of snow; their breasts seemed to be rent when they breathed it; the contact of it was intolerable to their bodies; and the spirit of wine, which had not been highly rectified, burst some of their thermometers by the congelation of the aqueous part. Extreme cold very often proves fatal to animals, in countries where the winters are very severe. Thus 7000 Swedes perished, at once, in attempting to pass the mountains which divide Norway from Sweden. It is not necessary, indeed, that the cold, in order to prove fatal to human life, should be so very intense as has been just mentioned. There is only requisite a degree somewhat below 32° of Fahrenheit, accompanied with snow or hail, from which shelter cannot be obtained. The snow

which falls upon the clothes, or the uncovered parts of the body, then melts, and by a continual evaporation carries off the animal heat to such a degree, that a sufficient quantity is not left for the support of life. In such cases, the person first feels himself extremely chill and uneasy; then begins to grow listless, unwilling to walk or use exercise to keep himself warm; and at last becomes drowsy, sits down to refresh himself with sleep, and wakes no more. An instance of this was seen not many years ago at Terra del Fuego, where Dr. Solander, with some others, having taken an excursion up the country, the cold was so intense, that one of their number died. The Doctor himself, though he had warned his companions of the danger of sleeping in that situation, could not be prevented from making that dangerous experiment himself; and though he was awaked with all possible expedition, his body had so much shrunk in bulk, that his shoes fell off his feet, and it was with the utmost difficulty that he was recovered. In those parts of the world where vast masses of ice are produced, the accumulation of it, by absorbing the heat of the atmosphere, occasions an absolute sterility in the adjacent countries, as is particularly the case with the island of Iceland, where the vast collections of ice floating out from the Northern Ocean, and stopped on that coast, are sometimes several years in thawing. Indeed, where great quantities of ice are collected, it would seem to have a power like fire, of both augmenting its own quality and of communicating it to adjacent bodies.

The conversion of all temperatures, however low, of any liquid or solid whatever, into a vapor, is uniformly accompanied with the abstraction of heat from surrounding bodies, or, in popular language, the production of cold; and the degree of refrigeration will be proportional to the capacity of the vapor for heat, and the rapidity of its formation. The application of this principle to the uses of life, was first suggested by Drs. Cullen and Black, but it has been greatly improved and extended by Mr. Leslie. Dr. Cullen seems to have been the first who applied the vacuum of an air-pump to quicken the evaporation of liquids, with a view to the abstraction of heat, or the production of artificial cold and congelation. In the year 1755 he plunged a full phial of ether into a tumbler of water, and on placing it under the receiver, and exhausting the air, the ether boiled, and the surrounding water froze. Mr. Edward Nairne, a London optician, published in 1777 in the Transactions of the Royal Society, 'an account of some experiments made with an air-pump.' After stating, that at a certain point of rarefaction the moisture under the pump furnished an atmosphere of vapor, which effected his comparative results with the mercurial gauge and pear gauge, he says, 'I now put some sulphuric acid into the receiver, as a means of trying to make the remaining contents of the receiver, when exhausted as much as possible, to consist of permanent air only, unadulterated with vapor.' He was thus enabled by this artificial dryness to exhibit certain electrical phenomena to great advantage. The next step which Mr. Nairne took, was to produce artificial cold by the air-pump. 'Having lately received

from my friend Dr. Lind,' says he, 'some ether prepared by' the ingenious Mr. Woolfe, I was very desirous to try whether I could produce any considerable degree of cold by the evaporation of ether under a receiver whilst exhausting.' Accordingly he succeeded in sinking a thermometer, whose bulb was from time to time dipped into the ether in vacuo, 103° below 56° , the temperature of the apartment. Mr. Nairne made no attempt to condense the vapor in vacuo by chemical means, and thus to favor its renewed formation from the liquid surface; which we consider to be the essence of professor Leslie's capital improvement on Cullen's plan of artificial refrigeration. After Nairne's removing the vapor of water by sulphuric acid, to produce artificial dryness, there was indeed but a slight step to the production of artificial cold, by the very same arrangement; but still this step does not appear to have been attempted by any person from the year 1777 to 1810, when professor Leslie was naturally led to make it, by the train of his researches on evaporation and hygrometry.

Having in the month of June introduced a surface of sulphuric acid under the receiver of an air-pump, and also a watch glass filled with water, he found that after a few strokes of the pump, the water was converted into a solid cake of ice, which being left in the rarefied medium, continued to evaporate, and after the interval of about an hour totally disappeared. When the air has been rarefied 250 times, the utmost that under such circumstances can perhaps be effected, is that the surface of evaporation is cooled down 120° Fahrenheit in winter, and would probably, from more copious evaporation and condensation, sink nearly 200° in summer. If the air be rarefied only fifty times, a depression of 80° , or even 100° will be produced.

We are thus enabled by this elegant combination, to freeze a mass of water in the hottest weather, and to keep it frozen, till it gradually waste away, by a continued but invisible process of evaporation. The only thing required is, that the surface of the acid should approach tolerably near that of the water, and should have a greater extent; for otherwise the moisture would exhale more copiously than it could be transferred and absorbed, and consequently the dryness of the rarefied medium would become reduced, and its evaporating energy essentially impaired. The acid should be poured to the depth of perhaps half an inch, in a broad flat dish, which is covered by a receiver of a form nearly hemispherical; the water exposed to congelation may be contained in a shallow cup, about half the width of the dish, and having its rim supported by a narrow porcelain ring, upheld above the surface of the acid by three slender feet. It is of consequence that the water should be insulated as much as possible, or should present only a humid surface to the contact of the surrounding medium; for the dry sides of the cup might receive, by radiation from the external air, such accessions of heat as greatly to diminish, if not to counteract the refrigerating effects of evaporation. This inconvenience is in a great measure obviated, by investing the cup with an outer case, at the interval of about half an inch. If both the cup and

its case consist of glass, the process of congelation is viewed most completely; yet when they are formed of a bright metal, the effect appears, on the whole, more striking. But the preferable mode, and that which prevents any waste of the powers of refrigeration, is to expose the water in a saucer of porous earthen-ware. At the instant of congelation, a beautiful net-work of icy spicula pervades the liquid mass.

The disposition of the water to fill the receiver with vapor, will seldom permit even a good air-pump to produce greater rarefaction than that indicated by three-tenths of an inch of mercury, beneath the barometrical height, at the time. But every practical object may be obtained by more moderate rarefactions, and a considerable surface of acid. The process goes on more slowly, but the ice is very solid, especially if the water have been previously purged of its air by distillation, or boiling for a considerable time. If we use a receiver, with a sliding wire passing down from its top through a collar of leathers, and attach to it a disc of glass; or on applying this to the surface of the water cup, we may instantly suspend the process of congelation; and raising the disc as suddenly, permit the advancement of the process.

'In exhibiting the different modifications of this system of congelation to my pupils,' says Dr. Ure, 'I have been accustomed for many years to recommend the employment of a series of cast-iron plates, attachable by screws and stop-cocks to the air-pump. Each iron disc has a receiver adapted to it. Thus we may, with one air-pump, successively put any number of freezing processes in action. A cast-iron drum of considerable dimensions being filled with steam, by heating a small quantity of water in it, will sufficiently expel the air for producing the requisite vacuum. When it is cooled by affusion of water, one of the above transferrer plates being attached to the stop-cock on its upper surface would easily enable us, without any air-pump, to effect congelation by means of sulphuric acid, in the attenuated atmosphere. Suppose the capacity of the receiver to be one-sixtieth of the iron cylinder; or aeriform rarefaction to this degree would be effected in a moment by a turn of the stop-cock; and, on its being returned, the moisture below would be cut off, and the acid would speedily condense the small quantity of vapor which had ascended. This cheap and powerful plan was publicly recommended by me upwards of ten years ago, when I had a glass model of it made for class illustration.'

The combined powers of rarefaction, vaporisation, and absorption, are capable of effecting the congelation of quicksilver. If this metal, contained in a hollow pear-shaped piece of ice, be suspended by cross threads near a broad surface of sulphuric acid, under a receiver; on urging the rarefaction it will become frozen, and may be kept in the solid state for several hours. Or otherwise, having introduced mercury into the large bulb of a thermometer, and attached the stem to the sliding rod of the receiver, place this over the sulphuric acid and water cup on the air-pump plate. After the air has been rarefied about fifty times, let the bulb be dipped repeatedly into the very cold but unfrozen water, and

again drawn up about an inch. In this way it will become incrustated with successive coats of ice, to the twentieth of an inch thick. The cup of water being now withdrawn from the receiver, the pendent icicle cut away from the bulb, and the surface of the ice smoothed with a warm finger, the receiver is again to be replaced, and the bulb being let down within half an inch of the acid, the exhaustion must be pushed to the utmost. When the syphon-gauge arrives at the tenth of an inch, the icy crust opens with fissures, and the mercury, having gradually descended in the tube till it reach its point of congelation, or 39° below zero, sinks by a sudden contraction almost into the cavity of the bulb. The apparatus being now removed, and the ball speedily broken, the metal appears a solid shining mass, that will bear the stroke of a hammer. A still greater degree of cold may be produced, by applying the same process to cool the atmosphere which surrounds the receiver.

When the acid has acquired one-tenth of water, its refrigerating power is diminished only one-hundredth. When the quantity of moisture is equal to one-fourth of the concentrated acid, the power of generating cold is reduced by a twentieth; and, when the dilution is one-half, the cooling powers become one-half or probably less. Sulphuric acid is hence capable of effecting the congelation of more than twenty times its weight of water, before it has imbibed nearly its own bulk of that liquid, or has lost about one-eighth of its refrigerating power. The acid should then be removed, and reconcentrated by heat.

The danger of using a corrosive acid in unskilful hands may be obviated by using oatmeal, desiccated nearly to brownness before a kitchen fire, and allowed to cool in close vessels. With a body of this, a foot in diameter and an inch deep, professor Leslie froze a pound and a quarter of water, contained in a hemispherical porous cup. Muriate of lime in ignited porous pieces, may also be employed as an absorbent. Even mouldering trap or whinstone has been used for experimental illustration with success.

By the joint operation of radiation and evaporation, from the surface of water, the natives of India are enabled to procure a supply of ice, when the temperature of the air is many degrees above the freezing point. Not far from Calcutta, in large open plains, three or four excavations are made in the ground, about thirty feet square and two feet deep, the bottom of which is covered to the thickness of nearly a foot with sugar canes, or dried stalks of Indian corn. On this bed are placed rows of small unglazed earthen pans, about an inch and a quarter deep, and somewhat porous. In the dusk of the evening, during the months of December, January, and February, they are filled with soft water, previously boiled and suffered to cool. When the weather is very fine and clear, a great part of the water becomes frozen during the night. The pans are regularly visited at sunrise, and their contents emptied into baskets which retain the ice. These are now carried to a conservatory made by sinking a pit fourteen or fifteen feet deep, lined with straw under a layer of coarse blanketing. The small

sheets of ice are thrown down into the cavity, and rammed into a solid mass. The mouth of the pit is then closed up with straw and blankets, and sheltered by a thatched roof.

COLDENIA, in botany, a genus of the tetragynia order, the tetrandria class of plants: *CAL.* tetraphyllous; *COR.* funnel-shaped; *STYLES* four; *SEEDS* two, bilocular. There is but one species, a native of India. It is an annual plant, whose branches trail on the ground, extending about six inches from the root. They are adorned with small blue flowers, growing in clusters, which come out from the wings of the leaves. They are propagated by seeds sown on a hot bed; when the plants come up, they may be removed each into a separate pot, and plunged into a hot bed of tanner's bark, where they are to remain constantly.

CODDING, or **KOLDING** a small town of Jutland, formerly the residence of the Danish kings and a considerable sea-port, but its harbour is now so choked with sand that its navigation is completely destroyed. Its castle on a hill, is a place of much importance being situated near the Sleswick frontier from which town it is but sixty-two miles distant. Lat. 55° 30' N., long. 9° 29' E.

COLDINGHAM, a parish of Scotland, in Berwickshire, nearly seven miles long and as many broad, but of a very irregular figure. It was formerly one great common, but was divided among the proprietors, about 1773, by authority of the Court of Session.

COLDINGHAM, a town in the above parish, supposed to be the Colonia of Ptolemy, and called by Bede the city of Colud, Coludum and Coldana. It was famous many ages ago for its convent which was the oldest nunnery in Scotland; for here Ethelreda took the veil in 1670. From the ancient name, Coludum, it would seem that it had been formerly inhabited by the religious called Culdees. In 870 it was destroyed by the Danes, but its name has been rendered immortal by the heroism of its nuns; who, to preserve themselves inviolate from those invaders, cut off their lips and noses; and thus rendering themselves objects of horror, were, with their abbess Ebba, burnt in the monastery by the disappointed savages. After this it lay deserted, till the year 1098, when king Edward founded on its site a priory of benedictines in honor of St. Cuthbert, and bestowed it on the monks of Durham. It has fairs, 25th July, and 24th of October. It is two miles and a half north-west of Eyemouth, and eight N. N. W. of Berwick.

COLDITZ, a town of Germany, in the circle of Leipsic, seated on the Mulda, ten miles north-east of Leipsic. It was several times pillaged by the Swedes and Hussites, during the civil wars of Germany, in the seventeenth century.

COLDSTREAM, a town of Scotland seated on the Tweed, over which it has a fine stone bridge to Cornhill in England. Here General Monk fixed his head quarters before he marched into England to restore Charles II. and raised that regiment, which is still called the Coldstream regiment of Guards. Few towns are better situated than Coldstream for manufactures. The banks of the Tweed are rich in corn and cattle, and coals are cheap. The roads from Berwick

to London, from Berwick to Kelso, and from Dunse to England, all pass through the town. The excellence of the wool from the neighbouring district, points out the woollen manufacture as being adapted to the place. No extensive trade, however, is carried on. It has fairs, 30th July and 12th November. It is 332 miles and a half north of London, and eleven south-west of Berwick.

COLE (Henry) D. D. was a native of Gadshill in the Isle of Wight, and elected from Winchester school to a fellowship at New College, Oxford. Having graduated as a bachelor of civil law he visited Italy, and on his return practised in the court of Arches. He obtained under Henry the VIIIth, the living of Chelmsford in Essex, with a stall in St. Paul's cathedral, and an archdeaconry; together with the wardenship of his college, to which he was elected in 1542, with the living of Newton Longueville, Bucks. In the next reign, however, he honestly sent in a resignation of his benefices; from his objections to the reformed doctrine of the Church, a circumstance not forgotten by Queen Mary, who made him provost of Eton, dean of St. Paul's, and judge of the court of Arches. He preached at Archbishop Crammer's execution, and was deprived of all his appointments by Queen Elizabeth. He died in prison in 1519.

COLE (Thomas), an eminent dissenting minister of the seventeenth century. He was educated at Westminster school, from whence he was elected student of Christ Church, Oxford, where he took his degree of M. A. In 1656 he was appointed principal of St. Mary Hall, where he was tutor to Locke. At the Restoration he was ejected for non-conformity, upon which he opened an academy at Nettlebed, but afterwards removed to London, where he settled, and became one of the lecturers at Pinner's Hall. He died in 1697. He wrote a Discourse on Regeneration, Faith, and Repentance, 8vo.; a Discourse of the Christian Religion in Sundry Points, 8vo.; the Incomprehensibility of imputed Righteousness by Human Reason, &c. 8vo.; and other tracts.

COLEBROOK, a rough hilly township of the United States, on the north line of Connecticut, in Litchfield county, thirty miles north-west of Hartford city. It was settled in 1756. Here are two iron works, and several mills, on Still river, a north-west water of Farmington river. In digging a cellar in this town, in 1796, the workmen, at the depth of about nine or ten feet, found three large tusks and two thigh bones of an animal, the latter of which measured each about four feet four inches in length, and twelve inches and a half in circumference. When first discovered they were entire, but as soon as they were exposed to the air they mouldered to dust. This adds another to the many facts which prove that a race of enormous animals, now extinct, once inhabited North America.

COLEBROOK DALE, a winding valley in the eastern part of Shropshire, on the banks of the Severn, between two vast mountains, which divide in various romantic forms, and are covered with beautiful hanging woods. In making a navigable canal to the Severn, in 1787, several springs of excellent native tar, or petroleum, were

here discovered, which, though now much reduced, flowed so copiously at first, as to afford from seventy to eighty gallons per day; so that barrels could hardly be got ready fast enough to barrel it up. A spring of brine was also discovered, as strong as most of that used for making salt. A work for obtaining mineral tar, from the condensed smoke of pit-coal, has been erected, and the most extensive iron works in England are established in this dale; which, with the bridge of cast iron over the Severn, add much to the natural romantic scenery of the place. 'The noise of the forges, mills, &c. (says Mr. Young) with all their vast machinery; the flames bursting from the furnaces, with the burning of coal, and the smoke of the lime kilns, are altogether horribly sublime.' The iron bridge was erected in 1779; the road over it, made of clay and iron flag, a foot deep, is twenty-four feet wide; the span of the arch is 100 feet six inches; and the height from the base to the centre forty feet. The weight of iron in all is 178 tons and a half.

COLEOPTERA, or beetle, the name of Linnaeus's first order of insects, thus ordinarily characterised, wings four, the upper crustaceous:—with a straight suture: giving the appearance of being covered with crustaceous shells. See ENTOMOLOGY.

COLERAIN, a large town of Ireland, in the county of Londonderry and province of Ulster, seated on the river Bann, four miles south of the coast. It was formerly a place of great consideration, being the chief town of a county erected by Sir John Perrot, during his government of Ireland; whereas it is now only the head of one of the baronies in the county of Londonderry; but it is still a corporation, and sends one member to the Imperial Parliament. It is very elegantly built. The port is indifferent, occasioned by the extreme rapidity of the river, which repels the tide, and makes the coming up to the town difficult; so that it has little trade, except its valuable salmon fishery, which amounts to some thousand pounds a year. Colerain is twenty miles north-east of Londonderry, and 114 from Dublin.

COLERAIN, a town of the United States in Georgia, on the north bank of St. Mary's river, Camden county, about forty-five miles from its mouth. On the 29th of June, 1796, a treaty of peace and friendship was concluded at this place, between the United States on one part, and the chiefs and warriors of the Creek nation on the other.

COLES (Elisha), a native of Northamptonshire, was born about the commencement of the seventeenth century, and embarked in trade, but afterwards became manciple at Magdalen College, Oxford, under the commonwealth. The Restoration displaced him; he however obtained a clerkship in the service of the East India Company. He published a highly Calvinistic work in favor of the doctrine of predestination, which is still held in estimation by the sect to which he belonged. He died in 1688.

COLES (E.), nephew of the above, was born in the same county, about the year 1640, and entered of the college of which his relation was a retainer. After the Restoration he first supported himself by private tuition in London, then be-

came usher at Merchant Tailors' school; but lost the situation by some alleged misconduct. Little of the particulars of his life is known; he died in Ireland in 1680, having compiled two dictionaries; one of his vernacular language, the other of Latin and English, with a correspondent rendering of English into Latin. Also *The Young Scholar's best Companion*; *A Hieroglyphical Bible for Youth*; *A Natural Method of Learning Latin*, 8vo.; *The complete English Schoolmaster*, 8vo.; *A System of Stenography*; a treatise bearing the whimsical title of *Nolens Volens, or you shall make Latin whether you will or no*; and a *Harmony of the Evangelists*.

COLESEED, *n. s.* From cole and seed. Cabbage seed.

Where land is rank, it is not good to sow wheat after a fallow; but *coleseed* or barley, and then wheat. *Mortimer.*

COLE-SEED, the seed of the *napus sativa*, or long-rooted, narrow leaved rape, called in English *navew*, and reckoned by Linnaeus among the brassicas or cabbage kind. See **BRASSICA**. This plant is cultivated to great advantage in many parts of England, on account of the rape oil expressed from its seeds. The practice of sowing it was first introduced by those Germans and Dutchmen who drained the fens of Lincolnshire; and hence the notion has generally prevailed, that it will thrive only in a marshy soil; but this is now found to be a mistake. In preparing the land, care must be taken to plough it in May, and again about midsummer, making the ground as fine and even as possible. It must be sown the very day of the last ploughing, about a gallon on an acre. In January, February, and March, it affords good food for cattle, and will sprout again when cut; after which it is excellent nourishment for sheep. If it is not too closely cropped, it will, after all, bear seed in July. The same caution however, is requisite with this food as with clover, till cattle are accustomed to it, as it is apt otherwise to swell them. When cultivated solely for the seed, it must be sown on deep strong land without dung, and must stand till one-half of the seeds at least are turned brown; which will be earlier or later, according to the season. In this state it is to be cut like wheat, and with the same care. Every handful as it is cut should be regularly ranged on sheets, that it may dry leisurely in the sun, which will commonly be in a fortnight; after which it must be carefully threshed out, and carried to the mill for expressing the oil. The produce of cole-seed is generally from five to eight quarters on an acre.

COLES-HILL, a market town of Warwickshire, seated on the Colne, at the side of a hill. It consists of one long street, with a smaller one branching from the middle towards the churchyard, which is on the summit of the eminence. The church is a very old structure, with a handsome decorated Gothic tower and spire. It has a market on Wednesday. It is eleven miles north-west of Coventry, and 104 from London.

COLESHY, a town of Southern India, in the province of Travancore. Here is a small harbour, where ships are secured from north and east winds, by the shelter of some rocks. The

Danes formerly had a small factory here Long. 77° 11 E., lat. 8° 12' N.

COLET (John), D. D., dean of St. Paul's, and son of Henry Colet, knight, was born in London in 1466. He was sent to Magdalen College, Oxford, where he remained seven years. About 1493 he went to Paris, and thence to Italy. On his return to England in 1497 he took orders, and read lectures gratis at Oxford, on the epistles of St. Paul. At this time he possessed the rectory of Dennington, and was also prebendary of York, and canon of St. Martin's le Grand. In 1502 he became prebendary of Sarum; prebendary of St. Paul's in 1505; and immediately after dean of that cathedral, having taken the degree of D. D. He was also chaplain to Henry VIII. He introduced the practice of preaching and expounding the Scriptures; and soon after established a perpetual divinity lecture in St. Paul's church, three days in the week; an institution which paved the way for the reformation. About 1508 dean Colet formed his plan for the foundation of St. Paul's school, which he completed in 1512, and endowed with estates, which now amount to a very large sum. In his station he so labored to restore discipline as to bring upon himself the charge of heresy: the clergy, whom he attempted to reform, became his enemies, and bishop Fitzjames complained of him to Warham, archbishop of Canterbury, who dismissed him without a hearing. Being seized with the sweating sickness, he died in 1519, aged fifty-three. He wrote, 1. Rudimenta Grammaticæ; 2. The Construction of the Eight Parts of Speech; 3. Daily Devotions; 4. Epistolæ ad Erasmus; 5. Several sermons; and other works which still remain in MS.

COLEWORT, *n. s.* Sax. *cahlþyrt*. A species of cabbage.

The decoction of *coleworte* is also recommended to bathe them.

Wiseman of an Erysipelas.

She took the *coleworts* which her husband got from his own ground (a small well-watered spot); She stripped the stalks of all their leaves; the best she culled, and then with handy care she dressed.

Dryden.

How turnips hide their swelling heads below,
And how the closing *coleworts* upward grow. *Gay.*

COLEWORT. See BRASSICA.

COLFORD, a town in Gloucestershire on the borders of Monmouthshire, near which there are considerable iron-works. It has a market on Friday; fairs, June 20th, and November 24th. It is twenty-three miles W. S. W. of Gloucester, and 124 from London.

COLIBERTI, or COLIBERTS, in law, were tenants in soccage, and particularly such villeins as were manumitted or made freemen. But they had not an absolute freedom; for, though they were better than servants, yet they had superior lords to whom they paid certain duties, and, in that respect, might be called servants, though they were of middle condition between freemen and servants.

COLIBRI, a species of humming bird in Brasil. See TROCHILUS.

COLIC, *n. s. & adj.* Lat. *colicus*. It strictly is a disorder of the colon; but loosely, any disorder of the stomach or bowels that is at-

tended with pain. There are four sorts: 1. A bilious colic, which proceeds from an abundance of acrimony or choleric irritating the bowels, so as to occasion continual gripes, and generally with a looseness; and this is best managed with lenitives and emollients. 2. A flatulent colic, which is pain in the bowels, from flatuses and wind, which distend them into unequal and unnatural capacities; and this is managed with carminatives and moderate openers. 3. An hysterical colic, which arises from disorders of the womb, and is communicated by consent of parts to the bowels; and is to be treated with the ordinary hysterics. 4. A nervous colic, which is from convulsive spasms and contortions of the guts themselves from some disorders of the spirits, or nervous fluid, in their component fibres; whereby their capacities are, in many places, strengthened, and sometimes so as to occasion obstinate obstructions: this is best remedied by brisk cathartics, joined with opiates and emollient diluters. There is also a species of this distemper, which is commonly called the stone colic, by consent of parts, from the irritation of stone or gravel in the bladder or kidneys; and this is most commonly to be treated by nephritics and oily diuretics, and is assisted with the carminative turpentine clysters.

Colicks of infants proceed from acidity, and the air in the aliment expanding itself, while the aliment ferments. *Arbuthnot.*

Intestine stone and ulcer, *colick pangs.* *Milton.*

COLICA, in medicine, the colic, a well known disease; characterised by a pain in the belly, and a sensation like a twisting of the intestines, attended with vomiting and costiveness. This disease is classed by Cullen under the class neuroses, order spasmi. It is occasioned very frequently by the poison of white lead. See MEDICINE.

COLIGNI (Gaspard De), admiral of France, was born in 1516. He signalised himself in his youth, in the reigns of Francis I. and Henry II., and was made colonel of infantry, and admiral of France, in 1552. Henry II. employed him in the most important affairs; but, after the death of that prince, he embraced the reformed religion, and became the chief of the protestant party: he strongly opposed the house of Guise, and rendered this opposition so powerful, that it was thought he would have overturned the French government. On the peace made after the battles of Jarnac and Montcontour, Charles IX. deluded Coligni into security by his deceitful favors; and, though he recovered one attempt upon his life, when he attended the nuptials of the prince of Navarre, he was included in the dreadful massacre of the protestants on St. Bartholomew's Day, 1572, and his body treated with wanton brutality by a misguided popish populace. A party, headed by the duke of Guise, broke into his house, and one of the servants of the latter named Besme, drawing his sword, the admiral said calmly, 'young man, you ought to respect my gray hairs; but do as you please, you can only shorten my life a few days.' Besme stabbed him repeatedly, and throwing his body through the window, it was for three days exposed to the in-

suits of the mob, and hung by the feet upon a gibbet. It was at length taken down by his cousin Montmorency, and buried in the chapel of Chantilly. Catherine de Medicis had his head embalmed, and sent as a present to Rome.

COLIMA, a small town of Mexico, situated in a large fertile valley of the same name, which produces cocoa, cassia, and sometimes gold. Near this town is a volcano with two peaks, from both of which smoke continually issues, and it occasionally belches forth flames. According to Dampier, this mountain is in lat. 18° 54' N., and long. 103° 24' W. The town is included in the intendancy of Guadalajara, and is 451 miles west from Mexico.

COLIN, or **KOLLIN**, a town of Bohemia, on the Elbe, with a castle of considerable strength. Garnets and topazes are procured in the neighbourhood, the polishing, &c., of which give employment to many of the inhabitants. Near here is the castle of Chotzemitz, where was fought the celebrated battle of that name between the Austrians and Prussians, June 18th, 1757. Colin is included in the circle of Kaurzim, and is twenty-eight miles east of Prague.

COLIOURE, a small, but ancient and strong town of France, in the department of Eastern Pyrenees, with a small port on the Mediterranean, defended by a castle on a rock. It is chiefly inhabited by fishermen. It was taken by the Spaniards in December, 1793, but surrendered to the French, with all its artillery and stores, after a siege of nineteen days, on the 26th of May, 1794. The national convention decreed that a column should be erected on the spot, in memorial that 'here 7000 Spaniards laid down their arms before the republicans.' It is five leagues south east of Perpignan, and five east of Ceret.

COLISEUM, the amphitheatre built at Rome by Vespasian. See **AMPHITHEATRE** and **CIRCUS**.

COLITES, in natural history, a name given by some writers to a kind of pebble, found in the shape of the human penis and testes, either separately or together.

COLLAERT (Adrian), an eminent engraver who flourished about 1550, born at Antwerp. After having learned the principles of engraving, he went to Italy. He worked entirely with the graver, in a firm neat style, but rather stiff and dry. The vast number of plates executed by him evince the facility with which he engraved; but though exceedingly neat, they are seldom highly finished.

COLLAERT (John), the son of Adrian, was also an excellent artist. He drew and engraved in the style of his father; and was equal to him in merit. He must have been very old when he died; for his prints are dated from 1555 to 1622. He assisted his father, and engraved besides a prodigious number of plates on various subjects. One of his best prints is Moses striking the rock, lengthwise, from Lambert Lombard. A great number of small figures are introduced into this print; and they are admirably well executed: the heads are fine, and the drawing very correct.

COLLAHUAS, a province of Peru, South America, bounded on the north by that of Chumbivilcas, east by that of Canes and Canches,

south-east by that of Lampa, south by that of Arequipa, and west by that of Camana. It is fifty-two leagues in length, south-east and north-west, and sixteen wide. Being situated in the Andes, its general temperature is bleak, but that part which borders on Camana is mild. The valleys produce wine, brandies, maize, wheat, pulse, and figs, which are preserved extensively as food. Other parts of this province feed large and small cattle, and native sheep. The whole province is very rocky, and the roads ill contrived and rough. It is rich, however, in silver mines, which are of great depth. Here are also gold, tin, lead, copper, and sulphur mines. The capital is Cailloma.

COLLA'PSE, *n. s.* } Lat. *collabor*, *collap-*
COLLA'PSION, *n. s.* } *sus*. To fall together; to close so as that one side touches the others. The act of closing; the state of vessels closed.

In consumptions and atrophy the liquids are exhausted, and the sides of the canals collapse; therefore the attrition is increased, and consequently the heat. *Arbushnot on Diet.*

COLLAR, *n. s.* & *v. a.* Lat. *collare*; Fr. *collier*. Whatever encloses the neck, even the clavicle, the bones on each side the neck are called the collar-bone; that which surrounds the neck of whatever constructed, and for whatever purpose worn, is the collar. To slip the collar is to get free, to disentangle from the collar, but this applies to collar only when it is the badge or instrument of slavery and drudgery. To collar is to seize by the collar, or the throat. But both the noun and verb are used in a different sense, as derived from Fr. *lier*, *colier*, Lat. *colligare*, it is applied to meat tied together to be cooked. A collar of brawn is the quantity bound up in one parcel. To collar beef, or other meat is to roll it up, and bind it hard and close with a string or collar.

The tapes of her white volupere,
Were of the same suit of hire colere.

Chaucer's Canterbury Tales.

When, as the ape him heard so much to talk
Of labour, that did from his liking baulk,
He would have slipt the collar handsomely.

Hubberd's Tale.

Her waggon spokes made of long spinners' legs,
The traces of the smallest spider's web,
The collars of the moonshine's watery beams.

Shakespeare.

He bore the majesty of a mighty emperor; his crown and sceptre of pure gold, a collar of pearls about his neck, his garment of crimson velvet, embroidered with precious stone and gold.

Milton. Hist. Moscov.

And ghostly Charles turning his collar low,
The purple thread about his neck doth show.

Marvell.

Ten brace and more of greyhounds;
With golden muzzles all their mouths were bound,
And collars of the same their neck surround.

Dryden's Fables.

That's nothing, says the dog, but the fretting of my collar: nay, says the wolf, if there be a collar in the case, I know better things than to sell my liberty.

L'Estrange.

A page riding behind the coach, fell down, bruised his face, and broke his right collar-bone.

Wiseman's Surgery.

Headlong he falls, and on the rugged stone,
Distorts his neck, and cracks the collar-bone. *Gay.*

COLLAR, in Roman antiquity, a sort of chain put generally round the necks of slaves who had run away after they were taken, with an inscription round it, intimating their being deserters, and requiring their being restored to their proper owners, &c.

COLLAR, in the modern sense, an ornament consisting of a chain of gold, enamelled, frequently set with ciphers or other devices, with the badge of the order hanging at the bottom, worn by the knights of several national orders over their shoulders, on the mantle, and its figure drawn round their armories. See **HERALDRY** and **ORDERS**.

COLLAR, KNIGHTS OF THE, a military order in the ci-devant republic of Venice, called also the order of St. Mark, or the Medal. The doge and the senate conferred this order; the knights bore no particular habit, only the collar, which the doge put around their necks, with a medal, wherein was represented the winged lion of the republic.

COLLAR OF A DRAUGHT HORSE, a part of harness made of leather and canvas, and stuffed with straw or wool, to be put about the horse's neck.

COLLATE, *v. a.* } Lat. *confero*, *collatum*.
COLLATION, *n. s.* } To compare one thing of
COLLATOR, *n. s.* } the same kind with another, as copies and manuscripts. To bestow, to confer.

Knowledge will be ever a wandering and indigested thing, if it be but a commixture of a few notions that are at hand and occur, and not excited from a sufficient number of instances, and those well *collated*.

Bacon's Nat. Hist.

They could not relinquish their Judaism, and embrace Christianity, without considering, weighing, and *collating* both religions. *South.*

The significance of the sacrament disposes the receiver to admit the grace of the Spirit of God, there consigned, exhibited and *collated*.

Taylor's Communicant.

A mandatory cannot interrupt an ordinary *collator*, till a month is expired from the day of presentation.

Ayliffe.

To read the titles they give an editor or *collator* of a manuscript, you would take him for the glory of letters. *Addison.*

He thrust out the invader, and *collated* Amsdorf to the benefice: Luther performed the consecration.

Atterbury.

Neither are we to give thanks alone for the first *collation* of these benefits, but also for their preservation. *Ray on the Creation.*

In the disquisition of truth, a ready fancy is of great use; provided that *collation* doth its office.

Grew's Cosmologia.

I return you your Milton, which, upon *collation*, I find to be revised and augmented in several places.

Pope.

COLLATERAL, *adj.* } Lat. *con* and *latus*.
COLLATERALLY, *adv.* } Side to side, running parallel; diffused on either side. In genealogy, those that stand in equal relation to some common ancestor; not direct, not immediate, concurrent.

They shall hear and judge 'twixt you and me;
If by direct or by *collateral* hand
They find us touched, we will our kingdom give
To you in satisfaction. *Shakespeare.*

In his bright radiance and *collateral* light
Must I be comforted, not in his sphere. *Id.*

Thus saying, from his radiant seat he rose
Of high *collateral* glory. *Milton.*

But man by number is to manifest
His single imperfection; and beget
Like of his like, his image multiplied
In unity defective, which requires
Collateral love and dearest unity. *Id.*

These pullies may be multiplied according to sundry different situations, not only when they are subordinate, but also when they are placed *collaterally*.

Wilkins.

By asserting the scripture to be the canon of our faith, I have created two enemies: the papists more directly, because they have kept the scripture from us; and the fanatics more *collaterally*, because they have assumed what amounts to an infallibility in the private spirit. *Dryden.*

The estate and inheritance of a person dying intestate, is, by right of devolution, according to the civil law, given to such as are allied to him, *ex latere*, commonly styled *collaterals*, if there be no *ascendants* or *descendants* surviving at the time of his death.

Ayliffe's Parergon.

All the force of the motive lies within itself: it receives no *collateral* strength from external considerations. *Atterbury.*

COLLATERAL RELATIONS, in genealogy, those who proceed from the same stock, not in the same line of *ascendants* or *descendants*, but being, as it were, aside of each other. Thus, uncles, aunts, nephews, nieces, and cousins, are *collaterals*, or in the same *collateral* line: those in a higher degree, and nearer the common root, represent a kind of *paternity* with regard to those more remote. See **GENEALOGY**.

COLLATIA, a town of the Sabines; thought to be distant between four and five miles east from Rome; situated on an eminence, upon the Anio. It existed in Cicero's time, but in Strabo's day was only a village; no trace now remains of it.

COLLATINA PORTA; from *Collatia*; a gate of Rome, at the *Cullis Hortulorum*, afterwards called *Pinciana*, from the *Pincii*, a noble family.

COLLATINUS (L. *Tarquinius*), the husband of the celebrated *Lucretia*, and one of the first two consuls of Rome. He was a native of *Collatia*. See **ROME**, **HISTORY** OF.

COLLATION, *n. s.* In law. It is applied also to a *repat*; a treat less than a feast.

Collation is the bestowing of a benefice, by the bishop that hath it in his own gift or patronage; and differs from institution in this, that institution into a benefice is performed by the bishop at the presentation of another who's patron, or hath the patron's right for the time. *Cowell.*

COLLATION, in canon law, differs from a common presentation, as it is the giving of the church to the person, while presentation is the giving of the person to the church. But *collation* supplies the place of presentation and institution; and amounts to the same as institution where the bishop is both patron and ordinary. Anciently the right of presentation to all churches was in the bishop; and now if the patron neglect to

present to a church, then this right returns to the bishop by collation: if the bishop neglect to collate within six months after the elapse of the patron, then the archbishop has a right to do it; and, if the archbishop neglect, then it devolves to the king; the one as superior, to supply the defects of bishops, the other as supreme, to supply the defects of government.

COLLATION, in common law, the comparison of a copy with its original, to see if it be conformable; or the report or act of the officer who made the comparison. A collated act is equivalent to its original, provided all the parties concerned were present at the collation.

COLLATION, in Scots law, that right which an heir has of throwing the whole heritable and moveable estates of the deceased into one mass, and sharing it equally with the others in the same degree of kindred, when he thinks such share will be more than the value of the heritage to which he had an exclusive title.

COLLATION is used among the Romanists for the meal made on a fast-day, in lieu of a supper. Only fruits are allowed in a collation: F. Lo-bineau observes, that anciently there was not allowed even bread in the collations in Lent, nor any thing beside a few comfits and dried herbs and fruits; which custom, he adds, obtained till A.D. 1513. Cardinal Humbert observes further, that in the middle of the eleventh century there were no collations at all allowed in the Latin church in the time of Lent; and that the custom of collations was borrowed from the Greeks, who themselves did not take it up till about the eleventh century.

COLLATI'VE, *adj.* Lat. *collaticius*. Done by the contribution of many.

COLLAUD, *v. a.* Lat. *collaudo*. To join in praising.

COLLEA'GUE, *n. s. & v. a.* Lat. *collega*. A partner in office and employment. To unite with, is the general sense of the verb.

Colleagues with this dream of his advantage,
He hath not failed to pester us with message,
Importing the surrender of those lands.

Shakespeare. Hamlet.

Easy it might be seen that I intend

Mercy *colleague* with justice sending thee. *Milton.*

The regents, upon demise of the crown, would keep the peace without *colleagues*. *Swift.*

COLLE'CT, *v. a.*

COLLECTA'NEOUS, *adj.*

COLLECTEDLY, *adv.*

COLLECTIBLE, *adj.*

COLLECTI'ON, *n. s.*

COLLECTI'VE, *adj.*

COLLECTIVE, *adj.*

COLLECTIVELY, *adv.*

COLLECTOR, *n. s.*

Lat. *colligo, collectum, collectaneus, collectitius, collector.*

The primary sense,

which runs through

all its multiplied de-

derivatives, is that of

gathering or bringing

together. When ap-

plied to the mind, it is bringing the thoughts on

any given subject to a focus; a man collects him-

self when he assembles his sentiments, and recovers,

by summoning together the powers of his mind, the self-command of which surprise or

fear had deprived him. When applied to the

exercise of the reasoning faculty, it signifies to

infer, as a consequence from arguments and facts,

collected and brought together. It refers to the

aggregate of things taken together, and never to

the detail; to the entire body composed of parts, but not to the parts individually and separately. In grammar, a collective noun is a word which expresses a multitude, though itself be singular; as, a company; an army.

The whole revolution of ages from everlasting to everlasting is so *collectedly* and presentifically represented to God. *Moss.*

It should be a weak *collection*, if whereas we say, that when Christ had overcome the sharpness of death, he then opened the kingdom of heaven to all believers; a thing in such sort affirmed with circumstances, were taken as insinuating an opposite denial before that circumstance be accomplished. *Hooker.*

Although we cannot be free from all sin *collectively*, in such sort that no part thereof shall be found in us, yet distributively all great actual offences, as they offer themselves one by one, both may and ought to be by all means avoided. *Id.*

A body *collective*, it containeth a huge multitude. *Id.*

Singly and apart, many of them are subject to exception, yet *collectively* they make up a good moral evidence. *Hale.*

Be collected;

No more amazement. *Shakespeare. Tempest.*

Affrighted much,

I did in time *collect* myself, and thought

This was so, and no slumber. *Id. Winter's Tales.*

This label

Is so from sense in hardness, that I can

Make no *collection* of it *Id. Cymbeline.*

The reverend care I bear unto my lord,

Made me *collect* these dangers in the duke.

Id. Henry VI.

When she, from sundry arts, one skill doth draw;

Gathering from divers flight, one act of war;

From many cases, like one rule of law;

These her *collections* not the senses are. *Davies.*

Whether thereby be meant Euphrates, is not *collectible* from the following words.

Browne's Vulgar Errors.

Antiquity has left many falsities controllable not only by critical and *collective* reason, but contrary observations. *Browne.*

As when of old some orator renowned

In Athens or free Rome, where eloquence

Flourished, since mute, to some great cause addressed

Stood in himself *collected*, while each part,

Motion, each act won audience, ere the tongue

Sometimes in height began, as no delay

Of preface breaking through his zeal of right. *Milton.*

They conclude they can have no idea of infinite space, because they can have no idea of infinite matter; which consequence, I conceive, is very ill *collected*. *Locke.*

Let a man *collect* into one sum as great a number as he pleases, this multitude, how great soever, lessens not one jot the power of adding to it. *Id.*

The peers, therefore, sit in parliament in their *collective*, the commons, in their representative body. *Bollingbroke.*

The three forms of government differ only by the civil administration being in the hands of one or two, called kings; in a senate, called the nobles; or in the people *collective* or representative, who may be called commons. *Swift.*

The best English historian, when his style grows antiquated, will be only considered as a tedious relater of facts, and perhaps consulted to furnish materials for some future *collector*. *Id.*

The commissions of the revenue are disposed of, and the collectors are appointed by the commissioner.

Swift.

Volumes without the collector's own reflections.

Addison.

The gallery is hung with a collection of pictures.

Id.

Here, like the bee, that on industrious wing,
Collects the various odours of the spring;

Walkers at leisure, learning's flowers may spoil,
Nor watch the wasting of the midnight oil.

Gay.

A great part of this treasure is now embezzled, lavished, and feasted away by collectors, and other officers.

Temple.

Nor perjured knight desires to quit thy arms,

Fairest collection of thy sex's charms.

Prior.

'Tis memory alone that enriches the mind, by preserving what our labour and industry daily collect.

Watts.

CO'LECT, *n. s.* Low Lat. *collecta*. A short comprehensive form of prayer, used at the sacrament; any short prayer.

Then let your devotion be humbly to say over proper collects.

Taylor's Guide to Devotion.

COLLECT, in the liturgy of the church of England, and the mass of the Roman Catholics, denotes a prayer, accommodated to any particular day, occasion, or circumstance. See LITURGY, and MASS. In general, all the prayers in each office are called collects; either because the priest speaks in the name of the whole assembly, whose sentiments and desires he sums up by the word oration, 'let us pray,' or, because those prayers are offered when the people are assembled together. The congregation itself is in some ancient authors called collect. The popes Gelasius and Gregory are said to have been the first who established collects. Despençe, of Paris, wrote a treatise on collects, their origin, antiquity, &c. Collect is sometimes also used for a tax, or imposition, raised by a prince for any pious design. Thus, in 1166, the king of England, coming into Normandy, appointed a collect for the relief of the holy land.

COLLEGATARY, *n. s.* Lat. *con* and *legatum*, a legacy. In the civil law, a person to whom is left a legacy in common with one or more other persons.

COLLEGE, *n. s.* Lat. *collegium*. A community; a number of persons living by some common rules.

On barbed steeds they rode in proud array,
Thick as the college of the bees in May.

Dryden.

A society of men set apart for learning or religion.

He is returned with his opinions,

Gathered from all the famous colleges,

Almost in Christendom. *Shakspeare. Henry VIII.*

I would the college of the cardinals

Would choose him pope, and carry him to Rome.

Id.

This order or society is sometimes called Solomon's house, and sometimes the college of the six days' work.

Bacon.

The house in which the collegians reside.

Huldah, the prophetess, dwelt in Jerusalem in the college.

Kings.

A college, in foreign universities, is a lecture read in public.

COLLEGES, ANCIENT. College, among the Romans, embraced, indifferently, those employed in

the offices of religion, of government, the liberal and even mechanical arts and trades; so that, with them, the word signified what we call a corporation or company. They had not only the college of augurs, and the college of capitolini, i. e. of those who had the superintendance of the capitoline games; but also colleges of artificers, collegia artificum; of carpenters, fabricatorum, or fabrorum tignariorum; of potters, figulorum; of founders, ærariorum; of locksmiths, fabrorum ferrariorum; of engineers, tignariorum; of butchers, laniorum; of dendrophori, dendrophororum; of centonaries, centonariorum; of makers of military casques, sagariorum; of tent makers, tabernaculiorum; of bakers, pistorum; of musicians, tibicinum, &c. Plutarch observes, that Numa first divided the people into colleges; that each consulting the interests of their colleges, whereby they were divided from the citizens of the other colleges, they might not enter into any general conspiracy against the public repose. Each of these colleges had distinct halls; and likewise, in imitation of the state, a treasury and common chest, a register, and one to represent them upon public occasions, and statutes like acts of parliament. These colleges had the privilege of manumitting slaves, of being legatees, and making by-laws for their own body, provided they did not clash with the laws of the republic.

COLLEGE, is used, in modern times, for a public place endowed with certain revenues, where the several parts of learning are taught. An assemblage of several of these colleges constitutes an university. The erection of colleges is part of the royal prerogative. The establishment of colleges or universities is a remarkable period in literary history. The schools in cathedrals and monasteries confined themselves, chiefly, to the teaching of grammar. There were only one or two masters employed in that office. But, in colleges, professors are appointed to teach all the different parts of science. The first obscure mention of academical degrees in the university of Paris (from which the other universities in Europe have borrowed most of their customs and institutions), occurs A.D. 1215. We notice the most celebrated institutions of this kind in Great Britain, and a few of the more conspicuous modern ones.

COLLEGE, GRESHAM, or COLLEGE OF PHILOSOPHY, a college founded by Sir Thomas Gresham, and endowed with the revenue of the Royal Exchange: one moiety of this endowment the founder bequeathed to the mayor and aldermen of London and their successors, in trust, that they should find four able persons to read, within the college, lectures on divinity, geometry, astronomy, and music; who are chosen by a committee of the common council, consisting of the lord mayor, three aldermen, and eight commoners, and allowed each, besides lodging, £50 per annum. The other moiety he left to the company of Mercers, to find three more able persons, chosen by a committee of that company, consisting of the master and three wardens, during their office, and eight of the court of assistants, to read lectures on law, physic, and rhetoric, on the same terms; with this limitation, that the several lecturers should read, in term

time, every day in the week except Sundays; in the morning in Latin, in the afternoon the same in English; but that in music to be read only in English. By the eighth of George III. cap. 32, the building appropriated to this college was taken down, and the excise office erected in its room. Each of the professors is allowed £50 per annum, in lieu of the apartments, &c. relinquished by them in the college, and is permitted to marry, notwithstanding the restriction of Sir Thomas Gresham's will. The lectures are now read in a room over the Royal Exchange; and the City and Mercers' company are required to provide a proper place for this purpose.

COLLEGE OF CIVILIANS, commonly called **Doctors' Commons**; a college founded by Dr. Harvey, dean of the Arches, for the professors of the civil law residing in London; where usually, likewise, reside the judges of the arches court of Canterbury, judge of the admiralty, of the prerogative court, &c. with other civilians, who all live, as to diet and lodging, in a collegiate manner, communing together; whence the appellation of **Doctors' Commons**. Their house being consumed in the great fire, they all resided at Exeter-house in the Strand till in 1672; when their former house was rebuilt, at their own expense, in a very splendid manner. To this college belong thirty-four proctors, who make themselves parties for their clients, manage their causes, &c.

COLLEGE OF HERALDS, OR COLLEGE OF ARMS, is a corporation founded by king Richard III., who, by charter bearing date the 2nd of March, in the first year of his reign, made the kings, heralds, and pursuivants of arms, one body corporate by the name of 'Le garter regis armorum Angliorum, regis armorum partium australium, regis armorum partium borealium, regis armorum walliz, et heraldorum, prosectorum, sive purserandorum armorum;' empowered them to have and use a common seal, and granted to them and their successors, for the use of the twelve principal officers of the corporation, a house with its appurtenances, then called *Colde Arbor*, and situated within the parish of All-Hallows the Less, in the city of London; they finding a chaplain to celebrate mass daily in the said house, or elsewhere at their discretion, for the good state of health of Anne the queen, and Edward, prince of Wales, during their lives, and for their souls after their decease. In consequence of the act of resumption, passed in the first year of the reign of king Henry VII., this house was seized into the king's hands, because it was supposed to belong personally to John Withe, garter, who then lived in it, and not to the officers of arms in their corporate capacity.

During the reign of Henry VII. and Henry VIII., the officers of arms frequently petitioned the throne for a grant of some house or place wherein to hold their assemblies, but without success. King Edward VI., however, in a charter dated the 4th of June, in the third year of his reign, and by authority of parliament, endeavoured to make them some amends, by confirming to them all their ancient privileges, as to be free and discharged from all subsidies, in all realms where they take their demoure; as also from all

tolls, taxes, customs, impositions, and demands as well from watch and ward, as from the election to any office of mayor, sheriff, bailiff, constable, scavenger, church-warden, or any other public office of what degree, nature, or condition soever.

Philip and Mary, by their charter bearing date the 18th day of July, in their first and second years, re-incorporated the kings, heralds, and pursuivants of arms by their former names; and to the intent that they might reside together, and consult and agree amongst themselves for the good of their faculty, and for the depositing and secure preservation of their records, inrolments, and other documents and papers, granted to them a messuage, with its appurtenances, called *Derby House*, situate in the parish of St. Benedict and St. Peter, within the city of London, and in the street leading from the south door of the cathedral church of St. Paul, to a place there called *Paul's Wharf*, and then late in the tenure of Sir Richard Sakevyle, knight, but theretofore parcel of the possessions of Edward, earl of Derby, and to be by the said corporation held in free burgage of the city of London. In the great fire of London, anno 1666, the college was entirely consumed: but the heralds had the good fortune to save all their muniments and books, which were deposited in the palace at Whitehall; from whence they were afterwards removed into the palace at Westminster, near to the court of requests, whereupon public notice was given in the London Gazette, that the herald's office was there kept. The college was afterwards rebuilt, and, as a regular quadrangular building, was considered one of the best designed and handsomest brick edifices in London, particularly the hollow archway of the great gate, which is esteemed a singular curiosity; but the college is now removed to the neighbourhood of Charing-cross.

The corporation consists of three kings of arms, Garter, Clarencieux, and Noroy, six heralds, viz. Windsor, Chester, Lancaster, Somerset, York, and Richmond, and four pursuivants, viz. Portcullis, Rouge-dragon, Bluemantle, and Rouge-Croix; who all take presidency according to the dates of their respective patents.

The arms of the college; argent, a cross gules between four doves rising azure. Crest. On a ducal coronet, or a dove rising azure. Supporters. Two lions rampant guardant argent, ducally gorged or.

The **COLLEGE OF HERALDS** in Scotland, consists of Lyon king of arms, six heralds, and six pursuivants, and a number of messengers.

COLLEGE OF JUSTICE, the supreme civil court of Scotland; otherwise called the court of session, or of council and session. See **SCOTLAND, LAW OF**.

COLLEGE OF PHYSICIANS, a corporation of physicians in London, who by several charters and acts of parliament of Henry VIII. and his successors, have certain privileges, whereby no man, though a graduate in physic of any university, may, without licence under the said college seal, practice physic in or within seven miles of London; with power to administer oaths, fine and imprison offenders in that and several other particulars; to search the apothecaries shops, &c. in and about London, to see if their drugs, &c. be wholesome, and their compositions ac-

ording to the form prescribed by the said college in their dispensatory. By the said charter they are also freed from all troublesome offices, as to serve on juries, be constables, keep watch, provide arms, &c. The society had anciently a college in Knight-riding Street, the gift of Dr. Linacre, physician to king Henry VIII. Since that time they have had a house built for them by the famous Dr. Harvey in 1652, at the end of Amen-corner, which he endowed with his whole inheritance in his lifetime; but this being burnt in the great fire, in 1666, a new one was erected, at the expence of the fellows, in Warwick-lane, with a noble library, given partly by the marquiss of Dorchester, and partly by Sir Theodore Mayerne. From this, as an inconvenient situation, the college has been removed to Pall Mall East, where a noble building has been erected on a site given by government. Of this college there are at present a president, four censors, eight electors, a register, and a treasurer, chosen annually in October; the censors have, by charter, power to survey, govern, and arrest, all physicians, or others practising physic, in or within seven miles of London; and to fine, amerce, and imprison them, at discretion. The number of fellows was anciently thirty, till king Charles II. increased their number to forty; and James II. giving them a new charter, allowed the number of fellows to be enlarged so as not to exceed eighty; reserving to himself and his successors the power of appointing and displacing any of them for the future. The college is not very rigorous in asserting their privileges; there being a great number of physicians, some of very good abilities, who practise in London, &c. without their licence, and are connived at by the college: yet by law, if any person not expressly allowed to practise, take on him the cure of any disease, and the patient die under his hand, it is deemed felony. In 1696 the college made a subscription, to the number of forty-two of their members, to set on foot a dispensary for the relief of the sick poor: since which they have erected two other dispensaries.

COLLEGE OF PHYSICIANS, EDINBURGH, was erected on the 29th of November 1681. The design of this institution was, to prevent the abuses daily committed by foreign and illiterate impostors, quacks, &c. For this reason, king Charles II. granted letters patent to erect into a body corporate and politic, certain physicians in Edinburgh and their successors by the title of the President and Royal College of Physicians at Edinburgh, with power to choose annually a council of seven, one whereof to be president: these are to elect a treasurer, clerk, and other officers; to have a common seal; to sue and be sued; to make laws for promoting the art of physic, and regulating the practice thereof, within the city of Edinburgh, town of Leith, and districts of the Canon-gate, Westport, Pleasance, and Potter-row; through all which the jurisdiction of the college extends. Throughout this jurisdiction, no person is allowed to practice physic, without a warrant from the college, under the penalty of £5 sterling the first month, to be doubled monthly afterwards while the offence is continued; one half the money

arising from such fines to go to the poor, the other to the use of the college. They are also empowered to punish all licentiates in physic, within these bounds, for faults committed against the institutions of the college; and to fine them of sums not exceeding 40s. On such occasions, however, they must have one of the bailies of the city to sit in judgment along with them, otherwise their sentence will not be valid. They are also empowered to search and inspect all medicines within their jurisdiction, and throw out into the street all such as are bad or unwholesome. That they may the better attend their patients, they are exempted from watching, warding, and serving on juries. They are, however, restrained from erecting schools for teaching the art of physic, or conferring degrees on any person qualified for the office of a physician; but are obliged to license all such as have taken their degrees in any other university, and to admit as honorary members all the professors of physic in the rest of the universities of Scotland. These privileges and immunities are not, however, to interfere with the rights and privileges of the apothecary surgeons, in their practice of curing wounds, contusions, fractures, and other external operations.

COLLEGE OF SURGEONS, ROYAL, LONDON, was incorporated by charter in 1800, under a master, two governors, and eighteen assistants. Its house is in Lincoln's-Inn-Fields. There is also at Edinburgh a Royal College of Surgeons of late institution, under a president, treasurer, and honorary fellows. This college is authorised for carrying into execution a scheme for providing for their wives and children, &c.; and for examining and licencing, if found qualified, all practitioners in surgery, within certain limits.

COLLEGE PRO PROPAGANDA FIDE, was founded at Rome in 1622, by Gregory XV. and enriched with ample revenues. It consists of thirteen cardinals, two priests, and a secretary; and was designed for the propagation of the Romish religion in all parts of the world. The funds of this college have been very considerably augmented by Urban VIII. and many private donations. Missionaries are supplied by this institution with a variety of books suited to their several appointments. Seminaries for their instruction are supported by it, as also a number of charitable establishments connected with, and conducive to, its main object.—Another college under this title was established by Urban VIII. in 1627, in consequence of the liberality of John Baptist Viles, a Spanish nobleman. This is set apart for the instruction of those who are designed for the foreign missions. It was first committed to the care of three canons of the patriarchal churches; but ever since 1641 it is under the same government with the former institution.

COLLEGE, SION, or the college of the London clergy, has been a religious house time of out mind, sometimes under the denomination of a priory, sometimes under that of a 'spital or hospital: at its dissolution under 31st Henry VIII. it was called Elsyn's 'Spital, from the name of its founder, a mercer, in 1329. At present it is a composition of both, viz. a college for the

lery of London, who were incorporated in 1630, in pursuance of the will of Dr. White, under the name of the President and Fellows of Sion College; and an hospital for ten poor men and as many women. The officers of the corporations are the president, two deans, and four assistants; who are annually chosen from among the rectors and vicars of London and are subject to the visitation of the bishop. They have a good library built and stocked by Mr. Simpson, and furnished by several other benefactors, chiefly for the clergy of the city, without excluding other students on certain terms; and a hall, with chambers for students, generally occupied by the ministers of the neighbouring parishes.

COLLEGE, ROYAL NAVAL, at Portsmouth. See ACADEMY.

COLLEGE, ROYAL MILITARY, at Farnham and at Marlow. See ACADEMY. •

COLLEGE, EAST INDIA, at Hertford. See HERTFORD.

COLLEGE, EAST INDIA, at Fort William, Calcutta, was a favorite project of the Marquis Wellesley's. It was first announced by an official minute of the governor, relative to the college of Fort William, dated the 18th August, 1800. *Asiatic Register*, 1800.

In this project he is supposed to have contemplated a magnificent repository of European principles and Asiatic erudition, in which the stores of written learning and recorded wisdom might indefinitely accumulate, and in which the sages of the east might find studious solitudes still more deeply attractive than the sacred shades of Benares. 'There certainly is no reason to question the truth of this notion,' says an able critic of this minute. 'Nothing is more credible than that such prospects as these might fill up the distance of the picture which lord Wellesley had framed to himself; but the utmost injustice would be done to the views of that enlightened statesman, if it were not distinctly admitted that his great object was one of a nature more pressing, more practical, and more closely congenial with that solicitude for the rights and happiness of the people, which, after all, constitutes the true sublime of legislation and government. Throughout his minute, the actual deficiencies of the civil service, and the means of supplying those deficiencies, form the grand and the solitary theme of discussion. He has no time to speak or to think of any thing else; and his reasoning must have been sadly thrown away on those, whom it has not convinced that this subject alone might worthily exercise the united reflection and eloquence of India and of England.'

With regard to the actual state of the qualification of the civil servants before the existence of the Calcutta college, the declarations of lord Wellesley were perfectly frank and explicit. Compared with the vast disadvantages under which the service had labored, he admits that those qualifications were great and even wonderful; compared with the exigencies of the state, with the number of the servants, and with the magnitude and arduous nature of the trusts confided to them, he pronounces them decidedly inadequate.

Incited by these considerations, lord Wellesley proceeded to establish, by public regulation, the college of Fort William. It was placed under the immediate government of a provost and a vice-provost. Professorships were instituted in a great variety of departments. An attendance on the college for three years was made compulsory on all persons appointed to the civil service of Bengal but the junior servants at the other presidencies were also to be admissible. Degrees were instituted as indispensable qualifications for certain offices in the service. The branches of knowledge for which provision was to be made were, the Oriental languages, nine in number; the Mahommedan and Hindoo systems of law; the principles of ethics, jurisprudence, and the law of nations; the English law; the regulations and laws of British India; the modern languages of Europe; classical literature; general history; the history of Hindostan; political economy, geography, mathematics, astronomy, natural history, botany, and chemistry. But this great project did not meet with the cordial concurrence of the directors of the East India Company at home. The college of Fort William was in the first instance suspended, but was afterwards continued on a reduced scale, which confined it to a seminary for the instruction of the Bengal civil servants in the Oriental languages appropriate to that presidency. At a subsequent period, a similar establishment, but proportionably smaller, was framed at Madras.

COLLEGE is a designation which certain respectable Dissenting bodies have given, of late, to some of their superior academical foundations. We can only notice here

CHESHUNT COLLEGE, an institution in the connexion, and originally under the patronage, of the countess of Huntingdon, who first founded and supported, at her own sole expense, an institution of this kind in Wales, for the instruction and introduction of young men designed for the ministry. This building, which was situate at Talgarth in the county of Brecon, was publicly opened, and a sermon preached on the occasion, by the Rev. George Whitfield, on the 24th of August, in the year 1768; and from it her ladyship had the satisfaction of seeing many eminent ministers go forth to teach and preach Jesus Christ.

In the year 1787 several of her friends, knowing that the aid afforded by lady Huntingdon must cease with her life (her ladyship's income being only a jointure), offered themselves to form a Society for the continuance and support of her college, when it should be deprived of her fostering care. This proposition being highly approved by lady H., she was pleased to appoint ten persons to act as Trustees of the Institution, whenever her decease should call such a trust into exercise; to whom she also bequeathed all her own property therein.

On lady Huntingdon's death, which happened on the 17th of June, 1791, the Trustees called together the friends of the Institution in London, and it was determined to remove the college from Wales, and to provide a suitable house and premises in the neighbourhood of the metropolis: shortly after, the freehold of the premises now

occupied, situate at Cheshunt, in Hertfordshire, about fourteen miles from London, was purchased; consisting of a family house, with offices, a large garden and orchard, bounded by the new river, with a field adjoining; comprising in the whole upwards of nine acres. This house was publicly opened for the new college on the 24th of August, 1792; a neat chapel has subsequently been erected on the premises.

COLLEGE, HIGHBURY, is a designation which has this year, 1826, been given to the institution, formerly called the Hoxton Academy (see our article ACADEMY) on its removal to Islington. Its principles and general management remain, we believe, the same; but new and handsome accommodations are afforded; the students have received a new stimulus, and the whole institution a new organisation.

COLLEGE, SERAMPORE, is a learned institution among the Baptist missionaries of that place, at present in its infancy; but owing its foundation entirely to the noble views and designs of Messrs Carey, Marshman, and their associates in the East, who have already raised a magnificent sum of money for its establishment, and propose, by offering a superior education to the respectable classes of the natives of India, to interest that continent more effectually in their other benevolent and Christian enterprises.

COLLEGE, MAYNOOTH. The royal college of St. Patrick was instituted by an act of the Irish parliament, in 1795, for the education of the Irish Roman Catholic clergy. Here is also a lay college, established by private subscription in 1802. The town of Maynooth is in the county of Kildare, twelve miles west by north of Dublin.

For the colleges of North America, see our article AMERICA, NORTH,

COLLE'GIAL, *adj.*, from college. Relating to a college; possessed by a college.

COLLE'GIAN, *n. s.*, from college. An inhabitant of a college; a member of a college.

COLLEGIANI, COLLEGIANS, or COLLEGIATES, a religious sect, formed among the Armenians and anabaptists in Holland, about the beginning of the seventeenth century; so called because of their colleges, or meetings, twice every week; where every man has the same liberty of expounding the scripture, praying &c. They are said to be all either Arians or Socinians; they never communicate in the college, but meet twice a-year from all parts of Holland at Rhinsbergh, whence they are also called Rhinsberghers, where they communicate together; admitting every one that presents himself, professing his faith in the divinity of the holy scriptures, and resolution to live suitably to their precepts and doctrines, without regard to his sect or opinion. They have no particular ministers, but each officiates as he is disposed.

COLLE'GIATE, *adj.* Low Lat. *collegiatus*. Containing a college; instituted after the manner of a college.

I wish that yourselves did well consider how opposite certain of your positions are unto the state of *collegiate societies*, whereon the two universities consist. *Hooker. Preface.*

A collegiate church was such as was built at a convenient distance from a cathedral church,

wherein a number of presbyters were settled, and lived together in one congregation.

COLLE'GIATE, *n. s.*, from *colleg.* A member of a college; a man bred in a college; an university man.

These are a kind of empirics in poetry, who have got a receipt to please; and no *collegiate* like them, for purging the passions. *Rymer.*

COLLEGIATE CHURCHES have no bishop's see, yet have the ancient retinue of the bishop, the canons and prebends. Such are Westminster, Rippon, Windsor, &c. governed by deans and chapters. Of these there are two kinds, some of royal, and others of ecclesiastical foundation; each of them, in matters of divine service, regulated in the same manner as the cathedrals. There are even some collegiate churches that have the episcopal rights. Some of these were anciently abbeys, which in time were secularised. The church of St. Peter's, Westminster, was anciently a cathedral; but the revenues of the monastery being, by the act of 1st Eliz. vested in the dean and chapter, it commenced a collegiate church. In several causes, the styling it cathedral, instead of collegiate church at Westminster, has occasioned error in the pleadings.

COLLET, *n. s.* Fr. from Lat. *collum*, the neck. Anciently something that went about the neck; sometimes the neck. That part of a ring in which the stone is set. A term used by turners.

COLLET, in glass-making, is that part of glass vessels which sticks to the iron instrument wherewith the metal was taken out of the melting-pot: these are afterwards used for making green glass.

COLLIDE, *v. a.* Lat. *collido*. To strike against each other; to beat, to dash, to knock together.

Scintillations are not the ascension of air upon collision, but inflammable effluences from the bodies *collided*. *Browne.*

COLLIER, *n. s.* } From coal. A digger of
Co'LLIERY, *n. s.* } coals, who works in the coal-pits; a coal merchant; a ship employed exclusively in the coal trade. Colliery is the place where coals are either dug or sold. It is sometimes applied to the trade itself.

I knew a nobleman a great grasier, a great timberman, a great *collier*, and a great landman. *Bacon.*

COLLIER is a vessel employed to carry coals from one port to another; chiefly from the north of England to the capital, and more southerly parts, though they are also sent to foreign markets.

COLLIER (Jeremy), a learned English non-jurist divine, born in 1650, and educated at Caius College, Cambridge. He came to London in 1685, where he was made lecturer of Gray's Inn; but the change of government that followed, soon rendered the public exercise of his function impracticable. He was committed to Newgate for writing against the revolution, and for carrying on a treasonable correspondence, but was released both times, without trial, by the intervention of friends. He carried his scruples so far, as to prefer confinement to the tacit acknowledgment of the jurisdiction of the court, by accepting his liberty upon bail. Agreeably

to these principles, he acted a very extraordinary part, with two other clergymen, at the execution of Sir John Friend and Sir William Perkins, by giving them solemn absolution, and by imposition of hands; absconding for which, he continued in outlawry to his death in 1726. These proceedings having put a stop to his activity, he employed his retired hours rather more usefully in literary works. In 1698 he attempted to reform our theatrical entertainments, by publishing his *Short View of the Immorality and Profaneness of the English Stage*, which engaged him in a controversy with the wits of the time; but as Mr. Collier defended his censures not only with wit, but with learning and reason, it is allowed that the decorum observed, for some time, by succeeding dramatic writers, was greatly to be attributed to his animadversions. He next undertook a translation of Morri's *Historical and Geographical Dictionary*, a work of extraordinary labor, and which appeared in four vols. folio. After this, he published *An Ecclesiastical History of Great Britain, chiefly of England*, in two vols. folio, which is allowed to be written with great judgment and impartiality. He was besides engaged in several controversies, to which his conduct and writings gave rise. In queen Anne's reign he had offers of considerable preferment, upon submission; but, being a nonjuror upon principle, he refused to listen to any terms. He died in 1726.

COLLIFLOWER, *n. s.* *Flos brassicæ*; from Sax. *cahl*, cabbage and flower; properly cauliflower. A species of cabbage. See **BRASSICA**.

COLLIGATION, *n. s.* Lat. *colligatio*. A binding together.

These the midwife contrived into a knot, whence that tortuosity or nodosity in the navel, occasioned by the *colligation* of vessels. *Browne's Vulgar Errors*.

COLLIMATION, *n. s.* Lat. *collimo*. The act of aiming at a mark; aim.

COLLIMATOR, **FLOATING**, in astronomy, an instrument invented by captain H. Kater, to supply the place of a level, or plumb-line, in astronomical observations, and to furnish a ready and perfectly exact method of determining the position of the horizontal or zenith point on the limb of a circle or zenith sector. Its principle is the invariability, with respect to the horizon of the position, assumed by any body of invariable figure and weight floating on a fluid. It consists of a rectangular box containing mercury, on which is floated a mass of cast-iron about twelve inches long, four broad, and half an inch thick, having two short uprights or Y's of equal height, cast in one piece with the rest. On these is firmly attached a small telescope, furnished with cross wires, or, what is better, crossed portions of the fine balance-spring of a watch, set flat-ways, and adjusted very exactly in the sidereal focus of its object glass. The float is browned with nitric acid to prevent the adhesion of the mercury, and is prevented from moving laterally by two smoothly polished iron pins, projecting from its sides in the middle of its length, which play freely in vertical grooves of polished iron in the sides of the box. When this instrument is used, it is placed at a short distance from the circle whose horizontal point is to be ascertained, on either

side, suppose the north, of its centre, and the telescopes of the circle and of the collimator are so adjusted as to look mutually at each other's cross wires, in the manner lately practised by Messrs. Gauss and Bessel, first of all coarsely, by trial, applying the eye to the eye-glasses of the two instruments alternately; and, finally, by illuminating the cross wires of the collimator by a lantern and oiled paper, taking care to exclude false light by a black screen, having an aperture equal to that of the collimator, and making the coincidence in the manner of an astronomical observation, by the fine motion of the circle. The microscopes on the limb are then read off, and thus the apparent zenith distance of the collimating point, intersection of the wires, is found. The collimator is then transferred to the other (south) side of the circle, and a corresponding observation made without reversing the circle, but merely by the motion of the telescope on the limb. The difference of the two zenith distances so read off is double the error of the zenith or horizontal point of the graduation, and their semi-sum is the true zenith distance of the collimating point, or the co-inclination of the axis of the collimating telescope to the horizon.

By the experiments detailed in captain Kater's paper, read before the Royal Society, January, 1825, it appears that the error to be feared in the determination of the horizontal point by this instrument, can rarely amount to half a second, if a mean of four or five observations be taken. In 151 single trials, two only gave an error of two seconds, and one of these was made with a wooden float.

COLLIN D'HARLEVILLE (John Francis), a French dramatist and advocate. He commenced his dramatic career in 1786, with the comedy of the *Inconstant*. This was followed by some others, previous to the appearance of *Le Vieux Célibataire*, which is considered as his chef d'œuvre. He afterwards produced a great variety of inferior dramas, and was the author of a poem entitled, *Melpomène et Thalia*, 1799, 8vo.; and of many pieces inserted in the *Almanac of the Muses*. He died at Paris in 1806, aged fifty. A collective edition of his works appeared in four vols. 8vo., 1805.

COLLINA, a gate of Rome, at the Collis Quirinalis, near the temple of Venus Erycina; called also *Salara*, because the Sabines carried their salt through it, and now *Salara*.

COLLINEATION, *n. s.* Lat. *collineo*. The act of aiming.

COLLINGTON, a parish of Scotland, in the county of Mid-Lothian, which approaches within two miles of Edinburgh. It extends about four miles east and west, and about five in a south and north direction, and takes in part of the Pentland Ridge, and Logan House Hill, the highest point being in this parish. This hill is found, by repeated barometrical observations, to be 1700 feet above the level of the sea at Leith. The arable lands slope gently from the skirts of the hills to the level of the river, and are enclosed and highly cultivated. The river Collington, or rather the Water of Leith, abounds with much romantic scenery; and in a course of ten miles, drives no fewer than seventy-one mills.

COLLINGWOOD (Cuthbert), baron, was born at Newcastle-upon-Tyne, 1748, and educated at the same school with lord chancellor Eldon. He entered the navy in 1761, and in the action of June the 1st, 1794, was flag-captain on board the *Prince*, admiral Bowyer. He commanded the *Excellent*, in 1797, during the battle off Cape St. Vincent. In 1799 was rear-admiral of the white, and promoted to the red in 1801. In 1804 he assisted in the blockade of Brest; but his most remarkable service was in the great victory of Trafalgar, in which his fine manner of bringing his ship into action, and the skill and bravery with which he fought her, excited the admiration of Nelson, upon whose fall, the command of the fleet devolved upon him. For his excellent conduct on this and other occasions, he was continued in the command of the fleet, and elevated to a barony. He died on board the *Ville de Paris*, while cruising off Minorca, the 7th of March, 1810, and was honored with a public funeral at St. Paul's.

COLLINS (Arthur), a famous genealogist, was born at Exeter in 1682. The first edition of his *Peerage* was published in 1708, and a second in 1715, four vols. folio. The latest edition was that of 1812, published under the care of Sir Egerton Brydges. He also wrote a *Baronetage*, which was first published in 1720, in two volumes, and subsequently, in 1741, in five volumes. His other works are: 1. *The Life of Cecil, lord Burleigh*, 1732. 8vo.; 2. *The Life of Edward the Black Prince*, 1740, 8vo.; 3. *Letters and Memorials of State*, collected by Sir Henry Sidney and others, 1746, two vols. folio; 4. *Historical Collections of the Noble Families of Cavendish, Holles, Vere, Harley, and Oglo*, 1752, folio. The private life of Collins is little known: except that George II. granted him a pension of £200 per annum, a short time before the year 1760, in which he died.

COLLINS (Anthony), a deistical writer, born at Heston, near Hounslow, in Middlesex, in 1676, was the son of Henry Collins, a gentleman of about £1500 a-year. He was first bred at Eton College, and then went to King's College, Cambridge. He was author of several curious books. His first remarkable piece was published in 1707, *An Essay concerning the Use of Reason in Propositions, the Evidence whereof depends on Human Testimony*. In 1702 he entered into the controversy between Mr. Clark and Dr. Dodwell, concerning the immortality of the soul. In 1713 he published his *Discourse on Free-Thinking*. In 1715 he retired into the county of Essex, where he acted as a justice of peace, and published a *Philosophical Essay concerning Human Liberty*. In 1718 he was chosen treasurer of the county, an office he discharged with great honor. In 1724 he published his *Historical and Critical Essay on the Thirty-Nine Articles*. Soon after, he published his *Discourse of the Grounds and Reasons of the Christian Religion*; to which is prefixed, *An Apology for Free Debate and Liberty of Writing*; which piece was immediately attacked by a great number of writings. In 1726 appeared his *Scheme of Literary Prophecy Considered, in a View of the Controversy occasioned by a late book, en-*

titled, A Discourse of the Grounds, &c. This was replied to by several writers, particularly by Dr. John Rogers, in his *Necessity of Divine Revelation asserted*; in answer to which, Collins wrote *A Letter to the Rev. Dr. Rogers, on Occasion, &c.* His health began to decline some years before his death, and he was very much afflicted with the stone, which at last put an end to his life at his house in Harley-square, in 1792. His curious library was open to all men of letters, to whom he readily communicated all the assistance in his power; he even furnished his antagonists with books to confute himself, and directed them how to give their arguments all the force of which they were capable.

COLLINS (John), F.R.S. an eminent accountant and mathematician, born in 1624, and bred a bookseller, at Oxford. Besides several treatises on practical subjects, he communicated some curious papers to the Royal Society, which are to be found in the early numbers of the *Philosophical Transactions*; and was the chief promoter of many other scientific publications in his time. He died in 1683; and about twenty-five years after, all his papers coming into the hands of the learned William Jones, Esq. F.R.S. it appeared that Mr. Collins had held a constant correspondence for many years with all the eminent mathematicians; and that many of the late discoveries in physical knowledge, if not actually made by him, were at least brought forth by his endeavours.

COLLINS (William), an admirable poet, born at Chichester, about A.D. 1724. He received his classical education at Winchester: after which he studied at Oxford, where he applied himself to poetry, and published his *Oriental Eclogues*. He was naturally possessed of an ear for all the varieties of harmony and modulation; and was, at once, capable of soothing the ear with the melody of his numbers, of influencing the passions by the force of pathos, and of gratifying the fancy by the luxury of his descriptions. With these powers he came to London, and first attempted lyric poetry. In 1746 he published his *Odes, Descriptive and Allegorical*: but the sale of this work not being answerable to its merit, he burnt the remaining copies in indignation. Being a man of liberal spirit and small fortune, his pecuniary resources were soon exhausted, and his life became a miserable succession of necessity, indolence, and dissipation. He projected books which he was not able to execute; and became in idea an historian, a critic, and a dramatic poet, but wanted the means to carry these ideas into execution. Obligated to subsist by the repeated contributions of a friend, or the generosity of a casual acquaintance, his spirits became oppressed, and he sunk into a sullen despondence. While in this gloomy state of mind, his uncle, colonel Martin, died, and left him a considerable fortune. But this came too late for enjoyment; he had been so long harassed by anxiety and distress, that he fell into a nervous disorder, which, at length, reduced the finest understanding to the most deplorable childishness. In the first stages of this disorder, he endeavoured to relieve himself by travelling, and passed into France: but the growing malady

obliged him to return; and having continued, with short intervals, in this pitiable state till 1756, he died in the arms of his sister. The ingenious Mr. Langhorne published his poetical works, with memoirs of the author, in one volume, 12mo.

COLLINSON (Peter), F. R. S., an eminent naturalist and antiquarian, descended of an ancient family, was born on the paternal estate called Hugal-hall, near Windermere-lake, in Westmoreland. Whilst a youth he began to make a collection of dried specimens of plants, and had access to the best gardens round London. He became early acquainted with the most eminent naturalists of his time; Drs. Derham, Woodward, Dale, Lloyd, and Sloane, were amongst his intimate friends. Collinson was elected a fellow of the Royal Society, December 12th, 1728, and perhaps was one of its most useful members, not only in supplying them with many curious observations himself, but in promoting a most extensive correspondence with learned and ingenious foreigners in all countries, and on every useful object. He communicated to the learned in distant parts of the globe the discoveries and improvements in natural history in this country, and received similar information from the most eminent persons in almost every other. His correspondence with the ingenious Cadwallader Colden, esq. of New York, and the justly celebrated Dr. Franklin, of Philadelphia, furnish instances of the benefit resulting from his attention to improvements. The latter communicated his first essays on electricity to Mr. Collinson in a series of letters which were then published, and have been reprinted. The account procured of the management of sheep in Spain, published in the Gentleman's Magazine for May and June, 1764, may not be considered among the least of the benefits accruing from his extensive correspondence. He was the first who introduced the great variety of seeds and shrubs which are now the principal ornaments of every garden; and it was owing to his indefatigable industry, that so many persons of the first distinction are now enabled to behold groves, transplanted from the western continent, flourishing as luxuriantly in their several domains as if they were indigenous to Britain. He had correspondents in almost every nation in Europe, some in Asia, and even at Pekin; who transmitted to him the most valuable seeds they could collect, in return for the treasures of America. The great Linnæus, during his residence in England contracted an intimate friendship with Mr. Collinson. Besides his attachment to natural history, he was very conversant in the antiquities of Britain, having been elected a member of the Society of Antiquaries, April 7th, 1737; and he often supplied them with curious articles. He died in 1768.

COLINSONIA, in botany, a genus of the monogynia order and decandria class of plants: natural order fortieth, personatæ: cor. unequal, under lip multifid, and the segments capillary: seed, one and perfect. There two species, natives of North America.

COLLIQUAMENTUM, in natural history, an extremely transparent fluid in an egg, observable after two or three days incubation, containing the first rudiments of the chick. It is in-

cluded in one of its own proper membranes; distinct from the albumen. Harvey calls it the oculus.

COLLIQUATE, *v. a. & v. n.* } Lat. *colli-*
COLLIQUABLE, *adj.* } *queo, colliqua-*
COLLIQUAMENT, *n. s.* } *tio, collique-*
COLLIQUANT, *adj.* } *facio.* Tomelt,
COLLIQUATION, *n. s.* } to dissolve, to
COLLIQUATIVE, *adj.* } turn from solid
COLLIQUAFATION, *n. s.* } to fluid. This
 is the only sense, and therefore every derivative, is
 as simple in its application as its etymon.

After the incorporation of metals by simple *colli-*
quefaction, for the better discovering of the nature and
 consents and dissents of metals, it would be tried by
 incorporating of their dissolutions.

Bacon's Physical Remains.

From them proceed rarefaction, *colliquesation*, can-
 coction, maturation, and most effects of nature.

Id. Natural History.

Ice will dissolve in fire, and *colliquate* in water or
 warm oils.

Brown's Vulgar Errors.

Glass may be made by the bare *colliquesation* of the
 salt and earth remaining in the ashes of a burnt plant.

Boyle.

The fire melted the glass, that made a great show,
 after what was *colliquated* had been removed from the
 fire.

Id.

A *colliquesative* fever is such as is attended with a
 diarrhœa, or sweats, from too lax a contexture of the
 fluids.

Quincy.

It is a consequent of a burning *colliquesative* fever,
 whereby the humours, fat, and flesh of the body are
 melted.

Harvey.

Any kind of universal diminution and *colliquesation*
 of the body.

Id. on Consumptions.

The tender consistence renders it the more *colli-*
quable and consumptive.

Id.

The fat of the kidneys is apt to be *colliquated* through
 a great heat from within, and an ardent *colliquesative*
 fever.

Id.

COLLIQUATION, in chemistry is applied to animal,
 vegetable, and mineral substances, tending
 towards fusion. See **FUSION**.

COLLIQUATION, in phisic, is applied to the
 solid parts, when they waste away, by the animal
 fluids being exhausted through the several glands,
 and particularly those of the skin, which occa-
 sion fluxes of many kinds, but mostly profuse
 and clammy sweats.

COLLISION, *n. s.* Lat. *collisio*. The act of
 striking two bodies together; the state of being
 struck together; a clash.

Or, by *collision* of two bodies grind

The air attrite to fire. *Milton's Paradise Lost.*

The flint and the steel you may move apart as
 long as you please; but it is the hitting and *collision*
 of them that must make them strike fire. *Bentley.*

Then from the clashes between popes and kings,
 Debate, like sparks from flint's *collision* springs.

Denham.

The devil sometimes borrowed fire from the altar
 to consume the votaries; and, by the mutual *collision*
 of well-meant zeal, set even orthodox Christians in
 a flame.

Decay of Piety.

COLLOCATE, *v. a.* } Lat. *colloco, collo-*
COLLOCAT'ION, *n. s.* } *catio.* To place; to
 station; the act of placing; the disposition of a
 thing; the state of being placed.

If you desire to superinduce any virtue upon a per-
 son, take the creature in which that virtue is most

eminent; of that creature take the parts wherein that virtue is *collocate*. *Bacon*.

In the *collocation* of the spirits in bodies, the *collocation* is equal or unequal; and the spirits congregate or diffused. *Id*.

COLLOCUTION, *n. s.* Lat. *collocutio*. Conference; conversation.

To **COLLO'GUE**, *v. a.* Probably from Lat. *colloquor*. To wheedle; to flatter; to please with kind words. A low word.

COL'LOP, *n. s.* Minshew derives it from coal and op, and says, it is a rasher broiled upon the coals. It is sometimes used for a slice of meat without any reference either to roasting or heating, and sometimes as a term of endearment.

Come, Sir page,

Look on me with your welkin eye, sweet villain,
Most dearest, my *collop*. *Shakespeare. Winter's Tale.*

Thou art a *collop* of my flesh,
And for thy sake I have shed many a tear.

Id. Henry VI.

The lion is upon his death-bed: not an enemy that does not apply for a *collop* of him. *L'Estrange.*

Sweetbread and *collops* were with skewers pricked About the sides. *Dryden's Fables.*

A cook perhaps has mighty things professed;
Then sent up but two dishes nicely drest:
What signifies Scotch *collops* to a feast?

King's Cookery.

COL'LOQUY, *n. s.* } Lat. *colloquium*. Con-
COLLO'QUIAL, *adj.* } ference, conversation;
alternate discourse; talk.

My earthly, by his heavenly over-powered,
In that celestial *colloquy* sublime,
As with an object that excels the sense,
Dazzled, and spent, sunk down.

Milton's Paradise Lost.

In retirement make frequent *colloquies*, or short discouragements, between God and thy own soul.

Taylor.

COLLOT D'HERBOIS (J. M.), a distinguished French revolutionist, was born at Maintenon, near Chartres. He was, early in life, a strolling actor, in which capacity he visited Lyons; and finally Paris, at the commencement of the public commotions. He was soon noticed as a street orator, and member of the jacobin club; and in 1792 accused La Fayette of treason at the bar of the National Assembly. The same year he published his *Almanach du Père Gerard*, in favor of a constitutional monarchy. After this he became the decided enemy of royalty; was one of the members of the municipality on the 10th of August, 1792, who procured the dethronement of Louis XVI.; a member of the Council of Justice, and a deputy of the National Convention. He demanded, at the first sitting, the abolition of royalty, and that death should be the punishment of emigration. As might have been expected, he voted for the execution of the king; and was soon after sent to Orleans and Lyons, where, in the name of liberty, he committed the most horrid butcheries, having assisted in the destruction of the Girondists. He was nominated, with other members of the jacobin club, to draw up the act of accusation against kings. His life was attempted in May, 1794, by a man named Admiral, who fired two pistols at him. July 18th he was appointed

president of the Convention, and joined with other members to procure the overthrow of Robespierre. On the 28th of August, Leconte, of Versailles, denounced him and others, as accomplices of the tyrant they had destroyed; and though this accusation was rejected, they were arrested in March, 1795, on fresh charges, and soon after condemned to exile. Collot, endeavouring to excite an insurrection of the negroes, was confined in the fortress of Sinamari, where he died in November, 1796. He wrote several dramatic pieces.

COL'LOW, *n. s.* More properly *colly*, from coal.

Collow is the word by which they denote black grime of burnt coals, or wood. *Woodward on Fossils.*

COLLU'CTANCY, *n. s.* } Lat. *collector*,
COLLU'CTA'TION, *n. s.* } *collocutio*. Con-
test, struggle; contrariety, opposition, spite.

The thermæ, natural baths, or hot-springs, do not owe their heat to any *collocation* or effervescence of the minerals in them. *Woodward's Nat. History.*

COLLU'DE, *v. n.* } Lat. *colludo*, *collusio*.
COLLU'SION, *n. s.* } To conspire in a fraud;
COLLU'SIVE, *adj.* } to act in concert for a
COLLU'SIVELY, *adv.* } bad purpose; to play
COLLU'SORY, *adj.* } into each others hands.

Collusion is, in our common law, a deceitful agreement or compact between two or more, for the one part to bring an action against the other to some evil purpose; as to defraud a third of his right. *Cowell.*

By the ignorance of the merchants, or dishonesty of weavers, or the *collusion* of both, the ware was bad, and the price excessive. *Swift.*

COLLUM, the neck. See **ANATOMY**.

COLLUMPTON, a neat town of Devonshire, seated on the river Columb, near its mouth. It carries on the woollen manufacture. It is ten miles north of Exeter, and 150 west by south of London.

COLLUTHIANS, a religious sect who rose about the beginning of the fourth century, on occasion of the indulgence shown to Arius by Alexander, patriarch of Alexandria. Several people being scandalised at so much condescension, Colluthus, a priest of the same city, hence took a pretence for holding separate assemblies, and by degrees proceeded to the ordination of priests, as if he had been a bishop; pretending a necessity for this to oppose Arius. To his schism he added heresy; teaching that God did not create the wicked, &c. He was condemned by a council held at Alexandria by Osius, A. D. 330.

COL'LY, *v. a. & n. s.* From coal. To grime with coal: to smut with coal.

Brief as the lightning in the *collied* night,
That in a speed, unfolds both heaven and earth

And, ere a man hath power to say, behold,
The jaws of darkness do devour it up. *Shakespeare.*

Suppose thou saw her dressed in some old hirsuit attire, out of fashion, coarse raiment, besmeared with soot, *colly*, perfumed with opopanax.

Barton on Melancholy.

COLLYBUS, *κόλλυβος*, in antiquity, the rate of exchange.

COLLYRÆ, or **COLLYRIDES**, in antiquity, an ornament of hair, worn by the women on their

necks. It was made in the form of the small roundish cakes called *κολυβάριαι*, *collyriae*.

COLLYRIDIANS, in church history, a sect towards the close of the fourth century, denominated from a little cake, called by the Greeks *κολυβάριαι*, *collyridia*, which they offered to the Virgin Mary. They were chiefly Arabian women, who, out of an extravagant veneration for the Virgin, met once a year to celebrate a solemn feast, and to render divine honors to Mary, as to a goddess; eating the cake which they offered in her name: St. Epiphanius, who relates the history of this superstitious ceremony, ridicules it. They sprung up in opposition to the Antidico-Marianitas.

COLLYRIUM, *n. s.* Lat. An ointment for the eyes.

COLMAN (George), a celebrated theatrical writer, was born at Florence about 1733. His father, Thomas Colman, esq. married a sister of the countess of Bath, being, at that time, British resident at the court of the grand duke of Tuscany. He received the early part of his education at Westminster school, where Churchill, Lloyd, Thornton, and others, who afterwards distinguished themselves in the literary world, were his intimate companions. His poetical genius appeared while at school; and a copy of verses which he addressed to his cousin lord Pulteney, were afterwards published in the Saint James's Magazine. From Westminster he removed to Christ Church College, Oxford, where he gave many proofs of his lively genius; and, in conjunction with Bonnel Thornton, produced a weekly paper called the *Connoisseur*, which was continued from January, 1754, to September, 1756, and published afterwards in 4 vols. 12mo. This work appeared about the same time with the *World*, the *Adventurer*, and the *Rambler*, and though it met not with an equal share of approbation, yet it may justly be affirmed that it contains some papers superior to any in them, for ludicrously portraying the manners of the day. After taking the degree of A. M. Mr. Colman left college, and took up his residence in London. He entered at Lincoln's Inn, and was soon admitted to the bar, but he never followed that profession; being more inclined to the pursuit of literature. In 1760 he published a dramatic piece of great humor, entitled *Polly Honeycombe*, which was acted at Drury-lane with great success; and the next year he produced the comedy of the *Jealous Wife*, which was thought superior to any which had appeared for many years. By the death of lord Bath in 1754, he came to the possession of a handsome fortune, which was considerably augmented by that of general Pulteney in 1767. Still, however, he continued to write for the stage, and, in conjunction with Garrick, produced that excellent comedy called the *Clandestine Marriage*. He also translated the comedies of Terence into blank verse, which added considerably to his fame as a writer. In 1768 he became a patentee of Covent-garden theatre, but soon after sold his share, and made a purchase of the Haymarket theatre from Mr. Samuel Foote, which he supplied either with original pieces or translations, and for which he was at considerable

VOL. VI.

pains to engage the ablest actors, particularly in comedy. Having translated Horace's *Art of Poetry*, he prefixed an ingenious account of the design of its author, and added to the value of the whole by numerous critical notes. Among a number of small pieces of the humorous kind, the *Genius*, and the *Gentleman*, were both productions of his. In 1789 he had a stroke of the palsy, which greatly impaired his understanding, in consequence of which his son was entrusted with the management of the theatre; and he died in August, 1794.

COLMAN (St.), the founder of the church and bishopric of Cloyne in Ireland, flourished about the end of the sixth century. A well, reputed holy, to the north-west of Cloyne, is dedicated to him, and is much frequented by the Irish Catholics on his anniversary, November 24th.

COLMAR, *n. s.* Fr. A sort of pear.

COLMAR, a large and handsome town of France, capital of the department of Upper Rhine and *ci-devant* province of Alsace. It is situated on two small rivers, the Fecht and the Lauch, is surrounded by a wall flanked with towers, and contains 15,000 inhabitants. This town is supposed to be the ancient *Argentivaria*. It was fortified towards the middle of the seventeenth century; but Louis XIV took it in 1673, and demolished the works; and the French have ever since retained it. It is twenty-seven miles north-west of Bale, and thirty-four S. S. W. of Strasburgh.

COLME, a river of France, which branches from the *Aa*, at *Watte*, in the department of the Straits of Calais.

COLN, a river of Essex, which rises near Clare in Suffolk, and, passing by Halstead and Colchester, runs into the German Ocean between Mersey Island and the main land. The famous Colchester oysters are bred in the salt water pools, at the mouth of this river.

COLNBROOK, a town of Buckinghamshire, seated on the river *Coln*, which separates this county from Middlesex. It is a great thoroughfare on the western road, and has several good inns.

COLOCYNTHIS. See *CUCUMIS*.

COLOGNA, a rich town in the Venetian territory, containing 6200 inhabitants, who trade in wine and silk. It lies twenty miles S. S. E. from Vicenza.

COLOGNE, an electorate of Germany, and formerly an archbishopric, but of late years secularised, and included in the grand duchy of the Lower Rhine, under the Prussian dominion. It is mostly situated on the left bank of the Rhine, which bounds it on the east, and separates it from the duchy of Berg; on the north it is bounded by Gueldres and Cleves, on the west by the duchy of Juliers, and on the south by the electorate of Treves. It is about ninety miles long, by about fourteen of average breadth, and contains a population of nearly 220,000 souls. The upper part of this country is covered with large forests; but in the lower, corn and flax are produced in great plenty. It is included between 50° 30' and 51° 25' N. lat., and 6° 35' and 7° 10' E. long., extending in a direction from south-east to north-west something in the

form of a semicircle. The Rhine, which is the principal river, is here a very considerable stream, receiving an accession of the waters of the Nethe, the Aar, the Erp, and the Neufs. The places of chief note are Cologne, the capital, Bonn, a very considerable town, once the metropolis and the residence of the elector, Bergheim, Bruyl, and Rheinburg. Great quantities of wine are sent out of this country by means of the Rhine, which flows nearly seventy miles along its borders. There are also some lead and iron mines. The religion most prevalent is the Roman Catholic; but free toleration is enjoyed by the Protestants, who are also eligible to fill public offices. Formerly the dignity of archbishop and that of elector were vested in the same person, who was arch-chancellor of the empire, and occupied the third place in the college.

COLOGNE, the capital of this electorate, is an ancient town, known to the Romans by the name of Colonia Agrippinæ because it was built by Agrippina, the wife of Claudius, and Colonia Ubiorum, from the Ubii, its ancient inhabitants. So early as the year 755 it was an archbishopric, and in 1260 it entered into the Hanseatic league, and was once considered one of the four principal Hanstowns. It is built in the form of a crescent, close to the Rhine, and is fortified with strong walls, flanked with thirty large towers, and surrounded with three ditches, the whole forming a circuit of nearly seven English miles; but it was taken by the French under general Jourdan, on the 6th of October, 1794, not only without resistance, but even with demonstrations of joy. The entrances to the town are by twenty-four gates, and within the walls there are nineteen parishes, two collegiate churches, two abbeys, thirty-nine monasteries, two establishments for noble ladies, an archiepiscopal seminary, and forty-nine chapels, besides some commandaries of the Teutonic order, and of the order of Malta. The French suppressed the university, which was established by pope Urban VI. in 1388, and established in its place a central school, with a library, a museum, philosophical apparatus, and botanic garden. The streets are generally narrow and crooked, and the houses very ill built, the only square worth noticing is the Forum-Novum, and the best buildings are the churches. The cathedral is vast but unfinished, in the Gothic style; it was built about the year 1248. Here they say three kings, or wise men, who came from the east to visit the Saviour are interred; they lay in a large purple shrine, spangled with gold, upon a pedestal of brass, in the middle of a square mausoleum, covered within and without with marble and jasper. Formerly it was opened every morning at nine o'clock, when the kings were seen lying at full length, with crowns of gold on their heads, garnished with precious stones. Their names, which are Gaspar, Melchion, and Balthasar, are in purple characters on a little grate, which is adorned with an infinite number of large rich pearls and precious stones,

particularly an oriental topaz, as big as a pigeon's egg, and valued at 30,000 crowns. Over against them are six large branches of silver, with wax candles which burnt night and day. The bones of these men, we are told, were brought to Constantinople by Helena, mother of Constantine, from thence to Milan by Eustorpius, bishop of that see, and afterwards hither by archbishop Rainold. In the Jesuits' college are the portraits of the first thirteen generals of that order, with Ignatius Loyola at their head; and in the church, which is the finest in Cologne, are many rich statues, with an amazing quantity of fine silver plate; and the utensils for mass are all of gold enriched with precious stones. In the Cordeliers' church, is the tomb of our famous countryman, Duns Scotus, surnamed Doctor Subtilis, with this epitaph, 'Scotia me genuit, Anglia me suscepit, Gallia me docuit, Colognia me tenet.' In the church of St. Ursula they pretend to show her tomb, and the bones of the 11,000 virgin martyrs, though this arises from a mistaken inscription; the heads of some of them are kept in cases of silver, some of them covered with stuff of gold and velvet. The canonesses of St. Ursula were all countesses, and had a large revenue. They have, as they say, three of the thorns of our Saviour's crown, and one of the vessels which contained the water that he converted into wine at the marriage of Cana. The church of St. Gestian has a subterraneous church under it. The clergy are very numerous, and had formerly very large revenues; there are said to be not fewer than 2000 ecclesiastics of all ranks. Baron Poinitz said, that though Cologne was one of the greatest cities, it was one of the most melancholy in Europe; there being nothing to be seen but priests, friars, and students, many of whom begged alms with a song; and nothing to be heard but the ringing of bells. The population of this city is estimated at 50,000, the greater part of whom are papists; the Protestants were formerly obliged to repair to the neighbouring town of Mulheim, in the duchy of Berg, for public worship, but they now enjoy toleration in this respect, and have many privileges. The trade of the town is chiefly in their hands.

The principal exports are wine, timber, earthenware, slates and several other minerals, fire-arms, and various articles of hardware and kitchen utensils. Linen, woollen, and silk stuffs, lace, and thread, are manufactured here; and great quantities of eau de Cologne, so famous throughout Europe. It was formerly governed by its own senate in civil matters; but criminal causes belonged to the jurisdiction of the elector and his chapter, of whom the inhabitants were very jealous, so that they would not permit him to reside in the city; his usual residence used, therefore, to be at Bonn. Cologne is seventeen miles east of Juliers, forty-seven from Maestricht, and ten north of Bonn. It is situated in 6° 55' E. long. and 50° 55' N. lat.

COLOMBIA.

IA, an extensive country, occupying a portion of the north and north-west of South America, between the 5° 50' S. and 12° 30' N. lat., and 58° long. On the north and north-east it is bounded by the Caribbean Sea and the Atlantic, on the west by the river Essequibo, and by Guiana, on the south by Brazil, and by Peru westward, while the eastern coast is washed by the great Pacific Ocean about twelve degrees of latitude from the north, where it is connected by the Isthmus of Darien with the province of Guayana in North America. In our article on the former we have treated, at some length, of this portion of the transatlantic world; and, in describing its rising prosperity and political importance, we have shown that an independent state are every day before us, and are apparent, we cannot forbear adding our former remarks.

The vast country, the eastern part was distinguished by the name of Venezuela, and the western was called New Granada, or Condinamarca, the name of the eastern portion being Quito; the two former now constitute the great divisions of the Republic of Colombia. For the minor divisions of these great districts, and the population of each, we cannot do better than refer the reader to the Tables given in the description of the Republic of Colombia, under the article on that subject.

The most prominent feature on the western coast is the great Cordillera of the Andes, which runs through the whole extent from north to south at an average distance of 150 miles from the Atlantic Ocean. Northward, about the second degree of latitude, a branch of this immense range strikes off in an east and north-east direction, and soon after another diverges a little to the west, and then due north; forming three principal main chains, with many subordinate ones, crossing the country in all directions, and the intervening valleys are watered by the great rivers and smaller streams, that rise from the mountains. It is in this region that the Andes reach their greatest elevation, and the stupendous Chimborazo lifts its lofty summit to a height of 7147 yards above the level of the sea, exceeded alone by the vast Himalayan chain of the eastern continent. This mountain towers above all the rest: but to the north and south of it, and east, others of a height little inferior are seen ascending to the skies, and exhibiting, with their snow-clad cones, a striking and beautiful contrast with the dark blue firmament above. The chief of these are Antisana, Cotopaxi, Illimiza, and Pichinga, varying in elevation about 1000 feet from each other. North of the equator this mighty chain diminishes gradually in height, and diverges in the third degree of latitude from the river Atrato, forming a narrow ridge at about 100 miles average distance from the coast, reaching to cape Vela; the greatest eleva-

tion of this branch is about 16,000 feet, the plain of Caraccas in which it stands being 2660 feet above the sea. The Caraccas coast, which is of an immense extent, affords a continuation of this great table land, furnishing the most tremendous precipices in the world, and is lost in the sea nearly opposite to the island of Trinidad. The Cordillera of Caraccas, sometimes, in the western part, exceeds 8,000 feet; it includes some large and beautiful valleys. What is called the Cordillera of the Cataracts of Orinoco forms the second great branch of the Andes; between the third and sixth degrees of north latitude it extends itself, forming the lofty plain of Tuquillo and St. Martin, and exhibiting the peaks of Umama and Cavanami. Here the rivers Guavari, Meta, Zama, and Ymerida, take their rise, and the awful cataracts of Aturé and Maypuré occur. Beyond these this chain is of greater height, and stretches in a southerly direction as far as the Portuguese frontiers, where a vast and impenetrable region of forest extends, over which no European has yet passed. Here are the sources of the magnificent river Orinoco, unknown both to the Spaniards and the civilised Indians themselves. The highest point of this Cordillera is Duida, a volcanic mountain above 8,465 feet high. Three vast plains run between the bases of these branches of the Andes, open to the Atlantic Ocean; the most northerly being that of Orinoco, luxuriant in herbage, but with comparatively few trees, and these widely scattered. Here an immense flat occurs, with vast savannahs, called Los Llanos (the Plains), where the residents of the towns and villages feed innumerable herds of cattle.

The enterprising Humboldt, who penetrated farthest and made the most valuable discoveries in this country, speaking of its general aspect, expresses himself thus:

When a traveller, newly arrived from Europe, penetrates for the first time into the forests of South America, nature presents herself to him under an unexpected aspect. The objects, that surround him, recall but feebly those pictures which celebrated writers have traced on the banks of the Mississippi, in Florida, and in other temperate regions of the New World. He feels at every step, that he is not on the confines, but in the very centre, of the torrid zone; not in one of the West India islands, but on a vast continent, where everything is gigantic—the mountains, the rivers, and the mass of vegetation. If he feel strongly the beauty of picturesque scenery, he can scarcely define the various emotions which crowd upon his mind; he can scarcely distinguish what most excites his admiration—the deep silence of those solitudes, the individual beauty and contrast of forms, or that vigor and freshness of vegetable life, which characterise the climate of the tropics. It might be said that the earth, overloaded with plants, does not allow them space enough to unfold themselves. The trunks of the trees are every where concealed

under a thick carpet of verdure; and if carefully transplanted the orchideæ, the pipers, and the pathos, which a single courbaril, or American fig-tree nourishes, we should cover a vast extent of ground. By this singular assemblage, the forests, as well as the flanks of the rocks and mountains, enlarge the domains of organic nature. The same lianas which creep on the ground, reach the tops of the trees, and pass from one to another at the height of more than 100 feet. We walked for some hours under the shade of these arcades, that scarcely admit a glimpse of the sky, which appeared to me of an indigo blue, so much the deeper, as the green of the equinoctial plants is generally of a stronger tint, with somewhat of a brownish hue. A great fern tree, very different from the polypodium arboreum of the West Indies, rose above masses of scattered rocks. In this place we were struck for the first time with the sight of those nests in the shape of bottles, or small pockets, which are suspended from the branches of the lowest trees, and which attest the admirable industry of the orioles, that mingle their warblings with the hoarse cries of the parrots and the macaws. These last, so well known for their vivid colors, fly only in pairs, while the real parrots wander about in flocks of several hundreds. A man must have lived in those climates, particularly in the hot valleys of the Andes, to conceive how these birds sometimes drown with their voice the noise of the torrents, which rush down from rock to rock.

Caraccas seems to form three distinct zones from east to west; first that of the cultivated land along the shore; then the pasturage, or savannahs; and lastly, one of forests, extending beyond the river Orinoco, penetrable only by means of the rivers that intersect them. It may be said, indeed, to exhibit the three most striking varieties of human society; that of the wild hunter in the woods of Orinoco, of the pastoral life in the savannahs, and the agricultural at the foot of the mountains, near the coast. Along the coasts of the Pacific, the Caribbean Sea, and the Atlantic, is a tract of country, reaching to the Cordilleras, the climate of which is hot, and most unhealthy; in parts where it is well watered the soil is luxuriant, but where the periodical rains fail, or the rivers are liable to dry up in their course, it is parched, and sterile. In the province of Coro, for instance, it has sometimes not rained for four years together, and seasons of similar drought, though not to so great a degree, have been experienced in other parts near the coast. In this region most of the rivers are short in their course, inconsiderable in the volume of their waters, and so rapid, and their beds generally so rocky, as to be navigable but a little distance from their mouths. The river Magdalena alone, which descends 700 miles along the valleys of the Andes, is navigable 550 miles above its mouth, as far as the port of Honda. The Cauca, in the valley of Antioquia, and the Atrato, in Choco, are considerable streams, the banks of which are covered with forests that bespeak a soil fertile to excess; but a burning climate renders human life highly precarious; and innumerable insects and poi-

sonous reptiles destroy all its comfort. As you ascend the mountains the climate grows mild, vegetation is uninterrupted through the whole year; wheat, leguminous plants, and all the productions of the temperate zone abound, and are of excellent quality; venomous animals are rare, and man feels the grateful salubrity of the temperature, conducive alike to his labor and enjoyment. This temperature continues to the height of 9000 feet above the level of the sea, where the air is cold and the sky cloudy, and vegetation slow and stunted. When you reach the elevation of 15,700 feet, you find no trace of it remaining except the lichen, which is found nearly 3000 feet higher; all is solitude, uninterrupted by a single living creature, except the equally solitary condor, and the few human beings whom love of enterprise and discovery may lead to tempt the difficulties of so lofty an ascent. The thermometer of Fahrenheit varies from 77° to 115° as you ascend to the height of 4800; and beyond that, to 8000 feet of elevation, from 50° to 77°. Beyond the mountainous districts, stretching eastward and southward, is an immense tract of level plains, from the Andes to the river Amazon, and the mountainous country, near the Orinoco. Vast savannahs are watered by the above river, and the numerous streams, that compose the Meta and the Apuré; the overflowings of which for four months in the year convert the country into a great lake or inland sea, on which the villages or cattle farms appear like so many islets. These plains are extremely rich in agricultural productions, and feed immense herds of cattle. When the rivers retire within their banks, the whole country is covered with the most luxuriant pasturage. The forests on the banks of the rivers abound with the most valuable timber, and dye-woods, and the soil is excellent for the cultivation of sugar, cotton, coffee, cocoa, indigo, and tobacco. Nature teems with animal and vegetable life; wild beasts, venomous reptiles, and insects, prove the torment of man, who vainly imagines all the comforts of existence designed for his sole use and convenience. Though the climate here is hot, it is not so unhealthy as that of the coast; the air is purified and refreshed by the breezes that are constantly passing over this vast grassy ocean, which extends from the Orinoco to the Andes, 300 miles, in almost every direction. Vera Cruz and Carthagenæ are the only ports in Condamarca or New Granada, that have any connexion with foreign colonies, or intercourse with any part of Europe, except Spain; the nature of its coast and the situation of its population on the Cordilleras, have few attractions for foreigners, and the dangerous gales of wind from the north render the Mexican Gulf, which bounds this country on the north, very little frequented during a part of the year. The Caraccas coasts, on the contrary, possess great advantages for foreign intercourse, from their great extent eastward, from the number of their forts, and their safe anchorage at all seasons. The ports of Cumana, Barcelona, La Guayra, Porto Cabello, Coro, and Maracaibo, present facilities of intercourse so great, that it is extremely difficult to restrain an illicit trade with foreign parts. The

most favorable parts of the country for colonisation are, unquestionably, the four maritime provinces of Orinoco, Caracas, Zulia, and Magdalena, near the Gulf of Paria: in the first of these provinces the land is extremely fertile, and particularly famous for the culture of the cocoa. The district of Barcelona is not only very fruitful, but it is almost uninhabited. Of all these provinces, however, Caracas is the most beautiful, and unrivalled for fertility; but a small portion only of its land is uncultivated, and there is hardly a single estate, that is not so shackled, as to involve a purchaser in endless litigations. Besides this, perhaps, emigrants would do well not to visit this province, since they might with great difficulty renounce its celestial climate and its lovely valleys for the, confessedly, greater advantages of other parts of Columbia. In Zulia the province of Merida has most attractions for the foreign settlers; it has a charming climate, and, though its territory is mountainous it is fruitful; all the grains and fruits of the temperate zone are produced in abundance on the high lands, while every tropical production, particularly sugar cane and cocoa, is yielded by the warmest valleys below. Maracaibo also, from its immense lake and gulf, possesses great advantages for agriculture and commerce; nearly a hundred rivers discharge themselves into its basin, the banks of which are amazingly fertile; but many of the settlements have been abandoned on account of their unhealthy climate. But Magdalena is the most advantageous for a foreign settlement; its lands are almost unoccupied, and produce in great abundance coffee, cocoa, cotton, sugar, rice, indigo, tobacco, maize, and fruits and vegetables of every kind. There are also extensive pastures for cattle, the soil of which is excellent. The climate is generally healthy, and the settler may find a temperature suited to his constitution, by ascending the mountains to a greater or less elevation. Game and fish are found in great plenty in the woods and in the adjacent seas. Two principal ports, Santa Marta on the west, and Ciudad del Hacha on the east, tend much to forward the commercial business of this province; the latter, especially, affording an excellent market for the produce raised in the country, and for every article of consumption brought from other parts. Saviuilla or Saldanilla, in Cartagena, is the natural port of Magdalena, and is destined, no doubt, by its situation, to become the principal mart for the trade of the interior, though it is now closed in favor of Santa Marta, the communication between which and the river Cauca is circuitous and troublesome, whereas Saviuilla lies at the very mouth of that river. The principal defect of this port is the extreme shallowness of water above it, so that even flat boats, when loaded, with difficulty can reach Baranquilla, but this might be remedied were the mouth, called Boca Viega, stopped up, and the great body of the water directed to the other outlet.

In common with all those countries through which the mighty chain of the Andes passes, Colombia is subject to frequent earthquakes.

There are several volcanoes in this part of that chain, particularly Cotopaxi, Pichincha, Sangai, and El Altar, or Altair, the description of which having been so fully given in the article *ANDES*, we forbear to enlarge. Caracas, as well as Quito, and the central parts, is liable to very sensible shocks of earthquakes. In 1797 dreadful ravages were produced by them in the month of December; on the first of May, 1802, at eleven at night, there was a pretty strong shock, with oscillation, from west to east; on the 20th of the same month, at four in the morning, another was felt in a vertical direction, and the earth did not recover its horizontal level for the space of two minutes; on the 14th of July following, two shocks occurred at forty minutes past two o'clock in the morning, and another at thirty-five minutes past six. The causes and local origin of these earthquakes must exist in the province of Cumana, since they are more violent there than elsewhere.

The seasons of this part of South America are only two, winter and summer; and these are marked not so much by heat and cold as by rain and drought. In Caracas, during the wet season, it rains for the space of three hours a day, and more commonly in the evening than in the morning. There are, however, some days in which not a drop of rain falls, and others when it rains incessantly, the country generally, plains, mountains, and valleys sharing its blessings and its inconveniences. It is not drizzling rain as in the northern regions; but it descends in torrents, producing more water in a single day than that of Europe does in a week. The total quantity is ten times that of the polar regions. The rivers inundate the country during the greater part of this season, and the lands are covered to an immense depth, only the tops of the tallest trees being visible, and serving for land-marks. This is the case, especially, in the north plain of Orinoco, which extends 450 miles in length and 120 in breadth. M. de Humboldt describes the dry season in Guiana as a horrible time, and gives an excellent picture of the regeneration of nature, especially of vegetation, on the return of the rain. Crocodiles, and other reptiles, seem then to revive, and multitudes of horses, oxen, wild asses, and ferocious animals, rush, panting with eagerness, from the burning desert to quench their thirst in the marshes, plunging into them and drinking with so much avidity, that they become swollen, and often die in a few hours. The effect is different, however, in some parts; along the coast of Cayenne, Surinam, Berbice, Demerara, and Essequibo the air is refreshed by the sea-breezes, the dry season is delightful, while, on the other hand, the rainy season is hotter and more unhealthy. The climate of Condinamarca is very various; the lofty Cordillera of the Andes, and the snows which constantly cover its summit, subject this country, though lying under the equator, to all the cold of the polar regions, while on the lower plains the heat is intense. The elevated spots between the ridges of the mountains are temperate and settled in their climate, and there Europeans chiefly fix their abode.

There are many lakes in Colombia, a great

number of which are formed by the rains, and others are the reservoirs of rivers, which flow into them. The former are frequently met with in the low grounds in the neighbourhood of the Orinoco; the greatest of the second description are Maracaibo and Valencia. The lake of Maracaibo has been already referred to in our article AMERICA, under the division of Colombia; it is very deep and navigable for the largest vessels; its waters are always fresh; but violent storms will sometimes force those of the neighbouring gulf into it. There is generally a considerable undulation on it, and when the north wind blows hard the waves rise very high. The shores in the vicinity are unhealthy in consequence of the vapors that arise in the night; but the richness of the soil in the western part has induced some Spaniards to take up their residence there, in order to cultivate cacao and provisions. On the south it is uncultivated, and without inhabitants; the northern side, though hotter, is much more healthy. The Indians build their villages on the margin of the lake, deeming it the most healthy plan; to one of these the Spaniards gave the name of Little Venice, or Venezuela, which was afterwards transferred to the whole province. There are four of these villages remaining, under the superintendance of a monk. There is a mine or vein of mineral pitch on the north-west of Lake Maracaibo, used in graving vessels, which emits, during the hot weather, coruscations from its surface like frequent lightnings; the natives call them St. Anthony's lanterns; they make use of them in steering by during the dark nights of the torrid zone. The lake of Valencia is of much less extent, being only forty miles long and twelve broad; it is situated in a valley, everywhere, except on the west, surrounded by lofty and steep precipices. Its banks are covered with the most luxuriant herbage. The waters of his lake are much subject to evaporation, and, being elevated more than 1300 feet above the level of the ocean, it is thought that they have some subterraneous communication. This gradual retreat of the waters, and some new islands appearing frequently, have given reason to believe that the lake may perhaps become dry. The southern shores are desert, and a gloomy monotony prevails in consequence of their being overshadowed by a ridge of high mountains, while on the north the country is cheerful and richly cultivated. This part of the shore has the appearance of a garden, regularly laid out with borders of cestrum, azedaracs, and other shrubs always blooming, which join together the scattered farms. The houses are surrounded with trees; the ceiba, with its large yellow flowers, entwines its branches with the purple erithryna; the most vivid vegetable colors form a pleasing contrast with the unclouded uniformity of the sky; and in the dry season artificial watering preserves the burning soil in a state of continual verdure and fertility. Here and there vast masses of granite rock break abruptly through the cultivated vegetation of the valley, nourishing on their bare and forked surfaces a few succulent plants that prepare mould for distant ages, and with their withered branches stand like signals on a high cliff. In ancient times this valley was

covered with waters, and there were probably shoals or islets in the midst of it. The lake has many islands on it, not less than fifteen, forming three clusters; the largest of these, Burro, is two miles long, and is inhabited by Mestizoes, who rear a few goats. The fish is abundant, but there are only three sorts, the guavina, the vagra, and the sardina; their flesh, however, is very insipid in flavor. On the southern shore tobacco is raised, and here are some of the finest plantations in the whole province. In Guiana is the lake of Parina or Parantipinca, an oblong piece of water about 100 miles long by fifty broad; in an island of which there is a rock of glittering mica, said to have been the site of the city of El Dorado, a supposed place, the streets of which were asserted to be paved with gold. This lake gives rise to the large river Rio Blanco, and is described as situated in lat. 3° 40' N., and long 67° 20' W.

It is difficult to find a country in the world so abundant in rivers; every valley has them, either of the larger or smaller description, and, if they are not navigable, yet they would copiously supply all the wants of the population, were it even increased a hundred fold. Those streams which take their rise on the northern sides of the mountains in Caraccas, and flow into the sea, are so fenced in by their rocky banks, and favored by the declivity of their channels, that they seldom overflow, and never for any length of time, or with much detriment to the country; but those which rise on the south of the same mountains, running in smoother and shallower beds, frequently mingle their water through a great part of the year, and form an immense sea in the country. Almost all of these flow to augment the waters of the Orinoco, which is not only one of the largest, but the finest of the rivers of the southern peninsula. We have treated of it among the rivers of South America, and shall not therefore repeat our observations. Rising in the lake Ipava, it winds a circuitous course, passing through lake Parima, and afterwards receiving the Guaviare; and more northward the Meta, the Apura, the Arauca, and a multitude of other streams, large and small, it issues by numerous estuaries into the Atlantic opposite to Trinidad. Seven of its mouths are navigable, but very dangerous; the largest is eighteen miles broad. The scenery on the banks of this great river is truly magnificent, forests of aromatic trees diffuse, to a great extent, their delightful odors and agreeable shade; birds of the most beautiful plumage are observed in every direction, and the traveller is astonished at the innumerable monkeys that are seen leaping from tree to tree, with the most surprising agility. Vast plains of the greatest verdure extend from the forests to a distance that no eye can reach. The cataracts of the Orinoco, said to be the most awful in the world, occur near the bend of the river at the villages of Maypures and Atures, in about 6° north latitude. From the end of April to October the waters are swelled by the rains, rising to the height of forty feet above their lowest level; they then begin to subside, and continue sinking till March, when they are at the lowest: they fluctuate in this way with constant regularity

The rains are not the only causes of this variation; the principal cause, no doubt, is the melting of the snows in the mountains of Bogota. The seas that wash the coasts of Colombia are not remarkable for any great variation in the tides; in some parts on the north and north-east, near the gulf of Paria, they rise during the equinoxes to six or seven feet; but near the mouths of the Orinoco they scarcely attain the height of ten inches. The trade winds prevail off the coasts, blowing from north-east by east; but nearer to the shore they blow only from nine in the morning till evening, and are succeeded in the night by the land breezes. All the coasts of Caraccas are exposed to rolling and monstrous billows, and there is only one port, the road of Porto Cabello, where the navy can ride securely.

The principal place on the north of this vast country is Caraccas; its port, La Guayra, is situated in lat. $10^{\circ} 36' N.$ and $67^{\circ} 10' W.$ long. This port is singularly situated; it is separated from the elevated valley of Caraccas by a chain of mountains descending directly into the sea, and forming a rocky wall for the backs of the houses of the town, not much more than 140 toises from the ocean. On this account serious damage is sometimes occasioned by the stones that fall from the heights. This circumstance also occasions a striking peculiarity in the surrounding prospect, there being no visible horizon, except what the sea forms on the north. This town has only two streets running east and west, and parallel to each other, but not in a direct line; they are narrow and badly paved, and the houses generally mean. The place is defended by batteries, of which that of Cerro Colorado is the chief; and the works on the sea-side are well disposed, and in good repair. The appearance of this town is singularly gloomy; one seems to be on an island, rocky and destitute of vegetation, and except Cape Blanco and Maiquetia, where there are a few cocoa trees, the horizon, the sea, and the heavens, are the only objects that meet the eye. The climate is the most ardent in all the country, not only from the scorching rays of the sun, but from the heat retained by the almost perpendicular rocks; and the air is considerably stagnated in the hollows of these mountains, and consequently has a more unwholesome effect upon the organs of the human frame, than the same degree of heat in the open country. By the thermometrical observations of Humboldt, it appears that La Guayra is one of the hottest places in the world, that the quantity of heat there, in the course of the year, is a little more than at Cumana; but that from November to January the atmosphere is cooler at La Guayra: probably this may arise from its more westerly position. This port, however, was not formerly so unhealthy, nor the yellow fever so prevalent as in Porto Cabello, Carthagena, and Santa Martha; but since the year 1797, to whatever cause it may be owing, this destructive malady has committed dreadful ravages. La Guayra is not a safe anchorage for ships; the depth of the water nearly a quarter of a league from the beach, is not more than eight fathoms; the sea is in constant agitation, and the surge runs high. It is,

consequently, difficult for vessels to take in their lading: this operation is done by the negroes and mulattoes, a remarkably strong race of men, who go up to their middles through the water; and it is particularly deserving of notice, that the sharks here, and at Santa Martha, are perfectly harmless, and never attack any one; while, at the opposite island, they are dangerous and blood-thirsty. The people, generally superstitious, attribute this to a bishop's having given his blessing to the sharks at both these places. In peaceable times the imports into this port amount to rather more than £500,000, and the exports of cacao, indigo, cotton, coffee, and hides, are nearly £350,000. 'When in the season of the great heat,' says the author of Colombia, 'we breathe the burning atmosphere of La Guayra, and turn our eyes towards the mountains, we are strongly impressed with the idea, that at the direct distance of 5,000 or 6,000 toises, a population of 40,000 souls assembled in a narrow valley, enjoys all the coolness of spring, of a temperature, which at night descends to 12° of the centesimal thermometer. This near approach of different climates is common in the Cordilleras of the Andes; but everywhere at Mexico, at Quito, in Peru and in New Grenada, a long journey must be made into the interior either by the plains, or by proceeding up the rivers, in order to reach the great cities, which are the centres of civilisation. The height of Caraccas is but a third of that of Mexico, Quito, and Santa Fe de Bogota; yet among all the capitals of Spanish America, which enjoy a cool and delicious climate in the midst of the torrid zone, Caraccas stands nearest to the coast. What a privilege to possess a sea-port at three leagues distance, and to be situated among mountains on a table land, which would produce a heat, if the cultivation of the coffee-tree were not preferred.'

Nothing can be finer than the road from La Guayra to the valley of Caraccas; it requires but three hours to travel it with good mules, and two to return; it takes about four or five hours to go on foot. It is very similar to that of St. Gothard, or of the Great St. Bernard in Switzerland; at first you ascend by a ridge of steep rocks, afterwards the ascent is rather more easy, and the windings of the road render the declivity more easy as in the old road over mount Cenis. The leap or Salto is a crevice that is crossed by a drawbridge, and on the top of the mountain there are real fortifications. At La Venta you find some most beautiful scenery; and when the clouds permit, the sea and the neighbouring coast present a magnificent prospect. You have an horizon of more than sixty-six miles in radius, the barren, white shore reflects the light in such a mass as to dazzle the beholder; while, at your feet, you see Cape Blanco, Maiquetia with its groves of cocoa-trees, La Guayra, and the vessels entering its port; and, when the sky is not clear, long trains of clouds, brightly illumined on their upper surface, present the appearance of islands floating on the ocean. Houses and trees are often seen bursting through the openings of the clouds, that are rolling one over another; and these objects thus appear at a greater depth, than when beheld through a serene atmosphere. Caraccas lies in a small valley near the lofty mountains of

Avila and the Silla, which give a character of gloom to its scenery, especially towards the end of the year; when the atmosphere in the evenings is thick, and when streams of vapors cling to the evergreen slopes of the hills. But in June and July the nights are delicious, the air is pure and transparent, and this is the season for enjoying the beauty of this scenery. The climate of the place is remarkably mild, the temperature in the day time being between 20° and 26°; and at night between 16° and 18°, being favorable equally to the plantain, the orange-tree, the coffee-tree, the apple, the apricot, and to corn. It is, however, generally, inconstant and variable, the inhabitants complain of having several seasons in a day, and those in rapid succession. These variations act violently on the human frame. Two winds generally prevail, one from the west, or sea side, and the other from the east or the interior of the country; the first called Catia, because it blows from that place through the ravine of Tipe, is loaded with humid vapors, which it deposits, as its temperature decreases; it causes dreadful head-aches to persons of irritable nerves, and the people shut themselves up in their houses to avoid it, as they do the sirocco in Italy. The mean temperature of the air may be about from 20° to 22°. Rains are frequent, and hail occurs here about every four or five years, though none falls in the low regions of the tropics. The comparative coolness of the climate agrees well with the cultivation of equinoctial productions. The sugar-cane thrives even on the heights above Caraccas; but in the valley the coffee-tree is preferred, which yields little fruit; but that little of the finest quality. Pine-apples of the highest flavor are produced at Baruto Empedrado, Buonavista, and on the way to Victoria. The traveller is surprised here with a sight of the culinary plants of our climates, and beholds the strawberry, the vine, and all the fruit trees of the temperate zone growing by the side of the coffee and banana tree. The best apples and peaches come from Macarao on the west of the valley, and the quince, not above four or five feet in height, has become wild. Excellent apples are sometimes produced from trees not grafted; there are no cherry-trees, and the olive-trees, though luxuriant in vegetation, bear little fruit. Four small rivers water the vicinity of Caraccas, the Guayra on the south, the Anauco and the Caroa on the east, and the Cactucho; these, after supplying the domestic wants of the town, unite in one bed, and flowing through the valley Chacao, at length mingle with the Tuy, and under that appellation fall into the ocean about thirty-six miles east of Cape Codera. The streets are in straight lines about twenty feet wide, crossing each other at right angles, at a distance of 300 feet; there are three squares that deserve the name; the houses are well built, and in the interior there are many storied and of fine appearance, some of brick, but the greater part of stone, with sharp roofs. The houses of the principal people are neatly and even richly furnished.

Coro is another principal town in Venezuela: it is situated on an isthmus separating the Gulf Venezuela or Maracaibo, from the Carribean

Sea, eight leagues to the west of Caraccas. It stands in a dry sandy plain, where scarcely anything grows but Indian figs, and plants of the Cactus family; the inhabitants have their fruit and vegetables from a place three leagues distant, and such is the great scarcity of water, that it is brought two miles on mules and asses into the town. It is, however, so well situated for trade with Porto Rico and St. Domingo, that the Spaniards fixed on it for their settlement on the coast of Terra Firma. Its streets are regular, but not paved, and the houses are mean; there are about 10,000 inhabitants, who possess little activity or enterprise, but are very proud of being descended from those who conquered the country. There are very few negroes; the Indians who live in the suburbs doing the laborious work; they are paid very low wages, and live with so much parsimony that they will not accommodate each other with a bit of fire without receiving a piece of wood in return. The next place of consequence is Porto Cavello or Puerto Cabello, thirty leagues to the north-east of Caraccas, in a fine harbour in the Golfo Triste; it is near Curacao, to which island it owes its importance. About a league from Porto Cavello is Barburate, a village and harbour, long infested by smugglers, but afterwards in the possession of the Guipuzcoa company, who built a town, wharf, and forts with immense warehouses, and ejected these most troublesome inmates. Guanara, ninety-three leagues south-west of Caraccas, is situated in a fine plain towards Varinas; the river, which gives its name to the town, affords excellent water for the inhabitants and their cattle, and irrigates their land; while there is no impediment to prevent the free circulation of the air. This city has a number of uniform and regular streets, with well-built houses, a handsome church, and a good hospital; its population is about 12,000. It is surrounded with fertile lands and rich pastures for cattle, of which they keep great numbers, and in which, as well as mules, their chief trade consists. Formerly they raised good tobacco in some parts, which was a great source of riches.

The next place of importance is Barquisimeto, about 120 miles W. S. W. of Caraccas, situated in an elevated plain, where it enjoys a happy temperature. It has a fine parish church, in which is a crucifix famed for working miracles, that is an object of devotion to the people, and yields an abundant revenue to the clergy. The town has a population of about 11,000 persons, who find sufficient employ in the plains, valleys, and rising grounds in the neighbourhood, in feeding cattle, and cultivating sugar and excellent wheat. Besides these there are Tocuyo, with about 10,000 inhabitants, who are said to be much addicted to suicide; San Carlos, a large and handsome town on the small river Aguaré, with a population of 9500 persons; Araura, with about 11,000 people, who are very indolent, and addicted to pleasure; Maracay, a beautiful town, forty miles south-west of Caraccas, having three-fourths of its houses built of stone, with an industrious, cleanly, and moral population; Victoria, founded by the missionaries, in the plain of which, though very low, European corn is cultivated in large quantities by a popu-

lation of nearly 8000 persons; Tulmero, in a valley near that of Aragua, containing about 8000 inhabitants, many of whom are free Indians, who are active and laborious, but much addicted to strong liquors, in which they spend in one week the produce of two months; San Matheo, the inhabitants of which are rich and industrious; Valenia, about sixteen miles south-west of Caracca, remarkable as the scene of the death of the tyrant Lopez de Aguieme, who having declared against Philip II., at the moment when he fell, plunged a dagger into the bosom of his only daughter, that she might not have to blush before the Spaniards at the name of the daughter of a traitor. Here the ants are so innumerable, that their excavations under the houses resemble underground canals, which fill with water in the rainy season, and cause great danger to the buildings; San Felipe, surrounded with a fertile soil, watered by a great number of rivulets, and exposed to violent rains and excessive heats; Carora, a handsome town, having three parish churches, in a parched and thorny plain, but favored with a healthy climate; San Juan Baptista del Pao, a city inhabited solely by proprietors of cattle; Calabozo, round which it is computed about 98,000 head of cattle wander in the pastures; San Luis de Cuba, San Sebastian de los Reyes, both feeding large herds of cattle; Nirgua, erected on account of the mines in its soil, but which is going to decay; and the Bay of Ocumara, five leagues east of Porto Cavello, which is an excellent port; the valleys round which contain a population of about 52,500 persons of different descriptions. The greater part of the inhabitants of these towns are farmers, who cultivate their lands, or feed numerous herds and flocks in the surrounding country; the rest are priests, physicians, escrivanas (who discharge the offices of barristers, attorneys, notaries, and even bailiffs), and a few shopkeepers. The territory of one town or village is separated from that of another by forests and natural meadows, or savannahs; and occasionally we find missions or villages of half-civilised Indians.

The government of Cumana, including New Barcelona and New Andalusia, is bounded on the north and east by the sea, on the west by the river Unara, and on the south by the Orinoco, on the left bank of which there are some inhabitants in several places. It is very mountainous, the Andes running through it as far as the Gulph of Paria, and giving birth to the rivers that flow into the Caribbean Sea on the north, and into the Orinoco on the south. The Unara is navigable nearly twenty miles from the sea, up to the village of San Antonio de Clarinas, its whole course being about sixty miles. By the Neveri the port of Barcelona carries on its trade in cattle and skins; at Cumana the small river Manganares is remarkable for having its banks lined with fruitful plantations. The soil in some parts is rather fertile; in others sandy, and presenting nothing but an inexhaustible mine of salt, both marine and mineral. In other places it is wonderfully fruitful, producing every species of vegetation, and the most precious trees, as the guaiacum, anacardium, Brasil, and Campeachy woods, down to the very coast of Paria. The climate varies

according to the different elevations of the mountains, valleys, and plains, in the interior. The most flourishing part of the country is the coast on the Gulf of Paria, where there are two villages, inhabited by French refugees and Spaniards, which are rising in importance; this district promises soon to be the richest in the province. The port of Cumana is capable of receiving all the navies of Europe, and the whole Gulf of Cariaco, thirty-five miles long, and sixty-eight broad, affords very good anchorage; the ocean being calm, and hurricanes never felt here. The city, situated at the foot of a hill, is commanded by the castle of St. Antonio, which forms a beautiful object to vessels advancing into the port, appearing as a bright object on the dark sides of the mountains that rise into the clouds. The town is only fifty-three feet above the level of the sea; the heat is very intense, and scarcely any rain ever falls in the plain; though in the neighbouring mountains it is frequent. There are no very remarkable buildings, owing to the dreadful effects of the last earthquake; on account of the frequency of these, the houses are low and slightly built, beauty and elegance being sacrificed to safety. In 1530 the whole coast was shaken, and a city called New Toledo destroyed; towards the end of the sixteenth century these shocks were very frequent, the sea sometimes rising fifteen or twenty fathoms; on the 21st of October, 1766, Cumana was overthrown, and great numbers perished; the tremblings continued hourly for fourteen months. The next year the inhabitants lived in the streets, when the shocks happened only once a month; in this earthquake the ground opened, and quantities of hot water were thrown out. In 1794 there was another tremendous convulsion, and in 1797 the earth heaved with frightful noises, and four-fifths of the city were destroyed. Half an hour before this there was a strong sulphureous smell, a loud noise was heard from under ground, and flames arose from the banks of the river. Though so constantly exposed to this dreadful visitation, the inhabitants of this place are very insensible to it; they think it never happens but at certain intervals, and that the weather and other appearances indicate its approach. The population of this town, comparing all the statements that have been given, may be about 17,000; they are not so rich as the Caraccans, but they are inclined to business, economical, and industrious; they trade abundantly in cattle, smoked meat, and salted fish; the retail trade is mostly carried on by Catalans, Biscayans, and Canarians, men who begin with a few dollars, and in a few years acquire fortunes by frugality and industry. These people first taught the natives to derive advantage from their local productions.

Provisions are remarkably cheap here; 'two pounds of beef,' says the author of Colombia, 'are sold at Cumana for twopence-halfpenny; and twenty-two pounds of salt meat at from three shillings and fourpence to four shillings and twopence. Fish is never weighed there: some days there is such a quantity caught by the fishermen, that they give ten, twelve, or fifteen, pounds weight for fivepence. The poor go to the

sea-side with maize, cakes, and eggs, and barter them for fish. Eggs are the small change in Cumana, Caraccas, and other provinces of Venezuela, where copper coin is unknown; the smallest piece in circulation being a medio-real in silver, worth twopence-halfpenny. If one goes into a shop to buy something worth less than twopence-halfpenny, they give as change two or three eggs; for a dozen of eggs there is worth only twopence-halfpenny. That is also the price of a measure of excellent milk, about a quart. A sheep is sold for a dollar; a fine turkey for twenty or twenty-five pence; a fowl for fivepence; a fat capon for from sevenpence-halfpenny to tenpence; a duck at the same price; game and wild-fowl are frequently sold cheaper than butcher's meat; and all those articles are still cheaper in the small towns of the interior.

'I lived,' says Lavaysse, 'at the best and dearest hotel in Cumana, at a dollar per day, including the expenses of my son and servant. They gave us for breakfast, cold meats, fish, chocolate, coffee, tea, and Spanish wine: an excellent dinner, with Spanish and French wines, coffee, and liqueurs: in the evening chocolate; I was well lodged and lighted. I should have expended but half that sum if I had gone to board and lodge in a family. In short, there is not a country in the world where one may live cheaper than in the province of Cumana. An excellent dinner may be had there for tenpence, not including wine, which does not cost more than fivepence per bottle to those who buy a quantity of it. Poor people drink punch, which is at a very low rate, for it does not cost above one penny per quart.'

The following description of the new salt-works in the neighbourhood of Araya, from the same pen, is worthy of attention. 'The new salt-works of Araya have five reservoirs or pits, the largest of which have a regular form, and 2300 square toises surface. Their mean depth is eight inches. Use is made both of the rain waters, which by filtration collect at the lowest part of the plain, and of the water of the sea, which enters by canals, or martellières, when the flood-tide is favored by the winds. The situation of these salt-works is less advantageous than that of the mere. The waters which fall into the latter pass over steeper slopes, washing a greater extent of ground. The natives make use of hand-pumps to convey the sea-water from one principal reservoir into the pits. It would nevertheless be easy enough to employ the wind as the moving power, since the breeze always blows strong on these coasts. The earth already washed is never carried away here, as is the custom from time to time in the island of Margarita; nor have wells been dug in the muriatiferous clay, to find strata richer in muriate of soda. The salt men generally complain of want of rain; and in the new salt-works it appears difficult to determine what is the quantity of salt that is owing solely to the waters of the sea. The natives estimate it at a sixth of the total produce. The evaporation is extremely strong, and favored by the constant motion of the air; so that the salt is collected in eighteen or twenty days after the pits are filled. Humboldt found (the 19th of

August, 1799, at three in the morning) the temperature of the salt water in the pits 32.5°, while the air in the shade was 27.2°, and the sand on the coast at six inches depth 42.5°.

The royal administration of the salt-works of Araya, dates only from the year 1792. Before that period they were in the hands of Indian fishermen, who manufactured salt at their pleasure, and sold it, paying the government the moderate sum of 300 piastres. The price of the fanega was then four reals (eight of these reals are equivalent to a piastre, or 105 sous French money, or 4s. 4½d. English); but the salt was extremely impure, gray, mixed with earthy particles, and surcharged with muriate and sulphate of magnesia. As the manufacture or labor of the salt-makers was also carried on in the most irregular manner, salt was often wanted for curing meat and fish—a circumstance that has a powerful influence, in these countries, on the progress of industry, as the lower class of people live on fish, and a small portion of tasajo. Since the province of Cumana has become dependent on the intendency of Caraccas, the sale of salt is under the excise; and the fanega, which the Guayquerias sold at half a piastre, costs a piastre and a half. This augmentation of price is slightly compensated by a greater purity of the salt, and by the facility with which the fishermen and farmers can procure it in abundance during the whole year. The salt-works of Araya yielded the treasury in 1799 a clear income of 8000 piastres.'

The other towns of any note in this province are Barcelona, a place of growing importance, especially in a commercial view; Cariaco, surrounded with extremely fertile plains, but of a hot and unhealthy climate; Carupano, built at the opening of two fine valleys, watered by two large rivers; Rio Caribe, whose valley is the temple of this country; Cumanacoa, surrounded with high mountains, and of rather a cold climate, though it is not more than 104 toises above the level of the sea; and several missionary establishments near the rivers and on the great plains, inhabited chiefly by Indians, who live in mud-huts, and cultivate their gardens, together with a large plot of ground which is common to all, and which is generally an indigo or sugar plantation. Near Cumanacoa is the great mountain Tumiriquiri, a vast rocky wall, rising from the forest; in one part the chain is broken by a precipice 900 feet wide, filled with trees, whose branches entwine completely with each other; through this crevice the Rio Jagua flows, and it is the abode of the jaguar, or American tiger, which is here very large and ravenous. Flames occasionally issue from two caverns in this precipice that may be seen at a great distance. The mountain is about 4400 feet above the level of the sea; its paths are traversed on mules, which are so sure footed, that an accident seldom happens. In a valley near this ridge is the cave of Guacharo, with a river running through it nearly thirty feet wide, and inhabited by a vast number of nocturnal birds, who build their nests in its arches. Once a-year the Indians destroy the young for the sake of a layer of fat, which covers the abdomen, which is perfectly free from

smell, and will keep for twelve months without becoming rancid. The monks purchase this oil for the purpose of cooking. These birds, called guacharoes, utter a mournful cry, which the Indians ascribe to the souls that are forced to go through this cave to the other world.

'They consider,' says Humboldt, 'that they are enabled to obtain permission to go out only when their conduct in this life has been without reproach. If it has been otherwise, they are retained for a shorter or longer time, according to the heinousness of their offences. This dark, wretched, and mournful abode, draws from them the mournings and plaintive cries heard without.

'The Indians have so little doubt of this fable, supported by tradition, being a sacred truth, commanding the utmost respect, that, immediately after the death of their parents or friends, they repair to the mouth of the cavern to ascertain whether their souls have met with any impediment. If they think they have not distinguished the voice of the deceased, they withdraw overjoyed, and celebrate the event by inebriety, and dances characteristic of their felicity; but, if they imagine they have heard the voice of the defunct, they hasten to drown their grief in intoxicating liquors, in the midst of dances adapted to paint their despair. So, whatever may be the lot of the departed soul, his relations and friends give themselves up to the same excesses: there is no difference but in the character of the dance.

'All the Indians of the government of Cumana and Orinoco not converted to the faith, and even many of those who appear to be so, have, notwithstanding, as much respect for this opinion as their ancestors could possibly have had. It appears that it is not, like so many others of its kind, the child of imposture or fanaticism; for it is not accompanied with any religious ceremony, the expense of which would increase the revenue of the inventor's benefice. The cavern itself shows no vestige of superstition having at any time obtained there the least monument of the empire imposture might have wished to exercise over credulity. This prejudice then is solely the effect of fear, ever ingenious in creating phantoms, and in imagining those things which flatter the illusion. Among the Indians 200 leagues from the cavern, to go down into Guacharo, is synonymous with *to die*.'

The forests of this country abound in monkeys of every kind, the most remarkable of which is the araquato, about three feet high, having its whole body covered with a thick coat of fur of a reddish-brown color; its face is rather black, and its beard long, and its eye, voice, and gait very melancholy. It is not vivacious as monkeys generally are, and the noise it makes, especially on an approaching change of weather, is singularly dismal. The valleys and banks of the rivers abound in Brasil and log-wood. The population of Barcelona and Cumana is about 100,000, one half of whom are Indians.

The island of Margarita forms a separate government from that of Cumana; it is situated in 10° 56' N. lat., and 64° and 65° W. long., being about forty-eight miles long and eighteen broad. It was famous for pearls, but the fishery has ceased for more than a century past. This island con-

sists of two parts, united by an isthmus, scarcely more than from eighty to 100 paces broad, and in some places not more than ten or twelve feet above the sea. There are three ports in the island, Pampetar, Puerto de la Mar, and Puerto del Norte; the former being the most important for its trade. The population is about 16,000. It has only three rivulets, just sufficient to turn mills; the water of the little river near Assumption is impregnated with sulphureted iron, magnesia, &c., so that the inhabitants prefer drinking water from ponds, though it is always muddy. There is scarcely enough agriculture to maintain the people. Provision is cheaper here than at Cumana.

This island is famous for parrots and other rare birds; scarcely a vessel leaves its ports without carrying away some of them. The manufactures are cotton stockings and hammocks of a peculiarly excellent quality; but the fisheries are the principal objects of trade; more than 300 Indians are employed in them; the quantity taken is incredible, and of innumerable kinds, the most common being the mullet, something like a hering. Salt is remarkably cheap; a barrel, of about 300 pounds, selling for twelvence-half-penny.

The province of Maracaibo, round the lake of that name, extends but a little way into the land; it is about 100 miles in length. The soil is unfruitful on the east and west shores; but, on the south, it is equal to that of the finest land in South America; the climate is generally hot and unhealthy, except in the south, near the snowy mountains of Merida. It is peopled by about 174,000 persons, chiefly Indians; a few whites only have settled on the borders of the lake towards the west. The towns on this lake are mostly built on posts of iron-wood, which becomes like a mass of stone from the quality of the water. The city of Maracaibo stands about six leagues from the sea, in a dry hot climate and on a sandy soil. The south wind, from its insalubrity, is here called the Destroyer; violent storms of thunder and lightning, with deluges of rain, are prevalent; but they are desirable, as, in failure of them, earthquakes are experienced. The town is built on the shore of a small gulf near Maracaibo Point; many of the houses are built of lime and sand, but however cheap tiles are, the inhabitants, from an idea of greater safety, obstinately adhere to the practice of covering the handsomest with a kind of reed called enea, growing on the borders of the lake. This mixture of reeds and tiles has a disagreeable effect, and from their combustible nature, they keep the city in constant danger. The most noble families are the descendants of the first conquerors; of these there are more than thirty, but most of them are poor, and the sense of their high extraction makes them ashamed of labor, and remarkably indolent. There are about 25,000 inhabitants, of which 5000 are negroes, who are all artisans of different descriptions.

'Notwithstanding the barrenness of resources which education finds at Maracaibo,' Depons says, 'we there see young persons so favored by nature, that the slightest elementary instruction at once develops in them all the faculties, which

in Europe do not manifest themselves until after long study, and the care of the best teachers. What adds to the singularity of the phenomenon is, that this excess of natural genius frequently becomes prejudicial to the tranquillity of the families of Maracaibo; for it is enough for many of these young men to know the conjugation and government of the verbs, in order to be qualified to write pieces, whose subtilty would appear to the knavish advocate better than the productions of the counsel who establishes his reasons on the principles of the civil law. Such suits as should never have been instituted, or which the tribunals would instantly have decided, become interminable and ruinous by the sophisms with which these scribblers envelope in darkness causes the most simple and clear. This disease, very prevalent at Maracaibo, is by no means a stranger in other Spanish territories. The penal laws which the legislature has been forced to enact, to lessen the number of these imps of chicane, whom they call *pendolistas* (quick writers), literally prove that the evil is general enough.

'In allowing that the inhabitants of Maracaibo have activity, courage, and genius,' says the same writer, 'we have nothing more to say in their favor. They are reproached with having very little regard to their word, and with thinking themselves not bound by their signature, until after they have in vain endeavoured to release themselves from it by law. Their reputation in this respect is so well established, that all strangers whom business draws to Maracaibo, say it is much better to form connexions of interest with the women than with the men, because they alone have there that good faith and firmness which, in every other part, is the peculiar heritage of the men.'

'Since the course of description has led me,' he adds, 'to speak of the women of Maracaibo, I ought not to let it be unknown that they are in their youth paragons of modesty; and in marriage, faithful wives, and excellent mothers of families. Affection for their husbands, the cares of their household, and the education of their children, are the objects which divide all their moments, and occupy all their solicitude. They know not, however, before marriage, any other amusement than music. Their favorite instrument is the harp. There are few houses in which the harmonious sound of this instrument is not heard every evening, and every day of festival.'

The other towns of this province are Truxillo, Gibraltar, Paruate, Las Barbacons, and San Pedro; Truxillo is celebrated for superior woollen manufactures, and excellent cheese.

Guiana, or Guayana, is an immense province, the precise boundaries of which cannot be ascertained. On the east, its shore extends to the mouth of the Orinoco, about thirty leagues, and westward it reaches to the river Yapura; besides which, it stretches along the Orinoco 400 leagues to the Rio Portuguesa. Besides this vast river, it has the Caroni, the Aruy, and the Caura, on the north; on the south, the Guaviare, the Yuritta, and the Atalapo; and, on the west, the Suapure, the Sippapu, besides a multitude of smaller streams. This province is divided into upper and lower, one east and the other west of

the Caroni. The soil is fertile in the extreme, the rivers periodically overflowing their banks, and leaving behind them a slime as prolific as the Nile; but this fine district is nearly waste, and a harbour for a number of cannibal tribes, of which the Caribs are the most formidable. The indigenous inhabitants are about 30,000, united into missions, the rest are independent Indians, who have not embraced Christianity; in the whole, constituting a population of 52,000 persons. Cattle constitute the riches of the province, in the export of which, and of a little tobacco, cotton, and indigo, their trade consists. Angostura is the chief place; it is about fifty leagues west of the confluence of the Caroni; when the water is high, the quays are frequently overflowed, and the caymans or crocodiles are sometimes seen in the streets. Notwithstanding its low situation it enjoys a mild temperature, Reaumur's thermometer scarcely rising to 24° in the hottest season.

The province of Varinas divides the territories of the former government of Caraccas from those of Condimamarca. It is intersected by large and numerous rivers, which inundate and fertilise its extensive plains. In one of the mountainous ridges of the country the Apure rises, which, after running a course of more than 500 miles, falls into the Orinoco by several mouths, receiving on its way the waters of numerous other streams, the largest of which are the Santo Domingo and Portuguese. Here also the Aranca and the Meta are among the fine rivers that intersect this country. Its total population amounted in 1807, to 141,000. The most remarkable features are its extensive plains, covered with luxuriant herbage and feeding innumerable herds of cattle. Its chiefs towns are Varinas, San Jayme, San Fernando de Apure, Pedraga and San Antonia.

Santa Fé lies on the west of the eastern Andes; it is very mountainous, but none of the summits of the chain in this country reach the region of eternal snows, though they are very near it. The lake Guatavita is one of the curiosities of this province. The following description of it is from the work entitled Colombia:—

'It is situate on the ridge of the Zipaquira mountains, north of the capital, in a wild and solitary spot, at the height of more than 8700 feet above the sea. It is a small oval piece of water, in a deep hollow of the same form, round which are cut ranges of steps, reaching to the brink of the lake, having served most probably for some religious ceremonies in use among the ancient possessors of this country. As it was supposed that a great quantity of treasure had been thrown into this lake, when Quesada conquered the kingdom of Cundinamarca, the Spaniards attempted to cut a canal through the mountain of which its banks are composed, in order to drain off the waters; but their design does not appear to have succeeded, for, after considerable excavations, it has been left off at little more than half the requisite depth.'

The same work thus describes two other grand natural objects in this country:—

'The cataract of the Tequendama, by which the river Funza joins the great Magdalena, is the most noted object in the country near the capital.

The Funza, or Bogota, after receiving the waters of the numerous small rivers which flow through the great plain, is about 140 feet in breadth, a short distance above the fall; approaching the crevice through which it dashes, its breadth is diminished to thirty-five, when, with accumulated force, it rushes down a perpendicular rock at two bounds, to the astonishing depth of 600 feet, into a dark and unfathomable gulf, out of which the river again issues under the name of Rio Meta, and continues its course, by an immense descent, till it joins the great river of Magdalena.

'The crevice of Icononzo is in the centre of the valley of Pandi, and appears to have been formed by some convulsion of nature, which has rent asunder the mountain. At the height of nearly 300 feet above the torrent (which forms beautiful cascades on entering and quitting the crevice) are seated these extraordinary bridges, one under the other; the breadth of the upper one being about forty feet, and its length upwards of fifty, composed of solid rock, in the form of an arch, seven or eight feet thick at its centre. Below this, and rather advanced on one side of it, at the depth of sixty feet, is another bridge, formed still more singularly; for as the mountain appears to have been rent away, or drawn from the upper, the inferior one seems to have fallen from the mountain, and three enormous masses of rock have descended from the opposite sides of the chasm, in such a manner that the upper mass forms the key of the other two. This lower bridge cannot be visited without much risk, as a narrow path alone leads to it along the brink of the precipice. In the centre is a hole, through which the abyss below can be seen, and numberless flights of nocturnal birds are observed hovering over the water, which flows through so dark a cavern that the sides cannot be distinguished.'

Bogota, the capital of this province, is a large and handsome city, with about 30,000 inhabitants; the plain in its neighbourhood is so fertile that it yields two harvests in the year. Here is one of the mints of Cundinamarca, the other is at Popayan. Besides the capital there are Tocaima, La Villa de la Purification, Honda, Mariquita, Muzo, Tunja, Leiva, Velez, San Gil, and Socorbo. This province is famed for its gold, silver, gems, salt, and coal, and for its fruitful plains, which breed numbers of horses, and mules, which are exported to Peru. The woods abound with game and wild animals, and the rivers with fish and alligators.

After these, in their order, are the provinces of Merida with its capital of the same name—of Santa Marta, with its immense and rapid rivers, crossed by bridges made of the roots of plants twisted together into immense ropes and stretched over them—Cartagena, of which copious mention has been made in the article AMERICA—Darien, on the gulf of that name—Panama, consisting of abrupt and broken chains of mountains, between two seas, being for the most part covered with thick forests—Veragua, the most northerly of the provinces of Tierra Firme, a mountainous and rugged country, with vast forests, interspersed with rich and fruitful valleys—Choco, the peculiarities of which we have al-

ready mentioned—Antioquia, famous for its gold mines, worked by 800 negroes—San Juan de Los Llanos—the large province of Popayan, in which is a pass of the Andes, 11,499 feet above the level of the sea, and not more than a foot and a half broad, where travellers can with the greatest difficulty pass each other—Quixos—Jaen de Bracamoras—Maynas—Quito—San Miguel de Ibarvia—Otabalo—Latacunga—Riobamba—Chimbo—Guyaquil—Cuenca—and Loxa. Quito is famous for the loftiest summits of the Andes, of which we have already spoken, and for the volcanoes of Pichincha and Cotopaxi, the loftiest volcano in the world.

'A most singular monument is observable on the top of the dike or chain of Tiopullo, consisting of a tumulus, and the ruins of one of the Peruvian palaces called *tambos*, situate in a plain covered with pumice-stones. The tumulus, if it be one, is upwards of 200 feet high, and is supposed to have been the burying-place of a chief. The palace is south-west of this hillock, nine miles from the crater of Cotopaxi, and thirty from Quito. It is in the form of a square, each side being about 100 feet in length, with four great door-ways, and eight chambers. Its walls are more than three feet thick, formed of large stones, regularly cut and laid in courses, and the whole is in tolerable preservation. It is called the palace of Callo. The great curiosity of this edifice consists in the beauty of the workmanship, as all the stones are cut into parallelo-pipeds, and laid in regular courses, and so nicely joined, that were it not that each stone is convexly and obliquely cut on the outside, their joints would not be visible.'

Quito is about 9510 feet above the level of the sea, having behind it the conical summit of Javirac, immediately under that of Pichincha.

The state of society in this country is much improved, and is still ameliorating. On this subject we shall make a short extract from captain Hall's concise and interesting work, and with this we must conclude, though much more might be said on so fruitful a subject.

'Under the Spanish government the political distinctions, which separated these various classes of inhabitants, were almost as numerous as, and infinitely more odious than, their physical varieties of features and complexion. By the laws of the Indies, the Indians were not only cut off from every civil employment or distinction, but were even denied the dignity of rational beings, being held in a state of perpetual pupillage, under the authority, principally, of their curates, who would hardly permit them to hold any intercourse with the rest of the inhabitants; the people of color were little better treated: besides being rigidly excluded from every employment of honor or consideration in the state, they were subjected to personal distinctions, the more painful because they could have no other object than that of gratifying the vanity of the privileged class at the expense of their unfortunate brethren. Such was the law prohibiting the women of color from wearing the manto, or black dress used at church, or from wearing any ornament of gold or silver; custom, besides, prohibited them the use of the alfombra, or carpet, at their devotions, and that

of an umbrella to screen them from the sun in the streets; all these distinctions are now happily abolished; the law of the republic sees none but citizens in every class of inhabitants, whatever may be their origin or the tinge of their complexions: the justice of this policy has been rewarded by the exertions of the people of color in aid of the independence of the country, of which they have been the firmest supporters, and Co-

lombia reckons among her best and bravest officers, men whom Spanish pride and tyranny deemed unworthy to sit at a white man's table. If any lingering prejudices still remain they are happily confined to female coteries, or an occasional explosion in a ball-room; even these last embers of irritated and childish pride it is the interest of the republic to see extinguished.'

COLOMNA (Fabius), a very learned botanist, born at Naples, about the year 1567. He became skilled in the languages, in music, designing, painting, and the mathematics; and died about the middle of the seventeenth century. He wrote, 1. *Φυτοβασανος*, seu Plantarum aliquot (ac piscium) Historia; 2. Minus cognitarum rariorumque Stirpium *επερασις*; itemque de aquatilibus, aliisque nonnullis animalibus, Libellus; and other works.

COLON, *n. s.* *κωλον*, a member; a point in grammar; see below. The greatest and widest of the intestines.

Now, by your cruelty hard bound,
I strain my guts, my *colon* wound. *Swift.*

The contents of the *colon* are of a sour, fetid, acid smell in rabbits. *Floyer on the Humours.*

COLON, in grammar. Grammarians generally assign the use of a colon to be, to mark the middle of a period; or to conclude a sense less perfect than a dot or period. Others say, a colon is to be used when the sense is perfect, but the sentence not concluded.

COLON, in anatomy, from *κωλος*, hollow, the name given to the greater portion of the large intestine. It begins where the ilium ends, in the cavity of the os ilium on the right side; thence ascending by the kidney, on the same side, it passes under the concave side of the liver, to which it is sometimes tied, as likewise to the gall-bladder, which tinges it yellow in that place; then it runs under the bottom of the stomach to the spleen in the left side, to which it is also knit; from thence it turns down to the left kidney; and thence passing, in the form of an S, it terminates at the upper part of the os sacrum, in the rectum. See **ANATOMY**.

COLONEL, *n. s.* } Of uncertain etymology.
COLONELLING, } gy. Skinner imagines it
COLONELSHIP, *n. s.* } originally *colonialis* the leader of a colony. Minshew deduces it from *columna*, a pillar: as *patris columnen*; *exercitus columnen*.

The chiefest help must be the care of the *colonel* that nath the government of all his garrison.

Captain or *colonel*, or knight in arms,
Whose chance on these defenceless doors may seize,
If deed of honour did thee ever please,
Guard them, and him within protect from harms. *Milton.*

Then did Sir Knight abandon dwelling
And out he rode a *colonelling*. *Burton's Hudibras.*
Whilst he continued a subaltern, he complained against the pride of *colonels* towards their officers; yet, in a few minutes after he had received his commission for a regiment, he confessed that *colonelship* was coming fast upon him. *Swift.*

COLONEL, in military affairs, the commanding officer of a regiment, and next in rank to a general. A colonel of a regiment, properly so called, is the nominal head of a given number of men; the clothing, &c. of whom is exclusively entrusted to him, as well as the appointment of an agent, who receives the pay and subsistence of the corps, but for whose solvency and character the colonel is responsible to the public. In the French and Spanish armies, this title is confined to the infantry and dragoons: the commander of a regiment of horse they usually call *maitre de camp*. A colonel may put an officer of his regiment in arrest, but must acquaint the general with it. He is not allowed a guard, but only a sentry from the quarter-guard. In his absence the lieutenant-colonel commands.

COLONEL-LIEUTENANT, the second in command in a regiment, whereof the king, prince, or other person of the first eminence, is colonel. These colonel-lieutenants have always a colonel's commission, and are usually general officers.

COLONEL BY BREVET, one who has obtained the rank of colonel in the army, without having that rank in any particular regiment.

COLONIA, in ancient geography, a town of the Trinobantes, a little above *Camelodunum*: now Colchester in Essex, according to Camden, who supposes it to take its name from the river *Coln*, and not that it was a colony: though others think Antonine's distances agree with *Sudbury*.

COLONIA EQUESTRIS, in ancient geography, a noble colony on the *Lacus Lemanus*. It appears to have been the work of Julius Cæsar, who settled there *Equites Lemitanei*: and to this *Lucan* is thought to refer. By the *Itinerary* it is supposed to have stood between *Lausanne* and *Geneva*, twelve miles from the latter, by *Peutinger's map*; which directs to *Noyon*, placed in *Cavo Lemano*, according to *Lucan's* expression, that is, a bay or cove of the lake. Its ancient name was *Noviodunum*; hence its modern name, *Noyon*, or, as some suppose, *Nevers*.

COLONIA METELLINA, a town of *Lusitania*, situated on the right or west side of the *Anas* or *Guadiana*; but now on the left or east side, from the river's shifting its bed or channel, and called *Medelin*, a town in *Estremadura*.

COLONIA MORINORUM, a town of *Gallia Belgica*, thought to be *Tarvenna*, the capital of the *Morini*; now called *Terrouen*.

COLONIA NORBENSIS, or *NORBA CÆSAREA*, a town of *Lusitania*, south of *Trajan's* bridge on the *Tagus*: now *Alcantara*, in *Estremadura*.

COLONIA TRAJANA, a town of *Belgica*, called also *Ulpia*, and *Tricesima*, from being the station of the thirtieth legion; now *Kellen*, in *Cleves*

COLONIA VALENTIA, a town of Spain, on the Turias; destroyed by Pompey, and restored by Julius Cæsar; still called Valencia.

COLONNADE, *n. s.* Ital. *colonna*, a column; a series of columns disposed in a circle, and insulated within side; any series or range of pillars.

Here circling *colonnades* the ground inclose,
And here the marble statues breathe in rows.

Addison.

For you my *colonnades* extend their wings. *Pope.*

COLONNADE, POLYSTYLE, is that whose number of columns is too great to be taken in by the eye at a single view. Such is the colonnade of the palace of St. Peter's at Rome, consisting of 284 columns of the Doric order, each above four feet and a half diameter, all in Tiburtine marble.

COLONOS, in ancient geography, an eminence near Athens, whither Œdipus, after his banishment from Thebes, is said to have retired: and hence Sophocles calls the tragedy on that subject, Œdipus Coloneus. A place sacred to Neptune, and where stood an equestrian statue of him. Here also stood Timon's tower: who, for his love of solitude, and hatred to mankind, was called Misanthropos.

COLONSA, or COLONSAY, one of the Western Islands of Scotland, so named from Colon, a popish saint, lying in the Atlantic Ocean, between the coast of Argyllshire and that of Ireland, four miles and a half west of Jura. It is separated from Oronsay by a narrow sound, which is dry at low water, and therefore both islands appear as one. They are both flat, compared with the towering peaks of Jura and Mull, though there is a considerable number of rugged heath-covered hills in them. They measure about 8000 acres, of which 3000 are arable. The air is pure and salubrious; the soil light and fertile. The best part of the ground maintains a fine breed of black cattle. There is a great quantity of fine coral on the banks round these islands, and a considerable quantity of kelp is annually made from the sea-weed thrown upon the coast. These islands constitute the west division of the parish of Jura and Colonsay.

COLONUS, a husbandman, or villager, who was bound to pay yearly a certain tribute, or at certain times of the year to plough some part of the lord's land; and from thence comes the word clown.

COLONY, *n. s.* } Lat. *colonia*. A body of
COLONIZE, *v. a.* } people drawn from the mother country to inhabit some distant place. The place itself by a metonymy; to plant with inhabitants; to settle with new planters.

There was never an hand drawn, that did double the rest of the habitable world, before this; for so a man may truly term it, if he shall put to account as well that that is, as that which may be hereafter, by the farther occupation and *colonizing* of those countries: and yet it cannot be affirmed, if one speak ingeniously, that it was the propagation of the Christian faith that was the adamant of that discovery, entry, and plantation; but gold and silver, and temporal profit and glory; so that what was first in God's providence, was but second in man's appetite and intention.

Bacon's Holy War.

Drains bath advantage by acquess of islands, which she colonizeth and fortifieth daily. *Howel's Vocal Forest.*

To these new inhabitants and colonies he gave the same law under which they were born and bred.

Spenser on Ireland.

Rooting out these two rebellious sects, he placed English colonies in their room. *Davies on Ireland.*

The rising city, which from far you see,
Is Carthage and a Tyrian colony. *Dryden's Virgil.*

Osis, or the Bæchus of the ancients, is reported to have civilized the Indians, planting colonies, and building cities. *Arbuthnot on Coins.*

While Chryseloras admired the venerable beauties of the mother, he was not forgetful of his native country, her fairest daughter, her imperial colony. *Gibbon.*

COLONY is a term that has been applied to three different kinds of emigrants, viz. 1. Those who leave their native country, when its inhabitants are become too numerous. 2. Those established by victorious princes among vanquished nations, to keep them in awe and obedience. 3. Colonies of commerce, of which the sole object is the extension of trade. I. By the first kind of colonies, some ages after the deluge, the east first, and successively all the other parts of the earth, became inhabited; and not to mention the Phœnician and Grecian colonies, so famous in ancient history, it is notorious that it was for the establishment of such colonies, that, during the declension of the Roman empire, those torrents of barbarous nations, issuing mostly out of the north, overran Gaul, Italy, and the other southern parts of Europe; and, after many bloody battles, shared it with the ancient inhabitants. II. The second kind of colonies were planted by the Romans more than any other people, to secure the numerous conquests they had made. The inhabitants of many cities in France, Germany, Spain, and even England, still value themselves on their having been originally Roman colonies. There were two kinds of colonies among the Romans: those sent by the senate; and the military ones, consisting of old soldiers, disabled by the fatigues of war, who were thus provided with lands as the reward of their services. The colonies sent by the senate were either Roman or Latin, i. e. composed either of Roman citizens, or Latins. The colonies Latinæ were such as enjoyed the jus Latii; viz. 1. that whoever was edile or prætor in a town of Latium, became for that reason a Roman citizen; and, 2. that the Latins were subject to edicts of their own, and not to those of the Roman magistrates. The colonies Romanæ, were such as had the jus Romanum, but not in its full extent; i. e. they had no right of suffrage, putting up for honors, magistracies, command in the armies, &c.; but the jus Quiritium only, or private right; as rights of liberty, sacrifice, marriage, &c. For it was long a rule, never to grant the liberty of the city in full to colonies. There were other colonies, which had little more than the name; only enjoying what they called jus Italicum, i. e. freedom from the taxes paid by the provinces. Such were the colonies of Tyre, Berytus, Heliopolus, Palmyra, &c. M. Vaillant has filled a volume in folio with medals struck by the several colonies, in honor of the emperors who founded them. III. The colonies of commerce are those established in modern times by the English, French, Spaniards, Portuguese,

Dutch, &c.; partly, certainly, for the motives already enumerated, and the peculiar condition of the mother country; but that have been mainly encouraged and protected by their home governments for the extension of trade.

The practice of settling commercial colonies in distant countries has been adopted by the wisest nations of antiquity, who acted systematically upon maxims of sound policy. This appears to have been the case with the ancient Egyptians, the Chinese, the Phœnicians, the commercial states of Greece, the Carthaginians, and even the Romans; for though the colonies of the latter were chiefly military, it could easily be shown that they were likewise made use of for the purposes of trade. The savage nations who ruined the Roman empire, sought nothing but to extirpate and hold in vassalage those whom they overcame; and, therefore, whenever princes enlarged their dominions at the expense of their neighbours, they had recourse to strong forts and garrisons to keep the conquered in awe. Machiavel labors to show, that the settling of colonies would have been a cheaper and better method of bridling conquered countries, than building fortresses in them. John de Witt, who was one of the ablest and best statesmen that ever appeared, strongly recommended colonies; as affording a refuge to such as had been unfortunate in trade; as opening a field for such men to exert their abilities, as through want of interest could not raise themselves in their own country; and as a supplement to hospitals and other charitable foundations, which he thought in time might come to be overcharged. Some, however, have ridiculed the supposed advantages of colonies, and asserted that they must always do mischief by depopulating the mother country. The history of our American colonies undoubtedly shows, that when colonists become numerous and opulent, it is very difficult to retain them in subjection to the parent state. It becomes then a question not easily answered, how far they are entitled to the rights they had as inhabitants of the mother country, or how far they are bound by its laws? Judge Blackstone says, 'Plantations, or colonies in distant countries, are either such where the lands are claimed by right of occupancy only, by finding them desert and uncultivated, and peopling them from the mother country; or where, when already cultivated, they have either been gained by conquest, or ceded to us by treaties. And both the rights are founded upon the law of nature, or at least on that of nations. But there is a difference between these two species of colonies with respect to the laws by which they are bound. For it has been held, that if an uninhabited country be discovered and planted by English subjects, all the English laws then in being, which are the birthright of every subject, are immediately there in force. But this must be understood with many and very great restrictions. Such colonists carry with them only so much of the English law as is applicable to their own situation, and the condition of an infant colony: such for instance, as the general rules for inheritance, and of protection from personal injuries. The artificial refinements and distinctions incident to the

property of a great and commercial people, the laws of policy and revenues (such especially as are enforced by penalties), the mode of maintenance for the established clergy, the jurisdiction of spiritual courts, and a multitude of other provisions, are neither necessary, nor convenient for them, and therefore are not in force. What shall be admitted, and what rejected, at what times, and under what restrictions, must, in cases of dispute, be decided in the first instance by their own provincial judicature, subject to the revision and control of the king in council; the whole of their constitution being also liable to be new modelled and reformed by the general superintending power of the legislature in the mother country. But in conquered or ceded countries, that have already laws of their own, the king may indeed alter and change those laws; but, till he does actually change them, the ancient laws of their country remain, unless such as are against the law of God, as in an infidel country.' Dr. Adam Smith thus argues against what has been called, in modern times, the colonial system.

'The European colonies of America have never yet furnished any military force for the defence of the mother country. The military force has never yet been sufficient for their own defence; and in the different wars in which the mother countries have been engaged, the defence of their colonies has generally occasioned a very considerable distraction of the military force of those countries. In this respect, therefore, all the European colonies have, without exception, been a cause rather of weakness than of strength to their respective mother countries.

'The colonies of Spain and Portugal only have contributed any revenue towards the defence of the mother country, or the support of her civil government. The taxes which have been levied upon those of other European nations, upon those of England in particular, have seldom been equal to the expense laid out upon them in time of peace, and never sufficient to defray that which they occasioned in time of war. Such colonies, therefore, have been a source of expense and not of revenue to their respective mother countries.

'The advantages of such colonies, to their respective mother countries, consist altogether in those peculiar advantages which are supposed to result from provinces of so very peculiar a nature as the European colonies of America; and the exclusive trade, it is acknowledged, is the sole source of all those peculiar advantages. In consequence of this exclusive trade, all that part of the surplus produce of the English colonies, for example, which consists in what are called enumerated commodities, can be sent to no other country but England. Other countries must afterwards buy it of her. It must be cheaper therefore in England than it can be in any other country, and must contribute more to increase the enjoyments of England than those of any other country. It must likewise contribute more to encourage her industry. For all those parts of her own surplus produce which England exchanges for those enumerated commodities, she must get a better price than any

other countries can get for the like parts of theirs, when they exchange them for the same commodities. The manufactures of England, for example, will purchase a greater quantity of the sugar and tobacco of her own colonies, than the like manufacturers of other countries can purchase of that sugar and tobacco. So far, therefore, as the manufactures of England and those of other countries are both to be exchanged for the sugar and tobacco of the English colonies, this superiority of price gives an encouragement to the former, beyond what the latter can in these circumstances enjoy. The exclusive trade of the colonies, therefore, as it diminishes, or, at least, keeps down below what they would otherwise rise to, both the enjoyments and the industry of the countries which do not possess it; so it gives an evident advantage to the countries which do possess it over those other countries.

This advantage, however, will, perhaps, be found to be rather what may be called a relative than an absolute advantage; and to give a superiority to the country which enjoys it, rather by depressing the industry and produce of other countries, than by raising those of that particular country above what they would naturally rise to in the case of a free trade. The tobacco of Maryland and Virginia, for example, by means of the monopoly which England enjoys of it, certainly comes cheaper to England than it can do to France, to whom England commonly sells a considerable part of it. But had France and all other European countries been, at all times, allowed a free trade to Maryland and Virginia, the tobacco of those colonies might, by this time, have come cheaper than it actually does, not only to all those other countries, but likewise to England. The produce of tobacco, in consequence of a market so much more extensive than any which it has hitherto enjoyed, might, and probably would, by this time, have been so much increased as to reduce the profits of a tobacco plantation to their natural level with those of a corn plantation, which, it is supposed, they are still somewhat above. The price of tobacco might, and probably would, by this time, have fallen somewhat lower than it is at present. An equal quantity of the commodities either of England, or of those other countries, might have purchased in Maryland and Virginia a greater quantity of tobacco than it can do at present, and, consequently, have been sold there for so much a better price. So far as that weed, therefore, can, by its cheapness and abundance, increase the enjoyments or augment the industry either of England or of any other country, it would probably, in the case of a free trade, have produced both these effects in somewhat a greater degree than it can do at present. England, indeed, would not in this case have had any advantage over other countries. She might have bought the tobacco of her colonies somewhat cheaper, and, consequently, have sold some of her own commodities somewhat dearer than she actually does: but she could neither have bought the one cheaper nor sold the other dearer than any other country might have done. She might, perhaps, have gained an absolute, but she would certainly have lost a relative advantage.

V O L. VI.

On the first of the topics here suggested, that the colonies are burdens, on account of the expense of the protection, &c., it has been well remarked 1. That in making up the accounts something must be allowed for the naval force necessary to be kept up in remote parts of the world, even if we had no direct interests in those of this kind. 2. That the colonies themselves, in many instances, contribute materially to their own defence and protection. With Jamaica, Canada, and our East India possessions this is the case: in some instances all the civil and military expense is *bonâ fide*, met by them; in others, as in many of the West India islands, a duty of 4½ per cent. is laid on the commerce of the colony, with this object directly in view. When the charge on the mother country shall be ascertained, making these allowances, what she also draws from them in taxes must be estimated, before the relative advantages or disadvantages to her industry for the possession, can be fairly computed.

In entering upon these more fully, we avail ourselves of an able abstract of the whole question, in a late number of the Quarterly Review. The ties of intercourse between protectors and dependent states, it is suggested, give rise to the formation of multifarious commodities in a European country, to pay for the exotic productions sent into it in return. If these articles equal in the value the expense of the colonies, here is a source of profit and enjoyment, not a burden, created: But on examination of the value of colonial intercourse, compared with that of independent states, it will appear that the exports made to the colonies exclusively originating in their demand, vastly exceed their real expense. Were this demand therefore to cease, so much of the labor of the producers would have to be directed to other objects, or cease also.

To this it may be added, that the very habits and prejudices of a colony, in close intercourse with the mother country, will always cause its thriving classes to imitate her manners, and to introduce the articles of her greatest profit and skill. But could we without the colonies rely on possessing the same extent of production, and consequently power to purchase of them or of other states, still the security and permanence of an intercourse under our control is an important consideration. The certainty of a home trade is acquired. The whole of the produced wealth is the property of natural born subjects. It is not on one side that of foreigners; nor are we exposed to interruptions from caprice or policy, or the occurrence of hostilities between other powers. A foreign state may, by regulations, draw its supplies, even of the staples and manufactures in which this country is confessedly superior, from other sources: and this stability in our relations will repay many sacrifices.

Another object of primary importance, attendant upon a colonial trade, is the employment of seamen. The right to supply and manage a large portion of the conveyance has ever been accounted a source of natural strength and property. Without the possession of colonies it is difficult to say how this can be attained, unless the sources of the produce were independent states, and would forego (what no state possessing

shipping ever did forego) compensating duties and favor shown to its own vessels.

Dependent possessions, again, scattered over all parts of the world, become secure marts from which commerce can be carried on with every quarter: without them, the intercourse with many places, in an imperfectly civilised or often disturbed state, would be precarious and hazardous; and they confer, wherever situated, a local influence, upholding the character and interests of the country. Thus Jamaica and the West India Islands have been the means of our extensive intercourse with South America, amid all the troubles to which that quarter has been subject and in the Mediterranean, Gibraltar and Malta, although not in themselves productive, become beneficial chains of communication with Barbary, and other parts. Our East India possessions, besides the commerce actually held with them, are the means of conducting an intercourse with every shore of the Indian seas.

'The question, in fine,' says the able paper adverted to, 'is, whether that country is best situated which is secure of a given place where the products of its labor can be exchanged, or that which has to seek throughout the world for permission to exchange them? Whether the colonies are best circumstanced, in seeking all the markets of the continent, or in being sure of the certain great market of this country? Whether it is better on both sides, to be subject to the caprices of nations, as well as the vicissitudes of seasons, or to be dependent only on the latter? Whether to give safety to the exchanges of labor, so far as in us lies, or to commit ourselves to all the chances and windings of other states? Let those who deal with independent countries answer how far their intercourse is secure and stable, and the nature and extent of their vent to be foreseen. Let the traders with Russia speak to the variations, not only arising from seasons but from altered tariffs, which every year brings forth, and tell us, whether at any period, it is possible to

take measures certain to be adapted to the custom-house regulations of that empire, and their effect upon consumption.'

We are then supplied with the following interesting facts respecting the colonial system of our neighbours. 'In 1699 Colbert estimated the number of French vessels engaged in foreign trade at 600. Of these not more than 100 were supposed to be employed in the commerce of the West Indies. At the revolution, France had not more than 1000 vessels engaged in distant voyages, or about 200,000 tons. Far the larger part of this very limited tonnage (compared with the great commerce of France) was owing to her West India colonies; for, from various reasons, her commerce with other parts was carried on in foreign shipping; that with her colonies was wholly her own. The tonnage of her European trade was only 152,000 tons. So entirely did the strength of the French marine appear, at that time, to depend on the colonies, that one of the ministers, M. Arnould, to whom we are indebted for the statements we present, exclaims; 'Quelles ressources a donc la France pour entretenir une force publique maritime? Quels moyens lui restent pour élever, instruire, et multiplier la classe précieuse des matelots? Le commerce de l'Amerique,—ne l'oublions pas, le commerce de l'Amerique.'

'The following table will show the rapid progress of the French West India colonies within the last century, and their importance to that country; together with the value of the product re-exported, and of that which was consumed at home. It will be seen that the general export of colonial produce, in the seven years average ending 1733, was 50,630,000 livres. In the five years ending 1788 the average was 93,056,000 livres, being an increase of four-fifths in five years. In 1788 the annual import of sugar into France was about 2,600,000 cwt. She was supposed to export about 1,400,000 cwt.; that is, more than half the quantity imported.

PERIOD.	IMPORTS.	EXPORTS.	HOME-CONSUMPTION.	
	Value in Liv. Tour. Average.	Value in Liv. Tour. Average.	Value in Liv. Tour. Average.	
1716 to 1725	{ 11,155,000	6,361,000	4,794,000	Value at the time.
	{ 17,211,000	9,815,000	7,396,000	Value in 1788.
1725 to 1732	{ 16,609,000	14,814,000	1,795,000	Value at the time.
Peace.	{ 18,131,000	16,014,000	2,117,000	Value in 1788.
1733 to 1735	{ 20,631,000	15,028,000	5,603,000	Value at the time.
War.	{ 21,845,000	15,912,000	5,933,000	Value in 1788.
1736 to 1739	{ 35,435,000	20,619,000	14,816,000	Value at the time.
Peace.	{ 37,519,000	21,832,000	15,687,000	Value in 1788.
1740 to 1748	{ 36,918,000	25,152,000	11,766,000	Value at the time.
War.	{ 39,090,000	26,630,000	12,460,000	Value in 1788.
1749 to 1755	{ 65,207,000	35,226,000	29,981,000	Value at the time.
Peace.	{ 69,043,000	37,298,000	31,745,000	Value in 1788.
1756 to 1763	{ 15,463,000	12,196,000	3,267,000	Value at the time.
War.	{ 16,373,000	12,913,000	3,460,060	Value in 1788.
1764 to 1776	{ 111,930,000	37,696,000	74,234,000	Value at the time.
Peace.	{ 116,605,000	39,146,000	77,459,000	Value in 1788.
1777 to 1783	{ 108,710,000	50,630,000	58,080,000	Value in 1788.
War.	{ 108,710,000	50,630,000	58,080,000	Value in 1788.
1784 to 1788	{ 193,250,000	93,056,000	100,194,000	Value in 1778.
Peace.	{ 193,250,000	93,056,000	100,194,000	Value in 1778.

'France, on the late peace, was no sooner re-possessed of colonies than her legislative body proceeded to establish her maritime commerce on a footing the first feature of which is favor to them; in a similar spirit she has granted the highest encouragement to her fisheries: thus a few years have sufficed to re-animate a marine which was nearly extinct, and which might have remained in that listless state, had she permitted those nations already in possession of the navigation of the seas to become her carriers.'

The following statement of the employment of

our shipping, for which we are indebted to the same source, will exhibit the tonnage clearing outwards to the principal colonial possessions, during the year ending the 5th of January, 1821; and will, likewise, furnish a contrast with the shipping engaged in the intercourse with the more important independent states. It will show, too, how large a portion of our foreign intercourse is carried on by the shipping of other countries; and how considerable a share of our navigation owes its existence to the strict colonial system.

	British Tonnage.	Foreign Tonnage.
British North American Colonies	300,695	
British West India Colonies	217,744	
East Indies	76,833	
France	80,361	50,954
United States	44,589	133,516
Holland	53,828	37,222
Germany	107,601	19,680
Russia	111,290	14,995
Sweden and Norway	15,641	51,102

The following is a statement of the official value of exports to the colonies at this period, and will show that they take as much British produce as the greater part of Europe; while again the colonial produce imported for re-exportation, forms a large portion of the exports to Europe.

	British Produce.	Foreign and Colonial.	Total.
British North American Colonies	£1,548,181	£452,852	£2,001,033
British West India Colonies	4,197,975	292,033	4,490,008
East Indies	2,039,507	382,256	2,421,763
France	246,144	734,677	980,821
Holland	1,158,120	1,129,555	2,287,675
Germany	5,581,856	2,827,114	8,408,970
Russia	1,630,047	406,016	2,036,063
United States	4,229,767	71,928	4,301,695

COLOPHON, in ancient geography, a town of Ionia, seated on a promontory on the Ægean Sea, and washed by the Halesus. It was destroyed by Lysimachus, in his war with Antigonus, in order to enlarge Ephesus: but, according to Pausanias, it was rebuilt in the neighbourhood, on a more commodious site. This is one of the cities that laid claim to the honor of giving birth to Homer. Of this town was the poet Antimachus.

COLOPHONEM ADDERE, the addition of a preponderating weight, a proverbial saying, explained by Strabo, who says, that the Colophonian horse generally turned the scales in favor of the side on which they fought.

COLOPHONY, *n. s.* Rosin; from Colophon, a city, whence it came.

Of Venetian turpentine, slowly evaporating about a fourth or fifth part, the remaining substance suffered to cool, would afford me a coherent body, or a fine *colophony*. *Boyle.*

Turpentine and oils leave a *colophony*, upon a separation of their thinner oil.

Floyer on the Humours.

COLOQUINTEDA, *n. s.* Lat. *colocynthis*; *κολόκυνθος*. The fruit of a plant of the same name, brought from the Levant, about the bigness of a large orange, and often called bitter apple. Both the seed and pulp are intolerably bitter. It is a violent purgative, of considerable use in medicine.

COLOQUINTIDA, in botany. See **CUCUMIS**.

C O L O R S.

CO'LORED, *v. a., v. n., & n. s.* } Lat. *coloro*,
 CO'LORED, *adj.* } *color*. The sub-
 CO'LORED, *part. adj.* } stantive has ap-
 CO'LORED, *n. s.* } plications which
 CO'LORED, *n. s.* } distinguish it
 CO'LORED, *n. s.* } from the verb,
 CO'LORED, *adj.* } and these we
 must mark. The appearance of bodies to the
 eye only; hue; dye. The freshness or appearance
 of blood in the face. In the plural, a standard;
 an ensign of war.

Colours we know I non, withouten drede,
 But swiche *colours* as grown in the mede,
 Of elles swiche us men die with or peinte;
Colours of rhetorike ben to me queinte;
 My spirit feleth not of swich matere.

Chaucer's Canterbury Tales.

Her hair shall be of what *colour* it please God.

Shakespeare.

He at Venice gave
 His body to that pleasant country's earth,
 And his pure soul unto his captain Christ,
 Under whose *colours* he had fought so long.

Id. Richard II.

Against all checks, rebukes, and manners,
 I must advance the *colours* of my love,
 And not retire. *Id. Merry Wives of Windsor.*

When on the east the morning ray,
 Hangs out the *colours* of the day,
 The bee through these known allies hums,
 Beating the dian with its drums. *Marve.*

For though our eyes can mought but *colours* see,
 Yet *colours* give them not their power of sight.

Davies.

he lights of *colours* are more refrangible one than
 another in this order; red, orange, yellow, green,
 blue, indigo, deep violet. *Newton's Optics.*

My cheeks no longer did their *colour* boast.

Dryden.

A sudden horror seized his giddy head,
 And his ears trickled, and his *colour* fled. *Id.*

All in a moment through the gloom were seen
 Ten thousand banners rise into the air
 With orient *colours* waving. *Milton's Paradise Lost.*

Each gaudy bird some slender tribute brings,
 And lends the growing insect proper wings;
 Silks of all *colours* must their aid impart,
 And every fur promote the fisher's art.

Gay's Rural Sports.

It is a vulgar idea of the *colours* of solid bodies,
 when we perceive them to be a red, or blue, or green
 tincture of the surface; but a philosophical idea,
 when we consider the various *colours* to be different
 sensations, excited in us by the refracted rays of light,
 reflected on our eyes in a different manner, according
 to the different size, or shape, or situation of the par-
 ticles of which surfaces are composed. *Watts.*

The verb signifies to mark with some hue or
 dye; to palliate; to excuse; to dress in specious
 colors, or fair appearances belied by the reality;
 to make plausible. In the neuter sense to blush.
 These applications are common to the substan-
 tive, and to all the other branches of the word;
 technically, to color strangers' goods, is when a
 freeman allows a foreigner to enter goods at the
 custom-house in his name, so that the foreigner

pays but single duty, when he ought to pay
 double.

They were glad to lay hold on so *colourable* a mat-
 ter, and to traduce him as an author of suspicious in-
 novation. *Hooker.*

We hope the mercy of God will consider us unto
 some mitigation of our offences; yet had not the sin-
 cerity of our parents so *colourable* expectations.

Brown's Vulgar Errors.

I told him that I would not favour or *colour* in any
 sort his former folly. *Raleigh's Remys.*

The *coloured* are coarser juiced, and therefore not
 so well and equally concocted.

Bacon's Natural History.

The process, howsoever *colourably* awarded, hath
 not hit the very mark whereat it was directed.

Bacon.

They have now a *colourable* pretence to withstand
 innovations, having accepted of other laws and rules
 already. *Spenser.*

Had I sacrificed ecclesiastical government and re-
 venues to their covetousness and ambition, they would
 have found no *colourable* necessity of an army.

King Charles.

He *colours* the falsehood of Æneas by an express
 command from Jupiter to forsake the queen.

Dryden's Dedicat. Æneid.

Titian, Paul Veronese, Van Dyck, and the rest of
 the good *colourists*, have come nearest to nature.

Dryden's Dufrenoy.

The rays, to speak properly, are not *coloured*: in
 them there is nothing else than a certain power and
 disposition to stir up a sensation of this or that *colour*.

Newton's Optics.

Transparent substances, as glass, water, and air,
 when made very thin by being blown into bubbles, or
 otherwise formed into plates, exhibit various colours,
 according to their various thinness; although at a
 greater thickness they appear very clear and *colour-
 less*. *Id.*

Pellucid *colourless* glass or water, by being beaten
 into a powder or froth, do acquire a very intense
 whiteness. *Bentley.*

We have scarce heard of an insurrection that was
 not *coloured* with grievances of the highest kind, or
 countenanced by one or more branches of the legisla-
 ture. *Addison's Freeholder.*

But as the slightest sketch, if justly traced,
 is by ill *colouring* but the more disgraced;
 So by false learning is good sense defaced. *Pope.*

Flowers fresh in hue, and many in their class,
 Implore the passing step, and with their dyes
 Dance in the soft breeze in a fairy mass;
 The sweetness of the violet's deep blue eyes,
 Kissed by the breath of heaven, seems *coloured* by its
 skies. *Byron's Child Harold.*

COLORS, in the Latin and Greek churches,
 are used to distinguish several mysteries and
 feasts celebrated therein. Five colors only are
 regularly admitted, viz. white, green, red, violet,
 and black. The white is for the mysteries of our
 Saviour, the feast of the Virgin, those of the
 angels, saints and confessors; the red is for the
 solemnities of the holy sacrament, the feasts of
 the apostles and martyrs; the green for the time
 between pentecost and advent, and from epi-
 phany to septuagesima; the violet in advent and
 Christmas, in vigils, rogations, &c. and in votive

masses in time of war; lastly, the black is for the dead, and the ceremonies thereto belonging. In the Greek church the use of colors is almost abolished, but red was, in the Greek church, the color for Christmas and the dead, as black among us.

Colors, in heraldry. The only colors in general use are the following:

Colors.	Precious Stones.	Planets.
Red	Ruby	Mars.
Blue	Sapphire	Jupiter.
Green	Emerald	Venus.
Purple	Amethyst	Mercury.
Black	Diamond	Saturn.
Orange	Hyacynth	Dr ^a .Head.

Gules, fig. 1, is expressed by lines perpendicular from top to bottom. Azure, fig. 2, by horizontal lines from side to side. Sable, fig. 3, by horizontal and perpendicular lines crossing each other. Vert, fig. 4, by hatched lines from right to left diagonally. Purpure, fig. 5, by hatched lines from the sinister chief to the dexter base, diagonally; and Tenne, tawny, fig. 6, by diagonal lines from the dexter to the sinister side of the shield, traversed by perpendicular lines.

Fig. 1. Fig. 2. Fig. 3. Fig. 4. Fig. 5. Fig. 6.



Colors, in the military art, are large silk flags fixed on half pikes, and carried by the ensign; whence the purchase of an ensign is called the purchase of a pair of colors. The size of the colors, in England, should be six feet six inches flying, and six feet deep on the pike, and the length of the pike nine feet ten inches. The cords and tassels of the whole are crimson and gold mixed.

Colors, CAMP, a small sort of colors placed on the right and left of the parade of the regiment when in the field: they are eighteen inches square, and of the color of the facing of the regiment, with the number of the regiment upon them.

COLOR-MAKING is the act of preparing the different kinds of colors used in painting, drawing, dyeing, calico-printing, &c. The art of dyeing is sufficiently important to claim our distinct notice; the colors of calico-printing follow; our remarks and directions in this paper are more particularly directed to the preparing of colors used in drawing and painting.

This art is altogether, as we have seen, a branch of chemistry; and one of the most curious, though least understood, parts of it. The principles on which color-making depends differ greatly, however, from those on which the theory of other parts of chemistry is founded; and the practical part being in the hands of those who often find

it their interest to conceal their methods, it happens that there is not only no distinct theory of this art, but few good receipts to be obtained for making any color.

SECT. I.—GENERAL DIVISIONS OF COLORS.

1. The first general division of colors is into opaque and transparent. The former comprehends such colors as, when laid over paper, wood, &c. cover them fully, so as to efface any other painting or stain that might have been there before. The latter includes colors of such a nature as to leave the ground on which they are laid visible through them. Of the first kind are white lead, red lead, vermilion, &c., of the second are the colors used for illuminating maps, &c.

2. A second division is into oil colors and water colors; or such as are appropriated to painting in oil and water. Most of those which are proper for painting in water, are also proper for being used in oil. There is, however, this remarkable difference betwixt colors when mixed with water and with oil, that such as are quite opaque in water will become perfectly transparent in oil. Thus, blue verditer, though exceedingly opaque in water, if ground with oil, seems totally to dissolve, and will become very transparent. The same thing happens to such colors as have for their basis the calx of tin, alabaster, or calcareous earth. The most perfectly opaque colors in oil are such as have lead, mercury, or iron, for their basis: to the latter, however, Prussian blue is an exception; for, though the basis of that color is iron, it proves quite transparent when ground with oil. In water colors, those prepared from metals, Prussian blue alone excepted, are always opaque; from vegetables or animals, transparent. Charcoals, however, whether vegetable or animal, are opaque both in water and oil.

3. Colors are farther divided into simple and compound. The simple are such as require nothing to be superadded, to make a full strong color, without regarding whether they are formed of many or few ingredients. In this view, white lead, red lead, vermilion, calces of iron, &c. are simple colors. The compounds are formed by the union of two or more coloring substances: as blue and yellow united together to form an orange, a white earth or calx mixed with the red color of cochineal or Brasil to form a lake, &c., and thus carmine, lake, rose pink, Dutch pink, English pink, &c. are compound colors.

4. The last and most important division of colors is into true and false. By true colors are meant those which retain their color under every possible variety of circumstances, without fading in the least: the false are such as do not; but either lose their color altogether, or change to some other.

SECT. II.—OF THE CAUSES OF THE FADING OF COLORS.

Colors are chiefly affected by their being exposed to the sun in summer, and to the cold air in winter; but to this there is one exception, viz. white lead; which, when ground with oil, retains its whiteness if exposed to the weather, but degenerates into a brownish or yellow color if kept

close. In water this substance is very apt to lose its color, whether exposed to the air or not. The great desideratum in color-making is to produce such colors as will not fade by exposure to the weather; and, indeed, it is to be regretted, that the most beautiful are in general the least permanent. It may for the most part, however, be expected, that the more simple any color is, the less liable it will be to change upon exposure to the air. The principal difficulty of ascertaining whether a color will fade or not, arises from our ignorance concerning the nature of coloring substances. We may hold it as a rule, however, that whatever change of color is produced in any substance by exposure to the sun and air, that color to which it changes will bid fair for being permanent, and therefore ought to be employed where it can be done.

Of such changes the instances are rare. One is in the purple of the ancients, which assumed its color by exposure to the sun, and consequently was exceedingly permanent. Another is in the solution of silver; which, being mixed with chalk, the precipitate turns to a purplish black where it is exposed to the sun. A third is in solutions of indigo by alkaline substances, which constantly appear green till exposed to the air by spreading them very thin, upon which they become almost instantaneously blue, and continue so ever after.

Sometimes, though still more rarely, a very remarkable change of color happens, upon mixing two vegetable juices together. Almost the only instance of this we have on the authority of Mr. Foster, who says that the inhabitants of Otaheite dye their cloth of a crimson color, by mixing together the yellow juice of a small species of fig with the greenish juice of a fern. But the most remarkable alterations of color are effected by different metallic and saline solutions, mixed with certain animal and vegetable substances; and with these the color-maker will be principally conversant.

It is a fact well known in chemistry, that acids mixed with blue vegetable juices turn them red, and alkalis green. It is equally certain, though not so generally known, that acids of all kinds generally tend to heighten red colors, so as to make them approach to the scarlet or true crimson; and alkalis to darken, or make them approach to blue or purple. Mixed with yellow colors, acids also universally tend to brighten the yellow; and alkalis to turn it to an orange, and make it become more dull. But, though this is very generally the case, all acids are not equally powerful in this respect. The nitrous acid is found to heighten the most of any, and the marine acid the least of the mineral ones. The vegetable acids are less powerful than the mineral. Thus, if with a tincture of cochineal in water or spirit of wine, is mixed pure nitrous acid, it will change the color to an orange or flame color, which it will impart to cloth. If the vitriolic acid is used, a full scarlet, inclining to crimson rather than orange, is produced. With marine acid a true crimson color, bordering on purple, is the consequence. Alkalis, both fixed and volatile, change the color to a purple which is brighter with the volatile than the fixed alkalis. It is obvious that, whatever colors are produced by

the mixtures of different substances together, the permanency of these colors can only be in proportion to the ability of such mixtures to resist the weather. Thus, suppose a high scarlet or orange color is produced by means of spirit of nitre, it is plain that, was such a color exposed to the air, it could remain no longer than the spirit of nitre which produced it remained. In proportion, therefore, as the spirit of nitre was exhaled, or otherwise destroyed, it behoved the color to fade, and at last to be totally destroyed: and thus, in proportion to the destructibility of the substances by which colors are produced, will be the disposition of such colors to fade, or the contrary.

Alkalis are in this respect much more destructible than acids, and consequently less proper for the preparation of colors. Of the acids, the nitrous seems most destructible, the vitriolic less so, and the marine least of all. From the extreme fixity of the phosphorine acid and sedative salt, perhaps they might be of service in preserving colors.

SECT. III.—OF THE FORMATION OF OPAQUE COLORS.

As all colors, whether derived from the animal or vegetable kingdom, must be extracted either by pure water or some other liquid menstruum, they cannot be used for the purposes of painting till the coloring substance is united with some earthy or solid matter, capable of giving it a body, as the workmen call it; and, according to the nature of this substance, the color will be transparent or otherwise. This basis ought to be of the most fixed and durable nature; unalterable by the weather, by acids, or by alkalis. It ought also to be of a pure white color, and easily reducible into an impalpable powder. For this reason all earthy substances should be avoided as being acted upon by acids; and, therefore, if any of these were added to heighten the color, they would be destroyed, and their effect totally lost. Precipitates of lead, bismuth, &c., though exceedingly fine and white, ought also to be avoided, as being apt to turn black by exposure.

Alumina, in many instances, answers very well: but the substance to be chiefly preferred to all others, is calx of tin, prepared either by fire or the nitrous acid. This is so exceedingly refractory as not only to be unalterable by alkalis, acids, or the sun and weather, but even by the focus of a very large burning mirror. It is besides white as snow, and capable of being reduced to an extreme degree of fineness, inasmuch that it is made use of for polishing metal-line speculums. For these reasons, it is the most proper basis for all fine colors. For coarse ones, the white precipitate of lead will answer very well. It has a very strong body, i. e. it is very opaque, and will cover well; may be easily ground fine, and is much less apt to turn black than white lead; it is besides very cheap, and may be prepared at the small expense of 3d. per pound.

The general method of extracting colors from any vegetable or animal substance, and fixing them on a proper basis, may thus be very easily

understood. For this purpose, a quantity of calx of tin is to be procured, in proportion to the quantity of color desired. This must be well rubbed in a glass mortar, with a little of the substance designed for brightening the color, as alum, cream of tartar, spirit of nitre, &c. after which it must be dried, and left for some time, that the union between the two substances may be as perfect as possible. If the color is to be a very fine one, suppose from cochineal, the coloring matter must be extracted with spirit of wine without heat. When the spirit is sufficiently impregnated, it must be poured by little and little upon the calx, rubbing it constantly, to distribute the color equally through all parts of the calx. The spirit soon operates, and leaves the calx colored with the cochineal. More of the tincture is then to be poured on, rubbing the mixture constantly as before; and thus, with proper management, may very beautiful colors, not inferior to the best carmine, be prepared at a moderate expense. In like manner by substituting, for the cochineal, Brasil wood, turmeric, logwood, &c. different kinds of red, yellow, and purple, will be produced. For the coarser colors aqueous decoctions are to be used in a similar manner; only as these are much longer evaporating than the spirit of wine very little must be poured on at a time, and the colors ought to be made in large quantity, on account of the tediousness of the process.

We have hitherto mentioned only the effects of the pure and simple salts, viz. acids and alkalis, on different colors; but by combining the acids with alkalis, earths, or metals, these effects may be varied almost ad infinitum; nor is there any rule yet laid down by which we can judge a priori of the changes of color that will happen on the admixture of this or that particular salt with any coloring substance. In general, the perfect neutral salts act weakly; the imperfect, especially those formed from metals, much more powerfully. Alum and sal ammoniac considerably heighten the color of cochineal, Brasil, turmeric, fustic, madder, logwood, &c. The same thing is done, though in a less degree, by common salt, Glauber's salt, saltpetre, and many other neutrals.

Solutions of iron in all the acids strike a black with each of the above-mentioned substance; and likewise with sumach, galls, and other astringents. Solutions of lead universally debase red colors to a dull purple. Solutions of copper change the purple color of logwood to a pretty good blue; and, in general, solutions of this metal are friendly to blue colors. The effects of solutions of gold, silver, and mercury, are not so well known; they seem to produce dark colors of no great beauty. The most powerful solution, however, with regard to a great number of colors, is that of tin, made in aqua regia. Hence we may see the fallacy of Mr. Delaval's hypothesis concerning colors, that the least refrangible ones are produced by the most dense metals: for tin which has the least density of any metal, has yet, in a state of solution, the most extraordinary effects upon the least refrangible colors as well as those that are most so. The color of cochineal is changed by it into the most beautiful scarlet; a similar change is made

upon the coloring matter of gum-lac. Brasil wood is made to yield a fine purple crimson; logwood, a beautiful dark purple; turmeric, fustic, weld, and all yellow-coloring woods and flowers, are made to communicate colors far more beautiful than can be got from them by any other method. The blue colors of the flowers of violet, eye-bright, iris, &c. are heightened so as to equal, if not excel, the blue produced by a solution of copper in copper in volatile alkali. In short this solution seems to be of much more extensive use in color-making, when properly applied, than anything hitherto thought of. It is not, however, universally serviceable. The color of madder it totally destroys, and likewise that of safflower, changing them both to a dull orange. It likewise spoils the color of archil; and, what is very remarkable, the fine red color of tincture of roses made with oil of vitriol is changed by it to a dirty green.

SECT. IV.—OF THE CHOICE OF COLORING MATERIALS.

One of the most important considerations in color-making is to choose such materials as produce the most durable colors. If these can be procured, an ordinary color from them is to be preferred to a bright one from those which fade sooner. In what the difference consists between the colors that fade and those which do not, is not known with any degree of certainty. From some appearances it would seem, that those substances which are most remarkable for keeping their color, contain a viscous glutinous matter, so combined with a resinous one as to be soluble in water and spirit of wine. The most durable red color is prepared from gum-lac. This is very strongly resinous, though, at the same time, so far glutinous, that the coloring matter can be extracted from it by water. Next to gum-lac are madder roots and cochineal. The madder is an exceedingly penetrating substance, inasmuch that, when given to animals along with their food, it tinges their bones of a deep red color. Its coloring matter is soluble both in water and spirit of wine. Along with the pure red, however, there is in madder a kind of viscous astringent substance, of a dark brown color, which seems to give the durability to the whole. The coloring matter of cochineal, though soluble both in water and spirit of wine, is very tenacious and mucilaginous, in which it bears some resemblance to the purpura of the ancients, which kept its color exceedingly well.

Where the colors are fugitive, the tinging substance seems to be too resinous or too mucilaginous. Thus the colors of Brasil, turmeric, &c. are very resinous, especially the latter; inasmuch that the coloring matter of turmeric can scarcely be extracted by water. Both these are perishable, though beautiful colors; and much more the red, purple, and blue dowers, commonly to be met with. These seem to be entirely mucilaginous without the least quantity of resinous matter. The yellow flowers are different, and in general keep their color pretty well. Perhaps fugitive colors might be rendered durable, by adding a proportion of gum or resin. A process has been given by Mr. Hellot for imparting durability to

the color of Brasil. It consists only in letting decoctions of the wood stand for some time in wooden casks till they grow stale and ropy. Pieces of woollen cloth, dyed in the liquor, acquired a color so durable that they were not in the least altered by exposure to the air during four months in the winter season. Whether this change in the durability of the color was effected by the ropiness following the fermentation, must be decided by future experiments.

SECT. V.—OF THE PIGMENTS COMMONLY SOLD IN THE COLOR SHOPS.

The preceding sections contain the substance of all that can as yet be depended upon for establishing a general theory of color-making. We now proceed to give an account of the different pigments generally to be found in the color shops.

1. **BLACK.**—These are the lamp-black, ivory-black, blue-black, and Indian-black. The first is the finest of what are called the soot-blacks, and is more used than any other. Its preparation is described in the Swedish Transactions for 1754, as a process dependent on the making of common resin: the impure resinous juice, collected from incisions made in pine and fir-trees, is boiled down with a little water, and strained whilst hot through a bag: the dregs and pieces of bark left in the strainer are burnt in a low oven, from which the smoke is conveyed through a long passage into a square chamber, having an opening on the top on which is a large sack made of this woollen stuff: the soot or lamp-black, concretes partly in the chamber, from whence it is swept out once in two or three days, and partly in the sack, which is now and then gently struck upon, both for shaking down the soot, and for clearing the interstices betwixt the threads, so as to procure a sufficient draught of air through it. In this manner lamp-black is prepared at the turpentine houses in England, from the dregs and refuse of the resinous matters which are there manufactured. Dr. Lewis has some curious observations on this subject. The soot, says he, arising in common chimneys, from the more oily or resinous woods, as fir and pine, is observed to contain more dissoluble matter than that from the other woods; and this dissoluble matter appears, in the former, to be more of an oily or resinous nature than the latter; spirit of wine extracting it most powerfully from the one, and water from the other. The oiliness and solubility of the soot seeming therefore to depend on those of the subject it is made from, it has been thought that lamp-black must possess these qualities in a greater degree than any kind of common soot. Nevertheless, on examining several parcels of lamp-black, procured from different shops, I could not find that it gave any tincture at all, either to spirit or to water. Suspecting some mistake or sophistication, or that the lamp-black had been burnt or charred, as it is to fit it for some particular uses, I prepared myself some soot from linseed oil, by hanging a large copper pan over the flame of a lamp to receive its smoke. In this manner the more curious artists prepare lamp-black for the nicer purposes; and from this collection of it from the flame of a lamp, the pigment probably received its name.

The soot so prepared gave no tincture either to water or spirits, any more than the common lamp-black of the shops. I tried different kinds of oily and resinous bodies with the same event; even the soots obtained from fish oils and tallow did not appear to differ from those of the vegetable oils and resins. They were all of a finer color than the lamp-black commonly sold.

Soot was also collected in like manner from fir, and other woods, by burning small pieces of them slowly under a copper pan. All the soots were of a deeper black color than those obtained from the same kinds of woods in a common chimney; and very little, if at all, inferior to those of the oils: they gave only a just discernible tincture to water and spirit, while the soots of the chimney imparted a strong deep one to both. The soot of mineral bitumens, in this close way of burning, appears to be of the same qualities with those of woods, oils, and resins: in some parts of Germany, great quantities of good lamp-black are prepared from a kind of pit-coal. It appears, therefore, that the differences of soots do not depend altogether on the qualities of the subjects, but in a great measure on the manner in which the subject is burnt, or the soot caught. The soots produced in common chimneys, from different kinds of wood, resinous and not resinous, dry and green, do not differ near so much from one another, as those which are produced from one kind of wood in a common chimney, and in the confined way of burning above-mentioned.

Ivory black is prepared from ivory or bones burnt in a close vessel. This, when finely ground, forms a more beautiful and deeper color than lamp-black; but, in the common methods of manufacturing, it is so much adulterated with charcoal dust, and so grossly levigated, as to be unfit for use. An opaque deep black, for water color, is made by grinding ivory black with gum-water, or with the liquor which settles from the whites of eggs after they have been suffered to stand a little. Some use gum-water and the whites of eggs together, and say, that a small addition of the latter makes the mixture flow more freely from the pencil, and improves its glossiness. It may be observed, however, that though ivory-black makes the deepest color in water as well as in oil painting, yet it is not on this account always to be preferred to other black pigments. A deep jet black color is seldom wanted in painting; and in the lighter shades, whether obtained by diluting the black with white bodies, or by applying it thin on a white ground, the particular beauty of the ivory-black is in a great measure lost.

Blue black is said to be prepared from the burnt stalks and tendrils of the vine. These, however, the color-makers seldom give themselves the trouble of procuring, but substitute in its place a mixture of ivory-black and common blue used for clothes.

Indian ink is an excellent black for water-colors. It has been discovered by Dr. Lewis to consist of a mixture of lamp-black and common glue. Ivory-black, or charcoal, he found to answer equally well, provided they were levigated to a sufficient degree of fineness, which indeed requires no small trouble.

2. **WHITE.**—The white colors commonly to be met with are, white-flake, white-lead, calcined hartshorn, pearl-white, Spanish-white, egg-shell white, and magistery of bismuth. The flake-white and white-lead are properly the same, though the preparation of the former is kept a secret. These are the only whites that can be used in oil, all the rest being transparent unless they are laid on with water. Calcined hartshorn is the most useful of the earthy whites, as being the least alkaline. Spanish white is only finely prepared chalk. Pearl white is made from oyster-shells; and egg-shell white from the shells of eggs. All these, by their attraction for acids, must necessarily destroy such colors as have any acid or metallic salt in their composition. The magistery of bismuth is apt to turn black, as are also flake-white and white-lead, when used in water. The white precipitate of lead is greatly superior as a water-color, to all these; being perfectly free of any alkaline quality, and not apt to lose its own color, or to injure that of other substances.

3. **RED.**—The red colors used in painting are of two sorts; viz. those which incline to the purples and such as are of a full scarlet and tend rather to the orange. The first are carmine, lake, rose-pink, red-ochre, and venetian-red. The second are vermilion, red-lead, scarlet-ochre, common Indian-red, Spanish-brown, and terra di Sienna, burnt. The preparations of carmine and lake, we have noticed in section III. Receipts have been delivered with the greatest confidence for making these fine colors; but all of them must necessarily prove ineffectual, because an earthy basis is recommended for striking the color upon: from the principles of chemistry, we are certain, that if aqua-fortis, or solution of tin, is made use of for brightening a color made with any earthy basis, it must infallibly be destroyed by that basis, by reason of its alkaline quality. Carmine is the brightest and most beautiful red color known; the best comes from France. Lake differs from it in being capable of mixture with oil; which carmine is not, unless with great difficulty. The former is also much more inclined to purple than carmine. This last quality, however, is reckoned a defect; and, accordingly, the more that lake approaches to the scarlet or true crimson, the more it is valued. On dropping solution of tin into an aqueous tincture of Brasil wood, a beautiful precipitate falls, of a purplish crimson color. This may be very well substituted in place of the dearer lakes on many occasions.

Rose pink is a very beautiful color, inclining more to the purple than scarlet. It seems to be made of chalk, colored with a decoction of Brasil wood, heightened by an alkaline salt; for which reason it is exceedingly perishable, and but little esteemed. The color might be made much more durable, as well as better, by employing for a basis the white precipitate of lead, and brightening it with solution of tin.

Red ochre and *Venetian red* differ in nothing from the colcothar of vitriol well calcined. The calces of iron may be made to appear either purplish, or inclining to the scarlet, according to the manner in which the calcination is performed.

If the matter is perfectly deprived of its phlogiston, and subjected to an intense fire, it always turns out red: but the mixture of a small quantity of inflammable matter gives it a purplish cast. Hence various paints are sold under different names, which yet differ from each other only in the slight circumstance above-mentioned: and such are the scarlet-ochre, Spanish-brown, and terra di Sienna burnt. It is remarkable, that the calces of iron never show their color till they become cold. Colcothar of vitriol, while hot, always appears of a very dark dusky purple.

Vermilion, the best red used in oil painting, does not answer well in water; minium or red-lead is rather an orange; and, like other preparations of lead, is in some cases apt to turn black.

4. **ORANGE.**—The only true orange-colored paints are red orpiment and orange lake. The first is a sublimate formed of arsenic and sulphur: the other may be prepared from turmeric infused in spirit of wine, having its color struck upon calx of tin, and brightened by a solution of that metal. All the shades of orange, however, may be extemporaneously prepared by mixing red and yellow colors together, in due proportions.

5. **YELLOW.**—The yellow paints most commonly used are, king's-yellow, Naples'-yellow, Dutch-pink, English pink, masticot, common orpiment, yellow-ochre, and terra di Sienna unburnt.

Kings' Yellow is evidently an arsenical preparation. Its color is exceedingly beautiful, but apt to fade; on which account, and its great price, it is seldom used.

Naples' yellow was for a long time thought to be a preparation of arsenic, but is now discovered to have lead for its basis. It is, therefore, apt to turn black and lose its color, which makes it the less valuable. It is used in preference to king's yellow, on account of its inferiority in price, though it is particularly liable to be spoiled by iron when moist; and therefore should never be touched by that metal unless previously ground in oil.

Dutch pink is said to be prepared by striking the colors of yellow berries upon finely levigated chalk. But of this there is great reason to doubt; the basis of Dutch-pink seems much more hard and gritty than chalk, and its color more durable than those struck upon that earth usually are. Very good yellow may be prepared with the white precipitate of lead, by using either yellow berries, fustic, or any other substance capable of yielding that color. English pink is paler than the Dutch, and keeps its color much worse.

Masticot is not apt to change, but the color is so dull that it is seldom used either in oil or water.

Common orpiment is a pretty bright greenish yellow. Its nauseous smell is greatly increased by grinding in oil; nor does it keep its color for any length of time. That kind least inclined to green is to be preferred for painting. See the difference between it and realgar, and the method of preparing them, under CHEMISTRY
Yellow ochre, and terra di Sienna are ferru-

ginous earths, capable of becoming red by calcination. Green vitriol precipitated by lime may be advantageously substituted for either of them.

Turbith mineral is little used in painting, though its fine yellow color seems greatly to recommend it. It is in all probability very durable; and should seem therefore worthy of a preference either to king's or Naples-yellow.

Gamboge can only be used in water, and is the most common yellow made use of for coloring maps, &c. though it is neither quite transparent nor very durable.

6. GREEN.—The only simple green color that has a tolerable degree of brightness is verdigris, or preparations of it. See CHEMISTRY, Index. This however, though a very beautiful color, is far from being durable. It is improved in color, though not in durability, by dissolution and crystallisation in distilled vinegar; in which state it is called distilled verdigris. A more durable water-color is made by dissolving the verdigris in cream of tartar, or rather the pure tartareous acid; but in oil this is found to be equally fugitive with the verdigris itself.

Compound greens are either made of Prussian or some other blue, mixed with yellow; but, in whatever way these colors can be compounded, the beauty of the green produced is greatly inferior to distilled, or even common verdigris. The tartareous solution of verdigris, mixed with a little gamboge, is the best transparent green water-color we have had an opportunity of trying; and a mixture of Prussian blue and turbith mineral is probably the best opaque one.

Sap green is a simple color, but exceedingly inferior to distilled verdigris, or even to the tartareous solution of verdigris, with gamboge. It is prepared from the juice of unripe buckthorn berries evaporated to the consistence of a gum. Its green color is greatly inclined to yellow.

A kind of compound green has been sometimes used, called Prussian green, which consists only of Prussian-blue and yellow-ochre. It has no beauty, nor is it durable. It is prepared as Prussian-blue, only not pouring on any spirit of salt to dissolve the ochreous sediment which falls at the same time.

Another green is also sometimes used, called terra verte. It is a native earth, probably impregnated with copper, of a bluish-green color, of that taint called sea-green. It is gritty, and therefore must be well levigated before it is used. Its color is durable, but not very bright.

7. BLUE.—The blue colors are ultra marine, Prussian blue, verditer, smalt, bice, and indigo. Of all these, ultramarine is the finest, but its great price hinders its being much used. It is a preparation from lapis lazuli; is an exceedingly bright color, and never fades with whatever substance it is mixed. It is now, however, in a great measure superseded by Prussian blue, to the disadvantage of painting in general; as Prussian blue, though very beautiful, is far from being durable. Prussian blue is of the best quality when it is deep, bright, and not inclined to purple. It ought to be tried by mixture with white lead, as the brightness of the color will appear much more when diluted, than when concentrated in lumps.

The preparation of blue verditer is kept a secret, and the best chemists have been puzzled to find out the method. The color is exceedingly bright, and has a considerable tinge of green. The following is a method of preparing a color equally beautiful, and agreeing in all respects with what is sold in the shops, except that of effervescing with acid:—Dissolve copper in strong caustic alkali, until the liquid has assumed a very deep blue color; and the deeper this color is, the finer will be the verditer. When the menstruum has dissolved as much of the metal as it can take up, it is to be poured out into a broad and well glazed earthen pan, held over a very gentle fire; and, from the moment it is put on, the liquor is to be continually agitated with a wooden spatula, so that the liquor may be heated as equally as possible. The whole secret consists in properly regulating the degree of heat; for, if it exceed the due proportion ever so little, the verditer will turn out a dirty green. The proper degree is about 90° of Fahrenheit's thermometer. In this gentle heat the alkali slowly evaporates; and, in proportion to its doing so, the verditer falls to the bottom. After it is once formed, freed from the alkaline liquor, and dried, it can bear the affusion of boiling water without the least injury. Dr. Priestley observes, that solution of copper in volatile alkali affords a blue precipitate by heat, but without mentioning the requisites for its success. In making this preparation, it is necessary to dissolve copper in its metallic state; for the solution of any calyx will not yield a blue but a green color. This color is durable in water, but dissolves in oil, and has then all the inconveniences of verdigris above mentioned.

Smalt is a glass colored with zaffre, a preparation from cobalt. It is commonly so grossly powdered that it cannot be used in painting, and its texture is so hard, that it cannot easily be levigated. Its color is exceedingly bright and durable; so that when finely levigated it is used instead of ultramarine. The most proper materials for levigating this substance seem to be the plates of M. Reaumur's porcelain recommended by Dr. Lewis.

Bice. For the preparation and qualities of bice, see ARMENUS and BICE.

Indigo is but little used in painting either in oil or water, on account of the dullness of the color. It requires no other preparation than being washed over. Its goodness is known by the darkness and brightness of the color. See INDIGO.

8. PURPLE.—The only simple color of this kind used at present is colcothar of vitriol. A beautiful purple lake may be prepared from logwood by solution of tin; but this method of preparing colors is very little known as yet.

9. BROWN.—The brown colors are bistre, brown ochre, Cologne earth, umbre, and brown pink.

Under the article BISTRE is given a process for making that color, by infusing soot in water, pouring off the tincture, and then evaporating it to an extract; but Dr. Lewis is of opinion with Mr. Landois in the French Encyclopedie, that the foot is either boiled in water, or ground with a little liquid of some kind into a smooth past;

it is then diluted with more water, and after standing for about half an hour till the grosser substance of the foot has settled, the liquor is poured off into another vessel, and set by for some days, that the finer parts may fall to the bottom, and this fine matter is the bistr. This is a very useful color in water, being exceedingly fine, durable, and not apt to spoil any other colors with which it is mixed.

Brown pink is said to consist of chalk tinged with the coloring matter of fustic, heightened by fixed alkaline salts. It is therefore very perishable, and is seldom used. The other browns are a kind of ochreous earths; for a description of which, see their proper articles.

SECT. VI.—OF THE ATTEMPTS MADE TO PRODUCE LAKES OF ALL COLORS FROM VEGETABLES.

We shall conclude with noticing some attempts that have been made to produce all the different colors from vegetables, after the manner of lakes; which, though the methods hitherto tried have for the most part failed of success, may perhaps lead to future and more successful exertions. From infusions of astringent vegetables, mixed with green vitriol, is produced a deep black liquor of very extensive use in dyeing. See *DYEING*. The substances which produce the deepest blacks are galls and logwood. When a decoction or infusion of the galls is dropped into a solution of the vitriol largely diluted with water, the first drops produce bluish or purplish-red clouds, which, soon mingling with the liquor, turn it uniformly of their color.

This difference in the color seems to depend on the quality of the water. With distilled water, or the common spring waters, the mixture is always blue. If we previously dissolve in the water the most minute quantity of any alkaline salt, too small to be discovered by any of the common means by which waters are usually tried, or if the water is the least putrid, the color of the mixture proves purple or reddish. Rain water, caught as it falls from the clouds in an open field, in clean glass vessels, gives a blue; but such as is collected from the tops of houses grows purple, with the mixture of vitriol and galls: from whence it may be presumed, that this last has contracted a putrid tendency, or received an alkaline impregnation, though so slight as not to be sensible by other ways of trial. Both the purple and blue liquors, on adding more of the astringent infusion, deepen to a black, more or less intense, according to the nature of dilution: if the mixture prove of a deep opaque blackness, it again becomes bluish or purplish, when further diluted. If suffered to stand in this diluted state for two or three days, the coloring matter settles to the bottom in form of a fine black mud, which, by slightly shaking the vessel, is diffused again through the liquor, and tinges it of its former color. When the mixture is of a full blackness, this separation does not happen, or in a far less degree; for though a part of the black matter precipitates in standing, yet so much remains dissolved, that the liquor continues black. This suspension of the coloring substance, in the black liquid, may be attributed in part to the gummy matter of the

astringent infusion increasing the consistence of the watery fluid; for the separation is retarded in the diluted mixture by a small addition of gum-arabic. If the mixture, either in its black or diluted state, is poured into a filter, the liquor passes through colored: only a part of the black matter remaining on the filter. The filtered liquor, on standing for some time, becomes turbid and full of fine black flakes; being freed from these, by a second filtration, it again puts on the same appearance; and thus repeatedly till all the coloring parts are separated, and the liquor has become colorless.

Dr. Lewis, from whose *Philosophical Commerce of Arts* this account is taken, informs us that this coloring matter, when separated from the liquor and dried, appeared of a deep black, which did not seem to have suffered any change from the air by exposure for upwards of four months. Made red-hot, it glowed and burned, but did not flame, and became a rusty-brown powder, which was readily attracted by a magnetic bar; though in its black state the magnet had no action upon it. The vitriolic acid, diluted with water, and digested on the black powder, dissolved the greatest part of it, leaving only a very small quantity of whitish matter. Solution of pure fixed alkaline salt dissolved very little of it: the liquor received a reddish brown color, and the powder became blackish brown. This residuum was attracted by the magnet after being red hot, though not before: the alkaline tincture passed through a filter, and mixed with a solution of green vitriol, struck a deep brownish black color, nearly the same with that which results from mixing with the vitriolic solution, an alkaline tincture of galls. It has also been attempted to produce black from a combination of other colors, as green may be produced from a mixture of blue and yellow. M. le Blon, in his *Harmony of Colors*, gives a method of forming black, by mixing together the three colors called primitive, viz. blue, red, and yellow; and M. Castel, in his *Optique des Couleurs*, published in 1740, says that this compound black has an advantage in painting, above the simple ones, of answering better for the darkening of other colors. Thus, if blue, by the addition of black, is to be darkened into the color called blue black, the simple blacks, according to him, if used in sufficient quantity to produce the requisite deepness, conceal the blue, while the compound blacks leave it distinguishable.

Le Blon does not mention the proportions of the three colors necessary for producing black. Castel directs fifteen parts of blue, five of red, and three of yellow; but takes notice, that these proportions are rather speculative than practically just, and that the eye only can be the true judge; our colors being all very imperfect, and our pigments or other bodies of one denomination or color being very unequal in their degree of intensity. He observes, that the pigments should all be of the deepest and darkest kind; and that, instead of taking one pigment for each color, it is better to take as many as can be got; for the greater discord there is of heterogeneous and discordant drugs, the more true and beautiful, he

says, will the black be, and the more capable of uniting with all other colors, without suppressing them, and even without making them tawney.

Dr. Lewis, by mixing different blue, red, and yellow colors, has not been able to produce a perfect black; but has often obtained from them very dark colors, such as may be called brown-blacks or gray-blacks; such as we commonly see in the dark part of paintings, and such as the charcoal and soot blacks appear when diluted a little. The ingredients being of a dark deep color is a very necessary condition; for bright blues, bright reds, and bright yellows mixed in such a proportion that neither color prevailed produced only a gray. In effect, all compositions of this kind, physically considered, can be no other than grays, or some of the intermediate tints between whiteness and darkness; and all these grays will be so much the lighter or darker as the component colors of themselves are bright or dark. To extract the coloring matter from the different kinds of vegetables of all colors, would certainly be a very valuable acquisition, could the colors so procured be made durable. On this subject nothing has appeared more satisfactory than what is delivered by Dr. Lewis in his notes on Neuman's Chemistry. His observations are curious, though they do not promise much success, with regard to fixing these vegetable colors. 'Among the infinite variety of colors, (says he), which glow in the flowers of plants, there are very few which have any durability, or whose fugitive beauty can be arrested by art, so as to be applied to any valuable purposes. The only permanent ones are the yellow, the red, the blue; and all the intermediate shades of purple, crimson, violet, &c. are extremely perishable. Many of these flowers lose their colors on being barely dried; especially if they are dried slowly, as has been usually directed, in a shady, and not warm place. The colors of all of them perish on keeping even in the closest vessels. The more hastily they are dried, and the more perfectly they are secured from the air, the longer they retain their beauty. The coloring matter extracted and applied on other bodies is still more perishable; oftentimes it is changed or destroyed in the hands of the operator. The color of many blue flowers is extracted by infusion in water; but there are some from which water gains only reddish or purplish blue. Of those that have been tried there is not one which gives any blue tincture to spirituous liquors: some give no color at all, and some a reddish one. The juice pressed out from the fresh flowers is for the most part blue. The blue juices and infusions are changed red by all acids. The marine acid seems to strike the most florid red. The flowers themselves, macerated in acid liquors, impart also a deep red tincture. Alkalis, both fixed and volatile, and lime water, change them to a green. Those infusions of the juices which have nothing of the native color of the flowers, suffer the same changes from the addition of acid and alkaline liquors: even when the flowers have been kept till their color is lost, infusions made from them acquire still a red color from the one, and a green from the other, though in a less degree than when

the flowers were fresh. The red color produced by acids is scarcely more durable than the original blue: applied upon other bodies, and exposed to the air, it gradually degenerates into a faintish purple, and at length disappears, leaving hardly any stain behind. The green produced by alkalis changes to a yellow, which does not fade so soon. The green, by lime water, is more permanent and more beautiful: green lakes, prepared from these flowers by lime-water, have been used as pigments by the painter. The flowers of cyanus (the common blue-bottle) have been greatly recommended, as affording elegant and durable blue pigments; but I never have been able to extract from them any blue color at all. Infusions of them in watery, spirituous, and oily liquors, are all, more or less, of a reddish cast, without any tendency to blue. Alum, which is said to heighten and preserve their blue color, changes it, like that of other blue flowers, to a purplish red; acids to a deep red; alkalis and lime-water to a green; solutions of tin added to the watery infusion, turns it to a fine crimson; on standing, a beautiful red *fecula* subsides, but it loses all its color by the time it is dry. The watery infusion, inspissated to the consistence an extract, appears of a dark reddish-brown; an extract made with rectified spirits is of a purplish color. The color of both extracts spread thin and exposed to the air quickly fades. Red flowers readily communicate their own red color to watery menstrua: among those that have been tried there is not one exception. Those of a full red color give to rectified spirit also a deep red tincture, brighter, though somewhat paler, than the watery infusion: but the lighter red flowers, and those which have a tendency to purplish, impart very little color to spirit, and seem to partake more of the nature of the blue flowers than of the pure red. Infusions of red flowers are supposed to be heightened by acids, and turned green by alkalis, like those of the blue; but this is far from being universal. Among those I have examined, the rose colors and purplish reds were changed nearly in the same manner as the blues; but the full deep reds were not. The deep infusion of red poppies is changed by alkalis, not to a green but to a dusky purple. The colors of yellow flowers, whether pale or deep, are in general durable. Many of them are as much so, perhaps, as any of the native colors of vegetables. The color is extracted both by water and by spirit. The watery infusions are the deepest. Neither alkalis nor acids alter the species of the color, though both of them vary its shade; acids rendering it paler, and alkalis deeper: alum likewise considerably heightens it, though not so much as alkalis. An infusion of the flowers, made in alkaline lee, precipitated by alum, gives a durable yellow lake. In some of the deep reddish-yellow, or orange-colored flowers, the yellow matter seems to be of the same kind with that of the pure yellow flowers, but the red to be of a different kind from the pure red ones; watery menstrua take up only the yellow, and leave the red, which may afterwards be extracted by rectified spirit of wine, or by water acuted by fixed alkaline salt. Such particularly are the saffron-colored flowers of

Carthamus. These, after the yellow matter has been extracted by water, are said to give a red tincture to lee; from which, on standing at rest for some time, a deep bright red fecula subsides; called, from one of the names of the plant which produces it, *saf-flower*; and, from the countries whence it is commonly brought to us, Spanish red, and China lake. This pigment impregnates spirit of wine with a beautiful red tincture, but communicates no color to water. I have endeavoured to separate, by the same treatment, the red matter of some of the other reddish yellow flowers, as those of garden marigold, but without success. Plain water extracted a yellow color, and alkaline lee extracted afterwards only a paler yellow: though the digestions were continued till the flowers had lost their color, the tinctures were no other than yellow, and not so deep as those obtained from the pure yellow flowers. The little yellow flosculi, which in some kinds of flowers are collected into a compact round disc, as in the daisy and corn-marigold, agree, so far as they have been examined, with the expanding yellow petals. Their color is affected in the same manner by acids, by alkalis, and by alum; and equally extracted by water and by spirit. But the yellow farina, or fine dust lodged on the tips of the stamina of flowers, appears to be of a different kind. It gives a fine bright yellow to spirit, and a duller yellow to water; the undissolved part proving in both cases of a dull yellowish-white. Both the watery and spirituous tinctures were heightened by alkaline liquors, turned red by acids, and again to a deep yellow on adding more of the alkali: I know no other vegetable yellow that is turned to red by acids.

White flowers are by no means destitute of coloring matter. Alkaline lixivium extract from some of them a green tincture, and change their colorless expressed juices to the same color; but I have not observed that they are turned red by acids. The flowers of the common wild convolvulus or bind-weed, which in all their parts are white, give a deep yellow or orange tincture to plain water; which, like the tincture of flowers that are naturally of that color, is rendered paler by acids, heightened a little by alum, and more considerably by alkaline salts. The vapors of the volatile vitriolic acid, or of burning sulphur, which whiten or destroy the color of the colored flowers, make no change in the white. The red juices of fruits, as currants, mulberries, elderberries, morello, and black cherries, &c. gently inspissated to dryness, dissolve again almost totally in water, and appear nearly of the same red color as at first. Rectified spirit extracts the tinging particles, leaving a considerable portion of mucilaginous matter undissolved; and hence the spirituous tincture proves of a brighter color than the watery. The red solutions, and the juices themselves, are sometimes made dull, and sometimes more florid, by acids, and generally turned purplish by alkalis. The colors of these juices are, for the most part, perishable. They resist, indeed, the power of fermentation, and continue almost unchanged, after the liquor has been converted into wine; but when the juice is spread thin upon other bodies, exsiccated, and exposed to the air, the color quickly alters and decays;

the bright lively red changes the soonest; the dark dull red stain from the juice of the black-cherry, is of considerable durability. The fruit of the American opuntia or prickly pear, the plant upon which the cochineal insect is produced, is perhaps an exception. This bright red fruit, according to Labat, gives a beautiful red dye. Some experiments, however, made upon the juice of that fruit, as brought into England, did not promise to be of any great advantage. The ripe berries of buckthorn stain paper of a green color. From these is prepared the substance called sap-green, a pigment sufficiently durable, readily soluble in water, but not miscible in oil. It is said that the berry of the *heliotropium tricoocum*, which grows wild about Montpellier, stains paper of a green color, and that this green turns presently to a blue; that the common blue paper receives its color from this juice; and that the red rags, called turnsole, employed for coloring wines and other liquors, are tinctured by the same juices, turned red by acids. According to M. Nissole, of the French Academy of Sciences, the coloring juice is obtained not from the berries, but from the tops of the plant gathered in August, ground in mills, and then committed to the press. The juice is exposed to the sun about an hour, the rags dipt in it, dried in the sun, moistened by the vapor which arises during the slaking of quicklime with urine, then dried again in the sun, and dipped again in the juice. The Dutch and others are said to prepare turnsole rags, and turnsole in the mass, from different ingredients, among which argil is a principal one. In some plants, peony for instance, the seeds, at a certain point of maturity, are covered with a fine shining red membrane. The pellicles of the seeds of a certain American tree afford the red masses brought into Europe under the names of *annotta*, *orlean*, and *rancou*. See ANOTTA. Mr. Pott, in the Berlin Memoirs, for the year 1752, mentions a very extraordinary property of this concrete. 'With vitriolic acid it produces a blue color of extreme beauty; but with this capital defect, that all salts and liquors and even common water, destroy it.' The specimen of *annotta*, which I examined, was not sensibly acted upon by spirit of vitriol; it received no change in its own color, and communicated none to the liquor. Nor did any visible change ensue upon dropping the acid into tinctures of *annotta* made in water or in spirit. The green color of the leaves of plants is extracted by rectified spirit of wine and by oils. The spirituous tinctures are generally of a fine deep green, even when the leaves themselves are dull-colored, or yellowish, or hoary. The color, however, seldom abides long even in the liquor; much less when the tinging matter is separated in a solid form, and exposed with a large surface to the air. The editor of the *Wurtemberg Pharmacopœia* observes, that the leaves of *acan* thus, or bear's breach, give a more durable green tincture to spirit than those of any other herb. Alkalis heighten the color both of the tinctures and green juices; acids weaken, destroy or change it to a brownish: lime-water improves both the color and durability: by means of lime, not elegant green lakes are procured from the leaves of *acanthus*, lilly of the valley, and several other plants. There are very few plants which com-

municate any share of their green color to water; perhaps none that give a green of any considerable deepness. The leaves of many herbs and trees give a yellow dye to wool or woollen cloth that has been previously boiled with a solution of alum and tartar. Weld, in particular, affords a fine yellow, and is commonly made use of for this purpose by the dyers, and cultivated in great quantities in some parts of England. There is no color for which we have such plenty of materials as for yellow. Mr. Hellot observes, that all leaves, barks, and roots, which on being chewed discover a slight astringency, as the leaves of the almond, peach, and pear trees, ash bark, the roots of wild patience, &c. yield durable yellows; that a large quantity of alum makes these yellows approach to the elegant yellow of weld; that if the tartar is made to prevail, it inclines them to an orange; that if the roots, barks, or leaves, be too long boiled, the yellow proves tarnished, and acquires shades of brown. See DYEING.

Indigo and weld are the most capital preparations from the leaves of plants. They are both very much used in dyeing, though the first only in painting. See INDIGO and WOAD. Both the indigo and woad plants give out their color, by proper management, to water, in form of a blue fecula or lake. Mr. Hellot supposes that a little blue fecula is procurable from many other vegetables. Dr. Lewis, however, never was able to produce the least appearance of either blue or yellow from any of the plants he tried by treating them in the manner used for the preparation of indigo.

There are various mosses which, like the indigo and woad plants, promise nothing of the elegant colors that can be extracted from them by art. The most remarkable of these is ARCHIL; see that article. Linnæus suspects that there are several other more common mosses from which valuable colors might be extracted; a quantity of sea moss having rotted, in heaps, on the shore, he observed the liquor in the heaps to be as red as blood; the sea-water, the sun, and the putrefaction, having brought out the color. Mr. Kalm, in an appendix to Linnæus's paper, in 1745, mentions two sorts of mosses actually employed in Sweden for dyeing woollen red: one is the lichenoides coralliforme apicibus coccineis of Ray's synopsis; the other the lichenoides tartareum, farinaceum, scutellarum umbone fusco, of Dillenius. This last is a white substance like meal clotted together, found on the sides and tops of hills. It is shaved off from the rocks after rain, purified from the stony matters intermixed among it, by washing with water, then dried in the sun, ground in mills, and again washed and dried: it is then put into a vessel with urine, and set by for a month: a little of this tincture added to boiling water makes the dyeing color.

In the Philosophical Transactions for 1754, there is an account of another moss which, prepared with urine, gives a beautiful and durable red or violet dye to wool and silk. This is the lichen foliaceus umbilicatus subtus lacunensis, Linnæi flora Suecica. It grows upon rocks, and is readily distinguishable from others of that class by looking as if burnt or parched, consisting of leaves as thin as paper, convex all over on the

upper side, with corresponding cavities underneath, adhering firmly to the stones by a little root under the leaves, and coming asunder, when dry, as soon as touched. It is gathered after rain, as it then holds best together, and parts easiest from the stone. In France a crustaceous moss, growing upon rocks in Auvergne, is prepared with lime and urine, and employed by the dyers as a succedaneum for the Canary archil. Mr. Hellot relates that he has met with several other mosses which, on being prepared in the same manner, acquire the same color. The most expeditious way, he says, of trying whether a moss will yield an argil, or not, is to moisten a little of it with a mixture of equal parts of spirit of sal ammoniac and strong lime water, and add a small proportion of crude sal ammoniac. The glass is then to be tied over with a piece of bladder, and set by for three or four days. If the moss be of the proper kind the little liquor which runs from it, upon the inclining vessel, will appear of a deep crimson color; and, this afterwards evaporating, the plant itself acquires the same color.

Dr. Lewis informs us, that he has tried a good number of the common mosses, many both of the crustaceous and foliaceous kind, and not a few of the fungi; as also the herbs chamomile and milfoil, which yield a blue essential oil; and thyme, whose oil becomes blue by digestion with volatile spirits; but never met with any that yielded a color like archil. Most of them gave a yellow or reddish-brown tincture. A few gave a deep red-color to the liquor; but, when diluted, it showed a yellowish cast, and when applied 'on cloth it gave only a yellowish-red. Though, in general, the blue colors of flowers are exceedingly perishable, there seem to be at least two exceptions to this rule; for the blue flowers of iris, or fleur-de-lis, and those of columbine, when treated with solution of tin, yielded a color tolerably permanent. Indeed, when experiments are made with a view to extract the color from any part of a vegetable, it should always be tried whether it can bear a mixture with this solution. If the color is not destroyed by it there is a very great probability that the solution will, by proper management, preserve and give a durability to it, which could scarcely be obtained by any other method.

There are several substances, however, used in color-making, with which solution of tin cannot bear to be mixed. These are, principally, sugar of lead and cream of tartar, as well as all the calcareous earths and alkaline salts. With alum it may be mixed very safely, and is in many cases the better for it. The roots of plants, however, seem to promise more durability of color than the upper parts. We have seen a blue color, of considerable durability and brightness, prepared from the roots of common radishes by expressing the juice, combining it with pipe-clay, and brightening it with a little alum.

In preparing liquid colors for maps, &c., there can be very little difficulty, if what is above laid down is attended to. The only color with which there can be any difficulty is blue; but the common solutions of indigo in alkalis or acids may be made to answer this purpose, though, on

account of their strongly saline qualities, they are not very proper. A method of procuring a beautiful transparent blue color is to extract the coloring matter from the Prussian blue, by caustic alkali. This laid upon paper appears of a dirty brown color; but, when washed over with a weak solution of green vitriol, is instantly changed to a most beautiful blue. This affords a method of procuring blue transparent colors of greater beauty than are usually met with. For further information, on this subject, see *PAINTING*, and *Tungri's Painters' and Varnishers' Guide*.

The following are the dye-stuffs used by the calico printers for producing fast colors. The mordants are thickened with gum, or calcined starch, and applied with the block, roller, plates, or pencil.

1. Black. The cloth is impregnated with acetate of iron (iron liquor) and dyed in a bath of madder and logwood.

2. Purple. The preceding mordant of iron, diluted: with the same dyeing bath.

3. Crimson. The mordant for purple, united with a portion of acetate of alumine, or red mordant, and the above bath.

4. Red. Acetate of alumina is the mordant, and madder is the dye-stuff.

5. Pale red, of different shades. The preceding mordant diluted with water, and a weak madder bath.

6. Brown or pompadour. A mixed mordant, containing a somewhat larger proportion of the red than of the black; and the dye of madder.

7. Orange. The red mordant; and a bath first of madder, and then of quercitron.

8. Yellow. A strong red mordant; and the quercitron bath, whose temperature should be considerably under the boiling point of water.

9. Blue. Indigo rendered soluble and greenish-yellow colored, by potash and orpiment. It recovers its blue color by exposure to air, and thereby also fixes firmly on the cloth. An indigo vat is also made, with that blue substance diffused in water with quicklime and copperas. These substances are supposed to deoxidise indigo, and at the same time to render it soluble.

10. Golden dye. The cloth is immersed alternately in a solution of copperas and lime-water. The protoxide of iron, precipitated on the fibre, soon passes, by absorption of atmospherical oxygen, into the golden-colored deutoxide.

11. Buff. The preceding substances in a more dilute state.

12. Blue vat, in which white spots are left on a blue ground of cloth, is made by applying to these points a paste composed of solution of sulphate of copper and pipe-clay; and, after they are dried, immersing it stretched on frames, for a definite number of minutes, in the yellowish-green vat of one part of indigo, two of copperas, and two of lime, with water.

13. Green. Cloth dyed blue, and well washed, is imbued with the aluminous acetate, dried, and subjected to the quercitron bath.

In the above cases the cloth, after receiving the mordant paste, is dried, and put through a mixture of cow-dung and warm water. It is then put into the dyeing vat or copper

FUGITIVE COLORS.

All the above colors are given by making decoctions of the different coloring woods; and receive the slight degree of fixity they possess, as well as great brilliancy, in consequence of their combination or admixture with the nitro-muriate of tin.

1. Red is frequently made from Brasil and Peachwood.

2. Black. A strong extract of galls, and deuto-nitrate of iron.

3. Purple. Extract of logwood, and the deuto-nitrate.

4. Yellow. Extract of quercitron bark, or French berries, and the tin solution.

5. Blue. Prussian blue and solution of tin.

Fugitive colors are thickened with gum-tragacanth, which leaves the cloth in a softer state than gum-senegal; the goods being sometimes sent to market without being washed.

For the modes of using the different articles used in dyeing, see them under their respective names in the order of the alphabet.

COLORATE, *adj.* } Lat. *coloratus*, *coloratus*, *coloratus*, *n. s.* } *ro*, *colorificus*. Colored, **COLORATION**, *n. s.* } marked or stained with some color; the art or practice of coloring; the state of being colored; that which has the power of producing dyes, tints, colors, or hues.

Some bodies have a more deperable nature than others, as is evident in *coloration*; for a small quantity of saffron will tinct more than a great quantity of Brasil. *Bacon.*

Amongst curiosities I shall place *coloration*, though somewhat better; for beauty in flowers is their pre-eminence. *Id. Natural History.*

In this composition of white, the several rays do not suffer any change in their *colorific* qualities by acting upon one another; but are only mixed, and by a mixture of their colours produce white. *Newton's Optics.*

Had the tunicles and humours of the eye been co-

lorate, many rays from visible objects would have been stoop. *Ray.*

COLOSSIS, or **COLOSSE**, in ancient geography, a considerable town of Phrygia Magna, in which the Lycus falls into a gulf, and at the distance of five stadia emerges again, and runs into the Meander. Orosius says, that in Nero's time it was destroyed by an earthquake.

COLOSSUS, } Lat. *colossus*, *colossus*. **COLOSSAL**, *adj.* } A statue of enormous magnitude; of the form, height, and bigness of such a statue; giantlike.

Not to mention the walls and palace of Babylon, the pyramids of Egypt, or *colosse* of Rhodes. *Temple.*

There huge *colossus* rose, with trophies crowned, And runic characters were graved around. *Pope.*

These general observations may be separately applied to the amphitheatre of Titus, which has obtaine

the name of the coliseum, either from its magnitude, or from Nero's *colossal* statue: an edifice, had it been left to time and nature, which might perhaps have claimed an eternal duration. *Gibbon.*

— thy mind
Expanded by the genius of the spot,
Has grown *colossal*, and can only find
A fit abode wherein appear enshrined
Thy hopes of immortality.

Byron's Childs Harold.

Colossus, the name of a celebrated statue of Apollo, at Rhodes. The Rhodians having compelled Demetrius of Macedon to raise the siege of their city, were so grateful for the supposed assistance of Apollo, that they resolved to erect an enormous brassen statue in honor of that deity: and Chares, the disciple of Lysippus, was entrusted with the project. But he had scarcely half finished the work when he found that he had expended all the money that he had demanded for the whole, which overwhelmed him so completely with grief and despair, that he hanged himself. Laches, his fellow countryman, finished the work in the space of twelve years, and placed the enormous statue on its pedestal across the entrance of the harbour, its feet placed on two rocks, so that the Rhodian vessels could pass under its legs. Pliny does not mention the latter artist, but gives all the honor to Chares. Scarcely sixty years however had elapsed before this monster of art was thrown from its place by an earthquake which broke it off at the knees. It remained in this situation till the conquest of Rhodes by the Saracens in A. D. 684, when it was beaten to pieces and sold to a Jew merchant, who loaded above 900 camels with its spoils. Its height, according to Strabo, was seventy cubits (about 100 English feet); but according to other writers it amounted to eighty cubits. Pliny relates that few persons could embrace its thumb, whilst its fingers were the size of ordinary statues. There was a winding staircase to go up to the top of it; from whence one might discover Syria, and the ships that went into Egypt. Among more modern works of this nature is the enormous colossus of San Carlo Borromeo at Arona, in the Milanese territory. It is of bronze, sixty feet in height, and has a staircase into its interior for the purpose of occasional repairs and restorations.

COLOSTRUM, the first milk of any animal after bringing forth young, called beestings. This milk is generally cathartic, and purges the meconium; thus serving both as an aliment and medicine. An emulsion, prepared with turpentine dissolved with the yolk of an egg, is sometimes called by this name.

COLSTON (Edward), an eminent philanthropist, born at Bristol in 1636. His father was engaged in the business of a Spanish merchant, to which he succeeded, and which he carried on very successfully, so that he acquired a large fortune. He disposed of the greatest part of his wealth to charitable institutions; and besides building and endowing several alms-houses and charity schools in his native city, he gave large sums during life, as well as by will at death, to hospitals and other beneficent purposes. He died in 1721 on his birth-day, and was interred

in All Saints' church, Bristol, where a sermon is yearly preached to commemorate him.

COLT, *n. s. & v. a.* } Signify the young o.
CO'LTISH, *adj.* } any animal. It is commonly used for the male offspring of a horse, it is also applied to a rough, skittish, is foolish fellow. The verb not only signifies to play and frisk like young animals, but partakes, says Thomson, of the Goth. *gailta, kailta*; to wanton, to be lascivious. It is also used by Shakespeare, in the sense of to befool.

And she sprong as a *colt* doth in the trave;
And, with hire hed, she writhed faste away,
And say'd I wul not kisse thee by my fay.

Chaucer's Canterbury Tales.

He was al *coltish*, ful of ragerie;
And ful of jergon as a ficked pie. *Id.*

What a plague mean ye, to *colt* me thus?

Shakespeare's Henry IV.

Ay, that's a *colt*, indeed; for he doth nothing but talk of his horse.

Id. Merchant of Venice.

As soon as they were out of sight by themselves, they shook off their brides, and began to *colt* anew more licentiously than before.

Spenser's State of Ireland.

The *colt* hath about four years of growth, and so the fawn, and so the calf. *Bacon's Natural History.*

Like *colts* or unmanaged horses, we start at dead bones and lifeless blocks. *Taylor's Holy Living.*

No sports, but what belong to war, they know;

To break the stubborn *colt*, to bend the bow.

Dryden's Æneid.

COLT, in zoology, is peculiarly used for a young male horse; the female being called a filly.

COLTS-FOOT, *n. s.* *Tussilago*; from colt and foot. It has a radiated flower, whose disk consists of many florets, but the crown composed of many half florets: the embryos are included in a multifid flower-cup, which turns to downy seeds fixed in a bed.

COLTSFOOT. See CACALIA

COLTS-TOOTH, *n. s.* From colt and tooth. An imperfect or superfluous tooth in young horses; a love of youthful pleasure; a disposition to the practices of youth.

Well said, lord Sands;

Your *colts-tooth* is not cast yet?

—No, my lord; nor shall not, while I have a stump. *Shakespeare.*

COLTER, *n. s.* Sax. *cultor*; Lat. *cultor*. The sharp iron of a plough that cuts the ground perpendicularly to the share.

COLUBER, in zoology, a genus of serpents belonging to the class amphibia. The characters are these: they have a number of scuta or hard crusts on the belly; and scutellæ or scales on the tail. Linnæus enumerates ninety-seven species under this name, distinguished solely by the number of scuta and scutellæ, and Gmelin 175. The most remarkable are the following:

1. *C. æstivus*, or the green snake, is all over of a green color. It inhabits Carolina; where it lives among the branches of trees on flies and other insects. It is of a small size, and easily becomes tame and familiar.

2. *C. annulatus*, or the little brown bead snake. is always small, and is seldom found above ground, but commonly dug up, and found twisting about the roots of shrubs and plants. All

NATURAL HISTORY.

1. ORDER BOA. Page 255, Vol. II.



Boa Constrictor.

3. COLUBER CERASTES.



Horned Piper.

2. ORDER COLUBER. Page 270, Vol. VI.
Coluber Naja.



Cobra di Capello.

4. ORDER CROTALUS. Page 686, Vol. II.



Crotalus Horridus. Rattle Snake.

the back and other parts of the body have transverse spots of brown and white so disposed as to have some resemblance to a string of English beads; whence probably it takes its name. It is quite harmless, and is a native of Virginia and Carolina.

3. *C. aspis*, with 146 scuta and forty-six scutellæ, is a native of France. It is poisonous, and is of a reddish color, with dusky spots on the back.

4. *C. berus*, or the common British viper, is found in many countries of Europe. It abounds in the Hebrides, and in many parts of Britain; particularly in the dry, stony, and chalky counties. According to Pennant, and other naturalists, they are viviparous, but proceed from an internal egg. This viper seldom grows longer than two feet; though Pennant tells us he once saw a female, which is nearly a third larger than the male, nearly three feet long. The ground color of the male is a dirty yellow, that of the female deeper. Its back is marked the whole length with a series of rhomboidal black spots, touching each other at the points; the sides with triangular ones; the belly entirely black. It has 146 scuta and thirty-nine scutellæ. There is a variety wholly black; but the rhomboid marks are very conspicuous, even in this, being of a deeper and more glossy hue than the rest. The head of the viper is inflated, which distinguishes it from the common snake. Catesby says, 'that the difference between the vipers and snakes or other serpents is, that the former have long hollow fangs or tusks, with an opening near the point; the neck is small, the head broad, the cheeks extending wide, scales rough, the body for the most part flat and thick; they are slow of motion; swell the head and neck when irritated, and have a terrible and ugly aspect.' The tongue is forked, the teeth small; the four canine teeth are placed two on each side the upper jaw: these instruments of poison are long, crooked, and movable; capable of being raised or depressed at the pleasure of the animal, and they instil their poison in the same manner. The vipers are said not to arrive at their full growth till they are six or seven years old; but they are capable of engendering at two or three. They copulate in May, and go about three months with their young. Mr. White informs us, in his History of Selborne, that a viper, which he opened, had in it fifteen young ones of the size of earth worms, about seven inches long. They twisted and wriggled about with great alertness; and, when touched, they erected themselves, and gaped very wide, showing immediate tokens of menace and defiance, though no fangs could be perceived, even with the help of glasses: which the author remarks, as an instance among others of that wonderful instinct which impresses young animals with a notion of the situation and use of their natural weapons, even before these weapons are formed. Mr. Pennant tells us that he has been assured of a fact mentioned by Sir Thomas Brown, though denied by the viper-catchers, that the young of the viper, when terrified, will run down the throat of the parent, and seek for shelter in its belly, in the same manner as the young of the opossum retire into the ventral pouch of the old one; whence

VOL. VI.

some have imagined that the viper is so unnatural as to devour its own young: but the food of these serpents is frogs, toads, lizards, and mice. It is also said that vipers prey on young birds: but whether on such as nestle on the ground, or whether they climb up trees for them, is quite uncertain; the fact, however, is very far from being recent; as Horace mentions it, *Epod. I.* The viper is capable of supporting very long abstinence; some having been kept in a box six months without food, and yet not abating of their vivacity. They feed only a small part of the year, but never during their confinement; for if mice, their favorite diet, should at that time be thrown into their box, though they will kill, yet they never will eat them. When at liberty, they remain torpid throughout the winter; but, when confined, have never been observed to take their annual repose. The method of catching them is by putting a cleft stick on or near their head; after which they are seized by the tail, and instantly put into a bag. The viper-catchers are very frequently bitten by them in the pursuit of their business, yet we very rarely hear of their bite being fatal. Sallad oil, applied in time, is said to be a certain remedy. The flesh of the British viper has been celebrated as a restorative, as well as that of the foreign kind.

5. *C. chersæa* is a native of Sweden, where it is called *asping*. It is a small reddish serpent, whose bite is said to be mortal.

6. *C. constrictor*, the black snake, is a native of several parts of America. They are very long, sometimes measuring six feet, and all over of a shining black. This species is not only perfectly harmless, but extremely useful in clearing the houses of rats, which it pursues with wonderful agility. In the time of copulation it is extremely bold and fierce, and will attack mankind; but its bite has no dangerous effect. It is so swift that there is no escaping its pursuit. Many ridiculous frights have happened from this innocent reptile. As every one in America is full of the dread of the rattlesnake, men are apt to fly at the sight of any of the serpent kind. This pursues, soon overtakes, and, by twisting round the legs of the fugitive, soon brings him to the ground; but he happily receives no injury.

7. *C. luridus* of Forster, called by Mr. Catesby the brown viper, is a native of Virginia and the Carolinas. It is about two feet long and large in proportion; very slow in its motion, even when threatened with danger. When attacked it defends itself with much fierceness, and its bite is as venomous as any. It preys chiefly upon lizards.

8. *C. naja*, or *cobræ*, with 193 scuta and sixty scutellæ, is a native of the East Indies, and is reckoned the most poisonous of all serpents. The root of the *lignum colubrinum* (*ophiorrhiza*) is said to have been pointed out to the Indians as an antidote against the bite of this serpent by the *viverra ichneumon*, a creature which fights with this serpent, and cures itself, when wounded, by eating of this plant. The Indians, when bitten, instantly chew it, swallow the juice, and apply the masticated root to the puncture. It is killed by the *ichneumon*. In India it is everywhere exhibited publicly as a

P

show, being previously deprived of its fangs; and is of course more universally known in that country than any other of the race of reptiles. It is carried about in a covered basket, and so managed by its proprietors as to assume, when exhibited, a kind of dancing motion; raising itself up on its lower part, and alternately moving its head and body from side to side for some minutes, to the sound of some musical instrument which is played during the time.

9. *C. prester* of Linnæus, the black viper of Catesby, is a native of Carolina and Virginia. It is short and thick, slow of motion, spreads its head surprisingly when irritated, very flat and thick, threatening with a horrid hiss. They are very poisonous; their bite being as deadly as that of the rattlesnake. They frequent the higher lands, and are of a rusty black color.

10. *C. punctatus* of Linnæus, called by Catesby the water viper, is a native of Carolina. According to Linnæus it is ash-colored, variegated with yellow spots. Catesby informs us that the head and back of this serpent are brown; the belly marked transversely with yellow, and also the sides of the neck. The neck is small, the head large, and the mouth armed with the destructive fangs of the viper or rattlesnake, next to which it is reckoned the largest serpent in this country. Contrary to what is observed in most other vipers, these are very nimble and active, and very dexterous in catching fish. In summer great numbers are seen lying on the branches of trees hanging over rivers; from which, on the approach of a boat, they drop into the water, and often into the boat on the men's heads. They lie in wait in this manner to surprise either birds or fish: after the latter they plunge with surprising swiftness, and catch some of a large size, which they bring ashore and swallow whole. The tail of this animal is small towards the end, and terminates in a blunt horny point about half an inch long.

11. *C. vipera*, the common viper of the shops, has 118 scuta, and only twenty-two scutellæ. The body is very short and of a pale color, with brownish spots; the head is gibbous and covered with small scales. It is a native of Egypt and other warm countries. It has always been remarkable for its poisonous nature; insomuch that vipers, when numerous, have often been thought the ministers of divine vengeance, like the plague, famine, and other national calamities. A notion also prevailed, among the ancients, that few or none of the parts of a viper were free from poison; for which reason they made no experiments or discoveries concerning the nature of these creatures. It is now, however, proved, by undoubted experiments, that the poison of vipers, as well as of all other serpents whose bite is hurtful, lies in a bag at the bottom of their great teeth or fangs. These teeth are perforated; and, when the creature bites, the compression of the bag forces out a little drop of the poison into the wound, where it produces its mischievous effects. The purpose answered by this poisonous liquor, to the creatures themselves, is probably the destruction of their prey; for, as serpents frequently feed upon animals of very considerable magnitude and strength, they would often undoubtedly make

their escape, did not the poisonous juice instilled into the wounds made by the serpent's teeth almost instantly deprive them of life, or at least of all power to struggle with their enemy. For an account of the symptoms produced by the bites of vipers, and other venomous serpents, in the human body, together with the best methods of cure, see *MEDICINE*. After the viper is deprived of those bags which contain its poison, it is entirely harmless; nay the flesh of it is highly nutritive.

CO'LUBRINE, *adj.* Lat. *colubrinus*. Belating to a serpent; cunning; crafty.

COLUMBA, in ornithology, the pigeon, a genus belonging to the order of passeræ. The characters of this genus are—the bill is straight, and descends towards the point; the nostrils are oblong, and half covered with a soft tumid membrane; and the tongue is not cloven. There are about eighty species, all natives of different countries. The following are the most remarkable:—

1. *C. coronata*, or great crowned pigeon, a very large species, about the size of a turkey. The bill is black, and two inches long; the irides are red; the head, neck, breast, belly, sides, thighs, and under tail coverts, cinereous blue; the head is crested; the back, rump, scapulars, and upper tail coverts, are of a deep ash-color, with a mixture of purplish chestnut on the upper part of the back and scapulars; the wing-coverts are ash colored within, and purplish chestnut on the outside and tip; quills deep blackish ash-color; tail the same, but of a light ash-color at the tip; the legs are blackish. This species inhabits the Molucca Isles and New Guinea. Its note is cooing and plaintive, like that of other pigeons, only louder in proportion. The mournful notes of these birds alarmed the crew of Bougainville much, when in the neighbourhood of them, thinking they were the cries of the human species. In France they were never observed to lay eggs, nor in Holland, though they were kept for some time; but Scopoli says, that the male approaches the female with the head bent into the breast, making a noise more like lowing than cooing; and that they not only made a nest on trees, in the menagerie where they were kept, but laid eggs. The nest was composed of hay and stalks. The female never sat, but stood upon the eggs; and he supposed it was from this cause alone, that there was no produce. They are said to be kept by some, in the East Indies, in their court-yards, as domestic poultry. The Dutch at the Moluccas call them crown-vogel, M. Sonnerat, as well as Dampier, found these in plenty at New Guinea; and it is probable that they were originally transported from that place into Banda, whence the Dutch chiefly now procure them.

2. *C. Malaccensis*, the Malacca pigeon described by Sonnerat is little bigger than the house sparrow. It is a most beautiful species, and the flesh is said to be extremely delicate. It has been transported into the Isle of France, where it has multiplied exceedingly.

3. *C. migratoria*, or pigeon of passage, is about the size of an English wood pigeon; the bill black; iris red; the head of a dusky blue; the

breast and belly of a faint red; above the shoulder of the wing there is a patch of feathers shining like gold; the wing is covered like the head, having some few spots of black (except that the larger feathers are dark brown), with some white on the exterior vanes; the tail is very long, and covered with a black feather, under which the rest are white; the legs and feet are red. They come in prodigious numbers from the north, to winter in Virginia and Carolina. In these countries they roost upon one another's backs in such quantities, that they often break down the twigs of trees which support them, and leave their dung some inches thick below the trees. In Virginia Mr. Cateby has seen them fly in such continued trains, for three days successively, that they were not lost sight of for the least interval of time, but somewhere in the air they were seen continuing their flight southward. They breed in rocks by the sides of rivers and lakes far north of St. Lawrence. They fly to the south only in hard winters, and are never known to return.

4. *C. oenas*, or the domestic pigeon, and all its beautiful varieties, derive their origin from one species, the stock dove; the English name implying its being the stock or stem from whence the other domestic birds spring. These birds, as Varro observes, take their Latin name, *columba*, from their voice of cooing. They were, and still are, to be found in most parts of our island in a state of nature; but probably the Romans first taught the Britons how to construct pigeon houses, and make birds domestic. The characters of the domestic pigeon are these:—it is of a deep bluish ash-color; the breast dashed with a fine changeable green and purple; the sides of the neck with a shining copper color; its wings marked with two black bars, one on the coverts of the wings, the other on the quill feathers; the back white, and the tail barred near the end with black. It weighs fourteen ounces. In the wild state it breeds in holes of rocks and hollows of trees; for which reason, some style it *columba cavernalis*, in opposition to the ring dove, which makes its nest on the boughs of trees. Nature always preserves some agreement in the manners, characters, and colors of birds reclaimed from the wild state. This species of pigeon soon takes to build in artificial cavities, and from the temptation of a ready provision becomes easily domesticated. Multitudes of these wild birds migrate into the south of England: and, while the beech woods were suffered to cover large tracts of ground, they used to haunt them in myriads, reaching a mile in length, as they went out in the morning to feed. They visit Britain the latest of any bird of passage, not appearing till November, and retiring in the spring. Mr. Pennant imagines, that their summer haunts are in Sweden, as Mr. Eckmark makes their retreat thence coincide with their arrival in Britain. Numbers of them, however, breed in cliffs on the coast of Wales, and of the Hebrides. The varieties produced from the domestic breed are numerous, and extremely elegant; they are distinguished by names expressive of their several properties, as tumblers, carriers, jacobines, croppers, powers, runts, turbites, owls, nuns, &c. The

most celebrated of these is the carrier pigeon. They are gregarious, lay only two eggs, and breed many times in the year. They bill during their courtship; the male and female sit, and also feed their young, by turns: they cast provision out of their craw into the young one's mouth; they drink, not by sipping, like other birds, but by continued draughts, like quadrupeds, and they have plaintive notes.

5. *C. palumbus*, the ring dove, is a native of Europe and Asia. It is the largest pigeon we have, and might be distinguished from all others by its size alone. Its weight is about twenty ounces; its length eighteen inches, and breadth thirty. The head, back, and coverts of the wings are of a bluish ash color; the lower side of the neck and breast are of a purplish red, dashed with ash color: on the hind part of the neck is a semi-circular line of white; above and beneath that, the feathers are glossy, and of changeable colors. This species forms its nest of a few dry sticks in the boughs of trees. Attempts have been made to domesticate them by hatching their eggs under the common pigeon in dove houses; but, as soon as they could fly, they always took to their native haunts. In the beginning of winter they assemble in great flocks, and leave off cooing, which they begin in March when they pair.

6. *C. turtur*, or turtle-dove, is a native of India. The length is twelve inches and a half, its breadth twenty-one; the weight four ounces. The irides are of a fine yellow, and the eye-lids encompassed with a beautiful crimson circle. The chin and forehead are whitish; the top of the head ash-colored mixed with olive. On each side of the neck is a spot of black feathers prettily tipped with white: the back ash-colored, bordered with olive brown; the scapulars and coverts of a reddish brown spotted with black; the breast of a light purplish red, having the verge of each feather yellow: the belly white. The tail is three inches and a half long; the two middle feathers of a dusky brown; the others black, with white tips; the end and exterior side of the outmost feathers wholly white. In the breeding season these birds are found in Buckinghamshire, Gloucestershire, Shropshire, and the west of England. They are very shy and retired, breeding in thick woods, generally of oak; in autumn they migrate into other countries.

COLUMBA (St.), a celebrated saint, sometimes called the Apostle of Scotland, who flourished in the sixth century. He founded a cell of monks in Iona, and the first religious were canons regular, of whom Columba was the first abbot; and his monks, till A. D. 716, differed from those of the church of Rome, but in the observation of Easter, and in the clerical tonsure, Columba led here an exemplary life, and was highly respected for the sanctity of his manners for many years. He is the first on record who had the faculty of the second sight, for he announced the victory of Aidan over the Picts and Saxons on the very instant it happened. He had the honor of burying in his island, Conval and Kinnatel, two kings of Scotland, and of crowning a third. At length, worn out with age, he died in Iona in the arms of his disciples; was interred there, but (as the Irish pretend) in after times

translated to Down; where, according to the epitaph, his remains were deposited with those of St. Bridget and St. Patrick :—

Hi tres in Duno tumulo tumulantur in uno;
Brigida, Patricius, atque Columba pius.

COLUMBA (St.), or the CONGREGATION OF ST. COLUMBA, a society of regular canons, who formerly had ninety-eight abbeys or monasteries in the British isles.

COLUMBANUS, a saint and a poet, born in Ireland, and brought up to a religious life among the disciples of St. Columba. He made great progress in learning, and early in life composed a book of psalms, and a number of moral poems. He is said to have belonged originally to a monastery of the name of Benchor. Columbanus passed from Britain into France, A. D. 589, and founded the monastery of Luxéville, near Besançon. He had been kindly received and patronised by king Childebert; but he was afterwards expelled France by the tyrannical queen Brunichild, on which he retired to Lombardy, and founded the monastery of Bobio. The *Regula Cœnobialis* and *Penitentialis*, which he established in that monastery, have been published in the *Codex Regularum* compiled by the learned Holstenius.

COLUMBARIA, in ancient geography, an island on the west coast of Sicily, opposite to Drepanum; said by Zonarias to have been taken from the Carthaginians by Numerius Fabius the consul; now called Columbara.

COLUMBARY, *n. s.* Lat. *columbarium*. A dovecot; a pigeon-house.

The earth of *columbaries*, or dove-houses, is much resired in the artice of saltpetre.

Brown's Vulgar Errors.

COLUMBIA, a county of New York, bounded on the north by Rensselaer, south by Duchess, east by the state of Massachusetts, and west by Hudson River, which divides it from Albany county. It is thirty-two miles in length, and twenty-two in breadth, and is divided into eight towns, of which Hudson, Claverack, and Kinderhook are the chief. It is said to contain an area of 594 square miles, or 380,160 acres, which gives about fifty-four persons to a square mile, and is one of the most flourishing portions of the United States. Although no part can be called mountainous, the surface is considerably diversified. On the eastern border is a hilly track, and the intermediate country to the Hudson is gently undulated, ranges of small hillocks being interspersed with extensive plains and valleys, and with many tracts of rich alluvial soil. In the southward the soil is a deep warm gravel, diversified with hill and dale, and adapted either for grain or pasture. It contains 3742 senatorial electors.

COLUMBIA RIVER, a river of North America, which, according to Mackenzie, rises in the Rocky Mountains, in about 54° 23' N. lat., and 121° W. long., and falls into the Pacific Ocean in 46° 10' N. lat., and 122° 45' W. long. Its source is not more than a few miles from that of the Unijah or Peace River, whose waters communicate with that great line of rivers and lakes which stretch across this part of the American

continent, and terminate in the St. Lawrence. Although the discovery of this river is claimed by the Spaniards, who call it *Entrada de Ceta*, it was first entered in modern times in 1791, by Mr. Gray, in the Columbia, and by this name it has since been called. Lieutenant Broughton, under the orders of Captain Vancouver, afterwards explored it for about 100 miles; and on the land side it was navigated a considerable way from its source by Mackenzie, in his journey across the continent. He found numerous rapids and falls; but as the stream enlarged the navigation was less impeded. Messrs. Lewis and Clarke entered this river at the point where it is joined by Lewis's River, in lat 46° 15' 13' N. and descended the stream to the ocean.

COLUMBIA, a county of Georgia, bounded on the north and east by the savannah, which separates it from the state of South Carolina, north-west of Richmond county. Its shape is very irregular.

COLUMBIA, an extensive territory, in the most central part of the United States, where the new city of Washington, the permanent seat of the general government, since 1800, is now building, in a situation equi-distant from the north and south extremities of the Federal Union, and nearly so from Pittsburgh and the Atlantic Ocean. Mr. Morse styles it 'a commercial territory, probably the richest, and commanding the most extensive internal resources of any in America.'

COLUMBIA, a post town of Virginia, in Goochland county, on the North side of James River, at the mouth of the Rivanni. It lies forty-five miles above Richmond, thirty-five from Charlottesville, and 328 south-west of Philadelphia.

COLUMBIA, a post town of South Carolina, the capital of Kershaw county, and the seat of government in that state. It is situated in Camden district, on the east side of the Congaree, just below the confluence of Saluda and Broad Rivers. The streets are regular, and the town has doubled its population very rapidly. It lies 115 miles N. N. W. of Charleston, thirty-five south-west of Camden, eighty-five from Augusta, in Georgia, and 678 south-west of Philadelphia.

COLUMBIA, a town of Pennsylvania, in Lancaster county, on the north-east bank of the Susquehanna, at Wright's Ferry, ten miles west of Lancaster, and seventy-six west by north of Philadelphia. It was laid out in 1797.

COLUMBIA, a town in the north-western territory, on the north bank of the Ohio, and on the west side of the mouth of Little Miami River, about six miles south-east by east of Fort Washington, eight east by south of Cincinnati, and eighty-seven north by west of Lexington, in Kentucky. Long. 83° 34' W., lat. 49° 20' N.

COLUMBIA, a township in Washington county, and district of Maine, on Pleasant River, adjoining Machias on the north-east. It was incorporated in 1796. It is nine miles from Steuben.

COLUMBIC ACID, in chemistry, a white colored substance, procured from columbium, a peculiar ore, deposited in the British Museum;

and the same with the tantalite of Ekeburgh, discovered by him in the ybrotantalite of Sweden. Dr. Wollaston's method of separating the acid from the mineral is peculiarly elegant. One part of tantalite, five parts of carbonate of potash, and two parts of borax, are fused together in a platina crucible. The mass, after being softened in water, is acted on by muriatic acid. The iron and manganese dissolve, while the columbic acid remains at the bottom. It is in the form of a white powder, which is insoluble in nitric and sulphuric acids, but partially in muriatic. It forms with barytes an insoluble salt, of which the proportions, according to Berzelius, are 24·4 acid, and 9·75 barytes. By oxidising a portion of the revived tantalum or columbium, Berzelius concludes the composition of the acid to be 100 metal and 5·485 oxygen.

COLUMBIERS, a town of France, in the department of Aveyron, and ci-devant province of Rouergue, in the district of Sauveterre, ten miles west of Rhodéz.

COLUMBINE, *n. s.* Lat. *columbina*. A plant with leaves like the meadow rue.

Columbines are of several sorts and colours. They flower in the end of May, when few other flowers shew. *Mortimer.*

COLUMBINE, *n. s.* Lat. *columbinus*. A kind of violet color, or changeable dove color.

COLUMBIUM, the metallic basis of the Columbic acid: the ore first discovered was from Massachusetts. It was of a dark brownish-gray externally, and more inclining to an iron-gray internally: the longitudinal fracture he found lamellated, and the cross fracture had a fine grain. Its lustre was vitreous, slightly inclining, in some parts, to metallic; moderately hard, and very brittle. The color of the streak, or powder, was dark chocolate brown. 'If the oxide of columbium, described under **COLUMBIC ACID**, be mixed with charcoal and exposed to a violent heat in a charcoal crucible, the metal columbium will be obtained. It has a dark gray color, and when newly abraded, the lustre nearly of iron. Its specific gravity, when in agglutinated particles, was found by Dr. Wollaston to be 5·61. These metallic grains scratch glass, and are easily pulverised. Neither nitric, muriatic, nor nitro-muriatic acid, produces any change in this metal, though digested on it for several days. It has been alloyed with iron and tungsten.'

COLUMBO, a town on the western coast of the island of Ceylon, where the Portuguese had a settlement; but which, after a bloody struggle, surrendered to the Dutch in 1656, from whom it was taken by the British in 1796. Colombo is the capital of the island, and the seat of government, although Trincomalee occupies more ground, and, on account of its situation and harbour, is considered of more consequence to this nation. In every other respect Colombo has by far the superiority. The country round Trincomalee is mountainous, wild, and barren; but Colombo is situated in a fertile country, and the rich district depending upon it is much wider, being nearly twenty leagues in length, and ten in breadth. Though the principal har-

bours in the island be at Trincomalee and Point de Galle, at certain seasons of the year they moor securely in the roads of Colombo. The town is built on a regular plan, being nearly divided into four equal quarters by two principal streets, which cross each other, and extend from side to side, with smaller ones running parallel, and connected by lanes between them. The natives live in the old town, without the walls of the new. The fort is much larger than that of Trincomalee; at the foot of the ramparts, on the inside, is a broad street or way, which goes round the whole fort, and communicates with the bastions and soldiers' barracks; and also affords, at the different angles, open spaces for their private parading. The governor's house is a handsome structure. There is here a fine botanical garden, and a school for the propagation of the Christian religion.

Colombo was the first European settlement on the island of Ceylon. The Portuguese arrived here in the year 1505, in the reign of Dermaprakrama-bahoo, king of Candy. The natives, who first saw the strangers, informed the king 'that a new people was arrived, white and beautifully made, who wore iron coats and iron caps, and drank blood and ate stones; who gave a gold coin for a fish, or even a lime; and who had a kind of instrument that could produce thunder and lightning, and balls which, put into these instruments, would fly many miles, and break ramparts, and destroy forts.' The king's brother examined them in disguise, and by his advice the Portuguese were well received, and permitted to trade and establish a settlement here.

'During the remainder of this reign, and the whole of the next, which was a short one,' says Dr. Davy, in his Sketch of the History of Ceylon, 'the Portuguese had very little influence in the country, and they remained in their original capacity of traders. In the next reign, that of Boowanyka-bahoo, in consequence of dissensions in the royal family, they began to gain ground and acquire political power. Engaged in a war with his brother Mihidoony, who refused to acknowledge the king's grandson as his successor, he sent an embassy to Portugal, with a figure of the infant prince in wax, begged protection for the child and his kingdom, and requested aid, which was most readily granted. The young prince was christened Don Juan Derna-pali. Troops were sent to Ceylon, with abundance of ammunition, to make good the promise that had been given. For some time, wherever the Portuguese appeared they were victorious. The king himself was almost one of the first to fall, by the new engines of war introduced; he was shot through the head when going to oppose his brother. He is said, by the native historians, to have ruined his country and religion, by his unnatural policy of having recourse to the Portuguese.

'During the life of his successor the island was in the most disturbed state; but Rajah Singha, of Sittawakka, succeeding, carried on the war with great vigor: he overcame all the native princes who opposed him; took Cotta, and destroyed it; besieged Colombo, and reduced the Portuguese to great straits. After his death the

Portuguese were again successful; they took Avisahavellé, possessed themselves of the whole of the maritime provinces, and of a great part of the Seven Korles, and seemed to have a fair prospect of becoming masters of the whole island. The only obstacle in the way of their ambition, was Maha-Wimmala-derma, a native prince of spirit and abilities, who, in the civil wars of the interior, when very young, had taken refuge at Colombo, from whence he was sent to Goa, and from thence, when the Portuguese were in danger of being driven out of the country by Rajah Singha of Sittawakka, he was sent back to Ceylon, to make a diversion in the high country in favor of his friends. He accomplished this, and more than was desired; he established himself at Singada-galla or Kandy, as an independent monarch, and governed the greater part of the country now included in the Kandyan provinces.'

He was succeeded by his brother Sennerat. At this time the greater part of the island had submitted to the Portuguese. But this prince made successful incursions upon the borders, and with the other native princes recovered the whole except Colombo, Galle, Jaffna, and Trincomalee.

To expel the European intruders entirely, the princes, in the middle of the seventeenth century, formed an alliance with the Dutch. Galle surrendered to the Dutch fleet; and, in about sixteen years after (1658), the Portuguese power in Ceylon was annihilated. We have sketched the rest of the history of its European connexion in the article CEYLON, which see.

This place lost its first three British governors within the space of one year. Colonel Petrie and general Doyle died, and colonel Bonnevaux of the Company's service was killed by the upsetting of his currie. 'The Pettah, or black town of Columbo,' says Mr. Hamilton, 'deserves particular notice on account of its extent and structure. In the street next to the sea is an excellent fish-market, well supplied from the sea, lakes, and rivers in the neighbourhood; fish being a considerable part of the food of the inhabitants. On the rivers in the vicinity of Columbo there are nearly 300 flat-bottomed boats moored, with entire families on board, who reside permanently in them, having no other dwellings. Columbo, for its size, is one of the most populous places in India, being estimated to contain above 50,000 inhabitants, who are a great mixture of almost every race of Asiatics. The language most universally spoken both by Europeans and Asiatics, who resort to Columbo, is the Portuguese of India, a base corrupt dialect, differing much from that spoken in Portugal.'

In the neighbourhood is made a considerable quantity of arrack; and cinnamon and pepper, the staple spices of the island, are largely exported hence to Europe. The imports are grain, cotton, and calico, coarse cloths, stockings, handkerchiefs, China-ware, tin, copper, and toys. About February in every year arrives a ship from Macao with hams, sugar, sweetmeats, teas, silks, velvets, nankeens, earthenware, &c. Accounts are kept in six dollars, a nominal coin, valued at a certain quantity of copper money, equal to about two shillings sterling. At this period cash is plentiful, and the whole town exhibits much of the bustle

of commerce. Beef, fish, pigs, and ducks, are generally both cheap and plentiful at Columbo. Mutton is dear, as no sheep can be reared in the vicinity; of which the abundance of cinnamon trees constitutes a great ornament.

COLUMBO ROOT, in medicine. This root comes to us in circular pieces, from half an inch or an inch to three inches in diameter, and divided into frusta, which measure from two inches to one quarter of an inch. The sides are covered with a thick corrugated bark, of a dark brown hue on its external surface, but internally of a light yellow color. All the thicker pieces have small holes drilled through them, for the convenience of drying. Columbo root has an aromatic smell; but is disagreeably bitter, and slightly pungent to the taste, somewhat resembling mustard seed, when it has lost, by long keeping, part of its essential oil. It appears to be corroborant, antiseptic, and powerfully anti-emetic. In the cholera morbus it alleviates the violent tormino, checks the purging and vomiting, corrects the putrid tendency of the bile, quiets the inordinate motions of the bowels, and recruits the exhausted strength of the patient. Its efficacy has also been observed in the vomitings which attend the bilious cholice; and in such cases, where an emetic is thought necessary, after administering a small dose of ipecacuanha, the stomach may be washed with an infusion of Columbo root.

COLUMBUS (Christopher), the celebrated navigator, and first discoverer of the islands of America, was a native of the republic of Genoa. Neither the time nor place of his birth, however, are known with certainty; except that he was descended of an honorable family, who, by various misfortunes, had been reduced to indigence. His parents were sea-faring people; and Columbus having discovered, in his early youth, an inclination for that mode of life, was encouraged by them to follow the same profession. He went to sea at the age of fourteen: his first voyages being to those ports in the Mediterranean frequented by the Genoese; after which he took a voyage to Iceland; and, proceeding still further north, advanced several degrees within the polar circle. After this Columbus entered into the service of a famous sea captain of his own name and family. This man commanded a small squadron, fitted out at his own expense; and by cruising, sometimes against the Mahomedans and sometimes against the Venetians, the rivals in this country in trade, had acquired both wealth and reputation. With him Columbus continued for several years, no less distinguished for his courage than experience as a sailor. At length, in an obstinate engagement off the coast of Portugal, with some Venetian caravans returning richly laden from the Low Countries, the vessel on board which he served took fire, together with one of the enemies' ships to which it was fast grappled. Columbus threw himself into the sea; laid hold of a floating oar; and by the support of it, and his dexterity in swimming, reached the shore, though about two leagues distant. After this disaster, Columbus repaired to Lisbon, where he married a daughter of Bartholomew Peres-

trullo, one of the captains employed by prince Henry in his early navigations, and who had discovered and planted the islands of Porto Santo and Madeira. Having obtained possession of the journals and charts of that experienced navigator, Columbus was seized with an irresistible desire to visit unknown countries. He first made a voyage to Madeira, and continued for several years to trade with that island, the Canaries, Azores, the settlements in Guinea, and all the other places which the Portuguese had discovered on the continent of Africa. By the experience acquired in such a number of voyages, Columbus now became one of the most skilful navigators in Europe. At this time, the great object of discovery was a passage by sea to the East Indies. This was attempted, and at last accomplished by the Portuguese, by doubling the Cape of Good Hope. The danger and tediousness of the passage, however, supposing it to be really accomplished, which as yet it was not, set Columbus on considering whether a shorter and more direct passage to these regions might not be found out; and, after long consideration, he became thoroughly convinced, that, by sailing across the Atlantic Ocean; directly towards the west, new countries, which probably formed a part of the vast continent of India, must infallibly be discovered. His conjectures were confirmed by the observations of modern navigators. A Portuguese pilot having stretched farther to the west than usual, took up a piece of timber, artificially carved, floating upon the sea; and as it was driven towards him by a westerly wind, he concluded that it came from some unknown land situated in that quarter. Perestrello had found to the west of the Madeira isles a piece of timber fashioned in the same manner, and brought by the same wind; and had seen also comes of an enormous size floating upon the waves, which resembled those described by Ptolemy, as productions peculiar to the East Indies. After a course of westerly winds, trees torn up by the roots were often driven upon the coast of the Azores; and at one time the dead bodies of two men with singular features, which resembled neither the inhabitants of Europe nor Africa, were cast ashore there. Even the mistakes of ancient geographers, as to the immense extent of India, as well as various other reasons, contributed to persuade Columbus, that the shortest and most direct course to the remote regions of the east, was to be found by sailing due west. Having already given a particular account of this great man's fruitless applications to the senate of Genoa, and the courts of Portugal and Spain, &c. as well as of his ultimate success with the latter, under the article AMERICA, it is only necessary here to mention the chief articles of his treaty with Ferdinand and Isabella; which was signed on the 17th of April, 1492. These were, that Columbus should be constituted high admiral in the seas, islands, and continent he should discover, with the same powers and prerogatives that belonged to the high admiral of Castile within the limits of his jurisdiction. He was also appointed viceroy in all those countries to be discovered; and a tenth of the products accruing from their productions

and commerce was granted to him for ever. All controversies or law-suits with respect to mercantile transactions were to be determined by the sole authority of Columbus, or of judges to be appointed by him. He was also permitted to advance one-eighth part of the expense of the expedition, and of carrying on commerce with the new countries; and was entitled, in return, to an eighth of the profit. But, though the name of Ferdinand was joined with Isabella in this transaction, his distrust of Columbus was still so violent, that he refused to take any part in the enterprise as king of Arragon; and, as the whole expense of the expedition was to be defrayed by the crown of Castile, Isabella reserved for her subjects of that kingdom an exclusive right to all the benefits which might accrue from its success. Not to repeat the account of his long and perilous voyage, already fully narrated under AMERICA, it is sufficient to mention here, that, after obtaining his grand object, the discovery of the New World, he returned to Spain and arrived at the port of Palos, on the 15th of March, 1493. As soon as the ship was discovered approaching, all the inhabitants of Palos, ran eagerly to the shore, where they received the admiral, with royal honors. The court was then at Barcelona, and Columbus immediately acquainted the king and queen of his arrival. They were no less delighted than astonished with the unexpected event. They gave orders for conducting him into the city with all imaginable pomp. They received him clad in their royal robes, and seated on a throne under a magnificent canopy. When he approached, they stood up; and raising him as he kneeled to kiss their hands, commanded him to take his seat upon a chair prepared for him, and to give a circumstantial account of his voyage. When he had finished his oration, which he delivered with much modesty and simplicity, the king and queen, kneeling down, offered up solemn thanks to God for the discovery. Every possible mark of honor that could be suggested by gratitude or admiration was conferred on Columbus; the former arrangement was confirmed, his family was ennobled, and a fleet ordered to be equipped, to enable him to go in quest of those more opulent countries which he still confidently expected to find. Notwithstanding all this respect, however, Columbus was no longer regarded than he was successful. The colonists he carried over were to the last degree unreasonable and unmanageable; so that he was obliged to use some severities towards them; and malicious complaints were made to the court of Spain against him for cruelty. On this, Francis de Bovadilla, a knight of Calatrava, was appointed to enquire into the conduct of Columbus; with orders, in case he found the charge of maladministration proved, to supersede him, and assume the office of governor of Hispaniola. The consequence of this was, Columbus was sent to Spain in chains, which he indignantly wore in the royal presence, and ordered that they should be buried with him. Notwithstanding his great services, and the solemnity of the agreement between him and Ferdinand, Columbus never could obtain the fulfilment of any

part of that treaty; so that disgusted with the ingratitude of a monarch, whom he had served with so much fidelity and success, and exhausted with fatigue, he ended his active and useful life at Valladolid, on the 20th of May, 1506, in the fifty-ninth year of his age. He was grave, though courteous in his deportment, circumspect in his words and actions, irreproachable in his morals, and exemplary in his religious duties. The following anecdote, which is related of him, will give some idea of his sagacity. While his vessels lay off Hispaniola, the Indians neglected to bring the provisions he had agreed for; on which he sent for the chiefs, and informed them that the God of the Christians was angry at their breach of faith, and as a proof of it, the following night the moon would rise with a threatening and bloody aspect. He knew that there would be an eclipse that night; but the Indians made light of the prediction till they saw it verified; on which, in great terror, they supplicated his forgiveness, and ever after brought the stipulated supplies regularly. Ferdinand, notwithstanding his ingratitude during his life, buried him magnificently in the Cathedral of Seville, and erected a tomb over him with this inscription, 'A Castilia y a Leon Nuevo Mundo dio Colon;' Columbus has given a New World to Castile and Leon.

COLUMBUS (Bartholemew), brother to Christopher, famous for his marine charts and spheres, which he presented to Henry VII. of England. See AMERICA. He died in 1514.

COLUMBUS (Don Ferdinand), the son of Christopher, and writer of his life. He entered into orders; and founded a library which he bequeathed to the church of Seville, to this day called the Columbine library. He died in 1560.

COLUMELLA (Lucius Junius Moderatus), a Roman philosopher, was a native of Cadiz, and lived under the emperor Claudius about A.D. 42. He wrote a book on agriculture, entitled *De Re Rusticâ*, and another *De Arboribus*.

COLUMELLA, in botzny, a genus of plants of the order polygama superflua, class syngenesia. Receptaculum, naked and cellular: CAL. cylindrical and imbricated; florets undivided: SEED crowned with a toothed margin. Species one only; a native of the Cape, having fine yellow flowers.

COLUMN, *n. s.* Lat. *columna*. A round pillar.

Some of the old Greek *columns* and altars, were brought from the ruins of Apollo's temple, at Delos. *Peacham.*

Round broken *columns* clasping ivy twined. *Pope.*

Where famed St. Giles's ancient limits spread,
An inrailed *column* rears its lofty head,
Here to seven streets seven dials count the day,
And from each other catch the circling ray. *Gay.*

Of many a statue the place was marked by an empty pedestal; of many a *column*, the size was determined by a broken capital. *Gibbon.*

Tully was not so eloquent as thou,
Thou nameless *column* with the buried base.
Byron's Childs Harold.

Any body of certain dimensions pressing vertically upon its base.

The whole weight of any *column* of the atmosphere, and likewise the specific gravity of its basis, are certainly known by many experiments. *Bentley.*

In the military art. The long file or row of troops, or of baggage, of an army in its march; an army marches in one, two, three, or more columns, according as the ground will allow.

With printers, a column is half a page, when divided into two equal parts by a line passing through the middle, from the top to the bottom; and, by several parallel lines, pages are often divided into three or more columns.

COLUMN. See ARCHITECTURE.

COLUMN, ASTRONOMICAL, a kind of observatory, in form of a very high tower built hollow, and with a spiral ascent to an armillary sphere placed a-top for observing the motions of the heavenly bodies. Such is that of the Doric order erected at the Hotel de Soissons at Paris by Catherine de Medicis, for the observations of Orontius Fineus a celebrated astronomer of that time.

COLUMN, CHRONOLOGICAL, that which bears some historical inscription digested according to the order of time; as by lustres, olympiads, fasti, epochas, annals, &c. At Athens there were columns of this kind, whereon were inscribed the whole history of Greece digested into olympiads.

COLUMN, FUNERAL, that which bears an urn, wherein are supposed to be enclosed the ashes of some deceased hero; and whose shaft is sometimes overspread with tears and flames, which are symbols of grief and of immortality.

COLUMN, GNOMONIC, a cylinder whereon the hour of the day is represented by the shadow of a stile. See DIAL.

COLUMN, HISTORICAL, is that whose shaft is adorned with a basso-relievo, running in a spiral line its whole length, and containing the history of some great personage: such are the Trajan and Antonine columns at Rome.

COLUMN, HOLLOW, that which has a spiral staircase within, for the convenience of ascending to the top; as the Trajan column, the staircase whereof consists of 185 steps, and is illuminated by forty-three little windows, each of which is divided by tambours of white marble. The monument, or fire-column, at London, has also a stair-case, but it does not reach to the top. These kinds of columns are also called *columnæ coelidæ*, or *cochlidæ*.

COLUMN, INDICATIVE, that which serves to show the tides, &c. along the sea-coasts. Of this kind there is one at Grand Cairo of marble, whereon the overflowings of the Nile are expressed; by this they form a judgment of the succeeding season; when the water, for instance, ascends to twenty-three feet, it is a sign of great fertility in Egypt. See NILOMETER.

COLUMN, INSTRUCTIVE, that raised, according to Josephus, lib. i. cap. 3, by the sons of Adam, whereon were engraven the principles of arts and sciences. Baudelot tells us, that the son of Pisistratus raised another of this kind, of stone, containing the rules and precepts of agriculture.

COLUMN, ITINERARY, a column with several

faces, placed in the cross ways in large roads; serving to show the different routes by inscriptions thereon.

COLUMN, LACTARY, at Rome, according to Festus, was a column erected in the herb-market, now the place Montanara, which had a cavity in its pedestal, wherein young children abandoned by their parents, out of poverty or inhumanity, were exposed, to be brought up at the public expense.

COLUMN, LEGAL. Among the Lacedemonians there were columns raised in public places, whereon were engraven the fundamental laws of the state.

COLUMN, LIMITROPHOUS, or **BOUNDARY**, that which shows the limits of a kingdom or country conquered. Such was that which Pliny says Alexander the Great erected at the extremity of the Indies.

COLUMN, MANUBIARY, from *manubie*, Latin, spoils of the enemy; a column adorned with trophies built in imitation of trees, whereon the spoils of enemies were anciently hung. See **TROPHY**.

COLUMN, MEMORIAL, one raised on occasion of any remarkable event; as the monument of London, built to perpetuate the memory of the burning of the city in 1666. It is of the Doric order, fluted, hollow, with a winding staircase; and terminated at top with waving flames. There is also another of this kind, in form of an obelisk, on the banks of the Rhine, in the Palatinate, in memory of the famous passage of that river by the great Gustavus Adolphus and his army.

COLUMN, MENIAN, any column which supports a meniana or balcony. The origin of this kind of column, Suetonius and Ascanius refer to one Menias; who, having sold his house to Cato and Flaccus, consuls, to be converted into a public edifice, reserved to himself the right of raising a column without-side, to bear a balcony, whence he might see the shows.

COLUMN, MILITARY, among the Romans, a column whereon was engraven a list of the forces in the Roman army, ranged by legions, in their order; to preserve the memory of the number of soldiers, and of the order observed in any military expedition. They had another kind of military column, which they called *columna bellica*, standing before the temple of Janus; at the foot of which the consul declared war, by throwing a javelin towards the enemy's country.

COLUMN, MILITARY, was a column of marble, raised by order of Augustus, in the middle of the Roman forum; from whence, as a centre, the distances of the several cities, &c. of the empire were reckoned, by other military columns disposed at equal distances on all the grand roads. It was of white marble, the same with that which is now seen on the balustrade of the perron of the capitol at Rome. Its proportion is massive, being in a short cylinder, the symbol of the globe of the earth. It was called *militarium aureum*, as having been gilt, at least the ball, by order of Augustus. It was restored by the emperors Vespasian and Adrian, as appears by the inscriptions.

COLUMN, SEPULCHRAL, anciently was a co-

lumn erected on a tomb or sepulchre, with an inscription on its base. Those over the tombs of persons of distinction were very large; those for the common people small: these last are called *stelæ* and *cippi*.

COLUMN, STATUARY, that which supports a statue. Such was that erected by pope Paul V., on a pedestal before the church of St. Maria, at Rome, to support a statue of the virgin, which is of gilt brass. This column was dug up in the temple of Peace; its shaft is a single block of white marble, forty-nine feet and a-half high, and five feet eight inches diameter, of the Corinthian order. The term may also be applied to Caryatides, Persians, termini, and other human figures, which do the office of columns, and which Vitruvius call *telamones* and *atlantes*. See **ARCHITECTURE**, **INDEX**.

COLUMN, TRIUMPHAL, a column erected among the ancients in honor of a hero; the joints of the stones, or courses of which were covered with as many crowns as he had made different military expeditions. Each crown had its particular name, as *vallarix*, which was beset with pikes in memory of having forced a pallisade; *muralis*, adorned with little turrets or battlements, for having mounted an assault: *navalis*, of prows and beaks of vessels, for having overcome at sea; *obsidionalis*, or *graminalis*, of grass, for having raised a siege: *ovans*, of myrtle, which expressed an ovation, or little triumph; and *triumphalis*, of laurel, for a grand triumph. See **CROWN**.

COLUMNA, a town of Russia, in the government of Moscow, with an archbishop's see: fifty miles south-east of Moscow.

COLUMNAR, *adj.* } From column. Form-
COLUMNARIAN, *adj.* } ed in columns.

White *columnar* spar, out of a stone-pit. *Woodward*.

COLUMNARIUM, in Roman antiquity, a heavy tribute, demanded for every pillar of a house. It was first laid on by Julius Cæsar, to put a stop to the extravagant expenses laid out on sumptuous buildings.

COLUMNIA, in botany, a genus of the class *didynamia*, order *angiospermia*: *CAL.* quinquepartite: *COR.* upper lip arched, and entire gibbous, antheræ convex: *CAPS.* bilocular. Species four, natives of the West Indies.

COLURES, *n. s.* Lat. *coluri*; *κολουροι*.

Two great circles supposed to pass through the poles of the world: one through the equinoctial points, Aries and Libra; the other through the solstitial points, Cancer and Capricorn. They are called the equinoctial and solstitial *colures*, and divide the ecliptic into four equal parts. The points where they intersect the ecliptic are called the cardinal points. *Harris*.

Thrice the equinoctial line

He circled; four times crossed the car of night

From pole to pole, traversing each *colure*. *Milton*.

COLURI, or **COLOURI**, a small island in the gulph of Engia, in the Archipelago, formerly *Salamis*.

COLURI, the capital of the above island, seated on the south side, at the bottom of the harbour, which is one of the finest in the world. The famous Grecian hero, Ajax, was king of this island, and it is famous in ancient history for the defeat

of the fleet of Xerxes, by that of the Greeks, under Themistocles, in the strait. It is now, however, but a small place; its commodities consist of wheat, barley, tar, rosin, pit-coal, sponges, and pot-ashes, which they carry to Athens. It is seven miles south from Athens, and is separated from the continent by a strait about a mile over.

COLUTEA, bladder senna, in botany; a genus of the decandria order, and diadelphia class of plants; natural order thirty-second, papilionaceæ; *CAL.* quinquefid; legumes inflated, opening at the upper part of the base. There are thirteen species, all deciduous flowering shrubs, adorned with many lobed leaves, and butterfly-shaped flowers, of a deep yellow or red color. They are propagated both by seeds and layers, and are hardy plants, though they sometimes require a little shelter when the weather is very cold.

COLYBA, or **COLYBUS**, in the Greek liturgy, an offering of corn and boiled pulse, made in honor of the saints and for the dead. The Greeks boil a quantity of wheat, and lay it in little heaps on a plate, separated from each other by leaves of parsley, adding beaten peas, nuts cut small, and grape stones. A little heap of wheat, thus seasoned, they call *κολυβα*. They have a particular formula for the benediction of the *colyba*. Balsamon refers the institution of this superstition to St. Athanasius; but the Greek Synaxary to the time of Julian the Apostate.

COLYMBUS, in ornithology, a genus belonging to the order of anseres. The bill has no teeth, subulated, straight, and sharp-pointed; the teeth are in the throat; the nostrils are linear, and at the base of the bill; and the legs are unfit for walking. This genus includes the divers, guillemots, and grebes, of which the following are the most remarkable species.

1. *C. arcticus*, or the black-throated diver, weighs about three pounds, and measures more than two feet to the end of the tail, and about three feet and a-half in breadth. The bill and the front are black; the hind part of the head and neck cinereous; the sides of the neck marked with black and white lines pointing downwards; the fore part of a glossy variable black, purple, and green. The back, scapulars, and coverts of the wings are black, marked, the two first with square, the last with round spots of white; the quill-feathers dusky; the breast and belly white; the tail short and black, legs partly dusky and partly reddish. This species is found in England, but is not common. It abounds in the northern parts of Europe, Norway, Sweden, and Denmark; in the inland lakes of Siberia; in Iceland, Greenland, the Ferroe Isles; and at Hudson's Bay. The Swedes dress their skins, which, like those of all this genus, are exceedingly tough, and use them for gun-cases and facings for winter caps.

2. *C. auritus*, the eared grebe, or dib-chick, is in length one foot to the rump; the extent is twenty-two inches; the bill black, slender, and slightly recurved; the irides crimson; the head and neck are black; the throat spotted with white; the whole upper side a blackish-brown, except the ridge of the wing about the first joint, and the secondary feathers, which are white; the

breast, belly, and inner coverts of the wings are white; the sub-axillary feathers, and some on the side of the rump, ferruginous. Behind the eyes, on each side, is a tuft of long, loose, rust-colored feathers hanging backwards; the legs are of a dusky-green. They inhabit the fens near Spalding, where they breed. No external difference is to be observed between the male and the female of this species.

3. *C. cornutus*, the horned grebe, is about the size of a teal; weight, one pound; length one foot; breadth, sixteen inches. Bill, one inch, dusky; head very full of feathers, and of a glossy deep green, nearly black; through each eye is a streak of yellow feathers, elongated into a tuft as it passes to the hind head: the upper part of the neck and back is dusky-brown: the fore part of the neck and breast dark orange-red; the lesser wing-coverts, cinereous; the greater wing and quills, black; middle ones, white; belly, glossy-white; legs, cinereous blue before, pale behind. It inhabits Hudson's Bay; and first appears in May, about the fresh waters. It lays from two to four white eggs in June, among the aquatic plants; and is said to cover them when abroad. It retires south in autumn; appears then at New York, staying till spring, when it returns to the north. For its vast quickness in diving, it is called the water-witch. At Hudson's Bay it is known by the name of seekeep.

4. *C. cristatus*, the crested diver, or cargoose, weighs two pounds and a half. Its length is twenty-one inches, the breadth thirty; the bill is two inches and a quarter long, red at the base and black at the point; between the bill and the eye is a stripe of black naked skin; the irides are a fine pale red; the tongue is a third part shorter than the bill, slender, hard at the end, and a little divided; on the head is a large dusky crest, separated in the middle. The cheeks and throat are surrounded with a long pendent ruff, of a bright tawny color, edged with black; the chin is white; from the bill to the eye is a black line, above that a white one; the hind part of the neck and back are of a sooty hue; the rump, for it wants its tail, is covered with a long soft down. The covert feathers on the second and third joints of the wing, and the under coverts are white; all the other wing feathers, except the secondaries, are dusky, those being white: the breast and belly are of a most beautiful silvery white, glossy as satin: the outside of the legs and the bottom of the feet are dusky; the inside of the legs and the toes a pale green. These birds frequent the meres of Shropshire and Cheshire, where they breed; and the great fen of Lincolnshire, where they are called gaunts. Their skins are made into tippets, and sold at as high a price as those which come from Geneva. This species lay four eggs of a white color, and the same size with those of a pigeon. The nest is formed of the roots of bugbane, stalks of water lily, pond weed, and water violet, floating among the reeds and flags; the water penetrates it, and the bird sits and hatches the eggs in that wet condition; the nest is sometimes blown from among the flags into the middle of the water. It is a careful nurse of its young, and feeds them most assi

duously, commonly with small eels. When the infant brood are tired, the parent will carry them either on its back or under its wings. It preys on fish, and is almost perpetually diving; it does not show much more than the head above water: and is very difficult to be shot, as it darts down on the least appearance of danger. It is never seen on land; and though disturbed ever so often, will not fly farther than the end of the lake. Its skin is out of season about February, losing then its bright color; and in the breeding time its breast is almost dark. The flesh is excessively rank.

5. *C. glacialis*, or northern diver, is three feet five inches in length; the breadth four feet eight inches; the bill to the corner of the mouth four inches long, black and strongly made. The head and neck are of a deep black; the hind part of the latter is marked with a large semilunar white band; immediately under the throat is another; both marked with oblong strokes pointing down: the lower part of the neck is a deep black, glossed with a rich purple; the whole under side of the body is white; the sides of the breast marked with black lines; the back, coverts of the wings, and scapulars, are black marked with white spots; those on the scapulars are very large, and square shaped; two at the end of each feather. The tail is very short, and almost concealed by the coverts, which are dusky, spotted with white; the legs are black. This species inhabits several parts of the north of Europe, but is not very frequent on our shores; nor ever seen southward except in very severe winters. It is seldom met with on land, being for the most part on the open sea, diving for fish, which it does with great agility, and flies high and well. It is common in Iceland and Greenland, where it breeds, and at the time frequents the fresh waters. It is plentiful in Norway, and all along the arctic coasts, as far as the river Ob, in the Russian dominions. The Barabrinians tan the breasts of this and other water fowls, whose skins the women prepare in such a manner as to preserve the down upon them; and sewing a number of them together, their husbands sell them, to make pelisses, caps, &c. Garments made of these are very warm, never imbibing the least moisture; and are more lasting than could be imagined. They are also met with in the lakes of Hudson's Bay. The natives of Greenland use the skins for clothing. The Indians about Hudson's Bay adorn their heads with circlets of their feathers, and call the birds *athinue moqua*. As they are seldom seen on the sea-coasts, but chiefly among the lakes, they are called by the Indians inland loons.

6. *C. immer*, or the ember goose, is superior in to a common goose. The head is dusky; the back, coverts of the wings, and tail, clouded with lighter and darker shades of the same. The primaries and tail are black; the under side of the neck spotted with dusky spots; the breast and belly silvery: the legs black. They inhabit the seas about the Orkneys; but in severe winters visit the southern parts of Great Britain. They are also found in Iceland, and most parts of northern Europe, in Kamtschatka, and Switzerland, particularly on the lake Constance,

where it is known by the name of *fluder*. It is said to dive well, and to rise at an amazing distance from the place where it plunged. The female makes her nest among the reeds and flags, and places it in the water; so that it is continually wet. They are difficult to be taken, either on land or swimming on the water; but are often caught under the water, by a hook baited with small fish, its usual food.

7. *C. niger*, the grylle, or black gaillemot, is in length fourteen inches, in breadth twenty-two; the bill is an inch and a half long, strait, slender, and black; the inside of the mouth red; on each wing is a large bed of white, which in young birds is spotted; the tips of the lesser quill-feathers, and the coverts of the wings, are white: the rest of the plumage is black. In winter it is said to change to white; and a variety spotted with black and white is not uncommon in Scotland. The tail consists of twelve feathers; the legs are red. These birds are found on the Bass Isle in Scotland; in the island of St. Kilda; on the rocks of Llandidno, in Caernarvonshire, and, as Mr. Ray imagines, in the Farn Islands off the coast of Northumberland. Except in breeding time they keep always at sea; and are not easily shot, diving at the flash of the pan. The Welsh call this bird *caecan longur*, or 'the sailor's hatred,' from a notion that its appearance forbodes a storm. It visits St. Kilda in March; makes its nest far under the ground; and lays a gray egg, or, as Stellar says, whitish and spotted with rust, and speckled with ash-color.

8. *C. sinensis*, the Chinese diver, described by Mr. Latham. The size is uncertain, but in the drawing the length was fourteen inches. The bill is dusky; irides ash color: the upper parts of the head, neck, body, wings, and tail, dusky greenish brown; the middle of the feathers much darker; the fore part of the neck the same, but considerably paler: chin pale rufous: breast and under parts of the body pale rufous white, marked with dusky rufous spots: the quills and tail are plain brown; the last short: legs ash-color.

9. *C. stellatus*, the speckled divers, a species less than the Chinese, weighs two pounds and a half, and is twenty-seven inches in length, and three feet nine inches in breadth. The bill is three inches long, bending upwards; and is of a pale horn color; the top of the upper mandible dusky; the head is dusky, dotted with gray: hind part of the neck plain dusky; the sides under the eye, the chin, and throat, white; fore part of the neck very pale ash-color; back dusky, marked with oval spots of white; sides of the breast and body of the same, but smaller; the spots on the tail and rump minute; breast and under part white; quills dusky; legs brown; webs and claws pale. This bird is pretty frequent in England, on the Thames, where it is called by the fishermen sprat loon, being often seen in vast numbers among the shoals of that fish, diving after them, and often approaching very near the boats while fishing. It is common about the Baltic, the White Sea, and Kamtschatka. It lays two eggs in the grass, on the borders of lakes near the sea. They are exactly oval, the size of those of a goose, dusky, marked with a few black spots. These birds are also frequent about the

fish ponds of France. They visit New York in winter, but return very far north to breed.

9. *C. troilus*, the troile, or foolish guillemot, weighs twenty-four ounces; its length is seventeen inches, the breadth twenty-seven and a half; the bill is three inches long, black, straight, and a harp pointed; near the end of the lower mandible is a small process; the inside of the mouth yellow; the feathers on the upper part of the tail are short and soft, like velvet; from the eye to the hind part of the head is a small division of the feathers. The head, neck, back, wings, and tail, are of a deep mouse-color; the tips of the lesser quill-feathers white; the whole under part of the body is pure white; the sides under the wings marked with dusky lines. Immediately above the thighs are some long feathers that curl over them. The legs are dusky. They are found in amazing numbers on the high cliffs of the British coasts, and appear at the same time with the auk. Though they are shot at, and see their companions killed, they will not quit the rock. They lay only one egg, which is very large; some are of a fine pale blue; others are white, spotted or elegantly streaked with lines crossing each other. They continue about the Orkneys the whole winter. The chief places they breed in are the isle of Priestholm, near Anglesey; on a rock called Godreve, near St. Ives; the Farn isles, and the cliffs about Scarborough. They are also found in most of the northern parts of Europe, at Spitsbergen, the coast of Lapland, and along the icy sea quite to Kamtschatka.

COMA, *n. s.* } Κῶμα. A morbid disposition to sleep; a lethargy; lethargic; sleepy to a disease.

Our best castor is from Russia; the great and principal use whereof, is in hysterical and *comatose* cases.

Grew.

COMA BERENICES, Berenice's hair, in astronomy, a constellation of the northern hemisphere, composed of unformed stars between the Lion's tail and Bootes. This constellation is said to have been formed by Conon, an astronomer, to console Berenice, the queen of Ptolemy Evergetes for the loss of a lock of her hair, which had been stolen out of the temple of Venus, where she had dedicated it on account of a victory obtained by her husband.

COMA SOMNOLENTUM, is when the patient continues in a profound sleep; and, when awaked, immediately relapses, without being able to open his eyes.

COMACCHIO, or COMACHIO, a town of Italy, in the ci-devant duchy of Ferrara, and territory of the church, afterwards included in the Italian republic, and department of the lower Po. It is situated in a marshy country called the Valley of Comachio, the see of a bishop, suffragan of Ravenna. It is twenty-seven miles south-east of Ferrara, forty south of Venice, and fourteen north of Ravenna.

COMART, *n. s.* This word, which we have only met with in one place, seems to signify treaty; article; from con and mart, or market.

By the same *comart*,

And carriage of the articles designed,

His fell to Hamlet.

Shakespeare. Hamlet.

COMARUM, marsh-cinquefoil, a genus of the polyginia order, and icosandria class of plants, natural order thirty-fifth, senticosæ: CAL. decemfid; the petals five, less than the calyx: receptacle of the seeds ovate, spongy, and persisting. There is but one species, a native of Britain. It rises about two feet high, and bears fruit somewhat like that of the strawberry. It grows naturally in bogs, and the root dyes a dirty red. The Irish rub their milking pails with it, and it makes the milk appear richer and thicker. Goats eat the herb; cows and sheep are not fond of it; horses and swine refuse it.

COMATE, *n. s.* Con and mate. Companion.

My *comates* and brothers in exile.

Shakespeare. As You Like It.

COMB in the end, and COMP in the beginning, of names, seem to be derived from the British kum, which signifies a low situation.

COMB, in Cornish, signifies a valley, and had the same meaning anciently in the French tongue.

COMB, *n. s.* Ang.-Sax. camb; κόμη. An instrument to separate and adjust the hair.

— but well wist I,

It was of Venus (redily)

This temple;—for in preitreature

I sawe anon right, hire figure

Naked yfetyng in a se;

And also on hire hedde parde,

Hire rosy garlande white and redde;

And hire combe for to kembe hire hedde;

Hire doves; and Cupido

Hire blinde sonne; and Vulcano,

That in his face ywas full broune.

Chaucer's House of Fame.

There on a day a noble youthful knight,

Seeking adventures in the salvage wood,

Did by great fortune get of her the sight,

As she sate carelesse by a cristal ffood

Combing her golden lockes, as seemed her good.

Spenser.

By fair Ligea's golden comb,

Wherewith she sits on diamond rocks,

Sleeking her soft alluring locks.

Milton.

I made an instrument in fashion of a comb, whose teeth, being in number sixteen, were about an inch and a half broad, and the intervals of the teeth about two inches wide.

Newton.

The top or crest of a cock, so called from its pectinated indentures.

Cocks have great combs and spurs, hens little or none.

Bacon.

High was his comb, and coral-red withal,

With dents embattled like a castle-wall.

The cavities in which the bees lodge their honey. Perhaps from the same word which makes the termination of towns, and signifies hollow or deep.

What do ye honey-combe! sweet Alisoun!

My faire birde! my swete sinamome!

Awaketh lemman min! and speketh to me.

Chaucer's Canterbury Tales.

The pretty bees, with daily paines contrive Their curious combes, and from the flowry fields, Doe bring that pleasant sweetness to their hive Which nectar and ambrosiac dainties yield.

Geo. Withers.

This in affairs of state,

Employed at home, abides within the gate,

To fortify the combs, to build the wall,
To prop the ruins, lest the fabric fall.

Dryden's Virgil.

To COMB, *v. a.* From the noun. To divide,
and clean, and adjust the hair with a comb.

Her care shall be

To comb your noddle with a three-legged stool.

Shakespeare.

Divers with us, that are grown grey, and yet would
appear young, find means to make their hair black, by
combing it, as they say, with a leaden comb, or the
like.

Bacon.

She with ribbons tied

His tender neck, and combed his silken hide.

Dryden's Æneid

There was a sort of engine, from which were ex-
tended twenty long poles, wherewith the man-moun-
tain combs his head.

Swift.

To lay anything consisting of filaments smooth,
by drawing through narrow interstices; as, to
comb wool.

COMB-BRUSH, *n. s.* Comb and brush. A brush
to clean combs.

COMB-MAKER, *n. s.* Comb and maker. One
whose trade is to make combs.

This wood is of use for the turner, engraver, carver,
and comb-maker.

Mortimer's Husbandry.

COMB-MAKING. The common sorts of combs
are generally made of the horns of bullocks, or of
elephants' and sea horses' teeth; some are made
of tortoise-shell; others of box, holly, and other
hard woods.

Bullocks' horns are prepared for being manu-
factured into combs by the tips being sawn off,
after which they are held in the flame of a wood
fire, till they become nearly as soft as leather.
In this state they are split open on one side and
pressed in a machine between two iron plates,
then plunged into a trough of water, whence they
come out hard and flat. When the horn is cut
to the size intended for the required combs,
several pieces are laid upon a pair of tongs,
adapted to the business, over a fire, made chiefly
of joiners' shavings, to soften them. They are
frequently turned, and, when sufficiently soft, are
put into a vice and screwed tight to complete the
flattening. When this process is finished, the
horns are perfectly flat and hard; they are then
given to a man who shaves, planes, or scrapes
off the rough parts with a knife, similar in shape
to one used by coopers, having two handles,
which the comb-maker works from him, across
the grain of the horn, from one end of the in-
tended comb to the other. When both sides are
perfectly smooth, it is delivered to the person
who cuts the teeth.

This workman fastens it with wedges, by that
part meant for the back, into an instrument
called a clam. The clam has a long handle,
which the workman places under him as he sits,
by which means he renders the object of his work
firm and steady, and he has, at the same time,
both hands at liberty to be employed in the
operation. The cutting of the teeth is com-
menced by a double saw, of which each blade is
something like the small one with which joiners
and cabinet-makers cut their fine work: with
this he forms the teeth. As this instrument
leaves the work square, and rather in a rough

state, particularly in the inside edge of each
tooth, it is followed by another about the size
and shape of a case knife, having teeth like a
file, on each flat side. After this, two others of
the same shape, but each finer cut than the other,
follow. One stroke, on each side of the comb, is
then given by a rasping tool, which is used to
take off any roughness that may remain on the
sides of the teeth: it is now delivered to another
operator, who polishes it with rotten-stone and
oil, applying them with a piece of buff leather.

The process used for making ivory combs, is
nearly the same as that just described, excepting
that the ivory is first sawn into thin slices. That
imported from Ceylon is preferred, as being
less liable to turn yellow, by exposure to the
atmosphere. The whiteness which ivory ac-
quires, depends chiefly on the degree of dryness
which it has attained. When yellow, its gelati-
nous matter is altered by the air, and appears
combined with the oxygen of the atmosphere.
Heat cannot be made use of for making ivory
pliant, though it is rendered softer by being ex-
posed to that agent. It is, as we have observed,
divided by the saw, and, for very delicate work,
the operation is sometimes performed under
water, to prevent its being heated or rent by the
action of the tool. It is polished with pumice
stone and tripoli. Ivory has been said to be-
come soft by being placed in mustard, but both
ivory and bone are softened by being immersed
in an alkaline lee made of soda and quick-lime.

We shall now give some account of the meth-
od of cutting combs adopted by Mr. William
Bunday, of Camden town, who obtained his
Majesty's letters patent for the invention. The
term of his exclusive privilege being complete, it
is open to any manufacturer to make what use
he pleases of the discovery. It appears at first
sight to be a singular circumstance, that in a
country famous for its attention to mechanical
processes, the teeth of ivory combs, should be
cut one stroke after the other, by the human
hand, assisted by no other tool than a pair of
saws rudely fastened in a wooden back, and kept
asunder, by means of a small slip of wood.
With these rough implements, however, it is,
that the very delicate superfine ivory combs,
containing from fifty to sixty teeth in an inch,
are manufactured. It may readily be conceived,
that the imaginations of mechanical men must
have been employed in an attempt to solve the
practical problem of constructing a machine,
which, without skill in the agent or first mover,
might perform all that men, converted by prac-
tice into a kind of living machines, are capable
of doing, but with less cost, or greater product,
in proportion as it is easier to maintain the one
than the other. Accordingly it is not difficult to
find traces of attempts of this kind during the
last forty years, in the traditions of our manu-
facturing towns and counties. From what causes
their failure may have arisen, since none of them
have been established to supersede the old prac-
tice, is not easy to discover, but it is certain that
Mr. Bunday's machine is the first and only one
which has yet appeared at the patent office. Its
construction is as follows:—

An iron fly-wheel of three feet in diameter, is

moved by a crank and treadle, or by any other power or means of application. On the same axis is a wheel or pulley, of fifteen inches diameter, which, by a gut, drives another pulley of nine inches attached to a puppet head above, and shears resembling those of a common foot lathe. An arbor is driven by this upper wheel, in the same manner as work is thrown round between centres before the mandrell in the common lathe. On the arbor are fixed a number of circular cutters, about two inches diameter, corresponding to the notches intended to be cut in the combs. These cutters are all of a thickness, and have brass washers between them, and also from another arbor in a frame there are steel pieces, called guiders, which stand between the cutters, and keep them regularly asunder, just above the place where the comb enters.

The comb is held, by a plate and two screws, upon the top of a block or carriage, which runs off and on by means of a platform, and dovetail upon the lathe bed. The comb moves in its own plane, right onward, to the centre or axis of the cutters, and the carriage is driven by a screw of ten threads in the inch, into which a knife edge from the carriage falls, instead of a nut. On the extremity or tail of the screw is fixed a spur wheel of thirty teeth driven by an endless screw, the arbor of which last is of course parallel to the arbor of the cutters. It is driven by a pulley of six inches concentric with the cutting arbor, and itself has a pulley of three.

Hence if the great wheel be moved once round, per second, the arbor will revolve $\frac{1}{3}$ times and the endless screw arbor $\frac{2}{3}$ times but from the dimensions of the screw, thirty revolutions of the endless screw make $\frac{1}{16}$ inch of the tooth, or 150 revolutions make $\frac{1}{2}$ inch. With this length of tooth, the great wheel will revolve forty-five times, and the cutting arbor seventy-five times. One side of the comb will therefore be cut in three quarters of a minute. The combs are pointed by applying them to an arbor, clothed with cutters, with chamfered edges and teeth $\frac{1}{16}$ inch deep: they are so applied by the hand. This arbor is driven by a wheel on the crank axis. The cutters are made of tempered steel, as are also the guides, the teeth of the cutters are set so as to clear the back or following part from the friction in the cut.

The cutters, the cutter washers, the guides, and the guide washers, are all ground flat and thin, upon a brass plate, in the same manner as optical work is ground; during which operation the piece is retained again on an upper movable plate, of its own size, by means of a circular rim or edge which is adjustable by screws, so as to form a deeper or shallower cell, as may be required. The guides are one-twentieth part thinner than the washers of the cutters, and the guide washers are somewhat thicker than the cutters, and there are grooves in the sides of the guides that the teeth of the cutters may pass clear, notwithstanding their side sets.

The writer had an opportunity of examining one of the cutters of this artist, which had been given by him to a friend. It was beautifully wrought, very uniform in its thickness, which was about the $\frac{1}{16}$ of an inch, and the sets of the

teeth, which seemed to have been affected by the blow of a punch on every other tooth, was extremely accurate: it was not perfectly flat, but had that kind of flexure which workman call a buckle. He also saw an ivory comb of forty teeth in the inch, which was very uniform, and equal to the best work done by hand, except that the cut seemed too wide.

It appears to be placed beyond a doubt, that combs may really be cut in this way; but whether to advantage must depend on the cast and durability of the cutters, which, it is to be feared, may be bended and spoiled in a course of work, by their incessant friction between the guides. It may also be remarked, that they cannot be taken off the arbor to sharpen or repair, and be put on again without changing the degree of fineness in the comb they will cut. For if we suppose an error of one-thousandth of an inch in grinding or callipering the cutters and washers, or in the different force of screwing them together on the arbor; this will make a difference of one-third of an inch, or the breadth of seventeen teeth in a superfine comb, No. 6, which if coarser would bring it more than half way to the sort called dandriff, or, if finer, would equal the box-comb. Besides which a much less difference would totally destroy the agreement or fitting between cutting and pointing. A more particular account of the patent invention, with engravings, may be found in the *Repertory of Arts* for the year 1796.

Tortoise-shell combs, as they are called, are very much used. It has, however, been properly observed, that the hard strong covering which encloses tortoises, and which is used on these occasions, is improperly denominated a shell; being of a bony contexture, but covered on the outside with scales, or rather plates of a horny substance. There are two general kinds of tortoises, viz. the land and the sea tortoise; the latter is divided into many distinct species, but the *testudo-imbricata* of Linnæus alone furnishes that beautiful shell so much admired in European countries. This consists of thirteen leaves or scales, eight of them flat, and five bent. The best tortoise-shell is thick, clear, transparent, of the color of antimony, sprinkled with brown and white.

Tortoise-shell, like horn, becomes soft in a moderate heat, as that of boiling water, so as to be pressed in a mould, into any form, the shell being previously cut into plates of a proper size. Two plates may likewise be united into one by heat and pressure, the edges being thoroughly cleaned, and made to fit close to one another. The tortoise-shell is conveniently heated for this purpose by applying a hot iron above and beneath the juncture, with the interposition of a wet cloth, to prevent the shell from being scorched by the irons; these irons should be pretty thick that they may not lose their heat before the union is effected.

Tortoise-shell being in so much request, many methods have been invented for the purpose of staining horn so as to imitate tortoise-shell; of which the following is one:—The horn to be dyed, being first pressed into a flat form, is to be spread over with a kind of paste made of two

parts of quick lime and one of litharge, brought into a proper degree of consistency with soap-lee. This paste must be put over all the parts of the horn except such as are intended to be left transparent, to give it a nearer resemblance to tortoise-shell; the horn must remain in this state till the paste be quite dry, when it is to be rubbed off. It requires a considerable share of taste and judgment to dispose the paste in such a manner as to form a variety of transparent parts, of different magnitudes and figures, to look like nature. Some parts are, by a neat process, rendered semi-transparent, which is effected by mixing whitening with a part of the paste, to weaken its operation in particular places; by this means spots of a reddish-brown will be produced, so as greatly to increase the beauty of the work. Horn thus dyed is manufactured into combs, which are frequently sold for real tortoise-shell: we shall now add two or three other directions on subjects connected with this business.

To make horn soft.—Take wood-ashes and quick lime; of these make a strong lee, and filter it clear, boil the shavings or chips of horn therein, and they will soon be reduced to a paste, this may be colored, and cast into any form required.

To prepare horn leaves in imitation of tortoise-shell.—Take of quick lime one pound, and litharge of silver eight ounces, mix them into a paste with urine, and make spots with it, in what form or shape you please, on both sides of the horn; when dry, rub off the powder, and repeat this as many times as necessary. Then take vermilion, prepared with size, lay it all over one side of the horn, as also on the wood to which you intend to fasten it. For raised work, form the horn in a mould of any shape, and when dry give it color with the aforesaid paste and vermilion; then lay clear glue, both on the horn and the wood on which it is to be fixed, and close it together. This work is to be done in rather a warm place: it is then to stand all night; the roughnesses are to be cut or filed off, and the horn polished with tripoli and linseed oil. Work finished in this manner is well adapted for ladies' combs.

Another method of imitating tortoise-shell with horns.—Take of nitrous acid two ounces, and of fine silver one drachm; let the silver be dissolved, and, having spotted or marbled your horn with wax, strike the solution over it; let it dry of itself, and the horn will be, in those places which are free from wax, of a brown or black color.

To dye ivory green, to be used as combs.—A green dye may be given to ivory, by steeping it in nitrous acid, tinged with copper or verdigris, or in two parts of verdigris and one of sal ammoniac, ground well together, with strong white wine vinegar poured on them; and by converting the nitrous acid into aqua regia, by dissolving a fourth part of its weight of sal ammoniac in it, ivory may be stained of a fine purple color.

To dye ivory, &c. with other colors.—Ivory, bone, horn, and other substances, adapted to the manufacture of combs may be stained yellow, by boiling them first in a solution of one pound of alum in two quarts of water, and then boiling

them in a solution of turmeric root. Ivory &c. may be stained blue, by first staining it green, and then dipping it in a solution of pearl-ashes, made strong, and boiling hot. It may be accomplished also by boiling in the tincture of indigo, prepared by the dyers, and afterwards in a solution of tartar, made by dissolving three ounces of white tartar, or cream of tartar in a quart of water.

Combs are sometimes set with brilliant stones, pearls, and even diamonds; and some are studded with cut steel. They are of various shapes, and are used to fasten up the hair, when ladies dress without caps. Of course combs may be had of all prices from a few pence to almost any sum. Journeymen comb-makers will earn from 25s. to two guineas per week.

COMBAT, *v. n.*, *v. a.* & *n. s.* } *Fr. combat-*
COMBATANT, *n. s.* } *tre; combat-*

tant. To fight, generally in a duel or hand to hand, but sometimes used for battle; it is also employed, figuratively, in the same sense with regard to matters of opinion. It is not strictly synonymous with *to oppose*; it is true one always opposes in combating, but not vice versa; a person's positions are combated, his interests are opposed.

But ere they could procede unto the place
Where he abode, themselves at discord fall,
With cruel combat loyned in middle space,
With horrible assault, and fury fell
They heaped huge strokes the scorned life to quell.
Spenser.

The noble *combat* that, 'twixt joy and sorrow, was
fought in Paulina! She had one eye declined for the
loss of her husband, another elevated that the oracle
was fulfilled.
Shakespeare.

Pardon me, I will not *combat* in my shirt. *Id.*
So frowned the mighty *combatants*, that hell
Grew darker at their frown. *Milton's Paradise Lost.*
Two planets rushing from aspect malign
Of fiercest opposition in mid sky,
Should *combat*, and their jarring spheres confound.
Id.

Who, single *combatant*,
Duelled their armies ranked in proud array,
Himself an army. *Id. Agonistes.*

Old Waller trumpet-general swore he'd write
This *combat* truer than the naval fight. *Marvell.*

He with his sword unsheathed, on pain of life,
Commands both *combatants* to cease their strife.
Dryden.

The *combat* now by courage must be tried. *Id.*
Their oppressors have changed the scene, and *com-*
bated the opinions in their true shape.
Decey of Piety.

Love yields at last, thus *combated* by pride,
And she submits to be the Roman's bride.
Granville.

But now so variously the *combat* bleeds
That Fame, though all her tongues should give them
breath,

Could not express the bold and warlike deeds
Of warriors ranging through this field of death. *Gay.*

The trials by single *combat* gradually obtained su-
perior credit and authority, among a warlike people,
who could not believe, that a brave man deserved to
suffer, or that a coward deserved to live. *Gibbon.*

The mariner not vainly brave
Combats the storm, and rides the wave,
To rest at last on shore. *Bentley.*

To *combat* may be glorious, and success
Perhaps may crown us, but to fly is safe. *Cowper.*

COMBAT, in our ancient law, was a formal trial of some doubtful cause or quarrel, by the swords or bastions of two champions. The last trial of this kind in England was between Donald lord Ray appellat, and David Ramsay, esq. defendant, when, after many formalities, the matter was referred to the king's pleasure. See BATTLE.

COMBER, *n. s.* From comb. He whose trade it is to disentangle wool, and lay it smooth for the spinner.

COMBER (Thomas), a learned English divine, born at Shermanbury, in Sussex, in 1575. He was the twelfth child of an ancient family, and, surviving all his elder brothers, inherited the estate. He was educated at Horsham school, from whence he removed to Trinity College Cambridge, where he made a great progress in all kinds of learning, particularly in the Oriental Languages. In 1596 he became a fellow of his college, and in 1598 took his master's degree. In 1607 he obtained leave to travel, and resided three years in France, where he contracted an intimacy with the learned Dr. Moulin. He took the degree of D. D. in 1616, and about the same time became chaplain to the king. Charles I. sent him to Scotland to confer with some of the presbyterian divines about the form of church government, and, in 1630, he was promoted to the deanery of Carlisle, and the year following appointed master of Trinity College; at which time he also served the office of vice-chancellor. As master of his college he acquired a great and deserved reputation; but, soon after the commencement of the rebellion, he was deprived of that and of his deanery. He was also imprisoned for his loyalty and otherwise ill-treated, but bore all his sufferings with calm resignation. He died in 1654, and was buried in the church of St. Botolph, Cambridge.

COMBER (Thomas), an eminent divine of the same family with the preceding, born at Westerham in Kent in 1645, educated at Cambridge; created D. D. and after several preferments in the church made dean of Durham. He was chaplain to Anne princess of Denmark, and to king William and queen Mary. He wrote 1. A Scholastical History of the Primitive and General use of Liturgies. 2. A Companion to the Altar. 3. A brief Discourse upon the offices of Baptism, Catechism, and Confirmation. He died in 1699, aged fifty-five.

COMBINE, *v. a. & v. n.* } Lat. *con* and
CO'MBINA'TE, *adj.* } *binus*, signifies ty-

COMBINA'TION, *n. s.* } ing two into one.
Fr. combiner. The first idea therefore is union of bodies, or qualities; commixture; conjunction: the next is copulation of ideas in the mind. As a term of science, combination is used in mathematics to denote the variation or alteration of any number of quantities, letters, sounds or the like, in all the different manners possible. Thus the number of possible changes or combinations of the twenty-four letters of the alphabet, taken first two by two, then three by three, &c. amount to 1,391,724,288,887,252,999,425,128,493,402,200. Its general applications are the following: to a union or league of private

persons for some certain purpose; it is now a in an ill sense, in those associations which spect the interests of the few to the injury of many. When applied to things combination an arbitrary action. Thus it differs from association. Association is a natural union, but combinations are formed either by design or accident nothing will associate but what harmonis things the most opposite in their nature are combined together. The verb signifies to join to ther; to keep in union; to agree; to accord; settle by compact; to join words or ideas to ther; the opposite of analyse.

These natures, from the moment of their first combination, have been and are for ever inseparable.

Hool

This cunning cardinal
The articles of the combination drew.

As himself pleased. *Shakespeare. Henry VI.*

God, the best maker of all marriages,
Combine your hearts in one, your realms in one.

Honour and policy, like unsevered friends
I' th' war, do grow together: grant that, and tell
In peace what each of them by th' other loses,
That they combine not there? *Id. Coriolanus*

She lost a noble brother; with him the sinew
her fortune, her marriage dowry: with both her combination husband, this well-seeming Angelo.

Id. Measure for Measure

My heart's dear love is set on his fair daughter;
As mine on hers, so hers is set on mine,
And all combined, save what thou must combine
By holy marriage. *Id. Romeo and Juliet*

Combine together 'gainst the enemy;
For these domestic and particular broils
Are not the question here. *Id. King Lear*

They aim to get all to their own will and power
under the disguises of holy combinations.

King Charles

Let us not then suspect our happy state,
As not secure to single or combined.

Milton's Paradise Lost

Ingratitude is always in combination with pride
and hard-heartedness. *South*

Friendship is the cement which really combines
mankind. *Government of the Tongue*

You with your foes combine,
And seem your own destruction to design.

Dryden's Aurengzebe.

They never suffer any ideas to be joined in their
understandings, in any other or stronger combination
than what their own nature and correspondence give
them. *Locke.*

Resolution of compound bodies by fire, does not so
much enrich mankind as it divides the bodies; as
upon the score of its making new compounds by new
combinations. *Boyle.*

Where the tall oak his spreading arms entwines,
And with the beech a mutual shade combines. *Gay.*

'Tis infamy to serve a hag,
Cats are thought imps, her broom a nag,
And boys against our lives combine
Because 'tis said your cats have nine. *Id.*

Wise,auteous, good! O every grace combined
That charms the eye, and captivates the mind!

Beattie.

The cry of the people in cities, and towns though
unfortunately (from a fear of their multitude and
combination), the most regarded, ought in fact to be
the least regarded, on the subject of monopoly. *Burke*

Before the time of Dryden those happy combinations of words which distinguish poetry from prose, had been rarely attempted. Johnson.

COMBINATION, in chemistry, signifies the union of two bodies of different natures, from which a new compound body results. For example, when an acid is united with an alkali, we say that a combination betwixt these two saline substances takes place; because from this union a neutral salt results, which is composed of an acid and an alkali.

COMBINATIONS, in the mathematics, I. In all combinations, if from an arithmetical decreasing series, whose first term is the number out of which the combinations are to be formed, and whose common difference is 1, there be taken as many terms as there are quotients to be combined, and those terms be multiplied into each other; and if from the series 1, 2, 3, 4, &c. there be taken the same number of terms, and they be multiplied into each other, and the first product be divided by the second, the quotient will be the number of combinations required. Therefore, if you would know how many ways four quantities can be combined in seven, multiply the first four terms of the series, 7, 6, 5, 4, &c. together, and divide the product, which will be 840, by the product of the first four terms of the series, 1, 2, 3, 4, &c. which is 24, and the quotient 35 will be the combination of 4 in 7. II. In all permutations, if the series 1, 2, 3, 4, &c. be continued to as many terms as there are quantities to be changed, and those terms be multiplied into each other, the product will be the number of permutations sought. Thus, if you would know how many permutations can be formed with five quantities, multiply the terms 1, 2, 3, 4, 5, together, and the product 120 will be the number of all the permutations.

COMBINATIONS, PROBLEMS IN. I. To find the number of changes that may be rung on twelve bells. It appears by the second aphorism, that nothing more is necessary here than to multiply the numbers from 1 to 12 continually into each other, and the last product will be the number sought, viz. 479,001,600. II. Suppose the whole twenty-four letters of the alphabet to be written so small, that no one of them shall take up more space than the hundredth part of a square inch: to find how many square yards it would require to write all the permutations of the twenty-four letters in that size? By following the same method as in the last problem, the number of permutations of the twenty-four letters will be found to be 62,044,840,173,323,943,936,000.

Now the inches in a square yard being 1296, that number multiplied by 100 gives 129,600, which is the number of letters each square yard will contain; therefore if we divide

62,044,840,173,323,943, 936,000

by 129,600, the quotient, which is

478,741, 050,720,092,160

will be the number of yards required to contain the above-mentioned number of permutations. But, as all the twenty-four letters are contained in every permutation, it will require a space twenty-four times as large; that is,

11,489,785,217,282,211,840.

Now the number of square yards contained on the surface of the whole earth is but

617,197,435,008,000,

therefore it would require a surface 18,620 times as large as that of the earth to write all the permutations of the twenty-four letters in the size above mentioned. III. To find how many different ways the eldest hand at piquet may take in his five cards. The eldest hand having twelve cards dealt him, there remain twenty cards, any five of which may be in those he takes in, consequently, we are here to find how many ways five cards may be taken out of twenty. Therefore, by aphorism I. if we multiply 20, 19, 18, 17, 16, into each other, which will make 1860480, and that number be divided by 1, 2, 3, 4, 5, multiplied into each other, which make 120, the quotient, which is 15504, will be the number of ways five cards may be taken out of twenty. From hence it follows that it is 15,503 to 1, that the eldest hand does not take in any five certain cards. IV. To find out the number of deals a person may play at the game of whist, without ever holding the same cards twice. The number of cards played with at whist being 52, and the number dealt to each person being 13, it follows, that by taking the same method as in the last experiment, that is, by multiplying 52 by 51, 50, &c. so on to 41, which will make

3,954,242,643,911,239,880,000,

and then dividing that sum by 1, 2, 4, &c. to 13, which will make 6,227,020,100, the quotient, which is 635,013,559,600 will be the number of different ways thirteen cards may be taken out of fifty-two, and consequently the number sought. We add the following table of combinations, or the arithmetical triangle.

	A												
1													
2													
3													
4													
5													
6													
7													
8													
9													
10													
11													
12	a	13.	66.	220.	495.	792.	924.	702.	495.	220.	66.	12.	1 b

The construction of this table is very simple. The line *A a* consists of the first twelve numbers. The line *A b* consists everywhere of units; and second term 3, of the line *B c*, is composed of the two terms 1 and 2 in the preceding rank: the third term 6, in that line, is formed of the two terms 3 and 3 in the preceding rank: and so of the rest; every term, after the first, being composed of the two next terms in the preceding rank: and by the same method it may be continued to any number of ranks. To find by this table how often any number of things can be combined in another number under thirteen, as suppose five cards out of eight; in the eighth rank look for the fifth term, which is 56, and that is the number required. Though we have shown in the foregoing problems the manner of finding the combination of all numbers whatever, yet as this table answers the same purpose for small numbers, by inspection only it will be found useful on many occasions; as will appear by the following examples. I. To find how many different sounds may be produced by striking on a harpsichord two or more of the seven natural notes at the same time.

1. The combinations of two in seven, by the foregoing triangle, are . . . 21
2. The combinations of 3 in 7 are . . . 35
3. The combinations of 4 in 7 are . . . 35
4. The combinations of 5 are . . . 21
5. The combinations of 6 are . . . 7
6. The seven notes all together once . . . 1

Therefore the number of all the sounds will be 120

II. Take four square pieces of pasteboard of the same dimension, and divide them diagonally, that is, by drawing a line from two opposite angles, as in the diagram, into eight triangles;

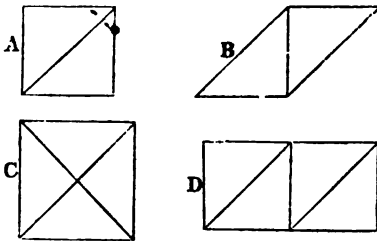

paint seven of these triangles with the primitive colors; red, orange, yellow, green, blue, indigo, violet, and let the eighth be white. To find how many chequers or regular four-sided figures, different either in form or color, may be made out of those eight triangles. First, by combining two of those triangles, there may be formed either the triangular square *A*, or the inclined square *B* called a rhomb. Secondly, by combining four of the triangles, the large square *C* may be formed; or the long square *D*, called a parallelogram. The first two squares consisting of two parts out of eight, each of them may, by the eighth rank of the triangle, be taken twenty-eight different ways, which makes fifty-nine. And the last two squares, consisting of four parts,

may each be taken by the same rank of the triangle seventy times, which makes 140
To which add the foregoing number . . . 56

And the number of the different squares }
that may be formed of the eight trian- } 196
gles, will be }

III. A man has twelve different sorts of flowers, and a large number of each sort. He is desirous of setting them in beds or flourishes in his parterre. Six flowers in some, seven in others, and eight in others, so as to have the greatest variety possible; the flowers in no two beds to be the same. To find how many beds he must have:

1. The combinations of 6 in 12, by the last rank of the triangle, are . . . 924
2. The combinations of 7 in 12 are . . . 792
3. The combinations of 8 in 12 are . . . 495

Therefore the number of beds must be 2211

IV. To find the number of chances that may be thrown on two dice. As each die has six faces, and as every face of one die may be combined with all the faces of the other, it follows that 6 multiplied by 6, that is 36, will be the number of all the chances; as is also evident from the following table:

Points.	No. of Chances.	No. of Points.
2 1 1	1	2
3 2 1 1 2	2	6
4 2 2 3 1 1 3	3	12
5 4 1 1 4 3 2 2 3	4	20
6 3 3 5 1 1 5 4 2 2 4	5	30
7 6 1 1 6 5 2 2 5 4 3 3 4	6	42
8 4 4 6 2 2 6 5 3 3 5	5	40
9 6 3 3 6 5 4 4 5	4	36
10 5 5 6 4 4 6	3	30
11 6 5 5 6	2	22
12 6 6	1	12
	36	252

It appears by this table, 1. That the number of chances for each point continually increases to the point of 7, and then continually decreases till 12; therefore, if two points are proposed to be thrown, the equality, or the advantage of one over the other, is clearly visible. It is easy from hence to determine whether a bett proposed at hazard, or any other game with the dice, be advantageous or not; if the dice be true, which, by the way, is rarely the case for any long time together, as it is so easy for those that are possessed of a dexterity of hand to change the true dice for false. 2. The whole number of chances on the dice being 252, if that number be divided by 36, the number of different throws on the dice, the quotient is 7: it follows, therefore, that at every throw there is an equal chance of bringing seven points. 3. As there are thirty-six chances on the dice, and only six of them doublets, it is five to one, at any one throw,

against throwing a doublet. By the same method the number of chances upon any number of dice may be found; for if 36 be multiplied by 6, that product, which is 216, will be the chances on three dice; and if that number be multiplied by 6, the product will be the chances on four dice, &c. Among the different purposes to which the doctrine of combination may be applied, those of writing in cipher, and deciphering, hold a principal place. See the article CIPHER. And, upon the same principle, those who have ingenuity and leisure, may amuse themselves and their friends, by cards previously marked with letters or words; which, after shuffling and dealing in seeming confusion, and apparently by chance, surprise the company by producing a sublime sentiment, or paying a polite compliment to each person present.

COMBLESS, *adj.* From comb. Wanting a comb or crest.

What, is your crest a coxcomb?—

—A *combless* cock, so Kate will be my head.

Shakespeare.

COMB-MARTIN, a town in Devonshire, seated on the Bristol Channel, at the mouth of the Severn, from which it has an inlet that runs through the town, with a cove for landing boats. There are lead-mines near it, which formerly produced some silver ore. It has a market on Saturday, and a fair on Whitsun-Monday. It is seven miles east of Ilfracomb, and 202 west of London.

COMBOOCOANAM, a neat town of the province of Tanjore, Hindostan, twenty miles N.N.E. from the city of Tanjore. It was formerly the capital of the Cholas, one of the most ancient of the Hindoo dynasties, from which, in latter times, the whole coast of Cholamundul (Coromandel) has taken its name: it contains many vestiges of its ancient splendor, and is chiefly, at present, inhabited by brahmins. Some of the tanks and pagodas are very fine, and the surrounding country is fertile and well cultivated.

COMBUST, *adj.*

COMBUSTIBLE, *adj.*

COMBUSTIBLENESS, *n. s.*

COMBUSTION, *n. s.*

Lat. comburo, combustum. } first adjective is used in astronomy and in astrology, but in what sense it is rather difficult to say. Milton alludes to planets that are combust, in the sense of their being obscured and out of sight by the brightness of the sun; and Chaucer represents it as synonymous with a bad aspect, or concealment from view. The general application is the same with the other derivatives, namely, having the quality of catching fire; susceptible of fire, aptness to take fire. Combustion is conflagration and consumption by fire. It is also used metaphorically for tumult, hurry, hubbub, bustle, hurly burly.

When a planet is not above eight degrees and a half distant from the sun, either before or after him, it is said to be *combust*, or in *combustion*. *Harris.*

And if I had, O Venus ful of mirth!

Aspects badde of Mars or of Saturne;

Or thou *combust*; or let were in my birth;

Thy father pray—al thilke harm disturne,

Of grace, and that I glad ain maie turne,

For love of him thou lovedest in the shawe,

I mene Aden that with the bore was slave.

Chamoor Troilus and Cressida.

We boast our light; but if we look not wisely on the sun itself, it smites us into darkness. Who can discern those planets that are oft *combust*, and those stars of brightest magnitude that rise and set with the sun, until the opposite motions of those orbs bring them to such a place in the firmament where they may be seen evening and morning? *Milton.*

Mutual *combustions*, bloodsheds, and wastes may enforce them, through very faintness, after the experience of so endless miseries. *Hooker.*

Prophesying with accents terrible,
Of dire *combustion*, and confused events,
New-hatched to the woeful time.

Shakespeare. Macbeth.

Those cruel wars between the houses of York and Lancaster, brought all England into an horrible *combustion*. *Raleigh.*

Charcoals made out of the wood of oxycedar, are white, because their vapours are rather sulphureous than of any other *combustible* substance.

Browne's Vulgar Errors.

How much more of power,
Army against army, numberless to raise
Dreadful *combustion* warring, and disturb,
Though not destroy, their happy aative seat!

Milton.

Sin is to the soul like fire to *combustible* matter; it assimilates before it destroys it. *South.*

They are but strewed over with a little penitential ashes; and will, as soon as they meet with *combustible* matter, flame out. *Decay of Piety.*

The future *combustion* of the earth is to be ushered in and accompanied with violent impressions upon nature. *Burnet.*

The flame shall still remain;
Nor, till the fuel perish, can decay,
By nature formed, on things *combustible* to prey.

Dryden.

But say, from whence this new *combustion* springs?

Id.

The comet moves in an inconceivable fury and *combustion*, and at the same time with an exact regularity.

Addison's Guardian.

COMBUSTIO PECUNIE, the ancient way of trying mixed and corrupt money, by melting it down upon payments into the exchequer. In the time of king Henry II. a constitution was made, called the trial by *combustion*; the practice of which differed little or nothing from the present method of assaying silver. But whether this examination of money by *combustion* was to reduce an equation of money only to sterling, viz. a due proportion of alloy with copper, or to reduce it to pure fine silver, does not appear. On making the constitution of trial it was considered, that though the money did answer in number and weight, it might be deficient in value, because mixed with copper or brass, &c.

COMBUSTION, in physic, has been defined, the operation of fire upon any inflammable substance, by which it smokes, flames, and is reduced to ashes. Dr. Ure describes it as the disengagement of heat and light which accompanies chemical combination. 'It is frequently,' he says, 'made to be synonymous with inflammation, a term which might be restricted, however, to that peculiar species of *combustion* in which gaseous matter is burned. Ignition is the incandescence of a body, produced by extrinsic means, without change of its chemical constitution.' There is no phenomenon in nature by which the attention

of philosophers has been more engaged, nor which has perplexed them more to account for, than this very common operation. To explain it, the most opposite and contradictory theories have been espoused; and, till very lately, science did not afford data sufficient to explain it in a rational manner. By former chemists it was supposed, that the parts of the combustible body itself were converted into fire. Accordingly, Sir Isaac Newton proposes it as a query, whether gross bodies and light are not convertible into one another! And many chemists of modern date, have determined this question in the affirmative, by maintaining that the light of the sun is, or contains, phlogiston. The interference of the air, however, in most cases of combustion known to us, proved a difficulty in this theory almost, if not totally, insurmountable; for if the fire proceed entirely from the combustible body, what occasion is there for any third substance distinct both from the fire and that body to produce combustion? This naturally excited a conjecture, that the fire by which the combustible body is consumed proceeds in reality from the air, and not from the body itself. And hence we see that Mr. Hutchinson's system of fire and air being convertible into one another, might have passed for a rational human theory, if he had not attempted to force it upon mankind as a divine revelation. The modern discoveries in aërology, however, have entirely disproved this hypothesis with regard to our atmosphere considered as a whole, at the same time that they point out the true method, as far as our faculties seem capable of comprehending it, by which this mysterious operation is performed.

It is now almost universally known, that the air we breathe is composed of two kinds of elastic fluids, only one of which contributes to the support of flame, as well as of animal life; and this part is found to be by far the least in quantity of the atmosphere we breathe. This kind of air, since its first discovery by Dr. Priestley, in 1774, has passed by the various names of dephlogisticated, empyreal, vital, and pure air, and is sometimes denominated oxygenous gas. It is computed from good observations, that, among the various component parts of our atmosphere, there is about one-fourth, $\frac{1}{4}$ according to Mr. Scheele, or, according to Mr. Cavendish, one-fifth of this pure fluid contained in it; and to this small part alone is owing the combustion of inflammable bodies. Since the establishment of this important fact, several theories of combustion have been formed.

Dr. Crawford endeavours to account for combustion, upon the exploded doctrine of phlogiston. By a great number of ingenious experiments he has endeavoured to show, that bodies, which contain a large portion of phlogiston, possess but a small share of specific heat or fire; on the contrary, that those with a large share of this last, contain but little phlogiston; and lastly, those which are deprived of phlogiston, increase their capacity for specific fire. Thus, when regulus of antimony is deprived of its phlogiston, by calcination, it nearly trebles its specific fire. The same changes take place in crocus martis and in iron. This fact is generally true, whatever be

the nature of the substance; and even the aëri-form ones are in the same case, for phlogisticated air has very little specific fire, common air has more of it, and dephlogisticated air shows a most prodigious quantity. From these facts it is clear, that phlogiston and fire are distinct, and incompatible substances; so that when one enters into the composition of any body, the other of course is expelled from it. Thus metals are calcined in consequence of a double attraction, by which the metal imparts its phlogiston to the air, while the air communicates its fire to the metallic calces, which is farther confirmed by the air found in metallic calces, whose increased weight by calcination corresponds to the air expelled from them, by their reduction to a metallic state. All combustible bodies are absolutely in the same case. Thus sulphur when burned contaminates the air, by the phlogiston it throws into it, and the produced vitriolic acid, if any, becomes impregnated with the same. In some cases the most intense heat or sensible fire is produced in the combustion; but in others it is very moderate. This variation generally depends on the quantity and quality of the vapors produced during the combustion; when these are very inconsiderable, and the residuum cannot absorb the fire emitted by the air, the remainder is precipitated or diffused all around, and produces a very sensible heat. On the contrary, if the vapors are capable of absorbing it, very little heat is produced. For instance, the vapor of waters absorbs about 800° of heat beyond that of its boiling state; from whence it follows, that, whenever there is a quantity of watery vapors produced by combustion, very little sensible fire must be felt. So when spirits of wine are fired, the heat then produced by the combustion is very inconsiderable, the greater part being absorbed by the watery vapors that are then produced; but, when the phosphorus of Kunkel is set on fire, the heat is very strong, there being but a small quantity of acid to carry off the specific fire that is set loose. This theory M. Magellan prefers to those of Messrs. Scheele, Fourcroy, and Lavoisier.

Combustible bodies, says M. Fourcroy, are those which have a strong attraction to unite with pure or dephlogisticated air; and combustion is nothing else but the act of that combination. This assertion is founded on the following facts: 1. That no substance can be burnt without air; 2. That the purer this air is the more rapid is the combustion; 3. That in combustion, an absorption or waste of air always takes place; and, 4. That the residuum contains often a very sensible quantity of that pure air which is absorbed, and which may sometimes be extracted from it.

According to this eminent chemist, dephlogisticated air is a compound of two substances, intimately combined; one is called by him the oxygenous principle, and the other specific elementary fire. During the combustion of sulphur, phosphorus, inflammable air, or any other substance of that kind, the oxygenous principle of the dephlogisticated air, combines with these bodies, to which it has a strong attraction, and forms new compounds of salts and other bodies; at the

same time that the elementary fire contained in these is set loose, and becomes sensible, producing heat and flame according to circumstances. Thus the fire produced in combustion does not proceed from the burned body, but from the decomposition of pure air, in which it is contained, in a latent and insensible state; while its oxygenous principle combines with the sulphur, phosphorus, or inflammable air, and forms vitriolic and phosphoric acids, or pure water.

As M. Scheele's theory, like that of Dr. Crawford, is founded on the ideal doctrine of phlogiston we shall give but a brief view of it. He considers heat and light themselves as compound substances. The former, according to him, consists of phlogiston and empyreal air. The calces of gold, reducible by heat alone, in a retort, show that phlogiston is contained in heat; because it combines with the calces to revive them, and the dephlogisticated air is found in the receiver. The precipitate per se of mercury, if revived in this manner, affords, he says, another instance of the truth of his doctrine: 'If phlogiston alone,' says he, 'could pass through the retort, there would not be found the empyreal air in the receiver, and the ignoble metals might be revived in the same manner.' Light, according to him, is a compound, containing phlogiston and heat, from which both may separate themselves in proper circumstances. A solution of silver in nitrous acid mixed with chalk, and exposed to the sun-shine, is revived into a metallic form by the phlogiston of light. Nitrous acid in a glass vessel, receives phlogiston from light, and becomes of an orange color; but if the glass be painted black, the acid receives the heat not the phlogiston. Even the various colored rays of light contain unequal shares of phlogiston; since the violet rays part more easily with their phlogiston to revive metals than any other. When light is not stopped in its passage, no heat is perceived; but if stopped in its course, the opposing body receives heat, and sometimes phlogiston. Light seems, therefore, to be the matter of heat, loaded with a superabundant quantity of phlogiston. That which comes out from a furnace produces heat on the surrounding bodies, which ascends with the rarefied air; proceeds forward in straight lines; and may be reflected from polished surfaces, with this peculiarity, that a concave glass mirror retains the heat, whilst it reflects the light; for although its focus is bright, yet it is not warm. A pane of glass also put before a burning mirror, retains the heat, and allows the light to pass through it. Fire is more or less heated to the luminous state of bodies, by which they are resolved into their constituent parts, and entirely destroyed. Combustion is the action of heat penetrating the pores of bodies, and destroying their cohesion; in this case the body parts with its phlogiston, provided there be a substance present which has a strong attraction for the inflammable principle. If the heating be performed in open air, the empyreal part, on account of its stronger attraction, unites with the inflammable principle, which is thus set at liberty; from which union the heat is compounded; and scarcely is this heat generated, when the combustible body is still more ex-

panded by it, and its phlogiston more laid open. The more the heat is increased, the more minute are the particles into which the combustible body is dissolved. The empyreal air meets more surfaces, comes in contact with more phlogiston, and forms an union with a greater quantity of it, which produces a radiant heat. At this moment the constituent parts of the combustible body are so much disunited by the still increasing heat, that the empyreal air, continuing to pour in upon it in streams, attracts the phlogiston in still greater quantities; and hence the most elastic substance, light, is composed; which, according to the quantity of combustible matter, shows various colors.

All this, however, is so exceedingly contrary to the common notions of mankind, that it can scarcely ever be seriously believed. The pure light of the sun can never be supposed by any mortal to consist principally of a substance as gross as the soot of our chimneys, without a degree of evidence of which the subject is quite incapable. With regard to the theory of Fourcroy, it is evidently deficient in one of the essential requisites to produce combustion, even fire itself; for if combustion depend only on the attraction between combustible bodies and pure air, then it ought to take place on all occasions wherever pure air and combustible bodies are presented to each other. But this is not the case; for though we put a piece of unlighted charcoal into a jar full of dephlogisticated air, no combustion will ensue. To produce this it is necessary that the charcoal be already, in part at least, in a state of combustion, or that fire be applied to it from without. This theory, therefore, instead of explaining the matter, gives not the smallest insight into it; since we are perpetually left to seek for the cause of the fire, which produced that in question; for the combination of a combustible body with air is the effect of combustion, not the cause. And Dr. Crawford's theory appears evidently insufficient from the following considerations: The degree of specific heat contained in bodies cannot be measured by any method yet known to us; that the phrase, quantity of heat, is vague, inaccurate, and improper; as expressing only the degree of sensible heat extricated, produced, generated, or which becomes perceptible in certain circumstances by us, without regard to the real quantity contained in the body itself, either originally, or after it has parted with that in question. Thus all experiments founded on the quantities of specific heat contained in different bodies, must be fallacious and inconclusive. Not to insist, however, on these general arguments, it is contrary to fact, that 'bodies which contain a large portion of phlogiston contain but a small share of specific heat,' and vice versa, as the Doctor asserts; which will appear from the following considerations: 1. The only methods by which we can measure the quantity of any material substance is either by its bulk or weight. 2. Whatever occupies space, and resists the touch, we have a right to call a material substance, whether we can see it, and weigh it, or not. Thus air, which is invisible, and not very easily ponderable, is universally allowed to be a sub-

stance and not a quality. 3. In cases where we cannot conveniently measure the weight of any substance, its quantity must always be judged of by its bulk. Thus the quantity of air contained in a bladder, or in a bellows, is always judged of by the degree of expansion of either. 4. Heat, which is still more subtle than air, is measured in this way, as Dr. Crawford himself acknowledges; for the expansions of mercury are, in an arithmetical progression, expressive of the real degrees of heat. 5. Applying this rule to bodies in general, we must conclude, that the expansions of all bodies will be in proportion to the degrees of heat which they contain. Thus, if a body is expanded by heat to double its bulk, and in this state remains even when the heating cause is withdrawn, we may then say with justice, that this body contains double the quantity of latent or specific heat that it did before, and so on. 6. As the vapor of water absorbs a vast quantity of heat, and likewise becomes prodigiously expanded in comparison with the water from whence it is produced, we may conclude that the quantity of heat absorbed, or of specific heat contained in the steam, is to the specific heat contained in the water as the bulk of the steam is to that of the water. It is difficult indeed to determine how much steam exceeds in bulk the water from which it is derived; but from some experiments, Dr. Black concludes that it is augmented in bulk between 1600 and 1700 times: and from the great quantity of heat emitted by steam during the process of condensation, which in some cases exceeds 1000° of Fahrenheit, we have reason to believe that the quantity of its expansion is proportionable to that of the heat absorbed. 7. As we have thus ascertained, by the great expansion of aqueous vapor, that it has absorbed a vast quantity of heat, it follows, that from the expansion of other substances we ought also to know the quantity of heat absorbed by them. In Dr. Priestley's experiments on the conversion of charcoal into inflammable air, he found that one grain of charcoal, dispersed by the heat of the sun in vacuo, gave six ounce measures of inflammable air. In another experiment, he found that 2½ grains of charcoal gave 15½ ounce measures of the same kind of air. But from a computation of the weight of the air so produced, it appears that at least an equal quantity of water with that of the charcoal goes to the composition of the aërial fluid. In measuring this expansion, therefore, we may allow one-half for that of the water requisite to form the inflammable air; and hence the grain of charcoal, properly speaking, absorbs only three ounce measures of fire. That this expansion was the effect of fire is evident: for there was nothing else present but fire, or the concentrated light of the sun; the experiment being performed by a burning-glass in vacuo. It cannot be a fact then, as Dr. Crawford asserts, that a phlogistic body contains but a small quantity of specific heat; for here so small a quantity as one grain of charcoal was made to contain as much specific fire as is equivalent in bulk to three ounce measures. The quantity of specific fire, therefore, contained in bodies, is not determined by their being combustible or not, or by their containing phlogiston or not. 8. The last

part of the doctor's theory must also be erroneous, viz. that 'In the act of combustion the dephlogisticated air communicates its fire to the combustible body.' For instead of this, when dephlogisticated and inflammable air, mixed together in due proportion, are set on fire, they shrink in a manner into nothing; so that instead of the one communicating its fire to the other, both of them throw out almost all the fire they contain; so that they are no longer air, but water. 9. Dr. Crawford's theory of combustion supersedes the necessity of any external cause to set on fire the combustible bodies. If dephlogisticated air attracts the phlogiston of the combustible body, and the phlogiston in the latter attracts the fire of the dephlogisticated air, the consequence of which is combustion: then, wherever dephlogisticated and inflammable air are mixed, combustion ought immediately to ensue. But this is not the case. A candle, a spark of electricity, or, in a word, some body already in a state of combustion, must be applied before we can produce the effect in question. We must therefore seek for the cause of combustion in the burning body applied, which will be found equally inexplicable: and thus we are not advanced one step in real knowledge, by Dr. Crawford's hypothesis.

The theory of Lavoisier was therefore, until a recent period, the only resort of chemists.

Dr. Robison, in his preface to Black's lectures, after tracing, with perhaps superfluous zeal, the expanded ideas of Lavoisier to the neglected germs of Hooke and Mayow, says, 'This doctrine concerning combustion, the great, the characteristic phenomenon of chemical nature, has at last received almost universal adoption, though not till after considerable hesitation and opposition; and it has made a complete revolution in chemical science.'

'The French theory of chemistry, as it was called,' says Dr. Ure, 'or hypothesis of combustion, as it should have been named, was for some time classed in certainty with the theory of gravitation. Alas! it is vanishing with the luminous phantoms of the day; but the sound logic, the pure candor, the numerical precision of inference, which characterise Lavoisier's Elements, will cause his name to be held in everlasting admiration.'

'It was the rival logic of Sir H. Davy,' continues this writer, 'aided by his unrivalled felicity of investigation, which first recalled chemistry from the pleasing labyrinths of fancy, to the more arduous but far more profitable and progressive career of reason. His researches on combustion and flame, already rich in blessings to mankind, would alone place him in the first rank of scientific genius.'

We copy, by permission, Dr. Ure's able digest of these researches:—'If Bacon were to revisit the earth,' it has been well said by another writer, 'this is exactly such a case as we should choose to place before him, in order to give him, in a small compass, an idea of the advancement which philosophy has made since the time when he had pointed out to her the route which she ought to pursue.'

'The phenomena of combustion may be con-

veniently considered under six heads:—1st. The temperature necessary to inflame different bodies. 2d. The nature of flame, and the relation between the light and heat which compose it. 3d. The heat disengaged by different combustibles in burning. 4th. The causes which modify and extinguish combustion, and of the safe-lamp. 5th. Invariable combustion. 6th. Practical inferences.

1st. Of the temperature necessary to inflame different bodies. 1st. A simple experiment shows the successive combustibilities of the different bodies. Into a long bottle with a narrow neck, introduce a lighted taper, and let it burn till it is extinguished. Carefully stop the bottle, and introduce another lighted taper. It will be extinguished before it reaches the bottom of the neck. Then introduce a small tube, containing zinc, and dilute sulphuric acid, at the aperture of which the hydrogen is inflamed. The hydrogen will be found to burn in whatever part of the bottle the tube is placed. After the hydrogen is extinguished, introduce lighted sulphur. This will burn for some time; and after its extinction phosphorus will be as luminous as in the air, and, if heated in the bottle, will produce a pale yellow flame of considerable density. Phosphorus is said to take fire when heated to 150° , and sulphur to 550° . Hydrogen inflames with chlorine at a lower temperature than with oxygen. By exposing oxygen and hydrogen, confined in glass tubes, to a very dull red (about 800° F.) they explode. When the heat was about 700° F. they combined rapidly with a species of silent combustion. A mixture of common air and hydrogen was introduced into a small copper tube, having a stopper not quite tight; the copper tube was placed in a charcoal fire; before it became visibly red-hot, an explosion took place, and the stopper was driven out. We see, therefore, that the inflaming temperature is independent of compression or rarefaction.

The ratio of the combustibility of the different gaseous matters is likewise, to a certain extent, as the masses of heated matters required to inflame them. Thus, an iron-wire $\frac{1}{40}$ th of an inch, heated cherry-red, will not inflame olefiant gas, but it will inflame hydrogen gas. A wire of $\frac{1}{8}$ th, heated to the same degree, will inflame olefiant gas. But a wire $\frac{1}{10}$ th of an inch must be heated to whiteness, to inflame hydrogen, though at a low red heat it will inflame biphosphureted gas. Yet wire of $\frac{1}{40}$ th, heated even to whiteness, will not inflame mixtures of fire-damp. Carbonic oxide inflames in the atmosphere when brought into contact with an iron wire heated to dull redness; whereas carbureted hydrogen is not inflammable, unless the iron is heated to whiteness, so as to burn with sparks. These circumstances will explain why a mesh of wire, so much finer or smaller, is required to prevent the explosion from hydrogen and oxygen from passing; and why so coarse a texture and wire are sufficient to prevent the explosion of the fire-damp, fortunately the least combustible of all the inflammable gases known. The flame of sulphur, which kindles at so low a temperature, will exist under refrigerating processes, which extinguish the flame of hydrogen and all carbureted gases. Let the smallest possible flame be made by a

single thread of cotton immersed in oil, and burning immediately upon the surface of the oil. It will be found to yield a flame about $\frac{1}{30}$ th of an inch in diameter. Let a fine iron wire of $\frac{1}{10}$ th of an inch, made into a ring of $\frac{1}{10}$ th of an inch diameter, be brought over the flame. Though at such a distance, it will instantly extinguish the flame, if it be cold; but if it be held above the flame, so as to be slightly heated, the flame may be passed through it without being extinguished. That the effect depends entirely on the power of the metal to abstract the heat of flame, is shown by bringing a glass capillary ring of the same diameter and size over the flame. This being a much worse conductor of heat, will not, even when cold, extinguish it. If its size, however, be made greater, and its circumference smaller, it will act like the metallic wire, and require to be heated to prevent it from extinguishing the flame. Now, a flame of sulphur may be made much smaller than that of hydrogen; one of hydrogen may be made much smaller than that of a wick fed with oil; and that of a wick fed with oil smaller than that of carbureted hydrogen. A ring of cool wire, which instantly extinguishes the flame of carbureted hydrogen, diminishes but slightly the size of a flame of sulphur of the same dimensions. By the following simple contrivance, we may determine the relative facility of burning, among different combustibles. Prepare a series of metallic globules of different sizes, by fusion at the end of iron wires, and light a series of very minute flames of different bodies all of one size. If a globule $\frac{1}{20}$ th of an inch diameter be brought near an oil flame of $\frac{1}{30}$ th in diameter, it will extinguish it, when cold, at the distance of a diameter. The size of the spherule adequate to the extinction of the particular flame, will be a measure of its combustibility. If the globule be heated, however, the distance will diminish at which it produces extinction. At a white heat, the globule, in the above instance, does not extinguish it by actual contact, though at a dull red heat it immediately produces the effect.

2d. Of the nature of flame, and of the relation between the light and the heat which compose it. The flame of combustible bodies may, in all cases, be considered as the combustion of an explosive mixture of inflammable gas, or vapor, with air. It cannot be regarded as a mere combustion, at the surface of contact, of the inflammable matter. This fact is proved by holding a taper, or a piece of burning phosphorus, within a large flame made by the combustion of alcohol. The flame of the taper, or of the phosphorus, will appear in the centre of the other flame, proving that there is oxygen even in its interior part. When a wire-gaule safe-lamp is made to burn, in a very explosive mixture of coal gas and air, the light is feeble, and of a pale color. Whereas the flame of a current of coal gas burnt in the atmosphere, as is well known by the phenomena of the gas-lights, is extremely brilliant. It becomes, therefore, a problem of some interest, 'Why the combustion of explosive mixtures, under different circumstances, should produce such different appearances?' In reflecting on the circumstances of these two species of combustion,

Sir H. Davy was led to imagine that the cause of the superiority of the light of the stream of coal-gas, might be owing to the decomposition of a part of the gas, towards the interior of the flame, where the air was in the smallest quantity, and the deposition of solid charcoal, which first by its ignition, and afterwards by its combustion, increased in a high degree the intensity of the light. The following experiments show that this is the true solution of the problem:—

‘If we hold a piece of wire-gause of about 900 apertures to the square inch, over a stream of coal-gas issuing from a small pipe, and if we inflame the gas above the wire-gause, left almost in contact with the orifice of the pipe, it burns with its usual bright light. On raising the wire-gause so as to cause the gas to be mixed with more air before it inflames, the light becomes feebler, and at a certain distance the flame assumes the precise character of that of an explosive mixture burning within the lamp. But though the light is so feeble in this case, the heat is greater than when the light is much more vivid. A piece of wire of platina, held in this feeble blue flame, becomes instantly white-hot. On reversing the experiment, by inflaming a stream of coal gas, and passing a piece of wire-gause gradually from the summit of the flame to the orifice of the pipe, the result is still more instructive. It is found that the apex of the flame, intercepted by the wire-gause, affords no solid charcoal; but, in passing it downwards, solid charcoal is given off in considerable quantities, and prevented from burning by the cooling agency of the wire-gause. At the bottom of the flame, where the gas burned blue, in its immediate contact with the atmosphere, charcoal ceased to be deposited in visible quantities.

‘The principle of the increase of the brilliancy and density of flame, by the production and ignition of solid matter, appears to admit of many applications. Thus, olefant gas gives the most brilliant white light of all combustible gases, because, as we learn from Berthollet’s experiments, related under carbureted hydrogen, at a very high temperature it deposits a very large quantity of solid carbon. Phosphorus, which rises in vapor at common temperatures, and the vapor of which combines with oxygen at those temperatures, is always luminous; for each particle of acid formed, must, there is every reason to believe, be white-hot. So few of these particles, however, exist in a given space, that they scarcely raise the temperature of a solid body exposed to them, though, as in the rapid combustion of phosphorus, where immense numbers are existing in a small space, they produce a most intense heat. The above principle readily explains the appearances of the different parts of the flame of burning bodies, and of flame urged by the blow-pipe. The point of the inner blue flame, where the heat is greatest, is the point where the whole of the charcoal is burned in its gaseous combinations, without previous deposition.

‘It explains also the intensity of the light of those flames in which fixed solid matter is produced in combustion, such as the flame of phosphorus and of zinc in oxygen, &c. and of

potassium in chlorine, and the feebleness of the light of those flames in which gaseous and volatile matter alone is produced, such as those of hydrogen and of sulphur in oxygen, phosphorus in chlorine, &c. It offers means of increasing the light of certain burning substances, by placing in their flames even incombustible substances. Thus the intensity of the light of burning sulphur, hydrogen, carbonic oxide, &c. is wonderfully increased by throwing into them oxide of zinc, or by placing in them very fine amianthus or metallic gause. It leads to deductions concerning the chemical nature of bodies, and various phenomena of their decomposition. Thus ether burns with a flame, which seems to indicate the presence of olefant gas in that substance. Alcohol burns with a flame similar to that of a mixture of carbonic oxide and hydrogen. Hence the first is probably a binary compound of olefant gas and water, and the second of carbonic oxide and hydrogen. When protochloride of copper is introduced into the flame of a candle or lamp, it affords a peculiar dense and brilliant red light, tinged with green and blue towards the edges, which seems to depend upon the chlorine being separated from the copper by the hydrogen, and the ignition and combustion of the solid copper and charcoal.

‘Similar explanations may be given of the phenomena presented by the action of other combinations of chlorine on flame; and it is probable, in many of those cases, when the color of flame is changed by the introduction of incombustible compounds, that the effect depends on the production, and subsequent ignition or combustion, of inflammable matter from them. Thus the rose-colored light given to flame by the compounds of strontium and calcium, and the yellow color given by those of barium, and the green by those of boron, may depend upon a temporary production of these bases, by the inflammable matter of the flame. Dr. Clarke’s experiments on the reduction of barytes, by the hydroxygen lamp, is favorable to this idea. Nor should any supposed inadequacy of heat in ordinary flame prevent us from adopting this conclusion. Flame, or gaseous matter, heated so highly as to be luminous, possesses a temperature beyond the white heat of solid bodies, as is shown by the circumstance, that air not luminous will communicate this degree of heat. This is proved by a simple experiment. Hold a fine wire of platinum about 1-20th of an inch from the exterior of the middle of the flame of a spirit-lamp, and conceal the flame by an opaque body. The wire will become white-hot in a space where there is no visible light. The real temperature of visible flame is perhaps as high as any we are acquainted with. Mr. Tennant used to illustrate this position by fusing a small filament of platinum in the flame of a common candle. These views will probably offer illustrations of electrical light. The voltaic arc of flame from the great battery differs in color and intensity, according to the substances employed in the circuit, and is infinitely more brilliant and dense with charcoal than with any other substance. May not this depend, says Sir H. Davy, upon particles of the substances separated by

the electrical attractions? And the particles of charcoal being the lightest among solid bodies, as their prime equivalent shows, and the least coherent, would be separated in the largest quantities. The heat of flames may be actually diminished by increasing their light, at least the heat communicable to other matter, and vice versa. The flame from combustion, which produces the most intense heat amongst those which have been examined, is that of a mixture of oxygen and hydrogen compressed in Newmann's blow-pipe apparatus. This flame is hardly visible in bright day-light, yet it instantly fuses the most refractory bodies; and the light from solid bodies ignited in it is so vivid as to be painful to the eye. This application certainly originated from Sir H. Davy's discovery, that the explosion from oxygen and hydrogen would

not communicate through very small apertures, and he himself first tried the experiment with a fine glass capillary tube. The flame was not visible at the end of this tube, being overpowered by the brilliant star of the glass, ignited at the aperture.

3. 'Of the heat disengaged by different combustibles in the act of burning.—Lavoisier, Crawford, Dalton, and Rumford, in succession, made experiments to determine the quantity of heat evolved in the combustion of various bodies. The apparatus used by the last was perfectly simple, and perhaps the most precise of the whole. The heat was conducted by flattened pipes of metal into the heart of a body of water, and was measured by the temperature imparted. The following is a general table of results:—

Substances burned, 1 lb.	Oxygen consumed in lbs.	Ice melted in lbs.			
		Lavoisier.	Crawford.	Dalton.	Rumford.
Hydrogen	7.5	295.6	480	320	
Carbureted hydrogen	4			85	
Olefiant gas	3.50			88	
Carbonic oxide	0.58			25	
Olive oil	3.00	149	89	104	94.07
Rape oil	3.0				124.10
Wax	3.0	133	97	104	126.24
Tallow	3.0	96		104	111.58
Oil of turpentine				60	
Alcohol	2.0?			58	67.47
Ether, sulphuric	3			62	107.03
Naphtha					97.83
Phosphorus	1.3	100		61	
Charcoal	2.66	96.5	69	40	
Sulphur	1.00			20	
Camphor				70	
Caoutchouc				42	

'The discrepancies in the preceding table are sufficient to show the necessity of new experiments on the subject. Count Rumford made a series of experiments on the heat given out during the combustion of different woods. He found that one pound of wood by burning, produced as much heat as would have melted from about thirty-four to fifty-four pounds of ice. The average quantity is about forty. MM. Clement and Desormes find that woods give out heat in the ratio of their respective quantities of carbon; which they state to be equal to one-half of their total weight. Hence they assign forty-eight pounds as the quantity of ice melted, in burning one of wood. In treating of acetic acid and carbon, I have already taken occasion to state, that they appear probably to overrate the proportion of carbon in woods.

'The preceding table is incorrectly given in several respects by our systematic writers; Dr. Thomson, for example, states, that one pound of hydrogen consumes only six pounds of oxygen, though the saturating proportion assigned by him is eight pounds. The proportions of oxygen consumed by olive oil, phosphorus, charcoal, and sulphur, are all in like manner erroneous. In vol. i. p. 184, of Dr. Black's Lectures, we

have the following notes: 'One hundred pounds weight of the best Newcastle coal, when applied by the most judiciously constructed furnace, will convert about 1½ wine hogsheads of water into steam, that supports the pressure of the atmosphere.' 1½ hogsheads of water weigh about 790 pounds. Hence one part of coal will convert nearly eight parts of water into steam. Count Rumford says, that the heat generated in the combustion of one pound of pit-coal, would make 36½ pounds of ice-cold water boil. But we know that it requires fully 5½ times as much heat to convert the boiling water into steam.

Therefore, $\frac{36.5}{5.5} = 6\frac{2}{3}$, is the weight of water that would be converted into steam by one pound of coal. Mr. Watt found that it requires eight feet surface of boiler to be exposed to fire to boil off one cubic foot of water per hour, and that a bushel, or eighty-four pounds of Newcastle coal, so applied, will boil off from eight to twelve cubic feet. He rated the heat, expended in boiling off a cubic foot of water, to be about six times as much as would bring it to a boiling heat from the medium temperature, 55°, in this climate. The mean quantity is ten cubic feet, which weigh 625 pounds. Hence one pound of coal

burnt is equivalent to boil off in steam nearly $7\frac{1}{2}$ pounds of water, at the temperature of 55° . In situations where wood was employed for fuel to Mr. Watt's engines, he allowed three times the weight of it, that he did of Newcastle coal. The cubical coal of the Glasgow coal district, is reckoned to have only three-fourths the calorific power of the Newcastle coal; and the small coal or culm requires to be used in double weight, to produce an equal heat with the larger pieces. A bushel of Newcastle coal is equivalent to a hundred weight of the Glasgow.

'I shall now describe the experiments recently made on this subject by Sir. H. Davy, subservient to his researches on the nature of flame. A mercurial gas-holder, furnished with a system of stop-cocks, terminated in a strong tube of platinum, having a minute aperture. Above this was fixed a copper cup filled with olive oil, in which a thermometer was placed. The oil was heated to 212° , to prevent any difference in the communication of heat, by the condensation of aqueous vapor: the pressure was the same for the different gases; and they were consumed as nearly as possible in the same time, and the flame applied to the same point of the copper cup, the bottom of which was wiped after each experiment. The results were as follows:—

Substances.	Rise of ther from 212° to	Oxygen consumed.	Ratios of heat.
Olefiant gas,	270°	6.0	9.66
Hydrogen,	238	1.0	26.0
Sulph. hydrogen,	232	3.0	6.66
Coal gas,	236	4.0	6.00
Carbonic oxide,	218	1.0	6.00

'The data on which Sir. H. calculates the ratios of heat, are the elevations of temperature and the quantities of oxygen consumed conjointly. We see that hydrogen produces more heat in combustion than any of its compounds, a fact accordant with Mr. Dalton's results in the former table; only Sir H. Davy's ratio is more than double that of Mr. Dalton's, as to hydrogen, and carbureted hydrogen. On this point, however, Sir H. with his usual sagacity remarks, that it will be useless to reason upon the ratios as exact, for charcoal was deposited from both the olefiant gas and coal gas during the experiment, and much sulphur was deposited from the sulphureted hydrogen. It confirms, however, the general conclusions, and proves that hydrogen stands at the head of the scale, and carbonic oxide at the bottom. It might at first view be imagined, that, according to this scale, the flame of carbonic oxide ought to be extinguished by rarefaction at the same degree as that of carbureted hydrogen; but it must be remembered, as has been already shown, that carbonic oxide is a much more easily kindled, a more ascensible gas.

'4. Of the causes which modify or extinguish combustion or flame. The earlier experimenters upon the Boylean vacuum observed, that flame

ceased in highly rarefied air; but the degree of rarefaction necessary for this effect has been differently stated. On this point, Sir H. Davy's investigations are peculiarly beautiful and instructive. When hydrogen gas, slowly produced from a proper mixture, was inflamed at a fine orifice of a glass tube, as in Priestley's philosophical candle, so as to make a jet of flame of about 1-6th of an inch in height, and introduced under the receiver of an air-pump, containing from 200 to 300 cubical inches of air, the flame enlarged as the receiver became exhausted; and when the gauge indicated a pressure between four and five times less than that of the atmosphere, was at its maximum of size; it then gradually diminished below, but burned above till its pressure was between seven and eight times less; when it became extinguished.

'To ascertain whether the effect depended upon the deficiency of oxygen, he used a larger jet with the same apparatus, when the flame, to his surprise, burned longer; even when the atmosphere was rarefied ten times; and this in repeated trials. When the larger jet was used, the point of the glass tube became white-hot, and continued red-hot till the flame was extinguished. It immediately occurred to him, that the heat communicated to the gas by this tube, was the cause that the combustion continued longer in the last trials when the larger flame was used; and the following experiments confirmed the conclusion. A piece of wire of platinum was coiled round the top of the tube, so as to reach into and above the flame. The jet of gas of 1-6th of an inch in height was lighted, and the exhaustion made. The wire of platinum soon became white-hot in the centre of the flame, and a small point of wire near the top fused. It continued white-hot till the pressure was six times less. When it was ten times it continued red-hot at the upper part, and, as long as it was dull red, the gas, though certainly extinguished below, continued to burn in contact with the hot wire; and the combustion did not cease until the pressure was reduced thirteen times. It appears from this result, that the flame of hydrogen is extinguished in rarefied atmospheres, only when the heat it produces is insufficient to keep up the combustion; which appears to be when it is incapable of communicating visible ignition to metal; and as this is the temperature required for the inflammation of hydrogen (see section 1), at common pressure, it appears that its combustibility is neither diminished nor increased by rarefaction from the removal of pressure.

'According to this view, with respect to hydrogen, it should follow, that those amongst other combustible bodies which require less heat for their ascension, ought to burn in more rarefied air than those that require more heat; and those which produce much heat in their combustion ought to burn, other circumstances being the same, in more rarefied air than those that produce little heat. Every experiment since made confirms these conclusions. Thus olefiant gas, which approaches nearly to hydrogen, in the temperature produced by its combustion, and which does not require a much higher temperature for its ascension, when its flame was made

by a jet of gas from a bladder connected with a small tube, furnished with a wire of platinum, under the same circumstances as hydrogen, ceased to burn when the pressure was diminished between ten and eleven times. And the flames of alcohol and of the wax taper, which require a greater consumption of caloric for the volatilisation and decomposition of their combustible matter, were extinguished when the pressure was five or six times less without the wire of platinum, and seven or eight times less when the wire was kept in the flame. Light carbureted hydrogen, which produces, as we have seen, less heat in combustion than any of the common combustible gases, except carbonic oxide, and which requires a higher temperature for its ascension than any other, has its flame extinguished, even though the tube was furnished with the wire when the pressure was below 1-4th. The flame of carbonic oxide, which, though it produces little heat in combustion, is as ascensible as hydrogen, burned when the wire was used, the pressure being 1-6th. The flame of sulphureted hydrogen, the heat of which is in some measure carried off by the sulphur produced by its decomposition during its combustion in rare air, when burned in the same apparatus as the olefant and other gases, was extinguished when the pressure was 1-7th. Sulphur, which requires a lower temperature for its ascension than any common inflammable substance, except phosphorus, burned with a very feeble blue flame in air rarefied fifteen times; and at this pressure the flame heated a wire of platinum to dull redness; nor was it extinguished till the pressure was reduced to 1-20th. From the preceding experimental facts we may infer, that the taper would be extinguished at a height of between nine and ten miles, hydrogen between twelve and thirteen, and sulphur between fifteen and sixteen. Phosphorus, as has been shown by M. Van Marum, burns in an atmosphere rarefied sixty times. Sir H. Davy found, that phosphureted hydrogen produced a flash of light when admitted into the best vacuum that could be made by an excellent pump of Nairne's construction. Chlorine and hydrogen inflame at a much lower temperature than oxygen and hydrogen. Hence the former mixture explodes when rarefied twenty-four times; the latter ceases to explode when rarefied eighteen times. Heat extrinsically applied, carries on combustion, when it would otherwise be extinguished. Camphor in a thick metallic tube, which disperses the heat, ceases to burn in air rarefied six times; in a glass tube which becomes ignited, the flame of camphor exists under a ninefold rarefaction. Contact with a red-hot iron makes naphtha glow with a lambent flame at a rarefaction of thirty times; though, without foreign heat, its flame dies at an atmospheric rarefaction of six. If the mixture of oxygen and hydrogen, expanded to its non-explosive tenuity, be exposed to the ignition of a glass tube, the electric spark will then cause an explosion, at least in the heated portion of the gases.

'We shall now detail briefly the effects of rarefaction by heat on combustion and explosion. We know that air, by being heated from 32° to

212° expands 3-8ths, or eight parts become eleven. Sir H. Davy justly estimates the temperature corresponding to an increase of one volume of air at 212°, into two volumes and a half, (which took place when the enclosing glass tube began to soften with ignition), at 1035° Fahrenheit. Sir H. introduced into a small glass tube, over well boiled mercury, a mixture of two parts of hydrogen and one of oxygen, and heated the tube by a spirit-lamp, till the volume of the gas was increased from 1 to 2.5. By means of a blow-pipe and another lamp, he made the upper part of the tube red-hot, when an explosion instantly took place. This experiment refutes the notions of M. de Grotthus, on the non-explosiveness of that mixture, when expanded by heat. He introduced into a bladder a mixture of oxygen and hydrogen, and connected this bladder with a thick glass tube of about 1-6th of an inch in diameter, and three feet long, curved so that it could be gradually heated in a charcoal furnace: two spirit-lamps were placed under the tube, where it entered the charcoal fire, and the mixture was very slowly passed through. An explosion took place before the tube was red-hot. This fine experiment shows, that expansion by heat, instead of diminishing the accendibility of gases, enables them, on the contrary, to explode apparently at a lower temperature; which seems perfectly reasonable, as a part of the heat communicated by any ignited body, must be lost in gradually raising the temperature. M. de Grotthus has stated, that if a glowing coal be brought into contact with a mixture of oxygen and hydrogen, it only rarefies them, but does not explode them. This depends on the degree of heat communicated by the coal. If it is red in day-light, and free from ashes, it uniformly explodes the mixture. If its redness be barely visible in the shade, it will not explode them, but cause their slow combination. The general phenomenon is wholly unconnected with rarefaction, as is shown by the following circumstance: when the heat is greatest, and before the invisible combination is completed, if an iron wire, heated to whiteness, be placed upon the coal within the vessel, the mixture instantly explodes.

'Subcarbureted hydrogen, or fire-damp, as has been shown, requires a very strong heat for its inflammation. It therefore offered a good substance for an experiment on the effect of high degrees of rarefaction, by heat, on combustion. One part of this gas, and eight of air, were mixed together, and introduced into a bladder furnished with a capillary tube. This tube was heated till it began to melt. The mixture was then passed through it into the flame of a spirit-lamp, when it took fire, and burned with its own peculiar explosive light, beyond the flame of the lamp; and when withdrawn, though the aperture was quite white-hot, it continued to burn vividly. That the compression in one part of an explosive mixture, produced by the sudden expansion of another part by heat, or the electric spark, is not the cause of combustion, as has been supposed by Mr. Higgins, M. Berthollet, and others, appears to be evident from what has been stated, and is rendered still more so by the following facts:—A mixture of biphosphureted hydrogen

gas and oxygen, which explode at a heat a little above that of boiling water, was confined by mercury, and very gradually heated on a sand bath. When the temperature of the mercury was 242°, the mixture exploded. A similar mixture was placed in a receiver communicating with a condensing syringe, and condensed over mercury till it occupied only one-fifth of its original volume. No explosion took place, and no chemical change had occurred; for, when its volume was restored, it was instantly exploded by the spirit-lamp. It would appear then that *the heat* given out by the compression of gases, is the real cause of the combustion which it produces; and that at certain elevations of temperature, whether in rarefied or compressed atmospheres, explosion or combustion occurs; that is, bodies combine with the production of heat and light. Since it appears that gaseous matter acquires a double, triple, quadruple, &c., bulk, by the successive increments of 480° Fahrenheit, $2 \times 480^\circ$, $3 \times 480^\circ$, &c., we may gain approximations to the temperature of flame, by measuring the expansion of a gaseous mixture at the instant of explosion, provided the resulting compound gas occupy, after cooling, the same bulk as the sum of its constituents. Now this is the case with chlorine and hydrogen, and with prussine and oxygen. The latter detonated in the proportion of one to two, in a tube of about two-fifths of an inch diameter, displaced a quantity of water, which demonstrated an expansion of fifteen times their original bulk. Hence $15 \times 480^\circ = 7200^\circ$ of Fahrenheit; and the real temperature is probably

much higher, for heat must be lost by communication to the tube and the water. The heat of the gaseous carbon in combustion in this gas, appears more intense than that of hydrogen; for it was found that a filament of platinum was fused by a flame of prussine (cyanogen) in the air, which was not fused by a similar flame of hydrogen. We have thus detailed the modifications produced in combustion by rarefaction, mechanical and calorific. It remains on this head to state the effects of the mixture of different gases, and those of different cooling orifices, on flame.

'In Sir H. Davy's first paper on the fire-damp of coal mines, he mentioned that carbonic acid had a greater influence in destroying the explosive power of mixtures of fire-damp and air, than azote; and he supposed the cause to be its greater density and capacity for heat, in consequence of which it might exert a greater cooling agency, and thus prevent the temperature of the mixture from being raised to that degree necessary for combustion. He subsequently made a series of experiments with the view of determining how far this idea is correct, and for the purpose of ascertaining the general phenomena of the effects of the mixture of gaseous substances upon explosion and combustion. He took given volumes of a mixture of two parts of hydrogen and one part of oxygen by measure, and, diluting them with various quantities of different elastic fluids, he ascertained at what degree of dilution the power of inflammation by a strong spark from a Leyden phial was destroyed. He found that for one of the mixture, inflammation was

	Prevented by.	Permitted with.	Cooling power, air, = 1.
Of hydrogen	8	6	2.66
Oxygen	9	7	1.12
Nitrous oxide	11	10	0.75 (the mean)
Subcarbureted hydrogen	1	$\frac{1}{2}$	2.18 (coal gas)
Sulphureted hydrogen	2	$1\frac{1}{2}$	
Olefant gas	$\frac{1}{2}$	$\frac{1}{2}$	1.6
Muriatic acid gas	2	$1\frac{1}{2}$	
Chlorine			0.66
Silicated fluoric gas	$\frac{1}{11}$	$\frac{1}{11}$	
Azote			1.33
Carbonic acid			0.727

The first column of the preceding table shows that other causes, besides density and capacity for heat, interfere with the phenomena. Thus nitrous oxide, which is nearly one-third denser than oxygen, and which, according to Delaroché and Berard, has a greater capacity for heat, in the ratio of 1.3503 to 0.9765 by volume, has lower powers of preventing explosion. Hydrogen also, which is fifteen times lighter than oxygen, and which in equal volumes has a smaller capacity for heat, certainly has a higher power of preventing explosion; and olefant gas exceeds all other gaseous substances, in a much higher ratio than could have been expected from its density and capacity.

'I have deduced the third column from Sir H. Davy's experiments on the relative times in which a thermometer, heated to 160°, when

plunged into a volume of twenty-one cubic inches of the respective gases at 52°, took to cool down to 106°. Where an elastic fluid exerts a cooling influence on a solid surface, the effect must depend principally upon the rapidity with which its particles change their places; but where the cooling particles are mixed throughout a mass with other gaseous particles, their effect must depend principally upon the power they possess of rapidly abstracting heat from the contiguous particles; and this will depend probably upon two causes, the simple abstracting power by which they become quickly heated, and their capacity for heat, which is great in proportion as their temperatures are less raised by this abstraction. The power of elastic fluids to abstract heat from solids, appears from the above experiments to be in some inverse ratio to their density; and there

seems to be something in the constitution of the light gases, which enables them to carry off heat from solid surfaces in a different manner from that in which they would abstract it in gaseous mixtures, depending probably on the mobility of their parts. Those particles which are lightest must be conceived most capable of changing place, and would therefore cool solid surfaces most rapidly: in the cooling of gaseous mixtures the mobility of the particles can be of little consequence.

Whatever be the cause of the different cooling powers of the different elastic fluids in preventing inflammation, very simple experiments show that they operate uniformly with respect to the different species of combustion; and that those explosive mixtures, or inflammable bodies, which require least heat for their combustion, require larger quantities of the different gases to prevent the effect, and vice versâ. Thus one of chlorine, and one of hydrogen, still inflame when mixed with eighteen times their bulk of oxygen; whereas a mixture of carbureted hydrogen and oxygen, in the proper proportions (one and two) for combination, have their inflammation prevented by less than three times their volume of oxygen. A wax taper was instantly extinguished in air mixed with one-tenth of silicated fluoric acid, and in air mixed with one-sixth of muriatic acid gas; but the flame of hydrogen burned readily in those mixtures; and in mixtures which extinguished the flame of hydrogen, the flame of sulphur burned. In cases, however, in which the heat required for chemical union is very small, as in the instance of hydrogen and chlorine, a mixture which prevents inflammation will not prevent combination; that is, the gases will combine without any flash. If two volumes of carbureted hydrogen be added to a mixture of one of chlorine with one of hydrogen, muriatic acid is formed throughout the mixture, and heat produced, as was evident from the expansion when the spark passed, and the rapid contraction afterwards; but the heat was so rapidly carried off by the quantity of carbureted hydrogen, that no flash was visible.

Experiments on combustion in condensed air, to see if the cooling power was much increased thereby, show that, as rarefaction does not diminish considerably the heat of flame in atmospheric air, so neither does condensation considerably increase it; a circumstance of great importance in the constitution of our atmosphere, which at all heights or depths, at which man can exist, still preserves the same relations to combustion. It may be concluded from the general law, that, at high temperatures, gases not concerned in combustion will have less power of preventing that operation, and likewise that steam and vapors, which require a considerable heat for their formation, will have less effect in preventing combustion, particularly of those bodies requiring low temperatures, than gases at the usual heat of the atmosphere. Thus a very large quantity of steam is required to prevent sulphur from burning. A mixture of oxygen and hydrogen will explode by the electric spark, though diluted with five times its volume of steam; and even a mixture of air and carbureted hydrogen gas, the

least explosive of all mixtures, requires a third of steam to prevent its explosion, whereas one-fifth of azote will produce that effect. These trials were made over mercury. Heat was applied to water over the mercury, and 37.5 for 100 parts = $\frac{3}{8}$, was regarded as the correction for the expansion of the gases.

We shall now treat of the effects of cooling orifices on flame. The knowledge of the cooling power of elastic media, in preventing the explosion of the fire-damp, led the illustrious English chemist to those practical researches which terminated in his grand discovery of the wire-gause safe-lamp. The general investigation of the relation and extent of those powers, serves to elucidate the operation of wire-gause, and other tissues or systems of apertures permeable to light and air, in intercepting flame, and confirms the views originally given of this marvellous phenomenon. We have seen that flame is gaseous matter, heated so highly as to be luminous, and that to a degree of temperature beyond the white heat of solid bodies; for air not luminous will communicate this degree of heat. When an attempt is made to pass flame through a very fine mesh of wire-gause of the common temperature, the gauze cools each portion of the elastic matter that passes through it, so as to reduce its temperature below that degree at which it is luminous. This diminution of temperature is proportional to the smallness of the mesh, and to the mass of the metal. The power of a metallic or other tissue to prevent explosion, will depend upon the heat required to produce the combustion, as compared with that acquired by the tissue. Hence, the flame of the most inflammable substances, and of those that produce most heat in combustion, will pass through a metallic tissue, that will interrupt the flame of less inflammable substances, or those that produce little heat in combustion. Or, the tissue being the same, and impermeable to all flames at common temperatures, the flames of the most combustible substances, and of those which produce most heat, will most readily pass through it when it is heated, and each will pass through it at a different degree of temperature. In short, all the circumstances which apply to the effect of cooling mixtures upon flame, will apply to cooling perforated surfaces. Thus, the flame of phosphureted hydrogen, at common temperatures, will pass through a tissue sufficiently large, not to be immediately choked up by the phosphoric acid formed, and the phosphorus deposited. If a tissue, containing above 700 apertures to the square inch, be held over the flame of phosphorus or phosphureted hydrogen, it does not transmit the flame till it is sufficiently heated to enable the phosphorus to pass through it in vapor. Phosphureted hydrogen is decomposed by flame, and acts exactly like phosphorus. In like manner, a tissue of 100 apertures to the square inch, made of a wire of one-sixtieth, will at common temperatures, intercept the flame of a spirit-lamp, but not that of hydrogen. But when strongly heated, it no longer arrests the flame of alcohol. A tissue which will not interrupt the flame of hydrogen when red-hot, will still intercept that of olefiant gas; and a heated tissue, which would

communicate explosion from a mixture of olefiant gas and air, will stop an explosion from a mixture of fire-damp, or carbureted hydrogen. The latter gas requires a considerable mass of heated metal to inflame it, or contact with an extensive heated surface. An iron-wire of one-twentieth of an inch, and eight inches long, red-hot, when held perpendicularly in a stream of coal gas, did not inflame it; nor did a short wire of one-sixth of an inch produce the effect, when held horizontally. But wire of the latter size, when six inches of it were red-hot, and when it was held perpendicularly in a bottle containing an explosive mixture, so that heat was communicated successively to portions of the gas, produced its explosion.

'The scale of gaseous accension, given in the first section, explains why so fine a mesh of wire is required to hinder the explosion from hydrogen and oxygen to pass; and why so coarse a texture and wire control the explosion of fire-damp. The general doctrine, indeed, of the operation of wire-gause, cannot be better elucidated, than in its effects upon the flame of sulphur. When wire-gause of 600 or 700 apertures to the square inch, is held over the flame, fumes of condensed sulphur immediately come through it, and the flame is intercepted. The fumes continue for some instants, but on the increase of the heat they diminish; and at the moment when they disappear, which is long before the gause becomes red-hot, the flame passes; the temperature at which sulphur burns being that at which it is gaseous. Where rapid currents of explosive mixtures, however, are made to act upon wire-gause, it is of course much more rapidly heated; and therefore, the same mesh which arrests the flames of explosive mixtures at rest, will suffer them to pass when in rapid motion. But, by increasing the cooling surface, by diminishing the apertures in size, or increasing their depth, all flames, however rapid their motion, may be arrested. Precisely the same law applies to explosions acting in close vessels. Very minute apertures, when they are only few in number, will permit explosions to pass, which are arrested by much larger apertures when they fill a whole surface. A small aperture was drilled at the bottom of a wire-gause lamp, in the cylindrical ring, which confines the gause. This, though less than one-eighteenth of an inch in diameter, transmitted the flame, and fired the external atmosphere, in consequence of the whole force of the explosion of the thin stratum of the mixture included within the cylinder, driving the flame through the aperture. Had the whole ring, however, been composed of such apertures separated by wires, it would have been perfectly safe.

'Nothing can demonstrate more decidedly, than these simple facts and observations, that the interruption of flame, by solid tissues, permeable to light and air, depends upon no recondite or mysterious cause, but on their cooling powers, simply considered as such. When a light, included in a cage of wire-gause, is introduced into an explosive atmosphere of fire-damp at rest, the maximum of heat is soon obtained: the radiating power of the wire, and the cooling effect of the atmosphere, more efficient from the ad-

mixture of inflammable air, prevent it from ever arriving at a temperature equal to that of dull redness. In rapid currents of explosive mixtures of fire-damp, which heat common gause to a higher temperature, twilled-gause, in which the radiating surface is considerably greater, and the circulation of air less, preserves an equable temperature. Indeed, the heat communicated to the wire by combustion of the fire-damp in wire-gause lamps, is completely in the power of the manufacturer. By diminishing the apertures, and increasing the mass of metal, or the radiating surface, it may be diminished to any extent. Thick twilled gause, made of wires one-fortieth, sixteen to the warp, and thirty to the weft, rivetted to the screw to prevent the possibility of displacement, forms a lamp cage, which, from its flexibility, cannot be broken, and from its strength cannot be crushed, except by a very violent blow. The lamp which has been found most convenient for the miner, is that composed of a cylinder of strong wire-gause, fastened round the flame by a screw, and in which the wick is trimmed by a wire passing through a safe aperture. Such have now been used for many years, in the most dangerous mines of England, without any accident. Whatever explosive disasters have happened since, may be imputed to the neglect, or gross and culpable mismanagement, of that infallible protector. See COAL.

'5. We have now arrived at the most curious of all Sir H.'s discoveries relative to fire, namely, invisible combustion. On passing mixtures of hydrogen and oxygen through tubes heated below redness, steam appeared to be formed without any combustion. This led him to expose mixtures of oxygen and hydrogen to heat, in tubes, in which they were confined by fluid fusible metal. He found, that by carefully applying a heat between the boiling point of mercury, which is not sufficient for the effect, and a heat approaching to the greatest heat that can be given without making glass luminous in darkness, the combination was effected without any violence, and without any light; and commencing with 212, the volume of steam formed at the point of combination appeared exactly equal to that of the original gases. So that the first effect, in experiments of this kind, is an expansion, afterwards a contraction, and then the restoration of the primitive volume. When this change is going on, if the heat be quickly raised to redness, an explosion takes place, with small quantities of gas, the invisible combustion is completed in less than a minute. It is probable that the slow combination without combustion, long ago observed with respect to hydrogen chlorine, oxygen and metals, will happen at certain temperatures with most substances that unite by heat. On trying charcoal, he found, that at a temperature which appeared to be a little above the boiling point of quicksilver, it converted oxygen pretty rapidly into carbonic acid, without any luminous appearance; and at a dull red heat, the elements of olefiant gas combined in a similar manner with oxygen, slowly and without explosion. The effect of the slow combination of oxygen and hydrogen is not connected with their rarefaction by heat.

for it took place when the gases were confined in a tube by fusible metal, rendered solid at its upper surface; and certainly as rapidly, and without any appearance of light. As the temperature of flame has been shown to be infinitely higher than that necessary for the ignition of solid bodies, it appeared probable that, in these silent combinations of gaseous bodies, when the increase of temperature may not be sufficient to render the gaseous matters themselves luminous, yet it still might be adequate to ignite solid matters exposed to them.

'Sir H. Davy had devised several experiments on this subject. He had intended to expose fine wires to oxygen and olefiant gas, and to oxygen and hydrogen, during their slow combination under different circumstances, when he was led, accidentally, to the knowledge of the fact, and at the same time to the discovery, of a new and curious series of phenomena. He was making experiments on the increase of the limits of the combustibility of gaseous mixtures of coal gas and air, by increase of temperature. For this purpose a small wire-gauche safe-lamp, with some fine wire of platinum fixed above the flame, was introduced into a combustible mixture, containing the maximum of coal gas. When the inflammation had taken place in the wire-gauche cylinder he threw in more coal gas, expecting that the heat acquired by the mixed gas, in passing through the wire-gauche, would prevent the excess from extinguishing the flame. The flame continued for two or three seconds after the coal gas was introduced; and, when it was extinguished, that part of the wire of platinum which had been hottest remained ignited, and continued so for many minutes. When it was removed into a dark room it was evident that there was no flame in the cylinder. It was immediately obvious that this was the result which he had hoped to attain by other methods, and the oxygen and coal gas in contact with the hot wire combined without flame, and yet produced heat enough to preserve the wire ignited and keep up their own secret combustion. The truth of this conclusion was proved by introducing a heated wire of platinum into a similar mixture. It immediately became ignited nearly to whiteness, as if it had been in actual combustion itself, and continued glowing for a long while. When it was extinguished the inflammability of the mixture was found to be entirely destroyed. A temperature much below ignition only was necessary for producing this curious phenomenon, and the wire was repeatedly taken out and cooled in the atmosphere till it ceased to be visibly red; yet, when admitted again, it instantly became red-hot. The same phenomena were produced with mixtures of olefiant gas and air, carbonic oxide, prussic gas, and hydrogen; and in this last case with a rapid production of water. The degree of heat could be regulated by the thickness of the wire. When of the same thickness, the wire became more ignited in hydrogen than in mixtures of olefiant gas, and more in mixtures of olefiant gas than in those of gaseous oxide of carbon.

'When the wire was very fine, as 1-80th of an inch in diameter, its heat increased in very combustible mixtures, so as to explode them.

The same wire, in less combustible mixtures, continued merely bright red, or dull red, according to the nature of the mixture. In mixtures not explosive by flame within certain limits, these curious phenomena took place, whether the air or the inflammable gas was in excess. The same circumstances occurred with certain inflammable vapors. Those of ether, alcohol, oil of turpentine, naphtha, and camphor, have been tried. There cannot be a better mode of illustrating the fact than by an experiment on the vapor of ether or alcohol, which any person may make in a minute. Let a drop of ether be thrown into a cold glass, or a drop of alcohol into a warm one; let a few coils of wire of platinum, of the 1-60th or 1-70th of an inch, be heated at a hot poker or a candle, and let it be brought into the glass: in some part of the glass it will become glowing, almost white-hot, and will continue so as long as a sufficient quantity of vapor and of air remain in the glass. When the experiment on the slow combustion of ether is made in the dark, a pale phosphorescent light is perceived above the wire, which is, of course, most distinct when the wire ceases to be ignited. This appearance is connected with the formation of a peculiar acrid volatile substance, possessed of acid properties. The above experiment has been ingeniously varied by sticking loosely on the wick of a spirit-lamp a coil of fine platinum wire, about $\frac{1}{10}$ of an inch in thickness. There should be about sixteen spiral turns, one-half of which should surround the wick, and the other rise above it. Having lighted the lamp for an instant, on blowing it out the wire will become brightly ignited, and will continue to glow as long as any alcohol remains. A cylinder of camphor may be substituted for both wick and spirit. The ignition is very bright, and exhales an odoriferous vapor. With oil of turpentine the lamp burns, invisibly, without igniting the wire; for a dense column of vapor is perceived to ascend from the wire, diffusing a smell by many thought agreeable. By adding essential oils in small quantities to the alcohol, various aromas may be made to perfume the air of an apartment. But the film of charcoal which in this case collects, on the platinum coil, must be removed, by ignition over another spirit flame, otherwise the effect ceases after a certain time. The chemical changes in general, produced by slow combustion, appear worthy of investigation. A wire of platinum introduced, under the usual circumstances, into a mixture of prussic gas (cyanogen), and oxygen in excess, became ignited to whiteness, and the yellow vapors of nitrous acid were observed in the mixture. In a mixture of olefiant gas, non-explosive from the excess of inflammable gas, much carbonic oxide was formed. Platinum and palladium, metals of low conducting powers, and small capacities for heat, alone succeed in producing the above phenomena. A film of carbon or sulphur deprives even these metals of this property. Thin laminæ of the metals, if their form admits of a free circulation of air, answer as well as fine wires; and a large surface of platinum may be made red-hot in the vapor of ether, or in a combustible mixture of coal gas and air.

'Sir H. Davy made an admirable practical

application of these new facts. By hanging some coils of fine platinum wire, or a fine sheet of platinum or palladium, above the wick of the safe-lamp in the wire-gause cylinder, he has supplied the coal-miner with light in mixtures of fire-damp no longer explosive. Should the flame be extinguished, by the quantity of fire-damp, the glow of the platinum will continue to guide him; and, by placing the lamp in different parts of the gallery, the relative brightness of the wire will show the state of the atmosphere in these parts. Nor can there be any danger, with respect to respiration, wherever the wire continues ignited; for even this phenomenon ceases when the foul air forms about two-fifths of the volume of the atmosphere. Into a wire-gause safe-lamp a small cage of fine wire of platinum, of 1-70th of an inch in thickness, was introduced, and fixed by means of a thick wire of platinum, about two inches above the lighted wick. This apparatus was placed in a large receiver, in which, by means of a gas-holder, the air could be contaminated to any extent with coal gas. As soon as there was a slight admixture of coal gas the platinum became ignited. The ignition continued to increase till the flame of the wick was extinguished, and till the whole cylinder became filled with flame. It then diminished. When the quantity of coal gas was increased, so as to extinguish the flame, the cage of platinum, at the moment of extinction, became white-hot, presenting a most brilliant light. By increasing the quantity of the coal gas still further, the ignition of the platinum became less vivid. When its light was barely sensible small quantities of air were admitted, and it speedily increased. By regulating the admission of coal gas and air it again became white-hot, and soon after lighted the flame in the cylinder, which as usual, by the addition of more atmospheric air, rekindled the flame of the wick.

'This beautiful experiment has been very often repeated, and always with the same results. When the wire for the support of the cage, whether of platinum, silver, or copper, was very thick it retained sufficient heat to enable the fine platinum wire to rekindle in a proper mixture, half a minute after its light had been entirely destroyed by an atmosphere of pure coal gas. The phenomenon of the ignition of the platinum takes place feebly in a mixture consisting of two of air and one of coal gas; and brilliantly in a mixture consisting of three of air and one of coal gas. The greater the quantity of heat produced, the greater may be the quantity of the coal gas, so that a large tissue of wire made white-hot will burn in a more inflammable mixture (that is containing more inflammable gas) than one made red-hot. If a mixture of three parts of air and one of fire-damp be introduced into a bottle, and inflamed at its point of contact with the atmosphere, it will not explode, but will burn like a pure inflammable substance. If a fine wire of platinum, coiled at its end, be slowly passed through the flame, it will continue ignited in the body of the mixture, and the same gaseous matter will be found to be inflammable, and to be a supporter of combustion. When a large cage of wire of platinum is introduced into a very small

safe-lamp, even explosive mixtures of fire-damp are burned without flame; and, by placing any cage of platinum in the bottom of the lamp round the wick, the wire is prevented from being smoked. Care should be taken, of course, that no filament of the platinum protrude through the wire-gause. It is truly wonderful that a slender tissue of platinum, which does not cost one shilling, and which is imperishable, should afford in the dark and dangerous recesses of a coal-mine, a most brilliant light, perfectly safe in atmospheres in which the flame of the safety-lamp is extinguished; and which glows in every mixture of carbureted hydrogen gas that is respirable. When the atmosphere becomes again explosive the flame is relighted. It is no less surprising, that thus also we can burn any inflammable vapour, either with or without flame, at pleasure, and make a slender wire consume it, either with a white or red heat.'

COMBUSTION, SPONTANEOUS. The spontaneous combustion of the human body is a topic of singular interest, and great scientific curiosity. When we reflect on the great quantity of wood or coals required for the burning of a dead human body, and the slowness with which this process is effected, its spontaneous occurrence, and rapid completion in the living body, at a mean temperature, and without the sensible intervention of any ignited material, is a circumstance not lightly to be credited. Nothing, however, is more certain than that such a phenomenon does take place; and, to philosophy, the contemplation of it is highly interesting. Accidents of this kind, indeed, involve many important questions: the character or life of an innocent person may be implicated in their investigation. Hence arises the necessity of acquiring precise knowledge respecting their nature, so that we may not rashly attribute to premeditated crime, the consequences resulting from a very different cause.

This remark is illustrated by the history of a man, whose wife perished at Rheims, in 1725, by the mysterious operation of spontaneous combustion. Her remains were discovered in the kitchen, about a foot and a-half from the fire-place: some parts of the head and lower limbs only, with a few of the joints of the back-bone, had escaped the conflagration. A young and handsome female lived in the house, and horrible suspicions were awakened against the husband, who underwent all the rigor of a criminal prosecution. He appealed from his first sentence; and, in the interval, the woman's death was ascertained to have been occasioned by spontaneous combustion: the unfortunate man, in consequence, was delivered at once from infamy and the scaffold.

It is unnecessary to revert for facts demonstrative of spontaneous combustion, to those remote periods when the mind, credulous from its ignorance of the physical sciences, blindly admitted the reality of appearances the most strange and incredible: later times have exhibited instances of it, sufficiently numerous and authentic to dissipate every doubt respecting its actual occurrence. In attempting to explain these, it is proper to bear in view, that they take place in the living body; and consequently, that we

must banish all explanations founded exclusively on the physical and chemical laws which regulate inanimate bodies.

From the observations already on record, it appears, that almost all the victims of spontaneous combustion were addicted to the use of strong spirits. Hence, it has been concluded, that the different parts of the bodies of such persons had undergone an alcoholic impregnation, and thus contracted a degree of combustibility sufficient to render them easily inflammable. This opinion seems, at first sight, to be supported by the dissection of persons who have died of intoxication, and whose bodies gave out a spirituous odor. It has been remarked, also, that the flame in these combustions exactly resembles burning spirits; that the individuals to whom this accident happens, were commonly very fat or very thin; and that, in the former case, the fat supports the flame, while in the latter, combustion is supported by the deficiency of moisture. But, on the other hand, can we, in sound physiology, admit the assimilation of any given substance, without its first undergoing certain changes? Vitality, or the living principle, destroys some combinations, and forms others. This faculty may, indeed, be modified by disease; yet it never entirely ceases but with life. We may even regard, as characteristic of vital action, the power it possesses of forming bodies more complicated than the products of inorganic nature. By this action are frequently modified the substances which come to it from the external world; and it then produces bodies, regarded by chemists as incapable of decomposition. Calcareous earth has been obtained from cones of pine growing upon a barren sand, which contained not one atom of that substance; and vegetables yield earthy constituents which form no part of the soil that gives them nourishment. Certain substances, nevertheless, preserve some of their properties after being assimilated, such as color and odor. Madder, when taken into the stomach, reddens the bones; log-wood communicates to the urine a red, and rhubarb a yellow tinge. Agaric, with which the natives of Kamtschatka intoxicate themselves, imparts its inebriating quality to their urine; and, by frictions with garlic, the breath is impregnated with the smell of this vegetable. But, it may be asked, are these substances really in the same state of combination, wherein they existed previously to their being submitted to digestion or absorption? Even on the supposition that alcohol might traverse the animated body, as it soaks a sponge, would not its extreme affinity for water oppose an insurmountable obstacle to its combustion? Do not, moreover, the inflammable eructations sometimes observed in gin-drinkers, show that the spirituous liquor has already undergone some modification in the stomach; since the vapor of ardent spirits is not susceptible of taking fire by simple contact with the atmosphere. Anatomical inspection of dead bodies does not afford inferences more conclusive, provided the gin, taken abundantly a short time before death, has not penetrated their structure, when that structure could no longer offer any vital resistance to its progress. This last supposition is confirmed by

VOL. VI.

the dissection of several gin-drinkers of both sexes, in whom no alcoholic odor, but inflammation of the stomach, could be detected. No weight, in fine, can be allowed to the resemblance of the flame, in human combustions, to that of burning alcohol, since it is common also to other inflammable substances, as hydrogen gas, and its combinations with carbon and sulphur. To these objections, may be added the fact, that intemperance cannot be imputed to all those persons, without exception, who have perished from spontaneous combustion. As to the state of corpulence or emaciation, it will be invariably found that the fat of the body is never sufficiently deprived of its aqueous part, and the wasting never sufficiently decided, to admit the supposition of a degree of dryness favorable to rapid conflagration.

When the different cases of spontaneous human combustion have been classified, for the purpose of deducing general conditions from them, it will be found, 1. That women are much more subject to it than men; now, it is evident, that the skin and cellular membrane of females are more tender and lax than those of man, and that women are more disposed to corpulence. 2. That spontaneous combustion has commonly occurred in aged persons, almost all those who have perished from it being past their sixtieth year. 3. That, independently of the state of debility proper to such age, these persons had suffered from particular debilitating affections. 4. That their debility must still further have been augmented by the circumstances of an inactive life. 5. That many among them were corpulent: now, corpulence, at an advanced age, almost invariably implies a relaxed state, particularly of the system called lymphatic; hence dropsy and constitutional infirmity are very common in such persons. 6. That the greater number of the victims of spontaneous combustion, were addicted to the use of ardent spirits. 7. That, near the place of the catastrophe, has almost constantly been found an ignited body of some kind, however small, as a lamp, or burning coals. 8. That the conflagration has been exceedingly rapid, and gained every part of the body ere succour could arrive. 9. That the flame was very light and unsteady, difficult of extinction by water; and only attacked the combustible substances around, when remaining for a considerable time in contact with them. 10. That the place where the combustion happened, exhaled a strong empyreumatic odor; and that the walls, ashes, and cinders, were covered with a fetid moisture and with fat. 11. That the trunk of the body, with the exception of a few bones, was commonly consumed; and that there remained, in most cases, a portion of the head and extremities, more or less considerable: and, 12. That, in the majority of these instances, the accident has taken place at a low temperature of the atmosphere, consequently in winter.

For a correct explanation of the singular appearances now under consideration, it will be necessary, first of all, to distinguish the combustibility from the combustion itself, or, in other words, the cause exciting it. The combustibility of the human body becomes here, as we may

R

suppose, a peculiar condition; since, in the healthy state, it ranks in the class of substances most difficultly combustible. This combustibility, then, is determined by the debility consequent upon age, diseases, bodily inactivity, and intemperance. The abuse of strong liquors, especially gin, debilitates the absorbent system in a signal degree; and this state may give rise, in certain cases, to the formation of a mass of substance, alike inflammable and susceptible of accumulating, in greater or less quantity, in different parts of the body, according to their different structure. The combustible substance ought, therefore, to possess the property of penetrating easily into the interstices of the body, and of losing nothing of its combustibility by contact with liquids. These conditions are, in no class of substances, better combined than in the inflammable gases; nor, independently of them, can the fact now claiming attention, be well explained. It is necessary, therefore, for the production of the spontaneous combustion, that an inflammable gas accumulate in the cells of the cellular membrane, as the fluid of dropsy is accumulated; and, without admitting the pre-existence of the whole quantity of gas requisite for the completion of the process, it may reasonably be supposed that it terminates in giving rise to a fresh extrication of gas from those parts of the burning body surcharged with hydrogen. By this theory is obviated the objection which the absence of a previously emphysematous state in the victims of spontaneous combustion has suggested; with some among them, however, this state seems really to have existed.

Hydrogen constitutes one of the principal elements of the animal body, and combinations the most various are there formed by it with caloric, carbon, sulphur, and phosphorus: after death, as in life, its presence is unequivocally detected. It may be useful, in this place, to review the different phenomena which, in demonstrating that truth, connect it most intimately with the subject of spontaneous human combustion. A flame was observed to issue from the skin of a pig, at the moment of its being cut into with a knife; and two eminent anatomists saw a vapor exhaling from the stomach of a woman whom they had just opened: it took fire on the approach of a lighted candle. A similar fact also occurred in examining the stomach of another female, who, in the four days preceding her death, had taken no food. In some other cases, the gas inflamed without the intervention of any ignited body, merely by contact with the atmosphere. On the opening of an ox, which had been for some time sick, an explosion took place, and flame bursting from the stomach, to the height of more than five feet, scorched the butcher, as well as a little girl who stood beside him. It lasted several minutes, and gave out a most disgusting odor. The production of hydrogen gas, during life, cannot be doubted. It is known to be daily extricated in the bowels, and observations analagous to these just enumerated are by no means rare. Inflammable eructations frequently occur, particularly in northern regions, where persons, after an immoderate indulgence in gin, have been exposed to a cold

atmosphere. Some years since, an accident of this kind befel a Bohemian peasant: he died in the presence of many witnesses, from a column of air taking fire upon its extrication from the stomach, and baffling all the ordinary means of extinction. In such cases, the decomposition of alcohol, and of animal substance contained in the stomach, has generated a quantity of phosphureted hydrogen, which instantly inflames upon contact with atmospheric air. This process, however, extends no farther; because the other parts of the body do not possess the conditions requisite for a more general conflagration.

Since, then, we cannot deny that the inflammable gases are developed in the human body, it cannot surely be going too far to admit their occasional accumulation in the cellular structure, in quantity proportioned to the laxity of that structure. Hence, it happens that the softest parts, and consequently the trunk, are most subject to these gaseous accumulations. But the human body, thus rendered highly combustible, cannot yet take fire without the intervention of an inflaming spark; for, even admitting that part of the inflammable principle consists of phosphureted hydrogen gas, we are unable to explain adequately, and in all cases, the general conflagration which ensues. By some, the presence of ignited bodies has been considered as the cause of this catastrophe; and others even assert that, strictly speaking, what really originates in accident, cannot be called spontaneous combustion. We are unable, however, from this view of the subject, to conceive how the burning should be so rapid, general, and complete, as it commonly is; and still less, on what part of the body it is first manifested. Instances of human combustion, moreover, have occurred, in which the presence of no ignited body could be suspected. In comparing these various considerations, with the fatal accident detailed in the subsequent history, the mind is led to regard electricity as exerting considerable influence in human combustion, or even as the occasional cause of this extraordinary phenomenon.

No one can doubt, for a moment, the ideoelectricity of many animals; and this state exists, in a very remarkable degree, with many individuals of the human species. Experiments were made, during a severe frost, upon a woman whose ideoelectricity was such, that sparks issued from her hair as often as it was combed: a Leyden phial was even charged, and alcohol inflamed, with these sparks. Sparks of electricity, indeed, have often been emitted from stockings of wool and silk, when being taken off the limbs: examples of this kind might be multiplied to an indefinite extent. Inflammable substances, accumulated in the bodies of those who have perished from spontaneous combustion, must, by their nature, increase the electric state. Warmth will equally favor the explosion of the inflaming sparks. Thus, the proximity of fire or a lighted candle may, in some instances, have aided the process of human combustion: in others, the same effect may have been produced by violent exercise or other causes capable of exciting electricity. The electric spark, thus developed, tra-

venes with extreme rapidity, bodies in any way impregnated with inflammable matter; and the latter, taking fire upon every point, can no longer be quenched by the fluid parts. Thus, the burning usually proceeds with such celerity, that the miserable victim has no time to call for assistance. The flame, as is proved by observation, at first spreads upon the surface of the body; because there, in contact with the air of the atmosphere, it is fitted to support combustion: it is subsequently propagated to the more deep-seated parts. This theory will explain, without difficulty, the following circumstances already alluded to, and which we again detail with their reasons.

I. Women are more subject than men to spontaneous combustion, because their more relaxed structure is favorable to gaseous accumulations.

II. Spontaneous combustion most frequently takes place in aged persons; because such are more addicted than the young to the use of ardent spirits; they employ less exercise; and their vital energy, particularly that of the lymphatic system, is weaker.

III. The characters of the flame, its lightness, mobility, and resistance to the action of water, are those of hydrogen gas. The natural phenomena in the production of which this gas enjoys a principal share, as *ignes fatæ* and certain meteors, exhibit similar appearances.

IV. The furniture and other surrounding objects are, on these occasions, little damaged; because hydrogen gas, in combustion, implicates the generality of combustible bodies, only when remaining in intimate contact with them.

V. The moisture which invariably covers the walls where the conflagration takes place, as well as the charred relics of the body, is furnished by the combustion of the hydrogen gas, and also by the evaporation of the liquids of the body itself. The oily appearance of it arises from the fat which the heat has fused; and the fetid odor proceeds from the empyreumatic oil.

VI. The trunk of the body has always suffered more from this kind of combustion than other parts; this circumstance is explained by the size of its cavities, and the looseness of their cellular structure: and,

VII. Winter is the season in which spontaneous human combustion most frequently occurs; because the cold air, which is a bad conductor of electricity, favors the ideo-electric state of the animal body.

This view of its nature is founded on inductions afforded by many (more than 100) well authenticated histories of spontaneous human combustion, recorded by diligent and faithful observers, in very different eras and countries. There would be little propriety, however, in swelling the present article by unnecessary extracts from these: yet there is one which possesses extraordinary interest, as the subject of it, having survived the accident for a time, was enabled to give an account of the various circumstances by which it was preceded and followed. The case was published in one of the Journals of Florence, for October, 1776, by Mr. Battaglia, the surgeon who attended the unfortunate sufferer. It is related nearly in the following terms:—

‘*Gio Maria Bertholi, resident priest at Monte Volere, went on business to a neighbouring fair; and, having spent the day in walking about the country, arrived in the evening at Femile, intending to sleep at the house of his brother-in-law. Immediately on his arrival, he was conducted to his chamber at his own request, when he had a handkerchief placed between his shirt and shoulders; and, being now left alone, he betook himself to his devotions. Scarcely had a few minutes elapsed, when an uncommon noise, mingled with cries, was heard issuing from his apartment. The people of the house were alarmed; and rushing in, found the priest stretched upon the floor, and surrounded by a light flame, which receded as they approached, and ultimately vanished. He was instantly placed in bed, and on the following morning visited by the surgeon, who, on examination, found the skin of the right arm and fore-arm detached from the muscles, and hanging loose. From the shoulders to the thighs, the integuments were similarly injured. These detached portions of skin having been altogether removed; and, mortification being perceived on the right hand, which had suffered most severely, the parts were scarified. Notwithstanding this precaution, it had fallen by the next day into a state of complete gangrene. On the third day, all the other scorched parts were discovered to have degenerated into the same condition. The unhappy man complained of unquenchable thirst, and was horribly convulsed. The discharges from his bowels were putrid and bilious, and his strength was exhausted by continual vomitings, accompanied with delirium, and a burning fever. After lying two hours in a state of insensibility, he expired on the fourth day. While he lay in this lethargic sleep, his attendant observed, with astonishment, that putrefaction had made considerable progress, so that the body exhaled an intolerable odor: worms crawled from it on the bed, and the nails were spontaneously detached from the fingers of the left hand.*

‘This unfortunate man informed the surgeon that first of all he had felt a blow, like that inflicted by a cudgel, upon the right arm; and that, at the same moment, he saw a light blue flame attach itself to his shirt, which was instantaneously reduced to ashes; yet his wrist-bands, at the same time, remained utterly untouched. The handkerchief, which, as formerly mentioned, had been introduced between his shoulders and shirt, was entire and free from every trace of burning. His drawers and breeches had equally escaped; but his cap was entirely consumed, although not a hair of his head had suffered from the flame. That this flame, says Mr. Battaglia, dispersed under the form of elementary fire, had destroyed the skin, and reduced the shirt and cap to ashes, without implicating the hair of the head, is a fact which I most confidently assert. Moreover, all the symptoms of the disease were those of a severe burn. The night of the accident was calm; the atmosphere very clear; no empyreumatic or bituminous smell; no appearance of smoke was perceived in the chamber; but the lamp, before full of oil, was become dry, and its wick reduced to a cinder.’ Such is the outline of this very

singular history, the chief incidents of which seem quite irreconcilable with the pre-conceived views of mankind. By minds peculiarly constructed, or habituated to peculiar modes of reflecting, it will consequently be regarded as needing a more than ordinary degree of testimony for its support. But it ought to be remembered that we have no more pre-conceived cause for doubting or believing the spontaneous combustion of the materials composing the human body, than of any other substances, simple or compound, in the material world around us. The reality of its occurrence, therefore, must be determined by the evidence of facts alone, and not by pre-conceived views: this, as well as all cases of the same kind have, with some minute shades of difference, been attended with the same characteristic appearances,—a fact which, independently of all other testimony, should be admitted as affording internal evidence of their authenticity.

COME, *v. n.*, pret. came; participle, come. Sax. *coman*; Dutch, *comen*; German *kommen*. Opposed to go, to remove from a distant to a near place; to draw near, to advance towards, to move in any manner towards another; implying the idea of being received by another, or of tending towards another. The word always respects the place to which the motion tends, not that place which it leaves; yet this meaning is sometimes almost evanescent and imperceptible. To advance from one stage or condition to another. After giving no fewer than sixty varieties of meaning or applications of this word, Dr. Johnson remarks:—Come is a word of which the use is various and extensive, but the radical signification of tendency hitherward is uniformly preserved. When we say he came from a place, the idea is that of returning, or arriving, or becoming nearer; when we say, he went from a place, we conceive simply departure, or removal to a greater distance. The butter comes; it is passing from its former state to that which is desired; it is advancing towards us. As far as each of these varieties is distinct and definite, we now present them in their proper order, with the illustrations annexed:

And troubled blood through his pale face was seen,
To come and go, with tidings from the heart.

Cæsar will come forth to-day.

Færie Queens.
Shakspeare. Julius Cæsar.
Coming to look on you, thinking you dead,
I speak unto the crown as having sense.

Id. Henry IV.

The colour of the king doth come and go,
Between his purpose and his conscience.

Id. King John.

By the pricking of my thumbs,
Something wicked this way comes. *Id. Macbeth.*

Though he would after have turned his teeth upon Spain, yet he was taken order with before it came to that.

Bacon.

Seditions, tumults, and seditious fames, differ no more but as brother and sister; if it come to that, that the best actions of a state are taken in an ill sense and traduced.

Id.

It is reported, that if you lay good store of kernels

of grapes about the root of a vine, it will make the vine come earlier, and prosper better.

Id. Natural History.

Then butter does refuse to come.

And love proves cross and humoursome. *Hudibras.*

To COME, to attain any condition or character.

A serpent ere he comes to be a dragon,

Does eat a bat.

Ben Jonson's Cataline.

He wondered how she came to know

What he had done and meant to do.

Hudibras.

The testimony of conscience, thus informed, comes to be so authentic, and so much to be relied upon.

South.

To become.

So come I a widow;

And never shall have length of life enough

To rain upon remembrance with mine eyes.

Shakspeare. Henry IV.

When he returns from hunting,

I will not speak with him; say I am sick.

If you come slack of former services,

You shall do well.

Id. King Lear.

How came the publican justified, but by a short and humble prayer?

Druppa's Rules for Devotion.

To arrive at some act, or habit, or disposition.

They would quickly come to have a natural abhorrence for that which they found made them slighted.

Locke.

To become present, and no longer future.

But home he goth, he mighte not sojourne,

The day wos come that homeward he must turne.

Chaucer's Canterbury Tales.

Learn to be well, or fairly make your will,

You've played, and loved, and ate and drank your fill,

Walk sober off before a sprightlier age

Comes trittering on and shoves you from the stage.

Pope.

In his lair,

Fixed passion holds his breath, until the hour

Which shall alone for years; none need despair:

It come, it cometh, and will come—the power

To punish or forgive—in one we shall be slower.

Byron's Child Harold.

To become present, and no longer absent,

Come then, come soone, come sweetest death to me,

And take away this long-lent loathed light:

Sharpe be thy wounds, but sweete the medicines be

That long captived souls, from weary thralldom free.

Spenser.

Come after them, for haply in my bower,

Amusement, knowledge, wisdom, thou may'st gain,

If I one soul improve, I have not lived in vain.

Beattie.

Borne on the swift, though silent wings of time,

Old age comes on apace to ravage all the clime. *Id.*

No dread of death, if with us die our foes,

Save that it seems even duller than repose:

Come when it will—we snatch the life of life,

When lost—what reck it—by disease or strife.

Byron.

To happen; to fall out.

The duke of Cornwall and Regan his duchess, will be here with him this night.—

—How comes that?

Shakspeare. King Lear.

To befall as an event.

Let me alone that I may speak, and let come on me what will.

Job xiii. 13.

To follow as a consequence.

Those that are akin to the king, never prick their fingers but they say, there is some of the king's blood

split. How comes that? says he, that takes upon him not to conceive; the answer is, I am the king's poor cousin, Sir.
Shakespeare. Henry IV.

To come about. To come to pass; to fall out; to come into being. Probably from the French *venir a bout*.

And let me speak to the yet unknowing world, how these things come about.
Shakespeare.

That cherubim, which now appears as a God to the human soul, knows very well that the period will come about in eternity, when the human soul shall be as perfect as he himself now is. *Addison's Spectator.*

To come about. To change; to come round.

The wind came about, and settled in the west for many days.
Bacon's New Atlantis.

On better thoughts, and my urged reasons, They are come about, and won to the true side.
Ben Jonson.

To come again. To return. There came water therout; and when he had drunk, his spirit came again, and he revived.
Judges, xv. 19.

To come after. To follow. If any man will come after me, let him deny himself, and take up his cross and follow me.
Matthew, xvi. 24.

To come at. To reach; to get within the reach of; to obtain; to gain. Neither sword nor sceptre can come at conscience; but it is above and beyond the reach of both.
Suckling.

Cats will eat and destroy your marum, if they can come at it.
Boelyn's Kalendar.

In order to come at a true knowledge of ourselves, we should consider how far we may deserve praise.
Addison.

To come by. To obtain; to gain; to acquire. This seems an irregular and improper use, but has very powerful authorities.

Things most needful to preserve this life, are most prompt and easy for all living creatures to come by.
Hooker.

Love is like a child,
That longs for every thing that he can come by.
Shakespeare.

To come in. To comply; to yield; to hold out no longer.

If the arch-rebel Tyrone, in the time of these wars, should offer to come in and submit himself to her majesty, would you not have him received?
Spenser on Ireland.

To come in. To become modish; to be brought into use.

Then came rich cloaths and graceful action in,
Then instruments were taught more moving notes.
Roscommon.

Silken garments did not come in till late, and the use of them in men was often restrained by law.
Arbutnot on Coins.

To come in. To be an ingredient; to make part of a composition.

A generous contempt of that in which too many men place their happiness, must come in to heighten his character.
Atterbury.

To come in. To accrue from an estate, trade, or otherwise, as gain.

I had rather be mad with him that when he had nothing, thought all the ships that came into the harbour his; than with you that, when you have so much coming in, think you have nothing.
Suckling.

To come in. To be gained in abundance. Sweetheart, we shall be rich ere we depart,
If fairings come thus plentifully in.
Shakespeare

To come in for. To be early enough to obtain; taken from hunting, where the dogs that are slow get nothing.

Shape and beauty, worth and education, wit and understanding, gentle nature and agreeable humour, honor and virtue, were to come in for their share of such contracts.
Temple.

If thinking is essential to matter, stocks and stoues will come in for their share of privilege.

One who had in their rear excluded been,
And could not for a taste o' th' flesh come in,
Licks the solid earth.
Tate's Juvenal.

The rest came in for subsidies, whereof they sunk considerable sums.
Swift.

To come in to. To join with; to bring help.

They marched to Wells, where the lord Audley with whom their leaders had before secret intelligence, came in to them; and was by them, with great gladness and cries of joy, accepted as their general.
Bacon's Henry VII.

To come into. To comply with; to agree to. The fame of their virtues will make men ready to come into every thing that is done for the public good.
Atterbury.

To come near. To approach; to resemble in excellence; a metaphor from races.

Whom you cannot equal or come near in doing, you would destroy or ruin with evil speaking.
Ben Jonson's Discoveries.

To come of. To proceed, as a descendant from ancestors.

Of Priam's royal race my mother came.
Dryden's Æneid.

Self-love is so natural an infirmity, that it makes us partial even to those that come of us, as well as ourselves.
L'Estrange.

To come of. To proceed as effects from their causes.

Will you please, Sir, be gone;
I told you what would come of this.
Shakespeare. Winter's Tale.

The hiccough comes of fulness of meat, especially in children, which causeth an extension of the stomach.
Bacon.

To come off. To deviate; to depart from a rule or direction.

The figure of a bell partaketh of the pyramids, but yet coming off and dilating more suddenly.
Bacon's Natural History.

To come off. To escape; to get free.

I knew the foul enchanter, though disguised;
Entered the very lime-twigs of his spells,
And yet came off.
Milton.

How thou wilt here come off, surmounts my reach.
Id.

If, upon such a fair and full trial, he can come off, he is then clear and innocent
South.

To come off. To end an affair; to take good or bad fortune.

Oh, bravely came we off,
When with a volley of our needless shot,
After such bloody toil, we bid good night.
Shakespeare. King John.

Ever since Spain and England have had any thing to debate one with the other, the English, upon all encounters, have come off with honor and the better.
Bacon.

To come off from. To leave; to forbear.

To come off from these grave disquisitions, I would clear the point by one instance more.

Felton on the Classics

To come on. To advance; to make progress. Things seem to *come on* apace to their former state.

Bacon.

There was in the camp both strength and victual sufficient for the obtaining of the victory, if they would not protract the war until winter were *come on*.

Knolles's History.

To come on. To advance to combat.

The great ordnance once discharged, the armies *came fast on*, and joined battle.

Knolles's History of the Turks.

Rhymer, *come on*, and do the worst you can; I fear not you, nor yet a better man.

Dryden.

To come on. To thrive; to grow big; to grow.

Come on, poor babe;

Some powerful spirit instruct the kites and ravens
To be thy nurses.

Shakespeare. Winter's Tale.

It should seem by the experiments, both of the milk and of the roses, that they will *come far* faster on in water than in earth; for the nourishment is easier drawn out of water than out of earth.

Bacon's Natural History.

To come over. To revolt.

They are perpetually teasing their friends to *come over* to them.

Addison's Spectator.

A man, in changing his side, not only makes himself hated by those he left, but is seldom heartily esteemed by those he *comes over* to.

Id.

To come over. To rise in distillation.

Perhaps also the phlegmatic liquor, that is wont to *come over* in this analysis, may, at least as to part of it, be produced by the operation of the fire.

Boyle.

To come out. To be made public; to appear upon trial; to be discovered.

Before his book *came out*, I had undertaken the answer of several others.

Stillingfleet.

It is indeed *come out* at last that we are to look on the saints as inferior deities.

Id.

I have been tedious; and, which is worse, it *comes out* from the first draught, and uncorrected.

Dryden.

To come out with. To give a vent to; to let fly.

Those great masters of chymical arcana must be provoked, before they will *come out with* them.

Boyle.

To come to. To consent or yield.

What is this, if my parson will not *come to*?

Swift.

To come to. To amount to.

The emperor imposed so great a custom upon all corn to be transported out of Sicily, that the very customs *came to* as much as both the price of the corn and the freight together.

Knolles's History of the Turks.

You saucily pretend to know

More than your dividend *comes to*.

Hudibras.

Animals either feed upon vegetables immediately, or, which *comes to* the same at last, upon other animals which have fed upon them.

Woodward's Natural History.

He pays not this tax immediately, yet his purse will find it by a greater want of money than that *comes to*.

Locke.

To come to himself. To recover his senses.

He falls into sweet ecstacy of joy, wherein I shall leave him till he *comes to himself*.

Temple.

To come to pass. To be effected; to fall out

It *cometh*, we grant, many times *to pass*, that the works of men being the same, their drifts and purpose therein are divers.

Hooker.

How *comes it to pass*, that some liquors cannot pierce into or moisten some bodies, which are easily pervious to other liquors?

Boyle's History of Firmness.

To come up. To grow out of the ground.

Over-wet, at sowing-time, with us breedeth much death, inasmuch as the corn never *cometh up*.

Bacon.

If wars should mow them down never so fast, yet they may be suddenly supplied, and *come up* again.

Id.

Good intentions are the seeds of good actions; and every man ought to sow them, whether they *come up* or no.

Temple.

To come up. To come up into use; as a fashion comes up.

To come up to. To rise; to advance.

Whose ignorant credulity will not
Come up to the truth.

Shakespeare. Winter's Tale.

Considerations there are, that may make us, if not *come up to* the character of those who rejoice in tribulations, yet at least satisfy the duty of being patient.

Wake's Preparation for Death.

To come upon. To invade; to attack.

Three hundred horse, and three thousand foot, English, commanded by Sir John Norris, were charged by Parma, *coming upon* them with seven thousand horse.

Bacon.

When old age *comes upon* him, it comes alone, bringing no other evil with it but itself.

South.

To come. In futurity; not present; to happen hereafter.

It serveth to discover that which is hid, as well as to foretel that which is *to come*.

Bacon's Natural History.

In times *to come*,

My waves shall wash the walls of mighty Rome.

Dryden.

COME. Participle of the verb.

Thy words were heard, and I am *come to* thy words.

Daniel.

COME. A particle of exhortation; be quick; make no delay.

Come, let us make our father drink wine.

Genesis xix. 32.

COME. A particle of reconciliation; or incitement to it.

Come, come, at all I laugh he laughs no doubt; The only difference is, I dare laugh out.

Pope.

COME. A kind of adverbial word for when it shall come; as, come Wednesday, when Wednesday shall come.

Come Candlemas, nine years ago she died.

Gey.

COME, *n. s.* From the verb. A sprout; a cant term.

That the malt is sufficiently well dried, you may know both by the state, and also by the falling off of the *come* or sprout.

Mortimer's Husbandry.

CO'MER, *n. s.* From come. One that comes.

Time is like a fashionable host,
That slightly shakes his parting guest by the hand;
But with his arms outstretched, as he would fly,
Grasps in the *comer*: welcome ever smiles,
And farewell goes out sighing.

Shakespeare. Troilus and Cressida.

COMING, n. s. From to come. The act of coming; approach.

Where art thou, Adam! went with joy to meet
My coming, seen far off? *Milton's Paradise Lost.*

Sweet the coming on
Of grateful evening mild. *Id.*

State of being come; arrival.
May 't please you, noble Madam, to withdraw
Into your private chamber; we shall give you
The full cause of our coming.

Shakespeare. Henry VIII.

Some people in America counted their years by the
coming of certain birds amongst them at their certain
seasons, and leaving them at others. *Locke.*

COMING-IN, n. s. Revenue; income.

Here's a small trifle of wives; eleven widows, and
nine maids is a simple coming-in for one man.

Shakespeare.

What are thy rents? what are thy coming-in?
O ceremony, show me but thy worth?
What is thy toll, O adoration? *Id. Henry V.*

COMING, particip. adj. From come. Fond;
forward; ready to come.

Now will I be your Rosalind in a more coming on
disposition; and ask me what you will, I will grant it.

Shakespeare.

That very lapidary himself, with a coming stomach,
and in the cock's place, would have made the cock's
choice. *L'Estrange.*

That he had been so affectionate a husband, was
no ill argument to the coming dowager. *Dryden.*

On morning wings how active springs the mind!
How easy every labour it pursues,
How coming to the poet every muse! *Pope's Horace.*

Future; to come.

Praise of great acts he scatters, as a seed
Which may the like in coming ages breed.

Roscommon.

COMEDY, n. s. Gr. *κωμῳδία*. A dra-
COMEDIAN, n. s. } matic representation; its
avowed intention is to exhibit life and manners,
and to correct the foibles and follies of mankind
by a natural and ridiculous exhibition of them.
It is opposed to tragedy. A comedian is a writer
of comedies; an actor of comedies; or a player
in general of either sex.

Melissarion, pretty honey-bee, when of a comedian
she became a wealthy man's wife, would be saluted
Madam Pithias, or Prudence. *Camden's Remains.*

Your honour's players

Are come to play a pleasant comedy.

Shakespeare. Taming of the Shrew.

Scaliger willeth us to admire Plautus as a comedian,
but Terence as a pure and elegant speaker.

Peacham of Poetry.

A *long*, exact, and serious comedy;
In every scene some moral let it teach,
And, if it can, at once both please and preach.

Pope.

The whining tragic love she scarce can bear,
But nauseous comedy ne'er shocked her ear. *Gay.*

COMEDY. The Romans made a subdivision
of comedy into ancient, middle, and new, accord-
ing to the various periods of the commonwealth.
Among the ancient comedies were reckoned
those of Livius Andronicus; among the middle,
those of Pacuvius; and among the new ones,
those of Terence. They likewise distinguished
comedy according to the quality of the persons

represented, and the dress they wore, into togatæ,
prætextatæ, trabeatæ, and tabernariæ, which last
agrees pretty nearly with our farces. Among us
comedy is distinguished from farce, as the former
represents nature as she is; the other distorts and
overcharges her. They both paint from the life,
but with different views; the one to make nature
known; the other to make her ridiculous. See
POETRY.

COMELY, adj. & adv. } From become; or
CO'MELINESS, n. s. } from Sax. *cpeman*,
to please. Graceful; decent; having dignity or
grandeur of mein or look. Comeliness seems to
be that species of beauty which excites respect
rather than pleasure: it signifies something less
forcible than beauty, less elegant than grace,
and less light than prettiness. Used of things,
decent; according to propriety.

To ride comely, to play at all weapons, to dance
comely, be very necessary for a courtly gentleman.

Ascham's Schoolmaster.

The service of God hath not such perfection of
grace and comeliness, as when the dignity of the place
doth concur. *Hooker.*

If the principal part of beauty is in decent motion,
no marvel though persons in years seem many times
more amiable; for no youth can be comely but by
pardon, and considering the youth as to make up the
comeliness. *Bacon.*

Soon after them all dauncing on a row,
The comely virgins come with girlondz dight,
As fresh as flowers in meadow greene doe grow.
When morning dew upon their leaves doth light;
And in their hands sweet timbrels all upheld on high.

Spenser.

Where, when the knight arrived, he was right well
Received, as knight of so much worth became
Of second sister, who did far excell
The other two; Medina was her name,
A sober, sad, and comely courteous dame. *Id.*

They skilled not of the goodly ornaments of poetry,
yet were sprinkled with some pretty flowers, which
gave good grace and comeliness. *Id. on Ireland.*

A careless comeliness when comely care. *Sidney.*
Oh, what a world is this, when what is comely
Envenoms him that bears it.

Shakespeare. As You Like It.

This is a happier and more comely time,
Than when these fellows ran about the streets,
Crying confusion. *Id. Coriolanus.*

He that is comely when old and decrepit, surely
was very beautiful when he was young. *South.*

Hardly shall you meet with man or woman so aged
or ill-favoured, but if you will commend them for
comeliness, nay and for youth too, shall take it well. *Id.*

Thou art a comely, young, and valiant knight.

Dryden.

There is great pulchritude and comeliness of pro-
portion in the leaves, flowers, and fruits of plants.

Ray on the Creation

A horseman's coat shall hide
Thy taper shape, and comeliness of side. *Prior.*

Now each his mistress toasts, by whose bright eye
He's fired; Cosmelia fair, or Dulcibell,
Or Sylvia, comely black with jetty eyes
Piercing, or any Celia, sprightly maid. *Gay.*

COMENIUS (John Amos), a grammarian and
Protestant divine, born in Moravia in 1592. He
was eminent for his attempt to introduce a new
method of teaching languages; for which purpose

he published some essays in 1616, and had prepared others when the Spaniards pillaged his library, after having taken the city of Fulnec, where he was minister and master of the school. Comenius fled to Lesna, in Poland, where he became a teacher of Latin. His *Janua Linguarum Reserata*, published in 1631, gained him great reputation, insomuch that he was offered a commission for regulating all the schools in Poland, and the parliament of England desired his assistance to regulate the English schools. He arrived at London in 1641; and would have been received by a committee to hear his plan, had not the parliament been then engaged on other more important subjects. He therefore went to Sweden, being invited by a generous patron, who settled a stipend upon him, and he now employed himself wholly in preparing his plans for the instruction of youth. In 1657 he published the different parts of his new method of teaching. He next began to explain the prophecies, the fall of Antichrist, and the commencement of the millennium which he fixed for 1672. He died in 1671 aged eighty.

COMESSAZZO, a town of Italy, in the cidevant duchy of Mantua, and department of the Upper Po, two miles and a half north of Sabionetta.

COMET, *n. s.* } Lat. *cometa*. Literally
COMETARY, *adj.* } a hairy star. For the
COMETIC, *adj.* } scientific description, see
ASTRONOMY.

And wherefore gaze this goodly company,
 As if they saw some wondrous monument,
 Some comet, or unusual prodigy?

Shakespeare. Taming of the Shrew.

Such his fell glances as the fatal light
 Of staring comets.

Crashaw.

I considered a comet, or, in the language of the vulgar, a blazing star, as a sky-rocket discharged by an hand that is almighty.

Addison's Guardian.

Fierce meteors shoot their arbitrary light,
 And comets march with lawless horrors bright.

Prior.

Refractions of light are in the planetary and cometary regions, as in our globe,

Cheyne's Phil. Prim.

Hast thou ne'er seen the comet's flaming sight?

The illustrious stranger passing, terror sheds
 On gazing nations, from his fiery train
 Of length enormous, takes his ample round
 Through depths of ether; coasts unnumbered worlds
 Of more than solar glory; doubles wide
 Heaven's mighty cape; and then revisits earth,
 From the long travel of a thousand years.

Young's Night Thoughts.

Lo! from the dread immensity of space,
 Returning with accelerated course,

The rushing comet to the sun descends,
 And as he sinks below the shading earth,
 With awful train projected o'er the heavens
 The guilty nations tremble.

Thomson's Seasons.

The hour arrived—and it became
 A wandering mass of shapeless flame,
 A pathless comet, and a curse,
 The menace of the universe.

Byron's Manfred.

COMETS. We have devoted a sector of our general article **ASTRONOMY** to the consideration of the different theories that have been espoused by men of science respecting the nature and orbits of these singular bodies. We know not whether we ought to add to these, the astronomico-theo-

logical reverie of Whiston, who assures us that he has discovered not only the place, but the nature of the punishment of the damned, in these (no longer) heavenly bodies. Whirled from remote regions of the universe into a nearer approach to the sun than other body of the solar system, and then back again into the extremest distance from it, he conceived them to be thus exposed alternately to the most ardent heat and the most benumbing cold. Certainly his conjecture may remind us of the general improbability of such bodies being inhabited by any race of beings like men.

It is remarkable that one of the early conjectures of science respecting these bodies, that they were accidental assemblages of small stars, has been so far revived, or rather perhaps reversed, in modern times, that Dr. Brewster has hazarded an opinion, that the planets Ceres and Pallas, may have derived their immense atmospheres from the explosion of a comet, and fixes upon that of 1770 as having been most probably the comet in question.

This comet was in that year most carefully observed for four months by M. Messier. M. M. Proserpin and Pingré first suspected that its orbit might be elliptical, and M. Lexell of St. Petersburg computed its elements in an elliptical orbit, and found that its period was five years and a half, and its greatest distance from the sun about that of Jupiter. It has, however, never re-appeared. This subject lately attracted the notice of the National Institute of France, at whose request Dr. Burckhardt repeated all the former calculations with great care. 'Here then,' says an able writer in the *Encyclopædia* of Dr. Brewster, 'is a most singular anomaly in the motion of the comet. While all the other comets which have been observed, move in orbits stretching far beyond the limits of the solar system, and revolve in periods of long duration, the comet of 1770 never wanders beyond the orbit of Saturn, and completes its revolution in the short period of five years and a half. The return of this body, therefore, was confidently expected by astronomers; but though it must now have completed nearly eight revolutions round the sun, and though more observations have been made in the heavens during the last forty years than perhaps during the two preceding centuries, yet the comet of 1770 has never re-appeared. We are consequently entitled to conclude, that the comet of 1770 is lost, which could happen only from its uniting with one of the planets, whose orbits it crossed. Now, if such an union took place, two consequences would obviously flow from it. The planet would suffer a sensible derangement in its motions, and its atmosphere would receive a vast accession of that nebulous matter, of which the comets are often wholly composed. Here, then, we have two distinct criteria to enable us to ascertain the individual planet by which the comet was attracted. The path of the comet intersects the orbits only of Venus, the Earth, Mars, the four new planets, and Jupiter, and therefore it must have united with one of these bodies, or with their satellites. Now, since the year 1770, neither Venus, the Earth, Mars, nor Jupiter, have suffered the smallest derangement of this kind, nor have they

received any visible addition to their atmospheres. We must, therefore, look to the four new planets for some indication of the presence of a comet, and, if they exhibit any phenomena that are unequivocally of this description, we must consider such a coincidence as a strong proof of the theory, or as one of the most wonderful facts in the history of science. Two of the new planets, Ceres and Pallas, exhibit, in the form and position of their orbits, evident marks of some great derangement; they are actually surrounded with atmospheres of an immense size. The atmosphere of Ceres is 675 English miles high, while that of Pallas rises to the height of 468 miles. Now the height of any of these atmospheres is greater than the united heights of the atmospheres of all the other planets, and is above a thousand times higher than they ought to have been, according to the ratio that exists between the globes and atmospheres of the other bodies of our system.' 'Let us enquire,' continues this writer, 'from what other source these atmospheres could be derived, if they were not imparted by the comet of 1770. If the four new planets are the fragments of a larger body, endowed with an extensive atmosphere, each fragment would obviously carry off a portion of atmosphere proportioned to its magnitude; but two of the fragments, Juno and Vesta, have no atmosphere at all, consequently the atmospheres of Ceres and Pallas could not have been derived from the original planet, but must have been communicated to them at a period posterior to the divergency of the fragments.' We leave the reader to form his own judgment of this curious hypothesis; certainly the facts on which this writer reasons are themselves most extraordinary.

It appears that twenty-four comets have passed between the Sun and the orbit of Mercury; thirty-three between the orbits of Mercury and Venus; twenty-one between the orbits of Venus and the Earth; sixteen between the orbits of the Earth and Mars; three between the orbits of Mars and Ceres; and one between the orbits of Ceres and Jupiter: that thirty-two Comets have appeared between the months of April and September, and sixty-six between September and April: that the greater part of the comets have their perihelion nearest to their ascending nodes: that fifty of the comets move from west to east and not in the opposite direction: and that the orbits of the comets are not confined to any particular region of the heavens, like the old planets, but seem to be inclined at every possible angle of the ecliptic.

COMETEAU, or COMMOTAU, a town of Bohemia in the circle of Saatz, with a handsome town-house. It was taken by Zisca, in 1421, and all the inhabitants, men, women, and children, were put to the sword. In 1648 it surrendered to the Swedes at discretion. It is seated in a fertile plain, thirty miles north-west of Prague.

COMETES, in botany, a genus of the monogynia order, and tetrandria class of plants. The involucrem is tetraphyllous and triflorous: CAL. tetraphyllous: CAPS. tricoccous. Species one only, a native of Surat.

COM'FIT, *n. s.* & *v. a.* } *Lat. bellaria arida;*
 CO'MFITURE, *n. s.* } *Dutch konfit.*
 It should seem that both are formed by hasty pronunciation from confect. A dry sweetmeat; any kind of fruit or root preserved with sugar, and dried.

From country grass to *confitures* of court,
 Or city's quelque-choses, let not report
 My mind transport.

Donne.

The fruit that does so quickly waste,
 Men scarce can see it, much less taste,
 Thou *confitest* in streets to make it last.

Cowley.

By feeding me on beans and pease,
 He crams in nasty crevices,
 And turns to *confits* by his arts,
 To make me relish for deserts.

Hudibras.

COM'FORT, *v. a.* & *n. s.* } *Low Lat. com-*
 CO'MFORTABLE, *adj.* } *forto. Salvia com-*
 CO'MFORTABLY, *adv.* } *fortat nervos.—*
 CO'MFORTER, *n. s.* } *Schol. Sal. To*
 CO'MFORTLESS, *adj.* } *strengthen; to en-*

liven; to invigorate; to sooth; to relieve in difficulty by assistance, by support, by consolation. That which mitigates the pressure of calamity, allays sorrow, and diminishes agony by a positive infusion of enjoyment. Comfort is the verbal expression of a thing which, to be understood, must be enjoyed, and it can be enjoyed only in merry England. It is the indigenous plant of our own soil, and cannot be made an exotic. 'Comfort, that genuine English word, describes what England only affords; we may find *pleasure* in every country, but *comfort* is to be found in our own country only; the grand feature in *comfort* is substantiality; in that of *pleasure*, it is warmth. *Pleasure* is quickly succeeded by pain; it is the lot of humanity, that to every *pleasure* there should be an alloy: *comfort* is that portion of pleasure which seems to lie exempt from this disadvantage; it is the most durable part of *pleasure*.'—*Crabbe.*

For which, this noble duk, as he we can,
Comforteth and honoureth every man;
 And made revel, all the longe night,
 Unto the strange lords, as was right.

Chaucer's Canterbury Tales.

The evidence of God's own testimony, added unto the natural assent of reason, concerning the certainty of them, doth not a little *comfort* and confirm the same.

Hooker.

Light excelleth in *comforting* the spirits of men: light varied doth the same effect, with more novelty. This is the cause why precious stones *comfort*.

Bacon's Natural History.

He had no brother, which, though it be *comfortable* for kings to have, yet draweth the subjects eyes aside.

Shakespeare. Henry VII.

The heavens have blest you with a goodly son,
 To be a *comforter* when he is gone. *Id. Richard III.*

Your children were vexation to your youth,
 But mine shall be a *comfort* to your age. *Id.*

My lord leans wond'rously to discontent;
 His *comfortable* temper has forsook him;
 He is much out of health. *Id. Timon.*

I will keep her ignorant of her good,
 To make her heavenly *comforts* of despair.
 When it is least expected.

Id. Measure for Measure.

Her soul heaven's queen, whose name she bears,
In comfort of her mother's fears,
Hath placed among her virgin train. *Ben Jonson.*

We need not fear
To pass commodiously this life, sustained
By him with many comforts, till we end
In dust, our final rest and native home. *Milton.*

On thy feet thou stood'st at last,
Though comfortless, as when a father mourns
His children, all in view destroyed at once. *Id.*
That noisable comfortless deafness had not quite
tired me. *Swift.*

Be comforted, relief is near,
For all our friends are in the rear. *Gay.*
Upon view of the sincerity of that performance,
hope comfortably and cheerfully for God's perform-
ance. *Hammond.*

As they have no apprehension of those things, so
they need no comfort againat them. *Tillotson.*

O false ambition!
Thou lying phantom! whither hast thou lur'd me!
Even to this giddy height; where now I stand
Forsaken, comfortless, with not a friend
In whom my soul can trust. *Brown's Barbarossa.*

Fancy from comfort wanders still astray;
Ah, Melancholy! how I feel thy power!
Long have I laboured to elude thy sway;
But 'tis enough, for I resist no more. *Beattie.*

Yet lingering comfortless in lonesome wild,
Were Echo sleeps 'mid caver'ned vales profound,
The pride of Troy, Dominion's daily child,
Pines while the slow hour stalks its sullen round. *Id.*

For if my desultory strain, with ruth
And indignation, make thine eyes o'erflow,
Alas! what comfort could thy anguish sooth,
Shouldst thou the extent of human folly know. *Id.*

COMFORTER, *n. s.* The third person of the
Holy Trinity; the paraclete, paraceto.

They were filled with the Holy Ghost, with spiritual
comfort, spiritual joy and exultation. Instead of
fearing and flying from their enemies, as before at
the apprehension and crucifixion of their Master, they
now boldly faced them, prepared to stand before rulers
to speak of God's testimonies, even 'before kings,
without being ashamed.' They were no longer
grieved or offended at the thought of suffering for the
truth; they rejoiced in tribulation of that sort, and
conceived themselves to have acquired a new dignity,
when 'counted worthy so to suffer.' Such was the
mighty change wrought in their minds, through the
power of 'the Holy Ghost, the Comforter.'

Bishop Horne's Sermons.

COMFORT, POINT, is the most south part of Eli-
zabeth-city county, in Virginia, formed by James
River, at its mouth in Chesapeake Bay. It lies
nineteen miles west by north of Cape Henry.

COMFREY, *n. s.* Lat. *consolida*; Fr. *com-
frie*, a plant.

COMICK, *adj.* } Lat. *comicus*; Fr.
Co'MICAL, *adj.* } *comique*. Relating to
Co'MICALLY, *adv.* } comedy, as distinguish-
Co'MICALNESS, *n. s.* } ed from tragedy.—
Mirthful, merry, diverting.

Stately triumphs, mirthful comick shows,
Such as befit the pleasure. *Shakespeare. Henry VI.*

I never yet the tragick muse essayed,
Deterred by thy inimitable maid;
And when I venture at the comick stile,
Thy scornful lady seems to mock my toil.

Waller.

A comick subject loves an humble verse;
Thyestes scorns a low and comick stile;
Yet comedy sometimes may raise her voice.

Roscommon.

Thy tragick muse gives smiles, thy comick sleep.
Dryden.

The greatest resemblance of our author is in the
familiar stile and pleasing way of relating comical ad-
ventures of that nature. *Id. Fables. Preface.*

Something so comical in the voice and gestures,
that a man can hardly forbear being pleased.
Addison on Italy.

That all might appear to be knit up in a comical
conclusion, the duke's daughter was afterwards joined
in marriage to the lord Lisle. *Hayward.*

They deny it to be tragical, because its catastrophe
is a wedding, which hath ever been accounted comical.
Gay.

For the dame, by her skill in affairs astronomical,
Imagined to live in the clouds was but comical. *Id.*

COMINES, a town of France, in the depart-
ment of the North, and ci-devant province of
French Flanders, situated on the river Lis, which
divides it into two parts. It has been much re-
duced since the period in which it gave birth to
the celebrated author below; but has still a po-
pulation of about 2000. It is five miles south-
west of Menin, seven north of Lisle, and
twenty-five south of Bruges.

COMINES (Philp De), an historian, born in
Flanders in 1446; and, although of noble de-
scendant, his education was very limited. He lived
first at the court of Charles the Bold, duke of
Burgundy, where he stayed about eight years;
when Louis XI. invited him to France; where
he was highly promoted, and executed several
successful negotiations. But on the death of
Louis he was thrown into prison by Charles
VIII.; but on being brought before the parlia-
ment of Paris he was released. Comines was
a man of more natural abilities than learning;
he spoke several living languages, but knew
nothing of the dead. He has left behind him
Memoirs of his own Times that are admired.
It was a saying of Catherine de Medicis, that
Comines made as many heretics in politics, as
Luther had done in religion.

COMINGES, a ci-devant territory of France,
the east division of the late province of Gas-
cony; about fifteen leagues in length, and six
in breadth, which is now included in the depart-
ment of Gers. It is the see of a bishop, whose
residence was at St. Bertrand, the capital.

COMITATUS, in law, a county. Ingulphus
tells us, that England was first divided into
counties by king Alfred; and the counties into
hundreds, and these again into tythings; and
Fortescue says, that regnum Angliæ per comi-
tatus, ut regnum Franciæ per bullivatus distin-
guitur. Sometimes it is taken for a territory or
jurisdiction of a particular place; as in Mat.
Paris, A.D. 1234. See *COUNTY*.

COMITIA, in Roman antiquity, general as-
semblies of the people, called by a magistrate
for the enjoyment or prohibition of anything
by their votes. They were of three sorts; cu-
riata, centuriata, and tributa; from the three
grand divisions of the city and people into
curiæ, centuriæ, and tribes.

COMITIA CALATA, from *calare*, to call, was in early times a common epithet for all the comitia, though it was at last restrained to two sorts of assemblies; those for the creation of priests, and those for the regulation of last wills and testaments.

COMITIA CENTURIATA were instituted by Servius Tullius; who, obliging every one to give a true account of what he was worth, according to those accounts divided the people into six classes, which he subdivided into 193 centuries. The first class, containing the equites and richest citizens, consisted of ninety-eight centuries. The second, taking in the tradesmen and mechanics, consisted of twenty-two centuries; the third of twenty; the fourth of twenty-two; and the fifth of thirty: the sixth, being filled up with the poorer sort, made but one century; and was seldom regarded, or allowed any power in public matters. Hence it is common with the Roman authors, when they speak of the classes, to reckon no more than five, the sixth not being thought worth their notice. This last class was divided into two parts, or orders; the *proletarii* and the *capite censi*. The former, as their name implies, were merely designed to stock the republic with men, as they could supply it with little money; and the latter, who paid the lowest tax of all, were marshalled by their heads. Persons of the first rank, from their pre-eminence, had the name of *classici*; whence the term classic. All others were said to be *infra classem*. The assembly of the people by centuries was held for the electing of consuls, censors, and prætors; for the judging of persons accused of what they called *crimen perduellionis*, or actions by which the party had showed himself an enemy to the state, and for the confirmation of all such laws as were proposed by the chief magistrates. The place appointed for their meeting was the *Campus Martius*; because in the primitive times their enemies, went armed to these assemblies. But it was afterwards thought sufficient to place a body of soldiers as a guard in the *janiculum*, where an imperial standard was erected, the taking down of which denoted the conclusion of the comitia. By the institution of these comitia, Servius Tullius took the whole power from the commons: for the centuries of the first and richest class being called out first, who were three more in number than all the rest put together, if they all agreed, as they generally did, the business was decided, and the votes of the other classes were needless. Accordingly the three last scarcely ever came to vote. The commons, in the time of the republic, to remedy this disadvantage, obtained, that, before they proceeded to voting at these comitia, that century should give their suffrages first upon whom it fell by lot, with the name of *centuria prerogativa*; the rest being to follow according to the order of their classes. The prerogative century being chosen by lot, the chief magistrates, sitting in a tent in the middle of the *Campus Martius*, ordered that century to come out and give their voices; upon which they separated from the rest, and came into an enclosed apartment, which they termed *septa*, or *ovilia*, passing over the

pontes, or narrow boards, laid for the occasion; on which account, *de ponte dejici* signifies to be denied the privilege of voting, and persons thus dealt with were called *depontani*. At the hither end of the *pontes* stood the *diribitores*, a sort of under officers, so called from their marshalling the people, and delivered to every man, in the election of magistrates, as many tables as there appeared candidates, one of whose names was written upon every tablet. A proper number of chests were set ready in the *septa*, and every body threw in which tablet he pleased. By the chests were placed some of the public servants, who taking out the tablets of every century, for every tablet, made a point in another tablet which they kept by them. Thus, the business being decided by most points, gave occasion to the phrase *omne tulit punctum*. The same method was observed in the judiciary process at these comitia, and in the confirmation of laws; except that, in both these cases, only two tablets were offered to every person, one marked a and the other u. r. See A. But though in the election of magistrates, and in the ratification of laws, the votes of that century, whose tablets were equally divided, signified nothing; yet in trials of life and death, if the tablets pro and con were the same in number, the person was acquitted.

COMITIA CURIATA owed their origin to the division which Romulus made of the people into thirty *curiæ*; ten being contained in every tribe. They answered in most respects to our parishes, being not only separated by proper bounds and limits, but distinguished by their different places for public worship, which was performed by priests called *curiones*. The power of calling these assemblies belonged at first only to the kings; but upon the establishment of the democracy, the same privilege was allowed to most of the chief magistrates, and sometimes to the pontifices. The persons who voted, were such Roman citizens as belonged to the *curiæ*; or lived in the city, and conformed to the rites of their *curiæ*; all those being excluded who dwell without the bounds of the city, retaining the ceremonies of their own country, though they had been admitted free citizens of Rome. These, and the other comitia, were held only as business required. The people being met together, and confirmed by the report of good omens from the augurs, the *rogatio*, or business to be proposed, was publicly read; after which the people divided into their proper *curiæ*, and consulted of the matter; and then the *curiæ* being called out, by lot, gave their votes man by man, in ancient times *vivâ voce*, and afterwards by tablets; the most votes in every *curiæ* going for the voice of the whole *curiæ*, and the majority of the *curiæ* for the general consent of the people. In the time of Cicero, the comitia curiata were so neglected, that they were formed only by fifty *lictores* representing the thirty *curiæ*; whence, in his second oration against Rullus, he calls them *comitia adumbrata*.

COMITIA TRIBUTA. The division of the people into tribes was an invention of Romulus, after he had admitted the Sabines into Rome; and though he constituted at that time only three,

yet as the state increased in power, and the city in number, they rose by degrees to thirty-five. For a long time after this institution, a tribe signified only a space of ground with its inhabitants. But at last it was considered as no longer pars urbis, but pars civitatis; not a quarter of the city, but a company of citizens living where they pleased. This change was chiefly occasioned by the original difference between the tribes in point of honor. For Romulus having committed all mechanic arts to the care of strangers, slaves, and libertines; and reserved the labor of agriculture to the freemen and citizens, who by this active course of life might be prepared for martial service; the tribus rusticæ were for this reason esteemed more honorable than the tribus urbanae. And all persons being desirous of getting into the more creditable division, by adoption, by the power of censors, or the like, that rustic tribe which had the most worthy names in its roll, had the preference to all others, though of the same general denomination. Hence all of the same great family, bringing themselves by degrees into the same tribe, gave the name of their family to the tribe they honored; whereas at first the generality of the tribes did not borrow their names from persons but from places. The first assembly of the tribes we meet with, was about A. U. C. 263, convened by Sp. Sicinius, tribune of the commons, upon the trial of Coriolanus. Soon after, the tribunes of the commons were ordered to be elected here; and at last, all the inferior magistrates, and the collegiate priests. The same comitia served for the enacting of laws relating to war and peace, and all others proposed by the tribunes and plebeian officers. They were generally convened by the tribunes of the commons; but the same privilege was allowed to all the chief magistrates. They were confined to no place; and therefore sometimes held in the comitium, or the capitol. This last sort of the comitia only could be held without the consent and approbation of the senate, which was necessary to the convening of the other two.

COMITIAL, *adj.* Lat. *comitia*. An assembly of the Romans. Relating to the assemblies of the people of Rome.

COMITIALIS MORBUS, an appellation given to the epilepsy, as the comitia of ancient Rome were dissolved, if any person in the assembly happened to be taken with this distemper.

COMITIUM, in Roman antiquity, a large hall in the forum, which occupied the entire space between the Palatine Hill, the Capitol, and the Via Sacra. It was separated originally from the forum by rows of steps and barriers; and was uncovered till the memorable year that Hannibal first entered Italy, when it was embellished and covered with a roof, supported by lofty and beautiful fluted columns of the Corinthian order. Three of them, with their architrave, are still standing in the ancient forum, near the church of Santa Maria Liberatrice. The capitals are wrought and finished on the side next the forum, but rough on the opposite side. In this hall the comitia were usually held.

COM'ITY, *n. s.* Lat. *comitas*. Courtesy; civility; good breeding.

COMMA, *n. s.* *Κόμμα*. The point which notes the distinction of clauses, and order a construction, in the sentence; marked thus (,).

Commas and points they set exactly right. *Pope*

COMMA, among grammarians, is differently used and defined by different authors. According to F. Bussier, the comma serves to distinguish those members of a period, in each of which is a verb and a nominative; thus, That so many people are pleased with trifles, is owing to a weakness of mind, which makes them love things easy to be comprehended. Besides this, the comma is used to distinguish, in the same member of a period, several nouns substantive, or nouns adjective, or verbs not united by a conjunction; thus, Virtue, wit, knowledge, are the chief advantages of a man. If the words are united in the same phrase with a conjunction, the comma is omitted; thus, the imagination and the judgment do not always agree. The ingenious author of the tract, *De Ratione Interpungendi*, printed with Vossius's *Element. Rhetor.* Lond. 1724, lays down the use of a comma to be, to distinguish the simple members of a period or sentence; i. e. such as only consist of one subject, and one definite verb. But this rule does not hold throughout; the same author instancing many particular cases not yet included herein, where yet the comma is advisable. See **PUNCTUATION**. It is a general rule that a comma ought not to come between a nominative and a verb, or an adjective and substantive, when these are not otherwise disjoined: thus, in the sentence, God ruleth with infinite wisdom, a comma between God and ruleth, or between infinite and wisdom, would be absurd. But to this exceptions may occur; as when not a single word, but a sentence, is the nominative; thus, in the above example, where the sentence, that so many people are pleased with trifles, forms the nominative to the verb is, a comma at trifles is proper, both for the sake of perspicuity, and as coinciding with a slight natural pause.

COMMA, in music. See **INTERVAL**.

COMMA'ND, *v. a. v. n. & n. s.* } Lat. *mando*;
COMMA'NDER, *n. s.* } Fr. *commander*;
COMMA'NDMENT, *n. s.* } *er.* To exercise the chief
COMMA'NDRESS, *n. s.* } authority; to issue mandates; to superintend; to govern: correlative to obey; and contrary to prohibit. The substantives are cognate with the verb, and but echo its various significations, with the exception of commander, which is used technically. A paving beetle, or a very great wooden mallet, with a handle about three feet long, to use in both hands: and likewise an instrument of surgery.

The preest him besieth all that ever he can
 To don as this Charon, this cursed man,
Commandeth him; and faste bleweth the fire
 For to come to the effect of his desire.

Chaucer's Canterbury Tales.
 After avarice cometh glotonie, which is expresse
 ayenst the commandment of God.

Id. The Persones Tale.
 The glossocomium, commonly called the commander, is of use in the most strong tough bodies, and where the laxation hath been of long continuance.

Wiseman's Surgery.

Fare- Queene of Love! my life thou maist *command*,
 Too tender price for all thy former grace,
 Which I receive at thy so bounteous hand;
 But never dare I speak her name or face. *Spenser.*

Thence she *commanded* me to prison new;
 Whereof I glad did not gaine say nor strive,
 But suffered that same dwarfe me to her dongeon drive. *Id.*

We'll do thee homage, and be ruled by thee;
 Love thee as our *commander* and our king. *Shakespeare.*
 I thought that all things had been savage here,
 And therefore put I on the countenance
 Of stern *commandment*. *Id. As you like it.*

Commanded always by the greater just;
 Such is the lightness of you common men. *Id. Henry VI.*

Up to the Eastern tower,
 Whose height *commands* as subject all the vale,
 To see the sight. *Id. Troilus and Cressida.*

Take pity of your town and of your people,
 While yet my soldiers are in my *command*. *Id. Henry V.*

They plainly require some special *commandment* for
 that which is exacted at their hands. *Hoober.*

To prescribe the order of doing in all things, is a
 peculiar prerogative, which wisdom hath, as queen of
 sovereign *commandress*, over all other virtues. *Id.*

The Romans, when *commanders* in war, spake to
 their army, and styled them, My soldiers. *Bacon's Apophthegms.*

Whatever hypocrites austerly talk
 Of purity, and place, and innocence,
 Defaming as impure what God declares
 Pure, and *commands* to some, leaves free to all.
 Our Maker bids increase: who bids abstain
 But our destroyer, foe to God and man? *Milton.*

His eye might there *command* wherever stood
 City, of old or modern fame, the seat
 Of mightiest empire. *Id.*

Of this tree we may not taste nor touch;
 God so *commanded*, and left that *command*
 Sole daughter of his voice. *Id. Paradise Lost.*

As there is no prohibition of it, so no *command* for
 it. *Taylor.*

Sir Frederick and Sir Solomon draw lots
 For the *command* of politicks and Scots:
 Hence fell to words, but quarrels to adjourn,
 Their friends agreed they should *command* by turn. *Marvell.*

Those two *commanding* powers of the soul, the un-
 derstanding and the will. *South.*

The steepy stand,
 Which overlooks the vale with wide *command*. *Dryden's Æneid.*

Be you *commandress* therefore, princess, queen
 Of all our forces, be thy word a law. *Fairfax.*

Command and force may often create, but can never
 cure, an aversion; and whatever any one is brought
 to by compulsion, he will leave as soon as he can. *Locke on Education.*

Should he, who was thy lord, *command* thee now
 With a harsh voice, and supercilious brow,
 To servile duties. *Dryden's Pers. Sat. 5.*

Charles, Henry, and Francis of France, often ad-
 ventured rather as soldiers than as *commanders*. *Hayward.*

One side *commands* a view of the finest garden in
 the world. *Addison's Guardian.*
 And on his brow such awe majestic sate

As seemed to speak him born for high *command*;
 Though now, for many a moon, the sport of Fate,
 A willing exile from his native land. *Gay.*

COMMANDERY, *n. s.* From *command*.
 A body of the knights of Malta, belonging to the
 same nation.

COMMANDERY, or COMMANDRY, a kind of be-
 nefice belonging to a military order, and con-
 ferred on ancient knights who had done service
 to the order. There are regular commanderies,
 obtained by merit: there are others of favor,
 conferred by the grand master: there are also
 commanderies for the religious, in the orders of
 St. Bernard and St. Anthony. The commanderies
 of Malta are of different kinds; for knights,
 chaplains, and brothers servitor. The knight to
 whom one of these is given is called commander;
 which agrees nearly with the *præpositus* set over
 the monks in places at a distance from the mo-
 nasters. Thus, the simple commanders of Malta,
 are rather farmers of the order than beneficiaries,
 paying a certain tribute, called *responsio*, to the
 common treasure of the order.

COMMANDINE, or COMMANDINUS (Fred-
 eric), born at Urbino in Italy, in the sixteenth cen-
 tury, and descended from a noble family. To great
 skill in mathematics he added a profound know-
 ledge of the Greek Tongue. He translated several
 of the Greek mathematicians into Latin, as
 Archimedes, Apollonius, Euclid, &c. which no
 writer till then had attempted.

COMMANOES, one of the small Virgin Isles,
 in the West Indies, situated to the N. N. E. of
 Tortula. Long. 63° 0' W., lat. 18° 25' N.

COMMANTAWANA, a bay on the north
 coast of the island of St. Vincent, about a mile
 east of Tarrata Point.

COMMATERIA, *adj.* } Lat. *con* and *ma-*
 COMMATERIA'LITY, *n. s.* } *teria*. Resembling
 another thing, or consisting of the same matter.

The beaks in birds are *commaterial* with teeth. *Bacon.*

The body adjacent and ambient is not *commaterial*,
 but merely heterogeneal towards the body to be pre-
 served. *Id.*

COMMELIN (John), a celebrated Dutch bo-
 tanist, was born at Amsterdam in 1629. He, as
 well as his father, was a magistrate of that city,
 where he formed a well-managed botanical gar-
 den, and died in 1692. His works are, 1. Cata-
 logus Plantarum Indigenarum Hollandiæ, 12mo.
 2. Catalogus Plantarum, Horti Medici
 Amstel. Besides which he assisted in the Hortus
 Indicus Malabaricus.

COMMELIN (Gaspar), physician and nephew of
 the above, was appointed professor in botany and
 director of the garden at Amsterdam. He pub-
 lished, 1. Flora Malabarica. 2. Prælua Anatomica,
 4to. 3. Prælua Botanica. 4. Icones
 Plantarum, præsertim ex Indiis collectarum. 5.
 Botanographia Malabarica, folio.

COMMELINA, in botany, a genus of the
 monogynia order and triandria class of plants;
 natural order sixth, *ensatæ*: cor. hexapetalous;
 nectaria three, of a cruciform figure, and inserted
 into their proper filaments. Species thirteen, all
 natives of warm climates. They are herbaceous
 plants, rising from two to four feet high, and
 adorned with blue or yellow flowers. Their
 culture is the same with that of the common
 exotics.

COMMEMORATE, *v. a.* } Lat. *con* and
COMMEMORABLE, *adj.* } *memoro*. To pre-
COMMEMORATION, *n. s.* } serve in memory
COMMEMORATIVE, *adj.* } that which is worthy
 to be mentioned with honor, by some public
 act or solemnity, which is the commemoration;
 and whatever tends to preserve the recollection
 is commemorative.

That which is daily offered in the church, is a daily
commemoration of that one sacrifice offered on the cross.

Taylor.

St. Austin believed that the martyrs, when the com-
memorations were made at their own sepulchres, did
 join their prayers with the churches, in behalf of those
 who there put up their supplications to God.

Stillingfleet.

Such is the divine mercy which we now *commemo-*
rate; and, if we *commemorate* it, we shall rejoice in
 the Lord.

Fiddes.

The annual offering of the Paschal lamb was *commemorative*
 of that first Paschal lamb.

Atterbury.

The original use of sacrifice was *commemorative* of
 the original revelation; a sort of daily memorial or
 record of what God declared, and man believed.

Forbes.

But who was she, the lady of the dead,
 Tombed in a palace? was she chaste and fair?
 Worthy a king's—or more—a Roman's bed?
 What race of chiefs and heroes did she bear?
 What daughter of her beauties was the heir?
 How lived—how loved—how died she? Was she not
 So honoured—and conspicuously there,
 Where meaner relics must not dare to rot,
 Placed to *commemorate* a more than mortal lot.

Byron's Childs Harold.

COMMENA (Anna), daughter of Alexius
 Comnenus, emperor of the East; a most accom-
 plished princess, equally eminent for learning
 and virtue. She flourished about the beginning
 of the twelfth century, and wrote The Alexiad, a
 history of the life and actions of her father,
 which is highly esteemed. It is in fifteen books,
 of which the first eight were published by Hes-
 chelius in 1610, and afterwards the whole fifteen
 were printed in the collection of the Byzantine
 historians; with a diffuse and incorrect Latin
 version by the jesuit Possinus, in 1651; but with
 excellent notes by the learned Du Fresne, in
 1670.

COMMENCE, *v. n. & v. a.* } Fr. *commencer*.
COMMENCEMENT, *n. s.* } To begin; to
 take date from, as from the beginning; to make
 a beginning, as to commence a suit.

Most shallowly did you these arms *commence*,
 Fondly brought here, and foolishly sent hence.

Shakespeare.

Man, conscious of his immortality, cannot be with-
 out concern for that state that is to *commence* after this
 life.

Rogers.

If wit so much from ignorance undergo,
 Ah! let not learning too *commence* its foe!

Pope.

The waters were gathered together into one place,
 the third day from the *commencement* of the creation.

Woodward's Natural History.

But if it is probable that the first men might see
 the *commencement* of these species of animals, whose
 formation required longer time than their own, it is
 not impossible, neither, that they might see the *commen-*
cement of those species, whose formation required
 a less time.

Boltonbrooke.

COMMEND, *v. a. & n. s.* } Lat. *commendo*,
COMMENDABLE, *adj.* } compounded of
COMMENDABLY, *adv.* } *com* and *mendo*;
COMMENDATION, *n. s.* } to commit to the
COMMENDATORY, *adj.* } good opinion of
COMMENDER, *n. s.* } others, and some-

times to their care; to represent as worthy of
 regard or kindness; to suggest to the memory;
 to praise, yet praise may be given either by
 equals or inferiors; but commendation is the
 part of a superior; it is praise coming from one
 above us, as a parent commends his child for an
 act of charity.

Father, into thy hands I *commend* my spirit. *Luke.*
 And I it hold vertuous and right *commendabil*,
 To have very knowlech of things reprovahill.

Chaucer's Canterbury Tales.

Certes, the *commendation* of the peple is ful false,
 and brotel for to trust; this day they praise, to-morwe
 they blame. Got wote, desire to have *commendation*
 of the peple hath caused deth to many a besy man.

Id.

The charge, which God doth unto me direct,
 Of his deare safety, I to thee *commend*;

Yet will I not forgoe, ne yet forget
 The care thereof, myselfe, unto the end,
 But evermore him succour and defend
 Against his foe and mine.

Spenser.

His fame would not get so sweet and noble an air
 to fly in as in your breath, so could not you find a
 fitter subject of *commendation*.

Sidney.

It doth much add to a man's reputation, and is like
 perpetual letters *commendatory*, to have good forms;
 to attain them, it almost sufficeth not to despise them.

Bacon's Essays.

Who is Silvia? What is she,
 That all our swains *commend* her?
 Holy, fair, and wise is she.

Shakespeare.

Signior Anthonia
Commends him to you.—

—Ere I ope his letter,

I pray you tell me how my good friend doth.

Id. Merchant of Venice.

Tell her I send to her my kind *commends*:
 Take special care my greetings be delivered.

Id. Richard II.

Hark you Margaret,
 No princely *commendations* to my king!—

—Such *commendations* as become a maid,

A virgin, and his servant say to him. *Id. Henry VI.*

The choice of them should be by the *commendation*
 of the great officers of the kingdom.

Bacon.

Order and decent ceremonies in the church, are
 not only comely, but *commendable*.

Id. Advice to Villiers.

Old men do most exceed in this point of folly,
commending the days of their youth they scarce remem-
 bered, at least well understood not.

Browne's Vulgar Errors.

Among the objects of knowledge, two especially
commend themselves to our contemplation; the know-
 ledge of God, and the knowledge of ourselves.

Hale's Origin of Mankind.

She guiltless damsel, flying the mad pursuit

Of her enraged step dame Guendoler,

Commended her fair innocence to the Lood

That staid her flight, with his cross-flowing course.

Milton.

Some say, (and many men doe these *commend*),

That all our deeds, and fortunes doe depend

Upon the motions of celestiall spheres;

And on the constellations of the starres.

George With-

Of preachers the shire beholdeth a number, all commendably labouring in their vocation.

Carew's Survey of Cornwall.

Good-nature is the most godlike commendation of a man.

Dryden's Juvenal. Dedication.

Each finding, like a friend,
Something to blame, and something to commend.

Pope.

When'er I hear a knave commend,
He bids me shun his worthy friend.
What praise! what mighty commendation!
But 'twas a fox who spoke the' oration
Foxe; this government may prize
As gentle, plentiful and wise.

Gay.

Such as a concurrence of two extremes, by most of the same commendators and disprovers.

Wotton.

COMMENDAM, low Lat. *commenda*.

Commendam is a benefice, which, being void, is commended to the charge and care of some sufficient clerk, to be supplied until it be conveniently provided of a pastor.

Conell.

It had been once mentioned to him, that his peace should be made, if he would resign his bishoprick, and deanery of Westminster; for he had that in commendam.

Clarendon.

COMMENDAM, in the ecclesiastical law, signifies also the administration of the revenue of a benefice, given to a layman, to hold by way of depositum for six months, in order to repairs, &c. Anciently the administration of vacant bishoprics belonged to the nearest neighbouring bishop; thence called commendatory. This custom appears to be very ancient. St. Athanasius says of himself, according to Nicephorus, that there had been given him in commendam, another church besides that of Alexandria, whereof he was stated bishop. When a priest is made bishop his parsonage becomes vacant; but, if the king give him power, he may hold it in commendam. A commendam recipere is to take a benefice de novo in the bishop's own gift, or in the gift of some other patron with his consent.

COMMENDATARY, *n. s.* from commendam. One who holds a living in commendam.

COMMENSA'LITY, *n. s.* from Lat. *commensalis*. Fellowship of table; the custom of eating together.

They being enjoined and prohibited certain foods, thereby to avoid community with the Gentiles, upon promiscuous commensality. *Brown's Vulgar Errors.*

COMMENDATUS, one who lives under the protection of a great man. Commendatii homines were persons who, by voluntary homage, put themselves under the protection of any superior lord; for ancient homage was either predial, due for some tenure; or personal, which was by compulsion, as a sign of necessary subjection; or voluntary, with a desire of protection. These last were sometimes called homines ejus commendati, as often occurs in Doomsday book. Commendati dimidii were those who depended on two several lords, and paid one-half of their homage to each; and sub-commendati were like sub-tenants under the command of persons who were themselves under the command of some superior lord. There were also dimidii sub commendati, who bore a double relation to such depending lords.

COMMENSURATE, *v. a. & adj.* Latin
COMMENSURATELY, *adv.*
COMMENSURABLE, *adj.*
COMMENSURABILITY, *n. s.*
COMMENSURABLENESS, *n. s.*
COMMENSURATION, *n. s.*

} Lat. *commensus*, or *commensior*, measuring in

accordance with some other thing, being suitable in measure to something else; that is commensurate which is made to rise to the same measure or degree. Dr. Johnson explains commensurability as the capacity of being compared with another, as to the measure; or of being measured by another. Thus an inch and a yard are commensurable, a yard containing a certain number of inches; the diameter and circumference of a circle are incommensurable, not being reducible to any common measure: proportion.

A body over great, or over small, will not be thrown so far as a body of a middle size; so that, it seemeth, there must be a commensuration or proportion between the body moved and the force, to make it move well.

Bacon's Natural History.

There is no commensurableness between this object and a created understanding, yet there is a congruity and connaturality.

Hale's Origin of Mankind.

Some place the essence thereof in the proportion of parts, conceiving it to consist in a comely commensurability of the whole unto the parts, and the parts between themselves.

Brown.

That division is not natural, but artificial, and by agreement, as the aptest terms to commensurate the longitude of places.

Id. Vulgar Errors.

They permitted no intelligence between them, other than by the mediation of some organ equally commensurate to soul and body.

Government of the Tongue.

All fitness lies in a particular commensuration, or proportion, of one thing to another.

South.

We are constrained to make the day serve to measure the year as well as we can, though not commensurately with each other; but by collecting the fraction of days in several years, till they amount to an even day.

Holder on Time.

Matter and gravity are always commensurate.

Bentley.

Is our knowledge adequately commensurate with the nature of things.

Glauville's Scapiae.

Those who are persuaded that they shall continue for ever, cannot chuse but aspire after a happiness commensurate to their duration.

Tillotson.

COMMENSURABLE IN POWER, is said of right lines, when the squares are measured by the same space or superficies.

COMMENSURABLE NUMBERS, whether integers or fractions, are such as can be measured or divided by some other number without any remainder; such are 12 and 18 as being measured by 6 and 3.

COMMENSURABLE SURDS, those that, being reduced to their last terms, become true figurative quantities of their kind; and are therefore as a rational quantity to a rational one.

COMMENT, *v. n. & n. s.* Lat. *commen-*

COMMENTARY, *n. s.*

COMMENTATOR, *n. s.*

COMMENTER, *n. s.*

} Lat. *commentum*, from *commisiscor*, to call to mind; does

not necessarily imply what is written; but commentary is never used of what is spoken. Commentary, says Crabbe, is a species of remark which often loses in good nature what it gives us

seriousness; it is mostly applied to particular persons or cases, and more commonly employed as a vehicle of censure than of commendation. This term, when not employed in personal cases, serves for explanation only. Commentaries are minute and elaborate expositions of the text of any author; but more especially applied to the sacred writings. It is sometimes used in the same sense with memoir, in the modern affectation reminiscences, which serves so many coxcombs as the vehicle of self-gratulation and disgusting vanity.

In such a time as this, it is not meet
That every nice offence should bear its *comment*.

Shakespeare.

Enter his chamber, view his lifeless corpse,
And *comment* then upon his sudden death.

Id. Henry IV.

Forgive the *comment* that my passion made
Upon thy feature; for my rage was blind.

Id. King John.

Verè, in a private *commentary* which he wrote of
that service, testified that eight hundred were slain.

Bacon.

A company of stern readers dislike the second of
the *Æneads*, and Virgil's gravity, for inserting such
amorous passions in an heroic subject; but Servius,
his *commentator*, justly vindicates the poet's worth,
wisdom, and discretion, in doing as he did.

Barton's Anat. Mel.

Slily as any *commentator* goes by
Hard words or sense.

Donne.

Such are thy secrets, which my life makes good,
And *comments* on thee; for in every thing
Thy words do find me out, and parallels bring,
And in another make me understand.

Herbert.

All that is behind will be by way of *comment* on
that part of the church of England's charity.

Hammond's Fundamentals.

In religion, Scripture is the best rule; and the
church's universal practice, the best *commentary*.

King Charles.

All this without a gloss or *comment*,
He could unriddle in a moment,
In proper terms, such as men smatter
When they throw out and miss the matter.

Hudibras.

Adam came into the world a philosopher, which
appeared by his writing the nature of things upon
their names; he could view essences in themselves,
and read forms without the *comment* of their re-
spective properties.

South's Sermons.

Criticks having first taken a liking to one of these
poets, proceeded to *comment* on him, and illustrate
him.

Dryden's Juvenal. Dedication.

I have made such expositions of my authors, as no
commentator will forgive me.

Dryden.

All the volumes of philosophy,
With all their *comments*, never could invent
So politick an instrument.

Prior

Still, with itself compared, his text peruse;
And let your *comment* be the Mantuan muse. *Pope.*

No *commentator* can more ally pass

O'er a learned unintelligible place.

Id.

They shew still the ruins of Cæsar's wall, that
reached eighteen miles in length, as he has declared
it in the first book of his *commentaries*.

Addison on Italy.

Galen's *commentator* tells us, that bitter substances
engender cholera, and burn the blood.

Arbuthnot on Aliments.

COMMENTITIOUS, *adj.* Lat. *commentiti-
tius*. Invented; fictitious; imaginary.

It is easy to draw a parallelism between that an-
cient and this modern nothing, and make good its re-
semblance to that *commentitious* inanity.

Glanville's Scopiai.

COMMERCE, *n. s. & v. n.* } Lat. *com* and
COMMERCIAL, *adj.* } *merces*. Mer-

chandise; traffic, literally an exchange of com-
modities, and generally interchange or inter-
course. It can subsist only between persons.
'Commerce,' says Crabbe, 'is a species of general
but close intercourse; it may consist either of
frequent meeting and regular co-operation, or in
cohabitation.'

Places of public resort being thus provided, our
repair thither is especially for mutual conference,
and, as it were, *commerce* to be had between God and
us.

Hooker.

How could communities,
Degrees in schools, and brotherhoods in citi
Peaceful *commerce* from dividable shores,
But by degrees stand in authentick place?

Shakespeare. Troilus and Cressida.

Ezekiel, in the description of Tyre, and of the
exceeding trade that it had with the East, as the
only mart town, reciteth both the people with whom
they *commerce*, and also what commodities every
country yielded.

Raleigh.

Come, but keep thy wonted state,
With even step and musing gait,
And looks *commerce*ing with the skies,
Thy wrapt soul sitting in thine eyes.

Milton.

When they might not converse or *commerce* with
any civil men; whither should they fly but into
the woods and mountains, and there live in a wild
manner.

Sir J. Davies.

In any country that hath *commerce* with the rest
of the world, it is almost impossible now to be
without the use of silver coin,

Locke.

Instructed ships shall sail to quick *commerce*,
By which remotest regions are allayd;
Which make one city of the universe,
Where some may gain, and all may be supplied.

Dryden.

These people had not any *commerce* with the other
known parts of the world.

Tillotson.

Now *Commerce*, wealthy goddess, rears her head,
And bids Britannia's fleets their canvass spread.

Gay.

Good-nature, which consists in overlooking of
faults, is to be exercised only in doing ourselves jus-
tice in the ordinary *commerce* and occurrences of life.

Addison.

From the revolution to the death of queen Anne,
however trade and *commerce* might be aided and
encouraged in other respects, they were necessarily
subjected to depredations abroad, and over-loaded by
taxes at home, during the course of two great wars.

Bolingbroke.

I should venture to call politeness benevolence in
trifles, or the preference of others to ourselves, in
little, daily, and hourly occurrences in the *commerce*
of life.

Chatham.

COMMERCE, in the unrestricted sense of the
term, will embrace all the proceedings whereby
an exchange of commodities is effected, whether
by individuals or a nation; and whether for re-
sale or consumption by the purchaser or receiver
of a commodity: while, as a science, it is ob-
viously divisible into its external and internal

branches. Practically, indeed, the word trade has often been used to express the latter. But the history and principles of the entire subject, and its political bearings, have been, until recently, always discussed under the term at the head of this article.

Our views of such a subject in the present paper must be, of course, general: and here the principles of commerce, regarding it only in theory, might seem to require consideration before we enter upon its history. In point of fact, however, the only sound doctrines upon the subject are the fruit of experience. Theories have been continually demolished by the new facts which have been developed in the ever-changing, and, thank heaven, the ever-improving condition of large communities of mankind. In the present age, especially, this science has been, in common with many others, entirely revolutionised and remoulded; in part by the labors of men who have united a knowledge of its practical details with considerable scientific research and original genius, and in part by the peculiar circumstances and extraordinary political revolutions of the last thirty years. Mr. Locke and Dr. Adam Smith led the way, perhaps, to the scientific consideration which the true 'wealth of nations,' has lately received. The late Mr. Ricardo, Mr. Baring, and other practical merchants and traders, have contributed their quota of important information to the incipient system; and we must, on the whole, fully award to the modern science of POLITICAL ECONOMY that prominent station that has been claimed for it. It now properly embraces the nature and principles of commercial science; and the reader is referred to that article for every thing that is abstract or systematic in this science. Our present article will be confined to a brief sketch of the history of commerce, generally; the actual state of the commerce of different countries will be treated under their respective names.

There is no doubt but commerce is nearly as ancient as the world itself. It seems, however, pretty evident that the early inhabitants of Arabia were the first who made long voyages. Their country was most happily situated for this purpose; being a peninsula washed on three sides by the famous Arabian, Indian, and Persian seas. That Arabia was very early inhabited is certain; and the first notice we have of any considerable trade refers it to the Ishmaelites, settled in the higher part of that country. To them Joseph was sold by his brethren, when they were going down to Egypt with spicery, balm, and myrrh. Here they appear as inland traders; but the halm and myrrh only were productions of their country. For the spicery they must have had commerce with other nations; and such was this commerce, that, in ancient times, the fame of Arabia for spices led many great authors of antiquity to conclude that spices actually grew there. Indeed there seems little doubt of the extent of this commerce, for in succeeding times Strabo and other authors tell us they were very great traders: they mention particularly what ports they had; the prodigious magazines they kept of the richest kinds of goods; the great wealth they amassed; how magnificently they lived and what extravagant sums of money they

expended in carving, building and statues. It is expressly said they had spices, rich gums, sweet-scented woods, and ivory in abundance. All this not only shows that they had a large and flourishing commerce, but that they traded extensively to the East, for there only were those commodities to be obtained. That the Arabians were the first discoverers of the route to India seems also very probable; they lay nearer and more convenient than any other nation; and, as the situation of their country would naturally incline them to navigation, so with the monsoons they could regularly sail to and from the Indies with great facility. Taking all these things together, there seems good reason to contend that commerce flourished first among the Arabians; and their history exhibits them as, at this early period, both a free and happy people; in consequence.

Egypt is celebrated among the ancient nations for carrying everything to perfection; and it is certain that no pursuit was cultivated there more early, with more assiduity, or with greater success, than commerce. We have seen that the richest commodities were transported thither by land; and it is certain that the most valuable manufactures were invented and perfected in Egypt, long before they were undertaken in other countries: for, as Warburton justly observes, at the time Joseph came into Egypt, the people were not only possessed of all the conveniences of life, but were remarkable for their magnificence, their politeness, and even for their luxury, which argues a long standing traffic. Indeed, the advantages of their country, lying along the Red Sea, and the many benefits arising to them from the Nile, which they emphatically called 'The River,' or 'The River of Egypt,' gave them an opportunity of carrying their inland trade not only to a greater height than any other country then known, but even higher than it has ever been carried by any nation, China excepted; and it has even been thought that the Chinese received, at an early period, some of their institutions and habits from the Egyptians. By such methods, under a wise and well-regulated government, promoting a spirit of industry among the people, the Egyptians became numerous, rich, and powerful; and their country, for large cities, magnificent structures, and continual abundance, the glory and wonder of the old world.

Though the Phœnicians possessed only a narrow slip of the coast of Asia, and were surrounded by powerful and warlike nations, that prevented them from extending themselves on that side, yet they rendered themselves famous by erecting the first naval power that makes any figure in history; in raising which, they availed themselves of all the creeks, harbours, and ports of their territory; and improved them in such a manner that they were no less remarkable for their strength, than for their convenience. Every thing that could contribute to increase their power was attended to; and, while they were admired for their formidable fleets and armies, they were no less so for the advantages they derived from commerce. They were also celebrated by antiquity as the inventors of arithmetic and astro-

romy; and the long voyages they undertook, when no other nation (except the Arabians and Ezekiel) could venture farther than their own coasts, shows them to have been considerable proficient in the latter science. It was by these arts that Tyre and Sidon became the most famous marts in the universe; and were the resort both of their neighbours and distant nations, as the storehouses of the world. The two celebrated kings of Israel, David and Solomon, considered their friendship and alliance as of great advantage.

It is not improbable that the latter received from the Phœnicians the first hints of the great advantages that he might derive from the possession of the ports of Elath and Eziongeber, and of the commerce that might from thence be carried on. It is certain that he made use of their assistance in equipping his fleets at these ports; and from thence his vessels, manned chiefly by Phœnicians, sailed to Ophir and Tarsish, bringing into his country various unknown curiosities, and riches in such abundance, that 'He made silver in Jerusalem as stones, and cedar-trees as sycamores that grow in the plains.' If this appear wonderful, let us consider that the return of one voyage only to Ophir produced 450 talents of gold, equal to 51,328 lbs. of our Troy weight, about £2,463,744 sterling, and we cannot doubt of the immense profit arising from this commerce. It also merits notice that the queen of Sheba or Saba, which lies in that part of Arabia before mentioned, having heard, with surprise, the reports that were spread of Solomon's magnificence, made a journey to his court on purpose to satisfy herself; and from the presents she carried with her, 120 talents of gold (£657,650), spices in great abundance, and precious stones, probably the cause of her journey was an opinion that no country was so rich as her own. In confirmation of what is before noticed of the Arabians trading to India, as well as of their having at this time penetrated farther than any others, it is said in this part of Scripture, 'neither were there any such spices as the queen of Sheba gave to king Solomon.' While Solomon reigned he cultivated the arts of peace, kept the wheel of commerce going, and his people employed, thus providing equally for the extension of their happiness and of his own power; while he rendered the land of Israel the glory and wonder of the East. But, under the kings that followed him, the trade of Judea sunk almost as suddenly as it rose; and in a short time they lost those ports on the Red Sea upon which their Indian commerce depended.

The Phœnicians and Egyptians, then became, as it were, heirs of the trade of the world. Egypt monopolised that of the Indies, which, with her corn and manufactures, brought such a great balance of wealth into the country, as enabled her monarchs to accomplish those memorable works, that, in spite of time and the devastations of war, remain the lasting monuments of her power. The Phœnicians drew from Egypt a great part of those rich commodities and manufactures which they exported into all the countries lying between them and the Mediterranean Sea. For the glory and strength of

these governments, as founded on trade, we need only look into the sacred books of Isaiah and Ezekiel, whose accounts are abundantly confirmed by profane history: by comparing these data we behold the industry of the inhabitants of this small country triumphing over all obstacles, and procuring the greatest plenty in a barren soil, and immense riches where, without industry, there must have been the greatest poverty. After the destruction of old Tyre, by Nebuchadnezzar, the spirit of its inhabitants produced a Phœnix, little inferior in beauty to its parent; which soon became mistress of the sea, over which it held supreme dominion till subdued by Alexander the Great.

That this prince's views were far more extended than his conquests, will appear to any one who considers his plan of power; they will behold a greater politician than a conqueror. He framed in his own mind an idea of universal monarchy; and though he was for making use of force to acquire, he very well knew that commerce only could preserve, an empire, which was to have no other limits than those which nature had assigned the world. He thought of placing his capital in Arabia; and of disposing things in such a manner, as to have commanded the most distant parts of the Indies, while he maintained a connexion with the most remote countries in Europe. Though he lived scarcely to sketch the outline of his extravagant scheme, the specimen he left in his new city of Alexandria, sufficiently shows how just and how correct his notions were. That city, which it may be said he designed with his own hand, and which was built under his eye, became, in after times, all that he expected, the glory of Egypt, and the centre of commerce.

Tyre, while in her glory as mistress of the sea, founded her noble colony of Carthage, which, whether considered as a capital, a strong fortress, or a commodious port, was admirably situated. On the coast of Africa, equally distant from all the extremities of the Mediterranean, with a fine country behind it, and no power near it capable of restraining its commerce or its growth, its inhabitants rose rapidly to the greatest wealth and power; and their conquests were astonishing: yet these will not bear comparison with their navigation. Westward they stretched as far as Britain; and the Scilly Islands, which are now so inconsiderable, were to them an India, the route to which they carefully concealed. On the other side, they discovered a great part of the African coast, the Canary Islands; and some have thought they even found the way to America. So long as they confined themselves to trade, and the arts connected with it, their power continually increased; but when luxury took the place of industry, and a spirit of ambition banished their old maxims of frugality and labor, their acquisitions ceased, and their destruction soon followed. See CARTHAGE.

In Egypt the Ptolemies, who succeeded Alexander, entered deeply into that monarch's scheme, and they reaped the fruit of his wise establishment. By encouraging trade Ptolemy Philadelphus made his subjects immensely rich, and himself exceedingly powerful. An ancient author

says that he had 120 galleys of war, of a large size, and above 400 other vessels, small and great; which, were it not for the other wonders related of him, would seem incredible. He raised a new city on the coast of the Red Sea; he opened harbours, constructed quays, built inns at proper distances on the roads, and cut a canal from sea to sea. He who comprehended the importance of commerce, so as to dare such expenses as these, might have treasures, armies, and fleets, at his pleasure. Under him Alexandria appeared in pomp and splendor; how great this was, we may judge by what we are told was the produce of her customs, which fell little short of two millions of our money annually; and Ptolemy, who understood trade so well, would never cramp it by high duties. If the revenue of the prince from a single port was so great, what must have been the wealth of his subjects?

After Egypt became a Roman province, Alexandria maintained her dignity; and the Romans were struck with the majesty of her appearance. They had hitherto paid little regard to traffic, but they soon comprehended the advantages of such a port and a mart as Alexandria. They confirmed her privileges, protected her inhabitants, and took every possible measure to preserve her commerce; and such was the effect, that she preserved it longer than Rome could preserve her power. She even maintained considerable importance after being made dependent on Constantinople: and under the Arabs recovered no small share of her ancient pre-eminence, as the centre of the trade of the civilised world.

After the Roman empire was overrun by barbarians, and the arts and sciences had nearly perished with that power which cultivated and protected them, commerce was in a manner overwhelmed and lost, and individual merchants either forced by necessity, or led by inclination, took shelter in a few scattered islands lying near the coast of Italy. These would scarcely have been thought to offer a human habitation in time of peace; being divided from each other by narrow channels, so encumbered with shallows, that it was impossible for strangers to navigate them; but here these refugees settled in the sixth century, and finding themselves tolerably safe, they united for improving their condition, and augmenting their security; and became, in the eighth century, a well-settled republic. Such was the rise of the famous and potent state of Venice: her growth was quick, and the increase of her power amazing: she extended her commerce on all sides; and taking advantage of the barbarous maxims of the Mahomedan monarchies, she drew upon herself the profits of the Indian trade, and, in some sense, made Egypt a province, and the Saracens her subjects. While her traffic thus swelled beyond conception, and she became the common mart of all nations, her naval power became also great, and she stretched her conquests not only over Italy, but through the islands of the Archipelago; so as to be at once mistress of the sea, of many fruitful countries, and of part of the great city of Constantinople. But ambition, and the desire of lording it over their neighbours, brought upon them those evils

which produced first a falling off in their commerce, and then of their power.

While commerce raised Venice the Rich on the narrow, marshy, unprofitable, and unwholesome islands in the Adriatic, she erected Genoa the Proud on the inhospitable shores of Liguria; and though surrounded by ambitious and warlike neighbours, in a narrow and unproductive country, and disturbed by perpetual factions and successive revolutions, the trade of Genoa made her rich and great. Her merchants traded to all countries, and acquired wealth by carrying the commodities of the one to the other. Her fleets became formidable, and her conquests important. She subjugated the adjacent island of Corsica, fixed a colony at Caffa, and for some time possessed the coasts on both sides of the Black Sea. The pursuit of commerce begat continual wars between her and Venice; which, though they terminated in leaving the latter mistress of the sea, were fatal to both; but the avarice of the Genoese may be said to have destroyed them, by inducing them to abandon the fair profits of trade for the vile ones of usury.

In another part of the world, about the middle of the thirteenth century, a confederacy of maritime cities was formed, solely regarding commerce, which they extended far and wide. See HANSE TOWNS. When they had become immensely rich and powerful, their behaviour awakened various princes to a more particular view of the dangers that such a league might produce, and the advantages that would naturally flow to their respective states, by recovering their trade, thus in some part made over to others, entirely to themselves. Though from this time the Hanseatic alliance declined, and is now totally dissolved, the cities of Lubeck, Hamburgh, and Bremen, sufficiently mark to what splendor and dignity this confederacy arrived.

Portugal and Spain next demand attention; and by subjects of these states, in a space of about fifty years, such discoveries were made as changed the whole face of affairs in the commercial world. The kingdom of Portugal was small, but well cultivated, very populous, and favored with a variety of good ports; which, with a succession of wise princes, who fostered the arts and sciences, encouraged industry, and extended the wealth and happiness of their subjects, prompted some lively spirits among them, about the beginning of the fifteenth century, to attempt discoveries in distant quarters. They were countenanced by a young heroic prince, who pushed on their endeavours with such success, that step by step the coast of Africa, was surveyed, as far as the Cape of Good Hope, which they thus named; and Vasquez de Gama at last happily discovered a new route to the East Indies, the point principally in view. Thus, in a short space of time, Portugal, from an inconsiderable power, grew one of the richest in Europe, gaining a vast accession of territory in Asia and Africa, and raising a naval power superior to any seen for ages preceding.

About the same time Christopher Colon or Columbus, under the patronage of Isabella Queen of Castile, and wife to Ferdinand the Wise, dis-

covered America; and, after Columbus's death, the discovery of a passage to the Spice Islands, which he aimed at, was perfected by Magellan.

The consequences that naturally followed on the discovery of a passage by the Cape of Good Hope, and of a fourth part of the globe in the western hemisphere, were, as before hinted, an entire change in the state of Europe, producing not only in Portugal and Spain, but in most other nations, a desire of visiting these remote parts, of establishing colonies and manufactures; of exporting commodities, and of raising, settling, and protecting, new establishments. Thus Europe in general received a lasting and invaluable benefit; and its potentates made themselves not only formidable, but even terrible, in those parts of the earth where before their fame was scarcely known.

The naval power of Portugal, which, as we have seen, was very great, received an incurable wound by falling under the power of Spain; and this alone, it would naturally be supposed, must have raised the latter to a monopoly of commerce, and the universal dominion of the sea; yet the very pursuit of a design so injurious to the interests of mankind, quickly ruined that power. The haughty temper of the Spaniards, fostered by the boundless ambition of their princes, obliged other nations, in their own defence, to pay more attention to navigation than they otherwise would have done. The English and Dutch, particularly, who had hitherto been blind to the advantages of their situation, were roused by the injuries they received; and the spirit of revenge prompted them to enterprise. In short, the pains taken by Spain to keep all the riches flowing from these discoveries to herself, and the dangerous, detestable, and destructive uses she made of those immense riches, produced effects directly opposite to those she looked for, and her enemies became rich, powerful, and happy, while her commerce dwindled away, and her naval power sunk and crumbled to pieces.

The inhabitants of the Seven Provinces, made poor by her oppression, and driven mad by her severities, shook off her yoke, and became potent and rich. They had learned by distresses the necessity of establishing a moderate and equal government; and the mildness of that government, with the blessings it procured to its subjects, increased their number, and elevated their hopes. The consequences were surprising both to friends and enemies; in a short time every fishing village was improved into a trading town; little towns grew up into large and magnificent cities; inland boroughs were filled with manufactures; and within half a century the oppressed states of Holland became high and mighty. Even amidst the danger and expenses of a war carried on against far superior forces these people attained a degree of political strength and importance which not only enabled them to defy the Spaniards, but made the latter glad to solicit their friendship.

None of the triumphs of commerce, either in ancient or modern history, were of so rapid or so strong a growth as this; and it will admit of no dispute, that the republic of the United Pro-

vinces owed her freedom, her power, and her wealth, entirely to industry and trade. The productions of their country would not support a tenth part of its inhabitants; they were without timber or maritime stores; without coal or lime; and their havens, though commodious, were difficult of entry. Yet these provinces were soon enriched; their store-houses became full of corn; their magazines contained every earthly commodity; their shipping was enormous, and their naval stores abundant. And the increase of their population was equally surprising. Had their land been pleasant and fruitful it would have been nothing strange; but that men should force nature, lay out gardens, raise palaces, dig canals, plant woods, and ransack all quarters of the earth for fruits and flowers, to make a paradise on a dead plain or ungrateful heath, in the midst of fogs and standing lakes, appears almost incredible.

The foreign commerce of BRITAIN, it may easily be conceived, must have been a work of time. The natives would first think of necessities, then of conveniences, and lastly of superfluities. Such tribes as came originally from the continent might have other ideas; but as we can only think of fear or indigence driving them hither, so it is likely that succeeding generations would fall off from the manners of their ancestors; and their circumstances affecting their desires would make them another sort of people. It is clear, however, that the inhabitants of the opposite continent, early maintained a foreign traffic, and came over and bartered their goods for the raw commodities of the Britons, till they gradually taught the latter to improve their leather and wicker boats, and to venture themselves over to Gaul.

Things were in this situation when the Romans invaded Britain, and by falling under that power our ancestors caught the manners and customs of their conquerors. At that time the arts and sciences flourished throughout the empire; with learning the Romans introduced foreign commerce everywhere, made excellent high roads, established colonies, and fixed standing camps and fortresses in proper places. These improvements were soon extended to Britain. They were also careful with regard to marts or emporiums for the conveniency of traders, of which they left many, and among the rest London, not more famous for her present extensive trade, than venerable for her antiquity. The abandonment of this island by the Romans was followed by a new deluge of barbarity: the Saxons effaced almost all the improvements of our civilised conquerors, and, upon the establishment as it were of a new people, things were to begin a new. Yet that they were inclined to, and made some advances in, foreign commerce, is sufficiently evident: Alfred the Great formed projects of vast discoveries to the north, and actually sent persons of great prudence and abilities into the east, who brought home various curiosities, which were preserved in the treasury of the church of Salisbury for many ages.

Though the Danes were our masters only a short time, yet from their becoming so by a maritime force, and from the establishment of their

countrymen on the opposite shores of France, as well as in the other parts of Europe, we may justly conclude that they corresponded with them, and that had their dominion continued longer it would have produced many advantages. But the Normans, men of the same race, dispossessed them here; and partly under color of right, partly by force, erected that monarchy, which, not without various alterations and changes, subsists even to our time.

We cannot here trace the ebbings and flowings of our commerce through every reign; but the opinion commonly entertained, that we had little or no trade before the time of Queen Elizabeth, seems to have but feeble support from history. The reign of that princess, however, was brilliant in every point of view. At her accession the finances of the nation were in a desperate condition; the crown was in debt, the treasury empty, the nation involved in a foreign war directly against her own interests, and our coasts naked. It had no credit abroad, nor concord at home; the great men were split into factions, and the common people distracted and dejected. In this sad situation of affairs, the first establishment of our commerce was effected. The government was compelled to act with caution, to draw assistance from every quarter, and to promote by every means the welfare of the people, both to support the expenses of the state, and to give a popular turn to her councils. Elizabeth encouraged her subjects to arm against the Spaniards, that they might be accustomed to the sea, and acquire a knowledge in navigation. She erected several companies, and was attentive to their pursuing the ends for which they were designed. During her whole reign, she particularly encouraged industry at home, and the honor of the country abroad; our commodities and manufactures were improved, the art of ship-building was brought to perfection, our ports were filled with able seamen, and English merchants were justly respected. In short, the seeds of British wealth, sown in her time, have been springing up ever since. See ENGLAND.

COMMERSONIA, in botany, a genus of the pentagynia order, and pentandria class of plants: CAL. a monophyllous, five-parted, corolliferous perianth, with sharp ovated segments; COR. five linear petals; STAM. five very short filaments at the bases of the petals; pericarp a globular, hard, quinquelocular nut, with two ovated seeds in each division. Species one only; native of Otaheite and the South Sea Islands.

COMMIGRATE, *v. n.* } Lat. *com* and *mi-*
COMMIGRATION, *n. s.* } *gro*. To remove in a body, or by consent, from one country to another.

Both the inhabitants of that, and of our world, lost all memory of their *commigration* hence.

Woodward's Natural History.

COMMINATION, *n. s.* } Lat. *comminatio*.
COMMINATORY, *adj.* } A threat; a denunciation of punishment; a curse. The day of curses in the English church, otherwise called Ash-Wednesday, when the comminatory or denunciatory portions of the Levitical law are read, and all the people say *Amen*.

Some parts of knowledge God has thought fit to seclude from us; to fence them not only by precept and *commination*, but with difficulty and impossibilities.

Decay of Piety.

COMMINGLE, *v. a. & v. n.* Lat. *commisceo*. To mix into one mass; to unite intimately; to blend; to unite one with another.

Blest are those,

Whose blood and judgment are so well *commingled*,
That they are not a pipe for fortune's finger,
To sound what stop she please. *Shakespeare. Hamlet.*

Dissolutions of gum tragacanth and oil of sweet almonds do not *commingle*, the oil remaining on the top till they be stirred. *Bacon's Physical Remains.*

Thy fanes, thy temples, to thy surface bow,
Commingling slowly with heroic earth,
Broke by the share of every rustic plow:
So perish monuments of mortal birth,
So perish all in turn, save well recorded worth.

Byron's Child Harold.

COMMUNUTE, *v. a.* } Lat. *commينو*. To
COMMUNUTABLE, *adj.* } grind; to pulverise;
COMMUNUTION, *n. s.* } to break into small
parts. It is also used in the sense of attenuation.

Causes of fixation are the even spreading of the spirits and tangible parts, the closeness of the tangible parts, and the jejuneness or extreme *communion* of spirits; of which the two first may be joined with a nature liquifiable. *Bacon.*

Parchment, skins, and cloth drink in liquors, though themselves be entire bodies, and not *comminuted*, as sand and ashes. *Id. Natural History.*

The best diamonds are *commisable*; and are so far from breaking hammers, that they submit unto pestilation, and resist not any ordinary pebble. *Brown.*

This smiting of the steel with the flint both only make a *commination*, and a very rapid whirling and melting of some particles; but that idea of flame is wholly in us. *Bentley.*

COMMISERATE, *v. a.* } Lat. *com* and *mi-*
COMMISERABLE, *adj.* } *serior*. To pity;
COMMISERATION, *n. s.* } to compassionate.

It has relation to suffering, and more especially to suffering arising from criminality of conduct. A culprit dying under the penalty of the law excites our commiseration. Thus it is compassion peculiarly modified. Compassion is a call, a demand of nature, to relieve the unhappy. Commiseration is the sympathy which we feel with the guilty wretch, whose offence we deplore, but whose sorrows excite us to do all we can for his relief. Commiseration is represented as the feeling which our wretchedness excites in the Supreme Being. Commiseration is also the tenderness which we feel towards those who are below us in station or character, when they are overwhelmed with calamity.

These poor seduced creatures, whom I can neither speak nor think of but with much *commiseration* and pity. *Hooker*

Forgive a moiety of the principal
Glancing an eye of pity on his losses,
That have of late so huddled on his back;
Enough to press a royal merchant down,
And pluck *commiseration* of his state
From brassy bosoms, and rough hearts of flint,
From stubborn Turks, and Tartars, never trained
To offices of gentle courtesy. *Shakespeare.*

Live, and hereafter say
A mad man's mercy bade thee run away.

— I do defy thy *commiseration*,
And apprehend thee for a felon here.

Id. Romeo and Juliet.

It is the sinfulness thing in the world to destitute a plantation once in forwardness: for besides the dishonour, it is the guiltiness of blood of many *commiserable* persons.

Bacon's Essays.

This was the end of this noble and *commiserable* person, Edward eldest son to the duke of Clarence.

Id. Henry VII.

She ended weeping; and her lovely plight
Immoveable, till peace, obtained from fault
Acknowledged and deplored, in Adam wrought
Commiseration.

Milton's Paradise Lost.

Then we must those, who groan beneath the weight
Of age, disease, or want, *commiserate.*

Denham.

We should *commiserate* our mutual ignorance, and endeavour to remove it.

Loche.

I prevailed with myself to go and see him, partly out of *commiseration*, and partly out of curiosity.

Swift.

CO'MMISSARY, n. s. } Bar. Lat. *commis-*
CO'MMISSARIŒSHIP, n. s. } *sarius.* An officer made occasionally for a certain purpose; a delegate; a deputy. It is a title of ecclesiastical jurisdiction, appertaining to such as exercise spiritual jurisdiction, at least so far as his commission permits, in places of the diocese so far distant from the chief city, as the chancellor cannot call the subjects. An officer who draws up list of the numbers of an army, and regulates the procurement and conveyance of provision or ammunition.

The *commissaries* of bishops have authority only in some certain place of the diocese, and in some certain causes of the jurisdiction limited to them by the bishop's commission.

Ayliffe.

A *commissariship* is not grantable for life, so as to bind the succeeding bishop, though it should be confirmed by the dean and chapter.

Id. Parergon.

But is it thus you English bards compose?

With Runic lays thus tag inispid prose?

And when you should your heroes deeds rehearse,
Give us a *commissary's* list in verse.

Prior.

COMMISSARY-GENERAL, OF THE MUSTERS, an officer appointed to muster the army, to know the state of each regiment and company, to receive and inspect the muster rolls, and to keep an exact account of the strength of the army. A new appointment has been created in the person of inspector-general of cavalry, which answers every purpose for which that of muster-master general was intended, as far as regards the cavalry.

COMMISSARY-GENERAL, OF PROVISIONS, has the charge of furnishing the army in the field with all sorts of provision, forage, &c. by contract. He has under him various commissaries, store-keepers, clerks, &c.

COMMISSION, n. s. & v. a. } From *com-*
COMMISSIONATE, v. a. } *mit,* signifies
COMMISSIONER, n. s. } the act of committing, or putting into the power of another, a trust; a warrant by which any trust is held, or authority exercised. Charge; mandate; office; employment. A number of persons may be joined together to execute a trust, and they are a commission; and each individual is a commissioner. Commission is also used in the sense of

perpetration; the act of committing sin. Sins of commission are distinguished in theology from sins of omission.

Discrete he was, and of gret reverence;
He seemed swiche; his wordes were so wise:
Justice he was fol often in assise,
By patent, and by pleine *commissioun.*
For his science, and for his high renown.

Chaucer. Cant. Tales.

Commission is the warrant, or letters patent, that all men exercising jurisdiction, either ordinary or extraordinary, have for their power.

Cowell.

Omission to do what is necessary,
Seals a *commission* to a blank of danger.

Shakespeare. Troilus and Cressida.

The subject's grief
Comes through *commissions*, which compel from each
The sixth part of his substance, to be levied
Without delay.

Id. Henry VIII.

He led our powers;
Bore the *commission* of my place and person;
The which immediacy may well stand up,
And call itself your brother.

Id. King Lear.

It was both a strange *commission*, and a strange obedience to a *commission*, for men in the midst of their own blood, and being so furiously assailed, to hold their hands contrary to the laws of nature and necessity.

Bacon's War with Spain.

—What thou canst attain, which best may serve
To glorify thy Maker, and infer
Thee also happier, shall not be withheld
Thy hearing, such *commission* from above
I have received, to answer thy desire
Of knowledge within bounds.

Milton.

Draw no *commission* lest the court should lye,
And disavowing treaty ask supply.

Marvell.

As he was thus sent by his father, so also were the apostles solemnly *commissionated* by him to preach to the Gentile world, who, with indefatigable industry and resolute sufferings, pursued the charge; and sure this is competent evidence, that the design was of the most weighty importance.

Decay of Piety.

Every *commission* of sin introduces into the soul a certain degree of hardness.

South's Sermons.

He indulges himself in the habit of known sin, whether *commission* of something which God hath forbidden, or the omission of something commanded.

Roger's Sermons.

The archbishop was made one of the *commissioners* of the treasury.

Clarendon.

Suppose itinerary *commissioners* to inspect, throughout the kingdom, into the conduct of men in office, with respect to morals and religion, as well as abilities.

Swift.

I was made a colonel; though I gained my *commission* by the horse's virtues, having leapt over a six-bar gate.

Addison's Freeholder.

He for his son a gay *commission* buys,
Who drinks, whores, fights, and in a duel dies.

Pope.

Like are their merits, like rewards they abare;
That shines a consul, this *commissioner.*

Id. Dunciad.

'Tis pitiful
To court a grin when you should woo a soul;
To break a jest, when pity should inspire
Pathetic exhortation; and address
The kitsch fancy with facetious tales,
When sent with God's *commission* to the heart.

Cowper.

COMMISSION, in commerce. See FACTORAGE.
COMMISSION OF BANKRUPTCY. See BANKRUPT.

COMMISSION OF LUNACY, issues out of the court of chancery, whether a person represented to be a lunatic, be so or not. See LUNACY.

COMMISSION OF TEINDS, a court at Edinburgh, which came in place of a committee of the Scottish parliament, for erecting new parishes, and valuing teinds for the support of the clergy. It is vested in the lords of session. See LAW.

COMMISSION, in military affairs, the situation of any officer (above a sergeant, who holds no commission) in his majesty's service, either in the line, the volunteers, or militia; in all of which, except the militia, the commissions must have the royal sign manual, and are issued from the war-office. Commissions in the militia do not bear the royal sign manual, but that of the lieutenant of the county,—they having previously been laid before his majesty for fourteen days to approve them.

COMMISSIONERS OF CUSTOMS. See CUSTOMS.

COMMISSIONERS OF EXCISE. See EXCISE.

COMMISSIONERS OF THE NAVY. See NAVY.

COMMISSIONERS OF THE TREASURY, LORDS. See EXCHEQUER, AND TREASURY.

COMMISSURE, *n. s.* Lat. *commissura*. Joint; a place where one part is joined to another.

All these inducements cannot countervail the inconvenience of disjoining the *commissures* with so many strokes of the chissel. *Wotton's Architecture*.

This animal is covered with a strong shell, jointed like armour by four transverse *commissures* in the middle of the body, connected by tough membranes.

Ray on the Creation.

COMMISSURE, among anatomists, is sometimes used for a suture of the cranium or skull. See SUTURE.

COMMISSURE, in architecture, &c. denotes the joint of two stones, or the application of the surface of the one to that of the other. See MASSORY. Commissure is also used by some authors for the small metuses or interstices of bodies, or the little clefts between the particles, especially when the particles are broadish and flat, and lie contiguous to one another, like thin plates or lamellæ.

COMMIT, *v. a.* } Lat. *committo*; Fr.
COMMITMENT, *n. s.* } *commettre*. To put to-
COMMITTEE, *n. s.* } gether; to put into a
COMMITTABLE, *adj.* } persons hands by way of trust. It also signifies to perpetuate. It carries the idea of doing something wrong. In the first sense it is almost synonymous with commission, as commission, in one of its acceptations, is synonymous with commit. The kind of trust to which the verb very frequently refers, is that of committing, or sending to prison. Committee bears a striking analogy to commissories. Cowell thus explains its application:—'Those to whom the consideration or ordering of any matter is referred, either by some court to whom it belongs, or by consent of parties. As in parliament, after a bill is read, it is either agreed to and passed, or not agreed to; or neither of these, but referred to the consideration of some appointed by the house to examine it farther, who thereupon

are called a committee.' Committer is a magistrate that sends a criminal to jail; or, the criminal who perpetrates the offence, that renders a jail his appropriate residence.

The mighty goddess also, of nature,
That under God hath the whole governance
Of worldly things committed to her cure,—
Disposed have, through her wise purveiance,
To give my lady so moche suffiance
Of al vertues.

Chaucer. Complaint of the Black Knight.

Thou ne shalt not also make no lesinges in thy confession, for humilitee; peraventure, to say, that thou hast committed and don swich sinnes of which that thou ne wene never guilty.

Id. The Persones Tale.

It is for your health, thus to commit
Your weak condition to the raw, cold morning.

Shakespeare.

Here comes the nobleman that committed the prince, for striking him about Bardolph.

Id. Henry IV.

It did not appear by any new examinations or commitments, that any other person was discovered or impeached. *Bacon.*

Besides the mistakes committible in the solary compute, the difference of chronology disturbs his computes. *Brown.*

So, though my ankle she has quitted,
My heart continues still committed;
And, like a bailed and main-prized lover,
Although at large, I am bound over. *Hudibras*

He'd prove a buzzard is no fowl,
And that a lord may be an owl,
A calf an alderman, a goose a justice,
And rookes committe-men and trustees. *Id.*

A ravenous cat will punish in the mouse
The very same offences in the house
Which hee himselfe committe; yea, for that vice
Which was his own (with praise) hee kills the meic.
George Withers.

There, in a bribed committee, they contrive
To give our birth-rights to prerogative:
Give, did I say? They sell, and sell so dear,
That half each tax Danby distributes there.

Marvell.

Such an one makes a man not only a partaker of other men's sins, but a derivor of the whole guilt to himself, yet so as to leave the committer as full of guilt as before. *South.*

All corners were filled with covenanters, confusion, committe-men, and soldiers, serving each other to their ends of revenge, or power, or profit; and these committe-men and soldiers were possess with this covenant. *Walton.*

Manchester had orders to march thither, having a committee of the parliament with him, as there was another committee of the Scottish parliament always in that army; there being also now a committee of both kingdoms residing at London, for carrying on the war. *Clarendon.*

Letters out of Ulster gave him notice of the inhuman murders committed there upon a multitude of the Protestants. *Id.*

A creeping young fellow committed matrimony with a brisk gamesome lass. *L' Estrange.*

'Tis policy
For son and father to take different sides;
Then lands and tenements commit no treason. *Dryden.*

Is my muse controuled
By servile awe? Born free, and not be bold!

At least I'll dig a hole within the ground,
And to the trusty earth *commit* the sound.

Id. Persius.

Vexed at the charge, I to the flames *commit*
Rhymes, similies, lord's names, and ends of wit.

Gay.

Whatever errors I may have *committed* in publick
life, I have always loved my country. *Bolingbroke.*

Can you *commit* unchecked by shame

What in a beast so much you blame?

What is a law if those that make it

Become the forwardest to break it?

Beattie.

COMMITMENT, in our law, takes place where the offence is not bailable, or the party cannot find bail. It must be by proper warrant, containing the cause of the commitment; and continues till put an end to by a trial, or in due course of law; imprisonment being intended only for safe custody, and not for punishment.

It is said, that wheresoever a justice of peace is empowered by any statute to bind a person over, or to cause him to do a certain thing, and such person, being in his presence, shall refuse to be bound, or to do such thing, the justice may commit him to the gaol to remain there till he shall comply. 2 Hawk. P. and C. cap. 16. §. 2. It also seems agreed by the old books, that wheresoever a constable or private person may justify the arresting another for a felony or treason, he may also justify the sending or bringing him to the common gaol; and that every private person has as much authority, in cases of this kind, as the sheriff or any other officer; and may justify such imprisonment by his own authority, but not by the command of another. *Id.* §. 3. But inasmuch as it is certain, that a person lawfully making such an arrest may justify bringing the party to the constable, in order to be carried by him before a justice of peace; and inasmuch as the statutes of 1 and 2 P. and M. cap. 13., and 2 and 3 P. and M. cap. 10., which direct in what manner persons brought before a justice of the peace for felony shall be examined by him, in order to their being committed or bailed, seem clearly to suppose, that all such persons are to be brought before such justice for such purpose; and inasmuch as the statute of 31 Car. II. cap. 2, commonly called the habeas-corpus act, seems to suppose that all persons who are committed to prison are there detained by virtue of some warrant in *writing*, which seems to be intended of a commitment by some magistrate, and the constant tenor of the late books, practice, and opinions, are agreeable hereto; it is certainly most adviseable at this day, for any private person who arrests another for felony, to cause him to be brought, as soon as conveniently he may, before some justice of the peace, that he may be committed or bailed by him. The privy council and secretary of state may commit: but on an enquiry made into the source of this power in cases of libels and other state crimes, 2 Wils. 275, 11 S. T. 317. 9, it appears that the king being the principal conservator of the realm, the secretary of state has so much of the royal authority transferred to him as justifies commitment for these crimes, but not the seizure of papers. Respecting the manner of commitment, it is enacted by 2 and 3 P. and M. cap.

10, that justices of peace shall examine persons brought before them for felony, &c., or suspicion thereof, before they commit them to prison, and shall bind their accusers to give evidence against them. A justice of the peace may detain a prisoner a reasonable time, in order to examine him; and it is said, that three days is a reasonable time for this purpose. Every commitment must be in writing, and under the hand and seal, and show the authority of him that made it, and the time and place; and must be directed to the keeper of the prison. It may be either in the king's name, and only attested by the justice, or in the justice's name. And it ought to set forth the crime with convenient certainty, otherwise the officer is not punishable, by reason of such mittimus, for suffering the party to escape; and the court before whom he is removed by habeas corpus, ought to discharge or bail him.

Every such mittimus, again, ought to have a lawful conclusion, viz. that the party be safely kept till he be delivered by law, or by order of law, or by due course of law; or that he be kept till further order (which shall be intended of the order of law), or to the like effect; and if the party be committed only for want of bail, it seems to be a good conclusion of the commitment, that he be kept till he find bail: but a commitment till the person who makes it shall take further order, seems not to be good; and it seems that the party committed by such, or any other irregular mittimus, may be bailed. 2 Hawk. P. C. cap. 16. §. 18. A commitment grounded on an act of parliament ought to be conformable to the method prescribed by the statute; and all commitments must be to some prison within the realm.

COMMITTEE OF PARLIAMENT. At a select committee, although any member may be present, none can speak, or vote, but those named, for the committee; and the chairman has no more than a casting vote, when the parties are equal. Sometimes the whole house is resolved into a committee; on which occasion each person has a right to speak and reply as often as he pleases: an expedient they usually have recourse to, in extraordinary cases, and where any thing is to be thoroughly canvassed. When the house is not in a committee, each gives his opinion regularly, and is only allowed to speak once, unless to explain himself. The standing committees, appointed by every new parliament, are those of privileges and elections, of religion, of grievances, of courts of justice, and of trade; though only the former act.

COMMIT, *v. a.* } Lat. *commisceo*. To
COMMITION, *n. s.* } mingle; to blend; to
COMMITTION, *n. s.* } mix; to unite with
COMMITTURE, *n. s.* } things in one mass.
Union of various substances; in corporation.
The mass formed by mingling different things

Of Cerberus whylome he was begot,
And fell Chimæra, in her darksome den,
Through fowle *commixture* of his filty blot;
Where he was fostred long in stygian fen,
Till he to perfect ripenessse grew; and then
Into this wicked world he forth was sent
To be the plague and scourge of wretched men.

Spenser.

A dram of gold dissolved in aqua regia, with a dram of copper in aqua fortis, *commixed*, gave a great colour.

Bacon.

In the *commixture* of any thing that is more oily or sweet, such bodies are least apt to putrefy, the air working little upon them.

Id. Natural History.

Fair ladies, masked, are roses in the bud,
Or angels veiled in clouds, are roses blown;
Dismasked, their damask sweet *commixture* shown.

Shakespeare.

Were thy *commixion* Greek and Trojan, so
That thou could'st say, this hand is Grecian all,
And this is Trojan.

Id. Troilus and Cr. ssida.

Some species there be of middle and participating natures, that is, of birds and beasts, as bats, and some few others, so confirmed and set together, that we cannot define the beginning or end of either; there being a *commixion* of both in the whole, rather than adaption or cement of the one unto the other.

Broune's Vulgar Errors.

I have written against the spontaneous generation of frogs in the clouds; or, on the earth, out of dust and rain water *commixed*.

Ray on the Creation.

All the circumstances and respect of religion and state intermixed together in their *commixture*, will better become a royal history, or a council-table, than a single life.

Wotton.

Far in the sky they form their long array,
And land and ocean stretch'd immense survey
Deep, deep beneath; and triumphing in pride,
With clouds and winds *commixed*, innumerable ride.

Beattie.

COMMIXION, in Scots law, is a method of acquiring property, by mixing or blending together different substances belonging to different proprietors. See LAW.

COMMODATE, COMMODATUM, in the civil jurisprudence, the loan or free use of any thing movable or immovable for a certain time, on condition of restoring again the same individual after a certain term. There is this difference between a loan and a commodate, that the latter is gratis, and does not transfer the property; the thing must be returned in essence, and without impairment: so that things which consume by use or time cannot be objects of accomodate, but of a loan; in regard they may be returned in kind, though not in identity. See LAW.

COMMODE, *n. s.* The head-dress of women, French.

She, like some pensive statesman, walks demure,
And smiles, and hugs, to make destruction sure;
Or under high *commodes*, with looks erect,
Barefac'd devours, in gaudy colours deck'd.

Glanville.

COMMODIANUS, of Gaza, a Christian author in the fourth century, who wrote a work in Latin verse, entitled Institutiones: M. Davies published a fine edition of it in 1711, at the end of Minucius Felix.

COMMODOUS, *adj.* } Lat. *commodus*, or
COMMODOUSLY, *adv.* } *con*, and *modus*. Ac-
COMMODOUSNESS, *n. s.* } cording to the measure and degree required; fit; suitable; accomodate to any purpose without obstruction; contrariety, or impediment; conveniently, easily, pleasantly.

Wisdom may have framed one and the same thing to serve *commodiously* for divers ends.

Hooker.

If they think we ought to prove the ceremonies *commodious*, they do greatly deceive themselves. *Id.*

The place requireth many circumstances; as the situation near the sea, for the *commodiousness* of an intercourse with England.

Bacon.

Such a place cannot be *commodious* to live in; for being so near the moon, it had been too near the sun.

Raleigh's History.

Bacchus had found out the making of wine, and many things else *commodious* for mankind.

Id. History of the World.

He will instruct us praying, and of grace
Beseeching him, so as we need not fear
To pass *commodiously* this life sustained
By him with many comforts, till we end
In dust, our final rest and native home.

Milton.

At the large foot of an old hollow tree,
In a deep cave seated *commodiously*,
His ancient and hereditary house,
There dwelt a good substantial country mouse.

Cowley.

To that recess, *commodious* for surprise,
When purple light shall next suffuse the skies,
With me repair.

Pope's Odyssey.

COMMODITY, *n. s.* In Latin *commoditas*, signifies in its abstract sense convenience; and in an extended application anything that is convenient or fit for use, which being also saleable, the word has been employed for things that are sold. Commodity is employed only for articles of the first necessity; accommodation, general convenience, particular advantage, are all senses in which it has been used by our best authors of the elder time. It is now more restricted in its application.

They knew, that howsoever men may seek their own *commodity*, yet if this were done with injury unto others, it was not to be suffered.

Hooker.

There came into her head certain verses, which, if she had had present *commodity*, she would have rejoined as a retraction to the other.

Sidney.

Travellers turn out of the highway, drawn either by the *commodity* of a foot-path, or the delicacy or the freshness of the fields.

Ben Jonson's Discoveries.

Some offer me *commodities* to buy,
Even now a tailor called me in his shop,
And showed me silks that he had bought for me,
And, therewithal took measure of my body.

Shakespeare.

Commodity, the bias of the world,
The world, which of itself is poised well,
Till this advantage, this vile drawing bias,
This away of motion, this *commodity*,
Makes it take head from all indifferency,
From all direction, purpose, course, intent.

Id. King John.

Commodities are moveables, valuable by money, the common measure.

Locke.

COMMODORE, *n. s.* Probably corrupted from the Spanish *commandador*. The captain who commands a squadron of ships; a temporary admiral.

COMMODORE, in the British marine, is a general officer, invested with the command of a detachment of ships of war destined on any particular enterprise, during which time he bears the rank of brigadier-general in the army, and is distinguished from the inferior ships of his squadron by a broad red pendant tapering towards the outer end, and sometimes forked. Commodore is also a name given to some select ship in a

fleet of merchantmen, which leads the van in time of war, and carries a light in her top to conduct the rest, and keep them together. The oldest captain in the fleet always commands.

COMMODOUS (L. Aurelius Antoninus), the unworthy son of Marcus Antoninus, succeeded his father in the Roman empire, A. D. 180. His whole reign was a series of lust and folly, corruption and rapacity, injustice and cruelty. He kept 300 female concubines, and committed incest with all his sisters. Affecting to imitate Hercules, he wore a lion's skin, and carried a knotted club. He publicly fought with the gladiators, and boasted of his dexterity in killing the wild beasts in the amphitheatre. He required divine honors from the senate, and they were granted. Afraid to trust himself in the hands of a barber, he burnt his beard; but, by way of amusement, and under pretence of shaving his courtiers, he cut off their noses. Martia, one of his concubines, whom he had marked for death, poisoned him; but, as the poison did not quickly operate, he was strangled by a wrestler, A. D. 192; in the thirty-first year of his age, and the thirteenth of his reign. The servile senate no sooner heard of his death, than they ordered that the corpse of him, whom they had so lately deified, should rot upon a dunghill.

COMMOIGNE, in old records, a brother monk, residing in the same monastery.

- COMMON, *n. s.*
- CO'MMON, *n. s. & adv.* from the *adj.*
- CO'MMONABLE, *adj.*
- CO'MMONAGE, *n. s.*
- CO'MMONALTY, *n. s.*
- CO'MMONER, *n. s.*
- CO'MMONLY, *adv.*
- CO'MMONNESS, *n. s.*
- CO'MMONS, *n. s.*
- CO'MMON-PLACE, *n. s.*
- CO'MMONWEAL, *n. s.*
- CO'MMONWEALTH, *n. s.*

I. lat. con and munus; Fr. commun. 'The joint office or property of many. It has regard to the multitude of objects, and to those objects

as possessed or accessible by everybody. It signifies abundant as opposed to rare and scarce; mean and vulgar as opposed to what is distinguished and noble: open and free as opposed to what is appropriated and enclosed; usual and customary as opposed to what is infrequent and singular; lower as opposed to higher, when applied to the houses of parliament. In composition, as in common-place book, it retains its general meaning, and signifies a book to be filled with a multitude of things, ranged, however, under general heads—and as in commonwealth, which signifies the public, the multitude, the general body of the people; or a civil polity and government, in which the many are interested, and which is or ought to be administered for their benefit.

This fierce arcite hath, of his helme, ydon;
And on a courser, for to shew his face,
He priketh endelong the large place,
Loking upward upon this emelie;
And she again him cast a frendliche eye,
(For women, as to speken in *commune*,
They folwen the favour of fortune)
And was all his in chere as his in hert.

Chaucer's Canterbury Tales.

Tyrants, that make men subject to their law,
I will suppress, that they no more may raine;
And lordings curbe that *commons* over-aw;
And all the wealth of rich men to the poore will draw.

Spenser.

Behold this ring,
Whose high respect and rich validity
Did lack a parallel: yet, for all that,
He gave it to a *commoner* o' the camp. *Shakespeare*

Bid him strive
To gain the love o' the *commonalty*; the duke
Shall govern England. *Id.*

My good lord,
How now for mitigation of this bil
Urged by the *commons*? Doth his majesty
Incline to it, or no? *Id. Henry VI.*

Look, as I blow this feather from my face,
And as the air blows it to me again,
Such is the lightness of you *common* men. *Id.*

This hand of yours requires
Much castigation, exercise devout;
For here's a strong and sweating devil here,
That *commonly* rebels. *Id. Othello.*

I am more than *common* tall. *Id. As you like it.*
Their sons are well tutored by you: you are a good
member of the *commonwealth*. *Id. Love's Labour Lost.*
Then take we down his load, and turn him off,
Like to the empty ass, to shake his ears,
And graze in *commons*. *Id. Julius Caesar.*

Two foundations bear up publick societies; the one inclination, whereby all men desire sociable life; the other an order agreed upon, touching the manner of their union in living together: the latter is that which we call the law of a *common-wealth*. *Hooker.*

I myself too will use the secret acknowledgment of the *commonalty*, bearing record of the God of Gods. *Id.*

Much good land might be gained from forests and chases, and from other *commonable* places, so as there be care taken that the poor *commoners* have no injury. *Bacon to Villiers.*

Though life and sense be *common* to man and brutes, and their operations in many things alike; yet by this form he lives the life of a man, and not of a brute; and hath the sense of a man, and not of a brute. *Hale's Origin of Mankind.*

Flying bullets now,
To execute his rage, appear too slow;
They miss, or sweep but *common* souls away;
For such a loss Opdam his life must pay. *Wallor.*

Or as the man, whom princes do advance
Upon their gracious mercy-seat to sit,
Doth *common* things, of course and circumstance,
To the reports of *common* men commit. *Davies.*

As the obsequious air and waters rest
Till the dear Halcyon hatch out all its nest;
The *commonwealth* doth by its losses grow,
And, like its own seas, only ebbs to flow. *Marvell.*

The emmet joined in her popular tribes
Of *commonalty*. *Milton's Paradise Lost.*

These three to kings and chiefs their scenes display.
The rest before the' ignoble *commons* play. *Dryden's Fables.*

Is not the separate property of a thing the great cause of its endearment? Does any one respect a *common* as much as he does his garden? *South.*

The Papiasts were the most *common* place, and the butt against whom all the arrows were directed. *Clarendon.*

Where no kindred are to be found, we see the possessions of a private man revert to the community, and so become again perfectly *common*; nor can any

one have a property in them, otherwise than in any other things *common* by nature. *Locke.*

Neither is it strange that there should be mysteries in divinity, as well as in the *commonest* operations in nature. *Swift.*

Blot out that maxim, *res nolunt diu male administrari*: the *commonness* makes me not know who is the author; but sure he must be some modern. *Id.*

There is hardly a greater difference between two things, than there is between a representing *commoner* in his public calling, and the same person in *common* life. *Id.*

This *commoner* has worth and parts,
Is praised for arms, or loved for arts:
His head aches for a coronet;
And who is blessed that is not great? *Prior.*

Hipparchus was going to marry a *common* woman, but consulted Philander upon the occasion. *Spectator.*

The peers are in some points, I speak it with all the respect due to them, *commoners* with coronets on their coats of arms; and, affecting to act as such, it is plain they desire very wisely to be taken for such, on many occasions. *Bolingbroke.*

A huge *common-place* book, wherein all the remarkable sayings and facts that we find in history are to be registered, may enable a man to talk or write like Bodin, but will never make him a better man, nor enable him to promote, like a useful citizen, the security, the peace, the welfare, or the grandeur of the community to which he belongs. *Id.*

A man may prescribe, in a que estate, for a *common* appurtenant to a manor; but, if he would prescribe for a *common* in gross, he must prescribe in himself and his ancestors. *Blackstone's Commentaries.*

Amidst no *common* pomp the despot sate,
While busy preparations shook the court;
Slaves, eunuchs, soldiers, guests, and santons wait;
Within, a palace, and without, a fort;
Here men of every clime appear to make resort. *Byron's Childs Harold.*

COMMON, in grammar, such verbs as signify both action and passion are called *common*; as, *asperno*, I despise, or am despised; and also such nouns as are both masculine and feminine, as *parents*.

COMMON, in geometry, is applied to an angle, line, or the like, which belongs equally to two figures.

COMMON, in law, *communia* (i. e. *quod ad omnes pertinet*), signifies that soil, the use whereof is common to a particular town or lordship; or the profit that a man has in the land of another person, usually in common with others; or a right which a person has to put his cattle to pasture into ground that is not his own. And there is not only *common* of pasture, but also *common* of piscary, *common* of estovers, *common* of turbary, &c. And, in all cases of *common*, the law doth much respect the custom of the place; for there the rule is, *consuetudo loci est observanda*. See **COMMONTY**.

COMMONALTY, the lower of the two divisions of the civil state. See **CIVIL**. The *commonalty*, like the nobility, are divided into several degrees: and as the lords, though different in rank, are yet all peers in respect of their nobility; so the *commoners*, though some are greatly superior to others, are all in law *commonalty*, in respect to their want of nobility. This comprehensive term, therefore, includes—knights of the garter;

knights Jannerets; baronets; and knights of the bath, nat being otherwise peers; knights bachelors; all originally ranked as inferior degrees of nobility, though now classed as *commoners*: esquires; gentlemen; merchants; yeomen; tradesmen or artificers; laborers.

COMMONWEALTH, in English history, the title assumed by the government after the death of Charles I. under the protectorate of Cromwell, and till the restoration of Charles II. See **ENGLAND, HISTORY OF**.

COMMON COUNCIL. See **COUNCIL**.

COMMON DIVISOR, a quantity or number which exactly divides two or more other quantities or numbers, without leaving any remainder.

COMMON LAW contains those customs and usages which have, by long prescription, obtained in this nation the force of laws. It is distinguished from the statute law, which owes its authority to acts of parliament. See **LAW**.

By the *common* law any man might dispose of his lands to any other private man at his own discretion, especially when the feudal restraints of alienation were worn away. *Blackstone's Commentaries.*

COMMON-PLACE-BOOK is a register of what things occur, worthy to be noted, in the course of thinking or study, so disposed as that among a number of subjects any one may be easily found. The advantages of making a *common-place* book are many: it not only assists a person to read with accuracy and attention, but induces him to think for himself, provided he considers it not solely as a register of sentiments that strike him in the course of reading, but as a register of his own thoughts upon various subjects. There are various methods of arranging *common-place* books; that of Locke is as good as any that have hitherto been contrived. The first page is to serve as a kind of index to the whole, and to contain references to every place or matter therein: in the commodious contrivance of which index, so as it may admit of a sufficient variety of materials, without confusion, all the art consists. For this purpose, the first page, or, for more room, the two first pages that front each other, are to be divided, by parallel lines, into twenty-five equal parts; whereof every fifth line is to be distinguished by its color or other circumstance. These lines are to be crossed perpendicularly by others, drawn from top to bottom; and in the several spaces thereof, the several letters of the alphabet, both capital and minuscule, are to be duly written. The form of the lines and divisions, both horizontal and perpendicular, with the manner of writing the letters therein, will be conceived from the annexed diagram; in which what is to

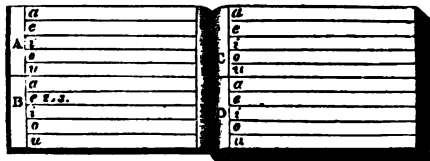

be done in the book for all the letters of the alphabet, is here shown in the first four, *A, B, C,* and *D*. Suppose I would enter down a passage that refers to the head beauty, *B*, being the initial letter, and *e* the first vowel, I look in the

index for the partition *B*, and therein the line *e* (which is the place for all words whose first letter is *b*, and first vowel *e*; beauty, blemish, bread, &c.), and finding no numbers already down to direct me to any page of the book where words of this characteristic have been entered, I turn forward to the first blank page I find (which, in a fresh book, as this is supposed to be, will be page second), and here write what I have occasion for under the head beauty; beginning the head in the margin, and indenting all the other subsequent lines, that the leading word may be conspicuous. This done, I enter the page where it is, viz. 2. in the index in the space *Be*; from which time, the class *be* becomes wholly in possession of the second and third pages, which are consigned to letters of this characteristic.

COMMON PLEAS. A king's court now held in Westminster Hall, but anciently movable. 'The court of common pleas,' says Tomlins, 'does not possess any original jurisdiction; nor has it, like the court of king's bench, any mode of proceeding in common cases peculiar to itself. Its authority is founded on original writs issuing out of the court of chancery: which original writs are the king's mandates for the court to proceed in the determination of the causes mentioned therein. In all personal actions, therefore, brought by and against common persons, the only way of proceeding in this court is by original. There is indeed one other way of proceeding in this court, in common cases, which is sometimes used: and which is called proceeding by original *quare clausum fregit*. This method of proceeding is grounded, in point of law, upon the same kind of original writ as the usual proceeding by *capias* is, the only difference between them being in the mesne process after the original is sued out; or at least supposed so to be. Instead of the process to compel the appearance of the defendant being by *capias* against his person, it is in this case by summons and distress against his goods. In a word, it is the same as the ancient mode of proceeding in this court was, before the general introduction of the *capias*. The advantage and use of this mode of proceeding by original *quare clausum fregit*, is where a defendant has effects which can be distrained, but he himself cannot be met with to be personally served; the process by *capias* requiring personal service, which is not required in the process by summons. In this court are four judges, created by letters patent; the seal of the court is in the custody of the chief justice.

COMMON PRAYER, the 'liturgy of the church of England. See **LITURGY**. Clergymen are to use the public form of prayers prescribed by the book of Common Prayer: and refusing to do so, or using any other public prayers, are punishable by stat. 1 Eliz. c. ii.

COMMONITION, n. s. Lat. *commonitio*. Advice; warning; instruction.

COMMONS, n. s. } Food; fare; diet; so
COMMONER, n. s. } called from colleges, where it is eaten in common. A student of the second rank at the university of Oxford; one that eats at the common table.

He painted himself of a dove colour, and took his *commons* with the pigeons. *L'Esrange.*

Meanwhile she quenched her fury as the flood,
And with a lenten sallad cooled her blood:
Their *commons*, though but coarse, were nothing
scant;
Nor did their minds an equal banquet want.

Dryden.

The doctor now obeys the summons,
Likes both his company and *commons*. *Swift.*

COMMONS, or HOUSE OF COMMONS. See **PARLIAMENT**. The house of commons consists of members chosen from among such men of property in the kingdom as have no seats in the house of lords, every one of whom has thus a voice in parliament, either personally or by his representatives. In a free state, every man who is a free agent, ought to be in some measure his own governor; and therefore a branch at least of the legislative power should reside in the whole body of the people. It therefore is wisely contrived, that the people should do that, which it is impracticable for them to perform in person, by representatives chosen in a number of minute and separate districts, wherein all the voters are or may be easily distinguished. The counties are therefore represented by knights elected by the proprietors of lands; and the cities and boroughs by citizens and burgesses, chosen by the mercantile, or supposed trading interest of the nation. Each member, though chosen by one particular district, when elected and returned, serves for the whole realm; for the end of his coming thither is not particular but general; not barely to advantage his constituents, but the commonwealth. The peculiar laws and customs of the house of commons relate principally to the raising of taxes, and the elections of members to serve in parliament. See **ELECTIONS** and **TAXES**.

COMMONS, DOCTORS. See **COLLEGE**.

COMMONTY, in Scots law, sometimes signifies lands belonging to two or more common proprietors. Sometimes a heath or muir, though it should belong in property to one, if there has been a promiscuous possession upon it by pasture; and the act 1695, mentions commonities belonging in property to the king and to royal boroughs. See **LAW**.

COMMORANT, adj. } Lat. *commorans*.
COMMORANCE, n. s. } Resident; dwelling;
COMMORANCY, n. s. } inhabiting.

The very quality, carriage, and place of *commorance*, of witnesses is plainly and evidently set forth. *Hale*.
An archbishop, out of his diocese, becomes subject to the archbishop of the province where he has his abode and *commorancy*. *Ayliffe's Parergon*.
The abbot may demand and recover his monk, that is *commorant* and residing in another monastery. *Id.*

COMMOTAU. See **COMETAU**.

COMMOTE, an ancient term in Wales, denoting half a cantred, or hundred; containing fifty villages. See **HUNDRED**. Wales was anciently divided into three provinces; each of these subdivided into cantreds, and every cantred into two commotes or hundreds. Silvester Girald, however, tells us, in his Itinerary, that a commote is but a quarter of a hundred.

COMMOTION, n. s. } It. *commotio*. A

COMMOTIONER, n. s. } motion of several together. Tumult; insurrection; public dis-

order; perturbation; disorder of mind; restlessness. Applied to any object in motion.

By flattery he hath won the common hearts;
And, when he'll please to make commotion,
Tis to be feared they all will follow him.

Shakespeare. Henry VI.

He could not debate any thing without some commotion, when the argument was not of moment.

Clarendon.

Sacrifices were offered when an earthquake happened, that he would allay the commotions of the water, and put an end to the earthquake.

Woodward. Natural History.

The people, more regarding commotioners than commissioners, flocked together, as clouds cluster against a storm.

Hayward.

COMM'OVE, *v. a.* Lat. *commoveo*. To disturb; to agitate; to put into a violent motion; to unsettle. This word is now become obsolete.

Straight the sands,

Commov'd around, in gathering eddies play.

Thomson's Summer.

COMMUNE, *v. n.*

COMMUNICABILITY, *n. s.*

COMMUNICABLE, *adj.*

COMMUNICANT, *n. s.*

COMMUNICATE, *v. a. & v. n.*

COMMUNICATIO, *n. s.*

COMMUNICATIVE, *adj.*

COMMUNICATIVENESS, *n. s.*

Lat. *communio*. To converse; to impart sentiments mutually. Communicable is more

extended in its meaning, it refers not only to sentiments, but to anything that may become the common possession of more than one. Communicate is from the Latin *communicatus*, the participle of *communico*, contracted from *communifico*, which signifies to make common property with another. To impart to others what is in our own power; to bestow; to confer a joint possession. It is also a term of theological application, as the Lord's Supper is the boon which the blessed Redeemer has conferred upon all the members of his mystical body indiscriminately; they have all a joint and common interest in it; and when they receive it, as they ever ought to do, in society with each other, they are said to communicate; and the solemn festival is called 'The Communion.' It more generally means something in common to two or more, as the houses communicate, that is, there is a passage between them, by which either may be entered from the other. Communicative is used in the sense of free, unreserved, and the quality of those who are unworthy of confidence, more from their natural infirmity, than any privy of will or intention. Communion, likewise, is to be understood in the general sense of intercourse.

Communion destroyeth the prison of helle, and taketh weke and feble all the strengthes of the devils, and restoreth the yeftes of the Holy Ghost, and of all good vertues, and it clenseth the soule of sinne, and deliverth it fro the peine of helle, and fro the compaignie of the devil, and fro the servage of sinne, and it restoreth it to all goodes spirituelle, and to the compaignie and communion of holy chirche.

Chaucer. The Perceus Tale.

Consider, finally, the angels, as having with us that communion which the apostle to the Hebrews ascribeth; and in regard whereof angels have not disclaimed to profess themselves our fellow servants.

Hooker.

Communicants have ever used it; and we, by the form of the very utterance, do show we use it as communicants. *Id.*

Sith eternal life is communicable unto all, it behooveth that the word of God be so likewise. *Id.*

Charles the Hardy would communicate his secrets with none; and, least of all, those secrets which troubled him most. *Bacon.*

I will commune with you of such things
That want no ears but yours.

Shakespeare. Measure for Measure.

Then commune, how that day they best may ply
Their growing work. *Milton's Paradise Lost.*

The happy place

Rather inflames thy torment, representing
Lost bliss, to thee no more communicable.

Id. Paradise Regained.

The primitive Christians communicated every day. *Taylor.*

Where God is worshipped, there he communicates his blessings and holy influences.

Id. Worthy Communicant.

Ideas, as ranked under names, are those that, for the most part, men reason of within themselves, and always those which they commune about with others. *Locke.*

His majesty frankly promised, that he could not, in any degree, communicate to any person the matter, before he had taken and communicated to them his own resolutions. *Clarendon.*

They resolved that the standing of the communion table in all churches should be altered. *Id.*

Secrets may be carried so far, as to stop the communication necessary among all who have the management of affairs. *Swift.*

We have paid for our want of prudence, and determine for the future to be less communicative. *Id. and Pope.*

He is not only the most communicative of all beings, but he will also communicate himself in such measure as entirely to satisfy; otherwise some degrees of communicativeness would be wanting. *Norris.*

A constant frequenter of worship, and a never-failing monthly communicant. *Atterbury's Sermons.*

The map shows the natural communication providence has formed between the rivers and lakes of a country at so great a distance from the sea.

Addison on Italy.

When one that holds communion with the skies,
Has filled his urn where these pure waters rise,
And once more mingles with us meaner things,
'Tis even as if an angel shook his wings;
Immortal fragrance fills the circuit wide,
That tells us whence his treasures are supplied.

Cowper.

The whole body is nothing but a system of such canals, which all communicate with one another, mediately or immediately. *Arbutnot on Aliments.*

Those who speak in publick are better heard when they discourse by a lively genius and ready memory, than when they read all they would communicate to their hearers. *Watts.*

'Tis said thou holdest converse with the things
Which are forbidden to the search of man;
That with the dwellers of the dark abodes,
The many evil and unheavenly spirits
Which walk the valley of the shades of death,
Thou communest. *Byron's Manfred.*

Speed to thy castle, shut thy chamber door,
Bind fast thy soul by every solemn vow
Never to hold communion with that object.

Matwin's Bertram.

COMMUNES, in botany, the name of a class in Linnæus's *Methodus Calycina*, consisting of two plants which, like teasel and dandelion, have a calyx or flower-cup common to many flowers or florets. These are the aggregate or compound flowers of other systems.

COMMUNICATING, in theology, the act of receiving the sacrament of the eucharist. Those of the reformed, and of the Greek church, communicate under both kinds; the laity of the Romish, under only one. The oriental communicants receive the wine by a spoon, and anciently drank it through a pipe.

COMMUNICATION, LINES OF, in military affairs, trenches made to continue and preserve a safe correspondence between two forts or posts; or at a siege, between two approaches, that they may relieve one another.

COMMUNION, the celebration of the Lord's supper. The fourth council of Lateran decrees, that every believer shall receive the communion, at least, at Easter; but they did it much oftener in the primitive church. Gratian prescribes it as a rule for the laity, to communicate at Easter, Whitsuntide, and Christmas; and the council of Trent recommended frequent communion. So late as the ninth century, the communion was still received by the laity in both kinds; or rather the bread was dipped in the wine, as is owned by the Roman Catholics themselves. M. de Marca observes, that they received it at first in their hands, and believes the communion under one kind alone to have had its rise in the west under pope Urban II. in 1096, at the time of the conquest of the Holy Land. And it was more solemnly enjoined by the council of Constance in 1414. The twenty-eighth canon of the council of Clermont enjoins the communion to be received under both kinds, admitting only two exceptions; the first in favor of the sick, the second of the abstemious, or those who had an aversion for wine.

COMMUNION, FOREIGN, a punishment to which the canons frequently condemned their bishops and other clerks. This was a kind of suspension from the function of the order, and a degradation from the rank they held in the church. It had its name from the communion being only granted to the criminal on the footing of a foreign clerk. i. e. being reduced to the lowest of his order, he took place after all those of his rank, as all clerks, &c. did in the churches to which they did not belong. The second council of Agda orders every clerk who absents himself from the church, to be reduced to foreign communion.

COMMUNION, LAY, the communion under one kind. It was formerly a kind of canonical punishment, for clerks guilty of any crime, to be reduced to lay communion.

COMMUNION SERVICE, in the liturgy of the church of England, the office for the administration of the holy sacrament, extracted from several ancient liturgies, as those of St. Basil, St. Ambrose, &c. By the last rubric, part of this service is appointed to be read every Sunday and holiday, after the morning prayer, even though there be no communicants.

COMMUNITY, *n. s.* Lat. *communitas*, and *communis*. Its primary sense is simply the state

of being common: it has been extended, however, in its application—to those who are in a state of common possession; to the goods possessed as well as to the possessors; to the frequency or commonness of intercourse, or of observation. It also signifies the commonwealth, or body politic. 'Community in anything constitutes a community; a common interest; a common language; a common government is the basis of that community which is formed by any number of individuals.' 'Community has always a restricted and relative sense; in this it differs from society, which has a general and unlimited import.'—*Crabbe*.

He was but, as the cuckoo is in June,
Heard, not regarded; seen, but with such eyes,
As, sick and blunted with community,
Afford no extraordinary gaze. *Shakespeare.*

How could communities,
Degrees in schools, and brotherhood in cities,
But by degree stand in authentic place?
Id. Troilus and Cressida.

Sit up and revel,
Call all the great, the fair, and spirited dames
Of Rome about thee, and begin a fashion
Of freedom and community. *Ben Jonson.*

The undistinction of many in the community of name, or misapplication of the act of one unto the other, hath made some doubt thereof.

Browne's Vulgar Errors.

This text is far from proving Adam sole proprietor; it is a confirmation of the original community of all things. *Locke.*

It is not designed for her own use, but for the whole community. *Addison's Guardian.*

He lives not for himself alone, but hath a regard in all his actions to the great community. *Atterbury.*

COMMUTE, *v. a. & v. n.* Lat. *commuto*.
COMMUTABILITY, *n. s.*
COMMUTABLE, *adj.*
COMMUTATION, *n. s.*
COMMUTATIVE, *adj.*
Literally to exchange, to put one thing in the place of another; to ransom; to alter. Commute is chiefly applied to the exchanging one mode of punishment for another; but commutative, relative to exchange, as commutative justice, that honesty which is exercised in traffic, and which is contrary to fraud in bargains.

The law of God had allowed an evasion, that is, by way of commutation or redemption. *Brown.*

Some commute swearing for whoring; as if forbearance of the one were a dispensation for the other.

L'Esrange.

An innocent nature could hate nothing that was innocent; in a word, so great is the commutation, that the soul then hated only that which now only it loves; i. e. sin. *South's Sermons.*

Those institutions which God designed for means to further men in holiness, they look upon as a privilege to serve instead of it, and to commute for it. *Id.*

COMMUTUAL, *adj.* Con and mutual. Mutual; reciprocal. Used only in poetry.

Love our hearts, and Hymen did our bands,
Unite commutual in most sacred bands.

Shakespeare. Hamlet.

There, with commutual zeal, we both had strove
In acts of dear benevolence and love;
Brothers in peace, not rivals in command.

Pope's Odyssey.

COMO, a lake of Italy, in the Milanese, and on the confines of Switzerland and the Grisons. It is the largest lake in Italy, being twenty-eight miles in length from north to south, from three to six in breadth, and eighty-eight in circumference. Towards the south it is divided into two branches; at the end of the one stands the town of Como, and at that of the other Lecco. The Adda runs through it; and its banks are adorned with vines, chestnuts, almond-trees, and various towns and villages.

Como, a populous city of Italy, in the department of Lario, and ci-devant province of Comasco, pleasantly situated in a valley, enclosed by fertile hills, on the south branch of the lake, near the source of the Adda. It was built by the Gauls under Brennus; and called Novocomum. It was the birth-place of Catullus, Jovius, and Pliny the younger; the last of whom, in his letters, speaks with rapture of its delightful situation, and the adjacent romantic scenery. It is surrounded by a wall, defended by towers, and backed by a conical eminence, on which are the ruins of an ancient castle. The houses are mostly built of stone, and the cathedral is a handsome edifice of white marble, hewn from the neighbouring quarries. It is a bishop's see, and contains twelve parish churches, and 15,000 inhabitants. On the outside of one of the churches is a statue of Pliny, with a Latin inscription, dated 1419. The inhabitants trade with the Grisons, and carry on manufactures of silks, cottons, &c. Como is twenty miles north of Milan, and eighty north-east of Turin.

COMORA, an island of Africa, in the Indian Ocean, which gives name to the cluster, of which it makes one. It is about sixty miles long, and fifteen broad, and composed of ranges of mountains, forming in the centre a summit of 7500 feet elevation. It contains many villages, which are resorted to and inhabited by Madagascar pirates. Long. 43° 10' E., lat. 11° 50' S.

COMORA ISLANDS, a cluster of islands lying between the north end of Madagascar and the coast of Zanguebar. Authors differ greatly with regard to their number, some enumerating five, others eight, and others only three. The names of five have been given us: Angezeia, Comora, Joanna, or Hinzuan, Mayotta, and Mobilia. They all abound in cattle, sheep, hogs, and a variety of fruits and animals common in warm countries. They are said also to produce a peculiar kind of rice. The most remarkable of them, and which Europeans are best acquainted with, is Joanna. The inhabitants are here about 7000 in number, and are chiefly settled inland. They pay a religious veneration to a species of ducks, which are very numerous, and inhabit a sacred lake. Of late years they have been much harassed by bands of desperate pirates, who occupy the north-western part of Madagascar. These cross every year by the south-west, with from thirty to fifty canoes, and return by the north-east monsoon. Their depredations are said nearly to have depopulated these islands.

COMORRA, the capital of a district of Hungary. It is so well fortified, that the Turks could never take it. The greatest part of the inhabitants are Hungarians and Russians, who are

very rich, and are of the Greek religion. It was almost destroyed by an earthquake in 1783. It is seated between the Danube and the Waag, in the island of Schut; thirty-six miles south-east of Presburg, and seventy of Vienna. Long. 18° 25' E., lat. 47° 50' N.

COMPACT, *n. s.* Lat. *pactum*. A contract; an accord; an agreement; a mutual and settled appointment between two or more, to do or to forbear something. It had anciently the accent on the last syllable.

I hope the king made peace with all of us;
And the compact is firm and true in me.

Shakespeare. Richard III.

In the beginnings of speech there was an implicit compact, founded upon common consent, that such words, voices, or gestures, should be signs whereby they would express their thoughts. *South.*

Hast thou compacted for a lease of years
With hell, that thus thou ventur'st to provoke me.

Dryden's Duke of Guise.

Thou false fiend, thou liest!

My life is in its last hour,—that I knew,
Nor would redeem a moment of that hour;
I do not combat against death, but thee
And thy surrounding angels; my past power
Was purchased by no compact with thy crew.

Byron's Manfred.

COMPACT, *v. a. & adj.* Lat. *compactus*, the participle of *compingo*.
COMPACTEDNESS, *n. s.* Primarily to close; to
COMPACTLY, *adv.* join together with
COMPACTNESS, *n. s.* firmness; to consoli-
COMPACTURE, *n. s.* date; to bring close together. Thus, secondarily, it signifies to league with; to bring into a system; the derivatives have the same meanings without variation.

We see the world so compacted, that each thing preserveth other things, and also itself. *Hooker.*

Thou pernicious woman,

Compact with her that's gone, thinkest thou thy oaths,
Though they would swear down each particular fact,
Were testimonies? *Shakespeare. Measure for Measure.*

And over it a fair portcullis hung,
Which to the gate directly did incline,
With comely compass, and compacture strong,
Neither unseemly short, nor yet exceeding long.

Faerie Queene.

A wandering fire,

Compact of unctuous vapour, which the night
And the cold environs around condenses,
Kindled through agitation to a flame. *Milton.*

Sticking or compactedness, being natural to density, requires some excess of gravity in proportion to the density, or some other outward violence, to break it.

Digby on Bodies.

Is not the density greater in free and open spaces, void of air and other grosser bodies, than within the pores of water, glass, crystal, gems, and other compact bodies. *Newton's Opticks.*

The best lime mortar will not have attained its utmost compactness, till fourscore years after it has been employed in building. This is one reason why, in demolishing ancient fabrics, it is easier to break the stone than the mortar. *Boyle.*

This disease is more dangerous, as the solids are more strict and compacted, and consequently more so as people are advanced in age. *Arbutnot on Diet.*

Now the bright sun compacts the precious stone,
Imparting radiant lustre like his own.

Blackmore's Creation.

COMPAGES, *n. s.* Latin. A system of many parts united.

The organs in animal bodies are only a regular *compages* of pipes and vessels, for the fluids to pass through. *Ray.*

COMPAGINATION, *n. s.* Lat. *compago*. Union; structure; junction; connexion; con-texture.

The intire or broken *compagination* of the magneti-cal fabrick under it. *Browne's Vulgar Errors.*

COMPAGNIA DEL GONFALONE, (the com-pany of the standard), a society of players estab-lished in Rome in 1624, for the sole purpose of exhibiting, by dramatic representations, during the Easter week, the history and sufferings of Christ.

COMPANION, *n. s.* } French *compagnon*.
COMPANIONABLE, *adj.* } One with whom a
COMPANIONABLY, *adv.* } man frequently con-
COMPANIONSHIP, *n. s.* } verses, or with whom
 he shares his hours of relaxation. It differs from friend, as acquaintance from confidence. A partner; an associate company; train; fel-lowship; association.

How now, my lord? why do you keep alone?
 Of sorriest fancies your companions make?
Shakespeare. Macbeth.

Alcibiades, and some twenty horse,
 All of *companionship*. *Id. Timon.*

Bereaved of happiness, thou may'st partake
 His punishment, eternal misery;
 Which would be all his solace and revenge,
 Thee once to gain *companion* of his woe. *Milton.*

He had a more *companionable* wit, and swayed
 more among the good fellows. *Clarendon.*

With anxious doubts, with raging passions torn,
 No sweet *companion* near with him to mourn.
Prior.

Thus Nisus wandered o'er the pathless grove,
 To find the brave *companion* of his love. *Gay.*

While from his bending shoulder, decent hung
 His harp, the sole *companion* of his way,
 Which to the whistling winds responsive rung,
 And ever as he went some merry lay he sung.
Beattie.

The desert, forest, cavern, breakers' foam,
 Were unto him *companionship*; they spake
 A mutual language, clearer than the tone
 Of his land's tongue, which he would oft forsake
 For Nature's pages glossed by sunbeams on the lake.
Byron's Childe Harold.

COMPANY, *n. s. v. a. & v. n.* } Fr. *compag-*
COMPANABLENESS, *n. s.* } *nie*, either from
COMPANABLE, *adj.* } *con* and *pa-*
gus, one of the same town; or *con* and *panis*,
 one that eats of the same mess. Persons assem-
 bled together. A body of people met for
 any purpose, but more especially for the enter-
 tainment of each other, either by conversation,
 feasting, or any amusement; also the descrip-
 tive term employed to designate persons united
 in a joint trade or partnership; a number of
 some particular rank or profession united by
 charter; a body corporate. It is likewise ap-
 plied to a subdivision of a regiment of foot, so
 many as are under one captain; the adjective
 signifies social, fond of amusement and frolic.

Duk Theseus, with all his *compagnie*,
 Is comen home to Athens, his citee,
 With alle blisse and gret solempnitee.
Chaucer's Canterbury Tales

As he thereon stood gazing, he might see
 The blessed angels to and fro descend
 From highest heven in goodly *companee*,
 And with great joy into that city wend,
 As commonly as frend does with his frend. *Spenser.*

Towards his queen he was nothing uxorious, but
companionable and respective. *Bacon's Henry VIII.*
 A crowd is not *company*; and faces are but a
 gallery of pictures, where there is no love.

It is more pleasant to enjoy the *company* of him
 that can speak such words, than by such words to be
 persuaded to follow solitariness. *Sidney.*

I am
 The soldier that did *company* these three.
Shakespeare. Cymbeline.

Go, carry Sir John Falstaff to the Fleet;
 Take all his *company* along with him.
Id. Henry IV.

But O my virgin lady, where is she,
 How chance she is not in your *company*. *Milton.*
 Thus, through what path so'er of life we rove,
 Rage *companies* our hate, and grief our love. *Prior.*

Knowledge of men and manners, the freedom of
 habitudes, and conversation with the best *company* of
 both sexes, is necessary. *Dryden.*

Shakspeare was an actor, when there were seven
companies of players in the town together. *Dennis.*
 Abdallah grew by degrees so enamoured of her
 conversation, that he did not think he lived when he
 was not in *company* with his beloved Balsora.
Guardian.

This emperor seems to have been the first who in-
 corporated the several trades of Rome into *companies*,
 with their particular privileges. *Arbuthnot on Coins.*

In fine, to converse with historians is to keep good
company: many of them were excellent men, and
 those who were not such, have taken care, however,
 to appear such in their writings. *Bolingbroke.*

COMPANY, in a commercial sense, persons
 united in a joint trade or partnership. When
 there are only two or three persons joined in this
 manner, it is called a partnership; the term
company being applied to societies consisting of
 a considerable number of members, associated
 together by a charter obtained from the prince.

COMPANY, in commerce, is particularly appro-
 priated to those associations set on foot for the
 commerce of the remote parts of the world, and
 vested by charter with peculiar privileges. These
 associations are divided into general classes,
 called Joint Stock Companies, and Regulated
 Companies. Such companies, whether joint
 stock or regulated, sometimes have, and some-
 times have not, exclusive privileges. However
 injurious companies with joint stock, and incor-
 porated with exclusive privileges, may, at this
 time, be reckoned to the nation in general, it is
 yet certain, that they were the general parents of
 all our foreign commerce; private traders being
 discouraged from hazarding their fortunes in
 foreign countries.

When a company trades upon a joint-stock,
 each member sharing in the common profit or
 loss in proportion to his share in this stock, it is
 called a joint-stock company. Joint-stock com-

panies, however, established either by royal charter or by act of parliament, differ in several respects, not only from regulated companies, but from private copartneries. 1. In a private copartnership, no partner, without the consent of the company, can transfer his share to another person, to introduce a new member into the company. Each member however may, upon proper warning, withdraw from the copartnership, and demand payment from them of his share of the common stock. In a joint-stock company, on the contrary, no member can demand payment of his share from the company; but each member can, without their consent, transfer his share to another person, and thereby introduce a new member. The value of a share in a joint-stock is always the price which it will bring in the market; and this may be either greater or less, in proportion, than the sum which its owner stands credited for in the stock of the company. 2. In a private copartnership, each partner is bound only to the extent of his share. The trade of a joint-stock company is generally managed by a court of directors. The principal joint-stock companies in Great Britain are the South Sea and the East India Companies; to which may be added, though of inferior magnitude, the Hudson's Bay Company. See HUNSON'S BAY; INDIES, EAST, and SOUTH SEAS. The African, Turkey, and Russian Companies are rather regulated than made joint-stock companies by act of parliament. See AFRICAN COMPANY, &c. The anomalous and ephemeral projects of the last few years, we might almost say months, which have been designated as companies, we cannot be expected to notice. The exclusive privileges of all these associations have been thought at variance with that liberty which is the basis of fair trade; while their exemption from many of the liabilities of ordinary partnerships have offered great protection occasionally to knavish transactions. On the other hand, in the case of a public body, the capital it is said is matter of notoriety, and the responsibility of the individual partners admits of limitation, without injury to the creditors of the concern. But what say late events to this reasoning!

COMPANIES OF LONDON. See LONDON.

COMPANY, in military affairs, a small body of foot, commanded by a captain, who has under him a lieutenant and ensign. The number of private soldiers in a company is from fifty to 100; and a battalion, or regiment, consists of nine, ten, or eleven such companies, one of which is always grenadiers, and posted on the right: next them stands the colonel's company, and on the left the light infantry company. A company, moreover, has usually three or four sergeants, three or four corporals, and two drums. In the guards, the companies consist of 120 men each, as in the artillery. In the Austrian service a company consists of 200 men.

COMPANY, INDEPENDENT, or COMPANY, IRREGULAR, a company not incorporated into a regiment.

COMPANY OF SEIPS, a fleet of merchantmen, who make a charter-party among themselves; the principal conditions whereof usually are that

certain vessels shall be acknowledged admiral vice-admiral, and rear-admiral; that such and such signals shall be observed; that those which bear no guns shall pay so much per cent. of their cargo; and, in case they be attacked, that what damages are sustained shall be reimbursed by the company in general. In the Mediterranean such companies are called *conserves*.

COMPANY'S ISLAND, or UBIUP, an island in the North Pacific Ocean, about sixty miles in length, and thirty to forty-five in breadth. It appears to be uninhabited, and is in long. 151° 20' E., lat. 46° N.

COMPARE, v. a. & v. n.	} Lat. <i>comparo</i> ; Fr. <i>comparaison</i> . To make one thing the measure of another : to estimate the
COMPARABLE, adj.	
COMPARABLY, adv.	
COMPARATIVE, adj.	
COMPARATIVELY, adv.	
COMPARISON, n. s.	

relative goodness or badness, or other qualities of any one thing, by observing how it differs from something else. It may be observed that when the comparison intends only similitude or illustration by likeness, we use *to before* the thing brought for illustration; as he compared anger *to a fire*. When two persons or things are compared, to discover their relative proportion of any quality, *with* is used before the thing used as a measure. Simile; similitude; illustration by comparison. In grammar, the comparative degree expresses more of any quantity in one thing than in another; as the right hand is the stronger. It is also the formation of an adjective, through its various degrees of signification; as strong, stronger, strongest.

This present world affordeth not any thing comparable unto the public duties of religion. *Hooker*.

There resteth the comparative, that is, granted that it is either lawful or binding; yet whether other things be not to be preferred before the extirpation of heresies. *Bacon*.

The blossom is a positive good; although the remove of it, to give place to the fruit, be a comparative good. *Id.*

As fair and as good a kind of hand in hand comparison, had been something too fair and too good for any lady. *Shakespeare*.

I will hear Brutus speak.—

I will hear Cassius, and compare reasons. *Id.*

Solon compared the people unto the sea, and orators and counsellors to the winds; for that the sea would be calm and quiet, if the winds did not trouble it.

Bacon's Apophthegms.

As their small galleys may not hold compare With our tall ships. *Waller*.

Beyond compare the Son of God was seen Most glorious. *Milton's Paradise Lost.*

To compare

Small things with greatest. *Id. Regained.*

— If, wee with other things, man's age compare,
His life is but a day, for, equalled are
His years with hours; his months with minutes bee
Fit paralels; and, every breathing, wee
May terme a day yet, some, even at the night
Of that short day, are dead, and withered quite.

George Withers.

Our author saves me the comparison with tragedy; for he says, that herein he is to imitate the tragick poet.

Dryden.

Ho that has got the ideas of numbers, and hath taken the pains to *compare* one, two, and three to six, cannot chuse but know they are equal. *Locke.*

There could no form for such a royal use be *comparably* imagined, like that of the foresaid nation.

Wotton's Architecture.

Beauty is not known by an eye or nose; it consists in a symmetry, and it is the *comparative* faculty which notes it. *Glanville's Scepis Scientifica.*

The vegetables being *comparatiocly* lighter than the ordinary terrestrial matter of the globe, subsided last.

Woodward.

One can scarce imagine how so plentiful a soil should become so miserably unpeopled, in *comparison* of what it once was. *Addison's Remarks on Italy.*

There is no blessing of life *comparable* to the enjoyment of a discreet and virtuous friend.

Id. Spectator.

Demosthenes used to *compare* eloquence to a weapon, aptly enough; for eloquence, like every other weapon, is of little use to the owner, unless he have the force and the skill to use it. *Bolingbroke.*

And blooming Hyde with eyes so rare,

And Montague beyond *compare*.

Gay.

The sun appears very bright and large in *comparison* of the fixed stars, because we keep constantly near the sun, in *comparison* of our immense distance from the stars.

Ferguson.

The bower of bliss, the smile of love be thine

Unlaboured ease, and leisure's careless dream,

Such be their joys who bend at Venus' shrine,

And own her charms beyond *compare* supreme.

Beattie.

Ah, then all jollity seemed noise and folly

To the pure soul by fancy's fire refined,

Ah, what is mirth, but turbulence unholy,

When with the charm *compared* of heavenly melancholy.

Id.

Are not the mountains waves and skies, a part

Of me and of my soul, as I of them?

Is not the love of these deep in my heart

With a pure passion? Should I not contemn

All objects, if *compared* with these?

Byron. Childs Harold.

COMPARATES, *n. s.* from *compare*. In logic, the two things compared to one another.

COMPARATIVE ANATOMY, or ZOOTOMY, is that branch of anatomy which has for its object the dissection and investigation of the various parts of the bodies of brutes. See ANATOMY.

COMPARATIVE DEGREE, in grammar, the degree between the positive and superlative. See GRAMMAR.

COMPARETTI (Andrew), an Italian physician, born in Friuli in 1746. He studied at Padua, and finally settled at Venice, where he published his *Oecursus Medici*, and became in consequence professor of medicine in the university. In 1787 he published *Observationes de Luce Inflexa et Coloribus*, 4to., and, in 1789, *Observationes Anatomicæ de Aure Interna Comparata*, 4to. After these appeared a *Treatise on Vegetable Physiology*; another on the *Moving Powers of Insects*; and several on *Practical Medicine*. He died, December 22nd, 1801, much respected.

COMPARISON. See GRAMMAR.

COMPARISON, in rhetoric and poetry, is a figure whereby two things are considered with regard to a third, common to both. Comparison may be employed with success in putting a sub-

ject in a strong point of view. A lively idea is formed of human courage, by likening it to that of a lion; and eloquence is exalted in our imagination by comparing it to a river overflowing its banks, and involving all in its impetuous course. The same effect is produced by contrast: a man in prosperity becomes more sensible of his happiness, by contrasting his condition with that of a person in want of bread. Objects of different senses cannot be compared together; for such objects have no circumstance in common to admit either resemblance or contrast. Objects of hearing may be compared together; as also of taste, of smell, and of touch; but the chief funds of comparison are objects of sight; because, in writing or speaking, things can only be compared in idea, and the ideas of sight are more distinct and lively than those of any other sense. When a nation, emerging out of barbarity, begins to think of the fine arts, the beauties of language cannot long lie concealed; and when discovered, they are, generally, by the force of novelty, carried beyond all bounds of moderation. Thus, in the most ancient poems of every nation, we find metaphors and similes founded on the slightest and most distant resemblances, which, losing their grace with their novelty, wear gradually out of repute: and now, by the improvement of taste, no metaphor nor simile is admitted into any polite composition but of the most striking kind.

COMPART, *v. a.*

COMPARTIMENT, *n. s.* } *Lat. con* and *partior*;

COMPARTITION, *n. s.* } *Fr. comparter, com-*

COMPARTMENT, *n. s.* } *partiment.* To divide;

COMPARTMENT, *n. s.* } to mark out a general design into its various parts and subdivisions.

I will come to the *compartition*, by which the authors of this art understand a graceful and useful distribution of the whole ground plot, both for rooms of office and entertainment. *Wotton.*

I make haste to the casting and *comparting* of the whole work. *Id. Architecture.*

The temples and amphitheatres needed no *compartitions*.

Id.

The square will make you ready for all manner of *compartments*, bases, pedestals, and buildings.

Peacham on Drawing.

The circumference is divided into twelve *compartments*, each containing a complete picture. *Pope.*

COMPARTMENTS, in gardening, are an assemblage of beds, plots, borders, walks, &c. disposed in the most advantageous manner that the ground will admit of.

COMPARTMENTS, in heraldry, are also called *partitions*.

COMPASS, *v. a. & n. s.* *Fr. compasser*; *Ital. compassare*; *Lat. passibus metiri.* To encircle; to environ; to surround; to inclose: it has sometimes around, or about, added. Thus to defend to attack; to seize; to accomplish or attain any object, by a circuitous or indirect manner, or by strenuous efforts. The noun is derived from the verb, and partakes of primary meaning; it also signifies the power of the voice to express the notes of music; the instrument with which circles are drawn; but in this application rarely used in the singular; whence the instrument composed of a needle and cord whereby mariners steer.

Of al this world, the large compass.
Will not in mine armes tweine ;
Who so mokel wol embrace
Lite thereof shal distreine. *Chaucer's Proverbs.*
Round was the shape in manere of a *compos*
Ful of degrees, the height of sixty pos,
Thrit whan a man was set on no degree,
He letted not his felan for to see.

Id. Canterbury Tales.
What now is left, Clarinda ? what remains,
That we may *compass* this our enterprise. *Spenser.*
That which by wisdom he saw to be requisite for
that people, was by as great wisdom *compassed.*
Hooker's Preface.

O Juliet, I already know thy grief ;
It strains me past the *compass* of my wits.
Shakespeare.

This day I breathed first ; time is come round ;
And where I did begin, there shall I end :
My life is run its *compass.* *Id. Julius Cæsar.*

I see thee *compassed* with thy kingdom's peers,
That speak my salutation in their minds.
Id. Macbeth.

In his hand
He took the golden *compasses*, prepared
In God's eternal store, to circumscribe
This universe, and all created things.
Milton's Paradise Lost.

And their mount Palatine,
The' imperial palace, *compass* huge, and high
The structure. *Id. Paradise Regained.*

He had a mind to make himself master of Weymouth,
if he could *compass* it without engaging his
army before it *Clarendon.*

The knowledge of what is good and what is evil,
what ought and what ought not to be done, is a thing
too large to be *compassed*, and too hard to be mastered
without brains and study, parts and contemplation.
South.

Certain it is, that in two hundred years before (I
speak within *compass*) no such commission had been
executed in either of these provinces.
Davies on Ireland.

He that first discovered the use of the *compass*, did
more for the supplying and increase of useful com-
modities, than those who built workhouses. *Locke.*

From harmony, from heavenly harmony,
This universal frame began :

From harmony to harmony
Through all the *compass* of the notes it ran,
The diapason closing full in man. *Dryden.*

To ax one foot of their *compass* wherever they
think fit, and extend the other to such terrible lengths,
without describing any circumference at all, is to
leave us and themselves in a very uncertain stato.
Swift.

The English are good-confederates in an enterprise
which may be dispatched in a short *compass* of time.
Addison's Freeholder.

This author hath tried the force and *compass* of our
language with much success. *Swift.*

Tho' in your life ten thousand summers roll,
And tho' you *compass* earth from pole to pole,
Where'er men talk of war and martial fame,
They'll mention Marlborough and Cæsar's name.
Gay.

Now from the western mountain's brow
Compassed with clouds of various glow,
The sun a broader orb displays,
And shoots aslope his ruddy rays. *Beattie.*

Now must the pastor's arm his lambs defend :
For Spain is *compassed* by unyielding foes,
And all must share their all, or share subjection's
woes. *Byron's Childs Harold.*

COMPASS, an instrument of considerable use
in surveying land, dialling, &c. Its structure is
the same with that of the mariner's compass,
consisting, like it, of a box and needle. The
principal difference is, that instead of the needle
being fitted into the card, and playing with it on
a pivot, it here plays alone; the card being
drawn on the bottom of the box, and a circle
divided in 360° on the limb. This instrument is
of obvious use to travellers, to direct them in
their road; and to miners, to show them what
way to dig, &c.

How to take an angle by the compass.—Suppose
the angle required be DAE, apply that side of
the compass, where-
on the north is
marked, to one of
the lines AD; when
the needle rests, ob-
serve the degrees at
which its north
point stands, which
suppose eighty; so
many degrees does
the line decline from
the meridian. In the
same manner, take
the declination of
the line AE, which
suppose 215°; sub-
tract 80° from
215°, the remainder
is 135°; which sub-
tracted from 180°,
there will remain
45°, the quantity
of the angle re-
quired. But, if the
difference between
the declination on
the two lines exceed
180°, in that case
180° must be sub-
tracted from that
difference: the re-
mainder then is the
angle required. In
measuring angles by
the compass, there
need not any regard
be had to the varia-
tion, that being
supposed the same
in all the lines of
the angles.

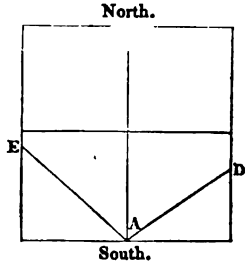

How to take a plot of field by the compass.—
Suppose the field A, B, C, D, E. For the greater

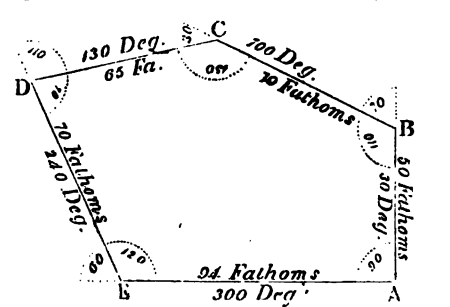

accuracy, let there be two sights fitted to the
meridian line of the compass, place it horizontal,
and through the sides look along the side AB,
or a line parallel to it, applying the eye to the
sight at the south point of the compass. Draw a
rough sketch of the field by the eye, and on the
corresponding line enter down the degree to
which the needle points, which suppose 90;
measure the length of the side, and enter that
too, which suppose ten chains. In this manner
proceed with all the rest of the sides and angles
of the field; the sides, which suppose 70, 65, 70,
44, 50 fathom; and the angles, which suppose

30, 100, 130, 240, 300 degrees. To protract the field, set down the several angles observed, one after another, and subtract the lesser from the next greater: thus you will have the quantity of the several angles, and the length of the lines that include them. All the angles of the figure, taken together, must make twice as many right angles, abating two, if no mistake has been committed.

How to take the declination of a wall by the compass.—Apply that side of the compass whereon the north is marked along the side of the wall; the number of degrees, over which the north end of the needle fixes, will be the declination of the wall, and on that side; e. g. if the north point of the needle tends towards the north, that wall may be shone on by the sun at noon; if it fix over 50° , counting from the north towards the east, the declination is so many degrees from north towards east. But since the needle itself declines from the north towards the west with us, 13° , it must be noted that, to retrieve the irregularity, 13° are always to be added to the degrees shown by the needle, when the declination of the wall is towards the east; but when the declination is towards the west, the declination of the needle is to be subtracted.

COMPASS, AZIMUTH. See AZIMUTH.

COMPASS, MARINER'S, the instrument used at sea by pilots, to direct and ascertain the course of their ships, consists of a circular brass box, which contains a paper card with the thirty-two points of the compass, fixed on a magnetic needle, that always turns to the north, excepting a small declination variable at different places. See VARIATION. The needle, with the card, turns on an upright pin fixed in the centre of the box. In the centre of the needle is fixed a brass conical locket or cap, whereby the card hanging on the pin turns freely round the centre. The top of the box is covered with a glass, that the motion of the card may not be disturbed by the wind. The whole is enclosed in another box of wood, where it is suspended by brass hoops or gimbals, to preserve the card horizontal. The compass-box is so placed in the ship, that the middle section of the box, parallel to its sides, may be parallel to the middle section of the ship along its keel. This important invention is usually ascribed to Flavio de Melfi, or Flavio Gioia, a Neapolitan, about the year 1302; and hence the territory of Principato, where he was born, has a compass for its arms. Others say, that Marcus Paulus, a Venetian, making a voyage to China, brought the invention with him in 1260. What confirms this is, that at first they used the compass in the same manner as the Chinese still do, i. e. they let it float on a little piece of cork, instead of suspending it on a pivot. It is added, that their emperor, Chiningus, a celebrated astrologer, had a knowledge of it 1170 years before Christ. The Chinese only divide their compass into twenty-four points. Fauchette relates some verses of Guoyot de Provence, who lived in France, A. D. 1200, which seem to make mention of the compass under the name of *marinette*, or *mariner's stone*; which show it to have been used in France nearly 100 years before either the *Mulite* or the Venetian. The French even lay claim

to the invention, from the fleur-de-lis, wherewith all nations still distinguish the north point of the card. With equal reason, Dr. Wallis ascribes it to the English, from its name compass, and which he observes is used in many parts of England to signify a circle.

The compass being of the utmost consequence to navigation, it is reasonable to expect that the greatest attention should be paid to its construction, and every attempt to improve it carefully examined; and, if proper, adopted.

The very great objections to which the common compass is liable, induced the ingenious Dr. Knight to contrive a new sea-compass, which is now in use on board all the ships of war. The needle, in this instrument, is quite straight, and square at the ends; and, consequently, has only two poles, though, about the hole in the middle, the curves are a little confused. Needles of this construction, after vibrating a long time, will always point exactly in the same direction; and, if drawn ever so little on one side, will return to it again, without any sensible difference. We may, therefore, conclude, that a regular paralleloiped is the best form for a needle, as well as the simplest, the holes for the caps being as small as possible. And, as the weight should be removed to the greatest distance from the centre of motion, a circle of brass, of the same diameter of the card, may be added. This will serve also to support the card, which may then be made of thin paper, without anything to stiffen it. This ring being fixed below the card, and the needle above it, the centre of gravity is placed low enough to admit of the cap being put under the needle, whereby the hole in the needle becomes unnecessary. The above observations will be easily understood, from viewing the several parts of the instrument, as represented on plate COMPASS, where fig. 1 is the card, with the needle KL, and its cap M, fixed upon it, being one-third of the diameter of the real card. Fig. 2 is a perspective view of the back of the card, where AB represents the turning down of the brass edge, C the under part of the cap, D and E two sliding weights to balance the card, and F, G, two screws that fix the brass edge, &c. to the needle. Fig. 3 is the pedestal that supports the card, containing a screwing needle, fixed in two small grooves to receive it, by means of the collet C, in the manner of a port crayon. D, the stem, is filled into an octagon, that it may be the more easily unscrewed.

The compass has sometimes been observed to be disturbed by the electricity of its glass cover; and this from so slight an application of the finger, as was barely necessary to wipe off a little dust. The same glass, rubbed a little more with the finger, a bit of muslin, or paper, would attract either end of the needle, so as to hold it to the glass for several minutes, far out of the due direction, according to that part of the glass which was most excited. And when the needle, after adhering to the glass, has dropped loose, and made vibrations, these would not be bisected, as usual, by that point where the needle should rest, but would either be made all on one side, or be very unequally divided, by means of some remains of electrical virtue in that part of the



Fig. 2.

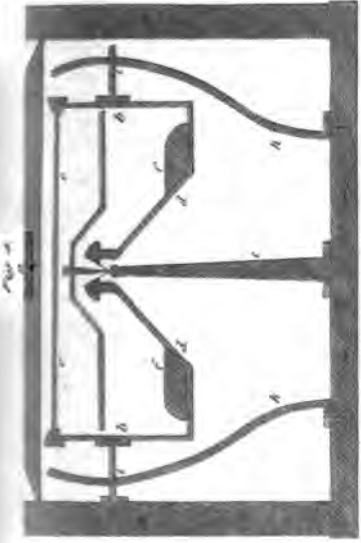

Fig. 5.

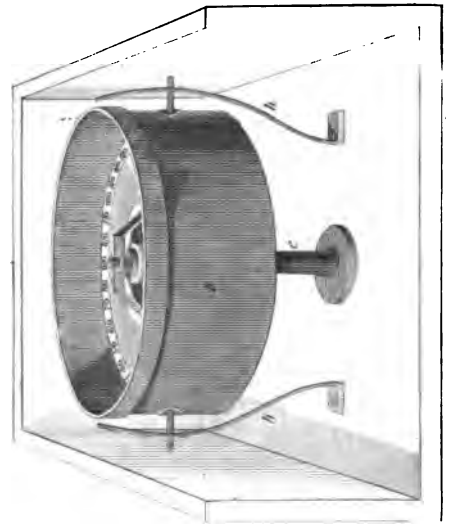
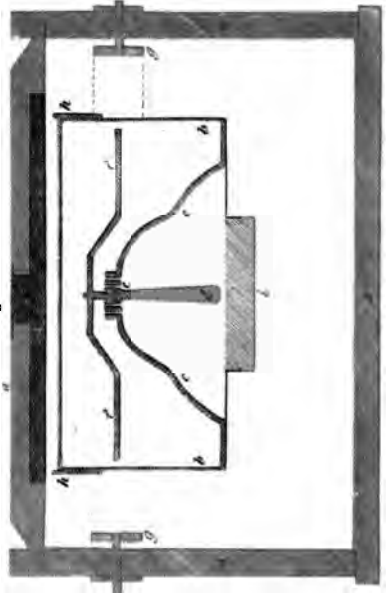

Fig. 3.



Fig. 6.



London: Published by Thomas Long, Chesnut-Street, Jan 1. 1841.

J. Sherry Sculp.

glass which had attracted the needle, until, at length, after fifteen minutes or more, all the electricity being discharged, the magnetical power took place. The remedy for this inconvenience is to moisten the surface of the glass; a wet finger will do it immediately and effectually. The mariner's compass, with a chart, is much less dangerously moved than the common compass with a bare needle; and the deeper, or farther distant, the needle hangs below the glass, the less disturbance it is likely to receive.

Notwithstanding the various contrivances that have been made to prevent the card from being much affected by the motions of the ship, they have always been found too delicate to encounter the shocks of a tempestuous sea. Improved compasses have been constructed by Mr. McCulloch, and for which he has obtained a patent, that are reported to be the best of any yet used. The particulars are as follow: plate COMPASS, fig. 4, is a section of the steering compass. *aaaa*, the common wooden box, with its lid. *bb*, the brass compass-box. *cc*, the glass cover to ditto. *dd*, the hollow conical bottom. *e*, the prop upon which the compass is supported, instead of gimbals, the spherical top of which is finely polished, and the apex of the hollow cone is fitted in a peculiar manner to receive it. *ff*, a quantity of lead run round the bottom and cone of the compass-box, to balance and keep it steadily horizontal. *gg*, the card and the magnetic needle, bent in such a manner, that the point of the conical pivot, on which it moves, and is supported, may be brought very near to the centre of gravity, as well as to the centre of motion. *hh*, two guards, which, by means of two pins, *ii*, affixed to the compass-box, prevents it from turning round and deceiving the steersman. Fig. 5 a perspective view of the steering compass, with the lid off and the front laid open. *hh*, the guards. *b*, the compass-box. *e*, the prop, &c. as in fig. 7. Fig. 6 is a section representing another application of the magnetic needle and card, constructed by Mr. McCulloch. *aaaa*, the common wood box. *bb*, the brass compass-box. *cc*, the brass support for the circle and pendulum. *d*, the pendulum. *e*, the agate. *ff*, the magnetic needle and card. *gg*, the brass circle. *hh*, the glass cover and brass ring. *i*, the lead weight. All the centres of motion are in the same plane. In one particular, this patent compass is considered as an improvement on the common compasses, inasmuch as the needle is both longer and broader; hence, its magnetism must be stronger, and of course the line of its magnetic direction correspondent with the card. In another particular, in order to prevent the motions of the vessel from affecting the needle, which is the most desirable object, the patent compass-box, instead of swinging in gimbals at right angles to each other, is supported in its very centre upon a prop; and, whatever motion the other parts of the box may have, this centre, being in the vertex of the hollow cone, may be considered as relatively at rest, and, therefore, gives little or no disturbance to the needle. Again, the pivot or centre upon which the needle turns, is so contrived as to stand always perpendicular over the centre of the compass-box,

an apex of the hollow cone, as upon a fixed point; and is, therefore, still less affected by the motions of the vessel. Thus, the centres of motion, gravity, and magnetism, are brought almost all to the same point; the advantages of which will be readily perceived by any person acquainted with mechanical principles. Experience, therefore, will ascertain the utility of this improvement.

COMPASS HILL, a hill in the isle of Canina, Scotland, remarkable for its effect on the polarity of the magnet.

COMPASSES, or PAIR OF COMPASSES, a mathematical instrument for describing circles, measuring figures, &c. The common compasses consist of two sharp-pointed branches or legs of iron, steel, brass, or other metal, joined together at the top by a rivet, whereon they move as on a centre. Those are best, wherein the pin or axle on which the joint turns, and also half the joint itself, is made of steel, as this metal wears more equably. The perfection of them may be known by the easy and uniform opening and shutting of their legs, one of which is sometimes made movable, for the admission of two other points to describe with ink, black lead, or other materials. One of these points has a small wheel for making dots. There are compasses of various kinds, accommodated to the various uses they are intended for: as,

COMPASSES, BEAM, consist of a long branch or beam, made of brass or wood, carrying two brass cursors, the one fixed at one end, the other sliding along the beam, with a screw to fasten it on occasion. To the cursors may be screwed points of any kind, whether steel for pencils, or the like. It is used to draw large circles, to take great extents, &c. To the fixed cursor is sometimes applied an adjusting micrometer screw, by which an extent is obtained to extreme nicety. Mr. Jones, of Holborn, has made beam compasses to adjust to the 5000th part of an inch.

COMPASSES, CLOCKMAKER'S, are joined like the common compasses, with a quadrant, or bow, like the spring compasses; only of different use, serving here to keep the instrument firm at any opening. They are made very strong, with the points of their legs of well tempered steel, being used to draw lines on paste-board or copper.

COMPASSES, CYLINDRICAL, AND SPHERICAL, consist of four branches, joined in a centre, two of which are circular, and two flat, a little bent on the ends. Their use is to take the diameter, thickness, or calibre of round or cylindrical bodies; such as cannons, pipes, &c.

COMPASSES, ELLIPTIC, are used to draw ellipses, or ovals of any kind: they consist of a beam, A, B, about a foot long, bearing three cursors; to one of which may be screwed points of any kind: to the bottom of the other two are rivetted two sliding dovetails, adjusted in grooves made in the cross branches of the beam. The dove-tails having a motion every way, by turning about the long branch, go backwards and forwards along the cross; so that when the beam has gone half way about, one of these will have moved the whole length of one of the branches; and when the beam has got quite round, the same dove-tail has got back the whole length of

the branch. It is the same with the other dovetail. The distance between the two sliding dovetails is the distance between the two foci of the ellipsis; so that, by changing that distance, the ellipsis will be rounder or slenderer. Under the ends of the branches of the cross are placed four steel points to keep it fast. The use of these compasses is easy; by turning round the long branch, the ink, pencil, or other point, will draw the ellipsis required.

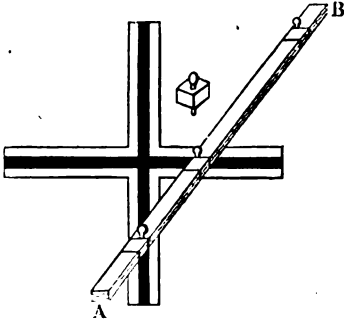

COMPASSES, LAPIDARY'S, are a piece of wood in form of the shaft of a plane, cleft at top, as far as half its length; with this they measure the angles, &c. of jewels and precious stones, as they cut them. There is in the cleft a little brass rule, fastened at one end by a pin; but so that it may be moved in the manner of a brass level: with this kind of square they take the angles of the stones, laying them on the shaft as they cut them.

COMPASSES OF THREE LEGS, or TRIANGULAR COMPASSES, are of the same structure with the common ones, but have an additional leg: their use is to take three points at once, and so to form triangles; to lay down three positions of a map to be copied at once, &c.

COMPASSES, PROPORTIONAL, are those whose joint lies between the points terminating each leg; they are either simple, or compound. In the simple, the centre is fixed, so that one pair serves only for one proportion. The compound, consists of two parts or sides of brass, which lie upon each other so nicely as to appear but one when they are shut. These sides easily open, and move about a centre, which is itself movable

in a hollow canal cut through the greatest part of their length. To this centre on each side is affixed a sliding piece, A, fig. 1, of a small length, with a fine line drawn on it serving as an index, to be set against other lines or divisions placed upon the compasses on both sides. These lines are, 1. A line of lines. 2. A line of superficies, areas, or planes. 3. A line of solids. 4. A line of circles, or rather of polygons to be inscribed in circles. These lines are all unequally divided; the first three from 1 to 20, the last from 6 to 20. Their uses are as follow: By the line of lines you divide a given line into any number of equal parts; for by placing the index A against 1, and screwing it fast, if you open the compasses, then the distance between the points at each end will be equal. If you place the index against 2, and open the compasses, the distance between the points of the longer legs BB, will be twice the distance between the shorter ones CC; and thus a line is bisected, or divided into two equal parts. If the index be placed against 3, and the compasses opened, the distances between the points will be as 3 to 1, and so a line is divided into two equal parts; and so you proceed for any other number of parts under 10. The numbers of the line of planes answer to the squares of those in the line of lines; for, because superficies or planes are to each other as the squares of their like sides; therefore, if the index be placed against 2 in the line of planes, then the distance between the small points will be the fine of a plane whose area is one; but the distance of the larger points will be the like side of a plane whose area is two; or twice as large. If the index be placed at 3, and the compasses opened, the distances between the points at each end will be the like side of planes whose area are as 1 to 3; and so of others. The numbers of the line of solids answer to the cubes of those in the line of lines; because all solids are to each other as the cubes of their sides or diameters; therefore, if the index be placed to number 2, 3, 4, &c. in the line of solids, the distance between the lesser and larger points will be the like sides of solids, which are to each other as 1 to 2, 1 to 3, 1 to 4, &c. For example: if the index be placed at 10, and the compasses be opened, so that the small points may take the diameter of a bullet whose weight is one ounce, the distance between the large points will be the diameter of a bullet or globe of ten ounces, or which is ten times as large. Lastly, the numbers in the line of circles are the sides of polygons to be inscribed in a given circle, or by which a circle may be divided into equal parts, from 6 to 20. Thus, if the index be placed at 6, the points of the compasses at either end, when opened to the radius of a given circle, will contain the side of a hexagon, or divide the circle into six equal parts. And thus, by placing the index at 7, 8, &c. we may divide it into seven or eight parts, and inscribe heptagons, octagons, &c.

COMPASSES, SPRING, or DIVIDERS, those with an arched head, which by its spring opens the legs; the opening being directed by a circular screw fastened to one of the legs, and let through the other, worked with a nut.

COMPASSES, TRISECTING, consist of two central rules, and an arch of circles of 120 degrees,

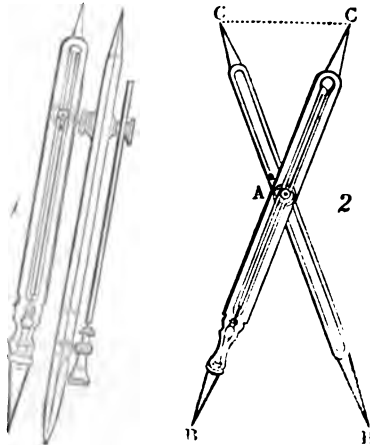

immovable, with its radius; which is fastened with one of the central rules like the two legs of a sector, that the central rule may be carried through all the points of the circumference of the arch. The radius and rule should be as thin as possible; and the rule fastened to the radius should be hammered cold, to attain the greater elasticity; and the breadth of the central rule should be triple that of the radius; there must also be a groove in this rule, with a dove-tail fastened on it for its motion, and a hole in the centre of each rule. The use of this instrument is to facilitate the trisection of angles geometrically; and it is said to have been invented by M. Targen.

COMPASSION, *n. s. & v. a.* } Fr. *compas-*
 COMPASSIONATE, *v. a.* } *sion*; from Lat.
 COMPASSIONATELY, *adv.* } *sion* and *pator.*
 Pity; commiseration; sorrow for the sufferings of others; painful sympathy; a call; a demand of nature to relieve the unhappy; pitiful tenderness.

I am your patron,
 Therefore, ye ought to have some *compassions*.
Chaucer. The Complaint of Mars.

But the wyld man, contrarie to her feare,
 Came to her creeping like a fawning hound,
 And by rude tokens made to her appeare
 His deepe *compassion* of her doleful stound,
 Kissing his hands, and crouching to the ground.

Spenser.
 Experience layeth princes torn estates before their
 eyes, and withal persuades them to *compassionate*
 themselves.

Raleigh.
 O heavens! can you hear a good man groan,
 And not relent, or not *compassion* him?

Shakespeare. Titus Andronicus.
 here never was any heart truly great and generous,
 that was not also tender and *compassionate*.

South's Sermons.
 Their angry hands
 My brothers hold, and vengeance these exact;
 This pleads *compassion*, and repents the fact.

Dryden's Fables.
 Evy, stern tyrant of the flinty heart,
 Can aught of Virtue, Truth, or Beauty charm?
 Can soft *Compassion* thrill with pleasing smart,
 Repentance melt, or Gratitude disarm.

Beattie.
 The fines were assigned to the rebuilding of St.
 Paul's, and thought therefore to be the more severely
 imposed, and the less *compassionately* reduced and ex-
 cused.

Clarendon.
 The good-natured man is apt to be moved with
compassion for those misfortunes or infirmities, which
 another would turn into ridicule. *Addison's Spectator.*

COMPASSION, or COMMISERATION, in ethics, a
 mixed passion, compounded of love and sorrow,
 and excited by the sight or recital of distress.
 Hobbs makes this a merely selfish passion, and
 defines it, as being fear for ourselves; Hutchin-
 son resolves it into instinct; but Dr. Butler
 more properly considers compassion as an ori-
 ginal, distinct, particular affection in human
 nature.

COMPATERNITY, *n. s.* Lat. *con* and *pater-*
nitatis.

Gossipred, or *compaternity*, by the canon law, is a
 spiritual affinity; and a juror that was gossip to either
 of the parties might, in former time, have been chal-
 lenged as not indifferent by our law.

Davies's State of Ireland.

COMPATIBLE, *adj.* } Corrupted by an
 COMPATIBILITY, *n. s.* } unskilful compliance
 COMPATIBLENESS, *n. s.* } with pronunciation,
 COMPATIBLY, *adv.* } from *compatibile*, from
 Lat. *cometo*, to suit, to agree. *Compatible* is
 found in good writers, and ought always to be
 used. Crabb derives it from *con* and *pator*,
 which signifies fitness to be suffered together.
 Consistency; the power of co-existing with
 something else; agreement with anything; sui-
 table to; fit for; consistent with; opposed to
 every thing that is incongruous.

The object of the will is such a good as is *compati-*
ble to an intellectual nature.

Hale's Origin of Mankind.

Our poets have joined together such qualities as are
 by nature the most *compatible*; valour with anger,
 meekness with piety, and prudence with dissimulation.

Broome.

COMPATIENT, *adj.* from Lat. *con* and *pator*.
 Suffering together.

COMPATRIOT, *n. s.* from Lat. *con* and *pa-*
tria. One of the same country.

The governor knew he was so circumspect as not to
 adhere to any of the factions of the time, in a neutra-
 lity indifferently and friendly entertaining all his *com-*
patriots.

Drummond.

COMPE'ER, *n. s. & v. a.* Lat. *compar*, equal;
 companion; colleague; associate.

Therein dwelt a burgeyse, the most seliper man,
 Of all the town throughout; and whatso he wan
 With treachery and gile, as doth some peres,
 Right so must he part with his *compeers*.

Chaucer. Cant. Tales.

In his own grace he doth exalt himself
 More than in your advancement.

—In my right,
 By me invested, he *compeers* the best.

Shakespeare. King Lear.

So spake the apostate angel, though in pain
 Vaunting aloud, but racked with deep despair,
 And him thus answered soon his bold *compeers*.

Milton.

For Bordeaux we with voice unanimous
 Declare such sympathy's in boon *compeers*.

Sesostris,

That monarchs harnessed, to his chariot yoked,
 Base servitude, and his dethroned *compeers*
 Lashed furiously.

Philips.

COMPEL, *v. a.* } Lat. *compello*, or *pello*,
 COMPELL'ABLE, *adj.* } to drive for a specific
 COMPELLER, *n. s.* } purpose, or to a point;
 to urge irresistibly; to take by force or violence;
 to gather together and unite in company. A latinism
compellere gregem; to seize; to empower.

So him dismounted low he did *compell*
 On foot with him to matchen equal fight.

Spenser.

You will *compel* me then to read the will?
Shakespeare. Julius Caesar.

But first the lawless tyrant, who denies
 To know their God, or message to regard,
 Must be *compelled* by signs and judgments dire.

Milton.

Our men secure nor guards nor centries held,
 But easy sleep their weary limbs *compelled*.

Dryden.

Yet has not oft the fraudulent guardian's fright,
 Compelled him to restore an orphan's right.

Gay.

The clouds above me to the white Alps tend,
And I must pierce them, and survey whate'er
May be permitted, as my steps I bend
To their most great and growing region, where
The earth to her embrace *compens* the powers of air.
Byron's Childs Harold.

COMPELLATION, *n. s.* Lat. from *compello*. The style of address; the word of salutation.

The stile best fitted for all persons, on all occasions, to use, is the *compellation* of Father, which our Saviour first taught. *Drupe's Rules of Devotion.*

The peculiar *compellation* of the kings in France, is by sire, which is nothing else but father. *Temple.*

COMPENDIUM, *n. s.* } Lat. *compendium*, *compendiarium*. Abridgement; summary; breviate; abbreviature; that which holds much in a limited space. Mr. Crabbe has thus distinguished the modes of meaning between two words that are erroneously considered to be synonymous. 'An abridgement,' he observes, 'is the reduction of a work into a smaller compass. A compendium is a general and concise view of any science, as geography or astronomy.'

By the apostles we have the substance of Christian belief *compendiously* drawn into few and short articles. *Hooker.*

The inviting easiness and *compendiousness* of this assertion, should dazzle the eyes. *Bentley's Sermons.*
After we are grown well acquainted with a short system, or *compendium* of a science, which is written in the plainest and most simple manner, it is then proper to read a larger regular treatise on that subject. *Watts on the Mind.*

Fix in memory the discourses, and abstract them into brief *compenda*. *Id. Improvement on the Mind.*

They learned more *compendious* and expeditious ways, whereby they shortened their labours, and gained time. *Woodward.*

COMPENSATE, *v. a.* } Lat. *compenso*; } compounded of *com*
COMPENSE, *v. a.* } and *pensatio*; *pensus*
COMPENSABLE, *adj.* } and *pendo*. To pay; } hence to recom-
COMPENSATION, *n. s.* } pense; to make amends; to countervail; to counterbalance a loss by an equivalent. Making up a deficiency, atoning, or satisfying for an injury.

Poynings, the better to make *compensation* of his service in the wars, called a parliament. *Bacon.*

The length of the night, and the dews thereof, do *compensate* the heat of the day. *Id. Natural History.*

It seemeth, the weight of the quicksilver doth not *compense* the weight of a stone, more than the weight of the aqua fortis *Id.*

All other debts may *compensation* find;
But love is strict, and will be paid in kind. *Dryden's Aurengzebe.*

The pleasures of life do not *compensate* the miseries. *Prior.*

Nature to these, without profusion kind,
The proper organs, proper powers, assigned;
Each seeming want *compensated* of course,
Here with degrees of swiftness, there of force. *Pope.*

Compensation is a species of relation. It is relation when the defects of one part, or of one organ, are supplied by the structure of another organ. *Paley's Theology.*

COMPENSATION, in law. Where the same person is debtor and creditor, the mutual obligations, if they are for equal sums, are extinguished by compensation; if for unequal, the lesser obligation is extinguished, and the greater diminished, as far as the concurrence of debt and credit goes.

COMPERENDINATE, *v. a.* } Lat. *com-*
COMPERENDINATION, *n. s.* } *perendino*; to delay; delay; dilatoriness.

COMPETENT, *adj.* } Latin *competens*.
COMPETENCE, *n. s.* } Suitable; fit; ade-
COMPETENCY, *n. s.* } quate; proportion-
COMPETENTLY, *adv.* } ate; adapted to any purpose without defect or superfluity. Capacity, applied to intellectual power and judicial authority. Ability equal to any given task; official right to decide on any given question. It is also used in the sense of reasonable and moderate.

If there be any power in imagination, the distance must be *competent*, the medium not adverse, and the body apt and proportionate.

To draw men from great excess, it is not amiss, though we use them unto somewhat less than is *competent*. *Bacon's Natural History.*
Hooker.

For *competence* of life I will allow you,
That lack of means enforce you not to evil. *Shakespeare. Henry IV.*

The greatest captain of the English brought rather a guard, than a *competent* army, to recover Ireland. *Davies on Ireland.*

That is the privilege of the Infinite Author of things, who never slumbers nor sleeps, but is not *competent* to any finite being. *Locke.*

I think it hath been *competently* proved. *Bentley.*

Something of speech is to be indulged to common civility, more to intimacies, and a *competency* to those recreative discourses which maintain the cheerfulness of society. *Government of the Tongue.*

Some places require men *competently* endowed; but none think the appointment to be a duty of justice bound to respect desert. *Wotton.*

Reason's whole pleasure, all the joys of sense, Lie in three words, health, peace, and *competence*. *Pope.*

There are who deaf to mad Ambition's call,
Would shrink to hear the obstreperous trump of Fame,
Supremely blest if to their portion fall
Health, *competence* and peace. *Beattie.*

A *competency* ought to secure a man from poverty; or if he wastes it makes him ashamed of publishing his necessities. *Johnson's Life of Dryden.*

COMPETENTES. See CATECHUMENS.
COMPETIBLE, *adj.* }
COMPETIBLENESS, *n. s.* } See COMPATIBLE.

Those are properties not at all *competible* to body or matter, though of never so pure a mixture. *Glanville.*

It is not *competible* with the grace of God so much as to incline any man to do evil. *Hammond on Fundamentals.*

COMPETITION, *n. s.* Lat. *con* and *petitio*; and *competu*, the verb, which signifies to seek together the same object, with an emulous desire of success to ourselves: hence rivalry, contest. It also signifies double claim; claim of more than one to one thing.

The ancient flames of discord and intense wars, upon the *competition* of both houses, would again return.

Bacon.

Competition to the crown there is none, nor can be.

Id.

For God,

Nothing more certain, will not long defer

To vindicate the glory of his name

Against all *competition*, nor will long

Endure it doubtful, whether God be Lord

Or Dagon.

Milton's Samson Agonistes.

Though what produces any degree of pleasure be in itself good, and what is apt to produce any degree of pain be evil, yet often we do not call it so when it comes in *competition*; the degrees also of pleasure and pain have a preference.

Locke.

The prize of beauty was disputed till you were seen; but now all pretenders have withdrawn their claims: there is no *competition* but for the second place.

Dryden.

COMPETITOR, *n. s.* Lat. *con* and *petitor*.

An opponent; one that has a claim opposite to another's; a rival.

The Guilford's are in arms,

And every hour more *competitors*

Flock to the rebels. *Shakespeare. Richard III.*

How furious and impatient they be,

And cannot brook *competitors* in love.

Id. Titus Andronicus.

Selymes, king of Algiers, was in arms against his brother Mechemetes, *competitor* of the kingdom.

Knoll's History.

COMPIEGNE, or **COMPEIGNE**, a handsome old town of France, in the department of Oise, and ci-devant province of the Isle of France. The heroic maid of Orleans was taken prisoner here in 1430. It is seated near a large forest, at the confluence of the Aisme and the Oise, and contains several churches, one of which possesses the first organ ever seen in France. The palace of Compiègne was a favorite hunting seat of the French monarchs. Population 1290. It is forty-eight miles north-east of Paris. Long. 2° 55' E., Lat. 49° 25' N.

COMPILE, *v. a.*

COMPILATION, *n. s.*

COMPILEMENT, *n. s.*

COMPLER.

Lat. *compilo*. To write;

to compose; to draw up

from various authors, to

collect into one body;

to contain; to comprise, not used. Compilation is applied generally to an assemblage or coacervation, as in the following instance:—

There is in it a small vein filled with spar, probably since the time of the *compilation* of the mass.

Woodward on Fossils.

After so long a race as I have run

Through fairy land, which those six books *compile*,

Give leave to rest me.

Spenser.

I was encouraged to assay how I could build a man; for there is a moral as well as a natural or artificial *complement*, and of better materials.

Wotton on Education.

Some painful *compilers*, who will study old language, may inform the world that Robert earl of Oxford was high treasurer.

Swift.

In poetry they *compile* the praises of virtuous men and actions, and satires against vice.

Temple.

COMPITALIA, or **COMPITALITA**, feasts held among the ancients in honor of the Lares; so called from *compitum*, a cross-way; because the feast was held in the meeting of several roads. The *compitalia* are more ancient than the building of Rome. Dionysius of Halicarnassus and Pliny indeed, say, they were instituted by Servius Tullus; but this only signifies that they were then introduced into Rome. The feast being movable, the day whereon it was to be observed was proclaimed every year. It was ordinarily held on the 4th of the nones of February. Macrobius observes, that they were held not only in honor of the Lares, but also of Mania, the goddess of madness. The priests who officiated at them were slaves and freed-men, and the sacrifice a sow. They were re-established after long neglect, by Tarquin II. on occasion of an answer of the oracle that they should sacrifice heads for heads; i. e. that for the health and prosperity of each family, children were to be sacrificed: but Brutus, after expelling the kings, in lieu of those barbarous victims substituted the heads of garlic and poppy; thus complying with the oracle by sacrificing heads. During the celebration of this feast, each family placed at the door of their house the statue of the goddess Minia. They also hung up at their doors figures of wood, representing men and women; accompanying them with supplications that the Lares and Mania would be contented with those figures, and spare the people of the house.

COMPLACENCE, *n. s.* } Lat. *complacens*;

COMPLACENCY, *n. s.* } low Lat. *complac-*

COMPLACENT, *adj.* } *centia*. Pleasure,

gratification, more especially that which is derived from self approbation. The cause of pleasure; civility; complaisance; softness of manners; affability.

I by conversing cannot these erect
From prone, nor in their way *complacence* find.

Milton.

O thou, in heaven and earth the only peace
Found out for mankind under wrath! O thou,
My sole *complacence*!

Id. Paradise Lost.

When the supreme faculties move regularly, the inferior affections following, there arises a serenity and *complacency* upon the whole soul.

South.

Complacency and truth, and manly sweetness,
Dwell ever on his tongue, and smooth his thoughts

Addison.

With mean *complacence* ne'er betray your trust,
Nor be so civil as to prove unjust.

Pope.

COMPLAIN, *v. n. & a.*

COMPLAINANT, *n. s.*

COMPLAINER, *n. s.*

COMPLAINING, *n. s.*

COMPLAIN, *n. s.*

Fr. *complandre*,

complainte, *n. s.*

to mention

with sorrow and

resentment; to mur-

mur; to lament; to inform against. A complainant is one who urges a suit, or commences a prosecution against another; a complainer is a murmurer, a lamenter; one who bewails or accuses. Complaint sometimes signifies the representation of what aggrieves; sometimes it is used for the cause of the evil, and not unfrequently for the evil itself.

And most of al, for this I me *complain*,
That she hath joy to laughen at my paine.

Chaucer. Complaint of the Black Knight.

Complaineth eke ye lovers al in fere,
For her that, with unfained humble chere,
Was ever redy to do you succour;
Complaineth hire that, er, hath be you dere;
Complaineth beaute, fredome and manere;
Complaineth hire that endeth your labour;
Complaineth thilke ensample of al honour,
That never dyd but gentilnesse;
Kytheth therefore in hire some kindnesse.

Chaucer. The Complaint of Mars.

I cannot find any cause of *complaint*, that good laws
have so much been wanting unto us, as we to them.

Hooker's Dedication.

Lord Hastings,
Humbly *complaining* to her deity,
Got my lord chamberlain his liberty.

Shakespeare. Richard III.

Now, master Shallow, you'll *complain* of me to the
council?

Id. Merry Wives of Windsor.

In evil straight this day I stand
Before my judge, either to undergo
Myself the total crime, or to accuse
My other self, the partner of my life;
Whose failing, while her faith to me remains,
I should conceal, and not expose to blame
By my *complaint*.

Milton.

How wisely nature did decree
With the same eyes to weep and see;
That having viewed the object vain,
They might be ready to *complain*.

Marvell.

For't has been held by many that,
s Montaigne playing with his cat
Complains she thought him but an ass,
Much more she would Sir Hudibras,
Congreve and this author are the most eager *com-*
plainants of the dispute.

Butler

Collier's Defence.

Gaufride, who couldst so well in rhyme *complain*
The death of Richard, with an arrow slain.

Dryden's Fables.

Philips is a *complainer*; and on this occasion I told
lord Carteret, that *complainers* never succeed at court,
though railers do.

Swift.

The poverty of the clergy in England hath been the
complaint of all who wish well to the church.

Id.

To hear you prate would vex a saint;
Who have most reason of *complaint*?
Replies the cat.

Gay.

One, in a *complaint* of his bowels, was let blood till
he had scarce any left, and was perfectly cured.

Arbutnot.

But, if pity inspire thee, renew the sad lay;
Mourn, sweetest *complainer*, man calls thee to mourn;
O soothe him whose pleasures like thine pass away,
Full quickly they pass—but they never return.

Beattie.

That I want nothing, said the prince, or that I
know not what I want, is the cause of my *complaint*;
if I had any known want I should have a certain
wish; that wish would excite endeavour, and I
should not then repine to see the sun move so slowly
towards the western mountains, or lament when the
day breaks and sleep will no longer hide me from
myself.

Johnson. Rasselas.

Loud *complaint*, however angrily
It shapes its phrase, is little to be feared,
And less distrusted.

Byron's Dogs of Venice.

COMPLAISANCE, n. s. } Fr. *complaisance*,
COMPLAISANT, adj. } complaisant. Ci-
COMPLAISANTLY, adv. } vility; adulation;
COMPLAISANTNESS, n. s. } desire of pleasing,
with desire to please ceremoniously. Easy of
persuasion, bland, acquiescent.

Her death is but in *complaisance* to her. *Dryden*

Fair Venus wept the sad disaster
Of having lost her favorite dove:
In *complaisance* poor Cupid mourned;
His grief relieved his mother's pain. *Prior.*

There are to whom my satire seems too bold;
Scarce to wise Peter *complaisant* enough,
And something said of Chartres much too rough. *Pope.*

In plenty starving, tantalized in state,
And *complaisantly* helped to all I hate;
Freated, caressed, and tired, I take my leave. *Id.*

COMPLANATE, v. a. } Lat. *planus*. To
COMPLANE. } level; to reduce to
a flat and even surface.

The vertebrae of the neck and back-bone are made
short and *complanated*, and firmly braced with muscles. *Derham.*

COMPLEAT. See COMPLETE.

COMPLEMENT, n. s. Lat. *complementum*.
Perfection; fullness; completion; complement.
Complete set; complete provision; the full
quantity or number. Adscitious circumstances;
appendages; parts not necessary, but ornament-
al: whence ceremony was called complement,
now corrupted to compliment.

Our custom is both to place it in the front of our
prayers as a guide, and to add it in the end of some
principal limbs or parts, as a *complement* which fully
perfecteth whatsoever may be defective in the rest. *Hooker.*

They as they feasted had their fill,
For a full *complement* of all their ill. *Hubberd's Tale.*

The sensible nature, in its *complement* and integrity,
hath five exterior powers or faculties. *Hale's Origin of Mankind.*

A doleful case desires a dolefull song,
Without vain art or curious *complements*;
And squalid fortune, into looseness srong,
Doth scorn the pride of wonted ornaments.

Spenser.

Garnished and decked in modest *compliments*,
Not working with the ear, but with the eye. *Shakespeare.*

The god of love himself inhabits there,
With all his rage, and dread, and grief, and carr;
His *complement* of stores, and total war. *Prior.*

COMPLETE, adj. & v. a. } Lat. *completus*.
COMPLETELY, adv. } Perfect; full;
COMPLEMENT, n. s. } having no defi-
COMPLETENESS, n. s. } ciencies; having
COMPLETION, n. s. } no degrees, and
therefore not properly admitting more and most;
finished, ended, concluded.

With us the reading of scripture is a part of our
church liturgy, a special portion of the service which
we do to God; and not an exercise to spend the time,
when one doth wait for another coming, till the as-
sembly of them that shall afterwards worship him
be *complete*.

Hooker.

When I approach
Her loveliness, so absolute she seems
And in herself *complete*, so well to know
Her own, that what she wills to do or say,
Seems wisest, virtuousest, discreetest, best.

Milton's Paradise Lost.

Of a tall statue and of sable hue
Much like that son of Kish, that lofty Jew,
Twelve years *complete* he suffered in exile,
And kept his father's asces all the while. *Martini.*

Allow me to give you, from the best authors, the origin, the antiquity, the growth, the change, and the complement of satire among the Romans.

Dryden's Dedication to Juvenal.

This course of vanity almost complets,
Tired in the field of life, I hope retreat. *Prior.*

This was a full entire harmony and consent of all the divine predictions, receiving their completion in Christ. *South.*

Whatever person would aspire to be completely witty, smart, humorous, and polite, must be able to retain in his memory every single sentence contained in this work. *Swift.*

If any disposition should appear towards so good a work, the assistance of the legislative power would be necessary to make it more complete. *Id.*

To town he comes, completes the nation's hope,
And heads the bold trained-bands, and burns a pope. *Pope.*

He makes it the utmost completion of an ill character to bear a malevolence to the best men. *Id.*

The happy morn that shall her bliss complete,
And all her rivals' envious hopes defeat. *Gay.*

These parts go to make up the completeness of any subject. *Watts's Logick.*

That sabre's whirling sway,
Sheds fast atonement for its first delay;
Completes his fury, what their fear begun,
And makes the many basely quail to one. *Byron. Corsair.*

COMPLEX, *adj. & n. s.* } Lat. *complexus*.
COMPLEXED, *adj.* } Composite; of
COMPLEXEDNESS, *n. s.* } many parts; not
COMPLEXLY, *adv.* } simple; including
COMPLEXNESS, *n. s.* } many particulars.
COMPLEXURE, *n. s.* } Complication, in-
volution of many particular parts in one integral.
The opposite of simplicity.

This parable of the wedding supper comprehends in it the whole complex of all the blessings and privileges exhibited by the gospel. *South's Sermons.*

Ideas made up of several simple ones, I call complex; such as beauty, gratitude, a man, the universe; which, though complicated of various simple ideas, or complex ideas made up of simple ones, yet are considered each by itself as one. *Locke.*

From the complexedness of these moral ideas, there follows another inconvenience, that the mind cannot easily retain those precise combinations. *Id.*

I know that all words which are signs of complex ideas, furnish matter of mistake and cavil. *Bolingbroke.*

With such perfection framed
Is this complex stupendous scheme of things. *Thomson's Spring.*

A secondary essential mode, called a property, sometimes goes toward making up the essence of a complex being. *Watts.*

COMPLEXION, *n. s.* } Latin, *complexio*.
COMPLEXIONAL, *adj.* } The enclosure or in-
COMPLEXIONALLY, *adv.* } volution of one thing
in another. The color of the external parts of any body. The temperature of the body according to the various proportions of the four medical humors.

Ire sikeness, or constellation,
Win, wo, or changing of complexion,
Causeth ful oft to don amis or spoken;
On every wrong, a man may not be wroken. *Chaucer. Cant. Tales.*

Amongst them all sate he which wonned there,
That hight Phantastes by his nature trew;
A man of yeares, yet fresh, as mote appere,
Of swarth complexion and of crabbed hew,
That him full of melancholy did shew. *Spenser.*
Men judge by the complexion of the sky
The state and inclination of the day. *Shakespeare. Richard II.*

What see you in those papers, that you lose
So much complexion? *Id. Henry V.*

Men and other animals receive different tinctures from complexional efflorescencies, and descend still lower as they partake of the fuliginous and denigrating humours. *Broune.*

An Indian king sent unto Alexander a fair woman, fed with poisons, either by converse or copulation complexionally to destroy him. *Id. Vulgar Errors.*

'Tis ill, though different your complexions are,
The family of heaven for men should war. *Dryden's Fables.*

The methods of providence, men of this complexion must be unfit for the contemplation of.

Barnes's Theory of the Earth.

Let melancholy rule supreme,
Choler preside, or blood, or phlegm,
It makes no difference in the case,
Nor is complexion honour's place. *Swift.*

If I write on a black man, I run over all the eminent persons of that complexion. *Addison's Spectator.*

Her wan complexion's like the withered leek,
While Katherine pears adorn my ruddy cheek. *Gay.*

Though the terms of proposition may be complex, yet where the composition of the argument is plain, simple, and regular, it is properly called a simple syllogism, since the complexion does not belong to the syllogistick form of it. *Watts.*

COMPLEXION. Few questions in philosophy have engaged the attention of naturalists more than the diversities of the human species, among which that of color is the most remarkable. The great differences in this respect have given occasion to several authors to assert, that the whole human race have not sprung from one original; but that as many different species of men were at first created, as there are now different colors to be found. It appears, indeed, a matter of no small difficulty to account for the remarkable variations of color that are to be found among different nations. On this subject Dr. Hunter published a thesis, in which he determined absolutely against any specific difference among mankind. He commences with a definition of the term species including all those animals under the same species, which produce issue capable of propagating others resembling the original stock. As in the case of plants, one species comprehends several varieties depending upon climate, soil, culture, and similar accidents; so he considers the diversities of the human race to be merely varieties of the same species, produced by natural causes, and gives the following view of the different colors observable among mankind: I. Black: 1. Africans under the line; 2. Inhabitants of New Guinea; 3. Inhabitants of New Holland. II. Swarthy: 1. The Moors in the Northern parts of Africa; 2. The Hottentots on the Southern parts of it. III. Copper-colored: The East Indians. IV. Red: The Americans. V. Brown: 1. Tartars; 2. Persians; 3. Arabs;

4. Africans on the coast of the Mediterranean ; 5. Chinese. VI. Brownish : The inhabitants of the southern parts of Europe ; as 1. Sicilians ; 2. Spaniards ; and 3. Turks ; also 4. Samoiedes ; 5. Laplanders ; 6. Abyssinians. VII. White : Most of the other European nations, as, 1. Swedes ; 2. Danes ; 3. Britons ; 4. Germans ; 5. Poles, &c. ; 6. Kabardinski ; 7. Georgians ; 8. Inhabitants of the islands of the Pacific Ocean. The doctor thinks there can be no dispute as to the seat of color being placed in the skin ; that it is not even extended over the whole of this, but confined to that part named the cuticle, consisting of the epidermis and reticulum ; and that it chiefly occupies the latter of these.

The cuticle is much thicker and harder in black people, he observes, than in white ones ; the reticulum in the latter being a thin mucus, in the form of a thick membrane. He concludes that this seat of color in whites is transparent, and either totally deprived of vessels, or furnished with very few ; as the yellow color appearing in jaundice vanishes on the cause of the disease being removed ; which is not the case with stains in the cuticle from gunpowder, or similar causes. He next points out three causes, destroying the pellucidity of the cuticle, giving it a brown color, and rendering it thicker. These are, access of air, filthy habits, and the heat of the sun. The influence of each of these he proves by many examples ; and considers the last as by much the most powerful. Hence, he accounts for all the diversity of color observed among mankind.

This subject has been further illustrated by Mr. Clarkson, in a dissertation introduced into his Essay on the Commerce and Slavery of the Human Species. The old anatomists, he observes, usually divided the skin into two parts or laminæ ; the exterior and thinnest, called by the Greeks epidermis, by the Romans cuticula, and hence by us cuticle ; and the interior, called by the former derma, and by the latter cutis, or true skin.

Malpighi, an eminent Italian physician of the last century, was the first that discovered that the skin was divided into three laminæ ; the cuticle, the true skin, and a certain coagulated substance, situated between both, which he distinguished by the title of rete mucosum, and which adhered so firmly to the cuticle, as, in all former anatomical preparations, to have come off with it ; which led the ancient anatomists to believe, that there were but two divisible portions in the human skin. This discovery was sufficient to ascertain the point in question ; for it appeared afterwards that the cuticle, when divided according to this discovery from the other lamina, was semi-transparent ; that the cuticle of the blackest negro was of the same transparency and color as that of the purest white ; and hence, the true skins of both being invariably the same, that the rete mucosum was the seat of color. This has been farther confirmed by all subsequent anatomical experiments ; by which it appears, that whatever be the color of this coagulated substance, nearly the same is the apparent color of the upper surface of the skin. The transparency of the cuticle is a matter of ocular demonstration in white people. It is conspicuous in every blush ; for no one

can imagine, that the cuticle becomes red as often as this happens ; nor is it less discoverable in the veins, which are so easy to be discerned ; for no one can suppose that the blue streaks, which he constantly sees in the fairest complexions, are painted, as it were, on the surface of the upper skin. From these, and other observations, no maxim is more true in physiology, than that the rete mucosum, being of a different color in different inhabitants of the globe, and appearing through the cuticle or upper surface of the skin, gives them that various appearance which strikes us so forcibly in contemplating the human race. Whatever causes, therefore, co-operate in producing this different appearance, they produce it by acting upon the rete mucosum ; which, from the almost incredible manner in which the cuticle is perforated, is as accessible as the cuticle itself. These causes are probably those various qualities of things, which, combined with the influence of the sun, contribute to form what we call climate. For whoever considers, that the mucous substance is found to vary in its color, as the climates vary from the equator to the poles, must be instantly struck with the analogy, and conclude the mucous substance to be the genuine cause of the phenomenon. The natives of many places in Asia are found to have their rete mucosum black ; those of Africa, situated near the line, of the same color ; those of the maritime parts of the same continent, of a dusky brown, nearly approaching to it ; and the color becomes lighter or darker, in proportion as the distance from the equator is greater or less.

The only objection of any consequence that has ever been made to the hypothesis of climate, is this, that people under the same parallels are not of the same color. But it does not follow that those countries which are at an equal distance from the equator, should have their climates the same. Indeed nothing is more contrary to experience. Climate depends upon a variety of accidents. High mountains in the neighbourhood of a place make it cooler, by chilling the air that is carried over them by the winds. Large spreading succulent plants have the same effect ; they afford agreeable cooling shades, and a moist atmosphere from their continual exhalations, by which the ardor of the sun is much abated. On the other hand, soil of a sandy nature retains the heat in an uncommon degree, and makes the summers considerably hotter than those which exist in the same latitude where the soil is different. To the proximity of burning sands, and and to the sulphurous and metallic particles continually exhaling from the earth, is, therefore, to be ascribed the different degrees of blackness by which some African nations are distinguishable from others, though under the same parallels. To the preceding arguments, may be added one that seems incontrovertible, viz. that when the black inhabitants of Africa are transplanted to colder, or the white inhabitants of Europe to hotter climates, their children are of a different color from themselves ; that is, lighter in the first, and darker in the second instance. See our article CLIMATE.

This doctrine is adopted by professor Zimmerman of Brunswick, in his celebrated work, The

Geographical History of Man, &c. who confirms it by observing, that the mountaineers of warm climates, as in Barbary and Ceylon, are much fairer than the inhabitants of the valleys: that the Saracens and Moors, who conquered the northern part of Africa, from being brown, are become like the negroes near the equator; that the Portuguese who settled at Senegal in 1400, became blacks; and the Jews in Abyssinia of the dark complexion of the original natives.

Upon the whole, color and figure may be styled habits of the body; created, not by great and sudden impressions, but by continual and almost imperceptible touches. Of habits, both of mind and body, nations are susceptible as well as individuals. They are transmitted to offspring and augmented by inheritance. Long in growing to maturity, national features, like national manners, become fixed only after a succession of ages. They become, however, fixed at last; and if we can ascertain any effect produced by a given state of weather or of climate, it requires only repetition, during a sufficient length of time, to augment and impress it with a permanent character. The sanguine countenance will, for this reason, be perpetual in the highest latitudes of the temperate zone; and we shall always find the swarthy, the olive, the tawny, and the black, as we descend to the south. The uniformity of the effect in the same climate, and on men in a similar state of society, proves the power and certainty of the cause. The foregoing observations are excellently illustrated by new facts, and enforced by additional reasoning, founded on considerable personal investigation of facts, by Dr. Samuel Stanhope Smith, professor of moral philosophy in New Jersey, in his Essay on the Causes of the Variety of Complexion and Figure in the Human Species; to which we refer the reader.

COMPLICATE, *v. a. & adj.* } *Lat. compli-*
COMPLICATEDNESS, *n. s.* } *co.* To entan-
COMPLICATION, *n. s.* } gle one with
 another; to join; to involve mutually. To unite
 by involution of parts one in another. To form
 by the union of several parts into one.

Though the particular actions of war are *complicate* in fact, yet they are separate and distinct in right.

Bacon.

Dreadful was the din
 Of hissing through the hall! thick swarming now
 With *complicated* monsters, head and tail.

Milton's Paradise Lost.

There is a great variety of intelligibles in the world, so much objected to our senses, and every several object is full of subdivided multiplicity and *complicatedness*.

Hale's Origin of Mankind.

Commotion in the parts may make them apply themselves one to another, or *complicate* and dispose them after the manner requisite to make them stick.

Boyle's History of Firmness.

The notions of a confused knowledge are always full of perplexity and *complications*, and seldom in order.

Wilkins.

In case our offence against God hath been *complicated* with injury to men, we should make restitution.

Tillotson.

Attachment to a private person must comprehend a great concern for his character and his interest; but

attachment to one who is or may be a king, much more; because the character of the latter is more important to himself and others; and because his interests are vastly more *complicated* with those of his country, and in some sort with those of mankind.

Bolingbroke.

When the disease is *complicated* with other diseases, one must consider that which is most dangerous.

Arbutnot on Diet.

What pleasure would felicitate his spirit if he could grasp all in a survey, as a painter runs over a *complicated* piece wrought by Titian or Raphael.

Watts on the Mind.

By admitting a *complication* of ideas, and taking too many things at once into one question, the mind is dazzled and bewildered.

Watts's Logick.

COMPLICE, *n. s.* French, from low Lat. *complex*, an associate. One who is united with others in an ill design; an associate; a confederate; an accomplice.

To arms, victorious noble father,

To quell the rebels and their *complices*.

Shakespeare. Henry VI.

Justice was afterwards done upon the offenders, the principal being hanged and quartered in Smithfield; and divers of his chief *complices* executed in divers parts of the realm.

Haywood.

The marquis prevailed with the king, that he might only turn his brother out of the garrison, after justice was done upon his *complices*.

Clarendon.

COMPLIMENT, *n. s., v. a., & n.* } Fr. *compliment*. An

COMPLIMENTAL, *adj.* } act or ex-

COMPLIMENTALLY, *adv.* } pression of

COMPLIMENTER, *n. s.* } civility, usually understood to include some hypocrisy, and to mean less than it declares: this is properly complement, something superfluous, or more than enough. See **COMPLEMENT**.

What honour that,

But tedious waste of time, to sit and hear

So many hollow *compliments* and lyes,

Outlandish flatteries?

Milton's Paradise Regained.

The watchman gave so very great a thump at my door, that I awaked, and heard myself *complimented* with the usual salutation.

Taylor.

She *compliments* Menelaus very handsomely, and says he wanted no accomplishment either of mind or body.

Pope.

This falsehood of Ulysses is intirely *complimental* and officious.

Broome.

This speech has been condemned as avaricious; Eustathius judges it spoken artfully and *complimentally*.

Id.

Many women doat upon a man for his *complement* only, and good behaviour: they are won in an instant.

Burton's Anatomy of Melancholy.

Churlish despite ne'er looked from his calm eye,
 Much less commanded in his gentle heart:

To basest men fair looks he would impart;

No could he cloak ill thoughts in *complimental* art.

Fletcher's Purple Island.

How did you praise my shape and graceful air!

And woman thinks all *compliments* sincere. *Gay*

The brief proclaimed, it visits every pew,

But first the squire's, a *compliment* but due:

With slow deliberation he unties

His glittering purse, the envy of all eyes. *Cowper.*

COMPLINE, *n. s.* Fr. *complire*; low Lat. *completinum*. The last act of worship at night, by which the service of the day is completed.

At morn and eve, besides their anthems sweet,
Their peny masses, and their *complines* meet.

Hubbard's Tale.

If a man were but of a day's life, it is well if he
lasts till even-song, and then says his *complins* an
hour before the time.

Taylor's Holy Living.

COMPLO'RE, *v. n.* Lat. *comploro*. To
make lamentation together.

COMPLLOT, *n. s. & v. a.* } Fr. from *com-*
COMPLOTT'ER, *n. s.* } *pletum*, for *com-*

plexum, low Lat. *Menage*. A confederacy in
some secret crime; a plot; a conspiracy. To
form a plot; to conspire; to join in any secret
design, generally criminal.

I cannot, my life, my brother, like but well
The purpose of the *complot* which ye tell.

Hubbard's Tale.

I knew their *complot* is to have my life.

Shakespeare. Henry VI.

Jocasta too, no longer now my sister,
Is found *complotter* in the horrid deed.

Dryden and Lee's Oedipus.

A few lines after, we find them *complotting* together,
and contriving a new scene of miseries to the Trojans.

Pope.

COMPLUTENSIAN POLYGLOTT, so called
from Complutum, the Latin name of Alcalá,
in Spain, was the first polyglott ever published.
It was the work of cardinal Ximenes, and was
completed in 6 vols. folio. See **BIBLE** and
ALCALÁ.

COMPLY, *v. n.* } Skinner derives it from
COMPLI'ANCE, *n. s.* } the Fr. *complaire*; but
COMPLI'ANT, *adj.* } probably it comes from
COMPLI'ER, *n. s.* } complier to bend to.

Plier is still in use. To yield to; to be obse-
quious to; to accord with; to suit with. It has
with before as well persons as things.

The *compliant* boughs

Yielded them. *Millon's Paradise Lost.*

The rising sun *complies* with our weak sight,
First gilds the clouds, then shows his robe of light.

Waller.

He was a man of few words, and of great *com-
pliance*; and usually delivered that as his opinion,
which he foresaw would be grateful to the king.

Clarendon.

We are free from any necessary determination of
our will to any particular action, and from a necessary
compliance with our desire, set upon any particular,
and then appearing preferable, good.

Locke.

Remember I am she who saved your life,
Your loving, lawful, and *complying* wife.

Dryden.

He made his wish with his estate *comply*;
Joyful to live, yet not afraid to die.

Prior.

What *compliances* will remove dissension, while the
liberty continues of professing what new opinions we
please?

Swift.

Suppose a hundred new employments were erected
on purpose to gratify *compliers*, an insupportable diffi-
culty would remain.

Id.

Nothing can save him but divorce,

And here the wife *complies* of course.

Gay.

He came early and departed late; laboured to re-
commend himself by assiduity and *compliance*; excited
their curiosity after new arts, that they might still
want his assistance; and when they made any ex-
cursion of pleasure or enquiry entreated to attend
them.

Johnson's Rasselas.

COMPONE, **COMPONED**, or **GOBONY**, in her-
aldry. A bordure compone is that formed or
composed of a row of angular parts, or chequers
of two colors.

COMPONED, or **COMPOSED**, is
also used in general for a bor-
dure, a pale, or a fess, composed
of two different colors or metals
disposed alternately, separated
and divided by filets, as in the
diagram annexed.



COMPONENT, *adj.* Lat. *componens*. That
which constitutes a compound body.

The bigness of the *component* parts of natural
bodies may be conjectured by their colours.

Newton's Opticks.

COMPORT, *v. n., v. a. & n. s.* } Fr. *compor-*
COMPORTABLE, *adj.* } *ter*; from La-
COMPORTANCE, *n. s.* } *tin porto*. To

COMPORTMENT, *n. s.* } agree; to suit;

to behave; to carry; with the reciprocal pro-
noun. Consistent, as opposed to contradictory
behaviour; gesture of ceremony; conduct.

Some piety's not good there, some vain disport
On this side sin, with that place may *comport*.

Doussé.

So beene they both atone, and doen
Their bevers bright each other for to greet,
Goodly *comportance* each to other beare,
And entertaine themselves with court'sies meet.

Spenser.

At years of discretion, and *comport* yourself at
this rantpole rate! *Congrave's Way of the World.*

I shall account concerning the rules and manners
of deportment in the receiving, our *comport* and con-
versation in and after it.

Taylor's Worthy Communicant.

Children in the things they do, if they *comport* with
their age, find little difference, so they may be doing

Locke.

We cast the rules and cautions of this art into some
comortable method.

Wotton's Architecture.

By her serious and devout *comportment* on these so-
lemn occasions, she gives an example that is very
often too much wanted.

Addison's Freeholder.

COMPOSE, *v. a.* } Fr. *composer*; Lat.
COMPOSED, *part. adj.* } *compono*. To form a

COMPOSEDLY, *adv.* } mass by joining dif-
COMPOSEDNESS, *n. s.* } ferent things together,

COMPOSER, *n. s.* } to place anything in
COMPOSITIVE, *adj.* } its proper form and

COMPOSITOR, *n. s.* } method; to put in the
COMPOSURE, *n. s.* } proper state for any

purpose; to put together a discourse or sentence;
to constitute by being parts of a whole—to calm;
to quiet, to adjust, and tranquilise the mind.

Words so pleasing to God, as those which the Son
of God himself hath *composed*, were not possible for
men to frame.

Hooker.

Nor did Israel 'scape
The infection, when their borrowed gold *composed*
The calf in Oreb.

Milton's Paradise Lost.

Now will be the right season of forming them to be
able writers and *composers* in every excellent matter.

Milton.

Flowers dress the altars for the cloaths

The sea-born amber we *compose*.

Marvell.

He would undertake the journey with him, by which
all his fears would be *composed*.

Clarendon.

The whole army seemed well *composed* to obtain that by their swords which they could not by their pen. *Clarendon.*

A man was walking before the door very *composedly* without a hat. One crying, Here is the fellow that killed the duke; every body asked, which is he? The man without the hat very *composedly* answered, I am he. *Id.*

Zeal ought to be *composed* of the highest degrees of all pious affections. *Spratt.*

The *composer* has so expressed my sense, where I intended to move the passions, that he seems to have been the poet as well as the *composer*.

Dryden's Albion and Albanus, Preface.

Compose thy mind;

Nor frauds are here contrived, nor force designed. *Dryden.*

Yet, to *compose* this midnight noise,

Go freely search where'er you please. *Prior.*

How doth the sea exactly *composes* itself to a level superficies, and with the earth make up one spherical roundness. *Roy.*

The Mantuan there in sober triumph sate,

Composed his posture, and his look sedate. *Pope.*

Ye murmuring streams that in meanders roll,
The sweet *composer* of the pensive soul
Farewell. *Gay.*

Discourses on such occasions are seldom the productions of leisure, and should be read with those favourable allowances that are made to hasty *composers*. *Atterbury.*

The style of Georgias of Leontium was formed into short sentences, *composed* generally of two members balanced against each other. The style of Isocrates, on the contrary, is swelling and full; and he is said to be the first who introduced the method of *composing* in regular periods which had a studied music and harmonious cadence. *Gibbon.*

Of jarring elements *composed* the noise,

When Chaos from his old dominion torn,

With all his bellowing throng,

Far, far was hurled, the void abyss along. *Beattie.*

COMPOSING STICK, an instrument used in printing, which, from its name, appears to have been originally made of wood, but has long been made of brass or iron. See **PRINTING**.

COMPOSITE. See **BOTANY**.

COMPOSITE, *adj.* Lat. *compositus*.

The *composite* order in architecture is the last of the five orders of columns; so named, because its capital is composed out of those of the other orders; and it is also called the Roman and Italic order. *Harris.*

Some are of opinion that the *composite* pillars of this arch were in imitation of the pillars of Solomon's temple. *Addison.*

COMPOSITE NUMBERS are such as can be measured exactly by a number exceeding unity; as 6 by 2 or 3, or 10 by 5, &c., so that 4 is the lowest composite number. Composite numbers, between themselves, are those which have some common measure besides unity; as 12 and 15, as being both measured by 3.

COMPOSITE ORDER. See **ARCHITECTURE**.

COMPOSITION, *n. s.* Lat. *compositio*. The act of forming an integral of various dissimilar arts; a mass formed by mingling different ingredients; the act of bringing simple ideas into complication: opposed to analysis, or the separation of complex notions; the arrangement of various figures in a picture; the act of discharg-

ing a debt by paying part; the sum paid; written work; adjustment; regulation; the state of being compounded; union; conjunction; combination; consistency; congruity; compact; agreement; terms on which differences are settled.

To take away all such mutual grievances, injuries, and wrongs, there was no way but only by going upon *composition* and agreement amongst themselves. And again, all publick regiment, of what kind soever, seemeth evidently to have arisen from deliberate advice, consultation, and *composition* between men, judging it convenient and behoveful. *Hooker.*

There is no *composition* in these news,

That gives them credit. —

—Indeed they are disproportioned.

Shakspeare. Othello.

A preacher, in the invention of matter, election of words, *composition* of gesture, look, pronunciation, motion, useth all these faculties at once.

Ben Jonson's Discoveries.

The disposition in a picture is an assembling of many parts; is also called the *composition*, by which is meant the distribution and orderly placing of things, both in general and in particular. *Dryden's Dufresnoy.*

The investigation of difficult things, by the method of analysis, ought ever to precede the method of *composition*. *Newton's Opticks.*

In the time of the Yucas reign of Peru, no *composition* was allowed by the laws to be used in point of medicine, but only simples proper to each disease. *Temple.*

When I read rules of criticism, I enquire after the works of the author, and by that means discover what he likes in a *composition*. *Addison's Guardian.*

Love mixed up all, and his best clay employed,
Then called the happy *composition* Floyd. *Swift.*

Contemplate things first in their own simple natures, and afterwards view them in *composition* with other things. *Watts.*

COMPOSITION, in commerce, a sum of money in part payment of a debt, which the creditors accept in liquidation of the whole, and for which they give a general acquittance to the debtor.

COMPOSITION, in literature, the art of forming and arranging sentiments, and clothing them with language suitable to the nature of the subject.

COMPOSITION, in logic, a method of reasoning, whereby we proceed from some general self-evident truth to other particular and singular ones. In arranging our thoughts, there are two ways of proceeding equally within our choice: for we may suppose the truths, relating to any part of knowledge, as they presented themselves to the mind in the manner of investigation; carrying on the series of proofs in a reverse order, till they at last terminate in first principles; or, beginning with these principles, we may take the contrary way; and from them deduce, by a direct train of reasoning, all the several propositions we want to establish. This diversity in the manner of arranging our thoughts gives rise to the two-fold division of method established among logicians, called analytic and synthetic.

COMPOSITION, in music, is the art of inventing and writing airs; of accompanying them with a suitable harmony; and forming a complete piece of music in all its parts.

COMPOSITION, in music, is also applied to such pieces as are formed according to the rules of the art. Hence duettos, trios, quartets, &c. are called compositions.

COMPOSITION, or COMPOSING, in printing, the arranging of several types or letters in the composing stick in order to form a line; and of several lines ranged in order, in the galley, to make a page; and of several pages to make a form. See PRINTING.

COMPOST, *n. s. & v. a.* } Lat. *compositum*.
 Co'MPOSTURE, *n. s.* } A mixture of various substances for enriching the ground; manure; to manure; to enrich with soil.

The earth's a thief,
 That feeds and breeds by a *composture* stolen
 From general excrements. *Shakespeare. Timon.*

By removing into worse earth, or forbearing to compost the earth, water-mint turneth into field-mint, and the colewort into rape. *Bacon's Natural History.*

As for earth, it *composteth* itself; for I knew a garden that had a field poured upon it, and it did bear fruit excellently. *Id.*

There, as his dream foretold, a cart he found,
 That carried *compost* forth to dung the ground.
Dryden.

In vain the nurling grove
 Seems fair awhile, cherished with foster earth;
 But when the alien *compost* is exhaust,
 Its native poverty again prevails. *Philips.*

COMPOST, in agriculture, a mixture of manure. An oil compost is recommended in the Geographical Essays, upon a supposition that the food of vegetables is of an oily nature. It is made as follows: Take of North American potassa 12 lbs. Break the salt into small pieces, and put it into a convenient vessel with four gallons of water. Let the mixture stand forty-eight hours; then add of coarse train oil fourteen gallons. In a few days the salt will be dissolved, and the mixture, upon stirring, will become nearly uniform. Take fourteen bushels of sand, or twenty of dry mould; upon these pour the above liquid ingredients. Turn this compost frequently over, and in six months it will be fit for use. When the liquid ingredients are put to one or two hogsheds of water a liquid compost will be formed, which must be used with a water cart. This compost, however, the inventor himself owns to be inferior to rotten dung.

On the supposition that vegetables are supported by matters of a saline nature, composts formed of different sorts of salts have been contrived, but with little success. A famous composition of this kind was once sold by patent, under the name of Baron Van Haak's compost; but the Geographical Essays report it as a very poor one. The crop could not have been worse had it been left destitute of every assistance. Composts, made with putrefied animal substances, answer much better, in most cases, than any other kind of manure, but they are difficult to be procured. The following is recommended by Dr. Hunter of York. 'Take a sufficient quantity of saw-dust, incorporate it with the blood and offal of a slaughterhouse, putting a layer of one and a layer of the other till the whole becomes a moist and fetid composition. Two loads of this compost, mixed

with three loads of earth will be sufficient for an acre of wheat or spring cotton. Being a kind of top dressing, it should be put on at the time of sowing, and harrowed in with the grain. As this kind of compost lies in a small compass, it seems well adapted for the use of those farmers who are obliged to bring their manures from a distance. It is besides extremely rich, and will probably continue in the land much longer than fold-yard or stable dung. I apprehend that it is capable of restoring worn out land to its original freshness; and I am induced to be of that opinion from the appearance of the crop now growing upon land much impoverished by bad management. Mixing dung in a state of fermentation with peat, says Mr. Loudon, or forming what in Scotland are called meadow-bank middens is a successful mode of increasing the quantity of putrescent manure. The peat being dug and partially dried may either be carted into the farm-yard and spread over the cattle court, there to remain till the whole is carted out and laid upon a dunghill to ferment; or it may be mixed up with the farm-yard dung as carted out. If care be taken to watch the fermenting process, as the fire of a clay kiln is watched, a few loads of dung may be made to rot many loads of peat.

COMPOSTELLA, or ST. JAGO DE COMPOSTELLA, a considerable town of Spain, the capital of Galicia, with an archbishop's see, and a university founded in 1532. It was the Brigantium of the ancients. The public squares, and the churches, particularly the metropolitan, are magnificent, and it has a great number of monasteries for both sexes. It is pretended that the body of St. James was buried here; and pilgrims still walk in procession to the church, and visit a wooden image of the saint. The archbishop is one of the richest prelates in Spain. This town is the seat of the military order of St. Jago, or St. James, having eighty-seven commanderies, and a revenue, it is said, of 200,000 golden ducats. Some trade is carried on in wine, fruit, and fish; and manufactures of silk-stockings, hats, paper, and leather. Population about 12,000. It is seated on a peninsula, formed by the rivers Tamba and Ulla, 270 miles north-west of Madrid.

COMPOSTELLA, NEW, a rich town of Mexico in the province of Xalisco, and intendency of Guadalupe, built in 1331. It is situated near the South Sea, 400 miles north-west of Mexico. The soil is barren and the air unhealthy; but there are several mines of silver at St. Peaque, and some excellent tobacco in its neighbourhood.

COMPOTATION, *n. s.* Lat. *compotatio*.
 The act of drinking or tipping together.

Secrecy to words spoke under the rose, only mean,
 in *compotation*, from the ancient custom in symposiack meetings, to wear chaplets of roses.

Brown's Vulgar Errors.

If thou wilt prolong
 Dire *compotation*, forthwith reason quits
 Her empire to confusion and misrule,
 And vain debates; then twenty tongues at once
 Conspire in senseless jargon; nought is heard
 But din and various clamour, and mad rant.

Philips

COMPOUND, *v. a., v. n., adj. & n. s.* } Lat.
COMPOUNDABLE, *adj.* } *compo-*
COMPOUNDER, *n. s.* } *no.* To

mingle many ingredients together in one mass; to form by uniting various parts; to mingle in different positions; to combine; to adjust a difference by some recession from the rigor of claims; to discharge a debt by paying only part. To bargain in the lump; to come to terms by granting something on each side.

Here what? quod I, ' the grete sowne
 (Quod he) ' that rombleth up and downe,
 In Fame's House, full of tidings,
 Bothe of faire speche and of chidings,
 And of false and sothe, *compounded*.
 Herken wel; it is not rowned.

Chaucer's House of Fame.

Therefore, conspiring all together plaine,
 They did their counsels now in one *compound*,
 Where singled forces faile, conioynd may gaine.
 The Blatant Beast, the fittest meanes they found
 To work his utter shame, and thoroughly him con-
 found. *Spenser.*

I would to God all strifes were well *compounded!*
Shakespeare.

Here 's a fellow will help you to-morrow; *compound*
 with him by the year. *Id. Measure for Measure.*
 If there be any discord or suite between any of the
 family, they are *compounded* and appeased.

Bacon's New Atlantis.

Where it and Tigris embrace each other under the
 city of Apamia, there do they agree of a joint and
compounded name, and are called Pisis-Tigris.

Raleigh's History of the World.

O then let me in time *compound*
 And parley with those conquering eyes,
 Ere they have tried the force to wound,
 Ere with their glancing wheels they drive
 In triumph o'er hearts that strive,
 And them that yield but more despise. *Marvell.*

They were, at last, glad to *compound* for his bare
 commitment to the Tower. *Clarendon.*

Pray but for half the virtues of this wife;
Compound for all the rest, with longer life.

Dryden.

But useless all, when he despairing found
 Catullus then did with the winds *compound*.

Id. Juvenal.

The ideas, being each but one single perception,
 are easier got than the more complex ones; and
 therefore are not liable to the uncertainty which at-
 tends those *compound* ones. *Locke.*

Love why none one passion call,
 When 'tis a *compound* of them all;
 Where hot and cold, where sharp and sweet,
 In all their equipages meet. *Swift.*

Those softners, sweetners, *compounders*, and ex-
 pedient-mongers, who shake their heads so strongly.
Id.

We cannot have a single image that did not enter
 through the sight; but we have the power of altering
 and *compounding* those images into all the varieties of
 picture. *Addison's Spectator.*

Those who are his greatest admirers, seem pleased
 with them as beauties; I speak of his *compound* epi-
 theta. *Pope.*

Shall I, ye gods! he cries, my debts *compound?*
Gay.

Compound substances are made up of two or more
 simple substances. *Watts's Logick.*

The value of any object that supplies the wants or
 pleasures of mankind, is *compounded* of its substance
 and its form, of the materials and its manufacture.

Gibbon.

COMPOUND INTEREST, interest upon interest, is
 that which is reckoned not only upon the princi-
 pal, but upon the interest itself; which hereby
 becomes a sort of additional principal. See
INTEREST.

COMPOUND NUMBERS, those which can be
 divided by some other number besides unity,
 without leaving any remainder; such are 18, 20,
 &c. the first being measured by the numbers 2,
 6, or 9; and the second by the numbers 2, 4,
 5, 10.

COMPREHEND, *v. a.* } Lat. *compre-*
COMPREHENSIBLE, *adj.* } *hendo, compre-*
COMPREHENSIBLY, *adv.* } *hensibilis*; Fr.
COMPREHENSION, *n. s.* } *comprehensibile*;
COMPREHENSIVE, *adj.* } Lat. *comprehensio*. To com-
COMPREHENSIVELY, *adv.* } prise; to in-
COMPREHENSIVENESS, *n. s.* } clude; to contain; to imply. It applies parti-
 cularly to the mind; thus too it signifies
 intelligible; conceivable by the understanding.

The power of the mind to admit and contain
 many ideas at once. The noun is used in the
 sense of summary; epitome; compendium; ab-
 stract; abridgement, in which much is comprised.
 In rhetoric it is a trope or figure by which the
 name of a whole is put for a part, or that of a
 part for the whole, or a definite number for an
 indefinite.

' Sir!' quod he, ' sithens firste Frouthe
 Have any maner witte fro youthe,
 Or kindly understandinge
 To *comprehende* in any thinge
 What love was in mine owne wit.

Chaucer's Piers of the Duchesse.

Rome was not better by her Horace taught,
 Than we are here to *comprehend* his thought.

Waller.

In the Old Testament there is a close *comprehension*
 of the New, in the New an open discovery of the
 Old. *Hooker.*

Lest this part of knowledge should seem to any
 not *comprehensible* by axiom, we will set down some
 heads of it. *Bacon.*

It would be ridiculous to grow old in the study of
 every necessary thing, in an art which *comprehends* so
 many several parts. *Dryden's Dufresnoy.*

No other fear himself could *comprehend*,
 Than lest heaven fall ere thither he ascend.
Marvell.

You gentle shepherds, and you snowy sires,
 That sit around, my rugged rhymes attending;
 How may I hope to quit your strong desires,
 In verse uncouth, such wonders *comprehending*.

Fletcher's Purple Island.

So diffusive, so *comprehensive*, so catholic a grace is
 charity, that whatever time is the opportunity of any
 other virtue, that time is the opportunity of charity.

Spratt's Sermons.

You give no proof of decay of your judgment, and
comprehension of all things, within the compass of an
 human understanding. *Dryden.*

The horizon sets the bounds between the enlight-
 ened and dark parts of things, between what is and
 what is not *comprehensible* by us. *Locke.*

His hand unstained, his uncorrupted heart,
His *comprehensive* head; all interests weighed,
All Europe saved, yet Britain not betrayed.

Pope's Epistles.

Compare the beauty and *comprehensiveness* of legends on ancient coins. *Addison on Ancient Medals.*

As when some skillful cook to please each guest,
Would in one mixture *comprehend* a feast,
With due proportion and judicious care,
He fills his dish with different sorts of fare,
Fishes and fowls deliciously unite
To feast at once the taste, the smell, and sight. *Gay.*

'Tis he alone, whose *comprehensive* mind,
From situation, temper, soil, and clime,
Explored a nation's various powers can bind,
And various orders in one form sublime
Of policy. *Beattie.*

Then farewell Horace; whom I hated so,
Not for thy faults but mine; it is a curse
To understand, not feel thy lyric flow,
To *comprehend*, but never love thy verse.

Egmont. Childs Harold.

COMPREHENSION, in English church history, denotes a scheme proposed by Sir Orlando Bridgman in 1667-8, for relaxing the terms of conformity in behalf of Protestant Dissenters, and admitting them into the communion of the church. A bill for this purpose was drawn up by lord chief baron Hale, but disallowed. The attempt was renewed by Tillotson and Stillingfleet in 1674, and the terms were settled to the satisfaction of the non-conformists; but the bishops refused their assent. This scheme was likewise revived again immediately after the Revolution; the king and queen expressed their desire of an union; however the design failed after two attempts, and the act of toleration was obtained.

COMPREHENSION, in metaphysics, is that act of the mind whereby it comprehends or knows any object that is presented to it on all the sides on which it is capable of being apprehended or known.

COMPRESS, v. a. & n. s.	} Lat. <i>compressus, compressio.</i> To force into a narrower compass; to squeeze together. To embrace.
COMPRESSIBILITY, n. s.	
COMPRESSIBLE, adj.	
COMPRESSIBLENESS, n. s.	
COMPRESSION, n. s.	

COMPRESSION, n. s. }
Compressibility is the quality of being compressible; the quality of admitting to be brought by force into a narrow compass; as air may be compressed, but water can by no violence be reduced to less space than it naturally occupies; and compression is the act of bringing the parts of any body more near to each other by violence; the quality of admitting such an effect of force as may compel the body compressed into a narrower space.

Whenever a solid body is pressed, there is an inward tumult in the parts, seeking to deliver themselves from the *compression*; and this is the cause of all violent motion. *Bacon.*

Tears are the effects of the *compression* of the moisture of the brain, upon dilatation of the spirits.

Bacon's Natural History.

There being spiral particles, accounts for the elasticity of air; there being spherical particles, which give free passage to any heterogeneous matter, accounts for air's being *compressible*.

Chaynes's Philosophical Principles.

We tried whether heat would, notwithstanding so forcible a *compression*, dilate it.

Boyle's Spring of the Air.

Her Neptune eyed, with bloom of beauty blest,
And in his cave the yielding nymp^h *comprest*.

Pope's Odyssey.

There was in the island of Io, a young girl *comprest* by a genius, who delighted to associate with the muses. *Pope.*

COMPRINT, v. n. Lat. *comprimere.* To print together; it is commonly taken, in law, for the deceitful printing of another's copy, or book, to the prejudice of the rightful proprietor.

COMPRISE, v. a. Fr. *comprendre, compris.* To contain; to comprehend; to include.

Rome was the whole world, and all the world was Rome,
And if things named their names doo equalize,
When land and sea ye name, then name ye Rome;
And naming Rome, ye land and sea *comprise*. *Spenser.*

Necessity of shortness causeth men to cut off impertinent discourses, and to *comprise* much matter in few words. *Hooker.*

Do they not, under doctrine, comprehend the same that we intend by matters of faith? Do not they, under discipline, *comprise* the regimen of the church? *Id.*

But with this sad news surpris'd,
Soon she let that niceness fall,
And would gladly yfild to all
So it had his stay *comprised*. *Marell.*

The wretched have no country; that dear name *Comprises* home, kind kindred, fostering friends,
Protecting laws, all that binds man to man—
But none of these are mine;—I have no country.—
Maturin's Betram.

COMPROBATION, n. s. Lat. *comprob.* Proof; attestation.

That is only esteem'd a legal testimony, which receives *comprobation* from the mouths of at least two witnesses. *Brown.*

COMPROMISE, n. s. & v. a. } Lat. *compromissio, compromissum.* *Compromissum.* Compromise is a mutual promise of two or more parties at difference, to refer the ending of their controversies to the arbitrement or equity of one or more arbitrators. A compact or bargain, in which some concessions are made on each side. The verb signifies to compound; to adjust a compact by mutual concessions. Shakspeare uses it in the simple sense of to accord, and to agree.

Wars have not wasted it, for warred he hath not,
But basely yielded, upon *compromises*,
That which his ancestors atchieved with blows. *Shakspeare. Richard II.*

Laban and himself were *compromised*,
That all the yearlings, which were streaked and pied,
Should fall as Jacob's hire. *Id. Merchant of Venice.*

COMPROVINCIAL, n. s. From *con* and *provincial.* Belonging to the same province.

At the consecration of an archbishop, all his *comprovincials* ought to give their attendance.

Ayliffe's Paragon.

COMPT, n. s. & v. a.	} Lat. <i>computus</i> ; Fr. <i>compte.</i> Account; computation; reckoning. The verb is now spelt <i>count</i> , which see The adjective is employed in the sense of accountable;
COMPTER, n. s.	
COMPTIBLE, adj.	

responsible; ready to give account; subject; submissive.

Good beauties, let me sustain my scorn; I am very amiable even to the least sinister usage. *Shakespeare.*

Your servants ever
Have theirs, themselves, and what is theirs, in *compt*,
To make their audit at your highness' pleasure,
Still to return your own. *Id. King John.*

Disdain not, Snow! my humble verse to hear,
Stick thy black pen awhile behind thy ear:
Whether thy *compter* shine with sums untold,
And thy wide-grasping hand grew black with gold.

Gay.

COMPTON (Henry); bishop of London, was the youngest son of Spencer earl of Northampton, and born in 1632. After the Restoration he became cornet of a regiment of horse; but soon after, quitting the army, was made bishop of Oxford in 1674; and in 1675 bishop of London. He was entrusted with the education of the two princesses Mary and Anne, whom he afterwards married to the princes of Orange and Denmark; and their firmness in the protestant religion was in a great measure owing to their tutor, to whom, when popery began to prevail at court, it was imputed as an unpardonable crime. He was suspended from his ecclesiastical functions by James II. but restored again on the prince of Orange's invasion. He performed the ceremony of the coronation of that prince; was appointed one of the commissioners for revising the liturgy; and labored with much zeal to reconcile dissenters to the church. His spirit of moderation made him unpopular with the clergy, and in all probability checked his further promotion. He died in 1713 having published a Treatise on the Communion; Seven Letters on Religious Subjects, and a Translation of the Jesuits' Intrigues.

COMPTONITE. A new mineral found in ejected masses on Mount Vesuvius. It occurs crystallised, in oblique four-sided prisms, truncated. The angles of the oblique prism are probably 90° 51' and 88° 9'. Transparent, or semi-transparent. Gelatinises with acids, and it is sometimes accompanied with acicular arragonite. It was first brought to this country by lord Compton, in 1818.

COMPTRÖLL, v. a. } This word is writ-
COMPTRÖLLEB, n. s. } ten by some authors,
COMPTRÖLLERSHIP, n. s. } who did not attend to the etymology, for control; and some of its derivatives are written in the same manner. To control; to over-rule; to oppose. The noun signifies director; supervisor; superior intendant; governor.

This night he makes a supper, and a great one,
To many lords and ladies:
I was spoke to, with Sir Henry Guilford,
This night to be *comptrollers*. *Shakespeare. Henry VIII.*

The gayle for stannery-causes is annexed to the *comptrollership*. *Carew's Survey of Cornwall.*

The *comptrollers* of vulgar opinions pretend to find out such a similitude in some kind of baboons.

Temple.

My fates permit me not from hence to fly;
Nor he, the great *comptroller* of the sky.

Dryden's Æneid.

COMPULSATORY, adj. } Lat. *compulsator*.
COMPULSATIVELY, adv. } Having the force of compelling; co-active; with force; by restraint.

Which is no other,
But to recover from us by strong hand,
And terms *compulsatory*, those foresaid lands
So by his father lost. *Shakespeare. Hamlet.*

COMPU'LSION, n. s. Lat. *compulsio*. The act of compelling to something. Force; violence of the agent; the state of being compelled; violence suffered.

Bound unto me; but not with such hard bands
Of strong *compulsion* and straight violence
As now in miserable state he stands;
But with sweet love and sure benevolence,
Voide of malicious mind or foul offence. *Spenser.*

Such sweet *compulsion* doth in muneck lie,
To lull the daughters of necessity. *Milton.*

Compulsion thus transported! *Id. Paradise Lost.*

When the fierce foe hung on our broken rear,
With what *compulsion* and laborious fight
We sunk thus low. *Id.*

Compulsion is in an agent capable of volition, when the beginning or continuation of any action is contrary to the preference of his mind. *Locke.*

COMPU'LSIVE, adj. } Fr. *compulser*; Lat.
COMPU'LSIVELY, adv. } *compulsus*. Having the
COMPEU'LSIVENESS, n. s. } power to compel; forcible.

The Danube, vast and deep,
Supreme of rivers! to the frightful brink,
Urged by *compulsive* arms, soon as they reached,
New terror chilled their veins. *Phillips.*

The clergy would be glad to recover their dues by a more short and *compulsive* method. *Swift.*

COMPULSORY, adj. } Fr. *compulsoire*.
COMPULSORILY, adv. } Having the power of necessitating or compelling.

To say that the better deservier hath such right to govern, as he may *compulsorily* bring under the less worthy, is idle. *Bacon.*

He ereth in this, to think that actions, proceeding from fear, are properly *compulsory* actions; which, in truth, are not only voluntary, but free actions; neither compelled, nor so much as physically necessitated. *Bramhall against Hobbes.*

Kindly it would be taken to comply with a patent, although not *compulsory*. *Swift.*

COMPUNCTION, n. s. } Fr. *componction*,
COMPUNCTIOUS, adj. } from Lat. *pungo*,
COMPUNCTIVE, adj. } *punctum*, to prick.
The power of pricking; stimulation; irritation. Applied to the mind, it signifies the throbbings of remorse.

Stop up the access and passage to remorse,
That no *compassionate* visitings of nature
Shake my fell purpose. *Shakespeare. Macbeth.*

This is that acid and piercing spirit, which, with such activity and *compassion*, invadeth the brains and nostrils of those that receive it.

Brown's Vulgar Errors.

He acknowledged his disloyalty to the king, with expressions of great *compassion*. *Clarendon.*

COMPURGATION, n. s. } Lat. *compur-*
COMPURGATOR, n. s. } *gatio*. The practice of justifying one man's veracity by the testimony of another. *Compurgator* is the agent who yields such testimony.

The next query, or chalk-pit, will give abundant attestation: these are so obvious, that I need not be far to seek for a *compurgator*.

Woodward's Natural History.

COMPUTE, *v. a. & n. s.* } Lat. *computo*. To
 COMPUTABLE, *adj.* } reckon; to calcu-
 COMPUTATION, *n. s.* } late; to number;
 COMPUTER, *n. s.* } to count. The deri-
 COMPUTIST. } vatives have this ex-
 clusive application.

My princely father
 Then, by just computation of the time,
 Found that the issue was not his.

Shakspeare. Richard III.

Though there were a fatality in this year, yet divers
 were out in their account, aberring several ways from
 the true and just compute; and calling that one year
 which perhaps might be another.

Bronne's Vulgar Errors.

If, instead of twenty-four letters, there were twenty-
 four millions, as those twenty-four millions are a finite
 number, so would all combinations thereof be finite,
 though not easily computable by arithmetic.

Hale's Origin of Mankind.

And, as it works, the industrious bee
 Computes its time as well as we.

Marvell.

I have known some such ill computers, as to imagine
 the many millions in stocks so much real wealth.

Swift.

We pass for women of fifty: many additional years
 are thrown into female computations of this nature.

Addison's Guardian.

Alas! not dazzled with their noon-tide ray,
 Compute the morn and evening to the day;
 The whole amount of that enormous fame,
 A tale that blends their glory with their shame. *Pope.*
 The treasurer was a wise man, and a strict compu-
 tist. *Wotton.*

Did man compute
 Existence by enjoyment, and count o'er
 Such hours 'gaint years of life,—say, would he name
 threescore. *Byron. Childs Harold.*

COMRADE, *n. s.* Fr. *camerade*, from *camera*,
 a chamber; one that lodges in the same chamber,
contubernio fruitur. One who dwells in the
 same house or chamber. A companion; a part-
 ner in any labor or danger.

Rather I abjure all roofs, and chuse
 To be a comrade with the wolf and owl.

Shakspeare. King Lear.

He permitted them
 To put out both thine eyes, and fettered send thee
 Into the common prison, there to grind
 Among the slaves and asses, thy comrades,
 As good for nothing else. *Milton's Agonistes.*

A footman, being newly married, desired his com-
 rade to tell him freely what the town said of it. *Swift.*

His back was to the dashing spray—

Behind but close—his comrades lay.—

Byron. Bride of Abydos.

And then into a hoarser murmur grew,
 An ominous, and wild and desperate sound,
 And when his comrades thought each other knew,
 'Twas but his own, suppressed till now he found,
 And out they spake of lots of flesh and blood,
 And who should die to be his fellow's food.

Id. Don Juan.

CON. A Latin inseparable preposition, which,
 at the beginning of words, signifies union or as-
 sociation; as *concourse*, a running together; to
convene, to come together. Some authors omit
 the final consonant, in various instances, as co-
 temporary, instead of contemporary, but this
 practice is not to be recommended.

CON. A cant abbreviation of the Latin *contra*,
 against. Thus abridged it means the negative
 side of a question; and is always used in con-
 junction with the word *pro*.

Of many knotty points they spoke,
 And *pro* and *con* by turns they took. *Prior.*

CON, *v. a.* } Goth. *cunnan*; Swed. *kunna*;
 CO'NNER, *n.* } Ang.-Sax. *cennan*, *cunnan*. To
 CO'NNING, *n.* } have a knowledge of; to per-
 ceive; to study; to commit to memory; to learn;
 to look over. The first of the nouns is seldom, if
 ever used, but in the compound, an ale-counner.
 Conning which, as a noun, signifies knowledge,
 ability, is obsolete. Spenser says, 'Yet as I
 conne, my conning I will strain.' Shakspeare
 employs the phrase to con thanks, simply to ex-
 press, to thank. 'I con him no thanks for't in
 the nature he delivers it.' It is thus exactly
 equivalent to the French phrase, *savoir gré*. See
 COND.

And saide, Sire Knight, here forth no lith no way,
 Tell me what that ye seken by your fay,
 Peraventure it may the better be,
 These olde folk *con* mochel thing, quod she.
Chaucer. Cant. Tales.

Now certes I woldon my diligence
 To *conne* it all or Cristemasse he went. *Id.*

Ah! Cuddy, then quoth Colin, thou's a fon,
 That hast not seen least part of Nature's work:
 Much more there is unken'd than thou doest *kon*.

Spenser. Colin Clout's come home again.

Each rowme she sought, but them all empty fond;
 That all were fled for feare, but whether nether *hond*.

Id. Faerie Queens.

Pretty answers! have you not been acquainted with
 goldsmiths wives, and *conned* them out of rings?

Shakspeare.

Our understanding cannot in this body arrive so
 clearly to the knowledge of God, and things invisible,
 as by orderly *conning* over the visible and inferior
 creatures. *Milton.*

All this while John had *conned* over such a cata-
 logue of hard words, as were enough to conjure up
 the devil. *Arbutnot.*

My passions, when once lighted up, rag'd like so
 many devils, till they got vent in rhyme; and then the
conning over my verses, like a spell, soothed all into
 quiet. *Burns.*

CONARION, the pineal gland.
 CONATUS, a term frequently used in philo-
 sophy and mathematics, defined by some to be
 a quantity of motion not capable of being ex-
 pressed by any time or length; as the *conatus*
recedendi ab axemotus, is the endeavour which a
 body, moved circularly, makes to recede, or fly
 off from the centre of its motions.

CONAWANGO, or CONWONGA, a river of the
 United States, which rises in New York, and runs
 into the Alleghany on the north side.

CONCA (Sir Sebastian), a celebrated histo-
 rical and portrait painter, born at Gaeta in 1679.
 He was a disciple of the famous Francis Soli-
 mena; who employed him to sketch after his
 designs; and afterwards, by painting small por-
 traits at a low price, he obtained a considerable
 fortune. By this means also he acquired great
 freedom of hand in pencilling and coloring.
 His great patron was cardinal Ottoboni, who in-
 troduced him to pope Clement XI., for whom he

executed the picture of Jeremiah, in the church of St. John de Lateran, with universal applause. This pope, in a general assembly of the academicians of St. Luke, conferred on him the order of knighthood. Almost all the churches and chapels of Italy are enriched with his compositions. He was earnestly invited by Philip V. of Spain to visit his court, but could not be prevailed on to leave Rome. He painted two admirable pictures for the king of Poland, with figures as large as life; the one representing Alexander presenting Bucephalus to Philip, the other Alexander's marriage with Roxana. In 1757 Philip V. of Spain ennobled him. He was then seventy-eight, and died in 1761, aged eighty-two.

CONCAMERATE, *v. a.* } *Lat. concamero* ;
CONCAMERATION, *n. s.* } *Gr. καταμα.*
 To arch or vault over; to bend over in a concave form. The noun signifies an arch; a vault.

Of the upper beak, an inch and a half consisteth of one *concamerated* bone, bended downwards, and toothed as the other. *Grew's Museum.*

What a romance is the story of those impossible *concamerations*, and feigned rotations of solid orbs!

Glanville's Sceptis.

CONCAN, a district of southern India, on the west coast of Hindostan, in the province of Bejapore. It is separated from the rest of the continent by the western Ghauts. The country declines gradually from the mountains towards the sea, and is intersected by a number of small streams. The coast is broken into a number of small bays and harbours; and, as the land and sea breezes blow alternately on and from the coast, vessels steering along it are obliged to keep within sight of land. When the Moguls seized Hindostan they found this coast infested with pirates, and fitted out a fleet to protect their vessels. The Mahrattas armed against the Moguls, ravaged their possessions, and fitted out a fleet to protect the pirates. On this Conajee Angria, governor of Severndroog, one of the best fortresses on the coast, formed an independent state, and in a short time extended his dominions forty leagues along the coast, and six towards the mountains. His successors took the name of Angria, and made peace with the Mahrattas, on paying an annual tribute. They continued to make depredations on the coast, and to seize all vessels that passed that way, till 1756, when their fleet was destroyed, and the strong fort of Gheria, where the chief resided, was taken by admiral Watson and colonel Clive. The whole country, with the exception of Bancote, was now restored to the Mahrattas. The principal towns are Choul, Bancote or Fort Victoria, Dabul or Severndroog, Gheria, Tamana, and Rajpore. Concan lies between 16° and 19° N. lat.

CONCARNEAU, a sea-port town of France, in the department of Finisterre. It is ten miles S. S. E. of Quimper, and has a castle. Inhabitants, who live by the pilchard fishery, about 2000.

CONCATENATE, *v. a.* } *Old Fr. concathe-*
CONCATENATION, *n. s.* } *nation*; from *Lat. catena*, a chain. The old English spelling was

identical with the French. To link together; to connect in a successive order. The noun signifies a series of links; an unbroken succession.

If Chapman affected the reputation of rendering line for line, the specious expedient of chusing a protracted measure, which *concatenated* two lines together, undoubtedly favoured his usual propensity to periphrasis. *Warton. Hist. Eng. Poetry.*

The stoicks affirmed a fatal unchangeable *concatenation* of causes reaching even to the elicit acts of man's will. *South.*

CONCAVE, *v., n. s. & adj.* } *Fr. concave* ;
CONCAVATION, *n. s.* } *Sp. and Ital.*
CONCAVENESS, *n. s.* } *concavo* ; *Lat.*
CONCAVITY, *n. s.* } *concavus*. The
CONCAVOUS, *adj.* } interior; the hol-
CONCAVOUSLY, *adv.* } low of any spheri-
 cal, spheroidal, or elliptical body, as of a bowl, an arch, or an egg-shell, is concave; the word is opposed to convex, which denotes the exterior of such a body. The derivative words, of course, follow the meaning of the primary. We use the word hollow as synonymous with deceitful; and Shakspeare uses the word concave in the same sense.

Have you not made an universal shout,
 That Tyber trembled underneath his banks,
 To hear the replication of your sounds
 Made in his *concave* shores?
Shakspeare. Julius Cæsar.
 For his verity in love, I do think him as *concave* as a covered goblet, or a worm-eaten nut.
Id. As You Like It.
 The dolphin that carrieth Arion is *concavously* inverted, and hath its spine depressed.
Browne's Vulgar Errors.

At which the universal host sent up
 A shout that tore hell's *concave*.
Milton's Paradise Lost.

Niches that contain figures of white marble should not be coloured in their *concavity* too black. *Wotton.*

These great fragments falling hollow, inclosed under their *concave* surface a great deal of air.
Burnet's Theory.

Serene, though awful, on her brow the light
 Of heavenly wisdom shone: nor roved her eyes,
 Save to the shadowy cliff's majestic height,
 Or the blue *concave* of the' involving skies. *Beattie.*

Into the western bay, *concealed* by vast mountains,
 western winds only can blow. *Anne Seward.*

So on the shoreless air the intrepid Gaul
 Launched the vast *concave* of his buoyant ball.
Darwin.

Where lighter gases, circumfused on high,
 Form the vast *concave* of etherial sky. *Id.*

CONCAVO-CONCAVE, *adj.* Concave or hollow on both sides.

CONCAVO-CONVEX, *adj.* From concave and convex. Concave one way and convex the other.

I procured another *concavo-concave* plate of glass, ground on both sides to the same sphere with the former plate. *Newton.*

A *concavo-concave* pentangular plate, part of a shell that belongs to the entrochus. *Woodward on Fossils.*

CONCAUSE. From con and cause. A cause which co-operates with another.

A *concave* or instrument. *Cudworth.*

CONCEAL, *v. a.* } - Fr. *celer*; Lat. *concelo*. To keep
CONCEALABLE, *adj.* } hidden, secret, undi-
CONCEALEDLY, *adv.* } vulgued; to secrete
CONCEALEDNESS, *n. s.* } from search; to dis-
CONCEALER, *n. s.* } semble. **Conceal-**
CONCEALING, *n. s.* } ment is the act of
CONCEALMENT, *n. s.* } hiding, of keeping secret; the state of being
 hidden; the place wherein a person or thing is
 concealed; a place of retirement or shelter.

I thither went, where I did long *conceal*
 Myself, till that the dwarf did me reveal.
Spenser's Faerie Queene.

Thus merely with the garment of a grace
 The naked and *concealed* fiend he covered,
 That the unexperienced gave the tempter place,
 Which like a cherubim above them hovered.

Shakespeare. A Lover's Complaint.
 Come, Catesby, thou art sworn
 As deeply to effect what we intend,
 As closely to *conceal* what we impart.

Id. Richard III.
 She never told her love;
 But let *concealment*, like a worm i' th' bud,
 Feed on her damask cheek.

Id. Twelfth Night.
 He is a worthy gentleman,
 Exceedingly well read, and profited
 In strange *concealments*. *Id. Henry IV.*

Returning a lye unto his Maker, and presuming to
 put off the Searcher of Hearts, he denied the omnis-
 ciency of God, whereunto there is nothing *concealable*.
Browne's Vulgar Errors.

They were to undergo the penalty of forgery, and
 the *concealer* of the crime was equally guilty.
Clarendon.

There is but one way I know of conversing safely
 with all men, that is, not by *concealing* what we say
 or do, but by saying or doing nothing that deserves to
 be *concealed*. *Pope.*

A person of great abilities is zealous for the good
 of mankind, and as solicitous for the *concealment*
 as the performance of illustrious actions.
Addison's Freeholder.

The cleft tree
 Offers its kind *concealment* to a few
 Their food its insects, and its moss their nests.
Thomson.

Quick, blushing as abashed, she half withdrew;
 One hand a bough of flowering myrtle waved,
 One graceful spread, where, scarce *concealed* from
 view,

Soft through the parting robe her bosom heaved.
Beattie.

That hour arrived, his work begins;
 He spins and weaves, and weaves and spins;
 Till circle upon circle wound
 Careless around him and around,
Conceals him with a veil, though slight,
 Impervious to the keenest sight. *Cowper.*

But now beneath this walnut shade,
 He finds his long last home,
 And waits, in snug *concealment* laid,
 Till gentler Puss shall come. *Id.*

The London ladies were always too handsome for
 me; then they are so defended; such a circumvallation
 of hoop, with a breast-work of whalebone, that
 would turn a pistol-bullet, much less Cupid's arrows,
 then turret on turret on top, with a store of *concealed*
 weapons, under pretence of black pins,—and above
 all, a standard of feathers that would do honour to a
 knight of the bath. Upon my conscience, I could as
 soon embrace an Amazon, armed at all points.
Sheridan.

Her head hung down, and her long hair, in steep-
 ing,
Concealed her features better than a veil:
 And one head o'er the ottoman lay drooping,
 White, waxen, and as alabaster pale.
Byron's Don Juan.

CONCEDE, *v. a.* } Fr. and Span. *con-*
CONCESSION, *n. s.* } *ceder*; Ital. and Lat.
CONCESSIONARY, *adj.* } *concedere*, from Lat.
CONCESSIVE, *adj.* } *con* and *cedere*. To
CONCESSIVELY, *adv.* } *concede* is to give up;
 to admit; to allow without dispute; to relin-
 quish; to resign. **Concession** is the act of
 giving up; the thing so given up. **Conces-**
sionary signifies that which is granted not as a
 right, but as an indulgence. **Concessive**, that
 which implies concession; **concessively**, by way
 of concession, granting the premises.

By expurgatory animadversions we might strike out
 great numbers of hidden qualities; and, having once
 a *conceded* list, we might with more safety attempt
 their reasons. *Browne.*

Some have written rhetorically and *concessively*;
 not controverting, but assuming the question, which,
 taken as granted, advantaged the illation. *Id.*

I still counted myself undiminished by my largest
concessions, if by them I might gain the love of my
 people. *King Charles.*

The *concession* of these characters was in a parlia-
 mentary way. *Hale's Common Law of England.*

When a lover becomes satisfied by small compli-
 ances, without further pursuits, then expect to find
 popular assemblies content with small *concessions*.
Swift.

The atheist, if you *concede* to him that fortune may
 be an agent, doth presume himself safe and invulner-
 able. *Bentley.*

Hypothetical, conditional, *concessive*, and exceptive
 conjunctions, seem in general to require a subjunctive
 mood after them. *Lowth's Grammar.*

I wished you to *concede* to America, at a time when
 she prayed *concession* at our feet. Just as much was
 I an American when I wished parliament to offer
 terms in victory, and not to wait the well chosen hour
 of defeat, for making good by weakness, and by sup-
 plication, a claim of prerogative, preeminence, and
 authority. *Burke.*

CONCEIT, *v. n. & n. s.* } Fr. *concept*; Sp.
CONCEITED, *adj.* } *concepto*; Ital. *con-*
CONCEITEDLY, *adv.* } *cestto*; Lat. *conceptus*.
CONCEITEDNESS, *n. s.* } Both the verb and
CONCEPTIVE, *adj.* } the noun have various
CONCEITLESS, *adj.* } shades of meaning,

some of which are become obsolete. They are
 disused in a good sense, and are now employed
 only as expressive of more or less of censure.
 The noun formerly signified a conception; an
 idea; an image formed by the mind; under-
 standing; quickness of apprehension; a plea-
 sant fancy; gaiety of imagination; acuteness:
 it now generally means a fantastical notion; a
 thought more brilliant than correct; opinionative
 pride; self-sufficiency. The verb and the par-
 ticipial adjective have shared the same fate. To
 be *conceited* once denoted, to be endowed with
 fancy; it is now applied to vain persons, to men
 who, without any good grounds, have lofty ideas
 of their own merit. This word is used with of
 before the object of conceit. *Conceitedly*, is fan-
 tastically; whimsically. *Conceitless*, is stupid

devoid of thought. The phrase, out of conceit with, means to have ceased to have a liking for the thing spoken of; it implies previous regard changed into an opposite feeling.

I shall be found of a quick conceit in judgment, and shall be admired. *Wisdom*, viii. 11.

Seest thou a man wise in his own conceit? There is more hope of a fool than of him.

Proverbs, xxv. 12.

A foolish faune indeed,
That couldst not hold thyself so hidden blest,
But wouldest needs thine owne conceits aread.

Spenser's Faerie Queene.

How often, alas! did her eyes say unto me, that they loved! and yet I, not looking for such a matter, had not my conceits open to understand them. *Sidney*.

The first kind of things appointed by laws humane, containeth whatsoever is good or evil, is notwithstanding more secret than that it can be discerned by every man's present conceit, without some deeper discourse and judgment. *Hooker*.

One of two bad ways you must conceit me,
Either a coward, or a flatterer.

Shakespeare. Julius Cæsar.

I shall not fail to approve the fair conceit
The king hath of you. *Id. Henry VIII*.

I know not how conceits may rob
The treasury of life, when life itself
Yields to the theft. *Id. King Lear*.

His wit is as thick as Tewksbury mustard: there is no more conceits in him than is in a mallet.

Id. Henry IV.

Thinkest thou I am so shallow, so conceitless,
To be seduced by thy flattery.

Id. Two Gentlemen of Verona.

They looked for great matters at their hands, in a cause which they conceited to be for the liberty of the subject. *Bacon*.

He was of countenance amiable, of feature comely, active of body, pleasantly conceited, and sharp of wit. *Kneller*.

Conceitously dress her, and be assigned
By you fit place for every flower and jewel:
Make her for love fit fuel. *Donne*.

The strong, by conceiving themselves weak, are thereby rendered as unactive, and consequently as useless, as if they really were so. *South's Sermons*.

Every man is building a several way, impotently conceited of his own model and his own materials.

Dryden.

Strong conceits, like a new principle, carries all easily with it, when yet above common sense. *Locke*.

Not that I dare assume to myself to have put him out of conceits with it, by having convinced him of the fantasticalness of it. *Tillotson, Preface*.

When men think none worthy esteem, but such as claim under their own pretences, partiality and conceitedness make them give the pre-eminence.

Collier on Pride.

What you write of me, would make me more conceited than what I scribble myself. *Pope*.

Some to conceits alone their works confine,
And glittering thoughts struck out at every line. *Id.*
Mallbranche has an odd conceit,

Prior.

Since by a little studying in learning, and great conceit of himself, he has lost his religion; may he find it again by harder study, under humbler truth.

Beattie.

The conceit of Mr. Hobbes, that in the nature of things there is no distinction between just and unjust, right and wrong; and that in civil society the will of human governors is the sole standard of duty, and

consequently of the law of nature; this conceits, I say we need not stop to examine. *Beattie*.

Philosophy, without his heavenly guide,
May blow up self conceits, and nourish pride,
But, while his province is the reasoning part,
Has still a veil of midnight on his heart. *Cowper*.

Our baritone I almost had forgot,
A pretty lad, but bursting with conceits—
With graceful action, science not a jot,
A voice of no great compass, and not sweet.

Byron's Don Juan.

CONCEIVE, *v. a. & n.* Fr. *concevoir*; Ital. *concepire*; Sp. *concepire*; Lat. *concipere*. To receive into, or form in, the uterus; to form in the mind; to comprehend; to think; to be of opinion that; to have an idea of; to become pregnant. Conceiving is apprehension; understanding. The derivatives do not stand in need of being defined.

I was shapen in iniquity, and in sin did my mother conceive me. *Psalms* li. 5.

Nebuchadnezzar hath conceived a purpose against you. *Jeremiah*.

There is a maner tree, as saith Seint Isidore, that whan men make a fire of the saide tree, and cover the coles of it with ashen, sothly the fire thereof wol last all a yere or more: and right so fareth it of rancour when it is ones conceived in the herte of som men. *Chaucer's Canterbury Tales*.

Sorowes many hath she suffrid trewly
Sith that she first conceived him and bare. *Id.*

What comfort can I wofull wretch conceive!
Or why should ever I henceforth desyre
To see faire heaven's face, and life not leave,
Sith that false traytour did my honour reeve?

Spenser's Faerie Queene.

It were a goodly storie to declare
By what strange accident faire Chrysgone
Conceived these infants. *Id.*

Her sickle hart conceived hasty fyre,
Like sparkes of fire that fall in sclender fiert. *Id.*

From her fayre eyes he took commandment,
And ever by her lookes conceived her intent. *Id.*

The grieved commons
Hardly conceive of me: let it be noised,
That, through our intercession, this revokement
And pardon comes. *Shakespeare. Henry VIII*.

This kiss, if it durst speak,
Would stretch thy spirits up into the air:
Conceives, and fare thee well. *Id. King Lear*.

Cadwal

Strikes life into my speech, and shews much more
His own conceiving. *Id. Cymbeline*.

O what avails me now that honour high,
To have conceived of God! or that salute,
Hail, highly favoured, among women blest!

Milton.

Though hereof prudent symbols and pious allegories
be made by wisor conceivers, yet common heads will
fly unto superstitious applications.

Brown's Vulgar Errors.

This man conceived the duke's death; but what was the motive of that felonious conception, is in the clouds. *Wotton*.

If it were possible to contrive an invention, whereby any conceivable weight may be moved by any conceivable power, with the same quickness, without other instrument, the works of nature would be too much subject to art. *Wilkins*.

The freezing of the words in the air, in the northern climes, is as *conceivable* as this strange union.

Glanville's Scepis.
The beauteous maid, whom he beheld, possessed;
Conceiving as she slept, her fruitful womb
Swelled with the founder of immortal Rome.

Addison.
Conceive of things clearly and distinctly in their own natures; *conceive* of things completely in all their parts; *conceive* of things comprehensively in all their properties and relations; *conceive* of things extensively in all their kinds; *conceive* of things orderly, or in a proper method. *Watts's Logick.*

Faults in the life breed errors in the brain:
And these reciprocally those again.
The mind and conduct mutually imprint
And stamp their image in each other's mint:
Each, sire and dam, of an infernal race,
Begetting and *conceiving* all that's base. *Cowper.*
Nothing can be *conceived* more hard than the heart of a thorough-bred metaphysician. It comes nearer to the cold malignity of a wicked spirit than to the frailty and passion of a man. *Burke.*

Although no man can command his conviction, I have ever considered a deliberate disposition to make proselytes in infidelity as an unaccountable depravity. Whoever attempts to pluck the belief or the prejudice on this subject, style it which he will, from the bosom of one man, woman, or child, commits a brutal outrage, the motive for which I have never been able to trace or *conceive*. *Sheridan.*

CONCELEBRATE. Old Fr. *concelebrer*; Lat. *concelebro*. To praise; to celebrate together.
CONCENT, v. & a. } Ital. and Span.
CONCENTFUL, adj. } *concento*; Lat. *con-*
CONCENTED, part. adj. } *centus*. The verb
CONCENTUAL, adj. } signifies singing together; the noun, a concert of voices; harmony; concord of sounds; and thence, figuratively, being consistent with; being in unison with. *Concentual* denotes harmonious.

All which together song full cherfully
A lay of love's delight with sweet *concent*.

Spenser's Faerie Queene.
Such musicke is wise words with time *concented*.

Id.
It is to be considered, that whatsoever virtue is in numbers, for conducing to *concent* of notes, is rather to be ascribed to the ante-number than to the entire number. *Bacon.*

Reasons borrowed from nature and the school-men, as subservient mediums, carry a music and *concent* to that which God hath said in his word. *Dr. Maine.*

'Tis in *concent* to his own principles, which allow no merit, no intrinsic worth, to accompany one state more than another. *Atterbury.*

Milton, full of these platonick ideas, has here a reference to this consummate or *concentual* song of the ninth sphere. *Warton. Notes on Milton.*

CONCENTRATE, v. a. } Fr. *concentrer*;
CONCENTRATION, n. s. } Lat. *con* and *centrum*; *κεντρον*. To compress into a small compass; to impel from all points towards the centre; the opposite of expanding or dilating. The act of so compressing or impelling.

Spirit of vinegar, *concentrated* and reduced to its greatest strength, will coagulate the serum. *Arbutnot on Aliments.*

All circular bodies that receive a *concentration* of the light, must be shadowed in a circular manner. *Peacham on Drawing.*

The phenomena of chemical explosions cannot be accounted for without the supposition, that some of the bodies employed contain *concentrated* or solid heat combined with them, to which the French chemists have given the name of *calorique*. *Darwin.*

Not that he was not sometimes rash, or so,
But never in his real and serious mood;
Then calm, *concentrated*, and still, and slow,
He lay coiled, like the boa in the wood;

Byron. Don Juan.

A kiss of youth and love,
And beauty, all *concentrating* like rays
Into one focus, kindled from above. *Id.*

CONCENTRE, v. a. & n. } Fr. *concentrer*;
CONCENTRICAL, adj. } Lat. *con* and *centrum*. The verb
CONCENTRICK, adj. } in its active
CONCENTRICALLY, adv. } meaning, is syn-
CONCENTRICKLY, adv. } nonymous with *concentrate*; in its neuter sense it signifies, to tend to a common centre; to have a centre in common with something else. Ben Jonson uses the word *concentric* as a noun, 'we are all *concentricks*.'

If, as in water stirred, more circles be
Produced by one, love such additions take;
Those, like so many spheres, but one heaven make;
For they are all *concentrick* unto thee. *Dennis.*

In the *concentrating* all their precious beams
Of sacred influence! *Milton.*

The bricks having first been formed in a circular mould, and then cut, before their burning, into four quarters or more, the sides afterwards join so closely, and the points *concentre* so exactly, that the pillars appear one intire piece. *Wotton.*

The having a part less to animate, will serve to *concentre* the spirits, and make them more active in the rest. *Decay of Piety.*

If a stone be thrown into stagnating water, the waves excited thereby continue some time to arise in the place where the stone fell into the water, and are propagated from thence into *concentrick* circles upon the surface of the water to great distances. *Newton's Opticks.*

Whatever turns the soul inward on itself, tends to *concentre* its forces, and to fit it for greater and stronger flights of science. By looking into physical causes, our minds are opened and enlarged; and in this pursuit, whether we take or whether we lose our game, the chase is certainly of service. *Burke.*

Whence in bright floods the vital air expands,
And with *concentric* spheres involves the lands. *Darwin.*

Turn to the Virtues—how different the decree!
Formed to connect, to blend, to associate, and to cooperate; bearing the same course, with kindred energies and harmonious sympathy, each perfect in its own lovely sphere, each moving in its wider or more contracted orbit, with different, but *concentrating* powers, guided by the same influence of reason, and endeavouring at the same blessed end—the happiness of the individual, the harmony of the species, and the glory of the Creator. *Sheridan.*

All heaven and earth are still: from the high host
Of stars, to the lulled lake and mountain-coast,
All is *concentrated* in a life intense,
Where not a beam, nor air, nor leaf is lost,
But hath a part of being, and a sense
Of that which is of all Creator and defence.
Byron's Child Harold.

CONCEPTACLE, *n. s.* Old Fr. *conceptacle*; Lat. *conceptaculum*. That in which any thing is contained; a vessel.

There is at this day resident, in that huge *conceptacle*, water enough to effect such a deluge.

Woodward's Natural History, Preface

CONCEPTION, *n. s.* Fr. *conception*; Ital. *concezione*; Span. *concepcion*; Lat. *conceptione*; being received or held within, is the primary idea of the noun.

With reference to the body, it means the act of becoming pregnant. As relating to the intellect, it signifies an idea; notion; purpose; the power of apprehending; the state of being conceived. Dryden uses it in the sense of a conceit, a pointed thought; but this meaning, even if it were ever given to the word by any one else, which is doubtful, is become obsolete. Conception denotes intelligible, fit to be conceived or understood; conceptuous, that which is fertile, ready to conceive; and conceptive, that which has the capability of conceiving.

I will greatly multiply thy sorrow by thy *conception*; in sorrow thou shalt bring forth children.

Genesis, iii. 16.

Her berth was of the wombe of morning dew,
And her *conception* of the ioyous prime.

Spenser's Faerie Queene.

Joy had the like *conception* in our eyes,
And, at that instant, like a babe sprung up.

Shakespeare.

Please your highness, note
His dangerous *conception* in this point:
Not friended by his wish to your high person,
His will is most malignant, and it stretches
Beyond you to your friends.

Id. Henry VIII.

Common mother,
Ensear thy fertile and *conceptuous* womb;
Let it no more bring out to ingrateful man.

Id. Timon.

And as if beasts conceived what reason were,
And that *conception* should distinctly show
They should the name of reasonable bear;
For, without reason, none could reason know.

Davies.

In hot climates, and where the uterine parts exceed in heat, by the coldness of this simple they may be reduced into a *conceptive* constitution.

Broume's Vulgar Errors.

Some of his attributes, and the manifestations thereof, are not only highly delectable to the intellectual faculty, but are more suitable and easily *conceivable* by us, because apparent in his works.

Hale's Origin of Mankind.

As *conceptions* are the images or resemblances of things to the mind within itself, in the like manner are words or names the marks, tokens, or resemblances of those *conceptions* to the minds of them whom we converse with.

South's Sermons.

Our own productions flatter us: it is impossible to be fond of them at the moment of their *conception*.

Dryden's Dufrenoy.

He is too statulent sometimes, and sometimes too dry; many times unequal, and almost always forced; and, besides, is full of *conceptions*, points of epigram, and witticisms; all which are not only below the dignity of heroic verse, but contrary to its nature.

Dryden's Juvenal, Dedication.

Whether they will call those immediate objects of their mind in thinking ideas or no, is perfectly in their own choice. If they dislike that name, they may call

them notions or *conceptions*, or how they please; it matters not, if they use them so as to avoid obscurity and confusion.

Locke.

I have always thought that truth and knowledge, by the ill and over eager management of controversies, lose a great deal of the advantages they might receive from the variety of *conceptions* there is in men's understandings.

Id.

The petty interests of such gentlemen, their low *conceptions* of things, their fears arising from the danger to which the very arduous and critical situation of public affairs may expose their places; their apprehensions from the hazards to which the discontents of a few popular men at elections may expose their seats in parliament; all these causes trouble and confuse the representations which they make to ministers of the real temper of the nation.

Burke.

But in his delicate form—a dream of love,
Shaped by some solitary nymph, whose breast
Longed for a deathless lover from above,
And maddened in that vision—are express
All that ideal beauty ever blest
The mind within its most unearthly mood,
When each *conception* was a heavenly guest.

Byron's Childs Harold.

CONCEPTION, in physiology, the first formation of the embryo, or fetus, in the womb. See ANATOMY, par. 19—30.

CONCEPTION, in logic, the simple apprehension or perception which we have of anything, without proceeding to affirm or deny anything about it. Lord Kames justly distinguishes between conception and perception; making the latter to denote the consciousness of an object when present, or to include the reality of its object; whereas conception expresses the forming an idea of an object whether present or absent, or without any conviction of its reality.

CONCEPTION, a city of South America, called also Penco, is the second city of Chili in rank, and stands on the north side of the Biobio a league from the sea. It was originally built three leagues to the north of its present position, and has been twice destroyed by earthquakes. Talcahuano, the port of the present city, is six miles distant, on the south-west side, of the bay of Conception. This is one of the largest and safest bays on the coast of the Pacific. It is ten miles long from north to south, and nine from east to west. The mouth opens towards the north, and is divided by the island of Quiriquina into two channels: the eastern and safest is two miles broad, and the western about a mile and a half. Both have sufficient depths of water for the largest vessels. There is good anchorage under the south side of the island of Quiriquina, but the best is at the south-west extremity of the bay, opposite the town of Talcahuano. The new city, built in 1763, is said to have once contained 20,000 inhabitants; but the events of the late revolution have desolated it; and Mr. Miers did not consider it to contain above a fourth of that population at the period of his late travel in Chili. Extreme poverty, he says, was the universal appearance of the place: its cathedral, palace, and public buildings, being destroyed, and its trade annihilated.

By this name, as well as that of Penco, the entire province of Puchacal is sometimes called: an extremely fertile district, extending from that

of Rere on the east to the Pacific Ocean, and from the province of Itata south to the Indian territory of Arauco, from which it is separated by the Biobio. 'The bay of Conception, with its secure ports,' says the above writer, 'its vicinity to the city of Conception, formerly the capital of Chili, the convenience of river navigation in the interior, the greater productiveness of soil in the adjacent territory, its climate more congenial to activity and industry, present much greater advantages for commercial traffic than Valparaiso, or any other port or harbour in Chili; and will, no doubt, in time become of the greatest importance.'

CONCEPTION, a town of North America, in New Spain, and in the audience of Guatemala. It is seated near the sea coast, 100 miles west of Porto Bello. Long. 81° 45' W., lat. 10° 0' N.

CONCEPTION, a town of the province and government of Paraguay, situate about ninety miles north of Assumption. Long. 57° 16' W., lat. 23° 23' S.—Also a small place in the island of Itamarca, on the coast of Brasil—a settlement of South America, in New Grenada, in the province of San Juan de los Llanos, on the river Meta—and the name of a number of other minor settlements scattered throughout South America.

CONCEPTION, a bay in the gulf of California, North America.—Also a bay of Chili.

CONCEPTION BAY, a large bay on the east coast of Newfoundland, between Cape St. Francis on the south and Flamorough-head north. It has numerous small harbours on the west side, where are the two settlements Carboniers and Havre de Grace.

CONCEPTION DEL PAO, a town of the province and government of Caraccas, situated near the plains of the Orinoco. It contains a population of about 2300 inhabitants, who are generally in good circumstances. There is good water near the place; but the heat is excessive, and the inundations, occasionally, terrible. Cattle are exported in large numbers by the Guarapiche, or by the Orinoco. It is 125 mile S. S. W. of Barcelona, 165 south-west of Cumana, and eighty-four south-east of Caraccas.

CONCEPTION, IMMACULATE, OF THE HOLY VIRGIN, is a popish festival, held on the 8th of December, and established in honor of the virgin Mary, on the supposition of her having been conceived and born immaculate, i. e. without original sin. The immaculate conception is the great point of controversy between the Scotists and Thomists; the former maintaining, and the latter impugning it. In the three Spanish military orders, of St. James of the sword, Calatrava, and Alacantara, the knights take a vow at their admission, to defend the immaculate conception. This resolution was first taken in 1052. Peter d'Alva has published forty-eight huge volumes in folio on the Mysteries of the Conception.

CONCERN, *v. & n.*
 CONCERNANCE, *n.*
 CONCERNEDLY, *adv.*
 CONCERNEDNESS, *n.*
 CONCERNING, *n. & prep.*
 CONCERNMENT, *n.*

Fr. *concerner* ;
 Ital. *concernere* ;
 Span. *concernir* ;
 low Lat. *concerno*.
 The primary word, and all its derivatives, imply something which excites considerable interest; something which is important in a worldly or moral point of view, whether with

relation to ourselves or to those who are dear to us. To be concerned, is to be anxious; to be much affected; to be sorry for; to participate in. To concern himself, has a condemnatory meaning; it indicates that the person spoken of meddles with that which does not concern him; that he acts intrusively. Concerning, as a preposition, has the meaning of relating to; as a noun, used by Shakspeare and others, it stands for business, affairs of moment. In familiar parlance, an extensive trade or business is called a large concern.

Vouchsafe ye then, whom only it concerns,
 To me those secret causes to display,
 For none but you, or who of you it learns,
 Can rightfully aread so doleful day.

Spenser. The Tears of the Muses.

A poet thrustest into the midst, even where it most concerneth him, and there recurring to the things forepast, and divining of things to come, maketh a pleasing analysis of all.

Id. to Sir W. Raleigh.

Exclude the use of natural reasoning about the sense of Holy Scripture, concerning the articles of our faith; and then, that the Scripture doth concern the articles of our faith, who can assure us? *Hooker.*

Coast Claudio may hear; for what I would speak of concerns him. *Shakspeare.*

I would not

The cause were known to them it most concerns. *Id.*

We shall write to you,

As time and our concerns shall importune. *Id.*

There is not any thing more subject to error, than the true judgment concerning the power and forces of an estate. *Bacon.*

Gracious things

Thou hast revealed; those chiefly which concern Just Abraham, and his seed.

Milton's Paradise Lost.

To mix with thy concerns I desist
 Henceforth, nor too much disapprove my own.

Id. Agonistes.

Sir, 'tis of near concernment, and imports
 No less than the king's life and honour.

Denham's Sophy.

He married a daughter to the earl, without any other approbation of her father, or concernment in it, than suffering him and her to come into his presence.

Clarendon.

They had more positively and concernedly wedded his cause, than they were before understood to have done. *Id.*

Providence, where it loves a nation, concerns itself to own and assert the interest of religion, by blasting the spoilers of religious persons and places.

South's Sermons.

When my concernment takes up no more room or compass than myself, then, so long as I know where to breathe and to exist, I know also where to be happy. *Id.*

Ah, what concerns did both your souls divide!
 Your honour gave us what your love denied.

Dryden.

While they are so eager to destroy the fame of others, their ambition is manifest in their concernments. *Id.*

Being a layman, I ought not to have concerned myself with speculations which belong to the profession. *Id.*

Mysterious secrets of a high concern,
 And weighty truths, solid convincing sense,
 Explained by unaffected eloquence.

Roscommon.

The well educating of their children is so much the duty and the concern of parents, and the welfare and prosperity of the nation so much depends on it, that I would have every one lay it seriously to heart.

Locke.

No doubt Ulysses, who was a prudent man, preached up passive obedience, and exhorted them to a quiet submission, by representing to them of what concernment peace was to mankind.

Id.

This manner of exposing the private concerns of families, and sacrificing the secrets of the dead to the curiosity of the living, is one of these licentious practices, which might well deserve the animadversion of our government.

Addison's Freeholder.

Why all this concern for the poor? We want them not, as the country is now managed: where the plough has no work, one family can do the business of fifty.

Swift.

Propositions which extend only to the present life, are small, compared with those that have influence upon our everlasting concerns.

Watts on the Mind.

Ah, what have I to do with conquering kings, Hands drenched in blood, and breast begirt with steel!

To those whom Nature taught to think and feel, Heroes, alas! are things of small concern.

Beattie.

He sees that this great roundabout,

The world, with all its motley rout,
Church, army, physic, law,
Its customs, and its businesses,
Is no concern at all of his,
And says—what says he?—Caw.

Cowper.

There's no more to be said of Trafalgar,
'Tis with our hero quietly inurn'd;
Because the army's grown more popular,
At which the naval people are concern'd.

Byron's Don Juan.

CONCERT, *v. a., v. n. & n. s.* Fr. *concerter*; Ital. *concertare*; Span. *concertar*; Lat. *concertare*. To form a plan together; to make preparation together for something that is to be done. The noun, as referring to the verb, signifies the act of communicating a design; the conjoint taking of proper measures to accomplish some purpose. In its second sense, the connexion of which with the first is obvious, it means many persons or instruments combined in one performance. See **CONSORT**.

Mark how, already, in his working brain
He forms the well concerted scheme of mischief.

Rowe.

All these discontents, how ruinous soever, have arisen from the want of a due communication and concert.

Swift.

Will any man persuade me that this was not, from the beginning to the end, a concerted affair.

Tatler.

When a number of persons, not acting in concert, having no interest to disguise what is true, or to affirm what is false, and competent judges of what they testify, concur in making the same report, it would be accounted folly to disbelieve them, especially if what they testified were credible in itself.

Beattie.

Whilst men are linked together, they easily and speedily communicate the alarm of any evil design. They are enabled to fathom it with common counsel, and to oppose it with united strength. Whereas, when they lie dispersed, without concert, or order, or discipline, communication is uncertain, counsel difficult, and resistance impracticable.

Burke.

Nature, exerting an unweary power,
Forms, opens, and gives cease to every flower;
Spreads the fresh verdure of the fields, and leads
The dancing Naiads through the dewy meads:

She fills profuse ten thousand little throats
With music, modulating all their notes;
And charms the woodland scenes and wilds unknown
With artless airs and concerts of her own.

Cowper.

CONCERTATION, *n. s.* } Lat. *concertatio*.
CONCERTATIVE, *adj.* } Strife; struggling
with; contention; contentious; prone to quarrel.

I wish to him whatever good himself desires to himself; these concertations between us notwithstanding.

Life of Fermat.

CONCERTO, Ital. *concerto*. A piece of music.

If that be the fashion I never will give
Any grand entertainment as long as I live;
For I'm of opinion, 'tis proper to cheer
The stomach and bowels, as well as the ear.
Nor me did the charming concerto of Abel,
Regale like the muffins I saw on the table.

Anstey.

With wire and catgut he concludes the day,
Quavering and semiquavering care away.
The full concerto swells upon your ear;
All elbows shake. Look in, and you would swear
The Babylonian tyrant with a nod
Had summoned them to serve his golden god.

Cowper.

CONCERTO, a composition for a particular instrument, accompanied by an orchestra, more or less complete, for the purpose of showing off the ability, or rather execution of the performer.

CONCERTATO, signifies a piece of music composed in such a manner, as that all the parts may have their recitativos, be it for two, three or more voices or instruments.

CONCERTO GROSSO, a title given in the sixteenth century to symphonies with a violin principal, and other parts, obligato.

CONCH, *n. s.* } Lat. *concha*; Gr. *κογχη*.
CONCHITE, *n. s.* } Conch is a sea-shell, which
CONCHOID, *n. s.* } is sometimes used as a trumpet. Conchite is a species of petrified shell. Conchoid is the name of a curve, so called from the resemblance to the shell of the same name. See **CONCHOID**.

He furnishes her closet first, and fills
The crowded shelves with rarities of shells:
Adds orient pearls, which from the conchs he drew,
And all the sparkling stones of various hue.

Dryden's Fables.

Nymphs, you adorn, in glossy volutes rolled,
The gaudy conch, with azure, green and gold.

Darwin.

And how, when undecieved, the pair they bore
With sounding conchs and joyous shouts to shore;
How they had gladly lived and calmly died,
And why not also Torquil and his bride?

Byron. The Island.

CONCHA, in zoology, a synonyme of the mytilus and solen.

CONCHITES MARMOR, a name given by the ancients to a species of marble dug near Megara, and remarkable for containing a great number of sea shells, and other marine bodies immersed in it.

CONCHOID, a curve invented by Nicomedes, and much used by the ancient mathematicians in the construction of solid problems; as we learn from the writings of Pappus of Alex-

andria. It is thus constructed: AP and BD,

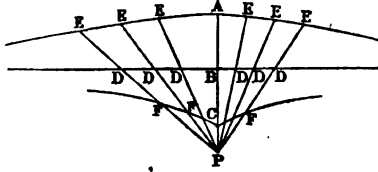

being two straight lines intersecting each other at right angles, from P draw any number of lines P F D E, &c. on which take always $DE = DF = AB$ or BC ; so shall the curve line drawn through the points E, E, E, be the first conchoid, or that of Nicomedes; and the curve drawn through all the other points F, F, F, is called the second conchoid, though they, in reality, be only parts of the same curve, having the same pole P, and four infinite legs, to which the line D B D is a common asymptote. Newton approves of the use of the conchoid for trisecting angles, or finding two mean proportionals, and for constructing solid problems in general; because we ought either to exclude all lines besides the circle and right line out of geometry, or admit them according to the simplicity of their descriptions, in which case the conchoid yields to none except the circle.

CONCHOLOGY, (*κογχη*, a shell, and *λογος*, a discourse), the science which treats of shells, or testaceous animals. Some writers on other branches of natural history, have considered this study as too frivolous to be termed scientific; and certainly it has not been, at present, pursued with that degree of success, nor been exhibited in such close connexion with the necessary pursuits of life, as many other portions of the natural system. Conchologists have arrived at little beyond a lucid arrangement of shells; and the shapes that have been given to them in nature's bounty, or in her vagaries. The peculiarities of the animals inhabiting them, have never been sufficiently known to form the basis of any complete classification either of them, or of their bodies.

'It is not of species only that we speak,' says Mr. Donovan, 'but of whole natural families or genera, not a single species of which has been yet discovered with the animal appertaining, so little are we acquainted with the molluscous orders, or animals inhabiting the shells. Of the shells we daily see in collections few are fished up alive, the far greater number are found on shores, dead or empty. Neither, if it were otherwise, are accurate descriptions of animals, whose parts are not easily seen, or anatomical investigations, which are in many cases necessary, within the capacity of every one. Many of their parts, and their respective functions, are not to be ascertained, except by comparative analogy, and which in itself presents an insurmountable difficulty, or a field of critical enquiry so extensive and complicated that few, even with the ability to pursue it with success, could be prevailed upon to devote that attention to the subject which it requires.'

The best writers on this subject, however, have not disregarded the character and structure of

the animal, as far as they have been known. Linnæus, in particular, whose arrangement of this branch of natural history, modern authors have found it most convenient to follow, includes a description of the animal in all his general distinctions.

We should here, perhaps, at once distinguish between testaceous and crustaceous animals. In England we denominate both shell-fish: but the latter, as the crab, lobster, &c. differ from animals properly testaceous, by possessing a crust or defence upon each separate limb: whereas the former are entirely naked in particular parts, and defended only by one permanent calcareous covering. Mr. Hatchet has pointed out a further distinction in the nature of their respective crusts or coverings, finding those of testaceous animals to consist only of carbonate of lime mixed with gelatinous matter, while in those of crustaceous animals the presence of phosphate of lime was detected. The echinus was the crustaceous body analysed.

Testaceous animals considered as a whole are composed, 1. Of a soft, molluscous body. 2. Of a hard calcareous shell, covering the body, and to which it is attached by certain muscles and ligaments. They are divided in the Linnæan system into univalves, bivalves, and multivalves, embracing thirty-six genera; the first two divisions being, in fact, those of Aristotle, and the last adopted from Dr. J. D. Major, a writer on this subject at the close of the seventeenth century. The genera are thus exhibited in the latest editions of the *Systema Nature*.

DIV. I.—MULTIVALVIA.

Gen. 1. *Chiton*.

2. *Lepas*, acorn shell.

3. *Pholas*, piddock or pierce-stone.

DIV. II.—BIVALVIA.

Gen. 4. *Mya*, Gaper.

5. *Solen*, razor or sheath-shell.

6. *Tellina*, double wedge-shell.

7. *Cardium*, cockle or heart-shell.

8. *Mastra*.

9. *Donax*, Wedge-shell.

10. *Venus*.

11. *Spondylus*, spondyle.

12. *Chama*.

13. *Arca*, ark-shell.

14. *Ostrea*, oyster.

15. *Anomia*, bowl-shell.

16. *Mytilus*, muscle.

17. *Pinna*, Nacæe.

DIV. III.—UNIVALVIA.

i. Spira regulari cochlea.

Gen. 18. *Argonauta*, argonaut or sailor.

19. *Nautilus*.

20. *Comus*, cone-shell.

21. *Cyprea*, gowry or cowry.

22. *Bulla*, dipper.

23. *Voluta*, rhomb-shell.

24. *Buccinum*, whelk.

25. *Strombus*, the screw.

26. *Murex*, the caltrop, or rock-shell.

27. *Trochus*, button-shell.

28. *Turbo*, whorl or wreath.

- 29. *Helix*, snail.
- 30. *Nerita*.
- 31. *Haliotis*, sea-ear.

ii. Absque spira regulari.

- 32. *Patella*, limpet.
- 33. *Dentalium*, tooth-shell.
- 34. *Serpula*, worm-shell.
- 35. *Teredo*.
- 36. *Sabella*.

Of these the inhabitants, as far as they are known, have been thus classed :

Shells.	Animals.		
1. <i>Chiton</i>	Doris		
2. <i>Lepas</i>	Triton		
3. <i>Pholas</i>	} Ascidia		
4. <i>Mya</i>			
5. <i>Solen</i>			
6. <i>Mytilus</i>			
7. <i>Tellena</i>			
8. <i>Cardium</i>	} Tethys		
9. <i>Mactra</i>			
10. <i>Donax</i>			
11. <i>Venus</i>			
12. <i>Spondylus</i>			
13. <i>Chama</i>			
14. <i>Arca</i>			
15. <i>Ostrea</i>			
16. <i>Pinna</i>			
17. <i>Conus</i>			
18. <i>Cypræa</i>	} Order MOLLUSCA.		
19. <i>Bulla</i>			
20. <i>Voluta</i>			
21. <i>Buccinum</i>			
22. <i>Strombus</i>			
23. <i>Murex</i>		} Limax	
24. <i>Trochus</i>			
25. <i>Turbo</i>		} Terebella	
26. <i>Helix</i>			
27. <i>Neritas</i>			
28. <i>Haliotis</i>			
29. <i>Patella</i>			
30. <i>Dentalium</i>			
31. <i>Serpula</i>			
32. <i>Teredo</i>			
33. <i>Sabella</i>			Nereis
34. <i>Argonæuta</i>			Sepia or Clio

The principal arrangements proposed before that of this great writer, were those of Lister (1685) ; Largius (1722) ; Bregnius (1732) ; Tournefort (1742) ; D'Argenville (*id*) ; Adanson (1757) ; to several of which Linnæus, and all modern writers, have been under considerable obligations. The earliest was a noble contribution to the science of natural history, entitled, *Historia sive Synopsis Methodica Conchyliorum, folio*; containing from 1050 to 1067 plates, engraved by Dr. Lister's daughters, and published in different portions from 1685 to 1699. Dr. Lister calls it 'the basis and foundation of all good Conchology.' We do not, however, apprehend that the detail of their systems is sufficiently interesting to modern readers to occupy the large space they would require here.

Since the *Systema Naturæ* has been complete, Mullen, in his *Zoology of Denmark*, has considerably enlarged our acquaintance with the inhabitants of the testacea. Of his system we may offer the following synopsis.

DIV. OF FAM. I. TESTACEA UNIVALVIA.

§ I. *Testacea univalvia, testa pervia.*

Gen. 1. *Echinus*. Testa crustacea, ano verticali, tentaculis simplicibus. 2. *Spatagus*. Testa crustacea, ano infero tentaculis penicillatis. 3. *Dentalium*. Testa calcarea, testa rude, tentaculis nullis.

§ II. *Testacea univalvia, testa patula.*

Gen. 4. *Akera*. Apertura effusa, tentaculis nullis. 5. *Argonæuta*. Apertura profunda, tentaculis binis. 6. *Bulla*. Apertura repanda, tentaculis binis setaceis, colliculo extrinsecus oculatis. 7. *Buccinum*. Apertura ovata, tentaculis binis triangularibus, angulo intrinseco oculatis. 8. *Carychium*. Apertura ovata, tentaculis binis truncatis conspicuis, angulo intrinseco oculatis. 9. *Vertigo*. Apertura subquadrata, tentaculis binis sublinearibus, apice oculatis. 10. *Turbo*. Apertura orbiculari, tentaculis binis setaceis, conspicuis, angulo extrinseco oculatis. 11. *Helix*. Apertura lunari, tentaculis quatuor linearibus, apice oculatis. 12. *Planorbis*. Apertura similunari, tentaculis binis setaceis, angulo intrinseco oculatis. 13. *Ancylus*. Apertura totali, tentaculis binis truncatis, occultis, angulo extrinseco oculatis. 14. *Patella*. Apertura totali, tentaculis binis setaceis, occulto angulo, extrinseco oculatis. 15. *Haliotis*. Apertura repanda, poris pertusa.

§ III. *Testacea univalvia, testa operculata.*

Gen. 16. *Tritonium*. Libera, apertura canaliculata, tentaculis duobus linearibus, angulo extrinseco oculatis. 17. *Trochus*. Libera, apertura sub-tetragona, tentaculis duobus, setaceis, colliculo extrinseco oculatis. 18. *Nerita*. Libera, apertura lunari, tentaculis duobus setaceis, angulo extrinseco oculatis. 19. *Valvata*. Libera, apertura circinnata, tentaculis duobus setaceis, angulo postico oculatis. 20. *Serpula*. Adnata, apertura orbiculari, tentaculis pinnatis.

DIV. OF FAM. II. TESTACEA BIVALVIA.

§ I. *Testacea bivalvia cardine dentata.*

Gen. 1. *Mya*. Testa altera extremitate hianti; cardine dente crasso solitario. 2. *Solen*. Testa utraque extremitate hianti; cardine dente reflexo, sæpe gemino. 3. *Tellina*. Siphone duplici murico; cardine dentibus utrinque tribus alternis. 4. *Cardium*. Siphone duplici, cirrato, pedeque falciformi; cardine dentibus mediis alternis, remotis penetrantibus. 5. *Venus*. Siphone duplici, cirrata, pedeque laminæformi, cardine dentibus tribus approximatis, lateraliqve divergentibus. 6. *Mactra*. Cardine dente medio complicato, adjecte foveola. 7. *Donax*. Cardine dentibus duobus lateraliqve solitario. 8. *Arca*. Cardine dentibus numerosis, alternis, penetrantibus. 9. *Terebratula*. Branchiis circinnatis; cardine dentibus alterius uncinatis, valvula superiore deorsum perforata.

§ II. *Testacea bivalvia, cardine edentulo.*

Gen. 10. *Anomia*. Branchiis simplicibus; valvula inferiore perforata. 11. *Ostrea*. Branchiis simplicibus, pede nullo; cardines fossula cava. 12. *Pecten*. Branchiis cirratis, pede juxta auriculum cardine fossula ovata byssum emittens. 13. *Mytilus*. Siphone duplici brevi; fossula lineare, byssum emittens.

Div. or Fam. III. TESTACEA MULTIVALVIA.

Gen. 1. *Chiton*. Valvulae dorsales, tentacula nulla. 2. *Lepas*. Valvulae erectae, tentacula bipartita. 3. *Pholas*. Valvulae ad cardinem, minores.

Mr. Pennant, in his *British Zoology*, finished in 1777, was the first author who classed the animals of Britain according to the Linnæan arrangement. In the fourth volume of the above work he enumerates 163 species of testacea, of which he furnishes many good figures. To a new edition of this work his son has since added the recently discovered species.

Da Costa's arrangement, differing considerably, from that of Linnæus and displaying great taste and originality, is the only other modern system for which we have room. His work appeared under the title of *British Conchology*, 4to. 1778. It contains seventeen plates, with 123 figures of rare shells, and 'possesses,' says Dr. Turton, 'the rare, and we believe unique, excellence of giving the whole of the synonymies in the words of the respective authors themselves.' He adopts the primary division of univalves, bivalves, and multivalves, but the univalves he divides into sixteen families, which are divided into four orders.

Order I. Simple; consisting of four families. 1. *Patella*. 2. *Haliotis*. 3. *Vermiculi*. 4. *Dentalia*.

Order II. includes but one family, 5. *Polythamia*.

Order III. Revolved. 6. *Turbinata involuta*.

Order IV. Turbinated. 7. *Cymbium*. 8. *Auris cochlea*. 9. *Cylindri*. 10. *Voluta*. 11. *Globosa*. 12. *Cassides*. 13. *Trochi*. 14. *Cochlea*. 15. *Buccini*. 16. *Murex*.

II. The BIVALVES include three orders.

Order I. With unequal valves, and shut close. Fam. 1. *Pecten*. 2. *Spondylus*. 3. *Ostreum*. 4. *Anomia*.

Order II. With equal valves, and shut close, is divided into three sections. Sect. 1. Multarticulate. Fam. 5. *Pectinoides*. 6. *Pectunculi*. 7. *Arca*. Sect. 2. Articulate. Fam. 8. *Pectuncululus*. 9. *Tellina*. 10. *Placenta*. Sect. 3. Inarticulate. Fam. 11. *Margaritifera*. 12. *Musculus*.

Order III. With valves that never shut close. Fam. 13. *Chama*, *gapers*.

III. The MULTIVALVES contain one order. Fam. 14. *Pholas*. 15. *Anatiferæ*. 16. *Balani*.

We have noticed the important work of Dr. Lister. To complete our sketch of British conchology we may further observe that several local descriptions of shells have been given to the public from the commencement of the eighteenth century, which exhibit great clearness of conception and correctness of arrangement.

Among these are the accounts given of testaceous animals in Dr. Wallace's *Description of the Orkney Islands*, published in 1700; by Mr. Plot, in his *History of Staffordshire and Oxfordshire*; by Mr. Morton, in his *Natural History of Northamptonshire*; and Dr. Pulteney, in his *Catalogue of the Shells of Dorsetshire*, published in Hutchinson's *History of that county*.

In 1784 Messrs. Boys and Walker discovered many new and curious minute testacea on the shores of our island, and published a small quarto volume, entitled, *Testacea Mirra rariora nuperime detecta in Arena Littoris Sandvicenſi*: containing several beautiful microscopic species.

In 1795 Berkenhout published his *Synopsis of the Natural History of Great Britain and Ireland*, containing a correct list of the British testacea then known.

Mr. Donovan's work on *British Shells*, five volumes, was completed in the year 1804. It contains short descriptions, with well executed figures, of the different species, excluding most of the microscopic subjects. Dr. Turton characterises it as containing 'beautiful and correct colored portraits of nearly the whole of the British shells.' Of Montagu's *Testacea Britannica*, or a *Natural History of British Shells*, and Supplement, in 3 vols. 4to. with thirty plates, 1803, he says, 'To this laborious and lyncean naturalist, who that of late has studied this elegant department of the Fauna of these islands, is not indebted for the greater part of his knowledge?' In the thirty plates and vignettes are figured about 230 species of the more rare and minute shells, all drawn and engraved under his immediate inspection, from original subjects in his own possession, and generally of his own collection. His cabinet of the natural history of the British islands is now in the British Museum.

A descriptive Catalogue of the British Testacea, by W. G. Maton, M. D. V. P. L. S. &c. and the Rev. Thomas Rackett, M. A. F. L. S. &c. in the eighth volume of the *Linnæan Transactions*; with six colored plates, is a valuable recent addition to the works on British conchology, as well as Mr. Wood's *General Conchology*, 8vo.; and Dr. Turton's own neat little volume, entitled, *A Conchological Dictionary of the British Islands*.

We ought not here, perhaps, to omit all notice of the arrangements that have been proposed by some celebrated modern French naturalists, among which that of Bosc, in his *Histoire Naturelle des Coquilles des Véra et des Crustacés*; and in the *Dictionnaire d' Histoire Naturelle*; and that of Lanark, in the *Système des Animaux sans Vertèbres*, are conspicuous. The last writer includes all the animals of the classes insects and vermes of Linnæus in his system, and divides the mollusca into two orders; the first termed cephalous, from possessing a head, includes the univalves; the second, termed acephalous, from the absence of a head, includes the bivalves. An abridgment of his plan is contained in his *Extrait du Cours de Zoologie*, Paris, 1812.

Having thus placed the principal systems and literary history of this study before the reader, we proceed to offer a short description of the

parts of shells, as they are generally classed: following the Linnæan arrangement,

i. *The parts of multivalves*, as they are generally described, are, 1. The *valves* (valvulæ), which are said to be more or less articulated, as they seem to form one shell. 2. The *ligaments*, which are membranaceous substances, connecting the valves, or lining the cavities. 3. The *base*, which is the extremity, or part opposite to the apex, and is often fixed to other bodies by a tubular fleshy substance, called the peduncle. There are also, 4. *Accessory valves*, sometimes called the operculum, which close the principal entrance, or unite themselves with the primary valves, and act with them.

ii. *The parts of bivalves* are, 1. The *hinge*, upon which as a fulcrum the two sides of the shell move. In some shells this part is smooth, in others the inner surface is furnished with teeth. 2. *Beaks*, or umbones, on each side of the hinge, which are reflex, divaricate, or spiral. 3. The *ligaments*, a strong cartilaginous membrane, which connects the valves. 4. A *groove*, called a *chink*, generally situated towards the beak. 5. The *base* of bivalves, situated in the beak. 6. The *margin* of the shell which occupies the circumference of the valves, and is divided into four parts. The inferior margin, or margin of the hinge; the anterior margin, or margin next to the ligament; the posterior margin, or margin on the side of the beaks opposite the ligament. There is usually in this last a small depression, or lunule. The superior margin occupies a portion of the shell between the ligament and posterior margin. But in some species, the valves being unconnected in part, are said to have the margin gaping. 7. The valves of bivalves are divided into right and left, equal and unequal, equilateral and inequilateral, the shell being supposed to rest on its hinge, with the ligaments behind. The length of a shell is a line drawn from the beaks to the superior margin. When the longitudinal line divides the valves into two equal parts, then the shell is said to be equilateral; if into unequal parts, it is considered inequilateral. 8. The *cicatrix* is a mark on the inside of the valves, where the muscles adhered. 9. The *beard*, *bysus*, a collection of threads, by which some shells adhere to rocks, stones, &c.

iii. *The parts of univalves* are, 1. The *aperture*, or mouth, through which the animal protrudes itself. This is one of the principal distinctions of univalve shells, and differs very much in shape, some being bimarginate, i. e. having a lip with a double margin; bilabiate, i. e. with a double lip; gaping, the lower part of the lip distended; coarctate, i. e. straight; effuse, i. e. having the lips separated by a sinus or gutter; reflex, spreading, resupinate, &c. To the aperture belong, 2. *Labium*, the lip, or the internal margin of the aperture. This is, in respect to position, exterior, anterior, or posterior; in respect to form coarctate, digitate, disengaged, cloven, mucronate, &c. 3. The *canal*, which is the continuation or prolongation of the aperture along the beak, and forms a gutter from its commencement to the extremity. The mouth of univalves also sometimes possesses an operculum, or lid. 4. The *apex*, or summit, in a univalve shell, is

the extreme point of the spire: in bivalves it is the most elevated point of that part of the shell in which the hinge is placed. 5. The *base*, is the extremity or part opposite to the apex. In shells with a rostrum or beak, it implies the lowest part of the beak. In shells without a beak, it is the lowest part, or that which is next the aperture. 6. The *whorl*, is a wreath or convolution of the shell, sometimes bifid, at others, obannelled, keeled, leafy, crowned, imbricate, lamellate, striate, lineate, &c. The contractions of the whorls are called geniculations. 7. The *spire* is a term used to describe all the whorls collectively, except the lower one, which is often called the body. The spire is a prominent feature of the univalve shell, and is either convex, crowned, capitate, or obtuse; attenuated, pointed, flattened, retuse, elevated, or depressed. 8. The *suture of the spire* is a fine spiral line, which separates the wreaths or whorls. 9. The *venter*, or belly, is the most prominent part of the body, generally situated in the vicinity of the lip, and formed by the convexity of the aperture. 10. The *umbilicus* is a circular perforation in the base of the body of many univalves. 11. The *costumella*, or *pillar*, runs through the centre of the shell in the inside, from the base to the apex, in most univalve shells, and appears to be the support of the spire, and to form that part of the shell. It is either abrupt, i. e. truncate at the base; elongated, i. e. so as to project beyond the body; flat; or planted.

For the peculiarities of the inhabitants of shells, as far as they are known, see MOL-LUSCA.

CONCHUCOS, a province of Peru, running along the centre of the Cordilleras. It is bounded on the north by Guamachucos, on the south by Caxatambo, east by Guamiles, and west by Huailas, being of irregular shape, and very various climate. Conchucos produces fruit, grain, &c. and excellent pasture for cattle. Here are also some mines of silver, which were formerly very rich, and some washing places for gold of the standard weight of twenty-three carats.

CONCHUCOS, a river of Peru, running south in the same province, and entering the Amazons.

CONCHYLIA, a general name for all petrified shells, as lympeps, cochleæ, nautili, conchæ, lepadæ, &c.

CONCIATOR, in glass-making, is, for the crystal glass, what the founder is at the green glass-houses. He weighs and proportions the salt on ashes and sand, works them with a strong fire till they run into lumps and become white; and if the metal be too hard, and consequently brittle, he adds salt and ashes, and if too soft, sand; still mixing them to a fit temper, which is only known by the working.

CONCIE'RGE, old Fr. *consierge*; low. Lat. *consergius*. A palace, castle, or house, keeper. The word is used by Buck, Aubrey, and perhaps some other of our old writers; but is become obsolete. In the French language it still maintains its ground.

CONC'LIABLE, old Fr. *conciliabile*. A conventicle; a small assembly. This word is now become obsolete.

Some have sought the truth in the conventicles and *concihables* of heretics and sectaries. *Bacon.*

CONCILIAR, *adj.* } Lat. *concilium*. That
CONCILIARLY, *adv.* } which relates to a council; that which has been decided by a council.

Having been framed by men of primitive simplicity, in free and *conciiliar* debates, without any ambitious regards. *Baker.*

CONCILIATE, *v. a.* } Lat. *concilio*. One
CONCILIATION, *n. s.* } of our etymologists,
CONCILIATING, *n.* } who finds in the Greek
CONCILIATOR, *n.* } the root of almost
CONCILIATORY, *adj.* } every English word,
CONCILIABLE, *adj.* } thus derives and defines conciliate and its derivatives. 'Καλεω, καλεω, voco; to call; unde concilium, concilio; to invite, or call to council; to unite in opinion, affection; also to acquire, to procure, or win favor.' His definition may be admitted, whatever may be thought of his derivation.

To the *conciliation* of sleep, it is required that there be a moderate repletion. *Gregory's Posthuma.*

It was accounted a fiftre, or plants that *conciliate* affection. *Brosens's Vulgar Errors.*

The very same tender, benevolent, feeling, liberal mind, which in the internal relations of life *conciliates* the genuine love of those who see men as they are rendered him an inflexible patriot. *Burke.*

In a great cause I should certainly wish, that my agent should possess *conciliating* qualities; that he should be of a frank, open, and candid disposition, soft in his nature, and of a temper to soften animosities and to win confidence. *Id.*

They would act towards them in the most *conciliatory* manner, and would talk to them in the most gentle and soothing language. *Id.*

You call these men a mob, desperate, dangerous, and ignorant; and seem to think that the only way to quiet the 'Bellua multorum capitum,' is to lop off a few of its superfluous heads. But even a mob may be better reduced to reason by a mixture of *conciliation* and firmness, than by additional irritation and redoubled penalties. *Byron. Speech on the Frame-breaking Bill.*

CONCINNATE, *v. a. & adj.* } Lat. *concin-*
CONCINNITY, *n. s.* } no, *concinni-*
CONCINNOUS, *adj.* } to. *Concin-*
nate, as a verb, means to make fit; as an adjective it signifies neat; trim; fit; compact. *Concinnity* is decency; fitness. *Concinnous*, that which is becoming; agreeable; pleasant. These words, however, are of rare occurrence in modern writers.

There a man would commend in Correggio delicateness, in Parmesano *concinuity*. *Wootton.*

CONCIONATOR, *n. s.* } Lat. *concio*, *con-*
CO'NCINNATORY, *adj.* } *cionarius*. A preacher. That which is used at public assemblies, whether religious or civil.

Their comeliness unbeguiled the vulgar of the old opinion the loyalists had formerly infused into them by their *concionatory* invectives. *Howell.*

CONCINO CONSINI (marshal d'Ancre), of France, a court favorite, who, with his wife Leonora Galigai, accompanied Mary de' Medici, into France in 1600. He rose during the regency of that princess, to become first gentleman of the bed-chamber, governor of Normandy, and marshal of France, without ever having seen a battle.

The French nobility, however, fawned on him, and he administered all the public favors. At length the young king (Louis XIII.), influenced by his favorite Luynes, gave an order for his arrest, and the captain of the guard, Vitry, demanding his sword, as he passing the drawbridge of the Louvre, upon his hesitation, shot him dead. His body, after his funeral, we are told, was dug up by the Parisian mob, and treated with the most brutal indignity; one wretch even tore out the heart, broiled, and ate it! His wife, being brought to trial, and interrogated as to what sorcery she had employed to bewitch the queen? replied, 'That of a strong mind over a weak one.' She was executed in 1617.

CONCISE, *adj.* } Fr. *concis*; Ital. and
CONCISELY, *adv.* } Sp. *conciso*; Lat. *con-*
CONCISENESS, *n. s.* } *cisus*. Short; pithy;
CONCISION, *n. s.* } brief; compressed; broken into short periods; expressed in few words; the opposite of diffuse. *Concision* signifies cutting off; destroying.

Beware of dogs, beware of evil workers, beware of the *concision*. *Philippians* iii. 2.

The *concise* stile, which expresseth not enough, but leaves somewhat to be understood.

Ben Jonson's *Discoveries*.
Giving more scope to Mezentius and Lausus, that version which has more of the majesty of Virgil has less of his *conciensness*. *Dryden.*

Where the author is obscure, enlighten him; where he is too brief and *conciise*, amplify a little, and set his notions in a fairer view. *Watts on the Mind.*

Ulysses here speaks very *conciisely*, and he may seem to break abruptly into the subject.

Brown on the Odyssey.
This book, de Rerum Natura, is *conciise* and methodical, and contains no very contemptible abstract of the physics which were taught in the decline of the Roman empire. *Burke.*

A man, once young, who lived retired
As hermit could have well desired,
His hours of study closed at last,
And finished his *conciise* repast,
Stopped his cruise, replaced his book
Within its customary nook,
And, staff in hand, set forth to share
The sober cordial of sweet air. *Cowper.*

This necessity of generally placing the accusative case after the verb is inconvenient in poetry; though it adds to the *conciensness* and simplicity of our language, as it saves the intervention of a preposition, or of a change of termination. *Darwin.*

CONCITE, *v. a.* } Fr. *conciter*; Lat.
CONCITATION, *n. s.* } *concito*. To stimulate; to urge on; to provoke. The act of stirring up. Both obsolete.

The revelations of heaven are conceived by immediate illumination of the soul; whereas the deceiving spirit, by *conciitation* of humours, produces conceited phantasies. *Brown.*

CONCITIZEN, Fr. *conciitoyen*. Knox and Stirling use this word as a synonyme for fellow-citizen.

CONCLAMATION, Lat. *conclamatio*. A simultaneous shouting, or calling out of many persons.

The Romans used *conclamation*, or a general outcry, set up at equal intervals before the corps, by persons who waited there on purpose. *Greenhill.*

CONCLAMATIO, in antiquity, a shout raised by those present at burning the dead, before they set fire to the funeral pile. The word was also applied to the signal given to the Roman soldiers to decamp, whence the expression *conclamare vasa*; and *conclamare arma*, was a signal for battle. It was likewise used for a practice of calling to a person deceased three times by his name; and, when no reply was returned, they thus expressed his decease, by 'conclamatum est.' Whence the same term was afterwards applied to the cessation of the Roman empire.

CONCLAVE, n. s. } Fr. *conclave*; Ital. **CONCLAVIST**, n. s. } *conclave, conclavi*; Sp. *conclave*; from Lat. *con* and *clavis*; because locked up. The assembly of cardinals to elect a pope; the room in which they are shut up; any private or secret assembly. **Conclavist** is the person who attends a cardinal during his abode in the conclave. See the next article.

I thank the holy *conclave* for their loves;
They have sent me such a man I would have
wished for. *Shakspeare.*

Still they cut their way,
Till to the bottom of hell's palace diving,
They enter Dis' deep *conclave*. *P. Fletcher.*

The great seraphick lords and cherubim
In close recess and secret *conclave* sat. *Milton.*

It was said of a cardinal, by reason of his apparent likelihood to step into St. Peter's chair, that in two *conclaves* he went in pope and came out again cardinal. *South's Sermons.*

Forthwith a *conclave* of the godhead meets,
Where Juno in the shining senate sits. *Garth.*

To the vestry indignant, he then stalked away,
Where churchwardens and sidesmen sat ranged in array,
And so grim did he look that their *conclave* astounded
Thought they saw Hamlet's ghost, or Don Quixote
dismounted. *Huddeford.*

CONCLAVE, the place in which the cardinals meet for the despatch of public business. The conclave is in the pontifical palace of the Vatican, and consists of a suite of grand halls or corridors, with rows of cells formed on each side of equal dimensions, being five feet long and four wide. Two are allotted to each cardinal; one for his eminence, and the other for his officer, called the conclavist, and his valet de chambre. They are all painted green, except those of the cardinals who were created by the deceased pope, whose cells are painted violet color, and the insides are lined with serge of the same color. On the election of a pope, the cardinals, after having heard all the bulls read which relate to the subject, the manner of living in conclave, &c. which they are all sworn to observe, are then kept in close conclave till they have decided upon which cardinal the election has fallen. The conclave is very strictly guarded by troops: neither the cardinals, nor any person shut up in it, are spoken to but at certain hours, even the provisions are examined, lest any letters should be conveyed from the ministers of foreign powers, or others, who might have an interest in influencing the issue of the election.

Vol. VI.

CONCLU'DE, v. a. & v. n. } Fr. *conclure*;
CONCLU'DENCY, n. s. } Ital. *concludere*;
CONCLU'DENT, adj. } Span. *concluir*;
CONCLU'DER, n. s. } Lat. *concludere*;
CONCLU'DINGLY, adv. } from *con* and *cludere*. To shut up;
CONCLU'SIBLE, adj. } to bring to a close;
CONCLU'SION, n. s. } to place beyond
CONCLU'SIONAL, adj. } the reach of further
CONCLU'SIVE, adj. } change; to
CONCLU'SIVELY, adv. } draw to a decisive
CONCLU'SIVENESS, n. s. } point; to comprehend in; to terminate; are the ideas conveyed by this whole class of words. The various shades of meaning will be rendered obvious by the authorities quoted below.

God hath *concluded* them all in unbelief, that he might have mercy upon all. *Romans xi. 32.*

Let us hear the *conclusion* of the whole matter: Fear God and keep his commandments; for this is the whole duty of man. *Eccles. xxii. 13.*

Unto a tent prince and princes
Me thought brought me and my maistres,
And said we werin at full age
There to *conclude* our marriage. *Chaucer.*

For whan that he himself *concluded* had,
Him thought eche other mannes wit so bad,
That impossible it were to reprie
Again his chois: this was his fantasie
Id. Cent. Tales.

And shortly to *concluden*, swiche a place
Was never in erthe in so litel a space. *Id.*

For many times when she woll make
A full gode syllogisme, I drede
That afterward there shall in dede
Folowe an ill *conclusion*.
Id. Romant of the Rose.

Ways of peaceable *conclusion* there are but these, two certain; the one a sentence of judicial decision, given by authority thereto appointed within ourselves; the other, the like kind of sentenco given by a more universal authority. *Hooker.*

The very person of Christ, therefore, for ever and the self-same, was only, touching bodily substance, *concluded* within the grave. *Id.*

They humbly sue unto your excellence,
To have a goodly peace *concluded* of
Between the realms of England and of France.
Shakspeare.

Is it *concluded* he shall be protector?
It is determined, not *concluded* yet;
But so it must be, if the king miscarry.
Id. Richard III.

Her physician tells me,
She has pursued *conclusions* infinite
Of easy ways to die.
Id. Antony and Cleopatra.

The king would never endure that the base multitude should frustrate the authority of the parliament, wherein their votes and consents were *concluded*.

Bacon's Henry VII.
This I speak only to desire Eupolis not to speak peremptorily, or *conclusively*, touching the point of possibility, till they have heard me deduce the means of the execution. *Bacon.*

For why should we the busy soul believe,
When boldly she *concludes* of that and this,
When of herself she can no judgment give,
Nor how, nor whence, nor where, nor what she is.
Davies.

Thus doth the wit, admitting all for true,
Build fond *conclusions* on those idle grounds. *Id.*

I can speak no longer; yet I will strain myself to breathe out this one invocation, which shall be my *conclusion*. *Hewel.*

Judgment concerning things to be known, or the neglect and *concludency* of them, ends in decision. *Hale.*

Consideration of things to be known, of their several weights, *conclusiveness*, or evidence. *Id. Origin of Mankind.*

Though these kind of arguments may seem more obscure, yet, upon a due consideration of them, they are highly consequential and *concludent* to my purpose. *Id.*

Examine whether the opinion you meet with, repugnant to what you were formerly embued with, be *concludingly* demonstrated or not. *Digby.*

The last dictate of the understanding is not always absolute in itself, nor *conclusive* to the will, yet it produces no antecedent nor external necessity. *Bramhall's Answer to Hobbes.*

'Tis as certainly *conclusible* from God's prescience, that they will voluntarily do this, as that they will do it all. *Hammond.*

Those that are not men of art, not knowing the true forms of syllogism, cannot know whether they are made in right and *conclusive* modes and figures. *Locks.*

If the consent of the majority shall not, in reason, be received as the act of the whole, and *conclude* every individual, nothing but the consent of every individual can make any thing to be the act of the whole: but such a consent is next to impossible ever to be had, if we consider the infirmities of health, and avocations of business, which in a number, though much less than that of a commonwealth, will necessarily keep many away from the public assembly. *Id.*

Youth, ere it sees the world, here studies rest; And age, returning thence, *concludes* it best. *Dryden.*

These are my theme, and how the war began, And how *concluded* by the godlike man. *Id. Æneid.*
And all around wore nuptial bonds, the ties Of love's assurance, and a train of lyes, That, made in lust, *conclude* in perjuries. *Id. Fables.*

The providences of God are promiscuously administered in this world; so that no man can *conclude* God's love or hatred to any person, by any thing that befalls him. *Tillotson.*

Can we *conclude* upon Luther's instability as our author has done, because, in a single notion, no way fundamental, an enemy writes that he had some doubts? *Atterbury.*

There is something infamous in the very attempt: the world will *conclude* I had a guilty conscience. *Arbutnot's History of John Bull.*

He granted him both the major and the minor; but denied him the *conclusion*. *Addison's Freeholder.*

I have been reasoning, and, in *conclusion*, have thought it best to return to what fortune hath made my home. *Swift.*

It might furnish matter *conclusive* in argument, and instructive in policy: but with all due submission to high authority, and with all decent deference to superior lights, it does not seem quite clear to a discernment no better than mine, that the premises in that piece conduct irresistibly to the *conclusion*. *Burke.*

Give me the lonely valley,
The dewy eve, and rising moon
Fair beaming, and streaming,
Her silver light the boughs among;
While falling, recalling,
The amorous thrush *concludes* his sang. *Burns.*

Hence he *concludes* that the hot air at the bottom of the Andes becomes temperate by its own rarefaction when it ascends to the city of Quito. *Darwin.*

Calm and alternate storm, moisture and drought, Invigorate by turns the springs of life In all that live, plant, animal, and man, And in *conclusion* mar them. *Cowper.*

His friends, who found he fled the town,
Concluded him a farmer grown;
And called him, in derision peasant,
Laertes, or the new-made peasant. *Sheridan.*

CONCOAGULATE, *v. a.* } Fr. *coaguler*;
CONCOAGULATION, *n. s.* } Lat. *coagulatus*.
To curdle or congeal one thing with another. The coagulating together of different bodies.

The saline parts of those, upon their solution by the rain, may work upon those other substances, formerly *concoagulated* with them. *Boyle's Experiments.*

They do but coagulate themselves, with *concoagulating* with them any water. *Id. History of Firmines.*

CONCOCT, *v. a.* } Lat. *con* and *coquere*
CONCOCTES, *n. s.* } To convert food into nu-
CONCOCTION, *n. s.* } triment by the stomach;
CONCOCTIVE, *adj.* } to perfect or sublime by heat; to bring to maturity or ripeness. Concoction is the act of so doing. Concoctive is that which possesses the power of performing those operations.

The maister cooke was cald *Concoction*,
A carefull man, and full of comely guise. *Sponsor's Faerie Queene.*

The working of purging medicines cometh two or three hours after the medicines taken; for that the stomach first maketh a proof, whether it can *concoct* them. *Bacon.*

The root which continueth ever in the earth, is still *concocted* by the earth; and fruits and grains are half a year in *concocting*, whereas leaves are out and perfect in a month. *Id.*

This hard rolling is between *concoction* and a simple maturation. *Id. Natural History.*

He, though he knew not which soul spake,
Because both meant, both spake the same,
Might thence a new *concoction* take,
And part far purer than he came. *Dennis.*

Asurdly he was a man of a feeble stomach, unable to *concoct* any great fortune, prosperous or adverse. *Hayward.*

Errors in education should be less indulged than any: these, like faults in the first *concoction*, that are never mended in the second or third, carry their afterwards incurrible taint with them through all the parts and stations in life. *Locks.*

The vital functions are performed by general and constant laws; the food is *concocted*, the heart beats, the blood circulates, the lungs play. *Chayne's Philosophical Principles.*

The notions and sentiments of others' judgment, as well as of our own memory, makes our property: it does, as it were, *concoct* our intellectual food, and turns it into a part of ourselves. *Watts on the Mind.*

The small close-lurking minister of fate,
Whose high *concocted* venom through the veins
A rapid lightning darts. *Thomson's Summer.*

Past indiscretion is a venial crime,
And if the youth, unmellowed yet by time,
Bore on his branch, luxuriant then and rude,
Fruits of a blighted side, austere and crude,
Maturer years shall happier stores produce,
And meliorate the well *concocted* juice. *Cowper.*

CONCOLOUR, *adj.* Lat. *concolor*. Of one color; without variety.

In *concolour* animals, and such as are confined unto the same colour, we measure not their beauty thereby; for if a crow or blackbird grow white we account it more pretty.

Browne.

CONCOMITATE, *v. a.*

CONCOMITANT, *n. s. & adj.*

CONCOMITANCE, *n. s.*

CONCOMITANCY, *n. s.*

CONCOMITANTLY, *adv.*

CONCOMITATION, *n. s.*

Lat. *con*, and *comitans*. The verb, which is unusual, signifies to be connected with anything collaterally; to come and go with it. Subsisting in concurrence with another thing, is denoted by concomitance and concomitancy. A concomitant is a person or thing which is collaterally connected with another.

The simple bloody spectation of the lungs, is differentiated from that which *concomitates* a pleurisy.

Harvey on Consumption.

In consumptions, the preternatural concomitants, an universal heat of the body, a torminous diarrhoea, and hot distillations, have all a corrosive quality. *Id.*

The spirit that furthereth the extension or dilatation of bodies, and is ever *concomitant* with porosity and dryness. *Bacon.*

He made him the chief *concomitant* of his heir apparent and only son, in a journey of much adventure. *Wotton.*

The secondary action subsisteth not alone, but in *concomitancy* with the other; so the nostrils are useful for respiration and smelling, but the principal use is smelling. *Browne.*

To argue from a *concomitancy* to a causality, is not infallibly conclusive. *Glassville's Sceptra.*

The other *concomitant* of ingratitude is hard-heartedness, or want of compassion. *South's Sermons.*

It has, therefore, pleased our wise Creator, to annex to several objects, and the ideas which we receive from them, as also to several of our thoughts, a *concomitant* pleasure, and that in several objects, to several degrees; that those faculties which he had endowed us with, might not remain wholly idle and unemployed by us. *Locke.*

And for tobacco, who could bear it?

Filthy *concomitant* of claret!

Prior.

Reproach is a *concomitant* to greatness, as satires and invectives were an essential part of a Roman triumph. *Addison.*

Horror stalks around,

Wild staring, and his sad *concomitant*

Despair, of object look.

Philips.

Where antecedents, *concomitants*, and consequents, causes and effects, signs and things signified, subjects and adjuncts, are necessarily connected with each other, we may infer. *Watts.*

The coloured fluid was carried to the extremities of the leaf by vessels most conspicuous on the upper surface, and there changed into a milky fluid, which is the blood of the plant, and then returned by *concomitant* veins on the under surface. *Darwin.*

CONCORD, *v. n. & n. s.*

CONCORDABLE, *adj.*

CONCORDANT, *n. s. & adj.*

CONCORDANTLY, *adv.*

CONCORDANCE, *n.*

CONCORDANCY, *n.*

CONCORDLY, *adv.*

Fr. *concorde*; Lat. *concordia*, *concors*. Concord, as a verb, signifies to agree, but is not now in common use. The

noun is of perpetual recurrence. It denotes peace; union; acting harmoniously together; suitability; agreement between persons and things; harmonious combination of sounds; the principal grammatical relation of one word to

another, distinct from regimen. The words derived from it do not require definition, with the exception of concordance, and concordate; the former of which, in addition to its obvious sense, has also that of a grammatical concord, and of a book, showing in how many texts of Scripture any word occurs; while concordate means a compact, a convention.

What *concord* hath Christ with Belial?

2 Cor. vi. 15.

Now cometh the suine of hem that maken discord among folke, which is a sin that Crist hateth utterly; and no wonder is, for he died for to make *concord*.

Chaucer's Cant. Tales.

But lovely *concord* and most sacred peace

Doth nourish virtue, and fast friendship breeds;

Weake she makes strong, and strong things doth increase,

Till it the pitch of highest praise exceeds.

Spenser's Faerie Queene.

After three *concordances* learned, let the master read unto him the epistles of Cicero.

Ascham's Schoolmaster.

Had I power, I should

Pour the sweet milk of *concord* into hell,

Uproar the universal peace.

Shakespeare. Macbeth.

The man who hath not music in himself,

Nor is not moved with *concord* of sweet sounds,

Is fit for treason. *Id. Merchant of Venice.*

The richest jewel in all the heavenly treasure,

That ever yet unto the earth was shown,

Is perfect *concord*, the only perfect pleasure

That wretched earth-born men have ever known,

For many hearts it doth compound in one.

Davies.

It appeareth by the *concord* made between Henry and Roderick the Irish king. *Id. On Ireland.*

Unsafe within the wind

Of such commotion; such as, to set forth

Great things by small, if nature's *concord* broke,

Among the constellations war were sprung. *Milton.*

Were every one employed in points *concordant* to

their natures, professions, and arts, commonwealths

would rise up of themselves. *Browne's Vulgar Errors.*

Have these who have writ about declensions, *con-*

corcis, and syntaxes, lost their labour? *Locke.*

Some of you turn over a *concordance*, and there hav-

ing the principal word, introduce as much of the verse

as will serve your turn. *Swift.*

How comes he to number the want of synods in

the Gallican church among the grievances of that

concordate, and as a mark of their slavery, since he

reckons all convocations of the clergy in England to

be useless and dangerous? *Id.*

His abilities, industry, and influence, were employed

without interruption to the last hour of his life, to

give stability to the liberties of his country; security

to its landed property; increase to its commerce; in-

dependence to its public councils; and *concord* to its

empire. *Burke.*

So to the sacred sun in Memnon's fane,

Spontaneous *concorde* quire the matins strain;

Touched by his orient beam, responsive rings

The living lyre, and vibrates all its strings.

Darwin.

So when with light and shade, *concordant* strife¹

Stern Clotho weaves the chequered thread of life,

Hour after hour the growing line extends,

The cradle and the coffin bound its ends. *Id.*

What one fine stimulated sense discerns,

Another sense by imitation learns—

So in the graceful dance the step sublime,

Learns from the ear the *concordance* of time. *Id.*

CONCORD, in grammar, that part of syntax,

or construction, by the rules of which nouns are put in the same gender, number, and case; and verbs in the same number and person with nouns and pronouns. See GRAMMAR.

CONCORD, in music, the relation of two sounds that are always agreeable to the ear, whether applied in succession or consonance.

CONCORD, a large and flourishing post town of Massachusetts, situated on the river Concord, in a healthy and pleasant spot, nearly in the centre of Middlesex county, eighteen miles north-west of Boston, and seventeen east of Lancaster. Its Indian name was Musquetequid; and it owes its present designation to the peaceable manner in which it was obtained from the natives; the first settlers having fairly purchased the spot, before they obtained an act of incorporation. This was on September 3rd, 1635; and they are said never to have had any contest with the Indians. For thirteen years previous to 1791, the average number of deaths was seventeen; and one in four of whom was seventy years old and upwards. The public buildings are very respectable. Over the river are three convenient bridges, one of which is 208 feet long, and eighteen feet wide, supported by twelve piers built after the manner of that over the Charles. This town is famous in the history of the revolution, having been the seat of the provincial congress in 1774, and the spot where the first opposition was made to the British troops on the memorable 19th of April, 1775. The general court frequently held their sessions here, when contagious diseases prevailed in the capital. It is 357 miles north-east of Philadelphia.

CONCORD, a flourishing post town of New Hampshire, is pleasantly situated on the west bank of the Merrimack, in Rockingham county, eight miles above Hookset falls. The legislature have often held their sessions here; and much of the trade of the upper country centers in it. A handsome toll bridge across the Merrimack, connects this town with Pembroke. Its Indian name was Penacook. It is fifty-five miles W. N.W. of Portsmouth, fifty-eight south-west of Dartmouth College, and seventy north from Boston.

CONCORD, FORM OF, in ecclesiastical history, a standard book among the Lutherans, composed at Torgaw, in 1576, and thence called the book of Torgaw. It was reviewed at Burg, by six Lutheran doctors of Germany, the principal of whom was James Andreae. It was first imposed on the Saxons by Augustus, and occasioned great opposition. The dispute was revived in Switzerland in 1718, when the magistrates of Bern published an order for adopting it as the rule of faith; the consequence of which was a contest, that reduced its credit and authority.

CONCORDANCE is a term that has generally been restricted to dictionaries or indexes of the Bible, wherein all the leading words are ranged alphabetically; and the books, chapters, and verses wherein they occur referred to. Cardinal Hugo de St. Charo is said to have employed 500 monks at once in compiling a Latin concordance. There are various concordances in that language; one, in particular, called the Concordance of England, compiled by J. Darling-

ton, of the order of Predicants; another, more accurate, by the Jesuit Zamora. In 1523 Rabbi Mordecai Nathan first published a Hebrew concordance, at Venice; but the best and most useful Hebrew concordance is that of Buxtorf, printed at Basil, in 1632. Calasius has given us concordances of the Hebrew, Latin, and Greek, in two columns: the first, which is Hebrew, is that of Rabbi Mordecai Nathan, verbatim, and according to the order of the books and chapters; in the other column is a Latin interpretation of each passage of scripture quoted by Rabbi Mordecai; this interpretation is Calasius's own; but in the margin he adds that of the LXX. and the Vulgate, when different from his. The work is in four volumes, folio, Rome, 1621.

Dr. John Taylor published, in 1754, a Hebrew concordance, in two volumes, folio, adapted to the English Bible, and disposed after the manner of Buxtorf. The Greek concordances are only for the New Testament; except one by Conrad Kircher, on the old, containing all the Hebrew words in alphabetical order; and underneath all the interpretations of them in the LXX., and, in each interpretation, all the places where they occur in that version. In 1718 Trommius published his Greek concordance for the LXX., at Amsterdam, in two volumes, folio; and Schmidius, improving on a similar work of H. Stephen, has given an excellent Greek concordance for the New Testament, the best edition of which is that of Leipsic, anno 1717. We have several very copious concordances in English, as Newmann's, Butterworth's, &c. but the last, and best esteemed, is that by Alexander Cruden, M. A.

CONCORDANT VERSES, such as have several words in common; but which, by the addition of other words, convey a different meaning. Such are these:

Et canis in silva venatur, et omnia servat.

Et lupus in silva nutritur, et omnia vastat.

CONCORDIA, in ancient geography, a town of Lusitania, on the Tagus, north-west of Trajan's bridge, mentioned by Ptolemy. 2. A town of the Nemetes, in Belgica, on the west side of the Rhine; a Roman fortress, situated between Brocomagus, and Noviomagus; now called Drusenheim. 3. A town of the Veneti, situated at the confluence of the rivers Romatinus Major, and Minor, thirty-one miles west of Aquileia. It was a Roman colony, and surnamed Julia, but destroyed by Attila. It is still called Concordia, and though ruinous is the see of a bishop. It lies in the province of Friuli, and *ci-devant* territories of Venice, ceded to the emperor, by the French, in 1797.

CONCORDIA, in the Roman polytheism, the goddess of concord. She had temples on the declivity of the capitol, in the portico of Livia, and on Mount Palatine. This last was built of brass by Cneius Flavius, on reconciling the senate and people. She was drawn with a cup in her right hand, and in her left a sceptre or cornucopiae. Her symbols were two hands joined, as is seen in coins of Nero and Aurelius Verus: also two serpents twisting about a caduceus.

CONCORPORATE, *v. a. & v. n.* } Lat. *con-*
CONCORPORATION, *n. s.* } and *corpus.*

To unite into one mass or substance. The union thus produced.

When we *concorporate* the sign with the signification, we conjoin the word with the spirit.

Taylor's Worthy Communicants.

Thus we chastise the god of wine
With water that is feminine,
Until the cooler nymph abate
His wrath, and so *concorporate*. *Cleveland.*

Concorporation with the mundane spirit. *More.*
CONCOURSE, *n. s.* Fr. *concourse*; Ital. *concorso*; Span. *concurso*; Lat. *concursum*. Many persons or things congregated together; the congregating of numerous persons or things; the point at which two bodies join or intersect.

Do all the nightly guards,
The city's watches, with the people's fears,
The *concourse* of all good men strike thee nothing?
Ben Jonson.

The coalition of the good frame of the universe was not the product of chance, or fortuitous *concourse* of particles of matter. *Hale's Origin of Mankind.*

The prince with wonder hears, from every part,
The noise and busy *concourse* of the mart.
Dryden's Virgil.

So soon as the upper glass is laid upon the lower, so as to touch it at one end, and to touch the drop at the other end, making with the lower glass an angle of about ten or fifteen minutes; the drop will begin to move towards the *concourse* of the glasses, and will continue to move with an accelerated motion, till it arrives at that *concourse* of the glasses. *Newton.*

But why should I his childish feats display?
Concourse, and noise, and toil, he ever died;
Nor cared to mingle in the clamorous fray
Of squabbling imps. *Beattie.*

CONCRE'ATE, *v. a.* old Fr. *concreer*; Lat. *con* and *creo*. To create simultaneously.

Upon loving God above all, and our neighbour as ourselves, hang all the law and all the gospel. And this, as a rule *concreated* with man, is that which the apostle calls the royal law; which if we fulfil, we do well. *Feltham.*

CONCRE'DIT. Lat. *concredidi*. To entrust with; to confide to the keeping of.

Hath the most celestial and important matters *concredited* to him. *Barrow.*

CONCREMATION. Lat. *concremo*. The burning of several things together.

CONCRETE, *v. a. & n.* Fr. *concret*; Ital. *concrete*; and Sp. *concreto*; Lat. *concretus*. To unite into one mass; to coalesce; to harden into a solid substance. *Concretion* is the act of the *concrete*

power in forming this union; and likewise the mass. *Concrete*, *concrement*, or *concreture*, so formed. In logic, *concrete* is opposed to abstract, and *concretely* to abstractly. *Concrescence* is the act or quality of being *concreted*.

A kind of mutual commutation there is, whereby those *concrete* names, God and man, when we speak of Christ, do take interchangeably one another's room; so that, for truth of speech, it skilleth not whether we say that the son of God hath created the world, and the son of man by his death hath saved it; or else that the son of man did create, and the son of God died to save the world. *Hooker.*

Seeing it is neither a substance perfect, nor *metemphoate*, how any other substance should thence take *conconcrescence*, hath not been taught.

Raleigh's History of the World.

Some plants, upon the top of the sea, are supposed to grow of some *concretion* of slime from the water, where the sea stirreth little.

Bacon's Natural History.

When wood and other bodies petrify, we do not ascribe their induration to cold, but unto salinuous spirit, or *concretive* juices. *Broune's Vulgar Errors.*

That there are in our inferior world divers bodies, that are *concreted* out of others, is beyond all dispute: we see it in the meteors. *Hale's Origin of Mankind.*

There is the cohesion of the matter into a more loose consistency, like clay, and thereby it is prepared to the *concrement* of a pebble or flint. *Id.*

The first *concrete* state, or consistent surface of the chace, must be of the same figure as the last liquid state. *Burnet.*

Sin, considered not abstractedly for the mere act of obliquity, but *concretely*, with such a special dependence of it upon the will as serves to render the agent guilty. *Norris.*

Heat, in general, doth not resolve and attenuate the juices of a human body: for too great heat will produce *concretions*. *Arbutnot on Aliments.*

If gold itself be admitted, as it must be, for a porous *concrete*, the proportion of void to body, in the texture of common air, will be so much the greater. *Bentley's Sermons.*

Concrete terms, while they express the quality do also either express, or imply, or refer to, some subject to which it belongs; as white, round, long, broad, wise, mortal, living, dead: but these are not always noun adjectives, in a grammatical sense; for a knave, a fool, a philosopher, and many other *concretes*, are substantives, as well as knavery, folly, and philosophy, which are the abstract terms that belong to them. *Watts's Logick.*

It is shrunk into the polished littleness of modern elegance and personal accommodation: it has evaporated from the gross *concrete* into an essence and rectified spirit of expense, where you have tuns of ancient pomp in a vial of modern luxury. *Burke.*

The impatient Senses, goaded to contract,
Forge new ideas, changing as they act;
And, in long streams dissevered, or *concrete*
In countless tribes, the fleeting forms repeat.
Darwin.

Many are the opinions both of ancient and modern writers concerning the production of pearls. Mr. Reaumur thinks they are formed like the hard *concretions* in many land animals, as stones of the bladder, gall stones, and bezoar, and hence concludes them to be a disease of the fish. *Id.*

CONCRETE, in natural philosophy and chemistry, signifies a body made up of different principles, or any mixed body: thus soap is a factitious *concrete*, mixed together by art; and anti-mony is a natural *concrete*, or a mixed body compounded in the bowels of the earth.

CONCRE'W. Lat. *concreasco*. To grow entangled. I know of no other authority but Spenser for this word; and he seems to have coined it for the sake of a rhyme. He says, of the squire of prince Arthur, that his locks, which were wont 'to sweat out dainty dew, he let to grow and griesly to *concrew*.'

CONCUBINE, *n. s.*
CONCUBINACY, *n. s.*
CONCUBINATE, *n. s.*
CONCUBINAGE, *n. s.*
CONCUBINARY, *n. s. & adj.* } Fr. *concubine*;
 } Ital. Span. and
 } Lat. *concubina*;
 } from *con* and
 } *cumbere*. A female who lives as a wife with a man, without being married to him. The state of being a concubine.

He wolde suffre for a quart of wine,
 A good felaw to have his *concubine*
 A twelvemonth, and excuse him at the full.
Chaucer. Cant. Tales.

I know I am too mean to be your queen,
 And yet too good to be your *concubine*.
Shakespeare. Henry VI.

When his great friend was suitor to him to pardon an offender, he denied him: afterwards, when a *concubine* of his made the same suit, he granted it to her; and said, Such suits were to be granted to whores.
Bacon.

Or like some strange disguised Messaline,
 Hires a night's lodging of his *concubine*.
Hall.

He caused him to paint one of his *concubines*, Cam-paspe, who had the greatest share in his affection.
Dryden.

The wife, though a bright goddess, thus gives place
 To mortal *concubines* of fresh embrace.
Gracville.

Adultery was punished with death by the ancient heathens: *concubinage* was permitted.
Brooms.

CONCUBINAGE, in the Roman law, was called *licita consuetudo*, an allowed custom. This expression, in the constitutions of the Christian emperors, signifies what we now call a marriage in conscience. Inheritances descended to children, which sprung from such a tolerated cohabitation. This concubinage they looked on as a kind of marriage, and even allowed it several privileges; but it was confined to a single person, and was of perpetual obligation as much as marriage itself. Hottoman observes, that the Roman laws had allowed of concubinage long before Julius Cæsar made that law, whereby every one was allowed to marry as many wives as he pleased. Valentinian allowed every man two. Cujas observes, that the ancient laws allowed a man to espouse, under the title of concubine, persons esteemed unequal to him, on account of the want of some qualities requisite to sustain the full honor of marriage. Though concubinage was beneath marriage, both as to dignity and civil effects; yet concubine was a reputable title, very different from that of mistress among us. The commerce was esteemed so lawful that the concubine might be accused of adultery in the same manner as a wife. This kind of concubinage is still in use in some countries, particularly in Germany, under the title of half marriage, *morgengabic marriage*, or marriage with the left hand; alluding to the manner of its being contracted, viz. by the man's giving the woman his left hand instead of his right. The children are not reputed either legitimate or bastards, but natural children, and capable only of donations. They retain the low rank of the mother; and are on this ground disqualified for inheriting the effects of the father.

CONCULCATE, *v. a.* } Fr. *conculquer*;
CONCULCATION, *n. s.* } Ital. *conculcare*; Sp.

conculcar; Lat. *conculcare*. To tread down; to tread under foot; to lay waste.
Conculcating and trampling under foot whatsoever is named of God.

CONCUPISCENCE, *n. s.* } Fr. *concupis-*
CONCUPISCENT, *adj.* } *cence*; Ital. *con-*
CONCUPISCENTIAL, *adj.* } *cupiscenza*; Sp.
CONCUPISCIBLE, *adj.* } *cupiscentia*;

Lat. *concupiscere*. An eager, earnest desire; a longing for; coveting after; libidinous desire; lechery. *Concupiscible* signifies exciting desire; eager to gain anything.

This *concupiscence*, when it is wrongfully disposed or ordained in man, it maketh him covert by covetise of flesh, fleshly sinne by sight of his eye, as to earthly thinges, and also covetise of highness by pride of herte.
Chaucer. Cant. Tales.

What thinge is the pleasure of swetness,
 And most bitter in final succession!
 Or what thing giveth man occasion
 In tender age to be *concupiscent*?
Chaucer.

Of just Davide by perâite penitence,
 Where rulers may see in a myrrour clear,
 The bytter fruite of false *concupiscence*,
 How Jewry bought Uria's death ful deare.
Scott of Surrey.

We know even secret *concupiscence* to be sin; and are made fearful to offend, though it be but in a wandering cogitation.
Hooker.

He would not, but by gift of my chaate body
 To his *concupiscent* intemperate last,
 Release my brother. *Shakespeare. Measure for Measure*

In our faces the evident signs
 Of foul *concupiscence*; whence evil store,
 Even shame, the last of evils.
Milton's Paradise Lost.

The schools reduce all the passions to these two heads, the *concupiscible* and irascible appetites.
South's Sermons.

What then!—are appetites and lusts laid down
 With the same ease that man puts on his gown?
 Will avarice and *concupiscence* give place,
 Charmed by the sounds—Your Reverence or your
 Grace?
Cowper.

CONCUR, *v. n.* } Fr. *concourir*;
CONCURRENCE, *n. s.* } Ital. *concurrere*;
CONCURRENCY, *n. s.* } Span. *concurrir*;
CONCURRENT, *n. & adj.* } Lat. *concurrere*. The
CONCURRENTLY, *adv.* } meaning which the
CONCURSIONS, *n. s.* } Latin root has, is
 easily to be discovered in all the modern derivatives from it. Conjoint action is always expressed or implied. To concur, therefore, signifies to unite in one point; to agree in opinion or actions; to be in unison with; to be a joint contributor to any effect or event. Concur takes to before the effects to which the agent contributes; and with before the person with whom the agent agrees. The secondary follow closely the sense of the primary words.

It is not evil simply to concur with the heathens, either in opinion or action; and that conformity with them is only then a disgrace, when we follow them in that they do amiss, or generally in that they do without reason.
Hooker.

Their *concurrency* in persuasion, about some material points belonging to the same polity, is not strange.
Id. Preface.

There is no difference between the *concurrent* echo and the iterant, but the quickness or slowness of the return.
Bacon.

I conjoin with these laws the personal presence of the king's son, as a *concurrent* cause of this reformation.
Davies on Ireland.

Struck with these great *concurrences* of things.

Crashaw.

For, without the *concurrent* consent of all these three parts of the legislature, no such law is, or can be made.
Hale.

The *concurrence* of the peers in that fury, can be imputed to the irreverence the judges were in.

Clarendon.

Their affections were known to *concur* with the most desperate counsels.
Id.

To have an orthodox belief, and a true profession, *concurring* with a bad life, is only to deny Christ with a greater solemnity.
South.

To all affairs of importance there are three necessary *concurrences*, without which they can never be dispatched; time, industry, and faculties.

Decay of Piety.

We have no other measure but our own ideas, with the *concurrences* of other probable reasons, to persuade us.
Locke.

Though reason favour them, yet sense can hardly allow them; and, to satisfy, both these must *concur*.
Temple.

All combined

Your beauty, and my impotence of mind;
And his *concurrent* flame, that blew my fire;
For still our kindred souls had one desire.

Dryden's Fables.

When outward causes *concur*, the idle are soonest seized by this infection.
Collier on the Spleen.

Extremes in nature equal good produce,
Extremes in man *concur* to general use.
Pope.

He views our behaviour in every *concurrence* of affairs, and sees us engage in all the possibilities of action.
Addison's Spectator.

Acts which shall be done by the greater part of my executors, shall be as valid and effectual as if all my executors had *concurred* in the same.

Swift's Last Will.

A bishop might have officers, if there was a *concurrency* of jurisdiction between him and the archdeacon.
Ayliffe.

Their omnifarious *concussions*, and combinations, and coalitions.
Bentley.

Governments of all kinds are administered only by men; and great mistakes, tending to inflame these discontents, may *concur*.
Burke.

He far exceeded all other statesmen in the art of drawing together, without the seduction of self-interest, the *concurrences* and co-operation of various dispositions and abilities of men, whom he assimilated to his character and associated in his labours.
Id.

CONCUSS, v. n. } Lat. *concutio*; *con-*
CONCUSSION, n. s. } *cussio*. The verb is of
CONCUSSION, n. s. } rare occurrence, and
CONCUSSIVE, adj. } appears to be now dis-
used. Daniel, the poet, says, 'concusated with uncertainty.' Concussation, which denotes violent agitation, or shaking, is also not frequent. Concussion signifies the act of shaking abruptly and violently; the state of being so shaken. A concussive power is possessed by the agent who performs the act.

It is believed that great ringing of bells, in populous cities, hath dissipated pestilent air; which may be from the *concussion* of the air.

Bacon's Natural History.

There want not instances of such an universal *concussion* of the whole globe, as must needs imply an agitation of the whole abyss.

Woodward's Natural History.

The strong *concussion* of the heaving tide
Rolled back the vessel to the island's side.

Pope's Odyssey.

The vast structure of superstition and tyranny, which had been for ages in rearing, and which was combined with the interest of the great and of the many; which was moulded into the laws, the manners, and civil institutions of nations, and blended with the frame and policy of states; could not be brought to the ground without a fearful struggle; nor could it fall without a violent *concussion* of itself and all about it.
Burke.

Winds from all quarters agitate the air,
And fit the limpid element for use,
Else noxious: oceans, rivers, lakes, and streams,
All feel the froshewing impulse, and are cleansed
By restless undulation; e'on the oak
Thrives by the rude *concussion* of the storm.
Cowper.

Palsy's cold hands the fierce *concussion* own,
And life clings trembling on her tottering throne.
Darwin.

COND, v. a. } Goth. *kunde*. To guide or
CON'DER, n. s. } conduct a ship; to give notice. Cond seems to be a maritime corruption of the verb to conn, or con. A conder is a person who stands before the compass, and gives direction to the helmsman how to steer; it is also the name of a man employed in the manner described in the following quotation. Some etymologists, and not unplausibly, derive conder from the French, *conduire*. 'Such as stand upon high places near the sea coast, at the time of herring fishing, to make signs to the fisher which way the shoal passeth, which may better appear to such as stand upon some high cliff, by a kind of blue color that the fish causeth in the water, than to those in the ships. These be likewise called huers, by likelihood of the French, *huyer, exclamare, and balkers*.' *Cowell.*

CONDAMINE (Charles Marie de la), a celebrated traveller and natural philosopher, was born in 1701, at Paris. His father, who was receiver-general of the taxes for the province of Bourbonnois, first procured him a situation in the army, but his desire of knowledge soon induced him to travel. In the year 1731, having resigned the military profession, he left his native country to visit the shores of the Mediterranean. He surveyed many parts of the coast of Africa and Asia, resided some time at Constantinople, and returned to Paris after nearly two years absence, where he published an account of his travels. This account was first read to the Academy of Sciences, as a member of which he had been admitted before his departure. By the same body he was appointed as one of their commissioners, in the splendid undertaking of measuring a degree of the meridian and of the equator in Peru; and on the sixteenth of May, 1735, he and his philosophic companions set sail from Rochelle for this destination. This undertaking was at first suggested by Condamine, and its difficulties and dangers suited his zealous and enterprising spirit. It is well known what success attended the labors of the academicians both in Lapland and Peru; and nothing but the share that Condamine had in bringing them to a happy termination could give them any place in this narrative. After the instructions of the academy were fulfilled, one of the greatest of Condamine's adventures commenced. Having been

stimulated, by his curiosity and spirit of enterprise, to attempt a passage across the American continent, along the river Amazons, he committed himself to the stream of that river with a single servant, and after encountering various dangers, and surmounting numerous obstacles, he arrived at Cayenne, where he was obliged to wait more than five months for a vessel to carry him to Europe. This delay, amid the anxious desires that he must have felt to communicate the result of his labors and observations to his countrymen, and to enjoy in return their surprise and their admiration, produced a depression of spirits that sensibly affected his health. He recovered, however, when the opportunity at last occurred of his returning to Europe; and, in a vessel provided for him by the governor of Surinam, he was conveyed to Holland, and from thence hastened to Paris, where he was received with such universal applause as to excite the jealousy of his colleague, Bougier, a man of more science and knowledge, but of retired and unassuming habits and manners. In 1757, several years after his return from South America, he undertook a journey to Italy for the benefit of his health; and, during his stay at Rome, procured from the church a dispensation to marry his niece. He afterwards published an account of several interesting observations he had made during this tour, in a book, entitled, *Extract d'un Journal de Voyage en Italie*. Inoculation for the small pox had been introduced about this time from Turkey into England; and in a visit which our traveller made to this country, he had observed the beneficial effects of the practice; on his return, therefore, he published in two volumes *Lettres et Memoires sur l' Inoculation*, stating what had been done, and what might be expected from doing more. While he was in London he was admitted a member of the Royal Society, an honor to which he had been elected several years before. He was also elected a member of many other learned societies, as those of Petersburg, Berlin, and Bologna. He died in 1774 in consequence of an operation for hernia. His peculiar propensities and habitual character may be collected from the foregoing brief account of his life. His reputation as a philosopher does not rank very high, although he had amassed extensive information, and was by no means destitute of science. Posterity will regard him rather as a man of brilliant parts and general knowledge, who, by his ardent and unremitting exertions, contributed to diffuse the light of science, than one who could add to its splendor, or bring new regions within its sphere.

CONDAPILLY, one of the northern Circars of Hindostan extending between the sixteenth and seventeenth degrees of north latitude, and sometimes called Mustapha Nagur; the entire district, occupies an area of 3400 miles, exclusive of the mountains on the west. It is on the whole well cultivated; but the diamond mines have long ceased to be productive. It is well watered by the Krishna and some minor streams. The principal towns are Condapilly, Masulipatam, and Tronvilloor.

CONDAPILLY, the capital of the above province, is situated on a hill and was formerly esteemed

a place of much strength; but the fortifications have of late been neglected. The principal officers of the government reside at Masulipatam. Condapilly, according to Mr. Hamilton, was first conquered from the Hindoo princes, about the year 1471, by the Bhamenee sovereigns of the Deccan, and it came into the British possession, along with the northern Circars, in 1765. Travelling distance from Hyderabad, 142 miles; from Madras 306; and from Seringapatam 444 miles.

CONDATCHY, a bay and town of the island of Ceylon, where is carried on a very extensive pearl fishery. The banks on which the oysters are found, extend about forty miles along this coast. See our article *Ceylon*. In the town reside the polishers and drillers of the pearls. The neighbourhood is distinguished for nothing else.

CONDE, a strong town of France, in the department of the North. It first came into the possession of France at the peace of Nimeguen, in 1679, when the works were strengthened. It was one of the French fortresses occupied by the allies of the second treaty of Paris, in 1815, and is now regarded as one of the strongest barrier-fortresses on this side the Netherlands. It was taken by the allies, July 10th, 1793, but retaken in October, 1794, and its name changed for a time, by a decree of the convention, to *Nord Libre*, or *North Free*. It is seated at the confluence of the Scheld and the Haisne, twelve miles south-east of Tournay, containing about 6000 inhabitants; thirteen miles west of Mons, seven N. N. E. of Valenciennes; and 117 north by east of Paris.

CONDE (Lewis de Bourbon, prince of), one of the greatest generals of his age, was born at Paris, September 7th, 1621. He was styled Duke d' Enghien, till by his father's death, in 1646, he succeeded to the title of prince of Conde. Three years previous to this event, at the age of twenty-two, the king, by the advice of cardinal Mazarine, gave him the command of the army destined to cover Champagne and Picardy; and in this station he soon established his reputation, by defeating the Spaniards at Rocroi, and by the siege and capture of Thionville. Having covered Alsace and Lorraine from the enterprises of the imperialists, he returned to Paris, and obtained the government of Champagne, and of the city of Stenai. In 1644, 1645, and 1646, he distinguished himself in the three battles of Fribourg; and by the taking of Philipsbourgh making himself master of the palatinate, and of the whole course of the Rhine, by the siege and conquest of Dunkirk, and by the siege of Lerida, from which though he was obliged to rise, he kept the Spaniards in awe, and cut to pieces their rear-guard. During the civil wars, arising out of the administration of cardinal Mazarine, and the conduct of the queen-mother, he joined the malcontents, for which conduct he was arrested and detained a year in prison. In the civil war which ensued, he was opposed by Turenne, and would probably have been defeated, but for the assistance of mademoiselle, the daughter of the duke of Orleans, who caused the cannon of the bastille to be fired at the king's troops. On the restoration of peace he

went into the Low Countries, where he joined the Spaniards. In 1659, on the peace of the Pyrenees, the prince was re-established in France, and afterwards employed in Flanders against the prince of Orange. He was wounded at the passage of the Rhine, but he continued the war, notwithstanding, with activity, and reduced the whole of Franche-Comté. Succeeding Turenne in the command of the French army, he was sent in 1675 into Alsace to check the progress of the imperial general Montecuculi. He obliged the enemy to cross the Rhine, and then closed his military career. He now retired to Chantilly to combat with the gout, and passed the rest of his life in cultivating the fine arts, in which he had considerable taste. He died in 1686, at Fontainebleau, leaving two sons.

CONDE'MN, *v. a.* } Fr. *condemner*; Ital. *condannare*, *condennare*; Sp. *condenar*; CONDE'MNABLE, *adj.* } *condannare*. Tooke CONDE'MNATION, *n. s.* } Lat. *condemnatio*. Tooke CONDE'MNATORY, *adj.* } considers the Ang- CONDE'MNEDLY, *adv.* } considers the Ang- CONDE'MNER, *n. s.* } Sax. *deman*, to deem, as being the root of the CONDE'MNING, *n. s.* } English word. To condemn is to pronounce criminal; to pass sentence; to censure; to reprehend; to inflict a fine; to show guilt by contrast.

The righteous that is dead shall *condemn* the ungodly which are living. *Wisdom iv. 16.*

And the king of Egypt put him down at Jerusalem, and *condemned* the land in an hundred talents of silver. *2 Chronicles xxxvi. 3.*

The son of man shall be betrayed unto the scribes, and they shall *condemn* him to death. *Mat. xx. 18.* There is therefore now no *condemnation* to them. *Rom. viii. 1.*

Who is he that *condemneth*? It is Christ that died, yea rather, that is risen again. *Rom. viii. 34.*

But O vaine judgment, and conditions vain, That which the prisoner points unto the free; The whiles I him *condemne*, and deeme his paine, He where he lists goes loose, and laughs at me. *Spenser's Faerie Queene.*

Condemned to that doungeon mercilesse, Where they should live in wo, and dye in wretchednesse. *Id.*

One while she blamed herselfe, another while She him *condemned* as trustlesse and untrew. *Id.*

My conscience hath a thousand several tongues, And every tongue brings in a several tale, And every tale *condemns* me for a villain. *Shakespeare, Richard III.*

Is he found guilty! — Yes, truly, is he, and *condemned* upon't. *Id. Henry VIII.*

And if we dare to judge our Maker's will, He can *condemn* us, and himself can clear. *Davies.* He commands to deface the print of a cauldron in ashes; which strictly to observe, were *condemnable* superstition. *Browne.*

Since thou determinest weakness for no plea, In man or woman, though to thy own *condemning*, Hear what assaults I had. *Milton. Samson Agonistes.*

The poet, who flourished in the scene, is *condemned* in the ruelle. *Dryden's Æneid, Preface.* He who was so unjust as to do his brother an injury, will scarce be so just as to *condemn* himself for it. *Loche.*

He that passes the first *condemnatory* sentence, is like the incendiary in a popular tumult, who is chargeable with all those disorders to which he gave rise. *Government of the Tongue.*

Some few are the only refusers and *condemners* of this catholic practice. *Taylor's Worthy Communionist.*

They who approve my conduct in this particular, are much more numerous than those who *condemn* it. *Spectator.*

Considered as a judge, it *condemns* where it ought to absolve, and pronounces absolution where it ought to *condemn*. *Fiddes's Sermons.*

Escaped the dungeon, does the slave complain, Nor bless the friendly hand that broke the chain? Say, pines not Virtue for the lingering morn, On this dark wild *condemned* to roam forlorn! *Beattie.*

The laws in many countries to *condemn* require more than a mere majority; less than an equal number to acquit. In our judicial tribunals we require unanimity either to *condemn* or absolve. *Burke.*

When the trial is by friends, if the decision should happen to be favourable, the honour of the acquittal is lessened; if adverse, the *condemnation* is exceedingly embittered. It is aggravated by coming from lips professing friendship, and pronouncing judgment with sorrow and reluctance. *Id.*

Condemns the injurious deed; the slanderous tongue, The thought that meditates a brother's wrong: Brings not alone the more conspicuous part, His conduct, to the test, but tries his heart. *Cowper.*

Your sneaking water drinkers all I utterly *condemn* 'em, He that would write like Homer, Must drink like Agamemnon. *Huddlesford.*

CONDENSE, *v. a. & n. & adj.* } Fr. *conden-* CONDENSATE, *v. a. & n. & adj.* } *ser*; Ital. *condensare*; Span. CONDENSATION, *n.* } *condensar*; Lat. CONDENSABLE, *adj.* } *condensare*. — CONDENSATIVE, *adj.* } The verbs *condense* and *condensate* are synonymous. Both mean to thicken; to compress into a narrower space; to be thickened; to be compressed into a narrower space. The kindred words do not require definition; with the exception of the scientific term condenser, which denotes an apparatus for compressing the air into a strong metallic vessel. See the next article.

CONDENSER, *n. s.* } CONDENSITY, *n. s.* } If by natural arguments it may be proved, that water, by *condensation*, may become earth; the same reason teacheth that earth, rarefied, may become water. *Raleigh's History.* By water-glasses the account was not regular; for, from attenuation and *condensation*, the hours were shorter in hot weather than in cold. *Browne's Vulgar Errors.*

Moving in so high a sphere, he must needs, as the sun, raise many envious exhalations; which, *condensed* by a popular odium, were capable to cloud the brightest merit. *King Charles.*

This agent meets with resistance in the moveable; and not being in the utmost extremity of density, but *condensable* yet further, every resistance works something upon the mover to condense it. *Digby on the Soul.*

Water by nature is white; yea, thickened or *condensate*, most white, as it appeareth by the hail and snow. *Peacham.*

They colour, shape, and size Assume, as likes them best, *condense* or rare. *Milton.*

The water falling from the upper parts of the cave, docs presently there *condense* into little stones. *Boyle's Scept. Chym.*

Some lead their youth abroad, while some condense their liquid store, and some in cells dispense.

Dryden's Virgil.

All vapours, when they begin to condense and coalesce into small parcels, become first of that bigness whereby azure must be reflected, before they can constitute other colours.

Newton's Opticks.

Such dense and solid strata arrest the vapour at the surface of the earth, and collect and condense it there.

Woodward.

The supply of its moisture is by rains and snow, and dews and condensation of vapours, and perhaps by subterraneous passages.

Bentley.

They might be separated without consociating into the huge condensate bodies of planets.

Id. Sermons.

For them the rocks dissolved into a flood,
The dews condensed into angelic food,
Their very garments sacred, old yet new,
And Time forbid to touch them as he flew.

Cowper.

O'er those blest isles no ice-crowned mountains towered,

No lightnings darted, and no tempests loured ;

Soft fell the vesper drops condensed below,

Or bent in air the rain-refracted bow.

Darwin.

When heaven's high vault condensing clouds deform,

Fair Amaryllis flies the incumbent storm,
Seeks with unsteady step the sheltered vale,
And turns her blushing beauties from the gale.

Id.

It is also well known, that the thinner the glass is, (which is thus coated on both sides so as to make a Leyden phial), the more electricity can be condensed on one of its surfaces, till it becomes so thin as to break, and thence discharge itself. Nor is it possible that the quantity of electricity condensable on one side of a coated phial, may increase in some high ratio in respect to the thinness of the glass.

Id.

CONDENSATION, is commonly applied to the conversion of vapor into water, by distillation, or naturally in the clouds. Vapor commonly condenses by the application of some cold substance. On touching it the vapor parts with its heat which it had before absorbed, immediately loses the proper characteristics of vapor, and becomes water. But though this is the most common and usual way in which we observe vapor to be condensed, nature certainly proceeds after another method: since we often observe the vapors most plentifully condensed when the weather is really warmer than at other times. See CLOUDS.

A CONDENSER is a pneumatic engine by which an uncommon quantity of air may be forced into a small space; so that sometimes ten atmospheres, or ten times as much air as there is at the same time in the same space, without the engine, may be thrown in by means of it, and its egress prevented by valves properly disposed.

It consists of a brass cylinder, wherein is a moveable piston, which being drawn out, the air rushes into the cylinder through a hole provided on purpose; and, when the piston is again forced into the cylinder, the air is driven into the receiver through an orifice, furnished with a valve to hinder its getting out. The receiver, or vessel containing the condensed air, should be made very strong, to bear the force of the air's spring thus increased; for which reason they are generally made of brass: its orifice is fitted with a female screw to receive the male screw at the

end of the condenser. Some condensers are made of glass for entertaining experiments, but they cannot bear much condensation.

CONDESCEND, *v. n.*

CONDESCENCE, *n. s.*

CONDESCENDENCE, *n. s.*

CONDESCENDENCY, *n. s.*

CONDESCENDING, *n. s.*

CONDESCENDINGLY, *adv.*

CONDESCENSION, *n. s.*

CONDESCENSIVE, *adj.*

CONDESCENT, *n. s.*

Alas, my lord! take from me this domage;
To my desire for mercy *condescende*,
For none but thou may my grievance amende.

Alas, my lord! take from me this domage;

To my desire for mercy *condescende*,

For none but thou may my grievance amende.

Chaucer.

They, rather to gratify Herodias, made way for so alight and easy a *condescent*.

Hall.

By the warrant of St. Paul's *condescendence* to the capacities he wrote unto, I may speak after the manner of men.

Montague.

This queen of most familiar *condescendings* is content to be our every week's prospect.

Hammond.

Can they think me so broken, so debased,
With corporal servitude that my mind ever
Will *condescend* to such absurd commands.

Milton.

Nor shall my resolution

Disarm itself, nor *condescend* to parody

With foolish hopes.

Denham's Sophy.

Spain's mighty monarch,

In gracious clemency does *condescend*,

On those conditions, to become your friend.

Dryden's Indian Emper.

He did not primarily intend to appoint this way; but *condescended* to it, as accommodate to their present state.

Tillotson.

It forbids pride, and ambition, and vain glory; and commands humility, and modesty, and *condescension* to others.

Id.

Raphael, amidst his tenderness, shews such a dignity and *condescension* in all his behaviour, as are suitable to a superior nature.

Addison.

We *condescendingly* made Luther's works umpires in the controversy.

Atterbury.

Courtesy or, *condescension* is an happy quality, which never fails to make its way into the good opinion, and into the very heart; and allays the envy which always attends a high station.

Id. Sermons.

This method carries a very humble and *condescending* air, when he that instructs seems to be the enquirer.

Watts.

There is, indeed, this difference from the Saxon times, that as in the itinerant exhibitions of the stage, for want of a complete company, they are obliged to throw a variety of parts on one performer, so our sovereign *condescends* himself to act, not only the principal, but all the subordinate parts of the play. He *condescends* to dissipate the royal character, and to trifle with those light subordinate lacquered sceptres, in those hands that sustain the ball, representing the world, or which wield the trident that commands the ocean.

Burke.

If guards, mechanically formed in ranks,
Playing at beat of drum their martial ranks,

Oshouldering and standing as if stuck to stone,
While condescending majesty looks on;
If monarchy consist in such base things,
Sighing, I say again, I pity kings!

Cooper.

If ever I should condescend to prose,
I'll write poetical commandments, which
Shall supersede beyond all doubt all those
That went before; in these I shall enrich
My text with many things that no one knows,
And carry precept to the highest pitch.

Byron's Don Juan.

CONDIGN, adj. } Fr. *condigne*; Ital. *con-*
CONDIGNNESS, n. s. } *degno*; Span. *condigno*;
CONDIGNITY, n. s. } Lat. *condignus*. Worthy;
CONDIGNLY, adv. } merited. When used in
conjunction with the word punishment, to which
it is almost confined, it implies a degree of se-
verity. Johnson says that it is always applied to
something deserved by crimes. This assertion
Mr. Todd controverts, and refers to our old
writers for proofs of the contrary. Johnson,
however, is in the right, as far as regards the
present time; the adjective being now never used
but in the manner which he specifies. Con-
dignity is equivalent to merit; desert.

Herself of all that rule she deemed most *condigne*.
Spenser's Faerie Queene.

Unless it were a bloody murderer,
I never gave them *condign* punishment.
Shakespeare. Henry VI.

Such a worthiness of *condignity*, and proper merit of
the heavenly glory, cannot be found in any of the best,
most perfect, and excellent of created beings.

Bishop Bull.

As Mercury has turned himself into me, so I may
take the toy into my head to turn myself into Mercury,
that I may swinge you off *condignly*.

Dryden's Amphitryon.

Consider who is your friend, he that would have
brought him to *condign* punishment, or he that has
saved him.

Arbutnot.

CONDILLAC (Stephen Bonnet de), was an
eminent French metaphysician, who attained
great distinction by his writings on the most ab-
struse subjects. The work by which he first
became known to the public, and which will
probably constitute his best passport to fame
among posterity, was a metaphysical treatise
which he published in 1746, entitled an Essay
on the Origin of Human Knowledge. Six years
afterwards he published a Treatise on Sensation,
which is regarded as more ingenious and more
original, if possible, than his first work. In the
following year he published a Treatise on the
Nature of Animals. His object is to show that
the actions they perform, and the faculties they
manifest, cannot be explained on the principles
of Descartes, of their being merely machines of
more delicate construction. His most extensive
work is entitled, A Course of Study, drawn up
for the Instruction of the Prince of Parma. This
was published in the year 1776, and consists of
sixteen volumes. His last work was entitled,
Commerce and Government considered rela-
tively to each other. He died in 1780, a short
time after the publication of the treatise above
mentioned, and left behind him a reputation for
talents of the first order, extensive general know-
ledge, and great metaphysical penetration.

CONDIMENT, n. s. Ital. *condimento*; Lat.
condimentum. Seasoning; sauce; that which ex-
cites the appetite by a pungent taste.

As for radiah and the like, they are for *condiments*
and not for nourishment. *Bacon's Natural History.*

Many things are swallowed by animals rather for
condiment, gust, or mendicament, than any substantial
nutriment. *Brounne.*

CONDISCIPLE, n. s. Lat. *condiscipulus*.
A schoolfellow; a fellow disciple.

A *condisciple* of his, or one that had been, hearing
so much of the man, went to him. *M. Casaubon.*

CONDISE, n. s. A conduit. The word is
used by Chaucer, and the spelling was probably
altered by him to make it chime with the ending
of the preceding line.

CONDITE, v. a. & adj. } Ital. and Lat. *con-*
CONDITEMENT, n. s. } *dir.* To pickle; to
CONDITING, n. s. } preserve by salt,
sugar, or aromatics; to season. *Conditement*
signifies a composition of conserves, powders,
and spice, blended together, by means of syrup,
into an electuary.

The most innocent of them are but like *condites*
or pickled mushrooms, which, carefully corrected,
may be harmless, but can never do good.

Taylor's Rule of Holy Living.

Scoltzij would fain have them use all summer the
condite flowers of succory, strawberry water, &c.

Burton. Anatomy of Melancholy.

Much after the same manner as the sugar doth, in
the *conditing* of pears, quinces, and the like.

Grew's Museum.

CONDITION, v. a. v. n., & n. s. } Fr. *con-*
CONDITIONAL, n. s. & adj. } *dition*; It.
CONDITIONALITY, n. s. } *condizione*;
CONDITIONALLY, adv. } Sp. *condi-*
CONDITIONARY, adj. } *cionary*; Lat.
CONDITIONATE, v. a. & adj. } *conditus*.
CONDITIONED, adj. } The lead-
CONDITIONLY, adv. } ing idea of

a condition is, the state, make, or disposition, of
any thing. The applications are numerous.
The noun denotes quality, whether good or bad,
moral or physical; distinctive property or attribute;
external circumstances; rank; terms of agree-
ment; the writing in which those terms are con-
tained. The verb signifies to stipulate; to enter
into terms. Conditional and conditionally mean
that the act is done under some condition, the
non-performance of which voids the contract.
Sidney uses conditionly in the sense of the latter
word. A condition is that which limits or res-
tricts what otherwise would be unconfined in
its operation. To conditionate is to qualify;
to regulate. Conditioned is the having proper-
ties, whether good or bad. Johnson denominates
conditionary an adjective, and defines it, stipu-
lated; but, in the sentence which he quotes,
unless we suppose a harsh ellipsis, the word is
equivalent to condition, and, consequently, is
a noun.

For trewliche I holde it a grete deinte,
A kinge's son in armis wel to do,
And be of gode *condicione* therto,
For grete power and moral vertus here
Is selde isene in one person ifere.

Chaucer. Troilus and Creseide.

But half so well beloved a man as he,
 Ne was ther never in court of his degre.
 He was so gentil of *condition*,
 That thurghout all the court was his renoun.

Id. Canterbury Tales.

Bli^hely, (quod he) come, sit the down ;
 I tel the on *condicions*,
 Thou shalte wholly with all thy wit
 Dy thyne entente to herlion it. *Id.*

Hardie thing it is to weene by might
 That man to hard *conditions* to bind,
 Or ever hope to match in equal fight,
 Whose prowesse paragone saw never living wight.
Spenser. Faerie Queene.

Every substance is *conditioned*
 To change her hew, and sendry forms to don,
 Meet for her temper and complexion. *Id.*

The child taketh most of his nature of the mother,
 besides speech, manners and inclination, which are
 agreeable to the *conditions* of their mothers.

Id. on Ireland.

For the use we have his express comment, for
 the effect his *conditional* promise ; so that, without
 obedience to the one, there is of the other no as-
 surance. *Hobbes.*

A rage, whose heat hath this *condition*,
 That nothing can allay, nothing but blood.
Shakespeare. King John.

To us all,
 That feel the bruises of the days before,
 And suffer the *condition* of these times
 To lay an heavy and unequal hand
 Upon our humours. *Shakespeare. Henry IV.*

I am, in my *condition*,
 A prince, Miranda. *Id. Tempest.*

I here entail
 The crown to thee, and to thine heirs for ever ;
Conditionally, that here thou take an oath
 To cease this civil war. *Id. Henry VI.*

The dearest friend to me, the kindest man,
 The best *conditioned*. *Merchant of Venice.*

I yield upon *conditions*.—We give none
 To traitors : strike him down.
Ben Jonson's Cataline.

Jupiter is hot and moist, temperate, modest, honest,
 adventurous, liberal, merciful, loving, and faithful ;
 that is, giving these inclinations : and therefore those
 ancient kings, beautified with these *conditions*, might
 be called thereafter Jupiter.

Raleigh's History of the World.

It was *conditioned* between Saturn and Titan, that
 Saturn should put to death all his male children. *Id.*

It seemed to us a *condition* and property of Divine
 Powers and Beings, to be hidden and unseen to
 others. *Bacon.*

He said, if he were sure that young man were king
 Edward's son, he would never bear arms against him.
 This case seems hard, both in respect of the *condi-
 tional*, and in respect of the other words.

Id. Henry VII.

Many are apt to believe remission of sins, but they
 believe it without the *condition* of repentance. *Taylor.*

Small towns, which stand stiff till great shot
 Enforce them, by war's law *condition* not. *Donne.*
 That ivy ariseth but where it may be supported, we
 cannot ascribe the same unto any science therein,
 which suspends and *conditionates* its eruption.

Brown's Vulgar Errors.

A false apprehension understands that positively,
 which was but *conditionally* expressed. *Id.*

The king himself met with many entertainments,
 at the charge of particular men, which had been
 rarely practised till then by the persons of the best
condition. *Clarendon.*

That which is mistaken to be particular and abso-
 lute, duly understood, is general, but *conditionate* ;
 and belongs to none who shall not perform the *con-
 dition*. *Hammond.*

Estimate the greatness of this mercy by the *con-
 dition* it finds the sinner in, when God vouchsafes it
 to them. *South's Sermons.*

Many scriptures, though as to their formal terms
 they are absolute, yet as to their sense they are *con-
 ditional*. *Id.*

We see large preferments tendered to him, but
conditionally, upon his doing wicked offices : con-
 science shall here, according to its office, interpose
 and protest. *Id.*

'Tis one thing, I must confess, to *condition* for a
 good office, and another thing to do it gratis.

L' Etrange.

Though uselessness, which is one of the *conditions*
 that makes punishments just, when it is away, may
 hinder punishments from being lawful in any body's
 hands ; yet uselessness, when present, being but one
 of those *conditions*, cannot give the other, which is a
 commission to punish ; without which also punish-
 ment is unlawful. *Locke.*

Not to be endured (a lie) in any one, who would
 converse with people of *condition*, or have any esteem
 or reputation in the world. *Id.*

And as this clear proposal of the promises may
 inspirit our endeavours, so is the *conditionality* most
 efficacious to necessitate and engage them.

Decey of Piety.

Would God in mercy dispense with it as a *condi-
 tionary*, yet we could not be happy without it, as a
 natural qualification for heaven. *Norris.*

Did we perfectly know the state of our own *con-
 dition*, and what was most proper for us, we might
 have reason to conclude our prayers not heard, if not
 answered. *Wake's Preparation.*

They will be able to conserve their properties un-
 changed in passing through several mediums ; which
 is another *condition* of the rays of light.

Newton's Opticks.

Condition, circumstance, is not the thing ;
 Bliss is the same in subject as in king.

Pope's Essay on Man.

Some desponding people take the kingdom to be in
 no *condition* of encouraging so numerous a breed of
 beggars. *Swift.*

The great inconvenience of public education arises
 from its being dangerous to morals ; and, indeed,
 every *condition* and period of human life is liable to
 temptation. *Beattie.*

In considering any complex matter, we ought to
 examine every distinct ingredient in the composition,
 one by one ; and reduce every thing to the utmost
 simplicity, since the *condition* of our nature binds us
 to strict law and very narrow limits. *Burke.*

CONDITION, in the civil law, a clause of obli-
 gation, stipulated as an article of a treaty, or a
 contract ; or in a donation of a testament, legacy,
 &c. in which last case a donee does not lose his
 donative if it be charged with any dishonor or
 impossible conditions.

CONDITIONAL CONJUNCTIONS, in grammar,
 are those which serve to make propositions condi-
 tional : as *if, unless, provided, &c.*

CONDITIONAL PROPOSITIONS, in logic, such as
 consist of two parts connected together by a condi-
 tional particle.

CONDITIONAL SYLLOGISM, a syllogism where
 the major is a conditional proposition. Thus,
 ' If there is a God, he ought to be worshipped.—

But there is a God;—therefore he ought to be worshipped.

CONDOLÉ, *v. n.* } Fr. *se condouloir*; It.
 CONDO'LEMENT, *n. s.* } *condolersi*; Sp. *condo-*
 CONDO'LENCE, *n. s.* } *lerse*; Lat. *condolere*,
 CONDO'LING, *n. s.* } from *con* and *dolere*.
 CONDO'LER, *n. s.* } To sympathise with;
 to express concern for the misfortunes or sorrows
 of others; to offer consolation; to lament or be-
 wail with another. It has *with* before the person
 who is the object of our pity. Condolence is
 the opposite of congratulation.

Amongst the which there was a nymph that hight
 Molanna, daughter of old father Mole,
 And sister unto Mulla, faire and bright,
 Unto whose bed false Bregog whylome stole,
 That shepheard Colin dearly did condole.

Spenser. Faerie Queene.

To persevere

In obstinate condolement, is a course
 Of impious stabbornness, unmanly grief.

Shakespeare. Hamlet.

I come not, Sampson, to condole thy chance,
 As these perhaps; yet wish it had not been,
 Though for no friendly intent. *Milton's Agonistes.*

Why should I think that all that devout multitude,
 which so lately cried Hosanna in the streets, did not
 also bear their part in these public condolings?

Bishop Hall.

Why should our poet petition Isis for her safe de-
 livery, and afterwards condole her miscarriage?

Dryden.

Your friends would have cause to rejoice, rather
 than condole with you. *Temple.*

I congratulate with the beasts upon this honour
 done to their king; and must condole with us poor
 mortals, who are rendered incapable of paying our
 respects. *Addison.*

The reader will excuse this digression, due by way
 of condoleance to my worthy brethren. *Arbutnot.*

We are still in the old cut; and have not so far
 conformed to the new Parisian mode of good-breed-
 ing, as to think it quite in the most refined strain of
 delicate compliment (whether in condoleance or congratu-
 lation) to say to the most humiliated creature that
 crawls upon the earth, that great public benefits are
 derived from the murder of his servants, the attempt-
 ed assassination of himself and his wife, and the mortifi-
 cation, disgrace, and degradation, that he has
 personally suffered. *Burke.*

CONDOM, a town of France, in the depart-
 ment of Gers, and ci-devant province of Gas-
 cony, containing about 7000 inhabitants, who
 manufacture wax and wool: the trade, princi-
 pally with Bourdeaux, is in corn, wine, brandy,
 leather, and the above manufactures. Condom
 was once a bishop's see, and filled by the cele-
 brated Bossuet before he became bishop of
 Meaux. The neighbourhood is very fertile and
 delightful. It is seated on the Baize and the
 Gelasse, twenty-eight miles south-east of Bour-
 deaux.

CONDOMA, in zoology. See CAPRA.

CONDONATION. Lat. *condonatio*. A
 forgiving of transgression. The word is now
 obsolete, except in the ecclesiastical court, when
 it is still in use, to express the forgiveness of a
 wife by a husband, after she has been unfaithful
 to his bed.

CONDOR, in ornithology. See VULTUR.

CONDORCET (John Antony Nicolas),
 Caritat, marquis of, a celebrated French author,
 philosopher, and politician. He was born at
 Ribemont in Picardy, in 1743, and educated at
 the college of Navarre, where he distinguished
 himself by his attachment to the study of the
 mathematics and physical science. On entering
 into public life, he became intimate with Vol-
 taire, D'Alembert, and the literati of their school.
 As a mathematician Condorcet first attracted
 public attention by a treatise on Integral Calcu-
 lations, composed when he was twenty-two years
 of age. His solution of the problem of the
 Three Bodies appeared in 1767, and the first
 part of his Essay on Analysis in 1768. He was
 admitted a member of the Academy of Sciences
 in 1769, and contributed greatly to enrich its
 memoirs by various papers on the most abstruse
 branches of mathematical science. Turgot soon
 after this united him with D'Alembert and Bos-
 suet, in constructing the various financial calcula-
 tions of his administration. Meanwhile he
 was indefatigable in the study of politics and
 metaphysics, and published a defence of the
 sect with which he was connected, from an at-
 tack upon them in the *Trois Siecles*; as well as
 a reply to M. Neckar's Essay on the Corn Laws.
 In 1773 he was appointed secretary to the Aca-
 demy of Sciences. In 1783 he pronounced an
 oration before the Academy on the influence of
 philosophy, and was received into that body.
 D'Alembert dying this year, Condorcet suc-
 ceeded to his place of secretary to the Academy,
 and rendered himself conspicuous by the publi-
 cation of eulogies on different eminent charac-
 ters; particularly by that on his predecessor.
 In his encomium on the famous Euler, he en-
 tered into a circumstantial account of the specific
 improvements in science and the mathematics
 suggested by that individual; a species of me-
 moir for which Condorcet had a peculiar taste.
 In 1787 he published his labored *Life of Vol-*
taire. His last biographical sketch was an
 eulogy on the celebrated Dr. Franklin, which
 appeared in 1790.

We now come to a somewhat more active
 part of the life of Condorcet. When the French
 revolution took place, he was the chief conductor
 of La Bibliothèque de l'Homme, designed to
 analyse the writings of the most eminent politi-
 cians; and of a newspaper entitled La Chro-
 nique de Paris, full of declamation against
 royalty; as well as an assistant in the *Journal de*
Paris. About the time the unfortunate Louis
 XVI. fled to Varennes, he proposed a paper called
 Le Republican, and became an active member
 of the Jacobin club. When the constituent na-
 tional assembly was dissolved, he was chosen
 representative for Paris, and adhered to the
 Brissotine party. He was now employed in
 drawing up a plan for public instruction, which
 he completed in two elaborate memoirs. He
 also drew up the manifesto addressed to the
 European powers by the people of France, on
 the approach of war, and became president of
 the national assembly.

In this capacity he wrote a letter of expostu-
 lation to the king, and is said to have vindicated
 the populace in insulting that unfortunate prince.

Amidst this degradation of royalty, it is also said, that he secretly solicited the office of tutor to the dauphin; but was decidedly rejected by the king, on account of his infidelity. When the trial of the king was agitated, Condorcet gave it as his opinion that he could not be brought to judgment in a legal manner; though his conduct in regard to the final sentence appears ambiguous. Madame Roland says 'the genius of Condorcet is equal to the comprehension of the greatest truths; but he has no other characteristic besides fear. It may be said of his understanding, combined with his person, that it is a fine essence absorbed in cotton.' After the death of the king, Condorcet was employed by the Girondists to frame a new constitution, which was approved by that party; though not by the people at large. Condorcet's native timidity prevented him from taking part with either the Gironde or mountain parties, during the struggle between them; and he escaped the general massacre of the Brissotines; but he fell under the invincible displeasure of the blood-thirsty Robespierre, and a decree of arrest was passed against him in July 1793. He concealed himself in Paris for about nine months; but a rumor of a domiciliary visit led him to quit his place of abode, and passing through the barriers without being noticed, he went to the house of a friend at Mont-Rouge, who unfortunately happened to be then in Paris, and was not to return for three days. He was thus obliged to pass two dreary nights in the open fields, and venturing to a small inn at Calmars, the keenness with which he devoured what he ordered and his meagre appearance, attracted the attention of an officer, through whom he was thrown into a dungeon, to be carried to Paris next day; but in the morning, 28th of March, 1794, was found dead; as it is supposed by poison, as he generally carried it about him. Thus terminated the life of Condorcet, after thirty years of study, consecrated to the sciences and his country, or rather to all Europe; and after laboring for years exclusively for the revolution and liberty. Not long after his death, appeared his Sketch of an Historical picture of the Progress of the Human Mind. He also left behind him in MS. a Treatise on Calculation, and an Elementary Treatise on Arithmetic; and published, besides the works already noticed, Letters to the King of Prussia, with whom, as well as with Catharine, empress of Russia, he kept up a correspondence. Although Condorcet was professedly hostile to revealed religion; he was, in a philosophical sense, a man of integrity and virtue.

CONDORE, or PULO CONDORÉ, an island in the Indian Ocean, near the coast of Cochin China. It has an excellent harbour; which induced the English East India Company to form a settlement here in 1702, but a quarrel happening, most of the factory were murdered by the Cochin Chinese, and the rest expelled in 1705. This and the neighbouring cluster of islands abound with mangoe trees. See MANGIFERA. The natives are of a dark olive color; short, but well shaped; their faces are long and their hair long and black; they have small black

eyes, high noses, thin lips, white teeth, and little mouths. The women are said to be licentious in their manners. The island is about twelve miles long and two broad.

CONDORMIENTES, Lat. in church history, religious sectaries, so named from lying all together, men and women, young and old. They arose in the thirteenth century, near Cologne; where they are said to have worshipped an image of Lucifer, and to have received oracular answers from him.

CONDRIEU, or CONDRIEUX, a flourishing town of France, in the department of the Rhone and Loire, remarkable for its wines. It is seated at the foot of a hill seventeen miles south of Lyons, and contains 4050 inhabitants.

CONDRUSII, in ancient geography, a people of Belgica, originally Germans, dwelling about the Maese, in the country, now CONDRUZ.

CONDU'CE, *v. a. & v. n.* Lat. *conducere*.
 CONDU'CEMENT, *n. s.* The verb followed by *to*, signifies to further some purpose; to contribute to bring about. By our old writers it was used in the sense of *to conduct*, but this is become obsolete. Conducement means tendency. Hale employs *conducibile* as a noun, 'the *conducibles* thereunto.' The adjective *conducibile* takes *to* after it.

The boring of holes in this kind of wood, and then laying it abroad, seemeth to *conduce* to make it shine.

Bacon.

The means and preparations that may *conduce* unto the enterprize.

Id. Holy War.

To both, the medium which is most propitious and *conducibile*, is air.

Id. Natural History.

He was sent to *conduce* hither the princess Henrietta Maria.

Wotton.

I give you free and full power to move the heads, or to do any other act fitting, or *conducement* to the good success of this business.

Archbishop Laud.

Which two contemplations are not inferior to any for either pleasantness in themselves, or *conducibleness* for the finding out of the right frame of nature.

H. More.

Those motions of generations and corruptions, and of the *conducibles* thereunto, are wisely and admirably ordered and contemporated by the rector of all things.

Hale.

None of these magnetical experiments are sufficient for a perpetual motion, though those kind of qualities seem most *conducibile* unto it.

Wilkin's Mathematical Magick.

I mention some examples of the *conduciveness* of the smallness of a body's parts to its fluidity.

Boyle.

An action, however *conducive* to the good of our country, will be represented as prejudicial to it.

Addison's Freeholder.

Every man does love or hate things, according as he apprehends them to *conduce* to this end, or to contradict it.

Tillemont.

They may *conduce* to farther discoveries for completing the theory of light.

Newton.

Our Saviour hath enjoined us a reasonable service; all his laws are in themselves *conducibile* to the temporal interest of them that observe them.

Bensley.

CONDUCT, v. a.
 CONDUCT, n. s.
 CONDUCTING, n. s.
 CONDUCTION, n. s.
 CONDUCTIOUS, ad.
 CONDUCTOR, n. s.
 CONDUCTRESS, n. s.

Fr. *conduire*; Ital. *condurre*; Span. *conducir*; Lat. *conducere*.
 To lead; to direct; to guide; to have the management of; to command troops; to usher

in. Conduct signifies the management of an affair; course of action; regularity of behaviour; the act of escorting or guarding; a guide; and, with the addition of the adjective *safe*, a written order to ensure protection from being injured. Conductious means hired. Conduction is an obsolete word for the act of training up. In addition to its obvious senses, conductor denotes a surgical instrument, and a body capable of transmitting the electric fluid. See ELECTRICITY and SURGERY.

I was ashamed to ask the king footmen and horsemen, and *conduct* for safeguard against our adversaries, *Ecdas 1.*

So having all things well about her dight,
 She on her way cast forward to proceede,
 And they her forth *conducted*.

Spenser's Faerie Queene.

Pray receive them nobly, and *conduct* them
 Into our presence. *Shakespeare. Henry VIII.*

Some three or four of you,
 Go, give him courteous *conduct* to this place. *Id.*

His majesty,

Tendering my person's safety, hath appointed
 This *conduct* to convey me to the Tower.

Id. Richard III.

Who is *conductor* of his people?
 As 'tis said, the bastard son of Gloucester.

Id. King Lear.

Young men, in the *conduct* and manage of actions,
 embrace more than they can hold, stir more than they
 can quiet, and fly to the end without consideration of
 the means. *Bacon.*

I shall straight *conduct* you to a hill side, where I
 will point you out the right path.

Milton on Education.

Conduct of armies is a prince's art. *Waller.*

O may thy power, propitious still to me,
Conduct my steps to find the fatal tree,

In this deep forest. *Dryden's Æneid.*

How void of reason are our hopes and fears!

What in the *conduct* of our life appears

So well designed, so luckily begun,

But when we have our wish, we wish undone?

Id. Juvenal.

Shame of change, and fear of future ill:

And zeal, the blind *conductor* of the will. *Id.*

Every man must, some time or other, be trusted

to himself and his own *conduct*; and he that is a

good, virtuous, and able man, must be made so within.

Locke.

If he did not entirely project the union and re-

gency, none will deny him to have been the chief

conductor in both. *Addison.*

Though all regard for reputation is not quite laid

aside, it is so low, that very few think virtue and *con-*

duct of absolute necessity for preserving it. *Swift.*

The persons were neither titularies nor perpetual

curates, but entirely *conductionious*, and removeable at

pleasure. *Ayliffe.*

There are even a sort of splendid impositions so

well contrived, that, at the very time the path of rec-

titude is quitted for ever, men seem to be advancing

into some higher and nobler road of public *conduct*.

Burke.

If an inquiry has carefully *conducted* should fail at
 last of discovering the truth, it may answer an end
 perhaps as useful, in discovering to us the weakness of
 our own understanding. If it does not make us know-
 ing, it makes us modest. *Id.*

His fable is well *conducted*, and for the most part
 consistent with itself, and connected with probable
 circumstances. *Beattie.*

Instead of advising their king to consult his own
 and his peoples' dignity, by making the law the rule
 of his *conduct*, they have used him much more cruelly
 than our Charles I. was used; they have made him a
 prisoner and a slave. *Id.*

Thou withered sibyl, my sage *conductress* (Fragal-
 ity), usher me into the refulgent, adored presence.
 The power (Wealth), splendid and potent as he now
 is, was once the puling nursing of thy faithful care
 and tender arms. *Burns.*

Here Ouse, slow winding through a level plain
 Of spacious meads, with cattle sprinkled o'er,
Conducts the eye along his sinuous course
 Delighted. *Cowper.*

The air, like all other bad *conductors* of electricity,
 is known to be a bad *conductor* of heat. *Darwin.*

CONDUCTORS, in electrical experiments, bodies
 that receive and communicate electricity.

CONDUCTORS, in surgery, are used in laying up
 sinuses and fistulas.

CONDUIT, n. Fr. *conduit*. A water course;
 the pipe whence the water obtains egress. It is
 derived from *conduct*, the water being *conducted*
 to the spot where it is wanted. The figurative
 use of the word is obvious.

The blode out of the wounde as brode asterte,
 As watir, whan the *conduits* broken is. *Chaucer.*

But all the liquor, which was foule and waste;

Not good nor serviceable elles for ought,

They in another great rownd vessel plaste,

Tell by a *conduit* pipe it thence was brought.

Spenser. Faerie Queene.

This face of mine is hid

In sap consuming winter's drizzled snow,

And all the *conduits* of my blood froze up.

Shakespeare.

I charge and command, that the *conduits* run
 nothing but claret wine. *Id. Henry VI.*

These *conduit* pipes of knowledge feed the mind;

But the other three attend the body still. *Davies.*

These organs of the nerves, which are the *conduits*

to convey them from without to their audience in the

brain. *Locke.*

God is the fountain of honour; and the *conduits*,

by which he conveys it to the sons of men, are virtu-

ous and generous practices. *South.*

Wise nature likewise, they suppose,

Has drawn two *conduits* down our nose. *Prior.*

CONDUITS are, in general, made of either

lead or iron; those of stone being expensive

and massy. The ancients, however, never used

any other: the Romans excelled all other na-

tions in the beauty of these works, above which

a great part of their city stood. The cement of

the stone works, beneath the water, soon became

as hard as the stones which they joined, and the

cloacine of Rome are yet among its most cele-

brated antiquities. In Cheapside, London, there

were once two celebrated conduits, the *Great* and

the *Little*. The *Great* conduit was the first cis-

tern of lead erected in the city: it was built in

1285, and constructed principally of castellated

stone. At the procession of Anne Boleyn it was

repaired, and ran with white and claret wine all

the afternoon.

CONDUPLICATE, *v. a.* } Lat. *conduplic-*
CONDUPLICATION, *n. s.* } *co, conduplicatio.*
 To double, doubling.

CONDYLE, or the **CONDYLOID PROCESS**.
 See **ANATOMY**.

CONDYLOMA, in medicine, a tubercle, or callous eminence, which arises in the folds of the anus, or rather a swelling or hardening of the wrinkles of that part.

CONDYLUS, in anatomy, a knot in any of the joints, formed by the epiphysis of a bone.

CONE, *n. s.* } Fr. *cone*; Ital. and
CONIC, *adj.* } Span. *cono*; Lat. *conus*;

CO'NICAL, *adj.* } *κωνος*. A solid body,
CO'NICALNESS, *n. s.* } the base of which is cir-
CO'NICALITY, *adv.* } cular, and which gra-
CON'FEROUS, *adj.* } dually diminishes in
CON'OID, *n. s.* } diameter, till it ends in
CON'OIDICAL, *adj.* } a point; also the fruit of

the fir tree. **Conoid** signifies a figure which bears a resemblance to a cone. **Coniferous** is defined in the quotation from Quincy. The meaning of the kindred words is obvious. See **CONIC SECTIONS**.

Now had night measured with her shadowy *cone*
 Half way up hill this vast sublunar vault.
Paradise Lost.

The tympanum is not capable of tension as a drum: there remains another way, by drawing it to the centre into a *conoid* form. *Holder.*

In a watering pot, shaped *conically*, or like a sugar-loaf, filled with water, no liquor falls through the holes at the bottom, whilst the gardener keeps his thumb upon the orifice at the top.

Boyle's Spring of the Air.
 The *cones* dependent, long, and smooth, growing from the top of the branch. *Keelyn.*

Tow'ring fire in *conic* forms arise,
 And with a pointed spear divide the skies. *Prior.*
 A brown flint of a *conic* figure: the basis is oblong. *Woodward.*

They are *conical* vessels, with their bases towards the heart; and, as they pass on, their diameters grow still less. *Arbutnot.*

Such trees or herbs are *coniferous*, as bear a squamous scaly fruit, of a woody substance, and a figure approaching to a *cone*, in which are many seeds; and when they are ripe, the several cells in the *cone* open, and the seeds drop out. Of this kind are the fir, pine, and beech. *Quincy.*

Burst from each pyramid expiring groans,
 And darker shadows stretched their lengthened *cones*.
Darwin.

In the West Indies the sea rises like a *cone* in the whirl, and is met by black clouds produced by the cold upper air and the warm lower air being rapidly mixed; whence are produced the great and sudden rains called water-spouts; while the upper and lower airs exchange their plus or minus electricity in perpetual lightnings. *Id.*

But, as these are necessarily more or less of a cylindrical or *cone* form, the nodules or globular flints above described, cannot have been constructed in this manner. *Id.*

CONE, in botany. See **CONUS**.

CONE, in geometry. See **CONIC SECTIONS**.

CONE, **MELTING**, in chemistry, is a hollow cone formed of copper or brass, with a handle, and with a flat bottom adjoining to the apex of the cone, upon which it is intended to rest. Its use is to receive a mass of one or more metals

melted together, and cast into it. This mass, when cold, may be easily shook out of the vessel, from its figure. Also, if a melted mass consisting of two or more metals, or other substances not combined together, be poured into this vessel, the conical figure facilitates the separation of these substances according to their respective densities. The cone ought to be well heated before the melted mass is thrown into it; that it may not contain any moisture, which would occasion a dangerous explosion. It ought also to be greased internally with tallow, to prevent the adhesion of the fluid matter.

CONE OF RAYS, in optics, includes all the several rays which fall from any radiant point upon the surface of a glass.

CONEY. See **CONY**.

CONFABULATE, *v. n.* } Old Fr. *confa-*
CONFABULATION, *n. s.* } *buler*; Lat. *confa-*
CONFABULATORY, *adj.* } *bulo*. To talk fa-
 miliarly together; to narrate tales; prattling; familiar talk; belonging to such talk.

I was going on in my *confabulation*, when Tranquillus entered. *Taylor.*

I shall not ask Jean Jacques Rousseau
 If birds *confabulate* or no;
 'Tis clear that they were always able
 To hold discourse at least in fable.

And even the child, who knows no better
 Than to interpret by the letter
 A story of a cock and bull,
 Must have a most uncommon skull. *Cowper.*

CONFAMILIAR, *adj.* Compounded of *con* and *familiar*. Glanville uses it to signify that which has an intimate connexion with.

CONFARRATION, *n. s.* Lat. *confarratio*. From *far*, corn. The solemnisation of marriage by eating bread together.

By the ancient laws of Romulus, the wife was by *confarration* joined to the husband. *Ayliffe's Par.*

CONFARRATION, among the ancient Romans, was used in the marriage of persons whose children were destined for the priesthood. It was the most sacred of their three modes of marrying. The pontifex maximus and flamen dialis joined and contracted the man and woman, by making them eat of the same cake of salted bread: whence the term *far*, signifying meal or flour. Ulpian says, it consisted in the offering up of some pure wheaten bread, and rehearsing a certain formula, in presence of ten witnesses.

Dionysius Halicarnassus adds, that the husband and wife did eat of the same.

CONFATED, *adj.* From *con* and *fate*. The word is of rare occurrence. In Search's Free will, &c., it is used to signify synonymously decreed; decreed at the same time with something else.

CONFECT, *v. a. & n. s.* } Fr. *confection*;
CONFECTION, *n. s.* } Ital. *confezione*; Sp.
CONFECTED, *ad.* } *confeccion*; Lat. *con-*
CONFECTORY, *n. s.* } *ficere*. To confect
CONFECTORER, *n. s.* } is, to make sweet-
CONFECTORY, *adj.* } meats with sugar;

or to preserve by means of that substance. **Confect**, now corrupted into *comfit*, is a sweetmeat, generally solid, and in the shape of small spheres or eggs. **Confection** signifies, primarily, a sweetmeat, or fruit preserved with sugar; and, secondarily, an assemblage of various ingredients.

The confectioner, or confectionary, is the person whose trade it is to make sweetmeats, desert cakes, and other delicacies of a similar kind.

Spices belonging to the potiquanes,
With many wholesome swete confections. *Henderson.*
Hast thou not learned me to preserve? yea so,
That our great king himself doth woo me oft
For my confections? *Shakespeare. Cymbelins.*
Of best things then, what world shall yield con-

fection
To liken her? *Shakespeare.*

Myself,
Who had the world as my confectionary,
The mouths, the tongues, the eyes, the hearts of men
At duty, more than I could frame employments. *Id.*

There will be a new confection of mould, which
perhaps will alter the seed. *Bacon.*

At supper eat a pippin roasted, and sweetened
with sugar of roses and carraway confects.

Harvey on Consumptions.

Nature's confectioner, the bee,
Whose suckers are moist alchimy,
The still of his refining mold
Minting the garden into gold. *Cleaveland.*

Confectioners make much use of whites of eggs.
Boyle.

He saw him devour fish and flesh, swallow wines
and spices, confections, and fruits of numberless
sweets and flavours. *Addison.*

The morning bounties ere I left my home.
The biscuit, or confectionary plum;
The fragrant waters on my cheeks bestowed
By thy own hand, till fresh they shone and glowed;
All this, and, more endearing still than all,
Thy constant flow of love, that knew no fall.

Cowper.

CONFECTOR, among the ancient Romans, a
sort of gladiator, hired to fight in the amphithe-
atre against beasts; thus called à conficiendis
bestiis, from their despatching and killing beasts.
The Greeks called them παραβολος, q. d. daring,
rash, desperate; whence the Latins borrowed
the appellations parabolani and parabolarii. The
Christians were sometimes condemned to this
sort of combat.

CONFEDER, v. a.
CONFEDERATE, v. a., n., n. s., adj. } Fr. con-
CONFEDERATING, n. s. } federer;
CONFEDERATION, n. s. } Ital. con-
CONFEDERACY, n. s. } federare;
CONFEDERATOR, n. s. } Sp. con-
federar;

Lat con & fedus. To confederate is, to league
together; to combine for the purpose of mu-
tually supporting, or conjointly attacking. A
confederation, or confederacy, is the league or
alliance so formed; and a confederate, or con-
federator, is one of the members of that alliance.
To confeder is obsolete.

For they have consulted together with one con-
sent: they are confederate against thee.

Psalm lxxxi. 5.

Judas sent them to Rome, to make a league of amity
and confederacy with them. *1 Macc. viii. 17.*

About her horse there stodin lustly
Withoutin any mo as thoughtin me,
Bountie, peritely well armed and richely,
And freshe Beaute, and Lust, and Jolite,
Asmerid Maner, Youthe, and Honeste,
Wisdomme, Estate, with Drede and Govirnaunce,
Confesid both by bonde and aliuaunce. *Chaucer.*

VOL. VI.

All the swords
In Italy, and her confederate arms,
Could not have made this peace.

Shakespeare. Coriolanus

Sir Edmond Courtney, and the haughty prelate,
With many more confederates, are in arms.

Id. Richard III.

What confederacy have you with the traitors?

Id. King Lear.

While the mind of man looketh upon second causes
scattered, it may sometimes rest in them, and go no
farther; but, when it beholdeth the chain of them
confederate and linked together, it must need fly to
providence and deity. *Bacon.*

The three princes enter into some strict league
and confederation amongst themselves.

Bacon's Henry VII.

They were confederated with Charles's enemy.
Knolles.

With these the Piercies them confederate,
And as three heads conjoin in one intent. *Daniel.*
Nor can those confederations or designs be durable,
when subjects make bankrupt of their allegiance.

King Charles.

By words men come to know one another's minds;
by those they covenant and confederate. *South.*

This is a principle which is thought to extend itself
to the dens of thieves, and the confederacies of the
greatest villains. *Locke.*

Virgil has a whole confederacy against him, and I
must endeavour to defend him. *Dryden.*

We still have fresh recruits in store,
If our confederates can afford us more. *Id. Æneid.*
It is a confederating with him to whom the sacrifice
is offered. *Atterbury.*

In a confederate war, it ought to be considered
which party has the deepest share in the quarrel.

Swift.

An avaricious man in office is in confederacy with
the whole clan of his district, or dependance; which,
in modern terms of art, is called to live and let live.

Id.

The friendships of the world are oft
Confederacies in vice, or leagues of pleasur.

Addison.

Oh race confederate into crimes, that prove
Triumphant o'er the eluded rage of Jove!

Pope's Statius.

But there is yet a liberty, unsung
By poets, and by senators unpraised,
Which monarchs cannot grant, nor all the powers
Of earth and hell confederate take away. *Cowper.*
Bad men, profaning friendship's hallowed name,
Form, in its stead, a covenant of shame:
A dark confederacy against the laws
Of virtue, and religion's glorious cause. *Id.*

The minister, however, takes no strong ground of
defence. I will not say he dare not take it. There
he sits, to receive the attack of the new confederacy,
who are not great in numbers, but in talents. The
ex-minister is mounted on a kind of hill-fort, to fire
down on the assailants, but the garrison is all manned
with deserters from the principles of the war!

Sheridan.

CONFEDERACY, in law. See CONSPIRACY.

CONFEDERATION OF THE RHINE, the title
by which several German states near the Rhine
associated themselves into a body, at the com-
mand, and under the protection, of the late
emperor Napoleon Buonaparte. These states
were formerly under the protection of the empe-
ror of Germany, and owed to him a certain
degree of allegiance; but, after humbling the
house of Austria in 1805, her haughty conqueror

proceeded to diminish, or to annihilate, the influence of her authority, beyond the boundary of her own territories. He effectually dissolved the constitution of the German empire, forced Francis II. to abdicate what, in fact, had been for some time only a title of dignity, without any substantial power, and united under his own superintendence, and for his own aggrandisement, the most considerable states, which had formerly acknowledged a real or nominal subjection to the emperor. The league by which they were bound together was drawn up by the French government, and contained forty stipulations, possessing at this time but little interest. It was signed at Paris, August, 1806.

CONFERR, *v. a. & n.* Fr. *conferer*; It. *conferenza*, *n. s.* } *ferire*; Sp. *conferir*;
 CONFERENCE, *n. s.* } Lat. *conferre*. To dis-
 CONFERRER, *n. s.* } course seriously, dis-
 CONFERRING, *n. s.* } cuss, or advise, together; to compare opinions and sentiments; to give; to bestow; and (but not of common use) to contribute or conduce to anything. Conference signifies conversing or discussing seriously; a formal meeting, convened for the purpose of discussing some important point; collation and comparison of things. Byron uses the verb in the sense of inflicted, which is, at least, unusual. When taken in the sense of to bestow, confer has on taken in the receiver of the gift; when it means to contribute it has to.

When they had commanded them to go aside out of the council, they *conferred* among themselves.

Actu iv. 15.

The *conference* of these two places, containing so excellent a piece of learning as this, expressed by so worthy a wit as Tully's was, must needs bring on pleasure to him that maketh true account of learning.

Ascham's Schoolmaster.

Sometime they deliver it, whom privately zeal and piety moveth to be instructors of others by *conference*; sometime of them it is taught, whom the church hath called to the public, either reading thereof, or interpreting.

Hooker.

You will hear us *confer* of this, and by an auricular assurance have your satisfaction.

Shakspeare. King Lear.

What passion hangs these weights upon my tongue! I cannot speak to her; yet she urged *conference*.

Shakspeare.

I shall grow skilful in country matters, if I have often *conference* with your servant.

Sidney.

Reading makes a full man, *conference* a ready man, and writing an exact man; and therefore, if a man write little, he had need have a great memory; if he *confer* little, he had need have a present wit; and, if he read little, he had need have much cunning, to seem to know that he doth not.

Bacon.

The words in the eighth verse *conferred* with the same words in the twentieth, make it manifest.

Raleigh.

Pliny *conferring* his authors, and comparing their works together, found those that went before transcribed by those that followed.

Browne.

Rest to the limbs, and quiet I *confer*

On troubled minds.

Waller.

He was thought to *confer* with the lord Colepeper upon the subject; but had some particular thoughts, upon which he then *conferred* with nobody.

Clarendon.

The *conferring* this honor upon him would increase the credit he had.

Coronation to a king, *confers* no royal authority upon him.

South.

If we *confer* these observations with others of the like nature, we may find cause to rectify the general opinion.

Boyle.

The Christian princess in her tent *confers* With fifty of your learned philosophera;
 Whom with such eloquence she does persuade,
 That they are captives to her reasons made.

Dryden's Tyrannic Love.

There is not the least intimation in scripture of this privilege *conferred* upon the Roman church.

Tillotson.

Thou *conferrest* the benefits, and he receives them; the first produces love, and the last ingratitude.

Arbutnot's Hist. of John Bull.

— I shall say nothing at all to your mad present — you have so long and often been of important service to me; and I suppose you mean to go on *confering* obligations until I shall not be able to lift up my face before you.

Burns.

On Noah, and in him on all mankind,
 The charter was *conferred*, by which we hold
 The flesh of animals in fee, and claim
 O'er all we feed on, power of life and death.

Cowper.

Much conversant with heaven, she often holds,
 With those fair ministers of light to man,
 That fill the skies nightly with silent pomp,
 Sweet *conference*.

Id.

It is not that I may not have incurred
 For my ancestral faults or mine the wound
 I bleed withal; and, had it been *conferred*
 With a just weapon, it had flowed unbound

Byron. Childe Harold.

CONFESS, *v. a. & v. n.*

CONFESSING, *n. s.*

CONFESSEDLY, *adv.*

CONFESS'ION, *n. s.*

CONFESS'IONAL, *n. s.*

CONFESS'IONARY, *n. s.*

CONFESS'IONIST, *n. s.*

CONFESS'OR, *n. s.*

CONFES'T, *adj.*

CONFES'TLY, *adv.*

CO'NFITENT, *n. s.*

Fr. *confesser*;
 It. *confessare*; Sp. *confesar*;
 Lat. *confiteri*. To disclose; to acknowledge; to own; to show; to attest; to shrieve; to admit to be true. Such are the meanings of the verb. Confession

signifies the acknowledgment of a crime; avowal; a formulary, containing articles of faith. Confessor has the three-fold meaning of one who boldly avows his faith, at the risk of life or fortune; a priest, who shrieves a penitent; one who owns his crimes. The confessional and confessionalary denote the box in which the priest sits to hear the penitent. Confest, a poetical word for confessed, has the sense of open; acknowledged; undisputed; apparent. A confessor or confitent, is he who confesses anything.

Whosoever therefore shall *confess* me before men, him will I *confess* also before my Father which is in heaven; but whosoever shall deny me before men, him will I also deny before my Father which is in heaven.

Matt. x. 32, 33.

Who, before Pontius Pilate, witnessed a good *confession*.

1 Tim. vi. 13.

He must *confess* him of all the conditions that belongeth to his sinne as forfoth as he can.

Chaucer. Cant. Tales.

Your owen mouth, by your *confession*, Hath damned you, and I wel it recorde.

Id.

Ful swetely herde he *confession*,

And pleasant was his abolution,
 He was an esy man to give penance.

Id.

Whereto himself he did to witness call,
Who being askt, accordingly *confessed* all.

Spenser's Faerie Queene.

He doth in some sort *confess* it—If it be *confessed*, it is not redressed.

Shakespeare. Merry Wives of Windsor.

If that the king

Have any way your good deserts forgot,

Which he *confesseth* to be manifold,

He bids you name your griefs.

Id.

Confess thee freely of thy sin ;

For to deny each article with oath,

Cannot remove nor choke the strong conception.

Id. Othello.

If there be one amongst the fair'st of Greece,
That loves his mistress more than in *confession*,
And dare avow her beauty and her worth
In other arms than hers ; to him this challenge.

Id. Troilus and Cressida.

See that Claudio

Be executed by nine to-morrow morning ;

Bring him his *confessor*, let him be prepared ;

For that's the utmost of his pilgrimage.

Id. Measure for Measure.

The doctrine in the thirty-nine articles is so orthodoxly settled, as cannot be questioned without danger to our religion, which hath been sealed with the blood of so many martyrs and *confessors*.

Bacon's Advice to Villiers.

Your engaging me first in this adventure of the Moxa, and desiring the story of it from me, is like giving one the torture, and then asking his *confession*, which is hard usage.

Temple.

They address to that principle which is *confessively* predominant in our nature.

Decay of Piety.

If we directly *confess*, you must commend his ingenuity, and pardon the fault, be it what it will, and pardon it so, that you never so much as reproach him with it, or mention it to him again : for, if you would have him in love with ingenuity, and by a constant practise make it habitual to him, you must take care that it never procure him the least inconvenience ; but, on the contrary, his own *confession*, bringing always with it perfect impunity, should be, besides, encouraged with some marks of approbation.

Locke.

I must *confess* I was most pleased with a beautiful prospect, that none of them have mentioned.

Addison on Italy.

In one of the churches I saw a pulpit and *confessional*, very finely inlaid with lapis-lazuli.

Id.

The patience and fortitude of a martyr or *confessor* lie concealed in the flourishing times of Christianity.

Id. Spectator.

Our beautiful votary took the opportunity of *confessing* herself to this celebrated father.

Id.

Tall thriving trees *confessed* the fruitful mould ;

The reddening apple ripens here to gold.

Pope's Odyssey.

Great geniusses, like great ministers, though they are *confessedly* the first in the commonwealth of letters, must be envied and calumniated.

Pope's Essay on Homer.

Human faults with human grief *confess* ;

'Tis thou art changed.

Prior.

But wherefore should I seek

Since the perfidious author stands *confest* ?

This villain has traduced me.

Rome's Royal Conv.

If our sin be only against God, yet to *confess* it to his minister may be of good use.

Wake's Preparation for Death.

I guess by the dear angel smile,

I guess by the love-rolling eye ;

But why urge the tender *confession*

'Gainst fortune's fell cruel decree—*Jeany.*

Burns.

How can I prevent all these arts of royal policy and all these displays of royal magnificence ? How can I prevent the successor of Frederick the Great from aspiring to a new, and, in this age, unexampled kind of glory ! Is it in my power to say that he shall not make his *confessions* in the style of St. Austin or of Rousseau ?

Burke

Can a truth by all *confessed*

Of such magnitude and weight,

Grow, by being oft impressed,

Trivial as a parrot's prate ?

Cooper.

Harmonious speech, whose pure and liquid tone Gives verse a music, scarce *confessed* its own ; As light from gems assumes a brighter ray, And clothed with orient hues, transcends the day.

Scribner.

Long had the giant form on Gallia's plains Inglorious slept, unconscious of his chains ; Round his large limbs were wound a thousand strings,

By the weak hands of *confessors* and kings.

Darwin.

From storms of hate thy mariner

And blast of chill indifference save ;

So to thy power I'll frame the votive lay

And moored in Lesbia's arms *confess* thy sovereign sway.

Id.

Oh never yet beneath

The breast of man such trusty love may breathe !

That trying moment has at once revealed

The secret long, and yet but half concealed ;

In baring to revive that lifeless breast,

Its grief seemed ended—but the sex *confest*.

Byron. Lara.

Never at our vesper prayer,

Nor e'er before *confession* chair

Kneels he, nor rocks he where arise

Incense or anthem to the skies,

But broods within his cell alone,

His faith and race alike unknown.

Id. The Giaour.

CONFESSION, among the Romish divines, has been advanced to the dignity of a sacrament. It is made to the priest, and is private and auricular. The priest is not to reveal what he hears in confession, under pain of the highest punishment. Catholics quote from the fathers, 'If the serpent, the devil, secretly bite a man, and thus infect him with the poison of sin, and this man still remain silent, and not do penance, nor be willing to make known his wound to his brother and master: the master who has a tongue that can heal, cannot be of service to him.' To which Protestants object that the priest is neither master nor physician in this case ; and is not competent to heal. The Romanists however add, 'The confession of sin is profitable [only] if amendment follow. For where is the use of showing the wound, if the medicine be not applied ?'

CONFESSION, in our law, is never to be divided, but always taken entire. A criminal is never condemned on his simple confession, without other collateral proofs ; nor is a voluntary extrajudicial confession admitted as any proof. A person is not admitted to accuse himself, according to that rule in law, *nemo auditur perire volens*.

CONFESSIONAL, or CONFESSIONARY, was also a place in churches under the great altar,

where the bodies of deceased saints, martyrs, and confessors, were deposited.

CONFESSOR, in ecclesiastical history, the word is frequently used for martyr; in after times it was confined to those who, after having been tormented by the tyrants, were permitted to live and die in peace. And at last it was also used for those who, after having lived a good life, died under an opinion of sanctity.

CONFESSOR, in the Romish church, also gives absolution. The church calls him in Latin confessorius, to distinguish him from confessor, a name consecrated to saints. The confessors of the kings of France, from the time of Henry IV. were constantly Jesuits: before him the Dominicans and Cordeliers shared the office between them.

CONFICIENT, *adj.* Lat. *conficiens*. That which causes or brings about; having efficacy.

CONFIDE, *v. n. & a.* Fr. *confier*; Ital. *confidarsi*; Sp. *confiar*. To put faith in; to trust implicitly, is the primary idea of to confide, and of all the words belonging to the same stock. Confidence, confident, and confidently, in some instances, are expressive of censure: they signify qualities, in themselves praiseworthy, carried to an excess; pushed into the limits of overbearingness or impudence. Confidential and confidentially, which imply an obligation to keep secret, are words of modern introduction; but are completely naturalised. A confidant is one who is entrusted with the secrets of the confider, and chiefly with those relating to love. Thus spelled, it is derived from the French, *confidant*. The English word confident has the same meaning.

CONFIDENCE, *n. s.*

CONFIDENT, *n. s. & adj.*

CONFIDENTIAL, *adj.*

CONFIDENTIALLY, *adv.*

CONFIDENTLY, *adv.*

CONFIDENTNESS, *n. s.*

CONFIDER, *n. s.*

CONFIDANT, *n. s.*

Beloved, if our heart condemn us not, then have we confidence towards God. 1 John iii. 21.
Be merciful unto them which have not the confidence of good works. 2 Eod. vit. 36.
Be not confident in a plain way. Eccl. xxxii. 21.
Submit you to high Providence, And ever in your noble hart prepenche, That all the sorrow in the world is lesse Than vertue's might, and value's confidence. Spenser. Faerie Queene.
Yet stirred not at all for doubt of more, But kept her place with courage confident. Id.
Sith only God surmounts all time's decay, In God alone my confidence do stay. Id. Visions of Ballay.
The fervent reprehenders of things established by public authority, are always confident and bold-spirited men; but their confidence, for the most part, riseth from too much credit given to their own wits, for which cause they are seldom free from errors. Hooker. Dedication.
Both valiant, as men despising death; both confident, as unwonted to be overcome. Sidney.
Alas, my lord, Your wisdom is consumed in confidence, Do not go forth to-day. Shakespeare. Julius Cæsar.
Douglas and the Hotspur, both together, Are confident against the world in arms. Id. Henry IV.

It is strange how the ancients took up experiments upon credit, and yet did build great matters upon them: the observation of some of the best of them, delivered confidently, is, that a vessel filled with ashes will receive the like quantity of water as if it had been empty; this is utterly untrue. Bacon.

Just confidence and native righteousness, And honor. Milton's Paradise Lost.

He had an ambition and vanity, and a confidence in himself, which sometimes intoxicated, and transported, and exposed him. Clarendon.

I am confident that very much may be done towards the improvement of philosophy. Boyle.

People forget how little they know, when they grow confident upon any present state of things. South.

Society is built on trust, and trust upon confidence of one another's integrity. Id.

Every fool may believe, and pronounce confidently, but wise men will conclude firmly. Id.

It is preposterous, therefore, to sacrifice his innocency to the attaining of confidences, and some little skill of bustling for himself among others, by his conversation with ill-bred and vicious boys; when the chief use of that sturdiness, and standing upon his own legs, is only for the preservation of his virtue. Locke.

Aristotle was certainly a knowing man, but nobody ever thought him so, because he blindly embraced, and confidently vented, the opinions of another. Id.

Confidence is a plant of slow growth in aged bosoms. Lord Chatham.

He alone won't betray, in whom none will confide. Congreve.

Martin composed his billet-deux, and entrusted it to his confidant. Arbuthnot and Pope.

We shall not be ever the less likely to meet with success, if we do not expect it too confidently. Atterbury.

He may sacrifice the royalists of France, whom he had called to his standard, as a salutary example to those who shall adhere to their native sovereignty, or shall confide in any other who undertakes the cause of oppressed kings and of loyal subjects. Burke.

It is an erect countenance; it is a firm adherence to principle; it is a power of resisting false shame and frivolous fear, that assert our good faith and honour, and assure to us the confidence of mankind. Id.

The man I trust, if shy to me, Shall find me as reserved as he; No subterfuge or pleading Shall win my confidence again, I will by no means entertain A spy on my proceeding. Conspir.

Sweet moralist! afloat on life's rough sea, The Christian has an art unknown to thee. He holds no parley with unmanly fears; Where duty bids he confidently steers, Faces a thousand dangers at her call, And, trusting in his God, surmounts them all. Id.
SIR BENJ.—To say truth, ma'am, 'tis very vulgar to print; and, as my little productions are mostly satires and lampoons on particular people, I find they circulate more by giving copies in confidence to the friends of the parties. Sheridan. School for Scandal.

CONFIGURATE, *v. n.* } Ital. *configurare*;
CONFIGURE, *v. a.* } Sp. *configurar*; Fr.
CONFIGURATION, *n. s.* } *configuration*; Ital. *configurazione*; Sp. *configuracion*; Lat *con* and *figura*. To configure is to adapt to a form; to configurate is to show like the mutual aspects of the planets. Configuration signifies the figure of the parts of anything; the outline of a thing;

and also the conjunction, or mutual aspects of stars.

He that was sharp-sighted enough to see the configuration of the minute particles of the spring of a clock, and observe upon what peculiar structure and impulse its elastic motion depends, would no doubt discover something very admirable; but if eyes so framed could not view at once the hand and the characters of the hour-plate, and thereby at a distance see what o'clock it was, their owner could not be much benefited by that acuteness; which, whilst it discovered the secret contrivance of the parts of the machine, made him lose its use. *Locks.*

The different effects of fire and water, which we call heat and cold, result from the so differing configuration and agitation of their particles. *Glanville's Sceptis.*

No other account can be given of the different animal secretions, than the different configuration and action of the solid parts. *Arbutnot on Aliments.*

There is no plastick virtue concerned in shaping them, but the configurations of the particles whereof they consist. *Woodward.*

Mother earth brought forth legs, arms, and other members of the body, scattered and distinct, at their full growth; which coming together, cementing and so configuring themselves into human shape, made lusty men. *Bentley's Sermons.*

Ideas consist of synchronous motions or configurations of the extremities of the organs of sense. *Darwin.*

CONFINE, v. a. & n. Fr. *confiner*; Ital. *confinare*; Span. *confinar*; Lat. *confinis*.
CONFINE, n. s. & adj. *confinare*; Span. *confinar*; Lat. *confinis*.
CONFIRMEDNESS, n. s. Limiting, circumscribing, retaining within certain bounds, is the master idea in all this class of words. To
CONFINELESS, adj.
CONFINEMENT, n. s.
CONFINER, n. s.
CONFINABLE,
CONFINITY, n. s.

confine, therefore, is to enclose, to restrain within a definite space; to immure; to fasten to or up. A confiner is one who lives on the confines or frontiers of a country; or who is a near neighbour; also one who puts another into confinement; and it is applied to things as well as to persons. Confinity signifies proximity.

I'll not over the threshold,—
—Fy, you confine yourself most unreasonably:
Come, you must go visit the good lady.

Shakespeare. Coriolanus.

I had been

As broad and general as the casing air;
But now I'm cabined, cribbed, confined, bound in.

Id.

Here in these confines slyly have I lurked,
To watch the waining of mine enemies.

Id. Richard III.

But that I love the gentle Desdemona,
I would not my unhusbed, free condition,
Put into circumscription and confine,
For the sea's worth.

Id. Othello.

The senate hath stirred up the confiners.

Id. Cymbeline.

Esteem him as a lamb, being compared
With my confineless harms.

Id. Macbeth.

The participles or confiners between plants and living creatures are such as have no local motion; such as oysters.

Bacon.

Half lost, I seek

What readiest path leads where your gloomy bounds
Confine with heaven.

Milton's Paradise Lost.

All bodies are confined within some place,
But she (the soul) all place within herself confines.

Davies.

Happy confiners you of other lands,
That shift your soil. *Daniel's Civil War.*

Where honour or where conscience does not bind,
No other tie shall shackle me;
Slave to myself I will not be;
Nor shall my future actions be confined
By my own present mind. *Cowley.*

Though gladness and grief be opposite in nature,
yet they are such neighbours and confiners in art, that the least touch of a pencil will translate a crying into a laughing face. *Wotton.*

Make one man's fancies, or failings, confining laws to others, and convey them as such to their successors. *Boyle.*

The idea of duration, equal to a revolution of the sun, is applicable to duration, where no motion was; as the idea of a foot, taken from bodies here, to distances beyond the confines of the world, where are no bodies. *Locke.*

He is to confine himself to the compass of numbers, and the slavery of rhyme. *Dryden.*

Full in the midst of this created space,
Betwixt heaven, earth, and skies, there stands a place
Confining on all three. *Id.*

Our hidden foes,
Now joyful from their long confinement rose. *Dryden's Virgil.*

'Twas ebbing darkness, past the noon of night,
And Phosphor on the confines of the light. *Id. Fables.*

The mind hates restraint, and is apt to fancy itself under confinement when the sight is pent up. *Addison.*

No subtle nor superfluous lore he sought,
Nor ever wished his Edwin to pursue,
'Let man's own sphere,' said he, 'confine his view
Be man's peculiar work his sole delight.' *Beattie.*

Even to those persons whose powers of observation are confined within a narrow circle, the exercise of the necessary arts may open inexhaustible sources of amusement, to alleviate the cares of a solitary and laborious life. *Id.*

After six weeks confinement I am beginning to walk across the room. They have been six horrible weeks; anguish and low spirits made me unfit to read, write, or think. *Burns.*

Peace may be the lot of the mind
That seeks it in meekness and love:
But rapture and bliss are confined
To the glorified spirits above. *Cowper.*

Yet Lesbia! like thy lute though Orpheus strung
His lyre to strains divine, its amorous lord
For thee had left Eurydice unstung,
And Pluto's gloomy confines unexplored. *Huddesford.*

Huddesford.

CONFIRM, v. a. Fr. *confirmer*; It. *confirmare*; Span. *confirmar*; Lat. *confirmare*. To make
CONFIRMABLE, adj. *confirmare*. To make
CONFIRMANCE, n. s. *confirmare*. To make
CONFIRMATION, n. s. stable; to fix beyond
CONFIRMATIVE, adj. doubt; to
CONFIRMATOR, n. s. strengthen; to settle; to perfect; are
CONFIRMATORY, adj. the ideas conveyed
CONFIRMEDNESS, n. s. by the verb to confirm.
CONFIRMER, n. s. These meanings are attached to all its
CONFIRMINGLY, adv. kindred words, which, therefore, it is needless to define. See CONFIRMATION.

I confirm thee in the high priesthood, and appoint thee ruler. *1 Macc. xi. 57.*
The testimony of Christ was confirmed in you. *1 Cor. i. 6.*

Ye that have not chosen in humble wise,
Without repenting, cheseth now your make,
Yet at the lest reneweeth your service,
And ye that have full chosen, as I devise,
Confirmeth it perpetually to dure. *Chaucer.*

I consent, and *confirme* every del
Your wordes all, and your opinion.

Id. Cant. Tales.

And to *confirmin* my ressonne
Thou wotist wel that speche is sowne,
Or ellis no man might it here.

Id. House of Fame.

So settled he his kingdome, and *confirmed* his right.

Spenser's Fuerie Queene.

Confirm the crown to me and to mine heirs.

Shakespeare. Henry VI.

He only lived but till he was a man :

The which no sooner had his prowess *confirmed*,

But like a man he died.

Id. Macbeth.

Be these sad sighs *confirmer*s of thy words ?

Then speak again.

Id. King John.

Embrace and love this man.—

— With brother's love I do it.—

— And let heaven

Witness how dear I hold this *confirmation* !

Id. Henry VIII.

The sea-captains answered, that they would perform his command ; and in *confirmation* thereof promised not to do any thing which besecemed not valiant men.

Knolles's History.

So was his will

Pronounced among the gods, and by an oath,

Which shook heaven's whole circumference, *confirmed*.

Milton.

Confirmed then I resolve,

Adam shall share with me in bliss or woe.

Id.

There wants herein the definitive *confirmitor*, and test of things uncertain, the sense of man.

Browne.

Wanting frequent *confirmation* in a matter so confirmable, their affirmation carrieth but slow persuasion.

Id.

It may receive a spurious inmate, as is *confirmable* by many examples.

Id.

What is prepared for in catechising, is, in the next place, performed by *confirmation* ; a most profitable usage of the church, transcribed from the practice of the apostles.

Id.

The arguments brought by Christ for the *confirmation* of his doctrine, were in themselves sufficient.

South.

If the difficulty arise from the *confirmedness* of habit, every resistance weakens the habit, abates the difficulty.

Decay of Piety.

These divisions also have given occasion to the reading these epistles by parcels, and in scraps, which has farther *confirmed* the evil arising from such partitions.

Locke.

Whilst all the stars that round her burn,

And all the planets in their turn,

Confirm the tidings as they roll,

And spread the truth from pole to pole.

Addison's Spectator.

That treaty, so prejudicial, ought to have been committed rather than *confirmed*.

Swift.

But martyrs struggle for a brighter prize,
And win it with more pain. Their blood is shed
In *confirmation* of the noblest claim,
Our claim to feed upon immortal truth,
To walk with God, to be divinely free,
To soar, and to anticipate the skies.

Cowper.

Chained to the chariot of triumphal Art,
We stand as captives, and would not depart.

Away !—there need no words, nor terms precise.

The paltry jargon of the marble mart,

Where Pedantry gulls Folly—we have eyes :

Blood—pulse—and breast, *confirm* the Dardan shep-
herd's prize.

Byron. Childs Harold.

CONFIRMATION, in law, a conveyance of an estate, or right in esse, from one man to another, whereby a voidable estate is made sure and unavoidable, or a particular estate is increased, or a possession made perfect.

CONFIRMATION, in the established church, is the ceremony of laying on of hands. In the primitive church it was administered, we are told, after baptism, if the bishop happened to be present. Throughout the East, it still accompanies baptism ; but the Romanists make it a distinct independent sacrament ; and the person to be confirmed, has a god-father and god-mother appointed him, as in baptism.

CONFISCATE, *v. a. & adj.*

CONFISCATION, *n. s.*

CONFISCATOR, *n. s.*

CONFISCATORY, *adj.*

To confiscate is by the prince to seize, to his own use, the property of the subject, as the penalty of some crime, really or pretendedly committed. It is a common resource of tyrants, and numerous modern examples of it have been afforded by Spain, under the dominion of the worthless Ferdinand. The origin of the word is thus traced by Cowel. ' Confiscare, confisquer, i. e. in publicum addicere ; from fiscus, which originally signifieth a hamper, pannier, basket, or freil ; but metonymically the emperor's treasure, because it was anciently kept in such hampers.' Shakspeare uses the adjective, confiscate, with the accent on the first syllable.

Thy lands and goods

Are, by the laws of Venice, *confiscate*

Unto the state of Venice.

Shakspeare. Merchant of Venice.

It was judged that he should be banished, and his whole estate *confiscated* and seized, and his houses pulled down.

Bacon.

It was in every man's eye, what great forfeitures and *confiscations* he had at that present to help himself.

Id. Henry VII.

Whatever fish the vulgar fry excel,

Belong to Cæsar, wheresoe'er they swim,

By their own worth *confiscated* to him.

Dryden's Juvenal.

So that no constitution fancier may go unsuited from his shop, provided he loves a pattern of pillage, oppression, arbitrary imprisonment, *confiscation*, exile, revolutionary judgment, and legalised premeditated murder, in any shapes into which they can be put.

Burke.

I see the *confiscators* begin with bishops, and chapters, and monasteries ; but I do not see them end there.

Id.

Those terrible *confiscatory* periods.

Id.

He fished

For wandering merchant vessels, now and then,

And sometimes caught as many as he wished ;

The cargoes he *confiscated*, and gain

He sought in the slave-market too, and dished

Full many a morsel for that Turkish trade,

By which, no doubt, a good deal may be made.

Byron. Don Juan.

CONFIT, *n. s.* } Fr. *confit*; Ital. *confitura*.
CONFITURE, *n. s.* } *fetta*; Sp. *confite*; Lat. *confectura*. A comfit; a sweetmeat; a confection.

It is certain, that there be some houses wherein *confitures* and pies will gather mould more than in others. *Bacon.*

We contain a *confiture* house, where we make all sweetmeats, dry and moist, and divers pleasant wines. *Id.*

Would you not use me scurvily again, and give me possets with purging *confits* in't?

Bosworth and Fletcher.

CONFIX, *v. a.* } Lat. *configo*, *confixum*.
CONFIXURE, *n. s.* } To fix down; to fasten; the act of fastening.

As this is true,

Let me in safety raise me from my knees;

Or else for ever be *confixed* here,

A marble monument!

Shakespeare. Measure for Measure.

CONFLAGRANT, *adj.* } Fr. *conflagration*;
CONFLAGRATION, *n. s.* } It. *conflagrazione*;
 Sp. *conflagracion*; Lat. *conflagrans*, *conflagratio*.
 Conflagration signifies a widely extended fire; conflagrant, burning together; being involved in a general fire.

The opinion deriveth the complexion from the deviation of the sun, and the *conflagration* of all things under Phaeton.

Broune's Vulgar Errors.

Then raise

From the *conflagrant* mass, purged and refined,

New heavens, new earth. *Milton's Paradise Lost.*

Next o'er the plains, where ripened harvests grow,
 The running *conflagration* spreads below.

Addison's Ovid.

Mankind hath had a gradual increase, notwithstanding what floods and *conflagrations*, and the religious profession of celibacy, may have interrupted.

Bentley's Sermons.

A *conflagration*, or a wintry flood,
 Has left some hundreds without home or food:
 Extravagance and avarice shall subscribe,
 While fame and self complacence are the bribe.

Cowper.

CONFLAGRATION OF THE WORLD. The ancient Pythagoreans, Platonists, Epicureans, and Stoics, appear to have had a notion of the general conflagration: though whence they should have derived it, unless from the sacred books, it is difficult to conceive; except, perhaps, from the Phœnicians, who had it from the Jews. Seneca says expressly, *Tempus advenit quo sidera sideribus incurrent, et omni flagrante materia uno igne, quicquid nunc ex deposito lucet ardebit.* This general dissolution the Stoics call *καταρωσις*, *ecpyrosis*. Mention of the conflagration is also made in the books of the Sybils, Sophocles, Hystaspes, Ovid, Lucan, &c. Dr. Burnet says, the Siamese believe that the earth will at last be parched up with heat; the mountains melted down; the earth's whole surface reduced to a level, and then consumed with fire. And the brahmins of Siam not only hold that the world shall be destroyed by fire, but also that a new earth shall be made out of it. Various are the sentiments of authors on the subject of the conflagration; the cause whence it is to arise, and the effects it is to produce.

CONFLATE, *adj.* } Lat. *conflatum*. The
CONFLATION, *n. s.* } act of blowing many instruments together; also casting of metal.

The sweetest harmony is, when every part or instrument is not heard by itself, but a *conflation* of them all. *Bacon.*

CONFLEXURE, *n. s.* Lat. *conflexura*. A bending or turning.

CONFLICT, *v. n.* } Fr. *confit*; Ital.
CONFLICT, *n. s.* } *conflicto*; Span. *con-*

CONFLICTATION, *n. s.* } *flicto*; Lat. *configo*,
conflictus. To fight; to contend; to strive ardently; to dash together. Violent collision; combat; strife; pangs of body or mind. Conflictation is synonymous with conflict; but it is obsolete.

And each one taking part in other's aide,

This cruel *conflict* raised thereabout

Whose dangerous success depended yet in doubt.

Spenser's Faerie Queene.

O! what a sight it was wistly to view

How she came stealing to the wayward boy;

To note the fighting *conflict* of her hue,

How white and red each other did destroy.

Shakespeare. Venus and Adonis.

Bare unhoused trunks,

To the *conflicting* elements exposed,

Answer mere nature. *Id. Timon.*

No assurance touching victories can make present *conflicts* so sweet and easy, but nature will shrink from them. *Hooker.*

You shall hear under the earth a horrible thundering of fire and water *conflicting* together.

Bacon's Natural History.

Pour dephlegmed spirit of vinegar upon salt of tartar, and there will be such a *conflict* or ebullition, as if there were scarce two more contrary bodies in nature. *Boyle.*

A man would be content to strive with himself, and *conflict* with great difficulties, in hopes of a mighty reward. *Tillotson.*

He perceived

The unequal *conflict* then, as angels look

On dying saints. *Thomson.*

Lashed into foam, the fierce *conflicting* brine

Seems o'er a thousand raging waves to burn. *Id.*

He said no more, for in his breast

Conflicting thoughts the voice suppressed:

The fire of vengeance seemed to stream

From his swol'n eyeballs' yellow gleam. *Beattie.*

These opposed and *conflicting* interests, which you considered as so great a blemish in your old and in our present constitution, interpose a salutary check to all precipitate revolutions. *Burke.*

He that wrestles with us, strengthens our nerves, and sharpens our skill. Our antagonist is our helper. This amicable *conflict* with difficulty obliges us to an intimate acquaintance with our object, and compels us to consider it in all its relations. It will not suffer us to be superficial. *Id.*

Every speck

Seen in the dim horizon turns these pale

With *conflict* of contending hopes and fears.

But comes at last the dull and dusky eve,

And sends thee to thy cabin, well prepared,

To dream all night of what the day denied. *Cowper.*

Hark! heard you not those hoofs of dreadful note?
 Sounds not the clang of *conflict* on the heath?
 Saw ye not whom the reeking sabre smote;
 Nor saved your brethren ere they sank beneath
 Tyrants and tyrant's slaves? *Byron's Child Harold.*

CONFLOW, v. n. } Fr. *confluent*; It.
 CONFLUX, n. s. } *confluente*; Sp. *con-*
 CONFLUENT, adj. } *fluente*; *confluencia*;
 CONFLUOUS, adj. } Lat. *confluere*. Hol-
 CONFLUENCE, n. s. } land, the translator,
 CONFLUXIBILITY, n. s. } as the Encyclopædia
 CONFLUXIBLENESS, n. s. } Metropolitana ob-
 serves, seems to be the only writer who has used the
 verb conflow; it was probably coined by him; and
 it deserves a place in our language. Confluence
 and confluent signify the junction of streams; the
 crowding of people to one spot; the multitude
 so formed; the concurring together of several
 circumstances to one end. Confluent and con-
 fluous mean running one into another. Boyle
 employs the word confluxibility to express a ten-
 dency to form a junction by flowing together.

You see this *confluence*, this great flood of visitors.
Shakespeare.

Knots, by the *conflux* of meeting sap,
 Infect the sound pine and divert his grain. *Id.*

Nimrod, who usurped dominion over the rest, sat
 down in the very *confluence* of all those rivers which
 watered Paradise. *Raleigh's History of the World.*

Some come to make merry, because of the *con-*
fluence of all sorts. *Bacon.*

You had found by experience the trouble of all
 men's *confluence*, and for all matters to yourself.
Bacon to Villiers.

To the gates cast round thine eye, and see
 What *conflux* issuing forth, or entering in. *Milton.*

He quickly by the general *conflux* and concourse of
 the whole people, streightened his quarters.
Clarendon.

We may there be instructed how to rate all goods
 by those that will concentrate into the felicity we shall
 possess, which shall be made up of the *confluence*,
 perfection, and perpetuity of all true joys. *Boyle.*

This will draw a *confluence* of people from all parts
 of the country. *Temple.*

At length, to make their various currents one,
 The congregated floods together run:
 These *confluent* streams make some great river's
 head,

By stores still melting and descending fed.
Blackmore.

In the veins, innumerable little rivulets have their
confluence into the great vein, the common channel of
 the blood. *Bentley.*

Thus where the veins their *confluent* branches bend,
 And milky eddies with the purple blend;
 The chyle's white trunk, diverging from its source,
 Seeks through the vital mass its shining course.
Darwin.

CONFORM, v. a. & n., & adj. } Fr. *con-*
 CONFORMABLE, adj. } *former*; It. *con-*
 CONFORMABLY, adv. } *formare*; Sp.
 CONFORMATION, n. s. } *conformar*;
 CONFORMER, n. s. } Lat. *con-*
 CONFORMIST, n. s. } *formare*. Min-
 CONFORMITY, n. s. } sheu, (No.

2294), gives the radical meaning with great clear-
 ness. 'To conforme,' says he, 'Lat. *conformare*,
à con and *formare*, q. eandem formam rei aliquid
 inopere.' Accordingly, to conform signifies, in
 its active senses, to reduce to a similar appearance,
 shape, manner, or opinion, with something else;
 and in its neuter sense; to give way; to comply
 with. That which has been so reduced becomes
 conformable to or with; acts conformably to, or

in conformity with, the agent by which the re-
 duction has been effected. Conform, as an
 adjective, means having a similarity to; being
 in consonance with. Conformation indicates the
 act of fashioning, or ordering a thing; the par-
 ticular texture and consistence of the parts of a
 body; and the act of producing suitability to
 anything. A conformer, or conformist, is one
 who conforms, who submits to; the words are
 particularly used with reference to the established
 church.

And then *conforming* it unto the light,
 Which in itself it hath remaining still,
 Of that first sun, yet sparkling in his sight.
Spenser.

Demand of them wherefore they *conform* not them-
 selves unto the order of the church? *Hooker.*

For all the kingdoms of the earth to yield them-
 selves willingly *conformable*, in whatever should be re-
 quired, it was their duty. *Id.*

By the knowledge of truth, and exercise of virtue,
 man, amongst the creatures of this world, aspireth to
 the greatest *conformity* with God. *Id.*

I've been to you a true and humble wife,
 At all times to your will *conformable*.
Shakespeare's Henry VIII.

Then followed that most natural effect of *conforming*
 one's self to that which she did like. *Sidney.*

Variety of tunes doth dispose the spirits to variety
 of passions *conform* unto them.
Bacon's Natural History.

Judge not what is best
 By pleasure, though to nature seeming meet;
 Created as thou art to nobler end,
 Holy and pure, *conformity* divine!
Milton's Paradise Lost.

Conformity in building to other civil nations, hath
 disposed us to let our old wooden dark houses fall to
 decay. *Graunt.*

Whatasoever should thus be universally useful, as a
 standard to which men should *conform* their manners,
 must have its authority either from reason or revela-
 tion. *Locke.*

Printers, binders, sellers, and others that make a
 trade, and gain out of them (books), have universally
 so odd a turn and corruption of mind, that they have
 a way of dealing peculiar to themselves, and not
 conform'd to the good of society, and the general fairness
 that cements mankind. *Id.*

Such a law of morality Jesus Christ hath given us
 in the New Testament, but by the latter of these ways,
 by revelation. We have from him a full and sufficient
 rule for our direction, and *conformable* to that of
 reason. *Id.*

So a man observe the agreement of his own
 imaginations, and talk *conformably*, it is all certainty.
Id.

The dissenting congregations are supposed by their
 teachers to be more accurately instructed in the
 matters of faith, and better to understand the Christian
 religion, than the vulgar *conformists*, who are charged
 with great ignorance—how truly I will not here de-
 termine. *Id.*

Among mankind so few there are,
 Who will *conform* to philosophic far.
Dryden's Juvenal.

We cannot be otherwise happy but by our *conformity*
 to God. *Tillotson.*

Many instances prove the *conformity* of the essay
 with the notions of Hippocrates.
Arbutnot on Aliments.

Where there happens to be such a structure and conformation of the earth, as that the fire may pass freely into these spiracles, it then readily gets out.

Woodward's Natural History.

The productions of a great genius, with many lapses, are preferable to the works of an inferior author, scrupulously exact, and conformable to all the rules of correct writing.

Addison.

The fragments of Sappho give us a taste of her way of writing, perfectly conformable with that character we find of her.

Id.

I have treated of the sex conformably to this definition.

Id.

This metaphor would not have been so general, had there not been a conformity between the mental taste and the sensitive taste.

Id.

Virtue and vice, sin and holiness, and the conformation of our hearts and lives to the duties of true religion and morality, are things of more consequence than the furniture of understanding.

Watts.

It is not your fond desires or mine that can alter the nature of things; by contending against which, what have we got, or shall ever get, but defeat and shame? I did not obey your instructions: no, I conformed to the instructions of truth and nature, and maintained your interest against your opinions, with a constancy that became me.

Burke.

Through the same plan of a conformity to nature in our artificial institutions, and by calling in the aid of her unerring and powerful instincts, to fortify the fallible and feeble contrivances of our reason, we have derived several other, and those no small benefits, from considering our liberties in the light of an inheritance.

Id.

CONFORT, *v. a.* } Fr. *conforter*; low
CONFORTATION, *n. s.* } Latin, *conforto*. To
CONFORTATIVE, *adj.* } strengthen; to comfort;
CONFORTATORY, *ns.* } to act as a corroborative. Obsolete.

For corroboration and confortation, take such bodies as are of an astringent quality, without manifest cold.

Bacon's Natural History.

CONFOUND, *v. a.* } Fr. *confondre*;
CONFUNDED, *part. adj.* } Ital. *confondere*;
CONFUNDEDLY, *adv.* } Sp. *confundir*;
CONFUNDEDNESS, *n. s.* } Lat. *confundere*.
CONFUNDER, *n. s.* } 'à con and *fundere*.

dere, to powre out, i. e. to powre out one with another,' says Minshew. To commingle things in such a manner that the separate parts can no longer be distinguished, is here the primary idea. Hence, to confound, means, to render indistinct, or unintelligible; to involve in perplexity; to deprive of the power of distinguishing; to astonish; to throw into consternation; to destroy; to subvert. Confounded and confoundedly are low words, never used but in familiar speech, or ludicrous composition. They indicate that which is hateful or shameful.

Let us go down, and there confound their language, that they may not understand one another's speech.

Gen. xi. 7.

Let them be confounded in all their power and might, and let their strength be broken.

Daniel, xxi.

O scathful harm, condition of poverthe, With thirst, with cold, with hunger so confounded.

Chaucer's Cant. Tales.

O feined woman all that may confound Vertue and innocence, thurgh thy malice Is bred in thee, as nest of every vice.

Id.

So gan he to disclose the whole debate, Which that straunge knight for him sustained had, And these two Sarazins confounded late.

Spenser's Faerie Queene.

But soonce the knights with their bright burning blades Broke their rude troupes, and orders did confound.

Id.

The gods confound thee! dost thou hold there still?

Shakespeare.

The sweetest honey

Is loathsome in its own deliciousness, And in the taste confounds the appetite.

Id.

Crooked eclipses 'gainst his glory fight, And time, that gave, doth now his gift confound.

Id. Sonnet lx.

Wrapt and confounded in a thousand fears, Like to a new-killed bird she trembling lies.

Id. Rape of Lucrece.

A thousand sparkling stars about her shone; But she herself did sparkle more alone Than all those thousand beauties would have done, If they had been confounded all in one.

Davies.

So deep a malice to confound the race Of mankind in one root.

Milton.

Two planets rushing from aspect malign, Of fiercest opposition, in mid sky Should combat, and their jarring spheres confound.

Id.

So spake the Son of God; and Satan stood A while as mute, confounded what to say

Id. Paradise Regained.

I am yet to think, that men find their simple ideas agree, though, in discourse, they confound one another with different names.

Locke.

They who strip not ideas from the marks men use for them, but confound them with words, must have endless dispute.

Id.

A most confounded reason for his brutish conception.

Grew.

Thy speculations begin to smell confoundedly of woods and meadows.

Addison's Spectator.

Now with furies surrounded,

Despairing, confounded, He trembles, he glows, Amidst Rhodope's snows.

Pope's St. Cecilia.

Sir, I have heard another story: He was a most confounded Tory; And grew, or he is much belied, Extremely dull before he died.

Swift.

Sighs from a breaking heart my voice confound; With trembling step, to join yon weeping train I haste, where gleams funeral glare around, And mixed with shrieks of woe, the knells of death resound.

Beattie.

Under misfortunes it often happens that the nerves of the understanding are so relaxed, the pressing peril of the hour so completely confounds all the faculties, that no future danger can be properly provided for, can be justly estimated, can be so much as fully seen.

Burke.

Cold, temperate, and torrid climate

Sees her infuriate lust of crime Burst every social bond, confound Order, spread insurrection round.

Huddesford.

But haughty still, and loth himself to blame, He called on Nature's self to share the shame, And charged all faults upon the fleshly form She gave to clog the soul, and feast the worm; Till he at last confounded good and ill, And half mistook for fate the acts of will.

Byron. Lara.

CONFRACT, *part.* Lat. *confractum*. Broken.
CONFRATERNITY, *n. s.* Lat. *con* and *fraternitas*. A brotherhood; a body of men united for some religious purpose.

We find days appointed to be kept, and a *confraternity* established for that purpose, with the laws of it. *Stillingfleet.*

CONFRICATION, *n. s.* Lat. *con* and *frico*. The act of rubbing against anything.

It hath been reported, that ivy hath grown out of a stag's horn; which they suppose did rather come from a *confrication* of the horn upon the ivy, than from the horn itself. *Bacon.*

CONFRIER, *n. s.* Fr. *confrere*. One of the same religious order.

CONFRONT, *v. a.* Fr. *confronter*; Ital.

CONFRONTATION, *n. s.* } *confrontare*; Sp. *con-*

CONFRONTER, *n. s.* } *frontar*. To stand, or cause to stand, face to face; to oppose one evidence to another in open court; to compare one thing with another. The act of bringing two evidences face to face. The person who confronts.

The East and West churches did both *confront* the Jews, and concur with them. *Hooker.*

Blood hath bought blood, and blows have answered blows,
 Strength matched with strength, and power *confronted* power. *Shakespeare. King John.*

We began to lay his unkindness unto him: he, seeing himself *confronted* by so many, went not to denial, but to justify his cruel falsehood. *Sidney.*

He spoke, and then *confronts* the bull;
 And on his ample forehead, aiming full,
 The deadly stroke descended. *Dryden's Virgil.*

When I *confront* a medal with a verse, I only shew you the same design executed by different hands. *Addison on Medals.*

The argument would require a great number of comparisons, *confrontations*, and combinations, to find out the connexion between the two manners. *Swinburne.*

CONFUCIUS, or **CONG-FU-TSE**, the greatest of the Chinese philosophers, whose memory is cherished as that of a saint, was born in the kingdom of Lu, now the province of Chang-tong, about 550 years before the birth of Christ: by which he seems to have been prior to Socrates, and contemporary with Pythagoras and Solon. At a very early period of life he gave proofs of uncommon talents; and being a descendant of the imperial family of the Chang dynasty, he was put under the ablest tutors, for cultivating and improving them. He had scarcely arrived at the years of maturity, when he evinced his acquaintance with all the literature of that era, particularly the canonical and classical books, ascribed to the legislators Yao and Chun. He had naturally an agreeable temper; and was distinguished for humility, sincerity, and disinterestedness; moderating his appetites, and contemning riches. He embraced, we are told, every opportunity afforded by the important station which he occupied in the kingdom of Lu, to estimate exactly the state of morals among his countrymen, and though he found them extremely vicious, formed and succeeded in the idea of a general reformation of morals. The torrent of corruption and depravity however returned; or Confucius became like many other reformers unreasonable and impatient in his expectations. At any rate he left Lu, in

the hopes of succeeding better in some distant kingdom; but, finding virtue everywhere overwhelmed by vice, he adopted the more humble employment of a teacher of youth, and trained, it is said, above 3000 scholars. He divided his doctrines into four parts, and his disciples into four classes: 1. Those who studied the moral virtues; 2. Those who studied the art of reasoning and public speaking; 3. Those who studied law and government; 4. Those who studied eloquence. He terminated his career in the seventy-second year of his age. His works are, 1. Tay-hio, i. e. The Grand Science, or school of adults, inculcating the duties of self-government, and obedience to the laws of right reason; 2. The Chong-yong, or the Immutable Medium; 3. Lung-yu, or Moral and Pithy Discourses; 4. Meng-tse, or the Book of Mencius; so named from one of the disciples, who is said to have completed it from his master's writings. There are also Hyau-king, treating of the respect due from children to their parents; and lastly, The Syau-hys, sentences, maxims, and examples, extracted from ancient and modern authors. His religion appears to have been that of pure theism. Numerous structures are raised to his honor in China: his books are regarded by the Chinese as the fountain of wisdom, and his descendants enjoy to this day the title of mandarins of the first order. See our article CHINA.

CONFU'SE, *v. a. & adj.* Fr. *confus*; It.

CONFU'SED, *adj.* and Sp. *confuso*,

CONFU'SEDLY, *adv.* Lat. *confusus*. —

CONFU'SEDNESS, *n. s.* Confuse is from

CONFU'SELY, *adv.* the same root as

CONFU'SION, *n. s.* confound, and is

CONFU'SIVE, *adj.* closely allied to it

in meaning. To confuse is to throw into disorder; to perplex; to render intricate; to deprive of the power of discerning and discriminating. Confusion signifies disorderly mixture; disarray; tumult; want of clearness in the ideas; hurry of ideas; amazement; distraction of mind; overthrow; destruction. The sense of the congenerous words is too obvious to require being defined.

Min herte may min harmes not bewrey;
 I am so *confuse* that I cannot say.

Chaucer. Cant. Tales.

Alas! ybrought is to *confusion*

The blood real of Cadme and Amphion. *Id.*

A rout of people they before them hend,

Flocking together in *confuse* array,

As if that there were some tumultuous affray.

Spenser. Faerie Queent.

Where when *confusedly* they came, they fownd

Their lady lying on the senselesse ground. *Id.*

God is not a God of sedition and *confusion*, but of order and of peace. *Hooker. Preface.*

These four nations are every where mixed in the Scriptures, because they dwell *confusedly* together.

Raleigh's History.

This is a happier and more comely time,

Than when these fellows ran about the streets

Crying *confusion*.

Shakespeare. Coriolanus.

The strength of their illusion,

Shall draw him in to his *confusion*.

Id. Macbeth.

God only wise, to punish pride of wit,
 Amongst men's wits hath this confusion wrought,
 As the proud tower whose points the clouds did hit,
 By tongues confusion was to ruin brought. *Davies.*

Thus roving on
 In confused march forlorn, the adventurous bands
 Viewed first their lamentable lot, and found
 No rest. *Milton.*
 He confusedly and obscurely delivered his opinion.
Clorendon.

The confusion of two different ideas, which a customary connexion of them in their minds hath made to them almost one, fills their heads with false views, and their reasonings with false consequences. *Locks.*

The propriety of thoughts and words, which are the hidden beauties of a play, are but confusedly judged in the vehemence of action. *Dryden.*

Confusion dwelt in every face,
 And fear in every heart,
 When waves on waves, and gulphs in gulphs,
 O'ercame the pilot's art. *Spectator.*

I viewed through a prism, and saw them most confusedly defined, so that I could not distinguish their smaller parts from one another. *Newton's Optics.*

The cause of the confusedness of our notions, next to the natural inability, is want of attention. *Norris.*

We may have a clear and distinct idea of the existence of many things, though our ideas of their intimate essences and causes are very confused and obscure. *Watts's Logic.*

Can mortal strength presume to soar so high!
 Can mortal sight, so oft bedimed with tears,
 Such glory bear!—for lo, the shadows fly
 From Nature's face; confusion disappears,
 And order charms the eye, and harmony the ears!
Beattie.

And now the tumults of the war,
 Mingling confusedly from afar. *Id.*

The nobility and the clergy, the one by profession, the other by patronage, kept learning in existence, even in the midst of arms and confusions, and whilst governments were rather in their causes than formed. *Burke.*

I saw thee gaze upon my face,
 Yet met with no confusion there:
 One only feeling couldst thou trace—
 The sullen calmness of despair. *Byron.*

CONFUSION, in a logical sense, is opposed to distinctness, or perspicuity; and may happen either in words, as when misconceived or misapplied; or in ideas, as when the idea of any thing presents something along with it, which does not properly belong to that thing. See IDEA and NOTION.

CONFUSION, in a physical sense, is a sort of union or mixture by mere contiguity. Such is that between fluids of contrary natures, as oil and vinegar, &c.

CONFUTE, *v. a. & n. s.* } Fr. *confuter*;
 CONFUTEMENT, *n. s.* } It. *confutare*; Sp.
 CONFUTER, *n. s.* } *confutar*; Lat.
 CONFUTABLE, *ad.* } *confutare*. To
 CONFUTANT, *n. s.* } convict of error;
 CONFUTATION, *n. s.* } to disprove the
 CONFUTATIVE, *ad.* } arguments or as-
 sertions of an antagonist. The confuter, or confutant, is the person who accomplishes the confutation, or confutement, of the confutable assertions. Confutative signifies that which confutes.

At the last day, that inquisitor shall not present to God a bundle of calumnies, or confutable accusations; but will offer unto his omniscience a true list of our transgressions. *Browne.*

Now that the confutant may also know, as he desires, what force of teaching there is sometimes in laughter. *Milton.*

An opinion held by some of the best among reformed writers, without scandal or confutement. *Id.*

We have promised that their own dearest doctors and divines should be their confuters. *Bishop Morton.*

He could on either side dispute;
 Confute, change hands, and still confute. *Hudibras.*

For a man to doubt whether there be any hell, and thereupon to live as if there were none, but, when he dies, to find himself confuted in the flames, must be the height of woe. *South.*

Man, 'tis true,
 Smit with the beauty of so fair a scene,
 Might well suppose the Artificer divine
 Meant it eternal, had he not himself
 Pronounced it transient, glorious as it is,
 And, still designing a more glorious far,
 Doomed it as insufficient for his praise.
 These therefore are occasional, and pass;
 Formed for the confutation of the fool,
 Whose lying heart disputes against a God;
 That office served, they must be swept away. *Cowper.*

CONFUTATION, in rhetoric, &c. part of an oration, wherein the orator strengthens his cause by destroying the opposite arguments of his antagonist; by denying what is apparently false, by detecting some flaw in the reasoning of the adverse party, by granting his argument, and showing its invalidity, or retorting it upon the adversary.

CONGAREE, a considerable river of South Carolina, formed by the confluence of the Saluda and Broad Rivers. Its junction with the Wateree forms the Santee, after a south-east course of ten miles.

CONGE, *v. n. & n. s.* Fr. *congé*; Ital. *congedo*; Mid. Lat. *comiatu*s. To take leave. Act of reverence; bow; courtesy. The word is sometimes written congie.

Where taking congee, each one by and by
 Departed to his home in dreadful awe.

Spenser. Mother Hubbard's Tale.
 I have congeed with the duke, and done my adieu
 With his nearest. *Shakspeare. All's Well.*

Or make a Spanish face with fawning cheere,
 With the island conge like a cavalier. *Hall.*

The captain salutes you with conge profound,
 And your ladyship curtsies half-way to the ground. *Swift.*

CONGES, in architecture, are rings, or ferrels, formerly used in the extremities of wooden pillars, to keep them from splitting, afterwards imitated in stone-work.

CONGE D'ELIRE is French; and signifies, in common law, the king's permission royal to a dean and chapter, in time of vacation, to choose a bishop. The king, as sovereign patron of all archbishoprics, bishoprics, and other ecclesiastical benefices, had in ancient times the free appointment of all ecclesiastical dignities; investing them first per baculum et annulum, and afterwards by his letters patent. In process of time he made the election over to others, under certain forms and conditions; as, that they

should, at every vacation, before they choose, demand of the king a *congé d'elire*, that is, licence to proceed to election.

A woman, when she has made her own choice, for form's sake, sends a *congé d'elire* to her friends.

Spectator.
CONGEAL, *v. a. & n.* Fr. *congeler*; It. **CONGEALMENT**, *n. s.* } *congellare*; Sp. *con-*
CONGEALABLE, *adj.* } *gelar*; Lat. *congelare*.
CONGELATION, *n. s.* } To convert into ice;
to fix into a substance by cold; to concreate. Congelation signifies the act of congealing; the state of being congealed. Congealable that which may be congealed; and congealment the concretion produced.

Little she weend that love he close conceald;
Yet still he wasted as the snow *congeald*;
When the bright sunne his beames theron doth beat.

Sponsor. Faerie Queene.
Oh, gentlemen, see! see! dead Henry's wounds
Open their *congeald* mouths, and bleed afresh.

Shakespeare. Richard III.
Too much sadness hath *congeald* your blood. *Id.*

Enter the city, clip your wives, your friends;
Tell them your feats, whilst they with joyful tears
Wash the *congealment* from your wounds.

Id. Antony and Cleopatra.
In the midst of molten lead, when it beginneth to *congeal*, make a little dent, into which put quicksilver wrapt in linen, and it will fix and run no more, and endure the hammer.

Bacon.
The consistencies of bodies are very divers: dense, rare, tangible, pneumatical, fixed, hard, soft, *congealable*, not *congealable*, liquefiable, not liquefiable. *Id.*

Many waters and springs will never freeze; and many parts in rivers and lakes, where there are mineral eruptions, will still persist without *congelation*.
Brown's Vulgar Errors.

When water *congeals*, the surface of the ice is smooth and level, as the surface of the water was before.
Burnet's Theory.

There are *congelations* of the redundant water, precipitations, and many other operations.

Arbutnot on Air.
The chymists define salt, from some of its properties, to be a body fixable in the fire, and *congealable* again by cold into brittle gleses or crystals.

Id. on Aliments.
In whose capacious womb
A vapoury deluge lies, the snow *congeald*.

Thomson. Winter.
If the moon had no atmosphere at the time of its elevation from the earth, or if its atmosphere was afterwards stolen from it by the earth's attraction, the water on the moon would rise quickly into vapour; and the cold produced by a certain quantity of this evaporation would *congeal* the remainder of it.

Darwin.
Mr. Hunter by very curious experiments discovered that the living principle in fish, in vegetables, and even in eggs and seeds, possesses a power of resisting *congelation*.
Id.

And if we gow and then a sigh must heave
At quitting even those we quit in strife,
No doubt we weep for those the heart endears—
That is, till deeper griefs *congeal* our tears.

Byron. Don Juan.
How long in his damp trance young Juan lay,
He knew not, for the earth was gone for him,
And time had nothing more of night nor day
For his *congealing* blood, and senses dim.

Id.

CONGELATION is applicable to metals, when they resume their solid form after being heated; to water when it freezes, to wax, spermaceti, &c. when they become solid after having been rendered fluid by heat; and, in general, to all processes, where the whole substance of the fluid is converted into a solid: but it differs from crystallisation; because, in the latter process, though the salt passes from a fluid to a solid state, a considerable quantity of liquid is always left. The process of congelation, in all cases, depends upon, or is at least accompanied with, the emission of heat, as has been evinced by experiments made not only in water, but on spermaceti, wax, &c.; for in all these, though the thermometer immersed in them continued, while fluid, to descend gradually till a certain period, yet it was as constantly observed to remain stationary, or even to ascend, while the congelation went on. The most difficult metal, of which the congelation has been actually ascertained, is mercury. This was long thought capable of resisting any degree of cold whatever; and it is only within these few years that its congelation, by artificial means, was known, and still more lately, that some climates were found to be so severe as to congeal this fluid by the cold of the atmosphere. See **COLD**.

CONGEMINATION, *n. s.* old Fr. *congenition*; Lat. *congeminitio*. A doubling; a frequent repeating.

CONGENERATE, *v. a.* } Fr. *congenere*,
CONGENER, *n. s.* } adjective, used only
CONGENERACY, *n. s.* } in anatomy and botany;
CONGENEROUS, *adj.* } Ital. *adj.*
CONGENEROUSNESS. } *congenere*; Latin, *congenerare*. The verb, which is little used, signifies to beget; to cause. Congener, which is adopted, without alteration, from the Latin, means that which is of the same kind or stock.

The cherry-tree has been often grafted on the laurel, to which it is a *congener*.
Miller.

Those bodies, being of a *congenerous* nature, do readily receive the impressions of their nature.

Brown's Vulgar Errors.
From extreme and lasting colds proceeds a great run of apoplexies, and other *congenerous* diseases.

Arbutnot on Air.
CONGENIAL, *adj.* } Lat. *con* and *genus*.
CONGENIALITY, *n. s.* } Partaking of the same
CONGENIALNESS, *n. s.* } nature or disposition;
CONGENIOUS, *n. s.* } similar in feelings and habits; suitable, beneficial, adapted to. Congenious, which means being of the same kind, is obsolete.

He sprung, without any help, by a kind of *congenial* composure, as we may term it, to the likeness of our late sovereign and master.
Wotton.

You look with pleasure on those things which are somewhat *congenial*, and of a remote kindred to your own conceptions.
Dryden's Dedicat. of Jun.

In the blood thus dropped there remains a spirit of life *congenious* to that in the body.

Smit with the love of sister arts we came,
And met *congenial*, mingling flame with flame.
Pope.
He acquires a courage, and stiffness of opinion, not at all *congenial* with him.
Swift.

And light along the fairy Pleasure,
Her green robes glittering to the morn,
Wantons on silken wing. And goblins all
To the damp dungeon shrink, or hoary hall,
Or westward, with impetuous flight,
Shoot to the desert realms of their *congenial* night.

Beattie.

If e'er in dusky cave or midnight bower
The young Endymion blessed your tender care;
If e'er you felt the sympathetic power,
Congenial spirits in pure essence share;
Let me, fair queen of eve! in thy still hour,
Clasp her I love; like thee, most chaste, most fair.

Leffley.

Whate'er the theme—through every age and clime,
Congenial passions meet the' according rhyme:
The pride of Glory—Pity's sigh sincere—
Youth's ardent blush—and Beauty's virgin tear.

Sheridan.

Congenial to my pensive breast
O'er shadowing clouds the skies invest;
Fast falling showers deform the glade,
No cheering ray dispels the shade.

Huddesford.

—All is gentle: nought
Stirs rudely; but, *congenial* with the night,
Whatever walks is gliding like a spright.

Byron. The Dogs of Venice.

CONGENITE, *adj.* Lat. *congenitus*. Of the same birth; born with another; connate; begotten together.

Many conclusions of moral and intellectual truths, seem, upon this account, to be *congenite* with us, connatural to us, and engraven in the very frame of the soul.

Hale's Origin of Mankind.

Did we learn an alphabet in our embryo-state? And how comes it to pass, that we are not aware of any such *congenite* apprehensions.

Glanville's Scepis.

CONGER, *n. s.* Lat. *congrus*; Gr. γογγρος. The sea-eel.

Many fish, whose shape and nature are much like the eel, frequent both the sea and fresh rivers; as the mighty *conger*, taken often in the Severn.

Walton's Angler.

CONGER, in zoology. See **MURENA**.

CONGER EEL'S HEAD, is a charge borne in heraldry; as *argent*, a conger's head coupé on a pale, name Gascoigne, a family from the Isle of Ely.



CONGERIES, *n. s.* Lat. A mass of small bodies heaped up together.

The air is nothing but a *congeries*, or heap of small, and for the most part, of flexible particles, of several sizes, and of all kinds of figures.

Boyle.

Each bud has a leaf, which is its lungs, appropriated to it, and the bark of the tree is a *congeries* of the roots of these individual buds.

Darwin.

CONGEST, *v. a.* } Lat. *congerere*, *con-*

CONGESTABLE, *adj.* } *gestum*. To heap up;

CONGESTION, *n. s.* } to accumulate; to collect together; to bring into one mass. Conges-

tion is, a heaping together; formation of a mass; a collection of pus, as in abscesses.

Yet his *congested* wealth shall melt like snow.

Sandys.

Congestion is then said to be the cause of a tumour, when the growth of it is slow, and without pain.

Wiseman.

CONGIARIUM, in antiquity, a largess or bounty of money, given by the Roman emperors to the people, upon certain occasions, by the hands of certain officers called sequesters, or divisores. Tiberius, Caligula, and Nero, stand in history among the most profuse in their *congiarii* to the people. Nero was the first who commemorated his corruption by stamping the money with which he bribed the slaves of Rome, with the image and superscription of baseness. The type of the medals or coins which represented, and were struck for the *congiarii*, exhibited the tyrant seated upon his suggestum, or chair, borne up by men, giving a tessera, or ticket.

CONGIARY, *n. s.* Lat. *congiarium*, from *congius*, a measure of corn. A gift distributed to the Roman people or soldiery, originally in corn, afterwards in money.

We see on them the emperor and general officers, standing as they distributed a *congiary* to the soldiers or people.

Addison.

CONGIUS, a liquid measure of the ancient Romans, containing one-quarter of the amphora, one-quarter of the urna, or six sextarii. The congius, in English measure, contains 2,070,676 solid inches; that is, seven pints 4942 solid inches.

CONGLACIATE, *v. n.* } Lat. *conglaciare*.
CONGLACIATION, *n. s.* } To convert into ice; to effect congelation. The state of being converted into, the act of converting into, ice.

If crystal be a stone, it is concreted by a mineral spirit, and lapidifical principles; for, while it remained in a fluid body, it was a subject very unfit for proper *conglaciation*.

Browne.

No other doth properly *conglaciate* but water: for the determination of quicksilver is properly fixation, and that of milk coagulation. *Id. Vulgar Errors.*

CONGLETON, a market-town of Cheshire, seated on the Dean. It has considerable manufactories of silk, cotton, and leather gloves; with a market on Saturday. The town is governed by a mayor and six aldermen, and is extremely clean and neat in its appearance. There is also a small but elegant chapel of ease. It is seven miles south of Macclesfield, and 164 north-west of London.

CONGLOBATE, *v. a. & adj.* } Lat. *con-*
CONGLOBATE, *v. a.* } *globare*, from *con-*
CONGLOBATELY, *adv.* } and *globus*, a
CONGLOBATION, *n. s.* } ball. To col-
CONGLOBULATE, *v. n.* } lect into a glo-
bular mass; to aggregate into a hard ball; to come together into a round mass. The act of forming such a mass; the mass itself. Dryden uses the adjective, *conglobate*, with the accent on the second syllable: 'Were fixed *conglobate* in his soul.'

Then he founded, then *conglobed*
Like things to like. *Milton's Paradise Lost.*

Thither they
Hasted with glad precipitance, up-rolled,
As drops on dust *conglobing* from the dry. *Id.*

In this spawn are discerned many specks, or little *conglóbations*, which in time become black. *Browne.*

The testicle, as is said, is one large *conglóbated* gland, consisting of soft fibres, all in one convolution.

Greuv.

Fluids are separated from the blood in the liver, and the other *conglobate* and *conglomerate* glands.

Cheyne's Philosophical Principles.

For all their centre found,

Hung to the goddess, and cohered around :

Not closer, orb in orb *conglobed*, are seen

The buzzing bees about their dusky queen.

Pope's Dunciad.

Compressed and *conglobated* into one gross and general idea.

Johnson.

A number of them *conglobulate* together, by flying round and round. *Id.*

CONGLOBATE GLANDS. See ANATOMY.

CONGLOMERATE, *v. a. & adj.* } Lat. *con-*

CONGLOMERATION, *n. s.* } *glomerare,*

from *con* and *glomerare*. To wind round, to form a bottom of thread, is the idea conveyed by the root of these words. The English verb also signifies to collect into a ball; to intertwine separate fibres into one spherical mass; to gather into masses. The meanings of the adjective and noun are obvious.

The beams of light, when they are multiplied and *conglomerate*, generate heat. *Bacon's Natural History.*

The multiplication and *conglomeration* of sounds doth generate rarefaction of the air. *Id.*

The liver is one great *conglomerated* gland, composed of innumerable small glands, each of which consisteth of soft fibres, in a distinct or separate convolution. *Grew's Cosmologia.*

Fluids are separated in the liver, and the other *conglobate* and *conglomerate* glands.

Cheyne's Philosophical Principles.

CONGLOMERATE FLOWERS are those growing on a branching foot-stalk, to which they are irregularly but closely connected. This mode of inflorescence is opposed to that in which the flowers are irregularly and loosely supported on their foot-stalks, hence termed a diffuse panicle. See PANICLE. The term is exemplified in several species of the poa, fescue grass, and agrostis.

CONGLOMERATE GLANDS. See ANATOMY.

CONGLUTINATE, *v. a., v. n., & adj.* } French

CONGLUTINATION, *n. s.* } *conglu-*

CONGLUTINATIVE, *adj.* } *tinier ;*

CONGLUTINATOR, *n. s.* } It. *con-*

glutinare; Span. *conglutinar*; Lat. *conglutinare*. The original meaning of *conglutinate* is, to glue together; whence, to effect a reunion of parts; to cause to adhere; to cement; to heal wounds; to unite by the intervention of a callus. *Conglutinative* remedies are *conglutinators*; that is, remedies capable of making wounds unite, of producing *conglutination*.

Starch, which is nothing but the flower of bran, will make a clinging paste, the which will *conglutinate* some things. *Sir W. Petty.*

The cause is a temperate *conglutination*; for both bodies are clammy and viscid, and do bridle the deflux of humours to the hurts. *Bacon's Natural History.*

To this elongation of the fibres is owing the union or *conglutination* of parts separated by a wound.

Arbuthnot on Aliments.

The osteocolla is recommended as a *conglutinator* of broken bones. *Woodward on Fossils.*

CONGO, an extensive country in the south-west of Africa: it is bounded on the north by the river Zaire, or Congo, which separates it from Loango; and on the west by the Atlantic. The

interior limits of the country are, at present, uncertain; the observations of our modern travellers having been, principally, directed towards the exploration of the river Zaire, rather than to the extent of the country. It is supposed, however, to extend several hundred miles in every direction.

Angola and Benguela are situated to the south; whilst the eastern frontier is stated to be composed of lofty and rugged mountains, inhabited by the savage tribe of the Giagas, who frequently make desolating incursions into the territory of Congo.

Before the expedition to explore the river Zaire, undertaken by captain Tuckey in 1816, we could scarcely be said to have any certain knowledge respecting the general appearance of the country. The missionaries, sent by the church of Rome, were, prior to this expedition, our only authorities, and their reports of the great splendor and civilisation of Congo have since been discovered to be much exaggerated. Captain Tuckey found the country far from being highly cultivated. He states that the alluvial banks, indeed, as far up as Embomma are covered with luxuriant verdure; but this is the effect of nature and not of cultivation. Higher up the river Zaire, he found bare mountains from 2000 to 3000 feet in height, composed chiefly of mica slate, sienite, and quartz; the villages and cultivated spots are, for the most part, situated in the ravines and tops of these mountains. Farther up still, the mountains open, and allow the river to flow in a wider channel. They are composed here of limestone and clay, and the greater part of the surface is fit for cultivation.

The vegetable productions of Congo appear to be ample, and, for several of the most valuable, it seems to have been indebted to the Portuguese: The large trees are only found in the valleys, or thinly sprinkled over the sides and summits of the hills; those which principally characterise the landscape, and appear to be very general along the whole extent of the shores, are the *adansonia*, *bombax pentandrum*, *anthoaleista*, *masanga* of the natives (the genus related to *cecropia*), *elæis Guiniensis*, *raphia rinifera*, and *pandanus coadlabrum*. On the alluvial banks, the mangrove, mixed with the palm, the *adansonia*, and the *bombax*, with occasional clusters of the Egyptian papyrus, forms the grand feature of vegetation. The principal articles of food are maize, *cassava*, both sweet and bitter, two kinds of pulse, the *cytissus cajaa*, and a species of *phaseolas*, and ground nuts (*arachis hypogæa*). The common yam, and another species of *dioscoria*, so bitter as to require four days boiling to free it from its pernicious qualities; sugar-cane, capsicum, and tobacco, are among the alimentary plants of secondary importance. The principal fruits are the plantain, pine-apples,—the first a native of the East and the other of the West Indies, pumpkins, the papaw, limes, oranges, the tamarind, and a fruit about the size of a plum, called *safa*. The plant, however, of the most importance to the natives, is the *elæis Guiniensis*, or oil-palm, which flourishes here as in all parts of Western Africa, and is, to the inhabitants of Congo, what the cocoa-tree is to many of the Asiatic islanders. From the juice of this tree they make their best

palm wine, a beverage which is found extremely pleasant and refreshing.

The fruits indigenous to Congo, are the anona *Senegalensis*, *sarcocepholas*, a species of cream-fruit, *chrysobolarias icaca*, a species of ximenia, and another of *antidesiva*. Professor Smith, the celebrated botanist attached to the expedition already alluded to, enumerates 620 species and genera of plants, in his Herbarium, which he had collected in Congo; of these only about 250 are absolutely new; nearly an equal number flourish in other parts of equinoctial Africa: and about seventy are found in other regions within the tropics. No natural order, that is absolutely new, exists in Professor Smith's Herbarium, nor has one family been found peculiar to equinoctial Africa.

Like all other parts of this mighty continent, Congo abounds in wild animals; among which may be enumerated lions, elephants, leopards, buffaloes, antelopes, wild-hogs, porcupines, and a great variety of monkeys, the principal species of which are of a large size, and have black faces. The rivers abound with those monsters, the hippopotamus and the crocodile. The lower part of it contains also plenty of excellent fish. Domestic animals are but of few species and scarce. Those chiefly used for food, are hogs, goats, fowls, Muscovy ducks, and pigeons. They have also a few sheep, for the most part spotted, and having hair instead of wool.

Congo is exempted from many of the noxious insects, &c. which generally swarm in hot climates. Their principal pests of this sort are bugs, fleas, and ants.

The vast and overwhelming armies, spoken of by the Catholic missionaries, Carli, Merolla, &c., have been discovered by captain Tuckey, to have existed only in the fertile brains of their historians, unless we can conceive, that in the space of two centuries, pestilence, famine, and the slave trade, have swept not only them, but even their very memory away from their native shores. Instead of the hosts of warriors, which could be counted only by hundreds of thousands, the prince who can now rally to his standard 200 troops, and furnish even half of these with muskets, becomes an object of terror and consternation to all this part of Africa. According to the statements put forth by the missionaries already mentioned, the population of Congo would place it on a level with the most prosperous countries of Europe. Captain Tuckey, however, found the country but very thinly inhabited: the most considerable banza, or town, he visited, was Cooloo, which did not contain above 100 huts, and the population did not exceed 600. Embomma, another town, consisted of sixty huts, and 500 inhabitants; and Inga, of seventy huts and 300 inhabitants. The principal town of the country is called Congo, and is situated about six days' journey in the interior.

The villages and towns of Congo are, generally, placed amidst groves of palm, and the beautiful *adansonia*. Their huts are constructed with large mats, woven together by the fibres of plants, or a reedy kind of grass which flourishes here in great abundance. An habitation of this kind can be erected in the course of a few minutes,

and at so moderate an expense, that a few fowls or ducks are generally considered an equivalent for a house composed of six pieces. The dwellings of the chenoo or chief, are, however, more elaborately formed; they consist of palm leaves very ingeniously matted together, and are, sometimes, enclosed within a fence of reeds. Their household furniture, like that of all uncultivated tribes, is extremely simple. Their beds and baskets are formed solely from the leaves and fibres of the palm: gourds and calabashes form their bowls and bottles. They manufacture rude earthen vessels for cooking their food, and wooden spoons for eating it. Their only clothing is a piece of baft, or grass matting, bound round their loins; the women use rings of brass or iron, bracelets of beads, cowries, seeds of plants, or lions' teeth by way of ornament; and so great is their love of finery, that but very few females are seen without having their arms, legs, or necks, graced with one or more of these articles.

The state of society in Congo, appears to be nearly the same as that which prevails amongst all negro nations; though, in their moral and physical character, they ought perhaps to be placed low in the scale of African civilisation. The Congoese may be divided into five classes:—the chenoo, and his family; the mafooks, or collectors of the revenue; the foomoos, or yeomanry; the fishermen and laborers; and, lastly, the slaves. The sovereignty of the chenoo is hereditary in the female line; thus no son of the chenoo can succeed his father unless his mother be of royal blood. The affia is little distinguished either by dress or accommodations from that of the subject:—a small staff of black wood, inlaid with lead or copper, is the official ensign of the chief. The daughters of the chenoo are allowed to choose their own husbands, over whom they become most absolute mistresses, and can even extend their prerogative to the selling of a refractory spouse to slavery; it will, therefore, be easily believed, that the honor of a royal alliance is a matter but of little emulation amongst the gallants of the Congoese court. There is a vast number of petty chiefs scattered throughout the territory, but all of these acknowledge a supremacy to the Blindy N' Congo, or general sovereign of the country, who resides at Congo, which is most probably the St. Salvador of the Portuguese:—this city, however, has not been visited by any recent traveller.

The Congoese are of middle size; their features are not so strongly marked, nor their color so deeply dyed, as those of the more northern tribes of negroes; and their physiognomy is said to express great openness, simplicity, and innocence. On Captain Tuckey's party first entering the river Zaire, they discovered a quantity of burnt human bones and skulls, hanging on the branches of some trees, which naturally led to the suspicion of the inhabitants being cannibals; it was subsequently found, however, that this was their place of public execution, and that nothing could be more abhorrent from their practice than the disgusting enormity of eating human flesh; it fact, it is a matter of great doubt, whether a negro cannibal at the present day exists. Indolence, the besetting vice of the

continent of Africa, appears to be their greatest hindrance to improvement. They make but little use of domestic animals for draught and agriculture. The women alone cultivate the land, carry the produce to market, range the forests to provide food and firing, and oftentimes, in their canoes, formed from the excavated trunks of the cotton-tree or bombax, skim the bosom of the most dangerous lakes to procure fish for their unnatural masters, while they supinely recline under the shade of the wide-spreading adansonias, the monarch of the forest wearing out the lazy hours stringing cowrie shells, or strumming on some musical instrument: or if they exert themselves at all, it is in dancing by moonlight, or indolently sauntering about their habitations. They are represented, however, as lively and good natured, hospitable, and at all times ready to share their miserable pittance with the stranger or passing sojourner. They are also said to be very honest; the rights of property are strictly observed, and the division is sometimes carried to so fine a point, that three, four, or six persons occasionally claim a right in a single fowl or pig. Every man in Congo has wives according to his degree or rank in society. The chenoo has as many as fifty, and some of the mafooks from ten to twenty. The females belonging to the highest dignitaries were offered to captain Tuckey's party on terms, and in language the most disgustingly obscene, for the most trifling consideration. The chenoo himself estimated the virtue of any of his wives or daughters, simply at the rate of a few beads or a glass of rum. The females, on their part, did not appear averse to these arrangements, but manifested much indignation when the offers of their husbands or fathers were despised or rejected by the Europeans. It is but justice to presume, however, that this disregard of modesty is unknown in those parts where the European slave merchant has not intruded; for, as captain Tuckey advanced farther up the river, he met with no recurrence of this offensive custom. Adultery amongst the natives is punished by the slavery of both the offenders; and, if one of the parties be the wife of a chenoo, the paramour is liable to suffer death. An atrocious crime, singular from the simple form of their society, prevails amongst the Congoese; it is that of poisoning. Amongst a people so little enlightened, it is matter of no wonder that superstition should be so prevalent. The Portuguese missionary Carazzi, a Capuchin friar, stated the principal body of the natives to be good Catholics; but the English who have lately visited Congo, found but few or no vestiges of the benefits of that civilisation and conversion so much extolled by the Romish church.

At Loando, the natives exhibited their relics, rosaries or crosses and Agnus Deis, jumbled together with their domestic fetiches. The fetiche may, indeed, be said to form their only religion, and there is nothing so vile in nature or art, that is not regarded by the negroes as fit for this potent charm against evil. The horn-hoof, hair, teeth, or bones, of the most savage animal that prowls through the forest; the feathers, claws, beaks, skulls, and bones, of the meanest bird that flies in the air; the shells and fins of fishes; the

heads or skins of the filthiest snakes or reptiles that crawl on the earth; pieces of old copper, iron, wood, seeds of plants, are severally used to form a fetiche, and sometimes it consists of a mixture of them all. The priests are the usual artificers of these fetiches, and are said to derive considerable emolument from the sale of them. These charms are considered by the negroes as a protection against every danger 'flesh is heir to;' and if it should so happen that the wearer perish, through the very means against which the fetiche had been adopted; it is not for want of protective potency in the charm, but for some offence, real or imaginary, of which the possessor has been guilty.

CONGRATULATE, *v. a. & n.*

CONGRATULATION, *n. s.*

CONGRATULANT, *adj.*

CONGRATULATOR, *n. s.*

CONGRATULATORY, *adj.*

Fr. *congratuler*, Ital. *congratulare*; Span. *congratular*; Lat. *congratulari*. To express joy to another that he has experienced any thing which contributes to his welfare; to compliment on any fortunate event; to rejoice in conjunction with; to felicitate ones' self. It is the opposite of condole. Sometimes, says Johnson, it has the accusative case of the cause of joy, and *to* before the person. He might have added, that this usage is obsolete.

He sent Hadoram his son to king David, to congratulate him, because he had fought against Hadazer, and smitten him. 1 Chron. xviii. 10.

Nothing more fortunately auspicious could happen to us, at our first entrance upon the government, than such a congratulator. Milton.

Forth rushed in haste the great consulting peers,
Raised from the dark divan, and with like joy
Congratulant approached him. Id. Paradise Lost.

I think the little I have enough, and do not desire to live higher, or die richer, than I am; and therefore you have reason rather to pity the folly, than congratulate the fortune, that engages me in the whirlpool. Locke.

An ecclesiastical union within yourselves, I am rather ready to congratulate to you. Spratt's Sermons.

The subjects of England may congratulate to themselves, that the nature of our government, and the clemency of our king, secure us. Dryden's Preface to Aurengzebe.

I cannot but congratulate with my country, which hath outdone all Europe in advancing conversation. Swift.

I congratulate our English tongue, that it has been enriched with words from all our neighbours. Watts's Logic.

I must be tolerably sure, before I venture publicly to congratulate men upon a blessing, that they have really received one. Burke.

The effect of liberty to individuals is, that they may do what they please; we ought to see what it will please them to do, before we risque congratulations which may be soon turned into complaints. Id.

To my inexpressible surprise, I found them in a sort of public capacity, by a congratulatory address, giving an authoritative sanction to the proceedings of the national assembly in France. Id.

Madam, a stranger's purpose in these lays
Is to congratulate and not to praise.
To give the creature the Creator's due
Were sin in me, and an offence to you. Cowley.

Peace ensues,

But spurious and shortlived; the puny child
Of self-congratulating Pride, begot
On fancied Innocence. Again he falls,
And fights again; but finds his best essay
A passage ominous, portending still
Its own dishonour by a worse relapse. *Id.*

With all my follies of youth, and, I fear, a few
vices of manhood, still I congratulate myself on hav-
ing had, in early days, religion strongly impressed on
my mind. *Burns.*

All the cities you have taken, all the armies which
retreated before your leaders, are but paltry subjects
of self-congratulation, if your land divides against it-
self, and your dragoons and executioners must be let
loose against your fellow citizens.

Byron. Speech on the Frame-breaking Bill.

CONGREGATE. Fr. *gre.* To agree together;
to unite harmoniously. Not in use.

For government,
Put into parts, doth keep in one consent,
Congreing in a full and natural close.

Shakespeare. Henry V.

To CONGREG'ET, v. n. From con and greet.
To salute reciprocally. Not in use.

My office hath so far prevailed,
That face to face, and royal eye to eye,
You have congregated. *Shakespeare. Henry V.*

CONGREGATE, v. a., v. n. & adj. } French
CONGREGATION, n. s. } *congreger*;
CONGREGATIONAL, adj. } Ital. *con-*
CONGREGATIONISTS, n. s. } *gregare*;

Span. *congregar*; Lat. *congregare*, from *con* and
grex, a flock. To collect into one spot; to as-
semble in numbers; to meet. Congregation signi-
fies the act of collecting together; a collected
mass of persons or things; an assemblage of
persons who are met for the public worship of
God. Congregate is collected; compact;
closely pressed together. Congregational is
public; general; and, more commonly, apper-
taining to an assembly of such Christians as hold
every congregation to be a separate and inde-
pendent church.

Take ye the sum of all the congregation of the chil-
dren of Israel, after their families, by the house of
their fathers, with the number of their names, every
male by their polls. *Numbers i. 2.*

Than by counsel of his wife Prudence, this Meli-
beus let
Callen a great congregation of folk. *Chaucer. Cant. Tales.*

Any multitude of Christian men congregated, may
be termed by the name of a church. *Hooker.*
The words which the minister first pronounceth,
the whole congregation shall repeat after him. *Id.*

He rails,
Even there where merchants most do congregatē,
On me, my bargains. *Shakespeare. Merchant of Venice.*

This brave overchanging firmament appears no
other thing to me, than a foul and pestilent congrega-
tion of vapours. *Id.*

Tempests themselves, high seas, and howling
winds,
The guttered rocks and congregated sands,
As having sense of beauty, do omit
Their mortal natures. *Id. Othello.*

These waters were afterwards congregated,
and called the sea. *Raleigh's History of the World.*

The means of reduction by the fire, is but by *con-*
gregation of homogeneal parts. *Bacon.*

Where the matter is most *congregate*, the cold is
the greater. *Id. Natural History.*

The dry land, earth; and the great receptacle
Of congregated waters, he called seas;
And saw that it was good. *Milton's Paradise Lost.*

'Tis true (as the old proverb doth relate)
Equals with equals often *congregate*. *Denham.*

The practice of those that prefer houses before
churches, and a conventicle before the *congregation*.

Heat *congregates* homogeneal bodies, and separates
heterogeneal ones. *Newton's Opticks.*

If those preachers who abound in epiphonemas
would look about them, they would find part of their
congregation out of countenance, and the other asleep.
Swift.

Every parish has a *congregational* or parochial pres-
bytery for the affairs of its own circle. *Warton.*

My subject is only general *congregational* psalmody.
Mason.

Ill fares the traveller now, and he that stalks
In ponderous boots beside his reeking team.
The wain goes heavily, impeded sore
By congregated loads adhering close
To the clogged wheels; and in its sluggish pace
Noiseless appears a moving hill of snow. *Cooper.*

Compared with this, how poor religion's pride,
In all the pomp of method, and of art,
When men display to congregations wide
Devotion's every grace, except the heart. *Burns.*

Explore the caverns dark and drear
Mantled around with deadly dew,
Where congregated vapours blue,
Fired by the taper glimmering near,
Bid dire explosion the deep realms invade.
Huddisford.

CONGREGATION, in the Romish church, is princi-
pally used for assemblies of cardinals, ap-
pointed by the pope, and distributed into cham-
bers, for the discharge of certain functions and
jurisdiction.

CONGREGATION is also used for a society of
religious cantoned out of an order; and making
a subdivision of it. Such are the congregations
of the oratory of Cluny, &c. among the Bene-
dictines.

CONGREGATIONALISTS, in ecclesiastical his-
tory, is a name sometimes given to those Pro-
testants who reject all church government, ex-
cept that of a single congregation, under the
direction of one pastor, with deacons, assistants,
or managers. It is equivalent to the modern
term independents.

CONGRESBURY, an ancient town of So-
mersetsshire, situated under the Mendip Hills,
six miles from Axbridge, and 134½ from London.
It is said to derive its name from St. Conger,
the son of an eastern emperor, who founded in
this place a cell for twelve canons. It was for-
merly a market town, but now ranks only as a
village.

CONGRESS, n. s. } Lat. *congressus*. A
CONGR'ESSION, n. s. } coming together; shock;
CONGR'ESSIVE, adj. } conflict; a meeting of
diplomats, to settle affairs between different
nations; the legislature of the North American
states. Congression is synonymous with con-
gress, in the first of the foregoing senses. Con-
gressive denotes coming together.

If it be understood of sexes conjoined, all plants are female; and if of disjointed and *congruence* generation, there is no male or female in them.

Brown's Vulgar Errors.

Here Pallas urges on, and Lausus there;
Their congress in the field great Jove withstands,
Both doomed to fall, but fall by greater hands.

Dryden's Æneid.

We sent out a solemn embassy across the Atlantic Ocean, to lay the crown, the peerage, the commons of Great Britain, at the feet of the American congress. That our disgrace might want no sort of brightening and burnishing, observe who they were that composed this famous embassy.

Burke.

SIR BENJ. In short, her face resembles a table d'hôte at Spa—where no two guests are of a nation.

CRABT. Or, a congress at the close of a general war—wherein all the members, even to her eyes, appear to have a different interest, and her nose and chin are the only parties like to join issue.

Sheridan. School for Scandal.

There is, therefore, no absurdity in believing that the most simple animals and vegetables may be produced by the congress of the parts of decomposing organic matter.

Darwin.

CONGRESS, AMERICAN, the legislative power of the United States, consisting of a senate and house of representatives. See AMERICA.

CONGREVE (William), a younger brother of an ancient family in Staffordshire. His father was steward of the earl of Burlington's estate in Ireland, where our author was born in 1672. When he first came to England he began to study the law, but his bias was towards polite literature and poetry. His first performance was a novel, entitled *Incognita, or Love and Duty Reconciled*. He soon afterwards began his comedy of the *Old Bachelor*, the composition of which had been his amusement during a slow recovery from a fit of illness. When brought on the stage, in 1693, it met with such universal approbation, that Congreve, though only nineteen years of age, was hailed as the support of the declining stage, and obtained the decided patronage of lord Halifax. In 1694 he produced the *Double Dealer*; which, however, did not meet with so much success as his former play. In 1695, when Betterton opened the theatre in Lincoln's-Inn-Fields, Congreve, joining with him, gave him his comedy of *Love for Love*, which was so well received, that Betterton immediately offered the author a share in the management of the house, on condition of his furnishing to it one play yearly. This offer he accepted; but, whether through indolence or fastidiousness, his *Mourning Bride* did not come out till 1697, nor his *Way of the World* till 1699. The indifferent success this last met with, completed that disgust to the theatre, which a long contest with Jeremy Collier, who had attacked the immoralities of some of his pieces, had begun, and he determined never more to write for the stage. It is probable, however, that he might not so soon have given way to this disgust, had not the easiness of his circumstances rendered him totally independent of the caprice of the town. The earl of Halifax had made him one of the commissioners for licensing hackney-coaches; and soon after, bestowed on him a post in the customs worth £600 per annum. In 1718 he was appointed

secretary of Jamaica; so that his income, at this period, was upwards of £1200 a-year, and the last twenty years of his life were spent in ease and retirement. When Voltaire was in England, he waited upon Mr. Congreve, and passed some compliments upon the merit of his works. Congreve thanked him; but said that he did not choose to be considered as an author, but only as a private gentleman. Voltaire, with the readiness so peculiar to him, replied, that if he had never been anything but a private gentleman, in all probability he had never been troubled with that visit. He died January 19th, 1729, aged fifty-seven; and, on the 26th following, was buried in Westminster Abbey.

CONGRU'É, *v. n. & adj.*

CONGRU'ENCE, *n. s.*

CONGRU'ENCY, *n. s.*

CONGRU'ENT, *adj.*

CONGRU'ITY, *n. s.*

CO'NGRUOUS, *adj.*

CO'NGRUOUSLY, *adv.*

CO'NGRUMENT, *n. s.*

Lat. *congruere*. 'Τερανος, *grus*; a crane; unde *congruo*; à *grubus* tractum; quæ se nonsegregant, sive cum volent, sive cum pascantur; to come together in flocks, like cranes, who never separate; also to agree; to unite.' The verb, which is not in use, means to be in agreement, or consistent with; suitable to. Congruity is fitness; correspondence; consistency. The same idea is common to all the kindred words. Congrument, which Johnson has admitted into his dictionary, Mr. Todd believes, and apparently with reason, to be a press error in some of the editions of Ben Jonson's works. He agrees with Mr. Whalley in reading congruent, and this reading undoubtedly improves the passage.

With what congruity doth the church of Rome deny, that her enemies do at all appertain to the church of Christ?

Hooker.

A whole sentence may fail of its congruity by wanting one particle.

Sidæus.

Our sovereign process imports at full,

By letters congruing to that effect,

The present death of Hamlet. *Shakespeare. Hamlet.*

The congruement (*congruent*) and harmonious fitting of periods in a sentence, hath almost the fastening and force of knitting and connexion.

Ben Jonson's Discovery.

For humble grammar first doth set the parts

Of congruent and well-acording speech;

Which rhetoric, whose state the clouds doth reach,

And heavenly poetry, do forward lead. *Darwin.*

This conjecture is to be regarded, because, congruously unto it, one having warmed the bladder, found it then lighter than the opposite weight.

Boyle's Spring of the Air.

Congruity of opinions to our natural constitution, is one great incentive to their reception.

Glanville.

The existence of God is so many ways manifest, and the obedience we owe him so congruous to reason, that the light of a great part of mankind give testimony to the law of nature.

Locke.

Wit lying most in the assemblage of ideas, and putting those together with quickness and variety wherein can be found any resemblance or congruity, thereby to make up pleasant pictures, and agreeable visions, in the fancy; judgment, on the contrary, lies quite on the other side, in separating carefully, one from another, ideas wherein can be found the least difference, thereby to avoid being misled by similitude, and by affinity, to take one thing for another.

Id.

Motives that address themselves to our reason, are fittest to be employed upon reasonable creatures : it is no ways *congruous*, that God should be always frightening men into an acknowledgement of the truth.

Atterbury.

The faculty is infinite, the object infinite, and they finitely *congruous* to one another.

Cheyne's Philosophical Principles.

These planes were so separated as to move upon a common side of the *congruent* squares, as an axis. *Id.*

It is an act of reasoning of which we are unconscious, except by its effects in preserving the *congruity* of our ideas.

Darwin.

CONI, a considerable town of Italy, in Piedmont, and a bishop's see; seated at the confluence of the Gesso and the Stura. It is said to have been first founded in 1520, during the pontificate of Celistus II. The inhabitants being divided into two factions, it surrendered to the French in 1641, but restored to Savoy soon after. It was again besieged by them in 1744, without being taken; but, on the 26th April,

1796, it surrendered to the republican troops under Buonaparte, previous to the peace with the king of Sardinia. It is strong by nature and art, and its trade is considerable, being the repository for all the traffic between Turin and Nice, and Lombardy, Switzerland, and Germany. Its principal articles of commerce are corn and hemp; but silk is the only manufacture. It lies thirty-five miles south of Turin, and thirty-four north of Nice, and has a strong citadel. Population about 10,000.

CONICA SCABRITIES. See BOTANY.

CONICHTHYODONTES, or PLECTRONITÆ, in natural history, the fossile teeth of fishes, so called from their resembling a cock's spur. They are of an oblong conic figure, broad at the base, narrow at the point, and a little crooked, and from one-tenth of an inch to two inches long. They are often found in England, in strata of stone or clay, with part of the jaw-bones; but it is not certain to what fish they belong.

CONIC SECTIONS.

INTRODUCTION.

CONIC SECTIONS are the figures formed by cutting a cone by a plane. They are five in number, corresponding to the different positions of the cutting plane; viz. a triangle, a circle, an ellipse, a parabola, and an hyperbola. The last three of these only are peculiarly called conic sections.

The more ancient mathematicians, before the time of Apollonius Pergæus, admitted only the right cone into their geometry, and they supposed a section made of it by a plane perpendicular to one of its sides; and as the vertical angle of a right cone may be either right, acute, or obtuse, this method of cutting these several cones produced all the three conic sections. The parabola was called the section of a right angled cone, the ellipse the section of the acute angled cone, and the hyperbola, the section of the obtuse angled cone. But Apollonius, who, on account of his writings on this subject, obtained the title of the Great Geometrician, observed that these sections might be obtained in every cone, both oblique and right, and that they depended on the different inclinations of the section to the cone itself.

There have been two methods employed in treating of the conic sections: by the one they are considered as cut out of the solid cone, which is the method of the ancients, and of some of the most elegant writers of the moderns; and by the other method certain curves are defined, either from some property by which any number of points may be found in them, or else by which they may be described mechanically upon a plane; or they are defined by means of an algebraical equation, and in either case these curves are shown to have the very same properties as those which are formed by the intersections of a plane and cone. Each of these methods has its

advantage; although some of the demonstrations of writers who have treated the subject geometrically, by the latter, be short and perspicuous, yet there are others, upon which depend some of the principal properties, that are tedious and difficult. The demonstrations of writers who have pursued the first method are free from this objection, being generally plain and concise; but they have been obliged to introduce so many previous propositions concerning the properties of lines touching and cutting conical surfaces, in order to arrive at the principal properties of the three sections, that it requires a considerable portion of time and resolution for a beginner in mathematical studies to go through them.

Some writers, who have treated the subject algebraically, have reduced the whole into a narrower compass; but, in their eagerness to avoid prolixity, they have fallen into another more exceptionable fault. The method in which they have deduced some of the properties, particularly the relations of the abscissæ and ordinates, is extremely operose and inelegant; each step in the process is so little connected with the preceding one, that it is scarcely possible to retain them in the memory.

The conic sections are of great use in physical, and plane, astronomy, as well as in all the physico-mathematical sciences, and, therefore, they have been much cultivated ever since their great importance in these sciences was known. The *abbé* Boscovich has deduced the properties of the conic sections in a very elegant manner from a property common to them all, and the same method has also been followed by the Rev. T. Newton, of Jesus College, Cambridge, in a very neat treatise upon the subject, published in 1794. We shall now proceed to demonstrate some of the most material properties of these figures, availing ourselves chiefly of the work of the last mentioned ingenious writer.

SECT. 1.—OF THE RELATION BETWEEN THE ABSCESSÆ AND ORDINATES IN ALL THE SECTIONS. PROPERTIES OF TANGENTS DRAWN TO THE CURVES, &c.

DEFINITIONS. See plate I. fig. 1, 2.

I. Let a point S , be assumed anywhere without a straight line DX , given by position, and let a point P be supposed to move always in such a manner, that PS , its distance from the given point, may be to PE , its distance from the line DX , in a given ratio, the curve described by the point P is called a conic section; which will be a parabola, an ellipse, or an hyperbola, according as PS is equal to, less, or greater than PE .

II. The indefinite straight line, DX , is called the directrix.

III. The point S is called the focus.

IV. The given ratio of SP to PE , is called the determining ratio.

V. If a line SD be drawn through the focus, perpendicular to the directrix, which is produced indefinitely, it is called the axis of the conic section.

VI. The point A , where the axis meets the curve, is called the vertex.

VII. A straight line LST , drawn through the focus parallel to the directrix, and terminated by the curve in the points L and T , is called the principal parameter, or the latus rectum.

COROLLARY 1. Fig. 2. SP being greater than PE in the hyperbola, two curves will be described, one on each side of the directrix; which are called opposite hyperbolas.

COR. 2. When the line SP comes into the position SAD , SP PE will be equal to SA , AD ; therefore SA is to AD in the determining ratio.

COR. 3. When SP comes into the position SL , or ST , the distance of P from the directrix will be equal to SD , and SL or ST will be to SD in the determining ratio, therefore $LS = ST$.

COR. 4. The latus rectum in the parabola is equal to twice the distance of the focus from the directrix, or to four times its distance from the vertex. For $SL = SD$, and $SA = AD$, therefore $LT = 2SD = 4SA$.

PROPOSITION I. Fig. 3, 4, 5.

If two straight lines, DQ , Dq , be drawn from the point D , where the axis meets the directrix, through L and T , the extremities of the latus rectum, which are produced both ways in the hyperbola; and through any point P in the conic section, a line QPP be drawn parallel to the directrix, meeting DL and DT in Q and q ; the segment QN , which is intercepted between either of the lines and the axis, will be equal to SP , the distance of P from the focus.

The triangles DNQ , DSL , are similar, therefore $NQ : ND :: SL : SD$, (that is Cor. 3. Def.) :: $SP : ND$. Hence $NQ = SP$, and in the same manner it may be proved that $Nq = Sp$.

COR. 1. If KAG be drawn through the vertex, parallel to the directrix, SA will be equal to AK or AG .

COR. 2. The lines DQ , Dq , touch the conic section in the points L and T . For the triangle SNP being right angled, SP or QN is always

greater than PN , except when P is at L , where they coincide, therefore DQ meets the curve only in one point L . In like manner it may be shown that Dq touches the curve at T .

PROP. II. Fig. 3, 4, 5.

If from the point G , where the straight line KG , which is drawn through the vertex, parallel to the directrix, meets either of the tangents DQ , Dq , a line GR be drawn through the focus S , and produced both ways in the hyperbola, it will be parallel to the other tangent DQ in the parabola; it will meet it somewhere in g in the direction GSg in the ellipse, and in the opposite direction in the hyperbola.

Let SG meet the directrix in X . The triangles SAG , SDX , are similar, now $SA = AG$, Cor. 1. Prop. 1, therefore $SD = DX$, but in the parabola, fig. 3, $SL = DS$, therefore SL is equal and parallel to DX ; and consequently XS is equal and parallel to DL . In the ellipse, fig. 4, SL is less than SD or DX , and therefore the lines DL , XS , must meet when produced in the direction XGS . In the hyperbola, fig. 5, SL is greater than SD or DX , and therefore the lines must meet when reduced in the direction SGX .

COR. 1. Because the triangles GAS , SNR , are similar, SN will be equal to NR .

COR. 2. Fig. 4, 5. Hence where Q coincides with g , in the ellipse or opposite hyperbola, QN will be equal to gM or SM ; therefore SP will be equal to SN ; and therefore SP will coincide with SN , and the curve will meet the axis in the point M .

COR. 3. Hence the whole ellipse, fig. 4, is contained between the lines GK , gk , on one side of the directrix.

COR. 4. In the parabola, fig. 3, NQ being always greater than NR , except at the vertex, SP is greater than SN ; therefore the curve will meet the axis only in one point A , and it will extend without limit on one side of the directrix.

COR. 5. In the hyperbola, fig. 5, NQ being greater than NR , except at A and M , SP is greater than SN , and the two curves will be extended without limit, on opposite sides of the directrix.

DEFINITIONS. Fig. 4, 5.

VIII. The tangents DLQ , DTq , which are drawn through the extremities of the latus rectum, are called focal tangents.

IX. The straight line AM , in the ellipse and hyperbola, is called the transverse axis, or the axis major.

X. If the transverse axis be bisected in C , the point C is called the centre of the ellipse or hyperbola.

XI. If a line BCb , which is bisected in C , be drawn perpendicular to the transverse axis, and CB , Cb , be each a mean proportional between SA , SM , the segments of the axis between the focus and the vertices, BCb is called the conjugate axis, or axis minor.

XII. A line PNp , drawn through any point N , in the axis parallel to the tangent KG , or perpendicular to the axis, and terminated by the curve at P and p , is called an ordinate to the axis.

Fig. 1.

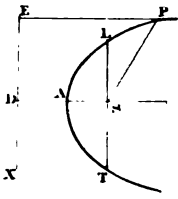

Fig. 2.

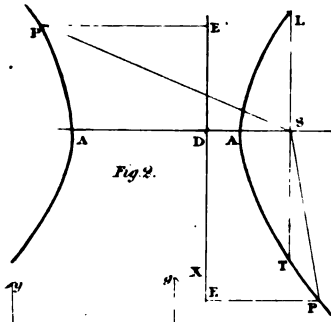

Fig. 3.

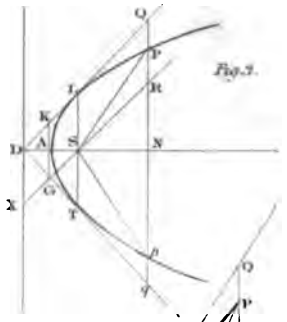

Fig. 4.

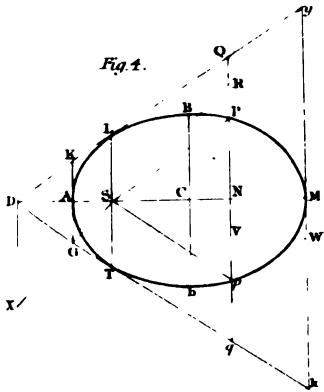

Fig. 5.

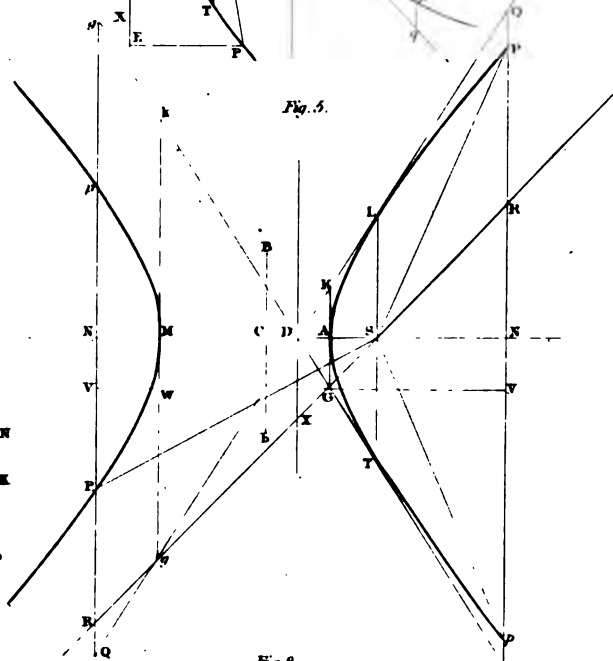

Fig. 6.

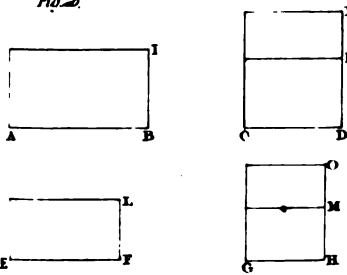

Fig. 6.

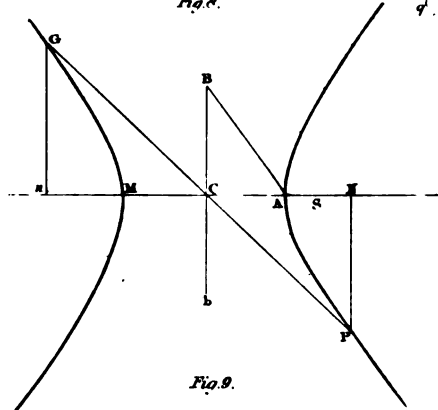

Fig. 7.

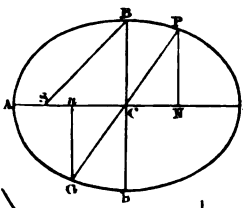

Fig. 9.

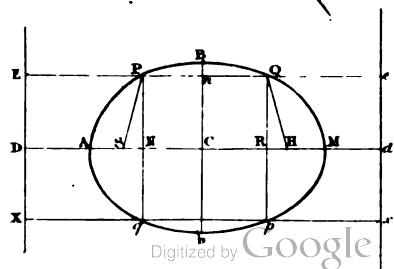
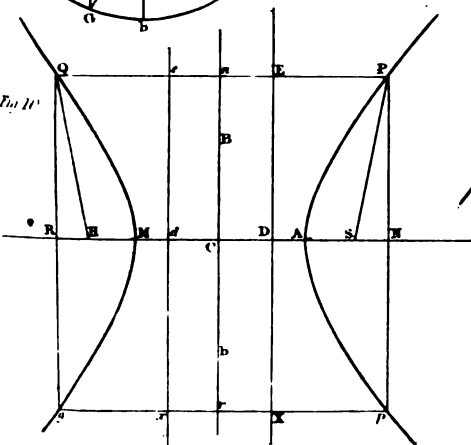

Fig. 10.



XIII. And AN the segment of the axis, intercepted between the ordinate and the vertex, in all the sections, as also the other segment NM in the ellipse and hyperbola, is called an abscissa.

XIV. Any line passing through the centre of an ellipse or hyperbola, and terminated both ways by the curve in the former, but by the opposite curves in the latter, is called a diameter.

XV. A line drawn through any point in the parabola parallel to the axis, is called a diameter of the parabola.

XVI. Any point where the diameter meets the curve is called a vertex to that diameter.

PROP. III. Fig. 3, 4, 5.

The axis bisects all its ordinates, and divides the conic section into two equal and similar parts.

Let PNp be any ordinate, meeting the axis in N. Join SP, Sp. Because SP = Sp, Prop. I. and SN is common to the two right angled triangles SNP, SNp, therefore Np = NP. And because all the ordinates are bisected, if the curve ATp be turned round upon the axis AN, and placed upon ALP, all the points p will coincide with the points P, and the curve ATp with the curve ALP.

PROP. IV. Fig. 3.

The square of the semi-ordinate to the axis in the parabola, is equal to the rectangle under the latus rectum and the abscissa.

Because the line Qq is bisected in N, QR. Rq + RN² = QN² = (by Prop. I.) PS² = PN² + NS² = (Cor. I, Prop. II.) PN² + NR². Therefore QR·Rq = PN². But QR = SL, and Rq = RN + Nq = (Because SN = NR, and NDq is half a right angle) SN + ND = 2NA. Therefore QR·Rq = 2AN·SL = AN·LT, and therefore PN² = AN·LT.

COR. 1. The latus rectum being constant, the abscissa varies as the square of the ordinate.

COR. 2. The parabola recedes from the axis without limit. For the abscissa, and therefore the square of the semi-ordinate, increases without limit.

COR. 3. Any line which is drawn parallel to the axis of the parabola, can meet the curve in one point only. For, if it were supposed to meet the curve in more points than one, the semi-ordinates drawn through the points of intersection would be equal, when the abscissæ are unequal, which is impossible.

LEMMA I. Fig. 6.

If four straight lines be proportionals, and any other four proportionals, the rectangle under the first and fifth is, to the rectangle under the second and sixth, as the rectangle under the third and seventh to the rectangle under the fourth and eighth.

Let AB : CD :: EF : GH and BI : DK :: FL : HM, and let AI, CK, EL, GM, be rectangles, then AI : CK :: EL : GM. For in DK, HM, produced if necessary, take DN, HO, such, that AB : CD :: DN : BI, and EF : GH :: HO : FL, and complete the rectangles CN, GO, then CN = AI and GO = EL. But AB : CD :: EF : GH :: DN : BI, therefore DN : BI :: EF : GH ::

HO : FL. But BI : DK :: FL : HM; therefore DN : DK :: HO : HM. Because CN : CK :: DN : DK, and GO : GM :: HO : HM; therefore, CN : CK :: GO : GM, and therefore, AI : CK :: EL : GM.

COR. If A, B, C, and D, be four straight lines, and A : B :: C : D, then A² : B² :: C² : D².

PROP. V. Fig. 4, 5.

The square of the semi-ordinate to the axis in the ellipse and hyperbola, to the rectangle under the abscissæ, as the square of the conjugate axis to the square of the transverse axis.

Through the point G, draw GVW in the ellipse, and VGWV in the two hyperbolas parallel to AM. Then, because the lines KAG, QNg, gMk, are parallel.

QR : KG :: gR : gG :: VW : GW :: NM : AM, and Rq : gk :: GR : Gg :: GV : GW :: AN : AM; therefore, Lem. 1, QR·Rq : KG·gk :: AN·NM : AM². But it may be proved, as in the last proposition, that QR·Rq = PN², and because GK = 2SA, and gk = 2SM, therefore KG·gk = 4AS·SM = (by Def. 11.) 4B² = Bb². Therefore, PN² : Bb² :: AN·NM : AM², and alternately, PN² : AN·NM :: Bb² : AM².

COR. 1. Because AM, Bb, are bisected in C, PN² : AN·NM :: BC² : AC².

COR. 2. The square of the semi-ordinate varies as the rectangle under the abscissæ.

COR. 3. The conjugate axis in the ellipse is terminated by the curve; for, when the ordinate passes through the centre, the rectangle under the abscissæ is equal to the square of half the transverse axis, and therefore the square of the semi-ordinate is equal to the square of half the conjugate axis, and the ordinate is equal to the conjugate axis.

COR. 4. The two hyperbolas recede from the axis without limit; for the abscissæ, and therefore the square of the ordinate, increase without limit.

COR. 5. Those ordinates which are at equal distances from the centre of the ellipse, and the two hyperbolas are equal; and those which are nearer to the centre are greater in the ellipse, and less in the hyperbola, than those which are more remote.

COR. 6. Any line which is drawn parallel to the axis of the hyperbola will cut each of the opposite curves only in one point; for, if it be supposed to cut either of the curves in more points than one, the ordinates which are drawn through the points of intersection would be equal, when the distances from the centre are unequal.

PROP. VI. Fig. 4, 5.

The latus rectum of the ellipse and hyperbola is a third proportional to the transverse and conjugate axes.

For by Cor. 1, Prop. V. AC² : BC² :: AS·SM, or BC² : SL²; therefore AC : BC :: BC : SL and AM : Bb :: Bb : LT.

COR. Hence AN·NM : PN² :: AM : IT, for AM : LT :: AM² : Ab² :: AN·NM : PN²

PROP. VII. Fig. 7, 8.

The square of half the conjugate axis, in the ellipse and hyperbola, is equal to the difference of the squares of half the transverse axis, and the distance of the focus from the centre.

Because AM is bisected in C , the difference of the squares of AC and SC is equal to the rectangle ASM , that is, (Def. 11,) to the square of BC .

COR. 1. Fig. 7. If a line, SB , be drawn from the focus of the ellipse to the vertex of the conjugate axis, it will be equal to AC , half the transverse axis.

COR. 2. Fig. 8. If a line, AB , be drawn joining the vertices of the axes of a hyperbola, it will be equal to CS , the distance of the focus from the centre.

PROP. VIII. Fig. 9, 10.

The conjugate axis bisects all lines drawn parallel to the transverse axis, which are terminated by the ellipse, and by the opposite hyperbolas. Those lines which are equally distant from the centre are equal; and those which are nearer to the centre are greater in the ellipse, and less in the hyperbola, than those which are more remote.

Take CN any distance from the centre, between C and A in the ellipse, and in CA produced in the hyperbola. Take $CR = CN$, and draw the ordinates PNp , QRq ; join PQ , pq , meeting Bb in n and r . Because Pp and Qq are equal, Cor. 5, Prop. V., and they are bisected in N and R , the lines PQ , NR , pq , are equal and parallel, and because $Pnpr$ are equal to NC , and $Qnrq$ equal to RC , or NC , PQ , pq , are bisected in n and r , and they are at equal distances from the centre, because $CnCr$ are equal to PNp . Lastly, as Cn decreases PN decreases, and therefore CN , Cor. 5, Prop. V., increases in the ellipse, and decreases in the hyperbola; but Pn is equal to CN , Pn therefore increases in the former and decreases in the latter, as Cn , its distance from C , decreases.

COR. 1. The conjugate axis divides the ellipse into two equal and similar parts; the two opposite hyperbolas are equal and similar: and the ellipse and hyperbola have each of them another focus and directrix, which have the same properties as the former. Take $CH = CS$, and $Cd = CD$; through d draw xde perpendicular to Cd , meeting PQ , pq , in e and x , and join HQ . Then if the whole figure, $nQMqr$, be turned round upon the axis Bb , and placed upon $nPApr$, $nQrg$ will coincide with $nPrp$, and all the points Qq in the curve QMq , with all the points Pp in PAP . The straight line xde will also coincide with XDE , the point H with S , and the lines HQ , Qe with the lines SP , PE : therefore HQ is always to Qe in the ratio of SP to PE .

COR. 2. Suppose PQ , fig. 9, which is always parallel to AM , to move from the centre towards B , the points P , Q , will coincide at B , and the line EPQ will become a tangent to the ellipse; therefore the ordinates to the conjugate axis are parallel to the tangent at its vertex.

PROP. IX. Fig. 9.

The square of the semi-ordinate to the conjugate axis, in the ellipse, is to the rectangle under the abscissæ as the square of the transverse axis to the square of the conjugate axis.

For PnQ , being parallel to AM , is perpendicular to Bb , and it is bisected in n ; by the last Prop. it is therefore an ordinate to Bb , and by Prop. V. PN^2 , or $CN^2 : BC^2 :: AN \cdot NM : AC^2$, and by division $Bn \cdot nb : BC^2 :: CN^2$ or $PN^2 : AC^2$, and by alternation and inversion $Pn^2 : Bn \cdot nb :: AC^2 : BC^2 :: AM^2 : Bb^2$.

PROP. X. Fig. 9, 10.

The transverse axis, in the ellipse and hyperbola, is to the distances between the directrices in the determining ratio.

For $SA : AD :: SM : MD$, and alternately $SA : SM :: AD : MD$, therefore, by composition in the ellipse and division in the hyperbola,

$AM : SA :: Dd : AD$, and alternately, $AM : Dd :: SA : AD$, that is in the determining ratio.

COR. 1. Hence AC is to CD in the determining ratio.

COR. 2. The distance between the foci is to the transverse axis in the determining ratio.

For $SM : MD :: SA : AD :: HM : AD$, and alternately, $SM : HM :: MD : AD$, and by division in the ellipse and composition of the hyperbola, $SH : HM :: AM : AD$, and alternately, $SH : AM :: HM : AD :: SA : AD$.

COR. 3. Hence CS , CA , and CD are continual proportionals.

PROP. XI. Fig. 7, 8.

All the diameters of an ellipse or hyperbola are bisected in the centre.

From any point, P , in the curve draw PC to the centre, and PN perpendicular to the axis. Take $Cn = CN$; and draw nG parallel to NP , but on the other side of the axis, let it meet the curve in G , and join CG . Then, because $Cn = CN$, the semi-ordinates Gn , PN , will be equal, Cor. 5, Prop. V., and the angles at N and n are right angles, therefore the triangles CNP , CnG , are equal, therefore $CG = CP$, and the angle nCG is equal to PCP , hence it follows that GCP is a straight line which is bisected at C .

PROP. XII. Fig. 17, 18, Plate XVII.

If, from any point in the ellipse or hyperbola, two straight lines be drawn to the foci, the sum of these lines in the ellipse, and their difference in the hyperbola, is equal to the transverse axis.

Let P be any point in the ellipse or hyperbola, and let S and H be the two foci. Join PS , PH , and through P draw EPe , parallel to the axis, meeting the directrices in E and e . Then SP will be to PE , and HP to Pe , in the determining ratio, and alternately $SP : HP :: PE : Pe$, therefore, in fig. 17, $SP + HP$, and $SP - HP$, in fig. 18 is to SP as Ee or Dd is to PE ; and alternately, $SP \pm PH : Dd :: SP : PE :: AM : Dd$, Prop. X., therefore in the ellipse $SP + PH$, but in the hyperbola $SP - PH = AM$, the transverse axis.

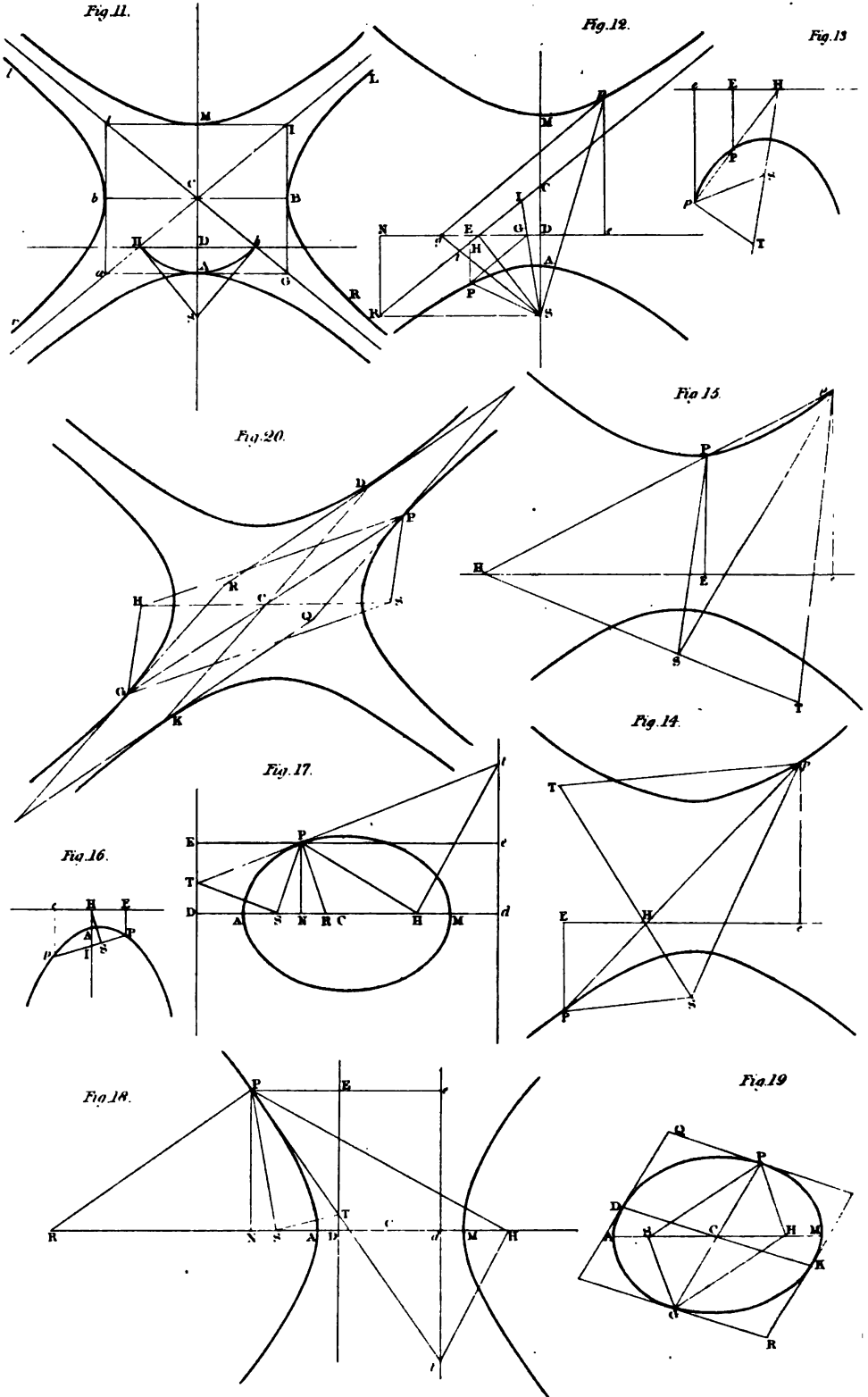

DEF. XVII. Fig. 11, Plate II.

If from the centre C. at the distance CA, half the transverse axis, a circle be described, cutting the directrix of the hyperbola in the points H, h, and lines be drawn from the centre through the points of intersection, these lines are called the asymptotes.

PROP. XIII. Fig. 11.

If lines SH, Sh, drawn from the focus S to the points H, h, in which the asymptotes cut the directrix, they will be perpendicular to the asymptotes; and these lines, as also AG, Aa, the segments of the tangents at the vertex, which is intercepted between the asymptotes, are each equal to half the conjugate axis.

For, Cor. 3, Prop. X., $CS : CA :: CA : CD$, that is, $CS : CH :: CH : CD$; now the angle HCS is common to the two triangles CHD, CSH, therefore these triangles are similar and the angle $CHS = CDH =$ a right angle. In the same way it may be proved that CHS is a right angle.

Again, $SH^2 = SC^2 - CH^2 = SC^2 - CA^2 = CB^2$ by Prop. VII; therefore $SH = CB$, in the same way it may be proved that $Sh = CB$; and because $CH = CA$, and CHS, CAa , are right angles, and the angle HCS is common to the triangles SHC, aAC, these triangles are equal, and $Aa = SH = BC$.

Cor. 1. Radius is to the sine of the angle contained by the asymptote and directrix in the determining ratio; for CA or CH is to CD in the same ratio, and $CH : CD ::$ radius : sine CHD.

Cor. 2. If a line PG, fig. 12, be drawn from any point P in the hyperbola, or in the opposite curve, parallel to the asymptote, meeting the directrix in G, PG will be equal to PS. Draw PE perpendicular to the directrix; and because the angle $PGE = CHD$, PG is to PE in the determining ratio, or as SP to PE, therefore $PG = PS$.

PROP. XIV. Fig. 12.

The asymptotes never meet the curve, but any other line drawn parallel to an asymptote will meet one of the hyperbolas.

For if it be possible, let the asymptote meet the curve in the point R. Join RS, and draw RN perpendicular to the directrix. Then by Cor. 1, last Prop., HR is to RN in the determining ratio or as SR to RN, therefore $RS = RH$, and the angle $RSH = RHS$; which is impossible, for by last Prop. RHS is a right angle. In the same way it may be proved that it cannot meet the opposite curve. Let any other line GP be drawn parallel to the asymptote; and first let it be nearer to the focus. Join SG, and produce it to meet the asymptote CH in I; then the angle $SGP = SIH$, which is less than SHR , a right angle; therefore, if GSP be made equal to SGP , SP GP will meet somewhere in P, which is a point in the curve. For draw PE perpendicular to the directrix, and the angle PGE being equal to CHD , PG is to PE in the determining ratio; therefore SP is to PE in the same ratio, and P is a point in the hyperbola.

Secondly, let gp be drawn parallel to the asymptote, at a greater distance from the focus. Join Sg, meeting HC in i; the angle $Sgp = SiH$, which is less than a right angle; if therefore gSp be made equal to Sgp , the lines Sp, gp, will meet when produced in some point, p, which is in the opposite hyperbola; for the angle pge being equal to CHD , pg is to pe, or SP is to pe in the determining ratio, therefore p is a point in the curve.

Cor. Hence, if any line be drawn through the centre of an hyperbola within the angle contained by the asymptotes, it will meet both the curves.

DEFINITIONS. Fig. 11.

XVIII. If AM be the transverse axis and Bb the conjugate axis of two opposite hyperbolas, and other two hyperbolas be described, of which the transverse axis is Bb, and conjugate axis AM, these hyperbolas are said to be conjugate to the former.

XIX. When the two axes are equal, the hyperbolas are said to be equilateral.

PROP. XV. Fig. 11.

The asymptotes are diagonals of the rectangle, which is made by drawing tangents through the vertices of the four hyperbolas.

Let the tangents GAa, IMi, which are drawn through the vertices of the transverse axis, meet the asymptotes in G, a, and I, i. Join IB, GB, as also ab, ib. The triangles MCI, ACA, are equal, for $AC = CM$, the angle $MCI = ACA$, and $CMi = CAa$, therefore $Mi = Aa$, which is equal to CB, Prop. XIII. In like manner it may be proved that $Mi = Cb = CB$; therefore IB, BG, are equal and parallel to MC, CA, the angles IBC, GBC , are each a right angle, and IBG is one straight line, which is equal and parallel to MA. For the same reason iba is one straight line, which is equal and parallel to MA; and because the lines IBG, iba, are perpendicular to the axis BCb, they are tangents to the conjugate hyperbolas, and $IGai$ is a rectangle of which the asymptotes Ia, Gi, are the diagonals.

Cor. 1. The asymptotes GCa, ICA, are also asymptotes to the conjugate hyperbolas. For $BI = BG = CA$, which is the semi-conjugate axis to the hyperbolas LBR, lbr.

Cor. 2. If the hyperbolas be equilateral, the asymptotes will be perpendicular to each other.

PROP. XVI. Fig. 13, 14, 15.

If a straight line Pp, which cuts a conic section, or opposite sections, into two points P, p, meets the directrix in H, and a right line HST be drawn through the focus, and SP, Sp, be joined; the angle PSH will be equal to pST.

Draw pT parallel to PS, and let it meet HS in T; and draw PE, pe, perpendicular to the directrix. The triangles HPE, Hpe, are similar, as also HSP, HTP, and $SP : PE :: Sp : pe$; and alternately $SP : Sp :: PE : pe :: HP : Hp :: SP : pT$, therefore $Sp = Tp$, and the angle $pST = pTS = PSH$.

Cor. 1. When P and p coincide, fig. 13, 15, or when HP becomes a tangent to the conic section, SP will coincide with Sp, and the angles PSH, pST will be right angles.

COR. 2. Hence if a line SP be drawn from the focus to any point P in a conic section, fig. 16, and SH be drawn perpendicular to SP, meeting the directrix in H, and HP be joined, it will touch the conic section in P.

COR. 3. It is evident from this proposition, that a straight line cannot cut a conic section in more points than two.

PROP. XVII., Fig. 16.

If a tangent be drawn to any point in the parabola, it will bisect the angle contained by the two straight lines drawn from the point of contact, one to the focus, and the other to the directrix.

Let PH which touches the parabola at P meet the directrix in H. Join SP, SH, and draw PE perpendicular to the directrix. The angle SPE is bisected by PH. For $SP = PE$ and PH is common to the triangles PSH, EPH; and PSH, PEH are right angles, therefore the triangles SPH, EPH, are similar, and the angles SPH = EPH.

COR. 1. Hence if a straight line PH bisects the angle SPE, it will be a tangent to the parabola at the point P.

COR. 2. Let PS meet the curve again in p, and let HI be drawn parallel to the axis, it will bisect Pp in I, and HI will be bisected by the curve in A. For angle IHP = HPE = HPI, therefore $IP = IH$, and if p H be joined, the line p H will be a tangent, and therefore for the same reason $Ip = IH$, therefore $IP = Ip$. Secondly, because SA = AH, the angle ASH = AHS, and the complements of these angles are equal, that is ASI = AIS, therefore $AI = AS = AH$.

PROP. XVIII., Fig. 17, 18.

If a tangent be drawn to any point in an ellipse or an hyperbola, and two lines be drawn from the point of contact to the foci, the angles contained by each of these lines and the tangent are equal. Let PT touch the ellipse or hyperbola at any point P, let it meet the directrices in T and t. Through P draw a line parallel to the axis AM meeting the directrices in E and e, draw PS, PH, to the foci, and join ST, Ht. Because the triangles TPE, tPe, are similar, $PE : PT :: Pe : Pt$, and by Sect. I., def. 1. $SP : PE :: HP : Pe$, therefore $SP : PT :: HP : Pt$, and the angles PST, PHT, are right angles, Cor. 1., Prop. XVI. therefore the triangles SPT, HPt, are similar, and the angle SPT = HPt.

PROP. XIX., Fig. 19, 20.

The tangents at any vertices of any diameter of an ellipse or an hyperbola are parallel.

Let PCG be any diameter of an ellipse, or hyperbola; draw the tangents PQ, GR, and join SP, PH, SG, GH. Because SC = CH, and CP = CG, and the angle SCP = GCH, the triangle SCP = HCG, and the angle SPC = HGC, also SP is equal and parallel to GH, therefore PH is equal and parallel to SG, and SPHG is a parallelogram, therefore the angle SPH = SGH, and the halves of these angles, fig. 20, or the halves of their supplements, fig. 19, will be equal, that is the angle SPQ =

HGR, and if these be added to the equal angles SPC, CGH, in the ellipse, and subtracted from them in the hyperbola, CPQ = CGR therefore PQ is parallel to GR.

DEFINITIONS. Fig. 17, 18.

XX. The straight line PR, which is drawn from the point of contact perpendicular to the tangent, intercepted between the tangent and the axis of a conic section, is called a normal.

XXI. The segment of the axis NR, which is intercepted between the ordinate and the normal, is called a subnormal.

XXII. If a straight line be drawn through any point in the diameter of a conic section, parallel to a tangent at the vertex, and terminated both ways by the curve, it is called an ordinate to the diameter.

XXIII. The segment of any diameter of a conic section, which is intercepted between an ordinate and the vertex, is called an abscissa.

XXIV. A diameter which is parallel to the tangent at the vertex of any diameter of the ellipse, or hyperbola, is called a conjugate diameter.

XXV. A line which is a third proportional to any diameter of the ellipse or hyperbola, and its conjugate, is called a parameter of that diameter.

XXVI. If a line be drawn through the focus of a parabola parallel to the ordinates of any diameter, terminated both ways by the curve, it is called a parameter to that diameter.

PROP. XX. Fig. 21, 22, 23. Plate III.

If two straight lines Pp, Qq, which meet each other in any part L, and are inclined to the directrix at any given angles LHX, LAX, cut a conic section, or opposite sections, in the points Pp and Qq; the rectangles LP.Lp and LQ.Lq will be in a constant ratio to each other.

Let S be the nearest focus. Join HS, and produce it if necessary; also join SP, Sp, draw LX, PE, perpendicular to the directrix, and draw LT, Lt, parallel to SP, Sp, meeting HS in T and t, because (prop. XVI.) the angle PSH = pST, fig. 21 and 23, and = pSW, fig. 22, the angle LTt = LtT and LT = Lt. On L as a centre, at the distance LT or Lt, describe a circle cutting H Pp in M and m. Join SL, and produce it to meet the circle in D and d; and because the triangles HPE, H LX, are similar, as also HPS, HLT, $LT : SP :: LH : PH :: LX : PE$; and alternately $LT : LX :: SP : PE$, that is in the determining ratio, therefore the radius of the circle is given, when the distance of L from the directrix is given, whatever be the position of the line Pp. And because LT is parallel to PS, and Lt to pS,

$$LP : TS :: LH : HT.$$

and pL : St :: LH : tH, therefore Lemma 1,

$$PL.Lp : TSSt :: LH^2 : HTtH.$$

But $TSSt = DS.Sd$, and $TH.Ht = MH.Hm = LH^2 - LM^2$, fig. 21, 22, or $= LM^2 - LH^2$, fig. 23. Therefore $PL.Lp : DS.Sd :: LH^2 : LH^2 - LM^2$, or $LM^2 - LH^2$. But $LH^2 : LT^2$ or $LM^2 :: PH^2 : PS^2$, and by division $LH^2 : LH^2 - LM^2$, or $LM^2 - LH^2 :: PH^2 : PH^2 - PS^2$, or $PS^2 - PH^2$; which ratio depends only

Fig. 21.

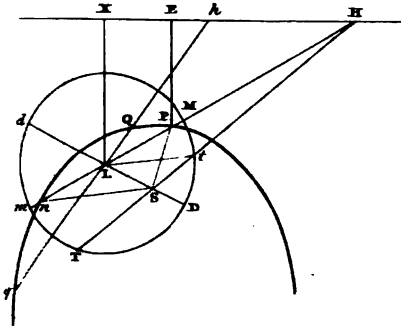

Fig. 22.

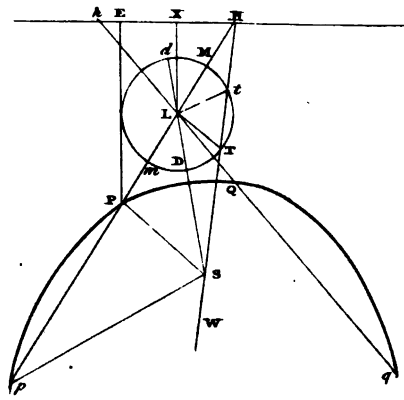

Fig. 23.

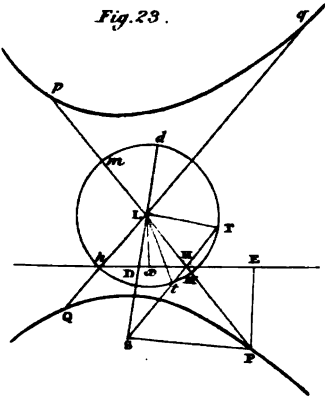

Fig. 25.

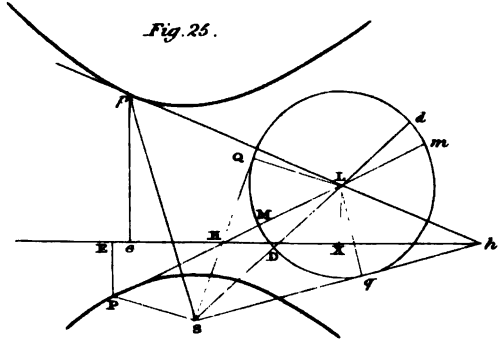

Fig. 24.

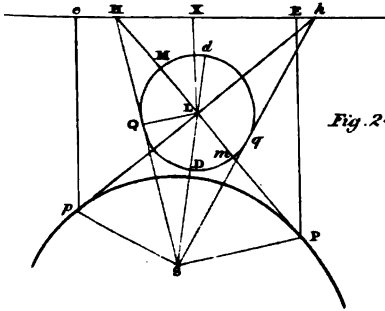

Fig. 29.

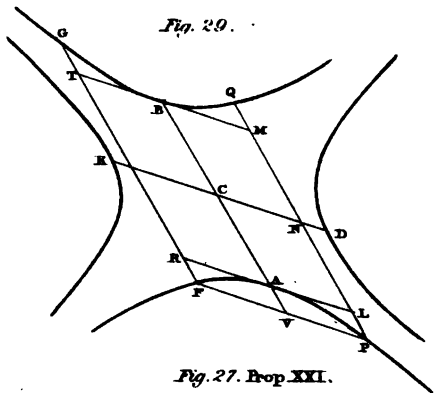

Fig. 27. Lemma II.

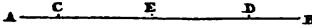

Fig. 27. Prop. XXI.

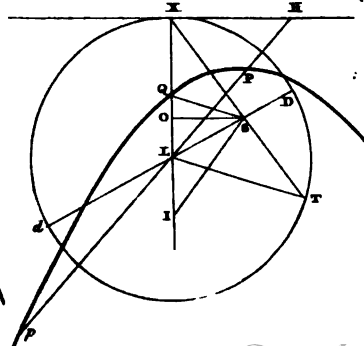

Fig. 28.

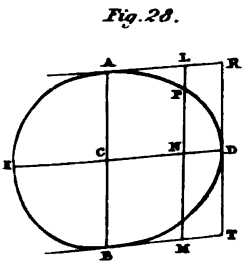

Fig. 30.

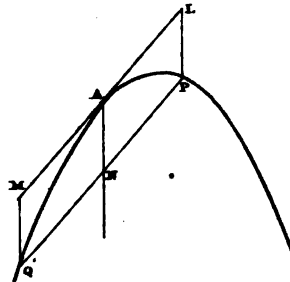

Fig. 32.

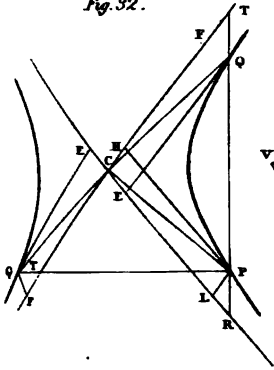

Fig. 33.

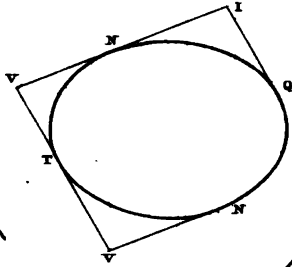

Fig. 31.

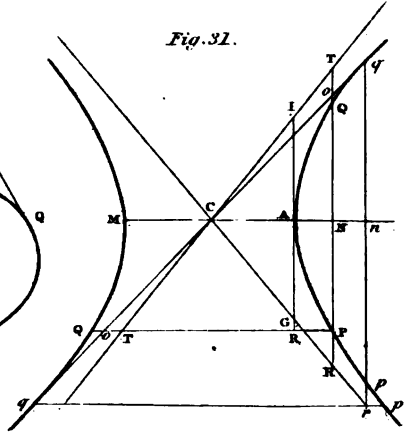

Fig. 34.

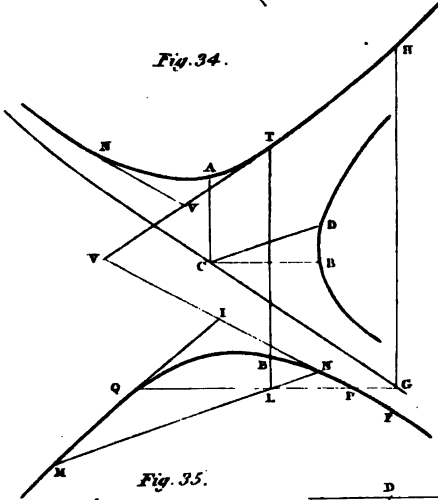

Fig. 36.

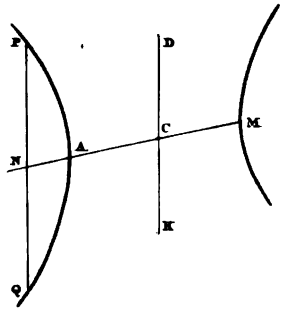

Fig. 35.

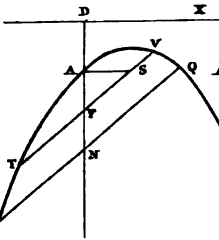
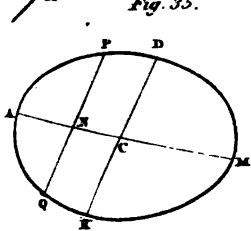

Fig. 37.

Fig. 38.

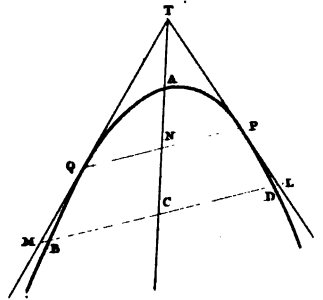

Fig. 30.

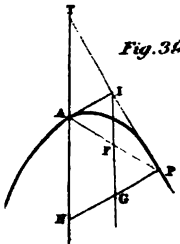

Fig. 40.

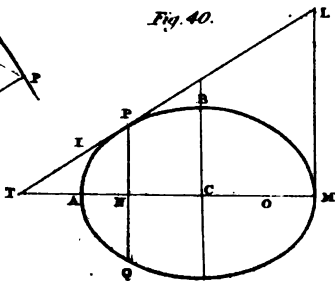
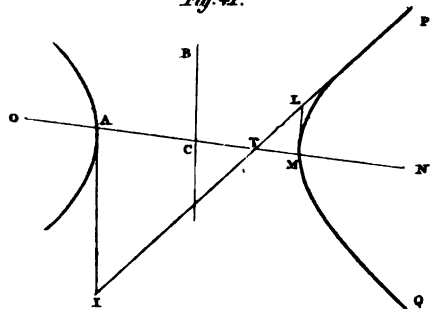

Fig. 41.



upon the determining ratio and the angle LHX, SP being to PH in a ratio, which is compounded of the ratios of SP to PE, and PE to PH, or of the determining ratio, and of the sine of the angle LHX to radius. In the same manner it may be proved that the rectangle QL·Lq is to DS·Sd in a ratio depending only on the determining ratio and the angle LHX, therefore PL·Lp is to QL·Lq in a constant ratio, whatever be the distance of L from the directrix.

Cor. 1. If either of the lines Pp, Qq, or both of them become tangents to the conic section, or opposite sections, the squares of the tangents must be substituted for the rectangles PL·Lp, QL·Lq. For let LP touch the section in P, fig. 24, 25. Then QL being parallel to SP, by the preceding Prop. LP : QS :: LH : HQ; and LP² : QS² :: LH² : HQ²; but QS² = DS·Sd, and QH² = MH·Hm = LH² - LM², therefore LP² : DS·Sd :: MH² LH² - LM², which was proved to be a constant ratio; therefore LP² is to Lp² or QL·Lq, fig. 22, in a constant ratio.

PROP. XXI. Fig. 27.

If two right lines QL, Pp, meeting each other at any point L, one of which is parallel to the axis, and the other is inclined to the directrix in a given angle, cut a parabola in the points Q, p, and P, the rectangle under QL, and the latus rectum will be to the rectangle PL·Lp in a constant ratio.

Draw LX perpendicular to the directrix; and from the centre L, at the distance LX, describe a circle, join QS, XS, let XS meet the circle in T, and join LT. Draw SO perpendicular to LX, take OI = OX, and join SI, then SI = SX, now LT = LX, and QS = QX, therefore LT is parallel to QS, and because the angle QSX = SXQ = S IX, the triangles QXS, SXI, are similar, and XI : XS :: XS : XQ :: ST : QL, therefore the rectangle IX·QL = XS·ST = DS·Sd, which by the preceding proposition is to PL·Lp in a constant ratio, and because IX = QOX, the distance of the focus from the directrix, therefore IX = latus rectum, therefore the rectangle under QL, and the latus rectum is to PL·Lp in a given ratio.

LEMMA II. Fig. 27.

If a straight line be divided in two points C and D, such, that the rectangle CA·AD = D·B·BC, or AC·CB = BD·DA, the part AC will be equal to BD. First, let CA·AD = DB·BC. Bisect CD in E; and CA·AD + EC² = AE², also D·B·BC + ED² = EB², but ED² = EC², therefore BE² = AE², and BE = AE; and therefore BD = AC. Secondly, let AC·CB = BDA, by bisecting AB in E, it may be shown as above, that ED = EC, and therefore BD = AC.

PROP. XXII. Fig. 28, 29.

All lines parallel to any diameter of the ellipse or hyperbola, which are terminated both ways by the ellipse, or opposite hyperbola, are bisected by the conjugate diameter.

Let ACB be any diameter of an ellipse, or hyperbola. Through the vertices A, B, draw the

tangents AL, BM; and through the centre C draw the diameter DCK parallel to AL or BM, which will be the conjugate diameter. Through N, any point in DK, draw LNM parallel to AB, meeting the ellipse or opposite hyperbolas in P and Q, and the tangents AL, BM, in L and M. Then AL being parallel to CN and BM, and LN = NM parallel to ACB, AL = BM, and LN = NM; and Cor. 1, Prop. XX, LA² : PL·LQ :: BM² : QM·MP, therefore PL·LQ = QM·MP, therefore Lem. 2, PL = QM, and, because LN = NM, PN = NQ.

Cor. 1. If the diameter DK bisect all lines parallel to AB, it will be the conjugate diameter AB.

Cor. 2. Fig. 28. If a straight line RDT be drawn through D the vertex of the conjugate parallel to AB, it will touch the curve in the point D.

PROP. XXIII.

Every diameter of a conic section bisects all its ordinates.

1st. If the section be an ellipse, it is evident from the last proposition; for the ordinates of any diameter are parallel to the conjugate diameter.

2dly. If the section be an hyperbola, fig. 29, of which ACB is any diameter; in the tangent RAL take AR = AL, through L and R draw PLQ, FRG, parallel to AB, meeting the opposite hyperbolas in P, Q, and F, G, and the tangent at B in M, T. Join PF, cutting the diameter in V: then PF will be an ordinate which is bisected at V: for by last Prop. PL = MQ and FR = TG; and Cor. 1, Prop. XX. FR·RG : RA² :: PL·LQ : LA², but LA² = RA², therefore FR·RG = PL·LQ, that is, RF·FT = LP·PM; therefore Lem. 2, RF = PL, and PLRF is a parallelogram, and therefore PF is parallel to RAL, and PV = VF.

Lastly, let the section be a parabola, fig. 30, of which AN is any diameter, and PNQ an ordinate; through the vertex A draw the tangent LAM; and draw PL, QM, parallel to NA, then PL = QM, but the rectangle under LP and the latus rectum is to LA² as the rectangle under MQ and the latus rectum to MA², therefore LA² = MA², and LA = MA, and therefore QN = PN.

PROP. XXIV. Fig. 31. Plate IV.

If a straight line cutting the hyperbola, or opposite hyperbolas, meet the asymptotes in two points; the segments between the hyperbola or hyperbolas, and asymptotes will be equal.

Let PQ cut the hyperbola, or the opposite hyperbolas in P and Q, and meet the asymptotes in R, T; the segments PR, QT, will be equal. For if PR be not equal to QT, let one of them as QT be the greater; take QO = PR, join CO, which, being produced, will meet the curve in some point q, Cor. Prop. XIV. Through q draw qpr parallel to QP meeting the curve in p and asymptote in r, bisect PQ in N, and draw the diameter CNn, and Pq, pg, will be ordinates to that diameter. Because NQ = NP and QO = PR, therefore NO = NR and ON : qn :: CN : Cn :: NR : nr, therefore nq = nr; but nq = np, therefore np = nr, which is absurd; therefore QT is not greater than PR.

Cor. If the line TNR be supposed to move from N to A , the points PQ will coincide in A , and IA will be equal to AG ; therefore, when a line touches an hyperbola, the segments between the point of contact and the asymptotes are equal.

PROP. XXV. Fig. 32.

If from any point P in the hyperbola PQ two straight lines PL, PH , be drawn to the asymptotes, and from any other point Q , in the same or in the opposite curve, there be drawn other two straight lines QE, QF , parallel to the two former lines PL, PH . The rectangle $QEQF$ will be equal to the rectangle $PLPH$.

Join PQ , and let it meet the asymptotes in R and T ; and because the triangles TQF, TPH , are similar, as also the triangles $RPL, RQE, QF:PH::TQ:TP::RP:RQ::PL:QE$; therefore the rectangle $QEQF$ is equal to the rectangle $PLPH$.

Cor. Hence if from any two points P, Q , in the same or in the opposite hyperbolas, two straight lines PL, QE , be drawn to the same or to different asymptotes parallel to the other asymptote; the rectangles $CLLP, CE'EQ$, will be equal; also the parallelogram $CLPH$ will be equal to the parallelogram $CE'QF$; and the triangle CLP to the triangle CEQ .

PROP. XXVI. Fig. 54.

If, from any point R in the asymptote of a hyperbola, there be drawn a straight line RT cutting the hyperbola, or opposite hyperbolas, in P or Q , and the other asymptote in T ; the rectangle PR, RQ , is equal to the square of the semidiameter which is parallel to RT .

Let AM, Bb be the two axes, join AB meeting the asymptote in N . Draw the tangent IAa meeting the asymptotes in I and a . Because Aa is equal and parallel to BC , Prop. XIII. AB is equal and parallel to aC , and $IA::Ia::AN:aC$, or AB ; now IA is half of Ia , therefore AN is half of AB and $AN=NB$.

Let CF be the semidiameter parallel to the line cutting the opposite hyperbolas, draw the tangent LFH meeting the asymptotes in L and H , draw FE parallel to CH , meeting the asymptote in E , and the conjugate hyperbola in D , and join CD . Because the rectangle $CNNA$ or $CNNB=CEEF$, Cor. Prop. XXV. and $CNNB=CEED$, therefore $CEEF=CEED$ and $EF=ED$, and FE is half of FD , but because LF is half of LH , Cor. Prop. XXIV. and FE is parallel to CH , FE is also half of CH , therefore $FD=CH$, and they are parallel, therefore CD is equal and parallel to FH , and CD is a conjugate diameter to CF . Let the line which cuts the hyperbola PFQ be parallel to CD or LH . Take any point t in the asymptote, and draw tr parallel to TR , cutting the curve or opposite curves in p and q , and the other asymptote in r . Draw PY, PZ, py, pz parallel to the asymptotes. Because the triangles PYR, pyr are equiangular.

$PR:PY::pr:py$, and in like manner,

$PT:PZ::pt:pz$; therefore Lem. 1.

$RP:PT::Yp:Pz::rppt':ypps$; but $Yp:Pz=ypps$, Cor. Prop. XXV.; therefore $R:P:P:T=$

$rppt'$; or since $RP=QT$, Prop. XXIV. $PR:RQ=pr:rg$; and when P is taken at F , the rectangle $PRRQ$ becomes FL^2 or FH^2 which is equal to CD^2 ; and when P in the opposite hyperbola is at M , the rectangle $PRRQ$ becomes equal to GC^2 .

PROP. XXVII.

If two right lines, meeting each other, cut or touch a conic section, or opposite sections, the rectangles under the segments between the points of concurrence and the points of intersection, or the squares of the tangents, will be to each other as the squares of the semidiameters to which the lines are parallel.

If the lines are parallel to any of the diameters of the ellipse, or of the opposite hyperbolas, the proposition is evident from Prop. XX., because the lines which meet each other make the same angles with the directrix as those which pass through the centre, and the latter are bisected in the centre. But if either of the lines PLQ, LRT , or both the lines PLQ, NLM , be parallel to some of the conjugate diameters of the hyperbola, fig. 34, produce QLP till it meet the asymptote in G , and through G , draw FGH parallel to LRT , meeting the opposite curves in F and H . Let CB, CD, CA , be the semidiameters which are parallel to QP, MN, RT . Then Prop. XX. $PLLQ:RLLT::PGGQ:FGGH::CB^2:CA^2$, by Prop. XXVI. In the same manner it may be proved, that $RLLT:NLLM::CA^2:CD^2$; therefore $PLLQ:NLLM::CB^2:CD^2$.

If the lines touch the conic section, or opposite sections, the squares of the tangents will be to each other as the rectangles under the segments of any two lines drawn parallel to them, which meet each other, and cut the section or opposite sections; and therefore they are as the squares of the semidiameters to which they are parallel.

Cor. fig. 33, 34. If two right lines IQ, IN , meeting each other in I , touch an ellipse or hyperbola in Q, N , and are parallel to two other lines VT, VN , which meet each other in V , and touch the ellipse or opposite hyperbola, or hyperbolas, in T, N ; $IQ:IN::VT:VN$; for IQ^2, IN^2 , are to each other as the square of the semidiameters to which they are parallel, and VT^2, VN^2 , are in the same ratio.

PROP. XXVIII. Fig. 35, 36

If an ordinate be drawn to any diameter of an ellipse or a hyperbola, the rectangle under the abscissa will be to the square of the semi-ordinate as the square of the diameter is to the square of its conjugate.

Let ACM be any diameter of an ellipse or hyperbola, to which PNQ is an ordinate, and let DCK be the conjugate diameter, which is parallel to PNQ . Then by the preceding proposition $ANNM:PNNQ$ (or PN^2):: $CA^2:CD^2::AM^2:DK^2$.

Cor. 1. Because the parameter is a third proportional to the diameter and its conjugate, the rectangle under the abscissa is to the square of the semi-ordinate as the diameter is to the parameter.

Fig. 42.

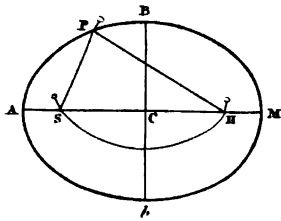

Fig. 44.

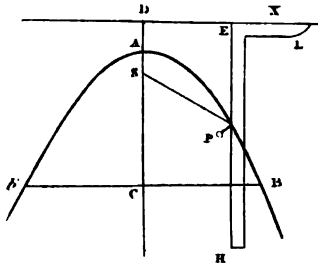

Fig. 51.

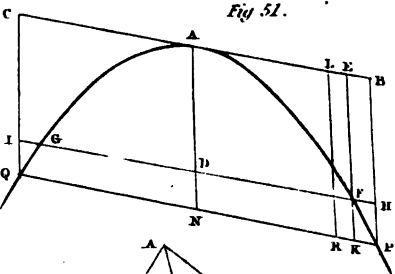

Fig. 48. 49.

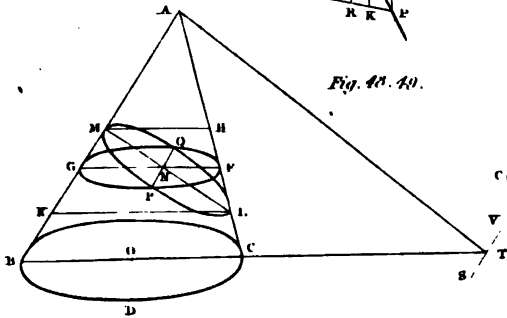

Fig. 52.

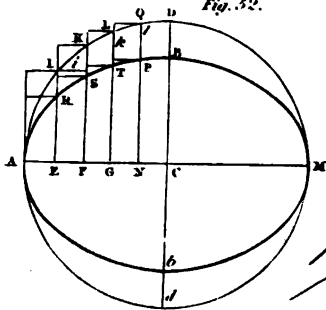

Fig. 43.

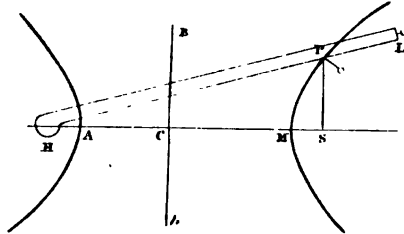

Fig. 45.

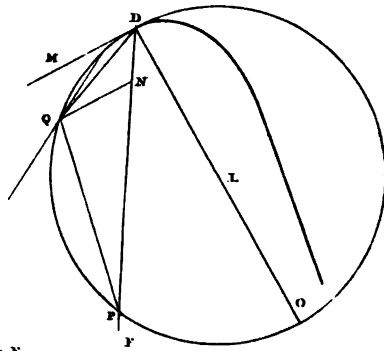

Fig. 46.

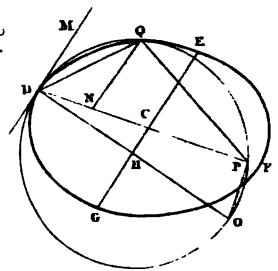

Fig. 40.

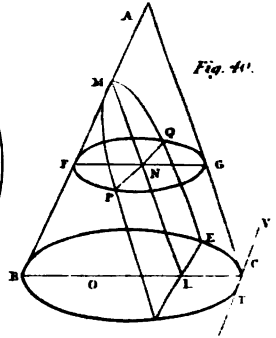

Fig. 50.

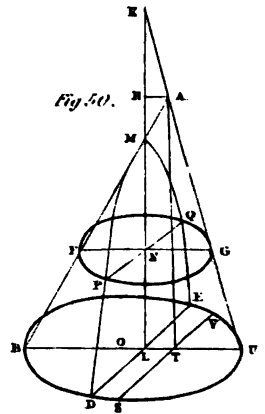

Fig. 47.

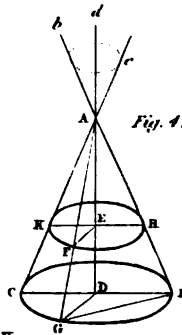

Fig. 54.

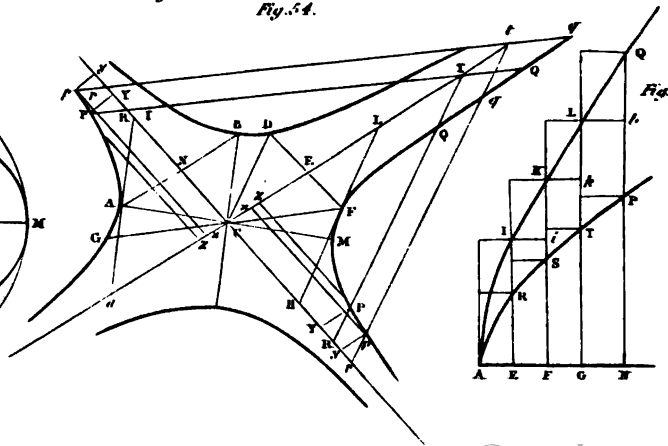
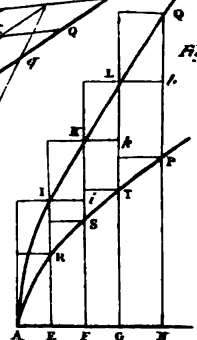

Fig. 53.



Cor. 2. The two conjugate diameters being constant, the rectangle under the abscissæ will vary as the square of the ordinate.

PROP. XXIX. Fig. 37.

If an ordinate be drawn to any diameter of a parabola, the square of the semi-ordinate is equal to the rectangle under the abscissæ and the parameter.

Let AN be any diameter of the parabola to which PNQ is an ordinate. Draw the parameter TSV, cutting the diameter in F; join SA, and let the diameter meet the directrix in D. Because TF is half of TV, Prop. XXIII. and AF is half of DF or TF, Prop. XVII. Cor. 2, AF:ET::FT:TV, and AFTV=F²T²; but AFTV:AN·TV::TF²:PN², Prop. XXI, therefore AN·TV=PN².

Cor. Because TV = 2TF = 4SA, 4SA·A N = PN².

PROP. XXX. Fig. 38.

If two tangents be drawn at the extremities of any right line which is terminated by a conic section, and which does not pass through the centre of an ellipse, they will meet each other in the diameter which bisects that right line.

Let PQ meet the curve in P and Q; bisect PQ in N, and through N draw the diameter CNT. Through P draw the tangent PT, meeting the diameter in T, and join TQ which will touch the conic section in Q. For draw any other line DCB parallel to PNQ, meeting TP, TQ, in L and M. The triangles TNP, TCL, are similar, as also TNQ, TCM, therefore,

NP:CL::TN:TC::QN:CM, and alternately NP:NQ::CL:CM, therefore CM=CL, which is greater than CD or CB, therefore M is without the section, and the line TQ meets the curve only in one point Q.

Cor. If two right lines which touch a conic section meet each other, a right line drawn through the point of concurrence, bisecting the line which joins the points of contact, will be a diameter of the section.

PROP. XXXI. Fig. 39.

If a tangent to any point in the parabola meet a diameter, and an ordinate be drawn to that diameter from the point of contact, the segment of the diameter between the vertex and the tangent will be equal to the abscissa.

Let TP, which touches the parabola in any point P, meet the diameter NA in T, and draw the ordinate PN. NA, will be equal to AT. Draw the tangent AI meeting PT in I; join AP, and draw the diameter IG cutting AP in F and PN in G; then AF=FP, Cor. Prop. XXIX. Therefore AI or NG=PG; and AI is half of NP; but AI:NP::TA:TN, therefore TA is the half of TP.

PROP. XXXII. Fig. 40, 41.

If a tangent to any point in an ellipse, or an hyperbola, meet a diameter, and from the point of contact an ordinate be drawn to that diameter, the semidiameter will be a mean proportional between the segments of the diameter, which are intercepted between the centre and the ordinate, and between the centre and the tangent.

Let PT touch the ellipse or hyperbola in any

point P, and meet the diameter MA in T; draw PNQ an ordinate to the diameter MA, CN:CA::CA:CT. Through the vertices A, M draw the tangents AI, ML, meeting PT in I and L, take CO=CN. Then Cor. Prop. XXVI. IP:IA::LP:LM, and alternately IP::LP::IA::LM, and because AI, NP, ML, are parallel, AN:NM::TA:TM, and by comp. fig. 41, or by div. fig. 40, ON:AN::AM:TA; and by taking the halves of the antecedents CN:AN::CA:AT, and by comp. fig. 40, or by div. fig. 41, CA:CN::CT:CA and by inversion CN:CA::CA:CT.

SECT. II. OF THE DESCRIPTIONS OF THE CONIC SECTIONS; AND OF DRAWING TANGENTS TO THE CURVES.

PROP. XXXIII. PROBLEM. Fig. 3, 4, 5. Plate I.

The focus, directrix, and determining ratio being given, to find any number of points in the conic section.

Let DX be the directrix and S the focus, draw SD perpendicular to DX, which produce indefinitely. Draw LST perpendicular to DS; and take SL and ST to SD in the determining ratio. Then LST, Cor. 3, def. is the latus rectum. Join DL, DT, and produce them indefinitely. Take DX=DS and join XS meeting DT in G, which Prop. II. will be parallel to DL in the parabola, it will meet it in some point g in the direction DL in the ellipse, and in the opposite direction in the hyperbola. Through G and g draw KAG, gMk, parallel to the directrix, meeting DL, DT, and the axis in K, G, A and g, k M; the points A, M, will therefore be the vertices of the axis. Through any point N, in the axis, between A and M in the ellipse, and anywhere on the same side of A with S in the parabola, and anywhere except between A and M in the hyperbola, draw QNg parallel to the directrix, and from the centre S, with a radius equal to QN, describe a circle cutting Qg in the points P, p; and join SP, Sp, which are each equal to QN; therefore P and p are points in the curve by the first proposition; and in this way may any number of points be found

PROP. XXXIV. PROBLEM. Fig. 42. Plate V.

Two unequal straight lines being given, which bisect each other at right angles, to describe an ellipse, of which the given lines shall be the axes.

Let AM, Bb, be the given lines of which AM is the greater. From the centre B, with a radius equal to AC, describe a circle meeting A M in S and H, which will be the foci, Prop. VII. Cor. 1. Take a string equal in length to AM, and fix the extremities of it at the points S and H, and by means of a pin let the string be stretched, and let the pin be carried round, till it return to the same point, the point M will describe an ellipse, of which AM, Bb, are the axes, as is evident from Prop. XII.

PROP. XXXV. PROBLEM. Fig. 43.

Two straight lines being given, which bisect each other at right angles, to describe an hyperbola, of which these lines shall be the axes.

Let AM, Bb , be the given lines, bisecting each other at right angles in C . Join AB , and take CS and CH , in AM produced both ways, equal to HB . At the point H let one end of a ruler be fixed, so that it may move round this point as a centre; and let a string be taken, the length of which exceeds that of the ruler by a line equal to AM ; let one end of the string be fixed at L , and the other at the point S ; apply the string by means of a pin at P , to the side of the ruler LH ; and let the ruler be moved about the centre H , while the string is constantly applied, and kept close to the ruler by the pin at P . Then the difference between the whole length of the string SPL and the ruler HL being equal to AM , the difference between HP and PS will be equal to AM ; and the point P will describe one of the opposite hyperbolas of which AM, Bb , are the axes, as is evident from Prop. XII.

PROP. XXXVI. PROBLEM. Fig. 44.

Two right lines being given, one of which is bisected by the other at right angles, to describe a parabola, in which the right line bisected shall be an ordinate, and the other line the axis.

Let AC, Bb , be the two given lines, one of which Bb , which is perpendicular to AC , is bisected in C . Find a third proportional to AC, CB ; and produce CA to D , so that AD may be a fourth part of that third proportional; take $AS = AD$, and draw DX perpendicular to DC . Let a ruler, the sides of which, HE, EL , are perpendicular to each other, be placed in the plane CDX , so that the side EL may be applied to DX ; and take a string equal in length to the side HE , one extremity of which must be fixed at H , and the other at S ; and let part of the string be applied, by means of the pin P , to the side of the ruler HE ; and whilst the side EL moves along DX , let the string be stretched by the pin, and constantly applied to HE . Then, because the whole length of the string HPS is equal to HE , the part SP will always be equal to PE ; therefore the point P will describe a parabola, by the first definition, of which AC is the axis, S the focus, and DX the directrix; and BCb will be an ordinate, because it is perpendicular to the axis, and CB is a mean proportional between the abscissa AC and $4 AS$, or the latus rectum.

PROP. XXXVII. PROBLEM. Fig. 24, 25. Plate III.

To draw a tangent to a conic section from any given point without it, which is not the centre of the hyperbola.

If the given point H be in the directrix, draw HS to the focus which is nearest to the directrix; draw SP perpendicular to SH , meeting the curve in P , and join HP , which will touch the conic section in P , Cor. 1. Prop. XVI.

If the given point be in any other situation, as at L , join LS , and draw LX perpendicular to the directrix. Take LD to LX in the determining ratio, and from the centre L , at the distance LD , describe a circle DMg . From S draw SQ a tangent to the circle, meeting the directrix H . Join LQ , and draw SP parallel to it, or perpendicular to SH . Join HL and produce

it to meet SP in P , which is in the conic section, and the line HP touches the curve at P . For the triangles HQL, HSP , are similar, as also LHX, PHE , therefore $SP : PH :: QL : LH$ and $PH : PE :: LH : LX$; therefore, $SP : PE :: QL : LX$, that is in the determining ratio; therefore P is a point in the curve, and because PSH is a right angle, PH is a tangent, Cor. 1, Prop. XVI. Cor. Because two lines SQ, Sg , may be drawn from the point S to touch the circle; two tangents LP, Lp , may be drawn from L to the conic section.

SECT. III. OF THE CURVATURE OF THE CONIC SECTIONS.

DEFINITIONS.

XXVII. A circle is said to touch a conic section in any point, when the circle and conic section have a common tangent in that point.

XXVIII. If a circle touch a conic section in any point, so that no other circle can be drawn between the conic section and that circle, it is said to have the same curvature with the section in the point of contact, and it is called the circle of curvature.

PROP. XXXVIII.

If a circle touch a conic section, and cut off from the diameter, which passes through the point of contact, a segment equal to its parameter, the conic section is of the same curvature with the circle at the point of contact.

First, let a tangent DM be drawn to any point D in the parabola, fig. 45; draw also the diameter DF , and the perpendicular DL ; through any point Q in the curve, near to D , let the circle DQO be described to touch DM in D , and meet DF in P ; join PQ, DQ , and draw QN parallel to MD , meeting DF in N . Then because the angle $DPQ = MDQ = DQN$, the triangles DNQ, PDQ , having a common angle at D are equi-angular; hence, $PD : DQ :: DQ : DN$, and $PDDN = DQ^2$; also $PD^2 : PQ^2 :: DQ^2 : QN^2$, therefore $PD^2 : PQ^2 :: PDDN : PDN$, where $P =$ parameter of DF . Now, it is evident, that the nearer the point Q is to the point D , the nearer will the circumference of the circle be to a coincidence with the curve at that point; and, therefore, as no portion of these curves, however small, can be the same, the circumference of the circle will have approached the nearest possible to a coincidence with the curve at D , when the point Q falls upon it; in which case, the last analogy becomes $PD^2 : PD^2 :: PD : P$, therefore, $PD = P$, the parameter of DF ; therefore, the proposition in the case of the parabola is manifest.

Next let DM be a tangent at any point in the ellipse or hyperbola, fig. 46; DF, EG , conjugate diameters; and DHO a perpendicular to the two parallels DM, EG .

Through any point Q in the curve, near to the point D , let the circle DQO be described to touch DM in D , and meet DF in P . Let PQ, QN be joined, and QN drawn parallel to DM , to meet DF in N . The triangles DNO, PND being similar, $DN : DQ :: DQ^2 : DP$ whence $DN : DP :: DQ^2 : DP^2$; but $DP : P$ (parameter)::

$FN \cdot ND : QN^2$; hence $DF \cdot DN : DP \cdot P :: PN \cdot ND : QN^2$. Or $DF : P :: FN \cdot DQ : DP \cdot QN^2$. But when Q and D coincide DQ and QN become equal, whence this analogy gives $DF : P :: DF : DP$, or $D P = P$ as before.

Cor. If, from any point D in an ellipse or hyperbola, a diameter DF be drawn, and a perpendicular DH to its conjugate EG, the radius of curvature at the point D is a third proportional to the perpendicular DH and the semi-conjugate diameter EC.

For since $DH : DC :: DP : DO$,
and $DC : EC :: EG : P$ or DP
therefore $DH : EC :: EG : DO :: EC : DP$, the radius of curvature.

SECT. IV. OF THE CONE AND ITS DIFFERENT SECTIONS.

DEFINITIONS. Fig. 47. Plate V.

XXIX. If any indefinite straight line passing through any fixed point A, without the plane of the circle CGB, be carried round the whole circumference of the circle, each of the surfaces generated by the motion is called a conical surface.

XXX. The solid contained by the conical surface and the circle CGB is called a cone.

XXXI. The point A is called the vertex of the cone.

XXXII. The circle CGB is called the base of the cone.

XXXIII. The right line AD passing through the vertex and the centre of the base is called the axis.

XXXIV. A right cone is that whose axis is perpendicular to the base.

XXXV. A scalene cone is that whose axis is inclined to the base.

PROP. XXXIX. Fig. 47.

If a cone be cut by a plane passing through the vertex, the section will be a triangle.

Let ABC be a cone of which AD is the axis; let GB be the common section of the base and cutting plane; join AB, AG. When the generating line comes to B and G, it will coincide with AB, AG; they are, therefore, in the surface of the cone, and they are in the plane which passes through the points A, B, G; therefore, the triangle ABG is the common section of the cone and the plane which passes through the vertex.

PROP. XL. Fig. 47.

If a cone be cut by a plane parallel to its base the section will be a circle, the centre of which is in the axis.

Let HFK be the section made by a plane parallel to the base of the cone, and let ACB, ADG, be the two sections of the cone, made by any two planes passing through the axis AD; let KH, EF, be the common sections of the plane HFK and the triangles ACB, ADG. Then, because the planes HFK, BGC, are parallel, EH, EF will be parallel to DB, DG, and EH : DB :: EA : AD : EF : DG; but DB = DG, therefore, EH = EF; and for the

same reason EF = EK, therefore, HFK is a circle of which E is the centre.

PROP. XLI. Fig. 48.

If a scalene cone ABDC be cut through the axis by a plane perpendicular to its base, making the triangle ABC, and from any point L in the straight line AC, LM, be drawn in the plane of the triangle, so that the angle ALM = ABC, and the cone be cut by another plane passing through LM, perpendicular to the triangle ABC; the common section LPMQ of this plane and the cone will be a circle.

Take any point N in the straight line LM; draw FNG parallel to CB; and let FPGQ be a section parallel to the base, passing through FG; then the two planes FPGQ, LPMQ, being perpendicular to the plane ABC, their common section PNQ is perpendicular to FNG; therefore, PN = NQ and PN² = FN · NG, but the angle ALM = ABC = AGF, and the angles at N being vertical, the triangles FLN, MGN, are similar, and MN : NG :: FN : NL; therefore, the rectangle MN · NL = FN · NG = PN², therefore, the section LPMQ is a circle, of which LM is a diameter. This section is called a subcontrary section.

PROP. XLII. Fig. 48, 49, 50.

If a cone be cut by a plane which does not pass through the vertex, and which is neither parallel to the base, nor to the plane of a subcontrary section; the common section of the plane and the surface of the cone will be an ellipse, a parabola, or an hyperbola, according as a plane passing through the vertex parallel to the cutting plane, falls without the cone, touches it, or falls within the cone.

Let ABDC be any cone; and let STV be the common section of a plane passing through its vertex and the plane of the base, which will fall without the base, will touch it, or will fall within it; let PMQ be a section made by a plane parallel to ASV, through O the centre of the base OT draw perpendicular to SV, meeting the circumference of the base in B and C; let a plane pass through A, B, and C, meeting the plane ASV in the line AT, the surface of the cone in AB, AC, and the plane of the section PMQ in LM; then LM will meet the side AB in M, and it will meet the other side AC, fig. 48, in L, within the cone, it will be parallel to it, fig. 49, and it will meet it in fig. 50, produced beyond the vertex in K.

Take any point N in the line LM; let FPGQ be a plane passing through N parallel to the base; and let FNG, PNQ, be the common sections of this plane and the planes ABC, PMQ; then PNQ will be the parallel to SV, and GF parallel to BT: and BT being perpendicular to SV, FNG is perpendicular to PNQ, therefore PN = NQ, and PN² = EN · NG. First, if the line STV be without the base, fig. 48, through M and L draw MHLK parallel to CB; then because the triangles LNF, LMH, are similar, also MNG, MLK,

LN : FN :: LM : HM, and
NM : NG :: LM : LK; therefore
LN · NM : FN · NG or PN² :: LM² : HM LK,
which ratio is the same wherever the point N

taken; the section LPMQ is therefore an ellipse of which LM is a diameter and PNQ an ordinate.

Secondly, if the line STV, fig. 49, touch the circumference of the base in C; let DLE be the common section of the base and the plane PMQ, which is parallel to PN, and perpendicular to BLC; and $BL \cdot LC = DL^2$, therefore $PN^2 : DL^2 :: FN \cdot NG : BL \cdot LC$ (or because $NG = LG$): $FN : BE$; but the triangles MNE, MLE, being similar, $FN : BL :: MN : ML$, therefore $PN^2 : DL^2 :: MN : ML$; and the section DME is a parabola, of which ML is a diameter, and PNQ an ordinate.

Lastly, fig. 50, let the line STV fall within the base; through the vertex A draw AH parallel to GF; and because the triangles MNE, MHA, are similar, as also KNG, KHA,

$$MN : NF :: MH : HA \text{ and}$$

$$KN : NG :: KH : HA; \text{ therefore}$$

$MN \cdot NK : FN \cdot NG$, or $NP^2 :: MH \cdot HK : HA^2$ that is in a constant ratio, therefore the section DME is a hyperbola, of which MK is a diameter and PNQ an ordinate.

SECT. V. OF THE AREAS OF THE CONIC SECTIONS.

PROP. XLIII. Fig. 51.

If any ordinate and abscissa of a parabola be completed into a parallelogram; the area of the parabola, included between the ordinate and the curve, is to the parallelogram as 2 to 3.

Let AN be the abscissa, and PQ the ordinate; let the parallelogram PQCB be completed; and let AN be divided $\dot{}$ into indefinitely small equal parts, of which ND is one; through D draw HI parallel to PQ, cutting the parabola in F and G, and through F draw KE parallel to NA; take $KR = KP$, and draw RL parallel to KE. By Prop. XXI. $HF \cdot HG : PN^2 :: HP : NA$, but because DN is indefinitely small, PQ or 2PN may be taken for HG; and $PK = HF$, also $NA = PB$, therefore $2PK \cdot PN : PN^2 :: HP : PB$; hence $2PK$, or $PR : PN :: HP : PB$, and as the parallelograms RB, PD, are also equiangular, they are equal, and the parallelogram PD : KB :: 2 : 1, and the sum of all the parallelograms in APN is to the sum of all those in APB in the same ratio of 2 to 1; but the sum of all the parallelograms in APN approaches indefinitely near to the curvilinear area APPN, when their breadths are continually diminished; and in like manner the sum of all the parallelograms in APB approaches to the curvi-

linear area AFPB; therefore area AFPN : area AFPB :: 2 : 1, and the area PAQ is to the parallelogram PBCQ as 2 to 3.

PROP. XLIV. Fig. 52, 53.

If two ellipses or two hyperbolas have a common axis, and an ordinate be drawn through the same point in the axis to each of the curves; the areas included between the common abscissa, the ordinates, and the two curves, also the whole areas of the ellipses will be to each other as the conjugate axes

Let AP, AQ, be two ellipses or two hyperbolas, take any abscissa AN, which is not greater than half the axis of the ellipse, and draw the ordinates NP, NQ. Let the abscissa AN be divided into any number of equal parts, AE, EF, FG, GN, &c.; draw the ordinates ERI, FSK, GTL, and complete the parallelograms AR, AI, ES, EK, &c.; also draw Fi, Kk, Ll, parallel to AN. Then it is evident that the difference between the circumscribed parallelograms AI, EK, FL, GQ, and the inscribed parallelograms Ei, Fk, Gl, is equal to GQ; and if parallelograms be inscribed in the same manner in the figure APN, the difference between these and the circumscribed parallelograms would be equal to GP, therefore the difference between each series of parallelograms, and the areas AQN, APN, will be less than the parallelograms GQ, GP, and because $GP : GQ :: NP : NQ$ and each parallelogram in the figure APN is to the corresponding parallelograms in the figure AQN in the same ratio, the sum of all those in APN is to the sum of all those in AQN as NP is to NQ, which is the same ratio with that of the conjugate axes. Conceive the breadths of the parallelograms to be now diminished, and their number increased, ad infinitum, and the parallelograms APN, AQN, will be ultimately equal to the areas APN, AQN, for the parallelograms GQ, GP, will now vanish, therefore the areas APN, AQN, are to each other as their conjugate axes; and if the sections be ellipses their whole areas are to each other in the same ratio.

COR. 1. If a circle be described about an ellipse, the area of the circle is to the area of the ellipse as the transverse axis is to the conjugate.

COR. 2. The area of an ellipse is equal to that of a circle whose diameter is a mean proportional between the two axes.

COR. 3. The areas of two ellipses are to each other as the rectangles under their axes.

INDEX TO THE DEFINITIONS IN THE PRECEDING TREATISE.

N. B. The figures refer to the corresponding numeral letters

ABSCISSA, 13, 23.
ASYMPTOTE, 17.
AXIS, conjugate, 11.
AXIS, major, 9.
AXIS, minor, 11.
AXIS of a cone, 33.
AXIS of a conic section, 5.
AXIS, transverse, 9.

BASE of a cone, 32.

CENTRE of an ellipse, 10.
CIRCLE of curvature, 28.
CIRCLE, touching a conic section, 27.
CONE, 30.
CONIC section, 1.
CONIC surface, 29.
CONJUGATE axis, 11.
CONJUGATE diameter, 24.
CONJUGATE hyperbola, 18.
DETERMINING ratio, 4.

DIAMETER, 14.
DIAMETER of a parabola, 15.
DIRECTRIX, 2.

ELLIPSE, 1.
EQUILATERAL hyperbola, 19.

FOCAL tangent, 8.
FOCUS, 3.

HYPERBOLA, 1.

LATUS rectum, 7.

NORMAL, 20.

OPPOSITE hyperbolæ, Cor. 1, to Def. 7.

ORDINATE, to the axis, 12.
ORDINATE, to the diameter, 22.

PARABOLA, 1.
PARAMETER of a diameter, 25, 26.
PRINCIPAL parameter, 7.

RIGHT cone, 34.

SCALENE cone, 35.
SUB-NORMAL, 21.

TRANSVERSE axis, 9.

VERTEX of the axis, 6.
VERTEX of a cone, 31.
VERTEX of a diameter, 16.

CONJECT, *v. n.*
CONJECTURE, *v. a. & n. s.*
CONJECTOR, *n. s.*
CONJECTURABLE, *adj.*
CONJECTURAL, *adj.*
CONJECTURALITY, *n. s.*
CONJECTURALLY, *adv.*
CONJECTURER, *n. s.*

Fr. *conjecturer* ;
Ital. *conghiettu-
rare* ; Span. *con-
jeturur* ; Lat. *con-
jicere*. To con-
jecture is, to guess ;
to divine ; to form
a supposition. It
implies that evidence is either imperfect, or en-
tirely wanting. To conject has the same mean-
ing, and also that of to cast together. But this
verb is obsolete in both senses. Conjecture, as a
noun, had formerly the additional meaning of
idea ; notion ; conception. Conjector and con-
jecturer are synonymous, but the latter of these
words is that which is in general use.

The knight at his great boldness wondered ;
And though he scord his yolle vanitee,
Yet mildly him to purpose answered,
For not to grow of naught he it *conjectured*.
Spenser. Faerie Queene.

Whatever may be at any time, out of Scripture,
but probably and *conjecturally* surmised. *Hooker.*

I intreat you then,
From one that but imperfectly *conjects*,
Your wisdom would not build yourself a trouble.
Shakespeare.

Now entertain *conjecture* of a time,
When creeping murmur, and the poring dark,
Fills the wide vessel of the universe. *Id. Henry V.*
They'll sit by the fire, and presume to know
Who thrives and who declines, side factions, and
give out
Conjectural marriages. *Id. Coriolanus.*

It were a matter of great profit, save that I doubt
it is too *conjectural* to venture upon, if one could dis-
cern what corn, herbe, or fruits, are likely to be in
plenty or scarcity. *Bacon.*

If we should believe very grave *conjecturers*, carni-
vorous animals now were not flesh devourers then.
Brown.

They have not recurred unto chronology, or the
records of time, but taken themselves unto probabi-
lities, and the *conjecturality* of philosophy.
Id. Vulgar Errors.

When we look upon such things as equally may or
may not be, human reason can then, at the best, but
conjecture what will be. *South.*

For so *conjectors* would obtrude,
And from thy painted skin conclude. *Swift.*

And darkness and doubt are now flying away,
No longer I roam in *conjecture* forlorn.
So breaks on the traveller, faint, and astray,
The bright and the balmy effulgence of morn.
Beattie.
How much that honourable gentleman was con-
sulted in the original frame and fabric of the bill,
commonly called Mr. Pitt's Indian bill, is matter only
of *conjecture*, though by no means difficult to divine.
Burke.

The cause, though worth the search, may yet elude
Conjecture and remark, however shrewd.
They take perhaps a well directed aim,
Who seek it in his climate and his frame. *Cowper.*

He, entering at the study door,
His ample area 'gan explore ;
And something in the wind
Conjectured, sniffing round and round,
Better than all the books he found,
Food chiefly for the mind. *Cowper.*

The land appeared a high and rocky coast,
And higher grew the mountains as they drew,
Set by a current towards it : they were lost
In various *conjectures*, for none knew
To what part of the earth they had been tost,
So changeable had been the winds that blew.
Byron. Don Juan.

CONJEE, or CANCHI, a district of the Car-
natic, Hindostan, in the collectorship of Arcot.
The face of the country is flat and sandy, but
interspersed with fruitful spots and watered by
the Palar. Towards the Ghauts it is thinly in-
habited. The villages have, generally, the re-
mains of a rampart and stone bastions around
them ; which were, formerly, necessary to protect
the inhabitants from the predatory troops of Tip-
poo, and other tyrants, who devastated the coun-
try. This district has its chief supply of water
from tanks and reservoirs, which are well managed
here, and adapted to all the agricultural purposes
of the inhabitants.

CONJEVERAM, or the Golden City, a con-
siderable town in the Carnatic, is forty-six miles
south-west from Madras. The streets are wide,
and cross each other at right angles, with a range
of cocoa-nut trees on each side ; but the houses
are of mud. The tanks, however, are lined with
stone, and generally in good order. Here is a
famous pagoda dedicated to Mahadwa. The
chief entrance is imposing : on the left, after
passing through it, is a large edifice which, the

brahmims assert, contains 1000 carved pillars. Many of the groupes of deities are composed with great skill. The sides of the steps leading up to it are formed by two well carved elephants drawing a car. The inner court, being considered of great sanctity, is not suffered to be inspected by strangers. The country around is a barren sand.

To CONJOINABLE, v. a. From *con*, together, and *jobbernot*, the head. To concert; to settle; to discuss. A low cant word.

What would a body think of a minister that should conjobbles matters of state with tumblers, and confer politicks with tinkers?
L'Estrange.

- CONJOIN, v. a. & n.
- CONJOINING, n.
- CONJOINT, adj.
- CONJOINTLY, adv.
- CONJUNCT, adj.
- CONJUNCTION, n. s.
- CONJUNCTIVE, adj.
- CONJUNCTIVELY, adv.
- CONJUNCTIVENESS, n. s.
- CONJUNCTURE, n. s.

Fr. *conjoindre*; Ital. *congiungere*; Sp. *conjuntar*; Lat. *conjungere*. To yoke together is the idea here conveyed. Hence, to conjoin is, to unite; to form into one; to connect with; to link

firmly together; to unite in marriage; to league with. Conjunction signifies union; association; the meeting of two planets in the same degree of the zodiac; a word that connects together the clauses of a period, and signifies the relation which they bear to each other. Conjunctive formerly meant closely united; but it now only means the mood of a verb which is used subsequently to a conjunction. Conjunction is, coincidence or co-operation of many circumstances or causes; a critical period; and, though seldom used in these senses, connexion; consistency.

And furthermore, no men shulde knowe his owen engendure, ne who shuld have his heritage, and the woman shuld be the lesse beloved for the time that she were *conjunct* to many men. *Chaucer. Cant. Tales.*

They did their counsels nor in one compound, Where single forces faile, *conioynd* may gaine. *Spenser. Faerie Queene.*

He will unite the white rose and the red; Smile heaven upon his fair *conjunction*, That long hath frowned upon their enmity. *Shakespeare.*

She is so *conjunctive* to my life and soul, That, as the star moves not but in his sphere, I could not but by her. *Id.*

This part of his *Conjoins* with my disease, and helps to end me. *Id. Henry IV.*

If either of you know any inward impediment, Why you should not be *conjoined*, I charge You on your souls to utter it. *Id. Much Ado.*

It pleased the king, his master, to strike at me; When he, *conjunct*, and flattering his displeasure, Tript me behind. *Id. King Lear.*

God, neither by drawing waters from the deep, nor by any *conjunction* of the stars, should bury them under a second flood. *Raleigh.*

The treaty gave abroad a reputation of a strict *conjunction* and amity between them. *Bacon.*

I never met with a more unhappy *conjunction* of affairs than in the business of that earl. *King Charles.*

I was willing to grant to presbytery what with reason it can pretend to, in a *conjunction* with episcopacy. *Id.*

Such censures always attend such *conjunctions*; and find fault for what is not done, as with that which is done. *Clarendon.*

Those are good mediums *conjunctively* taken, that is, not one without the other. *Brown.*

Common and universal spirits convey the action of the remedy into the part, and *conjoin* the virtues of bodies far disjoined. *Brown's Vulgar Errors.*

A gross and frequent error, commonly committed in the use of doubtful remedies, *conjointly* with those that are of approved virtues. *Id.*

Men of differing interests can be reconciled in one communion; at least, the designs of all can be *conjoined* in ligatures of the same reverence, and piety, and devotion. *Taylor.*

Let that which he learns next be nearly *conjoined* with what he knows already. *Loche.*

Herein, I think, lies the chief, if not the only, reason, why the male and female in mankind are tied to a longer *conjunction* than other creatures, viz. because the female is capable of conceiving, and de facto is commonly with child again, and brings forth to a new birth, long before the former is out of a dependency for a support on his parents' help, and able to shift for himself, and has all the assistance that is due to him from his parents. *Id.*

Thou wrongest Piritihous, and not him alone; But, while I live, two friends *conjoined* in one. *Dryden.*

The parts of the body, separately, make known the passions of the soul, or else *conjointly* one with the other. *Id.*

Man can effect no great matter by his personal strength, but as he acts in society and *conjunction* with others. *South.*

He is quick to perceive the motion of articulation, and *conjunctions* of letters in words. *Holder's Elements of Speech.*

Every virtue requires time and place, a proper object, and a fit *conjunction* of circumstances. *Addison's Spectator.*

Pompey and Cesar were two stars of such a magnitude, that their *conjunction* was as fatal as their opposition. *Swift.*

Silently as a dream the fabric rose; No sound of hammer or of saw was there: Ice upon ice, the well adjusted parts Were soon *conjoined*, nor other cement asked Than water interfused to make them one. *Comper.*

Conjoined, like birds of the same feather, Swear that you'll live and die together. *Huddeford.*

CONJOINT, or CONJUNCT, in heraldry, is used of charges when joined together; as *gules*, two lions rampant, conjoined under one head, *argent*, name Kellum. Or as, *argent*, seven mascles, conjunct three, three and one.



CONJOINT TETRACHORDS, two tetrachords or fourths, where the same chord is the highest of one and the lowest of the other.

CONJOINED IN LURE, is two wings with the points downward and joined at the top, as in the diagram.



CONISSALÆ, in mineralogy, a class of fossils naturally and essentially compounded, not inflammable, nor soluble in water, found in detached masses, and formed of crystalline matter debased by earth. Of this class there are two orders, consisting of only one genus each. Those of the first are found in form of a naturally regular and uniform powder; all the genuine particles of which are nearly of one determinate shape, appearing regularly concreted, and not fragments of others once larger. Conissalæ of the second order are found in form of a rude, irregular, and shapeless powder, the particles of which are never of any determinate figure, but seem broken fragments of once larger masses. To the former genus belong the different species of sand; and to the latter the saburræ, or grits.

CONJUGATE, *v. a., n. s., adj.* } Lat. *con-*
CONJUGATION, *n. s.* } *jugare*, from
CONJUGAL, *adj.* } *con* and *ju-*
CONJUGALITY, *n. s.* } *gum*. These
CONJUGALLY, *adv.* } words are

closely allied with conjoin and its congeners; both classes having the sense of to yoke together. To conjugate is to join together; to unite in marriage; to live together: but the verb thus applied seems to be nearly disused. Its most common meaning is, to inflect verbs; to repeat all the various terminations of verbs. The noun, which signifies agreeing in derivation with another word, is also of rare occurrence. In geometry, the conjugate diameter is, a right line which bisects the transverse-diameter. Conjugal is that which relates to matrimony. Conjugation means a couple; the act of uniting things; union; and, more commonly, the form of inflecting verbs through their series of terminations. The quotation from Cowper will show, however, that there is modern authority for using this noun in the sense of an union.

The general and indefinite contemplations and notions of the elements, and their *conjugations*, are to be set aside, being but notional; and illimited and indefinite axioms are to be drawn out of measured instances. *Bacon.*

Those drawing as well marriage as wardship, gave him both power and occasion to *conjugate* at pleasure the Norman and the Saxon houses. *Wotton.*

The supper of the Lord is the most sacred, mysterious, and useful *conjugation* of secret and holy things and duties. *Taylor.*

The heart is so far from affording nerves unto other parts, that it receiveth very few itself from the sixth *conjugation* or pair of nerves. *Browne.*

His grammatical argument, grounded upon the derivation of spontaneous from sponte, weighs nothing: we have learned in logick, that *conjugates* are sometimes in name only, and not in deed.

Brainhall's Answer to Hobbes.

Have those who have writ so much about declensions and *conjugations*, about concords and syntaxes, lost their labour, and been learned to no purpose? *Locke.*

The father, who is bound to take care for those he hath begot, is under an obligation to continue in *conjugal* society with the same woman longer than other creatures, whose young being able to subsist of themselves, before the time of procreation returns again, the *conjugal* bond dissolves of itself. *Id.*

Their *conjugal* affection still is tied,
 And still the mournful race is multiplied.

Dryden.

He marked the *conjugal* dispute,
 Nell roared incessant, Dick sat mute. *Swift.*
 All the various mixtures and *conjugations* of atoms
 do beget nothing. *Bentley.*

And seems it nothing in a father's eye,
 That unimproved those many moments fly?
 And is he well content his son should find
 No nourishment to feed his growing mind,
 But *conjugated* verbs and nouns declined?

Cowper.

Dick heard, and tweedling, ogling, bridling,
 Turning short round, strutting and sidling,
 Attested, glad, his approbation
 Of an immediate *conjugation*. *Id.*
 Indignant she answered, 'No chin-scraping sot
 Shall be fastened to me by the *conjugal* knot:
 No—to Tyburn repair, if a noose you must tie,
 Other fish I have got, Mr. Tonser, to fry.'

Huddesford.

CONJUGATE AXIS. See CONIC SECTIONS.

CONJUGATE HYPERBOLA. See CONIC SECTIONS.

CONJUGATION, in grammar. See GRAMMAR and LANGUAGE.

CONIUM, in botany, hemlock, a genus of the digynia order, and pentandria class of plants, natural order forty-fifth, umbellatæ. The partial involucre are halved, and mostly triphyllous; the fruit sub-globose and quinque-striated, the striæ crenated on each side. The three principal species are, 1. *C. Africanum*, with prickly seeds, a native of the Cape of Good Hope, and rarely growing above nine inches high. 2. *C. maculatum*, or the greater hemlock, grows naturally on the sides of banks and roads in many parts of Britain. It is a biennial plant which perishes after it has ripened its seeds. It flowers in June, and the seeds ripen in autumn. This species is sometimes applied externally, in the form of decoction, infusion, or poultice, as a discutient. 3. *C. tenuifolium*, with a striated seed, differs from the last in having taller stalks, which are not so much spotted. The leaves are much narrower, and of a paler green; and this difference is constant. It is a biennial plant, and grows naturally in Germany.

CONJURE, *v. a. & n.* } Fr. *conjurere*; It.
CONJURE, *v. n.* } *congiurare*; Sp. *con-*
CONJURER, *n. s.* } *jurar*; Lat. *conjurare*.
CONJURING, *n. s.* } To swear in concert;
CONJURATION, *n. s.* } to conspire; to bind
CONJURATOR, *n. s.* } by an oath to some
CONJUREMENT, *n. s.* } design common to

all the parties; to summon in a sacred name; to adjure solemnly; to evoke; to influence by enchantment; to practise charms or magical ceremonies. When the verb is used in the last two senses it has the accent on the first syllable. Conjunction is the form of solemnly summoning; an incantation; a conspiracy; but this last meaning is disused. A conjurer is one who uses enchantments; an imposter who pretends to be versed in magic. The word is also used ironically. Conjurement signifies a demand, or injunction, made with great earnestness.

Neece, I *conjure* and highly you defende,
 On his beholfe whiche that soul usall sende,

And in the vertue of coronis twaine,
Slea nat this man that hath for you this paine.

Chaucer. Troilus and Creseide.

Let us go now to that horrible swering of adjuration and *conjuracion*, as don those false enchantours and nigromancers in basins full of water, or in a bright swerde, in a cercle, or in a fire, or in a sholder bone of a shepe.

Id. Cant. Tales.

Ye wyndes I you *conjurjng* in chiefest of your rage,
That ye my lord safely send my sorrowes to aswage.

Earl of Surrey.

There was she faine

To call them all in order to her ayde,
And them *conjurjs*, upon eternal paine,
To counsel her, so carefully dismayed,
How she might heale hear sonne, whose senses were decayed.

Spenser. Faerie Queene.

Your *conjuracion*, fair knight, is too strong for my
poor spirit to disobey.

Sidney.

What black magician *conjurjs* up this fiend,
To stop devoted charitable deeds?

Shakespeare. Richard III.

What is he, whose griefs
Bear such an emphasis? whose phrase of sorrow
Conjurjs the wandering stars, and makes them stand
Like wonder-wounded hearers?

Id. Hamlet.

What drugs, what charms,
What *conjuracion*, and what mighty magick,
For such proceeding I am charged withal,
I won his daughter with.

Id. Othello.

Good doctor Pinch, you are a *conjurjer*;
Establish him in his true sense again.

Id. Comedy of Errors.

He in proud rebellious arms
Drew after him the third part of heaven's sons,
Conjur'd against the Highest.

Milton. Paradise Lost.

I should not be induc'd but by your earnest in-
terests and serious *conjurments*.

Milton.

I thought their own fears, whose black arts first
raised up those turbulent spirits, would force them to
conjurjs them down again.

King Charles.

He concluded with sighs and tears to *conjurjs* them,
that they would no more press him to consent to a
thing so contrary to his reason.

Clarendon.

I *conjurjs* you! Let him know,
Whate'er was done against him, Cato did it.

Addison's Cato.

You have *conjur'd* up persons that exist no where
else but on old coins, and have made our passions
and virtues visible.

Addison.

Our palaces are vast inhospitable halls. There the
bleak winds—there ' Boreas, and Burus, and Caurus,
and Argestes loud,' howling through the vacant lob-
bies, and clattering the doors of deserted guard-rooms,
appal the imagination, and *conjurjs* up the grim spec-
tres of departed tyrants—the Saxon, the Norman, and
the Dane, &c.

Burke.

Great skill have they in palmistry, and more
To *conjurjs* clean away the gold they touch,
Conveying worthless dross into its place;
Loud when they beg, dumb only when they steal.

Cowper.

And now, quoth poor unthinking Ralph,
'Tis over, and the brood is safe
(For ravens, though as birds of omen
They teach both *conjurers* and old women,
To tell us what is to befall,
Can't prophecy themselves at all).

Id.

It is by the majesty, by the form of that justice,
that I do *conjurjs* and implore your lordships to give
your minds to this great business.

Sheridan.

CONJURATION properly implies magic words characters, or ceremonies, whereby evil spirits, tempests, &c. are suppos'd to be raised, or driven away. The Romish priests formerly affirm'd that they could expel devils, by preparing holy water in a particular manner, and sprinkling it over the possessed, with a number of conjurations and exorcisms. Some authors make the difference between conjuration and witchcraft to consist in this, that the former effects its end by prayers and invocation of God's name, &c. to compel the evil spirit to do what is desired; whereas the latter attains its end by an immediate supplication to the devil himself. Both these, again, differ from enchantment and sorcery; in that these latter operate secretly and slowly by spells, charms, &c. without invoking infernal aid.

CONNARUS, Ceylon sumach, in botany, a genus of the decandria order, and monodelphia class of plants. The **STIG.** is simple: caps. bivalved, unilocular, and monospermous. The principal species is *C. monocarpus*, a native of India. It rises with a ligneous stalk eight or ten feet high, which is hard, rigid, and covered with a black bark, and divides upward into two or three branches with trifoliolate leaves, having long foot-stalks placed alternate. It is propagated by cuttings, and is treated like other exotics.

CONNATE, *adj.*

Lat. *con* and *natus*.

CONNA'SCENCE, *n. s.* } Brought into existence
along with another; being of the same birth.
Common birth; production at the same time;
being produced together with another being.

Christians have baptized these geminous births and double *connascencies*, as containing in them a distinction of soul.

Brown's Vulgar Errors.

Symphysis denotes a *connascence*, or growing together.

Wiseman.

Many, who deny all *connate* notions in the specula-
tive intellect, do yet admit them in this.

South.

Their dispositions to be reflected, some at a greater,
and others at a less thickness, of thin plates or bubbles,
are *connate* with the rays, and immutable.

Newton's Optics.

CONNATURALIZE, *v. a.*

Fr. *connatural*;

CONNATURAL, *adj.*

It. *connaturare*,

CONNATURALITY, *n. s.*

connaturale; Sp.

CONNATURALLY, *adv.*

connaturalizarse,

CONNATURALNESS, *n. s.*

connatural; Lat.

con and *nasoor*. The verb signifies to render consonant to; to unite by similarity of nature; to make natural to. It is seldom used. Connatural is, participating in the same nature; linked with the being; united by nature; natural in common to all.

First in man's mind we find an appetite

To learn and know the truth of every thing.

Which is *co-natural*, and born with it,

And from the essence of the soul doth spring.

Dewick.

There is a *connaturality* and congruity between that knowledge and those habits, and that future estate of the soul.

Hale.

Some common notions seem *connaturally* engraven in the soul, antecedently to discursive ratiocination.

Id.

Is there no way, besides
These painful passages, how we may come
To death, and mix with our *connatural* dust? *Milton.*

Whatever draws the on,
Or sympathy, or some *connatural* force,
Powerful at greatest distance to unite
With secret amity. *Id.*

Such is the *connaturalness* of our corruptions, except
we looked for an account hereafter.
Pearson on the Creed.

How often have you been forced to swallow sick-
ness, to drink dead psalms and foaming epilepsies, to
render your intemperances familiar to you,—before
ever you could *connaturalise* your midnight revels to
your temper. *Scott.*

These affections are *connatural* to us, and as we grow
up, so do they. *L'Estrange.*

CONNAUGHT, the most western of the four
provinces of Ireland, bounded on the east by
that of Leinster, on the west by the ocean, on
the north and north-west by part of the ocean
and province of Ulster, and on the south and
south-east by Munster. It is 130 miles long
and eighty-four broad; and was a distinct king-
dom till the reign of Henry II. It has no rivers
of note besides the Shannon, but possesses several
convenient bays and creeks; and the soil is fer-
tile in many places. It formerly contained many
dangerous bogs, overrun with wood, now in
some measure cleared; and produces abundance
of cattle, sheep, and deer: it is, however, still
the least cultivated of all the four provinces. It
contains six counties, one archbishopric, five
bishoprics, seven market-towns, ten boroughs,
and 330 villages. The distinction of Ireland
into provinces is said not to have been of late
regarded in any public documents.

CONNECT, v. a. & n.	} Ital. <i>connettere</i> ; Lat. <i>connectere</i> , from <i>con</i> and <i>nectere</i> . To link together; to knit together; to conjoin; to bring into union; to be coherent; to produce a consistent
CONNEX, v. a.	
CONNEXION, or	
CONNEXION, n. s.	
CONNECTIVE, or	
CONNEXIVE, n. s. & adj.	
CONNECTIVELY, adv.	
CONNEXING, n. s.	whole from the parts. Connexion is the state

of being conjoined; the act of joining; just rela-
tion to something which precedes or follows; co-
herence of parts. Connective, as a noun, signi-
fies a conjunction. In common parlance, a
man's connexions mean his relations and friends;
and to form a connexion with, is, to become
very intimate with; to join in business or politics
with; to enter into an immoral alliance with a
female.

My heart, which by a secret harmony
Still moves with thine, joined in *connexion* sweet.
Milton.

Contemplation of human nature doth, by a neces-
sary *connexion* and chain of causes, carry us up to the
Deity. *Hale.*

Those birds who are taught some words or sentences,
cannot *connex* their words or sentences in coherence
with the matter which they signify.

Id. Origin of Mankind.

The natural order of the *connecting* ideas must di-
rect the syllogisms; and a man must see *connexion* of

each intermediate idea with those that it *connects*, be-
fore he can use it in a syllogism. *Locke.*

We are all short-sighted, and very often see but
one side of the matter: our views are not extended to
all that has a *connexion* with it. From this defect I
think no man is free. *Id.*

The people's power is great and indisputable, when-
ever they can unite *connectively*, or by deputation,
to exert it. *Swift.*

They fly,

By chains *connexed*, and with destructive sweep
Behead whole troops at once *Philips.*

There must be a future state, where the eternal and
inseparable *connexion* between virtue and happiness
shall be manifested. *Atterbury.*

The predicate and subject are joined in a form of
words by *connexive* particles. *Watts's Logic.*

The diversified but *connected* fabric of universal jus-
tice is well cramped and bolted together in all its parts;
and depend upon it, I never have employed, and I
never will employ, any engine of power which may
come into my hands to wrench it asunder. *Burke.*

Paul Benfield's associate and agent was held up to
the world as legislator of Indostan. But it was neces-
sary to authenticate the coalition between the men of
intrigue in India, and the minister of intrigue in Eng-
land, by a studied display of the power of this their
connecting link. Every trust, every honour, every
distinction, was to be heaped upon him. *Id.*

Some legislators went so far as to make neutrality
in party a crime against the state. I do not know
whether this might not have been rather to overstrain
the principle. Certain it is, the best patriots in the
greatest commonwealths have always commended and
promoted such *connexions*. *Id.*

It does not, however, appear that in things so inti-
mately *connected* with the happiness of life, as mar-
riage, and the choice of an employment, parents have
any right to force the inclinations of their children.
Beattie.

I formed several *connexions* with other youngers who
possessed superior advantages, the youngling actors,
who were busy in the rehearsal of parts in which they
were shortly to appear on the stage of life, where,
alas! I was destined to drudge behind the scenes.
Burns.

No friendship will abide the test,
That stands on sordid interest.
Or mean self love erected;
Nor such as may a while subsist
Between the sot and sensualist,
For vicious ends *connected*. *Cowper.*

With many a sob, amid a thousand fears,
The beauteous wanderer pours her gushing tears;
Each soft *connection* rends her troubled breast.
Darwin.

CONNECTICUT, or as it was called by the
ancient inhabitants, Quinnickicut, one of the
United States of North America, is situated be-
tween 40° 58' and 42° 2' N. lat., and 3° 16' and
5° 10' E. long. It is seventy-two miles broad
and 100 miles long; and bounded on the north
by Massachusetts, on the east by Rhode Island,
on the south by Long Island Sound, and on the
west by the state of New York; containing
about 4674 square miles, or a computed area of
2,991,360 acres. The following table contains
a list of its counties, population, and chief towns.

Counties.	Towns.	Pop. in 1810.	Pop. in 1820.	Chief Towns.
New London	15	34,707	35,943	New London.
Middlesex	7	20,723	22,405	Middleton.
Litchfield	22	41,375	41,267	Litchfield.
Tolland	10	13,779	14,330	Tolland.
Windham	15	28,611	31,684	Brooklyn
Fairfield	18	40,950	42,739	Fairfield
Hartford	18	44,733	47,264	Hartford
Newhaven	17	37,064	39,616	Newhaven
	<hr/>	<hr/>	<hr/>	
	122	261,942	275,248	

The population in 1790 was 237,946; in 1800 251,002; in 1810, 261,942; and in 1820, 275,248. With the exception of Massachusetts, Connecticut is the most populous state in the United States, having an average of fifty-nine persons to each square mile. Many thousands emigrate every year to the western country.

Connecticut contains five incorporated cities; namely, Hartford, Newhaven, Middletown, New London and Norwich. The capitals of the state are Hartford and Newhaven; the sessions of the legislature are held alternately at these places. The counties are divided and sub-divided into townships and parishes, and every township has a corporation invested with sufficient power for its own internal regulation.

This state, upon the whole, enjoys a favorable climate; although for a few weeks during the summer the weather is excessively hot, and the winters are very severe. The maximum of heat may be quoted, however, at 91°, and the greatest cold 10° below 0; but the heat seldom exceeds 85° and the cold is rarely below 0. The winter generally sets in in November and ends in April. The spring is backward, but the summer and autumn are exquisitely beautiful. Near the sea coast the inhabitants suffer much from variable weather; in advancing farther inland, however, the sea breezes have less influence on the air, and the weather is, consequently, more equable. The north-west winds, which prevail during the winter solstice, acquire a piercing keenness from their passage over dreary wastes of ice and snow; but, as a compensation, the sky presents one unclouded expanse of cerulean blue, and the winter is considered favorable to health and longevity.

The face of the country is much diversified, presenting to the traveller a continual succession of mountains, hills, and valleys, on the whole, fertile, yet interspersed with portions of thin and barren land. Much of the soil has been under cultivation for nearly a century, and still retains its original strength. Its principal productions are Indian corn, wheat, rye, oats, barley, buckwheat, flax in great quantity, hemp, potatoes of various kinds, &c. The Connecticut farmers reap great advantage also from their crops of pumpkins, onions, turnips, and beans. There is scarcely a farm in the country which has not one or more orchards attached to it, from the produce of which excellent cider is made in large quantities. The soil is in general very well calculated for the purpose of pasturage, which enables the farmers to feed great numbers of cat-

tle and horses; a considerable quantity of grass is also cultivated. Various kinds of ores and minerals are found in the different parts of the state, as iron, copper, silver, lead, and antimony; they have also coal, free-stone, serpentine marble, limestone, &c.

In Connecticut a larger proportion of the population is engaged in manufactures than in any other of the United States, Rhode Island alone excepted. The manufacture of tin into culinary vessels is carried on to a great extent. The ware thus made is sold by pedlars in all parts of the United States and Canada. Here are also manufactories of hemp and cotton; and, of late, improved machinery has been introduced. The manufacture of gin is carried to a very great extent in Hartford county. Litchfield county is celebrated for its iron works, in which goods sufficient for the supply of the whole state are manufactured. Large quantities of guns are made at Hamden and Newhaven. Glass-works and tanneries have been introduced in various parts, and paper, hats, candles, leather, boots and shoes, nails, wooden dishes, and various articles of turnery are also made in many of the towns. A sail-cloth manufactory and a powder-mill have likewise been established. An oil as mild as sweet oil, and equally agreeable with salads, or for medicinal purposes, and of great use in paints and varnishes, is extracted from the seeds of the sun flower: oil-mills of a peculiar construction are used to extract it, and it is estimated that every bushel of seed will produce a gallon of oil, so that the cultivation of the flowers yields, in many instances, a greater profit than that of any other produce. There are large orchards of mulberry trees; and silk-worms have of late been so successfully reared, that a promise is held out of their not only producing a sufficient supply for the purposes of the inhabitants, but also a surplus for exportation.

The foreign trade of Connecticut is principally carried on with the West Indies, but the coasting trade to the southern States is considered more valuable. The amount of shipping belonging to the State was, in 1815, 50,358 tons, and it has increased of late years. The value of the exports for the years ending September 30th, 1820, was 421,931 dollars. Their exports consist principally of horses, oxen, mules, oak-staves, pine-boards, oak planks, hoops, Indian corn, beans, beef, pork, fish, butter, cheese, cider, &c. A large number of coasting-vessels are employed for the conveyance of produce from this to the

neighbouring States. To Massachusetts, Rhode Island, and New Hampshire, they carry pork, corn, wheat and rye; to Georgia, North and South Carolina, butter, cheese, salted beef, potatoes, cider, apples, hay, &c., and receive in return, rice, indigo, and money. Considerable quantities of the produce of the eastern divisions of the State are sold at Providence, Norwich, and Boston. But as New York is nearer, and the state of the markets well known, this city has become the principal mart for the produce of Connecticut, especially the western parts of the State.

The value of land and houses in Connecticut, as established by the assessors' books, was in 1814, 86,550,033 dollars. There are ten banks established in the State, the aggregate amount of whose capital is upwards of three millions and a half of dollars.

The size of the farms in Connecticut is from fifty to 400 acres, held in fee-simple. The farmers and their families are mostly clothed in home-spun cloths. Their woollens and linens are also of domestic manufacture, and, although coarser, are generally of a stronger texture than the produce of the European loom. The annual value of the flaxen goods made in families, was, in 1810, estimated at 2,303,078, and of woollen at 1,098,241 dollars. Linen and woollen manufactories have now, however, been introduced, and they will probably every day become more common.

The principal towns and cities, besides what have already been mentioned, are Norwich, Middletown, Windsor, Weathersfield, Farmington, Milford, Stratford, Guildford, Stamford, Suffield, and Enfield. The houses in the smaller towns are generally constructed of wood, but the sides are neatly clap-boarded and painted white. They are seldom above two stories high. The roofs are slanting, covered with shingles, and painted of a slate color. Sash windows, with green Venetian blinds, are however, very common. The places of worship are built of similar materials as the houses; but generally surmounted by a spire, having one or two bells. The chief rivers are the Thames, the Connecticut, and the Housatonic, with their tributary streams. The whole range of the coast is indented with harbours, many of which are commodious and safe. The principal mountains are, the Lyme range; the Mount Tom range; the Green Mountain range, and the Tachcorac range, and these in most instances extend in a southerly direction the whole extent of the State. The inhabitants are almost entirely of English descent; the original stock from which they sprung consisted of 3000 souls, who settled in the towns of Hartford, Newhaven, &c., about the years 1635—1636. The inhabitants of Connecticut have long been celebrated for their industry, sobriety, and strict piety. It is said, that an instance of capital punishment does not occur above once in every nine or ten years. There is a law to prevent travelling on a Sunday; but strangers contravene it, although the elders go about to the different inn-keepers to forbid them to let out their horses. If a traveller arrive, he can generally find a saddled horse, and has only to mount and pursue for some short distance a

bye road. A great desire for improvement manifests itself in every town. Every district has its public school. The law requires, that a grammar-school be kept in every county town throughout the whole State. Yale College, which was founded in 1700, has been long celebrated as an eminent seat of learning. The library of this college contained, in 1820, 7000 volumes, and the students, amounting to 412, had libraries containing 2000 more. The consequence of this state of society is, a continued increase of population, so that although there have been more emigrated from this than from any other of the United States, it is at present full of inhabitants. Other causes concur doubtless in this effect: the greater proportion of the inhabitants are laborious husbandmen; their farms furnish them with all the necessaries, and many of the conveniences, but with few or none of the luxuries of life. They are temperate and industrious, and their subsistence does not depend on mere accidental circumstances. Here is no necessity for a long apprenticeship to fit them for a business, or a large stock of money required for them to commence with advantage, all which circumstances combined, operate as a never-failing inducement for early marriages. The people of Connecticut are remarkably well informed with respect to their rights; and, as is invariably the case in parallel circumstances, are tenacious to an excess of the least incroachment on them. This disposition frequently degenerates, in private life, into a litigious spirit, which unhappily affords ample employment to a numerous body of lawyers.

The Congregationalists are the most numerous religious denomination at present in Connecticut. Next to them are the Episcopalians and Baptists. There are very few of any other sect. In 1818 the former had 213 congregations, the Episcopalians sixty-nine, and the Baptists about seventy. Until the year 1818, Connecticut was governed by the charter of Charles II., granted in 1662, and which conveyed ample privileges to the people. The powers of the present government are vested in the three departments, the legislative, executive, and judicial. The first consists of a senate and house of representatives; the members of both of these bodies are elected annually, and meet once in each year, alternately at Newhaven and Hartford. The executive government consists of a governor and lieutenant-governor, who are elected by the people every year. All bills must be presented to the governor, but he has no vote upon legislative acts: if he disapprove of them, he returns them with his objections. The legislature may pass them, however, but in such cases the votes must be determined by the yeas and nays, and the names of the members entered on the Journals. The lieutenant-governor is the ex-officio speaker of the senate. The judicial power of Connecticut is vested in a supreme court of Errors, a superior court, and such inferior courts as the legislature may from time to time please to establish. The assembly appoint the judges and justices of the peace, and the judges hold their offices during good behaviour. Justices of the peace are elected annually. No judge or justice is allowed to re-

tain his office after he has arrived at seventy years of age. Every white male citizen of the United States, who has a settlement in the State, who is twenty-one years of age, of good moral character, and has paid a state tax within a year, is eligible as an elector. No person is bound to support or be a denizen of any particular religious sect. The governor and all the officers are liable to impeachment, which must be prosecuted by the house of representatives, and tried by the senate. No law can pass without the concurrence of both houses. Connecticut has ever been a republic, and may perhaps be cited as the most perfect and happy one that has ever existed in any time or in any country.

CONNECTICUT, a large river of North America, the most considerable one in the eastern part of the United States. It rises in the high lands, which separate the states of Vermont and New Hampshire from Lower Canada, and has been surveyed about thirty-five miles beyond the forty-fifth degree of latitude, to its northern head spring; from which, to its mouth, is upwards of 300 miles, through a thick settled country; having upon its banks a great number of the most flourishing and pleasant towns in the United States. It is from eighty to 100 rods wide, at a distance of 130 miles from its mouth. Its course between Vermont and New Hampshire, as well as through Massachusetts, and part of Connecticut, is generally S. S. W. until it reaches the city of Middleton; after which it runs a S. S. E. course to its mouth. The navigation of this beautiful river, which fertilises the land through which it runs, is much obstructed by falls. Two of these are between New Hampshire and Vermont; the first are called the Fifteen-miles falls. Here the river is rapid for twenty miles. The second remarkable fall is at Walpole, formerly called the Great Fall, but now named Bellows Falls. Above these, the breadth of the river is, in some places, twenty-two, in others not above sixteen, rods. The depth of the channel is about twenty-five feet, and commonly runs full of water. In September, 1792, however, owing to the severe drought, the water of the river, it is said, passed within the space of twelve feet wide and two and a half deep. A large rock divided the stream into two channels, each about ninety feet wide.

When the river is low, the eastern channel is dry, being crossed by a solid rock; and the whole stream falls into the western channels, where it is contracted to the breadth of sixteen feet, and flows with astonishing rapidity. There are several perpendicular falls one above another, within the length of half a mile, the largest of which is that where the rock divides the stream. Notwithstanding the velocity of the current at Bellows Falls, the salmon pass up the river, and are taken many miles above; but the shad proceed no farther. On the steep sides of the island rock, at the fall, hang several arm chairs, secured by a counterpoise; in these the fishermen sit to catch salmon with fishing nets. In the course of the river through Massachusetts are falls at South Hadley, around which locks and canals were completed in 1795, by an enterprising company, incorporated in 1792 by the legislature of

Massachusetts. In Connecticut the river is obstructed by falls at Enfield; to render which navigable in boats, a company has been incorporated, and a sum of money raised by lottery, but nothing effectual is yet done. The average descent of this river from Weathersfield in Vermont, 150 miles from its mouth, is two feet to a mile, according to the barometrical observations of J. Winthrop, Esq. made in 1786. The rivers and streams which fall into the Connecticut are numerous. At its mouth is a bar of sand, which considerably obstructs the navigation; it has ten feet water on it at full tides, and the same depth to Middleton, from which the bar is thirty-six miles distant. Above Middleton there are shoals which have only six feet water at a high tide; and here the tide ebbs and flows only about eight inches. Three miles above that city the river is contracted to about forty rods in breadth by two high mountains. On almost every other part the banks are low, and spread into fine extensive meadows. In the spring floods, which generally happen in May, these meadows are covered with water. At Hartford the water sometimes rises twenty feet above the common surface of the river, and, having no other outlet but the above-mentioned strait, it is sometimes two or three weeks before it returns to its usual bed. These floods add nothing to the depth of water on the bar at the mouth of the river, as it lies too far off in the sound to be affected by them. This river is navigable to Hartford city, upwards of fifty miles from its mouth; and the produce of the country, for 200 miles above it, is brought thither in boats. These boats are flat-bottomed, long, and narrow, and of so light a make as to be portable in carts. Before the construction of locks and canals on this river, they were taken out at three different carrying places, all of which made fifteen miles. Sturgeon, salmon, and shad, are caught in great plenty in their seasons, from the mouth of the river upwards; but the sturgeon cannot ascend the upper falls; besides a variety of small fish, such as pike, carp, perch, &c.

CONNICTATION, *n. s.* Lat. *conniveo*. A winking.

CONNIVE, *v. n.* } Fr. *conniver*; Lat. *con-*
CONNIVENCY, *n. s.* } *niere*. To wink at a
CONNIVENT, *adj.* } fault, that is, to pretend
CONNIVER, *n. s.* } not to see it; to acqui-
CONNIVANCE, *n. s.* } esce in wrong doing,
which it is our duty to prevent. This meaning runs through all the kindred words. Conniver, however, is applied by Milton in the sense of dormant; inattentive; and, as will be seen in the quotation, the Spectator gives to the verb its primary sense of to wink. But neither of these meanings is now in use.

It is better to mitigate usury by declaration, than to suffer it to rage by connivance. *Bacon.*

Disobedience, having gained one degree of liberty, will demand another: every vice interprets a connivance, an approbation. *South.*

The licentiousness of inferiours, and the remissness of superiours, the one violates, and the other connives. *Decay of Piety.*

This artist is to teach them how to nod judiciously, to connive with either eye. *Spectator.*

With whatever colours he persuades authority to *connive* at his own vices, he will desire its protection from the effects of other mens'. *Rogers.*

For the amusement of a few young soldiers, two or three thousand poor unarmed and innocent men may be murdered in one night, with the *connivance*, nay, and by the authority, of the law. *Beattie.*

Ye knew at least, by constant proofs addressed To ears and eyes, the vices of the rest.

But ye *connive* at what ye cannot cure,
And evils, not to be endured, endure,
Lest power exerted, but without success,
Should make the little ye retain still less. *Cooper.*

It has been stated that the persons in the temporary possession of frames *connive* at their destruction; if this be proved upon inquiry, it were necessary that such material accessories to the crime should be principals in the punishment.

Byron. Speech on the Flame-breaking Bill.

CONNIVENTES VALVULÆ, CONNIVENT VALVES, in anatomy, wrinkles, cellulæ, and vasculæ, in the inside of the ilium and jejunum. See **ANATOMY.**

CONNOISSEUR, n. s. } French. A judge;
CONNOISSEURSHIP. } a critic. It is often used of a pretended critic.

Reason the *connoisseur*, and bright load star
In this world's sea to avoid the rock of chance.

Davies.

Your lesson learnt, you'll be secure

To get the name of *connoisseur.*

Swift.

SIR. BENJ. NAY now, Lady Sneerwell, you are severe upon the widow. Come, come, 'tis not that she paints so ill—but when she has finished her face, she joins it so badly to her neck, 'that she looks like a mended statue, in which the *connoisseur* sees at once that the head's modern, though the trunk's antique.

Sheridan. School for Scandal.

I leave to learned fingers, and wise hands,

The artist and his ape, to teach and tell

How well his *connoisseurship* understands

The graceful bead and the voluptuous swell:

Let these describe the undescribable.

Byron. Childs Harold.

CONNOR, an ancient village of Antrim in Ireland, from which the bishopric of Down and Connor receives its latter name. On the bank of the Kells-water, are the ruins of a very ancient round tower, supposed to have been erected about the time of the Saxon invasion of England, and said to have been the residence of several kings. About 1200 silver pence of Edward I. were dug up here in 1820, which are supposed to have been brought over by some of the soldiers of that prince in 1318. It is eighty-nine miles from Dublin.

CONNOR (Bernard), M.D. and F.R.S. was born in Kerry, Ireland, about A.D. 1666. He studied physic in the university of Montpellier; and afterwards went to Paris. From thence he travelled to Venice, and through great part of Germany, to Warsaw, where he was made physician to king John Sobieski. In 1695 he came to England, read lectures in London, Oxford, and Cambridge, and became a member of the Royal Society and College of Physicians. He wrote a singular philosophical and medical treatise in Latin, entitled *Evangelium Medici*; tending to explain the miracles performed by Christ as natural events, upon the principles of natural philosophy. He wrote also a History of

Poland; Dissertations on Mount Vesuvius, &c. and died in 1698, aged thirty-two.

CONNOTATE, v. a. } Sp. *connotar*; Lat.

CONNÔTE, v. a. } *con* and *notare*. To

CONNOTA'TION, n. s. } connotate is to designate something besides itself; to imply; to infer. To connote signifies, to imply; to betoken; to include; and now, more frequently, to denote. Connotation is implication of something more than itself; inference; illation.

By reason of the co-existence of one thing with another, there ariseth a various relation or *connotation* between them. *Hale's Origin of Mankind.*

God's foreseeing doth not include or *connotate* predetermining, any more than I decree with my intellect. *Hammond.*

Good, in the general notion of it, *connotes* also a certain suitableness of it to some other thing. *South.*

Plato by his ideas means only the divine essence with this *connotation*, as it is variously imitable or participable by created beings. *Norris.*

CONNU'BIAL, adj. Lat. *connubialis*. Matrimonial; nuptial; pertaining to marriage; conjugal.

Should second love a pleasing flame inspire,
And the chaste queen *connubial* rites require.

Pope's Odyssey.

So years successive, from perennial roots,
The wire or bulb with lessened vigor shoots,
Till curled leaves, or barren flowers, betray
A waning lineage, verging to decay;
Or till, amended by *connubial* powers,
Rise seedling progenies from sexual flowers. *Darwin.*

He left to his vizier all state affairs,

And showed but little royal curiosity:

I know not if he had domestic cares—

No process proved *connubial* animosity.

Byron. Don Juan.

CONNUMERATION, n. s. Lat. *con* and *numerare*. A reckoning together.

CONOCARPUS, in botany, the button tree, a genus of the monogynia order and pentandria class of plants, natural order forty-eighth, aggregate: cor. pentapetalous: the seeds naked, solitary, inferior; the flowers aggregate. There are three species, of which the best known are, *C. freca* and *C. procumbens*, both natives of the West Indies. They rise to about sixteen feet, but are of no beauty, nor is the wood of them used for any mechanical purpose in the countries where they grow naturally. They are, however, preserved in some botanic gardens in Britain for the sake of variety.

CONOID is a figure generated by the revolution of a conic section about its axis; there are, consequently, three kinds, answering to the three conic sections, viz. the elliptical conoid, or spheroid, the hyperbolic conoid, and the parabolic conoid. If a conoid be cut by a plane in any position, the section will be of the figure of some one of the conic sections; and all parallel sections of the same conoid are like and similar figures.

CONON, a renowned Athenian general and admiral, who flourished about A. A. C. 395. After his defeat by Lysander, (see **ATTICA**), he fled to Evagoras king of Cyprus: after which he put himself under the protection of Artaxerxes king of Persia; with whose army he delivered Athens from its oppressors, and rebuilt

its walls. In the 360th year of Rome, he overcame the Lacedemonians in a sea-fight near Cnidus upon the coast of Asia, depriving them of the sovereign rule they had on sea ever since the taking of Athens, but falling into the hands of Teribazus, a Persian, he was put to death.

CONOPS, in zoology, a genus of insects belonging to the order diptera. The characters are these: the rostrum is porrected, and jointed like a knee. The antennæ terminate by a flat and solid articulation, resembling the bowl of a spoon, with a lateral bristle, which, when closely examined, appears to be very hairy. Of this genus there are twelve or thirteen species; but our limits only allow us to notice, 1. *C. calcitrans* is to be found every where, especially in autumn, when it harasses the horses, and draws blood from them with its sting. 2. *C. macrocephala* might at first sight be mistaken for a species of wasp. It is smooth; the forepart of the head is lemon-color, as are the poisers; the feet are dun-colored. The thorax is variegated with black and reddish dun. The same takes place with respect to the segments of the abdomen; some of which are edged with lemon-color, chiefly the second, and part of the third, towards the sides. The wings are brown, watered, and clouded. This beautiful conops is found in meadows.

CONOVIVUM, in ancient geography, a town of the Ordovices, in Britain. From its ruins arose, at the distance of four miles, Aberconway, a town on the mouth of the Conway, in Caernarvonshire; and on the spot where Conovium stood is a hamlet, called Caerhean, the old town.

CONQUASSATE, *v. n.* } It. and Lat. *con-*
 CONQUASSATION, *n. s.* } *quassare*. To shake;
 to agitate violently; to dash to pieces. Agitation; concussion.

Vomits do violently *conquassate* the lungs.

Harvey.

CONQUER, <i>v. a. & n.</i>	} Fr. <i>conqueris</i> ; It. <i>conquistare</i> ; Sp. <i>conquistar</i> ; Lat. <i>conquerrere</i> . To overcome; to bring under subjection; to surmount; to master; to win.
CONQUEROR, <i>n. s.</i>	
CONQUERESS, <i>n. s.</i>	
CONQUERABLE, <i>adj.</i>	
CONQUERMENT, <i>n. s.</i>	
CONQUEST, <i>n. s.</i>	
CONQUESTOR, <i>n. s.</i>	

A conqueror is too frequently a sanguinary and unprincipled being, at once the scourge and the disgrace of mankind; though he has been dignified with the name of a hero by the folly of some, and the knavery of others. It is to be hoped that, in time, the human race will become enlightened enough to see the necessity of putting an early stop to the career of such pestilent ravagers.

And I saw, and beheld a white horse; and he that sat on him had a bow; and a crown was given unto him: and he went forth *conquering* and to *conquer*.

Rev. vi. 2.

Ther was a duk that highte Theseus;
 Of Athenes he was lord and governour,
 And in his time swiche a *conqueror*,
 That greater was ther non under the sonne;
 Ful many a rich contree had he wonne.
 What with his wisdom and his chevalrie,
 He *conquerd* all the regne of Femiaie.

Chaucer. *Canterbury Tales*.

Til on a time befel there such a caas,
 That out of Rome was sent a senatour
 To *conqueris* realms, and bring honour
 Unto the toune of Rome. *Id.*

And eke Mercuries his message hath presented,
 That nedis to the *conquest* of Itaile
 My destinie is sone for to saile. *Id.*

He lettes me to pursue a *conquest* welnere woone,
 To follow where my paynes were lost, ere that my
 sute begunne. *Earl of Surrey*.

With conqueror's hands for bathde in their owne
 blood,
 And Cesar weeping over Pompeys head. *Sachville*.

Lo the infernall powres,
 Covering your foe with cloud of deadly night,
 Have borne him hence to Plutoe's balefull bowres:
 The *conquest* your's, I yours's, the shield and glory
 your's. *Spenser. Faerie Queene*.

So those which whilom went with pollid cheeks,
 The Roman triumph's glory to behold,
 Now on these ashie tombs shew boldness vain,
 And *conquerd* dare the *conqueror* disdain.
Id. The Ruins of Rome.

Bouduca! the victorious *conqueres*.
Id. The Ruins of Time.
 Put him to choler straight; he hath been used
 Ever to *conquer* and to have his word of contradiction.
Shakespeare. Coriolanus.

Both tugging to be victors, breast to breast;
 Yet neither *conqueror* nor *conquered*. *Id. Henry VI*.
 I'll lead thy daughter to a *conqueror's* bed;
 To whom I will retail my *conquest* won,
 And she shall be sole victress. *Id. Richard III*.

A perfect *conquest* of a country reduces all the
 people to the condition of subjects. *Davies on Ireland*.
 Welcome, great Stagirite, and teach me now
 All I was born to know;
 Thy scholar's victories thou dost undo;
 He *conquered* the earth, the whole world you.
Cowley.

The *conquered* also, and inlaved by war,
 Shall, with their freedom lost, all virtue lose
 And fear of God. *Milton*.

Deserving freedom more
 Than those their *conquerors*, who leave behind
 Nothing but ruin wheresoe'er they rove.
Id. Paradise Regained.

More willingly I mention Air,
 This our old *conquest*; than remember hell,
 Our hated habitation. *Id.*
 While the heap is small, and the particulars few,
 he will find it easy and *conquerable*. *South*.

We *conquered* France, but felt our captive's charms;
 Their arts victorious triumphed o'er our arms. *Pope*.
 A critic that attacks authors in reputation, is as
 the slave who called out to the *conqueror*, Remember,
 Sir, that you are a man. *Addison's Guardian*.

The difference in favour of the first *conquerors* is
 this; the Asiatic *conquerors* very soon abated of their
 ferocity, because they made the *conquered* country
 their own. They rose or fell with the rise or fall of
 the territory they lived in. Fathers there deposited
 the hopes of their posterity; and children there be-
 held the monuments of their fathers. Here their lot
 was finally cast, and it is the natural wish of all that
 their lot should not be cast in a bad land. *Burke*.

Though *conquest* on my banner wait,
 And triumph make my battles great,
 Yet, 'tis not love of power or might
 That arms me for the clashing fight,
 But love of her, whose blessed smile
 Approves my strength, o'erplays my toil.

Le Feley.

Her's are the willing chains o' love
By *conquering* beauty's sovereign law ;
And aye my Chloris' dearest charm,
She says she lo'es me best of a'. *Burns.*

Give me the line that ploughs its stately course
Like a proud swan, *conquering* the stream by force ;
That, like some cottage beauty, strikes the heart,
Quite unindebted to the tricks of art. *Cowper.*

Laurels may flourish round the *conqueror's* tomb,
But happiest they who win the world to come ;
Believers have a silent field to fight,
And their exploits are veiled from human sight. *Id.*

Of all the trophies gathered from the war,
What shall return ! The *conqueror's* broken car !
The *conqueror's* yet unbroken heart ! Again
The horn of Poland sounds, and not in vain.
Lützen, where fell the Swede of victory,
Beholds him *conquer*, but, alas ! not die.
Byron. The Age of Bronze.

CONQUEST, in history, the name given to the invasion of England by William of Normandy ; who, overcoming Harold at the battle of Hastings, founded the Norman dynasty, and was hence called William the Conqueror. See ENGLAND, HISTORY OF.

CONRAD II. emperor of Germany, was elected in 1004. He was obliged to take the field against most of the German dukes who had revolted from him ; and put Ernest duke of Suabia under the ban of the empire, being one of the earliest instances of such a proscription. He died in 1039.

CONRAD III. emperor of Germany in 1138. The duke of Bavaria opposed his election, who being put under the ban of the empire, and deprived of his duchy, could not survive his disgrace. The margrave of Austria was ordered by the emperor to take possession of Bavaria ; but Welsti, uncle to the deceased duke, attacking him, was defeated near the castle of Winsburgh. The battle fought upon this occasion is famous in history, as having given rise to the party names of Guelphs and Gibbelines, afterwards assumed in Italy. The parole of the day with the Bavarians was Welsti, from the name of the general ; that of the Imperialists Werblingen, from a small village where Frederic duke of Suabia, their commander, had been nursed : by degrees these names served to distinguish these two parties ; and the Italians, who could not accustom themselves to such rough words, formed from them Guelphs and Gibbelines. Conrad died in 1152.

CONRAD JUNIOR, or CONRADIN, son of Conrad IV., was acknowledged emperor by the Gibbelines, who received him in triumph at Rome : but pope Alexander IV. had published a crusade against this orphan ; and Urban VII., his successor, gave the empire to Charles of Anjou, brother to Louis IX. king of France ; and the unfortunate youth, though powerfully supported even by the Turks, lost a battle, in which he was taken prisoner, and was publicly beheaded, by order of his base opponent, at Naples in 1229, in the eighteenth year of his age. In him ended the race of the dukes of Suabia, which had produced several kings and emperors.

CONSANGUINEOUS, *adj.* } Lat. *consan-*
CONSANGUINITY, *n. s.* } *guineus, con-*

sanguinitas. Being near of kin ; of the same blood. Relationship by blood ; by common descent, and not merely by marriage.

Am I not *consanguineous* ? Am I not of her blood ?
Shakespeare. Twelfth Night.

I've forgot my father ;

I know no touch of *consanguinity.*

Id. Troilus and Cressida.

There is the supreme and indissoluble *consanguinity* and society between men in general ; of which the heathen poet, whom the apostle calls to witness, saith, We are all his generation. *Bacon's Holy War.*

The first original would subsist, though he outlived all terms of *consanguinity*, and became a stranger unto his progeny.

Brown's Vulgar Errors.

Christ has condescended to a cognation and *consanguinity* with us. *South.*

It would (among public misfortunes) be an evil more natural and tolerable, that the house of commons should be infected with every epidemical phrensy of the people, as this would indicate some *consanguinity*, some sympathy of nature with their constituents, than that they should in all cases be wholly untouched by the opinions and feelings of the people out of doors. By this want of sympathy they would cease to be a house of commons. *Burke.*

Let a man read Virgil with attention, and with taste, and then be a cruel parent, or an undutiful child, if he can. And let him ask his own heart this question, whether human nature would not be deprived of many of its best affections, and human society of its best comforts, if the ideas of those projectors were to be realised, who propose to improve the political art, by annihilating the attachments of *consanguinity.* *Beattie.*

CONSANGUINITY, in English law, is kindred, either lineal or collateral, by blood or birth ; as affinity is kindred by marriage. In the descent of land it is important to ascertain who shall take it as next of blood, and who, in administration of other property, is next of kin.

Lineal consanguinity is that which subsists between persons of whom one is descended in a direct line from the other, as between a man and his father, grandfather, and great-grandfather, and so upwards, in the direct ascending line : or between a man and his son, grandson, great-grandson, and so downwards in the direct descending line. Every generation, in this lineal direct consanguinity, constitutes a different degree, reckoning either upwards or downwards : the father is related in the first degree ; and so likewise is the son, grandsire, and grandson, in the second ; great-grandsire and great-grandson in the third. This is the only natural way of reckoning the degrees in the direct line, and therefore universally obtains, as well in the civil and canon as in the common law.

Collateral kindred, or consanguinity, answers to the same description : collateral relations agreeing with the lineal in this, that they descend from the same stock or ancestor ; but differing in this that they do not descend one from the other. Collateral kinsmen are such then as lineally spring from one and the same ancestor, who is the stirps, or root, the stipes, trunk or common stock, from whence these relations are branched out. As if a man has two sons, who have each a numerous issue ; both these issues are lineally descended from him as their common ancestor ; and they are collateral kinsmen

to each other, because they are all descended from this common ancestor, and all have a portion of his blood in their veins, which denominates them consanguineous.

The very being of collateral consanguinity consists in this descent from one and the same common ancestor. Thus Titus and his brother are related, because both are derived from one father. Titus and his first cousin are related, because both descend from the same grandfather; and his second cousin's claim to consanguinity is, that they are both derived from the same great-grandfather. In short, as many ancestors as a man has, so many common stocks he has from which collateral kinsmen may be derived. It appears that each person, at the twentieth degree, or the distance of twenty generations, has above a million of ancestors; and if a similar calculation be made of collateral kindred at the distance of twenty degrees forward, on the supposition that each couple of ancestors leave, one with the other, only two children, the number will be 274,877,906,944: as by the following tables:—

TABLE I.

Lineal Degrees.	Number of Ancestors.
1	2
2	4
3	8
4	16
5	32
6	64
7	128
8	256
9	512
10	1024
11	2048
12	4096
13	8192
14	16384
15	32768
16	65536
17	131072
18	262144
19	524288
20	1048576

It is evident that each person has two ancestors in the first degree, and that the number is doubled at every remove, because each of his ancestors has also two immediate ancestors of his own. In order to find the number of ancestors at any particular degree, we need only to find a power of 2, the index of which is the number of degrees; e. g. 2^2 , 2^{10} , 2^{18} , &c. will give the corresponding number respectively. Or the number of ancestors at any even degree may be had by squaring the number of ancestors at half that number of degrees: thus 16, the number of ancestors at four degrees, is the square of 4, the number of ancestors at two; 256 is the square of 16; 65536 of 256; and the number of ancestors at forty degrees would be the square of 1048576, or upwards of a million of millions. These powers are easily found by means of logarithms.

TABLE II.

Collateral Degrees.	Number of Kindred.
1	1
2	4
3	16
4	64
5	256
6	1024
7	4096
8	16384
9	65536
10	262144
11	1048576
12	4194304
13	16777216
14	67108864
15	268435456
16	1073741814
17	4294967296
18	17179069184
19	68719476736
20	274877906944

This calculation may also be made by squaring the couples, or half the number of ancestors, at any given degree; which will furnish us with the number of kindred we have in the same degree, at equal distance with ourselves from the common stock, besides those at unequal distances. Thus, in the tenth lineal degree, the number of ancestors is 1024; its half, or the couples, amounts to 512; the number of kindred in the tenth collateral degree amounts therefore to 262144, or the square of 512. And, if we will be at the trouble to recollect the state of the several families within our own knowledge, and observe how far they agree with this account; that is, whether, on an average, every man has not one brother or sister, four first-cousins, sixteen second cousins, and so on, we shall find, that the present calculation is very far from being overcharged.

CONSARCINATION, n. s. From Lat. *consarcino*. To piece. The act of patching together.
CONSCIENCE, n. s. Fr. *conscience*;
CONSCIENT, adj. Ital. *conscienza*;
CONSCIENCELESS, adj. Sp. *consciencia*;
CONSCIENT, adj. Lat. *conscientia*,
CONSCIENTIOUS, n. s. from *con* and *scire*.
CONSCIENTIOUSLY, adv. In its most obvious
CONSCIENTIOUSNESS, n. s. and extended
CONSCIONABLE, adj. sense, conscience
CONSCIONABLENESS, n. s. means that internal
CONSCIONABLY, adv. monitor which
CONSCIONARY, adj. heaven has placed
CONSCIOUS, adj. in the human
CONSCIOUSLY, adv. breast, to warn
CONSCIOUSNESS, n. s. against the com-
mission of crime, or to punish the criminal by the severity of its reproaches. In its secondary senses, all of which have more or less of reference to the primary idea, it signifies equitable conduct; consciousness; the real sentiments, scruple; principle of action; and, in familiar and ludicrous style, reason; that which is reasonable. The conscientious man is he who acts strictly according to the dictates of a good conscience. Conscious denotes, having the power of thinking; being able to know one's own thoughts

and actions; being aware of a thing; being admitted to the knowledge of (in which case it has to before the noun); bearing witness by the dictate of conscience to anything, because we know that we have been a participator in it. Conscience, Locke defines to be, the perception of what passes in a man's own mind; thence, its secondary application, to an internal sense of criminality or innocence. Bacon uses conscient in the sense of conscious. Consciatory, which is of rare occurrence, indicates that which relates to conscience.

This is thank-worthy, if a man, for conscience toward God, endure grief. 1 Peter ii. 19.

But for to speken of hire conscience,
She was so charitable and so pitous
She wolde wepe if that she saw a mous
Caughte in a trappe if it were ded or bledde.

Chaucer. Cant. Tales.

He that troseth him so muckel in his good conscience that he despiseth and setteth at nought his good name or los, and recketh not though he kepe not his good name, n' is but a cruel cherl. *Id.*

When a people have no touch of conscience, no sense of their evil doings, it is bootless to think to restrain them. *Spenser.*

What heavens, what altars, what enraged hetes,
(Here heaped up with termes of love unkynd)
My conscience cleare with guilty bande would bind?

Id. Faerie Queene.

The reason why the simpler sort are moved with authority, is the conscience of their own ignorance. *Hooker.*

A knave very voluble; no farther conscionable than in putting on the mere form of civil and humane seeming. *Shakespeare.*

Why dost thou weep? Can'st thou the conscience lack,

To think I shall lack friends! *Id. Timon.*

Dost thou in consciences think, tell me, *Emilia,*
That there be women do abuse their husbands
In such gross kind? *Id. Othello.*

Now is Cupid a child of conscience; he makes resolution. *Id. Merry Wives of Windsor.*

Yet though these men against their consciences strive,

There are some sparkles in their flinty breasts,
Which cannot be extinct, but still revive;

That, thou they would, they cannot quite be beasts. *Davies.*

We must make a conscience in keeping the just laws of superiours. *Taylor's Holy Living.*

A prince must be used conscionably as well as a common person. *Id.*

What you require cannot, in conscience, be deferred beyond this time. *Milton.*

Who against faith and conscience can be heard

Infallible? *Id. Paradise Lost.*

They did in their consciences know, that he was not able to send them any part of it. *Clarendon.*

The queen had been solicitous with the king on his behalf, being conscionous to herself that he had been encouraged by her. *Id.*

Children are travellers newly arrived in a strange country; we should therefore make conscience not to mislead them. *Locke.*

It will be a wonderful conscientiousness in them, if they will content themselves with less profit than they can make. *Id.*

Since conscientiousness always accompanies thinking, and it is that which makes every one to be what he calls self, and thereby distinguishes himself from all other thinking things; in this alone consists personal identity, i. e. the sameness of a rational being. *Id.*

If these perceptions, with their conscientiousness, always remained in the mind, the same thinking thing would be always conscientiously present. *Id.*

Lead a life in so conscientious a probity, as in thought, word, and deed, to make good the character of an honest man. *L'Esrange.*

There is the erroneous as well as the rightly informed conscience; and, if the conscience happens to be deluded, sin does not therefore cease to be sin, because a man committed it conscientiously. *South.*

The rest stood trembling, struck with awe divine;
Æneas only, conscious to the sign,
Pressaged the event. *Dryden's Æneid.*

Hector was in an absolute certainty of death, and depressed with the conscience of being in an ill cause. *Pope.*

An honest mind is not in the power of a dishonest: to break its peace, there must be some guilt or conscientiousness. *Id.*

Conscience signifies that knowledge which a man hath of his own thoughts and actions; and because, if a man judgeth fairly of his actions by comparing them with the law of God, his mind will approve or condemn him; this knowledge or conscience may be both an accuser and a judge. *Swift.*

Among substances, some are thinking or conscious beings, or have a power of thought. *Watts's Logick.*

If spirit be without thinking, I have no idea of any thing left; therefore conscientiousness must be its essential attribute. *Id.*

A conscientious person would rather doubt his own judgment, than condemn his species. He would say, I have observed without attention, or judged upon erroneous maxims; I trusted to profession, when I ought to have attended to conduct. *Burke.*

What is the moral law of nature is a question that has often been proposed. That (I would answer) is incumbent on us by the law of our nature, which, after candid inquiry, our reason and conscience declare to be right. *Beattie.*

How blest the youth in yonder valley laid!

Soft smiles in every conscious feature play,
While to the gale low-murmuring through the glade
He tempers sweet his sprightly-warbling lay. *Id.*

Guilt, still by sleepless Conscience bayed,
Feasts fearful on his ill-got spoils,
While Honesty incessant toils,
By Poverty way-laid. *Lefley.*

Curse on his perjured arts! dissembling smooth!

Are honour, virtue, conscience, all exiled?

Is there no pity, no relenting ruth,

Points to the parents fondling o'er their child?

Then paints the ruined maid, and their distraction wild?
Burns.

The cause is Conscience—Conscience oft

Her tale of guilt renews:

Her voice is terrible though soft,

And dread of death ensues. *Cowper.*

My mother! when I learned that thou wast dead,

Say, wast thou conscious of the tears I shed? *Id.*

Throned in the vaulted heart his dread resort,

Inexorable Conscience holds his court,

With still small voice the plots of Guilt alarms,

Bares his masked brow, his lifted hand disarms;

But, wrapped in night with terrors all his own,
He speaks in thunder, when the deed is done. *Darwin.*

Pale shoot the stars across the troubled night,

The timorous moon withholds her conscious light. *Id.*

Perhaps the recollection of the deed my conscience cannot justify, may haunt me in such gloomy and un-social fits, that I shall hate the tenderness that would

believe me, break from your arms, and quarrel with your fondness!
Sheridan.

Her very smile was haughty, though so sweet;
Her very nod was not an inclination;

There was a self-will even in her small feet,
As though they were quite *conscious* of her station.

Byron. Don Juan.

CONSCIENCE, COURTS OF, are courts of recovery of small debts, constituted by act of parliament in London, Westminster, &c. and other populous and trading districts.

CONSCRIBE, *v. a.* } Lat. *conscribere*,

CO'NSCRIPT, *n. & adj.* } from *con* and *scribere*.

CONSCRIPTION, *n. s.* } To enroll; to call together for military service. The Roman senators were called conscript fathers, from their names being written on a register. Conscript has of late years been well known as the appellation of the French recruits; and conscription as that of the operation by which they have been obtained.

CONSECRATE, *v. a. & adj.* } Fr. *consacrer*;

CONSECRATION, *n. s.* } It. *consacrare*;

CONSECRATOR, *n. s.* } *consagrar*;

CONSECRATORY, *adj.* } Sp. *consagrar*;

Lat. *consacrare*, from *con* and *sacrare*. To render sacred; to hallow; to set apart for religious uses; to devote to the service of; to canonise. Rendered sacred; devoted, dedicated to. The rite by which a person or thing is dedicated to the service of God, or devoted to any purpose; the act of canonising. The person who performs the rite.

He shall *consecrate* unto the Lord the days of his separation, and shall bring a lamb of the first year for a trespass offering.
Numbers vi. 12.

The *consecration* of his God is upon his head.

Id. vi. 7.

Enter into the holiest by the blood of Jesus, by a new and living way, which he hath *consecrated* for us.
Hebrews x. 20.

At the erection and *consecration*, as well of the tabernacle as of the temple, it pleased the Almighty to give a sign.
Hooker.

When thou reviewest this, thou dost review

The very part was *consecrate* to thee.

Shakespeare. Sonnet lxxiv.

His words of *consecration*, which you yourself in your letter do rightly term true *consecratory* words.

Bishop Morton.

Shall I abuse this *consecrated* gift

Of strength, again returning with my hair?

Milton.

The calendar swells with new *consecrations* of saints.

Hale.

We must know that *consecration* makes not a place sacred, but only solemnly declares it so; the gift of the owner to God makes it God's, and consequently sacred.
South.

Whether it be not against the notion of a sacrament, that the *consecrator* alone should partake of it.

Atterbury.

A bishop ought not to *consecrate* a church which the patron has built for filthy gain, and not for true devotion.
Ayliffe.

Those forms of bright perfection, which the bard, While boundless hopes and boundless views inflame, Enamoured *consecrates* to never-dying fame.
Beattie.

What says the prophet? Let that day be blessed

With holiness and *consecrated* rest.

Pastime and business, both it should exclude,
And bar the door the moment they intrude;

Nobly distinguished above all the six

By deeds in which the world must never mix.

Cooper.

The lover too shuns business and alarms,

Tender idolater of absent charms.

Saints offer nothing in their warmest prayers,

That he devotes not with a zeal like theirs:

'Tis *consecration* of his heart, soul, time;

And every thought that wanders is a crime. *Id.*

CONSECRATION is used for the benediction of the elements in the eucharist.

CONSECRATION, in Jewish antiquity. The Mosaic law ordained, that all the first born, both of man and beast, should be sanctified or consecrated to God. We find also, that Joshua consecrated the Gibeonites, as David and Solomon did the Nethinims, to the service of the temple; and that the Hebrews sometimes consecrated their fields and cattle to the Lord, after which they were no longer in their own power.

CONSECRATION, among antiquaries, is the representation on models of the apotheosis of an emperor, or his translation among the gods. On one side is the emperor's head, crowned with laurel, sometimes veiled; and the inscription gives him the title of divus: on the reverse is a temple, a bustum, an altar, or an eagle taking its flight towards heaven, either from off the altar, or from a cippus. Sometimes the emperor is seen in the air, borne up by the eagle; the inscription always *consecratio*. These are the usual symbols: yet on the reverse of that of Antonius is the Antonine column. In the apotheoses of empresses, instead of an eagle there is a peacock. As to the honors rendered these princes after death, they were explained by the words *consecratio, pater, divus, ad deos*. Sometimes around the temple or altar are put *memoria felix, or memoriae aeternae: for princesses aeternitas, and sideribus recepta; on the side of the head, dea or Æa*.

CONSECRATION of churches, &c. Among the ancient Christians, the consecration of churches was performed, it is said, with much solemnity. In what manner it took place for the first three ages, however, is uncertain; the authentic accounts reaching no higher than the fourth century. Some assert the consecration to have consisted in setting up the sign of the cross, or in placing a communion table in the church; others, that a panegyric sermon only, was preached in commemoration of the founder, and that they then proceeded to prayers; one of which was composed on purpose. The Roman Catholics bestow the ceremony of a formal consecration on almost every utensil, as well as building, used for sacred purposes, &c. In England, churches have been always consecrated with particular ceremonies, the form of which is left to the discretion of the bishop. That observed by Archbishop Laud, in the beginning of the seventeenth century, in consecrating St. Catherine Creed church, in London, gave great offence. The bishop came attended with several of the high commission, and some civilians. At his approach to the west door of the church, which was shut, and guarded by halberdiers, some that were appointed for that purpose, cried with a loud voice.—'Open, open, ye everlasting doors, that the king of glory may come in!' Presently the doors were opened, and

Laud, with some doctors and principal men, entered. As soon as they were within the place, his lordship fell down upon his knees; and, with eyes lifted up, and his arms spread abroad, said, This place is holy; the ground is holy: in the name of the Father, Son, and Holy Ghost, I pronounce it holy. Then, walking up the middle aisle towards the chancel, he took some of the dust, and threw it into the air several times. When he approached near the rail of the communion table, he bowed towards it five or six times; and, returning, went round the church, with his attendants in procession; saying first the hundredth and then the nineteenth Psalm, as prescribed in the Roman Pontifical. He then read several collects, in one of which he prays God to accept of that beautiful building, and concludes thus: We consecrate this church, and separate it unto thee as holy ground, not to be profaned any more to common use. In another he prays, That all who should hereafter be buried within the circuit of this holy and sacred place, may rest in their sepulchres in peace, till Christ's coming to judgment, and may then rise to eternal life and happiness. Then the bishop, sitting under a cloth of state, in the aisle of the chancel, near the communion table, took a written book in his hand, and pronounced curses upon those who should hereafter profane that holy place by musters of soldiers, or keeping profane law courts, carrying burdens through it: and at the end of every curse he bowed to the east, and said, Let all the people say, Amen. When the curses were ended, he pronounced a like number of blessings upon all that had any hand in framing and building that sacred and beautiful church; and on those that had given or should hereafter give, any chalices, plate, ornaments, or other utensils; and at the end of every blessing, he bowed to the east, and said, Let all the people say, Amen. After this came the sermon, then the sacrament, which the bishop consecrated and administered in the following manner: As he approached the altar, he made five or six low bows, and coming up to the side of it, where the bread and wine were covered, he bowed seven times. Then, after reading many prayers, he came near the bread, and, gently lifting up the corner of the napkin, he retreated hastily a step or two, and made three low obeisances; his lordship then advanced, and, having uncovered the bread, bowed three times as before. Then he laid his hand on the cup, which was full of wine, with a cover upon it; which, having let go, he stepped back, and bowed three times towards it; then he came near again, and lifting up the cover of the cup looked in it; and seeing the wine, let fall the cover again, retired back, and bowed as before. Then the elements were consecrated; and the bishop, having first received, gave it to some principal men in their surplices, hoods, and tippets; after which, many prayers being said, the solemnity of the consecration ended. The performance of this ceremonial was one of the crimes urged against Laud by the Commons.

CONSECTARY, *n. s. & adj.* Lat. *consectarius*. A consequence deduced from premises; a corollary. Consequent; following as a natural consequence.

From the inconsistent and contrary determinations thereof, *consectary* impieties and conclusions may arise.

Browne.

These propositions are *consectaries* drawn from the observations.

Woodward's Nat. Hist.

CONSECUTE, *v. n.* } Lat. *consequi*; *con-*
CONSECUTION, *n. s.* } *secutio*. The verb,
CONSECUTIVE, *adj.* } which signifies to fol-
CONSECUTIVELY, *adv.* } low close, to come up
 with, is not in use. Consecution is a chain of consequences; a series of deductions; a connected chain of propositions; succession; following in regular sequence. In the school of philosophy, consecutively is opposed to antecedently, and, in some instances, to effectually or causally.

The month of *consecution*, or, as some term it, of progression, is the space between one conjunction of the moon with the sun unto another.

Browne's Vulgar Errors.

Some *consecutions* are so intimately and evidently connected to or found in the premises, that the conclusion is attained, and without any thing of ratiocinative progress.

Hale.

The moon makes four quarterly seasons within her little year, or month of *consecution*.

Holder.

In a quick *consecution* of colours, the impression of every colour remains in the sensorium.

Newton's Opticks.

That obligation upon the lands did not come into disuse but by fifty *consecutive* years of exemption.

Arbuthnot on Coins.

CONSELVE, a considerable town and district of the Venetian territory, Italy, in the Paduan, containing forty-one villages, and 40,000 souls. The town has 5,700 inhabitants and a fine cathedral.

TO CONSEMINATE, *v. a.* Lat. *consequino*. To sow different seeds together.

CONSENTION, *n. s.* Lat. *concentio*. Agreement; accord.

A great number of such living and thinking particles could not possibly, by their mutual contact, and pressing and striking, compose one greater individual animal, with one mind and understanding, and a vital *consension* of the whole body.

Bentley.

CONSENT, *v. a. & n. s.* } Fr. *consenter*,
CONSENTER, *n. s.* } It. *consentire*; Sp.
CONSENTING, *n. s.* } *consentir*; Lat. *con-*
CONSENTA'NEOUS, *adj.* } *sentire*, from *con* and
CONSENTA'NEOUSLY, *adv.* } *sentire*. To agree
CONSENTA'NEOUSNESS, } to; to be of the
CONSENTIENT, *adj.* } same mind; to co-
 operate; to allow that a thing shall be done. The act of yielding; of giving permission; unity of action or opinion; relation to; correspondence or coherence with; tendency to one end; joint acting together; one part of the body being sympathetically affected by action on some other part. *Consentaneous* signifies agreeable to; consistent with: *Consentient* is concurring in; being of one opinion.

In this we *consent* unto you, if ye will be as we be.

Genesii.

Ye han yourselven shewed here to-day
 So high sentence, so holily, and well,
 That I *consent*, and confirme every del
 Your wordes all, and your opinion.

Chaucer. Cant. Tales.

Also a man should sorrow, for all that ever he hath desired against the lawe of God, with perfite *consenting* of his reason. *Id.*

Then all that evening (welcomed with cold And cheareless hunger) they together spent; Yet found no fault, but that the hag did scold And rayle at them with grudgefull discontent, For lodging there without her own *consent*.

Spenser. Faerie Queene.

And all her sister nymphes with one *consent* Supplide her sobbing breaches with sad complement. *Id.*

Ye comets scourge, the bad revolting stars That have *consented* unto Henry's death.

Shakespeare. Henry VI.

I am far from excusing or denying that compli-
ance; for plenary *consent* it was not. *King Charles.*

The authority due to the *consentions* judgment and practice of the universal church.

Oxford Reasons against the Covenant.

It will cost no pains to bring you to the knowing, nor to the practice; it being very agreeable and *consentaneous* to every one's nature.

Hammond. Pract. Cat.

The fighting winds would stop there and admire,
Learning *consent* and concord from his lyre.

Cowley. Davideis.

What in sleep thou didst abhor to dream,
Waking thou never wilt *consent* to do. *Milton.*

Demons found

In fire, air, flood, or under ground,
Whose power hath a true *consent*
With planet or with element. *Id.*

Paracelsus did not always write so *consentaneously* to himself, that his opinions were confidently to be collected from every place of his writings, where he seems to express it. *Boyle.*

Nor can such an usurper, or any deriving from him, ever have a title, till the people are both at liberty to *consent*, and have actually *consented*, to allow and confirm him in the power he had till then usurped. *Locke.*

Nobody doubts but an express *consent*, of any man entering into any society, makes him a perfect member of that society, a subject of that government. *Id.*

When thou canst truly call these virtues thine,
Be wise and free by heaven's *consent* and mine. *Dryden's Pers.*

Such is the world's great harmony, that springs
From union, order, full *consent* of things. *Pope.*

Children are not *consenting* to their relation, but their relation, without their actual *consent*, binds them to its duties; or rather it implies their *consent*, because the presumed *consent* of every rational creature is in unison with the predisposed order of things. *Burke.*

Thither with one *consent* they bend,
Their sorrows with their lives to end,
While each, in thought, already hears
The water hissing in his ears. *Beattie.*

LIEUT. Upon my word the army is very much obliged to him. Well, then, I must marry the girl first, and ask his *consent* afterwards. *Sheridan. St. Patrick's Day.*

CONSENTES, in Roman antiquity, the twelve superior gods, or Dii majorum gentium. The word signifies as much as consentientes; that is, who consented to the deliberations of Jupiter's council. Ennius has briefly expressed their names in these lines,

Juno, Vesta, Minerva, Ceres, Diana, Venus, Mars,
Mercurius, Jovi, Neptunus, Vulcanus, Apollo.

CONSENZA, a town of Naples, in Calabria Citerior, anciently called Consentia, sixteen miles from the coast. It is an archbishop's see, with a considerable revenue.

CONSEQUENCE, *n. s.*

CO'NSEQUENCY, *n. s.*

CO'NSEQUENT, *n. s. & adj.*

CONSEQUENTLY, *adv.*

CONSEQUENTIAL, *adj.*

CONSEQUENTIALLY, *adv.*

CONSEQUENTIALNESS, *n. s.*

CONSEQUENTNESS, *n. s.*

Fr. *consequence* ;
Ital. *conseguenza* ;

Span. *consequencia* ; Lat. *consequentia*. That

which follows in
sequence; the re-
sult of a cause;

a deduction from premises; the last member of a syllogism; consecution; that which can exercise an influence over; that which is of importance; Consequent, as a noun, is synonymous with consequence; as an adjective, it signifies regularly deduced; arising out of a cause. Consequential means necessarily springing from a certain cause; justly deduced from the premises. Of late years it has been perverted to the sense of conceited, pompous; but this use of it is at once an absurdity and a vulgarism. The ideas conveyed by consequentially, are, with correct inference; with a just connexion of thoughts; as a consequence of; eventually; in a regular series. Consequently denotes, in consequence of; necessarily; of course. Consequentness is regular connexion of propositions; coherence and just arrangement of discourse.

Doth it follow that they, being not the people of God, are in nothing to be followed? This *consequenter* were good, if only the custom of the people of God is to be observed. *Hooker.*

The instruments of darkness

Win us with honest trifles, to betray us

In deepest consequence. *Shakespeare. Macbeth.*

Spirits that know

All mortal consequences have pronounced it. *Id.*

But things of weight and consequences indeed

Himself doth in his chamber then debate;
Where all his counsellors he doth exceed,
As far in judgment, as he doth in state. *Davies.*

They were ill paid; and they were ill governed,
which is always a *consequent* of ill payment. *Id. on Ireland.*

Let them examine the *consequenter* of the whole body of the doctrine I deliver.

Digby on the Soul, Dedication.

Asserted without any colour of scripture-proof, it is of very ill *consequence* to the superstrucing of good life. *Hammond.*

Though these kind of arguments may seem obscure; yet, upon a due consideration of them, they are highly *consequential* and concludent to my purpose. *Hale's Origin of Mankind.*

Shun the bitter consequences; for know,

The day thou eatest thereof, thou shalt die.

Milton's Paradise Lost.

Sorrow being the natural and direct offer of sin, that which first brought sin into the world, must, by necessary *consequence*, bring in sorrow too. *South.*

This satisfaction, or dissatisfaction, *consequent* upon a man's acting suitably or unsuitably to conscience, is a principle not easily to be worn out. *Id.*

He could see *consequents* yet dormant in their principles, and effects yet unborn. *Id.*

There is *consequently*, upon this distinguishing principle, an inward satisfaction or dissatisfaction in the heart of every man, after good or evil. *South.*

This relation is so necessary, that God himself cannot discharge a rational creature from it; although *consequently* indeed he may do so, by the annihilation of such creatures. *Id.*

The little, or almost insensible, impressions on our tender infancies have very important and lasting *consequences*: and there it is, as in the fountains of some rivers, where a gentle application of the hand turns the flexible waters into channels that make them take quite contrary courses. *Looke.*

It was not a power possible to be inherited, because the right was *consequent* to, and built on, an act perfectly personal. *Id.*

In the most perfect poem a perfect idea was required, and *consequently* all poets ought rather to imitate it. *Dryden.*

Can syllogism set things right?
No, majors soon with minors fight.
Or, both in friendly consort joined,
The *consequences* limps false behind. *Prior.*

We sometimes wrangle, when we should debate;
A *consequential* ill which freedom draws;
A bad effect, but from a noble cause. *Id.*

The anger of Achilles was of such *consequence*, that it embroiled the kings of Greece. *Addison's Spectator.*
Nobody writes a book without meaning something, though he may not have the faculty of writing *consequently*, and expressing his meaning. *Id. Whig Examiner.*

Their people are sunk in poverty, ignorance, and cowardice; and of as little *consequences* as women and children. *Swift.*

If such persons can answer the ends of relief and profit to themselves, they are apt to be careless enough about either the means or the *consequences*. *Burke.*

To enable men to act with the weight and character of a people, and to answer the ends for which they are incorporated into that capacity, we must suppose them (by means immediate or *consequential*) to be in that state of habitual social discipline, in which the wiser, the more expert, and the more opulent, conduct, and by conducting enlighten and protect the weaker, the less knowing, and the less provided with the goods of fortune. *Beattie.*

This once believed, 'twere logic misappled,
To prove a *consequence* by none denied,
That we are bound to cast the minds of youth
Betimes into the mould of heavenly truth. *Cowper.*

Beware of too sublime a sense
Of your own worth and *consequence*. *Id.*

Dangle, I have brought you two pieces, one of which you must exert yourself to make the managers accept, I tell you that: for 'tis written by a person of *consequence*. *Sheridan.*

When a proposal is made to emancipate or relieve, you hesitate, you deliberate for years, you temporise and tamper with the minds of men; but a death-bill must be passed off hand, without a thought of the *consequences*. *Byron. Speech on the Frame-breaking Bill.*

CONSERANS, a ci-devant territory of France, being the south-west division of the late province of Gascony. It was bounded on the east by Poix, on the south by Catalonia, and on the north-west by Comings. It is now included in the department of Gers.

CONSER'TION, *n. s.* Lat. *consero.* Fitness, adaptation.

What order, beauty, motion, distance, size,
Conser'tion of design, how exquisite! *Young.*

CONSERVE, *v. a. & n.* } Fr. *conserver* ;
CONSERVER, *n. s.* } Ital. *conservare* ;
CONSERVANT, *adj.* } Sp. *conservar* ; Lat.
CONSERVABLE, *adj.* } *conservare*, from
CONSERVANCY, *n. s.* } *con* and *servare*.
CONSERVA'TION, *n. s.* } To keep safe; to
CONSERVATIVE, *adj.* } protect; to candy
CONSERVATOR, *n. s.* } fruit. A conserve
CONSERVATORY, *n. s.* } is a sweetmeat

made of fruit; but this meaning is now principally used with reference to those preparations with which apothecaries make up their medicines into pills or boluses; a place in which anything is kept: this last meaning also is obsolete. Conserver and conservator is he who keeps; who preserves. Conservation is the act of preserving. 'A conservatory,' says Johnson, 'is a place where anything is kept in a manner proper to its peculiar nature, as fish in a pond, corn in a granary.' The word, however, except when used figuratively, is now rarely applied to anything but a building in which tender and exotic plants are protected from the inclemency of the weather. As an adjective, its application is obvious. Courts of conservancy are courts held by the lord mayor of London, for the preservation of the fishery, and the prevention of nuisances, on the river Thames; he being, *ex officio*, conservator of the river.

Geffray, thou wotist full wel this,
That every kindly thinge that is
Yhath a kyndely stede, there he
May best in it conserved be.

Chaucer. House of Fame.

And this place of whiche I the tel,
There as Fame doth yliste to dwell,
Is sette amidde of these thre,
Heven, and erthe, and eke the se,
As moste *conservative* of soun. *Id.*

Conservative of kinges, dukes, and relmes. *Id.*
Will't please your honour to taste of these *con-*
servers? *Shakespeare.*

They have in Turkey and the East certain confections, which they call *servets*, which are like to candid *conservees*, and are made of sugar rind lemons.

Boon's Natural History.

It is an enquiry of excellent use, to enquire of the means of preventing or staying of putrefaction; for therein consisteth the means of *conservation* of bodies. *Id.*

A *conservatory* of snow and ice, such as they use for delicacy to cool wine in summer. *Id.*

For that you declare that you have many sick amongst you, he was warned by the *conservator* of the city, that he should keep at a distance. *Id. New Atlantis.*

He hath been most industrious, both collector and *conservor* of choice pieces in that kind. *Hagstedt.*

The spherical figure, as to all heavenly bodies, so it agreeth to light, as the most perfect and *conservative* of all others. *Peacham.*

The lords of the secret council were likewise made *conservators* of the peace of the two kingdoms, during the intervals of parliament. *Clarendon.*

Nothing was lost out of these stores, since the art of *conserving* what others have gained in knowledge is easy. *Temple.*

In the Eastern regions there seems to have been a general custom of the priests having been the perpetual *conserver* of knowledge and story. *Id.*

Tuberoses will not endure the wet of this season; therefore set the pots into your *conserves*, and keep them dry.

Boelyn's Kalendar.

You may set your tender trees and plants, with the windows and doors of the greenhouses and *conservatories* open, for eight or ten days before April. *Id.*

Though there do indeed happen some alterations in the globe, yet they are such as tend rather to the benefit and *conservation* of the earth, and its productions, than to the disorder and destruction of both.

Woodward's Natural History.

The water dispensed to the air and atmosphere by the great abyss, that subterranean *conservatory*, is by that means restored back. *Id.*

They will be able to *conserve* their properties unchanged in passing through several mediums; which is another condition of the rays of light.

Newton's Opticks.

If wealth is the obedient and laborious slave of virtue and of public honour, then wealth is in its place, and has its use; but if this order is changed, and honour is to be sacrificed to the *conservation* of riches, riches which have neither eyes nor hands, nor anything truly vital in them, cannot long survive the being of their vivifying powers, their legitimate masters, and their potent protectors. *Burke.*

All your sophisters cannot produce any thing better adapted to preserve a rational and manly freedom than the course that we have pursued, who have chosen our nature rather than our speculations, our breasts rather than our inventions, for the great *conservatories* and magazines of our rights and privileges. *Id.*

We next inquire, but softly and by stealth. Like *conservators* of the public health, Of epidemic throats, if such there are, And coughs, and rheums, and phthisic, and catarrh, That theme exhausted, a wide chasm ensues, Filled up at last with interesting news, Who danced with whom, and who are like to wed, And who is hanged, and who is brought to bed.

Cowper.

Then her skin, smooth and white as a gallipot; her mouth as round and not larger than the mouth of a penny phial; her lips *conserve* of roses; and then her teeth—none of your sturdy fixtures—ache as they would, it was but a small pull, and out they came, I believe I have drawn half-a-score of her poor dear pearls. *Sheridan.*

CONSERVATOR, an officer ordained for the preservation of the privileges of some cities and communities, having a commission to judge of, and determine, the differences among them. In most Catholic universities there are two conservators; the conservator of royal privileges, or those granted by kings; and the conservator of apostolical privileges, or those granted by the Pope. The first takes cognizance of personal and mixed causes between the regents, students, &c. and the latter of spiritual matters between ecclesiastics. Sometimes there were appointed, anciently, conservators of treaties of peace between princes; who were judges of the infractions made on the treaty, and charged with procuring satisfaction to be made.

CONSERVATOR OF THE PEACE, in the ancient English customs, was a person who had a special charge, by virtue of his office, to see the king's peace kept. Till the erection of justices of the peace by Edward III. there were several persons who by common law were interested in keeping the same; some having that charge as incident to

other offices; and others simply, or of itself, called custodes, or conservators of the peace. The chamberlain of Chester is still a conservator in that county; and petty constables are, by the common law, conservators, &c. in the first sense, within their own jurisdiction: so are also the coroner and the sheriff within their own county. The king is the principal conservator of the peace within all his dominions: the lord chancellor, lord treasurer, lord high steward, lord marshal, lord high constable, all the justices of the court of king's bench, by their office, and the master of the rolls, by prescription, are general conservators of the peace through the whole kingdom, and may commit breakers of the peace, and bind them in recognisances to keep it.

CONSERVATOR OF THE TRUCE, AND SAFE CONDUCTS, was an officer appointed in every seaport, under the king's letters patent. His charge was to enquire of all offences committed against the king's truce, and safe conducts upon the main sea, out of the franchises of the cinque ports, as the admirals were wont to do; and such other things as are declared, anno 3 Henry V. cap. 6.

CONSERVATORY, in gardening, is distinguished from the greenhouse by the circumstance of its affording protection only to the plants; while the greenhouse is used for the rearing of them. The conservatory is also often attached to the house as an apartment for the display of scarce and valuable plants during the time of their greatest beauty and perfection, which are removed from the greenhouse, stove, and hot-house, to the conservatory for such temporary exhibition.

CONSERVE, in pharmacy, a form of medicine contrived to preserve the flowers, herbs, roots or fruits of several simples, as near as possible to what they were when fresh gathered. See PHARMACY.

CONSE'SSION, *n. s.* } Lat. *concessus*. A
CONSESSOR, *n. s.* } sitting together. One that sits with others.

CONSIDER, *v. a. & n.* } Fr. *considerer*;
CONSIDERABLE, *adj.* } Ital. *considerare*;
CONSIDERABLENESS, *n. s.* } Span. *considerar*;
CONSIDERABLY, *adv.* } Lat. *considerare*.
CONSIDERANCE, *n. s.* } Etymologists are
CONSIDERATE, *adj.* } at variance with respect
CONSIDERATELY, *adv.* } to the origin
CONSIDERATENESS, } of the rest of these
CONSIDERATION, *n. s.* } verbs. Some derive
CONSIDERATIVE, *adj.* } it from stargazing; others from
CONSIDERATOR, *n. s.* } sitting fixed in
CONSIDERER, *n. s.* } thought, in contemplation. The
CONSIDERING, *n. s.* }
CONSIDERINGLY, *adv.* }

latter seems to be the most natural. To consider is, to meditate seriously on; to weigh the reasons on each side; to examine carefully; to turn in the mind; to pay a proper degree of attention or respect to; to reward for service. That which is worthy of consideration, above mediocrity, important, is considerable. He who goes prudently to work; who makes a proper allowance for the failings of others, is considerate, acts considerately. Consideration signifies the act of considering; deliberate weighing of reasons;

prudence; worthiness of being regarded; an equivalent; a compensation; motive of action; the ground on which a conclusion is formed. Considering, as a noun, denotes hesitation; in its other sense, that of making allowance for; taking all things into consideration. Johnson classes it with the conjunctions.

None *considereth* in his heart, neither is there knowledge nor understanding. *Isaiah* xliv. 1

Let us *consider* one another to provoke unto love and to good works. *Hebrews* x. 24.

Consider all this, and red upon my vote,
As wisely as I shall evermore
Emforth my might thy trewe servant to be.

Chaucer. Cant. Tales,

The Lord bath of his high discretion
Considered that it were destruction
To gentill blood to fighten in the gise
Of mortal battaile now in this surprise. *Id.*

Well seemd the ape to like the ordinaunce
Yet well *considering* the circumstance,
As pausing in greet doubt awhile he staid.

Spenser. Mother Hubbard's Tale.

The *consideration*, in regard whereof the law forbiddeth these things, was not because these nations did use them. *Hooker.*

Let us think with *consideration*, and *consider* with acknowledging, and acknowledge with admiration. *Sidney.*

Widow, we will *consider* of your suit;
And come some other time to know our mind.

Shakespeare. Henry VI

Take away with thee the very services thou hast done, which if I have not enough *considered*, to be more thankful to thee shall be my study.

Id. Winter's Tale.

At our more *considered* time we'll read,
Answer, and think upon this business.

Id. Hamlet.

Many mazed *considerings* did throng,
And pressed in with this caution. *Id. Henry VIII.*

After this cold *considerance*, sentence me;
And as you are a king, speak in your state
What I have done that misbecame my place.

Id. Henry IV.

I will converse with iron-witted fools,
And unrespective boys: none are for me.
That look into me with *considerate* eyes.

Id. Richard III.

The breath no sooner left his father's body,
But that his wildness mortified in him;
Consideration, like an angel, came,
And whir'd the offending Adam out of him,

Shakespeare. Henry V.

I'll not dissemble, sir; where'er I come,
I love to be *considerative*.

Ben Jonson.

Circumstances are of such force, as they sway an ordinary judgment of a wise man, not fully and *considerately* pondering the matter.

Bacon's Colours of Good and Evil.

Consider,

Thy life hath yet been private, most part spent
At home.

Milton's Paradise Regain'd.

He had been made general upon very partial, and not enough deliberated, *considerations*. *Clarendon.*

Many brought in very *considerable* sums of money. *Id.*

We must not always measure the *considerableness* of things by their most obvious and immediate usefulness, but by their fitness to make or contribute to the discovery of things highly useful. *Boyle.*

VOL. VI.—PART 2.

The *consideration* of human frailty ought to check this vanity: but since it does not, but that, with a sort of allowance, it shows itself in almost all religious societies, the playing the trick round sufficiently turns it into ridicule. *Locke.*

As to present happiness and misery, when that alone comes in *consideration*, and the consequences are removed, a man never chooses amiss. *Id.*

Foreigners can never take our bills for payment, though they might pass as valuable *considerations* among our own people. *Id.*

It is *considerable*, that some urns have had inscriptions on them, expressing that the lamps were burning. *Wilkins.*

A vain applause of wit for an impious jest, or of reason for a deep *considerer*.

Government of the Tongue.

He was obliged, antecedent to all other *considerations*, to search an asylum. *Dryden.*

In painting, not every action, nor every person, is *considerable* enough to enter into the cloth.

Dryden's Dufrenoy.

'Twas grief no more, or grief and rage were one
Within her soul: at last 'twas rage alone;
Which burning upwards, in succession dries
The tears that stood *considering* in her eyes.

Id. Fables.

It seems necessary in the choice of persons for greater employments, to *consider* their bodies as well as their minds, and ages and health as well as their abilities. *Temple.*

Eternity is infinitely the most *considerable* duration. *Tillotson.*

I grant it to be in many cases certain, that it is such as a *considerate* man may prudently rely and proceed upon, and hath no just cause to doubt of. *Id.*

Lucan is the only author of *consideration* among the Latin poets, who was not explained for the use of the dauphin; because the whole Pharsalia would have been a satire upon the French form of government. *Addison's Freeholder.*

Many can make themselves masters of as *considerable* estates as those who have the greatest portions of land. *Addison.*

It is not possible to act otherwise, *considering* the weakness of our nature. *Spectator.*

I desire no sort of favour so much, as that of serving you more *considerably* than I have been yet able to do. *Pope.*

Such a treatise might be consulted by jurymen, before they *consider* of their verdict. *Swift.*

These speculations, however erroneous, were still useful; for though men err in assigning the causes of natural operations, the works of nature are by this means brought under their *consideration*; which cannot be done without enlarging the mind. *Burke.*

I do not say, sir, that all these establishments, whose principle is gone, have been systematically kept up for influence solely: neglect had its share. But this I am sure of, that a *consideration* of influence has hindered any one from attempting to pull them down. *Id.*

The direct power of the king of England is *considerable*. His indirect, and far more certain power, is great indeed. He stands in need of nothing towards dignity; of nothing towards splendour; of nothing towards authority; of nothing at all towards *consideration* abroad. *Id.*

The fabulist and the novel-writer deceive nobody; because, though they study to make their inventions probable, they do not even pretend that they are true; at least, what they may pretend in this way is con-

sidered only as words of course, to which nobody pays any regard. *Beattie.*

Resigned

To sad necessity, the cock foregoes
His wonted strut; and, wading at their head
With well considered steps, seems to resent
His altered gait and stateliness retrenched.

Cowper.

ABS. Mild, gentle, *considerate* father—I kiss your hands! What a tender method of giving his opinion in these matters Sir Anthony has! I dare not trust him with the truth. I wonder what old wealthy hag it is that he wants to bestow on me! yet he married himself for love! and was in his youth a bold intriguier, and a gay companion! *Sheridan.*

CONSIGN, *v. a. & n.* } Fr. *consigner*; Lat. *consignare*, from *con* and *signare*, To make a formal transfer of anything; to send; to entrust; to appropriate; to submit to the same terms with another; to consent to: the last two meanings are obsolete. Consignation is the act of consigning, and also of signing. A consignment is, the act of consigning; the thing consigned; the writing by which the thing is consigned. Consignature signifies, say 'Cotgrave and Sherwood,' a full stamping or absolute signature of.

Thou hast finished joy and moan;
All lovers young, all lovers must
Consign to thee, and come to dust.

Shakespeare. Cymbeline.

A maid yet rosed over with the virgin crimson of modesty: it were a hard condition for a maid to consign to. *Id.*

As the hope of salvation is a good disposition to wards it, so is despair a certain *consignation* to eternal ruin. *Taylor.*

If we find that we increase in duty, then we may look upon the tradition of the holy sacramental symbols as a direct *consignation* of pardon.

Taylor's Worthy Communicant.

The French commander *consigned* it to the use for which it was intended by the donor.

Dryden's Fables, Dedication.

Men, by free gift, *consign over* a place to the Divine worship. *South.*

Ask all the merchants who act upon *consignments*, where is the necessity (if they answer readily what their correspondents draw), of their being wealthy themselves. *Tatler.*

At the day of general account, good men are then to be *consigned over* to another state, a state of everlasting love and charity. *Atterbury.*

The four evangelists *consigned* to writing that history. *Addison.*

Atrides, parting for the Trojan war,
Consigned the youthful consort to his care. *Pope's Odyssey.*

A posterity, which, if this nefarious robbery under the fraudulent name and false colour of a government, should in full power be seated in the heart of Europe, must for ever be *consigned* to vice, impiety, barbarism, and the most ignominious slavery of body and mind. *Burke.*

What lost a world, and bade a hero fly?
The timid tear in Cleopatra's eye.
Yet be the soft triumvir's fault forgiven—
By this—how many lose not earth—but heaven!
Consign their souls to man's eternal foe,
And seal their own to spare some wanton's woe.

Byron. The Corsair

CONSIGNIFICATION, *n. s.* Similar signification.

CONSIGNMENT, in law, the depositing any sum of money, bills, papers, or commodities, in good hands; either by appointment of a court of justice, in order to be delivered to the persons to whom they are adjudged; or voluntarily, in order to their being remitted to the persons they belong to, or sent to the places they are designed for.

CONSIGNMENT OF GOODS, in commerce, is the delivering or making them over to another; thus, goods are said to be consigned to a factor, when they are sent to him to be sold, &c. or when a factor sends back goods to his principal, they are said to be consigned to him.

CONSIMILAR, *adj.* } Lat. *consimilis*. The
CONSIMILARLY, *adj.* } adjectives are synony-
CONSIMILITUDE, *n. s.* } mous, and signify hav-
CONSIMILITY, *n. s.* } ing one common re-
semblance; being alike. The nouns denote likeness, resemblance.

By which means, and their *consimilarity* of disposition, there was a very conjunct friendship between the two brothers and him *Aubrey.*

CONSIST, *v. n.* } Fr. *consister*; It. *con-*
CONSISTENCE, *n. s.* } *sistere*; Span. *consister*;
CONSISTENCY, *n. s.* } Lat. *consistere*, from *con*
CONSISTENT, *adj.* } and *sistere*. To exist in

CONSISTENTLY, *adv.* } consequence of; to re-
main undissipated; to be comprised in; to be composed of; to co-exist; to agree with. Consistence and consistency signify state with relation to material existence; degree of density or rarity; substance; durable state; congruity with self or with something else; unchangeableness of principle or conduct. Consistent is, not contradictory to; acting uniformly; firm, as opposed to fluid.

He is before all things, and by him all things consist. *Columian.*

None alive may salve the sore

But only she that hurt me so,
In whom my life doth now consist,
To save or slay me as she lyst.

Songes and Sonettes.

Yet wisely moderated her owne smart,
Seeing his honor, which she tenderd chiefe,
Consisted much in that adventure's priefe.

Spenser. Faerie Queene.

Flame doth not mingle with flame, as air doth with air, or water with water, but only remaineth contiguous; as it cometh to pass betwixt *consisting* bodies.

Bacon's Natural History.

There is the same necessity for the Divine influence and regimen, to order and govern, conserve and keep together, the universe in that *consistence* it hath received, as it was at first to give it, before it could receive it. *Hale's Origin of Mankind.*

Meditation will confirm resolutions of good, and give them a durable *consistence* in the soul

Hammond.

Pestilential miasms insinuate into the humoral and consistent parts of the body. *Harvey on Consumptions.*

Necessity and election cannot consist together in the same act. *Bramhall against Hobbes.*

His majesty would be willing to consent to any thing that could consist with his conscience and honour. *Clarndon.*

With reference to such a lord, to serve, and to be free, are terms not consistent only, but equivalent.

S. M. H.

His friendship is of a noble make, and a lasting consistency. *Id.*

If in having our ideas in the memory ready at hand, *consists* quickness of parts; in this of having them unconfused, and being able nicely to distinguish one thing from another, where there is but the least difference, *consists*, in a great measure, the exactness of judgment, and clearness of reason, which is to be observed in one man above another. *Locke.*

Arbitrary absolute power, or governing without settled standing laws, can neither of them *consist* with the ends of society and government. *Id.*

If the holy Scriptures were but laid before the eyes of Christians, in their connexion and *consistency*, it would not then be so easy to snatch out a few words, as if they were separate from the rest, to serve a purpose, to which they do not at all belong, and with which they have nothing to do. *Id.*

Nothing but what may easily *consist* with your plenty, your prosperity, is requested of you. *Spruit's Sermons.*

I pretend not to tie the hands of artists whose skill *consists* only in a certain manner which they have affected. *Dryden.*

You could not help bestowing more than is *consistent* with the fortune of a private man, or with the will of any but an Alexander. *Id. Fables, Dedication.*

The land would *consist* of plains, and valleys, and mountains, according as the pieces of this ruin were disposed. *Burnet.*

I carried on my enquiries farther, to try whether this rising world, when formed and finished, would continue always the same, in the same form, structure, and *consistency*. *Id.*

A great part of their politicks others do not think *consistent* with honour to practise. *Addison on Italy.*

On their own axis as the planets run,
Yet make at once their circle round the sun;
So two *consistent* motions act the soul,
And one regards itself, and one the whole.

It cannot *consist* with the Divine Attributes, that the impious man's joys should, upon the whole, exceed those of the upright. *Atterbury.*

Let the expressed juices be boiled into the *consistency* of a syrup. *Arbutnot on Aliments.*

The sand, contained within the shell, becoming solid and *consistent*, at the same time that of the stratum without it did. *Woodward's Natural History.*

The only way of securing the constitution will be by lessening the power of domestic adversaries, as much as can *consist* with lenity. *Swift.*

One advantage is as little as possible sacrificed to another. We compensate, we reconcile, we balance. We are enabled to unite into a *consistent* whole the various anomalies and contending principles that are found in the minds and affairs of men. From hence arises, not an excellence in simplicity, but one far superior, an excellence in composition. *Burke.*

We see, then, that our liberty does not *consist* either in the power of doing what we please, or in being governed by laws made by ourselves. *Beattie.*

Time was, he closed as he began the day
With decent duty, not ashamed to pray;
The practice was a bond upon his heart,
A pledge he gave for a *consistent* part;
Nor could he dare presumptuously displease
A power, confessed so lately on his knees.

Cowper.

Can glory's lust
Reach the freed spirit or the fettered dust?

Small care hath he of what his tomb *consists*—
Nought if he sleeps—nor more if he exists;
Alike the better-seeing shade will smile
On the rude cavern of the rocky isle,
As if his ashes found their latest home
In Rome's pantheon, or Gaul's mimic dome.

Byron. The Age of Bronze.

CONSISTENTS, in church history, a kind of penitents who were allowed to assist at prayers, but who could not be admitted to receive the sacrament.

CONSISTORY, *n. s.* } Fr. *consistoire*; It.
CONSISTORIAL, *adj.* } and Sp. *consistorio*;
CONSISTORIAN, *adj.* } Lat. *consistorium*. Po-
etically, consistory is applied to any solemn assemblage of persons. Shakspeare makes it also signify a place of residence. In its restricted, and more usual sense, it means the tribunal, or place of justice, in the spiritual courts; the assembly of cardinals; the assembly of the ministers and elders of the reformed church, especially that of the French Protestants. Consistorial is that which belongs to, or emanates from, a consistory, as a consistorial decree. Dr. Griffiths, in his sermon, which was animadverted upon by Milton, denominates the Presbyterians 'consistorian schismatics.'

To speke thei shall not be so bold,
For sompning to the *consistory*,
And make hem saie with the mouthe I lie.

Chaucer. Canterbury Tales.

An offer was made, that, for every one minister, there should be two of the people to sit and give voice in the ecclesiastical *consistory*. *Hooker. Preface.*

How far I've proceeded,
Or how far further shall, is warranted
By a commission from the *consistory*,
Yea the whole *consistory* of Rome.

Shakspeare. Henry VIII.

My other self, my counsel's *consistory*, my oracle,
I, as a child, will go by thy direction.

Id. Richard III.

In mid air
To council summons all his mighty peers
Within thick clouds, and dark, tenfold involved,
A gloomy *consistory*. *Milton's Paradise Regained.*

Christ himself, in that great *consistory*, shall deign to step down from his throne. *South.*

A late prelate, of remarkable zeal for the church, were religions to be tried by lives, would have lived down the pope and the whole *consistory*. *Atterbury.*

At Jove's assent, the deities around
In solemn state the *consistory* crowned,

Pope's Statius.

An official, or chancellor, has the name *consistorial* audience with the bishop himself that deposes him.

Agliff's Persegon.

CONSISTORY is particularly used for the pope's senate and council, before whom judiciary causes are pleaded at Rome. This consistory, or college of cardinals, never meets but when the pope pleases to convoke it: he presides in person mounted on a magnificent throne, and habited in his pontificalia; on the right sit the cardinal bishops and priests, and on the left the cardinal deacons. The other prelates, protonotaries, auditors of the rota, and other officers, are seated on the steps of the throne: the courtiers on the ground: ambassadors on the right, and consistorial and fiscal advocates behind the cardinals.

Besides the public consistory, there is also a private one, held in a retired chamber, called the chamber of pagegay; the pope's throne being only raised two steps. Nobody is admitted but the cardinals, whose opinions are collected, and called sentences. Here are first proposed and passed all bulls for bishoprics, abbeys, &c. Hence bishoprics and abbeys are said to be consistorial benefices; as they must be proposed in the consistory, the annates be paid to the pope, and his bulls taken. Anciently they were elective; but by the concordate, which abolishes elections, they are appointed to be collated by the pope alone, on the nomination of the prince. Consistory was also used, among the reformed, for a council or assembly of ministers and elders, to regulate their affairs, discipline, &c.

CONSISTORY, or COURT CHRISTIAN, in the English laws, is a council of ecclesiastical persons, or the place of justice in an ecclesiastical or spiritual court. Every archbishop and bishop has a consistory court, held before his chancellor or commissary, either in his cathedral, in some chapel, aisle, or portico, or in some other convenient place of his diocese, for ecclesiastical causes. The spiritual court was anciently, in the time of the Saxons, joined with the county or hundred court; and the original of the consistory court, as divided from those courts, is found in a law of William I. quoted by Lord Coke. From this court there lies an appeal to the archbishop of each province.

CONSO'CIATE, *v. a. v. n., & n. s.* } Lat. *con-*
 CONSOCIA'TION, *n. s.* } *sociare.* To
 confederate with; to associate with; to join;
 to cement; to coalesce. A confederate; a partner.
 Alliance; fellowship; intimacy.

Patridge and Stanhope were condemned as *conso-*
citates in the conspiracy of Somerset. *Hayward.*

There is such a *consociation* of offices between the
 prince and whom his favour breeds, that they may
 help to sustain his power, as he their knowledge.

Ben Jonson's Discoveries.

The ancient philosophers always brought in a su-
 pernatural principle to unite and *consociate* the parts
 of the chaos. *Burnet.*

By so long and so various *consociation* with a prince,
 he had now gotten, as it were, two lives in his own
 fortune and greatness. *Wotton.*

If they cohered, yet by the next conflict with other
 atoms they might be separated again, without ever
consociating into the huge condense bodies of planets.
Bentley's Sermons.

CONSOLE, *v. a.* } Fr. *consoler*;
 CONSOLATE, *v. a.* } It. *consolare*; Sp.
 CONSOL'ABLE, *adj.* } *consolar*; Lat.
 CONSOLA'TION, *n. s.* } *consolari.* To
 CONSOLA'TOR, *n. s.* } soothe; to cheer;
 CONSO'LATORY, *n. s. & adj.* } to comfort; to al-
 leviate mental anguish; to restore cheerfulness
 to the wretched. Consolatory, as a noun, sig-
 nifies that which, either verbally or in writing,
 contains something capable of comforting. The
 meaning of the other derived words is sufficiently
 obvious.

I will begone,
 That painful rumour may report my flight,
 To console thine ear.

Shakspere. All's well that ends well.

We, that were in the jaws of death, were now
 brought into a place where we found nothing but *con-*
solations. *Bacon.*

What may some what *consolate* all men that honour
 virtue, we do not discover the latter scene of his
 misery in authors of antiquity.

Brown's Vulgar Errors.

Against such cruelties,
 With inward *consolations* recompensed;
 And oft supported so, as shall amaze
 Their proudest persecutors.

Milton's Paradise Lost.

Consolatories writ
 With studied argument, and much persuasion sought,
 Lenient of grief and anxious thought. *Id. Agonistes.*

Others the syren sisters compass round,
 And empty heads *console* with empty sound.

Pope's Dunciad.

Pride once more appears upon the stage, as the
 great consoler of the miseries of man.

Commentaries on Pope's Essay on Man.

Let the righteous persevere with patience, sup-
 ported with this *consolation*, that their labour shall not
 be in vain. *Rogers.*

They have a right to the acquisitions of their
 parents; to the nourishment and improve- ment of their
 offspring; to instruction in life, and to *consolation* in
 death. *Burke.*

Our groves were planted to *console* at noon
 The pensive wanderer in their shades. At eve
 The moonbeam, sliding softly in between
 The sleeping leaves is all the light they wish,
 Birds warbling all the music. *Cooper.*

Ah, where can sympathy reflecting find
 One bright idea to *console* the mind? *Darwin.*

And she would have *consolated*, but knew not how—
 Having no equals, nothing which had e'e
 Infected her with sympathy till now.

Byron. Don Juan.

CONSOLE, *n. s.* in architecture, is a part or
 member projecting in manner of a bracket, or
 shoulder-piece, serving to support a cornice,
 bust, vase, beam, and frequently used as keys of
 arches.

CONSOLIDATE, *v. a., v. n., & adj.* } Fr. *con-*
 CONSOLIDA'TION, *n. s.* } *solider*;
 CONSOL'DATIVE, *adj.* } It. *con-*
 CONSOLIDANT, *adj.* } *solidare*;

Sp. *consolidar*; Lat. *consolidare.* To compact
 into a solid body; to render hard; to make
 stable; to combine two parliamentary bills into
 one; to unite two benefices; to become hard;
 to acquire stability. Consolidation is the act of
 uniting into a solid mass; the act of giving con-
 firmation to a thing. Consolidant and consoli-
 dative signify that which is capable of healing
 wounds; of effecting the union of severed
 parts.

In hurts and ulcers in the head, dryness maketh
 them more apt to *consolidate.*

Bacon's Natural History.

The word may be rendered, either he stretched, or
 he fixed and *consolidated*, the earth above the waters.
Burnet's Theory.

The effect of spirits in stopping hemorrhages, and
consolidating the fibres, is well known to chirurgeons
Arbuthnot

The *consolidation* of the marble, and of the stone,
 did not fall out at random.

Woodward's Natural Hist.

The toiling steeds expand the nostril wide,
While every breath, by respiration strong
Forced downward, is consolidated soon
Upon their jutting chests. *Cowper.*

CONSOLIDATION, in law, is borrowed from the civil law; where it properly signifies an union of the possession, or occupation, with the property. Thus, if a man have by legacy usum fructum fundi, and afterwards buy the property, or fee-simple, of the heir; this is called a consolidation.

CONSOLIDATION, in medicine and surgery, the action of uniting broken bones, or the lips of wounds, by means of consolidating remedies, which, cleansing with a moderate heat and force, taking corruption out of the wounds, and preserving the temperature of the parts, cause the nourishment to be fitly applied to the part affected. Among the many instances of the consolidating power of blood and flesh, we have a very remarkable one in Bartholine's Medical Observations. A man being condemned to have his nose cut off by the hand of the common executioner, the friends, who were to be present, provided a new loaf of warm bread, which was cut in the middle, and the nose received in it as it fell from the face: the nose was after this nicely placed on the face again; and, being sewed on, the whole in time consolidated, and left no other marks of the ignominy than the scar round the whole nose, and the traces of the stitches.

CONSONANCE, *n. s.* } Fr. *consonance* ;
CONSONANCY, *n. s.* } Ital. *consonanza* ;
CONSONANT, *n. s. & adj.* } Sp. *consonancia* ;
CONSONANTLY, *adv.* } Lat. *consonans*. Accordance of sound ;
CONSONANTNESS, *n. s.* } consistency ;
CONSONOUS, *adj.* } congruity with ; concord ; friendship : the latter sense is obsolete. Consonant signifies, agreeable to ; conformable to ; according with. As a noun, it means a letter which requires to be united with a vowel before it can be sounded. Consonous is, agreeing in sound ; symphonious.

Were it *consonant* unto reason to divorce these sentences, the former of which doth shew how the latter is retained. *Hooker.*

This *consonantly* it preacheth, teacheth, and delivereth, as if but one tongue did speak for all. *Id.*

Let me conjure you by the rights of our fellowship, by the *consonancy* of our youth. *Shakspeare. Hamlet.*

Such decisions held *consonancy* and congruity with resolutions and decisions of former times.

Hale's Law of England.

Ourselves are formed according to that mind which frames things *consonantly* to their respective natures.

Glanville's Scepsis.

That where much is given there shall be much required, is a thing *consonant* with natural equity.

Decay of Pisty.

Religion looks *consonant* to itself. *Id.*

Every one may observe a great many truths which he receives at first from others, and readily assents to, as *consonant* to reason, which he would have found it hard, and perhaps beyond his strength, to have discovered himself. Native and original truth is not so easily wrought out of the mind as we, who have it delivered and already dug and fashioned into our hands, are apt to imagine. *Locke.*

In all vowels the passage of the mouth is open and free, without any appulse or an organ of speech to another : but in all *consonants* there is an appulse of the organs, sometimes (if you abstract the *consonant* from the vowels) wholly precluding all sound ; and, in all of them, more or less checking and abating it.

Holder's Elements of Speech.

He discovers how *consonant* the account which Moses hath left of the primitive earth, is to this from nature. *Woodward.*

The two principal *consonances* that most ravish the ear, are by the consent of all nature, the fifth and the octave. *Wotton.*

He considered these as they had a greater mixture of vowels or *consonants*, and accordingly employed them as the verse requires a greater smoothness.

Pope's Essay on Homer.

And winds and waters flowed

n consonance.

Thomson's Spring.

CONSOPIATE, *v. a.* } Lat. *conspire*. To
CONOSPITE, *v. a. & adj.* } lull to sleep. The
CONSOPIATION, *n. s.* } act of lulling to sleep.
The adjective signifies quieted ; calmed.

The masculine faculties of the soul were for a while well slaked and *conspited*. *Mora.*

Its clamorous tongue thus being *conspite*. *Id.*

One of his maxims is, that a total abstinence from intemperance is no more philosophy than a total *conspiation* of the senses is repose. *Digby to Pope.*

CONSO'RT, *v. a. & n.* } Fr. *consorts* ; Ital.

CO'NSORT, *n. s.* } and Span. *consorte* ;

CON-O'RTABLE, *adj.* } Lat. *consors*. To as-

CONSO'RTION, *n. s.* } sociate with ; to join

CO'NSORTSHIP, *n. s.* } with ; to marry : and,

in our old writers, to accompany. Consort is a companion ; a wife or husband ; an assembly ; a number of instruments playing together ; conjunction with. It had formerly the accent on the second syllable. Consortable is, comparable to ; ranking with ; suitable. Consortion signifies partnership ; fellowship ; society.

A *consort* of music in a banquet of wine, is as a signet of carbuncle set in gold. *Eccles. xxxii. 5.*

But Coridon durst not with him *consort*,
Ne durst abide behind, for dread of worse effort.

Spenser. Faerie Queene.

Then all the people, as in solemn feast,
So him assembled with one full *consort*,
Rejoicing at the fall of that great beast. *Id.*

So forth they pas, a well-*consorted* payre,
Till that at length with Archimage they meet. *Id.*

To this sweet voice a dainty music fitted
Its well tuned strings, and to her notes *consorted*.

Id. Britain's Ida.

What will you do ? Let's not *consort* with them.
Shakspeare.

I'll meet with you upon the mart,
And afterward *consort* you till bed time. *Id.*

Fellowship,

Such as I seek, fit to participate
All rational delight ; wherein the brute
Cannot be human *consort*. *Milton.*

Male he created thee, but thy *consort*
Female for race ; then bless'd mankind, and said,
Be fruitful, multiply, and fill the earth.

Id. Paradise Lost.

He with his *consorted* Eve,
The story heard attentive. *Id.*

Thy Bellona, who thy *consort* came
Not only to thy bed, but to thy fame *Denham.*

He begins to consort himself with men, and thinks himself one. *Locke on Education.*

Which of the Grecian chiefs consorts with thee? *Dryden.*

He single chose to live, and shunned to wed, Well pleased to want a consort of his bed. *Id. Fables.*

He was *consortable* to Charles Brandon under Henry VIII. who was equal to him. *Wotton.*

His warlike amazon her host invades, The' imperial consort of the crown of spades. *Pope.*

Take it singly, and it carries an air of levity; but, in consort with the rest, has a meaning quite different. *Atterbury.*

So thou, with sails how swift! hast reached the shore

' Where tempests never beat nor billows roar' And thy loved consort on the dangerous tide Of life, long since has anchored by thy side. *Cooper.*

Sweet fruits and kernels gathers from his board, With milk and butter piles the plenteous board; While on the heated earth his consort bakes Fine flour, well kneaded, in unleavened cakes. *Darwin.*

Emperors are only husbands in wives' eyes, And kings and consorts oft are mystified, As we may ascertain with due precision, Some by experience, others by tradition. *Byron. Don Juan.*

CONSPICUOUS, *adj.* } Lat. *conspicuosus*.
CONSPICUOUSNESS, *n. s.* } That which may
CONSPICUOUSLY, *adv.* } easily be seen. A
seeing; beholding; sight; sense of seeing. Conspicuity, says Johnson, is, I believe, peculiar to Shakspeare, and perhaps corrupt.

What harm can your bisson *conspicuities* glean out of this character? *Shakspeare. Coriolanus.*

CONSPERSION, Lat. *consersio*. A sprinkling about.

CONSPICUOUS, *adj.* } Ital. *conspicuo*;
CONSPICUOUSLY, *adv.* } *conspicuo*; Sp. *con-*
CONSPICUOUSNESS, *n. s.* } *spicuo*; Lat. *con-*
CONSPICUITY, *n. s.* } *spicuosus*. That
which is obvious; capable of being seen from far; eminent for virtue, crime, talent, or rank; placed in a prominent situation. Conspicuity is brightness; favorableness to the sight.

Or come I less *conspicuous*? Or what change Absents thee? *Milton's Paradise Lost.*

Looked on with such a weak light they appear well proportioned fabrics; yet they appear so but in that twilight, which is requisite to their *conspicuousness*. *Boyle's Proem Essay.*

Such a patriot, formed in this happy way of improvement, cannot fail, as we see, to give notable decisions upon the bench of quarter-sessions, and eminent proofs of his skill in politics, when the strength of his purse and party have advanced him to a more *conspicuous* station. *Locke.*

If this definition be clearer than the thing defined, midnight may vie for *conspicuity* with noon. *Glanville's Scepsis.*

He attributed to each of them that virtue which he thought most *conspicuous* in them. *Dryden's Juvenal, Dedication*

Thy father's merit points thee out to view, And sets thee in the fairest point of light, To make thy virtues or thy faults *conspicuous*. *Addison's Cato.*

The house of lords, *Conspicuous scene!* *Pope's Epist. of Horace.*

These methods may be preserved *conspicuously*, &c. entirely distinct. *Watts's Logic.*

I have a hundred times wished that one could resign life as an officer resigns a commission; for I would not take in any poor, ignorant wretch, by selling out. Lately I was a sixpenny private, and, God knows, a miserable soldier enough; now I march to the campaign, a starving cadet: a little more *conspicuously* wretched. *Burns.*

Inscribed above the portal, from afar *Conspicuous* as the brightness of a star, Legible only by the light they give, Stand the soul-quickenng words—BELIEVE AND LIVE. *Cooper.*

CONSPIRE, *v. n.* } Fr. *conspirer*; Ital.
CONSPIRER, *n. s.* } *conspirare*; Sp. *con-*
CONSPIRACY, *n. s.* } *spirar*; Lat. *conspirare*,
CONSPIRATOR, *n. s.* } from *con* and *spirare*.
CONSPIRANT, *n. s.* } Etymologists have la-
CONSPIRATION, *n. s.* } bored very hard to
CONSPIREMENT, *n. s.* } find some other root
CONSPIRINGLY, *adv.* } than the Latin *con*
and *spirare*; but their labors do not appear to have been very successful. To act together, as if all had but one breath, is the meaning indicated by the Latin, and it certainly appears to be that which is found in the derivatives. To conspire is, to league together closely for criminal purposes; to plot; to form base, felonious, or treasonable plans; in an innocent sense, it means to act in conjunction; to agree together. A conspiracy is a concert of persons to commit a crime; a concurrence of circumstances; a tendency of several causes to one event. The law always uses the word in an evil sense.

When shapen was all her *conspiracie* From point to point. *Chaucer. Cant. Tales.*
The Temones shall backe returne in her fontaine. And where he rose the sunn shall take his lodging, Ere I in this finde peace or quietness, Or that love, or my lady right wialy, Leave to conspire against me wrongfully. *Wyat.*

As two broad beacons, sett in open fields, Send forthe their flames far off to ever shyne, And warning give, that enemies conspire With fire and sword the region to invade, So flamed his eyne with rage and rancorous yre. *Spenser. Faerie Queene.*

Where they in secret counsel close conspired How to effect so hard an enterprize. *Id.*

Tell me what they deserve, That do conspire my death with devilish plots Of damned witchcraft. *Shakspeare. Richard III.*

What was it That moved pale Cassius to conspire? *Id. Antony and Cleopatra.*

O conspiracy! Shamest thou to show thy dangerous brow by night, When evils are most free? *Id. Julius Cæsar.*

Take no care, Who chase, who frets, and where conspires are: Macbeth shall never vanquished be. *Id. Macbeth.*

Stand back thou manifest conspirator, Thou that contrivest to murder our dread lord. *Id. Henry VI.*

Thou art a traitor, Conspirant 'gainst this high illustrious prince. *Id. King Lear.*

When the time now came that misery was ripe for him, there was a conspiracy in all heavenly and earthly things, to frame fit occasions to lead him unto it. *Sidney.*

Let the air be excluded; for that undermineth the body, and *conspireth* with the spirit of the body to dissolve it. *Bacon.*

There is in man a natural possibility to destroy the world; that is, to *conspire* to know no man.

Broune's vulgar Errors.
Either violently without mutual consent for urgent reasons, or *conspiringly* by plot of lust or cunning malice. *Milton.*

One put into his hand a note of the whole *conspiracy* against him, together with all the names of the *conspirators.* *South.*

When scarce he had escaped the blow

Of faction and *conspiracy,*

Death did his promised hopes destroy. *Dryden.*

One would wonder how, from so differing premises, they shou'd infer the same conclusion, were it not that the *conspiration* of interest were too potent for the diversity of judgment. *Decay of Piety.*

The press, the pulpit, and the stage,

Conspire to censure and expose our age.

Roscommon.

So moist and dry, when Phœbus shines,

Conspiracy give the plant to grow. *Heigh.*

Vehement passion does not always indicate an infirm judgment. It often accompanies and actuates, and is even auxiliary to a powerful understanding; and when they both *conspire* and act harmoniously, their force is great to destroy disorder within, and to repel injury from without. *Burke.*

The very elements, though each be meant

The minister of man, to serve his wants,

Conspire against him. With his breath he draws

A plague into his blood; and cannot use

Life's necessary means, but he must die. *Cowper.*

In the vices, on the other hand, it is the discord that ensures the defeat—each clamours to be heard in its own barbarous language; each claims the exclusive cunning of the brain; each thwarts and reproaches the other; and even while their fell rage assails with common hate the peace and virtue of the world, the civil war among their own tumultuous legions defeats the purpose of the foul *conspiracy.* *Sheridan.*

CONSPIRACY, in English law, was once used almost exclusively, for an agreement of two or more persons falsely to indict one, or to procure him to be indicted of felony; who, after acquittal, shall have writ of conspiracy. Now, it is no less commonly used for the unlawful combination of journeymen to raise their wages, or to refuse working, except on certain stipulated conditions; in offence particularly provided for by stat. 2 & 3 E. VI. c. 15 (revised, continued, and confirmed by stat. 22 & 23. Car. II. c. 19, now expired): which enacts among other things, that 'if any artificers do conspire, they shall not do their works but at a certain price, or shall not take upon them to finish that another hath begun, or shall do but a certain work in a day, or shall not work but at certain times, every person so *conspiring*, shall forfeit for the first offence £10, or be imprisoned twenty days, for the second £20, or be pilloried, and for the third £40, or be pilloried, lose an ear, and become infamous.'—This stat. 2 & 3 E. VI. c. 15, appears to be yet in force, though not frequently resorted to for remedy in this case; the proceeding being usually by indictment for conspiracy. Journeymen confederating and refusing to work unless for certain wages, may be indicted for a conspiracy; notwithstanding the statutes which regulate their

work and wages do not direct this mode of prosecution; for this offence consists in the *conspiring* and not in the refusal, and all conspiracies are illegal, though the subject matter of them may be lawful. The fact of conspiring may be collected by the jury from collateral circumstances. Black. Rep. 392, Stra. 144. And if the parties concur in doing the act, although they were not previously acquainted with each other, it is conspiracy. Unlawful combinations of workmen were prohibited and punished by the act 39 G. III. c. 81, which was repealed, and more effectual provision enacted by 39 and 40 G. III. c. 106. By this latter act all contracts (except those between masters and men) for obtaining advance of wages, altering the usual time of working, decreasing the quantity of work, &c. are declared illegal.—Workmen making such illegal contracts are punishable by imprisonment: and the like punishment is inflicted on workmen entering into combinations to procure advance of wages, or preventing other workmen from hiring themselves, or procuring them to quit their employ, &c.—All meetings and combinations for effecting such illegal purposes are punishable in like manner: and offenders giving evidence against each other are indemnified. This act also provides for settling all disputes between masters and workmen by arbitration, with an appeal to the quarter sessions.

CONSPIRATORS are, by statute, defined to be such as bind themselves by oath, covenant, or other alliance, to assist one another falsely and maliciously to indict persons, or falsely to maintain pleas, or to any treason.

CONSPIRING POWERS, in mechanics, all such as act in a direction not opposite to one another.

CONSPISSATION, *n. s.* Thickness.

CONSPURCATE, *v. a.* } Latin, *conspurco.*

CONSPURCATION, *n. s.* } To defile. Defilement; pollution.

CONSTABLE, *n. s.* }

Fr. *connetable*; Ital.

CO'NSTABLESS, *n. s.* }

constabile; Sp. *con-*

CO'NSTABLERIE, *n. s.* }

destable. Dr. John-

CO'NSTABLESHIP, *n. s.* }

son refers to the Lat.

CO'NSTABLEWICK, *n. s.* }

comes stabuli, as the

original of constable; Verstegan traces the word from Ang.-Sax. *cygning*, abbreviated into king and stable, i. e. the prop or stay of the king. Johnson's derivation seems, however, to be the true one. Cowel and Chambers have well described the office of constable, and the change which time has effected in it. (See also the next article.)

The *constable* of the castle down is fare,

To seen this wrecke, and al the ship he sought,

And fond this very woman ful of care.

Chaucer. Cant. Tales.

Till Jesu hath converted thurgh his grace

Dame Hermegild, *constableness* of that place. *Id.*

Than Dredé had in her baillie

The keping of the *constablerie.*

Id. Romant of the Rose.

When I came hither, I was lord high *constable,*

And duke of Buckingham; now peer Edward Bohun.

Shakespeare.

The knave *constable* had set me in the stocks, in the common stocks, for a witch.

Id. Merry Wives of Windsor.

This keepership is annexed to the *constablership* of the castle, and that granted out in lease.

Carew's Survey of Cornwall.

He cannot drink five bottles, bilk the score,
Then kill a *constable*, and drink five more;
But he can draw a pattern, make a tart,
And has the ladies' etiquette by heart. *Cowper.*

To *over-run* the CONSTABLE. Perhaps from *Fr. conte stable*, the settled, firm, and stated account. To spend more than what a man knows himself to be worth; a low phrase.

CONSTABLE is derived from comes stabuli, an officer anciently well known in the empire; so called because, like the great constable of France (an office suppressed by Louis XIII.), as well as the lord high constable of England, he was to regulate all matters of chivalry, tilts, tournaments, and feats of arms, which are performed on horseback.

CONSTABLE, LORD HIGH, OF ENGLAND, is the seventh great officer of the crown; and he, with the earl marshal of England, was formerly judge of the court of chivalry, called in king Henry IV's time *curia militaris*, and now the court of honor. It is the fountain of the martial law, and anciently was held in the king's hall: The power of the lord high constable was formerly so great, and of which so improper a use was made, that so early as the 13th of king Richard II. a statute passed for regulating and abridging it, together with that of the earl marshal of England; and, by this statute, no plea could be tried by them or their courts, that could be tried by the common law of the realm. The office of constable is said by some to have existed before the conquest. After the conquest, the office went with inheritance, and by the tenure of the manors of Harlefield, Newham, and Whitenhurst, in Gloucestershire, by grand serjeanty, in the family of the Bohuns, earl of Hereford and Essex, and afterwards in line of Stafford as heirs general to them; but, in 1521, this great office became forfeited to the king in the person of Edward Stafford, duke of Buckingham, who was that year attainted for high treason; and in consideration of its extensive power, dignity, and large authority, both in war and peace, it has never been granted to any person, otherwise than *hac vice*, to attend at a coronation, or trial by combat.

CONSTABLE, LORD HIGH, OF SCOTLAND, is an officer of great antiquity and dignity. The first upon record is Hugo de Morvelle, in the reign of David I. He has two grand prerogatives, viz. 1. The keeping of the king's sword, which the king, at his promotion, when he swears fealty, delivers to him naked. Hence the badge of the constable is a naked sword. 2. The unlimited command of the king's armies in the field, in the absence of the king; but this command did not extend to castles and garrisons. He was likewise judge of all crimes committed within two leagues of the king's house, which precinct was called the chalmers of peace; though his jurisdiction came at last to be exercised only as to crimes during the time of parliament, which some extended likewise to all general conventions. This office was conferred heritably upon the noble family of Errol, by king Robert Bruce; and

with them it still remains, being expressly reserved by the treaty of union.

CONSTABLES, in the ordinary meaning of the word, are, 1. *The Constable of the Hundred*, or the High, Chief, or Head Constable (as he is otherwise called). By the statute of Winton or Winchester, 13 Ed. I. c. 6, it is ordered that in every hundred or franchise there shall be chosen two constables to make the view of armor, and to present the defaults of armor, and of the suits of towns and of highways, &c. Lombard, on Constables, p. 3, Coke 4 Inst. 267, and Hale 2 P. C. 96, all agree in declaring that constables of the hundred were first introduced by this statute.

2. *The Constable of the Vill*, or Petty Constable, as he is frequently called, to distinguish him from the officer last mentioned, is generally understood by the term constable, when mentioned without any peculiar addition. This constable has been repeatedly acknowledged by the law, to be 'one of the most ancient officers in the realm for the conservation of the peace,' Poph. 13. 4 Inst. 265. It must be confessed, however, that no mention of him by this identical name, is anywhere found to occur anterior to the reign of king Henry III. when it was provided that, in every village or township, there should be constituted a constable or two, according to the number of the inhabitants. But it is pretty certain that Lord Coke's idea is right, and that this officer is actually owing to the institution of the frankpledge, usually attributed to king Alfred, and was, in fact, originally the senior or chief pledge of the tithing or decima. The powers and duties of this officer are very extensive, and are considered by Sir T. Tomline under the following heads. I. 1. His quality; and 2. qualifications. II. 1. His election; and 2. Who are exempted. III. His power and authority. IV. His duty. [These two are in many instances co-extensive, and are therefore carefully to be compared together]. V. His protection, indemnity, and allowances; and lastly, VI. His responsibility and punishment. We must refer to his elaborate Law Dictionary for the full exhibition of these topics; and are indebted to it for the following brief abstract of them.

1. The constable was ordained to repress felons and to keep the peace, of which he is a conservator by the common law. His office is, therefore, first, original or primitive as conservator of the peace; and secondly, ministerial and relative to justices of the peace, coroners, sheriffs, &c. whose precepts he is to execute. He is, however, an officer only for his own precinct, and cannot execute a warrant directed to the constable of the vill, or to all constables, generally, of that particular jurisdiction: for he is constable no where else; nor is he compellable to do it, though the warrant be directed to him by name; but he may, if he will, and so indeed may any other person.

2. The common law requires, that every constable should be idoneus homo, i. e. apt and fit to execute the said office; and he is said in law to be idoneus, who has these three things, honesty, knowledge, and ability.

3. He must be an inhabitant of the place for which he is chosen. But he ought not to be the

keeper of a public house. This is made an express disqualification in Westminster, by stat. 29 Geo. III. c. 25.

4. The objects of his power, authority, and duty, may be thus classed in alphabetical order; viz.

Affray	Malt
Ale-houses	Measures
Armed going	Militia
Bawdy-houses	Night Walkers
Bridges	Physicians, College of
Burglary	Plague
Customs	Poor's Rate
Distress, for rent	Postage
Drunkenness	Presentments
Escape	Riot
Felons	Robbery
Fires	Scavengers
Fishing, unlawful	Scolds
Forcible entry	Servants
Game acts	Soldiers
Gunpowder	Statutes
Hawkers and pedlars	Sunday
Highways	Swearing
Horses	Thieves, petty
Ilue and Cry	Turpikes
Husbandry	Vagrants
Inkeepers	Warrants of Justices
Juries	Watch
Laborers	Weavers, Kiddermins.
Land-tax acts	Weights
Lead. See THIEVES.	Wreck.
Lottery Offices illegal	

CONSTABLE OF THE TOWER, a general officer who has the chief superintendance over the tower, and is lord lieutenant of the tower hamlets. He holds his appointment by letters patent from the king, and is not removable at pleasure. The tower, being a state prison, is also considered as a garrison, of which the constable is governor.

CONSTANCE, a city belonging to the grand duchy of Baden, situated on the Upper Lake of Constance. It is very ancient, and was erected into a bishopric in 750, the see being removed from Windish, a place in Switzerland, about six miles distant. It has a handsome bridge, and several fine structures. It formerly carried on a brisk trade in watches and printed linens, and was well fortified; but has much declined of late.

It is famous for the council held here from 1814 to 1818, when there were three popes; who were all deposed, and Martin V. was elected. This body of so named divines, caused John Huss and Jerome of Prague to be burnt, though the emperor Sigismund had given them a safe conduct, pursuant to the disgraceful maxim, 'that no faith is to be kept with heretics.' See HUSS. The dungeon of the convent where Huss was confined, which is only eight feet long, six broad, and seven high, and the stone to which he was chained, are still shown. His head carved in stone is erected upon the house where he was seized, and his statue serves for a pillar on which the pulpit of the cathedral stands. Constance was formerly in alliance with the cantons of Basil and Zurich, with whose assistance the inhabitants expelled the bishop, and embraced the doctrines of the reformation; but the Protestant

cantons being defeated in 1631, the emperor Charles V. compelled them to re-admit the bishop and the popish religion. The majority of the people, however, still continued Protestants; and Joseph II. in 1785, restored the free exercise of that religion with many other privileges, which in 1787 encouraged 350 emigrants from Geneva to settle in it. The population, however, is little more than 4000. At the congress held in 1802 for determining the indemnifications to those princes who had suffered by the cessions to France, this bishopric, with the exception of the convents and chapters, was transferred to Baden. It is thirty miles north-east of Zurich.

CONSTANCE, one of the largest lakes of Switzerland, which separates it from Germany. On its banks, between Aberlingen and Moerspony, the French, under general Ferino, engaged the left wing of the Austrians, under the Archduke Charles, and completely routed them, 21st and 22nd of March, 1799. The extensive sheet of water consists properly of two lakes; viz. 1. Constance, Lower, or Zeller Zee, a lake between Germany and Switzerland, sixteen miles long and ten broad. 2. Constance, Upper, or Boden Zee, a large lake between Germany and Switzerland, thirty-five miles long, and twelve broad. The Rhine connects both lakes, and they are often treated as one. At the eastern extremity is a considerable island, on which stands the town of Lindau, once a free imperial city. It is said to be 350 fathoms deep near Mershourg. Owing to the melting of the snow from the adjacent mountains, it is deeper in summer than in winter. There are several towns on its banks, which exhibit the most charming landscapes. It is famous for trout.

CONSTANT, *adj.* } Fr. *constant*; It. *cos-*
CONSTANTLY, *adv.* } *tante*; Sp. *constante*;
CONSTANCE, *n. s.* } Lat. *constans*. Fixed;
CONSTANCY, *n. s.* } firm; unalterable; not
CONSTANCENESS, *n. s.* } to be shaken; resolute;
 consistent; steady; faithful in love and friendship. These meanings of the adjective are to be found in the adverb and the nouns. Shakspeare uses constancy in the sense of veracity; reality.

— He so often hadde hire don offence
 And she aye sade and *constant* as a wall
 Continuing qver hire innocence over all.

Chaucer. Cant. Tales.

Shamefast she was in maiden's shamefastnesse,
Constant in herte out of idel businessse
 To drive hire out of idel elogardie. *Id*

With fawning words he courted her awhile,
 And looking lovely, and oft sighing sore,
 Her *constant* hart did tempt with diverse guile.

Spenser. Faerie Queene.

The laws of God himself no man will ever deny to be of a different constitution from the former, in respect of the one's *constancy*, and the mutability of the other. *Hooker*

Both loving one fair maid, they yet remained *constant* friends. *Sidney.*

Some shrewd contents
 Now steal the colour from Bassanio's cheek;
 Some dear friend dead; else nothing in the world
 Could turn so much the constitution
 Of any *constant* man.

Shakspeare. Merchant of Venice.

But all the story of the night told over,
More witnesseth than fancy's images,
And grows to something of great *constancy*,
But, however, strange and admirable. *Shakespeare.*

Rocks, pillars, and heaven's axle-tree,
Exemplify her *constancy* ;
Great changes never change her. *Davies.*

The world's a scene of changes, and to be
Constant, in nature were inconstancy. *Cowley.*

If you take highly rectified spirit of wine, and de-
phlegmed spirit of urine, and mix them, you may
turn these two fluid liquors into a *constant* body.

Boyle's History of Firmness.

Constancy is such a stability and firmness of
friendship, as overlooks and passes by lesser failures
of kindness, and yet still retains the same habitual
good-will to a friend. *South.*

This seems to me to be that beauty, which shines
through some men's actions, sets off all that they do,
and takes with all they come near; when by a *con-*
stant practice they have fashioned their carriage, and
made all those little expressions of civility and re-
spect, which nature or custom has established in con-
versation, so easy to themselves, as they seem not
artificial or studied, but naturally to follow from a
sweetness of mind and a well-turned disposition. *Loche.*

Now through the land his care of souls he stretch'd,
And like a primitive apostle preached ;
Still cheerful, ever *constant* to his call ;
By many followed, loved b most, admired by all. *Dryden.*

It is strange that the fathers should never appeal ;
nay, that they should not *constantly* do it. *Tillotson.*

In a small isle, amidst the widest seas,
Triumphant *constancy* has fixed her seat ;
In vain the syrens sing, the tempests beat. *Prior.*
For the attainment of these ends, his policy con-
sisted in sincerity, fidelity, directness, and *constancy*. *Burke.*

I'll pu' the budding rose, when Phœbus peeps in
view,
For it's like a baumy kiss o' her sweet bonnie mou ;
The hyacinth's for *constancy*, wi' its unchanging
blue,
And a' to be a posie to my ain dear May. *Burns.*

Thump after thump rounds the *constant* nail,
That seems to swing uncertain, and yet falls
Full on the destined ear. Wide flies the chaff,
The rustling straw sends up a frequent mist
Of atoms, sparkling in the noonday beam. *Cowper.*

J. SURF. O, madam, punctuality is a species of
constancy, a very unfashionable quality in a lady.

Sheridan. School for Scandal.

His heart was one of those which most enamour us,
Wax to receive, and marble to retain.
He was a lover of the good old school,
Who still become more *constant* as they coo.. *Byron. Beppo.*

She was all which pure ignorance allows,
And flew to her young mate, like a young bird
And never having dreamt of falsehood, she
Had not one word to say of *constancy*. *Id. Don Juan.*

CONSTANTIA, a district at the Cape of
Good Hope, consisting of two farms, which pro-
duced the well known wine once much prized
in Europe, by the name of Cape or Constantia
wine. See CAPE OF GOOD HOPE.

CONSTANTINA, or CONSTANTIA, a consi-
derable province of the territory of Algiers,

bounded on the north by the Mediterranean, on
the east by Tunis, on the south by the desert, and
on the west by Algiers Proper, or Titterie. It
is 230 miles in length, and 100 in breadth, being
the most fertile and best cultivated portion of the
Algerine states. Its principal internal produc-
tions are grain, hides, and wax ; but the coral
fishery on its shores has been the chief attractor
to European nations. It is governed by a bey,
half independent of the Algiers despot, who col-
lects his tribute from the southern districts every
two or three years, assisted by a chosen body of
troops.

CONSTANTINA, the capital of the above
territory, is the largest and strongest town in the
eastern part of Algiers, and is seated on the top
of an immense rock. It is only to be reached
by steps cut out of the rock ; and the usual way
of punishing criminals is to throw them down
this precipice. Here are many Roman anti-
quities, particularly a triumphal arch in fine pre-
servation. The neighbourhood is very fruitful
and watered by the Rummel, a river which flows
through the rock for upwards of a quarter of a
mile. It is seventy-five miles from the sea-coast,
and 210 east by south of Algiers.

The French formerly established the settlements
of Bona, La Callee, Cullu, and Tabarea, on this
coast, for which they agreed to pay a tribute of
£4000 a year to the bey ; but these places were
wrested from them by Great Britain in the late
war, and finally ceded to that power by the
treaty with Algiers in 1806 : we agreeing to pay
£11,000 annually to the bey.

CONSTANTINE I., surnamed the Great, the
first emperor of the Romans who embraced
Christianity. Dr. Anderson, in his Royal Ge-
nealogies, makes him not only a native of Bri-
tain, but the son of a British princess. It is
certain that his father, Constantius Chlorus, was
at York, when, upon the abdication of Diocle-
sian, he shared the Roman empire with Galerius
Maximinus in 305, and that he died in York in
306, having first caused his son, Constantine, to
be proclaimed emperor by his army, and by the
Britons. Galerius at first refused to admit
Constantine to his father's share in the imperial
throne ; but, after having lost several battles, he
consented in 308. Maxentius, who succeeded
Galerius, opposed him ; but, being defeated, he
drowned himself in the Tiber. The senate then
declared Constantine first Augustus and Licinius
his associate in the empire in 313. These
princes published an edict, in their joint names,
in favor of the Christians ; but soon after, Licinius,
jealous of Constantine's renown, conceived
an implacable hatred against him, and renewed
the persecutions against the Christians. This
brought on a rupture between the emperors,
and a battle, in which Constantine was victo-
rious. A short peace ensued ; but Licinius
having shamefully violated the treaty, the war
was renewed ; when, Constantine totally defeat-
ing him, he fled to Nicomedia, where he was
taken prisoner, and strangled in 323. Const-
antine, now become sole master of the whole em-
pire, immediately formed the plan of establishing
Christianity as the religion of the state ; for which
purpose, he convoked several ecclesiastical coun-

cils; but, finding he was likely to meet with great opposition from the pagan interest at Rome, he conceived the design of founding a new city, to be the capital of his Christian empire. See CONSTANTINOPLE.

The glory Constantine had acquired, by establishing the Christian religion, was tarnished by the part he took in the persecutions carried on by the Arians, towards the close of his reign, against their Christian brethren who differed from them. Seduced by Eusebius, of Nicomedia, he banished several eminent prelates; soon after which he died, A. D. 337, in the sixty-sixth year of his age, and thirty-first of his reign. Constantine was chaste, pious, laborious, and indefatigable; a great general, successful in war, and deserving his success by his valor and genius; a protector of the arts, and an encourager of them by his beneficence. If we compare him with Augustus, we shall find that he ruined idolatry by the same address that the other used to destroy liberty. Like Augustus, he laid the foundation of a new empire; but less skilful, he could not give it the same stability; he weakened the body of the state by giving it a second head at Constantinople; and transporting the centre of motion and strength too near the eastern extremity, he left without heat, and almost without life, the western parts, which soon became a prey to the barbarians. The pagans were too much his enemies to do him justice. Eutropius says, that in the former part of his reign he was equal to the most accomplished princes, and in the latter to the meanest. The younger Victor, who makes him to have reigned more than thirty-one years, pretends, that in the first ten years he was a hero; in the twelve succeeding ones a robber; and in the ten last a spendthrift. It is easy to perceive, with respect to these two reproaches of Victor's, that the one relates to the riches which Constantine took from idolatry, and the other to those with which he loaded the church. A modern historian, of infidel principles, has followed this mode of depicting the character of Constantine very singularly. 'In the life of Augustus,' says Gibbon, 'we behold the tyrant of the republic, converted, almost by imperceptible degrees, into the father of his country and of human kind. In that of Constantine, we may contemplate a hero, who had so long inspired his subjects with love, and his enemies with terror, degenerating into a cruel and dissolute monarch, corrupted by his fortune, or raised by conquest above the necessity of dissimulation.'

The reality of the miracle by which Constantine is said to have been converted to Christianity, is the great 'historical doubt' of his life; and his domestic conduct, perhaps, his greatest reproach. At the instigation of his second wife, Fausta, he is said to have listened to the most improbable accusations against his eldest son, Crispus, a very amiable prince. Not only was he described as plotting secretly against his father's authority, but his mother-in-law is stated to have charged him with an attack upon her honor. On this he was suddenly apprehended, and put to death, without even the form of a trial, on the twentieth anniversary of the emperor's reign. His grandmother, Helena, convinced of his inno-

cence, resolved, it is added, to bring his accuser's motives to light, and found means of convicting her of an adulterous connexion with a slave of the palace, for which she was suffocated in the steam of a vapor-bath. The part which the emperor took in these proceedings is not exactly defined by historians; but, as he has not wanted eulogists, we may presume, that as it has never been offered, nothing like an honorable exculpation of him is to be found.

Eusebius's account of the miracle alluded to, is thus abridged by M. Milner:—'While he was marching with his forces in the afternoon, previous to his great battle with Maxentius, A. D. 312, the trophy of the cross appeared very luminous in the heavens, higher than the sun, with this inscription, *ϠΟΥΡΩ ΝΙΚΑ*, 'conquer by this.' He and his soldiers were astonished at the sight; but he continued pondering on the event till night. And Christ appeared to him when asleep, with the same sign of the cross, and directed him to make use of the symbol as his military ensign. Constantine obeyed, and the cross was henceforward displayed in his armies.—History of the Church of Christ, vol. ii. p. 41. Eusebius adds, that Constantine communicated this wonderful circumstance to his friends in the morning, and sending for ingenious workmen, gave them a description of the sign, and saw them make one like it in gold and precious stones; which, says he, 'we have seen.'

This imitation of the visionary cross was afterwards the labarum of the army, and consisted of a cross, surmounted by the figure P or P , and encircled with a crown of gold; this being, according to the Greek orthography, the initial letters of the name of Christ. 'The victorious emperor himself having told it to us,' says Eusebius, who wrote this history a long time after, 'when we had the honor of his acquaintance and conversation. and having likewise confirmed it with an oath, who can refuse his assent to it, especially when following events have borne testimony to the truth of it?' To which, in effect, the judicious Lardner answers, 1. This relation is delivered by Eusebius upon the sole credit of Constantine; whereas a thing of so public a nature could not have rested upon his credit and authority only, if it had been true. Other witnesses might have been called to vouch for the truth of an event, so surprising and so recent, i. e. twenty years before Eusebius wrote the life of Constantine; and the historian, from dutiful affection for the emperor, and from a just concern for his own honor would not have failed to add something to this purpose. 2. The oath or oaths of Constantine upon this occasion, rather bring his relation into suspicion. 3. Eusebius renders this whole account suspicious, by not mentioning the place of this wonderful sight; and this defect renders it probable that Eusebius himself did not believe this story, nor intend to vouch for the truth of it. 4. There are other things concerning the standard, related by Eusebius, which he also had from Constantine, and which are very unlikely, if not altogether incredible. Wherever the standard was, says the historian, the enemies fled. and this is not improbable, because it might animate Constantine's soldiers,

and terrify the enemy. But it is added, that the salutary trophy was a safeguard to him who bore it, and there never was any one wounded in this service. This relation, for which Eusebius does not make himself answerable, surpasses all credible accounts of miracles; that when many darts were thrown, none should strike the bearer, nor yet light upon the upper part of the standard, where were the cross and the motto, but only, and always, upon the narrow circumference of the spear, or pole of the standard. 5. Lactantius, or the author of the book *Of the Deaths of Persecutors*, who wrote a few years after this appearance in the heavens is supposed to have happened, says nothing of it, but only mentions Constantine's dream or vision in his sleep.

Dr. Lardner's doubts on this subject are the more entitled to consideration, as he is far from forming an unfavorable opinion of Constantine's general character. 'We should be willing,' says he, 'to make allowances in favor of princes, and especially of long reigns. It is next to impossible for human wisdom and discretion, in the course of many years filled with action, not to be surprised into some injustice, through the bias of affection, or the specious suggestions of artful and designing people. Though, therefore, there may have been some transactions in this reign which cannot easily be justified, and others that must be condemned, yet we are not to consider Constantine as a cruel prince or a bad man.'

For ourselves, we apprehend, that neither the object nor the evidence of the miracle in question are worthy the Christian cause. How the emperor should identify the person of Christ, in the vision which is thought the more credible part of the narrative, seems difficult to conceive; and to us it is perfectly incomprehensible, that the Saviour should thus commission the symbol of his peaceful and holy religion to become, at once, that of the destruction of mankind.

CONSTANTINOPLE, the capital of the Turkish empire, called by the ancients Byzantium, and by the modern Turks Stampol or Istampol, is situated on the western shore of the Bosphorus. No situation can combine greater advantages: the Euxine Sea on the north, and the Mediterranean on the south, open to its commerce easy communications with the most fertile and important nations of the three continents; and nothing can be more superb than the view presented by the adjacent country, as the traveller approaches it. The city seems to rise from the bosom of the sea, like the vision of an enchanter's wand, the seven hills upon which it is built successively presenting themselves, crowned with glittering kiosks, gilded domes, and tapering minarets, intermixed with innumerable cypress trees, a green hill, beautifully sloping upwards from its walls, terminating the prospect. It is of a triangular form, its obtuse angle extending into the sea of Marmora, and the base facing the west, and has a wall from fourteen to twenty feet in height, running along the side towards the sea, surmounted at intervals with towers, and containing six gates. Its fortifications have suffered much from the effects of time, and many parts of them are in ruins. On the land side facing the west, is the celebrated wall built by Theodosius, ex-

tending five miles in length, and a fosse twenty-five feet wide. This wall, though it has stood the shock of so many attacks, is still in a state of amazing preservation: it is flanked with lofty towers, and has five gates, with stone bridges over the fosse. The Porta Sancti Romani, where the emperor Constantine Paleologus fell covered with glorious wounds, is associated with the most interesting recollections. The remaining wall of the triangle is formed of alternate courses of freestone and bricks, and has thirteen gates. All the angles were originally surmounted with towers, having conical roofs, but of these one was destroyed by an earthquake in 1768, and another is rapidly mouldering into decay. The whole area surrounded by these walls is 2000 acres, and their circumference about fourteen English miles.

The interior of Constantinople, however, presents a widely different appearance from the splendid coup d'œil, afforded by its exterior. Mr. Sandys remarks, 'I think there is not in the world any object that promiseth so much afar off, and entered, that so deceiveth the expectation.' It is indeed an assemblage of slanting, gloomy, and dirty streets, bearing no names, and so infested with filth and ordure, that one would suppose that the office of cleaning them is left entirely to the dogs and vultures which prowl about in great numbers, and the rain of heaven. The houses are very low (none of them being allowed to exceed twenty feet in height), and for the most part composed of wood or earth, and few of them boasting of the luxuries of glazed windows or chimneys. Owing to the combustible materials of which the houses are composed, and the proverbial improvidence of the Turks, fires are of very frequent occurrence; nay, it is said, that one would find it a matter of difficulty to point out the site of a single house in Constantinople where a fire has not been seen. Of the streets, the one leading from the seraglio to the Atmejdán is by far the most imposing; but if the Turks may, with any degree of justice, claim for their city the proud name of 'New Rome,' it must be attributable to the gloomy grandeur which is diffused over it, by its numerous palaces, mosques, bagnios, bazaars, and caravan-sarais.

The seraglio, however, is the most celebrated of all the buildings of Constantinople. It is situated on the eastern promontory, and, with its gardens, covers one of the seven hills. This palace was originally built by Mahomet II. but has been much enlarged and beautified by succeeding sultans, who have occupied it not merely for their women and their retinues, but with all the pomp and pageantry of the court, and a vast crowd of the officers attached to the government. It is supposed to contain upwards of 10,000 inhabitants. The grand entrance is on the west, through a marble portico, called, the *Baba-hoomajin*, or *Sublime Porte*; and from this entrance it is supposed the *Ottomar Court* took its title of *Porte* or *Sublime Porte*, affixed at present to all its public transactions and records. It is in this place that state delinquents are beheaded, and their heads are displayed for three days after their execution. The first court contains the mint, the principal

mosque (St. Sophia), and the officers of the vizier's divan. At the first two gates guards are always stationed. At about a thousand paces distance from the other gate, is situated the Baba-Salem (gate of health), which conducts to the second court. Through this gate none but the sultan can enter on horseback. The court contains the grand audience chamber, in which the sultan receives the ambassadors of foreign courts. The throne on which he reclines on these occasions, has been much admired for its great magnificence; it has the shape of a bed, and is covered with precious stones, and embroideries of pearls and jewels. The gate which leads to the third court is called Baba-Saadi, or the Gate of Happiness. Into this those only who compose the sultan's suite, being Mahomedans, are allowed to enter: ambassadors from foreign courts, and others who are favored with an audience, are conducted to the presence chamber by a covered passage. Beyond this court are situated the various apartments of the Haram, which generally contain about 500 unhappy females. From the elevated position of many of these abodes they may be seen from the city, but none of them can be visited, excepting those devoted to the summer residence of the females, during the time they are in their winter apartments. The furniture of the palace is said to be very magnificent. The audience chamber, in which the sultan and sultan-mother receive the visits of ceremony from the sultanas, is wainscotted with jasper, inlaid with ivory and mother of pearl, and has a kind of sofa which extends round the room; the walls are decorated with a profusion of mirrors, and the costly presents received from foreign powers; and the hangings are composed of cloth of gold, richly embroidered with fringes strung with pearls. The palace library contains several important Greek, Latin, and Oriental manuscripts; but as no Christian is permitted to enter this apartment, the exact number and value of its contents is entirely conjectural. According to Dr. Clarke, the gardens display nothing of refined taste in their arrangement, or of great curiosity in their contents, but the prospect from them is unrivalled.

Constantinople contains 130 public baths, and scarcely a street is to be found that has not its fountains. Many of these baths are very elegant structures, formed of hewn stone, and having the floors of their inner apartments paved with marble. The manner in which they are used by the Turks resembles the lustrations of the Greeks rather than our mode of bathing. The fountains are for the most part low square buildings, roofed with lead, and profusely decorated with gilding and paint, and inscribed with verses from the Koran, and favorite Mahomedan doctors. According to the most accredited statements the city altogether contains upwards of 300 mosques. The most celebrated, both for its antiquity and splendor of architecture, is, as we have already stated, St. Sophia. This magnificent building, said to be more extensive than St. Peter's at Rome, stands near the principal gate to the seraglio. It was originally built by Constantine the Great, but during a popular sedition, which took place in the reign of Justinian, it was burnt to the ground; in the same reign,

however, arose the present sumptuous edifice. It is built in the form of a Greek cross; the length from east to west being 270 feet, and the breadth from north to south 243. It is ornamented by a dome of so imperceptible a curve, that the perpendicular concavity is not more than one-sixth of the diameter. The principal vestibule is on the west side, and is twenty-eight feet wide, having nine doors of bronze, ornamented with a variety of subjects in alto relievo. The dome rests on pillars composed of the finest marble. Andronicas added two immense buttresses to it in 1317, and the Turkish emperor, Selim II., four minarets, so that the exterior beauty of the building is greatly marred by the heterogeneous nature of its component parts. The interior of the church has been much defaced by the Turks. Its grand dome rests upon four arcades, which are connected with a like number of cupolas, and the whole blending together form an amazing expanse of roof. The spacious pavement is completely covered with the richest carpets. Nothing can exceed the splendor of the interior during the celebration of a Turkish festival; from the roof are suspended an innumerable quantity of lamps, composed of colored glass, globes of crystal, ostrich eggs, and ornaments of gold and silver, which reflect their radiance from the green jasper and porphyry pillars, with which the stupendous concave is thronged, 'and glitter,' as the Turkish writers say, 'like the stars in the firmament.' The whole interior of the dome was originally ornamented with rich Mosaic work upon a golden ground; but the Turks have obliterated all its beauty by covering it with white-wash. The revenues of St. Sophia, which amount to nearly £3000 per annum, principally arise from land held under a species of tenure, called *vacuf* which is somewhat analogous to our church lands: they are expended in keeping the mosque in repair, and in paying the officiating imams. Of the mosques, several were originally Greek churches. The most celebrated, built by the Turkish sultans, are those of Mahomet II., situated on one of the seven hills, and of the sultan Achmet I., which has six minarets of amazing height and extraordinary beauty. There is also one, erected by Bajazet, in which are ten columns of verd antique, four of jasper, and six of Egyptian granite.

Most of these mosques are situated in squares or public places, and are generally surrounded by lofty colonnades of marble, having gates of brass. In the centre of the area is placed a fountain of polished marble. The remains of the founders of each mosque are deposited with such reliques as are supposed worthy of preservation, in a chapel attached to the principal building. The Greeks have twenty-three churches in Constantinople; there are also six Roman Catholic convents, several Jewish synagogues, and a Swedish church. The Christian churches have the appearance of private houses; no spires or bells being permitted to any religious edifice, excepting the mosques. The Protestant envoys, viz. the English, Swedish, and Dutch have chaplains attached to their respective suites.

Amongst the most curious and useful esta-

blishments of Constantinople may be mentioned the bazaars. They generally consist of immense square stone buildings, lighted by domes, and are admirably adapted to the exigencies of the climate. Almost every trade is carried on in its own particular quarter, and quite separated from all others. In one street nothing is to be purchased but arms and military accoutrements; another is devoted to the exclusive sale of jewels, diamonds, and precious stones; in a third you meet with nothing but silks, generally worn by the Turks, and in the manufacture of which the Armenians employ 10,000 looms. Whole streets are set apart for the sale of books, Arabic, Persian, and Turkish MSS.; for pipe-makers, shoemakers, farriers, confectioners, &c. One of the most noted bazaars is appropriated to the sale of drugs, the spices of the east, and medicines, amongst which opium holds the foremost place. The bazaars are closed at an early hour every evening.

The numerous khans, situate in different parts of the city, afford ample accommodation for the merchants who frequent Constantinople from all quarters of the Turkish empire. The woman-market is held every Friday morning, in a large enclosed court, surrounded with numerous apartments. Hither the unhappy female-slaves are brought to be sold, some of them from an immense distance. The Egyptian and Abyssinian women are generally bought for domestic purposes, whilst the Georgians and Circassians are devoted to the harems of the wealthy, or the seraglio of the sultan. Some of these sell for several thousand piastres.

Constantinople is rich in antiquities. The most conspicuous is perhaps the Grecian Hippodromus, which is still in a state of excellent preservation. It is an enclosure, extending about 250 paces in length and 150 in breadth, and was used for the exhibition of public games, &c. During the time of the Greek empire the circus was ornamented with numerous statues, obelisks, &c. but few of these have escaped the successive ravages of the Turks, the French, and the Venetians. There are still remaining, however, many fragments of Greek and Roman sculpture, in different quarters of the city. The Atmedoa is to this day used by the Turkish noblesse as the place where they exercise themselves in their military game, called dijiri. This game consists in darting a white wand, of about four feet in length, at each other, whilst on horseback; in avoiding the darts of their antagonists; in stopping their horses when in full gallop, &c. The successful exercise of it requires great strength and agility.

Nothing can be more contradictory than the statements of different travellers, with respect to the population of Constantinople. Habesci says it amounts to 1,500,000, whilst on the other hand Eton reduces it to less than 300,000, and alleges, in proof of the correctness of his computation, that it does not occupy so large a site as the city of Paris, and that the buildings are smaller, and more open. It is impossible to ascertain precisely the number of inhabitants, as the Turks keep no registers: most modern travellers, however, concur in estimating the number at about

400,000. This population is of a very mixed character; scarcely one-half are Turks, the rest Greeks, Jews, Armenians, and Franks. These latter, when they appear in the streets and public places, present a singular contrast in their timid and circumspect behaviour, to the haughty, superb gait, and supercilious appearance of the Turks.

The walking costume of the females has in it something graceful; it consists of a mantle which covers the whole body, the eyes alone being visible, so that it is impossible to distinguish the age of the fair perambulator; and to address a lady in the streets is considered a great violation of good manners. What gives a very picturesque appearance to a Turkish crowd is the custom which prevails of every different trade and nation being habited in the costume of his respective country or profession. This produces an almost endless variety of color and pattern in their dress, and presents groupes and combinations of effect which painters in all countries have delighted to transfer to their canvas.

The Greek nobility, resident at Constantinople, principally occupy the Phonar, a northern district of the city. Their sole ambition appears to be directed to the obtaining some paltry place under the Turkish government, such, for instance, as that of interpreter, or provincial governor.

The most terrific enemy to the inhabitants of Constantinople is the plague. From the year 1783 to 1785, it is said, upwards of 100,000 children and young persons fell victims to this awful visitation. Most authors have concurred in attributing the great ravages committed by this evil, rather to the perverse carelessness and total inanity of the Turks, than to any peculiar disadvantage of the climate. This, however, is by no means healthy, being subject to continuous transitions from excessive heat to the piercing blasts of the north-east. Pooquerille estimates the average of the climate in ordinary years at sixty-six days of rain, four of snow, six of fog, twenty cloudy, forty variable, and fifteen thunder; thus, according to this calculation, 214 days of uniform serenity remain. This city is occasionally visited by tremendous thunder-storms, and earthquakes are not infrequent. To these inconveniences may be added the scarcity of pure water in many parts, and the confined, crooked, and filthy state of the streets in every quarter.

The harbour of Constantinople in respect both to its security and the accommodation it is capable of affording to ships, is said to be one of the finest in the world. It separates the European quarters, Galata and Pera, from the north of the city, and is formed of a branch of the Bosphorus. It is about seven miles in length, and its breadth at the entrance is 500 yards. It is capable of containing 1200 ships. From its curved outline and the rich galleys which occasionally ride at anchor upon its waters, it, at an early period, obtained the appellation of the Golden Horn, which it still retains. Ships can approach close to the shore, and unload their cargoes with the utmost facility, owing to the steepness of the banks and the little influence

the tides have in these seas. The greatest inconvenience attending the harbour is said to be produced by a considerable current, which prevails along the south side, and which it requires some precaution to avoid in putting out to sea, lest the vessel be driven on the projecting point of the seraglio, where there is a tremendous torrent.

The commerce of Constantinople is insignificant; Dr. Clarke says, 'The ships which crowd its ports have no connexion with its welfare; they are for the most part French, Venetian, Ragusan, Sclavonian, and Grecian vessels, to and from the Mediterranean, exchanging the produce of their own countries for the rich harvests of Poland; the salt, honey and butter of Ukraine; the hides, tallow, hemp, furs and metals of Russia and Siberia; the whole of which exchange is transacted in other parts without any interference on the part of Turkey.' Thus with almost the finest situation, and some of the greatest facilities of any country in the world, Turkey is comparatively unknown as a commercial nation; and the manufactories do not, at the present day, produce a sufficient supply of goods for their own consumption. They generally pay their imports either in specie, or in gold and diamonds.

The intelligent traveller, just quoted, gives altogether a most gloomy picture of the trade and habits of this metropolis. 'We landed at Galata,' says he, 'in the midst of dunghills, on which a number of large, lean, and mangy dogs with their whelps, wallowing in mire, and all covered with filth and slime were sprawling or feeding. The appearance of a Frank (the name applied to every Christian in the Levant, of whatever nation,) instantly raises an alarm among the animals, who never bark at the Turks; and, as they were roused by our coming on shore, the noise became so great that we could not hear each other speak. To this clamour were added the brawlings of a dozen porters, vociferously proffering their services, and beginning to squabble with each other as fast as any of them obtained a burden. At length we were able to move on, but in such confined, stinking, and yet crowded lanes, that we almost despaired of being able to proceed. The swarm of dogs, howling and barking, continually accompanied us, and some of the largest attempted to bite. When we reached the little inn of Pera, where a few small rooms, like the divisions in a rabbit-hutch, had been prepared for our reception, we saw at least fifty of these mongrels collected round the door of the yard, like wolves disappointed of their prey. The late storms had unroofed several of the houses in Pera; that in which we lodged was among the number; one corner of it had been carried away with the wind, so that, without climbing to the top for a view of the city, we commanded a fine prospect of the Golden Horn, and part of Constantinople, through the walls of our bed-rooms, which were open to the air. Pera had recently suffered in consequence of a conflagration which had nearly consumed every house in the place. There was reason to believe some improvement would take place during its restoration; but we found it rising from its ashes like a new phoenix, without the slightest deviation from the form and appear-

ance of its parent. The exception only of one or two houses formerly of wood and rebuilt with stone might be noticed; but all the rest were as ugly, inconvenient, and liable to danger as before; and were it not for a few workmen, employed in fronting the houses of the merchants, no stranger could discover that any accident had taken place.

Considering the surprising extent of the city and suburbs of Constantinople, the notions entertained of its commerce, and the figure it has long made in history; all the inconveniences if not the luxuries of life, might be there expected. Previous to an arrival, if any enquiry is made of merchants and other persons who have visited the place, as to the commodities of its markets, the answer is almost always characterised by exaggerations. They will affirm that everything a stranger can require may be purchased in Constantinople as in London, Paris, or Vienna; whereas, if truth be told, hardly any one article good in its kind can be procured. Let a foreigner visit the bazaars, properly so called, he will see nothing but slippers, clumsy boots of bad leather, coarse muslins, pipes, tobacco, coffee, cook-shops, drugs, flower-roots, second-hand pistols, poniards, and the worst manufactured wares in the world. In Pera, where Greeks and Italians are supposed to supply all the necessities of the Franks, a few pitiful stalls are seen, in which everything is dear and bad. Suppose a stranger to arrive from a long journey, in want of clothes for his body; furniture for his lodgings; books or maps for his instruction and amusement; paper, pens, ink, cutlery, shoes, hats; in short, those articles which are found in almost every city of the world; he will find few or none of them in Constantinople, except of a quality so inferior as to render them incapable of answering any purpose for which they were intended. The few commodities exposed for sale are either exports from England, unfit for any other market, or, which is worse, German and Dutch imitations of English manufacture. The woollen cloths are hardly suited to cover the floor of their own counting-houses; every article of cutlery and hardware is detestable; the leather used for shoes and boots is so bad that it can scarcely be wrought; hats, hosiery, linen, buttons, buckles, are all of the same character; of the worst quality, and yet of the highest price. But there are other articles of merchandise, to which we have been accustomed to annex the very name of Turkey, as if they were the peculiar produce of that country; and these at least a foreigner expects to find; but not one of them can be had. Ask for a Turkish carpet, you are told you must send for it to Smyrna; for Greek wines, to the Archipelago; for a Turkish sabre, to Damascus; for the sort of stone expressly denominated *turquoise*, they know not what you mean; for red leather, they import it themselves from Russia or from Africa; still you are said to be in the centre of the commerce of the world; and this may be true enough with reference to the freight of vessels passing the straits which is never landed. View the exterior of Constantinople, and it seems the most opulent and flourishing city of Europe; examine its interior, and its miseries and deficiencies are so

striking, that it must be considered the meanest and poorest metropolis of the world.

'Never was there a people in possession of such advantages, who either knew or cared so little for their enjoyment. Under a wise government, the inhabitants of Constantinople might obtain the riches of all the empires of the earth. Situated as they are, it cannot be long before other nations, depriving them of such important sources of wealth, will convert to better purpose the advantages they have so long neglected.'

The police of Constantinople is perhaps unequalled by that of any other city in the world, and certainly exceeds the celebrated system adopted by Louis XIV. of France. By the Mahomedan law, theft is constituted a capital offence, yet the Government have found it expedient in some measure to connive at its commission: with this view they have a separate officer of police to superintend this particular class of criminals. He is styled *zyndan hassekisi* (keeper of the prison) and is in fact no other than the captain, or chief of thieves. He is, or was lately, selected from the servants of the Aga of the Janissaries, and his office is held so long as he is considered capable of discharging its duties; his incapacity being deduced from his inability to apprehend any particular thief, whose person is sought after. The moment an offender is caught, his whole interest is put in requisition, presents are sent, and the friends of the delinquent have immediate communication with the *zyndan hassekisi*, who on his part (should he espouse the culprit's cause) employs all his interest with the higher powers to save his life, and to get him transferred to the *Bagnio*, or great prison of the Arsenal, from whence after a few weeks incarceration he manages to procure his discharge. In the meantime the name of the new thief, every minutia characteristic of his person, and his most favorite modes of carrying on his profession, are noted down with the most punctilious accuracy in the books of the *zyndan*, and from this moment he becomes a member of the fraternity. A thief who has not thus propitiated the favor of this officer, is sure to be executed the first time he is convicted. The protegés of the *zyndan hassekisi*, are of both sexes, and of every age and country. Every disguise, from that of a man of rank to a mendicant, is assumed by them, and they exercise their professional talents with little or no hazard. Their gains, however, are taxed; for not only is he who has actually committed robbery obliged to give a portion of the effects stolen, but he against whom an information is laid, and who is apprehended on suspicion, cannot procure his release without handsomely paying for it. The *zyndan*, from the circumstance of his being selected from the corps of the *Mumgi*, is necessarily a person of some experience in the predatory profession; and every thief being known to excel in some particular branch of it, one for instance in forcing a door, another for his dexterity in picking locks, a third in inventing a feasible pretext for entering a house, &c. when any person lodges a complaint at the police office, he is minutely interrogated as to all the particulars of the case; the *zyndan hassekisi* summonses before him those who are known to pursue that particu-

lar line of the profession, and the guilty person is speedily detected. The stolen property is now soon recovered; notwithstanding which, if the owner of it do not handsomely fee the *zyndan*, it is divided amongst the thief and some few persons in office. The city guard is composed of a troop appointed to each gate; besides three or four men to most of the streets. These keep continually parading the city day and night. The gates are regularly closed one hour after sunset.

The suburbs of Constantinople are very thickly inhabited, and extend from the north of the city, near the harbour. The names of the principal of these, are Galata, Pera, and Scutari; Galata is chiefly peopled by the merchants and sea-faring men of all nations. Pera occupies a lofty hill immediately to the westward of Galata; and is built almost exclusively of wood and unburnt bricks. The streets are confined and badly paved, but the air and water are salubrious, and the prospects it affords from its elevated situation are exceedingly beautiful. Scutari lies on the Asiatic side of the Bosphorus, but is considered as belonging to the suburbs of Constantinople. It is built on the site of the ancient Chrysolopolis and presents a remarkably picturesque appearance from the city. This suburb is the general rendezvous for the Asiatic caravans, and is principally remarkable as containing the finest cemeteries in the Ottoman Empire, some of them extending for many miles to the east and south of the town.

A belief entertained by the Turkish noblesse, that their capital will one day be re-taken by the Christians, has constituted this their most fashionable place of residence, as being farthest removed from the European side. To these may be added the suburb of St. Demetri, which is crowded with Greeks, and Tophana (the Iron foundry) situated on the north side of the harbour, and separated from Galata, by one of the cemeteries of which we have spoken above. There is also a village, in the immediate vicinity of the city, called Eyub from Eyub or Job, the name of one of Mahomet's standard-bearers; Mahomet II. having in a revelation discovered the burial place of this man (who was killed by the Saracens in their first siege of Constantinople) caused a splendid mausoleum and mosque to be raised over his ashes.

The environs of the capital exhibit but a melancholy appearance. A few Greeks did indeed cultivate a portion of the land, and are amply repaid for their toil by plentiful crops, but the Turks often devastate and pillage them, unchecked by the interference of the Government. Along the line of coast, however, numerous splendid palaces, with beautiful hanging gardens, are to be met with; and a few vineyards are scattered about the neighbourhood of Pera. Of the character of the inhabitants of this capital we shall speak more particularly under the head *TURKEY*. We may add, however, that the excessive indolence of the Turks, and the wretched policy of their Government, are seen nowhere beside in such striking colors. E. long. of the mosque of St. Sophia 28° 55' 15" N. lat. 41° 1' 27".

CONSTAT, in law, a certificate which the

clerk of the pipe and auditors of the exchequer make at the request of any person who intends to plead or move in that court for the discharge of anything; and the effect of it is, the certifying what does constare upon record, touching the matter in question. A constat is held to be superior to a certificate; because this may err or fail in its contents; that cannot, as certifying nothing but what is evident upon record. The exemplification, under the great seal, of the enrolment of any letters patent, is also called a constat.

CONSTELLATE, *v. a. & n.* } *Fr. constel-*
CONSTELLATION, *n. s.* } *lation; Ital.*
constellazione; Sp. constellacion; Iat. constel-
latus. To shine with conjoint lustre; to unite the splendor of several lucent bodies. The accent was formerly on the first syllable. Constellation signifies several stars forming one cluster, and known by a particular name; also, figuratively, any assemblage of excellencies.

For the stars of heaven, and the constellations thereof, shall not give their light. *Isaiah xiii. 10.*

Fortune yeven hath this advenrite:
 Som wikke aspect or disposition
 Of Saturne, by som constellation,
 Hath yeven us this, although we had it swora.
Chaucer. Cant. Tales.

The earth, the air, resounded;
 The heavens and all the constellations rung.
Milton's Paradise Lost.

Great constitutions, and such as are constellated into knowledge, do nothing till they outdo all.
Browne's Vulgar Errors.

The condition is a constellation or conjuncture of all those gospel graces, faith, hope, charity, self-denial, repentance, and the rest.

Hammond's Pract. Catechism.
 The several things which engage our affections do, in a transcendent manner, shine forth and constellate in God.
Boyle.

A constellation is but one;
 Though 'tis a train of stars. *Dryden.*
 'T every polished gem we find,
 Illuminating heart or mind,
 Provoke to imitation;
 No wonder Friendship does the same,
 That jewel of the purest flame,
 Or rather constellation. *Lowper.*

CONSTELLATION, in astronomy, is a system of several stars near one another. Astronomers not only mark out the stars, but, to bring them into order, they distinguish them by their situations and positions in respect to each other; and distribute them into constellations, allowing several stars to make up one constellation. For the better distinguishing them, they reduce these constellations to the forms of animals, as men, bulls, bears, &c.; or to the images of some things known, as of a crown, a harp, a balance, &c.; or give them the names of those, whose memories they wish to transmit to future ages. The division of the stars by images and figures is of great antiquity, for, in the Book of Job, Orion, Arcturus, and the Pleiades are mentioned; and we meet with the names of many constellations in the writings of Homer and Hesiod. The ancients, in their division of the firmament, took in only so much as came under their notice,

distributing it into forty-eight constellations; but the modern astronomers comprehend the whole starry firmament, dividing it into three regions, viz. the zodiac, the region above, and that below it.

CONSTERNATION, *n. s.* *Fr. consternation; Ital. consternazione; Span. consternacion; Lat. consterno.* Excessive surprise; dismay; wonder; utter helplessness arising from fear.

They find the same holy consternation upon themselves that Jacob did at Bethel, which he called the gate of heaven. *South.*

The natives, dubious whom
 They must obey, in consternation wait
 Till rigid conquest will pronounce their liege. *Philips.*

The nature of courage is, without a question, to be conversant with danger; but, in the palpable night of their terrors, men under consternation suppose, not that it is the danger, which, by sure instinct, calls out the courage to resist it, but that it is the courage which produces the danger. *Burke.*

CONSTIPATE, *v. a.* } *Fr. constiper; Ital.*
CONSTIPATION, *n. s.* } *costipare; Span. constipar; Lat. constipare.* To render thick; to compress into little space. The act of compressing or condensing; stoppage from fulness; costiveness of the intestines. Both the verb and the noun are now chiefly used in the latter sense.

Of cold, the property is to condense and constipate. *Bacon.*

This worketh by the detention of the spirits, and constipation of the tangible parts. *Id. Natural History.*
 Omitting honey, which is laxative, and the powder of some loadstones in this, doth rather constipate and bind, than purge and loosen the belly. *Browne's Vulgar Errors.*

It may, by amassing, cooling, and constipating of waters, turn them into rain. *Ray on the Creation.*

The inactivity of the gall occasions a constipation of the belly. *Arbuthnot on Aliments.*

There might arise some vertiginous motions or whirlpools in the matter of the chaos, whereby the atoms might be thrust and crowded to the middle of those whirlpools, and there constipate one another into great solid globes. *Bentley.*

It requires either absolute fulness of matter, or a pretty close constipation and mutual contact of its particles. *Id.*

CONSTITUTE, *v. a. & n. s.* } *Fr. consti-*
CONSTITUTER, *n. s.* } *tuer; Ital. costi-*
CONSTITUTION, *n. s.* } *tituire; Span.*
CONSTITUTIONAL, *adj.* } *constituir; Lat.*
CONSTITUTIONALIST, *n. s.* } *constituere.* To
CONSTITUTIONALLY, *adv.* } constitute is,
CONSTITUTIONIST, *n. s.* } to make to be;
CONSTITUTIVE, *adj.* } to give regular
CONSTITUENT, *n. s. & adj.* } existence to;

to set up; to fix; to ordain; to depute; to appoint to office. The constituter is, the person who performs these acts; and the power by which he performs them is denominated constitutive. The noun, constitute, of old meant an established law. As an adjective, constituent signifies that which makes anything what it is; that which is an essential, integral part of. As a noun, it denotes the person or thing which performs the act of constituting; an indispensably necessary part of; he who deposes another to act for him. Constitution has several meanings.

The two prominent are, form of government; the state of the body with relation to strength and weakness, health and disease. It also denotes the act of constituting; mode of being; particular texture of parts; natural qualities; disposition with respect to temper; particular law; established usage. Constitutional, is that which is inherent in the corporeal constitution; in conformity with the civil constitution. Constitutionally means done legally; done according to the rules of the constitution. A constitutionist is one who is zealous for the constitution under which he lives; a constitutionalist, one who adheres to, or who has assisted in forming, a constitution. The last of these words is chiefly applied to those who formed, or defended, the French constitution of 1791.

We lawfully may observe the positive constitutions of our own churches. *Hooker.*

Dametas, according to the constitution of a dull head, thinks no better way to show himself wise than by suspecting every thing in his way. *Sidney.*

Some dear friend dead; else nothing in the world Could turn so much the constitution Of any constant man.

Shakespeare. Merchant of Venice.

The Norman conquering all by might, Mixing our customs, and the form of right, With foreign constitutions he had brought. *Daniel.*

Although it be placed among the non-naturals, that is, such as, neither naturally constitutive nor merely destructive, do preserve or destroy.

Brown's Vulgar Errors.

We must obey laws appointed and constituted by lawful authority, not against the law of God.

Taylor's Holy Living.

Their first composure and origination requires a higher and nobler constituent than chance.

Hale's Origin of Mankind.

He defended himself with undaunted courage, and less passion than was expected from his constitution.

Clarendon.

The elements and constitutive parts of a schismatick, being the esteem of himself, and the contempt of others.

Decay of Piety.

The obstruction of the mesentery is a great impediment to nutrition: for the lymph in those glands is a necessary constituent of the aliment.

Arbutnot on Aliment.

Amongst many bad effects of this oily constitution, there is one advantage; such who arrive to age, are not subject to stricture of fibres.

Id.

Nothing can be more reasonable than to admit the nominal division of constitutionists, and anti-constitutionists.

Bolingbroke.

It is impossible that the figures and sizes of its constituent particles should be so justly adapted, as to touch one another in every point.

Boutley's Sermons.

This is more beneficial than any other constitution.

Id.

This light being trajected through the parallel prisms, if it suffered any change by the refraction of one, it lost that impression by the contrary refraction of the other: and so, being restored to its pristine constitution, became of the same condition as at first.

Newton's Opticks.

It is not probable any constitutional illness will be communicated with the small-pox by inoculation.

Sharp's Surgery.

Fierce licentiousness begets violent restraints. The military arm is the sole reliance; and then, call your constitution what you please, it is the sword that

governs. The civil power, like every other that call in the aid of an ally stronger than itself, perishes by the assistance it receives. *Burke.*

A true natural aristocracy is not a separate interest in the state, or separable from it. It is an essential integrant part of any large body rightly constituted.

Id.

By a constitutional policy, working after the pattern of nature, we receive, we hold, we transmit our government and our privileges, in the same manner in which we enjoy and transmit our property and lives.

Id.

I could wish, undoubtedly, (if idle wishes were not the most idle of all things,) to make every part of my conduct agreeable to every one of my constituents. *Id.*

I have often observed, in the course of my experience of human life, that every man, even the worst, has something good about him; though very often nothing else than a happy temperament of constitution inclining him to this or that virtue. *Burke.*

But will sincerity suffice?

It is indeed above all price,

And must be made the basis;

But every virtue of the soul

Must constitute the charming whole,

All shining in their places. *Cowper.*

Patient of constitutional control,

He bears it with meek manliness of soul. *Id.*

There are valetudinarians in reputation as well as in constitution; who, being conscious of their weak part, avoid the least breath of air, and supply their want of stamina by care and circumspection.

Sheridan. School for Scandal.

CONSTITUTIONS, APOSTOLICAL, a collection of regulations attributed to the apostles, and supposed to have been collected by St. Clement, whose name they likewise bear. It is the general opinion, however, that they are spurious, and that St. Clement had no hand in them. They appeared first in the fourth century, but have been much changed and corrupted since. They are divided into eight books, consisting of a great number of rules and precepts, relating to the duties of Christians, and particularly the ceremonies and discipline of the church.

CONSTR'AIN, *v. a.*

CONSTR'AINABLE, *adj.*

CONSTR'AINEDLY, *adv.*

CONSTR'AINER, *n. s.*

CONSTR'AIN'T, *n. s.*

CONSTR'AIN'TIVE, *adj.*

Fr. *contraindre*;

Ital. *costringere*; Sp.

costringer; Lat. *con-*

stringere; from *con-*

and *stringere*. To

compel; to prevent

by force; to violate; to embrace closely; to tie together; to constringe; to produce in opposition to nature; to withhold. Overpowering force; compulsion; act of restraining the desire; confinement.

But all for nought, the end is this, that he

Constrained was he needs must her wed,

And taketh this olds wif, and goth to bed.

Chaucer. Canterbury Tales.

Save I, alas! whom care of force doth so constrain,

To wale the day, and wale the night continually in payne.

Earl of Surrey.

Wherewith he gript her gorge with so great paine,
That soon to loose her wicked bonds did her constrain.

Spenser. Faerie Queene.

His limbs were waxen weak and raw,

Thro' long imprisonment, and hard constraint. *Id.*

Whereas men before stood bound in conscience to do as reason teacheth, they are now by virtue of human law *constrainable*; and, if they outwardly transgress, punishable. *Hooker.*

What occasion it had given them to think, to their greater obduration in evil, that through a forward and wanton desire of innovation we did *constrainedly* those things, for which conscience was pretended. *Id.*

Thy sight, which should
Make our eyes flow with joy,
Constrains them weep. *Shakespeare. Coriolanus*

I did suppose it should be on *constraint*;
But, heaven be thanked, it is but voluntary.
Id. King John.

Her spotless chastity,
Inhuman traitors! you *constrained* and forced.
Id. Titus Andronicus.

Not through any *constraining* necessity, or *constrain-*
ing vow. *Carew's Cornwall.*

The soft weapons of paternal persuasions, after mankind began to forget the original giver of life, became overweak to resist the first inclination of evil; or after, when it became habitual, to *constrain* it. *Raleigh.*

Love must freehearted be, and voluntary,
And not enchanted, or by fate *constrained*. *Davies.*
Bitter *constraint*, and sad occasion dear,
Compels me to disturb your season due. *Milton. Lycidas.*

In this northern tract our hoarser throats
Under unripe and ill *constrained* notes. *Waller.*

My sire in caves *constrains* the winds,
Can with a breath their clam'rous rage appease;
They fear his whistle, and forsake the seas. *Dryden.*

Namur subdued, is England's palm alone;
The rest besieged, but we *constrained* the town. *Id.*

Constrained him in a bird, and made him fly
With party-colored plumes, a chatt'ring pye. *Id.*

Like you, a man; and hither led by fame,
Not by *constraint*, but by my choice, I came. *Id.*

The constant desire of happiness, and the *constraint*
it puts upon us to act for it, nobody, I think, accounts
an abridgment of liberty. *Locke.*

Every one's natural genius should be carried as far
as it could, but to attempt the putting another upon
him will be but labour in vain; and what is so plae-
tered on will at best sit but untowardly, and have al-
ways hanging to it the ungracefulness of *constraint*
and affectation. *Id.*

When to his lust *Aegythus* gave the rein,
Did fate or we the adult'rous act *constrain*? *Pope's Odyssey.*

How the strait stays the slender waist *constrain*. *Gay.*

Sweet bird, whom the winter *constrains*—
And seldom another it can—
To seek a retreat while he reigns,
In the well-sheltered dwellings of man. *Cowper.*

CONSTRIC'T, v. a. } *Fr. constriction*; *It. constrictione*; *Span. con-*
CONSTRIC'TIVE, adj. } *striccion*; *Lat. con-*
CONSTRIC'TION, n. s. } *striccion*; *Lat. con-*
CONSTRIC'TOR, n. s. } *stringere, constrictum.*
To bind; to press tight together; to contract;
to cause to shrink. Contraction; shrinking to-
gether; compression produced by some internal
quality. Having the power of causing to
contract; the agent in the act of so causing.

The air, which these receive into the lungs, may
serve to render their bodies equivoquant to the wa-
ter; and the *constriction* or dilatation of it may pro-
bably assist them to ascend or descend in the water.
Ray on the Creation.

Such things as *constrict* the fibres, and strengthen
the solid parts. *Arbutnot on Dist.*

He supposed the *constrictors* of the eyelids to be
strengthened in the supercilious. *Id. and Pope's Mart. Scrib.*

CONSTRINGE, v. a. } *Fr. constringent*; *It. con-*
CONSTRINGENT, adj. } *costringente*; *Lat. con-*
stringens, constringere. To compress, or bind
together, the particles of a substance; to force
anything to contract itself. Having a binding
quality. See **CONSTRAINT**, and **CONSTRUCT**.

The dreadful spout,
Which shipmen do the hurricane call,
Constringed in mass by the almighty sun.
Shakespeare. Troilus and Cressida.

Try a deep well, or a conservatory of snow, where
the cold may be more *constringent*. *Bacon's Natural History.*

Strong liquors, especially inflammatory spirits, in-
toxicato, *constringe*, harden the fibres, and coagulate
the fluids. *Arbutnot.*

Winter binds
Our strengthened bodies in a cold embrace
Constringent. *Thomson's Winter.*

CONSTRU'CT, v. a. } *Fr. and Ital. con-*
CONSTRUC'TER, n. s. } *struere*; *Span. con-*
CONSTRUC'TION, n. s. } *struir*; *Lat. con-*
CONSTRUC'TIONAL, adj. } *struere.* To build;
CONSTRUC'TIVE, adj. } to frame; to form;
CONSTRUC'TIVELY, adv. } to put together. The
CONSTRUC'TURE, n. s. } act of building; the

form of a building, *construction*: disposition of
parts; grammatical arrangement of words; in-
terpretation; meaning; mental representation;
manner of describing a geometrical figure or pro-
blem; manner of reducing a known equa-
tion into lines and figures. See the next arti-
cle. *Constructive* and *constructively* signify, by
construction.

In which sense although we judge the apostle's
words to have been altered, yet hereunto we do not
require them to yield, that think any other *construc-*
tion more sound. *Hooker.*

There's no art
To show the mind's *construction* in the face
Shakespeare.

This label, whose containing
Is so from sense in hardness, that I can
Make no collection of it; let him shew
His skill in the *construction*. *Shakespeare. Cymbeline.*

It cannot, therefore, unto reasonable *constructions*
seem strange, or savour of singularity, that we have
examined this point. *Brown's Vulgar Errors.*

Let there be an admiration of those divine attributes
and prerogatives, for whose manifesting he was pleased
to *construct* this vast fabric. *Baile's Usefulness of Natural Philosophy.*

Some particles constantly, and others in certain
constructions, have the sense of a whole sentence con-
tained in them. *Locke.*

They shall the earth's *constructions* closely bind,
And to the centre keep the parts confined. *Blackmore.*

The ways were made of several layers of flat
stones and flint: the *construction* was a little various,
according to the nature of the soil, or the materials
which they found. *Arbutnot.*

Religion, in its own nature, produces good will
towards men, and puts the mildest *construction* upon
every accident that befalls them. *Spectator.*

He that would live at ease, should always put the best construction on business and conversation.

Collier on the Spleen.

They have a power given to them, like that of the evil principle, to subvert and destroy; but none to construct, except such machines as may be fitted for further subversion, and further destruction. *Burke.*

The precept given by a wise man, as well as a great critic, for the construction of poems, is equally true as to states:—Non satis est pulchra esse poemata, dulcia suntu. *Id.*

Such *constructive* whole, residing in a part only, is one of the most violent fictions of positive law, that ever has been or can be made on the principles of artificial incorporation. *Id.*

If shrewd, and of a well constructed brain,
Keen in pursuit and vigorous to retain,
Your son come forth a prodigy of skill;
As, wheresoever taught, so formed, he will;
The pedagogue, with self-complacent air,
Claims more than half the praise as his due share.

Cooper.

But man is a carnivorous production,
And must have meals, at least one meal a day!
He cannot live, like woodcocks, upon suction,
But, like the shark and tiger, must have prey:
Although his anatomical construction
Bears vegetables in a grumbling way.

Byron's Don Juan.

CONSTRUCTION, in algebra, a method of reducing a known equation into lines and figures. An equation may be formed, or the roots determined, by the intersections of a straight line with another line or curve, of equal dimensions with the equation to be constructed; for the roots of the equation are the ordinates of the curve at the points of intersection with the right line; and it is generally understood, that a curve may be cut by a right line in as many points as its dimensions amount to. In this manner, therefore, a simple equation will be constructed by the intersection of one right line with another; a quadratic equation, or an affected equation of the second rank, by the intersection of one right line with a circle, or any of the conic sections, which are all lines of the second order, and which may be cut by the right line in two points, and so produce the two roots of the quadratic equation. A cubic equation may be constructed by the intersection of the right line with a line of the third order, &c. &c. If, however, some other line of a higher order be made use of instead of the right line, then the second line, by whose intersections with the former the roots of the equation are to be determined, may be taken as many dimensions lower as the former is taken higher; and whatever be the height of an equation, it will generally be constructed by the intersections of two lines, whose dimensions, when multiplied together, make up the dimensions of the given equation. Thus, the intersections of a circle with the conic sections, or of these with each other, will construct the biquadratic equations, or those of the fourth power, because $2 \times 2 = 4$; and the intersections of the circle or conic sections with a line of the third order, will construct the equations of the fifth and sixth powers, &c. &c.

CONSTRUE, *v. a.* Fr. *construire*; Ital. *costruire*; Span. *construir*; Lat. *construere*. To show the signification of; to explain; to interpret.

If she give me I force not,
And if she take it again she cares not
Conster what this is and tell not,
For I am faste sworne, I may not.

Wyat.

That much she musd, yet could not construe it,
By any ridling skill or commune wit.

Spenser. Faerie Queene.

I must crave that I be not understood or construed, as if any such thing, by virtue thereof, could be done without the aid and assistance of God's most blessed Spirit. *Hooker.*

Yet at my parting sweetly did she smile,
In scorn or friendship, nill I construe whether
Shakspeare The Passionate Pilgrim.

Construe the times to their necessities,
And you shall say, indeed, it is the time,
And not the king, that doth you injuries.

Id. Henry IV.

Virgil is so very figurative, that he requires (I may almost say) a grammar apart to construe him.

Dryden.

Thus we are put to construe and paraphrase our own words, to free ourselves either from the ignorance or malice of our adversaries. *Stillington.*

When the word is construed into its idea, the double meaning vanishes. *Addison on Ancient Medals.*

CONSTUPRATE, *v. a.* } Fr. *constuprer*;
CONSTUPRATION, *n. s.* } Span. *constuprar*;
Lat. *constuprare*. To ravish; to debauch; to defile. Violation; defilement

Their wives and loveliest daughters constuprated.

Burton.

The very sight is a kind of constupration.

Bp. Hall.

CONSUBSIST, *v. n.* To exist at the same time with.

There are some who hold two *consubisting* wills, an active and an elective, the latter continually directing the former. *Ab. Tucker.*

CONSUALIA, in antiquity, feasts held in honor of the god Consus, or Neptune. They were introduced with a magnificent cavalcade, because Neptune was reputed to have first taught men the use of horses. Evander is said to have first instituted this feast; it was re-established by Romulus, because some god, under the denomination of Consus, suggested to him the rape of the Sabines. To this feast all his neighbours were invited; and, to draw the greater concourse of people, he gave out that he had found an altar hid under the ground, which he intended to consecrate, with sacrifices to the god to whom it had been originally erected. Taking advantage of the confidence of the people who had assembled, and who were then engaged in the solemnities and sacrifices of the festival, he forcibly seized and carried away all their women. The consualia were of the number of sacred feasts. Originally, they were not distinguished from those of the circus; whence Valerius Maximus says, the rape of the Sabine women was effected at the games of the circus. Plutarch observes, that during this solemnity, horses and asses were exempted from all labor, and were led through the streets adorned with crowns and garlands, &c.

Festus says, the cavalcade was performed with mules; it being an opinion, that this was the first animal used to draw the car. Servius places the consulia on the 13th August; Plutarch on the 18th, and the old Roman calendar on the 21st of that month.

CONSUBSTANTIATE, *v. a., n. s.* Fr. *con-*
 CONSUBSTANTIATION, *n. s.* [*& adj.*] *substanti-*
 CONSUBSTANTIAL, *adj.* *tiel*; Sp. *sub-*
 CONSUBSTANTIALITY, *n. s.* *subst-*
 CONSUBSTANTIALIST, *n. s.* *stancial*;

Lat. consubstantialis. To unite in one common substance or nature; to profess consubstantiation. Consubstantiate, as an adjective, means united. Consubstantial is, having the same essence; being of the same nature. Consubstantiality signifies, existence of more than one in the same subject; participation in the same nature. A Lutheran is a consubstantialist.

The Lord our God is but one God; in which indivisible unity, notwithstanding we adore the Father, as being altogether of himself, we glorify that *consubstantial* Word, which is the Son; we bless and magnify that co-essential Spirit, eternally proceeding from both, which is the Holy Ghost. *Hooker.*

It continueth a body *consubstantial* with our bodies; a body of the same, both nature and measure, which it had on earth. *Id.*

In their conceits the human nature of Christ was not *consubstantial* to ours, but of another kind. *Brerewood.*

He might almost *consubstantiate* and unite himself to his Saviour. *Hammond.*

The eternity of the Son's generation, and his co-eternity and *consubstantiality* with the Father, when he came down from heaven. *Id. on Fundamentals.*

Transubstantiation, *consubstantiation*, real presence, articles and distinctions set up by men without authority from Scripture, and other less differences, which good Christians may differ about without endangering their salvation. *Locke.*

The *consubstantiating* church and priest, Refuse communion to the Calvinist. *Dryden.*

In the point of *consubstantiation*, towards the latter end of his life, he changed his mind. *Atterbury.*

CONSUBSTANTIATION, *ομοουσιος*, was a term first used by the fathers of the councils of Antioch and Nice, to express the orthodox doctrine of the Trinity the more precisely, and to serve as a barrier and precaution against the errors and subtleties of the Arians, who owned every thing except the consubstantiality. The Arians allowed that the word was God, as having been made God; but they denied that he was the same God, and of the same substance with the Father; accordingly, they exerted themselves to the utmost to abolish the use of the word. The emperor Constantine used all his authority with the bishops to have it expunged out of the symbols; but it was retained, and is still the distinguishing criterion between an Athanasian and an Arian. Curcellæus maintains, that it was an innovation in doctrine in the council of Nice, to admit an expression, the use of which had been abolished by the council of Antioch.

CONSU'ETUDE, *n. s.* Lat. *consuetudo.* Custom or usage.

CONSUL, *n. s.* Fr. Ital. Span. Lat.
 CO'NSULAR, *adj.* } *consul.* The chief magis-
 CO'NSULARY, *adj.* } trate of the Roman re-
 CO'NSULATE, *n. s.* } public, and, for a short
 CO'NSULSHIP, *n. s.* } period, of the French; an officer commissioned to reside in a foreign port, to protect the commerce of his nation. In Rome, consular man was one who had filled the office of consul. Consulate and consulship signify, the office of consul. See the next article.

Or never be so noble as a *consul*,
 Nor yoke with him for tribune.

Shakespeare. Coriolanus.
 Rose not the *consular* men, and left their places,
 So soon as thou sat'st down? *Ben Jonson's Catiline.*

The patricians should do very ill,
 To let the *consulship* be so defiled. *Id.*
Consuls of moderate power in calms were made;
 When the Gauls came, one sole dictator swayed.

Dryden.
 His name and *consulate* were effaced out of all public registers and inscriptions. *Addison on Italy.*
 The *consular* power had only the ornaments, without the force, of the royal authority. *Spectator.*

CONSULS, in Roman history, were two magistrates invested with supreme authority for one year, and annually chosen in the Campus Martius. Brutus and Collatinus, the two first consuls, were elected A. U. C. 244. For 144 years afterwards the consuls were always chosen from patrician families, but the people, A. U. C. 388, obtained the privilege of electing one of the consuls from their own body, and sometimes both were plebeians. The first consul among the plebeians was L. Sextius. The *legitimum tempus*, the time fixed by law for the consulship, was forty-three years of age. The candidate was always to appear at the election as a private man, without a retinue, and it was requisite before he canvassed for the office, that he should have discharged the functions of a quaestor, ædic, and prætor. Sometimes these qualifications were disregarded. Valerius Corvinus was made a consul in his twenty-third year, and Scipio in his twenty-fourth. Young Marius, Pompey, and Augustus, were also under the proper age when they were invested with the office, and Pompey had never been quaestor or prætor.

The power of the consuls was unbounded, and they knew no superior but the gods and the laws; but, after the expiration of their office, their conduct was minutely scrutinised by the people, and their misbehaviour often punished. The badge of their office was the prætexta, a robe fringed with purple, afterwards changed for the toga picta or palmata. They were preceded by twelve lictors, carrying the fasces, or bundle of rods, in the middle of which appeared an axe. The axe, as being the characteristic rather of tyranny than of freedom, was taken away from the fasces by Valerius Publicola, but it was restored by his successor. They took the fasces by turns monthly, preceded by the lictors, while at Rome, lest the appearance of two persons with the badges of authority, should raise apprehensions in the multitude. While one appeared publicly in state, only a crier walked before the other and the lictors followed behind without the fasces. Their authority was equal, yet the Va-

erian law gave the right or priority to the elder, and the Julian law to him who had most children; and he was generally called consul-major or prior. As their power was absolute, they presided over the senate, and could convene and dismiss it at pleasure. The senators were their counsellors; and among the Romans, the manner of reckoning their years was by the names of the consuls. By M. Tullio Cicerone et L. Antonio Consulibus, for instance, the year of Rome 689, was always understood. This custom lasted from A. U. C. 244, till A. U. C. 1294, or 541 of the Christian era. In public assemblies the consuls sat in ivory chairs, and held in their hand an ivory wand, called Scipio eburneus, which had an eagle on its top as a sign of dignity and power. When they had drawn by lot the provinces over which they were to preside during their consulship, they went to the capitol to offer their prayers to the gods, and to entreat them to protect the republic; after this, they departed from the city arrayed in their military dress and preceded by the lictors. Sometimes the provinces were assigned them by appointment of the senators. At their departure they were provided by the senate with whatever was requisite during their expedition. In their provinces, they were both attended by the twelve lictors, and equally invested with legal authority. They were not permitted to return to Rome without the special command of the senate; and they always remained in the province till the arrival of their successor. At their return they harangued the people, and solemnly protested that they had done nothing against the laws or interest of their country, but had faithfully and diligently endeavoured to promote the greatness and welfare of the state. No man could legally be consul two years successively, yet this institution was sometimes broken, and we find Marius re-elected consul after the expiration of his office during the Cimbric war. The office of consul, so dignified during the times of the commonwealth, became a mere title under the emperors, and retained nothing of its authority but the useless ensigns of original dignity. Even the duration of the office, which was originally annual, was reduced to two or three months by Julius Cæsar; but they who were admitted on the first of January, denominated the year, and were called ordinarii. Their successors during the year were distinguished by the name of suffecti. Tiberius and Claudius abridged the time of the consulship; and the emperor Commodus made no less than twenty-five consuls in one year. Constantine the Great renewed the original institution, and permitted them to be a whole year in office.

CONSULS, in trade, are officers appointed by the king at different foreign ports, to protect the commerce of our merchants. They are to keep up a correspondence with the British ministers residing in the courts whereon their consulate depends. They are to attend to the interests of the nation; to dispose of the sums given, and the presents made, to the lords and principals of places, to obtain their protection, and prevent insults of the natives on the merchants of the nation. It was stipulated by the treaty of Utrecht, between Great Britain and Spain, that

the consuls residing in the dominions of the king of Spain, should take inventories of the estates of the English dying intestate in Spain; and that such estates should be entrusted to two or three merchants, for the security and benefit of the heirs and creditors. And it is enacted, by the statute 9th George II., that it shall be lawful for persons appointed by the consuls at the ports of Cadiz and St. Mary's in Spain, with the majority of the British factors and merchants there, to receive from all English and Irish ships trading there, any sums of money not exceeding two rials plate per ducat on the freight of goods and merchandise there imported, and on all tonnage goods, not exceeding two rials plate per ton, and all their bills of lading shall specify to pay the same, under the denomination of contribution. And that all British and Irish commanders, trading to the said ports, and delivering there, shall, within ten days after their arrival, deliver a manifesto, upon oath, specifying the particulars of the cargo, and to whom consigned; which oath is to be administered by the consul, or by a person appointed by him; and the clearances shall be detained till payment of the money is made; and, should any depart without his clearances, the consul, on the return of any such master to any port in the king's dominions, may have an action at law against him for the said money. All monies raised to be applied to the relief of shipwrecked mariners, or other distressed persons, his majesty's subjects, and such other benevolent uses as the consul shall appoint.

CONSULT, *v. a., v. n. & n. s.*

CONSULTATION, *n. s.*

CONSULTATIVE, *adj.*

CONSULTER, *n. s.*

CONSULTIVE, *adj.*

Fr. *consulter*; Ital. *consultare*; Sp. *consultar*; Lat. *consultare*. To deliberate together; to ask advice of; to act with a reference to; to debate on; to contrive. Consult and consultation are synonymous; but the latter is most in use in prose, the former in poetry. They signify the act of consulting; a determination; an assembly of persons met to deliberate on something. Consultative is, having a power of consulting.

There shall not be found among you a charmer, or a consulter with familiar spirits, or a wizard.

Deut. xviii. 11.

Consult not with the slothful for any work.

Eccles. xxxvii.

Thou hast consulted shame to thy house, by cutting off many people.

Heb. ii. 10.

A senate-house, wherein three hundred and twenty men sat consulting always for the people.

1 Mac. viii. 15.

The chief priests held a consultation with the elders and scribes.

Mark xv. 1.

Every man,

After the hideous storm that followed, was
A thing inspired; and, not consulting broke
Into a general prophecy, that this tempest,
Dashing the garment of this peace, aboded
The sudden breach on't.

Shakespeare. Henry VIII.

Divers meetings and consults of our whole number, to consider of the former labors.

Bacon.

He sent for his bosom friends, with whom he most confidently consulted, and showed the paper to them, the contents whereof he could not conceive.

We are, in the first place, to *consult* the necessities of life, rather than matters of ornament and delight.

L'Étrange.

A *consultation* was called, wherein he advised a salivation.

Wise man of Aboceens.

Yourself in person head one chosen half,
And march to oppress the faction in *consult*
With dying Dorax. *Dryden's Don Sebastian.*

He said, and rose the first; the council broke;
And all their grave *consults* dissolved in smoke.

Id. Fables.

The senate owes its gratitude to Cato,
Who with so great a soul *consults* its safety,
And guards our lives, while he neglects his own.

Addison.

A *consult* of coquets below
Was called, to rig him out a beau. *Swift.*

They (neutrals) are generally chosen, because they have no opinion of their own; and as far as they can be got in good earnest to embrace any opinion, it is that of whoever happens to employ them (neither longer or shorter, narrower or broader), with whom they have no discussion or *consultation*. The only thing which occurs to such a man when he has got a business for others into his hands, is how to make his own fortune out of it.

Burke.

Consult life's silent clock, thy bounding vein;
Seems it to say—Health here has long to reign!

Cooper.

CONSU'ME, *v. a. & n.* } Fr. *consuner*; Ital.
CONSU'MABLE, *adj.* } *consumare*; Sp. *con-*
CONSU'MER, *n. s.* } *sumir*; Lat. *con-*
sumere. To destroy by fire; to waste; to destroy;
to waste away. Consumable is, that which is
capable of being destroyed; that which may be
worn out or spent. See CONSUMPTION.

Thou shalt carry much seed out into the field, and
shalt gather but little in; for the locusts shall *con-*
sume it. *Deut. xxviii.*

Thou likenest it also to wilde fire,
The more it brenneth the more it hath desire
To *consume* every thing that bren't would be.

Chaucer. Cant. Tales.

I dye though not incontinent,
By processe yet *consumingly*,
Is waste of fire which doth relent,
If you as wilfull will deny. *Wyat.*

His face was leane, and sumdeate pynd away,
And eke his hands *consumed* to the bone. *Sackville.*

For Heven itselfe shall their successe envy,
And them with plagues and murrins pestilent
Consume, till all their warlike puissance be spent.
Spenser. Faerie Queene.

His warlike shield all closely covered was,
Ne might of mortall eye be ever seene;
Not made of steele, nor of enduring bras,
(Such earthly mettals soon *consumed* beene),
But all of diamond perfect pure and cleene
It famed was. *Id.*

Where two raging fires meet together,
They do *consume* the thing that feeds their fury.
Shakespeare.

Pair flowers, that are not gathered in their prime,
Rot and *consume* themselves in little time.

Id. Venus and Adonis.

Our growing rich or poor depends only on, which
is greater or less, our importation or exportation of
consumable commodities. *Locke.*

Money may be considered as in the hands of the
consumer, or of the merchant who buys the commo-
dity, when made to export. *Id.*

Thus in soft anguish she *consumes* the day,
Nor quits her deep retirement. *Thomson's Spring.*

He sleeps in dust. Ah, how shall I pursue
My theme! To heart-consuming grief resigned,
Here, on his recent grave I fix my view,
And pour my bitter tears. Ye flowery lays, adieu!

Boastie.

To joys forbidden man aspires,
Consumes his soul with vain desires;
Folly the spring of his pursuit,
And disappointment all the fruit. *Cooper.*

I have a silent sorrow here,
A grief I'll ne'er impart;
It breathes no sigh, it sheds no tear,
But it *consumes* my heart! *Sheridan.*

And, Oh! that pang where more than madness
lies!

The worm that will not sleep—and never dies,
Thought of the gloomy day and ghastly night,
That dreads the darkness, and yet loaths the light,
That winds around, and tears the quivering heart!
Ah! wherefore not *consume* it—and depart!

Byron. The Bride of Atydes.

CONSUMMATE, *v. a. & adj.* } Fr. *con-*
CONSUMMATELY, *adv.* } *sonner*; It.
CONSUMMATION, *n. s.* } *consumare*;
Ital. *consumar*; Lat. *consummare*. To perfect;
to bring to a conclusion; to crown the whole.
Completion; accomplishment; the end of the
world; the end of life.

From the first beginning of the world unto the last
consummation thereof, it neither hath been, nor can be,
otherwise. *Hoober.*

I do but stay till your marriage be *consummate*.
Shakespeare.

There shall we *consummate* our spousal rites. *Id.*
Yourself, myself, and other lords, will pass
To *consummate* this business happily. *Id. King John.*

Ghost, unlaid, forbear thee!
Nothing ill come near thee!
Quiet *consummation* have,
Unremoved be thy grave. *Id. Cymbeline.*

The person was cunning enough to begin the *con-*
summate the fraud in the stronger.

Brown's Vulgar Errors.

Earth, in her rich attire
Consummate, lovely smiled. *Milton's Paradise Lost.*
Last the bright *consummate* flower
Spirits odorous breathes. *Id.*

He had a mind to *consummate* the happiness of the
day. *Tatler.*

Gratian, among his maxims for raising a man to
the most *consummate* greatness, advises to perform
extraordinary actions, and to secure a good historian.
Addison's Freeholder.

That just and regular process, which it must be
supposed to take from its original to its *consummation*.
Id. Spectator.

Under the conduct of Felix Ragusinus, a Dalmatian,
consummately learned in the Greek, Chaldaick,
and Arabic languages. *Warton. H. E. Poetry.*

How'er ingenious on his darling theme
A sceptic in philosophy may seem,
Reduced to practice, his beloved rule
Would only prove him a *consummate* fool. *Cooper.*

There was the *consummation* and the crown,
The flower of Israel's infamy full blown;
Thence date their sad declension and their fall,
Their woes, not yet repealed, thence date them all. *Id.*

CONSUMPTION, *n. s.* } Fr. *consomption* ;
 CONSUMPTIVE, *adj.* } Ital. *consumazione* ;
 CONSUMPTIVELY, *adv.* } Span. *consuncion* ;
 CONSUMPTIVENESS, *n. s.* } *consumptio*. The act
 of wearing out, or applying to the purpose of
 subsistence ; waste ; the state of wasting away ; a
 disease of the lungs, accompanied by hectic fever,
 and gradual loss of flesh. Destructive ; exhaust-
 ing ; diseased by consumption. Consumptively,
 and consumptiveness, always refer to the disease,
 and signify tendency to it.

Consumption sow

In hollow bones of man. *Shakespeare. Timon.*

The stoppage of women's courses, if not looked to,
 sets them into a *consumption*, dropsey, or other disease.

Harvey.

Nothing taints sound lungs sooner than inspiring
 the breath of *consumptive* lungs.

Id.

The lean, *consumptive* wench, with coughs decayed,
 Is called a pretty, tight, and slender maid. *Dryden.*

In commodities, the value rises as its quantity is
 less and vent greater ; which depends upon its being
 preferred in its *consumption*.

Locke.

The essential and distinguishing character of a con-
 firmed *consumption*, is a wasting of the body by reason
 of an ulcerated state of the lungs, attended with a
 cough, a discharge of purulent matter, and a hectic
 fever.

Blackmore.

Etna and Vesuvius have sent forth flames for this
 two or three thousand years, yet the mountains them-
 selves have not suffered any considerable diminution
 or *consumption* ; but are, at this day, the highest moun-
 tains in those countries.

Woodward.

A long *consumptive* war is more likely to break this
 grand alliance than disable France.

Addison on the War.

By an exact regimen a *consumptive* person may hold
 out for years.

Arbuthnot on Diet.

Consumption near ; a joyless meagre wight,
 Panting for breath, and shrinking into shade,
 Eludes the grasp : thin as the' embodied air,
 Which erst deceived Ixion's void embrace,
 Ambitious of a goddess ! scarce her legs
 Feeble she drags, with wheezing labour on,
 And motion slow : a willow wand directs
 Her tottering steps, and marks her for the grave.

W. Thompson.

The balance between *consumption* and production
 makes price. The market settles, and alone can settle,
 that price.

Burke.

A more uniform quantity of heat may be serviceable
 to *consumptive* patients than can be met with in this
 country, as the lungs cannot be clothed like the exter-
 nal skin, and are therefore subject to greater extremes
 of heat and cold in passing in winter from a warm
 room into the frosty air.

Darwin.

A puny *consumptively* disposed mother. *Beddoes.*

CONSUMPTION, in medicine, is of very exten-
 sive signification, implying all disorders that
 bring any decay upon the constitution ; but is
 most commonly used for the phthisis pulmonalis.
 See MEDICINE.

CONSUMPTION, in fariery. See FARRIERY.

CONSUS, a name of Neptune, the pagan god
 of counsel. He had an altar under ground in
 the great circus at Rome, to show that counsel
 ought to be kept secret. See CONSUALIA.

CONSUTILE, *adj.* Lat. *consutilis*. That is
 sewed together.

CONTABULATE, *v. a.* } Lat. *contabulare*.
 CONTABULATION, *n. s.* } To floor with boards.
 Joining of boards together ; flooring. Both words
 are obsolete, and never were much in use.

CONTACT, *n. s.* } Fr. *contact* ; Ital. *con-*
 CONTACTION, *n. s.* } *tatto* ; Span. *contacto* ; Lat.
contactus. Touch ; close union ; juncture of two
 bodies. The act of touching.

The Platonists hold, that the spirit of the lover doth
 pass into the spirits of the person loved, which causeth
 the desire of return into the body ; whereupon fol-
 loweth that appetite of *contact* and conjunction.

Bacon's Natural History.

That deleterious it may be at some distance, and
 destructive without corporal *contaction*, there is no
 high improbability.

Brown's Vulgar Errors.

When the light fell so obliquely on the air, which
 in other places was between them, as to be all re-
 flected, it seemed in that place of *contact* to be wholly
 transmitted.

Newton's Opticks.

The air, by its immediate *contact*, may coagulate
 the blood which flows along the air-bladders.

Arbuthnot on Diet.

The emphatic speaker dearly loves to oppose,
 In *contact* inconvenient, nose to nose,
 As if the'gnomon on his neighbour's phiz,
 Touched with a magnet, had attracted his.

Cowper.

The surface of the earth nearer the pole moves
 slower than it does in our latitude ; whence the re-
 gions of air brought from thence, move slower,
 when they arrive hither, than the earth's surface
 with which they now become in *contact* ; that is,
 they acquire an apparently easterly direction, as the
 earth moves from west to east faster than this new
 part of its atmosphere.

Darwin.

CONTAGION, *n. s.* } Fr. *contagion* ;
 CONTAGIOUS, *adj.* } Ital. *contagio*, *conta-*
 CONTAGIOUSNESS, *n. s.* } *gione* ; Span. *conta-*
tagio, *contagion* ; Lat. *contagio*. The effluvia
 by which diseases are propagated ; infection ;
 propagation of disease or mischief ; pestilential
 emanations ; plague. Infections caught by ap-
 proach or contact ; figuratively, caught by sym-
 pathy ; venomous ; pestilential. The quality of
 being contagious.

And of thy light my soule in prison light,
 That troubled is by the *contagion*
 Of my body, and also by the wight
 Of earthly lust and false affection.

Chaucer. Cant. Tales.

Or that the charme and veneme which they droock,
 Their blood with secret filth infected hath,
 Being diffused through the senseless tronck,
 That through the great *contagion* direful deadly stonck.

Spenser. Faerie Queene.

But being growen strong, it forth doth bring
 Sorrow, and anguish, and impatient paine
 In the inner parts, and lastly, scattering
Contagious poyson close through every vaine,
 It never rests till it have wrought his final bane. *Id.*

If we two be one, and thou play false,
 I do digest the poison of thy flesh,
 Being strumpeted by thy *contagion*.

Shakespeare. Comedy of Errors.

Will he steal out of his wholesome bed,
 To dare the vile *contagion* of the night ?

Shakespeare. Julius Caesar.

The jades,
That drag the tragic melancholy night,
From their misty jaws
Breathe foul, *contagious* darkness in the air.
Shakespeare. Henry VI.

In infection and *contagion* from body to body, as the plague and the like, the infection is received many times by the body passive; but yet is, by the strength and good disposition thereof, repulsed. *Bacon.*

Nor will the goodness of intention excuse the scandal and *contagion* of example. *King Charles,*

Down fell they,
And the dire hiss renewed, and the dire form
Caught by *contagion*. *Milton. Paradise Lost.*

An excellent preservative against the *contagiousness* of sin. *Mountague.*

But when thou seest a single sheep remain
In shades aloof, or couched upon the plain;
Or listlessly to crop the tender grass;
Or late to lag behind, with truant pace;
Revenge the crime, and take the traitor's head,
Ere in the faultless flock the dire *contagion* spread.
Dryden. Georgic III.

We sicken soen from her *contagious* care,
Grieve for her sorrows, groan for her despair. *Prior.*

Wide o'er the human field, the body, spreads
Contagious war, and lays its beauties waste.
W. Thompson.

Frantic with fear, they sought by flight to shun
The fierce *contagion*. O'er the mournful land
The infected city poured her hurrying swarms.
Armstrong.

Men in this deplorable state of mind find a comfort
in spreading the *contagion* of their spleen. They find
an advango too; for it is a general popular error to
imagine the loudest complainers for the public to be
the most anxious for its welfare. *Burke.*

Long may the hardy sons of rustic toil
Be blest with health, and peace, and sweet content!
And, oh! may Heaven their simple lives prevent
From luxury's *contagion*, weak and vile. *Burns.*

Excess, the scrofulous and itchy plague,
That seizes first the opulent, descends
To the next rank *contagious*, and in time
Taints downward all the graduated scale
Of order, from the chariot to the plough.
Cowper.

You meet *contagion* issuing from afar,
And dash the baleful conqueror from his car;
When, guest of Death! from charnel vaults he steals,
And bathes in human gore his armed wheels.
Darwin.

CONTAGION, in some diseases, is only conveyed by immediate contact, as the venom of the pox; in others, by infected clothes, as the scabies; and in others it is transmitted through the air at a considerable distance, by effluvia arising from the sick, as in the plague and other pestilential disorders; in which case the air is said to be contagious, though this has been disputed. Although no attempt to investigate the nature of contagion, or to ascertain the properties of contagious matter, has hitherto proved successful, yet the means which have been effectually employed, either to abate its virulence or to destroy it entirely, afford a pretty fair inference that this matter is of a chemical nature. In 1773 the fumes of muriatic acid were successfully used by

Morveau in purifying the cathedral of Dijon; and it was doubtless from this that Dr. Carmichael Smyth was led to propose the fumes of nitric acid.

In November, 1795, this was tried on board several ships then lying at Sheerness; and, being found to answer the purpose of destroying the contagion which prevailed among the mer, government afterwards liberally rewarded Dr. Smyth for his discovery. The wards of the Union hospital ship were at this time very much crowded with patients; and of 200 sick persons on board, three-fourths were in different stages of a malignant contagious fever, which made a very rapid progress, and produced very fatal effects on the attendants and ship's company. Here the experiments were begun, conducted by Mr. Menzies, surgeon of the Discovery, and Mr. Bassan, surgeon of the Union. The following were the materials and apparatus employed in the process: A quantity of fine sand, twenty-four earthen pipkins, twenty-four common tea-cups, some long slips of glass for spatulas, a quantity of concentrated sulphuric acid, and a quantity of salt-petre (nitrate of potassa). Having then shut up all the ports and scuttles, the sand, previously heated in iron pots, was scooped out into the pipkins with an iron ladle, and in this heated sand, in each pipkin, a small tea-cup was immersed, containing about half an ounce of sulphuric acid, to which, after it had acquired a proper degree of heat, an equal quantity of nitrate of potassa in powder was gradually added, and the mixture stirred with a glass spatula till the vapor arose from it in considerable quantity. The pipkins were then carried through the wards by the nurses and convalescents, who kept walking about with them in their hands, occasionally putting them under the cradles of the sick, and in every corner where any foul air was suspected to lodge. They continued this fumigation till the whole space between decks, fore and aft, was filled with vapor, appearing like a thick haze. At first the vapor excited a tickling cough among the patients; but this generally ceased as the wards became more generally filled; and perhaps even this might be partly owing to the inattention of those who carried the pipkins, coming too close to the faces of the sick, and causing them to inhale the strong vapor arising from the cups. During the fumigation the bed-clothes and body-clothes of the sick were exposed as much as possible to the nitrous vapor; and all the foul linen removed from them was instantly immersed in a tub of cold water, afterwards carried on deck, rinsed out, and hung up till nearly dry, and then fumigated before it was taken to the washers: a precaution extremely necessary in every case of infectious disorder. Cleanliness and ventilation were likewise carefully attended to. This first experiment took up three hours; and about an hour after, the vapor having completely subsided, the ports and scuttles were opened to admit fresh air. After this first fumigation the air of the hospital was very sensibly sweetened; and the process was repeated next morning; when the people employed, being now more expert, finished the whole in about an

hour; and, the vapor subsiding in an hour, the fresh air was freely admitted. In the evening fumigations fewer pipkins were used, as the fresh air could not be afterwards so freely admitted as in the morning. The offensive and disagreeable smell arising from so many sick crowded together being by the fumigation perceptibly destroyed, even to the attendants, they were led to confide in its efficacy, to throw off the dread with which they had formerly approached the cradles of the diseased, and to perform the duties of the hospital with regularity and alacrity. Not one person in the ship was attacked with the fever, from the 26th of November, when the fumigation was first resorted to, till the 25th of December, though in the course of the three preceding months above one-third of all the people on board had been seized with the distemper, and it had proved fatal to more than one-fourth of these; and there was no probability but that sickness and mortality would have increased in proportion as the contagion spread, and as the despondency of the people, who considered themselves as so many devoted victims, increased.

'The principal diseases excited by poisonous miasmata,' says Dr. Hooper, 'are intermittent, remittent, and yellow fevers, dysentery, and typhus. The virus of the last is generated in the human body itself, and is sometimes called the typhoid fomes. The other miasmata are produced from most vegetable matter, in some unknown state of decomposition. The contagious virus of the plague, small-pox, measles, chincough, cynanche maligna, and scarlet fever, as well as of typhus and the jail fever, operates to a much more limited distance through the medium of the atmosphere, than the marsh miasmata. Contact of a diseased person is said to be necessary for the communication of plague; and approach within two or three yards of him, for that of typhus. The Walcheren miasmata extended their pestilential influence to vessels riding at anchor, fully a quarter of a mile from the shore.

'The chemical nature of all these poisonous effluvia is little understood, according to this writer. They undoubtedly consist, however, he adds, of hydrogen, united with sulphur, phosphorus, carbon, and azote, in unknown proportions, and unknown states of combination. The proper neutralisers or destroyers of these gasiform poisons, are nitric acid vapor, muriatic acid gas, and chlorine. The last two are the most efficacious; but require to be used in situations from which the patients can be removed at the time of the application. Nitric acid vapor, may, however, be diffused in the apartments of the sick, without much inconvenience. Bed-clothes, particularly blankets, can retain the contagious fomes in an active state, for almost any length of time. Hence, they ought to be fumigated with peculiar care. The vapor of burning sulphur or sulphureous acid is used in the East, against the plague. It is much inferior in power to the other antioimic re-agents. There does not appear to be any distinction commonly made between contagious and infectious diseases.' See INFECTION and QUARANTINE.

CONTAIN, v. a. & n. } Fr. *contenir*; Ital. }
 CONTAINABLE, adj. } *contenere*; Span. *con-* }
 CONTAINER, n. s. } *tenir*; Lat. *continere*. }
 CONTE'NT, n. s. } To include within,

as a vessel; to comprehend in; to restrain; to keep within bounds; to live contentedly. The content, or contents, signify that which is contained in any thing. When the word is used with reference to that which is contained in a writing, the plural is always used. In other cases, authorities vary, some using the singular, and some the plural.

There are many other things which Jesus did, the which if they should be written every one, I suppose that even the world itself could not contain the books that should be written. *John xxi. 25.*

Wherefore also it is contained in the scripture.

1 Pet. ii. 6.

But that if God him grauntin grace

That he may, er he hennis pace,

Contein undir obedience

Through the vertue of pacience

Chaucer. Romaunt of the Rose.

How can they all in this so narrow verse

Contayned be, and in small compasse held?

Spenser's Faerie Queene.

— Seven hundred princes, which maintaynd

With mightie dedes their sondry governments,

That were too long their infinite contents

Here to record, ne much materiall. *Id.*

Their king's person contains the unruly people from

evil occasions. *Id.*

I tell you, sirs,

If you should smile, he grows impatient.—

—Fear not, my lord, we can contain ourselves.

Shakespeare.

Though my heart's content firm love doth bear,

Nothing of that shall from mine eyes appear. *Id.*

I have a letter from her,

Of such contents as you will wonder at. *Id.*

Some place it (the soul) in the root of life, the heart;

Some in the river, fountain of the veins;

Some say, she's all in all, and all in every part;

Some say she's not contained, but all contains.

Davies.

This island had then fifteen hundred strong ships of great content. *Bacon.*

Gently instructed I shall hence depart,

Greatly in peace of thought, and have my fill

Of knowledge what this vessel can contain. *Milton.*

What seemed fair in all the world, seemed new

Mean, or in her summed up, in her contained. *Id.*

The air, containable within the cavity of the col-

pile, amounted to eleven grains. *Boyle.*

I shall prove these writings not counterfeits, but

authentic; and the contents true, and worthy of a

divine original. *Grew's Cosmologia.*

The contents of both books come before those of the

first book, in the thread of the story.

Addison's Spectator.

Experiments are made on the blood of healthy animals: in a weak habit serum might afford, other con-

tents. *Arbuthnot.*

I felt the ardour of my passion increase, till I could

no longer contain. *Arbuthnot and Pope.*

At thy firmest age

Thou hadst within thy bole solid contents,

That might have ribbed the sides and planked the

deck

Of some flagged admiral.

Cooper.

The morn is up again, the dewy morn,
With breath all incense, and with cheek all bloom,
Laughing the clouds away with playful scorn,
And living as if earth contained no tomb,—
And glowing into day. *Byron. Childs Harold.*

CONTAMINATE, *v. a. & adj.* } Fr. *conta-*
CONTAMINATION, *n. s.* } *miner*; Ital.
contaminare; Sp. *contaminar*; Lat. *contaminare*.
To pollute; to defile; to stain; to corrupt by
base mixture; to render vile and degraded. Pol-
lution; defilement.

Shall we now
Contaminate our fingers with base bribes?
Shakespeare. Julius Cæsar.
A base pander holds the chamber door,
Whilst by a slave, no gentler than a dog,
His fairest daughter is *contaminated*.
Id. Henry V.

Do it not with poison; strangle her in her bed,
Even in the bed she hath *contaminated*. *Id. Othello.*
I quickly shed
Some of his bastard blood, and in disgrace
Bespoke him thus; *contaminated*, base
And misbegotten blood I spill of thine.
Id. Henry VI.

The sons of idiots, of ignoble birth,
Contaminate, and viler than the earth. *Sandy.*
Though it be necessitated, by its relation to flesh, to
a terrestrial converse; yet 'tis, like the sun, without
contaminating its beams. *Glancille's Apol.*

He that lies with another man's wife, propagates
children in another's family for him to keep, and *contami-*
nates the honor thereof as much as in him lies.
Ayliffe's Parergon.

The only two openings by which I could enter the
temple of Fortune, was the gate of niggardly economy,
or the path of little chicaning bargain-making. The
first is so contracted an aperture, I never could squeeze
myself into it; the last I always hated—there was
contamination in the very entrance. *Burns.*

CONTE'CK, *n. s.* The derivation is uncer-
tain. Tyrwhit conceives the word to be from
the Saxon; Skinner supposes it a corruption of
contest; and Mr. Todd is disposed to think that
we are indebted for it to the French, and points
out *attaquer* as the parent. It means quarrel;
contention; but has long been obsolete. Spenser
seems to be the latest authority for the use of it

What now? seide Gamelyn; brother,
Evil motè ye the;
Wollè ye beginnin *contek*,
And than so sonè fe?
Chaucer. Cant. Tales.
— Afterwards they gan with fowle reproch
To stirre up strife, and troublous *contecke* broch.
Spenser. Faerie Queene.

CONTE'CTION. Lat. *contego*, *contectum*.
A covering.
CONTE'MERATED, *adj.* Lat. *contemeratus*.
Violated; defiled.
CONTE'MN, *v. a.* } Ital. *contemnere*; Lat.
CONTE'MNER, *n. s.* } *contemnere*; Gr. *Τεμνω*.
CONTE'MNING, *n. s.* } *Seco*, to cut off; whence
temno, *contemno* To despise; to set at nought;
to neglect; to defy.

So much the more was Calpene offended,
That him to no revenge he forth could call,
But both his challenge and himself *contemned*.
Spenser. Faerie Queene.

What am I that thou shouldst *contemne* me thus?
Or what great danger dwells upon my suit?
Shakespeare. Venus and Adonis.
Yet better thus, and known to be *contemned*,
Than still *contemned* and flattered. *Id. King Lear.*
O ye sweet nymphs that beauty's loss do fear,
Contemn the drugs that physic doth devise,
And learn of love this dainty exercise (dancing).
Davies.

Eve, thy contempt of life and pleasure seems
To argue in thee something more sublime
And excellent than what thy mind *contemns*. *Milton.*
He counsels him to persecute innovators of wor-
ship, not only as *contemners* of the gods, but as dis-
turbers of the state. *South.*

Pygmalion then the Tyrian sceptre sway'd,
One who *contemned* divine and human laws:
Then strife ensued. *Dryden. Virgil's Æneid.*
Such worth the Laurel could alone repay,
Profaned by Cibber, and *contemned* by Gray;
Yet hence its wreath shall new distinction claim,
And, though it gave not, take from Warton fame.
Huddesford.

There is many a pang to pursue me:
They may crush, but they shall not *contemn*—
They may torture, but shall not subdue me—
'Tis of thee that I think—not of them. *Byron.*

CONTE'MPER, *v. a.* } It. *contemperare*,
CONTE'MPERATE, *v. a.* } *contemperare*; Span.
CONTE'MPERAMENT, *n. s.* } *contemperar*; Lat.
CONTE'MPERA'TION, *n. s.* } *contemperare*. To
CONTE'MPERING, *n. s.* } *temper*; to mode-
rate; to diminish the strength or virulence of,
by admixture; the act of tempering or dimi-
nishing any quality; a due mixture; proportion.
Contemperament is the degree of any quality.
Contemperring, as a noun, is mixing; blending
with.

The mighty Nile and Niger do not only moisten
and *contemperate* the air, but refresh and humectate
the earth. *Brown.*
The use of air, without which there is no contin-
uation in life, is not nutrition, but the *contemperation*
of fervour in the heart. *Id. Vulgar Errors.*

There is not greater variety in men's faces, and in
the *contemperations* of their natural humours, than
there is in their fantasies. *Hale's Origin of Mankind.*

There is nearly an equal *contemperament* of the
warmth of our bodies to that of the hottest part of the
atmosphere. *Dorham.*
The leaves qualify and *contemper* the heat, and hin-
der the evaporation of moisture. *Ray on the Creation.*
If blood abound, let it out, regulating the patient's
diet, and *contemperring* the humours.
Wiseman's Surgery.

CONTE'MPLATE, *v. a. & n.* } Fr. *contem-*
CONTE'MPLA'TION, *n. s.* } *pler*; Ital. *com-*
CONTE'MPLATIST, *n. s.* } *templare*; Sp.
CONTE'MPLATIVE, *adj.* } *contemplar*;
CONTE'MPLATIVELY, *adv.* } Lat. *contem-*
CONTE'MPLA'TOR, *n. s.* } *plare*. The root
of contemplate is referred, by Vossius and others,
to *templum*, because temples were so situated as
to be seen from all sides. The verb means, to
think deeply and deliberately; to muse; to
study; to meditate. Contemplation is studious
thought; devout meditation; the faculty of
study. The meaning of the kindred words is
obvious.

Yet note their hungry view be satisfide
But seeing, still the more desir'd to see,
And ever firmly fix'd did abide
In *contemplation* of divinitie. *Sponsor. Faerie Queene.*

How now! what serious *contemplation* are you in?
Shakespeare.

So many hours must I take my rest;
So many hours must I *contemplate*. *Id. Henry VI.*

I have breathed a secret vow
To live in prayer and *contemplation*,
Only attended by Nerissa here.
Id. Merchant of Venice.

In the Persian tongue the word *magus* imports as much as a *contemplator* of divine and heavenly science.
Raleigh's History.

I am no courtier, nor versed in state affairs: my life hath rather been *contemplative* than active. *Bacon.*

The Platonick *contemplators* reject both these descriptions, founded upon parts and colours.
Browne's Vulgar Errors.

Sapor had an heaven of glass, which he trod upon,
contemplating over the same as if he had been Jupiter.
Peacham.

And these three powers three sorts of men do make;
For some, like plants, their veins do only fill;
And some, like beasts, their senses' pleasures take;
And some, like angels, do *contemplate* still. *Davies.*

Fixt and *contemplative* their looks,
Still turning over nature's books. *Denham.*

There are two functions, *contemplation* and practice, according to that general division of objects; some of which entertain our speculation, others employ our actions. *South.*

The same idea, when it again recurs without the operation of the like object on the external sensory, is remembrance: if it be sought after by the mind, and with pain and endeavour found, and brought again in view, it is recollection: if it be held there long under attentive consideration, it is *contemplation*. *Locke.*

We should make greater progress in the discovery of rational and *contemplative* knowledge, if we sought it in the fountain, in the consideration of things themselves; and made use rather of our own thoughts, than other men's, to find it. *Locke.*

So many kinds of creatures might be to exercise the *contemplative* faculty of man. *Ray on the Creation.*

How can I consider what belongs to myself, when I have been so long *contemplating* on you.
Dryden's Jew. Preface.

There is not much difficulty in confining the mind to *contemplate* what we have a great desire to know.
Watts.

He had from the beginning of his malady a distinct view of his dissolution, which he *contemplated* with that entire composure which nothing but the innocence, integrity, and usefulness of his life, and an unaffected submission to the will of Providence could bestow.
Burks.

They who consider with what infinite attention, by what a disregard of every perishable object, through what long habits of piety and *contemplation* it is, any man is able to attain entire love and devotion to the Deity, will easily perceive, that it is not the first, the most natural, and the most striking effect, which proceeds from that idea. *Id.*

If God vouchsafes to reveal himself to mankind, can we suppose that he chooses to do so in such a manner as that none but the learned and *contemplative* can understand him?
Id.

See where he sits *contemplative* and fixed,
Pleasure and wonder in his features mixed;
His passions tamed, and all at his control,
How perfect the composure of his soul! *Cooper.*

If in the course of such a life as was
At once adventurous and *contemplative*,
Men who partake all passions as they pass,
Acquire the deep and bitter power to give
Their images again as in a glass,
And in such colors that they seem to live.—
Byron. Don Juan.

CONTEMPORISE, v. a.
CONTEMPORARY, n. s. & adj.
CONTEMPORARINESS, n. s.
CONTEMPORANEOUS, adj.
CONTEMPORANEITY, n. s.

Fr. *contemporain*; It. & Span. *contemporaneo*; Lat. *contemporalis*, from *con* and *tempus*. To contemporise is used by Sir Thomas Browne, in the sense of to render contemporary. He seems to be the only person who has employed it. Contemporary, as an adjective, signifies existing at the same period; brought into existence at the same time with; of the same standing with; coeval. As a noun, it means the person or thing to which the adjective applies. It is sometimes, but incorrectly, written cotemporary; a practice which is well ridiculed by Bentley. See the quotation.

The indifferency of their existences, *contemporised* into our actions, admits a farther consideration.
Browne's Vulgar Errors.

A grove born with himself he sees,
And loves his old *contemporary* trees. *Cowley.*

It is impossible to make the ideas of yesterday, to-day, and to-morrow, to be the same; or bring ages past and future together, and make them *contemporary*.
Locke.

As he has been favorable to me, he will hear of his kindness from our *contemporaries*; for we are fallen into an age illiterate, censorious, and detracting.
Dryden's Jew. Preface.

Albert Durer was *contemporary* to Lucas.
Id. Dufresnoy.

The active part of mankind, as they do most for the good of their *contemporaries*, very deservedly gain the greatest share in their applauses.
Addison's Freeholder.

The Latins never use *co* for *con*, except before a vowel, as co-equal, co-eternal; but, before a consonant, they either retain the *n*, as *contemporary*, constitution, or melt it into another letter, as collection, comprehension; so that the word *cotemporary*, is a word of his own composition, for which the learned world will congratulate him.
Bentley.

Contemporaries all surpassed, see one;
Short his career, indeed, but ably run;
Churchill, himself unconscious of his powers,
In penury consumed his idle hours;
And, like a scattered seed at random sown,
Was left to spring by vigour of his own. *Cooper.*

CONTEMPT, n. s.
CONTEMPTIBLE, adj.
CONTEMPTIBLENESS, n. s.
CONTEMPTIBLY, adv.
CONTEMPTUOUS, adj.
CONTEMPTUOUSLY, adv.
CONTEMPTUOUSNESS, n. s.

Old Fr. *contempt*; Lat. *contemptus*. Scorn; slighting; the state of being scorned; the state of being degraded; offence against the authority of courts of law. For the latter sense, see the next article. Contemptible is that which is worthy of being

despised; that which is despised; and formerly, but this meaning is become a vulgarism, apt to treat with contempt. In this latter sense, contemptuous is the proper word. See CONTEMN.

It was neither in *contempt* nor pride that I did not bow. *Kather*,

She lightly to him leapt, and in his necke
Her proude foots setting, at his head did leuell,
Weening at once her wrath on him to wreak,
And his *contempt*, that did her judgment breake.

Spenser. Faerie Queene.

I throw my name against the bruising stone,
Trampling *contemptuously* on thy diadem. *Shakespeare.*

If she should make tender of her love, 'tis very possible he'll scorn it; for the man hath a *contemptible* spirit. *Id.*

To neglect God all our lives, and know that we neglect him; to offend God voluntarily, and know that we offend him, casting our hopes on the peace which we trust to make at parting, is no other than a rebellious presumption, and even a *contemptuous* laughing to scorn and deriding of God, his laws, and precepts. *Raleigh's Hist. of the World.*

Some much averse I found, and wond'rous harsh,
Contemptuous, proud, set on revenge and spite.

Milton's Agonistes.

Knowest thou not
Their language, and their ways? They also know,
And reason not *contemptibly*. *Id. Paradise Lost.*

The shame of being miserable
Exposes men to scorn and base *contempt*,
Even from their nearest friends. *Denham.*

The apostles and most eminent Christians were poor, and used *contemptuously*. *Taylor's Holy Living.*

There is no action, in the behaviour of one man towards another, of which human nature is more impatient than of *contempt*; it being an undervaluing of a man, upon a belief of his utter uselessness and inability, and a spiteful endeavour to engage the rest of the world in the same slight esteem of him. *South.*

Nobody of any credit can bear the imputation of a lie; a mark that is judged the utmost disgrace, which debases a man to the lowest degree of a shameful meanness, and ranks him with the most *contemptible* part of mankind, and the abhorred rascality. *Locke.*

If he governs tyrannically in youth, he will be treated *contemptuously* in age; and the baser his enemies, the more intolerable the affront. *L'Estrange.*

His friend smiled scornful, and with proud *contempt*
Rejects as idle what his fellow dreamt. *Dryden's Fables.*

Who, by a steady practice of virtue, comes to discern the *contemptibleness* of baits wherewith he allures us. *Decay of Piety.*

Rome, the proudest part of the heathen world, entertained the most *contemptuous* opinion of the Jews. *Atterbury.*

Nothing, says Longinus, can be great, the *contempt* of which is great. *Addison.*

From no one vice exempt,
nd most *contemptible* to shun *contempt*. *Pope's Ep.*

Thus to administer the opiate potion of amnesty, powdered with all the ingredients of scorn and *contempt*, is to hold to his lips, instead of 'the balm of hurt minds,' the cup of human misery full to the brim, and to force him to drink it to the dregs. *Burke.*

Yet life still lingers in thee, and puts forth
Proof not *contemptible* of what she can,
Even where death predominates. *Cowper.*

You should never bestow pity on those who take pains for your *contempt*: pity those whom nature abuses, never those who abuse nature. *Sheridan.*

Lone, wild, and strange, he stood alike exempt
From all affection, and from all *contempt*:
His name could sadden, and his acts surprise;
But they that feared him dared not to despise.

Byron. The Corsair

CONTEMPT, in law, is a disobedience to the rules and orders of a court, which hath power to punish such offence; and as this is sometimes a greater, and sometimes a lesser offence, so it is punished with greater or less punishment, by fine or imprisonment.

<p>CONTEND, v. a. & n. CONTENDENT, n. s. CONTENDEE, n. s. CONTENDING, n. s. CONTENTION, n. s. CONTENTIOUS, adj. CONTENTIOUSLY, adv. CONTENTIOUSNESS, n. s.</p>	<p>Fr. <i>contendre</i>; It. <i>contendere</i>; Sp. <i>contender</i>; Lat. <i>contendere</i>. <i>Terw. Æol.</i> <i>revus</i>, whence the ancient Latin, <i>tanno</i>. To stretch, to extend, is the primary idea.</p>
--	---

To contend is, then, to stretch the faculties, or the strength, in a struggle with any one; to strive against any person; to vie with; to act emulously; to dispute any thing; to have a struggle for; to insist positively. Contend takes *with*, and sometimes *against*, before the opponent; *for*, and sometimes *about*, before the cause of contention. Contendent, and contender, signify an antagonist; a champion: the first of these meanings is disused. Contention is, quarrel; emulation; ardor; strenuousness of endeavour. He who is contentious is of that troublesome and disagreeable class of persons who are prone to quarrel; fond of dispute; perverse

Distress not the Moabites, neither contend with them in battle; for I will not give thee of their land. *Deut. ii. 9.*

Avoid foolish questions and genealogies, and contentions and strivings. *Tit. iii. 9.*

Her lying tongue was in two parts divided,
And both the parts did speake, and both *contended*.
Spenser. Faerie Queene.

Thereto the blatant beast, by them set on,
At him began aloud to barke and bay
With bitter rage, and fell *contention*. *Id.*

But being aged now, and weary too
Of warres delight and world's *contentious* toyle,
The name of knighthood he did disavow. *Id.*

Can we with manners ask what was the difference?
—Safely, I think; 'twas a *contention* in publick. *Shakespeare.*

His wonders and his praises do *contend*
Which should be thine or his *Id. Macbeth.*

Thus art with arms *contending* was victor of the day,
Which by a gift of learning did bear the maid away. *Id. The Passionate Pilgrim.*

Thou thinkest much that this *contentious* storm
Invades us to the skin. *Id. King Lear*

None are so gross as to contend for this,
That souls from bodies may traduced be;
Between whose natures no proportion is,
When root and branch in nature still agree. *Davies.*

We shall not *contentiously* rejoin, or only to justify our own, but to applaud and confirm his maturer assertions. *Browne.*

The question which our author would contend for, if he did not forget it, is, what persons have a right to be obeyed. *Locke.*

The *contenders* for it look upon it as undeniable. *Id.*

Your own earnestness and contention to effect what you are about, will continually suggest to you several artifices. *Holder.*

Their airy limbs in sports they exercise,
And on the green contend the wrestler's prize. *Dryden's Aeneid.*

In all notable changes and revolutions, the *contendents* have been still made a prey to the third party. *L' Etrange*

Rest made them idle, idleness made them curious, and curiosity contentious. *Decay of Piety.*

The ancients made contention the principle that reigned in the chaos at first, and then love; the one to express the divisions, and the other the union of all parties in the middle and common bond. *Burnet's Theory of the Earth.*

Do not contentiousness, and cruelty, and study of revenge, seldom fail of retaliation? *Beasley's Sermons.*

Those disputes often arise in good earnest, where the two *contenders* do really believe the different propositions which they support. *Watts on the Mind.*

Others corrupting religion, as these have perverted philosophy, contend, that Christians are redeemed into captivity; and the blood of the Saviour of mankind has been shed to make them the slaves of a few proud and insolent sinners. *Burke.*

Thrice happy they whom kindred souls unite,
By virtue chastened, yet alive to love;
Whose sole contention is to give delight,
Whose pleasures few can feel, but all approve. *Leffroy.*

Men deal with life, as children with their play,
Who first misuse, then cast their toys away;
Live to no sober purpose, and contend
That their Creator had no serious end. *Cooper.*

Then—with each feature working from the heart,
With feelings loosed to strengthen—not depart:
That rise—convulse—contend—that freeze, or glow,
Flush in the cheek, or damp upon the brow. *Byron. The Corsair.*

CONTENT, *v. a., n. s. & adj.* } Fr. *content-*
CONTENTATION, *n. s.* } *er*; Ital. *con-*
CONTENTED, *part. adj.* } *tentare*; Sp. *contentar*; Lt. *contentus*. To
CONTENTEDLY, *adv.* } render satis-
CONTENTEDNESS, *n. s.* } fied; to be sa-
CONTENTFUL, *adj.* } tisfied with;
CONTENTFULLY, *adv.* } to remove a
CONTENTLESS, *adj.* } cause of com-
CONTENTLY, *adv.* } plaint; to please; to gratify

Content is moderate happiness; the temperate point of life; equally remote from elevation and depression; acquiescence in any thing. In parliamentary language the contents are those members who vote on the affirmative side of a question. Contentation, which signifies satisfaction, content; is out of use. Contentment signifies, being satisfied, but without feeling any lively pleasure; gratification.

For as we thought we had our travail's spon
In soch wise as we heldin us content;
Then eche of us toke othir by the sleeve,
And forth withal as we shulde take our leve. *Chaucer.*

Contented with thine owne estate,
Ne wish for death, ne feare his might. *Earl of Surrey.*

Alas howe harde and steely hartes had they,
That not contented there to have thee dye,
With fettered gyves in prison where thou laye,
Increase so far in hateful crueltye,
That buryall to thy corps they eke denye. *Sackville.*

Among good things I prove and finde,
The quiet life doth most abound,
And sure to the contented mynde
There is no riches may be founde. *Songes and Sonettes.*

That them repented much so foolishly
To come so far to seek for misery,
And leave the sweetness of contented home,
Though eating hips, and drinking watry fome. *Spenser. Mother Hubbard's Tale.*

The noblest mind the best contentment has. *Id. Faerie Queene.*

Content thyself wish this much, and let this satisfy
hee, that I love thee. *Sidney.*

I seek no better warrant than my own conscience,
nor no greater pleasure than mine own contentation. *Id.*

Submit you to the people's voices,
Allow their officers, and be content
To suffer lawful censure. *Shakespeare. Coriolanus.*

Is the adder better than the eel,
Because his painted skin contents the eye? *Id.*

Best states, contentless,
Have a distracted and most wretched being.
Worse than the worst, content. *Id. Timon.*

If a man so temper his actions, as in some one of
them he doth content every faction, the musick of
praise will be fuller. *Bacon.*

She cannot in this world contented be,
For who did ever yet, in honor, wealth,
Or pleasure of the sense contentment find?

So when the soul finds here no true content,
And, like Noah's dove, can no sure footing take,
She doth return from whence she first was sent. *Davies.*

Dream not of other worlds,
Contented that thus far has been revealed,
Not of earth only, but of highest heaven. *Milton's Paradise Lost*

Angling was, after tedious study, a calmer of un-
quiet thoughts, a moderator of passions, a procurer of
contentedness. *Walton's Angler.*

One thought content the good to be enjoyed;
This every little accident destroyed. *Dryden.*
Great minds do sometimes content themselves to
threaten, when they could destroy. *Tillotson.*
Foe to loud praise, and friend to learned ease,
Content with science in the vale of peace. *Pope's Epistles.*

Some place the blise in action, some in ease;
Those call it pleasure, and contentment these. *Id. Essay.*

The shield was not long after incrustated with a new
rust, and is the same, a cut of which hath been en-
graved and exhibited, to the great contentation of the
learned. *Arbutnot and Pope.*

Having no spirit of order, he never looked for-
ward; content by any temporary expedient to ex-
tricate himself from a present difficulty. *Burke.*

From labour health, from health contentment
springs;

Contentment opes the source of every joy. *Beattie.*
He that holds fast the golden mean,
And lives contentedly between

The little and the great,
 Feels not the wants that pinch the poor,
 Nor plagues that haunt the rich man's door,
 Imbittering all his state. *Cowper.*

CONTERMINABLE, adj. } Ital. *conter-*
CONTERMINATE, adj. } *minare, conter-*
CONTERMINOUS, adj. } *minale*; Span.
contermino; Lat. *conterminus*. Conterminable
 is, capable of the same bounds. Conterminate,
 that which has a common boundary with another.
 Conterminous, that which has the same
 bounds with; that which borders on.

Love and life are not *conterminable*.
Sir H. Wotton.

A strength of empire fixed
Conterminates with heaven. *B. Jonson.*

This conformed to many of them, as were *conter-*
minous to the colonies and garrisons, to the Roman
 laws. *Hale.*

CONTERRANEAN, adj. } Ital. and Sp.
CONTERRANEUS, adj. } *conterraneo*; Lat.
conterraneus. Of the same soil or country.

I hold that of the orator to be a wild extravagant
 speech, that if women were not *conterranean* and
 mingled with men, angels would descend and dwell
 among us. *Howell.*

CONTESSERATION, n. s. Lat. *con* and
teseratus. An assemblage; a variety.

That person of his which afforded such a *contessa-*
tion of elegancies. *Oley.*

CONTEST, v. a. & n. } Fr. *contester*; Ital.
CONTEST, n. s. } *contestare*; Sp. *con-*
CONTESTATION, n. s. } *testar*; Lat. *contesta-*
CONTESTABLE, adj. } *ri*. To dispute; to
CONTESTABLENESS, n. s. } strive against; to
CONTESTINGLY, adv. } strive with; to liti-
CONTESTLESS, adj. } gate; to emulate.

Contestation, which signifies debate, strife, Barrow
 uses in the sense of proof, testimony—'by a
 solemn contestation ratified on the part of God.'
 Contestless means indisputable. Contestingly,
 in a disputing manner. But these words are not
 of frequent occurrence.

I do *contest*
 As holy and as nobly with thy love,
 As ever in ambitious strength I did
 Contend against thy valour. *Shakespeare. Coriolanus.*

This of old no less *contests* did move,
 Than when for Homer's birth seven cities strove. *Denham.*

After years spent in domestick, unsociable *con-*
testations, she found means to withdraw. *Clarendon.*

'Tis evident upon what account none have pre-
 sumed to *contest* the proportion of these ancient pieces.
Dryden's Dufresnoy.

These native propensities, these prevalencies of
 constitution, are not to be cured by rules, or a direct
contest, especially those of them that are the humbler
 and meaner sort, which proceed from fear and low-
 ness of spirit; though with art they may be much
 mended, and turned to good purpose. *Locke.*

The difficulty of an argument adds to the pleasure
 of *contesting* with it, when there are hopes of victory.
Barnet.

Doors shut; visits forbidden, and, which was
 worse, divers *contestations* even with the queen herself.
Wotton.

Of man, who dares in pomp with Jove *contest*,
 Unchanged, immortal, and supremely blest?
Pope's Odyssey.

Leave all noisy *contests*, all impudest clamours,
 and brawling language. *Watts.*

Henry the Second, during his *contest* with the
 church, had the address to preserve the barons in his
 interests. Afterwards, when the barons had joined
 in the rebellion of his children, this wise prince found
 means to secure the bishops and ecclesiastics. *Burke.*

Between Nose and Eyes a strange *contest* arose,
 The spectacles set them unhappily wrong;
 The point in dispute was, as all the world knows,
 To which the said spectacles ought to belong. *Cowper.*

A bumper of good liquor
 Will end a *contest* quicker
 Than justice, judge, or vicar:
 So fill a cheerful glass,
 And let good humour pass. *Sheridan.*

CONTEX, v. a. } Fr. *contare*; Ital.
CONTEXT, v. a. & adj. } *contesto*; Span. *con-*
CONTEXT, n. s. } *texto*; Lat. *contas-*
CONTEXTURAL, adj. } *tum*, past participle
CONTEXTURE, n. s. } of *contexere*. Cot-

grave, and after him Sherwood, defines the noun
 very satisfactorily: 'A context; a whole web,
 composition, worke; or, an interlacing, ioyning,
 or weaving together; also the forme or stile of a
 proces, booke, or discourse.' To which, how-
 ever, may be added that, with references to a
 book, context means the general tenor of; the
 parts which come before and after any passage
 quoted; and that, as an adjective, it denotes
 firmly knit together; closely interwoven. As a
 verb it signifies, as does also context, to knit or
 weave together; to form a junction between the
 parts of. Both verbs are obsolete; though it is
 not easy to perceive why they have fallen into
 disuse. Contextural is that which has relation to
 the human frame. Contexture, Johnson fully
 and perspicuously describes to be the disposition
 of parts, one amongst others; the composition
 of any thing out of separate parts; the system;
 the constitution; the manner in which any thing
 is woven or formed.

That chapter is really a representation of one, which
 hath only the knowledge, not practice, of his duty, as
 is manifest from the *contest*. *Hammond on Fundamentals.*

Nature may *contes* a plant, though that be a per-
 fectly mixt concrete, without having all the elements
 previously presented to her to compound it of. *Boyle.*

The fluid body of quicksilver is *contased* with the
 salts it carries up in sublimation. *Id.*

If the quotation in the verse produced were con-
 sidered as a part of a continued coherent discourse,
 and so its sense were limited by the tenour of the
context, most of these forward and warm disputants
 would be quite stripped of those, which they doubt not
 now to call spiritual weapons; and they would often
 have nothing to say, that would not show their weak-
 ness, and manifestly fly in their faces. *Locke.*

Every species, afterwards expressed, was produced
 from that idea, forming that wonderful *contexture* of
 created beings. *Dryden's Dufresnoy.*

He was not of any delicate *contexture*; his limbs
 rather sturdy than dainty. *Wotton.*

Hollow and thin, for lightness; but withal *contest* and firm, for strength. *Derham's Physico-Theology.*

Hence 'gan relax
The ground's *contesture*; hence Tartarian dregs,
Sulphur and nitrous spume, enkindling fierce,
Bellowed within their darksome caves. *Philips.*

CONTIGNATION, *n. s.* Lat. *contignatio*.
A frame of beams joined together; a story. The act of framing or joining a fabric of wood; the act of laying rafters together.

We mean a porch, or cloister, or the like, of one *contignation*, and not in storied buildings.

Wotton's Architecture.

Where more of the orders than one shall be set in several stories or *contignations*, there must be an exquisite care to place the columns one over another.

Wotton.

They were easily led to consider the flames that were consuming France, not as a warning to protect their own buildings, (which were without any party-wall, and linked by a *contignation* into the edifice of France), as a happy occasion for pillaging the goods, and carrying off the materials of their neighbour's house.

Burke. Let. on Reg. Peace. Let. ii.

CONTIGUOUS, *adj.* } Fr. *contigu*; Ital.
CONTIGUOUSLY, *adv.* } and Span. *contiguo*;
CONTIGUOUSNESS, *n. s.* } Lat. *contiguus*, from
CONTIGUITY, *n. s.* } *contingere*. Meeting, with actual contact; being nigh, without actual contact; being in the immediate vicinity of; bordering upon. Contiguous sometimes has with after it.

Flame doth not mingle with flame as air doth with air, or water with water, but only remaineth *contiguous*; as it cometh to pass betwixt consisting bodies.

Bacon's Natural History.

Water, being *contiguous* with air, cooleth it, but moisteneth it not.

Id.

The loud misrule
Of chaos far removed; lest fierce extremes,
Contiguous, might distemper the whole frame.

Milton.

He defined magnetical attraction to be a natural imitation and disposition conforming unto *contiguity*.

Browne.

The immediate *contiguity* of that convex was a real space.

Hale's Origin of Mankind.

The East and West,
Upon the globe a mathematic point
Only divides: thus happiness and misery,
And all extremes, are still *contiguous*.

Denham's Sophy.

Distinguish them by the diminution of the lights and shadows, joining the *contiguous* objects by the participation of their colours.

Dryden's Dufresnoy.

Thus disembroiled, they take their proper place,
The next of kin *contiguously* embrace,
And foes are sundered by a larger space.

Dryden's Ovid.

When I viewed it too near, the two halves of the paper did not appear fully divided from one another, but seemed *contiguous* at one of their angles.

Newton's Opticks.

Often, when we do not immediately call to mind what we wish to remember, we set ourselves, as it were, to search for it; we meditate on other things or persons, that seem to be like it, or contrary to it, or *contiguous*, or to bear any other relation to what we are in quest of; and thus, perhaps, we at last re-

member it. This continued effort of voluntary remembrance is called recollection. *Beattie.*

O for a lodge in some vast wilderness,
Some boundless *contiguity* of shade,
Where rumour of oppression and deceit,
Of unsuccessful or successful war,
Might never reach me more!

Cooper.

Called by thy voice, *contiguous* thoughts embrace
In endless streams, arranged by time or place;
The muse historic hence in every age
Gives to the world her interesting page.

Darwin.

CONTINENT, *n. s. & adj.* } Fr. *continent*;
CONTINENTAL, *adj.* } It. and Sp. *cont-*
CONTINENTLY, *adv.* } *tinente*; Lat.
CONTINENCE, *n. s.* } *continentis*, past
CONTINENCY, *n. s.* } part of *contine-*

nere. As an adjective, continent signifies having the power of forbearing; the power of containing our own passions within due bounds. He is continent who, to use the words of Minshew, 'contains or bridles himself from pleasures, either in covetousness, gluttony, or revelry.' The adjective has also, in some old writers, the meanings of continuous; opposing. The noun formerly meant not only a vast tract of continuous land, as Europe, but likewise that which contains anything. In the latter sense it is obsolete. Contenance, in the sense of continuity, is equally disused. It now means self-command; mastery over the passions

Virginitee is great perfection,
And *contenance* eke with devotion.

Chaucer. Cant. Tales.

Such power it had that to no woman's wast
By any skill or labour it would sit,
Unless that she were continent and chaste
But it would lose or break, that many had disgrast.

Spenser. Faerie Queene.

A harder lesson to learn *contenance*
In ioyous pleasure than in grievous paine;
For sweetness doth allure the weaker sense
So strongly, that unethates it can refrain
From that which feeble nature covets faine.

Id.

Thou God of winds, that reignest in the seas,
Thou reignest also in the continent.

Id.

Where is he!—
In her chamber, making a sermon on *continency* to
her, and rails, and swears, and rates.

Shakespeare's Teming of the Shrew

Suffer not dishonour to approach
The' imperial seat; to virtue consecrate,
To justice, *contenance*, and nobility.

Id. Titus Andronicus.

Life
Hath been as *continent*, as chaste, as true
As I am now unhappy.

Id. Winter's Tale.

I pray you, have a *continent* forbearance, till the
speed of his rage goes slower.

Id. King Lear.

My desire
All *continent* impediments would o'erbear,
That did oppose my will.

Id. Macbeth.

O cleave, my sides!

Heart, once be stronger than thy *continent*;
Crack thy frail case.

Id. Antony and Cleopatra.

The north-east part of Asia, if not *continent* with
the west side of America, yet certainly is the least
disjoined by sea of all that coast of Asia.

Brewerwood on Languages.

Whether this portion of the world were rent
 By the rude ocean from the continent,
 Or thus created, it was sure designed
 To be the sacred refuge of mankind.

Waller.

Chastity is either abstinence or *continence*: abstinence is that of virgins or widows; *continence*, of married persons.

Taylor.

Content without lawful vengery, is *continence*; without unlawful, chastity.

Grew's *Cosmologia*.

He knew what to say; he knew also when to leave off, a *continence* which is practised by few writers.

Dryden's *Fables*. Preface.

Answers ought to be made before the same judge, before whom the depositions were produced, lest the *continence* of the course should be divided; or, in other terms, lest there should be a discontinuance of the cause.

Ayliffe's *Parergon*.

The declivity of rivers will be so much the less, and therefore the *continents* will be the less drained, and will gradually increase in humidity.

Bentley's *Sermons*.

No *continental* power was willing to lose any of its *continental* objects for the increase of the naval power of Great Britain.

Burke.

High towering palms, that part the southern flood,
 With shadowy isles, and *continents* of wood.

Darwin.

CONTINGE, *v. n.*
 CONTINGENT, *n. s. & adj.*
 CONTINGENTLY, *adv.*
 CONTINGENTNESS, *n. s.*
 CONTINGENCE, *n. s.*
 CONTINGENCY, *n. s.*

Fr. *contingent*;
 Ital. and Span. *contingente*; Lat. *contingens*, pres. part. of *contingere*. The verb *continge*, whi.

means to touch, to reach, to happen, is obsolete. Nor does it appear ever to have been in general use. That which is contingent, is that which occurs fortuitously; that which may happen, but cannot be reckoned upon as certain. A contingent is a thing under the dominion of chance, a proportion which each person is to furnish, in a certain case: thus, the quota of troops, or money, supplied by a German prince, in time of war, is denominated his contingent. Contingence, and contingency, signify the quality of being fortuitous; a circumstance that may happen. Contingently is, accidentally; not regularly.

Their credulities assent unto any prognosticks, which, considering the *contingency* in events, are only in the presence of God.

Broune's *Vulgar Errors*.

Aristotle says, we are not to build certain rules upon the *contingency* of human actions.

South.

Hazard naturally implies in it, first, something future; secondly, something *contingent*.

Id.

His understanding could almost pierce into future *contingents*, his conjectures improving even to prophecy.

Id.

For once, O heaven! unfold thy adamant book
 If not thy firm, immutable decree,

At least the second page of great *contingency*,
 Such as consists with wills originally free.

Dryden.

By *contingents* we are to understand those things which come to pass without any human forecast.

Grew's *Cosmologia*.

I first informed myself in all material circumstances of it, in more places than one, that there might be nothing casual or *contingent* in any one of those circumstances.

Woodward.

It is digged out of the earth *contingently*, and indifferently, as the pyrite and agates.

Id. *Natural History*.

No theatric audience in Athens would bear what has been borne, in the midst of the real tragedy of

this triumphal day; a principal actor weighing, as it were in scales hung in a shop of horrors,—so much actual crime against so much *contingent* advantage,—and, after putting in and out weights, declaring that the balance was on the side of the advantages.

Burke.

Could chance

Find place in his dominion, or dispose
 One lawless particle to thwart his plan;
 Then God might be surpris'd, and unforseen
 Contingence might alarm him, and disturb
 The smooth and equal course of his affairs.

Cowper.

CONTINUE, *v. a. & adj.*
 CONTINUE, *v. a. & n.*
 CONTINUER, *n. s.*
 CONTINUATE, *n. s.*
 CONTINUATELY, *adv.*
 CONTINUAL, *adj.*
 CONTINUALLY, *adv.*
 CONTINUANCE, *n. s.*
 CONTINUATION, *n. s.*
 CONTINUATIVE, *n. s.*
 CONTINUATOR, *n. s.*
 CONTINUEDLY, *adv.*
 CONTINUITY, *n. s.*
 CONTINUOUS, *adj.*
 CONTINUOUSLY, *adv.*

Fr. *continuer*;
 Ital. *continuare*;
 Span. *continuar*;
 Lat. *continuare*.
 Uninterrupted action; unbroken succession of time, space, or matter; unchanging, or unceasing existence; are the primary ideas of all the words under this head. To continue is, to proceed incessantly; to have no stop or break; to remain in the same state, or place; to last; to protract; to persevere; to perpetuate. To continue is to connect closely together. Formerly, continuous and continual were used synonymously; but now, as Johnson observes, continual is used of time, and continuous of space. Continuative is an expression indicating permanence; a grammatical conjunction, under which head Harris classes, *if, because, therefore, &c*

Thy kingdom shall not *continue*.

1 Samuel xiii. 14.

O *continue* thy loving kindness unto them.

Psalms xxxvi. 10.

In thy book all my members were written, which in *continuance* were fashioned.

Id. cxxxix. 16.

He that is of a merry heart hath a *continual* feast.

Proverbs xv. 15.

The multitude *continues* with me now three days, and have nothing to eat.

Matthæw xvi. 32.

If ye *continue* in my word, then are ye my disciples indeed.

John viii. 31.

To them who, by patient *continuance* in well doing, seek for glory, and honour, and immortality, eternal life.

Romans ii. 7.

For here we have no *continuing* city, but we seek one to come.

Hebrews xiii. 14.

God give thee good chance,

And in vertue send thee *continuance*.

Chaucer's *Canterbury Tales*.

Lo see myne eyes flow with *continual* teares,
 The body still away sleepless it weares.

Wyat.

Styl to the death sortoesed with the wave
 Of restless woe, in terror and dispeyre,
 They lead a lyef *continually* in feare.

Sackville.

All that same evening she in flying spent,
 And all that night her course *continued*.

Spenser's *Faerie Queene*.

There sate a man of ripe and perfect age,
 Who did them meditate all his life long,
 That through *continual* practise and usage
 He now was grown right wise and wondrous sage.

Id.

For who sees not, that Time on all doth prey ?
But times do change and more *continually*,
So nothing here long standeth in one stay. *Id.*

——— through long *continuance* of his course,
He seems the world is runne quite out of square
From the first point of his appointed sourse. *Id.*

We are of him and in him, even as though our
very flesh and bones should be made *continuate* with
his. *Hooker.*

You either fear his humour, or my negligence, that
you call in question the *continuance* of his love.

Shakespeare. Twelfth Night.
Old woes, not infant sorrows, bear them mild ;
Continuance tames the one. *Id. Raps of Luorece.*

A most incomparable man, breathed, as it were,
To an untirable and *continuate* goodness. *Id. Timon.*

I would my horse had the speed of your tongue,
and so good a *continuer*. *Id. Much ado about Nothing.*

The drawing of boughs into the inside of a room
where fire is *continually* kept, hath been tried with
grapes. *Bacon.*

Wool, tow, cotton, and raw silk, have, besides the
desire of *continuance* in regard of the tenuity of their
thread, a greediness of moisture. *Id.*

It is certain, that in all bodies there is an appetite
of union, and evitation of solution of *continuity*. *Id.*

They imagine that an animal of the longest dura-
tion should live in a continued motion, without that
rest whereby all others *continue*.

Brown's Vulgar Errors.
It seems injurious to Providence to ordain a way of
production which should destroy the producer, or con-
trive the continuation of the species by the destruction
of the *continuator*. *Id.*

The popular vote
Inclines here to *continus*, and build up here
A growing empire. *Milton.*

The dark abyss, whose boiling gulf
Tamely endured a bridge of wond'rous length,
From hell *continued*, reaching the utmost orb
Of this frail world. *Id.*

Other care perhaps
May have diverted from *continual* watch
Our great forbider. *Id.*
The water ascends gently, and by intermissions ;
but it falls *continuously* and with force. *Wilkins.*

These Remish casuists speak peace to the consci-
ences of men, by suggesting something which shall
satisfy their minds, notwithstanding a known avowed
continuance in sins. *South.*

Here Priam's son, Deiphobus, he found,
Whose face and limbs were one *continued* wound ;
Dishonest, with lopped arms, the youth appears,
Spoiled of his nose, and shortened of his ears.

Dryden's Æneid.
After the great lights there must be great shadows,
which we call repose ; because in reality the sight
would be tired, if it were attracted by a *continuity* of
glittering objects. *Dryden.*

Moderate punishments that are *continued*, that men
find no end of, know no way out of, sit heavy, and
become immoderately uneasy. *Loche.*

As the breadth of every ring is thus augmented, the
dark intervals must be diminished, until the neigh-
bouring rings become *continuous*, and are blended.

Newton's Opticks.
That pleasure is not of greater *continuance*, which
arises from the prejudice or malice of its hearers.

Addison's Freeholder.
You know how to make yourself happy, by only
continuing such a life as you have been long accus-
tomed to lead. *Pope.*

By perseverance, I do not understand a *continually*
uniform, equal course of obedience, and such as is not
interrupted with the least act of sin. *Norris.*

To these may be added *continuatives* : as, Rome
remains to this day ; which includes at least two
propositions, viz. Rome was, and Rome is.

Watt's Logic.
That texture, or cohesion of the parts of an animal
body, upon the destruction of which there is said to
be a solution of *continuity*. *Quincy.*

To whose dread expanse,
Continuous depth, and wond'rous length of course,
Our floods are rills. *Thomson's Summer.*

He (king John) was indolent, yet restless in his
disposition ; fond of working by violent methods,
without any vigour ; boastful, but *continually* betraying
his fears ; showing, on all occasions, such a desire of
peace as hindered him from ever enjoying it. *Burke.*

Though civil society might be at first a voluntary
act (which in many cases it undoubtedly was), its
continuance is under a permanent standing covenant,
co-existing with the society ; and it attaches upon
every individual of that society, without any formal
act of his own. *Id.*

All critics would agree that a Freinshenius would
have been thought to have managed the supplemen-
tary business of a *continuator* most unskilfully, and to
have supplied the hiatus most improbably, if he had
not filled up the gaping space in a manner somewhat
similar, though better executed. *Id.*

All thou couldst have of mine, stern Death ! thou
hast ;

The parent, friend, and now the more than friend .
Ne'er yet for one thime arrows flew so fast ;
And grief with grief *continuing* still to blend,
Hath snatched the little joy that life had yet to lend.

Byron. Childs Harold.
CONTINUED BASS, in music, thus called, says
Rousseau, because it is continued through the
whole piece. Its principal use, besides that of
regulating the harmony, is to support the voice
and preserve the tone.

CONTINUED PROPORTIONS, in arithmetic, is
that where the consequent of the first ratio is
the same with the antecedent of the second ; as
4 : 8 :: 8 : 16 ; in contradistinction to discrete
proportion.

CONTINUITY is defined by some schoolmen
the immediate cohesion of parts in the same
quantum ; by others, a mode of body whereby
its extremities become one ; and by others, a
state of body resulting from the mutual impli-
cation of its parts. There are two kinds of con-
tinuity, mathematical and physical. The first is
merely imaginary, since it supposes real or phys-
ical parts where there are none. The other or
physical continuity, is that state of two or more
particles, in which their parts are so mutually
implicated as to constitute one uninterrupted
quantity.

CONTINUO, or **BASSO CONTINUO**, in music,
is the continual or thorough bass, which is some-
times marked in music books by the letters
B. C.

CONTOBADITES, a sect which appeared in
the sixth century. Their first leader was Severus
of Antioch ; who was succeeded by John the
grammarian, surnamed Philoponus, and one
Theodosius, whose followers were also called
Theodosians. Part of them, who received a book
composed by Theodosius on the Trinity, formed

a separate body, and were called Contobabdites, from some place where they held their assemblies. The Contobabdites allowed of no bishops; which is the only peculiar circumstance recorded concerning them.

CONTO'RT, *v. a.* } *Fr. contorsion; Ital. con-*
CONTO'RTION, *n. s.* } *torsione; Sp. contorcion;*
Lat. contortus, from contorquere. To twist; to
 turn away; to wring; to writhe. A bending;
 twisting; distorting of; grimace.

The vertebral arteries are variously *contorted*. *Ray.*
 Disruption they would be in danger of, upon a
 great and sudden stretch or *contortion*. *Id.*

Air seems to consist of spires *contorted* into small
 spheres, through the interstices of which the particles
 of light may freely pass. *Cheyne.*

How can she acquire those hundred graces and mo-
 tions, and airs, the *contortions* of every muscular mo-
 tion in the face? *Swift.*

Returning he proclaims by many a grace,
 By shrugs and strange *contortions* of his face,
 How much a dunce, that has been sent to roam,
 Excels a dunce, that has been kept at home. *Cooper.*

CONTOUR, *n. s.* *Fr.* The outline; the
 line by which any figure is defined or terminated.
CONTOURNE, in heraldry, is used when a
 beast is represented standing or running with its
 face to the sinister side of the escutcheon, they
 being always supposed to look to the right, if not
 otherwise expressed.

CONTOURNIATED, a term among antiqua-
 ries applied to medals, the edges of which ap-
 pear as if turned in a lathe. This sort of work
 seems to have had its origin in Greece; and to
 have been designed to perpetuate the memories
 of great men, particularly, those who had borne
 away the prize at the solemn games. Such are
 those remaining of Homer, Solon, Euclid, Pytha-
 goras, Socrates, and several athleteæ.

CONTRA. A Latin preposition, used in com-
 position, which signifies against.

CONTRABAND, *v. a.* } *Fr. contre-*
CONTRABANDIST, *n. s. & adj.* } *bande; It. con-*
trabando; Sp. contrabando. That is, contrary
 to proclamation. Contraband, as a verb, is not
 in use, smuggle, which is synonymous with it,
 being always employed. Prohibited goods;
 goods which have not paid the custom-house
 duty. Prohibited; illegal; unlawful. Contra-
 bandist, is a smuggler.

If there happen to be found an irreverent expres-
 sion, or a thought too wanton, in the cargo, let them
 be staved or forfeited, like *contraband* goods.

Bryden's Fables. Pref.

Miraculous must be the activity of that *contraband*,
 whose operations in America could, before the end of
 that year, have re-acted upon England, and checked
 the exportation from hence. *Burke.*

The *contraband* trade was at that time very success-
 ful, and it sometimes happened to me to fall in with
 those who carried it on. Scenes of swaggering riot
 and roaring dissipation were till this time new to me;
 but I was no enemy to social life. *Burns.*

Church quacks, with passions under no command,
 Who fill the world with doctrines *contraband*,
 Discoveries of they know not what, confined,
 Within no bounds—the blind that lead the blind.

Cooper.

CONTRABAND GOODS, are articles of foreign
 merchandise, the use of which is forbidden by
 law; and a violation of which law exposes the
 goods themselves to the liability of confiscation,
 and places in the same liability to seizure all
 other allowed merchandise found with them in
 the same box, bale, or parcel, together with the
 horses, waggons, &c. which conduct them. There
 are some contraband goods, which, besides the
 forfeiture, are attended with several penalties and
 disabilities.

CONTRA'CT, *v. a., v. n. &*
CO'NTRACT, *n. s.* } *Fr. contracter;*
Ital. contrarre,
CONTRACT'ION, *n. s.* } *contracere; Sp.*
CONTRACTEDLY, *adv.* } *contratar; Lat.*
CONTRACTEDNESS, *n. s.* } *contrahere, from*
CONTRACTIBI'LITY, *n. s.* } *con and trahere.*
CONTRACTIBLE, *adj.* } To contract is,
CONTRACTIBLENESS, *n. s.* } to reduce with-
CONTRACTILE, *adj.* } in smaller di-
CONTRACTIVE, *n. s.* } mensions; to
CONTRACT'ION, *n. s.* } lessen; to cor-
CONTRACTOR, *n. s.* } rugate; to draw

together; to make a bargain; to betroth; to ac-
 quire; to incur; to shorten; to epitomise; to
 shrink up; to bargain for. A contract signifies
 an agreement between two parties; a compact;
 the act which betroths a man and woman. Con-
 traction is, the act of contracting; of shrinking;
 state of being contracted; reduction of two
 vowels or syllables into one; any thing in its
 state of abbreviation. Contractor is, generally,
 the party who contracts; in its restricted sense,
 it means a person who undertakes to supply the
 government with provisions, money, or other ar-
 ticles of necessity. Thus applied, the word has
 sometimes been synonymous with knave. Con-
 tractile is, possessing the power of contracting,
 of shrinking up. The meaning of the kindred
 words is obvious.

When the soule is put in our bodies right anon is
contract original sinne. *Chaucer. Cant. Tales.*

Wedlocke *contract* in blood, and eke in blood
 Accomplished, that many deare complaind.

Spenser. Faerie Queene.

First was he *contract* to Lady Lucy;
 Your mother lives a witness to that vow

Shakespeare. Richard III.

Touched you the bastardy of Edward's children?—
 —I did, with his *contract* with lady Lucy,
 And his *contract* by deputy in France. *Id.*

The truth is, she and I, long since *contracted*,
 Are now so sure that nothing can dissolve us.

Shakespeare.

Some things induce a *contraction* in the nerves,
 placed in the mouth of the stomach, which is a great
 cause of appetite. *Racon.*

Yet if affliction once her wars begin,
 And threat the feebler sense with sword and fire,
 The mind *contracts* herself and shrinketh in,
 And to herself she gladly doth retire. *Davies.*

Why love among the virtues is not known;
 It is, that love *contracts* them all in one. *Dome.*
 Of enemies he could not but *contract* good store,
 while moving in so high a sphere. *King Charles.*

To him the angel with *contracted* brow. *Milton.*

Let the measure of your affirmation or denial be
 the understanding of your *contractor*; for he that de-
 ceives the buyer or the seller by speaking what is

true, in a sense not understood by the other, is a thief.

Taylor's Rule of Living Holy.

Who, I beseech you, is it in this case, that makes the sect? Is it not those who *contract* the church of Christ within limits of their own contrivance? who, by articles and ceremonies of their own forming, separate from their communion all that have not persuasions which just jump with their model? *Locke.*

These established sects under the specious names of national churches, which, by their *contracted* and arbitrary limits of communion, justify against themselves the separation and like narrowness of others.

Id.
Justice, and keeping of *contracts*, is that which most men seem to, agree in.

The agreement upon orders, by mutual *contract*, with the consent to execute them by common strength, they make the rise of all civil governments. *Temple.*

He that but conceives a crime in thought,
Contracts the danger of an actual fault.

Dryden's Juvenal.

On him thy grace did liberty bestow;
But first *contracted*, that, if ever found,
His head should pay the forfeit. *Id. Fables.*

Comparing the quantity of *contraction* and dilatation made by all the degrees of each colour, I found it greatest in the red. *Newton's Opticks.*

She was a lady of the highest condition in that country, and *contracted* to a man of merit and quality.

Tattler.

Oil of vitriol will throw the stomach into involuntary *contractions*.

Arbutnot on Aliments.

Small air bladders, dilatable and *contractible*, are capable to be inflated by the admission of air, and to subside at the expulsion of it. *Id.*

By this continual *contractibility* and dilatability by different degrees of heat the air is kept in a constant motion. *Id.*

The arteries are elastick tubes, endued with a *contractile* force, by which they squeeze and drive the blood still forward. *Id.*

Like friendly colours, found them both unite,
And each from each *contract* new strength and light.

Pope.

Shall Ward draw *contracts* with a statesman's skill?
Or Japhet pocket, like his grace, a will? *Id.*

The main parts of the poem, such as the fable and sentiments, no translator can prejudice but by omissions or *contractions*. *Id. Essay on Homer.*

Neither he, nor any man, nor number of men, have a right (except what necessity, which is out of and above all rule, rather imposes than bestows) to free themselves from that primary engagement which every man born into a community so much *contracts* by his being born into it, as he *contracts* an obligation to certain parents by his having been derived from their bodies. *Burke.*

As they who live retired are disconcerted at the sight of a stranger; as he whose body has never been made pliant by exercise cannot perform new motions either gracefully or easily; so the man, who has *contracted* a habit of ruminating upon a few things and overlooking others, is fluttered, and at a loss, whenever he finds himself, as he often does, in unexpected circumstances. *Beattie.*

An Italian writer asserts, that if the top of the forest be touched, all the filaments which support the cylindrical anther will *contract* themselves, and thus by raising or depressing the anther, the whole of the prolific dust is collected on the stigma. *Darwin.*

Contractile earths in sentient forms arrange,
And life triumphant stays their chemic change.

Straight all subscribed—Kings, Gods, Mates,
Singer, Actor,—

A Flanders figure-dancer our *contractor*.

But here, I grieve to own, though it be to you,
He acted—even as most *contractors* do;
Sold what he never dealt in, and the amount
Being first discharged, submitted his account.

Sheridan.

CONTRACT, an agreement, written, or verbal, which serves as a proof of the consent granted, and the obligation passed between two parties. Among the ancient Romans *contracts*, and all voluntary acts, were written, either by the parties themselves, or by one of the witnesses, or by a domestic secretary of one of the parties, whom they called a notary, but who was no public person as among us. The *contract*, when finished, was carried to the magistrate, who gave it a public authority by receiving it inter acta, into the number of acts under his jurisdiction; giving each of the parties a copy thereof, transcribed by his clerks or domestic registers, and sealed with his seal. This practice passed into France, where it continued long. An express *contract* is where the terms of the agreement are openly uttered, as to pay a stated price for certain goods. An implied *contract* is such as reason and justice dictate, and which the law therefore supposes every man will perform: thus, if a man takes up wares from a tradesman, without any agreement of price, the law concludes that he *contracted* to pay their real value. In law these are good *contracts*, because there is one thing in consideration for another; but if a person promises to give or pay a certain sum, which afterwards, being demanded, he refuses to pay, no action lies to recover it; because such a promise does not amount to a *contract*, being only a simple promise, termed in law *nudum pactum*. But if any thing was given in consideration of such a promise, though only to the value of a penny, it is esteemed a good *contract*, and of course will be binding. Regard should be had to the time in, and from, which *contracts* are made; and there is a difference where a day of payment is fixed, and where there is not; for when a day is fixed, the *contract* is good immediately, and an action lies on it failing payment; but it is otherwise where the time of payment is not fixed.

CONTRACTS, NULL, are those prohibited by law: such are all *contracts* between persons incapable of contracting, as minors, religious, lunatics, wives without consent of their husbands, &c.

CONTRADICTION, *v. a.*

CONTRADICTER, *n. s.*

CONTRADICTION, *n. s.*

CONTRADICTIONAL, *adj.*

CONTRADICTIONOUS, *adj.*

CONTRADICTIONOUSNESS, *n. s.*

CONTRADICTIVE, *adj.*

CONTRADICTORY, *n. s. & adj.*

CONTRADICTORILY, *adv.*

CONTRADICTORINESS, *n. s.*

CONTRADICTORIOUS, *adj.*

CONTRADICTORIOUSLY, *adv.*

Fr. *contradire*; Ital. *contraddire*; Sp. *contradecir*; Lat. *contradicere*, from *contra* and *dicere*. To assert the contrary to what has been affirmed; to deny; to be in

opposition to; to gainsay. Contradiction is denial of the truth of; attempt to refute; inconsistency; incongruity; contrariety, in thought or effect. Contradictory signifies in opposition to; not consistent with; in logic, that which is in

the fullest opposition, where both the terms of one proposition are opposite to those of another. Contradictory is, replete with contradictions; prone to cavil. The meaning of the other words of the same class is obvious.

But when the Jews saw the multitudes, they were filled with envy, and spake against those things which were spoken by Paul, *contradicting* and blaspheming. *Acts* xiii. 45.

And without all *contradiction* the less is blessed of the better. *Hebrews* vii. 7.

Laws human must be made without *contradiction* unto any positive law in scripture. *Hooker*.

All *contradictions* grow in those minds, which neither absolutely climb the rock of virtue, nor freely sink into the sea of vanity. *Sidney*.

I *contradict* your bans :
If you will marry, make your loves to me. *Shakespeare. King Lear*.

It is common with princes to will *contradictories*; for it is the solecism of power to think to command the end, and yet not to endure the means. *Bacon*.

That tongue,
Inspired with *contradiction*, durst oppose
A third part of the gods. *Milton's Paradise Lost*.

Can he make deathless death? That were
Strange *contradiction*, which to God himself
Impossible is held; an argument
Of weakness, not of power. *Id*.

Such as have discoursed hereon, have so diversely, contrarily, or *contradictorily* delivered themselves, that no affirmative from thence can be reasonably deduced. *Broune*.

To ascribe unto him a power of election, not to chase this or that indifferently, is to make the same thing to be determined to one, and to be not determined to one, which are *contradictories*.
Bramhall's Answer to Hobbes.

When fashion hath once established what folly or craft began, custom makes it sacred, and it will be thought impudence, or madness, to *contradict* or question it. *Locke*.

It would be a direct *contradiction*, for any one to enter into society with others for the securing and regulating of property; and yet to suppose his land, whose property is to be regulated by the laws of the society, should be exempt from the jurisdiction of that government, to which he himself, the proprietor of the land, is a subject. *Id*.

It is not lawful to *contradict* a point of history which is known to all the world, as to make Hannibal and Scipio contemporaries with Alexander. *Dryden*.

The Jews hold, that in case two rabbies should happen to *contradict* one another, they were yet bound to believe the *contradictory* assertions of both. *South's Sermons*.

If truth be once perceived, we do thereby also perceive whatsoever is false in *contradiction* to it. *Greve's Cosmologia*.

This opinion was, for its absurdity and *contradictiousness*, unworthy of the refined spirit of Plato. *Norris*.

The rules of decency, of government, of justice itself, are so different in one place from what they are in another, so party-coloured and *contradictious*, that one would think the species of men altered according to their climates. *Collier*.

If a gentleman is a little sincere in his representations, he is sure to have a dozen *contradictors*.
Swift's View of Ireland.

This objection, from the *contradictoriness* of our dreams, sounds big at first, and seems very unpromising to be accounted for. *Baxter*.

The best of men appear sometimes to be strange compounds of *contradictory* qualities: and, were the accidental oversights and folly of the wisest man,—the failings and imperfections of a religious man,—the hasty acts and passionate words of a meek man;—were they to rise up in judgment against them;—and an ill-natured judge be suffered to mark, in this manner, what has been done amiss,—what character so unexceptionable as to stand before him? *Sterne*.

Patient of *contradiction* as a child,
Affable, humble, diffident, and mild;
Such was Sir Isaac, and such Boyle and Locke:
Your blunderer is as sturdy as a rock. *Cowper*.
Nothing simple, nothing unmixed: all affected plainness, and actual dissimulation; a heterogeneous mass of *contradictory* qualities; with nothing great but his crimes, and even these contrasted by the littleness of his motives, which at once denote both his baseness and his meanness, and mark him for a traitor and a trickster. *Sheridan*.

CONTRADISTINGUISH, v. a. } Ital. *con-*
CONTRADISTINCT, adj. } *traddistin-*
CONTRADISTINCTION, n. s. } *guere*; Lt.
CONTRADISTINCTIVE, adj. } *contra* and *distinguer*. To distinguish on the other side; to distinguish not simply by differential, but by opposite qualities; to mark evidently the difference or opposition of qualities.

That there are such things as sins of infirmity, in *contradistinction* to those of presumption, is a truth not to be questioned. *South*.

The primary ideas we have peculiar to body, as *contradistinquished* to spirit, are the cohesion of solid, and consequently separable, parts, and a power of communicating motion by impulse. *Locke*.

We must trace the soul in the ways of intellectual actions, whereby we may come to the distinct knowledge of what is meant by imagination, in *contradistinction* to some other powers. *Glanville's Scep sis*.

This pleasure arising from the activity of the system, is supposed to constitute the happiness of existence, in *contradistinction* to the ennui, or tedium vite. *Darwin*.

CONTRAFISSURE, n. s. From *contra* and *fissure*.

Contusions, when great, do usually produce a fissure or crack of the skull, either in the same part where the blow was inflicted, and then it is called fissure; or in the contrary part, in which case it obtains the name of *contrafissure*. *Wiseman*.

CONTRAHENTS, n. s. Lat. *contrahens*. Contracting parties.

CONTRAINDICATE, v. a. } Lat. *contra*
CONTRAINDICANT, n. s. } and *indicare*.
CONTRAINDICATION, n. s. } These words,

in their primary English application, belong to medical science. See MEDICINE. To *contra-indicate* is to manifest symptoms, which show that a remedy commonly used in a disease must not, in this case, be resorted to. Bark and acids, for instance, are usually given in fevers; but if there be inflammation, or difficulty of breathing, those symptoms are *contraindications*, which forbid the administration of acids and bark.

Vomits have their use in this malady; but the age and sex of the patient, or other urgent or *contraindicating* symptoms, must be observed.

Harvey on Consumptions.

I endeavour to give the most simple idea of the dis-temper, and the proper diet: abstracting from the complications of the first, or the *contraindications* to the second.
Arbutnot on Aliments.

Throughout it was full of *contraindicants*. *Burke.*

CONTRAMURE, *n. s.* Fr. *contremure*. In fortification, is an out-wall built about the main wall of a city.

CONTRANATURAL, *adj.* From *contra* and *natural*. Not accordant with nature; unnatural.

To be determined and tied up, either by itself, or from abroad, is violent and *contranatural*.

Bishop Rust.

CONTRANITENCY, *n. s.* From Lat. *contra* and *nitens*. Reaction; a resistency against pressure.

CONTRAPOSITION, *n. s.* From *contra* and *positio*. A placing over against; placing in opposition to. In logic, 'a changing of the whole subject into the whole predicate, and the contrary; keeping both the same quantity and quality, but altering the terms from finite to infinite.'

CONTRAPUNTIST: Ital. *contrappunto*. One who has skill in counterpoint.

Counterpoint is certainly so much an art, that to be what they call, a learned *contrapuntist*, is with harmonists a title of no small excellence. *Mason.*

CONTRAREGULARITY, *n. s.* From *contra* and *regularity*. Contrariety to rule.

It is not only its not promoting, but its opposing, or at least its natural aptness to oppose, the greatest and best of ends; so that it is not so properly an irregularity as a *contraregularity*. *Norris.*

CONTRARIENTS. In the reign of king Edward II. Thomas earl of Lancaster, taking part with the barons against the king, it was not thought fit, in respect of their great power, to call them rebels or traitors, but *contrarients*; and hence we have a record of those times, called *Rotulum Contrarietium*.

CONTRARY, *v. a. n. s. & adj.* } Fr. *contrarier*; It. *contrariare*; Lat. *contrarius*. To cross; to thwart; to contradict; to run counter to. *Contrary*, as a substantive, signifies that which is of opposite qualities; a proposition opposed to some other; a fact which is at variance with the allegation. Chaucer uses it in the sense of a rival; an opponent. Diametrically opposite to, of an entirely different nature, quite inconsistent with, are the meanings of the adjective. On the contrary, is on the other side. To the contrary, is to an opposite intent. In logic, contraries are, propositions which are inter-destructive, but the one of which being proved to be false, the truth of the other does not follow as a consequence. Contrariant means inconsistent; contradictory; repugnant to. Contrariwise is conversely; oppositely; on the contrary. The rest of the words of this class do not require explanation.

CONTRARIANT, *adj.*
CONTRARIES, *n. s.*
CONTRARIETY, *n. s.*
CONTRARILY, *adv.*
CONTRARINESS, *n. s.*
CONTRARIOUS, *adj.*
CONTRARIOUSLY, *adv.*
CONTRARIWISE, *adv.*
CONTRARY-MINDED, *adj.*

But the ship was now in the midst of the sea-tossed with waves: for the wind was *contrary*.

Matthew xiv. 24.

Then said Paul unto him, God shall smite thee, thou whited wall; for sittest thou to judge me after the law, and commandest me to be smitten *contrary* to the law?

Acts xxiii. 3.

So that *contrariwise* ye ought rather to forgive him, and comfort him, lest perhaps such a one should be swallowed up with overmuch sorrow.

2 Corinthians ii. 7.

In all the court ne was ther wif ne maide, Ne widowe, that *contraried* that he saide, But said he was worthy to han his life.

Chaucer. Cant. Tales.

They live *contrary* to Christes life, In hie pride against mekenesse, Against sufraunce they usin strife, And angre ayenst sobrenesse.

Id.

This is to sayn, that whether he or thou May with his hundred, as I spake of now, Sle his *contrary*, or out of listes drive, Him shall I yeven Emelie to wive.

Id.

Others rejoice to see the fire so bright, And wene to play in it, as they pretend, But fynd *contrary* of it, as they entende.

Wyat.

When I came to court, I was advised not to *contrary* the king.

Latimer.

He which will perfectly recover a sick, and restore a diseased, body under health, must not endeavour so much to bring it to a state of simple *contrariety*, as of fit proportion in *contrariety* unto those evils which are to be cured.

Hooker.

Finding in him the force of it, he would no further *contrary* it, but employ all his service to medicine it.

Sidney.

Made no resistance, nor could her *contraire*, But ready passage to her pleasure did prepare.

Spenser. Faerie Queene.

That sayd, her rownd about she from her turnd, She turned her *contrary* to the sunne; Thrice she her turnd *contrary* and returned; All *contrary*; for she the right did shunne.

Id.

But this coy damsell thought *contrariwise*, That such proud looks would make her praised more.

Id.

No *contraries* hold more antipathy, Than I and such a knave.

Shakespeare. King Lear.

He pleaded still not guilty: The king's attorney, on the *contrary*, Urged on examinations, proofs, confessions, Of diverse witnesses.

Id. Henry VIII.

He will be here, and yet he is not here; How can these *contrarieties* agree?

Id. Henry IV.

Many things, having full reference To one consent, may work *contrariwise*.

Id. Henry V.

But what can be *contrary* to the mind, Which holds all *contraries* in concord still? *Davies.*

God of our fathers, what is man! That thou towards him, with hand so various, Or might I say *contraries*, Temperest thy providence through his short course?

Milton.

The various and *contrary* choices that men make in the world, do not argue that they do not all pursue good; but that the same thing is not good to every man alike.

Locke.

God has stamped certain characters upon men's minds, which, like their shapes, may perhaps be a

little mended, but can hardly be totally altered and transformed into the *contrary*. *Id.*

Though all men desire happiness, yet their wills carry them so *contrarily*, and consequently some of them to what is evil. *Id.*

There is a *contrariety* between those things that conscience inclines to, and those that entertain the senses. *South.*

He that believes it, and yet lives *contrary* to it, knows that he hath no reason for what he does. *Tillotson.*

They did it, not for want of instruction to the *contrary*. *Stillingfleet.*

If justice stood on the side of the single person, it ought to give good men pleasure to see that right should take place; but when, on the *contrary*, the commonweal of a whole nation is overborn by private interest, what good man but must lament? *Swift.*

Every thing that acts upon the fluids, must, at the same time, act upon the solids, and *contrariwise*. *Arbuthnot on Aliaments.*

If two universals differ in quality, they are *contraries*; as, every vine is a tree, no vine is a tree. These can never be both true together, but they may be both false. *Watts's Logick.*

The very depositions of witnesses themselves being false, various, *contrariant*, single, inconcludent. *Ayliffe's Parergon.*

We know that over-labouring a point of this kind, has the direct *contrary* effect from what we wish. *Burke.*

Nor need we wonder, that each nation should be affected most agreeably with its own wit and humour. For, not to mention the prejudice that one naturally entertains in favour of what is one's own, a native must always understand, better than foreigners can, the relations, *contrarities*, and allusions, implied in what is ludicrous in the speech and writings of his countrymen. *Beattie.*

Thy senate is a scene of civil jar,
Chaos of *contrarities* at war;
Where sharp and solid, phlegmatic and light,
Discordant atoms meet, ferment, and fight. *Cropper.*

CONTRAST, v. a. & n. s. Fr. *contraster*; Ital. *contrastare*; Span. *contrastar*; Lat. *contra* and *stare*. To place in opposition to, for the purpose of making a comparison between, or heightening the effect of one of the things compared.

The figures of the groups must not be all on a side, that is, with their faces and bodies all turned the same way; but must *contrast* each other by their several positions. *Dryden.*

We ought to compare our subject with things of a contrary nature; for discoveries may be, and often are, made by the *contrast*, which would escape us on the single view. *Burke.*

He personates a sea-faring man, and with wonderful propriety supports the plainness and simplicity of the character: and this gives to the whole narrative an air of truth, which forms an entertaining *contrast*, when we compare it with the wildness of the fiction. *Beattie.*

Hard was the task, and painful to forbear,
When every social charm at once invited;
And sad the *contrast* of such social fare,
To sit alone in the mind's gloom benighted. *Lefley.*

Here also grateful mixture of well matched
And sorted hues (each giving each relief,
And by *contrasted* beauty shining more)
Is needful. *Courper.*

Attend all ye who boast—or old or young—
The living libel of a slanderous tongue!
So shall my theme as far *contrasted* be,
As saints by fiends, or hymns by calumny. *Sheridan.*

Thick leaves shall form our coronal, like springs;
And round our necks shall glauce the Hooni strings:
So shall their brighter hues *contrast* the glow
Of the dusk bosoms that beat high below. *Byron. The Island.*

CONTRAST, in painting and sculpture, expresses a difference of position, attitude, &c. of two or more figures; as where, in a groupe of three figures, one is shown before, another behind, and another sideways, they are said to be in contrast. The contrast is not only to be observed in the position of several figures, but also in that of several members of the same figure: thus, if the right arm advance furthest, the right leg is to be hindermost; if the eye be directed one way, the arm to go the contrary, &c. Contrast must be pursued even in the drapery.

CONTRATE'NOR. From *contra* and *tenor*. In music, the middle part; the counter tenor.

CONTRATE WHEEL, in watch-work, that next to the crown-wheel, the teeth and hoop of which lie contrary to those of the other wheels; whence its name.

CONTRAVALLATION, n. s. From Lat. *contra* and *vallo*. The fortification thrown up by the besiegers, round the city, to hinder the sallies of the garrison.

When the late czar of Muscovy first acquainted himself with mathematical learning, he practised all the rules of circumvallation and *contravallation* at the siege of a town in Livonia. *Watts's Logick.*

CONTRAVALLATION, in military affairs, a line of fortifications formed to protect the besiegers of a place from any sallies of the garrison, as the line of circumvallation does from any outward attack. As the ancient garrisons included every man able to bear arms in a fortified town, these lines were more frequent than at present, and are to be found in every ancient work on fortification, since the time of Homer.

CONTRAVE'NE, v. n. } Fr. *contravenir*;
CONTRAVE'NER, n. s. } Ital. *contraovenire*;
CONTRAVENTION, n. s. } Span. *contravenir*;
Lat. *contra* and *venire*. To oppose; to hinder; to baffle; to disobey. Opposition; disobedience.

It was observed by one of the chiefs of Sky, that fifty armed men might, without resistance, ravage the country. Laws that place the subjects in such a state, *contravene* the first principles of the compact of authority; they exact obedience, and yield no protection. *Johnson.*

If Christianity did not lend its name to stand in the gap, and to employ or divert these humours, they must of necessity be spent in *contraventions* to the laws of the land. *Swift.*

CONTRAVERSION, n. s. Lat. *contra* and *vertere*. A turning the opposite way.

CONTRE, in heraldry, an appellation given to several bearings, on account of their cutting the shield contrary and opposite ways: thus we meet with contre-bend, contre-chevron, contre-pale, &c., when there are two ordinaries of the same nature opposite to each other, so as color may be opposed to metal, and metal to color.

CONTRACTATION, *n. s.* Lat. *contractatio*. Touching; handling; dalliance.

CONTREMBLING, *adj.* From *con* and *trembling*. Vibrating; shaking; quivering.

CONTRIBUTE, *v. a. & n.*

CONTRIBUTION, *n. s.*

CONTRIBUTIVE, *adj.*

CONTRIBUTER, *n. s.*

CONTRIBUTOR, *n. s.*

CONTRIBUTORY, *adj.*

CONTRIBUTARY, *n. s. & adj.*

to furnish a share to some common stock; to assist in furthering some end; to bear a part. He who does this is a contributor, or contributor, and the share which he supplies is his contribution, and is contributive, or contributory, to some purpose. Contribution, in a military sense, is the money paid for the support of an army lying in a country. Contributory is, paying tribute to the same sovereign; a fellow-contributory.

It hath pleased them of Macedonia to make a certain contribution for the poor saints. *Rom. xv. 26.*

The people 'twixt Philippi and this ground
Do stand but in a forced affection;
For they have grudged us contribution.

Shakespeare. Julius Cæsar.

I promised we would be contributors,
And bear his charge of wooing, whatsoever.

Shakespeare.

Thus we are engaged in the objects of geometry and arithmetic; yea, the whole mathematicks must be contributory, and to them all nature pays a subsidy.

Glanville's Scepsis.

Beggars are now maintained by voluntary contributions.

Gravins's Bills of Mortality.

As the value of the premises renders them most proper incentives to virtue, so the manner of proposing we shall find also highly contributive to the same end.

Decay of Piety.

Art thou a true lover of thy country? zealous for its religious and civil liberties? and a cheerful contributor to all those public expences which have been thought necessary to secure them?

Atterbury.

Whatever praises may be given to works of judgment, there is not even a single beauty in them to which the invention must not contribute.

Pope's Essay on Homer

His master contributed a great sum of money to the Jesuits' church, which is not yet quite finished.

Addison on Italy.

This happy sensibility to the beauties of nature should be cherished in young persons. It engages them to contemplate the Creator in his wonderful works; it purifies and harmonizes the soul, and prepares it for moral and intellectual discipline; it supplies an endless source of amusement; it contributes even to bodily health.

Beattie.

He travels and expatiates; as the bee
From flower to flower, so he from land to land;
The manners, customs, policy, of all
Pay contribution to the store he gleans;
He sucks intelligence in every clime.

Cowper.

He need not remind us, that there is no great danger of our chancellor of the exchequer making any such experiment, any more than of the most zealous supporters of the war in this country, vying in their contributions with the abettors of republicanism in that.

Sheridan.

Although truth exacts

These amiable descriptions from the scribes,
As most essential to their hero's story,
They do not much contribute to his glory.

Byron. Don Juan.

CONTRISTATE, *v. a.* } Fr. *contrister*; It.
CONTRISTATION, *n. s.* } *contristare*; Sp. *contristar*; Lat. *contristare*; to make sad; to inspire with sorrow. The act of making sad; dejection; gloominess; trouble; discontent; melancholy. Both words are out of use.

Blackness and darkness are but privatives, and therefore have little or no activity: somewhat they do *contristate*, but very little.

Bacon's Nat. Hist.

Incense and nidorous smells, such as were of sacrifices, were thought to intoxicate the brain, and to dispose men to devotion; which they may do by a kind of sadness and *contristation* of the spirits, and partly also by heating and exalting them.

Id.

CONTRITE, *adj.* } Fr. *contrit*; Ital. and
CONTRITENESS, *n. s.* } Sp. *contrito*; Lat. *contritum*, *n. s.* } *tritum*. Bruised; much worn; thence, worn with woe; harassed and humbled with the sense of guilt; repentant. In the books of divines, contrite is sorrowful for sin, from the love of God and desire of pleasing him; and attrite is sorrowful for sin, from the fear of punishment. The same distinction holds good in the nouns, contrition and attrition. Contrition also signifies the act of grinding; but this, as well as contrite in the sense of bruised, is obsolete.

If ther be a confessor to whom he may shrive him,
and that he be first veray contrite and repentant.

Chaucer. Cant. Tales.

Now shalt thou understand what is behevoful and necessary to every parit penance; and this stont on three thinges, *contrition* of herte, confession of mouth, and satisfaction.

Id.

'Here in this bottle,' sayd the sory mayd,

I put the tears of my *contrition*,

Till to the brim I have it fall defrayd.

Spenser's Faerie Queene.

Her *contrite* sighs unto the clouds bequeathed
Her winged spright. *Shakespeare. Rape of Lucrece.*
With tears

Watering the ground, and with our sighs the air
Frequenting, sent from hearts *contrite*, in sign
Of sorrow unfeigned, and humiliation meek.

Milton.

Fruits of more pleasing favour, from thy seed
Sown with *contrition* in his heart, than those
Which, his own hand manuring, all the trees
Of Paradise could have produced.

Id. Paradise Lost.

What is sorrow and *contrition* for sin? A being grieved with the conscience of sin, not only that we have thereby incurred such danger, but also that we have so unkindly grieved and provoked so good a God.

Hammond's Practical Catechism.

Your fasting, *contrition*, and mortification, when the church and state appoints, and that especially in times of greater riot and luxury.

Spratt's Sermons.

My future days shall be one whole *contrition*;
A chapel will I build with large endowment,
Where every day an hundred aged men
Shall all hold up their withered hands to heaven.

Dryden.

Some of those coloured powders, which painters use, may have their colours a little changed, by being very elaborately and finely ground; where I see not what can be justly pretended for those changes,

besides the breaking of their parts into less parts by that *contrition*. *Newton's Opticks.*

The *contrite* sinner is restored to pardon, and, through faith in Christ, our repentance is entitled to salvation. *Rogers.*

CONTRIVE, *v. a. & n.* } The derivation
CONTRIVER, *n. s.* } of contrive is thus
CONTRIVEMENT, *n. s.* } traced by Skinner
CONTRIVANCE, *n. s.* } from: 'Tent. tref-
CONTRIVABLE, *adj.* } *fen, attingere;*
CONTRIVING, *n. s.* } *antreffen, offen-*
dere, invenire; to invent; find out; unde Gall. *contrower; excogitare; extundere.* To contrive is to imagine; to frame; to manage cleverly; to design; to conspire; to wear away the time; but the last of these meanings is obsolete. Contrivance is the act of contriving; management; the thing contrived; plan; plot; artifice; disposition of parts or causes; making use of scanty materials to the best advantage. Contrivement is invention.

Three ages, such as mortal men *contrive*.

Faerie Queene.

Please ye, we may *contrive* this afternoon,
 And quaff carouses to our mistress' health. *Shakespeare.*

One that slept in the *contriving* lust, and waked to do it. *Id. King Lear.*

I, the mistress of your charms,

The close *contriver* of all harms,

Was never called to bear my part. *Id. Macbeth.*

It will hence appear how a perpetual motion may seem easily *contrivable*. *Wilkins's Dædalus.*

There is no work impossible to these *contrivances*, but there may be as much acted by this art as can be fancied by imagination. *Id. Mathematical Magic.*

What more likely to *contrive* this admirable frame of the universe than infinite wisdom? *Tillotson.*

Our poet has always some beautiful design, which he first establishes, and then *contrives* the means which will naturally conduct him to his end. *Dryden.*

Have I not managed my *contrivance* well,
 To try your love, and make you doubt of mine? *Id.*

Is it enough

That making habits, and a borrowed name,
Contrive to hide my plenitude of shame? *Prior.*

Scenes of blood and desolation, I had painted as the common effects of those destructive machines; whereof, he said, some evil genius, enemy to mankind, must have been the first *contriver*.

Swift's Gulliver's Travels.

It would our ancestors at the revolution have deserved their fame for wisdom, if they had found no security for their freedom, but in rendering their government feeble in its operations, and precarious in its tenure; if they had been able to *contrive* no better remedy against arbitrary power than civil confusion. *Burke.*

When I hear the simplicity of *contrivance* aimed at and boasted of in any new political constitutions, I am at no loss to decide that the artificers are grossly ignorant of their trade, or totally negligent of their duty. The simple governments are fundamentally defective, to say no worse of them. *Id.*

Some, more acute, and more industrious still,
Contrive creation; travel Nature up
 To the sharp peak of her sublimest height,
 And tell us whence the stars; why some are fixed,
 And planetary some; what gave them first
 Rotation; from what fountain flowed their light.

Cowper.

To prove at last my main intent
 Needs no expense of argument,

No cutting and *contriving*—
 Seeking a real friend we seem
 To adopt the chymist's golden dream,
 With still less hope of thriving. *Id.*

They made a fire, but such a fire as they
 Upon the moment could *contrive* with such
 Materials as were cast up round the bay,
 Some broken planks, and oars, that to the touch
 Were nearly tender, since so long they lay
 A mast was almost crumbled to a crutch.

Byron. Don Juan.

CONTR'OL, *v. a. & n. s.* } Fr. *controler*
CONTR'OLLABLE, *adj.* } Cotgrave and
CONTR'OLLER, *n. s.* } Sherwood refer
CONTR'OLLERSHIP, *n. s.* } the origin of control
CONTR'OLLING, *n. s.* } to *contre-*
CONTR'OLMENT, *n. s.* } *rolle*, 'a controlement, or contrarolement; the copy of a roll (of account, &c.) To control, therefore, in its primitive sense, is to check by means of the roll. Skinner says, '*rola, rotula*, unde Fr. Gall. *contre-rolle, contra-dicere*, to contradict; gainsay; reprove; an inspector; ruler; director. The verb now bears the meaning of, to exercise authority over; to restrain; to oversee; to regulate; sometimes, though seldom, to overbear; to confute. The noun control, in addition to its obvious meanings, signifies a register, or account, kept by another officer, that each may be checked by the other. Controlment is, the act of superintending, or restraining; the state of being controlled; opposition; hostility.

Who shall *control* me for my works? *Ecd. v. 3.*
 Authority to convent, to *control*, to punish, as far as with excommunication, whomsoever they think worthy: *Hooker.*

Were it reason that we should suffer the same to pass without *controlment*, in that current meaning, whereby every where it prevaileth. *Id.*

Give me a staff of honour for mine age;
 But not a sceptre to *control* the world.

Shakespeare. Titus Andronicus.

— Art made tongue-tyed by authority,
 And Folly (doctor-like) *controlling* skill.

Id. Sonnet lxxvi.

Here have we war for war, and blood for blood,
Controlment for *controlment*. *Id. King John.*

He does not calm his contumelious spirit,
 Nor cease to be an arrogant *controller*.

Id. Henry VI.

As for the time while he was in the Tower, and the manner of his brother's death, and his own escape, she knew they were things that a very few could *control*. *Bacon's Henry VII.*

They made war and peace with one another, without *controlment*. *Davies on Ireland.*

Let partial spirits still aloud complain,
 Think themselves injured that they cannot reign;
 And own no liberty, but where they may,
 Without *control*, upon their fellows prey. *Waller.*

Passion is the drunkenness of the mind, and therefore, in its present workings, not *controllable* by reason. *South.*

If the sinner shall win so complete a victory over his conscience, that all those considerations shall be able to strike no terror into his mind, lay no restraint upon his lusts, no *control* upon his appetites, he is certainly too strong for the means of grace. *Id. Sermons.*

The great controller of our fate
 Deigned to be man, and lived in low estate.
Dryden.

I feel my virtue struggling in my soul :
 But stronger passion does its power control.
Id. Aurengzebe.

No legislator, at any period of the world, has willingly placed the seat of active power in the hands of the multitude : because there it admits of no control, no regulation, no steady direction whatsoever. The people are the natural control on authority ; but to exercise and to control together is contradictory and impossible.
Burke.

If you set them to transact with such persons, they are instantly subdued. They dare not so much as look their antagonist in the face. They are made to be their subjects, not to be their arbiters or controllers.
Id.

Reader, attend—whether thy soul
 Soars fancy's flights beyond the pole,
 Or darkling grubs this earthly hole,
 In low pursuit ;
 Know, prudent, cautious, self-control,
 Is wisdom's root.
Burns.

Roll on, thou deep and dark blue ocean—roll !
 Ten thousand fleets sweep over thee in vain ;
 Man marks the earth with ruin—his control
 Stops with the shore.
Byron. Childe Harold.

CONTROLLER, an officer appointed to control or oversee the accounts of other officers ; and, on occasion, to certify whether things have been controlled or examined. In Britain we have several officers under this title ; as controller of the navy, the customs, the mint, besides the following :—

CONTROLLER OF THE HANAPER, an officer who attends the lord chancellor daily, in term and in seal time, to take all things sealed in leather bags from the clerks of the hanaper, and to mark the number and effect thereof, and enter them in a book, with all the duties belonging to the king, and other officers for the same, and so charge the clerk of the hanaper with them.

CONTROLLER OF THE HOUSEHOLD, the second officer under the lord steward. His office is to control the accounts and reckonings of the Green Cloth, of which board he is always a member. He carries a white staff, and is always one of the privy council.

CONTROLLERS OF THE PELL, two officers of the exchequer, who are the chamberlain's clerks, and keep a control of the pell of receipts, and going out.

CONTROLLER OF THE PIPE, an officer of the exchequer, that makes out a summons twice every year, to levy the farms and debts of the pipe. See PIPE and EXCHEQUER.

- CONTROVERSE, v. a. & n. s.
- CONTROVERSAL, adj.
- CONTROVERSIAL, adj.
- CONTROVERSIALIST, n. s.
- CONTROVERSION, n. s.
- CONTROVERSER, n. s.
- CONTROVERSOR, n. s.
- CONTROVERSY, n. s.
- CONTROVERSY-WRITER, n. s.
- CONTROVERT, v. a.
- CONTROVERTER, n. s.
- CONTROVERTIBLE, adj.
- CONTROVERTIST, n. s.

Fr. *contro-*
verser ; Ital.
controverte-
re ; Sp. *con-*
trovertir ;
 Lat. *contro-*
versus, from
con and *ver-*
tere. Con-
 troverse is
 obsolete in
 both its
 forms : it is
 synonymous with controvert and controversy.

To controvert is to debate ; to dispute ; to deny the truth of ; to call in question. Controversy is the written maintaining of conflicting opinions ; a lawsuit ; a quarrel ; opposition. The last two senses are unusual. Controversialist is a modern word for controverser, controversor, controvert-er, controvertist, and controversy-writer. It is scarcely necessary to say that it signifies a disputant ; one who engages in controversy. Formerly, this kind of being was too apt to disregard decorum, and almost reduce literary and theological contests to a level with the contests of Billingsgate. In this instance, modern refinement has produced not merely a change, but an amendment.

If there be a controversy between men, and they come unto judgment, that the judges may judge them, then they shall justify the righteous, and condemn the wicked.
Deut. xxv. 1.

The Lord hath a controversy with the nations.

Without controversy great is the mystery of godliness.
1 Timothy.

Persuasion ought to be fully settled in men's hearts, that, in litigations and controverted causes of such quality, the will of God is to have them to do whatsoever the sentence of judicial and final decision shall determine.
Hooker.

How cometh it to pass that we are so rent with mutual contentions, and that the church is so much troubled ? If men had been willing to learn, all these controversies might have died the very day they were first brought forth.
Id.

So fitly now here commeth next in place,
 After the proofe of prowess ended well,
 The controversies of beauties souveraine grace.
Spenser, Faerie Queene.

But this good Sir did follow the plain word,
 Ne medled with their controversies vain.
Id. Mother Hubbard's Tale.

And controversy hence a question takes,
 Whether the horse by him became his deed,
 Or he his manage by the well-doing steed.
Shakespeare. A Lover's Complaint.

The torrent roared, and we did buffet it,
 With lusty sinews ; throwing it aside,
 And stemming it with hearts of controversy.
Id. Julian Cant.

Discouraging of matters dubious, and many controvertible truths, we cannot without arrogance intreat a credulity, or implore any farther assent than the probability of our reasons, and verity of our experiments.
Brounne's Vulgar Errors.

This left no room for controversy about the title, nor for encroachment on the right of others.
Locke.

It happens in controversial discourses, as it does in the assailing of towns, where, if the ground be but firm wherein the batteries are erected, there is no further enquiry whom it belongs to, so it affords but a fit rise for the present purpose.
Id.

Controversial writing is not wholly unprofitable ; and book-merchants of whatever kind or degree, undoubtedly receive no small advantage from a right improvement of a learned scuffle.
Shafesbury.

Who can think himself so considerable as not to dread this mighty man of demonstration, this prince of controvertists, this great lord and possessor of first principles.
Tillotson.

If any person shall think fit to controvert them, he may do it very safely for me.

Cheyne's Philosophical Principles.

Railery and wit were never made to answer our inquiries after truth, and to determine a question of rational controversy. *Watts.*

They, strangers to the controversial field, Where delata, always foiled, yet scorn to yield, And never checked by what impedes the wise, Believe, rush forward, and possess the prize. *Cowper.*

CONTRU'SION, *n. s.* Latin, *contrudere*. Thrusting against; pressing together.

CONTUMACY, *n. s.* } Fr. *contumace* ;
CONTUMACIOUS, *adj.* } It. Sp. and Lat.
CONTUMACIOUSLY, *adv.* } *contumacia*. The
CONTUMACIOUSNESS, *n. s.* } French have the verb *contumacer*, which now signifies to cast for non-appearance; to non-suit; to out-law. Its meaning was formerly far more extensive. Sherwood defines it, 'to deale stubbornly, be perverse; follow his own will; disobey, or rebel against his superiors; to make a contempt; also to judge, or proceed against, as disobedient, obstinate, rebellious; to punish or censure, a contempt.' In the English words are retained those meanings which the French verb has lost. All of them convey the idea of obstinacy; perverseness; contempt of superior authority. In law, contumacy is a wilful disobedience to any lawful summons or judicial order.

Contumacia, presumption, irreverence, pertinacie, vainglorie, and many other twiggas that I cannot declare. *Chaucer. Cant. Tales.*

There is another very efficacious method for subduing of the most obstinate *contumacious* sinner, and bringing him into the obedience of the faith of Christ. *Hammond's Fundamentals.*

Such acts

Of *contumacy* will provoke the Highest To make death in us live. *Milton. Par. Lost.*

From the description I have given of it, a judgment may be given of the difficulty and *contumaciousness* of cure. *Wiseman.*

These certificates do only, in the generality, mention the party's *contumacies* and disobedience. *Ayliffe's Parergon.*

He is in law said to be a *contumacious* person, who, on his appearance afterwards, departs the court without leave. *Id.*

CONTUMELY, *n. s.* } Fr. *contumelie* ;
CONTUMELIOUS, *adj.* } It. Sp. and Lat.
CONTUMELIOUSLY, *adv.* } *contumelia*. Rude-
CONTUMELIOUSNESS, *n. s.* } ness; contemptu-
ousness; insolence or scurrility of language; taunt; reproach. Contumelious is, affrontive; reproachful; inflicting ignominy; brutal.

Than stondesth the sinne of *contumelie*, or strif and chere, and battureth and forgeth by villain's reprehenses. *Chaucer. Cant. Tales.*

If the helm of chief government be in the hands of a few of the wealthiest, then laws, providing for continuance thereof, must make the punishment of *contumely* and wrong, offered unto any of the common sort, sharp and grievous, that so the evil may be prevented. *Hooker.*

The people are not wont to take so great offence, when they are excluded from honours and offices, as when their persons are *contumeliously* trodden upon. *Id.*

The oppressor's wrong, the proud man's *contumely*, The pang of despised love, the law's delay. *Shakespeare's Hamlet.*

With scoffs and scorns, and *contumelious* taunts, in open market-place produced they me To be a public spectacle. *Id. Henry VI.*

Fie, lords! that you, being supreme magistrates, Thus *contumeliously* should break the peace. *Id.*
It was undervalued and depressed with some bitterness and *contumely*. *Clarendon.*

Why should any man be troubled at the *contumelious* of those, whose judgments deserve not to be valued? *Tillotson.*

As it is in the highest degree injurious to them, so it is *contumelious* to him. *Dacey of Piety.*

Eternal *contumely* attend that guilty title, which claims exemption from thought, and arrogates to its wearers the prerogative of brutes. *Addison. Guardian.*
In all the quarrels and tumults at Rome, though the people frequently proceeded to rude *contumelious* language, yet no blood was ever drawn in any popular commotions, till the time of the Gracchi. *Swift.*

This business was not ended, because our dignity was wounded, or because our patience was worn out with *contumely* and scorn. We had not disgorged one particle of the nauseous doses with which we were so liberally crammed by the mountebanks of Paris, in order to drug and diet us into perfect tameness. *Burke.*

CONTUND, *v. a.* Fr. *contondant*; It. & Sp. *contudente*; Lat. *contundere*. To bruise; to beat violently; to pound.

CONTURBATION, *n. s.* Lat. *conturbatio*, from *con* and *turba*; $\tau\upsilon\rho\beta\eta$. Disturbance; confusion; disorder.

CONTUSE, *v. a.* } Fr. *contus*, *contusion* ;
CONTU'SION, *n. s.* } Ital. *contuso*, *contusione* ;
Span. *contuso*, *contusion* ; from Lat. *contundere*. To beat together; to bruise without breaking the flesh. The act of bruising or pounding; the state of being bruised or pounded; a bruise.

That winter lion, who in rage forgets Aged *contusions*, and all bruise of time.

Shakespeare. Henry VI.

Of their roots, barks, and seeds, *contused* together, and mingled with other earth, and well watered with warm water, there came forth herbe much like the other. *Bacon.*

The bones, in sharp colds, wax brittle; and all *contusions*, in hard weather are more hard to cure. *Id.*
Take a piece of glass, and reduce it to powder, it acquiring by *contusion* a multitude of minute surfaces, from a diaphanous, degenerates into a white body. *Boyle on Colours.*

The ligature *contuses* the lips in cutting them, so that they require to be digested before they can unite. *Wiseman.*

Adjoining close to Kilwick's echoing wood, Where oft the bitch fox hides her hapless brood, Reserved to solace many a neighbouring squire, That he may follow them through brake and brier, *Contusion* hazarding of neck or spine, Which rural gentlemen call sport divine. *Cowper.*

CONVALE'SCE, *v. n.* } Lat. *convalescere*.
CONVALESCENCE, *n. s.* } The verb, which is
CONVALESCENCY, *n. s.* } now obsolete, signi-
CONVALESCENT, *adj.* } fies to be returning to health. Convalescence and convalescency mean restoration to health; recent recovery from disease. Convalescent is, being in a recovering state; free from disease, but not yet having recovered strength.

Being in a place out of the reach of any alarm she recovered her spirits to a reasonable *convalescence*.

Clarendon.

And every morn his colour freshlier came,
 And every day helped on his *conulescence*;
 'Twas well, because health in the human frame
 Is pleasant, besides being true love's essence.

Byron. Don Juan.

CONVALLARIA, the lily of the valley, in botany, a genus of the monogynia order, and hexandria class of plants; *COB. sexfid*: BERRY spotted and trilocular. There are twelve species, of which three are natives of Britain, viz.:—*C. Maialis*, May lily. *C. multiflora*, Solomon's seal; and *C. polygonatum*, sweet-smelling Solomon's seal. They are all plants of considerable beauty, and may easily be propagated by their creeping roots.

CONVENÆ, an ancient people of Gallia Narbonensis, said by Pliny to have been originally robbers and slaves, whom Pompey compelled to settle at the foot of the Pyrenees, after the Ser-torian war.

- CONVENE, *v. a. & n.*
- CONVENT, *v. a.*
- CONVENEB, *n. s.*
- CONVENING, *n. s.*
- CONVENT, *n. s.*
- CONVENTICLE, *v. a. & n. s.*
- CONVENTICLER, *n. s.*
- CONVENTION, *n. s.*
- CONVENTIONAL, *adj.*
- CONVENTIONARY, *adj.*
- CONVENTIONIST, *n. s.*
- CONVENTUAL, *n. s. & adj.*
- CONVENABLE, *adj.*
- CONVENIENT, *adj.*
- CONVENIENTLY, *adv.*
- CONVENIENTNESS, *n. s.*
- CONVENIENCE, *n. s.*
- CONVENIENCY, *n. s.*

Fr. *convenir* ;
 It. *convenire* ; Sp. *convenir* ; Latin *convenire*, from *con* and *venire*.
 To come together, is the primary idea in all this class of words.
 To convent, says Johnson, is to call before a judge or judicature; and this is, undoubtedly, one of its meanings. But, in our old writers, it has also the

sense of convene, an instance of which we have given from Spenser. To convene is, to summon together; to convoke; to cite judicially; to come together; to assemble. Hence convent, conventicle, convention, mean aggregates of persons; persons collected together. Convent is the residence of a body of monks, or nuns. Conventicle is, in its general sense, an assembly; a meeting; but, in its customary sense, an assembly for religious worship, consisting of persons who do not belong to the church establishment; the bigotry of some of our ancestors induced them to attach to it a disgraceful idea, and to persecute those who composed it. See CONVENTICLE. Convention is the act of coming together; union; a contract; something settled by common consent; a provisional agreement; an assembly of persons. In this latter sense, the word has received a blot, from the conduct of the French legislature which bore the name of the convention. Conventional is, stipulated; agreed on by compact; settled by common consent, and not inhering in the nature of the thing. Convenience and conveniency denote, fitness; propriety; commodiousness; ease; accommodation; fitness of time and place;—that is, a concurrence, a coming together, of circumstances favorable to doing or enjoying something. Convenient, which is suitable, commodious, takes to or *for* before the following noun; and Johnson justly observes that 'perhaps it ought gene-

rally to have *for* before persons, and to before things.' Convenable is, consistent with; agreeable to. It is obsolete.

Give me neither poverty nor riches, feed me with food convenient for me. *Prov. xxx. 8.*

I have none English convenient and digne,
 Myne herte's hele lady! the with to honour.

Chaucer.

Yet maugre love, and all his gods beside,
 I do possess the world's most regiment,
 As if ye please it into parts divide,
 And every part's inholders to coment,
 Shall to your eyes appear incontinent.

Spenser. Faerie Queene.

But what strange fortunes unto him befell,
 Ere he attained the point by him intended,
 Shall more conveniently in other place be ended. *Id.*

He is so meek, wise, and merciable,
 And with his word his work is comenable

Id. Pastorals.

It behoveth, that the place where God shall be served by the whole church be a publick place, for the avoiding of privy conventicles, which, covered with pretence of religion, may serve unto dangerous practises.

Hooker.

In things not commanded of God, yet lawful, because permitted, the question is, What light shall shew us the conveniency which one hath above another? *Id.*

He with his oath

By all probation will make up full clear,
 Whenever he's convented.

Shakespeare. Measure for Measure.

He came to Leicester;
 Lodged in the abbey, where the reverend abbot,
 With all his coment, honourably received him.

Id. Henry VIII.

Ay, all of you have laid your heads together
 (Myself had notice of your conventicles)
 And all to make away my guiltless life.

Id. Henry VI.

Use no farther means;

But, with all brief and plain conveniency,
 Let me have judgment.

Id. Merchant of Venice.

I this morning know
 Where we shall find him most conveniently.

Id. Hamlet.

They sent forth their precepts to attach men, and convent them before themselves at private houses.

Bacon's Henry VII.

No man was better pleased with the convening of this parliament than myself.

King Charles.

Conventional services reserved by tenures upon grants, made out of the crown or knights service.

Hale's Common Law.

The ordinary covenants of most conventiary tenants are, to pay due capon and due harvest journeys.

Carew's Survey.

All the factious and schismatical people would frequently, as well in the night as the day, convene themselves by the sound of a bell.

Clarendon.

They are to be reckoned amongst the most general affections of the conventions, or associations, of several particles of matter into bodies of any certain denomination.

Boyle.

There are settled periods of their convening, or a liberty left to the prince for convoking the legislature.

Locke.

God, who hath given the world to men in common, hath also given them reason, to make use of it to the best advantage of life and conveniency. *Id.*

As to his meals, I should think it best that, as much as it can be *conveniently* avoided, they should not be kept constantly to an hour. For when custom hath fixed his eating to certain stated periods, his stomach will expect victuals at the usual hour, and grow peevish if he passes it. *Locke.*

Every man must want something for the *convenience* of his life, for which he must be obliged to others.

Calamy's Sermons.
Who far from steeples and their sacred sound,
In fields their sullen *conventicles* found. *Dryden.*

Another crop is too like to follow; nay, I fear, it is unavoidable, if the *conventiclers* be permitted still to scatter. *Id.*

In short-sighted men, whose eyes are too plump, the refraction being too great, the rays converge and *convex* in the eyes, before they come at the bottom.

Newton's Opticks.
I have read a sermon of a *conventual*, who laid it down that Adam could not laugh before the fall.

Addison's Spectator.
If he revoked this plea too, 'twas because he found the expected council was dwindling into a *conventicle*, a packed assembly of Italian bishops; not a free convention of fathers from all quarters. *Asterbury.*

Health itself is but a kind of temper, gotten and preserved by a *convenient* mixture of contraries.

Arbuthnot on Aliments.
Public *conventions* are liable to all the infirmities, follies, and vices of private men. *Swift.*

There was a pair of spectacles, a pocket perspective, and several other little *conveniences*, I did not think myself bound in honour to discover.

Swift's Gulliver's Travels.
And now the' almighty father of the gods
Convenes a council in the blest abodes. *Pope's Stat.*

They are commanded to abstain from all *conventicles* of men whatsoever; even, out of the church, to have nothing to do with publick business. *Id.*

Those are called *conventual* priors, that have the chief ruling power over a monastery. *Id.*

What organ it is that shall declare the corporate mind is so much a matter of positive arrangement, that several states, for the validity of several of their acts, have required a proportion of voices much greater than that of a mere majority. These proportions are so entirely governed by *convention*, that in some cases the minority decides. *Burke.*

Mild was the morn, the sky serene,
The jolly hunting band *convene*,
The beagle's breast with arduous burns,
The bounding steed the champaign spurs,
And Fancy oft the game describes,
Through the hound's nose, and huntsman's eyes. *Beattie.*

Thy parliaments adored on bended knees
The sovereignty they were *convened* to please;
Whate'er was asked, too timid to resist,
Complied with, and were graciously dismissed. *Cowper.*

I seek divine simplicity in him,
Who handles things divine; and all besides,
Though learned with labour, and though much admired

By curious eyes and judgments ill informed,
To me is odious as the nasal twang
Heard at *conventicle*, where worthy men,
Misled by custom, strain celestial themes
Through the pressed nostril, spectacle-bedstrid. *Id.*

Then first necessity invented stools,
Convenience next suggested elbow chairs,
And Luxury the accomplished sofa last. *Id.*

And this example well may prove

That nought's so eloquent as love:
For oft had orators, whose style was
Mellifluent as the seers of Pylos,
Convened, debated, and returned—
While still the rage of battle burned.

But Cupid's sweeter elocution
Brought matters quick to a conclusion. *Sheridan.*

The horrid crags, by toppling *convent* crowned,
Byron's Child Harold.

Nothing but sound, as is manifest, can perfectly be represented by sound; and beyond this, the resemblance, between the flow of a verse and the idea excited by the words, must be wholly *conventional*, and not in any degree actual and self-existent.

Symmons. Pref. to the Æneis.

CONVENER, the title given to the præses of the fourteen deacons of the incorporations, or trades of Edinburgh, from his power of convening the deacons, or the whole incorporations, upon any emergency. He is elected by the fourteen deacons, and the two trades counsellors; wears a gold chain, and is a governor of the Trades Maiden Hospital; but is not ex-officio a member of the ordinary town council; though the magistrates generally appoint him one.

CONVENTICLE is a diminutive of convent; denoting, properly, a secret assembly of a part of the monks of a convent, to make a party in the election of an abbot. Hence the word stands for any seditious, or irregular assembly. F. Doucine observes, the accidentals always esteemed the fifth general council an unlawful conventicle. The term is said to have been first applied in England to the schools of Wickliffe, and has been since used to signify the religious assemblies of all who do not conform to the established doctrines and worship of the church of England. By 22 Car. II. cap. 1, it is enacted: that if any persons of the age of sixteen years, subjects of this kingdom, shall be present at any conventicle, where there are five or more assembled, they shall be fined 5s. for the first offence, and 10s. for the second: persons preaching incur a penalty of £20. Suffering a meeting to be held in a house, is liable to £20 penalty. Justices of the peace have power to enter such houses, and seize persons assembled, &c. And if they neglect their duty, they forfeit £100. And if any constable, &c. know of such meetings, and do not inform a justice of peace, or chief magistrate, he shall forfeit £5. But the 1st W. & M. cap. 18, ordains, that Protestant dissenters shall be exempted from penalties: though if they meet in a house with the doors locked, barred, or bolted, such dissenters shall have no benefit from that statute. Officers of the government, &c. present at any conventicle, at which there shall be ten persons, if the royal family be not prayed for in express words, shall forfeit £40, and be disabled 10 Anne, cap. 2.

CONVENTION is also a name given to an extraordinary assembly of parliament, or the estates of the realm, held without the king's writ. Of this kind was the convention parliament which restored Charles II. This parliament met above a month before his return, and sat full seven months after his restoration, and enacted several laws still in force, which were confirmed by stat. 13;

Car. II. c. 7, and c. 14. Such also was the convention of estates in 1689, who, upon the retreat of king James II., came to a conclusion that he had abdicated the throne, and that the right of succession devolved to king William, and queen Mary; whereupon their assembly expired as a convention, and was converted into a parliament.

CONVENTION OF ESTATES, in Scotland, was partly of the nature of a parliament; but differing in this, that the former could only lay on taxes, while parliament could both impose taxes and make laws.

CONVENTION OF FRANCE, NATIONAL, the representatives of the French people, who met on the 20th of September, 1792, and among their first acts abolished monarchy in that kingdom. See FRANCE, HISTORY OF

CONVENTUS JURIDICI, in Roman antiquity, courts of justice established in the provinces; with jurisdictions circumscribed within certain limits, whither all who were within the limits of these courts were to repair for justice.

CONVERGE, *v. n.* } Lat. *convergere*. To
 CONVERGENCY, *n. s.* } tend to one point; to
 CONVERGENT, *adj.* } one common centre.
 CONVERGING, *adj.* } Tendency to one point.
 Tending to one point.

Where the rays from all the points of any object meet again, after they have been made to converge by reflexion or refraction, there they will make a picture of the object upon a white body. *Newton's Opticks.*

EnswEEPING first

The lower skies, they all at once converge
 High to the crown of heaven. *Thomson's Autumn.*

Converge reflected light with nicer eye
 The midnight owl, and microscopic fly. *Darwin.*

When a fly inserts its proboscis between these anthers (of the apocynum and rose-milfolium), to plunder the honey, they converge closer, and with such violence as to detain the fly, which thus generally perishes. *Id.*

CONVERSE, *v. n.* } Fr. *converser* ;
 CONVERSE, *n. s.* } It. *conversare* ; Sp.
 CONVERSIBLE, *adj.* } *conversar* ; Latin,
 CONVERSABLY, *adv.* } *conversari*. To con-
 CONVERSABLENESS, *n. s.* } verse is, to hold
 CONVERSANT, *adj.* } intercourse with ;
 CONVERSATION, *n. s.* } to be acquainted
 CONVERSATIVE, *adj.* } with ; to talk with ;

to discourse familiarly, in which case it has on before the thing; to have commerce with one of the opposite sex. Converse is, talk; acquaintance; familiarity. Converse is a word of a more poetical order than conversation, and implies somewhat less of familiarity than the latter. Easy talk, chit-chat, may be called conversation; but can scarcely be dignified with the name of converse. Conversation has the additional meanings of behaviour; mode of living; knowledge by long acquaintance with. Conversant signifies, having a thorough knowledge of; having intercourse with, in which case it is followed by *among* or *with*; relating to, in which sense it has *about*, and formerly had *in*, after it. Conversable is, having talent for conversing; being communicative. Conversative indicates, relating to social commerce; to public life; not contemplative.

All that Moses commanded, Joshua read before all the congregation of Israel, with the women, and the little ones, and the strangers that were conversant among them. *Jos. viii. 35.*

Having your conversation honest among the Gentiles. *1 Peter.*

She went to Pamela's chamber, meaning to joy her thoughts with the sweet conversation of her sister. *Sidney.*

Whiles thou now in Elysian fields so free,
 With Orpheus, with Linus, and the choice
 Of all that ever did in rimes rejoice,
 Conversant, and doost hear their heavenly lays. *Spenser. The Ruines of Time.*

Let them make some towns near to the mountain's side, where they may dwell together with their neighbours, and be conversant in the view of the world. *Spenser's State of Ireland.*

The matters wherein church polity is conversant, are the publick religious duties of the church. *Hooker.*

I will converse with iron-witted fools,
 And unrespective boys: none are for me,
 That look into me with considerate eyes. *Shakespeare. Richard III.*

His apparent, open guilt;
 I mean his conversation with Shore's wife. *Id.*

Never to be infected with delight,
 Nor conversant with ease and idleness. *Id. King John.*

Old men who have loved young company, and been conversant continually with them, have been of long life. *Bacon.*

I set down, out of long experience in business, and much conversation in books, what I thought pertinent to this business. *Id.*

Go therefore half this day, as friend with friend,
 Converse with Adam. *Milton's Paradise Lost.*

Gabriel, this day by proof thou shalt behold,
 Thou, and all angels conversant on earth
 With man, or men's affairs, how I begin
 To verify that solemn message. *Id. Paradise Regained.*

Men then come to be furnished with fewer or more simple ideas from without, according as the objects they converse with afford greater or less variety. *Locke.*

It is easy to observe, that many young men continue longer in the thought and conversation of schoolboys than otherwise they would, because their parents kept them at that distance, and in that low rank, by all their carriage to them. *Id.*

To such a one, an ordinary coffee-house gleaner of the city is an arrant statesman, and as much superior too, as a man conversant about Whitehall and the court, is to an ordinary shopkeeper. *Id.*

We had conversed so often on that subject, and he had communicated his thoughts of it so fully to me, that I had rot the least remaining difficulty. *Dryden.*

The knowledge of men and manners, the freedom of habitudes, and conversation with the best company. *Id.*

Those who are conversant in both the tongues, I leave to make their own judgment of it. *Id. Dufrancy.*

Though it be necessitated, by its relation to flesh, to a terrestrial converse; yet it is, like the sun, without contaminating its beams. *Glauville's Apeol.*

Finding him little studious and contemplative, she chose to endue him with conversative qualities of youth. *Wotton.*

Being asked by some of her sex, in how long a time a woman might be allowed to pray to the gods, after

having conversation with a man? If it were a husband, says she, the next day; if a stranger, never.

Guardian.

That fire and levity which makes the young scarce conversible, when tempered by years, makes a gay old age.

Addison.

By experience and conversation with these bodies, a man may be enabled to give a near conjecture at the metallic ingredients of any mass.

Woodward.

Formed by thy converse happily to steer
From grave to gay, from lively to severe. *Pope.*

For him who lonely loves

To seek the distant hills, and there converse
With nature. *Thomson's Summer.*

In a small degree, and conversant in little things, vanity is of little moment. When full grown, it is the worst of vices, and the occasional mimic of them all. It makes the whole man false. It leaves nothing sincere or trust-worthy about him. His best qualities are poisoned and perverted by it, and operate exactly as the worst.

Burke

Blest be the day I 'scaped the wrangling crew;
From Pyrrho's maze, and Epicurus' sty;
And held high converse with the godlike few,
Who to the enraptured heart, and ear, and eye,
Teach beauty, virtue, truth, and love, and melody.

Beattie.

In conversation too, let us always mind what is saying and doing around us, and never give the company ground to suspect, that our thoughts are elsewhere. Attention is a chief part of politeness.

Id

Words learned by rote, a parrot may rehearse,
But talking is not always to converse;
Not more distinct from harmony divine,
The constant creaking of a country sign. *Cowper.*

MARIA. Oh, he has done nothing; but 'tis for what he has said—his conversation is a perpetual libel on all his acquaintance.

Sheridan.

To climb the trackless mountain all unseen,
With the wild flock that never needs a fold;
Alone o'er steep and foaming falls to lean;
This is not solitude; 'tis but to hold
Converse with Nature's charms, and view her stores
unrolled. *Byron. Child Harold*

Even at the holy altars as they stood,
His impious weapon shed Sicheus' blood.
Then, conversant with fraud, he tries his coils;
And long his sister's anxious love beguiles.

Symonds's Virgil.

CONVERSI, a title formerly given to Jews, who were converted to Christianity in England. Henry III. built them a house in London, and allowed them a competent subsistence for their lives.

CONVERSION, in war, a military motion, whereby the front of a battalion is turned where the flank was, in case the battalion is attacked in the flank.

CONVERT, *v. a. & n.*
CONVERT, *n. s.*
CONVERTER, *n. s.*
CONVERTIBLE, *adj.*
CONVERTIBILITY, *adj.*
CONVERTIBLY, *adv.*
CONVERTITE, *n. s.*
CONVERSE, *n. s.*
CONVERSELY, *adv.*
CONVERSABLE, *adj.*
CONVERSION, *n. s.*

Fr. *convertir*; It. *convertire*; Span. *convertir*; Lat. *convertere*, from *con* and *vertere*, to turn accordingly; to turn to or from, to change, is the primary idea conveyed by all these words. To convert, is to turn from infidelity or paganism, to the true faith; from vicious to virtuous courses; from one use,

state, or substance, to another; to change one proposition for another; to undergo a change. The agent in any of these acts is the converter; the patient is the convert or convertite; and the change which he has undergone is his conversion. In algebra, conversion of equations is the reducing of a fractional equation into an integral one. Convert and convertite are, however, applied only to persons. Convertible signifies, capable of being changed; transmutable; so much alike that one is used for the other. In geometry, a proposition is said to be the converse of another, when, after drawing a conclusion from something first proposed, we proceed to suppose what had been before concluded, and to draw from it what had been supposed. Thus, if two sides of a triangle be equal, the angles opposite to those sides are also equal; the converse of the proposition is, that if two angles of a triangle be equal, the sides opposite to those angles are also equal. Conversely means, with change of order; in a contrary order; reciprocally.

Then will I teach transgressors thy ways, and sinners shall be converted unto thee. *Psalms li. 13.*

The abundance of the sea shall be converted unto thee, the forces of the Gentiles shall come unto thee. *Isa. li. 5.*

They passed through Phenice and Samaria, declaring the conversion of the Gentiles. *Acts xv. 4.*

He which converteth the sinner from the error of his way, shall save a soul from death, and shall hide a multitude of sins. *James v. 20.*

And so ferforth she gan our lay declare,
That she the Constable, er that it was eve,
Converted, and on Crist made him beleve. *Chaucer. Conf. Tales.*

What maketh this but Jupiter the king,
The which is pricee and cause of alle thing,
Converting alle unto his proper wille,
From which it is derived soth to telle? *18*

For theft and riot they ben conversible,
Al can they play on giterne or ribible. *Id.*
At last, when long she struggled had in vaine,
She gan to stoup, and her proud mind convert
To meeke obeysance of Love's mighty raine.

Spenser. Faerie Queene.

The love of wicked friends converts to fear:
That fear, to hate. *Shakespeare. Richard II.*
He thence departs a heavy convertite;
She there remains a hopeless cast-away.

Id. Rape of Lucrece.

Artificial conversion of water into ice, is the work of a few hours; and this of air may be tried by a month's space. *Bacon.*

As fire converts to fire the things it burns;
As we our meats into our nature change. *Davies.*
Nor would I be a convertite so cold,

Donne.

As not to tell it.
They rub out of it a red dust which converteth into worms, which they kill with wine. *Sandy's Travels.*
Crystal will callify into electricity, and convert the needle freely placed. *Brown's Vulgar Errors.*

Minerals are not convertible into another species, though of the same genus; nor reducible into another genus. *Harvey.*

The papists cannot abide this proposition converted: all sin is a transgression of the law; but every transgression of the law is sin. *Hale.*

When Platonism prevailed, the converts to Christianity of that school interpreted Holy Writ according to that philosophy. *Locke.*

Though it be not the real essence of any substance, it is the specifick essence, to which our name belongs, and is convertible with it. *Id.*

There never was any person ungrateful, who was not also proud; nor, convertibly, any one proud, who was not equally ungrateful. *South's Sermons.*

If the whole atmosphere was converted into water, it would make no more than eleven yards water about the earth. *Burnet.*

The gall is not an alkali; but it is alkaliescent, conceptible and convertible into a corrosive alkali. *Arbuthnot on Aliments.*

The conversion of the aliment into fat, is not properly nutrition. *Id.*

Many, that call themselves Protestants, look upon our worship to be idolatrous as well as that of the Papists; and put prelacy and popery together, as terms convertible. *Swift.*

Water converted into ice occupies a greater space than it did before, as appears by the bursting of bottles filled with water at the time of their freezing. *Darwin.*

Whimsical enough, faith! My father wants to force me to marry the very girl I am plotting to run away with!—He must not know of my connexion with her yet a while. He has too summary a method of proceeding in these matters.—However, I'll read my incantation instantly.—My conversion is something sudden, indeed—but I can assure him it is very sincere. *Sheridan.*

CONVERT, in a monastic sense, a lay friar, or brother, admitted for the service of the house; without orders, and not allowed to sing in the choir. The word was anciently used for persons who embraced the monkish life at the age of discretion. But in the eleventh century, when they began to receive into monasteries illiterate persons, incapable of being clerks, and only destined for bodily labor, the signification of the word was necessarily changed.

CONVEX, *n. s. & adj.* } Fr. *convex*; It. and Sp. *convexo*; Lat. *convexus*. A convex is, a body which swells externally into a spherical or elliptical form. Convex, as an adjective, means the opposite of concave; swelling externally into a spherical or elliptical form. A convexo-concave body is, that of which the internal surface corresponds with the outward protuberance. The remaining words it is unnecessary to define.

Dolphins are straight; nor have they their spine *convexed*, or more considerably embowed than either sharks, porpoises, whales, or other cetaceous animals. *Browne's Vulgar Errors.*

They be drawn *convexedly* crooked in one piece; yet the dolphin, that carrieth Arion, is concavously inverted, and hath its spine depressed. *Id.*

In circuit to the uttermost *convex* Of this great round. *Milton.*

Almost all, both blunt and sharp, are *convexly* conical; they are all along *convex*, not only per ambitum, but between both ends. *Grew's Musaeum.*

It is the duty of a painter, even in this also, to imitate the *convex* mirror, and to place nothing which glares at the border of his picture. *Dryden's Dufresnoy.*

These are the phenomena of thick *convexo-concave* plates of glass, which are every where of the same thickness. *Newton.*

Convex glasses supply the defect of plumpness in the eye, and, by increasing the refraction, make the rays converge sooner, so as to converge distinctly at the bottom of the eye if the glass has a due degree of *convexity*. *Id. Opticks.*

A comet draws a long-extended blaze; From east to west burns thro' the ethereal frame, And half heaven's *convex* glitters with the flame. *Tickel.*

If the eye were so piercing as to descry even opake and little objects a hundred leagues off, it would do us little service; it would be terminated by neighbouring hills and woods; or, in the largest and evenest plain, by the very *convexity* of the earth. *Bentley.*

The stem of the bamboo is not hollow till it rises more than one foot from the earth; the divisions between the cavities are *convex* downwards. *Darwin.*

CONVEXITY is of particular import in catoptrics and dioptrics, where it is applied to mirrors and lenses. A convex mirror represents its images smaller than the objects; as a concave one represents them larger: a convex mirror reflects the rays from it, diverging; and therefore disperses and weakens their effect: as a concave one reflects them converging, so as they concur in a point, and have their effect increased: and by how much the mirror is a portion of a smaller sphere, by so much does it diminish the objects, and disperse the rays the more. A convex lens is either convex on both sides, called a convexo-convex; or it is plain on one side and convex on the other, called a plano-convex; or concave on one side, and convex on the other, called a convexo-concave, or concavo-convex, as the one or the other surface prevails, i. e. as this or that is a portion of a smaller sphere. All convex lenses inflect the rays of light in their passage, i. e. send them out from their convex surface converging, so as that they concur in a point or focus: hence burning lenses. Convex lenses magnify, i. e. represent their images larger than their objects; and this the more as they are portions of smaller spheres.

CONVEY, *v. a.* } Lat. *convehere*, from *con* and *vehere*. To CONVEYANCE, *n. s.* } remove from one place CONVEYANCER, *n. s.* } to another; to hand from one to another; to remove furtively; to transmit; to transfer; to impart; to manage with privacy. Conveyance is, the act of removing or carrying from one place to another; the road by which is conveyed; the means of removal; transmission from one to another; the method of secretly removing something from a place; the act of transferring property; the writing by which property is transferred; secret management; juggling artifice. A conveyancer is a lawyer, who draws up the conveyances, or deeds, by which property is transferred. A conveyer is, a person who conveys; but is never used in the sense of conveyancer, and vice versâ.

Let letters be given me to the governours beyond the river, that they may convey me over till I come into Judea. *Neh. ii. 7.*

I will convey them by sea, in floats, unto the place thou shalt appoint me. *1 Kings. v. 9.*

She hath the trashid without wene ;
The god of love had they nat sene,
Ne had Idlitesse the *conceide*
Within the verge where mirthe him pleide.

Chaucer. Romaunt of the Rose.

For by this wre. . . being strait betrayed,
To one John Milton, sheriffe of Shropshire then,
All sodaynly was taken, and *conveyed*
To Salisbury, wyth rout of harnest men. *Sackville.*

It cometh herein to pass with men, unadvisedly
fallen into error, as with them whose state hath no
ground to uphold it, but only the help which, by sub-
tile *conveyances*, they draw out of casual events, arising
from gay to day, till at length they be clean spent.

Hooker.

His blessed body, spoiled of lively breath
Was afterward, I know not how, *conceid*,
And fro me hid. *Spenser. Faeris Queene.*

The earl of Desmond, before his breaking forth into
rebellion, *conveyed* secretly all his lands to feoffices in
trust. *Id.*

Doth not the act of the parents, in any lawful grant
or *conveyance*, bind their heirs for ever thereunto? *Id.*
There was one *conveyed* out of my house yesterday
in this basket. *Shakespeare. Merry Wives of Windsor.*

I will *convey* the business as I shall find means, and
acquaint you withal. *Id. King Lear.*

We powt upon the morning, are unapt
To give or to forgive ; but when we've stuffed
These pipes, and these *conveyances* of blood,
With wine and feeding, we have suppler souls.
Id. Coriolanus.

Iell her thou mad'st away her uncle Clarence,
Her uncle Rivers ; ay, and for her sake,
Mad'st quick *conveyance* with her good aunt Ann.

Id. Richard III.

I am this day come to survey the Tower ;
Since Henry's death, I fear, there is *conveyance*.
Id. Henry VI.

Nay, call the Cynic but a wittie foole,
Thence to abjure his handsome drinking bowl,
Because the thirstie swain with hollow hand
Conceid the stream to wet his drie weasand. *Hall.*

The *conveyers* of waters of these times content them-
selves with one inch of fall in six hundred feet.

Brerewood on Languages.

This begot a suit in the Chancery before the lord
Coventry, who found the *conveyances* in law to be so
firm, that in justice he must decree the land to the
earl. *Clarendon.*

Can they not juggle, and with slight
Conveyance play with wrong and right?

Hudibras.

Some single imperceptible bodies must come from
them to the eyes, and thereby *convey* to the brain some
motion which produces those ideas. *Loche.*

A divine natural right could not be *conveyed* down,
without any plain, natural, or divine rule concerning
it. *Id.*

Our author has provided for the descending and
conveyance down of Adam's monarchical power, or
paternal dominion, to posterity. *Id.*

Iron works ought to be confined to places where
there is no *conveyance* for timber to places of vent, so
as to quit the cost of the carriage. *Temple.*

Those who stand before earthly princes, in the
nearest degree of approach, who are the dispensers
of their favours, and *conveyers* of their will, to others,
do, on that very account, challenge high honours to
themselves. *Atterbury.*

Verbal descriptions infusing sublime horror, are
such as *convey* lively ideas of the objects of supersti-

VOL. VI.

tion, as ghosts and enchantments ; or of the thoughts
that haunt the imaginations of the guilty ; or of those
external things which are pleasingly terrible, as storms,
conflagrations, and the like. *Beattie.*

I admire,

None more admires, the painter's magic skill,
Who shows me that, which I shall never see,
Conveys a distant country into mine,
And throws the English light on English walls.

Cowper.

Ghostly counsel, if it either fall
Below the exigence, or be not backed
With show of love, at least with hopeful proof
Of some sincerity on the giver's part ;
Or be dishonoured in the exterior form
And mode of its *conveyance* by such tricks
As move derision, or by foppish airs
And histrionic mummery, that let down
The pulpit to the level of the stage ;
Drops from the lips a disregarded thing. *Id.*

A *conveyancer* he is—employ him who list :
Forbidding his aspect, and close is his fist ;
With more coin in his pocket than brains in his head,
Yet a book he has written that nobody read.

Huddesford.

But taking him into her father's house
Was not exactly the best way to save,
But like *conveying* to the cat a mouse,
Or people in a trance into their grave.

Byron. Don Juan.

CONVEYANCE, in English law. The most com-
mon conveyances are deeds of gift ; bargain and
sale ; lease and release ; fines and recoveries ;
and settlements to uses. For the following out-
line of the common law, upon this curious sub-
ject, we are indebted to Tomlin's Dictionary.

Feoffments and grants were the two chief modes
used in the common law for transferring property.
The most comprehensive definition that can be
given of a feoffment seems to be, a conveyance
of corporeal hereditaments, by delivery of the
possession, upon, or within view of, the heredita-
ments conveyed. This delivery was thus made,
that the lord and the other tenants might be
witnesses to it. No charter of feoffment was
necessary ; it only served as an authentication of
the transaction ; and when it was used, the lands
were supposed to be transferred, not by the char-
ter, but by the livery which it authenticated
Soon after the conquest, or perhaps towards the
end of the Saxon government, all estates were
called fees ; the original and proper import of
the word feoffment is, the grant of a fee It
came afterwards to signify a grant with livery of
seisin of a free inheritance to a man and his heirs ;
more respect being had to the perpetuity, than
to the feudal tenure, of the estate granted In
early times, after the conquest, charters of feoff-
ment were various in point of form. In the time
of Edward I. they began to be drawn up in a
more uniform style. The more ancient of them
generally run with the words *dedi, concessi, or*
donavi. It was not till a later period that *feoffavi*
came into use. The more ancient feoffments
were also usually made in consideration of, or
for the homage and service of the feoffee, and to
hold of the feoffor and his heirs. But after the
stat. *quia emptores* (18 Edward I. stat. 1) feoff-
ments were always made to hold to the chief lords
of the fee, without the words *pro homagio et*
servitio. See 1 Inst. 6 a : 271 b.

The proper limitation of a feoffment is to a man and his heirs; but feoffments were often made of conditional fees (or estates tail as they are now called), and of life estates; to which may be added, feoffments of estates given in frank-marriage and frankalmoigne. To make the feoffment complete, the feoffor used to give the feoffee seisin of the lands; this is what the feudists call investiture. It was often made by symbolical tradition, but it was always made upon or within view of the lands. When the king made a feoffment he issued his writ to the sheriff, or some other person to deliver seisin: other great men did the same; and this gave rise to powers of attorney.

A *grant*, in the original signification of the word, is a conveyance or transfer of an incorporeal hereditament. As livery of seisin could not be had of these, the transfer of them was always made by writing, in order to produce that notoriety, which in the transfer of corporeal hereditaments was produced by delivery of the possession. But in other respects a feoffment and a grant did not materially differ. Such was the original distinction between a feoffment and a grant; but from this real difference in their subject matter only, a difference was supposed to exist in their operation. A feoffment visibly operated on the possession; a grant could only operate on the right of the party conveying. Now as possession and freehold were synonymous terms, no person being considered to have the possession of the lands but he who had at least an estate of freehold in them, a conveyance which was considered as transferring the possession, must necessarily be considered as transferring an estate of freehold; or, to speak more accurately, as transferring the whole fee. But this reasoning could not apply to grants; their essential quality being that of transferring things which did not lie in possession; they therefore could only transfer the right; that is, could only transfer that estate which the party had a right to convey. It is in this sense the expressions are to be understood, that a feoffment is a tortious and a grant a rightful conveyance. The introduction of uses produced a great revolution in this part of our laws. Uses at the common law, were, in most respects, what trusts are now. When a feoffment was made to uses, the legal estate was in the feoffee. He filled the possession, did the feudal duties, and was in the eye of the law the tenant of the fee. The person to whose use he was seized, called the cestuy que use, had the beneficial property of the lands; had a right to the profits; and a right to call upon the feoffee to convey the estate to him, and to defend it against strangers. This right at first depended on the conscience of the feoffee; if he withheld the profits from the cestuy que use, or refused to convey the estate as he directed, the feoffee was without remedy. To redress this grievance the writ of subpoena was devised, or rather adopted from the common law courts, by the court of chancery, to oblige the feoffee to attend in court and disclose the trust; and then the court compelled him to execute it. Thus uses were established: they were not considered as issuing out of, or annexed to the land, as a rent or condition, or a right of

common; but as a trust reposed in the feoffee, that he should dispose of the lands at the discretion of the cestuy que use, permit him to receive the rents, and in all other respects to have the beneficial property of the lands.

A conveyance cannot be fraudulent in part, and good as to the rest: for if it be fraudulent and void in part, it is void in all, and it cannot be divided. 1 Lib. Abr. 311. Fraudulent conveyances to deceive creditors, defraud purchasers, &c. are void, by stats. 13 Eliz. cap. 5, 27 Eliz. cap. 4. See FRAUD.

CONVICIATE, *v. a.* } Old Fr. *convicé*;
CONVICIOUS, *adj.* } Lat. *convicior*. To rail at; to clamor at; to raise an outcry. These words are both obsolete. So is the French noun, *convicé*, which Sherwood defines 'a reproach, railing word, biting tearme, spitefull scoff, despicable gird, or glance, malicious taunt.'

CONVICINITY, *n. s.* Lat. *con* and *vicinus*. Nearness; proximity.

CONVICIT, *v. a. & adj.* } Lat. *convincere*,
CONVICIT, *n. s.* } from *con* and *vin-*
CONVICITION, *n. s.* } *cere*. To prove the
CONVICITIVE, *adj.* } guilt of; to detect in
CONVICITIVELY, *adv.* } a criminal act; to confute; to show by proof; to destroy; but this last meaning is obsolete. The adjective means convicted; detected in the fact. A convict is one who has been convicted. Conviction is detection of guilt; the act of convicting; the act of convincing; full belief; assent of the mind to the truth of any thing; state of being convinced. Convictive signifies that which has the ability to convince.

And they which heard it, being convicted by their own conscience, went out one by one. *John viii. 9.*

If there be no such thing apparent upon record, they do as if one should demand a legacy by virtue of some written testament, wherein there being no such thing specified, he pleadeth that there it must needs be, and bringeth arguments from the love which always the testator bore him; imagining that these proofs will convict a testament to have that in it, which other men can no where by reading find. *Hooker*.

When therefore the apostle requireth ability to convict hereticks, can we think he judgeth it a thing unlawful, and not rather needful, to use the principal instrument of their conviction, the light of reason? *Id.*

Before I be convicted by course of law,
To threaten me with death, is most unlawful.

Shakespeare. Richard III.

Things, that at the first shew seemed possible, by ripping up the performance of them, have been convicted of impossibility. *Bacon's Holy War.*

Although not only the reason of any head, but experience of every hand, may well convict it, yet will it not by divers be rejected. *Browne's Vulgar Errors.*

The third best absint is condemned,
Convict by flight, and rebel to all law;
Conviction to the serpent none belongs.

Milton's Paradise Lost.

We see generally that numbers of them exactly jump in a whole large collection of doctrines, consisting of abundance of particulars, as if their notions were, by one common stamp, printed on their minds, even to the least lineament. This is very hard, if not impossible, to be conceived of those who take up their opinions only from conviction. *Locke*

The manner of his conviction was designed, not as a peculiar privilege to him, but as a standing miracle, a lasting argument for the conviction of others, to the very end of the world. *Attorney.*

Convict a papist he, and I a poet.

Pope's Epistle of Horace.

By the civil law, a person convict, or confessing his own crime, cannot appeal. *Ayliffe's Parergon.*

He that accuses all mankind of corruption, ought to remember that he is sure to convict only one. *Burke.*

Once on a time an emperor, a wise man,
No matter where, in China or Japan,
Decreed, that whosoever should offend
Against the well known duties of a friend,
Convicted once, should ever after wear,
But half a coat, and show his bosom bare. *Cowper.*

The police, however useless, were by no means idle: several notorious delinquents had been detected; men liable to conviction, on the clearest evidence, of the capital crime of poverty; men, who had been notoriously guilty of lawfully begetting several children, whom, thanks to the times!—they were unable to maintain. *Byron. Speech on the Frame-breaking Bill.*

CONVICTION, in law, is either where a man is outlawed, or appears and confesses, or else is found guilty by the inquest. *Crompton Inst. 9.* In the summary proceedings directed by acts of parliament for the conviction of offenders, and inflicting the penalties imposed by those acts, there is no intervention of a jury, but the person accused is acquitted or condemned by the suffrage of such person only as is appointed by the statute for his judge. It is implied in law that there must be a conviction before judgment, though not so mentioned in the statute; and where by any statute a second offence is made felony, or subjected to a heavier penalty than the first, it is always implied that such second offence should be committed after a conviction of the first. *1 How. 13-107.* Judgment amounts to a conviction, though it does not follow that all are adjudged who are convicted. *Horn. 14.* A conviction ought to be in the present tense, not in the time past. *Ld. Raym. 1376. Str. 608.* A conviction ought to be on an information or claim precedent. *Ld. Raym. 510.* When the conviction of offenders before justices of the peace, &c. is ordered by act of parliament, it must be intended after summons to bring them in, that they may have an opportunity of making their defence; and if it be otherwise the conviction shall be quashed. Of the summary convictions warranted by the law, are, 1. Those for offences and frauds against the laws of excise, and for the protection of other branches of the public revenue; which are to be enquired into and determined by the commissioners of the respective departments, or by justices of peace in this country. Some writers have the ultra-loyalty to plead for these as 'a species of mercy to the delinquents, who would be ruined by the expense and delay of frequent prosecutions by action or indictment.' 2. Those had before justices of the peace, in order to inflict divers petty pecuniary mulcts, and corporeal penalties, denounced by act of parliament, for various offences against the good order of society; such as common swearing, drunkenness, ragrancy, idleness, &c. See JUSTICE OF PEACE, and titles of various offences.

These used formerly to be punished by the verdict of a jury in the court leets, and sheriff's tourn, the king's ancient courts of law. These convictions proved very promptly: but the law requires a party to be summoned before the proceedings can commence: but if the summons be neglected, a magistrate may proceed by examining witnesses upon oath, and make his conviction of the offender in writing. He then usually issues his warrant, either to apprehend the offender, in case corporeal punishment is to be inflicted; or to levy the penalty incurred by distress and sale of his goods. Magistrates, it is said, ought to state in the conviction the whole of the evidence for and against the defendant. *8 T. R. 220.* But where power of conviction is by statute given to a magistrate, he is the sole judge of the weight of the evidence given before him, and the higher court will not examine whether or not he has drawn a right conclusion from the evidence.

CONVINCE, *v. a.* } *Fr. convaincre; It. convincere; Lat. convincer, n. s.* } To compel any one to assent to the truth of a disputed proposition; to prove the guilt of; to evince; to overpower; to surpass. The last meanings are obsolete. The other words, of the same stock, closely resemble the verb in the senses which they bear.

To convince all that are ungodly among them, of all their ungodly deeds. *Jude 15.*

It was a famous present for a prince,
And worthy work of infinite reward,
That treasons could bewray, and foes convince. *Spenser. Faerie Queene.*

Your Italy contains none so accomplished a courtier, to convince the honor of my mistress. *Shakespeare. Cymbeline.*

There are a crew of wretched souls
That stay his cure; their malady convinces
The great assay of art. *Id. Macbeth.*

When Duncan asleep, his two chamberlains
Will I with wine and wassel so convince,
That memory, the warder of the brain,
Shall be a fume. *Id.*

Knaves, be such abroad,
Who having, by their own importunate suit,
Or voluntary dotage of some mistress,
Convinced or supplied them, they cannot chuse
But they must blab. *Id. Othello.*

The discovery of a truth, formerly unknown, doth rather convince man of ignorance, than nature of error. *Raleigh.*

Upon what uncertainties, and also conceivable falsities, they often erected such emblems, we have delivered. *Browne.*

This he did so particularly and convincingly, that those of the parliament were in great confusion. *Clarendon.*

Convince a man ever so much, that plenty has an advantage over poverty; make him see and own, that the handsome conveniences of life are better than nasty penury; yet as long as he is content with the latter, and finds no ungracious in it, he moves not. *Locke.*

If that be not convincement enough, let him weigh the other also. *Deacy of Piety. 2 E 2*

O seek not to convince me of a crime,
Which I can ne'er repent, nor can you pardon.

Dryden.

But, having shifted every form to 'scape,
Convinced of conquest, he resumed his shape.

Id. Virgil.

That which I have all this while been endeavouring to convince men of, and to persuade them to, is no other but what God himself doth particularly recommend to us, as proper for human consideration.

Tillotson.

The resurrection is so convincingly attested by such persons with such circumstances, that they who consider and weigh the testimony, at what distance soever they are placed, cannot entertain any more doubt of the resurrection than the crucifixion of Jesus.

Atterbury.

LADY T. Why, if my understanding were once convinced—

JOSEPH S. O, certainly, madam, your understanding should be convinced. Yes—yes—heaven forbid I should persuade you to do any thing you thought wrong. No, no, I have too much honour to desire it.

Sheridan.

Oh! too convincing,—dangerously dear
In woman's eye the unanswerable tear!
That weapon of her weakness she can wield,
To save subdue—at once her spear and shield.

Byron.

CONVIVE, *v. a.* } Lat. *convivere.* To
CONVIVAL, *adj.* } entertain; to feast; to
CONVIVIAL, *adj.* } feast together. The verb
CONVIVIALITY, *n. s.* } is obsolete, though the act of which it is expressive was never more common. Convivial is relating to an entertainment; festal; jovial. Convivial men too often are men who, as Shakspeare says, 'put an enemy into their mouths, to steal away their brains,' and this folly is covered with the name of conviviality.

First, all you peers of Greece, go to my tent,
There in the full convive you.

Shakspeare. Troilus and Cressida.

I was the first who set up festivals;
Not with high tastes our appetites did force,
But filled with conversation and discourse
Which feasts, convivial meetings we did name.

Denham.

Your social and convivial spirit is such, that it is a happiness to live and converse with you.

Dr. Newton.

The plump convivial parson often bears
The magisterial sword in vain, and lays
His reverence and his worship both to rest
On the same cushion of habitual sloth.

Cowper.

As for vulgar fellowships, and connexions, where a man is to act the pleasant fellow and set the table in a roar, if he has not the spirit and discretion to decline them, he will soon find his professional talents sacrificed to his convivial ones.

Cumberland.

CONVINDRUM, *n. s.* A low jest; a quibble; a mean conceit; a cant word.

Mean time he smokes, and laughs at merry tale,
Or pun ambiguous, or convindrum quaint.

Philips.

CONVOCATE, *v. a.* } Fr. *convoquer*; Ital.
CONVO'KE, *v. a.* } *convocare*; Span. *convocar*.

CONVOCA'TION, *n. s.* } *vocac*; Lat. *convocare.*
To call together; to summon to an assembly; to convene. The verb convoke is the most in use. Convocation is, the act of summoning to

an assembly; an assembly; an assembly of the clergy for consultation upon matters ecclesiastical, in time of parliament: and, as the parliament consists of two distinct houses, so does this; the one called the upper house, where the archbishops and bishops sit severally by themselves; the other the lower house, where all the rest of the clergy are represented by their deputies. See the next article.

On the eighth day shall be an holy convocation unto you.

Lev. xxiii. 20.

This dolie dreme, this ugly vision,
Brought till an ende, Crescide fro it awoke,
And all that court and convocacion
Vanished awaie.

Henderson. Testament of Crescide.

Diaphantus, making a general convocation, spake to them in this manner.

Sidney.

I have made an offer to his majesty,
Upon our spiritual convocation,
As touching France, to give a greater sum
Than ever at one time the clergy yet
Did to his predecessors part withal.

Shakspeare. Henry IV.

Assemblies exercise their legislature at the times that their constitution, or their own adjournment, appoints, if there be no other way prescribed to convocate them.

Locke.

This is the declaration of our church about it, made by those who met in convocation.

Stillingfleet.

When next the morning warms the purple east,
Convokes the peetrage.

Pope's Ode on the

The senate originally consisted all of nobles, the people being only convoked upon such occasions as fell into their cognizance.

Swift.

Stamp with charmed foot, convokes the alarmed Gnomes

From golden beds and adamantine domes.

Darwin.

CONVOCA'TION, an assembly of the clergy of England, by their representatives, to consult of ecclesiastical matters. It formerly sat for business during the session of parliament, and consists of an upper and a lower house. In the upper sit the bishops. In the lower the inferior clergy are represented by their proctors: it consists of all the deans and archdeacons, of one proctor for every chapter, and two for the clergy of every diocese. The lower house chooses its prolocutor, who is to take care that the members attend, to collect their debates and votes, and to carry their resolutions to the upper house. The convocation is summoned by the king's writ, directed to the archbishop of each province, requiring him to summon all bishops, deans, archdeacons, &c.

The power of the convocation is limited by a statute of Henry VIII. They are not to make any canons, or ecclesiastical laws, without the king's licence; nor, when permitted, can they put them in execution, but under several restrictions. They have the examining and censuring of all heretical and schismatical books and persons, &c. but there lies an appeal to the king in chancery, or to his delegates. The clergy in convocation, and their servants, have the same privileges as members of parliament. In 1665 the convocation of the clergy gave up the privilege of taxing themselves to the house of commons, in consideration of their being allowed to vote at elec-

tions of members for that house. Since that period they have seldom been allowed to do any business; and are generally prorogued from time to time till dissolved, a new convocation being called along with a new parliament.

CONVOLVE, *v. a.* } Ital. *convolgere* ;
 CONVOLUTED, *part. adj.* } Lat. *convolvere*. To
 CONVOLUTION, *n. s.* } roll or unfold together; to roll one part upon another; to twist together in knots. Convolution is, the act of convolving; the state of being convolved. Convoluted signifies, twisted together; rolled upon itself.

He writhed him to and fro convolved. *Milton.*
 It is a wonderful artifice how newly hatched maggots, not the parent animal, because she emits no web, nor hath any textrine art, can convolve the stubborn leaf, and bind it with the thread it weaves from its body. *Derham.*

Observe the convolution of the said fibres in all other glands, in the same or some other manner. *Crew's Cosmologia.*

A thousand secret, subtle pipes bestow,
 From which, by numerous convolutions wound,
 Wrapped with the attending nerve, and twisted round. *Blackmore.*

This differs from Muscovy-glass only in this, that the plates of that are flat and plain, whereas these are convoluted and inflected. *Woodward on Fossils.*

And tossed wide round,
 O'er the calm sea, in convolution swift
 The feathered eddy floats. *Thomson's Autumn.*

Used to milder scents, the tender race
 By thousands tumble from their honey'd domes
 Convolved and agonizing in the dust. *Id.*

Where with vast convolution Draco holds
 The elliptic axis in his scaly folds,
 O'er half the skies his neck enormous rears,
 And with immense meanders parts the Bears. *Darwin.*

CONVOLUTION, in botany, a winding motion, proper to the trunks of some plants, as the convolvulus; the claspers of vines, bryony, &c.

CONVOLVULUS, in botany, bind-weed, a genus of the pentandria order, and the monogynia class of plants; natural order twenty-ninth, campanaceae: cor. campanulated and plaited; stic. two; caps. bilocular, and the cells disperous. Of this genus there are 120 species. The most remarkable are the following:—1. *C. batatas*, or Spanish potato, has esculent roots, resembling the potato, which are annually imported from Spain and Portugal, where they are greatly cultivated for the table; but they are too tender to thrive in the open air in Britain. 2. *C. Canariensis*, with soft woolly leaves, is a native of the Canaries, but has long been preserved in the British gardens. It has a strong fibrous root, from whence arise several twining woody stalks, which, where they have support, will grow more than twenty feet high, garnished with oblong heart-shaped leaves, which are soft and hairy. The flowers are produced from the wings of the leaves, several standing upon one foot-stalk. They are for the most part of a pale blue; but there is a variety with white flowers. 3. *C. jalappa*, or jalap, used in medicine, is a native of Haleppo in Spanish America, situated between Vera Cruz and Mexico. It has a large root of an oval form,

which is full of a milky juice; from which come out many herbaceous twining stalks, eight or ten feet high, garnished with variable leaves; some of them being heart-shaped, others angular, and some oblong and pointed. They are smooth, and stand upon long foot-stalks: the flowers are shaped like those of the common greater bind-weed, each foot-stalk supporting only one flower. This species does not thrive in this country, unless constantly kept in a stove. The roots are purgative. See JALAP. 4. *C. nil*, or blue bind-weed, rises with a twining stalk eight or ten feet high, garnished with heart-shaped leaves, divided into three lobes, which end in sharp points. These are woolly, and stand upon long foot-stalks. The flowers also come out on long foot-stalks, each sustaining two flowers of a very deep blue color, whence their name of anil or indigo. This is one of the most beautiful plants of the genus: it flowers all the latter part of the summer, and in good seasons the seeds ripen very well in the open air. 5. *C. purpureus*, or major, is an annual plant growing naturally in Asia and America, but has long been cultivated in the British gardens. This species, properly supported, will rise ten or twelve feet high in warm summers. There are three or four lasting varieties: the most common has a purple flower; the others have a white, a red, or a whitish-blue flower, which last has white seeds. They flower in June, July, and August, and their seeds ripen in autumn. They are propagated by seeds sown on a hot-bed in spring, and towards the end of May they should be planted in warm borders, and supported by stakes. 6. *C. sepium*, or large white bind-weed. 7. *C. tricolor*, or minor, is a native of Portugal; but has been long cultivated in the gardens of this country. It is an annual plant, which has several thick herbaceous stalks growing about two feet high, which do not twine like the other sorts, but decline towards the ground, upon which many of the branches lie prostrate; they are garnished with spear-shaped leaves, which sit close to the branches: the foot-stalks of the flowers come out just above the leaves of the same joint, and at the same side of the stalks. They are about two inches long, each sustaining one large, open, bell-shaped flower, which in some is of a fine blue color with a white bottom; in others they are pure white, and some are beautifully variegated with both colors. The white flowers are succeeded by white seeds, and the blue by dark colored seeds; which difference is pretty constant.

CONVOY, *v. a.* } Fr. *convoyer* ; Ital. *con-*
 CONVOY, *n. s.* } *vogliare* ; Span. *convoyat* ;
 CONVOYING, *n. s.* } low Lat. *conviare*. To act as a guide, a protection, an escort. A convoy is, that which escorts for the purpose of protecting; the thing protected; the act of attending as a protector; conveyance; but this last sense is obsolete. Both the verb and the noun are most commonly used with reference to protection afforded by sea.

Sister, as the winds give benefit,
 And convoy is assistant, do not sleep,
 But let me hear from you. *Shakespeare. Hamlet.*

Such fellows will learn you by rote where services were done; at such a breach, at such a *convoy*.

Shakespeare. Henry V.

Swift, as a sparkle of a glancing star,
I shoot from heaven to give him safe *convoy*.

Milton's Paradise Regained.

Had not God set peculiar value upon his temple, he would not have made himself his people's *convoy* to secure them in their passage to it. *South's Sermons.*

My soul grows hard, and cannot death endure;
Your *convoy* makes the dangerous way secure.

Dryden's Pref. Dufresnoy's.

Convoy ships accompany their merchants, till they may prosecute the voyage without danger.

Dryden's Prof. Dufresnoy.

But hark! a rap comes gently to the door;
Jenny, who kens the meaning o' the same,
Tells how a neebor lad cam o'er the moor,
To do some errands, and *convoy* her hame.

Burns.

CONVOY, in military affairs, a detachment of men employed to guard any supply to a town or army, and prevent its falling into the hands of the enemy. As the conducting of a convoy is one of the most important and most difficult of all military operations, the officer who commands a convoy must take all possible precautions for its security, and endeavour, before its march, to get himself well informed concerning the out parties of the enemy. And as the commanding officer of the place from which the convoy is to march, and those of such other places as he is to pass by, are most likely to afford him proper assistance, he should take every measure in his power to secure a communication with them.

CONUS, a cone, in botany, a species of fruit, or scaly seed-vessel, so termed by Tournefort and other botanists. Linnæus substituted *strobilus* in its place.

CONFUSANCE, *n. s.* } Fr. *connoissance*. Cognizance; notice; knowledge of. *Conusable* is, liable to be tried. *Conusant* is, acquainted with. They are all law terms.

CONVULSE, *v. a.* } Fr. *convulsion*; Ital. *convulsione*; Span. *convulsar*; Lat. *convellere*, *convulsively*, *adv.* } *vulsum*. To give an irregular spasmodic motion to the muscles; to distort; to throw into disorder. In its medical sense, *convulsion* is a diseased action of muscular fibres, known by alternate relaxations, with violent and involuntary contractions of the muscular parts, without sleep. See **MEDICINE**. In its wider sense, it signifies motion that is irregular and violent; tumult; commotion; disturbance.

They are irregular and *convulsive* motions, or straggling of the spirits. *Hale's Origin of Mankind.*

If my hand be put into motion by a *convulsion*, the indifferency of that operative faculty is taken away.

Locke.

All have been subject to some *convulsions*, and fall under the same *convulsions* of state, by dissensions or invasions. *Temple.*

Her colour changed, her face was not the same,
And hollow groans from her deep spirit came;
Her hair stood up; *convulsive* rage possessed
Her trembling limbs, and heaved her lab'ring breast.

Dryden.

Follows the loosened, aggravated roar,
Enlarging, deepening, mingling peal on peal,
Crushed horrible, *convulsing* heaven and earth.

Thomson.

No wizard mutters the tremendous spell,
Nor sinks *convulsive* in prophetic swoon;
Nor bids the noise of drums and trumpets swell,
To ease of fancied pangs the labouring Moon,
Or chase the shade that blots the blazing orb of noon.

Beattie.

Earth yawns!—the crashing ruin sinks!—o'er all
Death with black hands extends his mighty pall;
Their mingling gore the fiends of Vengeance quaff,
And Hell receives them with *convulsive* laugh.

Darwin.

Here roams the wolf, the eagle whets his beak,
Birds, beasts of prey, and wilder men appear,
And gathering storms around *convulse* the closing year.

Byron. Childs Harold.

Thus much she viewed an instant and no more—
Her struggles ceased with one *convulsive* groan;
On her sire's arm, which until now scarce held
Her writhing, fell she like a cedar felled.

Id. Don Juan.

CONVULSION, a diseased action of muscular fibres, known by alternate relaxations, with violent and involuntary contractions of the muscular parts, without sleep. Cullen arranges *convulsion* in the class *neuroses*, and order *spasmi*. See **MEDICINE**.

CONWAY, a town of North Wales in Caernarvonshire, called also **ABERCONWAY**, which see.

CONWAY, a river of North Wales, which rises from a lake where the counties of Caernarvon, Denbigh, and Merioneth meet; and after flowing through the vale, along the east border of Caernarvonshire, which it separates from Denbighshire, falls into the Irish sea at Conway. This river, though its course from the lake to its mouth is only twelve miles, yet is so deep, in consequence of the many brooks it receives, that it is navigable by ships of good burden for eight miles. Small pearls are occasionally found in large black muscles taken in this river.

CONWAY, a valley of Caernarvonshire, equally beautiful and romantic. It is a long narrow tract, abounding in corn fields, pasture, and groves, and forming a fine contrast to the bleak mountain of Snowdon above it.

CONWAY, a township of Nova Scotia, in the province of New Brunswick, Sudbury county, on the western bank of St. John's River. It has the bay of Fundy on the south, and a pretty good harbour called Musquash Cove, at the west point.

CONWAY, a township of the United States, in the north-east corner of Stafford county, New Hampshire, on Saco river, incorporated in 1765. It contains 575 inhabitants, and was called Pigwacket by the Indians.

CONWAY, a thriving township in Hampshire county, Massachusetts, incorporated in 1767, and containing 2092 inhabitants. It lies thirteen miles north-west of Northampton, and 115 north-west by west of Boston.

CO'NY, *n. s.* } Fr. *conain*, *conail*;
CO'NY-BURROW, *n. s.* } Ital. *coniglio*; Span. *co*
CO'NY-CATCH, *v. n.* } *nejo*; Dutch *konijn*;
CO'NY-CATCHER, *n. s.* } Ger. *kaninchen*; Sw. *kaning*; Lat. *cuniculus*. A rabbit; an animal

that lives in holes called cony-burrows; figuratively, a simpleton. To cony-catch is an old verb, now obsolete, signifying to trick; to cheat; to make a dupe of; and a cony-catcher is, of course, a swindler; a cheat; a trickster; a rascal.

Comis there were also playing,
That *comis* out of their claspers.

Chaucer. Cant. Tales.

For none I trow, that hath a witta so badde,
To set his hay for *comis* over rivers,
Nor yet set not a dragege nette for an hare. *Wyat.*

Sometime he runs among the flocks of sheep,
To make the cunning hounds mistake their smell;
And sometime, where earth-delving conies keep,
To stop the loud pursuers in their yell.

Shakespeare. Venus and Adonis.

I have matter in my head against you, and against
your cony-catching rascals.

Id. Merry Wives of Windsor.

With a short-legg'd hen,
Lemons and wine for sauce; so these a cony
Is not to be despis'd of, for our money.

Ben Jonson's Epigrams.

The husbandman suffers by hares and conys, which
eat the corn and trees. *Mortimer's Hunt.*

CONY. See LEPUA.

CONY, AMERICAN. See CAVIA.

CONY, BRASILEAN. See CAVIA.

CONYBEARE (John Jesus), a modern divine and geologist, was the son of Dr. William Conybeare, rector of St. Botolph, Bishopsgate, and grandson of Dr. Conybeare, bishop of Bristol. He was born in 1779, and educated at Westminster school; from whence, in 1797, he was elected to a studentship of Christ Church, Oxford. Here afterwards he gained, in two years, the undergraduate's prize for a Latin poem, entitled *Meligio Brahmæ*. He took the degree of M.A. in 1804, and became usher of Westminster school; but in 1807 returned to college, and was elected to the Anglo-Saxon professorship of the university, a station for which his antiquarian taste and knowledge particularly qualified him. In 1812 he was chosen poetry professor, and preached in 1824 the Bampton Lecture. To the *Annals of Philosophy* he made some valuable communications on some scientific subjects, particularly on the mineralogy of Devon, Cornwall, and Wales. He has also some valuable papers in the *Archæologia*, on the Saxon poetry. He succeeded to the stall which his father had held in the cathedral of York; and in 1812 obtained the college living of Bathaston in Somersetshire. Mr. Conybeare died at Blackheath, in June 1824; having again preached the Bampton Lectures for the year, which he published.

CONYZA, *leabane*, a genus of the polygamia superflua order, and syngenesia class of plants; natural order forty-ninth, composite. Pappus simple: cal. imbricated and roundish: cor. of the radius triad. There are ninety-one species.

CONZ, or CONSARBRUCK, a town of Germany, in the ci-devant territory of the Electorate of Treves, now annexed to France. It is included in the department of the Sarre and Moselle, and seated at the confluence of these rivers.

CONZA, a town of Naples, in the province of Principato Ultra, of which it is considered the capital. It is situated at the foot of the Apeanines, on the river Oanto; and is the see of an archbishop. Its principal commerce is in marble. It suffered greatly by an earthquake in 1694. Conza lies fifty-eight miles south-east of Naples. Long. 15° 39' E., lat. 40° 50' N.

COO, *v. a. & n. s.* } To make the same
COO'ING, *n. s.* } sound as a dove or pigeon. The word is imitative of the sound. Cooing is the note of the dove; invitation.

Let not the cooings of the world allure thee:
Which of her lovers ever found her true? *Young.*

The stock-dove only through the forest cooes
Mourningfully hoarse. *Thomson's Summer.*

Those ears that are offended by the sweetly wild notes of the thrush, the blackbird, and the nightingale, the distant cawing of the rook, the tender cooing of the turtle, the soft sighing of reeds and osiers, the magic murmur of lapsing streams, will be regaled and ravished by the extravagant and alarming notes of a squeaking fiddle, extracted by a musician who has no other genius than that which lies in his fingers: they will even be entertained with the rattling of coaches, the rumbling of carts, and the delicate cry of cod and mackerel. *Smollet.*

The timorous hare,
Grown so familiar with her frequent guest,
Scarce shuns me; and the stock dove unalarmed
Sits cooing in the pine-tree, nor suspends
His long love-ditty for my near approach. *Cooper.*

COOCH-BAHAR, or COOCH-BEHAR, a district of Hindostan, in the province of Bengal, lying between the twenty-sixth and twenty-seventh degrees of northern latitude. It is bounded on the north by Bootan, on the east by Rungamutty, on the south-west by Rungpore, and contains an area of 1300 square miles. It was formerly independent, and the rajah stamped coins called *Narain*, in his own name, some of which are still current in Bootan. In 1772 the rajah, being invaded by the rajah of Bootan, applied for British assistance, and became in consequence our ally and tributary. The amount of his tribute annually is 72,000 rupees. Parts of the country still under his sway are very unproductive; but those annexed to Rungpore are singularly fertile, producing great quantities of indigo and cotton. Cooch-bahar is in the collectorship of Rungpore. 'The lower ranks in the northern quarter,' says Mr. Hamilton, 'are so extremely indigent, that some years ago it was their custom to dispose of their children for slaves, without scruple, to any purchaser for a trifling consideration. It was quite common to see a mother dress up her child, with a view to enhance the price, and bring it to market. Although so little is necessary for the subsistence of a peasant, and food compared with other districts is cheap, yet their poverty and wretchedness are extreme.'

COOK, *v. a. & n. s.* } Old Fr. *cuq*; Fr.
COOKERY, *n. s.* } *cuisiner*; It. *cuoco*;
COOKLY, *adv.* } Span. *cocinero*; Ang.-
COOK-MAID, *n. s.* } Sax. *coc*; Ger. *koch*;
COOK-ROOM, *n. s.* } Dut. *kok*; Swed. *kock*;
COOK-SHOP, *n. s.* } Lat. *coquus*. To dress victuals; figuratively, to prepare for any purpose

One who dresses victuals. The art of dressing victuals.

And he will take your daughters to be confectionaries, and to be *cooks*, and to be bakers. 1 Sam. viii. 13. Awake, thou *coke*, quod he; God geve the sorwe, What aileth thee to slepen by the morwe?

Chaucer. Cant. Tales.

One mistress Quickly is in the manner of his nurse, or his dry-nurse, or his *cook*, or his laundry, his washer, and his wringer.

Shakespeare. Merry Wives of Windsor.

Hanging is the word, Sir; if you be ready for that, you are well *cookt*.

Shakespeare. Cymbeline.

Some man's wit

Found the art of *cook'ry* to delight his sense :
More bodies are consumed and killed with it,
Than with the sword, famine, or pestilence. *Davies.*

The commodity of this new *cook-room* the merchants having found to be so great, as that in all their ships the *cook-rooms* are built in their fore-castles, contrary to that which had been anciently used.

Raleigh's Essays.

The new-born babe by nurses overlaid,
And the *cook* caught within the raging fire he made.

Dryden.

Had either of the crimes been *cooked* to their palates, they might have changed messes.

Decay of Piety.

Their *cooks* could make artificial birds and fishes, in default of the real ones, and which exceeded them in the exquisiteness of the taste.

Arbutnot on Coins.

These are the ingredients of plants before they are prepared by *cookery*.

Id. on Aliments.

A friend was complaining to me, that his wife had turned off one of the best *cook-maids* in England.

Addison.

Not but that *cooks* and poets still were free
To use their power in nice variety;
Hence, mackerel seem delightful to the eyes,
Though dressed with inconsistent gooseberries;
Crabs, salmons, lobsters, are with fennel spread,
Who never touched that herb till they were dead;
Yet no man lards salt pork with orange peel,
Or garnishes his lamb with spitchocked eel.

King. Art of Cookery.

My guts ne'er suffered from a college *cook*,
My name ne'er entered on a buttry book.

Brampton. The Man of Taste.

In general, mankind, since the improvement of *cookery*, eat about twice as much as nature requires. Suppers are not bad, if we have not dined; but restless nights naturally follow hearty suppers, after full dinners.

Franklin.

And, while the hallowed mixture thickens,
Signing death-warrants for the chickens;
Else greatly pensive poring o'er
Accounts her *cook* had thumbed before. *Sheridan.*

COOKERY, in its simple and ordinary modes, is an art sufficiently familiar to every house-keeper; and, in its luxurious refinements, too copiously detailed in directories published for the purpose, to require any enlargement here, were it even to merit consideration in a work of this nature.

COOK, or } To make the note of the
COOK, v. n. } cuckoo. The word is imitative of the sound produced by the bird. It is found in both old English and Scottish poetry, but is now obsolete.

COOK (James), the most celebrated of modern navigators, was the son of James Cook, a peasant

of Marton, in the North Riding of Yorkshire, where he was born October 27th, 1728. He was one of nine children, and was first sent to school by Mr. Skottow, his father's employer, where he was instructed in writing and the elements of arithmetic. Before the age of thirteen he was bound apprentice to a shopkeeper at Straith, ten miles from Whitby; but, some disagreement arising, the indentures were cancelled, and he bound himself apprentice to Messrs. Walkers of Whitby, who had several vessels in the coal trade. After serving them several years he entered, during the war of 1775, as a volunteer on board the *Eagle*, a king's ship of sixty guns, to which vessel Sir Hugh Palliser was soon after appointed. This officer perceived Cook to be an active and diligent seaman; and his promotion was forwarded by a letter of recommendation from Mr. Osbaldeston, M. P. for Scarborough. On the 15th of May, 1759, he was appointed master of the *Mercury*, which sailed to America, and joined the fleet under Sir Charles Saunders at the siege of Quebec. On this occasion he was recommended by captain Palliser to take the soundings of the St. Lawrence, between the island of Orleans and the north shore, which he performed in the most complete manner; and soon after to survey the most dangerous parts of the river below Quebec. These were his first efforts with the pencil. On the 22nd of September he was appointed master of the Northumberland, stationed at Halifax, where he first read Euclid, and studied astronomy and other branches of science. In 1762 he was with the Northumberland, assisting at the recapture of Newfoundland. The same year he returned to England, and married Miss Elizabeth Batts, of Barking in Essex. Early in 1763, when captain, afterwards admiral, Greaves was appointed governor of Newfoundland, Mr. Cook went out with him to survey the coasts of the island. In the beginning of 1764, Sir Hugh Palliser being appointed governor of Newfoundland and Labradore, Cook accompanied him as surveyor, and had the Grenville schooner to attend him; in which situation he continued till 1767. While thus occupied he gave a specimen of his progress in astronomy, in a short paper, printed in the 57th volume of the Philosophical Transactions, entitled Observation of an Eclipse of the Sun at the island of Newfoundland, August the 5th, 1766, with the longitude of the place of observation deduced from it: this was one of the Burgeo Islands near Cape Ray, in N. lat. 27° 56' 19". In the mean time the spirit for geographical discovery, which had gradually declined since the beginning of the seventeenth century, began to revive. Two important voyages had been performed in the reign of George II. under captains Middleton, More, and Smyth, to discover a north-west passage through Hudson's Bay to the East Indies. Two others, under captains Byron, Wallis, and Carteret, had been undertaken by order of his late Majesty; and, before the return of these navigators, another voyage was resolved upon for astronomical purposes. Towards the end of the year 1767, the Royal Society desiring to send astronomers into the Pacific to observe the transit of Venus over the sun's disk, which it

was calculated would take place in 1769, a memorial was presented to his Majesty on the subject, and he directed a vessel to be fitted out for the purpose. Otaheite being fixed on for the place of observation, the command of the vessel, named the Endeavour, was given to Mr. Cook, now made a lieutenant, and he sailed from England in 1768.

After accomplishing the astronomical part of his instructions at Otaheite, lieutenant Cook traced the eastern coast of New Holland, which he named New South Wales, from the thirty-eighth degree of latitude to its northern extremity; and proved, if he did not first discover, that it was separated from New Guinea, by passing through the channel which he named after his ship, Endeavour Strait. In this voyage he also visited New Zealand, which Tasman had but barely discovered; and, by ascertaining its extent, and division by a strait, which bears his name, chased the advocates for the southern continent from one of their strong holds. Cook likewise added several new islands among the group, to which he gave the name of Society Islands.

Mr. Green, an assistant in the observatory at Greenwich, went out with Cook, as astronomer, and he was likewise accompanied by Mr. (afterwards sir Joseph) Banks, and the Swedish naturalist, Dr. Daniel Solander. To the report of the commander on his return to England, respecting New Holland, may be attributed the subsequent colonisation of Botany Bay. The conduct of this expedition, as well as its results, was so creditable to Mr. Cook, that on his return in July 1771, he was raised to the rank of master and commander in the navy. An account of the voyage, drawn up by Dr. Hawkesworth, was speedily published, and became very popular.

A second voyage was planned for him in the course of the following year; and his majesty's ship Resolution being appointed to the service, he sailed from the Thames accompanied by the Adventure, captain Furneaux, on the most enlarged plan of discovery ever attempted. He was directed to circumnavigate the globe in the high southern latitudes, and to make such traverses into every corner of the great Southern Ocean, as might finally and effectually resolve the grand question of a southern continent accessible to navigation; and this interesting point his researches decided in the negative, beyond the possibility of doubt. The other fruits of this voyage were the correct knowledge of the land discovered by La Roche, in 1675, to which Cook gave the name of New Georgia; the discovery of the eternally frozen Sandwich Land, the nearest known land to the south pole; the ascertaining the extent of the Archipelago of the New Hebrides, which Quiros discovered, and Bougainville looked at; the discovery of New Caledonia, and of many islands of the division which, in this voyage, he named Friendly Islands.

This expedition was important, not only for its various contributions to the sciences and to navigation, but as exhibiting a method of preserving the health of seamen, and especially of guarding against the attacks of that fatal enemy

to sailors, the scurvy. Captain Cook so successfully combated the causes and symptoms of this and other general disorders among seamen, that only one man was cut off by it during the expedition. Having communicated his plans in this respect to the Royal Society, and the success which had attended them, he was chosen a fellow of that body, and his experiments were thought worthy of being rewarded by the Copleian gold medal. Government also recognised the value of his services by promoting him to the rank of post-captain in the navy, and a captainship in Greenwich Hospital.

Cook drew up his own narrative of the second voyage, but Dr. Douglas, afterwards bishop of Salisbury, superintended its passage through the press.

In 1776 this great navigator sailed on his third and last voyage, in the Resolution, accompanied by the Discovery, captain Clerk. In this voyage captain Cook was directed to examine the land in the southern ocean recently discovered by Kerguelen, and then to proceed through the Pacific to the coast of New Albion, from whence he was to proceed to the north along the coast of America to the latitude 65°, where he was to commence his search for a passage into the Atlantic, and particularly to examine all rivers or inlets pointing towards Hudson's and Baffin's Bays. In the event of not finding such passage, he was directed to seek one through the Frozen Ocean, either round Asia or America. As an encouragement to his crews, the reward of £20,000 for the discovery of a northern passage, which by the letter of the act of parliament was confined to the ships of his majesty's subjects, was now extended to those of his majesty, and £5000 were at the same time voted to any vessel that should first approach the pole within one degree.

Though the main object of this voyage was unsuccessful, that is, the discovery of a northern passage, it produced a vast addition to maritime geography. Kerguelen's Land was examined and its extent determined, several new islands were discovered in the South Pacific, former discoveries revisited, and many new lights thrown on the manners of the natives. The group of the Sandwich Islands in the North Pacific were likewise discovered, and a considerable portion of the western coast of North America.

The principal interest of this voyage, however, arises from the disastrous event that terminated the life of this great commander. He returned from the North Western coast of America to pass the winter of 1778 at Owhyhee, one of his recent discoveries. During his continuance here the crews of the ships were treated with the utmost hospitality and kindness by the natives, and their wants being liberally supplied, the natives were well remunerated. Early in February captain Cook sailed for Kamschatka, but was compelled by an accident to revisit his winter quarters. And a boat having been at this time stolen by one of the islanders, the captain went on shore to seize the person of the king, as a hostage till it was restored. The whole affair seems to have been ill managed on the part of the British commander and his officers.

He penetrated the country with an insufficient force, and the officer commanding his boat pushed off suddenly, when the life of captain Cook was dependent upon his being able to reach it. He was compelled to fire more than once on the natives, who struck him to the ground with a club, and despatched him afterwards with their spears.

His death took place February 14th, 1779; and his remains were recovered without difficulty. On the tidings of his fate reaching Europe, the highest public honors were paid to his memory not only at home, but by foreigners. A medal commemorative of his discoveries was struck by the Royal Society; his eulogy was pronounced in the Florentine Academy, and was made a prize subject by one of the French scientific societies: and the government bestowed pensions on his widow and three sons. Many designs were proposed to the Royal Society on this occasion; but the following was preferred and struck. On one side was the head of captain Cook in profile, with this inscription round it, *JAC. COOK OCEANI INVESTIGATOR ACERRIMUS*; and on the exergue, *REG. SOC. LOND. SOCIO SUO*. On the reverse is a representation of Britannia holding a globe, with this inscription round her, *NIL INTENTATUM NOSTRI LIQUEB*; and on the exergue, *AUSPICIS GEORGI III.*

Captain Cook may be ranked among the few popular men who have not been over-rated by an admiring country. Neither in his attachment to his profession, nor his nautical skill, has any British commander ever exceeded him. His personal intrepidity, his perseverance, his promptitude, and his humanity and equanimity of temper, were also remarkable: while in addition to these important qualities he possessed a respectable fund of general scientific knowledge, was unassuming but frank in his manners, and of a most excellent private character. The more detailed results of his voyages have become, of course, matter of history, and will be found in our descriptions of the various portions of the globe which he visited.

COOKA, *Dar*, a country of central Africa, supposed to be the same described by the Arabian geographers under the name of *Cauga*, and situated on or near the banks of the *Bahr el Fittre*.

COOKE (George Frederick), a popular theatrical performer, was born in Westminster, April 17th, 1756. His father was an officer in the army, who, dying young, left his wife in difficulties. Removing to Berwick-upon-Tweed, she apprenticed her son to a printer; but his genius spurned the trammels of business, and he was perpetually engaging his companions to assist in theatrical performances. His indentures in consequence of this were soon cancelled; and he was now tried in the navy; but from this he also broke away to join an itinerant company of actors. He became the hero of the scene at York, Newcastle, Chester, Manchester, and Liverpool, successively; acquired so much notice, that in 1794 he was engaged by the manager of the Dublin theatre, with which he continued connected until October 1800, when

he first appeared in London at Covent Garden theatre, in the character of Richard III. His reputation was at once established, and after several times repeating the part of Richard III. he acted *Iago*, *Macbeth*, *Shylock*, *Sir Giles Overreach*, *Sir Pertinax Maccyphoant*, *Kitely*, &c., with at least equal applause. Intemperance, however, ultimately destroyed his popularity. He became the plague and terror of English managers, and removed to the United States, where he displayed the same powerful abilities, and the same vicious weakness, until death, accelerated by intemperance, put an end to his career, March 25th, 1812. He married Miss Daniels, a singer of considerable talents, whom he is said to have treated with great cruelty, and from whom he was separated in July 1801, by the ecclesiastical court.

COOK'S BAY, a bay on the west coast of Easter Island, in the Pacific Ocean. Long. 109° 35' W., lat. 27° 11' S.

COOKS' COMPANY, one of the companies of the city London, incorporated in 1481. Their coat of arms is emblazoned *argent*, a chevron engrailed, *sable*, between three columbines.



COOK'S RIVER, now *Cook's Inlet*, an extensive arm of the sea, which penetrates into the north-west coast of North America, between Cape Elizabeth and Point Banks, that is, between long. 207° 9', and 207° 45' E. of Greenwich, lat. 58° 42', and 59° 10' N. Captain Cook sailed up this inlet seventy leagues without finding any termination, (see *Cook*), which induced him to think it was a river; and it was long described as such by geographers. But the error was ascertained by the expedition of captain Vancouver in 1794, who explored it to its extremity, which he found to be in long. 148° 43' W., lat. 61° 29' N. The shores on both sides of this bay are regular and unbroken, and near the coast is a border of low land, covered with wood, which continues to grow some distance up the mountains of the interior, which are wrapt in perpetual snow. West of the inlet, about seventy miles from its entrance, is a volcano, observed by Vancouver to emit large columns of pale smoke. As he advanced into this inlet his progress, in the month of May, was much impeded by ice. The inhabitants were similar in their manners and general appearance to those of Prince William's Sound.

COOK'S STRAIT, the strait which divides the two islands of New Zealand in the South Pacific Ocean.

COOL, *v. a. v. n., n. s. & adj.* } Anglo-Saxon, *celan*; Germ. *kulen*; Dutch, *koelen*; Swed. *kyla*. To cool is, to reduce the quantity of

heat in any substance. Thence, metaphorically, to appease passion; to moderate zeal; to become less pleased with; less anxious to obtain or accomplish some object. When used with reference

to the diminution of temperature, cool implies, the presence of a small remaining portion of warmth; that the substance approaches to coldness, but is not positively cold. Figuratively, it signifies, luke-warm; wanting in zeal; having entire self-possession. Cooler is, that which can reduce the heat of the body; a vessel in which any thing is cooled, particularly a vessel in which wort is cooled by the brewer. Coolness is, moderate cold; incipient rupture of friendship. Coolly is, without passion or violent emotion. The vulgar phrase of to cool the heels, means, to keep waiting.

And they heard the voice of the Lord God walking in the garden in the cool of the day. *Genesis* iii. 8.

And he cried and said, Father Abraham, have mercy on me, and send Lazarus, that he may dip the tip of his finger in water, and cool my tongue; for I am tormented in this flame. *Luke* xvi. 24.

Sit with thou there, my brother John,

The seide Gamelyn,

Fo to colke thy hotte bodie,

As I did colde myn.

Chaucer. Cant. Tales.

Why takest not of that same fruit of gold?

Ne sittest downe on that same silver stoole

To rest thy weary person in the shadow coole?

Spenser. Faerie Queene.

My lord Northumberland will soon be cooled.

Shakespeare. Henry IV.

My humour shall not cool; I will incense Ford to deal with poison; I will possess him with yellowness.

Shakespeare. Merry Wives of Windsor.

This difference consisteth not in the heat or coolness of spirits; for cloves and other spices, naphtha, and petroleum, have exceeding hot spirits, hotter a great deal than oil, wax, or tallow, but not inflamed.

Bacon's Natural History.

The toad loveth shade and coolness.

Id.

In dogs or cats there appeared the same necessity for a cooler as in man.

Harvey on Consumptions.

They parted with such coolness towards each other, as if they scarce hoped to meet again.

Clarendon.

Yonder the harvest of cold months laid up,

Gives a fresh coolness to the royal cup;

There ice, like crystal, firm and never lost,

Temper hot July with December's frost.

Waller.

You never cool while you read Homer.

Dryden.

The sheep enjoy the coolness of the shade.

Id. Virgil.

He set his leg in a pail-full as hot as he could well endure it, renewing it as it grew cool.

Temple.

Snow they use in Naples instead of ice, because, as they say, it cools or congeals any liquor sooner.

Addison on Italy.

He will keep his jealousy to himself, and repine in private, because he will be apt to fear some ill effect it may produce in cooling your love to him.

Id. Spectator.

Philander was enjoying the cool of the morning, among the dews that lay on every thing about him, and that gave the air a freshness.

Id. on Med.

Jelly of currants, or the jelly of any ripe subacid fruit, is cooling, and very agreeable to the stomach.

Arbuthnot on Diet.

Acid things were used only as coolers.

Id. on Aliments.

Motives that address themselves coolly to our reason, are fittest to be employed upon reasonable creatures.

Atterbury.

I'm impatient till it be done; I will not give myself liberty to think, lest I should cool.

Congreve's Old Bachelor.

Had they thought they had been fighting only other people's quarrels, perhaps it might have cooled their zeal.

Swift.

Your first wort being thus boiled, lade off into one or more coolers, or cool-backs, in which leave the surlage behind, and let it run off fine.

Mortimer's Husbandry.

Coolers are of two sorts; first, those which produce an immediate sense of cold, which are such as have their parts in less motion than those of the organs of feeling; and secondly, such as, by particular viscosity, or grossness of parts, give a greater consistence to the animal fluids than they had before, whereby they cannot move so fast, and therefore will have less of that intestine force on which their heat depends. The former are fruits, all acid liquors, and common water; and the latter are such as cucumbers, and all substances producing viscosity.

Quincy.

She in the gelid caverns, woodbine wrought,
And fresh bedewed with ever-spouting streams,
Sits coolly calm.

Thomson's Summer.

These are the sober, in whose cooler brains

Some thought of immortality remains;

The rest too busy or too gay to wait

On the sad theme, their everlasting state,

Sport for a day, and perish in a night,

The foam upon the waters not so light.

Cowper.

Green balks and furrowed lands, the stream that spreads

Its cooling vapour o'er the dewy meads,

Downs that almost escape the inquiring eye,

That melt and fade into the distant sky,

Id.

COOM, *n. s.* *Fr. ecume.* Soot that gathers over an oven's mouth; that matter that works out of the wheels of carriages; it is used in Scotland for the useless dust which falls from large coals.

COOMB, or COMB, *n. s.* *Fr. comble; Lat. cumulus.* A heap; a measure of corn containing four bushels.

COOMB, *n. s.* *Ang.-Sax. comb.* A narrow valley enclosed on either side with hills.

COOMBE (William), a miscellaneous author of respectable powers, was born at Bristol in 1741. His father was a considerable merchant, and in 1777 stood candidate for the city, but died during the canvass. Mr. Coombe was educated at Eton and Oxford; after which he is said to have dissipated a handsome fortune in fashionable pursuits. His first publication was a satire entitled the Diaboliad; but he did not affix his name to this performance; nor indeed to any of his numerous publications. His next and most voluminous work was The Devil upon Two Sticks in England, 4 vols. 12mo., published in 1790, and reprinted 1810. In 1810 also appeared Dr. Syntax's Tour in Search of the Picturesque. It was inserted in the Poetical Magazine, then in course of publication at Mr. Ackermann's; and written, as the writer of this paper has heard the ingenuous author declare, according as the fancy of the artist (Rowlandson), who supplied the decorations, suggested topics to his mind. Mr. Coombe regularly pinned up the sketch against a screen of his apartment in the king's bench, and wrote off his verses as the painter wanted them. The second part of the Diaboliad now made its appearance, and two further editions of Dr. Syntax; but they were the efforts of a jaded muse. In 1812 Mr. Ackermann published a history of Westminster Abbey, in

2 vols. 4to, by Mr. Coombe, who also was a principal contributor of essays, short pieces, illustrative of engravings, &c. to many of his miscellanies. He also claimed the authorship of the Letters that pass under the name of Lord Littleton. His last poem was the History of Johnny Quæ Genus. Mr. Coombe, as we have noticed, was fashionable and dissipated in youth; and became an inmate, in consequence, of the king's bench prison and its rules for upwards of twenty years, we believe. He stated indeed that a portion of this restraint was voluntary, and with a view to secure some property to a younger branch of his family. But he was always cheerful, gentlemanly, and interesting in his conversation. During the last years of his life, literature was his principal support. His death took place in his eighty-second year, at his lodgings in Lambeth-road, June 18th, 1823.

COOP, *v. a. & n. s.* } Icel. *kuppa*; Swed.
CO'OPER, *n. s.* } *kopp*; Dutch *kuype*;
CO'OPERAGE, *n. s.* } Ang.-Sax. *cyf*. That which keeps or holds: a barrel; a cage; a pen for animals. To coop, therefore, is to pen up; to circumscribe; to enclose. It is mostly used with the intensive particle *up*, and generally implies somewhat of close restraint. A cooper is a man who makes that sort of coops called barrels, casks, &c.; and a cooperage is a place in which he carries on his trade; also the price paid for his work.

That pale, that white-faced shore,
Whose foot spurs back the ocean's roaring tides,
And coops from other lands her islanders.

Shakespeare. King John.

The Englishmen did *coop up* the lord Ravenstein,
that he stirred not; and likewise held in strait siege the town.

Bacon.

Græchus was slain the day the chickens refused to eat out of the *coop*; and Claudius Pulcher underwent the like success when he contemned the tripodary augurations.

Brown,

The contempt of all other knowledge, as if it were nothing in comparison of law or physick, of astrology or chymistry, *coops* the understanding *up* within narrow bounds, and hinders it from looking abroad into other provinces of the intellectual world.

Locke.

They are *cooped in* close by the laws of their countries, and the strict guards of those whose interest it is to keep them ignorant.

Id.

There were a great many crammed capons together in a *coop*.

L'Estrange.

In the taking of a town the poor escape better than the rich; for the one is let go, and the other is plundered and *cooped up*.

Id.

Twice conquered cowards, now your shame is shown,

Cooped up a second time within your town!
Who dare not issue forth in open field.

Dryden's Æneid.

The Trojans *cooped* within their walls so long,
Unbar their gates, and issue in a throng.

Id.

What! *coop* whole armies in our walls again?

Pope.

Societies of artificers and tradesmen, belonging to some towns corporate, such as weavers and *coopers*, by virtue of their charters, pretend to privilege and jurisdiction.

Child.

'Tis the cruel gripe,
That lean, hard-handed Poverty inflicts,

The hope of better things, the chance to win,
The wish to shine, the thirst to be amused,
That at the sound of winter's hoary wing
Unpeople all our counties of such herds
Of fluttering, loitering, cringing, begging, loose
And wanton vagrants, as make London, vast
And boundless as it is, a crowded *coop*. *Cooper.*

COOPE'E, *n. s.* Fr. *coupé*. A motion in dancing.

COOPER (Anthony-Ashley), first earl of Shaftesbury. See SHAFTESBURY.

COOPER (John Gilbert), a celebrated author of the last century, was born in 1723; and descended from an ancient family in Nottinghamshire. He resided at Thurgarton priory, which was granted by king Henry VIII. to William Cooper, one of his ancestors. After studying under Dr. John Nicoll, at Westminster school, he became in 1743, a Fellow Commoner of Trinity College Cambridge; but quitted the university on his marriage with Susanna the daughter of William Wright, Esq., recorder of Leicester. In 1745 he published the Power of Harmony, a poem in 4to; and in 1746, and 1747, several essays and poems, signed Philalethes, in Dodsley's museum. With the assistance of the Rev. John Jackson of Leicester, he published with his name, The Life of Socrates, collected from the Memorabilia of Xenophon and the Dialogue of Plato, and illustrated by Aristotle, Diodorus Siculus, Cicero, &c. 1749, 8vo. In 1754 appeared his Letters on Taste, 8vo; an elegant volume, on which no small share of his reputation is founded; and in 1755, The Tomb of Shakspeare, a Vision, 4to. In 1756 he assisted Moore in the publication of The World; and attempted to rouse the indignation of his countrymen against the Hessians, then brought over to defend the nation, in a poem called the Genius of Britain, addressed to Mr. Pitt. In 1758 he published Epistles to the Great, from Aristippus in Retirement, 4to.; and The Call of Aristippus, Epistle IV., to Mark Akenside, M.D. Also, A Father's Advice to his Son, in 4to. In 1759 followed Ver Vert; or, the Nunnery Parrot; an Heroic Poem, in four cantos, inscribed to the abbess of D***, 4to; and, in 1764, Poems on Several Subjects, by the author of the Life of Socrates; with a prefatory Advertisement by Mr. Dodsley. He died at his father's house in May-fair, after a long and excruciating illness arising from the stone, April 14th, 1769.

COOPER (Samuel and Alexander), two eminent English miniature painters. Samuel was born in 1609, and bred under his uncle John Hoskins. He derived, however, his principal excellence from studying the works of Vanddyke. His pencil was chiefly confined to the head, in which, with all its dependences, especially the hair, he was inimitable. He died in 1672; and his pieces are universally admired all over Europe, selling for incredible prices. His brother, Alexander, became limner to Christina queen of Sweden.

COOPER, in geography, a large navigable river of the United States, which joins the Ashley, below Charleston city in south Carolina. These form a spacious and convenient harbour,

which communicates with the ocean, just below Sullivan's Island, which it leaves on the north seven miles south-east of the city. In these rivers the tide rises six feet and a half. The Cooper is a mile wide at the ferry, nine miles above Charleston.

COOPER, KING's, an officer in every custom-house and excise office.

COOPERS, COMPANY OF THE MYSTERY OF, was incorporated in 1530. Their coat of arms is emblazoned; party per pale *gules* and or a chevron between three hoops in a chief *azure*.



COOPERATE, *v. a.* } Fr. *coopérer*; Ital. }
 COOPERATION, *n. s.* } *cooperare*; Sp. *coope-*
 COOPERATIVE, *adj.* } *rar*; Lat. *cooperare*. }
 COOPERATOR, *n. s.* } To labor in conjunc- }
 COOPERANT, *adj.* } tion with to the same }
 end; to concur with another person or thing in producing the same effect. It has *with* before the agent, and *to* before the end. Conjoint labor employed to one purpose.

It puzzleth and perplexeth the conceits of many, that perhaps would otherwise *cooperate with* him, and makes a man walk almost alone to his own ends.

Bacon.

We might work any effect without and against matter; and this not holpen by the *cooperation* of angels or spirits, but only by the unity and harmony of nature.

Id. *Natural History*.

For age with virtue is *cooperative*. Davies.

His mercy will not forgive offenders, or his benignity *cooperates* to their conversions.

Brown's *Vulgar Errors*.

By giving man a free will, he allows man that highest satisfaction and privilege of *cooperating* to his own felicity.

Boyle.

All these causes *cooperating*, must, at last, weaken their motion.

Cheyne's *Philosophical Principles*.

The special acts and impressions by which the Divine Spirit introduces this charge, and how far human liberty *cooperates with* it, are subjects beyond our comprehension.

Rogers.

Vanity often *cooperates* with curiosity, for he that is an hearer in one place, wishes to qualify himself to be a principal speaker in some inferior company, and therefore more attention is given to narrations than any thing else in conversation.

Johnson.

If I might venture to appeal to what is so much out of fashion in Paris, I mean to experience, I should tell you, that in my course I have known, and, according to my measure, have *cooperated* with great men; and I have never yet seen any plan which has not been mended by the observations of those who were much inferior in understanding to the person who took the lead in the business.

Burke.

I scorn to take advantage of the eagerness of your zeal, and to prove that I think the sincerity of your zeal and attachment needs no such test, I will make your interest *cooperate* with your principle; I will quarter many of you on the public supply, instead of calling on you to contribute to it.

Sheridan.

COOPERING, is the art of manufacturing and keeping in repair casks and other vessels used for manufacturing, containing, and transporting various kinds of liquids. It must have been a trade almost coeval with the dawn of history, it being of the very first necessity; for, humble as it seems,

the art of coopering has enabled man to possess and retain the richest viands of foreign climes: it promotes and facilitates the export and import of the produce of distant countries: it has, therefore, enriched the merchant, supplied the wants and luxuries of the people, augmented the public revenue of all civilised countries, and given spirit to navigation. It is impossible, in reflecting on the utility of this trade, not to feel that it contributes a much greater quota of the necessaries and comforts of life, than it at first appears to do.

The trade in London is divided into several ramifications, and the persons carrying it on, as well as the journeymen, are confined to their respective departments. 1. The butt-cooper is engaged in manufacturing all kinds of casks for breweries, &c. also puncheons and hogsheds for distilleries. His working tools are but few in number; the first, an adze, similar to the same tool made use of by carpenters, except that the handle is shorter, being only about ten inches long: he has also an axe, and, with this and the adze, he reduces the staves to the form he wishes. He has also a bench, consisting of a piece of simple plank, and generally four or five feet long, and one foot wide, standing on four feet, raised to about two feet high at one end, and eighteen inches at the other, forming an inclined plane on its top. There are a stop and two upright keeps at each end of the top of the bench, which serve the purpose of keeping the stave firmly on it, in the operation of jointing. Their planes consist of two or three only, called jointers, similar to the same kind of tool used by joiners. The butt-cooper's is from three to four feet long, with which he makes all his joints; it requires to be kept in good order, and to be exactly true on its face, the mouth of the plane small, and the iron thin and sharp.

The shave, a machine similar to a tool called a spoke-shave, is of rather larger dimensions than the common one used by carpenters. But coopers use them of various sizes. It is a sharpened piece of hardened metal, with two legs let into a small block of beech wood, rounded on the face, and shaped at the ends so as to be held in the hand by the workman; the iron is sharpened as planes are, and it is fixed in the stock by two small wedges. With this tool the cooper smooths and finishes the inside and outside of all his casks, rounds and shapes their edges, and, in fine, finishes his work for use. The tool called a tooth, commonly, the old woman's tooth, is made not unlike the shave, except the iron which is in fact the tooth. It is very narrow and sharp, approaching an aris, and is used for making grooves round the top and bottom of the staves, to receive the ends of the cask. They use also a series of bits, called centre and doweling bits; the former for making perforations to insert cocks and other conveniences for filling or emptying casks; the latter for boring the edges of two opposite joints, in the tops and bottoms of vessels requiring to be doweled together.

Doweling is no more than fixing oaken pins in the joints; and is made use of only in large vessels, to prevent the joints from swagging from their places; it is of the greatest utility, and a

good cooper never neglects it; it is confined to the tops and bottoms only. A hoop, technically, is to the cooper a model, into which he fits all his staves; this model or hoop is of ascertained dimensions, and is as various as the numerous different vessels made use of: for instance, they have a hoop for butts, hogsheads, puncheons, barrels, and all other casks required for the different quantities of liquids to be vended at a butt-coopery, on a large scale. These are laid down, and the work is divided among the most expert in their several ways.

Some men are employed in hewing the staves, and reducing them to their lengths; others in jointing and fitting them into the hoop; and some in preparing the tops and bottoms; while others are cleaning and smoothing the staves to receive the ends and final hooping. The staves made use of by the butt-cooper, are invariably of oak, and until very lately were wholly imported from the Baltic, and sold in the market by a merchant, called the stave merchant. The staves are imported in the several lengths required, and sold by the thousand, under the following designations, viz. pipe staves about five feet six inches long, two inches thick, and six inches wide; hogshead staves four feet long; barrel staves three feet six inches long. There are also to be met with, long and short headings; the former run about thirty inches in length, and the latter from twenty to twenty-four inches; these various staves are found to meet most of the required purposes of coopery. The retail dealer sorts and divides them for the consumer into the best pipe staves, seconds, &c. and the same to the hogshead, and barrel staves. The headings are sold generally as imported; Dantzic and Hamburg staves are considered the best; although great quantities are imported from Riga, Memel, and Konigsberg. When all communication with the Baltic was stopped in the late war, staves rose as high as £500 per thousand, and the smaller in proportion. This gave rise to the introduction of staves from Canada, which soon superseded the necessity of the importation from the Baltic; and there is now in the market, from our own possessions in America, abundance of all descriptions, sold at two-thirds the price of those from the Baltic: they are, however, not found to be so durable, but they work better, and make a neater article.

Iron, the cooper is not in need of, because its place can be supplied with other materials, except for his working tools. But England abounding in iron, it is found economical to make our hooping of that metal. Iron hoops are obviously the best for the butt-cooper, whose staves are usually of good substance; but in cases in which the staves are thin, iron hoops should be avoided, or at least but partially employed. The oxide of iron, of which these hoops supply abundance, commonly known as rust, eats away and destroys the wood with which it comes in contact, as well as the hooping itself. Foreign casks are seldom bound by iron; not always from the want of the metal, but from fancying that it may be injurious to their contents; it is particularly avoided in France, and indeed, in all wine countries: in France the best coopery is practised. The hooping is sold,

as most iron work usually is, by the hundred, in various lengths, previously wrought in a mill at the furnaces, of great variety of thickness. It is cut by the cooper to the length he requires to hoop his butts, or other vessels, punched at the lap, and cold rivetted. Previously to putting on the hooping, the staves are dried, either by being exposed to an open fire, or in kilns; the latter is now the most approved in large manufactories.

2. The rundlet-cooper carries on a second branch of this trade; he makes use of all the tools used by the butt-cooper, except that his collection may be on a smaller scale. This manufacturer makes the bottles of various small contents for the use of the distiller, who sends out his spirits in them, consisting of bottles, from one gallon and upwards to twenty gallons; he uses the long and short headings, which he rends into two or more in thickness, according to the substance required in his bottles. This is an extensive branch of business.

3. The dry-cooper finds his employment in manufacturing hogsheads, and casks for containing every kind of dry produce: the leading feature of the employment in his line, is the making of hogsheads for sugar. His tools are of the same description as before named, but he works the staves out of all kinds of wood, and is not obliged to be so neat in his fittings, as the butt rundlet coopers. It is an extensive line of business at all sea-ports, in which great exports are constantly making: he supplies casks to pack the supplies in, of all dry articles, for both army and navy, as clothing and hats; besides military stores, which are, for convenience, usually packed in casks. His business is also extensive in supplying suitable and secure vessels for the apothecary general to the army, whose medicines are forwarded in a dry state, securely enclosed in casks, prepared by the dry-cooper.

4. The white-cooper manufactures all such domestic utensils as are used in private brewing, washing and dairies; such as churns pails, and every convenience required for the multiplied purposes of our domestic economy. At the white-coopers is to be found the most extensive employment of the staves called long and short headings. He proceeds in the manufacturing of his goods in a similar way to the butt-cooper; but rends his staves into several thicknesses, in order to make his articles lighter, and better adapted to their required purposes. He makes use of many different kinds of hoops; buying the iron hoops by weight, ready milled and fit for use; he having only to fit and cold rivet them on all his vessels bound by iron hooping. Many of the articles manufactured by this tradesman, are secured by wooden hoops; for instance, all tubs used in laundries and dairies, which, known to the trade by the name of white hoops, are generally rended out of ash wood. The white-cooper, to accommodate the housekeeper, usually keeps a shop, at which may be found exposed for sale, various articles required in domestic concerns. In London, to this branch of coopery, is sometimes added turnery, which, in a retail shop, supplies all kinds of brushes and baskets, with many other articles both convenient and useful.

5. The wine-cooper is a person employed in

drawing off, bottling, and packing wine, spirits, or malt liquor. In London, many persons follow this business only, and keep in their employ several assistants. It is common for persons of the first consequence to employ the wine-cooper to take charge of their wines. He has stipulated prices for all he does, charging his bottling off by the pipe, half-pipe, or as it may happen; he keeps a working butt-cooper in his employ to repair and job in the upholding, and supporting, the several casks in which wine and spirits are contained.

Under the trade of the Cooper, may also be included the manufacture of canteens, or those small vessels of wood in which soldiers, when on their march, or in the field, carry their liquor. These were formerly made of tin, but the use of wooden canteens has for some time been general in the British armies. They are made, in shape, very like barrels, cylindrical, seven inches and a half in diameter, and four inches long on the outside, holding three pints. These vessels have for several years been manufactured on a large scale at the Ordnance Wharf, Westminster Bridge. The wood made use of is the best foreign oak, and Mr. Smart, of the above wharf, has obtained his majesty's letters patent, for an improved method of preparing timber, so as to prevent its shrinking.

The manufacturing of backs and vats for brewers and distillers does not necessarily belong to coopering, it being a distinct branch of trade, and performed by persons called back and vat-makers: they work in English oak commonly, and take care to select that which is soundest and freest from knots, and saw it out into two inch, two and a half, and three inch planks, which are laid by for seasoning. We add a few particulars of this art as having grown out of that of which we have just treated. Carpenters work at this business, as the machines are of all shapes; for instance, the coolers for breweries are commonly oblong squares, and are made by this tradesman. The only particulars required in making good coolers, is that the sides be adequately strong, the joints well fitted, and the whole not too deep. The sides of a cooler of ordinary dimensions, should be at least two inches and a half thick; the joints should be well ploughed and tongued; the bottoms should be jointed in a similar way, and these will require doweling; the ends are grooved into the sides; and the whole is spilled together with iron pins. These vessels are sometimes scorched or charred in their insides, for the double purpose of preventing their decay, and also the too rapid acidity of the liquor exposed to cool in them. Mash-tuns, the under and jack backs, working tuns, and store vats, for the still and brew-house, are best manufactured at the back-makers, as every thing he does is on a large scale. He keeps materials better adapted to the purpose than can be found at the butt-coopers. The above vessels are usually made round; and they are prepared in a similar manner to those of the butt-maker, except that their staves are generally of English oak. Some of these vats are immense, particularly those called store vats, containing from twenty to thirty butts and upwards; the hoops are necessarily of iron, very

strong, and frequently joined by a nut and screw rivet, which allows of removal in case of repair and accident.

COOPER'S ISLAND, one of the lesser Virgin Isles, in the West Indies, situated south-west of Ginger Island, and uninhabited. It is five miles long and one broad. Lat. 18° 5' N., long. 63° 57' W.

COOPER'S TOWN, a post-town of New York, in Otsego County, and the chief town of the country round Otsego. It is pleasantly situated at the south-west end of the lake, twenty miles north-west of Cherry Valley, and seventy-three west of Albany. It is built on a plan regularly laid out in squares.

COOPER'S TOWN, a town of Pennsylvania, situated on the Susquehanna. Water is brought here from West Mountains, by a conduit of 470 pipes.

COOPTATE, *v. a.* } Fr. *coopter*; Lat. *coop-*
COOPTATION, *n. s.* } *tere*. To choose; adop-
tion; assumption.

Dubitation is the beginning of all knowledge: I confess this is true in the first election and *ooaptation* of a friend, to come into the true knowledge of him by queries and doubts. *Howel*.

COORDAIN, *v. a.* } Lat. *con* and *ordi-*
COORDINATE, *adj.* } *nare*. To keep within
COORDINATELY, *n. s.* } the same limits, class,
COORDINATENESS, *n. s.* } rank, or station. Co-
COORDINATION, *n. s.* } ordinate is holding
the same rank; not being subordinate. Thus, shell-fish may be divided into two coordinate kinds, crustaceous and testaceous; each of which is again divided into many species, subordinate to the kind, but coordinate to each other. The meaning of the kindred words is obvious.

In this high court of parliament there is a rare *ooordination* of power, a wholesome mixture betwixt monarchy, optimacy, and democracy.

Howel's Pre-eminence of Parliament.

When these petty intrigues of a play are so ill ordered, that they have no coherence with the other, I must grant that *Lysidius* has reason to tax that want of due connexion; for *ooordination* in a play is as dangerous and unnatural as in a state.

Dryden on Dramatic Poesy.

The word Analysis signifies the general and particular heads of a discourse, with their mutual connections, both *ooordinate* and subordinate, drawn out into one or more tables. *Watts*.

COORG, a district of Southern India, in the Western Ghauts, situated between the province of Mysore and Malabar. Its chief produce is spices, sandal-wood, teak-timber, and rice. The woods abound with elephants and wild beasts. Considerable importations of rice have lately been made from this district into the Mysore. Here the river Cauvery has its source, but Coorg contains scarcely any towns. The rajah and his family reside in the fortress of Mercara. The rajahs are mentioned as independent princes by Ferishta in 1583, and the present family have reigned since the year 1632. They are of the Nair caste, and the sovereign is termed the Vir Rajah. One of the rajahs formerly made a hedge and ditch along his whole eastern boundary; and they retained their independence till the year 1773, when Hyder Ali subjugated them.

Tippoo ordered the royal family to be removed from Bednore to the fort of Periapatam; whence the rajah escaped in the year 1788, and, by the assistance of a few brave subjects, expelled the armies of Tippoo from Coorg. Opportunely for this prince the British, in the year 1791, declared war against Tippoo, and, as he enabled general Abercrombie's army to reach Mysore, lord Cornwallis insisted, as one of the articles of peace with Tippoo, that he should relinquish all sovereignty over Coorg, and include it in the ceded territories. The rajah of Coorg afterwards co-operated with the British army under general Stuart; and, on the downfall of Tippoo, was guaranteed the free and uncontrolled management of his territory.

COOT, *n. s.* Fr. *cotte*; Dut. *maer-koet*. A small black water-fowl, seen often in fens and marshes.

A lake, the haunt
Of coots, and of the fishing cormorant.

Dryden's Fables.

COOTE (Sir Eyre), an eminent British general, was born in 1726. In 1745 he served in Britain against the rebels; and, in 1756, went out to the East Indies, where he distinguished himself in many important actions, particularly at the siege of Pondicherry, for which he was presented with a diamond-hilted sword by the directors of the East India Company. In 1769 he was made commander-in-chief of the Company's forces; but about the end of the following year he quitted Madras, and returned to England, where he was appointed governor of Fort St. George, and made knight of the Bath. In 1781 he went again to India, as commander-in-chief, and, in the following year, with 10,000 men, defeated Hyder Ali at the head of 150,000. Sir Eyre Coote died at Madras in 1783, and his body was brought to England, and interred at Rockwood, in Hampshire. The East India Company erected a fine monument to his memory in Westminster Abbey.

COOTS, or Coorsrown, a town of Pennsylvania, in Berks county, situated on a branch of Sauhoca Creek, seventeen miles N. N. E. of Reading, and north-west by north of Philadelphia.

COP, *n. s.* Ang-Sax. *cop*; Dut. *kop*; Ger. *kopf*; Wel. *coppa*; Ital. *copo*; Lat. *caput*. The head; the top of any thing; any thing rising to a head; as a cop, vulgarly cock, of hay; a cob-castle, properly cop-castle, a small castle, or house on a hill; a cob of cherry-stones, for cop, a pile of stones one laid upon another; a tuft on the head of birds.

The gan I on this hill to gone,
And found upon the coppe a wone.

Chaucer. The House of Fame.

His berd as any sowe or fox was rede,
And thereto brode as though it were a spade,
Upon the cop right of his nose he hade
A wert, and thereon stode a tuft of heres
Rede as the bristles of a sowes cres.

Id. Prol. to Cant. Tales.

COPAIBA, or balsam of copaiba, a liquid resinous juice, flowing from incisions made in the trunk of the *copaifera balsamum*. It is

transparent, of a whitish or pale-yellowish color, an agreeable smell, and a bitterish pungent taste. It is usually about the consistence of oil, or a little thicker: when long kept, it becomes nearly as thick as honey, retaining its clearness; but does not grow dry or solid, as most other resinous juices do. There is, indeed, a thick sort of balsam of copaiba, which is not transparent, and generally has a portion of turbid water liquor at the bottom. This sort is probably either adulterated by the mixture of other substances, or has been extracted by coction from the bark and branches of the tree: its smell and taste are much less pleasant than those of the genuine balsam. Pure balsam of copaiba dissolves entirely in rectified spirit, especially if the menstruum be previously alkalisied: the solution has a very fragrant smell. Distilled with water, it yields a large quantity of a limpid essential oil; and in a strong heat, without addition, a blue oil. The balsam of copaiba is a useful corroborating detergent medicine, accompanied with a degree of irritation. It strengthens the nervous system; in large doses proves purgative, promotes urine, and cleanses and heals excoriations in the urinary passages. Fuller observes, that it gives the urine an intensely bitter taste, but not a violent smell as the turpentine do. This balsam has been principally celebrated in gleets and the fluor albus, and externally as a vulnerary. The dose rarely exceeds twenty or thirty drops, though some direct sixty or more. It may be taken in the form of an *elæo-saccharum*, or in that of an emulsion, into which it may be reduced by triturating it with almonds, or rather with a thick mucilage of gum arabic, till they are well incorporated, and then gradually adding a proper quantity of water.

COPAIFERA, in botany, a genus of the monogynia order, and decandria class of plants. There is no calyx; there are four petals; the legumen ovate; one seed with an arillus. We know but of one species, viz. *C. balsamum*. This tree grows near a village called Ayapel, in the province of Antiochi, in the Spanish West Indies, about ten days journey from Cartagena. Great numbers of these trees grow to the height of fifty or sixty feet. Some of them do not yield any balsam; those which do, are distinguished by a ridge which runs along the trunks. They are wounded in the centre, and calabash shells, or other vessels, are placed at the wounded parts to receive the balsam, which flows wholly out in a short time. One of these trees will yield five or six gallons of balsam: but though they will thrive well after being tapped, yet they never afford any more balsam.

COPAL, gum copal, is a gum of the resinous kind, brought from New Spain, being the concrete juice of the *ruus copallinum*, which grows in these parts. See *Rhus*. It comes to us in irregular masses, some of which are transparent, and of different shades, from a light yellow to a deep brown. Some pieces are whitish and semi-transparent. To the smell it is more agreeable than frankincense; but has neither the solubility in water common to gums, nor in spirit of wine common to resins. By these properties it resembles amber; which has induced some to

think it a mineral bitumen resembling that substance. In distillation it yields an oil, which is indissoluble in spirit of wine. Copal itself is soluble in the essential oils, particularly in that of lavender, but not easily in the expressed ones. It may, however, be dissolved in linseed-oil by digestion, with a heat very little less than is sufficient to boil or decompose the oil. This solution, diluted with spirit of turpentine, forms a beautiful transparent varnish, which, when properly applied, and slowly dried, is very hard and durable. This varnish is applied to snuff-boxes, tea-boards, and other articles. It preserves and gives lustre to paintings, and greatly restores the decayed colors of old pictures, by filling up the cracks, and rendering the surfaces capable of reflecting light more uniformly.

COPARCENER, *n. s.* } Lat. *con* and *par-*
COPARCENERY, *n. s.* } *ticeps*. Coparcener
COPARCENY, *n. s.* } is defined in a
COPARTNER, *n. s.* } quotation from Cow-
COPARTNERSHIP, *n. s.* } ell. Coparcenery is
 joint succession. Coparceny, an equal share of coparceners. A copartner is a joint-partner; one who is in partnership with others.

Coparceners are otherwise called *parceners*; and, in common law, are such as have equal portion in the inheritance of the ancestor. *Cowell.*

This great lordship was broken and divided, and partition made between the five daughters: in every of these portions, the *coparceners* severally exercised the same jurisdiction royal, which the earl marshal and his sons had used in the whole province.

Davies on Ireland.

In descent to all the daughters in *coparcenery*, for want of sons, the chief house is allotted to the eldest daughter. *Hale's History of Common Law.*

In case the father left only daughters, the daughters equally succeeded to their father, as in *copartnership*. *Id.*

So should I have *copartners* in my pain;
 And fellowship in woe doth woe assuage.
Shakespeare. Rape of Lucrece.

Our faithful friends,
 Th' associates and *copartners* of our loss.
Milton's Paradise Lost.

Shall I to him make known
 As yet my change, and give him to partake
 Full happiness with me? Or rather not;
 But keep the odds of knowledge in my power,
 Without *copartner*? *Id.*

Rather by them
 I gained what I have gained, and with them dwell
Copartner in these regions of the world.
Id. Paradise Regained.

COPATAIN, *adj.* From *cop*. High raised; pointed.

Oh, fine villain! a silken doublet, a velvet hose, a scarlet cloke, and a *copatain* hat.
Shakespeare. Taming of the Shrew.

COPE, *v. a.*, *v. n.* & *n. s.* } Ang.-Sax. *cœppe*.
COPING, *n. s.* } } *Cope*, as a noun,
 means any covering for the head, but this sense is obsolete; a sacerdotal cloak; any thing which is expanded over the head; as the concave of the skies. The verb, in the sense of to contend, to struggle, to strive, says Johnson, 'is a word of doubtful etymology. The conjecture of Junius
 Vol. VI.

derives it from *koopēn*, to buy, or some other word of the same import: so that to cope with, signifies to interchange blows, or any thing else with another.' It has also been derived from *κῶπη*; *cædo*, *percutio*. Mr. Todd, however, observes, that 'it may, with as much propriety, be referred to *cop*, the head; and so imply, to make head against; like the French expression, *faire tête à quelqu'un*.' *Cope* has, besides, the various meanings, to cover, as with a cope; to reward; to interchange kindness with; to embrace. In the last three senses it is disused. *Coping* is the upper tier of masonry which covers the wall; that is, the *cop*, or head of the wall. See *Cor*.

All these were of costly stones, even from the foundation unto the *coping*. 1 Kings vii. 9.

For there was he nat like a cloisterere,
 With threadbare *cope*, as is a poure scolere,
 But he was like a maister or a pope.

Chaucer. Prolog. to Cant. Tales.

All these things that are contained
 Within this goodly *cope*, both most and least,
 Their being have, and daily are increast. *Spenser.*

Know my name is lost,
 By treason's tooth bare gnawn, and canker-bit;
 Yet am I noble as the adversary
 I come to *cope*. *Shakespeare. King Lear.*

I and my friend
 Have, by your wisdom, been this day acquitted
 Of grievous penalties, in lieu whereof,
 Three thousand ducats due unto the Jew,
 We freely *cope* your courteous pains withal.
Id. Merchant of Venice.

Let our trains
 March by us, that we may peruse the men
 We should have *coped withal*. *Id. Henry IV.*

It is likely thou wilt undertake
 A thing, like death, to chide away this shame,
 That *opes with* death itself, to 'scape from it.
Id. Romeo and Juliet.

Thou fresh piece
 Of excellent witchcraft, who of force must know
 The royal fool thou *apest with*. *Id. Winter's Tale.*

Thou art e'en as just a man,
 As e'er my conversation *coped withal*.
Id. Hamlet.

I will make him tell the tale anew;
 Where, how, how oft, how long ago, and when,
 He hath, and is again to *cope* your wife.
Id. Othello.

But Eve was Eve;
 This far his over-match, who, self-deceived,
 And rash, beforehand had no better weighed
 The strength he was to *cope with*, or his own.
Milton's Paradise Lost.

Over head the dismal hiss
 Of fiery darts in flaming volleys flew,
 And flying vaulted either host with fire;
 So, under fiery *cope*, together rushed
 Both battles main. *Id.*

The scholar believes there is no man under the *cope* of heaven, who is so knowing as his master.

Dryden.
 They perfectly understood both the hares and the enemy they were to *cope withal*. *L'Estrange.*

A very large bridge, that is a: made of wood, and *coped* over head, *Addison on Italy.*

Their generals have not been able to *cope with* the troops of Athens, which I have conducted.

Id. Whig Examiner.

The *coying*, the modillions, or dentils, make a noble show by their graceful projections.

Id. Freshetier.

Host *coyed* with host, dire was the din of war.

Philips.

If the mind apply itself first to easier subjects, and things near a-kin to what is already known; and then advance to the more remote and knotty parts of knowledge by slow degrees, it will be able, in this manner, to cope with great difficulties, and prevail over them with amazing and happy success. *Watts on the Mind.*

Such here the rage of Mars; as, danger proof,
The Greeks rushed on beneath their tortoise roof
To gain the wall: while some their ladders plant,
Fenced by their lifted shields; and climb, and pant,
And grasp the battlements: the Trojans there
Fight with the soul and weapons of despair.
Beneath the cope of death, their hands employ
Whatever chance affords them to destroy.

Symmons' Æneis.

COPEMAN, *n. s.* } Ang.-Sax. ceapman;
CO'PESMATE, *n. s.* } Dutch *koopman*. Cope-
man is a chapman. Copesmate is a companion;
a friend: 'perhaps,' says Dr. Johnson, 'for cups-
mate a companion in drinking, or one that dwells
under the same cope, for house.' Mr. Todd
suggests that it is rather from cope in the sense of
exchange; one who interchanges kindness with
another.

Ne ever staid in place, ne spake to wight,
Till that the fox his *copestmate* he had found.

Hubbard's Tale.

For *ceapman* we now say chapman, which is as
much as to say, a merchant or *copeman*. *Versteegan.*

COPENHAGEN, formerly Kiobmandsharn, the merchant's harbour. The principal city in the Danish monarchy, is situated on the east coast of the isle of Zealand, in lat. 55° 41' 4" N., and long. 12° 34' 15" E. It is one of the best built cities in the world, and decidedly the handsomest in the north of Europe; being about five miles in circumference, and fortified towards the land with regular ramparts and bastions. A broad, deep fosse surrounds the city, and on the sea-side it is defended by the Crown Battery. The citadel is situated on the north-east extremity, and completes the fortifications of the town.

The first mention of Copenhagen in history occurs about the year 1048. At that time it was an insignificant place, principally occupied by fishermen. In 1168 the king of Denmark presented this town to the celebrated bishop Absalon or Axel, who fortified the harbour, and built the castle of Axelhuus, to defend the coast against the bands of pirates who at that time infested the Baltic. On account of the protection which was thus afforded to the inhabitants, and the great convenience of its harbour, many other Zealanders were induced soon after to make it the place of their residence. It thus gradually increased, and in 1254 the city records represent it as surrounded by ditches, and well fortified. In 1284 it received new privileges; and, in 1443, was fixed upon as the place of residence by the Danish court. Like many other towns situate in a vicinity where timber is abundant, it was for many ages of its history constructed entirely of wood. In consequence of this, de-

structive fires were of very frequent occurrence; in 1728, and 1794, 2600 private houses, besides churches, public buildings, &c. were consumed to ashes by dreadful conflagrations. From this latter period the erection of wooden houses was prohibited, and the great regularity of the city is chiefly attributable to this circumstance. Since the attack of the British in 1807 the fortifications have been greatly improved.

Copenhagen consists of the Old Town, the New Town, and Christian's Haven. Some of the streets are broad and well paved, whilst others are narrow and very inconvenient. The buildings are chiefly composed of brick, or white calcareous stone, but the public edifices of freestone or Norwegian marble. The city is in many parts intersected by canals which afford great facilities for the conveyance of goods. The division called the Old Town, which is in fact the most modern, having been built since the disastrous fires mentioned above, occupies the western division of the city, north of the harbour. It contains the ruins of the magnificent palace of Christiansburg, built by Christian VI., and is said to have cost him 6,000,000 of dollars. This superb structure was nearly destroyed in the fire of 1794, but enough of it remains to convey an idea of its stupendous extent, and great magnificence. One of the wings remains entire, and is appropriated to the purposes of a national museum. It contains many very curious and interesting collections of animals, shells, minerals, paintings, antiquities, medals, dresses, and warlike and husbandry implements used by the Laplanders: it is well worthy the attention of the traveller. Nearly in the centre of the old town is situated the kongens nye tom, or king's new market: it is an irregular enclosure of great extent. A fine equestrian statue of Christian V. in bronze, decorates the centre of the area, and on one of its sides is the castle of Charlottenberg, formerly the residence of the queen, but now appropriated to the academy of the fine arts. This quarter contains also the observatory erected by Frederick V. for one of the disciples of Tycho Brahe. This building is particularly worthy of observation: it is constructed in a cylindrical form, and has a spiral carriage road, made of brick, to within twenty or twenty-five feet of the summit. The view of the city from one of the rooms, where the astronomical apparatus is kept, is said to be remarkably fine. Here also are the dock, the exchange, the theatres, the university, the artillery house, besides many other stately buildings, and churches; but the most interesting object is, perhaps, the pillar erected in honor of the late king, and of his having granted freedom to the peasants on the crown lands. The pillar is made of Norwegian granite; having the four corners of its base ornamented with four figures, representing peace, plenty, content, and industry.

The New Town, at least that part of it called Amalienburg, was built by Frederick V. It consists chiefly of an octagon, known by the name of Frederick's Square, opening into four rectangular streets, which have a very imposing effect. The grand entrance to this square is through a gate composed of double rows of Corinthian pillars. The enclosure is adorned by

four elegant palaces; one occupied by the king, another by the crown prince, a third by the king's brother, and the fourth is appropriated to the Marine Academy. An equestrian statue of Frederick V. occupies the centre of the square: it is said to have cost the Danish East Company, at whose expense it was erected, £80,000. One of the streets leading from this square conducts to the harbour, and another to Frederick's church, the monument of Danish pride and poverty. This building was begun many years ago, but, for want of funds to carry on the design, at present remains in an unfinished state. It was originally intended to have been the greatest ornament to Copenhagen, as indeed it would be were it finished.

The palace of Rosenberg, a small Gothic edifice, said to have been built by Inigo Jones, stands near the rampart; it contains the state apartment in which the king holds his annual bed of justice. The gardens attached to this palace are very extensive, and are the favorite promenade of the fashionable inhabitants.

Christian's Haven is situated on the small island of Amack, and is connected with the old town by two bridges. This quarter supplies Copenhagen, almost exclusively, with butter, cheese, fruit, and all kinds of vegetables. See **AMACK**.

Mr. M'Donald, in speaking of the general mode of building in Copenhagen, says, 'Instead of the usual right angles formed by the corners of the houses, at the extremities or divisions of the streets, the builders of Copenhagen have squared them off in a semi-octangular form, and thereby secured various advantages. Carriages and horses cannot so frequently run foul of each other, or run down persons on foot at the turnings of the streets; the space gained gives a free circulation to the air, and the look of as many handsome squares as there are street divisions in the city.' The houses of Copenhagen are for the most part spacious, consisting of four stories, and cellars sunk under ground; those of the nobility are particularly splendid, the light and elegant architecture of the modern Italians being most used. The tradesmen of this capital appear to have but little idea of setting off their commodities to the best advantage; their shops, as usual, are confined to the ground floor, and they make but little display in their windows.

Copenhagen contains twenty churches, and several synagogues, exclusive of its cathedral, which was destroyed during the late disastrous siege. The bishop of Zealand resides principally in this capital, where he has a splendid palace. The city also contains twenty-two hospitals, of which the most interesting, both as it regards its utility and regulations, is the lying-in-hospital; a school of midwifery, and a foundling are attached to this establishment. The University was founded in 1479. Divinity, law, medicine, and philosophy, are here taught by able masters; the average number of students is about 700, 168 of whom are maintained from the public funds. The library contains a considerable number of books, but few of them are of recent date; it also possesses a collection of Icelandic MSS. The Royal Library is a superb collection of up-

wards of 250,000 volumes; a few years ago it was enriched by the Arabic MSS. of Niebuhr.

The harbour of Copenhagen is formed by the straits of Kellebae, which separate Amack from Zealand, and though the entrance is so narrow that only one ship can pass at a time, the depth is sufficient to admit vessels of the largest size. Upwards of 500 ships can anchor at a time in this harbour; and the canals are so formed that merchantmen can come close to the warehouses that line the quays, to load and unload their cargoes. Every ship of war has its particular station, and is separated from the merchantmen by a kind of gallery. When the Danish navy was in its prosperity, this harbour presented a beautiful spectacle.

The trade of Copenhagen was very considerable at the commencement of the last century; it gradually increased until the war of the French revolution, which involving Holland and other maritime countries, a large transfer of business was made to the Danish capital, not only for the navigation of the European seas, but for remote voyages to India, &c. This branch of commerce carried on under the Danish name, but principally on the account of Great Britain, was mutually advantageous to both parties. Not a vestige of it, however, now remains; it received its death-blow at the bombardment of the English in 1807. The principal trade of Copenhagen is at present with Norway, Iceland, and the Faroe Isles. From Norway it receives all its cannon, shot, anchors, and iron work. Russia supplies it with flax, masts, sail-cloth, hemp, and cordage; Sweden with pitch and tar; and Germany with oak. The shipping belonging to this port may be averaged at 400 vessels, manned by 6000 seamen. The chief manufactures are woollen stuffs, sail-cloth, cotton stuffs, leather, spirituous liquors, and porcelain. There are also anchor foundries, roperies, and extensive dock-yards.

The bank of Copenhagen was established in 1736, by Christian VI. Accounts are kept in rix-dollars, marks, and schillings. The population of Copenhagen in 1769 amounted to 71,000, in 1801 to 90,000, and at present it is computed at 105,000. It is 170 miles north-east of Hamburg, 315 south-west of Stockholm, and 600 north-east of London.

COPERNICUS, or **KOPERNIK** (Nicholaus), an eminent astronomer, who led the way to the modern establishment of the new system of the universe, was born at Thorn, now subject to Prussia, then a town of Poland, according to some accounts, in January, but more correctly, we believe, according to others, February 19th, 1473. Frederick the Great boasts, in his *Cœuvres Posthumes*, rather prematurely, that he could reckon Copernicus amongst the great names of his country. Thorn was not seized by Prussia until 1793, and did not become a settled part of her dominions until 1814.

Such was the singular state of astronomical science, prior to the appearance of this great man, that the limits of vision are truly said to have been taken for the boundaries of the universe. As far back as the middle of the second century, Ptolemy had digested all the elements of ancient astronomy into his system, adding to

them his own observations. This was so far fortunate for the science, as the burning of the Alexandrian library annihilated almost all the labors of antiquity, and would doubtless have retarded the progress of astronomy in Europe for ages, had not the works of Ptolemy escaped that destruction. This is not the place to enter into any details of his system. Taking the heavens for a real sphere, and the stars for so many bodies attached to its vault, he believed that a uniform and circular motion tended to the perfection of nature's works, and thought that the earth was the centre of that motion; that the entire starry heavens, therefore, turned round it in twenty-four hours, from east to west. Besides this general and daily revolution, he made the sun and planets move round the earth, in their periodical courses; and, fixing the order of the respective position of these stars, he placed Mercury immediately after the moon—still further Venus, and after that the sun. He laid it down in his works, as a first principle of astronomy, that the earth could not have any motion.

Long-established observations, as well as his own, led him to perceive a particular movement of the sun and planets, sometimes direct and accelerated, and sometimes retarded. In order to account for these inequalities upon one uniform principle, and to explain all these changes of direction, Ptolemy conceived, with Apollonius, that circles more or less great and numerous were so disposed, that the centres of the one revolved on the circumference of the other: he furnished the orbits of the planets with these circles; and changing them at pleasure, on encountering new difficulties and embarrassments, he thus vainly hoped to account for the irregularities and phenomena of the movements of the sun and planets. This led Alphonso of Castile, eleven centuries afterwards, to exclaim: 'Had I been consulted at the creation, the universe would have been arranged in a more simple and rational manner.' He had no other meaning, probably, than that Ptolemy's world could not be the creation of eternal wisdom.

It was when these fanciful dreams had obtained universal credence, and no other mode of accounting for the phenomena of the universe was current, that Copernicus was born to arouse the human mind from their influence. His parents were Nicholas Copernicus, and Barbe of Wetzlerod, sister of the bishop of Varmie. Being sent to the university of Cracow to pursue his studies, he was in the list of pupils in 1492. He applied himself to the culture of Grecian and Latin literature, and particularly of mathematics. The school of Cracow, then the only one in Poland, was become very celebrated and flourishing in these three departments of learning. Jacob of Kobylin, Nicholas Szadek, Martin of Olkusz, afterwards eminent professors of mathematics, were school-fellows of Copernicus—the four were scholars of Albert Brudzewski, in astronomy and mathematics. When Brudzewski went into Lithuania to fill the post of secretary to the grand duke Alexander, afterwards king of Poland, Copernicus quitted his country for Bologna, where he pursued astronomical observations, not as a pupil, but according to the

testimony of Rheticus, as assisting and confirming the labors of Dominick Marie of Ferrara. He had been already instructed in astronomy and mathematics on leaving Poland. He acquired such a name for knowledge in Italy, that being called to Rome at twenty-seven years of age to profess the mathematics, his public lectures drew from all sides a numerous concourse of scholars. All his activity was not, however, absorbed by his public teaching; for, continuing his astronomical pursuits, he observed the eclipse of the moon in 1500. At his return to Poland, he passed through Padua, where he sustained a public examination in anatomy, and was deemed worthy of being received as doctor in medicine. In 1504 he was inscribed as member of the university of Cracow; and it appears that his design was to establish himself there, had not his uncle recalled him to Varnie, by making him a vebendary in his cathedral.

As soon as he was settled at Frauenbu., he devoted himself entirely to the observation of the heavens, and to perfecting the means and obtaining the assistance necessary to this object; applying particularly (as he declares in his epistle to Paul III. the sovereign pontiff), to the rigorous and profound examination of all the principles and hypotheses—in a word, to the entire doctrine of the astronomy of his own time. 'Let us figure to ourselves,' says Copernicus in this epistle, 'an assemblage of detached members of the human body, belonging to individuals of different heights and conformations. If one thought, out of these, to form one perfect, the disposition of the parts, and their different configurations, would present, in a discordant connexion, the hideous appearance of a monster, rather than of the regular human form. This is,' continues Copernicus, 'the aspect that the edifice of ancient astronomy offers to my view. The explanation of the celestial movements presents quicksands to me, on which opinions generally received are wrecked. Suppositions favorable in certain cases, and not capable of application in others—sometimes adopted, sometimes forcibly interpreted, sometimes abandoned, far from illuminating the progress of reasoning, produce as much confusion as obscurity.'

Copernicus, in fact, carried into the examination of astronomy, that profound and concentrated attention, that severe and scrupulous exactitude, which, while he compared, connected, or discussed previous notions, allowed him to take nothing for granted, and soon elicited those great outlines of his system: that the sun is a fixed star, surrounded by planets that revolve round him, and of which he is the centre and the great luminary; that, besides the principal planets, there are others of a secondary order that circulate as satellites round their principals, and, with these, round the sun; that the earth is a principal planet, subject to a triple movement; that all the phenomena of daily and annual movement, the periodical return of the seasons, all the vicissitudes of light, and temperature of the atmosphere which accompany them, are the results of the rotation of the earth round its axis, and of its periodical movement round the sun; that the apparent course of the stars is but an optical il-

lusion, produced by the real motion of the earth, and the oscillations of its axis—that, in fine, the movements of all the planets give place to a double order of phenomena, which it is essential to distinguish, and of which the one is derived from the earth's motion, and the other from the motions of these planets round the sun. Such are the eternal and immutable truths of the science of the stars, that Copernicus revealed and announced in his immortal work, *Revolutions of the Celestial Orbs*. 'In reading this master-piece,' says an able modern essay on the labors of this great man, 'to the perfection of which, the writings of the ancients was no assistance, and to which modern knowledge has added nothing, it would seem as if nature had unveiled to him the wonders of her simplicity. The principles of mechanism, or of the science of motion, were yet to be brought forth. They were waiting for Galileo, Kepler, Huygens, and Newton, to be conceived and revealed. They were waiting for Euler, Clairaut, d'Alembert, Lagrange, and Laplace, to be applied, developed, and understood. Why, then, does Bailly seek to reproach Copernicus with being ignorant of the parallel movement of the earth's axis, not being a third movement, distinct and separate, but only the result of the first two, considered under certain conditions? We know that this knowledge is the fruit of the century that has just closed. Copernicus, without knowing the laws of motion, discovered the result of general principles; and by the force of his genius he triumphed over those beautiful and profound combinations from which it is derived. Two centuries of intellectual exertions, were necessary to create a new science, which confirmed this original and happy conception.' The tenth chapter of his first book, contains an exposition of the arrangement of the celestial bodies. There Copernicus, in a manner, sketches out the general plan of the creation; assigns their classes to the celestial bodies, and ranges the planets in their movements round the sun. He asserts boldly in this connexion, that the distance of the fixed stars was almost infinite; insomuch, that all the distance between the earth and the sun, would appear to the eye, placed at the distance of those stars, as an insensible point. This assertion, since confirmed by the most delicate observations, demonstrates his extended views of the universe; and removing to a greater distance the boundaries of space, has finally indicated, in the immensity of the heavens, where the earth is lost, innumerable groups of suns and worlds, similar to our solar system. Bailly had therefore good reason for affirming, that the mathematics owe to Copernicus the first notion of infinity, which has since become the source of new sciences, and of the most astonishing discoveries. The principles of geometry being of essential use in astronomy, Copernicus, in following Ptolemy's work, gives the explanation of the right lines in a circle, and the method of estimating, by their means, the arcs and angles. A complete treatise of Trigonometry, particularly spherical, is placed at the end of the book. This was published separately, it seems some years before, and offers some very important problems in geometry, re-

solved by Copernicus, of which the history of mathematics has not, even to this day, rendered him the honor, in the erroneous supposition that he had drawn them from the work of Muller of Franconia, surnamed Regiomontanus, printed in 1533.

'The third book,' says the ingenious essayist we have adverted to, 'is a repository of the finest discoveries of which the sagacity of man can boast.' Copernicus 'satisfied himself that the fixed stars, preserving the same distance from the ecliptic, vary in their longitudes, or their distance from the equinoctial points; and as those stars never change position among themselves, he thence concluded, that their change in longitude was not the effect of their own movement, but that of the retrograding from east to west of the equinoctial points, known in astronomy under the name of precession of equinoxes. Combining afterwards the observations of Aristarchus of Samos, and those of Ptolemy and of the Arabians on the inclination of the ecliptic to the equator, with those which he had followed himself during thirty years, he deduced therefrom a change in this inclination. He confirmed two important phenomena; the one, which was first remarked by Hipparchus, and since known by all subsequent astronomers, that the equinoctial points had a retrograde movement; the other, the discovery of which is solely his own, that the movement was unequal, and that the obliquity of the ecliptic was subject to variations.' In this book he lays down in principle, that the axis of the earth, however it may be regarded as parallel to itself for explaining the seasons, is also found subjected to two movements of an extreme slowness: that, in the first place, the extremity of this axis, or the earth's pole, turns insensibly round that of the ecliptic, from east to west, in a period of about 26,000 years; and, as the movement of the axis necessarily affects that of the equator, the equinoctial points, gliding on the ecliptic, retrograde annually an arc of about fifty seconds: that, in the second place, this axis balances itself, like a lever that oscillates in its infinitely slow movement, sometimes elevating, sometimes lowering itself towards the ecliptic; and, as the inclination of these axes regulates that of their circles and of their planes, it follows that the balancing of the earth's axis brings a necessary alteration into the inclination of the equator from the ecliptic: from which it results, that the retrogradation of the equinoctial points, and all the changes in the position of the stars, are derived from two movements, to which the axis of our globe is, as will be presently shown, subjected in the annual revolution; that those two movements are so dependent one upon the other, that they are mutually influential on their respective accelerations and retardations; that, in fine, the trifling inequalities that affect them, are periodical—having a limit marked which they could not pass, and where they renew themselves, in order to accomplish the same revolution in a certain number of years or of ages.

Copernicus first asserted in this work the important theory of attraction. 'Gravity,' says he, 'is a tendency, that the author of nature has imprinted on all parts of matter, for uniting and

forming them into a mass. This property is not peculiar to the earth only; it belongs equally to the sun, to the moon, and to all the planets. It is thereby that the molecules of matter that compose those bodies, are united and rounded into globes, and preserve their spherical form. All the substances, placed at the surface of the celestial bodies, press equally towards the centres of those bodies; and this, without hindering those bodies from circulating in their orbits. Why should this constancy be any obstacle to the movement of the earth? Or, if we suppose that the centre of gravity ought, necessarily, to be that of all the movements, why place this centre in the earth, whilst the sun and all the planets have also their centres of gravity, and whilst the sun, by reason of its infinitely preponderating mass, would merit this preference? This choice is the more reasonable, inasmuch as all the phenomena, and all the appearances in the movements of the stars and planets, are deduced from it, in a manner at once simple and easy.

Science is in no small degree indebted to cardinal Schonberg, and Tydeman Gisius, bishop of Culm, whose pressing solicitations forced the work, *On the Revolutions of the Celestial Orbs*, into publication. Gassendi says, it was not finished before 1530; and several years more elapsed before the author could summon resolution to commit it to the press. He in fact but just lived to see a complete copy of it a few hours before his death, which took place at Frauenberg, in consequence of the rupture of a blood-vessel, and palsy, May 24, 1543. The account of his having been imprisoned for his discoveries, which we often see in print, is wholly without foundation. He was evidently too cautious and too orthodox to expose himself to that danger. In his epistle to the pope, alluded to in the beginning of this article, he says, 'If there be some who, though ignorant of mathematics, presume to judge concerning them, and dare to condemn this treatise, because they fancy it is inconsistent with some passages of scripture, the sense of which they have miserably perverted, I regard them not, and even despise their rash censure. It is notorious that Lactantius, a celebrated author, but an indifferent mathematician, only shows his own ignorance and folly when he derides those who hold that the earth has the form of a globe; and it ought not to give offence if we laugh in our turn. Mathematics are designed for mathematicians; who will, if I am not mistaken, consider our labors of some service to the ecclesiastical republic. For not long since, when in the Lateran council, under Leo X. the question about the emendation of the calendar was debated, it remained undetermined, because the lengths of the years and months, and the motions of the sun and moon, were not accurately measured. What I have done in this matter I submit principally to your holiness, and then to the judgment of all learned mathematicians.'

Copernicus appears to have occasionally acted in the direction of the civil affairs of his chapter and of the neighbourhood. He was administrator of the possessions of the prince in Allenstein; superintended some exertions of the government to establish a uniform coinage; and is said to

have left a MS. work on the management of the mint. He was often entrusted, in the absence of his diocesan, with the administration of the bishopric of Emerland, and nominated as a candidate for the see, in 1537, by king Sigismund. The election, however, was in favor of one of his competitors.

He seems also to have amused himself occasionally as an engineer, and constructed, half a mile up the river, an oblique dam fifteen ells and a half long, and a mill on the top of it by which water was raised for the supply of the town of Frauenburg. It was conveyed by a wheel to the top of a tower, from which it was carried by pipes to the house of each canon. This is said to have been the model of the great hydraulic machine at Marly, and the tower formerly bore the following inscription:—

Hic patiuntur aquæ sursum properare coactæ,
Ne careat sitiens Incola mentis ope,
Quod natura negat tribuit Copernicus arte,
Unum pro cunctis Fama loquatur opus

Some travellers in the district that gave birth to this illustrious philosopher, arrived 'at Frauenberg, 12th August, 1802, and entered the church, where the ashes of Copernicus reposed. Near the altar, belonging to the prebend of Copernicus, was a sepulchral stone, partly enclosed by a marble balustrade, that was carried round the great altar. Spheres, rudely graven, and the letters Nicol., pointed out the place where the remains of this illustrious man were deposited. The worthy chapter, who attach as much veneration to the memory of Copernicus, as zeal for whatever interests the common glory of a nation, gave the most obliging assistance. On washing the stone, one could distinguish the letters Nicol....Cop.....; and in the second line, Obiit AN. M..... The rest of the letters were effaced. Having raised the stone, we caused the opening to be digged, because, before the eighteenth century, the prebendaries of Varmie had no particular tombs. We were present at the work. Only a few half decayed bones were discovered. The chapter retained a sixth part of those mortal remains of Copernicus, and we brought away the rest,' they say, 'with a regular certificate, signed by the first prelates of the chapter. We sent to the church of Pulawy, one third of these precious relics, and kept the other two for the Society.' These gentlemen were members of the Literary Society of Warsaw, and communicated the above interesting facts to M. Sniadecki, to whose essay we have been much indebted for this paper.

COPERNICUS, the name of an astronomical instrument invented by Mr. Whiston, to exhibit the motions and phenomena of all the planets, according to the Copernican system.

COPIAPO, a district of South America, in the north of Chili, which abounds in minerals of all kinds, and particularly load-stone, lapis lazuli, saltpetre, sal gem, and pure sulphur. Gold also has been found here; and some silver mines have been recently worked. The province is bounded on the north by the Peruvian deserts; on the east by the Andes; south by Coquimbo; and west by the Pacific Ocean; being about 100

leagues in length from north to south, and forty-four broad from east to west. Its rivers are the Copiapo, Salado, Castagno, Totorel, Quebradaponda, Guasco, and Chollai. The grain and fruits are excellent, but the pasturage poor for want of rain. The temperature is mild, but the country thinly peopled; not containing, altogether, above 5000 inhabitants.

COPIAPO, a town of Chili, and one of its most important sea-ports, is situated immediately at the mouth of the river of the same name, in lat. 27° 15' S. The harbour affords good anchorage, is easy of access for vessels of any size, and, as it opens towards the west, is protected from the northerly and southerly winds.

COPIATA; from κοπρω, to cut; a grave digger. In the first ages of the church clerks were destined for this employment. A. D. 357 Constantine made a law in favor of the priests copiatæ, i. e. of those who had the care of interments; whereby he exempted them from the lustral contribution. Before that time they were called decani and lecticarii, because they were divided by decads, each of which had a bier for the carriage of the dead bodies. They had precedence of the chantors.

COPINSHA and CORNHOLM are two of the Orkney Islands, united by a reef, dry at half-tide. They are together not more than two miles in length, and two miles south-east of Mairland. The rocks are covered with sea-fowl.

COPIOUS, *adj.* } Fr. *copieux*; It. Sp. }
 COPIOUSLY, *adv.* } and Lat. *copia*. Lavishly }
 COPIOUSNESS, *n. s.* } bestowed; abundant; }
 exuberantly plentiful; flowing freely; abound- }
 ing in words or images. Copiously signifies }
 abundantly; diffusely; at large. Copiousness }
 is, abundance; exuberance of style,

Rose, as in dance, the stately trees, and spread
 Their branches hung with copious fruit. *Milton.*

Full measure only bounds
 Excess, before the all-bounteous king, who showered
 With copious hand, rejoicing in their joy. *Id.*

Hail, Son of God, Saviour of men! thy name
 Shall be the copious matter of my song
 Henceforth, and never shall my harp thy praise
 Forget, nor from thy Father's praise disjoin. *Id.*

The Roman orator endeavoured to imitate the co-
 piousness of Homer, and the Latin poet made it his
 business to reach the conciseness of Demosthenes.
Dryden.

These several remains have been so copiously de-
 scribed by abundance of travellers, and other writers,
 that it is very difficult to make any new discoveries
 on so beaten a subject. *Addison.*

This alkaline acrimony indicates the copious use of
 vinegar and acid fruits. *Arbuthnot on Aliments.*

The tender heart is peace,
 And kindly pours its copious treasures forth
 In various converse. *Thomson's Spring.*

Paul Benfield made (reckoning himself) no fewer
 than eight members in the last parliament. What
 copious streams of pure blood must he not have
 infused into the veins of the present? *Burke.*

This pleasure (of existence) is increased when the
 system is stimulated into stronger action than usual,
 as, after a copious dinner, and at the beginning of in-
 toxication. *Darwin.*

But chiefly Juno, that imperial power
 Who holds her influence o'er the nuptial eower,
 Their vows address: to her, the beauteous queen,
 With lifted eyes and supplicating mien,
 As her fair hands the sacred goblet hold,
 On the white heifer's forehead drains the gold.
 Before the gods with copious slaughter fed,
 And the crowned stirrines, she walks with solemn
 tread. *Symmons's Æneis.*

We admit that, by some powerful hands, our un-
 rhymed verse has been so constructed as to be cop-
 iously harmonious; and we are, of course, sensible
 that, in any language, rhyme is only one of the
 charms of verse, which cannot be availing when un-
 accompanied with the other requisites of poetic dic-
 tion. *Id. Pref. to Æneis.*

COPLAND, *n. s.* A piece of ground in
 which the land terminates with an acute angle.

COPLANT, *v. a.* From *con* and *plant*. To
 plant together.

COPORTION, *n. s.*, From *con* and *portion*.
 Equal share.

COPPA, in law, a cop or cock of grass, hay,
 or corn, divided into titheable portions, as the
 tenth cock, &c. This word denotes laying up
 the corn in cops or heaps, not bound up, that it
 may be the more fairly tithed; and in Kent they
 still retain the word, a cop or cap of hay, straw,
 &c.

CO'PPED, *adj.* From *cop*. Rising to a top
 or head.

It was broad in its basis, and rose copped like a su-
 gar-loaf. *Wiseman's Surgery.*

A galeated eschinus being copped and somewhat
 conic. *Woodward.*

CO'PPEL, *n. s.* } This word is variously
 CO'PPLE-DUST, *n. s.* } spelt; as *copel*, *cupel*,
cuple, and *cuppel*; but I cannot find its etymo-
 logy, says Dr. Johnson. It may, however, be
 traced to the Italian *copella*, or the Teutonic, *ko-
 pel*. See CUPEL.

COPPER, *v. a., n. s. & adj.* } Fr. *cuivre*;
 COPPER-COLORED, *adj.* } Ital. *cupro*; Sp.
 COPPER-MINE, *n. s.* } *cobre*; Dutch,
 COPPER-NOSE, *n. s.* } *koper*; Germ.
 COPPER-PLATE, *n. s.* } *kopfer*; Lat.
 COPPER-WIRE, *n. s.* } *cuprum*; from
 COPPER-WORK, *n. s.* } *κωπρος*, Cyp-
 COPPERAS, *n. s.* } rus. Pliny calls
 COPPERAS-WORK, *n. s.* } it. *as Cyprium*.
 COPPERSMITH, *n. s.* } A well-known
 COPPER-WORM, *n. s.* } metal; a large
 COPPERISH, *adj.* } vessel to boil
 COPPERERY, *adj.* } in, made of cop-
 per, and of greater magnitude than a boiling
 pot. The verb signifies, to cover with thin plates
 of copper. The compounds require no explana-
 tion; except, perhaps, copper-nose, which means
 a red, carbuncled nose; copper-work, which is
 a place where copper is manufactured; and cop-
 per-worm, which denotes a little worm in ships;
 a worm that gnaws garments; and a worm that
 breeds in the hand. Copperas is a name given,
 in common parlance, to the sulphates of copper,
 iron, and zinc. See CHEMISTRY.

Two vessels of fine copper, precious as gold.
Esop viii. 27.
 Alexander the copper-smith did me much evil: the
 Lord reward him according to his works.
2 Timothy iv. 14.

He went his way, and with the *coper* he came,
And this chanon it in his bondes name.

Chaucer. Cant. Tales.

And more for rank despight, than for great paine,
Shakt his long locks, colourd like *copper-wyres*.

Spenser. Faerie Queene.

He having colour enough, and the other higher, is
too flaming a praise for a good complexion: I had as
lieve Helen's golden tongue had commended Troilus
for a *copper-nose*.

Shakespeare.

They boiled it in a *copper* to the half; then they
poured it into earthen vessels.

Bacon's Natural History.

It may be questioned, whether, in this operation,
the iron or *copperas* be transmuted, from the cognation
of *copperas* with *copper*, and the iron remaining after
conversion.

Browne.

Gutta rosacea ariseth in little hard tubercles, affect-
ing the face all over with great itching, which being
scratched, looks red, and rises in great welks, render-
ing the visage fiery; and makes *copper-noses*, as we
generally express them.

Wiseman.

Salmoneus, as the Grecian tale is,

Was a mad *coppersmith* of Elis;

Up at his forge by morning peep.

Swift.

This is like those wrought at *copper-works*.

Woodward.

Some springs of Hungary, highly impregnated with
vitriolick salts, dissolve the body of iron put into the
spring, and deposit, in lieu of the iron particles car-
ried off, *coppery* particles brought with the water out
of the neighbouring *copper-mines*.

Id. On Fossils.

Copper is heavier than iron or tin; but lighter than
silver, lead, and gold.

Hill on Fossils.

Copper is the most ductile and malleable metal,
after gold and silver. Of a mixture of *copper* and
lapis calaminaris is formed brass; a composition of
copper and tin makes bell-metal; and *copper* and
brass, melted in equal quantities, produces what the
French call bronze, used for figures and statues.

Chambers.

Hence glow, refulgent tin, thy crystal grains,
And tawny *copper* shoots her azure veins.

Darwin.

COPPER, one of the six primitive metals, so
called because the island of Cyprus formerly
furnished great quantities of this metal, which,
in the days of Homer, was the one principally
used. The discovery and use of copper preceded
that of iron. Yet it is probable that iron was
known in the days of Homer's heroes; for in
speaking of polished iron and copper, he calls
the first white and the other red. Some authors
attribute the discovery of copper to Cadmus;
but, according to Strabo, it was first found at
Chalcis, a city in Eubœa, now called Negrop-
ont, whence its Greek name. Other authors
say it was first dug in the island of Cyprus, and
thence obtained its Latin appellation. The color
of this metal when pure is pale red, its spec-
ific gravity from 8.7 to 9.3, which depends not
only on its degree of purity, but also on its con-
densation by hammering. The specific gravity
of Japan copper is to water as 9000 to 1000;
but that of the Swedish kinds only as 8784 or
8843. The color, when clean, is very brilliant,
but it is extremely liable to tarnish. Its elas-
ticity is superior to that of any other metal except
steel. From this last quality masses of the metal
emit a loud and lasting sound when struck; es-
pecially when cast into such a form as may

make the metal vibrate in the most simple man-
ner possible. Thus, if cast into the hollow form
of a bell, without any cracks or imperfections, a
uniform tone will be produced by it; or at least
the tones produced by the stroke will consist of
a single predominant one, and of others that
have an agreement with it. When broken, by
often bending backward, it appears internally of
a dull red color, without any brightness, and of
a fine granulated texture, resembling some kinds
of earthenware. It continues malleable in a
red heat, and in this state extends much more
easily than when cold. In a heat far below igni-
tion, the surface of a piece of polished copper
becomes covered with various ranges of pris-
matic colors; the red of each order being nearest
to the end which has been most heated. Copper
rusts in the air; but the corroded part is very
thin, and preserves the metal beneath from fur-
ther corrosion. It is remarkably impatient of
moisture when in a state of fusion; and the
contact even of a very small quantity of water
will cause a vast mass of melted metal to be
thrown about with incredible violence, to the im-
minent danger not only of the bystanders, but
even of the strongest furnaces and buildings.
Effects of this kind are said to have been pro-
duced by so slight a cause as the workmen spit-
ting in a furnace full of melted copper. For an
account of the combinations of this metal with
salts, earths, and other metals, see CHEMISTRY.

Brunswick or Friesland green is prepared by
pouring a saturated solution of muriate of am-
monia over copper filings or shreds in a close
vessel, keeping the mixture in a warm place,
and adding more of the solution from time to
time, till three parts of muriate and two of cop-
per have been used. After standing a few weeks,
the pigment is to be separated from the unoxi-
dised copper, by washing through a sieve; and
then it is to be well washed and dried slowly in
the shade. This green is almost always adul-
terated with ceruse.

Verdigris, and other preparations of copper,
act as virulent poisons, when introduced in very
small quantities into the stomachs of animals. A
few grains are sufficient for this effect. Death is
commonly preceded by very decided nervous
disorders, such as convulsive movements, tetanus,
general insensibility, or a palsy of the lower ex-
tremities. This event happens frequently so
soon, that it could not be occasioned by inflam-
mation or erosion of the primæ viæ; and, in-
deed, where these parts are apparently sound.
It is probable that the poison is absorbed, and,
through the circulation, acts on the brain and
nerves.

The only chemical antidote to cupreous solu-
tions, whose operation is well understood, is
water strongly impregnated with sulphureted hy-
drogen. The alkaline hydrosulphurets are acrid,
and ought not to be prescribed.

But we possess, in sugar, an antidote to this
poison, of undoubted efficacy, though its mode
of action be obscure. M. Duval introduced into
the stomach of a dog, by means of a caoutchouc
tube, a solution in acetic acid, of four French
drachms of oxide of copper. Some minutes af-
terwards he injected into it four ounces of strong

syrup. He repeated this injection every half hour, and employed altogether twelve ounces of syrup. The animal experienced some tremblings and convulsive movements. But the last injection was followed by a perfect calm. The animal fell asleep, and awoke free from any ailment.

If we boil for half an hour, in a flask, an ounce of white sugar, an ounce of water, and ten grains of verdigris, we obtain a green liquid, which is not affected by the best tests of copper, such as ferroproussiate of potash, ammonia, and the hydrosulphurets. An insoluble green carbonate of copper remains at the bottom of the flask.

We extract the following abridged view of the ores of copper from Dr. Ure's excellent Chemical Dictionary:—

1. *Octohedral or native copper.* Color copper-red, frequently incrustated with green. Massive, imitative, and crystallised; in the perfect cube; the cube truncated, on the angles, on the edges, and on the edges and angles; the garnet dodecahedron; perfect octohedron; and rectangular four-sided prism. Lustre glimmering, metallic. Fracture hackly. Streak splendent. Completely malleable. Flexible, but not elastic. Difficultly frangible. Specific gravity 8.4 to 8.7. It consists of 99.8 of copper, with a trace of gold and iron. It occurs in veins, in granite, gneiss, &c., and is found chiefly in Cornwall.

2. *Octohedral red copper ore.*

a. Foliated red copper ore. Color dark cochineal-red. Massive, and crystallised, in the perfect octohedron, which is the primitive form; in the octohedron, truncated on the angles; on the edges, with each angle acuminated with four planes; bevelled on the edges, and each angle acuminated with eight planes. Lustre adamantine, inclining to semi-metallic. Cleavage four-fold. Translucent on the edges, or translucent. Streak muddy, tile red. Hardness between calcareous and fluor-spar. Brittle. Specific gravity 5.6 to 6.0.

b. Compact red copper ore. Color between lead-gray and cochineal-red. Massive and reniform. Lustre semi-metallic. Fracture even. Opaque. Streak tile red. Brittle.

c. Capillary red copper ore. Color carmine-red. In small capillary crystals. Lustre adamantine. Translucent.

The whole of these red ores are deutoxides of copper, and are easily reduced to the metallic state before the blow-pipe. They dissolve with effervescence when thrown in powder into nitric acid; and a green nitrate results. In muriatic acid no effervescence takes place. They occur principally in veins that traverse primitive and transition rocks; abundantly in the granite of Cornwall. The earthy red copper ore, which is rare, is a sub-species of the preceding.

d. Tile ore. The earthy tile ore has a hyacinth red color. It occurs massive and incrusting copper pyrites. It is composed of dull dusty particles. It soils slightly, and feels meagre. It occurs in veins, as at Lauterberg in the Hartz. The indurated tile ore has an imperfect flat conchoidal fracture; a streak feebly shining; and is intermediate between semi-hard and soft. It is an intimate combination of red

copper ore and brown iron ochre, containing from 10 to 50 per cent. of copper.

3. *Black copper, or black oxide of copper.* Color between bluish and brownish-black. It occurs massive, and thinly coating copper pyrites. It is composed of dull pasty particles, which scarcely soil. Streak slightly shining. Before the blow-pipe it emits a sulphureous odor, melts into a slag, and communicates a green color to borax. It is said to be an oxide of copper with oxide of iron. It occurs at Carharrac and Tincroft mines, in Cornwall.

4. *Emerald copper or diopside.* Color emerald green. It occurs only crystallised. The primitive form is a rhomboid of 123° 58'. The only secondary form at present known, is the equiangular six-sided prism. Lustre shining pearly. Cleavage three-fold. Fracture small conchoidal. Translucent. As hard as apatite. Brittle. Specific gravity 3.3. It becomes a chestnut-brown before the blow-pipe, and tinges the flame green, but is infusible; with borax it gives a bead of copper. Its constituents are, oxide of copper 28.57, carbonate of lime 42.83, silica 28.57.—*Vauquelin.* By Lowitz, it consists of 55 oxide of copper, 33 silica, and 12 water, in 100. It is found in the land of Kirguise, 125 leagues from the Russian frontier, where it is associated with malachite and limestone.

5. *Blue copper, or prismatic malachite,* of which there are two kinds,—the radiated and earthy.

The radiated has an azure-blue color. Massive, imitative, and crystallised. Its primitive form is an oblique prism. The secondary forms are, an oblique four-sided prism, variously bevelled, and a rectangular four-sided prism, or eight-sided prism, acuminated with four planes. Lustre vitreous. Cleavage threefold. Fracture imperfect conchoidal. Translucent. Color of the streak, lighter. Harder than calcareous spar. Brittle. Specific gravity 3.65. It is soluble with effervescence in nitric acid. With borax it yields a metallic globule, and colors the flux green. Its constituents are, copper 56, carbonic acid 25, oxygen 12.5 water, 6.5.—*Vauquelin.* It is found at Leadhills, in Dumfries-shire, and Wanlockhead in Lanarkshire, and at Huel Virgin and Carharrack, in Cornwall, and in many places on the continent.

b. Earthy blue copper. Color small-blue. Massive. Friable. Specific gravity 3.354. It is found in Norway, &c.

The velvet-blue copper belongs to the same species. Lustre glistening and pearly. It has been found only at Oravicza, in the Bannat, along with malachite and the brown iron stone.

6. *Malachite;* of which there are, the fibrous and compact.

a. Fibrous malachite. Color perfect emerald-green. Imitative, and crystallised, in oblique four-sided prisms, variously bevelled or truncated; and in an acute-angular three-sided prism. Crystals short, capillary, and acicular. Lustre pearly or silky. Translucent, or opaque. Softer than blue copper. Streak pale green. Brittle. Specific gravity 3.66. Before the blow-pipe it decrepitates, and becomes black. Its constituents are, copper 58, carbonic acid 18, oxygen 12.5 water 11.5.—*Klaproth.* It occurs principally in

veins. It is found at Sandlodge in Mainland, one of the Shetlands; at Landidno in Caernarvonshire; and in the mines of Arendal in Norway.

b. Compact malachite. Color emerald-green. Massive, imitative, and in four-sided prisms. Glimmering and silky. Fracture small grained uneven. Opaque. Streak pale green. Specific gravity 3.65. In veins, which traverse different rocks in Cornwall, Norway, &c. Brown copper, from Hindostan, is placed after this mineral by professor Jameson. Its color is dark blackish-brown. Massive. Soft. Specific gravity 2.62. It effervesces in acids, letting fall a red powder. Its constituents are, carbonic acid 16.7, deutoxide of copper 60.75, deutoxide of iron 19.5, silica 2.1.—*Dr. Thomson.*

7. Copper-green.

Common copper-green, or *chrysocolla*, contains three sub-species.

a. Conchoidal copper-green. Color verdigris-green. Massive, imitative, and incrusting. Glistening. Fracture conchoidal. Translucent. Harder than gypsum. Easily frangible. Specific gravity 2.0 to 2.2. It becomes black and then brown before the blow-pipe, but does not fuse. It melts and yields a metallic globule with borax. Its constituents are, copper 40, oxygen 10, carbonic acid 7, water 17, silica 26. It accompanies malachite. It is found in Cornwall, &c.

Silicious copper, or *kieselkupfer*, is a variety of the above. Color asparagus-green. In crusts. Glistening. Fracture even or earthy. Opaque. Soft. Its constituents are, copper 37.8, oxygen 8, water 21.8, silica 29, sulphate of iron 3.

b. Earthy iron-shot copper-green. Color olive-green. Massive, and in crusts. Friable. Opaque. Sectile.

c. Slaggy iron-shot copper-green. Color blackish-green. Massive. Glistening. Fracture conchoidal. Opaque. Soft. Easily frangible. It is probably a compound of conchoidal copper-green and oxide of iron. Both occur together, and pass into each other. It occurs in Cornwall, along with olivenite.

8. Prismatic vitriol, blue vitriol, or sulphate of copper. Color dark sky-blue. Massive, imitative, and crystallised. The primitive figure is an oblique four-sided prism, in which the lateral edges are $124^{\circ} 2'$, and $55^{\circ} 58'$; with edges and angles often truncated. Shining. Cleavage double. Fracture conchoidal. Translucent. Harder than gypsum. Specific gravity 2.1 to 2.2. Taste nauseous, bitter, and metallic. Its solution coats iron with metallic copper. Its constituents are, oxide of copper 32.13, sulphuric acid 31.57, water 36.3.—*Berzelius.* It occurs along with copper pyrites, in Parys-mine in Anglesea, and in Wicklow.

9. Prismatic olivenite, or phosphate of copper. Color emerald-green. Massive, and in oblique four-sided prisms of 110° . Cleavage double oblique. Glistening. Fracture splintery. Opaque. Streak verdigris-green. As hard as apatite. Brittle. Specific gravity 4 to 4.3. Fuses into a brownish globule. Its constituents are, oxide of copper 68.13, phosphoric acid 30.95. It is found at Virneburg on the Rhine, along with quartz, red copper ore, &c.

10. Diprismatic olivenite, or lenticular copper. Color sky-blue. Massive, but generally crystallised. In very oblique four-sided prisms. Bevelled. In rectangular double four-sided pyramids. Shining. Fracture uneven. Translucent. Harder than gypsum. Brittle. Specific gravity 2.85. Converted by the blow-pipe into a black friable scoria. Its constituents are, oxide of copper 49, arsenic acid 14, water 35.—*Chenevis.* Found in Cornwall.

11. Acicular olivenite. *a.* Radiated or cupreous arseniate of iron. Color dark verdigris-green. Massive, imitative, and in flat oblique four-sided prisms, acuminated or truncated. Lustre glistening pearly. Translucent on the edges. As hard as calcareous spar. Brittle. Specific gravity 3.4.

b. Foliated acicular olivenite, arseniate of copper. Color dark olive-green. In angular granular concretions, and in small crystals; which are oblique four-sided prisms; and acute double four-sided pyramids. Glistening. Fracture conchoidal. Translucent. Streak olive-green. As hard as calcareous spar. Brittle. Specific gravity 4.2 to 4.6. It boils, and gives a hard reddish-brown scoria before the blow-pipe. Its constituents are, oxide of copper 60, arsenic acid 39.7.—*Chenevis.* In the copper-mines of Cornwall.

c. Fibrous acicular olivenite. Color olive-green. Massive, reniform, and in capillary and acicular oblique four-sided prisms. Glistening and pearly. Opaque. As hard as calc-spar. Brittle. Fibres sometimes flexible. Streak brown or yellow. Specific gravity 4.1 to 4.2. Its constituents are, oxide of copper 50, arsenic acid 29, water 21. It occurs in Cornwall.

d. Earthy acicular olivenite. Color olive-green. Massive, and in crusts. Dull. Fracture fine earthy. Opaque. Very soft. It is found in Cornwall.

12. Atacamite or muriate of copper.

a. Compact. Color leek-green. Massive, and in short needle-shaped crystals, which are oblique four-sided prisms, bevelled or truncated. Shining and pearly. Translucent on the edges. Soft. Brittle. Specific gravity 4.4? It tinges the flame of the blow-pipe of a bright green and blue, muriatic acid rises in vapors, and a bead of copper remains on the charcoal. It dissolves without effervescence in nitric acid. Its constituents are, oxide of copper 73.0, water 16.9, muriatic acid 10.1.—*Klaproth.* It occurs in veins in Chili and Saxony.

b. Arenaceous atacamite, or copper-sand. Color grass-green. In glistening scaly particles. It does not soil. It is translucent. Its constituents are, oxide of copper 63, water 12, muriatic acid 10, carbonate of iron 1, mixed silicious sand 11. It is found in the sand of the river Lipes, 200 leagues beyond Copiapu, in the Desert of Atacama, which separates Chili from Peru.

13. Copper pyrites.

a. Octohedral copper pyrites. On the fresh fracture, its color is brass-yellow; but it is usually tarnished. Massive, imitative, and crystallised; in a regular octohedron, perfect, truncated or bevelled; and in a perfect or truncated tetrahe-

dron. Glistening. Fracture uneven. Hardness from calcareous to fluor spar. Brittle. Specific gravity 4.1 to 4.2. Before the blow-pipe, on charcoal, it decrepitates, emits a greenish-colored sulphureous smoke, and melts into a black globule, which assumes metallic lustre. It tinges borax green. Its constituents are, copper 30, iron 53, sulphur 12.—*Chenevix*. It contains sometimes a little gold or silver. It occurs in all the great classes of rocks. It is found near Tynedrum in Perthshire; at the mines of Ectou; at Pary's mountain; abundantly in Cornwall; and in the county of Wicklow in Ireland. The rich ores are worked for copper; the poor for sulphur.

6. Tetrahedral copper pyrites; of which species there are two sub-species, gray copper and black copper.

Gray copper. Color steel-gray. Massive and crystallised; in the tetrahedron, truncated or bevelled; and in the rhomboidal dodecahedron. Splendent. Fracture uneven. Hardness as calcareous spar and fluor. Brittle. Specific gravity 4.4 to 4.9. Its constituents are, copper 41, iron 22.5, sulphur 10, arsenic 24.1, silver 0.4.—*Klaproth*. It occurs in beds and veins in Cornwall, and many other places.

Black copper. Color iron-black. Massive and crystallised; in the tetrahedron, perfect, bevelled, or truncated. Splendent. Fracture conchoidal. Brittle. Specific gravity 4.85. Its constituents are, copper 39, antimony 19.5, sulphur 26, iron 7.5, mercury 6.25.—*Klaproth*. The mercury is accidental. It occurs in veins in the Hartz, and in Peru.

14. *White copper*. Color between silver-white and brass-yellow. Massive and disseminated. Glistening and metallic. Fracture uneven. Semihard. Brittle. Specific gravity 4.5. It yields before the blow-pipe a white arsenical vapor, and melts into a grayish-black slag. It contains 40 per cent. of copper; the rest being iron, arsenic, and sulphur. It occurs in primitive and transition rocks. It is found in Cornwall and Saxony.

15. *Copper-glance, or vitreous copper*.

Rhomboidal copper-glance.

§ 1. Compact. Color blackish lead-gray. Massive, in plates and crystallised. Primitive form, a rhomboid. Secondary forms, a low equiangular six-sided prism, and a double six-sided pyramid. Glistening, metallic. Harder than gypsum. Perfectly sectile. Rather easily frangible. Specific gravity 5.5 to 5.8. Its constituents are, copper 78.05, iron 2.25, sulphur 18.5, silica 0.75.—*Klaproth*.

§ 2. Foliated. Its constituents are, copper 79.5, sulphur 19, iron 0.75, quartz 1.—*Ullmann*. It occurs in primitive rocks. It is found also in transition rocks, at Fassney-burn in East Lothian; in Ayrshire; at Middleton Tyas in Yorkshire; in Cornwall, &c.

16. *Variegated copper*. Color between copper-red and pinchbeck-brown. Massive, in plates, and crystallised in six-sided prisms. Glistening metallic. Soft. Easily frangible. Specific gravity 5. It is fusible, but not so easily as copper-glance, into a globule, which acts powerfully on the magnetic needle. Its constituents are, copper 69.5, sulphur 19, iron 7.5, oxygen 4.

—*Klaproth*. It occurs in gneiss, mica slate, &c. It is found in Cornwall.

There are seventeen places in Britain in which, according to Dr. Campbell, copper-mines are found. See 2d vol. p. 44, of his Political Survey of Britain. These are, Cardiganshire, Cheshire, Cornwall, Cumberland, Derbyshire, Devonshire, Lancashire, Isle of Man, Northumberland, Shropshire, Somersetshire, Staffordshire, Yorkshire, Wales, Warwickshire, Westmoreland, and North Britain.

CO'PPICE, *n. s.* } Fr. *coupeur*, from
 COPSE, *v. a. & n. s.* } *couper*, to cut or lop;
 CO'PSY, *adj.* } *κόπρω*. Coppice and
 CO'PSE-WOOD, *n. s.* } copse are synonymous;
 the latter being only a contraction of the former.
 Both signify a wood, composed of underwood and small trees, which at stated times are cut for fuel. To copse is to preserve underwood.

A land, each side whereof was bounded both with high timber trees, and *copses* of far more humble growth. *Sidney*.

Upon the edge of yonder *coppice*,
 A stand, where you may have the fairest shoot *Shakespeare*.

In *coppice-woods*, if you leave staddles too quick,
 they run to bushes and briars, and have little clean underwood. *Bacon*.

The willows, and the hazel *copses* green,
 Shall now no more be seen
 Fanning their joyous leaves to their soft lays. *Milton*.

The east quarters of the shire are not destitute of *copse-woods*. *Carew's Survey of Cornwall*.

Oaks and brambles, if the *copse* be burned,
 Confounded lie, to the same ashes turned. *Waller*.
 The rate of *coppice* lands will fall upon the discovery of coal-mines. *Locke*.

But in what quarter of the *copse* it lay,
 His eye by certain level could survey. *Dryden's Fables*.

The neglect of *copsing* wood cut down, hath been of very evil consequence. *Swift's Address to Parliament*.

Raise trees in your seminaries and nurseries, and you may transplant them for *coppices* ground, walks, or hedges. *Mortimer's Husbandry*.

Beneath a *copse* of various hue
 In barbarous luxuriance grew.
 No knife had curbed the rambling sprays,
 No hand had wove the implicit maze. *Boswell*.

It chanced then on a winter's day,
 But warm and bright, and calm as May,
 The birds, conceiving a design,
 To forestall sweet St. Valentine,
 In many an orchard, *copse*, and grove,
 Assembled on affairs of love,
 And with much twitter, and much chatter,
 Began to agitate the matter. *Coppey*.

CO'PPLE-DUST, *n. s.* Probably for coppel, or cupel-dust. Powder used in purifying metals, or the gross parts separated by the cupel.

It may be also tried by incorporating powder of steel, or *copple-dust*, by pouncing into the quicksilver. *Bacon*.

CO'PPLE-STONES are lumps and fragments of stone or marble, broke from the adjacent cliffs, rounded by being bowled and tumbled to and again by the action of the water.

CO'PPLED, *adj.* From cop. Rising in a conic form; rising to a point.

There is some difference in this shape, some being flatter on the top, others more *cuppled*.

Woodward on Fossils.

COPTS, or COPIETS, in ecclesiastical history, a name given to those Egyptian Christians who are of the sect of Jacobites. Critics differ respecting the orthography, as well as the etymology of this word. It is sometimes written *Cophti*; at others *Copti*, *Cophitæ*, *Copties*, &c. Scaliger once thought the name derived from *Coptos*, an ancient town of Egypt, the metropolis of the Thebaid. Kircher mentions, that the word originally signifies cut or circumscribed; and was given them on account of their practising circumcision; Scaliger finally and more probably derives it from *Αἴγυπτος*, the ancient name of Egypt, by retrenching the first syllable. The Malchese Christians are clearly a distinct race.

The Copts are of native Egyptian descent, and have partly on that account, as well as for their supposed heresies, been depressed and persecuted by both their Christian and Mahomedan masters. Their ancient language, in which a valuable version of the New Testament is extant, appears to have been vernacular in the seventeenth century. They have a patriarch who resides at Cairo, but he takes his title from Alexandria; and has under him their few remaining bishops. The rest of the clergy, whether secular or regular, are composed of the orders of St. Antony, St. Paul, and St. Macarius, who have each their monasteries. Besides the orders of priests, deacons, and sub-deacons, the Coptis have likewise Archimandrites, a dignity which they confer with all the ceremonies of ordination. This, besides the authority it gives them with regard to the religious, comprehends the functions of archpriests. By a custom of 600 years standing, if a priest elected bishop be not already archimandrite, that dignity must be conferred on him before episcopal ordination. The second person after the patriarch, is the titular patriarch of Jerusalem, who generally resides at Cairo, and goes to Jerusalem every Easter. To him belongs the government of the Coptic church, during the vacancy of the patriarchal see. To be elected patriarch, it is necessary that the person have lived all his life in continence. He confers the bishoprics. To be elected bishop, the person must be either in the celibate, or not have been married more than once. The priests and inferior ministers are allowed to be married before ordination. They have a great number of deacons, and are said to confer that order even on children. They have three liturgies, which they vary occasionally, and very long offices. The monastic life is in great esteem among the Copts. Divorce is said to be very frequent among them; with the church of Rome they have seven sacraments, viz. baptism, the eucharist, confirmation, ordination, faith, fasting, and prayer. They deny the Holy Spirit to proceed from the Son; and only allow of three œcumenical councils; those of Nice, Constantinople, and Ephesus. They are also considered as monophysitic in their sentiments respecting the person of Christ, or to acknowledge but one nature and will in him 'after the union of the deity and humanity.' To these peculiarities may be

added, 1. Their practice of circumcising their children before baptism. 2. Their ordaining deacons at five years of age. 3. Their allowing of marriage in the second degree. 4. Their belief of a baptism by fire, which they are said sometimes to endeavour to confer literally. 5. Their forbearing to eat blood.

In the time of pope Paul IV. a Syrian was despatched to Rome from the patriarch of Alexandria, with letters to that pope; wherein he is said to have acknowledged his authority, and desired a person to be despatched to Alexandria, to treat about a union. Pursuant to which, Pius IV. successor to Paul, sent E. Roderic, a Jesuit, in 1561, in quality of apostolical nuncio; and forwarded, through the Venetian consul, a sum of money to the patriarch; but the Jesuit, upon a conference with two Copts deputed by the patriarch, was told, that the titles of father of fathers, pastor of pastors, and master of all churches, which he had bestowed on the pope in his letters, were only matters of compliment; and that since the council of Chalcedon, and the establishment of several patriarchs independent of one another, each was master of his own church. Here the negotiation of course terminated. At present it is supposed that the Copts are about 500,000 in number.

COPULA, n. s. Lat. The word which unites the subject and predicate of a proposition; as books are dear.

The *copula* is the form of a proposition; it represents the act of the mind, affirming or denying.

Watts's Logick.

COPULATE, v. a., v. n. & adj. } It. *copula*.
COPULA'TION, n. s. } *lare*; Sp.
COPULA'TIVE, n. s. & adj. } *copular*;
 Lat. *copulare*. To conjoin; to link together; to come together as different sexes. Copulation is, the congress of the opposite sexes. Copulative is fully defined in the quotation from Watts.

Sundry kinds, even of conjugal *copulation*, are prohibited as unwholesome. *Hooker.*

If the force of custom, simple and separate, be great, the force of custom *copulate*, and conjoined, and collegiate, is far greater. *Bacon.*

Not only the persons so *copulating* are infected, but also their children. *Wiseman's Surgery.*

Copulative propositions are those which have more subjects or predicates connected by affirmative or negative conjunctions: as, riches and honours are temptations to pride; Cæsar conquered the Gauls and the Britons; neither gold nor jewels will purchase immortality. *Watts's Logick.*

COPY, v. a. & v. n., n. s. } Fr. *copier*; Ital.
COPY-BOOK, n. s. } *copiare*; Span. *copiar*;
COPY-HOLD, n. s. } Dutch *kopieren*;
COPY-HOLDER, n. s. } Low Lat. *copia*.
COPY-MONEY, n. s. } 'Junius inclines, after his manner,' drily observes Dr. Johnson, 'to derive it from *κοπος*, labor; because, says he, 'to copy another's writing is very painful and laborious.' Another lexicographer also justly remarks, that 'perhaps this is rather too distant a derivation to be the right one; because many copies are taken with pleasure instead of wearisomeness.' To copy is, to transcribe; to

imitate; to strive to resemble. A copy is, a transcript from, or imitation of, an original; the original itself; an individual book; one of several books; an instrument by which any conveyance is made in law. Copier and copyist are synonymous, and signify a transcriber; an imitator; a plagiarist. The compound words are most of them of obvious meaning. Copyright and copyhold are fully described onwards.

The very having of the books of God was a matter of no small charge, as they could not be had otherwise than in written copies. *Hooker.*

It was the copy of our conference;
In bed he slept not, for my urging it;
At board he fed not, for my urging it.
Shakespeare. Comedy of Errors.

Thou knowest that Banquo and his Fleance lives;
But in them nature's copy's not eternal. *Id. Macbeth.*

If virtue's self were lost, we might
From your fair mind new copies write. *Waller.*

I have not the vanity to think my copy equal to the original. *Denham.*

Let him first learn to write, after a copy, all the letters in the vulgar alphabet.

Holder's Elements of Speech.

The first of them I have forgotten, and cannot easily retrieve, because the copy is at the press.

Dryden.

Set the examples, and their souls inflame
To copy out their great forefathers' fame.

Dryden's King Arthur.

Without invention a painter is but a copier, and a poet but a plagiarist of others. *Dryden's Dufrenoy.*

Some imagine, that whatsoever they find in the picture of a master, who has acquired reputation, must of necessity be excellent; and never fail, when they copy, to follow the bad as well as the good things. *Id.*

When a painter copies from the life, he has no privilege to alter features and lineaments, under pretence that his picture will look better. *Dryden.*

He steps forth, not only the copy of God's hands, but also the copy of his perfections, a kind of image or representation of the Deity in small.

South's Sermons.

He that borrows other men's experience, with this design of copying it out, possesses himself of one of the greatest advantages. *Decay of Piety.*

Several of our countrymen, and Mr. Dryden in particular, seem very often to have copied after it in their dramatic writings, and in their poems upon love. *Addison's Spectator.*

A coin is in no danger of having its characters altered by copiers and transcribers. *Id. on Coins.*

If a customary tenant die, the widow shall have what the law calls her free bench in all his copyhold lands. *Addison.*

The Romans having sent to Athens, and the Greek cities of Italy, for copies of the best laws, chose ten legislators to put them into form. *Swift.*

To copy her few nymphs aspired,
Her virtues fewer swains admired. *Id.*

He who hurts a harmless neighbour's peace,
Who loves a lie, lame slander helps about,
Who writes a libel, or who copies out. *Pope's Epist.*

Let the faint copier, on old Tiber's shore,
Nor mean the task, each breathing bust explore;
Line after line with painful patience trace,
This Roman grandeur, that Athenian grace. *Tichel.*

Whatever be the emotion the poet intends to raise in his reader, whether admiration or terror, joy or sorrow; and whatever be the object he would exhibit, whether Venus or Tisiphone, Achilles or Theristes, a palace or a pile of ruins, a dance or a battle, he generally copies an idea of his own imagination; considering each quality as it is found to exist in several individuals of a species, and thence forming an assemblage more or less perfect in its kind, according to the purpose to which he means to apply it. *Beattie.*

I threw off six hundred copies, of which I had got subscriptions for about three hundred and fifty.

Burns.

Her memory was a mine: she knew by heart
All Calderon and greater part of *Lopé*,
So that if any actor missed his part,
She could have served him for the prompter's copy.

Byron. Don Juan.

COPYHOLD, in English law, a tenure for which the tenant hath nothing to show but a copy of the rolls made by the steward of his lord's court; for the steward, as he enrols other things done in that court, registers such tenants as are admitted to any parcel of land or tenement belonging to the manor; and the transcript of this is called the court-roll, the copy of which the tenant takes from him, and keeps as his only evidence. This is called a base tenure, because it holds at the will of the lord: yet not simply, but according to the custom of the manor; so that if a copyholder break not the custom of the manor, and thereby forfeit his tenure, he cannot be turned out at the lord's pleasure. These customs of manors vary in one point or other almost in every manor. Some copyholds are finable at an uncertain rate, and some certain; that which is finable uncertain, the lord rates at what fine or income he pleases, when the tenant is admitted: that which is certain is a kind of inheritance, and called in many places customary: because the tenant dying, and the hold being void, the next of blood paying the customary fine, as two shillings for an acre, or so, cannot be denied his admission. Some copyholders have, by custom, the wood growing upon their own land, which by law they could not have. Some hold by the verge in ancient demesne; and though they hold by copy, yet are they, in account, a kind of freeholders: for if such a one commit felony, the king hath annum, diem, and vastum, as in case of freehold. Others again hold by common tenure, called mere copyhold; and they committing felony, their land escheats to the lord of the manor.

Copyhold land cannot be made at this day; for the pillars of a copyhold estate are, That it hath been demised time out of mind by copy of court-roll; and that the tenements are parcel of, or within, the manor. (1 Inst. 58. 4 Rep. 24.) Nor can a copyhold be created by operation of law: and therefore where wastes are severed from the manor, by a grant of the latter, with the exception of the former, though the copyholders continue to have a right of common in the wastes by immemorial usage; yet if afterwards a grant of the soil of those wastes be made to trustees for the use of the copyholders in free socage, the lands when enclosed, will be freehold, and not copyhold.

If the lord refuses to admit he shall be compelled in Chancery, 2 Cro. 368. And if the

lord refuse to admit a surrenderee, on account of a disagreement about the fine to be paid, the court of B. R. will grant a mandamus to compel the lord to admit without examining the right to the fine. 2 Term Rep. 484.—But that court will not grant a mandamus to admit a copyholder by descent. A copyholder, so long as he doeth his services, and doth not break the custom of the manor, cannot be ejected by the lord: if he be, he shall have trespass against him: but, if a copyholder refuses to perform his services, it is a breach of the custom, and forfeiture of his estate.

Customs ought to be time out of memory, to be reasonable, &c. And a custom in deprivation or bar of a copyhold estate, shall be taken strictly; but when for making and maintaining, it shall be construed favorably. An unreasonable custom, as for a lord to exact exorbitant fines; for a copyholder for life to cut down and fell timber-trees, &c. is void. A copyholder for life pleaded a custom, that every copyholder for life might, in the presence of two other copyholders, appoint who should have his copyhold after his death, and that the two copyholders might assess a fine, so as not to be less than had been usually paid; and it was adjudged a good custom. 4 Leon. 238. But a custom to compel a lord to make a grant, is said to be against law; though it may be good to admit a tenant.

A copyholder may surrender in court, by letter of attorney, and out of court by special custom. 9 Rep. 75, 76. A copyholder being in Ireland, the steward of a manor here made a commission to one to receive a surrender from him there, and it was held good. 2 Danv. 181. The intent of surrenders is, that the lord may not be a stranger to his tenant, and the alteration of the estate. As a copyholder cannot transfer his estate to a stranger by any other conveyance than surrender; so if one would exchange a copyhold with another, both must surrender to each other's use, and the lord admit accordingly. Comp. Cop. s. 39.

With respect to the devising of copyholds, the law formerly was, that no such devise could be made without a surrender to the use of the party's will; and that the lands did not then pass by the will but by the surrender, the will being considered only as declaratory of the uses of the surrender. Many evils were found to result in the cases of creditors wives, and children, from this necessity of a surrender to a will, and the courts of equity were astute in finding reasons for supplying the surrender, with due precaution in favor of the claims of the several parties. See 3 P. Wms. 98 in n. All these questions are now set at rest by a statute passed for that purpose, 55 Geo. III. c. 192, by which it is enacted, That in all cases where, by the custom of any manor in England [or Ireland, though instances of copyhold are rare there], any copyhold tenant of such manor may by will dispose of, or charge land, surrendered to the use of the will, every disposition or charge of any such copyhold, made by the will of any person who shall hereafter die, shall be as valid and effectual, although no surrender shall have been made to the use of the will, as if such surrender had been actually made. On admissions under testamentary dispositions,

the steward is allowed to charge his fees, as in cases of surrender to the use of the will. But the act is not to affect the validity of devises.

Fines are paid to the lord on admittances: and may be due on every change of the estate by lord or tenant. The lord may have an action of debt for his fine: or may distrain by custom. 4 Rep. 27. 13 Rep. 2. A covenant made by a copyholder with a stranger to assign and surrender his copyhold to him, which covenant is afterwards presented by the homage, does not give the lord any right to a fine before admission. 2 T. R. 484. The lord may recover from a copyholder the fine assessed by him on admittance, not exceeding two years' value of the tenement, although there be no entry of the assessment of such fine on the court rolls, but only a demand of such a sum for a fine, after the value of the tenement had been found by the homage, 6 E. R. 56:

An heriot is a duty to the lord, rendered at the death of the tenant, or on a surrender and alienation of an estate: and is the best beast or goods, found in the possession of the tenant deceased, or otherwise, according to custom. And for heriots, reliefs, &c. the lord may distrain, or bring action of debt. Plowd. 96. It seems that a custom for the homage to assess a compensation in lieu of heriot, to be paid by an incoming copyholder on surrender or alienation, is not good. 1 Bos. & Pul. 282.

Relief is a sum of money which every copyholder in fee, or freeholder of a manor, pays to the lord on the death of his ancestor; and is generally a year's profits of his land.

Services signify any duty whatsoever accruing unto the lord from tenants; and are not only annual and accidental; but corporeal, as homage, fealty, &c. Comp. Court. Keep. 7, 8, 9, &c. 31 Geo. 2. c. 14, provides that no person holding by copy of court-roll should be entitled, from that property, to vote at the election of knights for the shire. See *Cruise, Scriven, and Walker on Copyholds*.

COPYING MACHINES are amongst the useful modern inventions of which it is proper that we should offer some account.

Dr. Franklin proposed to use the common copperplate-printers' rolling press as a machine for copying letters. He directs the letter to be written with gummed ink, and then sanded over with emery powder. Thus prepared, it is to be laid on a smooth plate of pewter, and passed through the press. The impression of the emery is left on the pewter, and printing-ink being applied to the plate, an impression may be taken, which is a copy of the letter. In 1780 Mr. Watt of Birmingham proposed and obtained a patent for the following method of copying recent manuscripts. A sheet of unsized patent paper, very thin, is wetted and laid between two woollen cloths, to absorb the redundant moisture. Being laid on the manuscript, the two are passed together through a rolling or screw-press; when the thin paper is found to have received a reverse impression of the letter, legible when read through the transparent substance of the paper. Mr. Watt says that the thin paper may be wetted advantageously with a mixture of water, vinegar, oyster shells, boracic acid, and grill-nuts.

Mr. Ralph Wedgwood has obtained two patents for inventions of this kind. The first was in 1806. In this he proposes to employ, 1st, A sheet of paper, over both sides of which printer's ink is spread; this is allowed to dry during six weeks, between leaves of blotting paper; 2dly, A smooth pewter, or copper plate. 3dly, On the metal plate is laid a leaf of letter paper; over it the blackened paper before mentioned; and over this a leaf of thin paper, previously oiled, that it may be the more transparent. 4thly, On the paper thus disposed, the writing is performed by a style of agate, ground and polished to a smooth round point. The effect is, that the letter paper receives an impression from the blackened paper, and this impression is in the right direction, and constitutes the letter to be used as the original.

The upper oiled paper receives an impression which is inverted, but may be read in the right direction by looking through the paper. This constitutes the duplicate or copy. The apparatus, for which he obtained a patent in 1808, consists of a certain disposition of two leaves of paper, by folding or rolling. The part of the sheet on which a line of the original is written, is brought close to the part of the other sheet on which the corresponding line of the duplicate is written. The line of the original and of the duplicate are formed at the same time, by two pens fixed in the socket of one handle. The handle is held like a pen in the usual way. See *Repertory of Arts*, vol. xxvii. and xxxi. For Mr. Hawkins' and Mr. Brunel's polygraphs, see *POLYGRAPH*.

COPYRIGHT.

COPYRIGHT is the right which an author, or the publisher, or other person, to whom he transfers it, possesses to the *copy*, or original manuscript, of his works, and to the use and benefit, or profit, derivable from publishing them.

PART I.

OF THE TERM OF COPYRIGHT.

SECTION I.—BY THE COMMON LAW.

It is only since the invention of printing that any question as to the extent or duration of copyright could be expected to occur in the courts of justice. To take an author's manuscript without his consent was, of course, a criminal act, and punishable in proportion to the amount of the offence; according as the circumstances might constitute a fraud or theft. A single copy was then of much more value than after printing had multiplied the number of copies. The great manual labor necessarily bestowed on each copy, and the few readers at that time, rendered the publication of insignificant importance compared with what it has since become. We are not, therefore, to look for any very ancient records of the legal recognition of literary property, or of remedies against its infringement.

Printing was first introduced in England about the year 1471. During the arbitrary reigns which succeeded its establishment, the works which issued from the press naturally became the immediate subject of state regulations. The earliest evidence which occurs on the subject is to be found in the decrees of the Star Chamber. The authority of that arbitrary tribunal we are quite willing should be estimated as low as possible; but, in adducing the authorities which support the right in question, we are justified in pointing out that even the Star Chamber respected the rights of authors, and prohibited the printing of works without the consent of their owners.

Of the judges in recent times, before whom the title to perpetual copyright has been discussed, the majority have decided that by the

common law of England an author is entitled to the exclusive enjoyment of his copyright in *perpetuity*. The judges, however, were not unanimous, either on the point of common law, or of that of the legal effect of the statute of Anne, and we cannot deem it sufficient merely to describe the actual state of the law; especially as the subject is one of literary interest, and the glaring injustice of the existing regulations can scarcely be permitted long to continue.

We purpose, therefore, to relate briefly the progressive stages of the law; to consider the question according to the best legal authorities; to examine the meaning of the statute of Anne; the decisions of the various courts of justice; the objections to a perpetuity of the right; and its general policy and justice.

1.—Recognition of the Right by Acts of State.

In 1556, by a decree of the Star Chamber, it was forbidden to print against the force and meaning of any ordinance, &c. in any of the statutes or laws of the realm. By another decree in 1585, every book, &c. is to be licensed; 'nor shall any one print any book, &c. against the form or meaning of any restraint contained in any statute or laws of the realm, or contrary to any allowed ordinance set down for the good government of the Stationers' Company.' In 1623, by a proclamation reciting the above decree, and that the same had been evaded 'by printing beyond sea such allowed books, &c. as have been imprinted within the realm by such to whom the sole printing thereof by letters patent, or lawful ordinance or authority, doth appertain.'—And then the proclamation enforces the decree. Again, in 1637, by another decree, no person is to print or import any book or copy which the Company of Stationers, or any other person, hath or shall by any letters patent, order, or entrance in the register book, or otherwise, have the right, privilege, authority, or allowance solely to print. This decree evidently supposes a copyright to exist 'otherwise' than by patent, &c. which clearly could be by no other authority than the common law.

These appear to be all the acts of state relative

to the matter. Most of the judicial proceedings of the Star Chamber being lost or destroyed, no case of prosecution for printing without licence, or pirating another man's copy, has been found. But it is certain that, down to the year 1640, copies were protected and secured from piracy by a much speedier and more effectual remedy than actions at law or bills in equity. No licence could be obtained 'to print another man's copy;' not from any prohibition, but because the thing was immoral, dishonest, and unjust, and he who printed without a licence was liable to great penalties.—(4 Burrow, 2313). In 1640 the Star Chamber was abolished, and afterwards all regulations of the press by proclamations or decrees were deemed illegal. The licentiousness of the press, however, induced the two houses to make an ordinance which prohibited printing, unless the book was first licensed and entered in the register of the Stationers' Company. Copyrights, in their opinion, then could only stand upon the common law—both houses take it for granted. The ordinance, therefore, prohibits printing *without consent of the owner*, or importing (if printed abroad) upon pain of forfeiting the same to the *owner or owners* of the copies of the said books, &c. This provision necessarily supposes the property to exist; it is nugatory if there was no owner, and an owner could not at that time exist but by the common law.—(Ibid). In 1644 Milton published his famous speech for the liberty of unlicensed printing against this ordinance, and among the glosses which he says were used to color the ordinance and make it pass, he mentions 'the just retaining of each man his several copy; which God forbid should be gainsaid!' As one of the judges remarked on the argument in *Miller v. Taylor*, the authority of Milton, an enthusiast for liberty, is worth all the abstruse reasoning deduced from the rules of property in a supposed state of nature.

2. Recognition of the Right by Acts of Parliament.

In 1649 the long parliament made an ordinance which forbids printing any book legally granted, or any book entered, without consent of the *owner*, upon pain of forfeiture, &c. In 1662 the act of 13th & 14th Charles II. (the licensing act) prohibits printing any book unless first licensed and entered in the register of the Stationers' Company. It also prohibits printing without the consent of the owner, upon pain of forfeiting the book and 6s. 8d. each copy; half to the king and half to the *owner*; to be sued for by the *owner* in six months. The act therefore supposes an ownership at common law, and the *right* itself is particularly recognised in the latter part of the third section of the act, where the universities are forbid to meddle with any book or books, the *right* of printing whereof doth *solely and properly belong to any particular person or persons*.

The various provisions of this act effectually prevented piracies without actions at law or bills in equity by owners.

The licensing act of Charles II. was continued by several acts of parliament, but expired in

1679. Soon after which there is a case in Lilly's Entries, Hilary term, 31 Charles II., of an action brought for printing the Pilgrim's Progress 'of which he was and is the true proprietor, whereby he lost the profit and benefit of his copy.' But it does not appear that the action was proceeded in.

The licensing act was revived by 1 James II., cap. 7, and continued by 4 W. & M., cap. 24, and finally expired in 1694. Such is the state of the evidence as deduced from the acts of government and the legislature in the most despotic and unsettled times, and the inference is obviously strong, that if at those periods the rights of literature were respected, when, if ever, they were liable to abuse, they ought much more to be regarded and protected in an age like the present, which owes its improvements to the diffusion of knowledge.

We have next to turn to the only other source from which any public testimonials can be derived of the ancient usages and regulations which bear on the question, namely,

3. Ancient Custom of Entries in the Registry Books of the Stationers' Company.

It appears there is no ordinance or by-law relative to copies till after 1640; and yet from the erection of the Company, in 1556, copies were entered as property and pirating was punished. In 1558, and down from that time, there are entries of copies for particular persons. In 1559, and subsequently, there are persons fined for *printing other men's copies*. In 1573 there are entries which take notice of the *sale of the copy*, and the *price*. In 1582 there are entries with an express proviso 'that, if it be found *any other* has right to any of the copies, then the licence, touching such of the copies *so belonging to another*, shall be void.'

Before the reign of queen Anne it was usual to purchase from authors the perpetual copyrights of their works, and to assign them from hand to hand for valuable considerations; and to make them the subject of family settlements. Thus we find that, by the by-law of the Stationers' Company made in 1681, it is stated that divers of the members of the Company had great part of their estates in copies, and that, by the ancient usage of that company, when any books or copies were entered in their register to any of the members of that company, such persons were always reputed the proprietors of them, and ought to have the sole printing of them. By another by-law in 1694, after the above recitals, and stating that the copies were constantly bargained and sold amongst the members of the company as their property, and devised to their children and others for legacies and to their widows for their maintenance, it is ordained that, when any entry shall be made of any book or copy, by or for any member of the company, in such case if any other member shall, without licence or consent of the member for or to or by whom the entry is made, print, import, or expose to sale, &c., they shall for every copy forfeit twelve pence. Such is the legal and historical evidence down to the time of the act of 8 Anne.

SECT. II.—BY THE STATUTES.

It is evident from the preamble of the act passed in the year 1710, 8 Anne cap. 19, that the act was not introduced on the part of the public to restrain the duration of copyright. The imaginary evil of its perpetuity (which will be presently investigated) was not then suggested. It is manifest, on the face of the act, that it originated with the aggrieved authors and publishers. The important effects of the art of printing had become generally felt. The great demand for literary works excited the exertions of the booksellers and publishers, and it appears that all the members of the fraternity did not confine themselves to their own productions, but to supply the increased demand committed deceptions on the literary property of their contemporaries. It was natural that the greater part, if not all, of these dishonorable transactions should be committed by the lowest class of publishers, who were incompetent to pay any damages that might be recovered against them. The proof of the extent of the damage was also difficult, and it was therefore desirable that penalties and forfeitures should be inflicted, to protect the growing importance of literary property.

The act recites that printers, booksellers, and other persons, had of late frequently 'taken the liberty [not claimed the right] of printing and publishing books and other writings without the consent of the authors or proprietors, to their very great detriment, and too often to the ruin of them and their families. 'For preventing, therefore, such [mal] practices for the future, and for the encouragement of learned men to compose and write useful books, it was enacted that the authors of books already printed who had not transferred their rights, and the booksellers who had purchased copies, should have the sole right of printing them for the term of twenty-one years, and no longer; and the authors of books thereafter printed, and their assigns, should have the sole right for fourteen years, and no longer. But it was provided that, after the expiration of that term, the right should return to the author, if then living, for another fourteen years. And then it enacted the forfeiture of all books printed without the consent of the proprietor, and inflicted a penalty of one penny for every sheet: half the penalty to the crown, and the other to the informer. In 1801, by the 41st Geo. III. cap. 107, the penalty is increased to threepence per sheet. And, that 'persons may not through ignorance offend against the act,' the forfeitures and penalties do not attach unless the title to the copy of the book be entered in the register of the stationers' company. By the 15th Geo. III. cap. 53, sect 6, the title to the whole book and every volume thereof must be so entered. It was provided by 8 Anne that the act should not extend either to *prejudice or confirm* any right that the universities or any person had, or claimed to have, to the printing or reprinting any book or copy already printed or thereafter to be printed.

The act authorised the archbishop of Canterbury and other dignitaries to settle the prices of books, upon complaint made that they were un-

reasonable. This clause was repealed by 12 Geo. II. cap. 36, which at the same time prohibited the importation of books reprinted abroad which had been first composed and printed in Great Britain.

In 1814, by the 54th Geo. III. cap. 156, the term was extended from twenty-eight years *conditionally* on the life of the author, to the same term *absolutely*; with a further extension in favor of the author till his death, if he survived the twenty-eight years; and the advantage is given to the authors then living of books published before the act. We confine the statement of the statutory provisions in this place, to those which relate to the *duration* of the copyright, and refer to their appropriate sections the other enactments. The great question which has been discussed in the courts of justice regarding the limits of literary property depended on the construction of the 8th Anne. Before adverting to the grounds of the interpretation which was put upon it, we deem it appropriate, in the order of time, to notice the legal decisions which took place from the passing of the act in question down to the year 1774, when, contrary to all the previous decisions, it was for the first time determined by the house of lords that the common law right was merged in the statute.

SECT. III.—LEGAL DECISIONS ON THE QUESTION OF PERPETUITY.

1. The earliest decisions on the general question of literary property occurred in the *courts of equity*, which were resorted to as affording a more speedy remedy against invasions of copyright by an immediate injunction, than could be obtained by an action at law for damages. Numerous decisions took place, founded upon the principles of the common law, and on the supposition that a *perpetual* copyright belonged to authors and their assigns. The question upon the common law right to old copies of works could not arise till twenty-one years from the 10th of April, 1710, consequently the soonest it could arise was in 1731. In 1735 an injunction was granted by Sir Joseph Jekyll to restrain the printing of the *Whole Duty of Man*, the first assignment of which had been made seventy-eight years before that time. In the same year lord Talbot restrained the printing of Pope's and Swift's *Miscellanies*, though many of the pieces were originally published prior to the act, namely in 1701-2 and 1708. In 1736 Sir J. Jekyll granted another injunction for printing Nelson's *Festivals and Fasts*, though printed in 1703 in the life-time of the author, and he died in 1714. In 1739 an injunction was ordered by lord Hardwicke against printing Milton's *Paradise Lost*, the title to which was derived by an assignment of the author *seventy-two years* antecedently. And in 1752 another injunction issued in favor of Milton's *Paradise Lost*, with his *Life* by Fenton, and the notes of all the former editions. It was an injunction to the whole, so that printing the poem, or the life, or the notes, would have been a breach of the order. It has been urged in objection, that these injunction cases were only preliminary decisions, and that none of the suits were brought to a final hearing

Great caution, however, has been always exercised in granting injunctions at the commencement of a suit, because, if on further investigation it should be found erroneous, the loss of a defendant does not admit of reparation. The judgment therefore has been invariably given with great deliberation, and lord Mansfield said 'he looked at the injunctions which had been granted or continued before hearing as equal to any final decree; for that such injunction never is granted upon motion unless the legal property is made out, nor continued after answer unless it remains clear. The court of chancery never grants injunctions in cases of this kind when there is any doubt.' (4 Burrow, 2303). And lord Eldon, in *Hogg v. Kirby*, referring to the view taken by lord Mansfield, says that 'in these cases a court of equity takes upon itself to determine as well as it can the right in this period, and with a conviction that, if then the cause was hearing, they would act upon the same rule. The court takes upon itself that which may involve it in mistake, to determine the legal question. It is the decision of a judge sitting in equity upon a legal question, and therefore not having all the authority of a decision of a court at law, but giving an opinion, and pledged to maintain it, unless there should be occasion to alter it.' (8 Vesey, 224). So in the case respecting the publication of Lord Melville's *Trial*, lord Erskine observed that 'he was so much convinced by the arguments for the defendant as to the effect of an injunction, that unless he had a strong impression that at the hearing he should continue of the same opinion, and should grant a perpetual injunction, he would not grant the injunction then; which he only did as there was no probability that new facts would appear by the answer.' (*Gurney v. Longman*, 13 Vesey, 505). There are several cases reported upon questions regarding infringements of copyright *within* the period protected by the statutes: to these of course it is unnecessary to advert, as the general principle was not in any way included in the determination.

2. The general question was first argued in a *court of law* in the case of *Tonson v. Collins*, in the year 1762, relative to the copyright in the *Spectator*. It appears from the best authority, that so far as the court had formed an opinion, they all inclined to the plaintiff; but having received information that although the argument was conducted *bonâ fide* by the counsel, it was a collusive proceeding between the parties for the purpose of obtaining a judgment, which might be set up as a precedent, they refused to pronounce any decision. (1 Blackstone's Reports, 301, 321. 4 Burrow, 2327.) In the year 1769 the subject was discussed at great length with respect to *Thomson's Seasons*, in the case of *Millar v. Taylor* (4 Burr. 2303.) There was a difference of opinion in the court. Lord Mansfield and judges Aston and Willes were in favor of the right, and judge Yates against it. Judgment was of course given according to the opinion of the majority. In 1774 the subject came before the house of lords in the case of *Donaldson v. Beckett*, when it was finally determined that *an author has no property in his*

copyright, otherwise than according to the terms of the statute. The majority of the judges were of opinion that there was a right at common law, namely, judges Ashurst, Blackstone, Willes, Aston, Gould, Adams, the lord chief baron, and the lord chief justice of the common pleas, besides lord Mansfield. Of the opposite opinion were lord Camden, barons Eyre, Perrott, and Adams, and judge Yates. But there was a majority of seven to four that the right was restrained, or taken away by the statute which prescribed the term of fourteen years, and no longer.

SECT. IV.—CONSTRUCTION OF THE ACT OF 8 ANNE.

1. It is remarkable in the constructions put on the statute of Anne, which it was contended had the effect of merging the common law right, that such right is admitted and recognised by providing a *remedy* for the injury, although at common law we are told there is *no injury* whatever. The statute professed to encourage learning, and to prevent 'the printing of books without the consent of the authors or proprietors, to their detriment,' &c. Its object was avowedly not to limit the right, but to facilitate the remedy; yet it has been construed to reduce a perpetuity to a short term of years! In giving an additional protection to literary property, by inflicting a penalty, there might be some reason for limiting that species of punishment to a definite period. The penalty is not reserved to the author, but given to any one who may sue for it; and it is obvious therefore that it was designed as an act of *public* justice, independently of the *private* right to compensation at common law.

2. It should be recollected also that it was a remedial statute, and ought to have been construed liberally; instead of which, the contrary principle was adopted, as if the object of the act, as well as justice and policy, had required the *suppression* of literature, rather than its encouragement.

3. It is important to observe that the bill on which the act was founded, went to the committee as a bill to secure the undoubted property of copies for ever. By the law and usage of parliament, a new bill cannot be made in a committee: a bill to secure the property of authors, could not be turned into a bill to *take it away*. What the act gives, with a sanction of penalties, is for a term: the words 'and no longer' add nothing to the sense. Besides which, the proviso is express that the act shall not extend, to *prejudice* any right, not only of the universities, but of *any person*.

4. It is admitted that there is a perpetual right in a literary work *before* publication, and that such right exists according to the common law. Various cases in equity have been decided on this point, all of which are allowed by the opponents of perpetual copyright to be correctly determined. It is evidently most inconsistent to deny the right *after* publication, which is admitted to exist before it. A man it is granted may maintain trover or trespass for taking his manuscript; but how are the damages to be estimated! Surely not by the price of the paper, but the profit of the publication; and yet we are told he cannot appropriate to himself the advan-

age of publication. Whilst the work continues in manuscript, it can be of little or no value to him, and of none to the community. During that time he is welcome to it, but so soon as he is enabled to derive a profit for his labour, he is then told, 'it belongs to the public.' Such are the inconsistencies of injustice.

5. It has been also granted that the king's copyright continues *after* publication, and is in fact perpetual according to the common law. There are several cases reported in the law books for violating patents for prerogative copies after the expiration of the period limited by the statute (2 Shower's Reports, 258.—Modern Reports, 256). These cases prove that a copyright was a thing acknowledged at common law; since if the king had not the right, he could not grant it to the patentee. It is clear that the king by his prerogative has no power to *restrain* printing, which is a trade and manufacture; or to grant an *exclusive* privilege of printing any book whatsoever, except as a subject might, by reason of the copyright being his property. It is settled then that the king is owner only of the copies of all books or writings which he had the sole right originally to publish; as acts of parliament, orders of council, proclamations, and the common prayer book. These, and such like, are his *own* works, as he represents the state. So likewise where by *purchase* he had the right originally to publish; as the Latin Grammar, the year books, &c.; and in the last cases the property of the crown stands exactly on the same footing as private copyright: as to the year books, because the crown was at the expense of taking the notes; and the Latin Grammar, because it paid for the compiling and publishing it.

6. The right of the two universities in England, and the four in Scotland, with the colleges of Eton, Westminster, and Winchester, and Trinity College, Dublin, to a perpetuity in their copies, is now founded upon the statute law; but it is evident they were as much astonished at the decision in *Donaldson v. Beckett*, as any private author or publisher. After that decision they flew to parliament to reinstate them in their rights, and the act, which was immediately passed in 1775, is a virtual overthrow of the principle on which the house of lords had proceeded. There can be neither sense nor justice in allowing to these wealthy corporations a right which is denied to individuals. The universities, in their *corporate* capacity, have done nothing to merit the exemption. They are collectively behind the literary and scientific world in modern improvement. Nothing nationally great has originated from them to justify the granting of peculiar exemptions, and they are better able to bear the wrong which the laws inflict than individuals. The act obtained by the universities (15 Geo. 3, c. 53,) commences by reciting 'that authors may bequeath or give the copies of books composed by them to these universities and colleges, and may direct that the profits shall be applied as a fund for the advancement of learning, and that such useful purposes will frequently be frustrated, unless the sole printing and reprinting be secured to them in *perpetuity*.' Now it is not manifest that if the universities, as the

LEGATEES of authors, be entitled to this protection, the authors themselves are on every principle still more entitled to it? We admit of course that the universities are in possession of no more than their just and legal rights; but we maintain that private individuals, as well for their own sakes as for the interests of science and literature, are at least equally, if not in a higher degree, entitled to legal protection.

SECT. V.—OBJECTIONS TO THE PERPETUITY CONSIDERED.

1. The opponents of copyright insist that there is no authority at common law to support the claim of a perpetuity, and that *the custom* of exercising the right (if it ever existed) is not immemorial. The evidence on the first part of the objection has already been detailed in the first section, and the custom has been shown to exist ever since the invention of the art which gave value to the property in question. The claims of justice do not depend on antiquity. The principles of the unwritten law are indeed of the highest antiquity; but the objects to which they are applicable may be recent. There are many things, the uses of which were unknown in ignorant times, that have now become valuable, and it is as monstrous to shut out from legal protection the intellectual labors of ingenious men, as it would be to declare that the mariners' compass and gunpowder, which were inventions within the period of legal memory, cannot be included in the laws of property. The absence of judicial authority can form no objection to the claim. It was not decided till the year 1732 that a title to literary property could be maintained prior to publication; yet it is admitted, on all hands, that it was correctly determined (according to the principles of the common law) that no distance of time, however great, could authorise a publication without the consent of the author; as in the cases of Lord Clarendon's History and the Letters of Pope. Many points of law have been decided in recent times, for which there is no precedent. For instance, it is not many years since it was held actionable at common law to give knowingly a false character, on the faith of which credit had been given and loss sustained. The great maxim of the common law is, that there is *no injury without a remedy*.

2. Ideas, it is said, cannot be an object of property. Without entering into the abstract argument of the origin of property, it may be sufficient for all rational purposes to observe, that there is no real distinction between the rights of literary and landed property. Mr. Justice Blackstone classes literary compositions amongst the species of property acquired by *occupancy*, since they are grounded on labor and invention. On the question of the right to an exclusive enjoyment of the profit of the publication, he says, 'When a man by the exertion of his rational powers has produced an original work, he seems clearly to have a right to dispose of that identical work as he pleases; and any attempt to vary the disposition he has made of it, appears to be an invasion of that right.' (2 Commentaries 406.) The distinction cannot depend upon the degree of labor bestowed in the acquisition of land, for that is

often possessed without labor, and originally acquired as often by good fortune as by merit. The property in a literary work may be acquired in the same way. The first thought may have been accidental, and labor has enlarged and improved it. Wherefore is it that the posterity of those who have produced intellectual treasures should not inherit them, as well as the descendants of the accumulators of land or money? To say that the *definition of property* in the old legal authorities does not include the property in question, is nothing to the purpose. If it does not include it, the definition is a bad one, because it is not sufficiently comprehensive. Besides, if it possesses none of the usual characteristics of property, let it form a class of itself. Injustice should not be done for the sake of preserving consistency in verbal or metaphysical distinctions.

‘Nothing is more erroneous (says professor Christian) than the practice of referring the origin of moral rights, and the system of natural equity, to that savage state, which is supposed to have preceded civilised establishments; in which literary composition, and of consequence the right to it, could have no existence. But the true mode of ascertaining a moral right is to enquire, whether it is such as the reason, the cultivated reason of mankind, must necessarily assent to. Under whatever denomination of rights literary property may be classed, it seems founded upon the same principle of *general utility of society* which is the basis of all other moral rights and obligations.’ 2 *Comm.* 407. *Notes.*

It is granted that an author possesses a legal property in his literary labors whilst they remain in manuscript. But what real distinction can there be in the nature of the property; as it respects either the sentiments or the language, before publication and after? The law prohibits the publication, of his manuscripts without his consent, why should it not also protect the printed copy, and prevent the appropriation of the profit by any other person than the author?

3. But it is said, *others may arrive at similar conclusions.* It would be difficult to ascertain the right owner, and it would inconveniently increase litigation.

There is here an unfounded assumption. It is impossible for any two men to compose a work precisely similar, for no two minds are alike. They may arrive, indeed, at the same ‘conclusions.’ Thinking upon the subject, the truth may be apparent to both; but each will proceed by different methods, and those who are skilled in criticism would have no difficulty in determining which of the two was the plagiarist; and an intelligent jury, aided by competent witnesses, by the learning of the bar, and by the assistance of the bench, would surely be able to determine whether the work was colorably pirated from another, or an original and *bonâ fide* production.

But admitting that there might be occasional difficulty in identifying the works of one author from another, such cases would be rare. Are we to abandon the property in general, because it sometimes may be troublesome to ascertain it? There is frequent difficulty in identifying other species of property, nay, even in identifying persons; but no one has yet been wild enough

to propose the abolition of the laws of property, because the evidence of ownership is often doubtful. We do not conceive the difficulty would be greater in this, than in many other kinds of property. There are no insuperable obstacles in identifying a literary work within the time already limited by the statute, and the same rules might be applied if the time were extended.

That it will give rise to litigation, so long as men are dishonest, cannot be doubted; but the same occasional evil prevails in every kind of property. He who prints and publishes another man's copy, or makes such voluminous extracts from it as to injure its sale, knows, as well as the depredator of any thing else, that it is not his own; and if he has no sense of rectitude, he should be taught by the law that it is wrong, and punished either in purse or person for his transgression. There would be no greater degree of litigation than in proportion to the number of violations of the law of copyright, and the inclination of the injured to seek redress. Let the experiment be tried, and there will be no difficulty in providing remedies for any evil that may casually arise in the execution of the law.

4. *The composition is the property of the writer whilst in manuscript, but the act of publishing gives it to the world.* If there be any force as to mere legal reasoning in this objection, there is none as to reason or common sense. By the publication the author gives nothing whatever. He sells each copy for its price, and the purchaser may do what he pleases with the copy, except printing other copies. He may make use of the language and sentiments it contains in any way he thinks proper, except to the injury of the author. He may quote or abridge passages to improve his own works, provided the extracts be not of unreasonable length, or have not the effect of injuring the sale of the original. He may also lend or sell his copy, and may make a profit by the loan or sale. But he cannot appropriate to himself the profit derivable from the sale of other copies, the right to print which was never sold. The purchase he has made is for his own use, not the use of the public, and he must abide by the reasonable conditions of his bargain. It may be compared to the case of a proprietor of a theatre, who grants for a certain price a ticket of admission, which, if transferable, the purchaser may lend or let on hire; but who ever supposed that he had a consequent right to multiply copies, and sell them to the injury of the proprietor? So in the instance of a public water company, the contract includes the unlimited use by the person who pays for it, but conveys no right to vend the smallest portion. By analogy, therefore, to other kinds of limited sale, as well as from the reason of the case, it is clear that the act of publishing is no dedication to the public, so as to make the property common to all.

5. Another objection is, that the *patentees of mechanical inventions possess but a limited term*, and therefore, that the authors of literary or scientific works should be satisfied with the same measure of legal protection.

We shall not enter into the argument of the distinction between the superior and immediate profit derivable from machinery compared with literary improvement, for we are not satisfied it is well founded. 'It would be difficult,' said Mr. (afterwards lord) Thurlow, 'to confine this right merely to books, and not to extend it to other inventions. A learned author (bishop Warburton) has endeavoured at it, and brangled it and made sad stuff of it, he attempts a distinction between the labors of the head and of the hand; but in some machines the labor of the head is greater than that of the hand. Sir Isaac Newton had no other property in his Principia than lord Orrery had in his machine. If the labor of the head gives the right, the property is just the same; and it is possible that the invention of the mouse-trap cost its author the same labor of the head, that the Orrery did its nobler contriver; so that this ground of property depends entirely upon the difference of heads.' *Tonson v. Collins*, (Bl. Rep. 301.) But we rest on this—if there is a distinction in fact, we are glad the patentees suffer less wrong. If not, they are common sufferers, and should take part in seeking redress. It is a proof of the straits to which our opponents are driven, when they excuse one act of injustice by another.

6. It is objected, that it would prolong the power of the owner to deal with the public as he chose, and that he might *either suppress a valuable work, or put an exorbitant price upon it*; in both of which events the public would be injured.

The fear of *suppression* may be easily provided against. If the proprietor does not reprint the work when required, within a reasonable time, there would be no injustice in considering the copyright as abandoned. It is replied, that there would be a difficulty in proving an abandonment. We do not perceive the difficulty, at least in the majority of instances; and regulations, which experience would suggest, might be adapted to circumstances. Generally speaking, if it were worth while to reprint a work, the copies of which were exhausted, it would not be abandoned. Where it was out of print, notice might be given to the last publisher, and entered in the registry of the Stationer's Company; and if at the expiration of a certain length of time, (perhaps proportioned to the magnitude of the work,) it were not reprinted, it might then become common property.

There is no probability that the *price* of literature will be enhanced more than the price of land. Some ages ago a large price might have been required, and, as the demand was then limited, a high price was not unjustifiable. But since the development of the true principles of trade, there can be no apprehension of such a result. Every publisher now knows that the cheaper he sells his books, the greater is the sale, and that a small profit upon a rapid and extensive sale is ultimately more advantageous than a larger profit upon a slow and limited one. The more valuable the work, the cheaper it might be sold, on account of the greater number of purchasers. It is only of indifferent works which

are little demanded, that a high price could be necessary. So that the evil cures itself, and both the cause of literature and the interest of the public would be promoted, by enabling the proprietors of this kind of property to deal with it as unreservedly as with any thing else. Surely if the principle of free trade should any where be acted upon, it ought to prevail in favor of the press, that great instrument of national knowledge and improvement, and by which all other improvements are so much extended and promoted. Besides, the price might be restrained by a jury. Compensation for property is settled on many occasions under acts of parliament for roads and canals. It would be competent for an author or proprietor to prove the *capital* invested, and learned men might be called to estimate the *skill*, and publishers to prove what would be a fair or liberal remunerating price.

But then it is said if there be an actual right, it is improper to restrain it. We have no wish that it should be restrained: we do not apply for the restraint; we think it not only needless, but objectionable and unjust. We conceive that every man's own interest will be the best protection to the public for the fair exercise of the right. It is so in all other arts and trades, and why should it not be the same in those of printing and publishing? But if we cannot have the right without the restraint, we will submit to it. It is an odd objection that denies a right, because if exercised it may be injurious, and then rejects the restraint, because all restraints are reprehensible.

7. Glory (say the advocates of limited copyrights) is the reward of science, and those who deserve it scorn all meaner views. It was not for gain that Bacon, Newton, Locke, &c. instructed the world. There are various unanswerable replies to this piece of rhetoric. First. The question is not what are the motives of an author, glory or gain? but what is due in justice from the public to those who have conferred benefits upon it. *What is right?* If the benefit be perpetual, why should not the reward? If Shakspeare has left us volumes of intellectual gratification, which can die only (nay not even then) with the language in which they are written, why should not his descendants (long reduced to poverty) derive the benefit which justice demands, and which gratitude would cheerfully pay? Granting that Nelson and Wellington were stimulated to their immortal exertions by glory alone, do we owe them nothing because they have their reward? Were the titles and the wealth that were bestowed upon them needless? Besides, it may be asked, how do the national rewards of *substantial* property act in the way of excitement upon the conduct of others? Has the perpetual entailment of Blenheim had no influence upon the minds of subsequent warriors?

Secondly. Different men are compounded of different materials. The objection supposes all men alike; that all are influenced by the predominant passion of ambition. It is an objection founded in utter ignorance of human nature. A very large class certainly are desirous of renown. But there are *other classes besides*.

the ambitious: many men love their parents, wives, children, and kindred, and to that intense degree, that they will exert their powers more eminently for them than for the empty buzz of strangers or of distant posterity. Do these lawyer-like reasoners suppose that all men of warm affections are dolts, and that the stern and cold man of ambition is the only inheritor of genius and greatness? Now a man of this kind may care but little for 'gain' so far as he is personally concerned; but, for the sake of those who are dearer to him even than 'glory,' he may bestow more labor than the merely ambitious man, and wherefore should he not be permitted to receive that which the public would readily and gladly pay? Who is there that reads the *Paradise Lost*, that would not be delighted to know that, in paying its price, he had contributed his mite to avert the penalty in which had died the last descendant of its author? It is any thing but philosophical to talk of men in general as exerting themselves *disinterestedly*, and as 'scorning all mean views.' Small must be the knowledge of human nature which ventures upon such declamation. There are men of the strictest integrity, who far surpass the generous and the ambitious in acts of justice, and yet are influenced by motives of gain. Are all men who desire to be paid for the services they perform, mean?

Authors are not a peculiar race of men, able to live on the air, 'glory-crammed.' Neither, we suspect, were the judges who reasoned with such loftiness, able to live on the renown of administering the laws with impartiality!

There is yet another class, the most numerous of all, who are not actuated by any simple predominant motive, to whom neither glory, nor gain, are master passions, but who are influenced by *mixed motives*, and would bestow greater exertions if their social as well as their selfish feelings were gratified. Why should we not use all the means which justice permits, to incite men to the exertion of their best faculties? He who can by his works obtain not only the prospect of future fame, but the substantial advantage of immediate recompense, with a provision for his family after his death, will labor with greater diligence than those who are incited only by the desire of posthumous renown.

The reward of glory may indeed stimulate the production of works of pure genius, and the more especially as the exercise of the imagination is so peculiarly delightful; but this cannot be the case in an equal degree in the department of philosophy. Great, persevering, and often painful labor, is necessary to the accomplishment of many works of science, and therefore every possible inducement should be *added*, instead of being *diminished*, that may tend to encourage the prosecution of such labors.

Besides, an author, who wished for no other reward than 'renown,' might still exercise his liberality, and either present his labors gratuitously to the public, or bestow them on some meritorious object. He can do so now in favor of the universities, and the glory of the bequest would be the greater, because it would be more rare and generous.

SECT. VI.—OF THE JUSTICE AND POLICY OF UNLIMITED COPYRIGHT.

1. In examining the objections to a perpetuity of the right, we have stated several arguments, which prove both the justice and policy of placing literary on the same footing as other kinds of property. Referring to those statements, we have now to point out some general considerations, which could not appropriately be introduced in any other place. It is boasted of the laws of England, that they provide a remedy for every injury; and wherefore, we demand, should the wrongs of literary men be the only exception to this wide rule of general relief? The labor of the mind surely deserves as much protection as that of the body. Whatever may be suggested by the subtlety of legal reasoning, or the abstract definitions of the origin of property, no just (not to say liberal) man would deny that protection to the fruits of literary labor, which is given to those of every other kind. The same principle which establishes the policy as well as the justice, of guarding from invasion the accumulations made by *manual* industry, must confirm the right to the acquirements of *intellectual* industry. If property be not protected, it will not be acquired. The interest, the very existence of society, is inseparably connected with the encouragement of industry. And, as national wealth depends upon national labor, so does knowledge depend on intellectual exertion. But neither the corporeal nor the mental powers will be freely or fully exerted, unless they receive *without restraint* the beneficial produce of their exertion. Above all, this great principle should always be remembered that *whatever is the most just will ultimately be the most beneficial*. Honesty is at all times the best policy.

2. It is always a great evil that laws, if just, should be evaded; for there is not only the immediate injury to justice of the specific violation, but a general weakening of the salutary reverence which is entertained for national laws when founded on principles of reason and equity. Now both authors and the publishers to whom they have assigned their works, have a strong feeling that the limitation of copyright to the period of twenty-eight years is inconsistent with the regulations of all other arts and professions, at variance with the commonest principles of free trade, and equally injurious to authors and publishers; without any correspondent benefit to the public. It is natural, therefore, that every effort should be made to elude the consequences of that which they correctly think is an arbitrary and irrational infringement of their own rights, and of the property of their families: of a patrimony often earned at the expense of health and of the abridgment of life. And whilst acting under such feelings, there are few even of the coldest-hearted legislators, who would visit with much censure the plan of ingenuity and contrivance which has been resorted to by the parties interested, in saving themselves as much as possible from injury or diminishing its magnitude.

The proprietor of the copyright prior to its expiration takes care to prepare a new edition with

notes, and though the original work becomes common property, the notes are protected, on the ground of their constituting an original composition. By a sort of combination also amongst the principal booksellers, these new editions 'with notes,' receive a preference over others. The interpretation which the judges have put on this mode of publication, is exceedingly liberal; but, if it be right that publishers should resort to these expedients to protect their property, the law should allow it to be done openly instead of surreptitiously. An honorable man must revolt against a system, which subjects him to lose his property, or to practise devices and evasions which out of respect to the laws of his country he must dislike. And although by these means the mischief is somewhat practically diminished, much of it unavoidably remains. The work may not really require any notes, either of explanation or addition, or they may be such as the humblest talents can supply. There are, it is true, some subjects which are undergoing continued change, and the publications which treat of them require proportionate alterations. But if not so, the work is encumbered with useless comments, or the name of some eminent author is appended to a new edition, which the commonest writer might equally well supply.

3. On the policy of perpetual copyright, it has been demanded, What good would it produce to the public? The question ought to be, 'What evil?' for if there be no evil, there ought to be no restraint. But it is obvious that justice and policy are here (as they always are upon the whole) inseparable. By the extension of copyright the public would have *superior and cheaper publications*. By the present system, authors are discouraged from undertaking works which would become of standard usefulness, because such works demand the labor of a large portion of life; and, as that labor is not now rewarded in a sufficient degree, they apply their talents to the hasty composition of publications of merely temporary interest. Instead of selecting the important and useful, they consult the fashion of the age, and write to gratify some peculiar excitement which is productive of immediate profit, but generally terminates with the novelty of the occasion. The labor and expense of a work of great utility or magnitude, and the research and care which it demands, cannot be encountered in many instances so long as the law remains in its present state. We do not here speak of the works which are costly in their embellishments and illustrations, but of the purely scientific and literary labor which they demand; of the investigation of ancient records and scarce and abstruse works; of the comparison of conflicting documents, and the task of judicious selection from large masses of materials; of the accuracy with which all these things should be done, in collecting the materials, in adopting the best arrangement, and in selecting the most appropriate language; for all which much time and leisure must be allowed, or with the greatest talents the work will be imperfectly executed. We have here supposed a production chiefly of learning, research, and judgment. But if it be one of striking originality, the invention of a new sys-

tem, the task of experiment and induction may require a still wider range of exertion and longer continued perseverance, which it is not reasonable to suppose will be often bestowed without superior recompense. Now it is manifest that, if the period were extended, publishers could afford to pay a larger price to authors for their copyright in works of this valuable kind, because their interest in them would be of an enduring nature; and though the profit might not be rapid, its perpetuity would encourage them to undertake it. Furthermore, an author who possessed capital as well as talent might choose to embark it, and retain the entire copyright to himself and transmit it to his family.

The *cheapness* of a work would also be promoted, since the proprietor would not depend upon a sudden return for his capital, but might proportion his gain to the extent of its duration. As he would ultimately receive a better remuneration, he could afford to diminish its present amount. In order, however, to effect a sufficient reduction in the price of books, correspondent with that which they bear on the continent, the imposition of the presentation copies, the tax upon paper, and the duty on advertisements, should be abolished or greatly moderated; still the extension of copyright would be a commencement of a better state of things, and afford encouragement to effecting other improvements. Supposing, however, that no sensible diminution in the price of literary works should take place, it is evident at all events that the price would not be *increased*. And it is clear also that both the author and publisher would gain by it. The former would naturally obtain a superior price for that which was assigned *for ever*, compared with the limited period of twenty-eight years. And surely no one would object to the increase of the pittance which authors are in the habit of receiving, even if it should in a small degree enhance the price of literature; an effect, however, which we conceive would not take place; for the price is now as high as it can possibly be carried, and every means should be adopted to enable the booksellers to reduce it.

Not only individual publishers would gain by the extension, but it would promote the interest of publishers in general, if the property in a work were vested in the author and his assigns. Suppose that the moment a valuable book were published, every one had a right to pirate it, the effect would be that a general scramble would ensue to reprint cheaper editions than the original. A great number of persons would be engaged in doing the same thing; the market would be overstocked; none would be sufficiently remunerated; and all would be more or less injured. It would be analogous to permit the land of a deceased person to be retained by any one who could by stratagem or force obtain possession. Now something of the same kind must take place, though in a less degree, at the expiration of the statutory period; and although the evil is partially subdued by the evasions and combination before adverted to, still it cannot be generally avoided.

4. The consequences of the *injustice falls on the most useful authors*, whom it is the interest

of the public, in the highest degree, to protect and recompense. The best and most original works make the slowest advances in general circulation. Smith's *Wealth of Nations*, the labor of half a life, passed only through two editions in eight years. Hume's *History*, as well as his early philosophical works, fell dead-born from the press; and every one knows the obscurity in which Milton's immortal poem remained for many years. Before critics have passed their judgment, the public attention is not excited. Reviewers are not always impartial, nor always correct. Some of them may condemn from malice and prejudice; some from mistake and ignorance. The judgment of the public, therefore, may be misled, and it often requires many years to correct its erroneous impressions. Such will more particularly be the case with productions of a novel and original character. Discoveries, however important, are not always encouraged, particularly if they attack existing systems. Long time is often necessary to obtain even a candid hearing on some subjects, still more to render the works which treat of them sufficiently popular to recompense the author. It is a fact proved by indisputable evidence before a committee of the house of commons, that many important works of an expensive nature have not been published, owing to the hardships imposed by the law. A great part of that hardship is attributable to the heavy tax of the eleven presentation copies for the public libraries, which we shall presently examine; but much also of disadvantage arises, even as regards these costly publications, from the limitation of time, because the splendid engravings, which occasion the chief expense of many of these works, are equally doomed to common deprecation after the end of twenty-eight years.

5. No doubt it is wise to provide against evils; and if there were any good grounds for apprehending that the extension of the period would be productive of mischief to the public, it should certainly be refused. But we are *not without experience* on the subject.

It is now upwards of fifty years since the universities, by the 15 Geo. III. c. 53, obtained a confirmation of their right to the perpetual printing and publishing of their copies, and no disadvantage to the public, that we can learn, has yet arisen from its exercise; and to those fifty years must be added all the antecedent time during which they possessed the same undisturbed right. We, therefore, conclude that it may now be safely granted to the persons who were originally, and most naturally entitled to it; namely, the authors, from whom the universities themselves derived the advantage, and to whom they still look for similar donations.

6. *The state of the law in other countries* affords not only an additional and strong argument in favor of the policy of extending the rights of authors; but shows what other nations must think of the injustice of our regulations.

In France, the term of copyright is extended to twenty years after the author's decease. In Germany, it is *perpetual*. What is the consequence to literature and the public of this juster system? Do authors and publishers abuse the

power they possess? Do they suppress valuable works, or limit their usefulness by exorbitant prices? No! In France, as Dr. Johnson observed, they have a book on every subject. In Germany, the abundance of literary works is still more extensive. In both countries, the price of books is beyond all proportion lower than in Great Britain. Compare also the literature of France and Germany, where the one is limited (though *not* to the contracted period of twenty-eight years), and the other is free. Does the perpetuity of German copyrights render the writers less original or profound than those of France? Does it tend to superficiality? No! We believe there are of late years more great and original works of enduring excellence published by the German press than by that of any other country.

Let it be recollected also that most of the great works which constitute the glory of English literature were published prior to the interpretation of the law in 1774. True it is that, in spite of that interpretation, some additions of a standard nature have been made to the stock of national learning, but these have been encouraged by other means than acts of parliament; by the evasions of their exactions, and the irrepressible energy of a few of our distinguished countrymen.

SECT. VII.—OF THE TERM OF COPYRIGHT IN PRINTS, ETCHINGS, ENGRAVINGS, MODELS, STATUES, AND BUSTS.

The 8th Geo. II., cap. 13, is an act intended for the encouragement of the arts of designing, engraving, and etching historical and other prints, and vests the sole right and liberty of printing them for fourteen years from the time of publication, the date to be engraved, with the name of the proprietor, on each plate and print; but it seems doubtful whether the name and date are essential to the recovery of damages in an action for piracy, though it is clear they are necessary in actions for penalties under the statute. 5 Term Rep. 41; 1 Campbell 94. The act is not confined to inventions, strictly, but comprises the designing or engraving anything that is already in nature. 2 Atkins 293. The *degree of originality* which entitles the inventor to the protection of the statute has been well defined by lord Ellenborough, who states the question thus: 'Whether the defendant has copied the main design? Whether there be such a similitude and conformity between the prints, that the person who executed the one set must have used the others as a model? In that case he is a copyist of the main design. But if the similitude can be supposed to have arisen from accident, or necessarily from the nature of the subject, or from the artist having sketched his designs merely from reading the letter-press of the plaintiff, the defendant is not answerable.' Roworth v. Wilkes, 1 Campbell 94.

The act inflicts a forfeiture for pirating either the whole or a part, and a penalty of five shillings for every print. By the 7th Geo. III., cap. 38, the right is extended to twenty-eight years. (Sect. 1.) And it includes the prints of any portrait, conversation, landscape, or architecture,

map, chart, plan, or any other print.' By the 2nd section, engravings, etchings, or works taken from 'any picture, drawing, model, or sculpture, either ancient or modern,' are entitled to the protection of the act. By the 17th Geo. III., cap. 57, an action for damages and double costs is given for engraving, etching, or printing any historical print, or print of any portrait, &c., without the consent of the proprietor, within the time limited by the former acts. The 38th Geo. III., cap. 71, vests in the same manner the sole right and property of making *models*, *copies*, or *busts*, for fourteen years, provided the name and date of publication be put thereon; and persons making copies without the written consent of the proprietor may be sued for damages. These provisions were rendered more effectual by the 54th Geo. III. cap. 56, by which double costs were given, and an additional term of fourteen years in case the maker of original sculptures, models, &c., should be living, except he should have directed himself of the right previous to the passing of the act.

PART II.

OF THE COPIES TO BE DELIVERED TO THE PUBLIC LIBRARIES.

SECT. I.—OF THE LAW.

The 8th Anne, cap. 19, which professed to encourage learning, and to prevent invasions upon the rights of authors, revived the tax of the three copies for the king's library, and for the universities of Oxford and Cambridge (originally imposed by the 13th and 14th Charles II., and revived at intervals, but discontinued about six years after the Revolution), and imposed six additional copies, namely, one for Sion College, one for the Faculty of Advocates at Edinburgh, and one for each of the four Scotch universities, making in all nine copies, to be delivered to the warehouse keeper of the Company of Stationers before publication. By the 41st Geo. III. cap. 107, in addition to the nine copies, one other copy was imposed for Trinity College, Dublin, and one also for the society of the King's Inn, Dublin. The 54th Geo. III. cap. 156, directs the eleven copies to be delivered within one month after demand, and such demand to be made within twelve months after publication. The penalty for neglect is £5 for each copy not so delivered. Such penalty to be recovered on the part of the library to which the delivery ought to have been made.

Second and subsequent editions are exempted, unless they contain additions or alterations. And the additions may be printed and delivered separately, if done in a uniform manner with the former edition. The copy for the British Museum must be on the *best paper* on which the work shall be printed; the other copies upon the paper on which the largest number or impression shall be printed for sale, together with maps and prints belonging thereto. It seems that the University of Cambridge is entitled to a copy on the best paper (16 East, 317); but, though it is stated in the report as the *result* of the decision, the quality of the paper is not any where noticed in the judgment pronounced by the court.

The title to the copy of every book, and the name and place of abode of the publisher, must be entered in the Stationers' Register, within one month for the bills of mortality, and three months for other parts, and in case of default the penalty on each book is £5, and eleven times its price. It is sufficient for magazines, reviews, and other periodical publications, to make the entry within one month after the publication of the first number or volume. The publishers, at their option, may deliver the copies to the libraries which are entitled to them, instead of the warehouse keeper of the Stationers' Company.

SECT. II.—OF BOOKS NOT REGISTERED AT STATIONERS' HALL.

1. *Analysis of the Acts of Parliament.*

It was for a long series of years considered as the sound and unquestionable interpretation of the statute of 8 Anne, that the universities were entitled to copies of such books only as were registered at Stationers' Hall, and to no others. It is, by the second section of the 8th Anne, that the entry at Stationers' Hall is directed to be made. The *object* of the provision is recited to be, that persons may not, through ignorance, offend against the act; but that the property in the book may be ascertained. And the penalties do not attach for printing without the consent of the proprietor, *unless* the title to the book shall be entered before publication in the registry of the Company.

It has been contended that this provision, as to the registry, is confined to the penalties mentioned in the first section of the act; and that in the fifth section, by which the nine copies are given, there is no reference to the prevention of persons being unwarily led into the penalties given by the first section. For the intention of the legislature, we ought, however, to look at the *preamble* of the act, which, after reciting the invasions upon the rights of authors and proprietors, 'to their very great detriment and ruin,' proceeds to enact the remedies contained in the statute; and the whole object of the act is to prevent the injuries in future, and to encourage learned men to compose and write useful books. The tax of the copies surely cannot, by possibility, be construed as a protection to literary property, or to prevent the ruin of authors. It is evidently a payment, exacted for the supposed benefits conferred by the statute, and a condition precedent to any claim on the remedies it provides.

The first section (after stating the general object of the act) secures the copyright for a term of years by certain penalties. The second provides that the work shall be registered. The third imposes a penalty on the Stationers' clerk for breach of his duty. The fourth regulates the price of books (since repealed). The fifth contains the proviso that nine copies shall be delivered to the warehouse keeper for the use of the university libraries, &c. Now it is true that the words 'provided always,' which commence the sections of many acts of parliament, are not invariably to be taken as referring to all the previous enactments; and sometimes these words very absurdly introduce an enactment perfect-

distinct from any thing that precedes it: yet here the common sense of the whole statute stands thus:—‘Authors have sustained very great detriment: to prevent which, in future, and to encourage the composition of useful books, we (the legislature) inflict certain penalties on the invasion of your rights, *provided* you register your books, and provided *also* that you present nine copies to the public libraries.’ Although there are two intervening sections on other subjects, the first, second, and fifth, are, in all fair construction, one enactment. It is impossible that the fifth section can be connected with either the third or fourth, which relate to the stationers’ clerk, and the price of books. If the conditions of registry and delivery are not complied with, the party cannot avail himself of the remedies afforded by the act. They are conditions precedent, and he has no claim under the act unless he performs them; but if he is satisfied with the remedy at common law, and chooses to abandon the protection of the statute, there seems no ground for imposing on him the tax inflicted by the statute, when he seeks no benefit under its provisions.

It was the understood practice for nearly a century, that the entry was necessary for no other purpose than to enforce the penalties against pirating the copyright. In the majority of cases no entry was made, because it is only in relation to some peculiar works that the remedy under the statute for the penalties is preferable to the ordinary action for damages. It appears that the books entered in the registry of the Stationers’ Company, during a period of fifty years subsequent to the statute of Anne, were not altogether at the rate of fifty annually. And it was the invariable custom to deliver to the libraries those works only which were so entered. Such was not only the understanding of the publishers and the Stationers’ Company, but of those who, acting for the libraries, were the most interested in a contrary construction. Until the case of the Cambridge University *v.* Bryer (which was decided in November 1812) it was never pretended that the statute entitled the universities to copies of unregistered books. Nay, further, it appears by the journals of the house of commons in 1775 (p. 351), that the house ordered, ‘That the committee make provision in the bill,’ then pending in parliament, ‘for enforcing the execution of a clause in the act of Anne, which provides that the several copies of each book printed *and registered* under the direction of the act, be delivered to the warehouse-keeper of the Stationers’ Company for the use of the several libraries therein described.’

Then the act 15 Geo. III. cap. 53, sect. 6, recites, that the provision relative to the delivery of the copies had not proved effectual, but had been eluded by the entry only of the title to a single volume, or of some part of the book; and *enacts* that no person should be subject to the penalties, unless the title to the copy of the whole book, and every volume, should be entered, *and unless* nine copies of the whole should be actually delivered for the use of the several libraries, &c. Here it is evident that the delivery of the presentation copies was a mere condition attached to the remedy, by way of penalty, given by the

statute against pirating. So also the 41st Geo. III., cap. 107, directs that in addition to the nine copies required by law to be delivered of each book, *which should be entered into the register book of the Stationers’ Company*, one other copy should be delivered for Trinity College, and one for the King’s Inns, Dublin, of all books which should thereafter be printed and published, *and the title to the copyright whereof should be entered in the register book of the Company*. It is clear therefore that before the right of the universities could attach, the entry must be made. There is nothing in the act to compel the entry. It was necessary only that those who sought protection under the statute should conform to its conditions: the one was to enter the book, the other to deliver certain copies. If the protection was not needed, the entry was not made, and consequently the copies ought not to have been required.

2. Legal Decisions.

It was decided by the court of king’s bench, in the case of Cambridge University *v.* Bryer (16 East. 317), that it is necessary to deliver a copy to the warehouse-keeper of the Stationers’ Company, although the book was *not* entered in the registry. This determination was founded on the construction put by the court on the 8th Anne, cap. 19, and is admitted to be a construction opposed to the provisions of the subsequent statutes of 15 Geo. III. and 41 Geo. III. Besides this conflict of legislative enactment, it also appears that lord Ellenborough, before whom the cause was tried, observed that he would reserve his opinion, as it might very fitly be made the subject of discussion elsewhere, and perhaps in some ulterior court of appeal, *to which it might not unfitly be carried*. On the argument of the case in the court of king’s bench, the court held, that though there arose some difficulty in the construction arising out of the two statutes of 15 and 41 Geo. III., the construction which was to be collected from those statutes, as being intended by the legislature at subsequent periods, was not sufficiently strong and cogent to overturn what the court understood to be the clear distinct sense of the statute of 8 Anne, in which the court was of opinion there was nothing ambiguous.

The court having decided in favor of the university, some discussion took place as to the defendant’s right to take the case into the court of exchequer chamber; and lord Ellenborough observed, that the question affected a great quantity of interest, and that no person could blame the defendant for having it further considered. It appears, however, that the defendant did not avail himself of the opportunity afforded him. On a question which seems to depend rather on the technical constructions of lawyers, than on the rational grounds of the subject, it may not be unimportant to state (on the authority of Mr. Sharon Turner) that when the action was brought by the university of Cambridge, the opinion of the attorney general was taken on behalf of the printer, and he thought that the 15th Geo. III., and 41st Geo. III., were legislative expositions of the statute of Anne, and showed that the nine copies directed to be delivered, were nine copies

of such books as should be entered at Stationers' Hall. And on a view of all the statutes taken together, and on the reason of the thing, he was of opinion that the universities, and other public libraries mentioned in the statutes, were not entitled to have copies of such books as were not entered in the register books of the Stationers' Company.

SECT. III.—INVESTIGATION OF THE GROUNDS OF THE LIBRARY-TAX OF ELEVEN COPIES.

That 'the law is beneficial to the universities' need not be disputed. The gratuitous contributions to their several libraries save their funds. But is the saving necessary or just? Have they not sufficient means to purchase every useful publication? Do they really make use of the current literature of the age? It cannot be requisite that every work that issues from the fertility of the press should be deposited in all the libraries. The works which are esteemed in these ancient colleges are those which have long maintained their rank as standard productions. The great bulk of modern publications are not introduced, and cannot, perhaps, with propriety, be introduced into the course of study pursued at the universities. A large part of the system of education is confined to ancient authors, and to subjects which do not admit of modern improvement. Indeed, the general plan of instruction is opposed to whatever is novel and speculative. Nothing is adopted but that which has been long tried and established; and we cannot conceive, therefore, what the heads of colleges have to do with those valuable but modern works, which they do not permit to be used.

Even if it were necessary to the welfare of the universities that each should possess a copy of every publication, it is iniquitous to exact them at the expense of individual authors or proprietors. The colleges, of which they are composed, are in general richly endowed, and if each college could not afford to possess itself of the modern publications, their united funds would certainly be amply sufficient. It may be true, that some of the Scottish colleges have but little surplus wealth to dispose of in the purchase of every kind of publication; but, whatever a few individuals may think to the contrary, we are persuaded that the intelligent people of Scotland in general possess too much just pride to plead the *poverty* of their universities as a ground for unjust exactions.

It is said, that 'the universities cannot purchase the *splendid editions* of great and expensive works, and yet they are works of which they stand in the greatest need. They give a university dignity and respectability; and, in some departments of liberal education, accurate drawings and engravings are essentially requisite.' Now, however agreeable to the eye are '*splendid editions*,' and however suited to the taste of the affluent, we exceedingly question their utility not only to the student but to the professed author. Fine plates and bindings are adapted to the literary idler and looker-on, but can scarcely surmount any one to intellectual exertion. These splendid trappings are for holidays, and not for days of learned labor. They tend, like great luxuries in general, more to enervate than invi-

gorate. That the welfare of a college is at all dependent on splendid editions, we, therefore, altogether deny. If they should be rich enough to purchase these luxuries, there can be no objection; for though not necessary to the real student and man of letters, they are agreeable. The '*respectability*' of the establishment surely cannot be promoted by robbing an author of any portion of his fair-earned reward, and drawing down upon itself the odium of the whole republic of letters. And its '*dignity*' can scarcely be increased by any other means than the opportunity it affords to attain sound, comprehensive, and accurate knowledge in the highest departments of philosophy and literature. It is beneath its real dignity to owe any of its attractions to the splendid decoration of its library; in which, indeed, there should be as little as possible addressed to the external sense, and every thing adapted to excite the intellect.

It is true, that the student may be assisted in his pursuits by occasional engravings, but those which are useful, are of a very different class to the splendid drawings which render some works so costly. Even in architecture, we apprehend, it is not necessary that the plates, for purposes of study, should be very costly; and besides, it is not in a college, that the education of an architect can be completed. Antiquarian works are of course expensive, but we are not aware that the universities profess to induct their pupils in the knowledge of antiquities, the study of which may safely be left to the Antiquarian Society. So also botany and zoology may be effectually studied without the aid of magnificent plates, which, indeed, are rather calculated to excite a taste for drawing, and to encourage a love of show and splendor, than to induce philosophical and studious habits. We can see no advantage to public education in attracting the pupil to quit the hard study, which can alone render him eminent in society, for the purpose of gratifying his taste in examining splendid folios, and admiring the productions of the arts of drawing and engraving.

'But the law is said to be beneficial to general literature, by affording to men of literary talents and industry the means of information, and enabling them to accomplish works of the highest merit and utility.' This is too barefaced an excuse for injustice; it is robbing Peter not to pay Paul, but to enable him dishonestly to live at the expense of Peter. The men of '*literary talents and industry*,' who *have* accomplished works of merit and ability, are to be deprived of a large part of their profit, where any exists, in order that others may avail themselves of the results of their industry gratuitously. Surely, the fellows of the learned universities who favor the world with their collegiate lucubrations, and who set their own price upon them, should stand on the same footing as other literary men, and purchase the materials which they require in the course of their labors. It may be very convenient, but it cannot be just, that by the aid of these universities a writer should possess himself of the property of his predecessors, for which no remuneration whatever has been made. And, after all, there is not the plea of *necessity*

in favor of the injustice. For it is the common practice of an author, who is engaged on a work in the preparation of which he has occasion to refer to a variety of books, to obtain them from his publisher, and it is a part of the understanding between them, that all the books which are necessary should be lent him. Of course, there is of all others the least difficulty in supplying the modern publications. And we presume no one who is tolerably acquainted with the history and circumstances of literature, can believe that it has been or is likely to be benefited or improved by the doctrine, for the first time laid down in 1812, that the universities are entitled to copies of every publication. We may venture to say, that if not the *best* authors of the present age, at least as good as any others are unconnected with the universities, and derive no advantage whatever from the accumulations which have been made in their libraries, either since 1812 when every book has been supplied, or prior to that time when the registered books only were delivered. Indeed it is absurd to suppose that the intellect of the country is to be advanced by such paltry means, and the true friends of academical learning are no doubt as much ashamed of the folly of such an argument as of the dishonesty of its principle. Supposing, however, all these considerations set aside, let us enquire what is really the use of the single copy given to any one university? In general the books are of no use whatever, to any one of the colleges. Of the far greater portion not a single page is ever read. It either is utterly useless, or is so considered for all collegiate purposes. Indeed how can it be otherwise when the libraries indiscriminately demand their copies of every publication? Of all the trash, folly, and obscenity, which find their way out of the press? But suppose the work to be really valuable, either for its profound philosophy or learning, or for the popularity of the subject, and the talent it indicates; then every one becomes desirous to read it; thousands of students apply for it. And what is the consequence? As but few can possibly obtain it, the book is either purchased, or borrowed from the common circulating libraries, and the copy in each of the eleven libraries has precisely the effect of preventing purchases from the author, for the sole benefit of a few individuals who can either do without the book, or afford to pay for it.

Another benefit of the law, however, is said to consist in *preserving the books* from the danger of loss, some of which are valuable, and others will to future times prove curious. The really valuable works there is no probability will ever be destroyed. The art of printing has disposed of all reasonable apprehension of that contingency; and we think it bad morality, even on the coldest application of the doctrines of expediency, to do an act of positive injustice for the sake of preserving something which may become *curiosities*. Certainly many a production, intrinsically worthless, may, from its extreme rarity or antiquity, obtain an artificial value in the estimation of those who are pleased with such things; but it is not politic (to say nothing of honesty) to injure and discourage the writers of the pre-

sent age, in order that a biblical antiquary may, some centuries hence, feed his idle vanity with the possession of a specimen of unique absurdity! To meet, however, the object of preserving a copy of every kind of publication, whether the offspring of the talented or the foolish; the moral or the vicious; it would be sufficient to deposit a single copy in the British Museum, or rather in a *national library*. To this, we are sure, no author or publisher would offer an objection, and this copy, so deposited, would serve the purpose, and render unnecessary the extra copy which every printer by the 39th Geo. III. cap. 79, sect. 27. 29, is obliged to reserve of every work he prints.

SECT. IV.—MISCHIEFS AND IMPOLICY OF THE TAX.

1. Injury to Literature.

The law has the effect of preventing the publication of expensive and valuable works. There are some books, so costly in the execution, and of which there are naturally so few purchasers, that a very small number only are published. However valuable of themselves, on account of the talent and expense bestowed on them, their *scarcity* increases the value. It is important that as few as possible should be printed, in order to afford an adequate and reasonable remuneration for the skill and capital embarked. To exact eleven copies of these is, in many instances, to take away the whole profit.

From the following list some judgment may be formed of the effect of the tax on this class of publications. It amounts almost to a prohibition.

	No. of Copies Printed.	Price of 11 Copies.		
		£.	s.	d.
Lord Valentia's Travels	50	577	10	0
Bloomfield's Norfolk	120	254	2	0
Sir R. Hoare's Wiltshire	60	207	18	0
Pallas's Travels	50	78	13	0
Morier's Travels	75	46	4	0
Nichols's Hogarth	250	184	16	0
Dibden's Bibliomania	18	92	8	0
Johnes's Froissart	26	335	10	0
——— Monstrelet	26	335	10	0
Philosophical Transactions	150	605	0	0
Boke of St. Albans	150	55	0	0
Dilletanti specimens	350	165	0	0

In some of these instances it will be observed that the eleven copies amount to a tax of upwards of £40 per cent. In others of £20, and the average of the whole exceeds £10 per cent. So that part of the works must have occasioned a great loss, and none of them would afford an adequate profit. The consequence will be, that such undertakings must generally be abandoned. There may indeed be a few enterprising publishers who may continue to embark their capital amidst such disadvantages, but the probability of course is that they will sustain a loss, and it is surely contrary to every principle of policy to continue such a system. It has been contended that 'the university libraries cannot purchase expensive books, and therefore the tax does not injure the

sale.' But the fact is not so: their ample funds enable them to patronise, and they have often purchased such publications. As instances, it may be mentioned that the public library at Cambridge, and the British Museum, both subscribed for Mr. Dibden's Typographical Antiquities, and Mr. Nichols's Leicestershire. And the library of the Faculty of Advocates at Edinburgh also subscribed for the former work. And the Bodleian Library and Trinity College, Dublin, for the latter. Such instances of encouragement were formerly numerous, and tended to increase the number of such undertakings; but the present law has obviously an opposite tendency. The names of these eminent libraries in the list of subscribers formed a strong recommendation, and probably produced an extension of the list. No such recommendation can now exist; in addition to which there is the loss of profit on the copies which they were accustomed to take. It is asserted that 'the law favors the sale of valuable publications, by affording an opportunity of seeing such works, and thus awakening a relish for them!' Can any thing be more ridiculous or unfounded in fact? If the public knew nothing of books but from their being deposited in the eleven libraries, we suspect few would be sold. It is unnecessary to say, that one single advertisement in a newspaper or review, has a better effect than if the work were deposited in every college in the kingdom. There is no want of relish for such publications if they could be obtained at a cheap rate; and the only true way to increase the demand is to remove all the imposts and burdens on literature so that the price may be reduced. The opportunity of seeing such works is afforded far more conveniently than in the university libraries: they may be seen in the shops of every respectable bookseller.

2. *Injury to Authors and Proprietors.*

The consequences of the tax upon *expensive* publications have already been pointed out. They are so injurious as to prevent many publications that might otherwise be prepared. Even in *ordinary* publications the tax is very burdensome. The publisher makes the most accurate computation he can of the number of copies which will probably be sold. According to the long established custom of the printing trade, the charge of the printing is made on each 250 copies, and therefore the loss on the eleven copies is precisely the whole price for which they would sell; or if eleven extra copies were printed, the expense would be of equal amount, because the charge for printing the eleven would be the same as for 250. Thus, supposing a work of forty sheets, the press-work at 4s. a sheet would be £8; and if the price were 16s. a copy, eleven copies would be £8 16s., whilst the printing of the eleven copies would cost £8 exclusive of the paper. But then it is said, 'the tax does not affect the authors or proprietors; it may be charged to the public.' It is not enough to tell us that the tax, whatever it is, may be charged in the price of the publication: will the public pay it? It need scarcely be replied that the smaller the price, the more extensive the sale. If the tax upon paper and

advertisements, as well as this library imposition, were removed, and the period of copyright extended, so that books might be published and made known for two-thirds of the present expense, the sale of them would increase not only in the proportion of that third which is now consumed in preliminary expense, but in a much greater degree; for not only the same sum would naturally be expended which has been applied in the purchase of literary works, and therefore the sale increased upwards of thirty per cent; but the reduced price would as naturally induce a still greater number to become purchasers, who are now deterred by the heavy amount of the present price. 'The tax is also alleged to be of trifling amount, and it is urged that where the work is popular, and a great number of copies are sold, the deduction of eleven can scarcely be felt. And when the work does not sell, the eleven copies may as well be placed in the public libraries as in the lumber-room of the publisher.' Will the universities be content to take copies of successful works only, and let the criterion of success be the sale of 1000 copies? It is true, that the far larger proportion of books are unsuccessful, and this fact should induce the legislature to give every possible encouragement. Out of the large profit on a few very fortunate publications, the proprietor may well afford to make a donation of eleven copies. But the question is a general one. To proceed on principle, the tax should be calculated on the general result. It is a cruel mockery to say that when all the copies are not sold, some of them may as well be placed in a library as in a lumber-room. They may be sold for something, and at the worst will always sell as waste paper. Besides, the argument is fallacious in itself; if the work will only sell for waste paper, it can be of no value to the universities; it can only 'lumber' their shelves in the same way that it is supposed to fill the publisher's warehouse: and though it has been insinuated, we presume it cannot be true, that the universities make a profit by the sale of their useless books. On the other hand, if the publication be really valuable, and tend to promote the great objects for which colleges were endowed, it is a wretched, and despicable, and bad spirit that will not remunerate the talent and industry by which they are benefited. Books are either good, bad, doubtful, or indifferent. The good (which perhaps are not extremely numerous) they ought to pay for; the bad they should of course reject; and the doubtful and indifferent no university can require, for the time of youth is valuable, and should not be thrown away in the perusal of questionable or idle productions.

SECT. V.—STATE OF THE LAW IN OTHER COUNTRIES, AND ANALOGY OF OTHER TAXES.

1. In America, Prussia, Saxony, and Bavaria, only one copy is required at the hands of authors and proprietors. In Austria, the imposition is extended to two copies; and, in the Netherlands, the libraries are entitled to three copies. In France, prior to the revolution, the law required two copies for the king's public library, one for the Louvre, and two for the chancellor and the

keeper of the seals. The two latter were evidently required with a view to the supervision of the police. Subsequently to the revolution, the number of copies has been reduced, and two only are now required for the use of the national library. But in all these cases the tax applies only where the copyright is reserved; and in these countries the duration of the rights of exclusive printing is either perpetual, or considerably more extensive than the term allowed in Great Britain.

2. Nothing can be more unprincipled than this anomalous taxation of literary property. No other class than the literary was ever proposed to be so taxed. There is, indeed, no instance in which any art, profession, or trade, is subjected to such an imposition. It is a direct tax upon industry, and an odious restraint upon the press. It has been said that authors of literary works ought not to be better protected, or to have a longer term of exclusive property, than the inventors of saw machines. For the purpose of the present argument, be it so. But if the period of protection be the same, let the author also stand on the same footing in other respects. What would be the feeling of those who possess mechanical genius, if the law compelled them to present eleven copies of every machine which they invented or improved? What, indeed, would the intelligent people of England think, if it should be suggested to parliament that it was expedient to deliver to the Royal Society, the Societies of Arts and Antiquaries, and other

scientific institutions, eleven specimens of every engine, however expensive, that ingenuity devised? What would have been the public feeling, if any one had possessed the audacity to propose that Mr. Watt should not be permitted to sell any of his steam engines, until he had deposited eleven of them gratuitously in the warehouse of the Royal Society?

3. We trust the time is not far distant when this disgrace to the government of a free and civilised country will cease to exist. We ask only that our literary brethren may be placed on equal footing with the fabricators of the commonest merchandise. If the tax on the raw material of paper must be still continued, at least the impost on the manufactured article of books, on every principle of trading policy and even-handed justice, ought immediately to be removed. If our literature be equal to that of the continental states, let us imitate their example; let us cease to injure, and really encourage, those to whom we are indebted for our eminence. If it be inferior, let us lose no time in removing every impediment from its way, and introducing every means that can facilitate its improvement and promote its rise. Let not Great Britain be the country in which literary property is burdened more oppressively, in a six-fold degree, than every other nation of the civilised world; rather let her abolish the imposition altogether, and surpass even the republics of the new world, as she undoubtedly might the monarchies of the old.

COQUET, *v. a., v. n., n. s. & adj.* } Fr. co-
COQUETTE, *n. s.* } queter. Dr.
COQUETRY, *n. s.* } Johnson
COQUETRY, *adj.* } refers the

origin of coquet to *coquart*, a prattler, which latter word Mr. Todd thinks may be from *coqueter*, tattle. Skinner, from the French *coqueter*, i. e. to chuck, as a cock among hens. Cotgrave, however, to whom this derivation and definition belonged, seems to have overlooked the most obvious circumstance of similarity,—the cock's extension of his notice to more than one. Thomson says 'coqueter, quater, from Lat. *quisito*, to seek after, to affect, corresponding with Fr. *rechercher*.' To these conjectures we are tempted to add another. In the old French, *coquetier* is, 'a seller of eggs, or of egge shels.' May not this be the origin of coquette, the name of a woman who gives merely a semblance of that which she professes to give; who pretends to offer an egg, which is nothing more than a shell. Coqueter is also a sea phrase, meaning, to propel a boat by sculling, that is, by the use of one oar in the stern, which is rapidly moved from side to side, like the tail of a fish. A coquette, then, if this be the etymology of the word, would be, one who keeps on in her amorous course by a constant alternation from side to side. 'A coquette,' says Johnson, 'is a gay airy girl; a girl who endeavours to attract notice.' But his definition is hardly copious enough. In its principal sense, both in French and English, a coquette means a general lover; a flirt; and,

it is almost unnecessary to add, a jilt. The derivatives require no explanation.

I was often in company with a couple of charming women, who had all the wit and beauty one could desire in female companions, without a dash of coquetry, that from time to time gave me a great many agreeable torments. *Addison's Spectator.*

The light coquettes in sylphs aloft repair,
And sport and flatter in the fields of air. *Pope.*
A coquette and a tinder-box are spark-led. *Arbuthnot and Pope.*

Coquet and coy at once her air,
Both studied, though both seem neglected;
Careless she is with artful care,
Affecting to seem unaffected. *Congreve.*

You are coquetting a maid of honour, my lord looking on to see how the gamblers play, and I railing at you both. *Swift.*

Phyllis, who but a month ago
Who married to the Tunbridge beau,
I saw coquetting 't other night,
In publick, with that odious knight. *Id.*

Such is your cold coquette, who can't say 'No,'
And won't say 'Yes,' and keeps you on and off-
On a lee shore, till it begins to blow—
Then sees your heart wrecked, with an inward scuffing. *Egmont. Don Juan.*

Nine times in ten 'tis but caprice or fashion,
Coquetry, or a wish to take the lead;
The pride of a mens child with a new ash on,
Or wish to make a rival's bosom bleed. *Id.*

COQUILMBO, a jurisdiction or intendency of Chili, forming the entire northern division of

Chili Proper, and containing the provinces of Copiapo, and Coquimbo Proper. For the former, see *COPIAPO*.

Coquimbo, Proper, is mountainous, extending from the Cordillera to the Pacific, and from the Guasco north, to the Chuapa south; being about seventy miles from east to west, and 190 miles from north to south. It is watered by the three small rivers Coquimbo, Limari, and Chuapa; the latter alone having any constant flow of water, even in the summer, and being then incapable of navigation, from its rapid descent, bad bottom, and insufficient depth. The sides are nearly perpendicular; a hanging lasso bridge serves for the passage of loaded mules and travellers, at times when it would be dangerous to ford the river. The chief places of this province are the towns of Coquimbo and Illapel. The chief copper mines of this province are situated in the Cuestas or ranges of Combalamba, of Llamabguí, of Huamalata, and of Las Vacas: those in the southern parts are copper and gold. Its population is estimated at about 15,000 souls. The most fertile part of the province is the small valley of Elque, watered by a branch of the Limari; and on the road between Illapel and Coquimbo. It is divided into several farms, which cultivate corn, the vine, fruit, and vegetables. The most important mines are in the interior, near the central Cordillera. A short distance to the north-east of the town of Coquimbo are some small copper mines, one of which called Cerro ore is worked. Illapel is also a mining town of some consideration, situated on a branch of the Chuapa, about eight leagues from its mouth.

The copper prepared at the mines of Illapel for sale, Mr. Miers informs us, is not suffered to be exported from any of the bays upon the bordering coast, nor even to be conveyed in small craft, either to Coquimbo or Valparaiso, but must be carried on the backs of mules to one of these places: Valparaiso at eighty leagues distance is the nearest of the two, and, as the road is better than that to Coquimbo, nearly all the copper produced is carried to that port. This is a great discouragement to the working of the mines: other circumstances during the revolution have also militated greatly against the success of mining, so as to cause many who have hitherto employed their capital, to withdraw it and employ it in agricultural occupations. Hence the cultivation of land in the valley of the Chuapa, as well as in the ravines leading into it, has somewhat increased. From the disadvantageous situation of Illapel with respect to the two sea-ports, the increasing demand for labor in Chili, and the consequent rise of wages, greatly enhanced as these will become from the influx of British capital and competition about to be attempted there, we may conclude that before long the mines of Illapel will cease to be worth working. Little indeed can be reasonably expected in the way of profit from any attempts by foreigners to carry on mining operations in Chili.

Coquimbo, the residence of the Governor Intendant, is situated on the south bank of the river of that name near its estuary, and is watered by a canal brought from the river at a higher level,

and distributed by artificial channels through the houses and gardens. It is a small place but its houses generally of brick, and of a neat appearance, being arranged in squares or quadras; the plaza or public square being at the southern extremity. The commerce of Coquimbo consists of the export of copper and a small quantity of the precious metals: the imports are, clothing, provisions, and other necessaries. The harbour of Coquimbo, twelve miles distant from the town, is of considerable size, well sheltered on the southern and western sides, and, though open towards the north, is secure at most seasons of the year, as the northerly tempestuous winds do not prevail at Coquimbo. It is formed by a promontory running into the sea about two miles. There are nine fathoms 300 yards off, and near three fathoms close in shore. To the southward of the promontory of the harbour is another bay, of a circular form, two miles in diameter, entered by an opening to the west three quarters of a mile broad, called La Herradura, Horse-shoe Bay; it possesses a good clay bottom, sixteen fathoms water in the middle, twenty-eight fathoms in the entrance, and five fathoms 250 yards off. But it is rocky on the north and south sides. A hill forming a promontory to the south of this bay is named the Cerra de La Gloria, and here copper was formerly worked.

COR. Lat. *corus*. A Hebrew measure

Ye shall offer the tenth part of a bath out of the *cor*, which is an homer of ten baths. *Ezek. xlv. 14.*

CORACHIE. A sea-port town of Afghaunistan, in the district of Tatta, and province of Sinde, fifty-seven miles from the city of Tatta, in lat. 24° 51', long. 67° 16' E., and supposed to be the Sangada of ancient history.

The bay affords shelter for vessels of 300 or 400 tons burden, from the beginning of September to the end of May. The entrance is narrow, and the deepest water about 200 yards from the western point, which is defended by a castle. On the eastern side are six rocky isles, and the water is shoal. At low water there is not more than one fathom and a half fine hard sand on the bar; but the tide rises twelve feet. The town contains 3000 houses, and is surrounded by a mud wall flanked with towers of no strength. The inhabitants, who are principally Hindoo merchants and traders, carry on a considerable trade, (this being the only sea-port in the province), in the export of saltpetre, rice, cotton, butter, oil, horses, and many other valuable commodities, brought from Cabul and the northern provinces. Its imports are metals, ivory, tea, sugar, spices, and the manufactures of India and Europe. During the rainy season a considerable intercourse is maintained with Tatta, by means of a creek navigated by dhingies or flat-bottomed boats. They import thence black pepper and spices, tin, iron, lead, steel, elephants' teeth, cochineal, quicksilver, sandal, and scented woods. The vicinity is level and sandy, covered with brushwood and other hardy plants, on which a number of camels are reared. The place belongs to the Ameers of Sind, who reside at Hyderabad, and are tributary to the king of Cabul. There is a constant communication kept up between Co-

rachie and Muscat, a journey of about twenty days.

CORACIAS, the roller, in ornithology, a genus of birds of the order of picæ: the characters are these:—The bill is straight, bending towards the tip, with the edges cultrated; the nostrils are narrow and naked; the legs for the most part short; the toes placed three before and one behind, and divided to their origin. One or other of the different species may be met with in all quarters of the globe. Ornithologists enumerate twenty-five species, though some of these are supposed to be only varieties. The following are the most remarkable:—

C. garrula, the garrulous roller, is about the size of a jay, the bill black, and at the base beset with bristles, but which do not cover the nostrils; the head, neck, breast, and belly, are of a light bluish green; back and scapulars reddish-brown; coverts on the ridge of the wing rich blue, beneath pale green; upper part and tips of the quills dusky; the lower parts and rumps of a fine deep blue; tail forked of a light blue; the outer feathers tipped with black above, and beneath with deep blue, as is the case with such part of the quill-feathers as is black above; the other tail feathers are dull green: the legs are short, and of a dirty yellow. Mr. Pennant observes that these birds are common in several parts of Europe, in most parts of which it is a bird of passage. They are found in Sweden and Denmark on the one hand, and as far as Africa on the other. Willoughby tells us, that in Germany, Sicily, and Malta, they are sold in the markets.

C. Sinensis, the Chinese roller, is of the size of a jay: The bill and irides are red: the head, hind part of the neck, back, rump, and upper tail coverts, are green: through the eyes on each side is a black stripe: the under parts of the body, from chin to vent, are yellowish-white, tinged with green; but the thighs are gray: the wing-coverts are olive brown; the quills the same, with a mixture of chestnut in some; and others, nearest the body, tipped with white; the tail is five inches in length, and wedge-shaped, the outer feathers shortening by degrees, like that of a magpie; all of them are more or less green, verging to black near the ends; the tips white: the legs and claws are of a pale red, and longer than in other rollers. It inhabits China, and is called at Canton sauta hoang, but is not very common.

CORACLE, *n. s.* Welsh *corwugle*, probably from Lat. *corium*, leather. A boat used in Wales, and some of the adjoining counties, by fishers, made by drawing leather or oiled cloth upon a frame of wicker work. It is nearly of an oval shape, from five to six feet long, and four feet broad, and is guided by a paddle. It is not capable of carrying more than one person conveniently, and can be managed only by those who are accustomed to this sort of conveyance.

CORAH, or Jehanabad, a district of the province of Allahabad, Hindostan, situated in the Dooab, or country between the Jumna and Ganges. It is enclosed in the collectorship of Cawnpore. It is a level fertile country, well watered, and producing abundance of grain,

sugar-cane, tobacco, and cotton; having also good roads, and navigable rivers east and west, it offers good mercantile advantages. The British first obtained an influence, in this province in the middle of the last century, when it was a condition of the treaty of peace with the Mahrattas, that Corah should be made over to the emperor Shah Alum; who regranted it to that power, in violation of the treaty, in 1771. After this it was tributary to the British for many years, at the rate of fifty lacks of rupees annually, and was finally transferred to them by Saadub Ali Khan in 1801.

CORAH, the capital of the district, is situated on the high road between Lucknow and the Deccan, about half way between the two rivers. Most of the houses are of mud, and have flat roofs, and the town is surrounded with a mud wall. Some of the better houses are of brick, and, as the residence of the collector, it is a large and flourishing town, and carries on a good trade in cotton and grain. It had formerly a mint, the rupees of which were inferior to those of Lucknow, but formed the general currency, both in the Dooab and Bundelcund.

CORAIR, a district of the province of Gundwanah, Hindostan, tributary to the Mahrattas, lying between the twenty-third and twenty-fourth degrees of north latitude, and about the eighty-third degree of east longitude. It is a poor country, but abounds in game. It is tributary to the Mahrattas. The inhabitants are called Chohans; the present capital is Sonehut.

CORAL, *n. s. & adj.* Lat. *corallium*; **CORALLINE**, *n. s. & adj.* } *κοραλλιον*. For a **CORALLOID**, *adj.* } description of coral, **CORALLOIDAL**, *adj.* } and the means of obtaining it, see the next article. Coral is also the name of an ornamented piece of coral, which infants wear round their necks when cutting their teeth. Coralline is, consisting of coral; approaching to coral; likewise one species of coral. See **CORALLINE**. Coralloid, and coralloidal, signify, having a resemblance to coral.

Ful fetise was hire cloke: as I was ware,
Of smal corall about hire arm she bare
A pair of bedes gauded all with grene.

Chaucer. Prol. to Cant. Tales.

My mistress' eyes are nothing like the sun,
Coral is far more red than her lips' red.

Shakespeare. Sonnet cxxix.

In the sea, upon the south-west of Sicily, much coral is found. It is a submarine plant; it hath no leaves; it brancheth only when it is under water. It is soft, and green of colour; but, being brought into the air, it becometh hard and shining red, as we see.

Bacon's Natural History.

This gentleman, desirous to find the nature of coral, caused a man to go down a hundred fathoms into the sea, with express orders to take notice whether it were hard or soft in the place where it groweth.

Brown's Vulgar Errors.

Now that plants and ligneous bodies may indurate under water, without approachment of air, we have experiment in *coralline*, with many *coralloidal* concretions.

Brown.

He hears the crackling sound of coral woods,
And sees the secret source of subterranean floods.

Dryden's Virgil.

A turret was inclosed

Within the wall, of alabaster white,
And crimson coral, for the queen of night,
Who takes in Sylvan sports her chaste delight.

Dryden.

Or where's the sense, direct or moral,
That teeth are pearl, or lips are coral? *Prior.*
Her infant grandame's coral next it grew;
The bells she jingled, and the whistle blew.

Pope.

At such time as the sea is agitated, it takes up
into itself terrestrial matter of all kinds, and in parti-
cular the *coralline* matter, letting it fall again, as it
becomes calm.

Woodward.

The pentadrous, columnar, *coralloid* bodies, that
are composed of plates set lengthways of the body,
and passing from the surface to the axis of it.

Id. on Fossils.

Coralline is a sea plant used in medicine; but much
inferior to the coral in hardness, sometimes greenish,
sometimes yellowish, often reddish, and frequently
white.

Hill.

In Falmouth there is a sort of sand, or rather *co-
ralline*, that lies under the oar.

Mortim. Husb.

Trim you the morning's lonely star,
Or do you guide pale Cynthia's car?
Pour you the runnels rippling wave,
Or sleep you in a coral cave?

Lefley

Then, Leobia! wake thy beauties, fresher far
Than Galatea boasted when she laved
In the smooth deep her coral-axled car,
And the stern heart of Neptune's son enslaved!

Huddesford.

Unknown to sex the pregnant oyster swells,
And coral insects build their radiate shells.

Darwin.

These perpendicular *coralline* rocks make some
parts of the Southern Ocean highly dangerous.

Id.

The granite, or moorstone, or porphyry, consti-
tute the oldest part of the globe, since the limestones,
shells, *coralloids*, and other sea productions, rest upon
them; and upon these sea productions are found clay,
iron, salt, and silicious sand or grit stone.

Id.

CORAL. See CORALLINA. There are pro-
perly but three kinds of coral; red, white, and
black: the black is the rarest, and most esteemed.
The red was formerly used in medicine, but is
now scarcely ever prescribed by any intelligent
practitioner, having no virtues superior to the
common testacea. When coral is newly taken
up out of the sea, the small protuberances on its
surface are soft, and yield, on being pressed, a
milky juice which effervesces with acids. The
cortical part with which the coral is all over
covered, is not near so compact as the internal,
and may easily be taken off whilst fresh; and
from this part it is usually freed before it comes
to the market. The greatest coral trade is in
Genoa and Leghorn. Coral is often imitated by
artificial compositions, some of which are made
to resemble it exactly; but the fraud may be
discovered by fire, the counterfeit not affording
alkaline earth like the genuine coral. The color-
ing ingredients in the artificial coral are cinnabar
and minium, which are easily discovered. The
natural coral seems to receive its color from iron;
for spirit of vitriol acquires from it a ferruginous
taste; and on calcining the coral, some particles
are found among the ashes that are attracted by
the magnet. According to Neumann, sixteen
ounces of coral, distilled in an open fire, yield
about six scruples and a half of volatile alkaline

VOL. VI.

spirit, with two or three grains of an empyreu-
matic oil: from the caput mortuum calcined,
five scruples and a half of fixed salt may be
extracted.

CORAL FISHERY. Red coral is found in the
Mediterranean, on the coast of the ci-devant
Provence, from Cape de la Couronne to that of
St. Tropez; about the isles of Majorca and Mi-
norca; on the south of Sicily; on the coasts of
Africa; and in the Ethiopic Ocean, about Cape
Negro. The divers say, that the little branches
are found only in the caverns whose situation is
parallel to the earth's surface, and open to the
south. The manner of fishing is nearly the same
wherever coral is found. The method used at
the bastion of France, under the direction of the
company established at Marseilles, is to send out
seven or eight men in a boat, and when the net
is thrown by the caster, the rest work the vessel,
and help to draw the net in. The net is com-
posed of two rafters of wood tied cross wise, with
leads fixed to them: to these they fasten a quan-
tity of hemp twisted loosely round, and inter-
mingled with some large netting. This instru-
ment is let down where they think there is coral,
and pulled up again when the coral is strongly
intangled in the hemp and netting. For this
purpose, six boats are sometimes required; and
if in hauling in, the rope happens to break, the
fishermen run the hazard of being lost. Before
the fishers go to sea, they agree for the price of
the coral, which is sometimes more, sometimes
less, a pound; and they engage, on pain of cor-
poral punishment, that neither they nor their
crew shall embezzle any, but deliver the whole
to the proprietors. When the fishery is ended,
which amounts one year with another to twenty-
five quintals for each boat, it is divided into
thirteen parts; of which the proprietor has four,
the casters two, and the other six men one each;
the thirteenth belongs to the company, to whom
the boat belongs.

CORAL RIVER, a river in New Mexico, which
runs a course west by south, and falls into
the head of the gulf of California, close by the
mouth of the Colledado.

CORAL-STONE, a kind of red and white agate,
found in Italy and some parts of Saxony, which
breaks in veins. That of Rochlitz in Saxony is
the most celebrated, and is found in globules
which have a kind of crust about them.

CORAL-TREE, n. s. Lat. *coraliodendron*. See
ERYTHRINA.

It is a native of America, and produces very beau-
tiful scarlet flowers; but never any seeds in the Euro-
pean gardens.

Miller.

CORALLINA, or CORAL, in zoology, a genus
belonging to the order of vermes zoophyta. The
trunk is radicated, jointed, and calcareous. The
species are thirty-eight, distinguished by the form
of their branches, and are found in the ocean
adhering to stones, bones, shells, &c. The corals
were formerly believed to be vegetable sub-
stances hardened by the air; but are now known
to be composed of congeries of animals, which
are even endued with the faculty of moving
spontaneously. The islands in the South Sea
are mostly coral rocks covered over with earth.

2 H

The little creatures, which have scarce sensation enough to distinguish them from plants, build up a rocky structure from the bottom of that sea, too deep to be measured by human art, till it reaches the surface. Some of these coralline islands appear to be of a much older date than others; particularly the Friendly Islands: and it is probable that as these submarine works are still going on, new islands may by that means frequently be produced. M. De Peyssonnel of Marseilles, in consequence of a series of experiments, from 1720 to 1750, seems to have been the first who threw a proper light upon the nature and production of coral and similar marine substances. Those bodies, which the count de Marsigli imagined to be flowers, this ingenious naturalist discovered to be insects inhabiting the coral; for upon taking branches of it out of the water, the flowers, which proceeded from a number of white points answering to the holes that pierced the bark, and the radiation of which resembled the flower of the olive tree, entered into the bark and disappeared; but upon being again restored to the water, they were some hours after perceptible. These flowers spread on white paper lost their transparency, and became red as they dried. The holes in the bark correspond to small cavities upon the substance of the coral; and when the bark is removed, there may be seen an infinite quantity of little tubes connecting the bark with the inner substance, besides a great number of small glands adhering to them; and from these tubes and glands the milky juice of coral issues forth: the holes in the bark are the openings through which the insects that form the substances for their habitation come forth; and those cavities which are partly in the bark and partly in the substance, are the cells which they inhabit. The organs of the animal are contained in the tubes, and the glandules are the extremities of its feet, and the milky liquor is the blood and juice of the animal, which are more or less abundant in proportion to its health and vigor. When the insects are dead, they corrupt, and communicate to the water the smell of putrid fish. This juice or liquor runs along the furrows perceived upon the proper substance or body of coral, and stopping by little and little becomes fixed and hard, and is changed into stone; and being stopped in the bark, causes the coral to increase proportionably and in every direction. In forming coral, and other marine productions of this class, the animal labors like those of the testaceous kind, each according to his species; and their productions vary according to their several forms, magnitudes, and colors. The coral insect, or polype, M. Peyssonnel observes, expands itself in water, and contracts itself in air, or when it is touched with the hand in water, or acid liquors are poured upon it: and he actually saw these insects move their claws or legs, and expand themselves, when the sea water containing coral was placed near the fire, and keep them in their expanded state when separated from the coral in boiling water. Broken branches of coral have been observed to fasten themselves to their branches, and have continued to grow; and this is the case when they are connected with detached pieces of rock and other substances, from

which no nourishment could be derived. The coral insects in their cells, not having been injured, continue their operations; and as they draw no nourishment from the stone of the coral, they are able to increase in a detached and separate state. Coral was found to be equally red in the sea as out of it: it was more shining when just taken out of the water than even when it is polished; and the bark by being dried becomes somewhat pale. M. Peyssonnel found that it grows in different directions, sometimes perpendicularly downwards, sometimes horizontally, and sometimes upwards; and in the caverns of the sea, open to every exposure. This system was little regarded, when first communicated to the Academy of Sciences at Paris in 1727, till Mr. Trembley's discovery of the fresh water polype; but since that time, it has been confirmed by the observations of M. Bernard de Jussieu on the sea coasts of Normandy, and those of M. de Reaumur near Rochelle. Mr. Ellis distributes corallines into four kinds: viz. corallines, *articulated*, consisting of short pieces of a stony or cretaceous brittle matter, whose surface is covered with pores or cells, which are joined by a tough, membranous, flexile substance, composed of many small tubes of the like nature compacted together. The stony part is soluble in vinegar, and the other part remains entire. It is fixed to rocks and shells by stony joints, which, as they rise, are united to others by extremely fine and slender tubes: these may be discovered by the eye, or a common magnifier. As the stems extend themselves, they become pennated by side branches which come out opposite to each other, and are jointed in the same manner; the joints of this species are like the upper part of an inverted cone, but a little compressed: the whole surface is covered over with very minute circular-shaped cells like pores. If a branch of this coralline is put into vinegar, these cells are dissolved with the whole oreaceous surface; instead of which there appear rows of minute ramifications, which seem to have communicated with each of these cells. Upon some specimens of this coralline, are seen small figures like seed vessels, with which the branches frequently terminate: they are also found on the sides. We frequently find these corallines of different colors, as red, green, ash, and white; but all of them, when exposed to the sun and air on the shore, become white. Corallines, *celliferous*, those which appear, when magnified, to be fine thin cells, the habitations of small animals connected together, and disposed in a variety of elegant forms like branches. These effervesce with acids. Corallines, *tubular*, are composed of a number of simple tubes, growing up nearly together; or of such branched ones as have neither denticles nor vesicles. These are horny and elastic, and recover their original form in water. Some of them appear wrinkled like the wind-pipe, and others like the intestines of small animals. Corallines, *vesiculated*, are distinguished by their horny hollow ramifications; most of them are furnished with little denticles on their branches, like leaves on mosses; and at certain seasons of the year they have small bodies like bladders, proceeding from their stems and branches, and

differing in form according to the different species. Their color, when dry, is of a yellowish or pale brown, and their nature is elastic. They are found adhering to rocks, shells, and fucuses, by small root-like tubes: they recover their form in water, after having been dried; and when put into vinegar, they cause no effervescence.

CORALLODENDRON. See **ERYTHRINA.**

CORALLOIDES FRUITIOS. See **ESCHARA** and **KERATOPHYLUM**: also **POLYPUS** and **SPONCIA.**

CORAM (Captain Thomas), was born about 1668, and spent the early part of his life in the station of master of a vessel trading to the colonies. Afterwards residing in the eastern part of London, among seafaring people, whose business often obliged him to come early into the city and to return late, he frequently saw young children exposed in the streets, through the indigence, or cruelty of their parents. This excited his compassion, and induced him to project the foundation of an hospital for foundlings. In this humane design he labored with indefatigable diligence for seventeen years; and by his application procured a number of the nobility and gentry to patronise and carry the scheme into execution, and at length obtained the royal charter for it. He was also highly instrumental in promoting the trade of America, by procuring a bounty upon naval stores imported from our colonies. He was likewise eminently concerned in founding the colonies of Georgia and Nova Scotia. His last charitable design, in which he lived to make some progress, was a scheme for uniting the North American Indians more closely to the British interest, by an establishment for the education of Indian girls. In short, he spent the greatest part of his life in laboring for the public, and experienced a fate too common with those who devote their talents to such purposes; being at last indebted for subsistence to the voluntary subscriptions of some public-spirited persons, at the head of whom was the late Frederic Prince of Wales. He died in 1751; and was interred, at his own desire, in a vault under the chapel of the Foundling Hospital.

CORAN. See **ALCORAN**, and **MAHOMETANISM.**

CORANICH, among the Scotch and Irish, the custom of singing at funerals, anciently prevalent in those countries, and still practised in several parts. Mr. Pennant having assisted at a funeral in the south of Ireland, gives the following account of it. 'The cries are called by the Irish uloghone and hullulu, two words very expressive of the sound uttered on these occasions; and being of Celtic stock, etymologists would swear to the origin of the *ολογηων* of the Greeks, and the *ululatus* of the Latins. Virgil is very fond of using the last whenever any of his females are distressed; as are others of the Roman poets, and generally on occasions similar to this.' 'It was my fortune to arrive at a certain town in Kerry at the time that a person of some distinction departed this life; my curiosity led me to the house, where the funeral seemed conducted in the purest classical form. The conclamation was set up by the friends, in the same manner as Virgil describes that consequential of Dido's death. Immediately after this followed another

ceremony, fully described by Camden in his account of the manners of the ancient Irish; the earnest expostulations and reproaches given to the deceased for quitting this world, where she enjoyed so many blessings, so good a husband, and such fine children. But when the time approached for carrying out the corpse, the cry was redoubled, *Tramulis ululatus aethera complent*: a numerous band of females waiting in the outer court to attend the hearse, and to pay in chorus the last tribute of their voices. The habits of this sorrowing train, and the neglect of their persons, were admirably suited to the occasion; their robes were black and flowing, resembling the ancient pallia; their feet naked, and their hair long and dishevelled. The corpse was carried slowly along the verge of a most beautiful lake, the *ululatus* was continued, and the whole procession ended among the venerable ruins of an old abbey.' A custom similar to this prevailed among the Hebrews, and bishop Lowth has given a beautiful description of it in his justly celebrated Lectures on the Sacred Poetry of the Hebrews.

CORANT, } French *courant*. A lofty
CORA'NTO, or } sprightly dance, says John-
COUBA'NTO, n. s. } son. Sir John Hawkins, however, remarks that the coranto is the most solemn of all dance tunes. Corant, or courant, was also a name formerly given to a newspaper.

He like a maid the better while I have a tooth in my head; why he is able to lead her a *couranto*.

Shakespeare. All's Well.
After this they danced galliards and *corantos*.

Ben Jonson.
Corants, avises, correspondences. *Id.*

The weekly *courants* with Paul's seal. *Id.*
It is harder to dance a *corant* well than a jig; so in conversation, even, easy, and agreeable, more than points of wit. *Temple.*

I would as soon believe a widow in great grief for her husband, because I saw her dance a *corant* about his coffin. *Wales.*

Here Mermaids press their liquid pillows,
And sing to sleep the growling billows;
Or make the ravished whales they chant to
In the churned ocean dance *coranto*. *Huddesford.*

CORAX. See **CORVUS.**

CORBACH, a town of Germany, in the late circle of the Upper Rhine, and principality of Waldeck, of which it is the capital. It was formerly imperial. It is divided into the Old and New town, the latter of which contains an academy; and near it on a high mountain is the castle of Eissenberg. The Hanoverians were defeated by the French near this town, in 1760. It lies twelve miles N. N. W. of Waldeck, and seventy east of Cologne.

CORBAN, n. s. An alms-basket; a receptacle of charity; a gift; an alms. See below.

They think to satisfy all obligations to duty by their *corban* of religion. *King Charles.*

CORBAN, in Hebrew קרבן, a gift or offering, made on the altar, and also the treasury of the temple where the offerings of money, &c. were deposited. Corban was also applied to those offerings which had life, in opposition to the minchab, or those which had not. It is derived from the word karab, which signifies to approach; because the victims were brought to the door o.

the tabernacle. Corban is also a ceremony which the Mahomedans perform at the foot of mount Ararat in Arabia, near Mecca. It consists in killing a great number of sheep, and distributing them among the poor.

CORBE, *n. s. & adj.* Fr. *courbe*. Corbe, a diminutive of corbel, signifies, as a noun, an architectural ornament. The adjective means crooked.

It was a bridge ybuilt in goodly wise
With curious corbes and pendants graven faire.

Spenser. Faerie Queene

For siker thy head very tottie is,
So thy corbe shoulder it leans amiss.

Id. Pastorals.

CORBEIL, a town of France, in the department of the Seine and Oise, and ci-devant province of the Isle of France. Its chief trade is in tanned leather. It is seated on both sides of the Seine, at its conflux with the Juine. Population 3500. Nine miles N. N. W. of Melun, and seventeen south of Paris.

CORBEILS, *n. s.* Little baskets used in fortification, filled with earth, and set upon the parapet, to shelter the men in firing upon the besiegers.

CORBEL, *n. s.* In architecture, the representation of a basket, sometimes placed on the heads of the caryatides.

CORBEL, or **CO'BIL**, *n. s.* A short piece of timber sticking out six or eight inches from a wall, sometimes placed for strength under the semigirders of a platform; a niche or hollow left in walls for figures or statues.

CORCHORUS, in botany, a genus of the monogynia order and polyandria class of plants; natural order thirty-seventh, columnæ: **COR.** is pentapetalous: **CAL.** pentaphyllous and deciduous: **CAPS.** many-valved and many-celled. There are fourteen species; of which the most remarkable is the *C. oltorius*, an annual, found in Asia, Africa, and America. It rises with a round, striated, upright, branched stalk, near two feet, furnished with leaves differing in shape; some being oval, some cut off straight at their base, and others almost heart-shaped. They are of a deep green color, and have a few teeth on the margins of their base, that end in bristly, reflexed, purplish, filaments. The flowers come out at the sides of the branches opposite to the leaves. They stand singly on very short peduncles; are composed of five small yellow petals, and a great number of stamina surrounding an oblong germen, which becomes a long, rough, sharp-pointed capsule, opening in four parts, each filled with greenish angular seeds. This plant is sown by the Jews about Aleppo, and is therefore called Jews' mallow. The leaves are a favorite salad among these people, which they boil and eat with their meat.

CORCYRA, in ancient geography, an island in the Ionian Sea, opposite to Thesprotia, a district of Epirus, called Scheria and Phœacia by Homer. By Callimachus it is called Drepane; its most ancient name, according to the Scholiasts from its curved figure. It was famous for the shipwreck of Ulysses and the gardens of Alcinous and is now called Corfu.

CORCYRA, a town in the above island, formerly powerful; situated about the middle of the east side, called the Town of the Phœacians by Homer; and now Corfu, from the *Koropus* of the middle age, the name of the citadel. It was a colony of Corinthians.

CORCYRA NIGRA, an island in the Adriatic, on the coast of Dalmatia; called Melsena by the Greeks to distinguish it from the above island. The epithet Nigra was added, from its woods of tall trees with which it is almost covered. It is now named Curzola.

CORD, *v. a. & n. s.* } Fr. *corde*; Ital. *corda*;
CO'RDAGE, *n. s.* } Span. *cordel*; Dut. *horde*;
CO'RDED, *adj.* } Welsh *cort*; Lat. *chorde*.

A rope; a string composed of several strands or twists, commonly of hemp; a quantity of wood for fuel, supposed to be measured with a cord; a pile eight feet long, four high, and four broad. Cordage is a quantity of cords; the ropes employed in rigging a ship. To cord is, to fasten with ropes; to tie up a package; to close by a bandage. Corded signifies that which is formed of ropes; secured with ropes.

She let them down by a cord through the window.
Joshua ii. 5.

Thine eyes shall see Jerusalem a quiet habitation,
a tabernacle that shall not be taken down; none of the
stakes thereof shall ever be removed, neither shall any
of the cords thereof be broken. *Lamiah xxxiii. 20.*

He set him up withouten wordes mo,
And with his axe he smote the corde atwo,
And down goth all. *Chaucer. Cant. Tales.*

Nor in this world there is none instrument
Delicious through winde or touch on corde,
As ferre as any wight hath er iwent,
That tonge tell or hertē maie record,
But at that fest it was well herd accorde.

Id. Troilus and Criseid.

In depe dispayre as did a wretch go,
With reedy corde out of his life to spede,
His stumbling foot did fynde an hoorde. *Wyal.*

She bore before her lap a dolefull squyre,
Lying athwart her horse in great distresse,
Fast bounden hands and feet with cordes of wire.

Spenser. Faerie Queene.

Fair Sthenobœa that herself did choke
With wilfull chord, for wanting of her will. *Id.*
This night he meaneth, with a corded ladder,
To climb celestial Silvia's chamber window.

Shakespeare.

Our cordage from her store, and cables, should be
made,
Of any in that kind most fit for marine trade.

Dreyton.

They fastened their ships, and rid at anchor with
cables of iron chains, having neither canvas nor cor-
dage. *Raleigh.*

Formed of the finest complicated thread,
These numerous cords are through the body spread.

Bleechers.

Spain furnished a sort of rush called spartum, use-
ful for cordage and other parts of shipping.

Arbuthnot on Coins.

Redoubling cords the lofty canvas guide,
And through inextricable mazes glide. *Falconer.*

Each lofty yard with slackened cordage reels,
Rattle the creaking blocks, and ringing wheels. *Id.*

Such he appeared as when, in battle slain,
The victor's chariot rapt him o'er the plain.

Black bloody dust his lineaments defaced ;
And through his wounded feet the cords were braced.
Symon's Æneis.

Thus by acclaim the public sentence known,
The walls we sever, and unfold the town.
All labour : some the encircling cordage tie ;
Some the wheel's motion to the feet supply. *Id.*

CORD-MAKER, *n. s.* From cord and make. One whose trade is to make ropes ; a ropemaker.

CORD-WOOD, *n. s.* From cord and wood. Wood piled up for fuel, to be sold by the cord.

CORDAGE, **ANCIENT**. The naval cordage of the earlier ages was, in all probability, only thongs of leather. These primitive ropes were retained by the Caledonians in the third century. The nations north of the Baltic had them in the ninth or tenth centuries : and the inhabitants of the western isles of Scotland still use them ; cutting the skin of a seal, or the raw and salted hide of a cow, into long pieces, and fastening the plough to their horses with them, or even twisting them into strong ropes of twenty or thirty fathoms length. But these, in the south of our island, and on the continent, were early superseded by the use of iron chains. The Veneti, who were so intimately connected with the Belgæ of Britain, used iron chains for their cables in the days of Cæsar. But in the more refined countries of the south, both thongs and these had long given place to vegetable threads. The Greeks appear to have used the common rushes of their country, and the Carthaginians the spartum, or broom of Spain. And as all the cordage of the Romans was made of these materials at their last descent on our island, so the art of manufacturing them would necessarily be introduced, with the Roman settlements, among the Britons. Under the direction of Roman artists their thongs of leather would naturally be laid aside, and the junci, or rushes of the plains, worked up into cordage. And what remarkably coincides with this opinion is, that the remains of old cables and ropes are still distinguished among the British sailors by the name of old junk. The Roman sails, which were composed of flax in the days of Agricola, were afterwards made of hemp ; and our own are therefore denominated cannabis or canvas by our mariners at present. And doubtless about the same period did the junk of the British cordage give way to the same materials ; the use of hempen ropes upon land, and of hempen nets for hunting, being very common among the Romans in the first century. See **ROPE-MAKING**.

CORDATE, *adj.* Lat. *cor*, *cordis*. Heart-shaped.

CORDATED, an appellation frequently given by naturalists to things somewhat resembling a heart.

CORDE' (Charlotte), a celebrated heroine during the French revolution, was born in 1768, of a good family near Seez in Normandy, and lived chiefly at Caen, where she was greatly admired for her beauty and spirit. She is described by J. Baptist Louvet as 'a stout, handsome, young woman, of a most engaging air—gentle yet noble, modest and beautiful ;—in her face and carriage, which were those of a fine and handsome woman, there was a mixture of gen-

tleness and majesty, which indicated the strength of her mind. Among the many officers who were massacred by the soldiery at the instigation of Marat, there was one Belsunce, a major, for whom Charlotte Cordé had a particular regard ; and the melancholy fate of this man animated her with sentiments of vengeance against the incendiary, whom she considered as the chief cause of all the bloodshed and anarchy that then distracted her country. Regardless of her own life, and determined to avenge the death of her lover, and rid the nation of a tyrant, she hastened to Paris, was introduced to the presence of Marat, to whom she presented a paper to read, and while he was thus employed, she stabbed him to the heart with a dagger, July 12th, 1793. Far from attempting to escape, she confessed the action ; and from the conclusion of a letter which she wrote to her father on the occasion, 'Crime begets disgrace, and not the scaffold,' she seems to have considered it no crime nor disgrace. She was guillotined on the 16th of July, 1793 ; manifesting at her execution, as she had also done at her trial, the most undaunted courage. The extraordinary conduct of this woman was accompanied with conduct no less extraordinary ; for as she was conveyed to the scaffold, a deputy of the city of Mayence, named Adam Lux, a young man, was so transported with admiration of her beauty, that he hastened to the tribunal and demanded to suffer death under the same instrument ; and he was accordingly condemned and executed.

CORDED, in heraldry, a cross wound about with cords as in the annexed diagram. He beareth, *argent* a St. George's cross, corded, *azure*, name Wilkinson.



CORDELI'ER, *n. s.* A Franciscan friar : so named from the cord which serves him for a cincture.

And who to assist but a grave *cordelier*. *Prior.*

CORDELIERS, or Franciscan friars, are clothed in thick gray cloth, with a little cowl, a chaperon, and cloak, of the same ; having a girdle of cord tied with three knots, whence the name. Their original name was Minor friars. The denomination Cordelier is said to have been first given them in the war of St. Louis against the infidels ; wherein the Friars Minor having repulsed the barbarians, and that king having enquired their name, it was answered, they were people cordeliez, 'tied with ropes.' They are professed Scotists.

CORDEMOI (Gerald 'de), a learned Cartesian philosopher and historian, born at Paris. Being appointed reader to the dauphin, he instructed that prince with great assiduity ; and in 1675 was received into the French Academy. He wrote a general history of France during the first races of the French Kings, in 2 vols. ; and six Discourses on the Distinction between Body and Soul, which were printed together in 1702, in 4to. He died in 1684.

CORDIA, in botany, a genus of the monogynia order, and pentandria class of plants ; natural

order forty-first, asperifolia: cor. funnel-shaped: style dichotomous or divided into two threads, and each of these divided into other two. There are eighteen species, of which the principal are, 1. *C. myxa*, the Assyrian plum, native of Assyria, Egypt, and the coast of Malabar. It rises to the height of a middling plum-tree; and its branches are furnished with oval, woolly leaves, standing without order. The flowers are produced in bunches, are white, and consist of one tubular petal, and a like calyx, nearly of an equal length, and both are cut into five parts at their brims. In their centre are five very small stamina, and one slender style crowned with an obtuse stigma. The germen is roundish, and swells to a plum of the same form, and about the size of a damson, of a dark brown color, a sweet taste, and very glutinous. These plums were formerly kept in the shops; and were accounted good for ob- tunding acrimony, and thereby stopping de- fluxions of rheum upon the lungs: but they are now little used. In some parts of Turkey they cultivate this tree in great abundance, not only for the sake of the fruit, but to make birdlime. 2. *C. sebestena*, the rough-leaved sebesten, grows naturally in both the Indies, and sends forth several shrubby stalks eight or ten feet high. The young leaves are serrated, but the full grown ones are not. They are of an oblong oval form, rough, of a deep green on the upper side, and stand alternately on short foot-stalks. The flowers terminate the branches in large clusters, are nearly of the shape and color of those of the marvel of Peru, and make a most beautiful appearance. Each has five stamina and one bifid style. The plums are much of the shape of those of the myxa, and are eaten in the same manner. The fruit of this tree is less valuable than the wood, a small piece of which thrown upon a clear fire will perfume a room with a most agreeable odor.

COR'DIAL, *n. s. & adj.* } Fr. *cordial*; Ital. *cordiale*; Span. *cordial*; Lat. *cor*. A medicine to increase the strength, or raise the spirits; that which comforts or exhilarates a person; that which puts him in heart. The adjective signifies reviving; strength-restoring; sincere; warm, as a cordial friend, a cordial reception. Brown uses cordiality to denote, relating to the heart; but its common meaning is sincerity; friendliness of intercourse; heartiness. Cordialness is synonymous with it. Cordially is sincerely; heartily.

Many restoratives of vertues rare,
And costly cordialles, she did apply,
To mitigate his stubborn malady.

Spenser. Fuarie Queens.

It is a thing I make, which hath the king
Five times redeemed from death: I do not know
What is more cordial. *Shakespeare. Cymbeline*

If nor a dramme of treacle soveraigne,
Or aqua vitæ, or sugar candian,
Nor lutchen cordials can it remedie,
Certes his time is come, needs mought he die.

Hell.

Cordials of pity give me now,
For I too weak for purges grow. *Cowley.*

He, with looks of cordial love,
Hung over her enamoured.
That the antients had any such respects of cordiality,
or reference unto the heart, will much be doubted.

Milton.

Doctrines are infused among Christians, which are apt to obstruct or intercept the cordial superstructing of Christian life of renovation, where the foundation is duly laid.

Hammond.

Where a strong inveterate love of sin has made any doctrine or proposition wholly unsuitable to the heart, no argument, or demonstration, no nor miracle whatsoever, shall be able to bring the heart cordially to close with, and receive it.

South's Sermons.

Your warrior offspring that upheld the crown,
The scarlet honour of your peaceful gown,
Are the most pleasing objects I can find,
Charms to my sight, and cordials to my mind.

Dryden.

He only took cordial waters, in which we infused sometimes purgatives.

Wisceman's Surgery.

A cordial, properly speaking, is not always what increaseth the force of the heart; for, by increasing that, the animal may be weakened, as in inflammatory diseases. Whatever increaseth the natural or animal strength, the force of moving the fluids and muscles, is a cordial: these are such substances as bring the serum of the blood into the proper condition for circulation and nutrition; as broths made of animal substances, milk, ripe fruits, and whatever is endued with a wholesome but not pungent taste.

Arbutnot on Aliments.

If Heaven a draught of heavenly pleasure spare,
One cordial in this melancholy vale,
'Tis when a youthful, loving, modest pair,
In others' arms breathe out the tender tale,
Beneath the milk-white thorn that scents the ev'ning gale.

Burns.

We must take human nature as it is: and, if a rude multitude cannot readily comprehend a moral or political doctrine, which they need to be instructed in, it may be as allowable to illustrate that doctrine by a fable, in order to make them attend and understand it, as it is for a physician to strengthen a weak stomach with cordials, in order to prepare it for the business of digestion.

Beattie.

That cordial thought her spirits cheered,
And through the cumbersome throng,
Not else unworthy to be feared,
Conveyed her calm along.

Cooper.

Then was the cordial poured, and mantle flung
Around his scarce clad limbs; and the fair arms
Raised higher the faint head which o'er it hung.

Byron. Don Juan.

CORDELLERAS. See **ANDES.**

COR'DINER, *n. s.* Fr. *cordonnier*. A shoemaker. It is so used in divers statutes.

CORDON, *n. s.* French. In fortification, a row of stones jutting out before the rampart and the basis of the parapet.

CORDONNIERS, FRERES, Fr. i. e. Brothers Shoemakers, the title of two pious societies, which existed in Paris before the revolution. They were established by authority about the middle of the seventeenth century; the one under the protection of St. Crispin, the other of St. Crispianus, two saints who had formerly honored the profession. They lived in community, and under fixed statutes and officers; by which they were directed both in their spiritual and secular concerns. The produce of their shoes was put into a common stock, to fur-

nish necessaries for their support ; the rest to be distributed among the poor.

CORDOVA, a small but fertile province of Spain, in Andalusia, formerly an independent kingdom. After the fall of the Roman empire it was subjected to the dominion of the Goths ; but in the eighth century it was raised by the Moors to a state of unequalled splendor. In 755 Abdelrahman, the heir male of the Omniad line, having passed over from Africa, at the head of a few desperate followers, raised a rebellion in Spain ; when, after a battle fought on the banks of the Guadalquivir, in which he overthrew the lieutenant of the caliph of Damascus, he became king of all the Moorish possessions in the south of Spain, and fixed, in 759, his royal residence at Cordova. Then began those flourishing ages of Arabian gallantry and magnificence, which rendered the Moors of Spain superior to all their contemporaries in arts and arms, and made Cordova one of the most splendid cities in the world. Agriculture and commerce prospered under the happy sway of this hero ; and the face of the country was changed from a scene of desolation, which the long wars and harsh government of the viceroys had brought on, into a most populous and flourishing state, exceeding in riches, number of inhabitants, activity, and industry, any prior or subsequent era of the Spanish history. He added new fortifications to the town, built a magnificent palace with delightful gardens, laid causeways through the marshes, made excellent roads to open ready communications between the great towns, and in 786 began the great mosque, which he did not live to finish. During two centuries, this court continued to be the resort of all professors of polite arts, and of such as valued themselves upon their military accomplishments : whilst the rest of Europe was buried in ignorance, debased by brutality of manners, or distracted by superstitious disputes. England, weakened by its heptarchy, was too inconsiderable even to be mentioned in the political history of the times ; France, though it had a gleam of reputation under Charlemagne, was still a barbarous, unpolished nation ; and Italy was in utter confusion ; the frequent revolutions and change of masters rendered it impossible for civilisation to acquire a permanent footing in so unstable a soil. Twelve caliphs succeeded to the throne of Abdelrahman at Cordova, but its repose was disturbed, and the power of the monarchs shaken, by those repeated insurrections to which despotic governments are exposed. In the reign of Abdalla, Suar Alcaisi, and afterwards Said, a native of Syria, raised the standard of revolt in the mountains of Alpujarras, between Cordova and Granada, and though joined by numbers of the discontented, was, after numerous conflicts, quelled by the general of Abdalla. The calm which succeeded these revolts was disturbed by Mahomed ben Abdallatiph, of a Persian family, established in Alhama, who, supported by a body of insurgents, proclaimed himself caliph, and maintained a long and doubtful war with his sovereign ; but was conquered, and finally met the fate of a traitor, during the reign of Abdelrahman the Third, in the year 924 of the Christian era. For nearly a century after

this period the sovereigns of Cordova enjoyed an undisturbed repose, till Soliman ben Alhaken, an adventurer from Africa, led a numerous army of Moors into Spain, where he was joined by the discontented Arabs ; and, after a rapid career, entered the city of Cordova, seated himself on the throne of the caliphs, and transmitted to his son Almanzor the power of the Mahomedans, who transferred the royal residence to Granada, in 1013, and whose successors made it their capital till its final subjugation by the Christians.

The modern province is divided into two naturally distinct districts by the Guadalquivir ; west of which the country is mountainous, and a perfect plain to the east. It is bounded on the north by Estremadura and La Mancha, on the east by Jaen and Granada, south by Seville, and west by Seville and Estremadura ; and occupies a space of about 4580 square miles. The entire population is between 250,000 and 260,000.

The valleys between the mountains, as well as the plain districts, are very productive in wine, oil, grain, and figs ; on the hills is the finest pasturage. The Guadalquivir is fed by several streams of less note. The chief towns besides Cordova, are Lucina and Montilla.

CORDOVA, or CORDUBA, an ancient city of Spain, the capital of the above province, is seated on the Guadalquivir, (over which it has a fine stone bridge), in a very extensive plain. The circumference is large, and the river winds round it very beautifully ; but it is not peopled in proportion to its extent, there being many orchards and gardens within the walls. There are many superb structures, palaces, churches, and religious houses. The bridge was built by the Moors, and is supported by sixteen arches. The ancient palace of the Moorish kings was large and beautiful, but has long since been converted into stables.

This city had anciently a university in which all the sciences were cultivated, and in which the elder Seneca, who wrote the Art of Persuasion ; Seneca, preceptor to Nero ; Gallio, the orator ; Lucan, author of the Pharsalia ; Seneca, the tragedian ; Seneca, the historian, and many other eminent men, prosecuted their studies : this university likewise flourished under the Moors. Cordova is the see of a bishop ; and contains, besides the cathedral, sixteen parish churches, forty convents, twenty-one hospitals, and two colleges. The cathedral church was built by the Moors for a mosque, out of the ruins of an ancient Roman temple, and it still retains the name of mezquita, or the mosque. This building is 334 feet in length, and 387 wide. It stands in an insulated position at the head of four of the principal streets. It is very rich in plate. Apart from the rest of the building is a square chapel in which the Moors preserved the book of the law. It is adorned with fine marbles, the entablature being supported by twelve columns, placed upon the shafts of other twelve, with a handsome dome. This building adjoins another square one, which has a cupola supported by eighty four columns of fine marble, and eight windows with sky-lights in alabaster ; and this last leads to a magnificent octagon building,

thirteen feet in height and width, and ornamented with marbles like the other buildings. In 1528 the cathedral was formed into a cross, by building a chapel in the middle, forming as it were a second church. The ancient church of the Martyrs is also a handsome building, containing several fine paintings, and a beautiful marble monument of Ambrosio Morales; it belongs to the Dominican convent. The church of the Capuchins, and that of St. Francis also, contain several excellent paintings. The royal palace resembles a citadel, and is encircled with walls. The episcopal palace formerly occupied by the Inquisition, is a large building with a noble marble staircase, spacious garden, and an orchard of orange trees. It contains various paintings of respectable masters. But the college of St. Paul is, perhaps, the finest public edifice in this noble city. Its entire front and magnificent staircase are of marble. The cloisters consisting of two ranges of porticoes one above the other, and supported by eighty marble columns, are also much admired. The library contains many rare books and pictures. The whole belongs to the Dominicans. The square called the Plaza Major is surrounded with very fine houses, under which are piazzas. The silk and gold lace manufactures are gone to decay, but a tolerable trade (for Spain) is carried on in gold and silver articles, and the staple manufactures of lace, ribbands, hats, Cordova leather, and baize. Though the art of softening leather and giving it a fine polish was invented at Cordova, the town possesses few tan yards. In the neighbourhood are vast numbers of orange and lemon trees, which render their fruits exceedingly cheap. The best horses in Spain come from hence. Population about 40,000. This city is seventy-five miles north-east of Seville, and 180 S.S. W. of Madrid.

Cordova, a province of La Plata, South America, formerly belonging to the vice-royalty of La Plata, or Buenos Ayres, but now ranking among the independent provinces. It is about 300 miles in length, and 210 broad, being bounded by the province of Tucuman to the north, by Buenos Ayres to the east, vast Indian plains or pampas south, and Cuyo west. It is traversed throughout its whole length by an immense chain of mountains, known as the Sierra de Cordova, the Campachin, or Achelan chain, and covered with perpetual snow. It is watered by the Torcera, which joins the La Plata, and some minor streams. This province is celebrated for its numerous herds of cattle, its horses, mules, and woollen manufactures: the young women of all ranks unite in the labors of the loom, and dye the wool themselves, according to Mr. Caldclough, most durably. 'The yellow color,' says this writer, 'is produced by the roots of the romeiro, or rosemary, and the blue by anil or indigo; the red is obtained from anoto. The ink and all the black dyes are produced by bruising the pods of the algarabilla, and mixing them with warm water and native sulphate of iron, which is carried a great distance as an article of trade; it is termed *caparrusa*, whence perhaps our copperas is derived. The algaraba, which is I believe, an acacia, is

a tree of great value, particularly the *algaroba blanca*. The pods are made by fermentation into a kind of chicha or drink, and it serves as well to feed cattle when the maize crop is deficient.' The looms he often found at work under the shade of trees. Cordova joined early in the late revolutionary movements, and a general congress of the then United Provinces was held in its capital in 1821; but it imbibed a jealousy of the preponderance obtained in the new republic by Buenos Ayres, and became detached from the Union. Its population is reckoned at 44,000. Its chief towns, beside the city of Cordova, are Mendoza, San Juan de Jablan, and San Luis de la Punta. The whole country has been frequently disturbed of late by incursions of the Indians from the south.

CORDOVA, or CORDUBA, a city of South America, the capital of the foregoing province, is said, proverbially, to be situated, *en un pozo*, in a well, and the site has the appearance of having been once a considerable depository of water, which has escaped in the direction of the river Primera, or Pune, near which it stands, in lat. 31° 30' S., and long. 63° 15' W. It was founded by the Spanish governor Carbera, in 1573. The streets are regular, and the houses built of brick are higher than the usual style of Spanish towns; most of them are adorned with balconies; but the ground on three sides of the town overtops the highest of them. The great square has one side covered with a neat *cabildo*, and the other with a cathedral. There are fourteen other churches. The population is estimated at 14,000. The neighbourhood is marshy, but very fertile in grain, fruits, and pasturage. A trade in the woollen manufactures and mules of the province was once very flourishing, but the revolution has almost entirely suspended the latter. The university, which comprises the ancient college of the Jesuits, is perhaps one of the finest remnants of the former magnificence of the order. It contains still about 100 students. The church is superb, rich enough, says a late traveller, to show the wealth of the founders, and sufficiently elegant to prove that men with enlightened minds, even without the assistance of models and designs, can possess a chastened and correct taste. The rooms are conveniently arranged, spacious, and numerous. One of the upper apartments was filled with the most expensive physical apparatus, all rapidly going to decay, and the names and purposes of which are now unknown to every inhabitant of the city. Another smaller apartment, in the rear of the pile, had been occupied by the printing press, the only one for a century which existed in this part of the world. The press remained concealed in this retreat for many years after the expulsion of the company.' The climate is intensely hot during summer, and ripens some fine grapes. The mountains of the vicinity contain veins of silver, lead, and copper; and a gold mine is said once to have been worked at Punilla, a short distance off. Old Dobrzhoffer speaks with his usual accuracy of a curious phenomenon yet observed here. 'Lofty rocks rise in every part of the Corduban district. I heard terrible noises like the explosion of cannon; but the natives as-

sured me, that these sounds were common to the neighbouring rocks, and happened perpetually. The air confined in the cavities of the mountain, and attempting a forcible passage through the chinks, when stopped by opposing rocks, and reverberated by their windings, bellows after this fearful manner. In the city of Corduba itself, a hollow murmur, resembling the knocks of a pestle in a wooden mortar, is frequently heard by night. This low mournful sound runs from one street to another, and is called by the Spaniards, *el pison*, or the paving hammer. 'The vulgar,' he adds, 'believe it to be the tramp of some spectre-horsemen riding through the city.' Captains Lewes and Clarke tell us of the same noises being heard by them in the rocky mountains of North America. Mr. Caldecleugh says he listened for it the three evenings he passed here in vain, but heard of it from respectable inhabitants, and by no means discredits, though he could not account for, the alleged sounds.

CORDOVA, or **CORDOBA**, a large and old city of Mexico, in the intendency or state of Vera Cruz. Its structures, both public and private, are surmounted by numerous handsome domes and towers, and there is a large square in the centre with Gothic arcades. The cathedral of the town, surrounded on three sides, occupies the fourth, and a fountain of water runs in the middle. The cathedral is considered as one of the most splendid structures in Mexico. All the streets are wide, straight, and well paved, and the houses mostly of stone. The vegetation around is extremely luxuriant, producing all the fine tropical fruits; but the inhabitants are said to be very indolent, and insensible of these advantages. A considerable trade is here carried on in sugar, which, as well as tobacco, flourishes in this neighbourhood. Cordova is 150 miles E. N. E. of Mexico. Inhabitants about 4000.

CORDOVAN, *n. s.* } Fr. *cordovan*; Ital. }
COR'DWAIN, *n. s.* } *cordovano*; Span. *cor-* }
COR'DWAINER, *n. s.* } *doban*; Swed. *kardow-* }
wan; Dut. *kordewaine*. A Spanish leather. It is generally supposed to derive its name from Cordova. Thomson, however, seems disposed to look for the origin of it in two Spanish words, which he states to mean sheep's leather. But to this there are two objections, namely, that his Spanish is incorrect, and that cordovan is not made from sheep skins. Cordwainer is a shoemaker.

His here, his berde, was like safroun,
 That to his girdle raught adown;
 His shoon of *cordewans*. *Chaucer. Cant. Tales.*

Buskins he wore of costliest *cordwayne*,
 Pirtch upon gold and paled part per part,
 As then the guize was for each gentle awayne.
Spenser. Faerie Queene.

CORDWAINERS, or **CORDINERS**, is still the title of the incorporation of shoemakers in Edinburgh. The first of the above etymologies is best warranted: for, the French workmen who prepare the corduas are still called *corduaniers*.

CORDUBA, in ancient geography, an illustrious city of Bætica, on the right or north side of the Bætis. It was the first colony sent into

those parts by the Romans, and named Colonia Patricia, because at first inhabited by principal men, both of the Romans and natives. It is mentioned by Silius Italicus in the second Punic war; and hence it is probable the first Marcellus, and not the second, was the founder. It was famous for the birth of the two Senecas and Lucan, and for its rich produce in oil. See **CORDOVA**.

CORDUROY, *corde du roi* (Fr.), in manufactures, a stuff originally formed of silk cloth, but now extensively formed in cotton in our clothing districts. Thickset, velveret, and velveteen, are varieties of it; and the comfortable clothing made from it for the poorer classes, are proofs that kingly garments like all others, change their owners. See **COTTON MANUFACTURE**.

CORDUS (Valerius), a learned botanist, the son of Etricius Cordus, a physician and poet of Germany. In the prosecution of the study of botany, he examined the mountains of Germany, and travelled into Italy; but being wounded in the leg by the kick of a horse, died at Rome in 1544. He wrote Remarks on Dioscorides, and other works.

CORE, *n. s.* Fr. *cœur*; Lat. *cor*. The heart; the central part of any thing; the capsules which contain the kernels in some fruits, as in the apple and pear; the pus in a boil. Bacon also uses it, corruptly from the French *corps*, to signify a body or collection.

Give me that man
 That is not passion's slave, and I will wear him
 In my heart's *core*; ay, in my heart of heart.

Shakespeare. Hamlet.

It is reported that trees, watered perpetually with warm water, will make a fruit with little or no *core* or stone. *Bacon.*

He was more doubtful of the raising of forces to resist the rebels, than of the resistance itself; for that he was in a *core* of people whose affections he suspected. *Id. Henry VII.*

In the *core* of the square she raised a tower of a furlong high. *Raleigh's History of the World.*

Launce the sore,
 And cut the head; for, till the *core* be found,
 The secret vice is fed, and gathers ground.

Dryden's Virgil.

Dig out the *cores* below the surface. *Mort. Huob.*

They wasteful eat,
 Through buds and bark, into the blackened *core*.

Thomson.

Never was this one unextinguishable truth destroyed from the heart of man, placed, as it is, in the very *core* and centre of it by his Maker, that man was not made the property of man; that human power is a trust for human benefit; and that when it is abused, revenge becomes justice, if not the bounden duty of the injured. *Burke.*

Alas! our young affections run to waste,
 Or water but the desert; whence arise
 The weeds of dark luxuriance, tares of haste,
 Rank at the *core*, though tempting to the eyes.

Byron. Childs Harold.

And if she met him, though she smiled no more,
 She looked a sadness sweeter than her smile,
 As if her heart had deeper thoughts in store
 She must not own, but cherished more the while
 For that compression in its burning *core*.

Id. Don Juan.

COREA, a peninsula north-east of China, between 99° and 109° of E. long., and between 32° and 46° of N. lat., said by the Jesuits to be divided into eight provinces, which contain forty cities of the first rank, fifty-one of the second, and seventy of the third. The capital is Hanching, where the king resides. They add that the people are well made, of a sweet and tractable disposition, fond of learning, music, and dancing; and in general resemble the Chinese; but they have little silk, and make use of linen cloth in its room. Their trade consists in paper, pencils, gold, silver, iron, varnish, sables, &c. In general it is a fertile country, though abounding in mountains, and tributary to China. The voyage of captains Hall and Maxwell into this neighbourhood has proved the breadth of this peninsula to be less than was supposed, as a great part of what was thought its western coast, proves to consist of an archipelago of innumerable small islands. Its length may now be taken at about 400 miles, and its average breadth at 150: but the interior is still only known by accounts received through China, and those of Humel, a Dutchman, who was shipwrecked here in the middle of the seventeenth century. According to these accounts a considerable quantity of the paper of Corea is annually imported as tribute into China. It is made of cotton, and is as strong as cloth, being written upon with a small hair brush or pencil; but must be covered with alum-water before it can be written upon in the European manner. It is not purchased by the Chinese for writing, but for filling up the squares of their sash-windows; because, when oiled, it resists the wind and rain better than that of China. It is used likewise as wrapping paper; and is said to be sufficiently tough to serve as the finest cotton cloth in lining clothes. It has also this singular property, that if it be too thick for the purpose intended, it may be easily split into two or three leaves. Like China, Corea has its men of letters, who form a distinct class by themselves, and undergo a similar course of examinations. Its written language is the same, though the spoken dialect is different. The British vessels in sailing along this coast were received hospitably, and a friendly intercourse took place with several chiefs; but great efforts were made to prevent the officers and crews from coming on shore; and when they landed they were, with a singular mixture of anxiety and civility, induced as soon as possible to re-embark.

COREIA, in antiquity, a festival in honor of Proserpine, named Core, Κορη, which in the Molossian dialect signifies a beautiful woman.

CO-REIGNERS, *s. s.* Those who rule or reign in conjunction.

CORELLI, (Archangelo), a famous Italian musician and composer, born at Fusignano, in Bologna, in 1653. About 1672 his curiosity led him to visit Paris, but, notwithstanding the character which he brought with him, he was driven back to Rome by Lully, whose jealous temper could not brook so formidable a rival. In 1680 he visited Germany, and met with a reception suitable to his merit from most of the German princes, particularly the elector of Bavaria; in whose service he was retained, and

continued for some time. After about five years stay abroad he returned to Rome. His proficiency on the violin was so great, that his fame soon spread throughout Europe. He was highly favored by that great patron of poetry and music cardinal Ottoboni, and regulated the musical academy held at his palace. Here Handel became acquainted with him; and a serenata of Handel's, entitled *Il Triomfo del Tempo*, being performed, the overture was in a style so new and singular, that Corelli was confounded in his first attempt to play it. While Corelli resided at Rome, many persons from other countries were ambitious of becoming his disciples. Of these it is said the late lord Edgcombe was one. Corelli died at Rome in 1717; and was buried in the church of the Rotunda. A monument with a marble bust was erected to his memory by Philip William, count palatine of the Rhine, under the direction of cardinal Ottoboni. For many years after his death, he was commemorated by a solemn musical performance in the Pantheon; where some of his concertos were performed by those who had been his pupils, in the same slow, distinct, and firm manner, without graces, in which they were played by the author himself. He was a passionate admirer of pictures, and lived in an uninterrupted friendship with Cignani and Carlo Marat; who presented him at times with pictures, both of their own painting, and by other masters: whereby he became possessed of a valuable collection of original paintings; all which, together with about £6000 sterling, he left to his friend Ottoboni; who, reserving the pictures to himself, generously distributed the rest among the relations of the testator.

COREOPSIS, tick-seeded sunflower, a genus of the polygamia frustanea order, and syngenesia class of plants, natural order forty-ninth, compositæ. Receptacle is paleaceous; pappus two-horned: CAL. erect and polyphyllous, surrounded with patent radiated leaflets at the base. There are twenty-five species, most of them herbaceous perennials. They are very flowery, and rise from three to eight feet, terminating by clusters of compound radiated flowers of a yellow color. They have all perennial fibrous roots, and annual stalks, which rise in the spring, flower from July to October, and decay to the root in November. The flowers are all shaped like sun-flowers, but smaller, and are very ornamental. They are easily propagated by slipping or dividing the roots in autumn, when the stalks decay; planting the slips at once where they are to remain; after which they require only to be kept free from weeds, and to have the decayed stalks cut annually in autumn.

CORFE-CASTLE, a borough and market town of England, in the county of Dorset, situated in the centre of what is called the Isle of Purbeck, governed by the mayor and barons, who claim the same privileges as the cinque ports. It takes its name from a castle, said to have been built by king Edgar, but now in ruins. Here Edward, king of England, called the Martyr, was murdered by order of Elfrida, to obtain the throne for her son Ethelred. It sends

two members to parliament. The town is built on a rising ground that declines to the east, and consists of two streets. The houses are mean, but built of stone. It is the only town in the island; and its parishes are very extensive. Its only trade is in stone, and knit stockings. It is separated from the castle by a stately bridge of four very high arches over a deep dry ditch. It has a market on Thursday, nearly disused; and fairs on May 12th, and Oct. 10th. It is eighteen miles S.S.W. of Poole, and 116 west of London.

CORFU, an island of the Mediterranean, at the mouth of the Adriatic, near the coast of Albania, about fifteen leagues long, and eight broad; anciently known under the names Scheria, Phæacia, Corcyra, and Drepane. In the best days of Greece, the Corcyrians formed a powerful republic; in succeeding times it belonged to the king of Naples; and was afterwards sold for 30,000 ducats to the Venetians, who maintained a fleet of galleys in the port, and a strong garrison, to defend this and the neighbouring islands. It was ceded to the French republic in Oct. 1797, by the treaty of Campo Formio; but was surrendered by capitulation to the united forces of the Turks and Russians on the 3rd of March, 1799. The island contains above 50,000 inhabitants, and is divided into four bailiwicks, or governments. The air is healthy, the land fertile, and the fruit excellent. Citrons, oranges, and the most delicious grapes, honey, wax, and oil, are exceedingly abundant. Some places are mountainous and barren, and good water scarce. The manufacture of salt is a source of great wealth, as well as employment to the inhabitants. The religious establishment is said to partake partly of the Greek, and partly of the Roman Catholic rites. The latter are followed by the members of the government. Under the Venetians an archbishop, named by the senate, was appointed by the pope. The population of Corfu generally profess themselves of the Greek church, at the head of which is a protopapa, chief priest, or bishop, chosen by an assembly of the clergy and noblesse. He is of a noble family, and distinguished from the chief priests of the other Ionian islands by his title of great protopapa. On his election, he generally gives an elegant and expensive entertainment to the higher order of the islanders, who will not scruple, we are told, to carry away part of the feast. He remains in office five years, and then returns to the ordinary class of papas.

Superstition and unaccountable vanity predominate in the character and manners of the Corfiotes. On the slightest provocation any one, it is said, may obtain the dreaded anathema of the protopapa, who, on receiving a sufficient bribe, will appear before the house of the victim at the head of his clergy, habited in black, and preceded by a crucifix and black flag, to pronounce the sentence. Sometimes the anathematized person obtains, at considerable expense, a counter-communication from the same ecclesiastic; and sometimes retaliates by the use of the poniard.

Marriages and funerals, in Corfu, are celebrated according to the Greek ritual. To prepare for the former a table is spread in the best apartment, on which a Bible is laid between two

wax tapers; having a salver at one side with a glass or small phial of wine and a little bread, and on the other a salver containing rose-colored garlands. The ceremony being performed, a crown is made, by interlacing the two tapers, and is placed over the nuptial bed. The bride is now seen dissolved in tears in order to express her modesty; but if, at the moment of consent, any bystander shall cast three knots on a cord and throw it in the fire, it is confidently believed that the husband will be completely enervated.

Preparations for burial are made the instant a person expires, and scarcely two hours elapse before it takes place. The body is clothed in the best apparel it ever wore, and on this occasion nothing but the head and hands are left exposed. It is now laid on carpeted tressels, with a cushion under the head and a crucifix in the hands; the whole being covered, if the person was unmarried, with artificial flowers. At the church, after the funeral service, all the friends kiss the deceased, at the same time muttering over him in a low whisper: it is thought a great token of regard to a stranger to invite him to pay this tribute of respect. The graves are frequently visited and crowned with flowers for the first three months after interment.

CORFU, the capital of the above island, the seat of a bailiff, a provveditor, a captain, &c. and the see of an archbishop, is four miles in circumference; and seated on the east coast. It is strongly fortified, and usually defended by a garrison of about 10,000 men. A number of excellent brass and iron cannon are mounted on the different forts; and the works have been much improved by major-general Paterson. In the last war between the Venetians and the Turks, this town was attacked by an army of 80,000 men, and attempted to be stormed several times by the enemy; but the garrison, which consisted of 12,000 men, under the command of count Schulenburg, made so gallant a defence, that they obliged them to raise the siege with considerable loss. For this service a magnificent statue was erected in memory of the count. In the city are many handsome Greek churches, the principal of which is that of St. Speridione, or the cathedral; it is embellished with some excellent paintings, and is most superbly ornamented. The body of the saint is preserved entire in a rich shrine within the church. It is deposited in a silver coffin ornamented with precious stones; and is in high preservation, though the saint died at Cyprus above 700 years ago. The Greeks, under the Venetian government, were most of them such fanatics, as to be continually offering their devotions at this shrine, believing that through the intercession of the saint, they would obtain all their wants, and that by offerings of money their sins would be forgiven them; by which means the church had amassed an immense treasure. Corfu has a good harbour, and a considerable traffic. The chief diversions of this place in winter are operas. By an accidental explosion of one of the powder magazines in the fortifications, towards the earlier part of the eighteenth century, not less than 2000 persons were killed and wounded; and by a similar catastrophe, in 1789,

600 individuals lost their lives, four galleys and several other vessels were sunk in the harbour, and many houses shattered. The inhabitants have erected a most excellent lazaretto, and are very particular in their precautions against the plague. N. lat. 39° 40', E. long. 19° 48'.

CORIA'CEOUS, *adj.* Lat. *coriaceus*. Consisting of leather; of a substance resembling leather.

A stronger projectile motion of the blood must occasion greater secretions and loss of liquid parts, and from thence perhaps spissitude and *coriaceous* concretions. *Arbuthnot on Aliments.*

CORIA'NDER, *n. s.* Lat. *coriandrum*. A plant.

Israel called the name thereof manna; and it was, like *coriander* seed, white. *Exodus* xiii. 31.

The species are, 1. Greater *coriander*; 2. Smaller testiculated *coriander*. The first is cultivated for the seeds, which are used in medicine: the second sort is seldom found. *Miller.*

CORIANDRUM, **CORIANDER**, a genus of the digynia order, and pentandria class of plants; natural order forty-fifth, umbellate: *cor.* radiated; the petals inflexed-emarginated; the involucre universal and monophyllous; the partial involucre halved; the fruit spherical. There are only two species, both herbaceous annuals, the leaves of which are useful for the kitchen, and the seeds for medicine. Both species have divided small leaves, somewhat resembling parsley. The species most generally cultivated is the *C. sativum*: it has a small fibrous white root, crowned by many parted leaves, having broadish segments; and in the centre an upright, round, branchy stalk, two feet high, having all the branches terminated by umbels of flowers, which are succeeded by globular fruit. It is propagated by seeds, which ought to be sown in March, either in drills a foot asunder, or by broad cast, and then raked in. When the plants are an inch or two high, they should be hoed to six or eight inches distance. The seeds when fresh have a strong disagreeable smell, which improves by drying, and becomes sufficiently grateful: they are recommended as carminative and stomachic. They are also much used by the brewers both in England and Holland, to give a flavor to their strongest beer. The ancients had an idea, that the juice of coriander would deprive people of their senses, and even of life. The leaves are sometimes used for culinary purposes in soups, and as an ingredient in salads; but as they are of a fetid smell, they are not esteemed in this country.

CORIARIA, the tanners', or myrtle-leaved sumach, a genus of the decandria order, and diœcia class of plants. Male; *cal.* pentaphyllous: *cor.* pentapetalous, very like the calyx, and united with it; the antheræ bipartite. Female, *cal.* pentaphyllous; the *styles* five, seeds five, covered with five succulent petals, forming altogether the resemblance of a berry. There are three species: *C. foemina*, and *C. myrtifolia*, are both natives of the south of France, but the latter is most commonly cultivated in this country. It is a pretty ornamental plant, with a shrubby pithy brown stem, closely branching

from the bottom, and forms a bushy head three or four feet over, thickly garnished with oblong, pointed, bright green leaves, having small spikes of whitish flowers at the ends of the branches. It is easily propagated by suckers from the root, which it affords plentifully, and may be taken off with fibres every autumn or winter. It may be also propagated by layers in autumn, which will take root in a year. It is much used in the south of France, where it naturally grows, for tanning of leather, whence its name of tanners' sumach. It also dyes a beautiful black color. The berries are dangerous, and when eaten generally occasion vertiges and epilepsies. The old leaves have the same effect upon cattle that eat them, but the young leaves are innocent.

CORIDOR, Italian and Spanish, in architecture, a gallery or long aisle round a building, leading to several chambers at a distance from each other, sometimes wholly enclosed, and sometimes open on one side.

CORIDOR, or **CORRIDOR**, in fortification, a road or way along the edge of the ditch, without side, about twenty yards broad, encompassing the whole fortification. It is also called the covert way, because covered with a glacis, or esplanade, serving as a parapet.

CORINNA, a celebrated Theban poetess, who is said to have gained the prize in competition with Pindar himself, five different times. She flourished about A. A. C. 450, and wrote fifty books of epigrams.

CORINGA, a sea-port in the Northern Circars of Hindostan, district of Rajahmundry, on the western side of the bay of Bengal. It is reckoned a very safe port for middling-sized vessels during the south-west monsoon, and has lately been improved by a wet dock. It carries on a considerable trade with Bengal and Pegu in teak wood, salt, and piece goods. The French were first established here, and part of their factory remains, but the English obtained possession of the place, together with the district in 1759, and established a factory at Ingeram, five miles to the south. In 1787 the greater part of the town, and nearly the whole of the inhabitants were swept away by a dreadful inundation from the sea.

CORINTH, *n. s.* } From the city of that
CORINTHIAN, *adj.* } name in Greece. A small fruit, commonly called currant: that which belongs to, or is derived from, Corinth.

Now will the *corinths*, now the rasp, supply
Delicious draughts. *Philips.*

The chief riches of Zant consist in *corinths*, which the inhabitants have in great quantities. *Brocme.*

CORINTH, a celebrated city of antiquity, for some time the most illustrious of all the Greek cities. It is said to have been founded 1514 years before Christ, by Sisyphus the son of Æolus, and grandfather of Ulysses. Various reasons are given for its name, but most authors derive it from Corinthus, the son of Pelops. It was situated in the south part of the Isthmus which joins the Peloponnesus to the continent. As the genius of the Corinthians led them to commerce rather than martial exploits, their city became the finest in all Greece. It was adorned

with the most sumptuous buildings, as temples, palaces, theatres, porticoes, &c. all enriched with a beautiful kind of column, which was called Corinthian, from this city. But though the Corinthians seldom or never engaged in a war with a view of enlarging, but rather of defending their little state, they did not forget to cultivate a good discipline both in time of peace and of war. Hence many brave and experienced generals have been furnished by Corinth to the other Grecian cities, and it was not uncommon for the latter to prefer a Corinthian general to any of their own. This city continued to preserve its liberty till A.A.C. 146, when it was pillaged and burnt by the Romans. It was at that time the strongest place in the world; but the inhabitants were so disheartened by a preceding defeat, and the death of their general, that they had not the presence of mind even to shut their gates. The Roman consul, Mummius, was so much surprised at this, that at first he could scarce believe it; but afterwards, fearing an ambuscade, he advanced with all possible caution. As he met with no resistance, his soldiers had nothing to do but destroy the few inhabitants who had not fled, and plunder the city. The men who had staid, were all put to the sword, and the women were sold for slaves. After this the city was ransacked by the greedy soldiers, and the spoils were said to have been immense. There were more vessels of all sorts of metal, more fine pictures and statues, done by the greatest masters, in Corinth, than in any other city in the world. All the princes of Europe and Asia, who had any taste in painting and sculpture, furnished themselves here with their richest movables: here were cast the finest statues for temples and palaces, and all the liberal arts brought to their greatest perfection. Many inestimable pieces of the most famous painters and statuariers fell into the hands of the ignorant soldiers, who either destroyed them, or parted with them for trifles. Polybius, the historian, was an eye witness to this barbarism of the Romans. He had the mortification to see two of them playing at dice on a famous picture of Aristides, which was accounted one of the wonders of the world. The piece was a Bacchus, so exquisitely done that it was proverbially said of any extraordinary performance, 'It is as well done as the Bacchus of Aristides.' This masterly piece of painting, however, the soldiers willingly exchanged for a more convenient table to play upon; but when the spoils of Corinth were put up to sale, Attalus king of Pergamus offered for it 600,000 sesterces, near £5000 of our money. Mummius was surprised at the high price offered for it, and imagined there must be some magical virtue in it. He therefore interposed his authority and carried it to Rome, notwithstanding the complaints of Attalus. Here this famous picture was lodged in the temple of Ceres, where it was at last destroyed by fire, together with the temple. Another extraordinary instance of the stupidity of Mummius is, that when the pictures were put on board the transports, he told the masters of the vessels very seriously, that if any of the things were either lost or spoiled, he would oblige them to find others at their own

cost; as if any other pieces could have supplied the loss of those inestimable originals, done by the greatest masters in Greece. When the city was thoroughly pillaged, fire was set to all the corners of it at the same time. The flames grew more violent as they drew near the centre, and uniting there made one prodigious conflagration. At this time the famous metalline mixture is said to have been made, which could never afterwards be imitated by art. The gold, silver, and brass, which the Corinthians had concealed, were melted, and ran down the streets in streams; and, when the flames were extinguished, a new metal was found, composed of several different ones, and greatly esteemed in after ages. Corinth lay desolate until Julius Cæsar settled there a Roman colony: when, in removing the rubbish and digging, many vases were found of brass, or earth finely embossed. The prices given for these curiosities excited industry in the new inhabitants. They left no burying-place unexamined; and Rome, it is said, was filled with the furniture of the sepulchres of Corinth. Strabo was at Corinth soon after its restoration by the Romans, and describes the Acrocorinthus, and its surrounding wall, as including a circuit of nearly eleven miles; the temple of Venus, &c. Strabo saw likewise Cleonæ from thence. Cenchrea was then a village. Lechæum had some inhabitants.

Corinth had flourished 217 years when it was visited by Pausanias. It had then a few antiquities, many temples and statues, especially about the Agora, or market place, and several baths. The emperor Adrian introduced water from a famous spring at Stymphalus in Arcadia; and it had various fountains alike copious and ornamental. The stream of one issued from a dolphin, on which was a brazen Neptune; of another, from the hoof of Pegasus, on whom Bellerophon was mounted. On the right hand, coming along the road leading from the market-place towards Sicyon, was the odeum and the theatre, by which was a temple of Minerva. The old gymnasium was at a distance. Going from the market-place towards Lechæum was a gate, on which were placed Phaeton and the Sun in gilded chariots. Pirene entered a fountain of white marble, from which the current passed in an open channel. They supposed the metal called Corinthian brass to have been immersed while red-hot in this water. On the way up to the Acrocorinthus were temples, statues, and altars; and the gate next Tenea, a village with a temple of Apollo, sixty stadia or seven miles and a half distant, on the road to Mycenæ. At Lechaum were a temple and a brazen image of Neptune. At Cenchrea were temples; and by the way from the city a grove of cypress trees, sepulchres, and monuments. Opposite was the Bath of Helen, tepid and salt water, flowing plentifully from a rock into the sea. Mummius had ruined the theatre of Corinth, and the munificence of the great Athenian, Atticus Herodes, was displayed in an edifice with a roof inferior to few of the most celebrated structures in Greece. The Roman colony was destined to suffer the same calamity as the Greek city, and from a conqueror more terrible than Mummius, Alaric the savage

destroyer of Athens and all Greece. In a country harassed with frequent wars, as the Peloponnesus has since been, the Acrocorinthus was a post too consequential to be neglected. It was besieged and taken in 1549 by Mahomet II.; and the lords of the Morea, brothers of Constantine XIII. refusing payment of the arrears of the tribute, which had been imposed by Amurath II. in 1447. The country now became subject to the Turks, except such maritime places as were in the possession of the Venetians; and many of the principal inhabitants were carried away to Constantinople. Corinth, with the Morea, was yielded to the republic at the conclusion of the war in 1698, and again by it to the Turks in 1715.

Corinth, now called Corantho and Gerame, is of considerable extent, standing on high ground, beneath the Acrocorinthus, with an easy descent towards the gulph of Lepanto; the houses being scattered, or in groups, except in the bazaar or market-place. Cypresses, among which tower the domes of mosques, with corn-fields, and gardens of lemon and orange trees, are interspersed. The air is reputed bad in summer, and in autumn exceedingly unhealthy. A modern traveller relates that, from the top of the Acrocorinthus, he enjoyed one of the most agreeable prospects which the world can afford. He conjectured the walls to be about two miles in compass, enclosing mosques, with houses and churches mostly in ruins. An hour was consumed in going up on horseback. It was a mile to the foot of the hill; and from thence the way was very steep, with many traverses. The families living below were much infested by corsairs. Dr. Clarke represents it as a straggling place. Above the bazaar are some beautiful relics of a temple, supposed to have been erected in honor of Octavia, the sister of Augustus. The Doric order pervades the building, which, in the time of Sir G. Wheeler, had eleven pillars; but the governor of the fortress had blown up four of them a short time before Dr. Clarke visited Corinth. Five out of the remaining seven support an entablature, and each consists of one entire piece of stone; but their dimensions are not accurately Doric. This distinguished traveller conjectures that he found the site of Schœnus, where the ancient Isthmian games were celebrated, near the spot where the Isthmian wall makes a sudden turn from the Corinthian (or Crissæan) to the Saronic Gulf, bearing away towards Mount Oneus and embracing the whole of the port of Schœnus. The ruins of the temple, stadium, Theatre, and wells, and other indications of the Isthmian town, surround this port, and are for the most part situated upon its sides, sloping towards the sea. The remains of the temple of Neptune are to the west end of the Isthmian wall; and a Greek chapel, also in a ruined state, now stands upon the area of the temple. It is built of white limestone, and the workmanship of its ornamental parts is extremely beautiful. It appears to have been of the Corinthian order; but all its columns and entablatures have fallen. To the south wall of its area adjoined the theatre; the coilon of which, almost filled and overwhelmed by the ruins of the temple, yet remains, facing the port. West of the theatre is

the Stadium, at right angles to the Isthmian wall, it has very high walls, and the stone front work, and some of its benches, remain at the upper end. It extends east and west, parallel to one side of the area of the temple. Just at the place where the Isthmian wall joins Mount Oneus, there is a tumulus, which is, perhaps, that supposed to contain the body of Melicertes, in honor of whom the Isthmian Games were celebrated, above 1300 years before the Christian era. It stands on a very conspicuous eminence above the wall, which here passes towards the S.S.E. quite to the port. *Travels*, vol. vi.

CORINTH, THE ISTHMUS OF, is a neck of land in the Morea, which joins the Morea to Greece, and reaches from the Gulf of Lepanto to that of Egina. The narrowest part of it is six miles over.

CORINTHIA, the daughter of Dibutas, a native of Sicyon or Corinth, and daughter of a potter there. She is said to have sketched the profile of her sleeping lover on a wall, by lamp-light, and afterwards to have made a model of clay. This incident, said to be the origin of the arts of design among the Greeks, is thus beautifully alluded to by Montgomery:—

Trembling with extacy of thought,
Behold the Grecian maid,
Whom love's enchanting impulse taught
To trace a slumberer's shade.
Sweet are the thefts of love;—she stole
His image while he lay,
Kindled the shadow to a soul,
And breathed that soul through clay.

Corinthia lived six or seven centuries before the Christian era.

CORINTHIAN, *n. s. & adj.* A native of Corinth; a licentious person. Relating to Corinth, or the licentious manners of Corinth. For the order, see ARCHITECTURE.

O ye *Corinthians*, our mouth is open to you, our heart is enlarged. 2 Cor. vi. 11.

I am so proud, Jack, like Falstaff, but a *Corinthian*, a lad of metal.

Shakespeare. King Henry IV. Part 1.

The sage and rheumatick old prelatess, with all her young *Corinthian* laity. *Milton.*

Behind these figures are large columns of the *Corinthian* order, adorned with fruits and flowers.

Dryden.

CORIO (Bernardine), an Italian historian, of an illustrious family, born at Milan, in 1460. He was secretary of state to that duchy; and the D. Lewis Sforza appointed him to write the history of Milan. He died in 1500. The best edition of his history is that of 1603, in folio. It is printed in Italian, and is very scarce.

CORIO LANUS (Caius Marcius), a famous Roman general; who took Corioli, whence his surname: but who, at last, was banished from Rome by the tribune Decius. He went to the Volsci, and persuading them to take up arms against the Romans, they encamped within four miles of the city. He would not listen to proposals of peace till he was prevailed upon by his wife Veturia, and his mother Volumnia, who were followed by all the Roman ladies in tears.

He was put to death by the Volsci as a traitor that had made them quit their conquest; upon which the Roman ladies went into mourning; and in the same place where his blood was shed a temple was consecrated to Feminine Virtue. See **ROME**.

CORIS, in botany, a genus of the monogynia order and pentandria class of plants: **COR.** monopetalous and irregular: **CAL.** prickly: **CAPS.** quinquevalved; superior. There is only one species, viz. the *C. Mospeliensis*, or blue maritime coris of Montpellier. There are two varieties, one with a red, and the other with a white flower; but these are only accidental, and arise from the same seeds. They grow wild in most places in the south of France; they seldom exceed six inches high, and spread near the surface of the ground like heath; in June, when full of flowers, they make a very pretty appearance. They may be propagated by sowing their seeds in a bed of fresh earth, and afterwards removing the young plants, some into pots, and others into a warm border.

CORISPERMUM, tickseed, a genus of the digynia order, and monandria class of plants; natural order twelfth, holoracæ: **CAL.** none: **PET.** two: **SEED** one, oval and naked. There are two species; neither of them remarkable for beauty.

CORITANI, an ancient people of Britain, who possessed the inland parts now included in the counties of Northampton, Leicester, Rutland, Lincoln, Nottingham, and Derby.

CORIVAL,
CORRIVAL, *v. a., n. s. & adj.* } Lat. *rivalis*.
CORRIVALRY, *n. s.* } to assume an
CORRIVALSHIP, *n. s.* } equality with;
 to endeavour to
 attain the same object. A competitor; that which rivals or competes with.

Where's then the saucy boat,
 Whose weak untimbered sides but, even now
 Corivalled greatness.

Shakspeare. Troilus and Cressida.

And many more *corrials*, and dear men
 Of estimation and command in arms.

Id. 1 Henry IV.

Not thinking, perhaps, that this would be to erect a power equal and *corriall* with that of God.

Bishop Fleetwood.

CORK, *v. a. & n. s.* } Span. *corcho*; Dut.
CO'RKY, *adj.* } *korch*; Ger. *kork*; Lat.
CO'RKING PIN. } *corfex*. The tree described in the next article; a stopper for a bottle made from the exterior bark of the cork-tree. To stop with, or elevate upon, cork. Consisting of, or resembling, cork. A corking-pin is a pin of the largest size; so called, perhaps, from its being used for the purpose of fastening up any thing securely.

I prythee take the cork out of thy mouth, that I may drink thy tidings. *Shakspeare. As You Like It.*
 Bind fast his corky arms. *Id. King Lear.*

And tread on corked stilts a prisoner's pace,
 And make their napkin for their spitting place.

Hall.

Be sure, nay very sure, thy cork be good;
 Then future ages shall of Peggy tell,
 That nymph that brewed and bottled ale so well.

King.

Nor stop, for one bad cork, his butler's pay.

Pope.

When you put a clean pillow-case on your lady's pillow, be sure to fasten it well with three corking-pins, that it may not fall off in the night.

Swift's Directions to the Chambermaid.

The cork tree grows near the Pyrenean hills, and in several parts of Italy, and the north of New England. *Montimer.*

So the cold rill from Cintra's steepy sides,
 Headlong, abrupt, in barren channels glides;
 Round the rent cliffs the bark-bound Suber spreads,
 And lazy monks recline on corky beds. *Darwin.*

Young Juan wandered by the glassy brooks,
 Thinking unutterable things; he threw
 Himself at length within the leafy nooks

Where the wild branch of the cork forest grew.

Egmont. Don Juan.

CORK, the largest county in Ireland, is situated in the province of Munster, and has in it a city of the same name, with the united sees of Cork and Ross. It is bounded on the north by Limerick, on the west by Kerry, on the south by the Atlantic Ocean, and on the east by Waterford. Its greatest length is 108, and its average breadth fifty-six, English miles. It contains 269 parishes, twenty-two baronies, and three boroughs; and returns seven members to parliament. Anciently the principality of the M'Carty's it was converted into a shire by king John, the first English lord of Ireland; and it abounds in military and ecclesiastical antiquities, as well as natural curiosities. The surface of the country is finely diversified; in one place presenting the boldest pictures imaginable, as at Glengarriff and Gougane Barra; in another, a continuous plain. The rivers are the Lee, Blackwater, Ouvain, Antreg, &c. The harbours are the deepest and best sheltered in Ireland. Within a comparatively short period, this county has undergone considerable change in its magisterial or civil government, and also in statistical improvement. It has been divided into two ridings, east and west, and subjected to the judicial authority of two barristers; an obvious advantage to the speedy administration of justice; and its inaccessible districts, which were many and widespread, have been brought within a few hours reach of the principal towns in the county. The road, for instance from Listowel to Cork, sixty-seven English miles, through the beautiful and romantic scenery of the Bogra mountains, saves thirty-six miles, passes through a region hitherto inaccessible, and reaches a summit level of 900 feet, by an ascent of only one foot in sixty. The road from Newmarket to Charleville, fourteen English miles, also through a hitherto unexplored country, is also a great improvement, as is the projected road from Tralee to Cork, by Castle Island, to fall in with the Bogra road at Bantyre Bridge, being only sixty-one miles, while the present road measures seventy-eight English miles.

The mineral productions of Cork are considerable; amongst the valuable districts of this class is Dromagh, the property of N. P. Leader, Esq., a coal-field of great extent. Here culm and coal are raised by 360 laborers, supporting

thereby about 1000 souls: 20,000 horse loads are sold annually at the pit mouth. This coal is chiefly used for agricultural purposes, and upwards of 40,000 acres of land, in that neighbourhood, derive the advantage of its vicinity. Potters' clay abounds here, and good coarse pottery is now manufactured, and finds a speedy sale at Mallow and elsewhere. In 1826 bolting mills were erected, and a distillery is building contiguous to the collieries. Dromagh is distant from Cork thirty miles; from Mallow twelve; from Killarney twenty-five; from Tralee thirty-five, and lies on the direct road from Cork to Tralee. The mines of Cappagh, six miles south-west of Skibborean, have been leased by lord Audley to the Mining Company of Ireland, and have been found singularly productive; the dressed ore shipped from Roaring-Water Bay contiguous to the mine, having brought a higher price at Swansea, than the copper ore of Cornwall. A second copper mine, of even greater promise, lies four miles west of Beerhaven, from this mine (in 1826) £10,000 worth of ore was exported to Swansea. There is a slate quarry at Glandore, now at full work, leased to the Imperial Mining Company. The pier erected in this little harbour by the Fishery Board, has proved peculiarly advantageous, as an export quay for the Glandore slates. The principal coast improvements are the piers erected by the Fishery Board, the most useful of which are those at Castlehaven, Clonakilty, and Dunworley. At the first of these stations a breakwater and pier have been constructed, affording shelter and safe lying, in fourteen feet depth at low water. There is nine feet of water at Clonakilty pier, at a place called Ring, and sometimes Faugheen; the safest approach is between the east side of Inirdoney and Arundel Castle. At Dunworley Cove, besides a pier, there is also an inner basin, formed from a noxious morass, where vessels may now float in safety at high water, and lie securely on the strand at ebb, when they are also conveniently disposed for repairing. The ebb current from this basin forms the channel of communication between it and the Cove.

CORK, a city of Ireland, the second in that country, and the capital of the county of this name, stands partly on an island in the river Lee, and is said to be coeval with the foundation of its cathedral (St. Finhar's), i. e. in the sixth century. The ancient city stood entirely on the island; was approached by two bridges, one at either end, and was intersected by canals, or rather branches of the river, somewhat resembling a Dutch town. These canals are now filled up, the town extends along the opposite banks: there are Parliament, Patrick's, New, and Clarke's bridges, thrown across the Lee, and a grant has lately been made for the erection of an additional bridge, having one arch of cast metal, turning on a swivel, so as not to impede the navigation. Wide and handsome streets are now erected, where formerly were unwholesome marshes. The county of the city of Cork contains twenty-two parishes and parts. It is under the surveillance of a corporation, whose charter was

granted by Charles I. and consisting of a mayor, two sheriffs, a recorder, several aldermen, and an unlimited number of freemen. Cork abounds in charitable foundations, hospitals, poor-schools and literary associations. There are 4000 children in the city deriving the benefit of education at schools supported by voluntary subscription solely. Several of the public buildings are of a respectable class: the commercial buildings, and Chamber of Commerce in particular. The Exchange, the design of an Italian artist, was a handsome elevation, but it is miserably situated. The appearance of the cathedral is venerable, as well as that of the deanery house adjacent to it. The new city gaol, built in the castellated style, is probably the most architectural edifice in Cork. The custom-house, a massive structure, stands on a piece of ground formerly called Lapp's Island, but now united to the main land, as well as Grafton Law, the spot on which the unfortunate duke of Grafton fell in 1690, which has long since lost its insular appellation. There are, also, a spacious market-house, built in the Tuscan order; a linen hall; a new market, under cover; an extensive barrack capable of accommodating 4000 infantry, and 1000 cavalry; several very elegant churches, Roman Catholic chapels, and religious meeting-houses for all classes of Christians. The most valuable, perhaps, of the public associations, is the Royal Cork Institution, incorporated in 1807, for scientific and literary objects, having a botanic garden, mineralogical collection, models of agricultural implements, &c. &c. Though the cessation of hostilities, upon the deposition of Napoleon, checked for a while the very rapid progress of city improvement, yet that interruption has been followed by a slow, and perhaps more wise, system of melioration in all civic and statistic matters. The erection of the new custom-house, in front of which vessels of 200 tons burden can discharge. The facing of the quay-wall from the custom-house to parliament bridge; the deepening of the river and levelling the bottom, so as to permit colliers of 150 tons burden to reach Parliament Bridge, and lie there at low water without liability to damage; and, lastly, the continuation of the magnificent quay-wall on the north side of the river, for a distance of one mile and a half, faced with hewn stone, are improvements, the result of good taste in the first instance; but, secondly, the consequence of an union of the most creditable description between two useful public bodies, the Harbour and Wide-street Commissioners, for the best interests of this promising city. Though the trade of Cork has diminished, it is still considerable; and owing to the spirited conduct of its inhabitants in river improvements, must of necessity increase. The chief trade here is victualling, which is still carried on with vigor and with advantage. The principal manufactures are glass, paper, glue, and sail-cloth. The West India fleets generally put into Cove for sea stores, and the British navy was once victualled from this place. See COVE.

CORK is the bark of a species of quercus See QUERCUS. To take off the bark an incision is

made from the top to the bottom of the tree, and at each extremity another round the tree, perpendicular to the first. When stripped from the tree, which does not, therefore, die, the bark is piled up in a pond or ditch, and loaded with heavy stones to flatten it, and reduce it into tables: hence it is taken to be dried; and, when sufficiently dry, put in bales for carriage. If care be not taken to strip the bark, it splits and peels off of itself; being pushed up by another bark formed underneath. The bark of cork, as well as the acorn, is of some use in medicine; both being reputed astringents, after being burnt and powdered when used externally; but the chief use of the former is, to put in shoes, slippers, &c. and to stop bottles. The Spaniards burn it to make that kind of light black we call Spanish-black, used by painters. Cups made of cork, are said by some to be good for hectic persons to drink out of. The Egyptians made coffins of cork; which, being lined with a resinous composition, preserved dead bodies uncorrupted. The Spaniards line stone walls with it, which not only renders them very warm, but corrects the moisture of the air.

CORK, FOSSIL, a name given to a kind of stone. It seems to be a species of amianthus, consisting of flexible fibræ loosely interwoven, and somewhat resembling vegetable cork. It is the lightest of all stones; by fire it is fusible and forms a black glass. It possesses the general qualities of AMIANTHUS. See that article.

CORK JACKET, or CORK WAISTCOAT, an invention of one Mr. Dubourg, a gentleman very fond of swimming, but subject to the cramp, which led him to consider of some method by which he might enjoy his favourite diversion with safety. The waistcoat is composed of four pieces of cork, two for the breast and two for the back: each pretty near, in length and breadth, to the quarters of a waistcoat without flaps; the whole is covered with coarse canvas, with two holes to put the arms through: there is a space left between the two back pieces, and the same between each back and breast piece, that they may sit the easier to the body. Thus the waistcoat is only open before, and may be fastened on the wearer with strings, or, if it should be thought more secure, with buckles and leather straps. It does not weigh above twelve ounces, and may be made up for about five or six shillings. Mr. Dubourg tried his waistcoat in the Thames, and found that it not only supported him on the water, but that two men could not sink him, though they used their utmost efforts for that purpose. This invention is calculated to be of vast service to those who, for the sake of health, bathe in the sea; and even the most delicate and timorous young lady might, by the help of one of these jackets, venture into a rough sea. Dr. Wilkinson of Woodford has improved this jacket, and rendered it much more accommodating to the motions of the body in swimming, by cutting the cork into small pieces, and quilting them between two waistcoats of canvas. A cork spencer has lately been invented, to save from drowning in cases of shipwreck; which consists of a belt, containing refuse pieces of cork, or old bottle-corks enclosed in any kind of light

stuff, and fastened round the body with tapes. See AIR-JACKET, and BAMBOO.

CORMAC M^CCULINAN, king and archbishop of Cashel, in Ireland, was a prince greatly celebrated by the Irish historians for his learning, piety, and valor. He wrote, in his native language, a history of Ireland, commonly called the Pealter of Cashel, which is still extant, and contains the most authentic account we have of the annals of the country to that period, about A. D. 900.

CORMANLINE, a native town on the Gold Coast of Africa, containing the Dutch fort of Amsterdam. This was originally built by the English; but as early as 1663 it was taken by admiral De Ruyter, and has ever since remained a Dutch possession. It is said to be airy and salubrious, but it has suffered dreadfully in the late wars with the Ashantees. It is three miles east of Anamaboa.

CORK-MASS, a ci-devant grand procession, annually made at Dinkirk, on St. John's day, June 24th; and said to have been established under king Charles V. After the celebration of high mass, the procession, consisting of the tradesmen of the town, began. Each person had a burning wax taper in his hand; and, after each company came a pageant, followed by the patron saint, usually of solid silver richly wrought and adorned. The companies were followed by music; next the friars in the habits of their order, the secular priests, and then the abbot magnificently adorned, and preceded by the host. Machines of various fantastical forms and devices, and as variously accoutred, formed a part of the show on this occasion.

COR-MEILLE, a noted plant common in the Highlands of Scotland. Its roots when dried are the support of the Highlanders in long journeys, amidst the barren hills, and a small quantity, like the alimentary powders, will for a long time repel the attacks of hunger. Infused in liquor it is an agreeable beverage, and like the nepenthe of the Greeks, exhilarates the mind. From the similitude of sound in the name, it seems to be the same with chara, the root discovered by the soldiers of Cæsar at Dyrrhachium, which steeped in milk was such a relief to the famished army. Perhaps it may have been the Caledonian food described by Dio, of which the quantity of a bean would prevent both hunger and thirst: and which, he says, they had ready for all occasions.

CORMORANT, *n. s.* Fr. *cormoran*; either from Lat. *corvus marinus*, or *corvus vorans*. A bird that preys on fish; a glutton; one who is rapacious.

The hote *cormerant*, full of gluttonie.

Chaucer. The Assembly of Fowles.

To which nor fish nor fowle did onoe approach,
But yelling meawes, with sea gullies hoars and bace,
And *cormoyraunts*, with birds of ravenous race.

Spenser. Faerie Queene

Let fame, that all hunt after in their lives,
Live registered upon our brazen tombs;
When, spite of *cormorant* devouring time,
The' endeavour of this present breath may buy
That honour which shall 'bate his scythe's keen edge.

Shakespeare.

Those called birds of prey, as the eagle, hawk,
puttock, and cormorant. *Peacham on Drawing.*

Thence up he flew, and on the tree of life
Sat like a cormorant; *Milton's Paradise Lost.*

Not far from thence is seen a lake, the haunt
Of coots, and of the fishing cormorant.

Dryden's Fables.

CORMORANT. See PELICANUS.

CORN, *v. a. & n. s.* } *Mæs.* Goth. *kurno*;
CORN, *adj.* } *Dan.* Swed. Ger. *korn*;
Ang.-Sax. *corn*; Dut. *koorn*. Martinus and
Skinner consider the Lat. *granum* to be the pa-
rent word. Junius contends that it is derived
from the Greek, *κορυνη, κορηνυνη, satio, saturo*, to
satisfy or fill. Much may be said on both sides.
Corn is the seeds which grow in ears, as wheat,
barley, &c.; unreaped grain; unthreshed grain;
any minute particle. To corn is to salt meat;
to form into small grains. Corny signifies pro-
ducing grain or corn; containing, or made from,
corn.

Thou shalt not muzzle the ox when he treadeth out
the corn. *Deut. xxv. 4.*

Thou shalt come to thy grave in a full age, like as
a shock of corn cometh in his season. *Job v. 26.*

Except a corn of wheat fall into the ground and die,
it abideth alone. *John xiii. 25.*

Wel coude he stelen corne und tollen thries;
And yet he had a thomb of gold parde,
A white cote and a blew hode wered he.

Chaucer. Proel. to Cant. Tales.

He wolde sowen som difficultee,
Or springen cockle in our clene corne.

Id. Cant. Tales.

By corpus Domini but I have triacle,
Or elles a draught of moist and corny ale,
Or but I here anone a mery tale,
Myn herte is lost for pitee of this maid. *Id.*

The people cry you mocked them; and, of late,
When corn was given them gratis, you repined.

Shakespeare.

All the idle weeds that grow

In our sustaining corn. *Id. King Lear.*

Landing his men, he burnt the corn all thereabouts,
which was now almost ripe.

Knolles' History of the Turks.

They lodge in habitations not their own,
By their high crops and corny gizzards known.

Dryden.

Tell me why the ant,
'Midst summer's plenty, thinks of winter's want;
By constant journeys careful to prepare
Her stores, and bringing home the corny ear. *Prior.*

Still a murmur runs

Along the soft inclining fields of corn.

Thomson. Autumn.

Through rustling corn the hare astonished springs;
Slow tolls the village-clock the drowsy hour;
The partridge bursts away on whirring wings;
Deep mourns the turtle in sequestered bower,
And shrill lark carols clear from her aerial tower

Beattie.

Come let us stray our gladsome way,
And view the charms of nature;
The rustling corn, the fruited thorn,
And every happy creature.

Burns.

And hills all rich with blossomed trees,
And fields which promise corn and wine,
And scattered cities crowning these,
Whose far white walls along them shine.

Byron. Childs Harold.

To strive too with our fate were such a strife

As if the corn-sheaf should oppose the sickle.

Men are the sport of circumstances, when
The circumstances seem the sport of men. *Byron.*

In fight or chace accomplished to prevail,
Her foot outstripped the pinions of the gale:
Light o'er the standing corn could urge its speed,
Nor in its flying passage bend the reed.

Symmons' Æneis.

CORN, INDIAN, or maize. See ZEA.

CORN, EARLIEST ACCOUNTS OF THE CULTURE
OF. Authors differ much with regard to the
first discovery and culture of corn. A very gen-
eral opinion is, that in the first ages men lived on
the spontaneous fruits of the earth; as acorns, and
the nut or mast produced by the beech; which,
they say, took its name, fagus, from the Greek
φάγω, to eat. It is added, that they had neither
the use of corn nor the art of preparing it. Ceres
has the credit of being the first who taught the
use of corn; others give that honor to Triptole-
mus; others share it between the two, making
Ceres the first discoverer, and Triptolemus the
first cultivator, of corn. Many of the learned,
however, maintain that it was in Egypt the art of
cultivating corn first began; and it is certain there
was corn in Egypt and the East long before the
time of Ceres.

CORN, METHODS OF PRESERVING. Corn is
very different from fruits, with respect to the
manner of its preservation. It is capable of being
preserved in public granaries, for pressing occa-
sions, and of being kept for several centuries.—
A short time after the siege of Metz, under Henry
II. of France, in 1578, the duke of Esperson laid
up vast stores of corn in the citadel, which was
preserved in good plight to the year 1707, when
the French king and his retinue, passing that
way, eat bread baked thereof. The chief thing
that contributes to the preservation of corn is, a
crust which forms on its surface, by the germi-
nation of the grain next underneath, to the thick-
ness of an inch and a half. On that at Metz
people walked without its giving way in the least.
At Sedan was a granary cut in a rock, wherein
a heap of corn was preserved 110 years: it was
covered with a crust a foot thick. For the pre-
servation of corn, the first method is to let it re-
main in the spike; the only expedient for con-
veying it to the islands and provinces of America.
The inhabitants of those countries save it in the
ear, and raise it to maturity by that precaution:
but this method of preserving it is attended with
several inconveniencies among us: corn is apt
to rot or sprout, if the least moisture is in the
heap; the rats likewise infest it, and our want
of straw also obliges us to separate the grain from
the ear. The second is to turn out and winnow
it frequently; or to pour it through a trough or
mill-hopper, from one floor to another. Being
thus moved and aired every fifteen days, for the
first six months, it will require less labor for the
future, if lodged in a dry place: but if, through
neglect, mites should be allowed to slide into the
heap, they will soon reduce the corn to a heap
of dust. This must be avoided by moving the
corn anew, and rubbing the places adjacent with
oils and herbs, whose strong odor may chase
them away; for which garlic and dwarf elder are

very effectual : they may likewise be exposed to the open sun, which immediately kills them. When the corn has been preserved from all impurities for the space of two years, and has exhaled all its fires, it may be kept for fifty or even 100 years, by lodging it in pits covered with strong planks, closely joined together : but the safer way is to cover the heap with quicklime, which should be dissolved by sprinkling it over with a small quantity of water ; this causes the grains to shoot to the depth of two or three fingers, and encloses them with an incrustation, as above mentioned, through which neither air nor insects can penetrate.

CORN, in farriery. See FARRIERY.

CORN-CHANDLER, *n. s.* FROM corn and chandler. One that retails corn.

CORN-FIELD, *n. s.* A field where corn is growing.

It was a lover and his lass,
That o'er the green corn-field did pass.

Shakespeare. As You Like It.

You may soon enjoy the gallant sights of armies,
encampments, and standards waving over your brother's corn-fields.

Pope.

CORN-FLAG, *n. s.* FROM corn and flag. A

plant. Miller enumerates eleven species of this plant, some with red flowers, and some with white. See GLADIOLUS.

CORN-FLOOR, *n. s.* The floor where corn is stored.

Thou hast loved a reward upon every corn-floor.

Hos. ix. 1.

CORN-FLOWER, *n. s.* FROM corn and flower. See CENTAUREA.

There be certain *corn-flowers*, which come seldom or never in other places, unless they be set, but only amongst *corn* ; as the blue-bottle, a kind of yellow marygold, wild poppy, and farritory.

Bacon's Natural History.

Corn-flowers are of many sorts : some of them flower in June and July, and others in August. The seeds should be sown in March : they require a good soil.

Mortimer.

CORN-HEAP. Store of corn.

CORN-LAND, *n. s.* FROM corn and land. Land appropriated to the production of grain.

Pastures and meadows are of such advantage to husbandry, that many prefer them to *corn lands*.

Mortimer's Husbandry.

CORN LAWS.

CORN LAWS. This is a topic which some of our readers, we apprehend, may be disposed to consider as wholly speculative ; while others will imagine that the practical details connected with it can only be interesting to a small portion of the community. We would not attempt to disturb these conclusions, were not the amplest proof to the contrary pressing upon us. In one sense, the laws and the trade in corn involve speculative questions enough, no doubt ; that is, they have become respectively, and in the different spheres of Parliament and Mark Lane, the speculations of interested law-makers and law-breakers, in the price of every Englishman's loaf, and, we might add, of every laboring man's pint of beer. For while the state of the wheat market determines the former, that of the barley market is, in its own peculiar way, the regulator of the latter. But this topic, for these very reasons, is, to the furthest possible degree, removed from being a mere abstract question.

Nor are the agriculturists, whether landlords or tenants, the only parties interested in its details. Corn laws are designed to make corn dear ; a large portion, the major part, of the community, we contend, are always interested in having corn cheap : it becomes exceedingly important, therefore, to this part of the community, to enquire why it is thought necessary to uphold a system that is meant to secure its general dearness ; and which, in aiming at a price that shall always be relatively higher than an equally good article can be procured for abroad, is principally felt in producing a perpetual fluctuation of price, that perplexes all the calculations of business, and disorganises every relation of society connected with the production or sale of that article.

The community at large, we are happy to be-

lieve, begin to feel the importance of this plain view of facts. The manufacturer, the tradesman, the merchant, and the banker, unite with many respectable agriculturists, both tenants and landlords, in calling for a full and final examination of the question. It is expected to be fully examined in the ensuing session of parliament, and the public are highly indebted to his majesty's ministers for the manly method of their procedure in preparation for the pending enquiry. We allude particularly to the measure adopted in the close of last year of employing Mr. Jacob on a mission to the continent to obtain accurate information as to the present state and resources of the corn countries of Europe, and the well-timed appearance of his Report on Foreign Corn and Agriculture. This is proceeding with the candour and confidence of a good cause ; and if the public do not sufficiently watch over and secure their own interests in the issue, it cannot be from information being withheld from them by government in this instance.

Assisted by this important document, and the valuable labors of many predecessors, we shall offer a few observations in the present paper, on the origin and history of our corn laws ; on the probable consequences of their entire repeal ; and on that practical measure which may at once and for a time secure those interests which would be effected by an entire repeal of them.

The landlords having been the legislators, our corn laws exhibit three several efforts on their part to obtain and maintain high rents. For, as it has been well and plainly said :—

‘Whatever raises the average price of corn, raises rent. A rise in the price of corn must evidently redound to the benefit either of the farmer or the landlord. But the farmer is effectually

ly prevented, by the competition of other capitalists, from obtaining more than the ordinary profits of stock. The benefit, therefore, of the increase of price, can belong to nobody but the landlord. Or, more shortly, rent is all that portion of the produce of the soil which remains after replacing the capital expended, together with the ordinary profit: and this surplus must obviously be greater when corn is dear, the quantity of corn being the same, than when it is cheap.'

The three efforts of our legislators alluded to are those of encouraging and rewarding exportation; of discouraging and even forbidding *all* trade in corn; and of prohibiting its importation;—measures equally enlightened, and equally efficacious, in producing immense public evils, without even any considerable private good. By an act of the 14th Henry VI. exportation was permitted without license when the price of wheat did not exceed 6s. 8d. per quarter, and barley 3s. 4d.; the pound sterling of silver being then, according to Dr. Kelly, worth about £1. 18s. 9d. of our present money, and therefore, these prices about equal to 12s. 11d. and 6s. 5½d. of our money.

In the enlightened reign of Edward IV. occurs the first of our statutes against importation, which was prohibited whenever the price of corn in England should be under the exportation price. The political agitations of these periods prevented the rigid execution of those enactments, but here is the nucleus of the system against which the whole power of administration, and the interests and common sense of nine-tenths of the people, have to contend in the reign of George IV. In the 5th and 6th of Edward VI. cap. 14, it was enacted, That whoever should buy any corn or grain, with intent to sell it again, should be reputed an unlawful engrosser, and should, for the first fault, suffer two months imprisonment, and forfeit the value of the corn; for the second, suffer six months imprisonment and forfeit double the value; and for the third, be set in the pillory, suffer imprisonment during the king's pleasure, and forfeit all his goods and chattels. By the same law no person could transport corn from one part to another, without a license, ascertaining his qualifications as a man of probity and fair dealing. Neither could corn be purchased to be laid up in granaries for home sale, until the quarter of wheat was at or under 6s. 8d. and oats at 2s. money of the time. The authority of three justices of the peace was necessary in order to grant a license. By 5 Eliz. cap. 12, no person might buy corn to sell again without license from the justices, at the quarter sessions.

'Our ancestors seem to have imagined,' says Dr. Smith, 'that the people would buy their corn cheaper of the farmer than of the corn merchant, who, they were afraid, would require, over and above the price which he paid to the farmer, an exorbitant profit to himself. They endeavoured, therefore, to annihilate his trade altogether. They even endeavoured to hinder as much as possible any middle man of any kind from coming in between the grower and the consumer; and this was the meaning of the many restraints which they imposed upon the trade of those whom they called kidders or carriers of corn.'

The periods of the civil wars and the early part of the reign of Charles II. were distinguished by high prices of corn, and great fluctuations in the price. By several successive statutes, therefore, an intermediate and regulated trade in corn was allowed, as when the price of wheat should not exceed 20s., 24s., 32s. and 40s. per quarter. Until by the 15th Car. II. cap. 7, the engrossing or buying of corn in order to sell it again, as long as the price of wheat did not exceed 48s. per quarter, and that of other grain in proportion, was declared lawful to all persons not being forestallers, that is, not selling again in the same market within three months. 'All the freedom which the trade of the inland corn dealer has ever yet enjoyed,' adds the author of the *Wealth of Nations*, 'was bestowed upon it by this statute.'

By the 12th of Charles II. cap. 4, the exportation of corn was permitted whenever the price of wheat did not exceed 40s. the quarter, and that of other grain in proportion. By the 15th of the same prince, this liberty was extended till the price of wheat exceeded 48s. the quarter; and by the 22nd to all higher prices. A poundage, indeed, was to be paid to the king upon such exportation. But all grain was rated so low in the book of rates, that this poundage amounted only upon wheat to a shilling, upon oats to four pence, and upon all other grain to six-pence the quarter. By the 1st of William and Mary, the act which established the bounty, this small duty was virtually taken off whenever the price of wheat did not exceed 48s. the quarter; and by the 11th and 12th of Will. III. cap. 20, it was expressly taken off at all higher prices.

The BOUNTY act alluded to remained in force, in its substance and spirit, to the fifty-fourth year of the reign of George III. The bounty payable under it at first amounted to 5s. for every quarter of wheat exported, while the price continued at or below 48s.; 2s. 6d. for every quarter of barley or malt, while their price did not exceed 24s.; and 3s. 6d. for every quarter of rye, when the price did not exceed 32s. It was importantly modified and enforced, however, by the 11th and 12th Will. III. cap. 20.

A further important modification of this act took place in the year 1773. The old bounty of 5s. upon the exportation of wheat was to cease by the statute now introduced, so soon as the price rose to 44s. the quarter, instead of 48s., the price at which it ceased before; that of 2s. 6d. upon the exportation of barley ceased so soon as the price rose to 22s. instead of 24s., the price at which it ceased before; and the bounties upon other grain in like manner. It is remarkable that at this time a bounty of 2s. per quarter was allowed on the exportation of oats, a species of grain that had never before been thus distinguished.

The exportation of wheat was *prohibited* by this statute so soon as the price rose to 44s. per quarter; that of rye so soon as it rose to 28s.; that of barley so soon as it rose to 22s.; and that of oats so soon as they rose to 14s.

To trace the history of the bounty system to its close: By the statutes 31 Geo. III. cap. 30, and 33 Geo. III. cap. 65, bounties were granted on exportation at certain prices, and the exportation

prohibited at higher prices. The quantity of corn to be exported was also settled by these acts, and 34 Geo. III. cap. 71, and 53 Geo. III. cap. 38. The maritime counties of England were divided into districts, and the exportation as well as importation of corn was to be regulated in London, Kent, Essex, and Sussex, by the prices at the Corn Exchange. The proprietors of this establishment were to appoint an inspector of corn returns, to whom weekly returns were to be made; and by whom, weekly accounts were to be transmitted of the average price to the receiver of the returns, and inserted in the London Gazette. The exportation in Scotland and other districts, was to be regulated by the prices at different appointed places, for which mayors, justices, &c. were to elect inspectors. By 44 Geo. III. cap. 109, and 45 Geo. III. cap. 86, this most extraordinary mode of ascertaining the average price, to regulate the importation and exportation of corn to and from Great Britain, is further provided for; and such average is to result from the prices in the twelve maritime districts of England and Wales.

By several subsequent acts made from time to time with a view to relieve the public against the scarcity or dearness of corn, and too numerous to particularise, the exportation and importation of corn and provisions are allowed to be prohibited and regulated by order of the king, or lord-lieutenant of Ireland, and council; until, by 54 Geo. III. cap. 69, grain, meal, malt, and flour, from any part of the United Kingdom, are permitted to be exported without payment of duty or receiving of bounty, all duties and bounties on the exportation of corn being repealed; and it is enacted, that it shall be lawful for any person to export at all times from any part of the United Kingdom, any corn, &c. without the payment of any duty of customs thereon.

The bounty system was clearly introduced, like all the other expedients of our legislators, with regard to corn, to raise its price, which had been gradually falling from 1649 to 1688, the period of its first adoption. In the preamble it is stated, 'that the exportation of corn and grain into foreign parts, when the price thereof is at a low rate in this kingdom, hath been a great advantage, not only to the owners of land, but to the trade of this kingdom in general.'

'The bounty, by extending the foreign market, contributed, no doubt,' as the able writer on this subject in the Supplement to the Encyclopedia Britannica argues, 'materially to the extension of cultivation; although, by forcing recourse to be had to worse soils in order to obtain the additional supplies of corn, it must have raised prices. In the period from 1740 to 1751, the cheapest in the last century, the bounties paid on exportation amounted in all to £1,515,000; and in 1749 alone they somewhat exceeded £324,000. The bounty, however, had by this time been much

too long in operation to permit the growers or exporters to realise any but the common and ordinary profits of stock; and, therefore, if it had never been granted, not only the quantity of corn exported, but the home price, which must have been regulated by the expense necessary to produce the increased supply required by the bounty on the poorest soils in cultivation, would have been reduced. But it is of importance to remark, how much this forced exportation must have raised the real price of corn.'

'That system of laws, therefore, which is connected with the establishment of the bounty,' says Dr. Smith, 'seems to deserve no part of the praise which has been bestowed upon it. The improvement and prosperity of Great Britain, which has been so often ascribed to those laws, may very easily be accounted for by other causes. That security which the laws in Great Britain give to every man, that he shall enjoy the fruits of his own labor, is alone sufficient to make any country flourish, notwithstanding these and twenty other absurd regulations of commerce; and this security was perfected by the Revolution, much about the same time that the bounty was established. The natural effort of every individual to better his own condition, when suffered to exert itself with freedom and security, is so powerful a principle, that it is alone, and without any assistance, not only capable of carrying on the society to wealth and prosperity, but of surmounting a hundred impertinent obstructions with which the folly of human laws too often incumbers its operations; though the effect of these obstructions is always more or less either to encroach upon its freedom, or to diminish its security. In Great Britain industry is perfectly secure; and, though it is far from being perfectly free, it is as free or freer than in any other part of Europe. Though the period of the greatest prosperity and improvement of Great Britain has been posterior to that system of laws which is connected with the bounty, we must not upon that account impute it to those laws. It has been posterior likewise to the national debt. But the national debt has most assuredly not been the cause of it.' We cannot turn from the history of this one absurdity in our system to its close, without hoping that the other and remaining factitious stimulants to price may be destined soon to follow its fate.

To return to the progress of the laws respecting importation. By the 22d of Charles II. cap. 13, the importation of wheat, whenever the price in the home market did not exceed 53s. 4d. the quarter, was subjected to a duty of 16s. the quarter; and to a duty of 8s. whenever the price did not exceed £4. Prior to the act of the 13th of the reign of Geo. III, the following were the duties payable upon the importation of the different sorts of grain, as collected by Dr. Smith:—

Grain.	Duties.	Duties.	Duties.
Beans to 28s. per quarter.	19s. 10d. after till	40s.	16s. 8d. then 12d.
Barley to 28s.	19s. 10d.	32s.	16s.
Malt is prohibited by the annual Malt-tax bill.			
Oats to 16s.	5s. 10d. after		9d.
Peas to 40s.	16s. 0d. after		9d.
Rye to 36s.	19s. 10d. till	40s.	16s. 8d. then 12s.
Wheat to 44s.	53s. 9d. till	53s. 4d.	17s.
till £4. and after that about 1s. 4d.			8s.
Buck wheat to 32s. per quarter, to pay 16s.			

These different duties were imposed, partly by the 22d of Charles II. in place of the Old Subsidy, partly by the New Subsidy, by the One-third and Two-thirds Subsidy, and by the Subsidy, 1747.

'By the memorable statute, 13th Geo. III. a new system, in some respects better than the ancient one, was established,' says the great author we have just quoted: 'with all its imperfections we may perhaps say of it what was said of the laws of Solon, that though not the best in itself, it is the best which the interests, prejudices, and temper of the time would admit of. *It may perhaps in due time prepare the way for a better.*'

By this statute the high duties upon importation for home consumption were taken off so soon as the price of middling wheat rose to 48s. the quarter; that of middling rye, peas or beans, to 32s.; that of barley to 24s.; and that of oats to 16s.; and instead of them a small duty was imposed of only *sixpence* upon the quarter of wheat, and upon that of other grain in proportion.

This statute also originated our warehousing system with regard to corn. It permitted, at the lowest prices, the importation of corn for exportation duty free; provided it was lodged in warehouses appointed in twenty-five of the different ports of Great Britain, under the joint-locks of the king and the importer.

By an act of the 31st Geo. III. the price, when importation could take place from abroad, at the duty of six-pence, was raised to 54s., under 54s. and above 50s. a middle duty of 2s. 6d., and under 50s. a prohibitory duty of 24s. 3d. was to be paid. It was also enacted, that foreign wheat might be imported, stored under the king's locks, and again exported free of duty; but, if sold for home consumption in the kingdom, it became liable to a warehouse duty of 2s. 6d.

In 1804 a clamor was raised by the farmers respecting the low price of corn: it resulted in the act of the 44th of the late king, which actually imposed a *prohibitory* duty of 24s. 3d. per quarter on all wheat imported when the home price was at or below 63s.; between 63s. and 66s. a middle duty of 2s. 6d.; and above 66s. the nominal duty of 6d. The price at which bounty was allowed on exportation was extended to 40s. and importation without bounty to 54s. We are happy to record the miscarriage of a second bill of this kind in 1814, by which foreign wheat imported when the home price was at or under 64s. was to pay a duty of 24s.; when at or under 65s. a duty of 23s. and so on, till the home price should reach 86s. when the duty was reduced to 1s., at which sum it became stationary. Corn imported from Quebec, or from the other British

colonies in North America, was to pay only half the duties on other corn.

The Resolutions respecting the corn trade, submitted to the house of commons, February 17th, 1815, by Mr. Robinson, the present chancellor of the exchequer, became, after much opposition, the basis of the 55th Geo. III. cap. 26. They were as follows:—

1st, That it is the opinion of this committee, that any sort of foreign corn, meal, or flour, which may by law be imported into the United Kingdom, shall at all times be allowed to be brought to the United Kingdom, and to be warehoused there, without payment of any duty whatever.

2d, That such corn, meal, and flour, so warehoused, may at all times be taken out of the warehouse, and be exported, without payment of any duty whatever.

3d, That such corn, meal, or flour, so warehoused, may be taken out of the warehouse, and be entered for home consumption in the United Kingdom, without payment of any duty whatever, whenever foreign corn, meal, or flour, of the same sort, shall be admissible into the United Kingdom for home consumption.

4th, That such foreign corn, meal, or flour, shall be permitted to be imported into the United Kingdom, for home consumption, without payment of any duty, whenever the average prices of the several sorts of British corn, made up and published in the manner now by law required shall be at or above the prices hereafter specified, viz.

	Per Quarter
Wheat	80s.
Rye, peas, and beans	53s.
Barley, bere, or bigg	40s.
Oats	26s.

But that whenever the average prices of British corn shall, respectively, be below the prices above stated, no foreign corn, or meal, or flour, made from any of the respective sorts of foreign corn above enumerated, shall be allowed to be imported or taken out of warehouse for home consumption, nor shall any foreign flour be at any time importable into Ireland.

5th, That the average prices of the several sorts of British corn, by which the importation of foreign corn, meal, or flour, into the United Kingdom is to be regulated and governed, shall continue to be made up and published in the manner now required by law; but that hereafter, if it shall at any time appear that the average prices of British corn, in the six weeks immediately succeeding the 15th February, 15th May, 15th August, and 15th November in each year,

shall have fallen below the prices at which foreign corn, meal, or flour, are by law allowed to be imported for home consumption, no such foreign corn, meal, or flour, shall be allowed to be imported into the United Kingdom, for home consumption, from any place between the rivers Eyder and Garonne, both inclusive, until a new average shall be made up and published in the London Gazette, for regulating the importation into the United Kingdom for the succeeding quarter.

6th, That such corn, meal, or flour, being the produce of any British colony or plantation in North America, as may now by law be imported into the United Kingdom, may hereafter be imported for home consumption without payment of any duty, whenever the average prices of British corn, made up and published as by law required, shall be at or above the prices hereafter specified, viz.

	Per Quarter.
Wheat	67s.
Rye, peas, and beans	44s.
Barley, here, or bigg	33s.
Oats	22s.

But that whenever the prices of British corn, respectively, shall be below the prices above specified, corn, or meal, or flour, made from any of

the respective sorts of corn above enumerated, the produce of any British colony or plantation in North America, shall no longer be allowed to be imported into the United Kingdom for home consumption.

7th, That such corn, meal, or flour, the produce of any British colony or plantation in North America, as may now by law be imported into the United Kingdom, shall at all times be permitted to be brought there and warehoused, without payment of any duty whatever.

8th, That such corn, meal, or flour, so warehoused, may at all times be taken out of the warehouse and exported, without payment of any duty whatever.

9th, That such corn, meal, or flour, so warehoused, may be taken out of warehouse, and entered for home consumption in the United Kingdom, whenever corn, meal, or flour, of the like description, imported direct from any such colony or plantation, shall be admissible for home consumption, but not otherwise.

By the 3d of Geo. IV. cap. 60, the Act of 1815 was repealed, and importation was permitted, when, for three months preceding the 15th of February, May, August, or November, the average prices exceeded the rates stated below, at the rates of duty affixed, viz.

When the average prices rate as below :

Description of Grain.	From British Possessions in America.	From all other parts.	Rate of Duty p. Quar.	Extra for the first 3 Months.
Wheat	If at 59s. per Quarter, but under 67s.	If at 70s. but under 80s.	12s.	5s.
Ditto	67s. 71s.	80s. 85s.	5s.	5s.
 If at or above 71s.	or if at or above 85s.	1s.	
Beans, peas, or rye	{ 39s. 44s.	44s. 53s.	8s.	3s. 6d.
	{ 44s. 46s.	53s. 55s.	3s. 6d.	3s. 6d.
 If at or above 46s.	or if at or above 55s.	8d.	
Barley, here, or bigg	{ 30s. 33s.	33s. 40s.	6s.	2s. 6d.
	{ 33s. 35s. 6d.	40s. 42s. 6d.	2s. 6d.	2s. 6d.
 If at or above 35s.	or if at or above 42s. 6d.	6d.	
Oats	{ 20s. 22s. 6d.	25s. 28s.	4s.	2s.
Ditto	{ 22s. 6d. 24s.	28s. 30s.	3s.	2s.
 If at or above 24s.	or if at or above 30s.	4d.	
Wheat Meal or Flour, and Oatmeal, are admitted for Consumption, either from British Possessions in America or from any other part, at the rates of duty hereunto affixed, when the average prices of the Rates above specified.—Peas, when prohibited as corn, are admitted for seed		7s. per Bushel.	WheatMeal or Flour, at per Cwt. { 3s. 3d. 1s. 7d. 4d. 4s. 10d. 2s. 2d. 2s. 2d. 6d.	1s. 7d. 1s. 7d.

By 7 Geo. IV. cap. 70. foreign corn, meal, and flour warehoused, were permitted to be taken out for home consumption, until the 16th day of August, 1826, at the following rates of duty, viz.

Wheat	12s. per quarter.
Beans, peas or rye	8s. ditto.
Barley, here, or bigg	6s. ditto.
Oats	4s. ditto.
Wheat meal or flour	3s. 3d. per cwt.

7 Geo. IV. cap. 71, an Act to empower his Majesty to admit foreign corn for home consumption, under certain limitations, until the 1st of January, 1827, or for six weeks after the commencement of the next ensuing session of parliament, if parliament shall not then be sitting.

The following is the detail. viz.

‘Whereas it may become expedient, for a time to be limited, to admit a further quantity of corn or flour for home consumption, in addition to the foreign corn, grain, meal or flour, which had been warehoused, or reported inwards to be warehoused, on or before the 2d day of May, 1826: Be it therefore enacted, by the King’s Most Excellent Majesty, by and with the advice and consent of the lords spiritual and temporal, and commons, in this present parliament assembled, and by the authority of the same, that at any time after the end of the present session of parliament, and until the 1st day of January,

1827, or for six weeks after the commencement of the then ensuing session of parliament, if parliament shall not then be sitting, it shall be lawful for his Majesty, by any order or orders to be by him issued, by and with the advice of his privy council, to admit to entry for home consumption any quantity of warehoused wheat or wheat flour not exceeding 500,000 quarters in the whole, or payment of such duty as shall be declared in any such order to be payable upon the entry of the same: provided always, that no such order in council shall continue in force for more than two calendar months from the day of the date thereof; and provided also, that no such order shall extend to admit to entry any wheat or wheat flour which had been warehoused, or re-ported inwards to be warehoused, before the said second of May.

'Provided always, that the duty so to be declared in any such order shall not in any case exceed the duty enacted by 3 Geo. IV. cap. 60.'

We should, perhaps, add that by the 12th Geo. III. c. 71, forestalling and regrating are declared to be offences at common law, and not done away by the repeal of the statute of 5 & 6 Ed. VI. c. 14, viz. *Forestalling* the market being considered an offence against public trade, and described by the said statute 5 & 6 Ed. VI. c. 14, as the buying or contracting for any cattle, merchandise, or victual coming in the way to the market, or dissuading persons from bringing their goods or provisions there; or persuading them to enhance the price when there: and *regrating* the buying of corn, or other dead victual, in any market; and selling it again in the same market, or within four miles of the place. Such is a brief, but we believe pretty complete, view of the history and present state of our corn laws.

We look forward confidently to their entire repeal, that is, ultimately; for we advocate a preparatory measure, as we shall proceed to show. Although we have not the happiness to believe all that Dr. Smith asserts, in support of the following observation, there is great weight in it. 'The laws concerning corn may every where be compared to the laws concerning religion. The people feel themselves so much interested in what relates either to their subsistence in this life, or to their happiness in a life to come, that government must yield to their prejudices, and, in order to preserve the public tranquillity, establish that system which they approve of. It is upon this account, perhaps, that we so seldom find a reasonable system established with regard to either of those two capital objects.' The supposition of an entire final repeal of the corn laws enables us best to meet the question, Who would be injured by it?

1. Not the *laborer*, or any *consumer*. The former certainly would not be so suddenly or largely benefited by it, as some declaimers flatter him. The principal mischief of high prices being in his case, the perpetual disarrangement of his relations with his employer: the 'changing of his wages ten times,' (as the Scripture phrases it, no slight evil however), when the peaceable and natural state of those relations might not require them to be changed at all. That is, he must receive, speaking generally, the same *real* wages

under all the changes of price: he must receive that which shall support him; or the lowest possible wages for producing the corn, or commodity on which he labors. His money-wages therefore rise and fall perpetually in value, when his real wages remain the same. But he would be benefited by not being *deceived*. The institutions of society, in the case of steady wages being afforded him, would no longer invite him to settle in this spot and marry in that: we add,—to be extravagant (often through being misled) at one season, while they compel him to beg, to receive parish allowance, or starve at another. None of the consumers of corn would be injured by the repeal of all the corn laws; all would be benefited: and who are not consumers? The landlord, as well as the farmer and laborer, belongs to this class; the banker, the merchant, the trader, the manufacturer, and all the professions. Various opinions have been offered as to the practical effects of an unrestricted importation of corn, in respect to its price. We shall attend to them again before we close this paper: but as the only classes opposing this measure do it avowedly in fear of a low price of corn, and we are arguing in hope of it, we may take it at 8s. 10s. 12s., or any supposed permanent diminution. Now the consumption of wheat in Great Britain only, in 1814, is estimated by Mr. Weston to have been 9,170,000 quarters; of barley, 6,335,000: if an unrestricted importation allowed us to receive the former at only 5s. a quarter cheaper, here would be a clear gain of £2,292,500 to the consumers, on wheat only,—to say nothing of the difference in regard to barley, which would more rapidly and steadily affect the price of all malt liquors and spirits distilled from malt. But,

2. Would the *farmer* be injured by an entire repeal of the corn laws? Not at all we contend. He is a capitalist. His interests are entirely confined to the amount of profit on his capital; and this is more uniformly increased by low wages and a quick return than from any other sources. As a consumer of corn he is positively and directly injured by its high price; and as a considerable employer of laborers still more. If, indeed, he is possessed of a lease, taken at a low rental, and continued through the period of high prices, he is so far benefited by that state of the markets; but at its termination will he not be raised accordingly,—his own improvements valued to him,—or his removal be made expedient?

3. It is quite clear that the *manufacturer* and *tradesman* must suffer by high prices of corn in their own consumption of it, and in the higher rate of wages they must pay—consequently in diminished profits, with regard to their home trade, and in the curtailing or extinguishing their power to meet foreign manufactures in the market. With these claims the banker and the wholesale merchant suffer in the same direct and almost incalculable way. There remains, therefore,

4. But the isolated class of *landlords* who could by any possibility be injured by a repeal of the statutes in question. They are estimated, according to some able modern writers, as owning one-fifth of the value of the produce of the land. That is, the entire rental they receive is equal to

about one-fifth of the value of the annual produce. Let us suppose it to be a fourth: the rest of the produce belongs to those who farm their own land, or to the actual cultivator of the soil. Here then are three-fourths of the produce of the whole country taxed at the rate of millions per annum, to ensure the greater rental of those interested in the remaining one-fourth! Or rather, the corn of the whole country, including that which belongs to them, is thus raised in price to the whole country.

It is of great moment here to consider the quantity of grain that would probably be imported into this country, in case of the restrictions of importation being removed, and its relative proportion to the consumption of the country. Dr. Colquhoun's estimate of that consumption in 1812 and 1814, concurs with the one we have before alluded to, i. e. Mr. Western's, and is as follows:—

Species of Grain.	Estimated Average of the Population of Great Britain and Ireland.	Each person averaged.	Consumed by man.	Consumed by Animals.	Used in Beer and Spirits.	Used in various Manufactures.	Total of Quarters.
		Quarters.	Quarters.	Quarters.	Quarters.	Quarters.	
Wheat .	9,000,000	1	9,000,000			170,000	9,170,000
Barley .	1,500,000	1½	1,875,000	210,000	4,250,000		6,335,000
Oats .	4,500,000	1½	6,750,000	10,200,000			16,950,000
Rye .	500,000	1½	625,000	59,000		1,000	685,000
Beans and Peas }	500,000	1	500,000	1,360,000			1,860,000
Totals .	16,000,000		18,750,000	11,829,000	4,250,000	171,000	35,000,000

But here, as the Edinburgh Reviewer, No. 88, has observed, is no allowance for seed; and there can be no doubt that Dr. Colquhoun has underrated the consumption of oats by at least one-half quarter in the consumption of each of the 4,500,000 individuals he supposes fed on them, or by 2,250,000 quarters. 'Adding, therefore, says this writer, to Dr. Colquhoun's estimate 5,500,000 of quarters for seed, and 2,250,000 for the deficiency of oats, it will bring it to 42,750,000 quarters. And, taking the increase of

population since 1813 into account, it does not appear to us that the annual average consumption of the different kinds of grain in the United Kingdom can now be estimated at less than 42,000,000 of quarters, exclusive of seed, and at 48,000,000 when it is included.'

On the basis of this estimate, or assuming 12,000,000 quarters of wheat to be the annual consumption of the empire, that consumption by a very simple calculation may be thus exhibited, in regard to smaller portions of time:—

The Consumption of	Wheat.	Other Grain.	Total.
	Quarters.	Quarters.	Quarters.
A year	12,000,000	36,000,000	48,000,000
Six months	6,000,000	18,000,000	24,000,000
Three months	3,000,000	9,000,000	12,000,000
Six weeks	1,500,000	4,500,000	6,000,000
One month	1,000,000	3,000,000	4,000,000
Two weeks	500,000	1,500,000	2,000,000
One week	250,000	750,000	1,000,000
One day	35,714	107,143	142,857

Let us now see what proportion the largest importations that have taken place, bear to this the total consumption of the empire. The total imports of wheat from all parts of the world, from the year 1800 to 1820, both inclusive, according to papers printed by order of the house of commons, amounted to only 12,577,029 quarters, giving an annual average of 589,906 quarters.

These were years of high, unprecedentedly high, prices: the whole commercial world, as the Reviewer observes, was ransacked with a view to the supply of the British market; yet such is the magnitude of our consumption, that the whole supply obtained did not amount, according to the official statements, to one-thirteenth part of it, or that of one month! This statement is of

itself, surely, as this writer triumphantly insists, 'sufficient to show that nothing can be more perfectly futile than the fears and apprehensions entertained by the agriculturists with respect to the excessive importations of foreign corn that would take place, were our ports thrown open.'

We are very happy to see Sir James Graham's able tract on 'Corn and Currency in an Address to the Land Owners,' confirm much of our forgoing reasoning. 'Since the year 1815,' he says to this important body, 'when the prohibition of the importation of foreign corn, excepting at a fixed price, was first substituted for a protecting duty, your constant and avowed object has been to raise the price of agricultural produce in this country greatly above the level

of the continental market; the obvious effect of this has also been to raise the rate of wages, and to reduce the rate of profits. By the rise of wages the laborer gains nothing, because, when corn is dear, all the articles of first necessity are also dear. Therefore, though his wages be increased, his real reward is no greater; but by the diminution of profits, every class of productive industry is deeply injured. For on all hands it is allowed, that profits fall as wages rise, and the capital of a nation is but the accumulation of the profits of its inhabitants. Rents, however, are raised by high prices, which force inferior soils into cultivation; since the lower the degree of fertility of the worst land in tillage, which yields no rent, but only reimburses the cultivator—the higher, on all land of superior quality, is the extra profit beyond the ordinary return of capital, when expended on the worst. This extra profit is rent; or, in the words of Mr. Mill, 'rent increases in proportion as the effect of the capital successively bestowed upon land decreases.' High prices, therefore, by increasing rents, benefit the landlords, but they confer no advantage on the laborer; they are an injury to the productive, and a tax on the unproductive, classes of the community.

It may be doubted even whether the existing system of prohibition be so entire a benefit to the land owner himself, as he would seem to imagine; for, in the variety of seasons, it is impossible that the land cultivated within these islands can, year by year, from one harvest to another, produce a supply of corn exactly commensurate with the demand. At one time the prohibitory system is unjust to the grower; at another, to the consumer. The grower is injured, when, after a harvest somewhat deficient, the ports are opened by a sudden rise of price, and a large accumulation of foreign corn is poured at once into this country; bringing on the farmer the losses incident to over-production, and ultimately on the landlord a correspondent decline of rent. The consumer is injured, in the interval between the rise of price and the importation of foreign grain; he is even exposed to the horrors of famine; for, in proportion as the demand for foreign grain is unusual, the supply in case of emergency must be precarious. Thus the alternate evils of redundancy and scarcity, unsteady prices and uncertain rents, are the inevitable consequences of the present system of our Corn Laws.

But the peculiar burdens of the agriculturists have been often dwelt upon in this discussion, and should be, in fairness, estimated. They are said to consist of all the *tithes*, the far greater proportion of the poor rates, and the land tax. With regard to the first of these burdens it is a rental paid by the landlords, in point of fact, we presume to the state, rather than the church, for specific purposes; that is, it is a part of the tenure on which all existing landholders have entered upon their property for the last ten or twelve centuries, and the method of its appropriation by the state, however obnoxious and objectionable, on some grounds, renders the supposed burden no more a hardship on landlords than other peculiarities of the respective tenures. Their deeds never conveyed to them

more than the value of nine-tenths of their estates, and other deeds or laws secure the other tenth to the state in trust for the church. But it seems that about a third part of the land in England and Wales, large tracts in Ireland and the whole of Scotland are tithe free. This impost is therefore by no means universal.

To the land-tax, as an ancient impost, some portion of these remarks may also be applied. Estates have been acquired under it; and all the existing relations of landlord and tenants (for it is in fact a tax on the rent) have grown up; it was originally imposed, we believe in the year 1693, at the rate of one shilling in the pound, on an ascertained rental, and has since been increased to four shillings. We do not, however, perceive the force of a distinction drawn by the Edinburgh Reviewer between a tax on rent, as the excess, or value of the excess, of produce obtained from the superior lands of a country over that portion of their produce, or value that is required to defray the expenses of cultivation, and to yield the farmer his profit—and a tax that should be laid more directly on the profits of the grower of corn. If the land-tax be imposed on the rents as an excess, so as to reduce that excess below the fair expectation of the landlord from his land, is he not entitled to require the farmer or the community to bear it with him? And, in point of fact, will he, and does he, not require the farmer to bear it with him in the shape of greater rent than he would otherwise pay? As far, therefore, as the land-tax is a species of impost on the agricultural interests, (whether falling on the landlord or tenant, which amounts to an *excess* of duties not laid on other raw produce, it is entitled we apprehend to consideration at the present time, and to compensation in the project of finally opening the ports. The poor-rates is the only other burden stated to fall peculiarly on this class of society; and the Reviewer, to whom we have more than once adverted, admits it to fall at the rate of one per cent. *ad valorem* heavier on this than on other parts of the community. We should rate the land-tax as equal to an *ad valorem* duty of five per cent. more. At this stage of our enquiry, therefore, we admit a claim for protecting duties of seven per cent.

But one evil consequence affecting the whole community has been loudly predicted as likely to follow from the free importation of corn. The placing our subsistence at the mercy of foreigners in the case of war: an argument, as Mr. Mills has well said, which 'implies an ignorance, both of history and of principle; of history, because, in point of fact, those countries which have depended the most upon foreign countries for their supply of corn, have enjoyed, beyond all other countries, the advantage of a steady and invariable market for grain; of principle, because it follows unavoidably, if what in one country is a favorable is in other countries an unfavorable season, that nothing but obtaining a great part of its supply from various countries can save a nation from all the extensive and distressing fluctuations which the variety of seasons is calculated to produce. Nor is the policy involved in this argument better than the political economy. It sacrifices a real good to escape the

chance of a chimerical evil; an evil so much the less to be apprehended, that the country from which another derives its supply of corn is scarcely less dependent upon that other country for a vent to its produce, than the purchasing country is for its supply. It will not be pretended that a glut of corn in any country, from the loss of a great market, with that declension of price, that ruin of the farmers, and that depression of rents, which are its unavoidable consequences, is an immaterial evil.' 'Upon this subject however,' says Mr. Whitmore, 'we may proceed upon proof and experience, and need not, therefore, trust to general reasoning. It is well known that this country constantly imports nearly all the hemp it uses; it is equally clear that, if deprived of it, the consequences to us, a maritime and commercial people, would be to the last degree injurious. If there be one article more than another, of which a hostile country would wish to deprive us, it would be this very article of hemp, which may fairly be considered the sinews of naval warfare. But were we ever deprived of it? Was there ever any serious obstruction, either to our naval armaments or to our commercial speculations, arising from a deficiency of this important article? If not, it is chimerical to imagine that we shall ever be deprived of the corn we are in the habit of importing.'

We feel that we have bestowed sufficient attention on the ordinary objections to a repeal of our present corn laws. Mr. Whitmore, one of the most sensible writers on this subject, concurs with Mr. Ricardo in recommending a duty of 10s. per quarter as a sufficient compensation for the excessive taxes on agriculture to which we have adverted. But the latter gentleman advised, as a measure of indulgence to the agriculturists, to give them time for gradually withdrawing their capital from the land, or that the duty should be originally fixed at 20s., and lowered 1s. every year until reduced to 10s. This we must consider a plea for excessive indulgence. The Edinburgh Reviewer has expressed our opinion that an ad valorem duty of ten per cent would be sufficient, or, what is preferable, a fixed duty of five or six shillings per quarter; for an ad valorem duty, as it has been often remarked, increasing with the price, falls heaviest in dear years, when it is of the greatest consequence that it should be least felt; and lightest in plentiful years, when the burden would be of little comparative consequence. Sir James Graham asks in behalf of the land owners for a fixed protecting duty of 15s. per quarter; and adds, with no slight appearance of justice, 'Since we must have a free trade in corn, let us have also a free trade in money, and destroy that fatal connexion between the government and a single chartered bank, which facilitates the prodigality of the ministers, and invests an irresponsible body with the most delicate and important function of the state—the control over the circulating medium. Nor will it be wise to stop even at this point; if the land owner is to give up his monopoly, for the public good, shall the East India Company and the West India proprietors be suffered, for one day, to retain the full enjoyment of their exclusive privileges? Shall the consumer be forced to pay an exorbitant price for his tea and for his

sugar, that particular interests may be benefited; and shall the nobility and gentry of these realms, the owners of the native soil, *alone* be sacrificed? On the contrary, let us adopt the sound principles of free trade; but let us not limit their application to the staple produce of our land. Let us destroy the heavy duties on timber, which, at the expense of every man building a ship or a house in the mother country, are at best a paltry premium to our colonies; and since we are bent on establishing an open competition with the foreign manufacturer, let us at once reduce largely those taxes which affect both the commerce and manufactures of our country. It is not the price of bread alone, which is a check to our industry; on the contrary, I am well convinced that its effect is insignificant, compared with the weight of taxation to which I have here alluded; and every notion of free trade is worse than visionary, unless accompanied by a large reduction of taxes and of duties. It is clear that the government itself so considers it; for, notwithstanding the boasted triumph of principles termed *liberal*, it has been deemed necessary, in the recent example of the silk trade, to protect the British manufacturer by a duty of thirty per cent on foreign silks imported, although he is subject to no direct tax on the raw material which he uses; but his claim for compensation, in the shape of this large protecting duty, is founded and admitted distinctly on the ground that competition with the foreigner must be ruinous, while in this country taxes on consumption are enforced to an extent unknown abroad; and oppressive, not to the manufacturer alone, but equally to the agriculturist and every member of the community. The experiment of the destruction of monopoly in one branch of industry, while it is suffered to continue with unabated force in others, is an outrage even of the semblance of justice; it is a shifting of the burthen from the protected to the unprotected, from the strong to the weak; and the landed interest is lost indeed, if it allow for one moment an experiment of this nature to be made on its property. The course, therefore, to be adopted by them, is to consent to a revision of the corn laws, to consent to free importation with a moderate protecting duty, but to force also at the same time a revision of all other monopolies, and to carry a reduction of taxes to a very large amount.'

On the whole our views embrace, as we are happy to believe those of the government and most modern writers do, not a great *alteration*, but a *greater steadiness* of price as the result of a free importation of corn. The details of Mr. Jacob's Report support this view of the subject in every page. He makes it evident that the resources of Poland, and the North of Europe, for furnishing any considerable supply of corn, have been vastly overrated. He found little of agricultural science and much less corn than he expected every where. The soil of the provinces near the sea is thin, sandy, and unproductive; while the more distant fertile provinces of Poland incur an expense, attending the carriage of their produce to Dantzic, amounting on an average to from 12s. to 18s. per quarter. Dantzic is clearly the principal foreign port from which we could obtain any regular supply. On its capabilities and past

history this intelligent gentleman therefore bestowed his principal attention.

‘The commerce of corn generally,’ he observes, ‘in the countries whose connexion with the sea is maintained by the river Vistula, has been extensive during a long series of years. The shipment to foreign countries was, during a long period, almost exclusively confined to the city of Dantzic.’

‘The government of Prussia viewed with some jealousy the trade of that city, which was then one of the independent Hanse Towns, and, having the land on both sides the river, from the boundaries of Poland to those of Dantzic, endeavoured, by forming the city of Elbing into a free mart, to draw the trade through that place and its port of Pillau.

‘Some success attended this plan, and the trade, was carried on through the two rival channels, with a competition which has been continued to the present time; for though Dantzic has been since added to the Prussian territories, and the preference given to Elbing consequently withdrawn, the latter city seems to have retained its proportionate share of the export of corn.

‘Attempts are at this time making by Russia, to divert the corn trade of Poland, but especially of the provinces of that country which have been separated from it, and are now comprehended in Russia, to the port of Riga as the place of shipment. For this purpose canals are now constructing, which are intended to facilitate the conveyance of goods to the river Duna. It is not however probable, that a very great proportion of the trade will be drawn into that channel. The port of Riga is closed by frost a much longer time than that of Dantzic; the passage from it to the countries where corn is wanted is longer; the climate is less favorable for drying the grain, after removing it from the barges preparatory to shipment; and it, at present, has not those spacious and well-adapted warehouses for the secure deposit of corn, by which Dantzic is eminently distinguished. Some portion of the corn is at present brought down to the sea-shore by the river Neimen, and after paying a transit duty to Prussia at the town of Schmaleningken, is conveyed to Memel. This branch of the trade is, however, but small, as it appears that in the three years 1816, 1817, and 1818, a period when the general trade was the greatest, the whole quantity that paid the transit duty was only 49,596 quarters of wheat, 21,830 quarters of barley, 185,292 quarters of rye, and 108,482 quarters of oats.

‘From the southern provinces of Poland, viz. Sandomir and Cracow, in which the greatest quantity of the best wheat is produced, a portion is annually sent into the neighbouring Prussian province of Silesia, by land, where a part of it is consumed by the few inhabitants of Breslaw, and the other cities, who eat wheaten bread. The greater part is, however, conveyed by the river Odo, and then by the canal which unites that river with the Havel, to the city of Berlin. It forms an article in the weekly returns of the corn-market of that capital; and, by the whiteness of its flour, is preferred for pastry and confectionary. In those years when the prices of grain have been the most raised in England, some of it has been sent here from Stettin, whilst those

of the inhabitants of that neighbourhood who used wheat, were supplied with an inferior kind of their own growth. Those other channels by which the surplus corn of Poland is distributed, bear however but a small proportion to that which passes by the mouths of the Vistula, at Dantzic and Elbing; and the manner in which the trade by these places is carried on may deserve detailed notices.

‘On the banks of the Vistula there are many warehouses well adapted for preserving corn at the places whence it is most convenient to embark it. The crops are generally removed from the farms of the proprietors as speedily as possible, and remain there in the power of the creditor, who either allows for it a stipulated price, or undertakes to convey it to Dantzic, to be sold at the risk of the debtor; but with the proceeds to be received by the creditor. The charges for warehousing, shipping, freight, tolls, commission, and other demands, have been lately so high, in proportion to the prices, that very small sums have been carried to the credit of the landholder; and, where estates are mortgaged, they have been generally insufficient in amount to keep under the growing interest.

‘There are two modes of conveying wheat to Dantzic by the Vistula. That which grows near the lower parts of the river, comprehending Polish Prussia, and part of the province of Plock and of Masovia, in the kingdom of Poland, which is generally of an inferior quality, is conveyed in covered boats, with shifting boards that protect the cargo from the rain, but not from pilfering. These vessels are long, and draw about fifteen inches water, and bring about 150 quarters of wheat. They are not, however, so well calculated for the upper parts of the river. From Cracow, where the Vistula first becomes navigable, to below the junction of the Bug with that stream, the wheat is mostly conveyed to Dantzic in open flats. These are constructed on the banks, in seasons of leisure, on spots far from the ordinary reach of the water; but which, when the rains of autumn, or the melted snow of the Carpathian mountains, in the spring, fill and overflow the river, are easily floated.

‘Barges of this description are about seventy-five feet long, and twenty broad, with a depth of two feet and a half. They are made of fir, rudely put together, fastened with wooden treenails, the corners dovetailed, and secured with slight iron clamps, the only iron employed in the construction. A large tree, the length of the vessel, runs along the bottom, to which the timbers are secured. This roughly cut keelson rises nine or ten inches from the floor, and hurdles are laid on it which extend to the side. They are covered with mats made of rye-straw, and serve the purpose of dunnage; leaving below a space in which the water that leaks through the sides and bottom is received. The bulk is kept from the sides and ends of the barge by a similar plan. The water, which these ill constructed and imperfectly caulked vessels receive, is dipped out at the end and sides of the bulk of wheat. Vessels of this description draw from ten to twelve inches of water, and yet they frequently get aground in descending the river. The cargoes usually consist of from 180 to 200 quarters of wheat.

‘The wheat is thrown on the mats, piled as

high as the gunwale, and left uncovered, exposed to all the inclemencies of the weather, and to the pilfering of the crew. During the passage, the barge is carried along by the force of the stream, oars being merely used at the head and stern, to steer clear of the sand-banks, which are numerous and shifting, and to direct the vessel in passing under the several bridges. These vessels are conducted by six or seven men. A small boat precedes with a man in it, who is employed in sounding, in order to avoid the shifting shoals. This mode of navigating is necessarily very slow; and during the progress of it, which lasts several weeks, and even months, the rain, if any falls, soon causes the wheat to grow, and the vessel assumes the appearance of a floating meadow. The shooting of the fibres soon forms a thick mat, and prevents the rain from penetrating more than an inch or two. The main bulk is protected by this kind of covering, and, when that is thrown aside, is found in tolerable condition. The vessels are broken up at Dantzig, and usually sell for about two-thirds of their original cost. The men who conduct them return on foot.

When the cargo arrives at Dantzig or Elbing, all except the grown surface is thrown on the land, spread abroad, exposed to the sun and air, and frequently turned over till any slight moisture that it may have imbibed is dried. If a shower of rain falls, as well as during the night, the heaps of wheat on the shore are thrown together in the form of the steep roof of a house, that the rain may run off, and are covered with a linen cloth. It is thus frequently a long time after the wheat has reached Dantzig before it is fit to be placed in the warehouses. The warehouses are very well adapted for storing corn. They consist, generally, of seven stories, three of which are in the roof. The floors are about nine feet asunder. Each of them are divided by perpendicular partitions, the whole length about four feet high, by which different parcels are kept distinct from each other. Thus the floors have two divisions, each of them capable of storing from 150 to 200 quarters of wheat, and leaving sufficient space for turning or screening it. There are abundance of windows in each floor, which are always thrown open in dry weather, to ventilate the corn. It is usually turned over three times a week. The men who perform the operation throw it with their shovels as high as they can, and thus the grains are separated from each other and exposed to the drying influence of the air.

The whole of the corn warehouses now left (for many were burnt during the siege of 1814) are capable of storing 500,000 quarters of wheat, supposing the parcels to be large enough to fill each of the two divisions of the floors, with a separate heap; but as, of late years, it has come down from Poland in smaller parcels than formerly, and of more various qualities, which must of necessity be kept distinct, the present stock of about 280,000 quarters is found to occupy nearly the whole of those warehouses which are in repair, or are advantageously situated for loading the ships. Ships are loaded by gangs of porters with great despatch, who will complete a cargo

of 500 quarters in about three or four hours. It is seen by Table No. 19, that within the last five or six years the whole quantity that has been brought down has been diminishing; but I was told that no sensible decrease had been observed in the number of the separate bulks, only that each bulk, or the growth of each estate, or of each consignor, was smaller.

The trade in wheat from Poland and Prussia, through Dantzig, is said to have been attended with most ruinous losses to all the persons who have been engaged in it. The growers asserted that none, for the last eight or nine years, had yielded sufficient to cover the expenses of cultivation, and that it has been regularly getting worse and worse ever since the year 1818. The Jews, who have taken the crops from the growers, have found the decline of the prices such, that if they sold on their arrival at Dantzig, it was attended with loss; and if they were in a condition to withhold from selling, and placed it in warehouses, the loss was eventually much greater. The trade of Dantzig, which is chiefly confined to corn, has been for several years in a very distressed state. The commodity in which the traders have dealt has of late so vastly declined in value, that what was purchased cheap at one period, became in a short time dear; the advances they made on what was consigned to them for sale, with the expense of conveyance, and of storing and preserving, soon amounted to more than the value of the wheat; and the consignors, in Poland, seldom united the ability and the disposition to make payments to indemnify them. The corn now in the warehouses has cost the merchants much more than the present value. The royal bank of Prussia, which has branches in the different cities of the kingdom, has advanced, on the security of the wheat now in store, half of what was the value at the time the several advances were made; and, as the price has declined, has required additional security. We subjoin the Table adverted to.

An account of the quantities of grain shipped down the Vistula, through the city of Thorn, from Russia and Poland, to Dantzig and Elbing, from the years 1816 to 1825.

FROM RUSSIA.					
	Wheat	Rye	Barley	Peas	Oats
	Qrs.	Qrs.	Qrs.	Qrs.	Qrs.
1816	62,221	115	252
1817	81,733	51,267	1535	..	535
1818	100,750	22,281	1744	4	271
1819	139,325	51,566	1306	378	17,656
1820	122,860	37,611	717	599	3819
1821	31,277	15,541	850	291	2027
1822	14,013	8
1823	20,684	5	17
1824	25,137	1367	62	..	25
1825	13,352	1471	309	137	..
	611,352	181,224	6775	1409	24,358

FROM AUSTRIA.					
	Wheat	Rye	Barley	Peas	Oats
	Qrs.	Qrs.	Qrs.	Qrs.	Qrs.
1816	2048	..	12
1817	2108	3526	1143	..	186
1818	3895	51	51	..	23
1819	1841	1695	101	107	669
1820	3305	804	58	188	104
1821	1057	305	70	48	88
1822	646
1823	1976	..	67	..	581
1824	8278	5	17
1825	240	1	..
	25,394	6386	1502	344	1668

FROM POLAND.					
	Wheat	Rye	Barley	Peas	Oats
	Qrs.	Qrs.	Qrs.	Qrs.	Qrs.
1816	60,173	3856	264	4	58
1817	111,542	66,418	2687	13	721
1818	143,395	44,663	3590	12	5472
1819	141,166	53,261	1734	482	18,326
1820	126,164	38,415	775	932	3922
1821	32,335	15,846	920	339	2115
1822	16,328	5185	64	12	1267
1823	34,943	5108	7	4	384
1824	93,968	4009	65	..	17
1825	176,215	7528	487	496	27
	936,229	244,289	10593	2296	32,390

Brought forward		608,503
In ports in the North Sea, as ascertained :		
Hamburgh	105,000
Bremen	27,970
Total	741,473

‘Of the wheat to which we have referred, as accumulated in the several ports, I was assured,’ says he, ‘nearly one-fourth part is of so bad a quality, as to find no market in this country, except in seasons of uncommon dearth. If, then, out of the whole 741,473 quarters, 556,330 quarters were to be sent to England, it would not be more than the consumption of ten days.’

His exhibition of the general agricultural distress of these provinces is very singular and affecting.

‘An estimate was made by a person eminently skilled in the value of land, who formed it upon actual sales made in the last four years. He divided it into three classes, according to their fertility. The lowest land in a state of cultivation, with good buildings and a competent number of peasants, he stated to be worth 1000 florins the huff. Valuing the florins at sixpence, though worth a fraction less, and taking the huff of thirty Magdeburg morgens, as equal to twenty-two English acres, the estimate would be a fraction less than 22s. sterling the English acre. The other kinds of arable land, of superior qualities, vary. The great mass is of the second class, or worth about 30s. but some is estimated at 5000 florins the huff, or £5. 10s. but little, however, is in this class, and that little is in the vicinity of the cities on the banks of the great rivers, or in some favored spots in the southern provinces. This estimate was rather founded on the state of affairs three or four years ago, than on their present condition; for I was told that such a number of estates had lately been offered for sale, that no price could be obtained for the greater part. All the enquiries I was enabled to make, in various parts of the country, led me to the belief, that the estimation here stated was, in the main, as correct as could be expected to be framed.

‘The Jews are almost exclusively the dealers in money. They are precluded from becoming landed proprietors, and their exclusion from the market tends to depress the prices in a very great degree. Though some of the richer individuals of that people pass through the ceremony of baptism, especially when they have mortgages on large estates, and mean to foreclose; the whole number of those who thus become qualified to purchase bears a small proportion to that of the properties that are offered for sale. I was assured from so many, and such various quarters, that I have no reason to doubt of the report, that almost every estate is deeply involved in debt. The fact is so notorious, that few proprietors feel any delicacy in acknowledging themselves to be partakers of the common lot of their neighbours. More than one, without any reserve, spoke to me on the sum annually required to pay interest on his mortgages, with as much coolness as an English farmer would speak of his rent, tithes, and taxes.

I do herewith duly certify, that the quantities, as above stated (scheffel anzahl in the original German account), have been extracted from authentic papers, and*the registers of the custom-house. MELLIN, Burgomaster.

Thorn, Aug. 23rd, 1825.

The stock of wheat in Dantzic and Elbing, at the period of his visit (Aug. 1825), was furnished to him as follows :

Dantzic	288,000 quarters.
Elbing	73,500 quarters.

The whole stock in the provinces connected with the Vistula, he afterwards brings into one point of view as consisting of

Pomerania	67,103	Quarters.
Dantzic and Elbing	361,500	
Lubeck	29,900	

Conjectural :

Denmark	25,000
Rostock and Wismar	25,000
Petersburgh, Riga, and Memel	100,000

Carried forward 608,503

'Among the mortgagees, the king of Prussia and some of his monied subjects are by far the greatest, in that part of Poland which was included in his dominions, till Poland was erected into a Grand Duchy by Buonaparte, under the government of the king of Saxony. It had long been the practice of the court of Berlin to assist agriculture, by loans to the proprietors of estates. This practice began under Frederick the Great, and was continued to the disastrous period that followed the battle of Jena. This assistance was extensively afforded to the newly acquired subjects of the part of Poland, which, in the division of that unfortunate country, fell to the share of Prussia. Though the king of Prussia has lost the government, his claims, and those of his subjects, on the individuals indebted to them, have been recognised; and though in many instances the interest has gone on increasing, the claims have not been rigidly enforced. It was remoured in Warsaw, but not on any authority, that the emperor Alexander, in his character of king of Poland, was negotiating a treaty with the court of Berlin, which had for its object the relief of the Poles, by purchasing the claims of the Prussians and assuming the debts to himself. The amount of the claims of Prussia was stated to me to be two millions of Prussian dollars, or £300,000 sterling, secured on various estates extending over near 1,500,000 acres.

'A more numerous class of mortgagees comprises the corporations of cities and towns, the trustees of hospitals, schools, colleges, monasteries, convents, and charitable institutions. Whatever capitals these may possess is lent on land; and the difficulty of obtaining the interest as it accrues, and, in some instances, of getting any, causes those establishments to languish, and decrease in their capacity to relieve distress.

'Family settlements are mostly made on the security of land: for a long period there was no other means of making provision for the young and the helpless; and, in the flourishing periods of agriculture, the interest was paid with punctuality. Of late, however, the widows and orphans, whose incomes were deemed free from risk, have become victims to the general depression of the value of the produce of the soil. The Jews, with all their characteristic shrewdness and sagacity, have become, in many instances, from mere necessity, mortgagees. When the debts of proprietors accumulated, and the price of produce fell, the monied men were often induced to secure themselves, as well as they could, by accepting mortgages where no payment could be obtained. The representation here given, is abundantly confirmed by the proceedings adopted in the diet when assembled in May last. The two houses, consisting almost exclusively of landed proprietors, settled a plan to administer relief, which received the emperor's sanction.

'A national bank is to be established, in which land-owners who are in debt, whether on mortgage or on simple contracts, may deposit a schedule of their estates, and a valuation of them: this valuation is to be made by themselves, and it is calculated it will not be made too high, because, as the present land tax is collected on the income, and future imposts are to be levied according to

this valuation, few will be induced to give more than the true value. On the valuation, an annual interest is to be paid to the bank, at the rate of six per cent. for twenty-eight years. This is to be considered as interest at the rate of four per cent.; and two per cent. is to form the means of discharging, by compound interest, the principal in twenty-eight years. The bank, on receiving the documents, is to deliver to the proprietors its debentures or certificates; which, twenty per cent. being deducted from them, are made a legal tender for the payment of all debts; and on which four per cent. interest is to be paid by the bank. When the instalment of the first year is paid, the two per cent. is to be divided among all the holders of the bank debentures, by a lottery. The drawers of the fortunate numbers will then be paid in full. The others will receive their interest, at the rate of four per cent. till their numbers are drawn prizes, some of which must, of course, wait till the expiration of the twenty-eighth year; at which period, upon this plan, if it should work well, all the debts will be liquidated. I have only noticed this project as a corroboration of the accounts I collected of the general state of embarrassment in which the land-owners in Poland are involved.'

We are particularly struck with the coincidence between the following remarks derived from an actual survey of the facts, and the previous reasoning of many able writers.

'If we calculate that the consumption of wheat in Great Britain is one quarter for each person for food, and about a seventh part more for seed and minor purposes, it will appear that in the first of the series we have been comparing, the quantity of wheat exported from Dantzic and Elbing would, with the then amount of our population, 11,000,000, be equal to twelve days consumption. In fact, however, out of the 5,059,163 quarters of wheat, which Dantzic exported, 1,000,014 were despatched to other countries. As we have only the gross exports from Elbing, without distinguishing what was sent to Great Britain from what was sent elsewhere, it may not be incorrect to assume, that one-fourth as from Dantzic was not sent to our markets; and then there will be a further reduction of 299,205 quarters. This will leave the whole quantity really furnished to us in the eleven years, 3,459,944 quarters, or an annual quantity of 314,540 quarters, being equal to about nine days of our consumption.

'At the second series our population had advanced, as numbered in 1821, the middle year of that series, to 14,000,000. The quantity of wheat sent to us from the Vistula had declined, and during the eleven years had been 1,252,271 quarters, or 113,842 annually. This would be equal to the whole of our consumption for betwixt two and three days.

'In the Appendix, No. 24, is shown the whole export of corn from Dantzic, for the last 166 years. By those tables, it appears that the wheat exported from that city, during that long period, was 19,581,947 quarters, or 117,963 quarters on the annual average of the period. In fact, the whole that Dantzic has exported in 166 years is not equal to the consumption of this kingdom,

with its present population, for more than fifteen or sixteen months. The annual importation would not now amount to two days and three quarters' consumption.'

We may now we think dismiss all fear of an overwhelming supply of corn from this part of the world.

Mr. Jacobs afterwards endeavoured to ascertain the quantity of corn conveyed by the Niemer to Memel; and by the Duna to Riga. He considers that the larger share of the produce of the fertile Russian provinces of this neighbourhood finds its market in the latter direction; and furnishes an account of the exportation of wheat from Riga for the last twelve years, which make it to average 21,381 quarters only annually; that of rye 134,822 quarters. He speaks of the fertility and comparative prosperity of Moravia. Wheat was selling last year for 20s. per quarter at Olmutz, while, on one side of the province, at Cracow, it only obtained 14s. and at Vienna 14s. 7d.

In France, through which he passed on his return, our traveller had not time to make minute observations.

'I was assured, however,' he says, 'that, for several years past, every cultivator of grain has been selling at far less than it has cost him. Some of the best judges of the subject have calculated that wheat, in the four classes of districts formed of the departments for the purposes of regulating the importation and exportation of corn, costs to the grower, on an average from twenty to twenty-two francs the hectolitre, or from 6s. 4d. to 6s. 11d. the Winchester bushel.

'How far this calculation may be correct, it would be presumption in me to assert. The corn laws of France are, however, founded on a supposition of this being the price necessary to secure a profit to the farmer. The kingdom is divided, for the purposes of the corn law, into four districts, each including departments in which the prices of grain are nearly alike. When wheat is below eighteen francs the hectolitre, or 5s. 7½d. the bushel in the cheapest of those districts, twenty francs or 6s. 4½d. in the next, twenty-two francs or 7s. 0½d. in the next, and twenty-four francs or 7s. 8d. in the highest, the importation of foreign wheat is prohibited. As the whole of the four districts form the regulating price, the average of wheat throughout the whole kingdom must rise to 6s. 8d. per bushel, before any foreign wheat can be introduced. The laws which regulate the corn trade of France, were passed in 1819 and 1821; and the price of corn has not, since the end of the year 1818, ever risen so high as to effect the opening of their ports. Since that year the price has been fluctuating, but declining at the following ratio.

Average of the whole of France.

	s.	d.
1820	5	3½
1821	4	11
1822	4	3½
1823	4	11
1824	4	6½
1825	4	3½

'Your lordships,' adds Mr. Jacob in the conclusion of his able report, 'have been pleased, in my instructions, to direct me to consider, with reference to the provinces communicating with the Baltic Sea by the Vistula, from the view I take of the country, what increase of cultivation would be likely to take place in consequence of such a stimulus being constantly in action, as would be applied, if an alteration were made in our laws, so as to leave our markets at all times accessible to the corn grown in Poland;' and further, I have been instructed, 'that, as it may be necessary to assume some given price in this country, in forming such an estimate, it was thought desirable to proceed upon a supposition of an average price of wheat at home, of 60s. to 64s. per quarter.

'This question involves so many considerations, depending not only on the present condition of the country, but on the political regulations to which it may hereafter be subject, that any reasonings applied must be in a great measure hypothetical and speculative; and any conclusions we may arrive at, must be liable to be affected by changes which cannot now be contemplated, or taken into calculation. The utmost that can be done is to approximate to a result, by a consideration of the principal circumstances on which it will depend, by reference to the fluctuations in past periods, and by an examination into the causes from which those fluctuations have proceeded.

'In obedience to this direction, I presume, with the diffidence which must be always felt in anticipating the effects of untried, and consequently doubtful experiments, to state my views on the subject. The effect of the stimulus here proposed must depend, in a great measure, on the assurance of its duration. The market for wheat which England presents, is the great object of attention to the cultivators in Poland, and to the merchants at the ports from whence its corn must be exported. Those persons have been accustomed to observe such frequent alterations in our laws relative to the corn trade, that any new enactments would, at first, be thought temporary and mutable, like those of former periods. This uncertainty has been the cause of heavy losses to them, and would therefore have the effect of causing the cultivators to pause before they made any great changes in their rotation of crops, or in the kinds of corn they would sow.

'The statements which are given in the part of this report more immediately relating to the kingdom of Poland, will show that the want of capital among the cultivators has proceeded to such an extent, from the losses they have sustained, that they must, in a great degree, be disabled from making any considerable improvement in cultivation, or raising any very large increase of produce in a short period. The great deficiency of live stock, which indeed may be resolved into a deficiency of capital, would be an impediment in the way of a rapid extension of the growth of wheat. Without manure, wheat cannot be grown beneficially, and without a stock of cattle, in some degree commensurate to the extent of the land, manure

cannot be obtained; and though to a certain degree the profit arising from the wool, and not from the meat, enables the landowners to support some few sheep, yet the want of a class of consumers, who can afford to make animal food their subsistence, must operate to prevent any great increase in the stocks of cattle. Such a class is not to be expected there, till a great improvement, or an increase of manufacturers, shall have taken place. The greater portion of the population of Poland is too poor to allow of their using animal food; the want of it is scarcely felt by persons always accustomed to live, with very little variation of diet, on rye bread.

'The labouring classes, too, being assured of a supply of the bare necessities of life, are little disposed to any great changes in their mode of work, or any exertion of strength or skill beyond that to which they have been accustomed. They have been, perhaps not without some reason, always represented as indolent, unskilful, filthy, and drunken; and averse to the improvements which their wiser and better superiors have attempted to introduce.

'Whilst the present low price of corn continues, and the corresponding low rate of wages, and the markets of Russia are open to the woollen cloths of Poland without duty, the profit of capital employed in that branch of industry must offer to it temptations that agriculture does not present. But if by any alterations the cloths of Poland should in the Russian custom-houses be placed on the footing of the cloths of other countries, or if a rise of corn and of wages should take place to such an extent as to make the Polish cloths dearer than those which are charged with duty, the effects might be to drive the capital from the cloth trade to the business of cultivation. The present want of capital may possibly be supplied by influx from other countries, but this must depend in a great measure on the internal government and political regulations of the country. The increase of manufactories in Poland, and the augmented population which they usually induce, might produce such a number of internal consumers as to leave much less surplus corn to export to other countries. It is true that wheat would be but little eaten by the manufacturers, but the increased demand for rye might make that kind of grain the most profitable to the grower; and he would then devote to the cultivation of it some portions of the land which, under different circumstances, would have been appropriated to the growth of wheat. The manufacturers in Poland are however of too little importance, at present, to make it desirable to hazard any conjectures on what the effects of their increase or diminution would be on the surplus quantity of exportable grain.

'A view of the past exportation from the Vistula, at different periods and under different circumstances, will perhaps give some assistance in forming an idea of what may be the result of future changes.'

He then shows, from a consideration of the returns of 166 years, the little variation that has taken place in the actual quantity of corn exported.

When divided into periods of about twenty-five years, the returns from Dantzie, exhibit the following annual exportation of wheat and rye from that port.

YEARS.	WHEAT.	RYE.	TOTAL.
	Quarters.	Quarters.	Quarters.
1651 to 1675	81,775	225,312	307,087
1676 to 1700	124,897	227,482	352,379
1701 to 1725	59,795	170,100	229,895
1726 to 1750	80,624	119,771	200,395
1751 to 1775	141,080	208,140	349,220
1776 to 1800	150,299	103,045	253,344
1801 to 1825	200,330	67,511	267,841

Giving an annual quantity of wheat and rye, of 279,794 quarters.

'During the ten years, from 1791 to 1801, there was a constant demand in France for foreign corn; several deficient harvests had been experienced at the beginning of the revolution. The agents of France were employed, both in Europe and America, in purchasing corn and hiring neutral vessels to convey it to France; paying but little regard to the price they gave for it, or to the rate of freight at which it could be transported. Holland, which scarcely has ever grown corn sufficient for its own consumption, felt a great want, owing to its internal sources of supply from Germany and Flanders being diverted from the usual channels by the circumstances of the war.

'Sweden for many years had looked for some supply from Prussia, not, indeed, of wheat to any extent, but chiefly of rye. During the period we are now considering, that country had been afflicted with several successive deficient harvests; and such was the distress from want of corn, that a large part of the population had been compelled to use the bark of trees as a substitute for rye. That kingdom thus became a market which could take as much as her poverty could find the means of paying for. In addition to these external circumstances, the land in Poland was less burthened with taxes than it is at present. The tenth Groschen war-tax was not then enacted. Some other taxes, then imposed, have not been since abandoned. In Prussia, likewise, taxation is higher now than from 1801 to 1805.

'These combined circumstances gave to the agriculture of Poland and Prussia a portion of capital, and motives to exertion, which produced the vast surplus that was exported from 1801 to 1805. Ten years of unexampled prosperity were, however, needed to reach the point which those years exhibit, and it was only by gradual steps that it was attained.

'The impulse given by the open markets, and by the high prices which had opened them, acted with accumulated force in the next five years, and raised the surplus, as we have seen, somewhat higher.

'If the same powerful stimulus could now be applied to excite the cultivators in Poland and in Prussia, to increase their supplies of corn, as

was experienced from 1791 to 1801, it would be reasonable to conclude that the result might be the same as is exhibited in the quantities of wheat exported from 1801 to 1805. It might produce, with ten years' increased exertion, and with the application of the capital created in those ten years of prosperity, a quantity equal to that which was exported in the years of the greatest surplus. I was told, when in Poland, that during those prosperous years, wheat was brought by land carriage to the Vistula, from distances far too great to bear the expenses without the enormous prices which it bore in the markets of England and France. It was sent, not only from the farthest parts of Galicia, but even from the vicinity of Brunn and Olmutz, in Moravia. It was said, that some of the wheat of Hungary was conveyed over the Carpathian mountains to Cracow, and there shipped in flats for Dantzic and Elbing, whilst Volhynia and Podolia were emptied of their stores.

'Whether these reports are true, or to whatever extent they are true, it is natural to suppose that the very high price which wheat had reached, in the years under consideration, must have vastly extended the limits of the circle from which it would be collected, and would induce the inhabitants to despatch to the high markets whatever could be spared by the exercise of the most rigid economy.

'By the constant application of all these powerful stimuli, which were in operation during ten years, we have seen that at length the surplus of wheat, which the Vistula and its borders extended to unusual dimensions, could yield, amounted to 550,000 quarters annually, or about sufficient, supposing the whole to be sent here, for the consumption of this kingdom, with its present population, during the space of twelve days.

'It is scarcely to be calculated that the same recurrence of circumstances, propitious to the agricultural prosperity of the lands on the border of the Vistula, should again present itself. Neither the demands of France or England are likely to be so great, or to continue for so long a period, as at that time. It is scarcely to be calculated upon, that any future wars will be so long in duration, or spread over so extensive a field of operations, as those which rose out of the revolution of France; and it is therefore not likely that the quantity exported will ever rise to so great an amount. Whatever stimulus may be applied to excite the agricultural improvement of the banks of the Vistula, its effect must be weak and powerless, when compared with the excitement it received from 1791 to 1805.

'If we suppose the cost of wheat to the grower in the vicinity of Warsaw, to be about 28s. per quarter, and all the expenses of conveyance to our markets to be 30s. more, and that it could be sold here for 60s. or 64s. We may presume that such a stimulus would produce great exertions, and a correspondent increase of supply; some abatement in the force of that stimulus would be probably felt in an increase of freight, and other charges, but the prospect of a profit of 12s. or 14s. would give a powerful impulse to cultivation. What is here stated, is upon the supposition, of course a mere supposition, that no duty would be imposed on foreign wheat on its introduction into this kingdom. Supposing a duty should be imposed, it will of course weaken the force of the stimulus; and if it should be so high, as, when added to the costs and charges, to raise it above the price at which it could be sold in our markets, it would become a repellent instead of a stimulus, especially if it should be viewed as a permanent enactment.

'If a duty in this country of 10s. or 12s. per quarter was imposed, it would not allow of such a profit, on the supposition of the price being from 60s. to 64s. as to induce any great exertions to increase cultivation in the bordering districts on the Vistula. The chance of a rise occasioned by war, by a winter so severe as to injure vegetation, or by a rainy harvest season, might induce those of a speculative turn to increase their growth of wheat; but those who have that turn, and have the means of indulging it, are so few, that they would produce no sensible increase in the general surplus.

'I see no reason to believe, that with such a duty as I have mentioned for England, and a price from 60s. to 64s. and with some similar regulation in France, that the surplus corn produced in Poland, including all the countries near enough to the Vistula to send their corn to that stream, would materially increase in common seasons, or very much, if at all, exceed the average produce of that country; the greater part of this might probably be wheat, and if the duty were alike on all the various qualities of that grain, none would be sent here but that part which is the driest, heaviest, and whitest. The inferior descriptions would not pay for importation, unless the average in England was much more than 64s.'

We subjoin the following documents respecting the modern prices of grain in all the great corn markets of Europe, from the Appendix of Mr. Jacob, and other sources.

TABLE I.
No. 1.—Account of the Average Prices of IRISH WHEAT per quarter since 1792.

	£.	s.	d.		£.	s.	d.		£.	s.	d.
1792	1	17	5	1799	3	1	4	1806	3	7	7
1793	2	4	11	1800	4	19	2	1807	3	7	9
1794	2	1	9	1801	4	8	1	1808	3	16	7
1795	3	1	0	1802	2	12	1	1809	3	18	2
1796	3	0	8	1803	2	9	4	1810	3	18	5
1797	2	2	7	1804	2	18	0	1811	3	10	5
1798	2	5	2	1805	3	9	2	1812	5	8	3

No. 2.—An Account of the Average Prices of BRITISH CORN per Quarter, and of OATMEAL per Boll, of 140 lbs. Avoirdupois, in England and Wales, since 1792, as ascertained by the Receiver of Corn Returns :

YEARS.	Wheat.			Rye.			Barley.			Oats.			Beans.			Peas.			Oatmeal.		
	£	s.	d.	£	s.	d.	£	s.	d.	£	s.	d.	£	s.	d.	£	s.	d.	£	s.	d.
1792	2	2	11	1	10	8	1	6	9	0	17	10	1	11	7	1	12	8	1	13	0
1793	2	8	11	1	15	11	1	11	9	1	1	3	1	17	8	1	18	4	1	18	11
1794	2	11	8	1	17	9	1	12	10	1	2	0	2	2	6	2	6	8	1	18	1
1795	3	14	2	2	8	5	1	17	8	1	4	9	2	6	8	2	13	4	2	3	6
1796	3	17	1	2	7	0	1	15	7	1	4	9	1	18	10	2	3	6	2	2	9
1797	2	13	1	1	11	11	1	7	9	0	16	9	1	7	6	1	13	5	1	13	10
1798	2	10	3	1	10	11	1	9	1	0	19	10	1	10	1	1	13	11	1	16	8
1799	3	7	6	2	3	9	1	16	0	1	7	7	2	4	7	2	5	2	2	5	0
1800	5	13	7	3	16	11	3	0	0	1	19	10	3	9	3	3	7	5	3	12	1
1801	5	18	3	3	19	9	3	7	9	1	16	6	3	2	8	3	7	8	3	10	0
1802	3	7	5	2	3	3	1	13	1	1	0	7	1	16	4	1	19	6	1	19	3
1803	2	16	6	1	16	11	1	4	10	1	1	3	1	14	8	1	18	6	1	18	7
1804	3	0	1	1	17	1	1	10	4	1	3	9	1	18	7	2	0	10	2	0	8
1805	4	7	10	2	14	4	2	4	8	1	8	0	2	7	5	2	8	4	2	3	8
1806	3	19	0	2	7	4	1	18	6	1	5	8	2	3	9	2	3	6	2	4	2
1807	3	13	3	2	7	6	1	18	4	1	8	1	2	7	3	2	15	11	2	4	3
1808	3	19	0	2	12	4	2	2	1	1	13	8	3	0	8	3	6	7	2	8	9
1809	4	15	7	3	0	9	2	7	3	1	12	8	3	0	9	3	0	2	2	11	4
1810	5	6	2	2	19	0	2	7	11	1	9	4	2	13	7	2	15	9	2	11	11
1811	4	14	6	2	9	11	2	1	10	1	7	11	2	7	10	2	11	6	2	8	6
1812	6	5	5	3	15	11	3	6	6	2	4	0	3	12	8	3	13	7	2	9	8
1813	5	8	9	3	10	7	2	18	4	1	19	5	3	16	5	2	18	6	2	3	5
1814	3	14	0	2	4	6	1	17	4	1	6	6	2	6	7	2	10	0	1	13	0
1815	3	4	4	1	17	10	1	10	3	1	3	10	1	16	1	1	18	10	1	10	0
1816	3	15	10	2	3	2	1	13	5	1	3	6	1	18	4	1	18	4	1	8	4
1817	4	14	9	2	16	6	2	8	3	1	12	1	2	12	0	2	11	5	1	19	3

No. 3.—An Account of the Average Prices of BRITISH CORN per Quarter, and of OATMEAL per Boll, of 140 lbs. Avoirdupois, in Scotland since 1792, as ascertained by the Receiver of Corn Returns :

YEARS.	Wheat.			Rye.			Barley.			Oats.			Beans.			Peas.			Oatmeal.		
	£	s.	d.	£	s.	d.	£	s.	d.	£	s.	d.	£	s.	d.	£	s.	d.	£	s.	d.
1792	1	19	4	1	4	11	1	3	1	0	16	6	1	7	1	1	6	10	0	14	6
1793	2	3	7	1	6	7	1	5	6	0	18	6	1	12	8	1	12	9	0	16	10
1794	2	5	4	1	7	5	1	5	0	0	18	10	1	12	5	1	12	7	0	16	11
1795	3	6	4	1	6	7	1	9	6	1	0	6	1	14	0	1	13	9	0	17	1
1796	3	11	5	1	10	9	1	9	11	1	2	0	1	18	2	1	17	9	0	19	5
1797	2	6	0	1	6	7	1	3	4	0	16	6	1	8	3	1	8	1	0	14	6
1798	2	3	5	1	6	9	1	2	3	0	17	7	1	9	8	1	10	1	0	15	9
1799	2	18	1	1	10	10	1	8	9	1	3	7	1	16	9	1	15	11	1	0	1
1800	4	11	2	2	18	3	2	11	4	2	2	5	3	13	7	3	14	11	1	18	9
1801	5	1	8	3	6	2	2	12	10	1	18	4	3	6	3	3	7	1	1	13	9
1802	3	4	6	1	13	10	1	9	6	0	19	5	1	13	3	1	13	2	0	16	10
1803	2	10	4	1	13	4	1	4	3	0	19	10	1	14	9	1	15	1	0	18	0
1804	2	13	3	1	18	8	1	7	4	1	2	3	1	16	1	1	15	9	0	19	2
1805	2	13	7	1	18	7	1	6	8	1	2	4	1	15	3	1	14	6	0	19	3
1806	3	16	4	1	14	4	1	17	0	1	4	0	1	16	5	1	16	2	1	0	0
1807	3	6	5	1	15	6	1	11	6	1	4	3	1	17	0	1	16	8	1	0	4
1808	3	6	7	1	19	0	1	14	7	1	7	1	2	7	9	2	7	1	1	2	11
1809	3	11	7	2	13	5	2	1	0	1	13	10	3	1	7	3	2	8	1	9	0
1810	4	5	6	2	11	6	2	0	1	1	12	1	2	15	8	2	16	6	1	8	7
1811	3	18	10	2	1	10	2	0	0	1	8	5	2	9	8	2	10	5	1	4	6
1812	3	11	9	2	0	10	1	16	6	1	4	6	2	1	7	2	2	2	1	1	0
1813	5	7	10	2	16	11	2	13	6	2	0	7	3	7	11	3	8	10	1	13	1
1814	4	16	2	3	6	6	2	12	8	1	17	9	3	2	10	3	4	6	1	12	4
1815	3	2	5	2	0	9	1	18	2	1	5	10	1	19	5	1	19	9	1	1	0
1816	2	13	6	1	19	2	1	7	8	1	2	9	1	13	2	1	13	0	0	18	6
1817	3	8	3	1	18	4	1	9	8	1	3	8	1	15	5	1	15	8	0	18	11

London, Aug. 14, 1818. (Signed) Wm. Dowding, Receiver of Corn Returns.

TABLE II., No. 1.—An Account of the quantities of WHEAT, RYE, BARLEY, and OATS, imported into Danzig, and exported from the same place, from the year 1792 to the year 1825; as also their highest and lowest prices during the same period.

YEAR.	IMPORTATION.				EXPORTATION.			
	WHEAT.	RYE.	BARLEY.	OATS.	WHEAT.	RYE.	BARLEY.	OATS.
1792	Quarters. 117,328	Quarters. 151,641	Quarters. 21,987	Quarters. 16,894	Quarters. 103,467	Quarters. 133,791	Quarters. 18,900	Quarters. 18,197
1793	175,003	170,541	20,055	5,376	173,828	154,056	20,234	4,032
1794	164,871	83,790	17,188	16,679	197,116	120,747	16,369	75,726
1795	123,911	24,511	12,012	4,242	144,627	1,879
1796	308,007	160,986	31,842	9,544	282,250	91,056	15,876	147
1797	302,159	140,143	39,018	11,382	251,832	80,661	17,188	21
1798	246,456	136,275	7,602	11,098	276,654	123,480	8,526	189
1799	282,324	115,668	29,588	12,768	262,752	139,856	8,568	4,735
1800	408,062	81,228	35,689	19,446	429,061	27,347	2,331	5,544
1801	456,901	126,735	54,568	15,088	394,831	100,716	37,789	10,090
1802	552,510	305,025	35,458	8,923	550,368	248,031	20,160	273
1803	424,421	338,446	42,347	13,471	358,515	303,145	12,694	1,491
1804	324,103	113,957	54,505	20,517	438,763	97,902	29,778	2,667
1805	471,660	9,901	4,410
1806	61,677
1807
1808
1809
1810	200,917
1811	44,982
1812
1813
1814	94,552	56,427	8,925	10,048	61,089	13,240	2,520	32
1815	35,322	31,342	12,265	10,657	15,530	2,289	63
1816	156,009	82,005	13,650	8,053	134,473	33,631	4,536	640
1817	233,310	156,555	27,300	11,141	222,201	135,607	26,155	3,223
1818	333,921	53,728	65,226	20,317	282,943	42,819	39,932	7,833
1819	305,655	45,980	30,550	5,271	123,186	23,600	30,513	4,966
1820	291,071	59,398	11,235	5,166	315,011	39,417	7,822	8,789
1821	93,534	42,777	14,343	13,493	137,256	10,174	3,792	1,155
1822	36,823	11,781	4,074	1,648	26,996	17,357	178
1823	67,988	15,561	4,357	2,971	56,106	56,353	557
1824	121,590	44,940	13,030	11,770	55,608	5,019	5,334	11,770
1825	54,370	8,484	9,912	1,879

* * 1806. War with England, and the blockade by Sweden. On the 16th Sept. 1805, all export of Corn was prohibited.—1807, 1809. No trade on account of the prohibitions and exactions of the French.

TABLE II. Continued—No. 2.

YEAR.	LOWEST PRICES.						HIGHEST PRICES.																				
	WHEAT.		EYE.		BARLEY.		OATS.		WHEAT.		EYE.		BARLEY.		OATS.												
	s.	d.	s.	d.	s.	d.	s.	d.	s.	d.	s.	d.	s.	d.	s.	d.											
1792	22	6 to 28	6	6	13	6 to 17	3	12	0 to 13	6	8	3 to 9	0	30	2 to 39	2	22	6 to 24	0	15	0 to 18	0	9	0 to 9	9		
1793	28	6	34	8	18	0	20	3	15	0	16	6	9	9	33	2	39	11	23	3	24	9	18	0	18	9	
1794	29	3	37	8	19	6	24	9	15	9	18	0	39	11	42	11	26	8	29	1	17	3	19	6	
1795	37	8	43	1	0	0	33	7	66	4	72	4	0	0	43	3	
1796	30	2	43	1	16	2	19	6	12	9	14	3	9	9	10	6	70	10	21	0	23	3	18	0	19	6	
1797	22	6	30	2	12	9	14	3	11	3	11	8	9	0	9	9	39	11	18	9	20	3	15	6	16	6	
1798	26	3	27	8	13	6	15	9	12	0	13	6	9	0	10	6	33	2	39	2	24	0	19	6	15	0	
1799	31	8	40	8	24	0	24	9	18	9	20	3	14	3	15	0	52	9	60	4	34	8	21	0	21	9	
1800	45	3	60	4	34	8	41	5	16	6	18	0	69	4	82	11	36	2	41	5	
1801	45	3	60	4	27	0	30	2	21	9	23	3	12	6	14	3	79	1	94	1	36	11	38	10	30	2	
1802	37	8	51	3	25	6	28	6	20	8	22	6	15	0	16	6	49	3	66	4	33	11	35	5	21	9	
1803	36	2	46	1	25	2	27	0	18	9	21	0	15	0	16	6	42	11	52	9	35	1	36	2	20	8	
1804	31	8	33	11	22	6	25	6	14	3	17	3	13	6	15	0	75	4	86	7	35	5	36	7	21	0	
1805	52	9	64	1	31	4	32	5	27	0	28	6	17	3	18	5	71	7	86	7	45	5	46	0	33	2	
1806	49	0	60	4	49	0	64	1	
1807
1808
1809
1810	30	11	45	3
1811	28	6	30	2
1812
1813
1814	22	6	35	8	16	6	18	9
1815	26	3	31	8	16	2	16	11	14	3	15	0	12	0	12	9	30	2	37	8	25	6	26	3	15	9	
1816	35	2	39	1	12	1	19	6	17	2	17	7	13	8	14	7	86	0	107	6	53	9	54	3	17	2	
1817	55	2	75	3	28	1	30	1	23	1	22	1	15	0	17	0	90	3	115	4	55	2	56	2	35	1	
1818	51	11	70	7	30	2	31	2	21	11	24	11	15	7	17	8	67	6	83	0	37	5	38	5	33	4	
1819	27	0	38	7	19	3	20	3	14	6	17	4	12	6	15	5	48	2	65	8	34	7	35	7	28	11	
1820	25	6	34	10	15	7	16	6	11	11	12	10	9	2	10	1	33	11	45	10	22	0	22	11	14	8	
1821	21	9	30	8	12	8	16	3	9	0	10	10	9	0	9	11	36	3	47	9	21	9	23	8	12	8	
1822	25	7	32	10	16	0	17	10	8	8	9	7	8	8	9	7	26	6	33	10	18	3	21	0	16	0	
1823	19	1	26	9	13	2	15	0	10	4	11	3	7	8	8	6	25	6	32	10	20	0	22	9	15	11	
1824	15	8	21	3	7	10	8	9	6	5 1/2	7	5	5	6 1/2	6	5 1/2	22	0	29	6	13	10	15	8	9	3	
1825	17	2	24	9	7	2	8	7	7	3	8	1	6	2 1/2	7	2	24	0	30	4	9	6	11	5	9	0 1/2	

* * * 1810. The prices of corn were only noted till the month of July.—1811. The exports restricted by the French, and prohibited in 1812. At the end of the year 1813 the prices rose considerably on account of scarcity during the siege.

TABLE III.—An Account of the Average Prices of Corn in the Market of Berlin, on St. Martin's Day, from the Year 1792 to the Year 1824.

YEAR.	WHEAT.		RYE.		WINTER BARLEY.		SUMMER BARLEY.		OATS.	
	Quarter.	d.	Quarter.	d.	Quarter.	d.	Quarter.	d.	Quarter.	d.
1792	26	5	19	10	16	7	16	6	11	7
1793	27	1	20	0	17	3	16	6	11	0
1794	31	4	25	10	20	8	20	8	15	2
1795	39	0	23	10	23	6	23	7	17	3
1796	38	9	17	11	16	7	14	10	10	4
1797	29	8	20	4	17	3	14	6	10	8
1798	31	8	26	8	20	10	18	1	15	10
1799	39	5	26	6	24	6	21	11	15	9
1800	39	1	35	4	23	7	19	9	13	11
1801	42	4	29	8	25	10	21	9	19	9
1802	47	2	41	4	32	8	29	8	26	4
1803	56	10	27	9	27	1	23	3	14	10
1804	56	6	49	6	34	6	28	9	20	0
1805	60	1	57	6	40	8	34	10	29	1
1806	77	6	61	4	58	1	56	2	31	8
1807	49	8	27	5	31	8	26	2	22	11
1808	45	6	42	6	37	4	34	1	20	4
1809	27	9	20	4	17	10	16	10	11	0
1810	26	0	16	0	16	4	14	7	12	3
1811	38	8	26	10	20	8	17	2	13	6
1812	38	0	25	2	20	1	19	10	13	3
1813	36	8	26	5	24	6	22	1	17	3
1814	39	4	28	8	22	7	20	0	15	2
1815	38	3	25	8	19	4	20	2	13	11
1816	65	10	45	5	36	6	30	4	19	6
1817	54	7	43	1	36	10	33	8	25	7
1818	51	8	38	1	35	6	29	8	20	10
1819	34	0	24	6	22	9	21	11	17	10
1820	31	8	18	0	15	0	13	11	9	10
1821	30	8	16	2	13	4	11	4	9	6
1822	26	10	21	2	17	1	14	4	14	7
1823	26	6	14	0	12	4	11	2	8	11
1824	20	4	11	6	10	11	11	0	7	10

TABLE IV.—Reduction into English Measures and Money of the Market Prices per Quarter, of Rye and Wheat in Warsaw, from the 24th June 1796 to the 24th June 1820.

The Price of every Year being the medium of all Prices through the whole Year from Midsummer to Midsummer, for One Quarter.

YEAR.	WHEAT.		RYE.		WHEAT.
	d.	Quarter.	d.	Quarter.	
1796	11	1	11	1	d. 20
1797	11	1	12	6 $\frac{1}{2}$	9
1798	15	2 $\frac{1}{2}$	15	2 $\frac{1}{2}$	21
1799	20	1 $\frac{1}{2}$	20	1 $\frac{1}{2}$	11 $\frac{1}{2}$
1800	28	10 $\frac{1}{2}$	28	10 $\frac{1}{2}$	24
1801	19	6 $\frac{1}{2}$	19	6 $\frac{1}{2}$	32
1802	19	6 $\frac{1}{2}$	19	6 $\frac{1}{2}$	47
1803	20	1 $\frac{1}{2}$	20	1 $\frac{1}{2}$	10 $\frac{1}{2}$
1804	28	2 $\frac{1}{2}$	28	2 $\frac{1}{2}$	33
1805	40	7 $\frac{1}{2}$	40	7 $\frac{1}{2}$	9 $\frac{1}{2}$
1806	34	7 $\frac{1}{2}$	34	7 $\frac{1}{2}$	32
1807	30	8 $\frac{1}{2}$	30	8 $\frac{1}{2}$	5
1808	29	6 $\frac{1}{2}$	29	6 $\frac{1}{2}$	39
1809	13	11 $\frac{1}{2}$	13	11 $\frac{1}{2}$	49
1810	9	9 $\frac{1}{2}$	9	9 $\frac{1}{2}$	6 $\frac{1}{2}$
1811	21	11 $\frac{1}{2}$	21	11 $\frac{1}{2}$	44
1812	15	8	15	8	10 $\frac{1}{2}$
1813	13	2 $\frac{1}{2}$	13	2 $\frac{1}{2}$	49
1814	29	6 $\frac{1}{2}$	29	6 $\frac{1}{2}$	6 $\frac{1}{2}$
1815	23	2 $\frac{1}{2}$	23	2 $\frac{1}{2}$	44
1816	28	6	28	6	10 $\frac{1}{2}$
1817	27	9 $\frac{1}{2}$	27	9 $\frac{1}{2}$	32
1818	25	0 $\frac{1}{2}$	25	0 $\frac{1}{2}$	47
1819	16	1 $\frac{1}{2}$	16	1 $\frac{1}{2}$	7 $\frac{1}{2}$
1820	22	3 $\frac{1}{2}$	22	3 $\frac{1}{2}$	0 $\frac{1}{2}$
Average .	22	3 $\frac{1}{2}$	22	3 $\frac{1}{2}$	33

TABLE V.
No. 1.—An Account of the Average Prices of WHEAT, per Winchester Bushel, in the Department of the Seine, agreeably to the Reports of the Prefects, made to the Minister of the Interior.—Extracted from the French Annals of Agriculture.

Months.	1815		1816		1817		1818		1819		1820		1821		1822		1823		1824		1825		Observations.
	s.	d.	s.	d.	s.	d.	s.	d.	s.	d.	s.	d.	s.	d.	s.	d.	s.	d.	s.	d.	s.	d.	
January	4	5½					8	3½			4	3½	6	2	4	5½	4	6½	4	3	4	4½	
February	4	2½					8	3½			4	7½	6	3	4	4	4	9½	4	3	4	3	
March	3	11½					7	5½			5	0½	5	10½	4	0½	5	4½	4	3½	4	4	
April	4	-					6	7		5	1	6	4½	5	3	3	5	5½	4	5½	4	4	
May	3	10½					6	2		4	9	6	10½	5	4½	0	5	3	4	3½	4	4	
June	4	1					6	1		4	9½	7	0	5	2½	3	11½	5	2	4	2½		
July	4	6½					6	8½		6	8½	6	3	5	3	4	6	3½	4	6½	4	3½	
August	5	4½					6	5½		6	0½	6	4½	5	3½	4	6½	4	8½	4	8½		
September							6	2½		5	0½	6	8½	4	9½	4	5½	4	9	4	9		
October							5	9½		4	9½	4	11½	4	4	4	4	6½	4	6	4	4	
November							5	7½		4	7½	6	6	4	9	4	5½	4	6	4	4		
December							5	2½		4	5½	6	4½	4	6½	4	3½	4	4	4	5		

No. 2.—An Account of the Average Prices of WHEAT throughout FRANCE, per Winchester Bushel, agreeably to the Reports made by the Prefects to the Minister of the Interior.—Extracted from the French Annals of Agriculture.

Months	1815		1816		1817		1818		1819		1820		1821		1822		1823		1824		1825		Observations.
	s.	d.	s.	d.	s.	d.	s.	d.	s.	d.	s.	d.	s.	d.	s.	d.	s.	d.	s.	d.	s.	d.	
January	5	0					8	6½			4	5	5	7½	4	3½	4	8	4	8	4	5½	
February	5	0					7	2½			4	8	5	6½	4	3	4	8	4	7½	4	5	
March	4	11½					7	0½		5	8½	5	5½	5	11½	4	11½	5	3½	4	8	4	
April	4	10½					7	0		5	7	5	2½	5	3½	4	1½	5	4½	4	8	4	
May	4	10½					6	4½		5	4½	5	9	5	1½	4	0	5	2½	4	8	4	
June	5	2					6	7½		5	5	5	1	5	0½	4	0	5	1½	4	7		
July	5	6½					6	11½		5	6½	5	6½	5	1½	4	7	5	1½	4	7	4	
August	5	11½					7	0		5	0	5	5	4	6	4	10	4	5½	4	5½		
September							6	0½		4	6½	5	7½	4	7½	4	3½	4	7	4	3½	4	
October							6	5½		4	5	5	7½	4	3½	4	3½	4	7½	4	4½		
November							6	2		4	4½	5	8½	4	6	4	6	4	7½	4	4		
December							6	0		4	0	5	9½	4	4	4	7	4	4	5½	4		

The Hectolitre of Wheat weighs 154lbs. or 75,384 killogrammes. According to Kelly, the Hectolitre = 263,796 bushels Winchester measure.

TABLE VI.—An Account of the Price of WHEAT, RYE, OATS, and BARLEY, at Hamburgh, in the Months of March and September, from the Year 1817 to 1836, inclusive.

YEAR.	DATE.	WHEAT.			RYE.			OATS.			BARLEY.			BULLION PRICE.			EXCHANGE ON LONDON.				
		z.	d.	q.	z.	d.	q.	z.	d.	q.	z.	d.	q.	z.	d.	q.	z.	d.	q.		
1817	March	Mecklenburg	69	3	81	9	Mecklenburg	41	6	44	8	Holstein	22	4	23	11	1248	36	2	35	2
—	—	Low Lands	52	1	67	0	Riga	42	1	43	1	Mecklenburg	20	0	21	5	1248	34	0	34	0
1818	September	Marks	70	2	73	2	Mecklenburg	50	10	52	10	Holstein	23	0	23	4	1244	33	1	33	1
—	—	Mecklenburg	64	3	70	4	Dantzic	41	8	42	2	Mecklenburg	27	7	29	7	1244	36	4	36	4
—	—	Magdeburg	69	4	72	8	Mecklenburg	39	10	46	3	Eider	23	0	23	8	1244	38	3	38	3
1819	September	Mecklenburg	63	11	70	7	Riga	38	11	46	8	Mecklenburg	11	1	13	1	1244	35	9	35	9
—	—	Do.	51	5	53	5	Mecklenburg	28	1	29	10	Do.	12	0	12	10	1244	35	8	35	8
—	—	Magdeburg	49	1	50	9	Do.	24	7	24	10	Holstein	12	1	14	6	1244	36	10	36	10
—	—	Mecklenburg	36	1	37	6	Do.	26	2	26	2	Do.	12	1	14	6	1244	37	5	37	5
1820	September	Mecklenburg	34	9	37	10	Dantzic	0	0	29	1	Do.	7	8	9	5	1244	37	5	37	5
—	—	Do.	37	3	38	9	Mecklenburg	15	4	20	8	Do.	10	8	13	9	1244	36	2	36	2
—	—	Braunschweig	37	8	38	3	Do.	18	1	19	4	Do.	6	1	7	7	1244	36	5	36	5
—	—	Marks	37	8	38	3	Mecklenburg	12	2	13	9	Holstein	9	2	9	10	1244	37	0	37	0
1821	March	Mecklenburg	31	0	31	5	Do.	19	11	22	4	Do.	17	0	18	10	1244	37	1	37	1
—	—	Marks	18	10	34	10	Mecklenburg	12	2	13	9	Do.	6	3	8	1	1244	36	7	36	7
—	—	Holstein	19	5	32	6	Do.	12	3	13	9	Do.	7	0	8	9	1244	36	2	36	2
—	—	Marks	40	6	49	10	Do.	9	10	11	1	Do.	5	10	7	4	1244	36	9	36	9
—	—	Mecklenburg	28	11	43	7	Do.	12	4	13	0	Do.	7	9	9	0	1244	36	8	36	8
—	—	Eider	26	6	39	0	Mecklenburg	10	2	12	5	Do.	7	0	8	7	1244	36	9	36	9
1822	March	Mecklenburg	19	9	28	10	Do.	10	2	12	5	Do.	7	0	8	7	1244	36	9	36	9
—	—	Marks	24	4	33	2	Mecklenburg	12	3	13	9	Do.	6	1	7	7	1244	36	9	36	9
—	—	Mecklenburg	21	3	27	4	Do.	15	6	16	1	Do.	6	10	0	6	1244	36	9	36	9
—	—	Magdeburg	26	0	26	9	Do.	19	11	22	4	Holstein	11	5	13	1	1244	37	1	37	1
1823	September	Mecklenburg	26	4	28	1	Do.	12	3	13	9	Do.	6	3	8	1	1244	37	1	37	1
—	—	Mecklenburg	23	10	30	5	Do.	12	3	13	9	Do.	6	3	8	1	1244	36	7	36	7
—	—	Holstein	22	4	26	3	Do.	12	3	13	9	Do.	6	3	8	1	1244	36	2	36	2
—	—	Mecklenburg	25	4	26	10	Do.	12	3	13	9	Do.	6	3	8	1	1244	36	2	36	2
—	—	Mecklenburg	21	6	26	4	Do.	12	3	13	9	Do.	6	3	8	1	1244	36	2	36	2
1824	March	Holstein	19	11	31	6	Do.	12	3	13	9	Do.	6	3	8	1	1244	36	2	36	2
—	—	Do.	18	1	20	6	Do.	12	3	13	9	Do.	6	3	8	1	1244	36	2	36	2
—	—	Mecklenburg	21	1	25	7	Do.	9	10	11	1	Do.	5	10	7	4	1244	36	2	36	2
—	—	Magdeburg	30	2	31	10	Do.	9	10	11	1	Do.	5	10	7	4	1244	36	2	36	2
—	—	Anhalt	19	1	20	3	Do.	12	3	13	9	Do.	6	3	8	1	1244	36	2	36	2
—	—	Marks	18	6	21	6	Do.	12	3	13	9	Do.	6	3	8	1	1244	36	2	36	2
—	—	Mecklenburg	17	2	18	6	Do.	12	3	13	9	Do.	6	3	8	1	1244	36	2	36	2
—	—	Anhalt	23	0	25	2	Do.	12	3	13	9	Do.	6	3	8	1	1244	36	2	36	2
—	—	Mecklenburg	18	8	21	10	Do.	12	3	13	9	Do.	6	3	8	1	1244	36	2	36	2
1825	March	Magdeburg	23	8	24	7	Holstein	11	6	12	1	Do.	7	9	9	0	1244	36	2	36	2
—	—	Mecklenburg	26	2	26	10	Do.	12	4	13	0	Do.	7	9	9	0	1244	36	2	36	2
—	—	Anhalt	26	2	26	10	Do.	12	4	13	0	Do.	7	9	9	0	1244	36	2	36	2
—	—	Mecklenburg	16	6	20	8	Do.	12	4	13	0	Do.	7	9	9	0	1244	36	2	36	2
—	—	Magdeburg	31	0	31	8	Mecklenburg	10	2	12	5	Do.	7	0	8	7	1244	36	2	36	2

TABLE VII.

Returns of the Prices of Wheat, of the best quality, in the different markets of Europe and America, during the year 1825.

		Per Quarter.		
		s.	d.	
Barcelona	June	48	0	
Santander	August	47	2	
France, average	30 September	35	4	
Palermo	3	32	7	
Livorno	1	32	3	
Genoa	10	31	5	
Nizza	15	31	5	
Antwerp	21 October	30	0	
Amsterdam	23 August	28	10	New Zealand Wheat.
Ditto		32	6	Konigsberg ditto.
New York	1 July	28	9	
Rotterdam	5 September	28	7	New Zealand ditto.
Dantzic	12	27	9	Very fine.
Ditto		26	4	Fine high mixed.
Ditto		24	6	Good mixed.
Ditto		23	0	Mixed red.
Naples	30 August	25	4	
Konigsberg	29 September	24	6	
Hamburgh	6	23	3	
Riga	20 October	22	5	
Bremen	5 November	24	6	Best Brunswick.
Ditto		16	0	Lower lands.
Embden	10	21	6	
Triest	31 August	20	10	
Civita Vecchia		20	4	
Groningen	7 September	19	6	
Wismar	19	17	6	
Rostock	15	18	0	
Kiel	10 November	17	6	
Lubeck	1 September	17	7	
Warsaw	5	14	9	
Vienna	27	14	7	
Munich	10 October	24	11	
Stettin	1 August	16	6	
Berlin	25 July	17	8	
Odessa	June	17	1	
Mayence	17 November	17	0	
Archangel	13 October	16	6	
Copenhagen	31 August	14	6	
Ditto	20 September	17	0	
Cracow	31 May	12	5	

CORN-LOFT. A granary.

CORN-MASTER, n. s. From corn and master. One that cultivates corn for sale. Not in use.

I knew a nobleman in England, that had the greatest audits of any man in my time; a great grasier, a great sheep-master, a great timber-man, a great collier, a great corn-master, and a great leadman.

CORN-METER. One who superintends the measuring of corn.

CORN-MARIGOLD, n. s. From corn and marigold. A flower. See CHRYSANTHEMUM.

CORN-MILL, n. s. From corn and mill. A mill to grind corn into meal.

Save the more laborious work of beating of hemp, by making the axle-tree of the corn-mills longer than ordinary, and placing pins in it to raise large hammers. Mortimer.

CORN-PIPE, n. s. From corn and pipe. A pipe made by slitting the joint of a green stalk of corn.

Now the shrill corn-pipes, echoing loud to arms, To rank and file reduce the straggling swarms.

Tichel.

CO'RN-ROCKET, n. s. From corn and rocket. A plant. A species of bunias.

CO'RN-ROSE, n. s. A species of poppy. See PAPAVER.

CO'RN-SALLAD, n. s. From corn and sallad. See VALERIANA.

Corn-sallad is an herb, whose top-leaves are a sallad of themselves. Mortimer's Husbandry.

CORN, n. s. Lat. cornu. A hard and painful excrescence, of a horny substance, on the feet; which excrescence it is the profession of the corn-cutter to eradicate. Milton uses corny to signify stiff and hard as horn. Corneous is, horny; like horn: cornicle, a little horn; corni-

fick, horn-making: cornigerous, horn-bearing. The definition of corniculate will be seen in the quotation from Chambers. Cornage is, a tenure by which a landholder is bound to blow a horn, in order to give notice of an invasion; also a mode of transferring property.

Ladies, that have your feet
Unplagued with *corns*, we'll have a bout with you.

Shakespeare. Romeo and Juliet.

The man that makes his toe
What he his heart should make,
Shall of a *corn* cry woe,
And turn his sleep to wake.

Id. King Lear.

Even in men, aches, and hurts, and *corns*, do en-
grieve either towards rain or towards frost.

Bacon's Natural History.

Such as have *corneous* or horny eyes, as lobsters,
and crustaceous animals, are generally dimighted.

Browne.

There will be found, on either side, two black fila-
ments, or membranous strings, which extend unto the
long and shorter *cornicle*, upon protrusion. *Id.*

Nature, in other *cornigerous* animals, hath placed the
horns higher, and reclining; as in bucks. *Id.*

Up stood the *corny* reed,
Embattled in her field.

Milton's Paradise Lost.

The hardest part of the *corn* is usually in the mid-
dle, thrusting itself in like a nail; whence it has the
Latin appellation of *clavis*. *Wiseman.*

The nail was not loose, nor did seem to press into
the flesh; for there had been a *cornscutter*, who had
cleared it. *Id.*

I have known a *cornscutter*, who, with a right educa-
tion, would have been an excellent physician.

Speator.

He first that useful secret did explain,
That pricking *corns* foretold the gathering rain.

Gay's Pastorals.

It looks as there were regular accumulations and
gatherings of humours, growing perhaps in some peo-
ple as *corns*. *Arbutnot.*

Thus Lamb, renowned for cutting *corns*,
An offered fee from Radcliff *scorns*. *Swift.*

The various submarine shrubs are of a *corneous* or
ligneous constitution, consisting chiefly of a fibrous
matter. *Woodward.*

Corniculate plants are such as produce many dis-
tinct and horned pods; and *corniculate* flowers are such
hollow flowers as have on their upper part a kind of
spur, or little horn. *Chambers.*

CORNS, in surgery, consist of indurations of
the skin arising on the toes, and sometimes on
the sides of the feet, where they are much exposed
to the pressure of the shoes. By degrees they
press farther down between the muscular fibres
of these parts, and by their irritation occasion
extreme pain. Many cures have been prescribed,
but the total removal of them is always found to
be attended with great difficulty. It has been
recommended to soften them with plasters, and
then to pull them up by the roots, to apply caus-
tic, &c. A muscle laid on, by way of plaster, is
also said to be effectual; but the best cure is to
bathe them frequently in warm water, and pare
away as much as possible of the indurated skin
without drawing blood; taking care to remove
the tightness of the shoe.

CORNAGE was very frequent in the northern

countries near the Picts' wall; and the horn was
blown when any invasion of the Scots was ob-
served. By stat. 12 Car. II. all tenures are
converted into free and common socage. An
old rental calls cornage, newt-geldt, q. d. newt-
geld. Lord Coke says, in old books it is called
horngeld.

CORNARIUS (John), a celebrated German
physician, born at Zwickow, in Saxony. His
original name was Hagenbot, but he is best
known by that of Cornarius. At twenty years
of age he taught grammar, and explained the
Greek and Latin classics to his scholars; and at
twenty-three was licentiate in medicine. He
objected to most of the remedies provided by the
apothecaries; and observing that the greatest
part of the physicians taught their pupils only
what is to be found in Avicenna, Rasis, and the
other Arabian physicians, he carefully sought
for the writings of the best physicians of Greece,
and employed about fifteen years in trans-
lating them into Latin, especially the works of
Hippocrates, Aetius, Eginetes, and a part of
those of Galen. He meanwhile practised phy-
sic with reputation at Zwickow, Frankfort, Mar-
purg, Nordhausen, and gena, where he died of
an apoplexy in 1558, aged fifty-eight. He also
wrote several medicinal treatises; published
editions of many poems of the ancients on medi-
cine and botany; and translated some of the
works of the fathers, particularly those of Basil,
and a part of those of Epiphanius.

CORNARO (Helena Lucretia), a learned Ve-
netian lady, daughter of John Baptist Cornaro.
She not only acquired a complete knowledge of
the languages and sciences, but went through the
philosophy of the schools; and at last took her
degree at Padua, being the first lady that ever
was made a doctor. She made a vow of perpet-
ual virginity, and devoted her time entirely to
study. The fame of her learning attracted the
attention of Louis XIV. who ordered the cardinals
Bouillon and D'Etrees to wait on her; and
they reported that her talents had not been exag-
gerated. She died in 1683.

CORNARO (Lewis), a Venetian noble, memo-
rable for having lived in health and activity to
above 100 years of age, by a rigid course of tem-
perance. By the ill conduct of some of his rela-
tions he was deprived of the dignity of a Venetian
noble; and, seeing himself excluded from all
employments under the republic, he settled at
Padua. In his youth he was of a weak consti-
tution, and by irregular indulgence reduced him-
self, at about forty years of age, to the brink of
the grave, under a complication of disorders; at
which extremity he was told, that he had no
other chance of his life, but by becoming sober
and temperate. Being wise enough to adopt
this counsel, he reduced himself to a regimen of
which there are very few examples. He allowed
himself no more than twelve ounces of food and
fourteen ounces of liquor each day; which be-
came so habitual to him, that when he was about
seventy years of age, the experiment of adding
two ounces to each by the advice of his friends,
had nearly proved fatal to him. At eighty-three
he wrote a treatise which has been translated into
English, and often printed, entitled, Sure and

Certain Methods of Attaining a Long and Healthful Life; in which he relates his own story, and extols temperance to a degree of enthusiasm. At length the yolk of an egg became sufficient for a meal, and sometimes for two, until he died with much ease and composure, at Padua, in 1566. The Spectator, No. 195, confirms the fact from the authority of the then Venetian ambassador, who was a descendant of the Cornaro family.

CORNAVIL, an ancient people of Britain, who dwelt in the country, beginning in the heart of the island, and extending to Chester: now divided into the counties of Warwick, Worcester, Salop, Stafford, and Cheshire.

CORNEA, Lat. The horny coat of the eye.

There is a bright spot seen on the *cornea* of the eye, when we face a window, which is much attended to by portrait painters; this is the light reflected from the spherical surface of the polished *cornea*, and brought to a focus. *Darwin.*

CORNEILLE (Michael), a celebrated painter, born at Paris in 1642, and instructed by his father, who was himself a painter of great merit. Having gained a prize at the Academy, young Corneille obtained a pension from Louis XIV. and was sent to Rome, where that prince had founded a school for young artists of genius. Having studied there some time, he gave up his pension, and applied to the antique with great care. He is said to have equalled Caracci in drawing, but in coloring he was deficient. Upon his return from Rome, he was chosen professor in the Academy at Paris; and was employed by Louis in all the great works he was carrying on at Versailles and Trianon, where are still to be seen some noble efforts of his genius.

CORNEILLE (Peter), a celebrated French poet, born at Rouen in 1606. He was brought up to the bar, which he attended for some time; but, being formed with a genius too elevated for such a profession, he soon deserted it. An affair of gallantry occasioned his writing his first piece, entitled *Malite*; which had prodigious success. Encouraged by the applause of the public, he wrote the *Cid*, and other tragedies that have immortalised his name. In his dramatic works he discovers a majesty, a strength and elevation of genius, scarcely to be found in any other of the French poets; and like our immortal Shakespeare, seems more acquainted with nature, than with the rules of critics. Corneille was received into the French Academy in 1647, and died dean of that academy in 1684, aged seventy-eight. Besides his dramatic pieces, he wrote a translation in French verse, of the *Imitation of Jesus Christ*, &c. The best edition of his works is that of 1682, in four volumes 12mo.

CORNEILLE (Thomas), brother of the above, was a member of the French Academy, and of that of Inscriptions. He discovered in his youth a great inclination to poetry; and published several dramatic pieces in 5 vols. 12mo, some of which were applauded by the public, and acted with success. He also wrote, 1. A Translation of Ovid's *Metamorphoses*, and some of Ovid's *Epistles*. 2. *Remarks on Vaugelas*. 3. A Dictionary of Arts, 2 vols. folio; and 4. A Univer-

sal, Geographical, and Historical Dictionary, in 3 vols. folio.

CORNEL, *n. s. & adj.* } Old Fr. *cornille*;
CORNELIAN-TREE, *n. s.* } from Lat. *cornus*. A species of tree. See CORNUS.

The *cornel-tree* beareth the fruit commonly called the *cornel* or *cornelian cherry*, as well from the name of the tree, as the *cornelian stone*, the colour whereof it somewhat represents. The wood is very durable, and useful for wheel-work. *Mortimer.*

Take a service-tree, or a *cornelian-tree*, or an elder-tree, which we know have fruits of harsh and binding juice, and set them near a vine or fig-tree, and see whether the grapes or figs will not be the sweeter.

Bacon's Natural History.

A huntress issuing from the wood,
Reclining on her *cornel* spear she stood. *Dryden.*

On wildings and on strawberries they fed;
Cornel and bramble-berries gave the rest,
And falling acorns furnished out a feast.

Dryden's Ovid.

Mean time the goddess, in disdain, bestows
The mast and acorn, brutal food! and strows
The fruits of *cornel*, as they feast around.

Pope's Odyssey.

A mount stood near: thick *cornels* shagged its head;
And there, with tall straight shoots, a myrtle spread.

Symonds' Æsop.

Two *cornel* javelins armed with steel they bear;
And some, bright quivers o'er their shoulders wear.

Id.

CORNEL TREE, in botany. See CORNUS.

CORNELIA, daughter of Scipio Africanus, and the mother of Tiberius and Caius Gracchus. She was courted by a king, but she preferred being the wife of a Roman citizen to that of a monarch. When a Campanian lady once made a show of her jewels at Cornelia's house, and intreated her to favor her with a sight of her own, Cornelia produced her two sons, saying, 'These are the only jewels of which I can boast.'

CORNELIA LEX, *Cornelian law*, in antiquity, a name given to sixteen Roman laws: viz. 1. De civitate, enacted A. U. C. 670, by Sylla; confirming the *Sulpician law*, and requiring the citizens of the eight newly elected tribes to be divided among the thirty-five ancient tribes. 2. De judiciis, in 673, ordaining, that the prætor should always observe the same invariable method in judicial proceedings, and that the process should not depend upon will. 3. De sumptibus, limiting the expenses of funerals. 4. De religione, in 677, restoring to the college of priests the privilege of choosing the priests, which by the *Domitian law* had been lodged in the hands of the people. 5. De municipiis, revoking all the privileges which had been granted to the towns that had assisted Marius and Cinna in the civil war. 6. De magistratibus, giving the power of bearing honors, and being promoted before the legal age, to those who had followed the interest of Sylla; while the sons and partizans of his enemies, who had been proscribed, were deprived of the privilege of standing for any office of the state. 7. De magistratibus, in 673, ordaining that no person should exercise the same office within an interval of ten years, or be invested with two different magistracies in one year. 8. De magistratibus, in 673, divesting the tribunes of the privilege of

making laws, interfering, holding assemblies, and receiving appeals. All such as had been tribunes were incapable of holding any office in the state by that law. 9. De majestate, in 670, making it treason to send an army out of a province, or engage in a war without orders, to influence the soldiers to spare or ransom a captive general of the enemy, to pardon the leaders of robbers or pirates, or for the absence of a Roman citizen to a foreign court without previous leave. The punishment was aquæ et ignis interdictio. 10. Giving the power to a man accused of murder, either by poison, weapons, or false accusations, and the setting fire to buildings, to choose whether the jury that tried him should give their verdict *palam vivâ voce*, or by ballot. 11. Making it aquæ et ignis interdictio to such as were guilty of forgery, concealing and altering of wills, corruption, false accusations, and the debasing or counterfeiting of the public oath. All who were accessory to this offense were deemed as guilty as the offender. 12. De pecuniis repetundis; by which a man convicted of peculation or extortion in the provinces was condemned to suffer the aquæ et ignis interdictio. 13. A law giving power to such as were sent into the provinces with any government, of retaining their command and appointment, without a renewal of it by the senate. 14. Another ordaining that the lands of proscribed persons should be common, especially those about Volaterræ and Fesulæ in Etruria, which Sylla divided among his soldiers. All the above were enacted by Sylla. 15. A law by C. Cornelius tribune of the people, in 686; it ordains that no person should be exempted from any law according to the general custom, unless 200 senators were present in the senate; and no person thus exempted could hinder the bill of his exemption from being carried to the people for their concurrence. 16. Another by Nasica, in 582, to make war against Perseus, son of Philip king of Macedonia, if he did not give proper satisfaction to the Roman people.

CORNELIAN-STONE. See **CARNELIAN.**

The seal a sunflower; 'Elle vous suit partout,'
The motto, cut upon a white *cornelian*;
The wax was superfine, its hue vermilion.

Byron. *Don Juan.*

CORNEMUSE, or } French *cornemuse*. A
CORNAMUTE, *n. s.* } kind of rustic flute,
says Johnson; but this definition is incorrect.
Cornemuse signifies the bagpipe. Both words
are obsolete.

CORNER, *n. s.* } French *corniere*. An
CORNERED, *adj.* } angle; the point at
CORNER-STONE, *n. s.* } which a perpendicular
CORNERWISE, *adv.* } line cuts a horizontal;
a secret or remote place; the utmost limit: thus
every corner is, the whole, or every part. *Corner-stone* is the principal stone; the stone which unites the two walls at the corner. *Cornered* is, having corners. *Cornerwise* is, with the angle placed in front.

The stone which the builders refused is become the head stone of the *corner*.
Psalm cxviii. 22.

It is better to dwell in a *corner* of a house top, than with a brawling woman and in a wide house.

Proverbs xxv. 24.

I am persuaded that none of these things are hidden from him; for this thing was not done in a *corner*.
Acts xxvi. 28.

And are built upon the foundation of the apostles and prophets, Christ himself being the chief *corner-stone*.
Ephesians ii. 20.

And eke about at the *corner*
Men seinen ovir the walls stonde
Gret engins, which ywere nere bonde.

Chaucer. *Romanse of the Rose.*

All these together in one heape were throwne,
Like carcases of beastes in butchers stall;
And in another *corner* wide were strowne
The antique ruins of the Romanes fall.

Spenser. *Faerie Queene.*

Thou in dull *corners* doest thyself inclose,
Ne tasteest princes pleasure. *Id*
There's nothing I have done yet, o' my conscience,
Deserves a *corner*. *Shakespeare.* *Henry VIII.*

Might I but through my prison, once a day,
Behold this maid, all *corners* else o' the' earth
Let liberty make use of. *Id.* *Tempest.*

See you yond' coign o' the' capitol, yond *corner-stone*?
Id. *Coriolanus.*

All the inhabitants, in every *corner* of the island,
have been absolutely reduced under his immediate
subjection. *Daniel.*

A mason was fitting a *corner-stone*.

Howell's Vocal Forest.

I turned, and tried each *corner* of my bed,
To find if sleep were there; but sleep was lost.

Dryden.

Those vices, that lurk in the secret *corners* of the island,
of the soul. *Addison*

The cattle mourn in *corners*, where the fence
Screens them, and seem half petrified to sleep
In unrecumbent sadness. There they wait
Their wonted fodder; not like hungry man,
Fretful if unsupplied; but, silent, meek,
And patient of the slow-paced swain's delay. *Cowper.*

I should like to support the present minister on fair ground; but what is he? a sort of outside passenger—or, rather, a man leading the horses round a *corner*, while reins, whip, and all, are in the hands of the coachman on the box! *Sheridan.*

CORNER-TEETH OF A HORSE, are the fore-teeth between the midding teeth and the tushes; two above and two below, on each side of the jaw, which shoot when the horse is four years and a half old.

CORNET, *n. s.* } Fr. *cornet, cornette*; It.
CORNETCY, *n. s.* } *cornetto*, from Lat. *cornus*.
CORNETTER, *n. s.* } Cotgrave and Sherwood
give a full definition of the word *cornet*. 'A *cornet*, a trumpe; a little horne; also a sea-cut, or cuttle-fish; a bugle, hutchet, or little horne; also a doctor's tippet; also a *cornet* of horse; and, the ensigne of a horse companie; also a fashion of shadow, or boone grace, used in old time, and at this day, by some old women; also the tuft, or tipping, of a hawkes hood.' A *cornet* of paper is, 'the *cornet*, or coffin of paper, wherein a grocer makes up his retailed parcel of spice;' so called from its being twisted into a horn-like form. 'The shadow or boone grace' was a sort of head-dress, which appears to have entirely veiled the face; for Surrey, in the sonnet quoted below, complains that it kept the face of his mistress always 'hydden from him,' so that he lost 'the lyghte of her fayre looks.' *Cornetcy* is the com-

mission of a cornet. Cornetter is one who blows the cornet.

Israel played before the Lord on psalteries, and on timbrels, and on cornets. 2 Sam. vi. 5.

I never sawe my lady laye apart
Her cornet blacke, in colde nor yet in heate,
Sith fyrst she knewe my grieffe was grovn so great.

Surrey.

These noblemen were appointed, with some cornets of horse and bands of foot, to put themselves beyond the hill where the rebels were encamped. Bacon.

Other wind instruments require a forcible breath; as trumpets, cornets, and hunters' horns.

Bacon's Natural History.

Seventy great horses lay dead in the field, and one cornet was taken. Hayward.

So great was the rabble of trumpeters, corneters, and other musicians, that even Claudius himself might have heard them. Hakewill on Provid.

They disceam'd a body of five cornets of horse very fall, standing in very good order to receive them.

Clarendon.

Cornets and trumpets cannot reach his ear;
Under an actor's nose, he's never near.

Dryden's Juvenal.

CORNET, in the ancient military art, a musical instrument, much in the nature of a trumpet, as in the diagram. When it only sounded, the ensigns were to march alone without the soldiers; whereas, when the trumpet only sounded, the soldiers were to move without the ensigns. Cornets and buccins gave the signal for the charge and retreat; and the cornets and trumpets sounded during the battle.



CORNET, in the modern military economy, is the third officer in the company, and commands in the absence of the captain and lieutenant. He takes his title from his ensign, which is square; and is supposed to be called by that name from cornu, because placed on the wings, which form a kind of points or horns of the army. Others derive the name from cornet; alleging that it was the ancient custom for these officers to wear coronets or garlands on their heads. Cornette was likewise the term used to signify the standard peculiarly appropriated to the light cavalry. Hence, cornettes and troops were synonymous terms to express the number of light-horse attached to an army. The standard so called was made of glazed silk, eighteen inches square, upon which the arms, motto, and cypher of the general who commanded the cavalry were engraved. A scarf, of white silk, was tied to the cornette whenever the cavalry went into action, in order to render the standard conspicuous.

CORNET OF A HORSE, is the lowest part of his pastern, that runs round the coffin, and is distinguished by the hair that joins and covers the upper part of the hoof.

CORNET-STOP, on an organ, is a compound treble stop, in the use of which, each finger-key acts upon, and occasions five pipes to sound at the same time, viz. one in unison with the note proper to that finger-key, and also with the same note in the stop, called diapason; another which is tuned a true major third above it; another a fifth, another an eighth, and the uppermost a true major seventeenth above the note.

CORNHERT (Theodore), an enthusiastic secretary of the States of Holland. He wrote at the same time against the Catholics, Lutherans, and Calvinists. He maintained that every religious communion needed reformation; but, he added, that no person had a right to engage in accomplishing it, without a mission supported by miracles. He was also of opinion, that a person might be a good Christian without being a member of any visible church.

CORNICE. Fr. *corniche*; Ital. *cornice*; Span. *corniga*, *cornisa*, *κορυφή*. The highest projection of a wall or column.

The *cornice* of the Palazzo Farnese, which makes so beautiful an effect below, when viewed more nearly, will be found not to have its just measures.

Dryden's Desfrenoy.

The walls were massy brass, the *cornices* high
Blue metals crowned, in colours of the sky.

Pope's Odyssey.

But lo! from high Hymettus to the plain,
The queen of night asserts her silent reign.
No murky vapour, herald of the storm,
Hides her fair face, nor girds her glowing form;
With *cornices* glimmering as the moon-beams play,
There the white column greets her grateful ray.

Byron. The Corsair.

CORNICE RING, in gunnery, the next ring from the muzzle backwards.

CORNICULARIUS, in antiquity, an officer in the Roman army, whose business was to assist the military tribune in quality of lieutenant. The cornicularii went the rounds in lieu of the tribune, and visited the watch. The name was given them from a little horn, called corniculum, which they used in giving orders to the soldiers; though Salmasius derives it from corniculum, the crest of a head-piece; it being an observation of Pliny, that they wore iron or brass horns on their helmets; and that these were called cornicula. In the Notitia Imperii we find a kind of secretary or register of this title. His business was to attend the judge, and enter his decisions. The critics derive the word, in this sense, from corniculum, a little horn to put ink in.

CORNICULUM, in ancient geography, a town of the Sabines, east of Crustumantum, towards the Anio. It was burnt by Tarquin; but restored again after the expulsion of the kings. It is now in ruins, and called Il Monte Gebnaro.

CORNICULUM. See CORNICULARIUS.

CORNISH, a town of New Hampshire, in Cheshire county, on the east bank of the Connecticut, between Claremont and Plainfield, about fifteen miles north of Charlestown, and sixteen south of Dartmouth College. It was incorporated in 1763.

CORNU AMMONIS, in natural history, a species of fossile shells, called also serpent stones, or snake stones. They are found of all sizes,

from the breadth of a sixpence to more than two feet in diameter; some of them rounded, others greatly compressed, and lodged in different strata of stones and clay; some again are smooth, and others ridged in different manners, their striae and ridges being either straight, irregularly crooked, or undulated. See SNAKE STONE.

CORNU CERVI. See HARTSHORN.

CORNUCOPIA, *n. s.* *Latina.* The horn of plenty; a horn topped with fruits and flowers in the hands of a goddess.

In the honeysuckle the petal terminates in a long tube, like a *cornucopia*, or horn of plenty; and the honey is produced at the bottom of it. *Darwin.*

CORNUCOPIÆ, among the ancient poets, a horn out of which proceeded abundance of all things, by a particular privilege which Jupiter granted his nurse, the goat Amalthea. The fable is thus interpreted: that in Lybia there is a little territory shaped like a bullock's horn, exceedingly fertile, given by king Ammon to his daughter Amalthea, whom the poets feign to have been Jupiter's nurse. See EGIS and AMALTHEA.

CORNUCOPIÆ, in botany, a genus of the digynia order, and triandria class of plants; natural order fourth, gramina. The involucre is monophyllous, funnel-shaped, crenated, and multiflorous: CAL. bivalved: COR. one valved. Species two; natives of the East Indies and of the south of Europe.

CORNUS, cornel-tree, cornelian cherry, or dog-wood, a genus of the monogynia order, and tetrandria class of plants; natural order forty-seventh, stellate. The involucre is most frequently tetraphyllous; the petals above the receptacle of the fruit four; the fruit itself a bilocular kernel. Of this genus there are twelve species; the most remarkable are the following:

1. *C. Florida*, or Virginian dog-wood, has a tree-stem branching twelve or fifteen feet high, and fine red shoots, garnished with large heart-shaped leaves: and the branches terminated by umbellate white flowers, having a large involucre succeeded by dark red berries. Of this species there are several varieties, chiefly distinguished by the color of their berries, which are red, white, or blue.

2. *C. mas* or cornelian cherry-tree, has an upright tree-stem, rising twenty feet high, branching, and forming a large head, garnished with oblong leaves, and small umbels of yellowish-green flowers at the sides and ends of the branches, appearing early in the spring, and succeeded by small, red, cherry-like, eatable, acid, fruit.

3. *C. sanguinea*, bloody twig, or common dog-wood, has an upright tree-stem, branching ten or twelve feet high, having blood-red shoots, garnished with oblong pointed nervous leaves two inches long; and all the branches terminated by umbellate white flowers succeeded by black berries; of this there is a kind with variegated leaves. All the species may be propagated by seeds, which ought to be sown in autumn, otherwise they will lie a year on the ground. When the plants come up, they should be duly watered in dry weather, and kept clean from weeds. The following autumn they may be transplanted into

the nursery; and, having remained there two or three years, they may then be removed to the places where they are to remain. They may also be propagated by suckers, of which they produce great plenty, or by laying down the young branches.

CORNUTE, *v. a.* } *Lat. cornutus.* To be
CORNU'TED, *adj.* } stow horns; to cuckold;
CORNU'TO, *n. s.* } horned; cuckolded. A
CORNU'TOR, *n. s.* } cuckold. A cuckold-
maker.

The peaking *cornuto*, her husband, dwelling in a continual larum of jealousy.

Shakspeare. Merry Wives of Windsor.

A barber's wife in Aristonetus threatened to *cornute* him. *Burton.*

He that thinks every man is his wife's suitor,
Defiles his bed, and proves his own *cornutor*.

Jordan.

I hope he cannot say that ever I gored any of my superiors, or that my being *cornuted* has raised the price of posthorns, lanthorns, or pocket ink-horns.

L' Extrange's Quixote.

CORNUTIA, in botany, a genus [of the angiospermia order, and didynamia class of plants; natural order fortieth, personatæ; CAL. quinque-dentated; STAM. larger than the corolla: STYL. very long: the berry monospermous. There are two species, viz.

C. pyramidata, with a blue pyramidal flower, and hoary leaves, which grows plentifully in several islands in the West Indies; at Campeachy, and at La Vera Cruz. It rises to the height of ten or twelve feet, with rude branches, the leaves being placed opposite. The flowers are produced in spikes at the end of the branches, and are of a fine blue color. They usually appear in autumn, and will sometimes remain in beauty for two months or more. The plant is propagated either by seeds or cuttings, and makes a fine appearance in the stove; but is too tender to bear the open air in this country: and *C. punctata*, a shrub with axillary trichotomous corymbs, opposite, ovate, pointed slightly; serrate leaves; blue flowers, with small white dots.

CORNWALL, the most westerly county of England, and extending also farther to the south than any other part of Great Britain, is bounded by the sea on its north, west, and south sides, and on the east by the river Tamar, which separates it from Devonshire except in a few places. Its general shape resembles a cornucopia. The Bristol Channel washes it on the north, and the British Channel on the south; the Land's End being the point where these two seas appear to unite. It is situated in the diocese of Exeter, and belongs to the western circuit. Its extreme length from its north-eastern angle to the Land's End is about ninety miles; and from the Land's End to the Ram's Head seventy miles. Its greatest breadth, from Moorwinstow to the Ram's Head, is a little more than forty-three miles. It rapidly contracts, however, towards its south-western promontory; so that its medium breadth between Padstow and Fowey does not exceed eighteen miles, and in its narrowmost part, between Mount's Bay and the Heyle River, it is not more than four miles. Its circuit is estimated at 200 miles, and its extent has been found by actual

survey to contain 758,484 statute acres; a little more than 1185 square miles.

Cornwall is divided into nine hundreds, 206 parishes, and twenty-three market towns, and contains about 183 inhabitants to each square mile, or one to every three acres and a half. The climate is on the whole healthy, although as in all other peninsular situations, especially those lying to the south-west, the weather is very inconstant. The south and west with their intermediate winds, sweeping over the waves of the Atlantic, collect in the passage huge bodies of clouds, which being rent by the hills discharge their contents in torrents of rain in the interior of the county. There is an adage, founded on the frequency of rain in this county, which says, that 'Cornwall will bear a shower every day of the week, and two upon a Sunday.' The storms around the coasts are frequently very violent; the damages they occasion, however, are principally confined to vessels at sea. Fogs are of very rare occurrence in this county, the constant circulation of adverse currents of air not allowing them time to arrive at any considerable degree of condensation.

Notwithstanding this mutability in the weather, the seasons are more equal in Cornwall than in almost any other county in England. The cold in winter is generally very moderate; snow seldom lying on the ground more than a few days; and the heat of the summer is rarely intense. In the southern part of this county the temperature is so mild, that myrtles, the balm of Gilead, hydrangea, geraniums, and many other tender plants flourish in the open air. Fruit-trees are very plentiful and productive, and even the fruit of the mulberry ripens in these quarters. On the coasts, however, the hardiest trees will not thrive. The tamarisk is the only shrub which seems capable of bearing the sea spray; it sometimes grows to the height of ten or twelve feet in the course of seven years, and forms an admirable shelter. Till quite lately, every attempt to raise plantations had proved abortive; but the more tender trees being now protected by rows of the pineaster fir, they are beginning to assume a more promising appearance.

The general surface of this county is remarkably dreary.—A ridge of bleak and rugged hills rising to the height of from 1000 to 1300 feet extends through its whole length; and the roads winding over these hills, or across rude and uncultivated moors and commons, impress upon the traveller's mind an idea of the excessive sterility of the soil. Yet amidst this dreary waste, some beautifully picturesque valleys, smiling in a romantic diversity of corn, woods, coppices, orchards, meandering rivulets, and verdant meadows, burst upon the sight; while the stupendous rocks, particularly about the Lizard and the Land's End, which form the mighty barriers to the fertile plains on the one hand, and frown defiance to the chafing of the angry ocean on the other, impress the mind with the sublimest and most agreeable sensations. The soil is extremely various in Cornwall:—in the higher lands it consists of a blackish earth, intermixed with gravel, and small particles of granite (or grown as it is called by the Cornish men), and bedded in a stratum of quartz. A light loam, mixed with

slaty matter, prevails principally on the low lands and banks of rivers. Various qualities of clay are found in different places; one kind is made into bricks, which are in great request for the erection of furnaces and smelting houses; and another is much valued when formed into moulds for casting metals. The mixture of the clayey loam, with the gravel on the surface, forms a very fine and productive soil.

Agriculture being but a subordinate concern in Cornwall, and the fines paid for the long leases, to which the farmers are subject, depriving them of that capital which ought to be invested in the improvement of the soil, it is not surprising that most of their farming operations should be conducted in a rude manner. In the eastern districts more grain is raised than is sufficient for the maintenance of the inhabitants, but in the less fertile parts the produce is by no means adequate to the consumption. The crops commonly cultivated are wheat, barley, and oats; a large proportion of the arable land, however, is appropriated to the production of potatoes, for which Cornwall is very celebrated. In the neighbourhood of Penzance two crops of this valuable vegetable are produced every year. Sea-wrack, sea-weed, damaged pilchards, and the refuse salt used in curing them, mixed with lime and sea-sand, is the principal manure used in this county. Nearly 200,000 acres of the interior are unenclosed and waste lands, affording scarcely sufficient pasturage for a miserable breed of goats and sheep. The best cattle found here are of the Devonshire breed, and are much used in labor. The true Cornish breed of sheep, now nearly extinct, is one of the worst descriptions in England. Of late years many different breeds have been introduced. Few horses are kept for ostentation, or live in idleness in this county; they, with mules, being more frequently used for transporting of burdens than carts or wag-gons.

Springs are every where abundant, and, uniting into rivulets and streams, form some not inconsiderable rivers, the principal of these are the Tamar, the Lynher, the Looe, the Fowey, the Camel or Alan, and the Fale. The Tamar rises on the summit of a moor, in the parish of Warminster, the most northern in the county; and hence taking a southerly direction, it is augmented by many tributary streams; and, after winding a course of forty miles, at length empties itself into a spacious basin called the Hamoaze. The farms are, for the most part, very small, seldom letting for more than from thirty to fifty pounds per annum, even in the most fertile parts of the county. What are denominated the duchy lands, however, are very extensive; the income derived from them, and the duty on the tin ore, being the only remaining parts of those immense hereditary revenues, which were anciently appropriated as a provision for the heir apparent to the crown. This provision was in the first instance made by Edward III. for his son Edward, the Black Prince, whom he created duke of Cornwall, with special limitation to the eldest son of him and his sons, kings of England for ever. The lands are at present let off under lease granted by the duchy; the consideration being a fine paid at the grant, and a reserved

rent during the lease. They are generally purchased for three lives.

The principal wealth of Cornwall arises from its mineral productions, which have been celebrated in all periods of its history. By an accurate survey of the mines, made in 1800, it was found that there were then forty-five of copper, twenty-eight of tin, eighteen of copper and tin, two of lead, one of lead and silver, one of copper and cobalt, one of tin and cobalt, and one of antimony; and since that time, especially during the late speculating mania, great numbers more have been opened. Such is the variety of minerals in Cornwall, that indications of almost every known metal have been traced here. By far the most important ores, however, are tin and copper.

The strata in which they are found extend from the Land's End to the Dartmoor Hills, Devonshire, in a direction from east to west, and consisting of granite and a variety of the graumacke, called by the miners killas. The principal mines at present in course of working are situated in the neighbourhood and to the westward of St. Austel, from which place, as far as the Land's End, they extend along the northern coast, embracing a breadth of about seven miles. They extend also to Kemyn, Gwennap, Stithians, Wendron, and Breage on the south, and to St. Agnes, Redruth, Illogan, Cambourne, Guinear, in a straight line through Lelant, Senor and Moroas, to the parish of St. Just on the north. The metals are found in veins or fissures called lodes: many lesser veins branch from the main lode, terminating in threads. There are various criteria by which experienced miners can immediately detect the existence of a lode of metal, such, for instance, as scattered fragments of ore, called shades, the metallic taste of the springs, and the presence of particular herbs. The course of the metals being from west to east, many rich lodes have been discovered by working drifts across the country in an opposite direction, that is, from north to south. Tin is nowhere found native; it occurs sometimes collected and fixed, and at others loose and dilated. In its fixed state it is either found in an horizontal layer of earth, or interspersed in grains or small masses in the natural rock. In its dispersed form, it is found either in a pulverised state, in stones called shades, or in a continued course of shades, called a stream. These streams extend, in many parts, to a considerable length, seldom less than a fathom in breadth, and from one to ten feet in depth. One of the tin-mines, in the neighbourhood of St. Austle, produced the amazing quantity of 2500 blocks per annum. The Poldue mine has also yielded as much as 1000 blocks yearly. When the ore is raised, it is divided into as many shares, or doles, as the miners call them, as there are adventurers and lords engaged in the undertaking. It is generally beaten into small pieces on the spot, and when it will pass through the holes of an iron grate, fixed in every mine, to one end of a box, in which the lifters work, it is carried by a stream into pits, and thence into vats, where it is washed and rendered sufficiently clear for the purposes of smelting. The tin is cast into blocks, weighing from 2½ cwt. to 3½ cwt.

they are not saleable, however, until assayed by the proper officers, and stamped with the duchy seal; this operation is called coining. Since the reign of Henry VIII. coinages have been held four times every year, namely, at Lady-Day, Midsummer, Michaelmas, and Christmas. The original towns for this purpose were, Launceston, Lestwithiel, Truro, and Helston. Charles II. added Penzance to the number, as affording greater facilities to the miners of the western districts.

The duke of Cornwall receives 4s. for every cwt. of white tin that is coined; and it is calculated, that the present average of the tin-mines amounts, annually, to 25,000 blocks, each block worth from £8 to £10: so that, according to this calculation, the income of the duchy of Cornwall, arising from the tin-mines alone, is not less than £10,000. The mining business is entirely regulated by a code, called the stannary laws, enacted by a court of stannators, or proprietors. These acts divide the tin-men into four divisions, under the superintendence of one warden: they have an appeal, however, from his decisions, in all suits of law and equity, to the duke of Cornwall in council; or in case this title should be in abeyance, to the crown. A vice-warden is appointed every month, whose office is to decide all stannary disputes; he also constitutes a steward for each precinct, who holds his court, called a stannary court (from the Latin word *stannum*, tin), every three weeks, when a jury, composed of six persons, decide disputes with a progressive appeal, however, to the vice-warden, lord-warden, and lords of the duke of Cornwall's council. The mines are under no other jurisdiction, excepting in such cases as affect land or life.

The copper-mines of Cornwall are very numerous, producing, on the average, 4700 tons annually, which, on a moderate calculation, are worth £350,000. The most productive copper-mines now working are Crennis and Huel Alfred, the former near St. Austle, and the other in the parish of Hayle. Veins of copper are not unfrequently found in cliffs, that are left bare by the sea, and sometimes in the fissures of rocks, in thin films, deposited by the impregnated water, running from the lodes of the copper ore. The most encouraging sign of a rich ore is the gossan, an earthy ochreous stone, of a red color, which crumbles like the rust of iron. The lodes of copper ore generally lie deeper than those of tin, and are chiefly of the pyritous and sulphureted kinds, with a small proportion of arsenic. The process of refining it is the same as that employed for the tin; when sufficiently refined, the scoria is removed, and it is emptied with ladles, coated with clay, into oblong moulds, containing about 150 pounds weight.

There are also a few lead-mines in this county; the kind of ore most frequently found is denominated galena, or pure sulphuret of lead, which is met with both in crystallisations, and in masses of a bluish-gray color, and foliated texture. The principal lead-mines are, Huel Pool and Huel Rose, in the neighbourhood of Helston. Gold has been found in Cornwall, but in such small quantities as not to warrant any expensive operations to procure it. The miners

are in the habit of carrying a quill about their person, in which they put the particles which are frequently found among the stream tin, and when full, sell it to the goldsmiths. The largest quantity ever found together, weighed fifteen penny-weights and sixteen grains. Silver is found in larger quantities, and the mine of Huel Mexico and the Herland copper-mine produced considerable returns of this metal. A particular account of this latter mine is published in the Transactions of the Royal Society for 1801. It is said, that this metal was found in such abundance, during the reigns of Edward I. and III., as to furnish the means for these monarchs to undertake their warlike enterprises.

Iron-mines are also common in Cornwall. Sulphuret of iron, called by miners mundic, of the different colors of green, blue, purple, gold, silver, and copper, are often blended with the copper and tin lodes. Great abundance of the semi-metals, bismuth, zinc, antimony, cobalt, molfram, menachanite, arsenic, manganese, molybdena, or the sulphuret of molybdenum, are also found here. The number of men, women, and children employed in the different processes of mining, and deriving their sole subsistence therefrom, has been estimated at 14,000.

Besides the metals enumerated, the county of Cornwall abounds in fossil substances of great value. Amongst these, the moor-stone, or granite, is of the first consequence. Slate and snap-rock, swimming-stone, Cornish diamonds, and China-stone may also be mentioned. This last-mentioned stone is the principal ingredient in the Staffordshire pottery. The Cornish diamonds are supposed to be the finest in England, consisting of beautifully crystallised and transparent quartz, in six-sided pyramids.

The fish which frequent the Cornish coast, are the pilchard, the blomer, or fin-fish (the physeta of the ancients), the grampus, the blue shark, the monk, or angel-fish, the sea adder, the sun-fish, &c. &c.; but of all these the most abundant and valuable is the pilchard. In size and form this fish very much resembles the common herring; immense shoals of them appear during the summer and autumn months, generally making their appearance at the Land's End in July. The number of persons employed in the pilchard fisheries, and in the different processes of salting the fish, &c., is about 5000, and the capital invested in the trade at least £300,000. From 40,000 to 60,000 hogsheads of these fish are caught in a season. Each hogshead, on the average, contains 3000 fish, and forty-eight hogsheads are computed to produce a ton of 252 gallons of oil, the price of which, some few years ago, was from £24 to £27. The principal fisheries on the southern coast are Mount's Bay, thence eastward to Devonshire; and on the northern, at St. Ives's. Besides the fish already mentioned, mackarel are caught in great plenty; also, the red mullet, and John Dories. Conger eels, of a most extraordinary size, weighing from sixty to 120 pounds are frequently caught; and oysters are in great abundances.

Cornwall can boast of but few manufactories, if we except those connected with the preparation of metals. There is a cloth manufactory at

Callington, a manufactory of crucibles at Calenio; at Truro a carpet-manufactory; at Penryn extensive paper-mills, and breweries that supply Falmouth; at Hayle there are extensive works for making copper spikes and nails for ship-building; and at Launceston, St. Austle, Bodmin, &c. coarse woollen-cloths are made. The chief exports of Cornwall are tin, copper, moor-stone, China-stone, fish, cattle, pigs, and potatoes. The chief trading ports are Padstow, Boscastle, Portrieth, the river Hayle, St. Ives's, Falmouth, Penzance, Fowey, Looe, and Truro.

The ancient Roman name of this part of Britain is Cornubia, the inhabitants were called Cornubii, both names probably originating in the circumstance of the land terminating in a point or promontory. Cornwall abounds in antiquities supposed to be Druidical, the most remarkable of which are, cairns, circles, and cromlechs. The celebrated loggan-stones consist of immense blocks of granite, one of them upwards of ninety tons in weight, so critically poised on the top of high rocks, that the slightest force is sufficient to stir them. Cornwall returns no less than forty-four members to the house of commons. It possesses more boroughs than any county in England: many of them, however, are places of little consideration, as it respects wealth and population; the number of voters scarcely ever exceeding fifty. The assizes are held at Launceston and Bodmin alternately. The population, in 1821, amounted to 262,600 souls.

CORNWALL, a township of the United States, in Addison county, Vermont, on Lake Champlain. Population 1000. Also, a township of the United States, in Orange county, New York; and the name of another township in Connecticut.

CORNWALL, CAPE, a cape on the west coast of Cornwall, at the extremity of England. Long. 5° 55' W., lat. 50° 10' N.

CORNWALL, CAPE, the south-west point of land on the north-west of the passage of Endeavour Straits, New Holland. Long. 141° E., lat. 10° 43' S.

CORNWALL, CAPE, a cape on the south-west side of an island near the north coast of New Holland. Long. 219° W., lat. 10° 43' S.

CORNWALL, NEW, a country in the western part of North America, bordering on the Pacific, and situated N. N. W. of New Hanover. It extends from Gardner's canal, lat. 53° 15' to Frederick's Sound, 57° 5' N. On this coast are the Prince of Wales's Archipelago, Queen Charlotte's Islands, Pitt's Archipelago, Duke of York's Island, Island of Revilla Gigedo, and various other smaller ones.

CORNWALLIS (Charles), marquis of, the eldest son of Charles, first earl of Cornwallis, was born in 1738, and received his education at Eton and St. John's College, Cambridge. In 1765 he was appointed aid-de-camp to the king, and colonel of foot. After passing through various promotions, he obtained, in 1793, the rank of general, and represented the borough of Eye, in parliament. In 1762 he succeeded to the peerage, but did not distinguish himself in parliament. He accepted, in 1776, a command in America, and distinguished himself at the

battle of Brandywine the following year, and at the siege of Charlestown. Being made, soon after, governor of South Carolina, he obtained the victories of Camden and Guilford, and formed a plan of invading Virginia, in which he failed, and was made prisoner, with his whole army. Pamphlets were published, on this occasion, in which lord Cornwallis blamed Sir Henry Clinton for not coming up to his aid in time; but, soon after his return to England, he was removed from his place of governor of the Tower. He was re-appointed, however, in 1784. In 1786 lord Cornwallis was sent out to India with the appointment of commander-in-chief and governor-general; and, not long after, the government of Bengal found it necessary to declare war against the sultan of the Mysore, for an attack upon the rajah of Travancore, the ally of the English. The first campaign was indecisive. In March, 1791, his lordship invaded Mysore, and in the year after besieged Seringapatam, and obliged Tippoo Saib to sue for peace; to give up part of his dominions; to pay a large sum of money, with a promise of a more considerable portion of treasure; and as hostages for the performance of this treaty, to entrust two of his sons to the care of the British. On the conclusion of the peace, lord Cornwallis returned to England, and was created a marquis, appointed master-general of the ordnance, and admitted a member of the privy-council. In 1798 he was appointed lord-lieutenant of Ireland, which office he filled until 1801, conducting himself with great firmness, judgment, and conciliation. In the same year he was sent to France, and signed the peace of Amiens. In 1804, on the recall of marquis Wellesley, lord Cornwallis was again appointed governor-general of India, and died the following year at Ghazepore, in the province of Benares. Lord Cornwallis, as a military man, was active, vigilant, and persevering; his personal character was amiable and unassuming; and, if his talents were not brilliant, his good sense, aided by a just ambition, effected much. He married Jemima, the daughter of James Jones, Esq. by whom he had one son, Charles, the late marquis, who has since died without issue.

CORO, a sea-port of the province and government of Venezuela, South America, situated in a dry sandy plain. The inhabitants, who amount to 10,000, carry on some commerce in mules, hides, goats, sheep-skins, &c., which are shipped at the port. The town has no aqueducts, and little water. That used by the inhabitants is brought to them and sold in barrels, on the backs of asses. The seat of government, civil and ecclesiastical, has been removed hence on account of its unfavorable situation. It is a league distant from the sea, and 240 miles west of Caraccas.

COROLLARY, *n. s.* Fr. *corollaire*; Lat. *corollarium*, from *corolla*; *finis coronat opus*. A conclusion from premises; something which follows in addition to the proposition demonstrated; formerly surplus, something more than was absolutely necessary.

Now since we have considered the malignity of this sin of detraction, it is but a natural *corollary*, that we enforce our vigilance against it.

Government of the Tongue.

Bring a *corollary*

Rather than want. *Shakespeare. Tempest.*

As a *corollary* to this preface, in which I have done justice to others, I owe somewhat to myself.

Dryden's Fables. Preface.

COROMANDEL, or **CHOLAMANDA**, is a line of coast extending along the east side of the bay of Bengal, from the Point Calymere to the mouths of the Krishna River, or about 350 miles. Its proper name is Chola Mandala, which signifies, in the Sanscrit language, the orbit or circle; though, probably, it received its name from the Chala dynasty, the ancient sovereigns of Tanjore. It is written Choramandel in the records of Madras, up to the year 1779. The coast of Coromandel is, for the most part, open roadstead; and, although it contains a number of flourishing towns, it does not possess a single harbour. Considerable difficulty is experienced in landing, on account of the surf, except in the bay of Coringa, and in those places where proper boats are provided. During the period the northerly wind, or monsoon, prevails here, a southerly wind reigns on the coast of Malabar, and vice versa. The northerly winds blow on this coast from about the middle of October till April, and such is their violence during the first months, that it is dangerous for any ships to be near the coast; the government's and company's are consequently ordered to quit it by the 15th of October. This period is called the great monsoon. The southerly winds set in about the middle of April, and continue till October; during these months Coromandel may be approached with perfect safety. Parching hot winds prevail in the course of these latter months, which wither up every trace of vegetation, and even check respiration; but when the rains fall, the plants revive, and the whole face of nature is restored to a beautiful verdure. It is an observation of the natives, which has been confirmed by the experience of many Europeans, that the longer these hot land winds blow, the more healthy are the following months, as they serve to purify the air.

Coromandel being situated within the tropics, has two rainy seasons; the first when the sun passes it in going to the north, and the other on the sun's return to the south. The climate, notwithstanding its fluctuations of temperature, is considered, on the whole, healthy, at least to those who do not expose themselves too much to the influence of the sun, or sleep in the dew.

CORON, a strong sea-port of the Mores, in the province of Belvedere, situated on a peninsula in the gulf to which it gives name. It was anciently called the gulf of Messene, and has a secure harbour, and some trade in corn and oil. In the middle of the peninsula is a high rock, which commands the fortifications; and on the opposite side stands a small suburb. It is the see of a Greek archbishop: sixteen miles south of Modon, forty south-west of Misitra, and eighty S.S.W. of Corinth.

CORONA, *n. s.* Latin. A large flat member of the cornice, so called because it crowns the entablature and the whole order. It is called by workmen the drip.

In a cornice the gola or cymatium of the *corona*, the coping, the modillions or dentelli, make a noble show by their graceful projections. *Spectator*

CORONA, in anatomy, denotes that edge of the glans penis where the preputium begins.

CORONA, in architecture. See **ARCHITECTURE**.

CORONA, in botany, a name given by some to the circumference or margin of a radiated compound flower. It corresponds to the radius of Linnæus; and is exemplified in the flat, tongue-shaped petals, which occupy the margin of the daisy and sun-flower.

CORONA, in antiquity, a crown of which there were several kinds, as *corona civica*, *muralis*, &c. See their respective articles.

CORONA, in natural history and optics, a luminous circle surrounding the sun, moon, planets, or stars. See **ANTHELION**, **HALO**, and **PARHELION**.

CORONA IMPERIALIS, in conchology, a name given by some to a species of voluta, differing from the other shells of that family, by having its head ornamented with a number of points, forming a sort of crown. See **VOLUTA**.

CORONA MONTE, an important place of Austria, in Tirol, to which the French retreated on the 24th February 1757, after being repulsed from Saluzo by the Austrians, who soon after dislodged them also from this place.

CORONÆ, in ancient geography, the name of two towns: 1. In Bœotia near mount Helicon, famous for the defeat of the Athenians and Bœotians by Agesilaus: 2. In Thessaly, having Narthacium on the east, and Lania, near the Sperchius, on the north.

CORONAL, *n. & adj.* } Fr. and Sp. *coro-*
CORONALLY, *adv.* } *nal*; Lat. *corona*. A
CORONARY, *adj.* } coronal is a crown.
CORONATION, *n. s.* } a garland. As an
CORONET, *n. s.* } adjective, it means

relating to the top of the head. Coronally is circularly; in a crown-like manner. Coronary signifies, relating to a wreath or crown; placed on the head like a crown; it is also applied to arteries, which are fancied to encompass the heart like a garland. See **ANATOMY**. Coronation is the act of crowning a king; the assembly present at that act; likewise the name given by some of our old writers to a species of flower, but the modern appellation of which I am unable to ascertain. Coronet is an inferior kind of crown, worn by peers; poetically, any ornamental head-dress. See **HERALDRY**.

And all should be within a terme,
 Without more excusation,
 Both feste and coronation. *Chaucer's Dream.*

And crowne your heades with heavenly coronall,
 Such as the angels wear before God's tribunall.
Id. Faerie Queene.

And on his hed like to a coronet
 He wore, what seemed strange to common view
Id.

Bring coronations, and sops in wine,
 Wern of paramours.
Spenser. Shepherd's Calendar.

Fortune smiling at her work therein, that a scaffold
 of execution should grow a scaffold of coronation.
Sidney.

The rest was drawn into a coronet of gold, richly set
 with pearl.
Id.

Willingly I came to Denmark,
 To shew my duty in your coronation.
Shakespeare. Hamlet.

A cough, Sir, which I caught with ringing in the
 king's affairs upon his coronation day. *Id. Henry IV.*

In his livery
 Walked crowns and coronets; realms and islands
 were
 As plates dropt from his pocket.

Id. Antony and Cleopatra.
 All the rest are countesses
 — Their coronets say so.
Id. Henry VIII.

The pomp of coronation
 Hath not such power my fame to spread,
 As this my admiration. *Davies.*

Under a coronet his flowing hair,
 In curls, on either cheek played.
Milton. Paradise Lost.

The basilisk of older times was a proper kind of
 serpent, not above three palms long, as some account;
 and differed from other serpents by advancing his
 head, and by some white marks, or coronary spots,
 upon the crown. *Brown.*

Now empress fame had published the renown
 Of Shadwell's coronation through the town.

Dryden's Macfl.
 Nor could our nobles hope their bold attempt,
 Who ruined crowns, would coronets exempt.

Dryden.
 A man of about forty-five years of age came to me,
 with a round tubercle between the sagittal and coro-
 nal suture. *Wiseman.*

Peers and dukes, and all their sweeping train,
 And garters, stars, and coronets appear. *Pope.*

In pensive thought recal the fancied scene,
 See coronations rise on ev'ry green. *Id.*

The substance of the heart itself is most certainly
 made and nourished by the blood, which is conveyed
 to it by the coronary arteries. *Bentley's Sermons.*

If there is an evil in this world, 'tis sorrow and
 heaviness of heart. The loss of goods—of health—
 of coronets and mitres, are only evil, as they occasion
 sorrow;—take that out—the rest is fancy, and dwell-
 leth only in the head of man. *Sterne.*

We boast some rich ones, whom the gospel sways,
 And one who wears a coronet and prays;
 Like gleanings of an olive-tree they show,
 Here and there one upon the topmost bough. *Cowper.*

The flesh (of the sturgeon) was so valued at the time
 of the emperor Severus, that it was brought to table
 by servants with coronets on their heads, and preceded
 by music. *Darwin.*

Courtiers for coronets their conscience pawn;
 Clerks in prunello crawl, then soar in lawn.
Huddesford.

Thick leaves shall form our coronal, like Spring's,
 And round our necks shall glance the Hooni strings.
Byron. The Island.

CORONALE Os, the os frontis. See **ANA-**
TOMY.

CORONARY ARTERIES. See **ANATOMY**.
CORONARY STOMACHIC, a vein inserted into
 the trunk of the splenic vein, which, by uniting
 with the mesenteric, forms the vena porta.

CORONARY VEIN, a vein diffused over the
 exterior surface of the heart.

CORONATION CEREMONIES, speaking histori-
 cally, seem to appertain to monarchical govern-
 ment, in every form of it, and abound with
 political, feudal, and national peculiarities, that

throw considerable light on history. Our French neighbours have their Historical Treatises on the subject by M. Merlin and others: and we have often pored over the splendid folio of Mr. Sandford, describing, with great exactitude, the coronation of James II. We cannot here enter very minutely into the subject; but the coronation of our monarchs presents too wide a field of meditation to an intelligent age to be wholly overlooked.

A brief account of the entire *regalia*, royal vestments, and principal *offices* of the splendid scene, is what we shall endeavour to furnish to the reader.

SECT. I.—OF THE REGALIA AND ROYAL VESTMENTS.

1. *The Regal Chair*.—The regalia of England are the symbols of a monarchical authority that has been transmitted by coronation ceremonies for upwards of ten centuries. But the incorporation of England, Scotland, and Ireland, into one united kingdom, was an event peculiar to the coronation of George IV. to have recognised.

The history of the Fatal Stone, called also by the Irish the Stone of Fortune, is very curious; and has induced the learned Toland to call it 'the ancientest respected monument in the world.' It is to be traced, on the best authorities, into Ireland; whence it had been brought into Scotland, and had become of great notoriety in Argyleshire, some time before the reign of Kenneth, or A. D. 834. This monarch found it at Dunstaffnage, a royal castle; enclosed it in a wooden chair, and removed it to the abbey of Scone, where for 450 years 'all kings of Scotland war crownit' upon it; or quhil y^e tyme of Robert Bruce. In quhais tyme, besyde mony othir crueltis done be kyng Edward Lang Schankis, the said chair of merbyll wes taikin be Inglismen, and brocht out of Scone to London, and put into Westmonistar, quhaer it remains to our dayis.'

An ancient Irish prophecy, quoted by Mr. Taylor in his learned 'Glory of Regality,' assures us, that the possession of this stone is essential to the preservation of regal power. It runs literally, 'The race of Scots of the true blood; if this prophecy be not false, unless they possess the Stone of Fate, shall fail to obtain regal power.' King Kenneth caused the leonine verses following to be engraved on the chair:—

Ni fallat fatum
Scoti quocunque locatum
Invenient lapidem
Regnare tenentur ibidem.

Thus given by Camden,
Or Fate is blind,
Or Scots shall find,
Where'er this stone
A royal throne.

A prophecy which is said to have reconciled many a true Scot to the Union in queen Anne's time; and which, since the extinction of the Stuart family, is remarkably fulfilled in the claims of the house of Brunswick,—George IV. being now the legitimate heir of both lines

Among the northern nations, the practice 'was to form a circle of large stones, commonly twelve in number, in the middle of which one was set

up, much larger than the rest: this was the royal seat; and the nobles occupied those surrounding it, which served also as a barrier to keep off the people who stood without. Here the leading men of the kingdom delivered their suffrages, and placed the elected king on his seat of dignity.' From such places, afterwards, justice was frequently dispensed.

The old man early rose, walked forth, and sate
On polished stone, before his palace gate;
With unguent smooth the lucid marble shone,
Where ancient Neleus sate, a rustic throne.'

Homer's Odyssey. Pope's Tr. l. 496—10

Thus arises the name of our court of king's bench.

At the coronation of our kings, the royal chair is now disguised in cloth of gold: but the woodwork, which forms its principal parts, is supposed to be the same in which Edward I. recased it, on bringing it to England.

2. *Of the Crowns*.—We can only speak to the growth and antiquity of their present 'fashion,' none of those now used being of older date than the reign of Charles II. This monarch issued a commission for the 'remaking such royal ornaments and regalia' as the rebellious parliament of his father had destroyed, in which 'the old names and fashions' were directed to be carefully sought after and retained. Upon this authority, we still have the national crown with which our monarchs are actually invested, called St. Edward's, although the great seal of the Confessor exhibits him wearing a crown of a very different shape.

Whether the parent of our present crowns was the eastern fillet, in the tying on of which there was great ceremony, according to Selden,—the Roman or Grecian wreath, a 'corruptible crown' of laurel, olive, or bay,—or the Jewish diadem of gold,—we shall leave to antiquarian research.

'This high imperial type of [England's] glory'

has slowly advanced, like the monarchy itself, to its present commanding size and brilliant appearance. From the coins and seals of the respective periods, several of our Anglo-Saxon princes appear to have worn only a fillet of pearl, and others a radiated diadem, with a crescent in front. Æthelstan's crown was of a more regular shape, resembling a modern earl's coronet. On king Alfred's there was the singular addition of 'two little bells;' and the identical crown worn by this prince seems to have been long preserved at Westminster, if it was not the same which is described in the Parliamentary Inventory of 1642, as 'king Alfred's crowne of gould wyer worke, sett with slight stones.' Sir Henry Spelman thinks, there is some reason to conjecture that 'the king fell upon the composing of an imperial crown;?' but what could he mean by this accompaniment?

Gradually the crown grew from ear to ear, and then from the back to the forehead; sometimes it is represented as encircling a cap or helm, and sometimes without. William the Conqueror and his successor wore it on a cap adorned with points, and with 'labels hanging at each ear;' the Plantagenets, a diadem orna-

mented with fleurs-de-lis or strawberry leaves; between which were small globes raised, or points rather lower than the leaves; Richard III. or Henry VII. introduced the crosses; about the same time (on the coins of Henry VII.) the arches first appear; and the subsequent varieties of shape are in the elevation or depression of the arches. The maiden queen wore them remarkably high. Blood's exploit with the new crown of Charles II. is told to all the young visitors at the Tower. It is only wonderful that, in that age of plots, no political object or accusation was connected with it.

3. *The Sceptre* is a more ancient symbol of royalty than the crown. Homer speaks of 'sceptred kings'—*σκηπτροῦχοι βασιλῆες*; and the book of Genesis, 'of far elder memory,' of a sceptre, as denoting a king or supreme governor. There is a very early form of delivering this ensign of authority preserved in the Saxon coronation services; and the coins and seals of succeeding reigns usually place it in the hand of our monarchs. Very anciently, too, our kings received at their coronations a sceptre for the right hand, surmounted by a cross; and for the left, sometimes called the verge, one that terminated in a globe, surmounted by a dove. The two great symbols of the Christian religion are thus professedly embraced; but the monarch never appears with two sceptres except on this occasion.

4. *The Ampulla, or Golden Eagle*, and the 'holy oil' which is poured from it, are connected, like the royal chair, with some of the miracles that no one now believes, and with some interesting historical facts.

Amongst the honors bestowed by the Virgin on St. Thomas à Becket (according to a MS. in the Cotton Library), he received from our Lady's own hands, at Sens, in France, a golden eagle, and a small phial of stone or glass, containing an unction, on whose virtues she largely expatiated. Being then in banishment, he was directed to give them in charge to a monk of Poitiers, who hid them in St. Gregory's church at that place, where they were discovered in the reign of Edward III., with a written account of the vision; and, being delivered to the Black Prince, were deposited safely in the Tower. Henry IV. is said to be the first prince anointed with these vessels.

'Holy oil' still retains its use, if not its virtue, in our coronations. The king was formerly anointed on the head, the bowings of the arms, on both shoulders, and between the shoulders, on the breast, and on the hands; but the ceremonials of the last two coronations only prescribe the anointing of the head, breast, and hands. In these, too, nothing is said of the 'consecration' of the oil, which seems anciently to have been performed on the morning of the coronation.

With the spread of Christianity, or rather of the papal domination, over the kingdoms of western Europe, came the adoption of this rite into the coronation ceremonies of its princes. It at once increased the influence of the church, and surrounded the monarch with a popular veneration. The three distinct anointings yet retained, (i. e. on the head, breast, and hands or

arms,) were said by Becket to indicate glory, holiness, and fortitude: another prelate, one of the greatest scholars of his age, assured our Henry III., that as all former sins were washed away in baptism, 'so also by this unction.' Richard II. is made to say, by Shakspeare, on the invasion of Bolingbroke,

Not all the water in the rough rude sea
Can wash the balm from an anointed king.

Sir Walter Scott, in his notes to *Marmion*, speaks of a singular ancient consecration of the kings at arms in Scotland, who seem to have had a regular coronation down to the middle of the sixteenth century,—only that they were anointed with wine instead of oil.

5. *The Royal Swords* are named, *Curtana*, or the *Sword of Mercy*; the *Sword of Justice* to the Spirituality; the *Sword of Justice* to the Temporality; and the *Sword of State*. Of these the last alone is actually used in the coronation, being that with which the king is girded after his anointing; the rest are only carried before him by certain great officers. But *Curtana* has been honored with a proper name since the reign of Henry III., at whose coronation it was carried by the earl of Chester. It is a flat sword, without a point; looking to which circumstance, and to its being also entitled the *Sword of Mercy*, some etymologists have traced it to the Latin *curto*, to cut short; while other writers, among whom is the learned Mr. Taylor, would transfer our researches to the scenes of ancient chivalry, and the exploits of Oger the Dane, or Orlando, as affording the title to this appendage of the monarchy. 'The sword of Tristan,' says this writer, 'is found (ubi lapsus!) among the regalia of king John; and that of Charlemagne, Joyeuse, was preserved to grace the coronation of the kings of France. The adoption of these titles was, indeed, perfectly consonant with the taste and feeling of those ages, in which the geste of chivalry were the favorite theme of oral and historical celebration; and when the names of Durlindana, of Curtein, or Escalibere, would nerve the warrior's arm with a new and nobler energy.'

The *Sword of Justice* to the Spirituality is obtuse, that of *Justice* to the Temporality sharp at the point. 'Henry VIII.' says a writer in a respectable periodical publication for July, 'seems to have exercised his taste in endeavouring to abolish this discrepancy.'

6. *Of the Ring, Spurs, and Orb; and St. Edward's Staff*.—In the book of Genesis we read of Pharaoh's ring being given by him to Joseph, as a method of investing him with power; and thus the Persian monarch Ahasuerus transferred his authority to Haman and to Mordecai. What is added in the Scripture narration of one of these latter cases; (*Esther*, iii. 10. and viii. 2.) will illustrate the significance of this mode of investiture.

By the exact mode that we have quoted from Scripture, do we find Offa, king of the East Angles, appointing Edmund as his successor; and with the ring, it is noticed, with which he had been invested at his own promotion to the royal dignity. On the detention of James II. by the fishermen of Sheerness, in his first attempt

at escape from this country, in 1688, it is particularly noticed in his Memoirs, 'The king kept the diamond bodkin which he had of the queen's, and the coronation ring, which for more security he put into his drawers.'

This is said to have been originally a favorite ring of the beautiful but unfortunate Mary queen of Scots; to have been sent by her, at her death, to James I.; through whom it came into the possession of our Charles I., and on his execution, was transmitted by bishop Juxon to his son. It lately came into the possession of his present Majesty, through the channels by which he has obtained all the remaining papers of the house of Stuart.

Richard II. resigned the crown to Henry IV. by transferring to him his ring. A paper was put into Richard's hands, from which he read an acknowledgment of being incapable of the royal office, and worthy, from his past conduct, to be deposed; that he freely absolved his subjects from their allegiance, and swore by the holy Gospels never to act in opposition to this surrender: adding, that if it were left wholly to him to name the future monarch, it should be Henry of Lancaster, to whom he then gave his ring.

The *Spurs* are a very ancient emblem of knighthood; in later coronations, the abundance of ceremonies has only allowed time for the king's heel to be touched with them. At the battle of Crecy, when Edward III. was requested to send reinforcements to his son, his reply was: 'No; tell Warwick he shall have no assistance. Let the boy win his spurs.'

The *Orb*, or *Mound* (Fr. monde), is an emblem of sovereignty, said to be derived from imperial Rome; and to have been first adorned with the cross by Constantine, on his conversion to Christianity. It first appears among the royal insignia of England on the coins of Edward the Confessor; but Mr. Strutt authenticates a picture of Edgar, 'made in the year 996,' which represents that prince kneeling between two saints, who bear severally his sceptre and a globe surmounted by a cross. This part of the regalia being indicative of supreme political power, has never been placed in the hands of any but kings or queens regnant. In the anomalous case of the coronation of William and Mary as joint sovereigns—the 'other world,' that Alexander wept for, was created; and the spare orb is still to be seen among the royal jewels of England!

The only remaining member of the regalia now in use is *St. Edward's Staff*; but whether so called from any of the pilgrimages of the Confessor—from its being designed to remind our monarchs of their being but pilgrims on earth—or simply from its being offered with the other regalia at that monarch's shrine, on the coronation of our kings, we have not the means of determining. All the regalia are supposed, indeed, to be in the custody of the dean, as the successor of the abbot of Westminster, at the period of each coronation.

7. *The Royal Vestments*, of England, are amongst the most gorgeous 'makings of a king' known to history. In the robes ordinarily designed to be worn in parliament; and consisting of a surcoat of the richest crimson velvet, and a mantle and hood of the same, furred with ermine,

and bordered with gold lace, the king first makes his appearance on the coronation day, (on which he wears a cap of state, of the same materials, and at this time only). These are, therefore, called his *Parliament Robes*, in distinction from the *Robes of Estate*, for which he exchanges them in the abbey, at the close of the coronation, and which only differ from the former in being made of purple velvet.

These sumptuous external robes are of course laid aside during the anointing, and other parts of the coronation service.

The *Armill*, or *Stole*, is the only ecclesiastical symbol now retained in the investiture of our kings. In 'MS. W. Y. in the College of Arms,' quoted by Mr. Taylor, Henry VI. is said to have been 'arrayed at the time of his coronation as a bishop that should sing mass, with a dalmatic like a tunic, and a stole about his neck. (Glory of Regality, p. 81). This writer insists that the conductors of our English coronations since Henry VII's time (at the least) have very singularly mistaken the stole for the armil of more ancient times, and transferred to the latter the form of delivery originally designed for 'a bracelet or royal ornament of the wrist.' It is singular that the form in question should appear, as it certainly does, to suit either symbol. 'Receive this armil as a token of the divine mercy embracing thee on every side.' The ornament at present in use embraces the neck.

SECT. II.—OF THE ASSISTANT OFFICES.

1. *Of the Prelate who crowns the King*.—As early as the Norman Conquest, this privilege of the see of Canterbury is spoken of as well established; and but two subsequent instances occur of its being overlooked or denied: both remarkably associated with the history of the papal power in this country. In the first, that of the coronation by the archbishop of York of prince Henry, son of Henry II., may be traced the incipient cause of the assassination of archbishop Becket, whose martyrdom became conducive to the highest triumphs of that power: in the second, queen Elizabeth's coronation by Oglethorpe, bishop of Carlisle, and the refusal of all the other prelates to assist in the ceremony, we behold its dying struggles for a dominion never more to be renewed.

2. *The Lord Great Chamberlain's office* commences with carrying the king his shirt on the morning of the coronation, and assisting the chamberlain of the household to dress his majesty. Queens regnant depute this office to some of the ladies of the household: we are told that the celebrated duchess of Marlborough last enjoyed it, at the coronation of queen Anne.

The office gives a claim to all the furniture of the royal chamber, in which its duties begin. The lord chamberlain is official governor of the palace for the time being, and the principal person attendant of the king.

3. *The Lord High Constable* also attends the royal person, assists at the reception of the regalia from the dean and chapter of Westminster, and, together with the earl marshal, ushers the champion into the hall.

4. *Of the Royal Championship*.—Whether we

consider its uninterrupted exercise, and that by one family, for so many centuries, its feudal import, or its present splendid and imposing effect, the office of champion certainly eclipses all the other services of the coronation.

Since the coronation of Richard II. A. D. 1377 (of which there is in Walsingham a detailed account) this office has been performed by a Dymoke, the head of the family of that name, who have held the manor of Scrivelsby in Lincolnshire, worth about £1200 per annum, by the tenure of this service. During the reigns of Edward II. and III. the right was in dispute: prior to that period, and from the days of the Conqueror it was vested in the far-famed family of Marmion, whose chief, as

— Lord of Fontenay,
Of Lutterworth and Scrivilbaye,
Of Tamworth tower and town,

came from Normandy with William, and is there supposed to have held the first of these possessions, on condition of performing the service of champion to the successive dukes.

The championship is connected also with a remarkable feature of ancient jurisprudence, the wager of battle, recently abolished. This was regarded as an appeal to the judgment of God; and succeeded, at the Conquest, the fires and other ordeals of our ancestors, which the Normans affected to despise. The reader, however, may be disposed to conjecture, that as much of the divine interposition might be expected to decide the healing of a burn or scald, as the issue of a battle.

The wager of battle was certainly of more splendid pretensions, and was introduced at first with these stipulations. If the opposite parties were countrymen, they were to follow their national customs, whatever they were; if the appellee were a foreigner, or of foreign descent, he might offer wager of battle, and on its being declined, purge himself by his own oath and that of his witnesses, according to the Norman law; or, if a native of the country, he might have his choice of the trial by ordeal or by battle.

The solemn feelings and great religious sincerity with which our forefathers regarded combats of this description, cannot be more powerfully or more accurately depicted, than in the memorable combat-scene of Ivanhoe.

An inquisitio mortem, dated the seventh of Edward III., speaks of the tenure of the manor appertaining to the royal champion as follows: 'That the manor of Scrivelsby is holden by grand sergenty, to wit, by the service of finding, on the day of coronation, an armed knight, who shall prove by his body, if need be, that the king is true and rightful heir to the kingdom.'

It is remarkable that this important document neither prescribes the absolute appearance of the lord of the manor as knight, but only that he is bound to 'find an armed knight' if required; nor does it describe the office as hereditary. With regard to the latter point, it would seem that possession is the entire law of the case, and we suppose the office would pass with the property by sale; with respect to the former, the honor seems to have called forth the valor of every

successive lord, and princes have seldom imagined that their subjects can in such a cause overstep their duty.

Anciently, the champion rode with the royal procession from the hall to the abbey, and proclaimed the challenge on his way, as well as at the feast: some instances have occurred of its being repeated also in the city, as at the coronation of Henry IV. At his predecessor's coronation it is remarked by Walsingham, that Sir John Dimmock, being armed according to custom, came to the door of the Abbey with his attendants before the service was concluded, and that the earl marshal of the day went out to him and said, he should not have made his appearance so soon.

The fate of our recent and future champions has become of late duly regarded by law. To challenge all who should dispute the pretensions of the king is rightly enough a post of honor; to accept the challenge would always, we know, have been still more bold; but an act of parliament passed during the regency (59 Geo. III. cap. 46.) abolishes altogether the trial and actual battle; so that the champion's lands, after being held with manifest peril for centuries, have at last become a peaceable possession; and all dispute respecting the crown is of course as fully disposed of. It no longer rests on the valor of a single arm—not even on that of a Marmion, or a Dymoke.

5. There was another office, that of the *Lord High Steward* of England, to which in former times much authority was attached. He possessed a kind of vice-regal power on the demise of the crown and until the coronation of the rightful heir, and was a governor of the kingdom immediately under the reigning monarch, so as to be able to control or remove the judicial servants of the crown, at any time. What was once the importance of this office is still indicated by the temporary guardianship of St. Edward's crown being committed to an officer bearing this title on the day of the coronation, and his honorable place of walking immediately before the king in procession. The earls of Leicester once enjoyed this great dignity hereditarily; through them it descended to the De Montford family, until, on the attainer of the last earl, it was granted by Henry III. to his younger son Edmund, by whom it became transmitted to John of Gaunt, and eventually to Henry IV. while duke of Lancaster; since which period it has been prudently suffered to merge in the crown.

6. The hereditary *Grand Almoner* of England is an honor attached to the barony of Bedford. Its duties are to collect and distribute certain monies at the coronation from a silver dish; which the almoner claims for his fee, together with all the cloth on which the king walks in procession from the door of the hall at Westminster to the abbey church.

7. The *Chief Butlership* is traced by authentic records into the hands of William de Albini, who came to England with William the Conqueror, and has been exercised by some of the noblest families in the country since. It is now an hereditary right of the duke of Norfolk as

earl of Arundel, and entitles the possessor to the best gold cup and cover, with all the vessels and wine remaining under the bar, and all the pots and cups, except those of gold and silver, which shall be in the wine cellar after dinner.

8. The *Dapifer* or *Sewer*, who, 'in his surcote, with tabard, sleeves, and a hood about his neck, and his towell above all, served the messes,' or arranged the dishes on the table of the coronation feast of Elizabeth, Henry VII.'s queen, is an ancient worthy of the royal day, whose office has become extinct. If the dishes are not become more tractable, or the royal observation less nice, royal feasting has become, perhaps, less rare in modern times, and this kind of skill, therefore, more common.

9. The *Grand Carver*—*Grand Panniter*, or provider of bread, and the Royal *Napier*, are offices that have also become extinct, while good carving and good living have been still found at the royal table; and while the *Chief Cup-bearer* has retained his office and the possession of the manor of Great Wymondley, in Hertfordshire, as his reward.

10. The *Chief Lardiner* is also still entitled to notice, as having the care and management of the royal larder, and being duly careful of 'the remainder of beef, mutton, venison, kids, lard, and other flesh: as also the fish, salt, &c. remaining in the larder,' which fall to his share of the feast. This office has been attached to the manor of Scoulton, in Norfolk, from the reign of Henry II.

11. Nor should we omit to notice that the Lord Mayor and Citizens of London claim a snug 'seat next the cupboard, on the left side of the hall,' in virtue of their right to assist the chief butler in his duties at the coronation feast; or that his lordship serves the king after dinner with wine in a gold cup, having the cup and its cover for a fee. It is remarkable that the city claims a right to perform the same service, and to receive a similar fee, at the coronation of our queens: but as this escaped her majesty's law officers in the late argument for her coronation, we will not suppose it had any connexion with the strong desire for that event at the Mansion House. The mayor, bailiffs, and commonalty of Oxford also claim to assist in the office of butler, and receive the humbler reward of three maple cups. With other presents—of grout or gruel, maple cups and napkins, to the king, gentle reader, we will suppose thou hast of late been sufficiently acquainted; but the conspicuous duty of the Barons of the Cinque Ports must not pass unnoticed.

12. These ports claim to furnish sixteen supporters of the royal canopy, in the following proportion, i. e. Hastings 3; Dover 2; Hithe 2; Rye 2; Sandwich 3; Romney 2; Winchelsea 2. It is called in an account of the coronation of Richard I. 'a silk umbraculum, borne on four lances:' but is now generally composed of cloth of gold; having a gilt silver bell at each of the four corners, which are supported by four staves of silver. The origin of this claim is involved in such remote antiquity, that a charter of Charles II. speaks of 'the time of the contrary being never remembered to have been.'

CORONE, in ancient geography, a town of Messenia, situated on the sea. Pausanias takes it to be the Apea of Homer; but Strabo, Thuria, and Pliny, Pedasus. It is now called Coron. See **CORON**.

CORONELLI (Vincent), a famous geographer, born at Venice. His skill in the mathematics brought him to the knowledge of the count d'Estrées, who employed him in making globes for Louis XIV. With this view Coronelli spent some time at Paris; and left a great number of globes there, which are esteemed. In 1685 he was made cosmographer to the state of Venice: and four years after, public professor of geography. He founded an academy of cosmography at Venice, and died in that city in 1718. He published above 400 geographical charts, an abridgment of cosmography, several books on geography, and other works.

CORONER, *n. s.* From Lat. *corona*, an officer whose duty is to enquire, on the part of the king, how any violent death was occasioned; for which purpose a jury is empannelled.

Go thou and seek the coroner, and let him sit o' my uncle; for he's in the third degree of drink; he's drowned. *Shakespeare.*

CORONER, an ancient officer in England, so called because he has principally to do with pleas of the crown, or such wherein the king is more immediately concerned. And in this light the lord chief justice of the king's bench is the principal coroner in the kingdom; and may, if he pleases, exercise the jurisdiction of a coroner in any part of the realm. But there are also particular coroners for every county of England; usually four, sometimes six, and sometimes fewer. This officer is of equal authority with the sheriff; and was ordained, together with him, to keep the peace when the earls gave up the wardship of the county. He is chosen by all the freeholders of the county court; and by the statute of Westminster: 1. It was enacted that none but lawful and discreet knights should be chosen; but it seems now sufficient if a man have lands enough to be made a knight, whether he be really knighted or not; for the coroner ought to have an estate sufficient to maintain the dignity of his office, and answer any fines that may be made upon him for his misbehaviour; and, if he has not enough to answer, his fine shall be levied upon the county, as a punishment for electing an insufficient officer. Now, indeed, through the culpable neglect of gentlemen of property, this office has been suffered to fall into disrepute, and get into low and indigent hands; so that although formerly no coroners would be paid for serving their country, and they were by the aforesaid statute of Westminster, 1. Expressly forbidden to take a reward under pain of great forfeiture to the king; yet for many years past they have only desired to be chosen for the sake of their perquisites; being allowed fees for their attendance by the stat. 3 Henry VII. cap. 1. which Sir Edward Coke complains of heavily, though since his time those fees have been much enlarged. The coroner is chosen for life, but may be removed, either by being made sheriff or choser. verderer, which are offices incompatible with the other; and by the stat. 25 Geo. II. cap.

29, extortion, neglect, or misbehaviour, are also with the other; and by the stat. 25 Geo. II. cap. 29, extortion, neglect, or misbehaviour are also made causes of removal.

His powers, like those of the sheriff, are either judicial or ministerial, but principally judicial. This is in a great measure ascertained by statute 4 Edward I. De officio coronatoris; and consist, first, in enquiring when any person is slain, ordies suddenly, or in prison, concerning the manner of his death. And this must be super visum corporis; for if the body is not found, the coroner cannot sit. He must also sit at the very place where the death happened. And his enquiry is made by a jury from four, five, or six, of the neighbouring towns, over whom he is to preside. If any be found guilty, by this inquest, of murder, he is to commit to prison for farther trial, and is also to enquire concerning their lands, goods, and chattels, which are forfeited thereby: but whether it be murder or not, he must enquire whether any deodand has accrued to the king, or the lord of the franchise, by this death; and must certify the whole of this inquiry to the court of king's bench, or the next assizes. Another branch of his office is to enquire concerning shipwrecks; and certify whether wreck or not, and who is in possession of the goods. Concerning treasure trove, he is also to enquire concerning the finders, and where it is, and whether any one be suspected of having found and concealed a treasure; 'and that may well be perceived,' saith the old statute of Edward I., 'where one liveth riotously, haunting taverns, and hath done so of long time; whereupon he might be attached and held to bail upon this suspicion only. The ministerial office of the coroner is only as the sheriff's substitute. For when just exception can be taken to the sheriff, for suspicion of partiality (as that he is interested in the suit, or of kindred to either plaintiff or defendant), the process must then be awarded to the coroner, instead of the sheriff, for execution of the king's writs.

CORONET. An inferior crown worn by the nobility. The coronet of a duke is adorned with strawberry leaves; that of a marquis has leaves with pearls interposed; that of an earl raises the pearls above the leaves; that of a viscount is surrounded with only pearls; that of a baron has only four pearls. See **CROWN**.

CORONILLA, jointed podded colutea, a genus of the decandria order, and diadelphia class of plants; natural order thirty-second, papilionaceæ: CAL. is bilabiated, with two segments above coalited; the vexillum scarce any longer than the alæ; the legumen much contracted between the seeds. To this genus Linæus also joins the emerus, or scorpion senna, though Mr. Miller makes it a distinct species. There are twenty-five species, all plants of considerable beauty, with very bright yellow flowers; but rather too tender for this climate, except the *C. emerus*. This species rises with a shrubby stem, branching numerously six or eight feet high, closely garnished with winged leaves of three pair of lobes, terminated by an odd one; and, at the sides of the branches, numerous long flower-stalks, each supporting two or three large

yellow flowers of the papilionaceous kind, succeeded by longish pods; it is easily propagated by seeds, and likewise by layers or cuttings. The leaves of this plant are esteemed laxative, and used as a substitute for common senna in some parts of Europe. A dye is procured by fermentation from the leaves like that of indigo.

CORPORAL. Fr. *caporal*; Ital. *caporale*; Span. *caboral*; probably from Lat. *caput*. A non-commissioned officer of infantry; the lowest in rank, whose office it is to place and remove sentinels.

The cruel *corporal* whispered in my ear,
Five pounds, if rightly tipt, would set me clear.

Gay.

CORPORAL, an inferior officer, under a serjeant, in a company of foot, who has charge over one of the divisions, places and relieves sentinels, and keeps good order in the corps de garde; he also receives the word from the inferior rounds, which passes by his corps de garde: there are generally three corporals in each company.

CORPORAL, **CORPORALE**, is also an ancient church term, signifying the sacred linen spread under the chalice in the eucharist and mass, to receive the fragments of the bread. Some say pope Eusebius first enjoined the use of the corporal; others ascribe it to St. Silvester. It was the custom to carry corporals to fires, and to heave them solemnly against the flames, in order to extinguish them. Philip de Comines says, 'the pope made Louis XI. a present of the corporale, whereon my lord St. Peter sung mass.'

CORPORAL OF A SHIP. An officer that hath the charge of setting the watches and sentries, and relieving them; who sees that all the soldiers and sailors keep their arms neat and clean, and teaches them how to use them. He has a mate under him.

A CORPORAL OF A SHIP OF WAR is under the master at arms, and is employed to teach the officers the exercise of small arms, or of musquetry; to attend at the gang-way, on entering ports, and observe that no spirituous liquors are brought into the ship, unless by express leave from the officers. He is also to extinguish the fires and candles at eight o'clock in winter, and nine in summer, when the evening gun is fired; and to walk frequently down in the lower decks in his watch, to see that there are no lights but such as are under the charge of proper sentinels.

CORPORATE, v. n. & adj.

CORPORATELY, adv.

CORPORATION, n. s.

CORPORATURE, n. s.

CORPORAL, n. s. & adj.

CORPORALITY, n. s.

CORPORALLY, adv.

CORPORAS, n. s.

CORPORAL, adj.

CORPORALIST, n. s.

CORPORALLY, adv.

CORPOROUS, adj.

CORPORITY, n. s.

Fr. *corporal*; Ital. *corporale*; Spanish *corporal*; Lat. *corporalis*, from *corpus*, the body. The verb, to incorporate, which meansto unite, to incorporate, is obsolete. Corporations will be found fully described in the quotation from Cowell, and under the separate article which relates to them. The word is vulgarly used to signify great fatness. The corporal, corporale or corporas, is the fine 'incu

cloth in which the eucharist is deposited, and which is looked upon with great reverence by the members of the Romish and Greek churches. Corporeal is relating to the body; belonging to the body; material, as distinguished from spiritual. 'In the present language,' says Johnson, 'when body is used philosophically in opposition to spirit, the word corporeal is used as a corporeal being; but otherwise corporal. Corporeal is having a body; corporal, relating to the body. This distinction seems not ancient.' Corporality and corporeity denote materiality; the quality of being embodied; corporature the state of being embodied; corporally, bodily; corporeous, bodily, having a body; corporeally, in a material or bodily manner; and corporately, in a corporate capacity; unitedly. A corporealist is one who denies the existence of spiritual substances.

A *corporation* is a body politic, authorized by the king's charter to have a common seal, one head officer or more, and members, able, by their common consent, to grant or receive, in law, any thing within the compass of their charter: even as one man may do by law all things, that by law he is not forbidden; and bindeth the successors, as a single man binds his executor or heir. *Cowell.*

Breaking forth like a sudden tempest, he overran all Munster and Connaught, defacing and utterly subverting all corporate towns that were not strongly walled. *Spenser on Ireland.*

Of angels we are not to consider only what they are, and do, in regard of their own being; but that also which concerneth them, as they are linked into a kind of *corporation* amongst themselves, and of society with men. *Hooker.*

They answer in a joint and corporate voice,
That now they are at fall. *Shakespeare. Timon.*

Whither are they vanished?
Into the air; and what seemed corporal
Melted, as breath, into the wind. *Id. Macbeth.*

To relief of lazars and weak age,
Of indigent faint souls past corporal toil,
A hundred alms-houses right well supplied. *Id. Henry V.*

Render to me some corporal sign about her,
More evident than this. *Id. Cymbeline.*
That God hath been otherwise seen, with corporal eyes, exceedeth the small proportion of my understanding. *Raleigh.*

If this light be not spiritual, yet it approacheth nearest unto spirituality; and if it have any corporality, then, of all other, the most subtle and pure. *Id.*

Of this we find some footstep in our law,
Which doth our root from God and nature take;
Ten thousand men she doth together draw,
And of them all one corporation make. *Davies.*

And from these corporal nutriments, perhaps,
Your bodies may at last turn all to spirit. *Milton's Paradise Lost.*

The swiftness of these circles attribute,
Though numberless, to his omnipotence,
That to corporeal substances could add
Speed almost spiritual. *Id.*

Since philosophy affirmeth, that we are middle substances between the soul and the body, they must admit of some corporeity, which supposeth weight or gravity. *Browne.*

The sun is corporally conjoined with basiliscus. *Id.*

Corporal punishments must necessarily lose that effect, and wear out the sense of shame, where they frequently return. Shame in children has the same place that modesty has in women; which cannot be kept, and often transgressed against. *Locke.*

He would come nearer to the discovery of the texture and motion of the minute parts of corporal things; and in many of them, probably, get ideas of their internal constitutions: but then he would be in a quite different world from other people; nothing would appear the same to him and others: the visible ideas of every thing would be different. *Id.*

It is the saying of divine Plato, that man is nature's horizon, dividing betwixt the upper hemisphere of immaterial intellects, and this lower of corporeity. *Glanville's Scipius.*

The one attributed corporeity to God, and the other shape and figure. *Stillingfleet.*

God being supposed to be a pure spirit, cannot be the object of any corporeal sense. *Tillotson.*

The course is finished which thy fates decreed,
And thou from thy corporeal poison freed. *Dryden's Fables.*

Beasts enjoy greater sensual pleasures, and feel fewer corporal pains; and are utter strangers to all those anxious and tormenting thoughts, which perpetually haunt and disquiet mankind. *Atterbury.*

The nobles of Athens being not at this time a corporate assembly, therefore the resentment of the commons was usually turned against particular persons. *Swift.*

When men, therefore, break up the original compact or agreement which gives its corporate form and capacity to a state, they are no longer a people; they have no longer a corporate existence; they have no longer a legal coercive force to bind within, nor a claim to be recognized abroad. They are a number of vague loose individuals, and nothing more. *Burke.*

The Corporation worshipful
He valued not an ace,
But swallowed the Mayor, asleep in his chair,
And picked his teeth with the mace. *Huddeford.*

I leave Don Juan, for the present—safe—
Not sound, poor fellow, but severely wounded;
Yet could his corporal pangs amount to half
Of those with which his Haidee's bosom bounded! *Byron. Don Juan.*

This noble personage began to look
A little black upon this new flirtation;
But such small licences must lovers brook,
Mere freedoms of the female corporation. *Id.*

CORPORATION ACT is that which prevents any person being legally elected into any office relating to the government of any city or corporation, unless he has within a twelvemonth previously received the sacrament of the Lord's Supper, according to the rites of the church of England; and which enjoins him to take the oaths of allegiance and supremacy when he takes the oath of office; otherwise his election is void.

CORPORATIONS. The first general division of corporations is into aggregate and sole. Another division of corporations, either sole or aggregate, is into ecclesiastical and lay.

CORPORATIONS, AGGREGATE, consist of many persons united together into one society, and are kept up by a perpetual succession of members, so as to continue for ever: of which kind are the mayor and commonalty of a city; the head and

fellows of a college; the dean and chapter of a cathedral church.

CORPORATIONS ECCLESIASTICAL, are where the members that compose it are entirely spiritual persons; such as bishops; certain deans and prebendaries; all archdeacons, parsons, and vicars; which are sole corporations: deans and chapters at present, and formerly prior and convent, abbot and monks, and the like, were bodies aggregate. These are erected for the furtherance of religion, and perpetuating the rights of the church.

CORPORATIONS, LAY, are of two kinds; civil and eleemosynary.

CORPORATIONS, CIVIL, are such as are erected for a variety of temporal purposes. The king, for instance, is made a corporation to prevent the possibility of an interregnum or vacancy of the throne, and to preserve the possessions of the crown entire; for, immediately upon the demise of one king, his successor is in full possession of the regal rights and dignity. Some corporations are erected for the good government of a town or particular district, as a mayor and commonalty, bailiff and burgesses, or the like; some for the advancement and regulation of manufactures and commerce, as the trading companies of London, Edinburgh, &c. and others for the better carrying on of divers special purposes, as churchwardens for conservation of the goods of the parish; the College of Physicians and Company of Surgeons in London, for the improvement of the medical science; the Royal Society for the advancement of natural knowledge; and the Society of Antiquaries for promoting the study of antiquities.

CORPORATIONS, ELEMOSYNARY, are such as are constituted for the perpetual distribution of the free alms, or bounty, of the founder, to such persons as he has directed. Of this kind are all hospitals for the maintenance of the poor, sick, and impotent; and all colleges; which last are founded for two purposes: 1. For the promotion of piety and learning by proper regulations and ordinances. 2. For imparting assistance to the members of those bodies, in order to enable them to prosecute their devotion and studies, with greater ease and assiduity. And all these eleemosynary corporations are, strictly speaking, lay, and not ecclesiastical, even though composed of ecclesiastical persons, and although they in some things partake of the nature, privileges, and restrictions of ecclesiastical bodies.

CORPORATIONS, SOLE, consist of one person only and his successors, in some particular station, who are incorporated by law, to give them some legal capacities and advantages, particularly that of perpetuity, which in their natural persons they could not have had. In this sense the king is a sole corporation; so is a bishop; so are some deans and prebendaries, distinct from their several chapters; and so is every parson and vicar. And the use of this institution will be apparent, if we consider the case of a parson of a church. At the original endowment of parish churches, the freehold of the church, the churchyard, the parsonage-house, the glebe, and the tithes of the parish, were vested in the then parson by the bounty of the donor, as a temporal

recompence to him for his spiritual care of the inhabitants, and with intent that the same emoluments should ever afterwards continue as a recompence for the same care. But how was this to be effected? The freehold was vested in the parson; and, if we suppose it vested in his natural capacity, on his death it might descend to his heir, and would be liable to his debts and incumbrances: or at best the heir might be compellable, at some trouble and expense, to convey these rights to the succeeding incumbent. The law, therefore, has wisely ordained that the parson, quatenus parson, shall never die, any more than the king, by making him and his successors a corporation. By which means all the original rights of the parsonage are preserved entire to the successor: for the present incumbent, and his predecessor, who lived seven centuries ago, are in law one and the same person; and what was given to the one, was given to the other also.

The first of these political constitutions were introduced, as Plutarch says, by Numa, who finding, upon his accession, the city torn to pieces by the two rival factions of Sabines and Romans, thought it a prudent and politic measure to subdivide these two into many smaller ones, by instituting separate societies of every manual trade and profession. They were afterwards considered by the civil law (in which they were called *universitates*), as forming one whole out of many individuals; or *collegia*, from being gathered together: they were adapted also by the canon law for the maintenance of ecclesiastical discipline; and from them our spiritual corporations are derived. But our laws have considerably refined and improved upon the invention, according to the usual genius of the English nation; particularly with regard to sole corporations, consisting of one person only, of which the Roman lawyers had no notion, their maxim being that *tres faciunt collegium*: though they held, that if a corporation, originally consisting of three persons, be reduced to one, *si universitas ad unum redit*, it may still subsist as a corporation, *et stet nomen universitatis*.

Corporations, by the civil law, seem to have been created by the mere act and voluntary association of their members; provided such convention was not contrary to law, for then it was *illicitum collegium*. It does not appear that the prince's consent was necessary to be actually given to the foundation of them; but merely that the original founders of these voluntary and friendly societies (for they were little more than such) should not establish any meetings in opposition to the laws of the state. But in England the king's consent, either impliedly or expressly given, is absolutely necessary to the erection of any corporation. The king's implied consent is to be found in incorporations which exist by force of the common law; to which our former kings are supposed to have given their concurrence; common law being nothing else but custom arising from the universal agreement of the whole community. Of this sort are the king himself, all bishops, parsons, vicars, churchwardens, and some others; who by common law have ever been held (as far as our books can

show us) to have been corporations, *virtute officii*: and this incorporation is so inseparably annexed to their offices, that we cannot frame a complete legal idea of any of these persons, but we must also have an idea of a corporation, capable to transmit his rights to his successors, at the same time. Another method of implication, by which the king's consent is presumed, is as to all corporations by prescription, such as the city of London, and many others, which have existed as corporations, time whereof the memory of man runneth not to the contrary; and, therefore, are looked upon in law to be well created. For, though the members of them can show no legal charter of incorporation, yet in cases of such high antiquity the law presumes there once was one; and that, by the variety of accidents which length of time may produce, the charter is lost or destroyed. The methods by which the king's consent is expressly given are either by act of parliament, or by charter. By act of parliament, of which the royal assent is a necessary ingredient, corporations may undoubtedly be created: but it is observable, that most of those statutes, which are usually cited as having created corporations, do either confirm such as have been before created by the king; as in the case of the college of physicians, erected by charter 10 Henry VIII., which charter was afterwards confirmed in parliament; or they permit the king to erect a corporation in futuro, with such and such powers; as is the case of the bank of England, and the society of the British fishery. So that the immediate creative act is usually performed by the king alone. All the other methods, therefore, whereby corporations exist, by common law, by prescription, and by act of parliament, are for the most part reducible to this of the king's letters patent, or charter of incorporation. The king's creation may be performed by the words *creamus, erigimus, fundamus, incorporamus*, or the like. Nay it is held that if the king grants to a set of men to have *gildam mercatoriam*, 'a mercantile meeting or assembly,' this is alone sufficient to incorporate and establish them for ever. The king, it is said, may grant to a subject the power of erecting corporations, though the contrary was formerly held: that is, he may permit the subject to name the persons and powers of the corporation at his pleasure; but it is really the king that erects, and the subject is but the instrument; for though none but the king, can make a corporation, yet *qui facit per alium facit per se*. In this manner the chancellor of the university of Oxford has power by charter to erect corporations; and has actually often exerted it in the erection of several matriculated companies, now subsisting, of tradesmen subservient to the students. When a corporation is erected, a name must be given to it; and by that name alone it must sue and be sued, and do all legal acts.

When a corporation is formed and erected, it acquires many powers and rights. Some of these are necessarily and inseparably incident to every corporation; which incidents, as soon as a corporation is duly erected, are tacitly annexed of course. As, 1. To have perpetual succession. This is the very end of its incorporation; for

there cannot be a succession for ever without an incorporation; and, therefore, all aggregate corporations have a power necessarily implied of electing members in the room of such as go off. 2. To sue or be sued, implead or be impleaded, grant or receive, by its corporate name, and do all other acts that natural persons may. 3. To purchase lands, and hold them, for the benefit of themselves and their successors. 4. To have a common seal; for a corporation, being an invisible body, cannot manifest its intentions by any personal act or oral discourse: it therefore acts and speaks only by its common seal. For though the particular members may express their private consents to any act, by words, or signing their names, yet this does not bind the corporation; it is the fixing of the seal, and that only, which unites the several assents of the individuals who compose the community, and makes one joint assent of the whole. 5. To make by-laws or private statutes for the better government of the corporation: which are binding upon themselves unless contrary to the laws of the land, and then they are void. But no trading company is allowed to make by-laws which may affect the king's prerogative, or the common profit of the people, under penalty of £40, unless they be approved by the chancellor, treasurer, and chief justices, or the judges of assize in their circuits: and even though they be so approved, still if contrary to law, they are void. These five powers are inseparably incident to every corporation aggregate. Corporations have a capacity to purchase lands for themselves and successors; but they are excepted out of the statute of wills; so that no devise of lands to a corporation by will is good; except for charitable uses, by statute 43 Eliz. c. 4, which exception is again greatly narrowed by the statute 9 Geo. II. c. 36.; and their privilege even of purchasing from any living grantor is much abridged; so that now a corporation, either ecclesiastical or lay, must have a licence from the king to purchase, before they can exert that capacity which is vested in them by the common law: nor is even this in all cases sufficient. These statutes are generally called the statutes of mortmain. See **MORTMAIN**. The general duties of all bodies politic, considered in their corporate capacity, may, like those of natural persons, be reduced to this single one; that of acting up to the end or design; whatever it be, for which they were created by their founder.

As any members may lose place in the corporation, by acting contrary to its laws or the laws of the land, so the body politic may also itself be dissolved in several ways; which dissolution is the civil death of the corporation: and in this case their lands and tenements revert to the person, or his heirs, who granted them to the corporation; for the law annexes a condition to every such grant, that, if the corporation be dissolved, the grantor shall have the lands again, because the cause of the grant faileth. The grant is indeed only during the life of the corporation, which may endure for ever; but when that life is determined, by the dissolution of the body politic, the grantor takes it back by reversion, as in the case of every other grant for life. The debts of a corporation, either to or from it, are

totally extinguished by its dissolution; so that the members of it cannot recover, or be charged with them, in their natural capacities: agreeably to that maxim of the civil law, *si quid universitati debetur, singulis non debetur; nec, quod debet universitas, singuli debent*. A corporation may be dissolved, 1. By act of parliament. 2. By the natural death of all its members, in cases of an aggregate corporation. 3. By surrender of its franchises into the hands of the king, which is a kind of suicide. 4. By forfeiture of its charter through negligence or abuse of its franchises; in which case the law judges that the body politic has broken the condition upon which it was incorporated, and thereupon the incorporation is void. And the regular course is to bring an information in the nature of a writ of quo warranto, to enquire by what warrant the members now exercise their corporate power, having forfeited it by such and such proceedings. The exertion of this act of law, for the purposes of the state, in the reigns of king Charles and king James II., particularly by seizing the charter of the city of London, gave great and just offence; though perhaps, in strictness of law, the proceedings in most of them were sufficiently regular; but the judgment against that of London was reversed by act of parliament after the Revolution; and by the same statute it was enacted, that the franchises of the city of London shall never more be forfeited for any cause whatsoever. And because by the common law corporations were dissolved, in case the mayor or head officer was not duly elected on the day appointed in the charter or established by prescription, it is now provided, that for the future no corporation shall be dissolved upon that account; and ample directions are given for appointing a new officer, in case there be no election, or a void one, made upon the charter or prescriptive day.

Two modern provisions of the law, with regard to corporations, are worth noticing here. 1. To prevent improper conduct in trading corporations in elections, and in disposing of the joint stock, it is by stat. 7 Geo. III. c. 48, enacted, that no member of such corporations shall be admitted to vote in the general courts, until he shall have been six months in possession of the stock necessary to qualify him: unless it comes to him by bequest, marriage, succession, or settlement; and only one half-yearly dividend is to be made of the profits of stock.

2. To facilitate the proceedings in cases of mandamus and quo warranto, and to prevent any undue advantage on either side, the stat. 12 Geo. III. c. 21, provides that, where any person shall be entitled to be admitted a freeman, &c., of any corporation, &c., and shall apply to the proper officer to be admitted, and shall give notice of his intention to move the court of king's bench for a mandamus, in case of refusal the officer shall pay all the costs of the application. And the same statute enacts, that the proper officer shall, on the demand of two freemen, permit them and their agents to inspect the entries of admission of freemen, and to take copies and extracts, under penalty of £100.

CORPOREITY is the quality of that which is corporeal, or is body; or that which constitutes

or denominates it such. The corporeity of God was the capital error of the Anthropomorphites. Some authors reproach Tertullian with admitting a corporeity in the Deity; but it is manifest that, by body, he means no more than substance. The Mahomedans reproach the Samaritans with this day, with a belief of the corporeity of God.

CORPORIFY, *v. a.* } Fr. *corporifier*; Lat. **CORPORIFICATION**. } *corpus*. To embody; to thicken into a body; to attribute body to spiritual beings. The act of embodying.

A certain spirituous substance, extracted out of it, is mistaken for the spirit of the world *corpified*.

Boyle.

CORPOSANT, or **CORPO-SANTO**, Ital., a name given to the volatile meteor, or ignis fatuus, often seen in a dark tempestuous night about the decks or rigging of a ship, but particularly at the extremities, as the mast-heads and yard-arms, and is most frequent in heavy rain accompanied with lightning. This appearance, which is nothing more than the electric fluid passing silently from the clouds to the water, or the contrary, by means of the humidity on the masts and rigging, was, in the dark ages of superstition, esteemed by some a good omen and by others an evil one; but modern philosophy has so happily explored its cause, that none but the most ignorant are now intimidated by it. The best ancient opinion is that of Varenus, who says that they usually wander, with uncertain motion, from place to place, sometimes appearing to cleave close to the sails and masts: but they frequently leap up and down with intermission, affording an obscure flame, like that of a candle burning faintly. They are produced by some sulphureous and bituminous matter, which being beat down by the motion of the air above, and gathering together, is kindled by the agitation of the air, as butter is gathered together by the agitation of the cream. And from this appearance we may infer, that storms come from sulphureous vapors that rarefy the air and fuel into motion.

CORPS, *n. s.* } Fr. *corps*; Lat. *corpus*. A **CORPSE**, *n. s.* } body; a body, in contempt; **CORSE**, *n. s.* } a dead body. Corps also means a body of troops; a number of persons acting together. In this sense some lexicographers contend that it is derived, through the French, from the Lat. *cohors*.

Spright Emelie, and houelth Palamon,
And Theseus his sister toke anon
Swonning, and bore her from the *corps* away.

Chaucer. Cant. Tal. s.

But al to late comith the lectuarie
When men the *corps* unto the grave carie.

Id. Troilus and Creseide.

Honour the place that such a jewel tread,
And kisse the ground whereas the *corps* doth rest.

Surrey.

That lewd ribauld
Laid first his filthy hands on virgin cleene,
To spoil her dainty *corps*, so fair and sheene,
Of chastity and honour virginal.

Spenser. Faerie Queene.

His *corps* was carried downe along the lee,
Whose waters with his filthy blood it stayned. *Id.*

O how great sorrow my sad soule assaid!
Then forth I went his woeful *corps* to find. *Id.*

Not a friend
Greet my poor *corps*, where my bones shall be thrown.
Shakespeare.

Cold numbness straight bereaves
Her *corps* of sense, and the' air her soul receives.
Denham.

Though plenteous, all too little seems
To stuff this man, this vast unhide-bound *corps*.
Milton.

He looks as man was made, with face erect,
That scorns his brittle *corps*, and seems ashamed
He's not all spirit. *Dryden's Don Sebastian.*

There was the murdered *corps* in covert laid,
And violent death in thousand shapes displayed.
Id. Fables.

See where the *corps* of thy dead son approaches.
Addison.

The *corps* was laid out upon the floor by the emper-
or's command: he then bid every one light his flam-
beau, and stand about the dead body. *Id. Guardian.*

Naturally men so formed and finished are the first
gifts of Providence to the world. But when they
have once thrown off the fear of God, which was in all
ages too often the case, and the fear of man, which is
now the case, and when in that state they come to
understand one another, and to act in *corps*, a more
dreadful calamity cannot arise out of hell to scourge
mankind. *Burke.*

Yon ruins sable from the wasting flame
But mark the once resplendent dome;
The frequent *corps* obstructs the sullen stream,
And ghosts glare horrid from the sylvan gloom.
Beattie.

O'er his pale *corps* their pearly sea-flowers shed,
And strewed with crimson moss his marble bed;
Struck in their coral towers the pausing bell,
And wide in ocean tolled his funeral knell. *Dorwin.*
Not so Haidee: she sadly tossed and tumbled,
And started from her sleep,—and, turning o'er,
Dreamed of a thousand wrecks, o'er which she stumbled,
And handsome *corpses* strewed upon the shore.
Byron. Don Juan.

CORPS, in architecture, a term borrowed from
the French, signifying any part that projects or
advances beyond the naked wall; and which
serves as a ground for some decoration or the
like.

CORPS DE GARDE, a post in an army, some-
times under covert, sometimes in the open air,
to receive a body of soldiery, who are relieved
from time to time, and are to watch in their
turns, for the security of a quarter, a camp,
station, &c. The word is also used for the men,
who watch therein. It is usual to have also a
small corps de garde, at a good distance before
the lines; to be the more readily advertized of
the approach of the enemy.

CORPULENCE, *n. s.* } *Fr. corpulence; It.*
CORPULENCY, *n. s.* } *corpulenta; Sp. cor-*
CORPULENT, *adj.* } *pulencia; Lat. corporu-*
lentia. Johnson defines corpulence, and corporu-
lency, to be, bulkiness of body; fleshiness; fulness
of flesh; spissitude; grossness of matter. Corpule-
nce, however, is now much more commonly
used to express increase of size from fat, rather
than from muscle.

We say it is a fleshy stile, when there is much
periphrasis, and circuit of words; and when, with
more than enough, it grows fat and corpulent.
Ben Jonson's Discoveries.

Excess of nourishment is hurtful; for it maketh the
child *corpulent*, and growing in breadth rather than in
height. *Becon.*

To what a cumbersome unwieldiness.
And burdensome *corpulencies*, my love had grown.
Donne.

It is but one species of *corpulency*; for there may
be bulk without fat, from the great quantity of muscu-
lar flesh, the case of robust people.

Arbuthnot on Aliments.

The muscular flesh serves for the vibration of the
tail; the heaviness and *corpulency* of the water re-
quiring a great force to divide it.

Ray on the Creation.

CORPULENCY is the occasion of various diseases,
and particularly of the apoplexy. It was held
infamous among the ancient Lacedæmonians.
Sennertus mentions a man that weighed 600
pounds, and a maid, thirty-six years of age, who
weighed 450. Bright of Malden, who died at
the age of twenty-nine, in 1750, weighed 616
pounds. Chiapin Vitelli, marquis of Cerona,
a noted Spanish general in his time, from an
excessive corpulency, is said to have reduced
himself, by drinking vinegar, to such a degree of
leanness, that he could fold his skin several
times round him. Castile soap, in the form of a
bolus, an electuary, pills, or dissolved in a gill
or more of soft water, from one to four drachms,
taken at bed-time, is strongly recommended
with a view of reducing corpulency, in a
Discourse on its Nature, Causes, and Cure, by
Malcolm Flemyng, M. D. London, 1760. See
MEDICINE.

CORPUS, i. e. a body, Lat. is used in matters
of learning, for several works of the same nature
collected and bound together. Thus Gratian
made a collection of the canons of the church
called corpus canonum. The corpus of the civil
law is composed of the digest, code, and institutes.
We have also a corpus of the Greek poets; and
another of the Latin poets.

CORPUS CHRISTI, a festival of the church
of England, kept on the Tuesday after Trinity-
Sunday, instituted in honor of the eucharist; to
which also one of the colleges in Oxford is de-
dicated.

CORPUSCULE, *n. s.* } *Lat. cor-*
CORPUSCULAR, *adj.* } *pusculum. A*
CORPUSCULARIAN, *n. s. & adj.* } *diminutive*
body; an atom; a small fragment. Corpuscu-
larian, as an adjective, signifies relating to bo-
dies; comprising bodies. 'It is,' says Johnson,
'the distinguishing epithet of that philosophy,
which attempts the rational solution of all phy-
sical appearances by the action of one body upon
another.' A corpuscularian is a philosopher of
that sect of philosophy.

As to natural philosophy, I do not expect to see
any principles proposed, more comprehensive and in-
telligible than the *corpuscularian* or mechanical.

Boyle.

This may be said, that the modern *corpuscularians*
talk, in most things, more intelligibly than the peripa-
tetics. *Bentley.*

The mechanical or *corpuscular* philosophy, though
peradventure the eldest, as well as the best in the
world, had lain dead for many ages in contempt and
oblivion. *Id.*

It will add much to our satisfaction, if those *corpuscles* can be discovered with microscopes.

Newton's Opticks.

Who knows what are the figures of the little *corpuscles* that compose and distinguish different bodies?

Watts's Logick.

In the spocynum androssifolium, the anthers converge over the nectaries, which consist of five glandular oval *corpuscles* surrounding the germ; and at the same time admit air to the nectaries at the interstice between each anther.

Darwin.

CORPUSCULARIAN PHILOSOPHY is that way of philosophising which endeavours to explain things, and to account for the phenomena of nature, by the motion, figure, rest, position, &c. of the *corpuscles*, or the minute particles of matter. Mr. Boyle sums up the chief principles of the corpuscular hypothesis, which now flourishes under the mechanical philosophy, in these particulars: 1. They suppose that there is but one catholic or universal matter, which is an extended, impenetrable, and divisible substance, common to all bodies, and capable of all forms. 2. That this matter, in order to form the vast variety of natural bodies, must have motion in some or all its assignable parts; and that this motion was given to matter by God, the Creator of all things, and has all manner of directions and tendencies. 3. Matter must also be actually divided into parts, and each of these primitive particles, fragments, or atoms of matter, must have its proper magnitude or size, as also its peculiar figure or shape. 4. They suppose also, these differently fixed and shaped particles may have as different orders and positions, whereof great variety may arise in the composition of bodies.

CORRA LINN, a grand cataract of the Clyde, in Lanarkshire, which is thus described by William Lockhart, Esq. of Baronald: 'The old castle of Corra, with Corra House, and the rocky and woody banks of the Clyde, form of themselves a beautiful and grand coup d'œil; but nothing can equal the striking and stupendous appearance of the fall itself, which, when viewed from any of the different seats placed here and there along the walks, must fill every unaccustomed beholder with awe and astonishment. The tremendous rocks around, the old castle upon the opposite bank, a corn-mill in the rock below, the furious and impatient stream foaming over the rock, the horrid chasm and abyss underneath your feet, heightened by the hollow murmur of the water, and the screams of wild birds, form at once a spectacle, both tremendous and pleasing. A summer-house is situated over a high rocky bank, that overlooks the Linn, built by Sir James Carmichael, of Bonniton, in 1708. From its uppermost room, it affords a very striking prospect of the fall; for, all at once, on throwing your eyes towards a mirror, on the opposite side of the room from the fall, you see the whole tremendous cataract pouring, as it were, upon your head. The Corra Linn, by a late measurement, is found to be eighty-four feet in height. The river does not rush over in one uniform sheet, like the Bonniton Linn, but in three different, though almost imperceptible, precipitate leaps. On the south bank, when the sun shines, a rain-

bow is perpetually seen forming upon the mists and fogs, rising from the violent dashing of the waters.' On a pointed rock, overhanging this stupendous scene, stands a solitary tower. It was lately inhabited, but is now in ruins. In floods, the rock and tower have been observed to shake in such a manner as to spill water in a glass standing on a table. A path leads to the top of the fall, into which projects a high rock, in floods insulated by the water; and from the top is a tremendous view of the furious stream. In the cliffs of this savage retreat the brave Wallace is said to have concealed himself, meditating revenge for his injured country.

TO CORRA'DE, *v. a.* Lat. *corrado*. To rub off; to wear away by frequent rubbing; to scrape together.

CORRADIATION, *n. s.* Lat. *con* and *radius*. A conjunction of rays in one point.

The impression of colour worketh not but by a cone of direct beams, or right lines, whereof the basis is in the object, and the vertical point in the eye; so as there is a *corradation*, and conjunction of beams.

Bacon's Natural History.

CORRADINI DE SEZZA (Peter Marcellinus), a learned civilian and cardinal, born at Sezza in 1658. He acquired the esteem and confidence of Clement XI., and died at Rome in 1743. He was the author of a learned and curious work, entitled, *Verum Latium Profanum et Sacrum*, 2 vols. folio, and a *History of Sezza*, in 4to.

CORRADO (Sebastian), an Italian grammarian of the sixteenth century, who taught Greek and Latin at Reggio, where he formed an academy of polite literature; and at length removed to Bologna, to be professor of those languages. He wrote several works, the most esteemed of which are, *Quæstura in qua Ciceronis Vita refertur*, an excellent performance; and *De Lingua Latina*. He died in 1556.

CORRECT , <i>v. a. & adj.</i>	} Fr. <i>corriger</i> ; Ital. <i>corregere</i> ; Span. <i>corregir</i> ; Lat. <i>corrigerè</i> , from <i>con</i> and <i>regere</i> . To punish; to amend; to remove error in writings, life, or things; to add something which removes some bad quality in another. Correction is punishment; the act of removing faults; amendment; that which is substituted in the place of anything wrong; reprehension; abatement of noxious qualities by the addition of something contrary. Corrective, as a noun, means that which has the power of amending; limitation: as an adjective, it denotes having the power of amending; the power of producing correctness. Corrector seems to be used by Shakspeare to express, a jail-bird; one who has been in the house of correction. So says Johnson; but, as the speech which he quoted is made to an officer of justice, the word appears rather to denote a corrector; one who punishes. Corrigible is that which may be amended; that which deserves punishment. Shakspeare employs it in the sense of having
CORRECTABLE , <i>adj.</i>	
CORRECTION , <i>n. s.</i>	
CORRECTIONER , <i>n. s.</i>	
CORRECTIVE , <i>n. s. & adj.</i>	
CORRECTLY , <i>adv.</i>	
CORRECTNESS , <i>n. s.</i>	
CORRECTOR , <i>n. s.</i>	
CORRIGIBLE , <i>adj.</i>	

power to correct; which, as Johnson observes, is neither proper, nor used.

To slander you is no thing min entent,
But to *correcten* that is mis I ment.

Chaucer. Cant. Tales.

Al so as a wise man sayth, that the judge that *correcteth* not the sinner, commaundeth and biddeth him do sinne.

I do vengeance and pleine *correction*
While I dwell in the signe of the Leon. *Id.*

When this childe sawe the yerde, he sayd to his maister, What thinke you to do? I wol bete thee, sayd the maister, for thy *correction*. Forsoth, sayd the childe, ye ought first *correct* yourself, that have lost all patience for the offence of a childe. *Id.*

O happy mixture! wherein things contrary do so qualify and *correct* the one the danger of the other's excess, that neither boldness can make us presume, as long as we are kept under with the sense of our own wretchedness; nor, while we trust in the mercy of God through Christ Josus, fear be able to tyrannize over us.

An offensive wife,

That hath enraged him on to offer strokes,
As he is striking, holds his infant up,
And hangs resolved *correction* in the arm
That was upreared to execution.

Shakespeare. Henry IV.

Our bodies are our gardens, to the which our wills are gardeners; so that, if we will either have it steril with idleness, or manured with industry, the power and *corrigible* authority of this lies in our will.

Id. Othello.

I will have you soundly swinged for this, you blue-boulded rogue! you filthy famished *corrector*!

Id. Henry IV.

To make ambitious, wholesome, do not take
A dram of country's dullness; do not add
Corrections, but as chymists purge the bad.

Donne.

He was taken up very short, and adjudged *corrigible* for such presumptuous language.

Howell's Vocal Forest.

Sad accidents, and a state of affliction, is a school of virtue; it *corrects* levity, and interrupts the confidence of sinning.

Taylor.

There seems to be such an instance in the regiment which the human soul exerciseth in relation to the body, that, with certain *corrections* and exceptions, may give some kind of explication or adumbration thereof.

Hale's Origin of Mankind.

They proceed with judgment and ingenuity, establishing their assertions not only with great solidity, but submitting them also unto the *correction* of future discovery.

Browne.

He that thinks absolute power purifies men's blood, and *corrects* the baseness of human nature, need read but the history of this or any other age to be convinced of the contrary.

Locke.

There are ladies, without knowing what tenses and participles, adverbs and prepositions are, speak as properly and as *correctly* as most gentlemen who have been bred up in the ordinary methods of grammar schools.

Id.

Humanly speaking, and according to the method of the world, and the little *corrections* supplied by art and discipline, it seldom fails but an ill principle has its course, and nature makes good its blow.

South's Sermons.

What verus can do, he has performed in this,
Which he presumes the most *correct* of his.

Dryden's Aur. Prolog.

Too much labour often takes away the spirit, by adding to the polishing; so that there remains nothing but a dull *correctness*, a piece without any considerable faults, but with few beauties.

Id. Desfrenoy.

Another poet, in another age, may take the same liberty with my writings; if, at least, they live long enough to deserve *correction*.

Id. Fables. Preface.

This is a defect in the first make of some men's minds, which can scarce ever be *corrected* afterwards, either by learning or age.

Burnet's Theory. Preface.

No man's body is as strong as his appetites, but heaven has *corrected* the boundlessness of his voluptuous desires by stinting his strength and contracting his capacities.

Tillotson.

I writ, because it amused me; I *corrected*, because it was as pleasant to me to *correct* as to write.

Pope's Preface.

Such lays as neither ebb nor flow,
Correctly cold, and regularly low.

Id. Essay on Criticism.

Mulberries are pectoral, *correctives* of bilious alkali.

Arbutnot.

I remember a person, who, by his style and literature, seems to have been the *corrector* of a hedgepress in Little-Britain, proceeding gradually to an author.

Swift.

Those pieces have never before been printed from the true copies, or with any tolerable degree of *correctness*.

Id.

We are all but children here under the great master of the family; and he is pleased, by hopes and fears, by mercies and *corrections*, to instruct us in virtue.

Watts.

In making a medicine, such a thing is called a *corrector*, which destroys or diminishes a quality that could not otherwise be dispensed with; thus turpentine are *correctors* of quicksilver, by destroying its fluidity, and making it capable of mixture.

Quincy.

It is difficult for the most wise and upright government to *correct* the abuses of remote delegated power, productive of unmeasured wealth, and protected by the boldness and strength of the same ill-got riches.

Burke.

Our Indian government is in its best state a grievance. It is necessary that the *corrections* should be uncommonly vigorous; and the work of men sanguine, warm, and even-impassioned in the cause.

Id.

To *correct* a child when one is in a passion, gives him an example of two vices at once, rage and revenge; for all *correction* of this kind is likely to be, and to the sufferer will appear to be, excessive; and seem to have, and perhaps really has, something vindictive in it.

Beattie.

Candid, and generous, and just,
Boys care but little whom they trust;

An error soon *corrected*—
For who but learns in riper years

That man, when smoothest he appears,
Is most to be suspected?

Comper.

CORRECTION, in printing, the act of retrenching the faults in a work; or the reading which the corrector gives the proofs; to point out and amend the faults, to be rectified by the compositor. The corrections are placed on the margin of each page, against the line where the faults are found. There are different characters used to express different corrections, as D or S, *dele*, for any thing to be effaced or struck out. When any thing is to be inserted, the place is marked in the line with a caret (^), and the insertion added in the margin. When a word, syllable, &c. is

to be altered, it is erased out of the proof, and that to be put in its room written in the margin; always observing, if there be several mistakes in the same line, that the corrections in the margin be separated by little bars or strokes, |. If a space be omitted, its place is marked with a caret, and the margin with †. If a space be wrong placed, as in the middle of a word, the two parts are connected with a curve, and the same character put in the margin. If a letter be inverted, it is expressed in the margin thus, \ominus .

If any thing be transposed it is marked thus: the shortest [are the] folliēs best: for, the shortest foliēs are the best: and in the margin is added *ts.* in a circle. If Roman characters are to be changed for Italic, or vice versâ, a line is drawn under them, thus, and Roman or Italic added in the margin; if to small capitals, a double line; and if to capitals a treble line. If a word or sentence is entirely omitted, the place is marked with a caret, and in the margin is inserted the word, *out.* If the letters of a word stand too far asunder, a line is drawn under them, and in the margin is put a crooked line or hook, thus, \hookrightarrow .

CORREGIO, a town of Italy, in the principality of the same name, and department of Crostolo, with a castle, eight miles north-west of Modena, nine south-east of Reggio, and twenty-five south of Mantua. Long. 11° 12' E., lat. 44° 46' N.

CORREGIO (Antonio), an eminent historical painter, born in 1494, whose original name, Allegri, was changed to that of his birth-place. Being descended of poor parents, and educated in an obscure village, he enjoyed none of those advantages which contributed to form the other great painters of that illustrious age. He studied none of the statues of ancient Greece or Italy; nor any of the works of the established schools of Rome and Venice. But Nature was his guide; and Corregio was one of her favorite pupils. The agreeable smile, and the profusion of graces which he gave to his madona's, saints, and children, have been said to be sometimes unnatural; but they are still amiable and pleasing. An easy and flowing pencil, a union and harmony of colors, and a perfect intelligence of light and shade, give an astonishing relief to all his pictures, and have been the admiration both of his contemporaries and his successors. Annibal Carracci, who flourished fifty years after him, studied and adopted his manner in preference to that of any other master. From want of curiosity, or of patronage, Corregio never visited Rome, but remained his whole life at Parma, where the art of painting was little esteemed, and poorly rewarded. This concurrence of unfavorable circumstances occasioned, at last, his premature death at the age of forty. He was employed to paint the cupola of the cathedral at Parma, the subject of which is an Assumption of the Virgin; and having executed it in a manner that has long been the admiration of every person of taste, for the grandeur of design, and especially for the boldness of the fore-shortenings, an art which he first and at once brought to the utmost perfection, he went to receive his payment. The

canons of the church, either through ignorance or baseness, found fault with his work; and although the price originally agreed upon had been very moderate, they alleged that it was far above the merit of the artist, and forced him to accept of the paltry sum of 200 livres; which, to add to the indignity, they paid him in copper money. To carry home this unworthy load to his indigent wife and children, poor Corregio had to travel six or eight miles from Parma. The weight of his burden, the heat of the weather, and his chagrin at this villanous treatment, immediately threw him into a pleurisy, which, in three days, terminated his life and his misfortunes, in 1534. For the preservation of this magnificent work the world is indebted to Titian. As he passed through Parma, in the suite of Charles V. he went instantly to see the chef d'œuvre of Corregio. While he was attentively viewing it, one of the principal canons of the church told him that such a grotesque performance did not merit his notice, and that they intended soon to have the whole defaced. 'Have a care of what you do,' replied the other; 'if I were not Titian, I would certainly wish to be Corregio.'

CORRELATE, *v. n. & n. s.* } Lat. *con* and
CORRELATIVE, *adj.* } *relatus.* To
CORRELATIVENESS, *n. s.* } stand in a re-
CORRELATIVELY, *adv.* } ciprocal rela-

tion to each other, as father and son, man and woman, prince and subject. Correlative is, having a reciprocal relation; a relation in which one state cannot exist without the other, they being mutually dependent. A correlate is one who stands in the opposite relation.

It is one thing for a father to cease to be a father, by casting off his son; and another for him to cease to be so, by the death of his son: in this the relation is at an end for want of a *correlate*. *South.*

Father and son, husband and wife, and such other *correlative* terms, seem nearly to belong one to another. *Id.*

Giving is a relative action, and so requires a *correlative* to answer it; giving, on one part, transfers no property, unless there be an accepting on the other. *Id.*

CORREPTION, *n. s.* Lat. *corripio, correptum.* Objurgation; chiding; reprehension; reproof.

If we must be talking of other people's faults, let it not be to defame, but to amend them, by converting our detraction into admonition and fraternal *correction*. *Government of the Tongue.*

CORRESPOND, *v. n.* } Fr. *corres-*
CORRESPONDENT, *n. s. & adj.* } *pondre*; Ital.
CORRESPONDENCE, *n. s.* } *correspondere*;
CORRESPONDENCY, *n. s.* } Sp. *correspon-*
CORRESPONDENTLY, *adv.* } *der*; Lat. *con-*
CORRESPONDING, *adj.* } *andrespondere.*
CORRESPONSIVE, *adj.* } To fit; to suit;

to match; to be adapted to; to be adequate to; to keep up an intercourse by letters. Correspondent is, suitable; adapted: a correspondent is one who keeps up a mutual intercourse with another by letters; one who transacts mercantile affairs for or with another residing in a different country. Correspondence and correspondency

the first is the most in use) signify, reciprocal relation of one thing to another; intercourse; friendship; interchange of offices or civilities. Corresponding and corresponsive mean, answerable; adapted to; proportioned to.

Between the law of their heavenly operations, and the actions of men in this our state of mortality, such *correspondence* there is as maketh it expedient to know in some sort the one, for the other's more perfect direction. *Honker.*

What good or evil is there under the sun, what action *correspondent* or repugnant unto the law which God hath imposed upon his creatures, but in or upon it God doth work, according to the law which himself hath eternally purposed to keep? *Id.*

Æriam's six gates i' the city, with massy staples,
And *corresponsive* and fulfilling bolts,
Sperrè up the sons of Troy.

Shakespeare. Troilus and Cressida.

Let such military persons be assured, and well reputed, of, rather than factious and popular; holding also good *correspondence* with the other great men in the state. *Bacon.*

I had discovered those unlawful *correspondencies* they had used, and engagements they had made to embroil my kingdoms. *King Charles.*

Sure the villains hold a *correspondence*
With the enemy, and thus they would betray us.

Denham.

He was pleased to command me to send to him, and receive from him all his letters from and to all his *correspondents* at home and abroad. *Id.*

Words being but empty sounds, any farther than they are signs of our ideas, we cannot but assent to them, as they *correspond* to those ideas we have, but no farther than that. *Locke.*

Whatever we fancy, things keep their course; and their habitudes, *correspondencies*, and relations keep the same to one another. *Id.*

The days, if one be compared with another successively throughout the year, are found not to be equal, and will not justly *correspond* with any artificial or mechanical equal measures of time.

Holder on Time.

And as five zones the' etherial regions bind,
Five *correspondent* are to earth assigned.

Dryden. Ovid.

It happens very oddly, that the pope and I should have the same thought much about the same time: my enemies will be apt to say that we hold a *correspondence* together, and act by concert in this matter. *Addiam.*

You might, if you pleased, have profited of our example, and have given to your recovered freedom a *correspondent* dignity. Your privileges, though discontinued, were not lost to memory. *Burke.*

Our political system is placed in a just *correspondence* and symmetry with the order of the world, and with the mode of existence decreed to a permanent body composed of transitory parts. *Id.*

returned home very considerably improved. My reading was enlarged with the very important addition of Thomson's and Shenstone's Works; I had seen human nature in a new phasis; and I engaged several of my school-fellows to keep up a literary *correspondence* with me. *Burns.*

Reasoning is that operation of the sensorium by which we excite two or many tribes of ideas, and then re-excite the ideas in which they differ or *correspond*.

Darwin.

These all assume, as circumstances require, the various forms of letter to the editor, occasional anecdote, impartial critique, observation from *correspondent*, or advertisement from the party.

Sheridan. The Critic.

DAN. And not a week but I receive fifty letters, and not a line in them about any business of my own.

SNEER. An amusing *correspondence*. *Id.*

Discussed the fashion which might next prevail,
And settled bonnets by the newest code,
Or crammed twelve sheets into one little letter,
To make each *correspondent* a new debtor.

Byron. Don Juan.

CORREZE, a department of France, bounded by those of Upper Vienne and Cruise on the north, Puy de Dome on the east, Cantal on the south-east, Lot on the south, and Dordogne on the west. It includes the ci-devant province of Limousin, and contains 255,000 inhabitants. It is divided into the arrondissements of Tulle (the capital), Brives, and Ussel. This department is watered by the Correze, the Dordogne, and the Upper and Lower Vezere, but none of them are well fitted for navigation. Northward it is mountainous, but the low grounds produce buck-wheat, rye, chestnuts, hemp, wine, and mushrooms. There are extensive heaths of juniper, and meadows which support many thousand sheep and cattle. The minerals are pit-coal, slate, free-stone, lime-stone, iron, lead, copper, and antimony; and the chief towns contain manufactures of wool, cotton, silk, brandy, paper, and oil.

CORREZE, a river of France, which rises about twenty miles north-east of Tulle, and passing by that town, Brives, &c. joins the Vezere, three miles below Brives. It gives name to the above department, through which it passes.

CORRIDOR, n. s. French. In fortification, the covert way lying round the whole compass of the fortifications of a place. In architecture, a gallery or long aisle round about a building, leading to several chambers at a distance from each other.

There is something very noble in the amphitheatre, though the high wall and *corridors* that went round it are almost entirely ruined. *Addiam on Italy.*

He passed the portal—crossed the *corridore*,
And reached the chamber as the strain gave o'er:
' My own Medora! sure thy song is sad.'
' In Conrad's absence would'st thou have it glad?'

Byron. The Corsair.

CORRIE (James), M. D. a young physician of very promising abilities, born at Ayre, October 20th, 1770. He was educated at Ayre; studied three years at the university of Edinburgh, where he was elected president of the Chirurgo-Physical and Chirurgo-Obstetrical Societies; and took his degrees of A. M. and M. D. at Glasgow, in 1791. He afterwards went to London, where he was admitted a member of the corporation of surgeons; and published his *Essay on the Vitality of the Blood*; a doctrine for which he was a zealous advocate. This work was dedicated to the late celebrated anatomist, John Hunter, esq. by whose recommendation, Dr. Corrie obtained an appointment in the service of the East India Company, at Conalore; but the climate provin;

too severe for his constitution, he died in 1794, while he was collecting materials for several other works on medicine and natural history.

CORRIGIOLA, in botany, a genus of the triptera order and pentandria class of plants; natural order fifty-fourth miscellaneous: CAL. pentaphyllous; the petals five; and one three-cornered seed. Species two; one common, on our own sea-coast; the other a poor Cape plant with green flowers.

CORRIVAL, *v. n. n. s. & adj.* } Lat. *rivalis*
CORRIVALLEY, *n. s.* } To vie with;
CORRIVALSHIP, *n. s.* } to emulate; to contend with for any thing. A corrival is a competitor; corrival is contending with.

They had governours commonly out of the two families of the Geraldines and Butlers, both adversaries and *corrivalls* one against the other.

Spenser on Ireland.

He, that doth redeem her thence, might wear
 Without *corrival* all her dignities.

Shakespeare. Henry IV.

But with the sunne *corrivaling* in light.

Fitzgeffry.

CORRIVATE, *v. a.* } Lat. *corrivate*. To
CORRIVATION, *n. s.* } draw into one stream.
 The running of waters together into one stream.

Rare devices to *corrivate* waters. *Burton.*

Corrivations of waters to moisten and refresh barren grounds. *Id.*

CORROBORATE, *v. a. & adj.* } Fr. *corro-*
CORROBORANT, *adj.* } borer; Ital.
CORROBORATION, *n. s.* } *corroborare*;
CORROBORATIVE, *n. s. & adj.* } Span. *corro-*
borar; Lat. *corroborare*, from *con* and *robur*.
 To confirm; to give support to; to establish; to give strength. A corroborative, or corroborant, is that which increases strength. Corroborative testimony is that which confirms or strengthens other testimony. Corroboration is the act of strengthening; or confirming; additional confirmation; additional strength.

To fortify imagination there be three ways; the authority whence the belief is derived, means to quicken and *corroborate* the imagination, and means to repeat it and refresh it. *Bacon.*

Machiavel well noteth, though in an ill-favoured instance, there is no trusting to the force of nature, nor to the bravery of words, except it be *corroborate* by custom. *Id.*

The lady herself procured a bull, for the better *corroboration* of the marriage. *Id.*

There be divers sorts of bracelets fit to comfort the spirits; and they be of three intentions, refrigerant, *corroborant*, and aperient. *Id.*

In the cure of an ulcer, with a moist intemperies, as the heart is weakened by too much humidity, you are to mix *corroboratives* of an astringent faculty; and the ulcer also requireth to be dried.

Wiseman's Surgery.

It was said that the prince himself had, by the sight of foreign courts, and observations on the different natures of people, and rules of government, much excited and awaked his spirits, and *corroborated* his judgment. *Wotton.*

As any limb well and duly exercised grows stronger, the nerves of the body are *corroborated* thereby. *Watts.*

CORRODE, *v. a.*

CORRODIATE, *v. a.*

CORRODENT, *n. s.*

CORRODIBILITY, *adv.*

CORRODIBLE, *adj.*

CORROSION, *n. s.*

CORROSION, *n. s.*

CORROSION, *n. s.*

CORROSION, *n. s.*

CORROSION, *n. s.*

CORROSION, *n. s.*

CORROSION, *n. s.*

CORROSION, *n. s.*

CORROSION, *n. s.*

CORROSION, *n. s.*

CORROSION, *n. s.*

CORROSION, *n. s.*

CORROSION, *n. s.*

CORROSION, *n. s.*

CORROSION, *n. s.*

CORROSION, *n. s.*

CORROSION, *n. s.*

CORROSION, *n. s.*

CORROSION, *n. s.*

CORROSION, *n. s.*

CORROSION, *n. s.*

CORROSION, *n. s.*

CORROSION, *n. s.*

CORROSION, *n. s.*

CORROSION, *n. s.*

CORROSION, *n. s.*

CORROSION, *n. s.*

CORROSION, *n. s.*

CORROSION, *n. s.*

CORROSION, *n. s.*

CORROSION, *n. s.*

CORROSION, *n. s.*

CORROSION, *n. s.*

CORROSION, *n. s.*

CORROSION, *n. s.*

CORROSION, *n. s.*

CORROSION, *n. s.*

CORROSION, *n. s.*

CORROSION, *n. s.*

CORROSION, *n. s.*

CORROSION, *n. s.*

CORROSION, *n. s.*

CORROSION, *n. s.*

CORROSION, *n. s.*

CORROSION, *n. s.*

CORROSION, *n. s.*

CORROSION, *n. s.*

CORROSION, *n. s.*

CORROSION, *n. s.*

CORROSION, *n. s.*

CORROSION, *n. s.*

CORROSION, *n. s.*

CORROSION, *n. s.*

CORROSION, *n. s.*

CORROSION, *n. s.*

CORROSION, *n. s.*

CORROSION, *n. s.*

CORROSION, *n. s.*

CORROSION, *n. s.*

CORROSION, *n. s.*

CORROSION, *n. s.*

CORROSION, *n. s.*

CORROSION, *n. s.*

CORROSION, *n. s.*

CORROSION, *n. s.*

CORROSION, *n. s.*

CORROSION, *n. s.*

Fr. *corroder*;

It. *corrodere*;

Span. *corroer*;

Lat. *corrodere*,

from *con* and

rodere. To de-

stroy by slow

destruction of

the surface;

to eat into; to

waste away;

to consume

gradually. Corrodiate is obsolete, as is also cor-

rosive, used as a verb. Corrosive, as a noun,

denotes that which has the quality of wasting

any thing away, or of fretting or giving pain.

As an adjective, its meanings are obvious. The

kindred words are all closely allied in sense to

the root whence they spring.

He meant his *corrosives* to apply,

And with strict diet tame his stubborn malady.

Faerie Queene.

If the maintenance of ceremonies be a *corrosive* to such as oppugn them, undoubtedly to such as maintain them it can be no great pleasure, when they behold that which they reverence is oppugned. *Hooker.*

Such speeches savour not of God in him that useth them, and unto virtuously disposed minds they are grievous *corrosives*. *Id.*

Care is no cure, but rather *corrosive*,

For things that are not to be remedied.

Shakespeare. Henry VI.

Away! though parting be a fretful *corrosive*,

It is applied to a deathful wound. *Id.*

A kind of poison worketh either by *corrosion*, or by a secret malignity and enmity to nature.

Bacon's Natural History.

Statesmen purge vice with vice, and may *corrode*

The bad with bad, a spider with a toad;

For so ill thralls not them, but they tame ill,

And make her do much good against her will.

Donne.

We do infuse, to what he meant for meat,

Corrosiveness, or intense cold or heat. *Id.*

Metals, although *corrodible* by waters, yet will not suffer a liquation from the powerfulest heat communicable unto that alment. *Brown's Vulgar Errors.*

The nature of mankind, left to itself, would soon have fallen into dissolution, without the incessant and *corroding* invasions of so long a time.

Hale's Origin of Mankind.

Gold, after it has been divided by *corrosive* liquors into invisible parts, yet may presently be precipitated, so as to appear again in its own form.

Grew's Cosmologia.

Fishes, which neither shew their meat, nor grind it in their stomachs, do by a dissolvent liquor there provided, *corrode* and reduce it into a chylus.

Ray on the Creation.

We know that aqua-fortis *corroding* copper, which is it that gives the colour to verdigrease, is wont to reduce it to a green-blue solution. *Boyle.*

At first it tasted somewhat *corrosively*. *Id.*

Saltpetre betrays upon the tongue no heat nor *corrosiveness* at all, but coldness, mixt with a somewhat languid relish retaining to bitterness. *Id.*

Hannibal the Pyreneans past,
 And steepy Alps, the mounds that nature cast;

And with *corroding* juices, as he went,

A passage through the living rock he rent.

Dryden's Juvenal.

2 M 2

That *corrosion* and dissolution of bodies, even the most solid and durable, which is vulgarly ascribed to the air, is caused merely by the action of water upon them; the air being so far from injuring and preying upon the bodies it environs, that it contributes to their security and preservation. *Woodward.*

The blood turning acrimonious, *corrodes* the vessels, producing almost all the diseases of the inflammatory kind. *Arbuthnot.*

Should jealousy its venom once diffuse,
Corroding every thought, and blasting all
Love's paradise. *Thomson's Spring.*

The sacred sons of vengeance, on whose course
Corrosive famine waits, and kills the year. *Id.*

The anodyne draught of oblivion, thus drugged, is well calculated to preserve a galling wakefulness, and to feed the living ulcer of a *corroding* memory. *Burke.*

The life-blood streaming through my heart,
Or my more dear immortal part,
Is not more fondly dear!

When heart-*corroding* care and grief
Deprive my soul of rest,
Her dear idea brings relief
And solace to my breast. *Burns.*

Like them, abandoned to ambition's sway,
I sought for glory in the paths of guile;
And fawned and smiled, to plunder and betray,
Myself betrayed and plundered all the while:
So gnawed the viper the *corroding* file. *Beattie.*

The cankered spoil *corrodes* the pining state,
Starved by that indolence their mines create. *Cowper.*

A fretful temper will divide
The closest knot that may be tied,
By ceaseless sharp *corrosion*;
A temper passionate and fierce,
May suddenly your joys disperse
At one immense explosion. *Id.*

And dost thou ask, what secret woe
I bear, *corroding* joy and youth?
And wilt thou plainly seek to know
A pang, even thou must fail to soothe? *Byron.*

CORROSIVE MURIATE, or CORROSIVE SUBLIMATE. See HYDRARGYRUS MURIATUS.

CORROSIVES, in surgery, are chiefly burnt alum, red and white precipitates of mercury, white vitriol, butter of antimony, lapis infernalis, &c. See ESCHAROTICS.

CORRODY, *n. s.* from Lat. *corrodo*. A defalcation from an allowance or salary; for some other than the original purpose.

Besides these floating burgesses of the ocean, there are certain flying citizens of the air, which prescribe for a *corrody* therein. *Carew.*

In those days even noble persons, and other meaner men, ordered *corrodies* and pensions to their chaplains and servants out of churches. *Ayliffe's Parergon.*

CORRRUGATE, *v. a. & adj.* } Fr. *corruga-*
CORRUGATION, *n. s.* } tion; Lat. *cor-*
CORRUGANT, *adj.* } rugare, from
con and *rugare*. To draw up into wrinkles or furrows; to contract; contraction into wrinkles; having the power of causing to wrinkle.

The cramp cometh of contraction of sinews: it cometh either by cold or dryness; for cold and dryness do both of them contract and *corrugate*.

Bacon's Natural History.

The pain of the solid parts is the *corrosion* or violent agitation of the fibres, when the spirits are irritated by sharp humours. *Floyer on the Humours.*

Extended views a narrow mind extend;
Push out its *corrugate*, expansive make. *Young.*

CORRU'PT, *v. a., n. & adj.* } Fr. *corrompre*; Ital. *corrompere*; Sp. *corrumpir*; Latin, *corrumper*, from *con* and *rumpere*. To mar; to de-
CORRU'PTER, *n. s.* } bauch; to de-
CORRU'PTFUL, *adj.* } file; to per-
CORRUPTIBLY, *adv.* } vert; to de-
CORRUPTIBLE, *n. s. & adj.* } prave; to taint;
CORRUPTIBLY, *adv.* } to become pu-
CORRUPTIBLENESS, *n. s.* } trid; to bribe. These are the meanings of the
CORRUPTING, *n. s.* } verb, and they run through all the kindred
CORRUPTION, *n. s.* } words. For the legal sense attached to corrup-
CORRUPTIVE, *adj.* } tion, see CORRUPTION OF BLOOD.
CORRUPTLESS, *adj.* }
CORRUPTLY, *adv.* }
CORRUPTNESS, *n. s.* }

We have dealt very *corruptibly* against thee, and have not kept the commandments. *Nehemiah i. 7.*

I fear lest by any means, as the serpent beguiled Eve through his subtily, so your minds should be *corrupted* from the simplicity that is in Christ. *2 Corinthians xi. 3.*

Evil communications *corrupt* good manners. *1 Corinthians xv. 33.*

So when this *corruptible* shall have put on incorruption, and this mortal shall have put on immortality, &c. *Id. v. 54.*

Let no *corrupt* communication proceed out of your mouth, but that which is good to the use of edifying. *Ephesians iv. 29.*

What they know naturally, as brute beasts, in those things they *corrupt* themselves. *Jude 10.*

The clotered blood for any leche-craft,
Corrupeth and is in his bouke ylef. *Chaucer. Cant. Tales.*

For Nature hath not taken his beginning
Of no partie ne cantel of a thing,
But of a thing that parfit is and stable,
Descending so till it be *corruppable*. *Id.*

A maner Latin *corrupt* was hire speche,
But algate therby was she understond. *Id.*
Corrupt was all this world for glotonie. *Id.*

Her breath *corrupt*, her keepers every one
Abhorring her, her sickness past recure. *Sackville.*

After that they againe returned beene,
That in that garden planted be agayne,
And grow afresh, as they had never seene
Fleahly *corruption*, nor mortal payne. *Spenser. Faerie Queene.*

Superfluous flesh did rot,
Amendment ready still at hand did wait,
To pluck it out with pincers fiery hot,
That soon in him was left no *corrupt* jot. *Id.*

Throw thyself down, with trembling innocence,
Nor dare look up with *corruptible* eye
On the dread face of that great Deity. *Spenser. Hymn of Heavenly Beauty.*

Our *corruptible* bodies could never live the life they shall live, were it not that they are joined with his body which is incorruptible, and that his is in ours as a cause of immortality. *Hooker.*

Corrupt, corrupt, and tainted in desire. Shakespeare.

But stay, I smell a man of middle earth ;
With trial fire touch me his finger-end ;
If he be chaste, the flame will back descend,
And turn him to no pain ; but if he start,
It is the flesh of a corrupted heart.

Id. Merry Wives of Windsor.

After my death I wish no other herald,
No other speaker of my living actions,
To keep mine honour from corruption,
But such an honest chronicler as Griffith.

Id. Henry VIII.

These kind of knaves I know, which in this plain-
ness

Harbour more craft, and more corrupter ends,
Than twenty silky ducking observants. *Id. King Lear.*

It is too late ; the life of all his blood
Is touched corruptibly. *Id.*

Peace, thou rude bawd !
Thou studied old corrupter, tye thy tongue up.
Beaumont and Fletcher.

From the vanity of the Greeks, the corrupters of all
truth, who without all ground of certainty vaunt their
antiquity, came the error first of all.

Raleigh's History of the World.

The region hath by conquest, and corruption of
other languages, received new and differing names. *Id.*

The aptness or propension of air or water to corrupt
or putrefy, no doubt, is to be found before it break
forth into manifest effects of diseases, blasting, or the
like. *Bacon.*

We have corruptly contracted most names, both of
men and places. *Camden's Remains.*

But though corruption cannot touch the mind,
By any cause that from itself may spring,
Some outward cause fate has perhaps designed,
Which to the soul may utter quenching bring.

Darwin.

It is a devouring corruption of the essential mix-
ture, which, consisting chiefly of an oily moisture, is
corruptible through dissipation.

Harvey on Consumptions

Language being the conduit whereby men convey
their knowledge, he that makes an ill use of it, though
he does not corrupt the fountains of knowledge, which
are in things, yet he stops the pipes. *Locke.*

Be the cause what it will, our Saviour found man-
kind under a corruption of manners and principle,
which ages after ages had prevailed, and must be
confessed was not in a way or tendency to be mended. *Id.*

It should be endued with an acid ferment, or some
corruptive quality, for so speedy a dissolution of the
meat and preparation of the chyle.

Ray on the Creation.

Some, who have been corrupt in their morals, have
yet been infinitely solicitous to have their children
piously brought up. *South's Sermons.*

All around

The borders with corruptless myrrh are crowned.
Dryden.

The several parts of which the world consists being
in their nature corruptible, it is more than probable,
that, in an infinite duration, this frame of things
would long since have been dissolved. *Tillotson.*

The wise contriver, on his end intent,
Careful this fatal error to prevent,
And keep the waters from corruption free,
Mixed them with salt, and seasoned all the sea.
Blackmore.

These great corrupters of Christianity, and indeed
of natural religion, the Jesuits. *Addison.*

Precepts of morality, besides the natural corruption
of our tempers, which makes us averse to them, are so
abstracted from ideas of sense, that they seldom get
an opportunity for descriptions and images.

Addison on the Georgicks.

Hear the black trumpet through the world pro-
claim,

That not to be corrupted is the shame. *Pope.*

Amidst corruption, luxury, and rage,
Still leave some ancient virtues to our age. *Id.*

As Rochefoucault his maxims drew
From nature, I believe them true ;
They argue no corrupted mind
In him ; the fault is in mankind. *Swift.*

The corruptions of the country are closely allied to
those of the town, with no further difference than
what is made by another turn of thought and method
of living. *Burke.*

No revenue, no, not a royal revenue, can exist
under the accumulated charge of ancient establish-
ment, modern luxury, and parliamentary political
corruption. *Id.*

These charms shall work thy soul's eternal health,
And love, and gentleness, and joy, impart.
But these thou must renounce, if lust of wealth
E'er win its way to thy corrupted heart. *Beattie.*

Thou polished and high finished foe to 'ruth,
Gray beard corrupter of our listening youth,
To purge and skim away the filth of vice,
That so refined it might the more entice,
Then pour it on the morals of thy son ;
To taint his heart, was worthy of thine own ! *Cowper.*

Would it not be right, then, to pull down this fabric
of corruption, to recall the government to its original
principles, and to re-establish the constitution upon
its true basis ? *Sheridan.*

CORRUPTION. See PUTREFACTION.

CORRUPTION OF BLOOD, in law. This is one of
those notions which our laws have adopted from
the feudal constitutions at the time of the Nor-
man conquest. It was unknown in those tenures
which are indisputably Saxon, or Gavel-kind,
wherein, though by treason, according to the an-
cient Saxon laws, the land is forfeited to the king,
yet no corruption of blood, no impediment of de-
scents, ensues ; and on judgment of mere felony,
no escheat accrues to the lord. But, by the law
of England, derived as above, a man's blood is
so universally corrupted by attainder, that his
sons can neither inherit to him nor to any other
ancestor, at least on the part of their attainted
father. See ATTAINDER. This corruption of
blood cannot be absolutely removed but by au-
thority of parliament. The king may excuse the
public punishment of an offender ; but cannot
abolish the private right which has accrued, or
may accrue, to individuals as a consequence of
the criminal's attainder. He may remit a for-
feiture in which the interest of the crown is alone
concerned ; but he cannot wipe away the corrup-
tion of blood ; for therein a third person hath an
interest, the lord who claims by escheat. If,
therefore, a man has a son, and is attainted, and
afterwards pardoned by the king ; this son cannot
inherit to his father, or father's ancestors ; be-
cause his paternal blood, being once corrupted
by his father's attainder, must continue so ; but if
the son has been born after the pardon, he may
inherit ; because, by the pardon, the father is
made a new man, and may convey new inherita-

ble blood to his after-born children. This corruption of blood has been long considered as a peculiar hardship; because the oppressive parts of the feudal tenures being now in general abolished, it seems unreasonable to reserve one of their most inequitable consequences. And therefore in most, if not all, of the new felonies treated by parliament since the reign of Henry VIII. it is declared that they shall not extend to any corruption of blood; and by the statute 7 Anne, cap. 21, the operation of which is postponed by the statute 17 Geo. II cap. 39, it is enacted, that after the death of the late Pretender and his sons, no attainder for treason shall extend to the disinheriting any heir, nor the prejudice of any person, other than the offender himself.

CORRUPTICOLÆ, a sect who rose out of the Monophysites in Egypt, about A. D. 519, under their chief Severus, the pretended patriarch of Alexandria. Their distinguishing doctrine was, that the body of Jesus Christ was corruptible; and that to deny it was to deny the truth of our Saviour's passion. On the other hand, Julian of Halicarnassus, another Eutychian, a refugee as well as Severus, in Alexandria, maintained that the body of Jesus Christ had been always incorruptible; that to say it was corruptible was to make a distinction between Jesus Christ and the Word, and by consequence to make two natures in Jesus Christ. The people of Alexandria were divided between the two opinions; the partisans of Severus were called *Corrupticolæ*, q. d. worshippers of something corruptible; and sometimes *Corruptibiles*; and the adherents of Julian *Incorruptibiles*, or *Phantasiastæ*. The clergy and secular powers favored the first; the monks and the people the latter.

CORSAIR, *n. s.* A pirate, or sea-robber; the vessel of a pirate.

He left a *corsair's* name to other times,
Linked with one virtue, and a thousand crimes.

Byron.

CORSAIR. The name is commonly given to the piratical cruisers of Barbary, who had their rise about the beginning of the sixteenth century. A corsair is distinguished from a privateer in this, that the latter has a commission, and only attacks the vessels of those at war with the state whence his commission his derived. The punishment of a corsair is to be hanged, without remission; whereas privateers are to be treated as prisoners of war. All corsair vessels are good prizes.

CORSELET, *v. a. & n. s.* Fr. *corselet*. A light armor for the forepart of the body. To encircle as a corselet does.

Some shirts of mail, some coats of plate put on,
Some doned a cuirace, some a corselet bright. *Fairfax.*

Her arms,

Able to knock Jove from a synod, shall
By warranting moonlight corselet thee.

Beaumont and Fletcher.

They lash, they foin, they pass, they strive to bore
Their corselets, and their thinnest parts explore.

Dryden.

But heroes, who o'ercome or die,
Have their hearts hung extremely high;
The strings of which, in battle's h. at,
Against their very corselets beat.

Prior.

CORSELETS were light breast-plates made to cover the whole body, anciently worn by the pike-men, who were usually placed in the front and flanks of the battle. Corselet also denotes a little cuirass.

CORSE PRESENT, *n. s.* A funeral present; a mortuary.

CORSET, *n. s.* French. A pair of boddice for a female.

CORSHAM, or **COSHAM**, a market town of England, in Wiltshire, where king Ethelred had anciently a palace, which the earls of Cornwall afterwards made their chief residence. It is now considerable for its woollen manufacture; and has a weekly market on Wednesday. The town is well built, and consists chiefly of a single street, in which stands a handsome market-house. The church is a fine ancient building. It is five miles south-west of Chippenham, and ninety-six west of London.

CORSICA, one of the largest islands in the Mediterranean, is situate between the territory of Genoa and the island of Sardinia, or between 41° and 42° of N. lat. and 8° and 10° of E. long. Its length is about 110 miles; its breadth very unequal; being in some places only a few French leagues. On account of the numerous gulfs and creeks which indent the coasts of this island, it is extremely difficult to ascertain its precise extent; it cannot, however, be less than 120 leagues round, and its superficies may be computed to contain 527 square leagues.

Corsica abounds in mountains; a vast range of which, in the shape of a cross, completely traverses the island, the summits of many of them glittering with perpetual snow. The two most celebrated for their height are Monte Rotondo (the Mons Aureus of the ancients), and Monte d' Oro, the former 9900 feet above the level of the sea, and the other 8720 feet. Fertile valleys extend on all sides of these mountains, reaching even to the coasts. The principal lakes are the Ino and the Creno, both situated in the interior of the island. The chief river is the Golo, which takes its rise from the lake Ino, and has a course of upwards of seventy miles. The Tarignano is also a considerable river, rising from the Lake Creno, and extending through the most uncultivated tract of the island. The Restonica may be mentioned, not so much on account of its size, as for the singular property it possesses of whitening every thing over which its waters flow. Besides these, there are many more of minor importance, which at once enrich and beautify the island.

The climate of Corsica is on the whole salubrious, instances of longevity being by no means unfrequent. The cold proceeding from the mountains is tempered by the sea-breezes, whilst, on the other hand, the piercing winds which blow over them considerably moderate the intensity of the summer's heat. The winters have been thought severe, and are not unfrequently accompanied by tremendous storms, yet, excepting in the neighbourhood of the stagnant pools, the air is for the most part clear and serene. The soil produces wheat, rye, barley, and millet, excellent wine, oranges, lemons, figs, and a variety of other fruits; but the chief wealth of the island consists

in its oil, chestnuts, and timber. The forests are particularly valuable, and very extensive. At the time this island came into the possession of the French, in the year 1768, it was ascertained that 160 square leagues of its surface were covered with forests. The most considerable at present is that of Vico. Among the resinous trees found in the Corsican forests, the pine and larch stand pre-eminent, both as respects the beauty of their form and foliage, and the excellence of their timber. Its agriculture is in a very rude state. The Corsican sheep are in general black or tawny; the mutton, however, is exceedingly delicate, and yields a very rich juice. The horned cattle are of a very inferior quality, and give but very little milk. Oil, as in Italy and all hot countries, supplies the place of butter. The mufoli, a kind of wild ram, covered with hair instead of wool, is an inhabitant of the loftier mountains; it is scarcely possible to approach it in a wild state, but, being taken young, it is easily tamed. Vast numbers of goats, deer, and wild boars, are also found in this island. Hunting the wild boar is one of the most favorite sports of the inhabitants; to pursue which they breed a peculiar race of dogs, between the mastiff and the shepherd's dog. Bees abound here, but the honey is somewhat bitter, owing, it is supposed, to the free access which the bees have to the box-wood and yew. Foxes, of a very large size, and extremely ravenous disposition, are also abundant on this island; but there are no wolves, and but very few venomous animals. The fisheries on the coast are very productive.

Among the mineral productions of Corsica may be mentioned silver, copper, lead, iron, antimony, granite, alum, porphyry, and jasper; serpentine stone, talc, saltpetre, rock-crystals, and asbestos. The silver mines are also rich, and the iron is said to equal the prepared ores of Spain in durability. The manufactures are coarse linen and woollen cloths and stuffs (goods of a finer description being imported), leather, lamp oil, wax and tallow candles, guns, and pistols.

The trade of this island is very inconsiderable, although it enjoys great commercial capabilities, both as it respects its natural productions and situation. The coast affords excellent anchorage to shipping; and there are numerous ports, into which the largest vessels can enter, and remain perfectly secure from storms. Its population amounted in 1740 to only 120,389, and in 1815 to 174,702. The intestine wars which have harassed this island for ages, will serve to account for its paucity of inhabitants. Pliny mentions no less than thirty-three large towns of Corsica; at present they are reduced to nine. By an enumeration which took place in the year 1740, this island was found to contain 133 parishes, 427 villages, and 26,854 hearths.

The literature of Corsica is at a very low ebb; since the island came last into the possession of the French, however, the education of their youth has been conducted on a much more liberal principle. In religion the Corsicans are Roman Catholics, and profess great zeal. There are five bishops in the island, who are suffragans of the archbishop of Pisa; about sixty-five convents of mendicant friars, who depend entirely on the

charity of the people for their support; two colleges of Jesuits; two convents of Dominicans; five of Servites; and one of missionaries; all of which have good possessions. There are no nunneries in the island.

Strabo describes the ancient Corsicans as brutal, ferocious, and stupid, but at the time he wrote, they were under the yoke of a tyrant. Pliny speaks of them whilst they enjoyed the protection of a more equitable master, as just, generous, valiant, and humane. In modern times the Genoese have painted them in the blackest colors, but they were at the very time ruling them with a rod of iron. Frederick the Great and Rousseau have praised them for their love of liberty and courage. Corsica has been successively conquered by the Carthaginians, the Romans, the Vandals, the Goths, the Lombards, the Saracens, the Franks, the Pisans, and the Genoese. Till the year 1736 it had groaned under an accumulating weight of misery: the imposition of another tax at this period, however, at once aroused their dormant courage, and the intrepid Stephen Theodore, baron de Neuhoff, arriving on the island at this juncture, they chose him for their leader, and proclaimed him king of Corsica and Capraia. He devoted himself with assiduity to their service, and procured supplies of money, arms, and provisions; and at tacked, with great intrepidity, the fortresses held by the Genoese. In the moment of enthusiasm, he succeeded in expelling the enemy from the island. But his triumph was of short duration; for the Genoese, having secured the assistance of France, again compelled the Corsicans to submit to their yoke; the baron was taken and thrown into prison, where he died, in extreme indignation, in 1755.

In 1753 the Corsicans had chosen the celebrated Pascal Paoli for their general. He enrolled all the inhabitants capable of bearing arms, disciplined his troops, caused money to be coined, and made his administration at once feared and respected. He waged a successful war with the Genoese, for the space of four years. They on their side, having become tired of the protracted contest, sold, in 1768, the sovereignty of the island to France. Hereupon the French invaded Corsica, with an army of 5000 men, under the command of the marquis de Chauvelin, supported by a naval force consisting of two ships of the line, two frigates, and six armed brigantines. Paoli defended his country to the last, but on the French receiving a reinforcement, under the command of the count de Vaux in 1769, he was obliged to seek an asylum in England. Paoli returned to Corsica in 1792, after having taken the oath of fidelity to the national assembly of France. He was elected mayor of Bastia, commander in chief of the national guard, and president of the department; but the execution of Louis XVI. at Paris, holding out every prospect of a civil war in France, Paoli embraced this opportunity to revolt, and called in the aid of England. After a violent struggle, the towers of Marsella, Fornelli, and San Fiorenzo were taken by the British troops, commanded by lieutenant-general Dundas, and shortly afterwards Corsica was declared united with Great Britain. On the 19th of

June, 1794, Sir Gilbert Elliot, the present lord Minto, was invested with the dignity of viceroy. Corsica did not, however, remain an appendage to the British crown for a long time; mutual jealousies arose between the English viceroy and Paoli, and the latter embarked for England, but not till he had exhorted his countrymen to maintain their allegiance to Great Britain. The dazzling splendor of the victories of their countryman, Buonaparte, made them forget the exhortations of Paoli, however, and they once more returned to their allegiance to France. The English troops finally evacuated the island in 1796. Corsica is at present a department of the French empire: the revenue drawn from it, however, barely equals the expenses of its administration.

CORSNED, or morsel of execration, a species of trial, or purgation, anciently in use. It consisted of a piece of cheese or bread, about an ounce in weight, which was consecrated with a form of exorcism; desiring of the Almighty that it might cause convulsions and paleness, and find no passage if the man was really guilty, but might turn to health and nourishment if he was innocent; as the water of jealousy among the Jews was, by God's especial appointment, to cause the belly to swell, and the thigh to rot, if the woman was guilty of adultery. This corsned was given to the suspected person, who, at the same time, received the sacrament. Historians assure us, that Godwin, earl of Kent, in the reign of king Edward the Confessor, abjuring the death of the king's brother, at last appealed to his corsned, which stuck in his throat and killed him. This custom has been long abolished, but the remembrance of it still subsists in certain phrases of abjuration; as, 'I will take the sacrament upon it;' 'May this morsel be my last,' &c.

CORSOER, a town of Denmark, on the west coast of Zealand, in a small peninsula, which extends into the Great Belt, that separates Zealand from Funen. It has a good harbour fit for light vessels, and is defended by a fort. It lies fifty-two miles south-west of Copenhagen.

CORT (Cornelius), a celebrated engraver, born at Hoorn, in Holland, in 1536. He went to Italy to complete his studies, and at Venice was courteously received by Titian, and engraved several plates from his pictures. He at last settled at Rome, where he died in 1578, aged forty-two. Bafan says, he was 'the best engraver with the burin, or graver only, that Holland ever produced.' Augustine Caracci was his scholar, and imitated his style. His engravings are very numerous; 151 according to Abbe Marolles.

CORTEMIGLIA, a town of Italy, in Piedmont, and late duchy of Montserrat, seated on the Bormida. Part of the town is defended with a wall and ancient towers: the other part, which is built at the foot of a hill, is surrounded by the river. It had anciently a beautiful castle, now fallen to decay. It is four miles north of Gorzegno, and sixteen east of Cherasco.

CORTES (Ferdinand), a Spanish general, born in Estramadura in 1485. He was bred at Salamanca to the law, which he, however, left for a military life, and in 1504 went to St. Domingo.

In 1511 he accompanied Velasquez to Cuba, and was chosen to conduct the troops sent for the conquest of Mexico. He first landed at Tabasco; soon after which, he destroyed his vessels, that his soldiers might have no retreat. After reducing the province of Tlascalca, Cortes marched directly to Mexico, which he conquered, and made the emperor Montezuma prisoner. In the mean time, Velasquez, being jealous of his success, sent a fleet against him, but without any effect; and Cortes completed the reduction of the Mexican empire in 1531, though not without committing the most horrible cruelties on the vanquished, without regard to rank, age, or sex. It probably was on this account he was coolly received on his return to Europe by Charles V. It is even said, that the emperor asked him who he was, to which Cortes replied, 'I am the man who has given you more provinces than your ancestors left you towns.' He died in 1554, aged sixty-three.

CORTEX, *n. s.* } Lat. *cortex*. The rind
CO'RTICAL, *adj.* } or bark of planks; a
CO'RTICATED, *adj.* } cover. Barky; belong-
CO'RTICOSE, *adj.* } ing to the rind. Resembling the rind of a tree. Full of bark.

This animal is a kind of lizard, a quadruped *cori- cated* and depilous; that is, without wood, fur, or hair. *Brown.*

Their last extremities form a little gland (all these little glands together make the *cortical* part of the brain), terminating in two little vessels.

Cheyne's Philosophical Principles.

CORTLANDT, a township of New York, in the northern part of the county of West Chester, on the east bank of Hudson river.

CORTON, an ancient town of Italy, in Etruria, mentioned by the Roman historians, seated north of the lake Thrasymenus; now called Cortona.

CORTONA, a town of Italy, in Tuscany, with a bishop's see and a celebrated academy. It contains seven churches, built with taste, and adorned with beautiful paintings; and several convents. It is thirty miles south-east of Sienna.

CORTUSA, bear's ear sanicle, a genus of the monogynia order, and pentandria class of plants, natural order twenty-first, precise: *cor.* wheel-shaped, with its throat like an elevated ring: *cap.* unilocular, oval, quinquevalved at the top. There are two species, both very low, flowery, herbaceous perennials, crowned by umbels of monopetalous wheel-shaped flowers, of a fine red color. Being natives of mountainous rocky parts abroad, they must have a dry lean soil; or they may be kept in pots of dry sandy earth in the shade, and in summer duly watered. Their propagation here is by slipping the roots in October.

CORVE'E, from *cura vis*, Lat. i. e. care of the road; in the ci-devant French customs, a kind of duty similar to that of our statute labor, but much more oppressive. Individuals were called upon to furnish both labor and materials for the construction and repair of the roads; and, upon this iniquitous system, all the roads in France were made and repaired, as there were no turnpikes. It was abolished in 1774 by the celebrated M. Turgot.

CORVETTE, *n. s.* French. A vessel of war, having fewer than twenty guns.

CORVETTO, *n. s.* The curvet. You must draw the horse in his career with his mane, and turn, doing the *corvetto* and leaping.

Peacocks on Draining.

CORVEY, a small principality of Germany, in the circle of Westphalia, twelve miles long, and twelve broad, with a town so named, and a celebrated abbey, founded A.D. 822. In the treaty of indemnification to those princes who had suffered by the cessions to France at the treaty of Luneville, this principality was transferred to Nassau Dillenburg. It lies on the west bank of the Weser, twenty-four miles east of Paderborn.

CORUNNA, a sea-port town of Spain, in the province of Galicia, of which it is called the capital, from being the seat of a royal residence, of a governor-general, and the intendant of the province. It is divided into the upper and lower towns. The former is seated on the side of a hill, surrounded with walls, and defended by a castle; the latter, called also the Paxeria, is situated at the bottom of a hill, on a tongue of land, washed on three sides by the Atlantic Ocean. The town is of a circular form, fortified in the ancient manner, and contains one collegiate, and four parish-churches, and four convents. The harbour is large and safe, and defended by two castles. The objects of interest are the royal arsenal, and an ancient tower, admired for its elevation and solidity. The population is about 4000, exclusive of the military. The harbour is spacious and secure, and provided with a handsome quay. On a high mountain, about three miles from it, is a light-house, which is discerned at sea for twenty leagues round Corunna. It is on the whole a commercial place; its principal articles of export being pilchards and cattle. A packet sails hence every month for the Havannah, touching at Porto Rico; another was usually despatched every two months to Buenos Ayres, Chili, Peru, and the Philippine Isles. The intercourse likewise between Spain and England, is chiefly kept up by packets from Corunna to Falmouth.

We must indulge ourselves by transferring to our pages, with some slight alteration, Dr. Southey's spirited narrative of the celebrated modern battle which takes its name from this town:—

'A British division, under general Hope, occupied a hill on the left, commanding the road to Betanzos; the height decreased gradually to the village of Elvina, taking a curved direction. At this village general Baird's division commenced, and bent to the right; the whole formed nearly a semicircle. On the right of Sir David Baird, the rifle corps formed a chain across a valley, and communicated with general Fraser's division, which was drawn up about half a mile from Corunna, near the road to Vigo. The reserve, under general Paget, occupied a village on the Betanzos road, about half a mile in the rear of general Hope. Outside of these posts was a magazine of 4000 barrels of gunpowder. It was now necessary to blow it up: the explosion shook the town like an earthquake, and a village near was totally destroyed.

'The French made their appearance on the morning of the 12th of January, 1809; but the British preparations for embarking were continued until the morning of the 16th, and the general gave notice that he intended, if the French did not move, to begin embarking the reserve at four in the afternoon.

'This was about mid-day. He mounted his horse, and set off to visit the out-posts; before he had proceeded far, a messenger came to tell him that the enemy's line were getting under arms; and a deserter arriving at the same moment, confirmed the intelligence. He spurred forward. Their light troops were pouring rapidly down the hill on the right wing of the British, and the advanced picquets were already beginning to fire. Lord William Bentinck's brigade, consisting of the 4th, 42d, and 50th regiments, maintained this post. The guards were in their rear. General Paget was ordered to advance with the reserve, and support lord William. The enemy opened a cannonade from eleven heavy guns, advantageously planted on the hills. Two strong columns, one advancing from a wood, the other skirting its edge, directed their march towards the right wing. A third column approached the centre; a fourth advanced slowly upon the left; a fifth remained half way down the hill, in the same direction. Both in number and weight of guns they had a decided superiority; and they fired with great effect from their commanding situation. Sir David Baird had his arm shattered with a grape-shot as he was leading on his division. The two lines of infantry advanced against each other; they were separated by stone walls and hedges which intersected the ground; but as they closed, it was perceived that the French line extended beyond the right flank of the British, and a body of the enemy was observed moving up the valley to turn it. Marshal Soult's intention was to force the right of the British, and thus to interpose between Corunna and the army, and cut it off from the place of embarkation. Failing in this attempt, he was now endeavouring to outflank it. Half of the 4th regiment was, therefore, ordered to fall back, forming an obtuse angle with the other half. This manœuvre was excellently performed, and they commenced a heavy flanking fire: Sir John Moore called out to them, that this was exactly what he wanted to be done, and rode on to the 50th, commanded by majors Napier and Stanhope. They charged the enemy most gallantly, and drove them out of the village of Elvina. The general now proceeded to the 42d. 'Highlanders,' said he, 'remember Egypt!' They rushed on, and drove the French before them till they were stopped by a wall; Sir John accompanied them in this charge. He now sent captain Hardinge to order up a battalion of guards to the left flank of the 42d. The officer commanding the light infantry conceived, at this, that they were to be relieved by the guards, because their ammunition was nearly expended, and he began to fall back. The general, discovering the mistake, said to them, 'My brave 42d, join your comrades; ammunition is coming, and you have your bayonets!' Upon this, they

instantly moved forward. Captain Hardinge returned, and pointed out to the general where the guards were advancing. The enemy kept up a hot fire, and their artillery played incessantly on the spot where they were standing. A cannon-shot struck Sir John, and carried away his left shoulder, and part of the collar-bone, leaving the arm hanging by the flesh. He fell from his horse on his back, his countenance did not change, neither did he betray the least sensation of pain. Captain Hardinge, who dismounted, and took him by the hand, observed him anxiously watching the 42d, which was warmly engaged, and told him they were advancing; and upon that intelligence his countenance brightened. Colonel Graham, who now came up to assist him, seeing the composure of his features, began to hope that he was not wounded, till he perceived the dreadful laceration. From the size of the wound, it was in vain to make any attempt at stopping the blood; and Sir John consented to be removed in a blanket to the rear. In raising him up, his sword, hanging on the wounded side, touched his arm, and became entangled between his legs; captain Hardinge began to unbuckle it, but the general said, in his usual tone and manner, and in a distinct voice, 'It is as well as it is; I had rather it should go out of the field with me.' Six soldiers of the 42d and the guards bore him. Hardinge, observing his composure, began to hope that the wound might not be mortal, and said to him, he trusted he might be spared to the army, and recover. Moore turned his head, and looking steadfastly at the wound for a few seconds, replied, 'No, Hardinge, I feel that to be impossible.'

'As the soldiers were carrying him slowly along, he made them frequently turn round, that he might see the field of battle, and listen to the firing, and he was well pleased when the sound grew fainter. A spring-waggon came up, bearing colonel Wynch, who was wounded: the colonel asked who was in the blanket, and being told it was Sir John Moore, wished him to be placed in the waggon. Sir John asked one of the Highlanders whether he thought the waggon or the blanket was best? and the man said the blanket would not shake him so much, as he and the other soldiers would keep the stop, and carry him easy. So they proceeded with him to his quarters at Corunna, weeping as they went.'

'General Paget, meantime, hastened with the reserve to support the right wing. Colonel Beckwith dashed on with the rifle corps, repelled the enemy, and advanced so far as nearly to carry off one of their cannon; but a corps, greatly superior, moved up the valley, and forced him to retire. Paget, however, attacked this body of the enemy, repulsed it, and pressed on, dispersing every thing before him, till the enemy, perceiving their left wing was now quite exposed, drew it entirely back. The French then advanced upon generals Manningham and Leith, in the centre, and there they were more easily repelled, the ground being more elevated, and favorable for artillery. The position on the left was strong, and their effort there was unavailing; but a body of them took possession of

a village on the road to Betanzos, and continued to fire from it, till lieutenant-colonel Nicholls attacked it, and beat them out. Night was now closing in, and the French had fallen back in all parts of the field. The firing, however, was not discontinued till it was dark. Never was any battle gained under heavier disadvantages. The French force exceeded 20,000 men, the British were not 15,000. The superiority in artillery was equally great. The enemy had met English guns on the way, sent off, thus late, to the patriotic armies, and these they had turned back, and employed against the English.' It is twenty-eight miles north of Compostella, and thirty north-west of Lugo.

CORVO, the smallest island of the Azores, being only twelve miles in circumference. It abounds in crows, whence the name.

CORUSCATE, *v. n.* } Lat. *coruscare*. To
CORUSCATION, *n. s.* } glitter; to dart forth
CORUSCANT, *adj.* } flashes or sparkles of
 light. A flash; a rapid darting forth, or vibration, of light. Glittering by flashes.

We see that lightnings and *coruscations*, which are near at hand, yield no sound. *Bacon's Natural Hist.*

We may learn that sulphurous steams abound in the bowels of the earth, and ferment with minerals. and sometimes take fire with a sudden *coruscation* and explosion. *Newton's Opticks.*

How heat and moisture mingle in a mass,
 Or belch in thunder, or in lightning blaze;
 Why mimbic *coruscations* strike the eye,
 And bold tornadoes bluster in the sky

Garth's Dispensary.

As flaming fire was more *coruscating* and enlightening than any other matter, they invented lamps to hang in the sepulchres of the rich, which would burn perpetually. *Greenhill.*

The line of lights, too, up to Charing Cross,

Pall Mall, and so forth, have a *coruscation*

Like gold as in a comparison to dross,

Matched with the continent's illumination,

Whose cities Night by no means deigns to gloss.

Byron. Don Juan.

CORUSCATIONS, ARTIFICIAL. There is a method of producing artificial *coruscations* or sparkling fiery meteors, which will be visible not only in the dark but at noon-day, and that from two liquors actually cold. Fifteen grains of solid phosphorus are to be melted in about a drachm of water; when this is cold, pour upon it about two ounces of oil of vitriol; let these be shaken together, and they will at first heat, and afterwards they will throw up fiery balls in great numbers, which will adhere like so many stars to the sides of the glass, and continue burning for a considerable time; after this, if a small quantity of oil of turpentine is poured in, without shaking the phial, the mixture will of itself take fire, and burn very furiously. The vessel should be large, and open at the top. Artificial *coruscations* may also be produced by means of oil of vitriol and iron, in the following manner: take a glass body capable of holding three quarts; put into it three ounces of oil of vitriol and twelve ounces of water; then warming the mixture a little, throw in, at several times, two ounces, or more, of clean iron filings; upon this an ebullition and white vapors will arise; then present a lighted candle to the mouth of the

vessel, and the vapor will take fire, and will afford a bright fulmination or flash like lightning. Applying the candle in this manner several times, the effect will always be the same; and sometimes the fire will fill the whole body of the glass, and even circulate to the bottom of the liquor; at others, it will only reach a little way down its neck. The great caution to be used in making this experiment is in making the vapor of a proper heat; for, if too cold, few vapors will arise; and, if made too hot, they will arise too fast, and will only take fire in the neck of the glass, without any remarkable coruscation.

CORVUS, in antiquity, a military engine, or rather gallery, moveable at pleasure by means of pulleys; chiefly by the Romans in boarding the enemy's ships to cover the men. The construction of the corvus was as follows: they erected, on the prow of their vessels, a round piece of timber, about a foot and a-half diameter, and about twelve feet long; on the top of which they had a block or pulley. Round this they laid a platform of boards, four feet broad, and about eighteen long, well framed and fastened with iron. The entrance was long-ways, and it was moved about on the upright piece of timber as on a spindle, and could be hoisted up within six feet of the top; around this was a sort of parapet, knee-high, defended with upright bars of iron, sharpened at the end; and, towards the top there was a ring, by the help of which, and a pulley or tackle, they raised or lowered the engine at pleasure. With this moveable gallery they boarded the enemy's vessels (when they did not oppose side to side), sometimes on their bow and sometimes on their stern. When they had grappled the enemy with these iron spikes, if they happened to swing broadside to broadside, then they entered from all parts; but, in case they attacked them on the bow, they entered two and two by the help of this machine, the foremost defending the fore parts, and those that followed, the flanks, keeping the boss of their bucklers level with the top of the parapet.

CORVUS, in ornithology, the raven or crow, a genus of birds of the order of pica, the distinguishing characteristics of which are these: the beak is convex and cultrated; the nostrils are covered with bristly feathers; the tongue is forked and cartilaginous; and the feet are of the walking kind. There are above forty species. The following are the most remarkable.

1. *C. caryocatactes*, the nut-cracker, is somewhat less than the jack-daw; the bill is strong, straight, and black; the color of the whole head and neck, breast and body, of a rusty brown; the crown of the head and rump are plain; the other parts marked with triangular white spots; the wings black; the coverts spotted like the body; the tail rounded at the end, black tipped with white; the vent feathers are white; the legs dusky. These birds are scattered in many parts of Europe, but nowhere so numerous as in Germany. They are also found in North America, but not near the sea-coasts, and seldom visit England. In manners, this bird resembles the jay, laying up a store of acorns and nuts.

2. *C. corax*, the raven of English authors, weighs three pounds, and is about two feet two

inches in length; the color is black, finely glossed with a rich blue, the belly excepted, which is of a dusky color. They are very docile, and may be trained up to fowling like hawks; to fetch and carry like spaniels; to speak like parrots; and may even be taught to imitate, in a great degree, the human voice, in singing. They have a great propensity to pilfer, often hiding things of value. They frequent the neighbourhood of great towns, where they are useful in devouring the carcasses and filth which would otherwise prove a nuisance. They also destroy many living animals; such as rabbits, ducks, chickens, and even lambs, which have been dropped in a weak state. In clear weather they fly in pairs to a great height, making a deep loud noise, different from the common croaking. Their scent is remarkably good, and they are very long lived. They make their nests early in spring, laying five or six eggs, of a pale, bluish-green color, spotted with brown. With us they build in trees; but in Greenland and Iceland in the holes of rocks, composing their nests of roots, twigs, and bones, and lining them with hair, moss, &c. Their flesh is eaten in Greenland by the natives, who use the skins as a warm under-covering.

3. *C. cornix*, the hooded crow, pretty much resembles the rook, feeding on insects, and flying together in great flocks. In England it is a bird of passage, visiting it in the beginning of winter, and leaving it with the woodcocks. In the maritime parts they feed on crabs and shell-fish. They are very common in Scotland: in many parts of the Highlands, and in all the Hebrides, Orkneys, and Shetland, it is the only species of genuine crow, the carrion and rook being unknown there. They breed and continue in those parts the whole year.

4. *C. corone*, the carrion crow, agrees with the raven, in the form of its body, as well as in its food, whence it was formerly distinguished from the rook, which feeds entirely on grain and insects, by the name of the gor, or gor-crow. Virgil says, that its croaking forebodes rain. It was also thought a bird of bad omen. England breeds more of this species than any other country in Europe. In the 24th of Henry VIII. they were grown so numerous that they were considered as an evil worthy of parliamentary redress; an act was passed for their destruction, in which rooks and choughs were included. Every hamlet was to provide crow-nets for ten years; and all the inhabitants, at certain times, during that space, were obliged to assemble, to consult of the proper means for extirpating them. But, though the crow abounds thus in Britain, it is so rare in Sweden, that Linnæus speaks of it only as a bird that he once knew killed there. It lays the same number of eggs as the raven, and of the same color; immediately after deserting their young they go in pairs. Both these birds are often found white or pied; an accident that befalls black birds more frequently than any others. Pennant says, he has seen one entirely of a pale brown color, not only in its plumage, but even in its bill and feet. The crow weighs about twenty ounces. Its length is eighteen inches; its breadth two feet two inches.

These birds have an instinctive propensity to plant trees in autumn; great numbers of them being seen employed in digging holes in the earth, and then dropping in acorns and other seeds, and covering them with earth and moss.

6. *C. frugilegus*, the rook, is the *corvus* of Virgil; no other species of this genus being gregarious. It differs not greatly in its form from the carrion crow; the most remarkable variation is in the nostrils and root of the bill; which in the crow are well clothed with feathers, but in the rook are bare, or covered only with some bristly hairs. This arises from its thrusting the bill into the earth, after the worms and erucæ of insects, on which it feeds; for it does not live on carrion. It feeds on all sorts of grain, with some loss to the husbandman, but which is doubly repaid by the good done him in extirpating the maggots of the chafer beetle, which in some seasons destroy whole crops of corn. The rook is a gregarious bird, sometimes being seen in immense flocks, so as almost to darken the air. These flights they regularly perform morning and evening, except in breeding time, when the daily attendance of both male and female is required for the use of incubation, or feeding the young; for they do both by turns. As they form themselves into societies, such places as they frequent during the breeding time are called rookeries; and they generally choose a large clump of the tallest trees for this purpose. The eggs are like those of crows, but less, and the spots larger. They begin to build in March, and after the breeding season forsake their nest trees, to roost elsewhere, but return to them in August: in October they repair their nests. In Britain they remain the whole year: yet both in France and Silesia they are birds of passage. Linnaeus says they build in Sweden. The young birds are accounted good eating, especially if put in a pie.

7. *C. glandarius*, the jay, is one of the most beautiful of British birds. The weight is between six and seven ounces: the length thirteen inches. The forehead is white streaked with black; the head covered with long feathers, which it can erect at pleasure into the form of a crest; the whole neck, back, breast, belly, and covert feathers of the wing, are faint purple dashed with gray. The first quill-feather is black; the exterior webs of the nine next are ash-colored; the interior webs dusky; the six next are black, but the lower sides of their exterior webs are white tinged with blue; the two next wholly black; the last a fine bay color tipped with black. The lesser coverts are a light bay: the greater covert feathers most beautifully barred with a lively blue, black, and white: the rest are black: the rump is white. The tail consists of twelve black feathers. The feet are pale brown; the claws large and hooked. Jays build chiefly in woods, making their nest of sticks, fibres of roots, and tender twigs; and lay five or six eggs, of the size of a pigeon's, cinereous olive, marked with pale brown. The young keep with the old ones till the next pairing time in spring; when they choose each his mate to produce their future progeny. In general they feed on acorns, nuts, seeds, and fruits of all kinds; but sometimes destroy young chickens and eggs, and even take

away birds that have been caught in a trap, or entangled with birdlime. They are often kept in cages, and will talk pretty well; but lose all their beauty, so conspicuous in a wild state.

8. *C. graculus*, the red-legged crow, is but thinly scattered over the northern world; no mention is made of it by any of the Faunists: nor do we find it in any other part of Europe except Britain and the Alps. It is produced in the island of Candia, and visits Egypt towards the inundations of the Nile. It affects mountainous and rocky places; builds its nest in high cliffs or ruined towers; and lays four or five eggs, white spotted with a dirty yellow. It feeds on insects, and also on new-sown corn. It commonly flies high, makes a shriller noise than the jackdaw, and may be taught to speak. It is a very tender bird, and unable to bear very severe weather; is of an elegant slender make; active, restless, and thieving. There are instances of houses being set on fire, by its picking up lighted sticks; on which account Camden calls it *incendiaria avis*. It is found in Cornwall, Flintshire, Caernarvonshire, and Anglesey, in the rocky cliffs along the shores; in Scotland as far as Strathnaver, and in some of the Hebrides. Its color is black, beautifully glossed over with blue and purple: the legs and bill are a bright orange inclining to red: the tongue is almost as long as the bill, and a little cloven: the claws are large, hooked, and black.

9. *C. monedula*, the jackdaw, generally weighs about nine ounces; and is thirteen inches long, and twenty-eight broad.

10. *C. pica*, the magpie, in length about eighteen inches, and weighs eight or nine ounces: both too well known to need particular description.

CORYATE (Thomas), a person who made himself famous by his whimsical extravagancies, was the son of a clergyman, and born at Oldcombe in Somersetshire in 1577. He acquired Greek and Latin at Oxford; and, coming to London, was received into the household of Henry prince of Wales, where he became acquainted with the wits of that age. In 1608 he took a long journey on foot; and, on his return, published his travels under the following strange title: *Crudities Hastily Gobbled up in Five Months' Travels, in France, Savoy, Italy, Rhetia, Helvetia, some parts of High Germany, and the Netherlands, London, 1611, 4to.* He wrote several other works. In 1612 he set out again with a resolution to spend ten years in travelling: he went first to Constantinople; and after travelling over a great part of the East, died of a flux at Surat in the East Indies. Some of the accounts of his peregrinations are to be found in Purchas's *Pilgrimages*.

CORYBANTES, in antiquity, priests of Cybele, who danced and capered to the sound of flutes, drums, &c. Catullus, in his poem called *Atys*, gives a beautiful description of them representing them as madmen. Maximus Tyrius says, that those possessed with the spirit of the Corybantes, as soon as they heard the sound of a flute, were seized with an enthusiasm, and lost the use of their reason. And hence the Greeks used the word *κορυβαντισμῶς*, to corybantise, to signify a person's being possessed with a devil. See ENTHUSIASM. Some say that the Cory

bantes were all eunuchs : and that hence Catullus, in his *Atys*, always uses feminine epithets in speaking of them. Diodorus Siculus says, that Corybas, son of Jason and Cybele, passing into Phrygia with his uncle Dardanus, there instituted the worship of the mother of the gods, and gave his own name to the priests.

CORYBANTICK, *adj.* From *corybantes*. Inflamed with a mad fury, like the priests of Cybele.

The divine seal is no *corybantick* fury, but a calm and regular heat, guided and managed by light and prudence.

CORYCOMACHIA, among the ancients, was a sort of exercise in which they pushed forwards a ball, suspended from the ceiling, and at its return either caught it with their hands, or suffered it to meet their body.

CORYLUS, the hazel, a genus of the polyandria order, and monocæa class of plants; natural order fiftieth, amentacææ. Male *CAL.* monophyllous, scale-like, trifid, and uniliferous: *COR.* none: *STAM.* eight. Female *CAL.* diphyllous and lacerated: no *COR.* two styles; and an egg-shaped nut. Mr. Miller reckons three species, other botanists only two. They are all of the large shrub kind, hardy and deciduous; and have several varieties valuable for their nuts, as also for their variety in large wildernesses and shrubby works. They prosper in any soil or situation, and turn out to good account in coppices to cut as underwood, and as poles for various uses, as hoops, spars, hurdles, handles to husbandry implements, walking sticks, fishing rods, &c. for which purposes they may be cut every fifth, seventh, or eighth year. The best method of propagating them is by layers, though they may also be raised from the nuts.

CORYMBIUM, in antiquity, an ornament of hair worn by the women.

CORYMBIUM, in botany, a genus of the monogamia order, and syngenesia class of plants; natural order forty-ninth, compositæ: *CAL.* diphyllous, uniflorous, and prismatical: *COR.* monopetalous and regular: there is one woolly seed below each floret. Species, four; natives of Africa.

CORYMBUS, *n. s.* } *Lat.* 'Amongst the
CORYMBIATED, *adj.* } ancient botanists,
CORYMBIFEROUS, *adj.* } says Quincy, 'corymbus was used to express the bunches or clusters of berries of ivy; amongst modern botanists it is used for a compounded discous flower, whose seeds are not pappous, or do not fly away in down; such are the flowers of daisies, and common marygold.' *Corymbiated* signifies garnished with branches of berries. '*Corymbiferous*, plants are distinguished into such as have a radiated flower, as the sun-flower; and such as have a naked flower, as the hemp-agrimony, and mugwort: to which are added those a-kin heretofore, such as scabious, teasel, thistle, and the like.' See *BOTANY*.

CORYNOCARPUS, in botany, a genus of the monogamia order, and pentandria class of plants: *CAL.* a pentaphyllous perianth: *COR.* five roundish, erect, and hollow petals: *STAM.* five subulated filaments arising from the base of the petals: *ANTH.* erect and oblong: *PERICARP.*

a monospermous, turbinate clavated nut. Species, one only; a native of New Zealand.

CORYPHA, mountain palm, or umbrella tree, in botany, a genus of plants of the order of palmæ: *COR.* tripetalous: *STAM.* six, with one pistil: the fruit a monospermous plum. There are two species; the chief is *C. umbracula*, a native of the West Indies, where it is called *coddapana*. It rises to a considerable height, and produces at the top many large palmated, plaited leaves, the lobes of which are long, and placed regularly round the end of a long spiny foot-stalk, in a manner representing a large umbrella. The flowers are produced on a branched spadix, from a compound spathe; they are hermaphrodite, and each consists of one petal, divided into three oval parts, and contains six awl-shaped stamina, surrounding a short slender style, crowned with a simple stigma. The germen is nearly round, and becomes a large globular fruit of one cell, including a large round stone. These plums having a pleasant smell are esteemed by the Indians.

CORYPHÆNA, in ichthyology, a genus belonging to the order of thoracici. The head is declined and truncated; the branchiostege membrane has six rays; and the back fin runs the whole length of the back. There are nineteen species, most of them natives of foreign seas. The most remarkable are the blue and parrot fishes.

CORYPHÆUS, from *κορυφή*, the top of the head, in the ancient tragedy, was the chief or leader of the company that composed the chorus. Hence *coryphæus* became a general name for the chief of any company, corporation, sect, opinion, &c. Thus Cicero calls Zeno the *coryphæus* of the stoics; and Eustatius of Antioch is called the *coryphæus* of the council of Nice.

CORYVREKAN, a dangerous whirlpool on the west coast of Scotland, between the isle of Scarba and the north point of Jura. Its vortex extends about a mile in circuit, and at full tide its numerous eddies form watery pyramids, which rise to a great height in the air, and, bursting with the noise of thunder, overwhelm all small vessels that come within the sphere of its attraction.

COS, or Coos, in ancient geography, an island on the coast of Caria, in Asia, fifteen miles west of Halicarnassus, and seventy in compass, called also Meropis; and hence Thucydides joins both names together, Cos Meropis. It was fruitful and produced good wine. It was the birthplace of Hippocrates, Apelles, and Philetas. The vestes Coac, made of silk, were famous for their fineness and color.

Cos, a town in the above island, mentioned by Homer, and originally called Astypalæa.

COSCYNOMANCY, *n. s.* *κοσκινον*, a sieve, and *μαντεια*, divination. The art of divination by means of a sieve, &c.

COSCINOMANCY, or divination by a sieve, was used, as appears from Theocritus, to discover the secrets of known persons, as well as to find out the unknown. The sieve being suspended, after rehearsing a formula of words, it was taken between two fingers only; and the names of the parties suspected repeated: he at whose name

the sieve turned, trembled, or shook, was reputed guilty of the evil in question. It was sometimes also practised by suspending the sieve by a thread, or fixing it to the points of a pair of shears, giving it room to turn, and naming the parties suspected.

COSECANT, *n. s.* in geometry, the secant of an arch, which is the complement of another to ninety degrees.

COSENAGE, in law, a writ that lies where the tressail, that is, the tritavus, the father of the besail, or great-grandfather, being seized in fee at his death of certain lands or tenements, dies; a stranger enters, and abates; then shall his heir have writ of cosenage.

COSENING, in law, an offence whereby any thing is done deceitfully, in or out of contracts, which cannot be fitly termed by any especial name. In the civil law it is called *stellionatus*.

COSENZA, a town of Naples, the capital of Calabria Citra, and sometimes giving name to that province, is built on seven small hills at the foot of the Apennines. It is the residence of a royal governor, an archbishop's see, and has a fort. The metropolitan is the only church within the walls; but there are three parish churches in the suburbs, and twelve convents in the town. The environs are beautiful, populous, and well cultivated, producing abundance of corn, fruit, oil, wine, and silk. Cosenza has often suffered by earthquakes, particularly in 1638. It is seated on the river Crate, ten miles from the sea coast, and 150 south-east of Naples. Population about 12,000.

COSHERING, *n. s.* Irish.

Cosherings were visitations and progresses made by the lord and his followers among his tenants; wherein he did eat them (as the English proverb is) out of house and home. *Davies.*

COSIER, *n. s.* Old Fr. *cousu*, from *couldre*, to sew. A botcher, says Johnson; but Minshew defines it a cobbler.

Do you make an alehouse of my lady's house, that ye squeak out your *cosiers'* catches, without any mitigation or remorse of voice? *Shakespeare. Twelfth Night.*

COSIGNIFICATIVE, *adj.* from *con* and *significative*. Having the same meaning.

COSINE, *n. s.* in geometry, the right sine of an arch, which is the complement of another to ninety degrees.

COSMETIC, *n. s. & adj.* } Fr. *cosmetique*;
COSMETICAL, *adj.* } *κοσμητικός*, from *κοσμεω*, to adorn. A preparation to improve beauty. Having the power of improving beauty; beautifying.

No better *cosmetics* than a severe temperance and purity, modesty and humility, a gracious temper and calmness of spirit; no true beauty without the signatures of these graces in the very countenance.

Ray on the Creation.

First robed in white, the nymph intent adores,
With head uncovered, the *cosmetick* powers. *Pope.*

LIEUT. Oh, hang fortune,—let that take its chance; there is a beauty in Lauretta's simplicity, so pure a bloom upon her charms.

DOCT. So there is, so there is. You are for beauty, as nature made her, hey! No artificial graces, no *cosmetic* varnish, no beauty in grain, hey! *Sheridan.*

COSMICAL, *adj.* } *Κοσμος*. Relating to
COSMICALLY, *adv.* } the world; rising or setting with the sun; not acronycal with the sun; not acronycally.

The *cosmical* ascension of a star we term that, when it riseth together with the sun, or in the same degree of the ecliptic wherein the sun abideth.

Brown's Vulgar Errors.

From the rising of this star not *cosmically*, that is, with the sun, but heliacally, that is, its emersion from the rays of the sun, the ancients computed their *canicular* days. *Id.*

COSMOGONY, *n. s.* } *Κοσμος* and *γονη*.
COSMOGONIST, *n. s.* } The birth of the world; the creation. He who gives an account of the creation.

The world is in its dotage, and yet the *cosmogony* or creation of the world has puzzled philosophers of all ages. *Goldsmith.*

The relation seems to have been in some measure approved by the sacred *cosmogonist* himself.

Coccey.

COSMOGRAPHY, *n. s.* } *Κοσμος* and *γραφω*
COSMOGRAPHER, *n. s.* } *φω*. A description
COSMOGRAPHICAL, } of the visible
COSMOGRAPHICALLY, *adv.* } world; a science showing the frame of the universe, distinct from geography, which lays down the situation and boundaries of particular countries. A cosmographer is one who is skilled in cosmography; one who writes a cosmographical description of the world.

The ancient *cosmographers* do place the division of the east and western hemisphere, that is, the first term of longitude, in the Canary and Fortunate Islands, conceiving these parts the extremest habitations westward. *Brown's Vulgar Errors.*

The terrella, or spherical magnet, *cosmographically* set out with circles of the globe. *Id.*

Here it might see the world without travel; it being a lesser scheme of the creation, nature contracted, a little *bosmography*, or map of the universe. *Smith.*

COSMOLABE, from *κοσμος*, world, and *λαβανω*, I take; an ancient mathematical instrument, serving to measure distances, both in the heavens and on the earth. The cosmolabe is in great measure the same with the astrolabe. It is also called pentacosm, or the universal instrument, by L. Morgard, in the treatise upon it, printed in 1612.

COSMOPLASTICK, *adj.* *κοσμος*, and *πλαστικός*. Relative to the formation of the world.

Be being no better than a *cosmoplastick* atheist.

Hallywell.

COSMOPOLITAN, *n. s.* } Gr. *κοσμος* and
COSMOPOLITE, *n. s.* } *πολιτης*. A citizen of the world; one who is at home in every place.

COSNE, a town of France, in the department of Nievre, and ci-devant province of Nivernois, seated at the confluence of the Loire and Noain, 110 miles south of Paris. Anchors for ships are made here; and its cutlery wares and gloves are much esteemed. Population 4700.

COSSPORE, a town and small district of Hindostan, tributary to the Birmans, bounds the district of Selhat in Bengal on the east. Gold is

found in some of its mines. Great part of the trade between Bengal and Assam formerly passed through this place. The inhabitants are Hindoos, governed by their own rajah.

COSSACKS. See **Dow** and **RUSSTA**, **SOUTHERN**.

COSSET, *n. s.* A lamb brought up without the dam.

And if thou wilt bewail my woeful teen,
I shall thee give y^a *cosset* for thy paine.

Spooner. Shepherd's Calendar,

COSSIMBAZAR, a considerable manufacturing town of Bengal, adjoining the southern suburbs of Moorshedabad. It is situated on the south-east bank of the Bhagarutty, and has both English, Dutch, and French factories. Silk and cotton stockings are its staple articles. Early in the eighteenth century the East India Company paid 25,000 rupees for the liberty of forming their establishment here; but it was not till 1742, that they obtained permission to fortify it. It was taken and plundered in 1756 by the nuwab Suraje Addouleh. The vicinity abounds with mulberry trees and game, and is watered by the Bhagarutty, Jellingy, and Ganges rivers.

COSSOVA, an extensive plain between Bulgaria and Rascia, memorable for two great battles fought on it, viz. 1st. between Lazarus prince of Servia and Amurath I.; and, 2d. between John Huniades and Mahomet II.; in both of which the Turks were victorious.

OST, *v. n. & n. s.* } *Arm. const*; Welsh,
CO'STLESS, *adj.* } *cost*; old Fr. *coressé*;
CO'STLINESS, *n. s.* } *Ital. costo*; Ger. & Dut.
CO'STLY, *adj.* } *kost*; Swed. *kosta*; Lat.

consto. To be purchased for or with a price. The price of a thing; luxury; expense; detriment. In law, used in the plural, the expense of a suit. Costly is high priced; expensive; sumptuous.

Have we eaten at all of the king's *cost*; or hath he given us any gift? *2 Samuel xix. 42.*

And of a mirth I am right now bethought,
To don you ase, and it shall *coste* you nought.

Chaucer. Prol. to Cant. Tales.

And thoughte it have *costed* me, yit wol I do my peyn,
For to pike hir purs to nyghts, and win my *cost* ageyn.
Id. Cant. Tales.

For living wit, I weene, cannot display
The roiall riches and exceeding *cost*,
Of every pillour and of every post,
Which all of purest bullion framed were.

Spooner. Faerie Queene.

And all the floore was underneath their feet
Bespredd with *costly* scarlett of great name. *Id.*
While he found his daughter maintained without
his *cost*, he was content to be deaf to any noise of in-
famy. *Sidney.*

Though not with curious *costliness*, yet with cleanly
efficiency, it entertained me. *Id.*

Why doest thou pine within, and suffer dearth,
Painting the outward walls so *costly* gay?
Why so large *cost*, having so short a lease,
Dost thou upon thy fading mansion spend?
Shakespeare. Sonnet calvi.

I shall never hold that man my friend,
Whose tongue shall ask me for one penny *cost*
To ransom home revolted Mortimer.

Id. Henry IV.

What they had fondly wished, proved afterwards to their *costs* over true. *Knolles' History of the Turks.*

And wilt thou, O cruel boat!
Put poor nature to such *cost*?
O! 'twill undo our common moths
To be at charge of such another. *Crashaw.*

Let foreign princes vainly boast
The rude effects of pride and *cost*
Of vaster fabricks, to which they
Contribute nothing but the pay, *Waller.*

Nor have the frugaller sons of fortune any reason
to object the *costliness*; since they frequently pay
dearer for less advantageous pleasures.

Glanville's Scepia.

It is strange to see any ecclesiastical pile, not by
ecclesiastical *cost* or influence, rising above ground;
especially in an age in which men's mouths are open
against the church, but their hands shut towards it.

South's Sermons.

It is to be remembered, that no man borrows mo-
ney, or pays use, out of mere pleasure; it is the want of
money drives men to that trouble and charge of bor-
rowing; and proportionably to this want, so will every
one have it, whatever price it *cost* him. *Locke.*

The dagger and poison are always in readiness;
but to bring the action to extremity, and then recover
all, will require the art of a writer, and *cost* him many
a pang. *Dryden.*

He whose tale is best, and pleases most,
Should win his supper at our common *cost*. *Id.*

Leave for awhile thy *costly* country-seat;
And, to be great indeed, forget
The nauseous pleasures of the great. *Id.*

Fourteen thousand pounds are paid by Wood for the
purchase of his patent; what were his other visible
costs, I know not; what his latent, is variously con-
jectured. *Swift.*

The chapel of St. Laurence will be perhaps the most
costly piece of work on the earth, when completed.

Addison.

He is here speaking of Paradise, which he represents
as a most charming and delightful place; abounding
with things not only useful and convenient, but even
the most rare and valuable, the most *costly* and de-
sirable. *Woodward's Nat. Hist.*

Thes could no *costly* gem ensnare,
No trinket to adorn thy hair:
No Carian slave didst thou request,
No precious chain, no Tyrian vest. *Sheridan.*
An ivory inlaid table spread with state
Before them, and fair slaves on every side;
Gems, gold, and silver, formed the service mostly,
Mother-of-pearl and coral the less *costly*

Byron. Don Juan.

COSTS, in law, imply the expenses of a suit
recovered by the plaintiff, together with damages.
Costs were not allowed by the common law, the
amercement of the vanquished party being his
only punishment; but they are given by statute.
Costs are allowed in Chancery for failing to
make answer to a bill exhibited, or making an
insufficient answer; and if a first answer be cer-
tified by a master to be insufficient, the defendant
is to pay 40s.; £3. for a second insufficient an-
swer; £4 for the third, &c. But if the answer
be reported good, the plaintiff shall pay the de-
fendant 40s. costs.

COST, *n. s.* } Old Fr. *coste*; Lat. *costa*.
CO'STAL, *adj.* } A rib or side. Belonging to
the ribs.

Betwixt the *costs* of a ship. *Ben Jonson.*

Hereby are excluded all cetaceous and cartilaginous fishes; many pectinal, whose ribs are rectilinear; and many *costal*, which have their ribs embowed.

Browne's Vulgar Errors.

COSTA (Christopher), a celebrated botanist of the sixteenth century, born in Africa. His father was a native of Portugal. Christopher, to perfect himself in the knowledge of simples, went into Asia, where he was taken prisoner, but found means to make his escape, and after several voyages, practised physic at Burgos. He wrote, 1. *A Treatise on Indian Drugs and Medicines.* 2. *His Voyages to the Indies.* 3. A book in praise of Women; and other works.

COSTA FURTACO DE MENDOCA (Hippolyto Joseph da), a Portuguese freemason, and latterly chargé d'affaires for Brasil in England, was bachelor of divinity and doctor of laws in the university of Coimbra. He fled to England from the prison of the inquisition, and published in 1811, a work in 2 vols. 8vo, containing *A Narrative of the Persecution of the Author, a native of Colonia da Sacramento, on the River La Plata, imprisoned and tried at Lisbon, by the Inquisition, for the pretended crime of Freemasonry.* His book comprises the statutes of the holy office; but, though frequent allusions are made to his escape from captivity, the singular mode in which it was effected is omitted. This has been thus supplied:—'The door of the cell in which Da Costa was confined opening into a hall, which was the centre of the prison, he had opportunities for remarking that the daily labors of his jailors terminated with throwing a bundle of keys on a table where a lamp was left burning. By patience and perseverance with abundant exercise for circumspection, in the consciousness of spies, by daylight, through apertures in the walls and ceiling of his cell, he succeeded in forming, out of an old pewter plate, a key which would unlock its door. Upon making his final attempt, the bundle of keys proved to be a proper collection for threading the entire labyrinth, not excepting the outer gate. Besides the keys and lamp, there was a book, containing, among other records, the minutes of his own repeated examinations. This he took with him, and carefully closing and locking every door after him, he made his way, without interruption, to the outside of the prison walls. It was necessary for him to remain six weeks secluded and disguised in the neighbourhood, before he could venture to take shipping, as every bark in the port and on the neighbouring coasts was subjected to the unremitting scrutiny of the officers of the inquisition; and in the course of their victim's rides on horseback, he frequently recognised these his old acquaintance engaged in their search after him. At length he took his departure from Portugal, and reached England in safety, bringing with him the book and keys of the inquisitors, as trophies of his success.' M. da Costa published also in London, the *Correio Braziliense*, a monthly magazine in the Portuguese language, and a small ingenious tract on the Origin of Building. He died in the beginning of 1824, at Kensington.

COSTA RICA, i. e. the rich coast, a province of the new state of Guatimala, in what was formerly

Spanish North America, bounded on the south-east by Veragua, and extending from the Spanish Main to the Pacific Ocean, east and west. It is a very mountainous district, and but little known to Europeans; but is said to contain some considerable mines of the precious metals, and to be very fertile in some parts in cocoa and pasturage. The commerce consists of cattle, hides, wax, and honey. The capital is Cartage, and it has several good ports on the Pacific.

COSTANZO (Angelo di), an Italian historian and poet, lord of Catalupo, was born in 1507, of a noble and ancient family of Naples, and died about 1591. He wrote, 1. *A History of Naples*, from 1250 to 1489; the best edition of which is that of Aquila, in 1582, in folio, very scarce. 2. *Italian Poems*, which are esteemed, and have had several editions.

COSTARD, *n. s.* } From *coster*, a
CO'STARD-MONGER, *n. s.* } head, says John-
CO'STER-MONGER, *n. s.* } son, in which he
follows Skinner. The *Ency. Met.* however, affirms, that there is no authority for the word *coster*. Costard is the head; an apple round and bulky, like the head. *Costard-monger*, with which *coster-monger* is synonymous, is a dealer in apples; a fruiterer.

Take him over the *costard* with the hilt of thy sword. *Shakespeare. Richard III.*

The wilding, *costard*, then the well-known pom-water. *Drayton.*

He'll rail like a rude *coster-monger*.

Beaumont and Fletcher.

Many country vicars are driven to shifts; and if our greedy patrons hold us to such conditions, they will make us turn *coster-mongers*, graziars, or sell ale. *Barton on Melancholy.*

COSTARD (George), a clergyman of the church of England, and author of several learned works, was born about 1710. He was educated at Wadham College, Oxford; and took the degree of M. A. in 1733. He was first appointed curate of Islip, in Oxfordshire, and published, in 1747, some Observations on the Book of Job, 8vo. In 1750, *Two Dissertations*: 1. On the meaning of Job, chap. xlii. ver. 11. 2. On the Signification of the Word *Hermes*. In 1752 he published, in 8vo, at Oxford, *Dissertationes II. Critico-Sacræ, quarum primâ explicatur, Esek. xiii. 18. Altera vero, 2 Reg. x. 22.* In 1755 he wrote a letter to Dr. Birch, which is preserved in the British Museum, respecting the meaning of the phrase *sphæra barbarica*. Some time after, he published a second edition of Dr. Hyde's *Historia Religionis veterum Persarum, eorumque Magorum*; which was printed under his inspection at the Clarendon Press. Mr. Costard's extensive learning having now recommended him to the notice of lord Chancellor Northington, he obtained in 1764, the vicarage of Twickenham in Middlesex, in which situation he continued till his death. In 1767 he published, in one vol. 4to. *The History of Astronomy*, with its application to Geography, History, and Chronology; occasionally exemplified by the Globes. In 1778 he published, in 8vo, a *Letter to Nathaniel Brassey Halhead, esq.* containing some Remarks on his Preface to the Code of Gentoo Laws. This appears to have been the last of his separate pub-

lications; but he wrote several papers in the Philosophical Transactions, on astronomical and chronological subjects. Mr. Costard died January 10th, 1782. He was a man of extensive learning, and eminently skilled in Grecian and oriental literature.

COSTIVE, *adj.* } Fr. *constipé*; Lat. *con-*
COSTIVENESS, *n. s.* } *stipatus*. Having the intestinal excretions hardened and obstructed; backward in speech or composition; apt to become bound up; stiff; formal. Costiveness is, an obstructed state of the intestinal canal; coldness; formality; tardiness of expression, either oral or written.

When the passage of the gall becomes obstructed, the body grows *costive*, and the excrements of the belly white. *Browne*.

Costiveness has ill effects, and is hard to be dealt with by physick; purging medicines rather increasing than removing the evil. *Locke on Education*

While faster than his *costive* brain indites,
Philo's quick hand in flowing letters writes;
His case appears to me like honest Teague's,
When he was run away with by his legs. *Prior*.

Clay in dry seasons is *costive*, hardening with the sun and wind, till unlocked by industry, so as to admit of the air and heavenly influences.

Mortimer's Husbandry.

You must be frank, but without indiscretion; and close, but without being *costive*. *Chatterfield*.

A reverend disputant of the same *costiveness* in public elocution with myself. *Wakefield*

COSTMARY. A herb. See **TANACETUM**.

The purple hyacinth, and fresh *costmary*.
Spenser. Virgil's Gnat.

COSTREL, *n. s.* Supposed to be derived from *coster*. A bottle.

COSTUME, *n. s.* Old Fr. and It. *costume*; low Lat. *costuma*. Distinctive dress, habit, or character.

COSTUS, in botany, a genus of the monogynia order, and monandria class of plants; natural order eighth, scitamineæ: cor. interior, inflated and ringent, with the under slip trifid. There is but one species, viz. *C. Arabicus*, a native of the Indies. The root was formerly in some esteem as an attenuant, and serviceable in venereal complaints; but it is now rarely prescribed, or met with in the shops.

CO-SUFFERER, *n. s.* from *con* and sufferer. A companion in suffering.

Should as *co-sufferers* commiserate. *Wycherly*.

CO-SUPREME, *n. s.* from *con* and supreme. One who shares in supremacy.

The phenix and the dove,
Co-supremes and stars of love.

Shakespeare. Pass. Pilgrim.

COT, *n. s.* } Goth. *kot*; Ang.-Sax.
COTE, *n. s.* } *cot, cote*; Welsh, *cwt*. A
COTLAND, *n. s.* } small dwelling; a hut; a
COTSWOLD, *n. s.* } mean habitation; a place
COTTAGE, *n. s.* } for sheep or doves to live
COTTAGED, *adj.* } in. In the last sense, cote
COTTAGELY, *adj.* } is the word commonly
COTTAGER, *n. s.* } used. Cottage is syno-
COTTIER, or } nymous with cot, except
COTTIER, *n. s.* } in as far as relates to doves

VOL. VI.

and sheep. A cottager, cotter, or cottier, is one who resides in a cot, or cottage. Cotland is land attached to his dwelling. In law, however, cottager is the technical description of one that lives on the common without paying rent, and without any land of his own. Cotswold, from Ang.-Sax. *cote*, a cottage, and *fold*, a place void of wood, signifies sheepcotes in an open country, and from this the Cotswold hills, in Gloucestershire, have their name.

Hezekiah made himself stalls for all manner of beasts, and cots for flocks. *2 Chronicles xxxii. 28.*

The sea coast shall be dwellings and cottages for shepherds, and folds for flocks. *Zeph. ii. 6.*

Wher ther was swiche a congregation
Of peple, and eke so strait of herbergeage,
That they ne founde as moche as a *cottage*
'n which they bothe might flogged be.

Chaucer. Cant. Tales.

Which hardly doen, at length she gon them pray,
That in their *cottage* small that night she rest her may.

Spenser. Faerie Queene.

To things of riper season self applyd,
And learned of timber lighter *cotes* to frame,
Such as might save my sheep and me from shame.

Id. Shepherd's Calendar.

They were right glad to take some corner of a poor *cottage*, and there to serve God upon their knees.

Hooker.

The self-same sun that shines upon his court
Hides not his visage from our *cottage*, but
Looks on both alike. *Shakespeare. Winter's Tale.*

Besides, his *cot*, his flocks, and bounds of feed
Are now on sale; and at our sheep *cot* now,
By reason of his absence, there is nothing
That you will feed on. *Id. As You Like It.*

The husbandmen and plowmen be but as their work-folks and labourers; or else mere *cottagers*, which are but housed beggars. *Bacon's Henry VII.*

Let the women of noble birth and great fortunes nurse their children, look to the affairs of the house, visit poor *cottages*, and relieve their necessities.

Bishop Taylor.

They envy others whatever they enjoy of estates, houses, or ornaments of life, beyond their tenuity or *cottagely* obscurity. *Id.*

Himself goes patched like some bare *cottyer*,
Lest he might ought the future stock appeyre.

Hall.

It is difficult for a peasant, bred up in the obscurities of a *cottage*, to fancy in his mind the splendors of a court. *South.*

Is it reasonable, that the eldest brother, because he has the greatest part of his father's estate, should thereby have a right to take away any of his younger brothers' portions? or that a rich man who possessed a whole country, should from thence have a right to seize, when he pleased, the *cottage* and garden of his poor neighbour? *Locke.*

A stately temple shoots within the skies;
The crotchets of their *cot* in columns rise;
The pavement, polished marble they behold;
The gates with sculpture graced the spires and tiles
of gold. *Dryden. Baucis and Philemon.*

Beneath our humble *cottage* let us haste,
And here, unenvied, rural dainties taste.

Pope's Odyssey.

The most ignorant Irish *cottager* will not sell his cow for a groat. *Swift's Address to Parliament.*

2 N

As Jove vouchsafed on Ida's top, 'tis said,
At poor Philemon's *cot* to take a bed. *Fenton.*

Even humble Harling's *cottaged* vale
Shall learn the sad repeated tale,
And bid her shepherds weep. *Collins.*

The *cottage*-curs at early pilgrim bark;
Crowned with her pail the tripping milk-maid sings;
The whistling ploughman stalks afield, and, hark!
Down the rough slope the ponderous waggon rings. *Beattie.*

Our humble *cot*, and hamely fare,
Ye freely shall partake it,
That gallant badge, the dear cockade,
Ye're welcome for the sake o't. *Burns.*

The power, incensed, the pageant will desert,
The pompous strain, the sacerdotal stole;
But haply, in some *cottage* far soart,
May hear, well pleased, the language of the soul;
And in his book of life the inmates poor enrol.
Then homeward all take off their several way;
The youngling *cottagers* retire to rest. *Id.*

Yon *cottage*, who weaves at her own door,
Pillow and bobbins all her little store;
Content though mean, and cheerful if not gay,
Shuffling her threads about the livelong day,
Just earns a scanty pittance, and at night
Lies down secure, her heart and pocket light. *Cowper.*

The poorest peasant of the poorest soil,
The child of poverty, and heir to toil,
Early from radiant Love's impartial light,
Steals one small spark to cheer his world of night:
Dear spark! that oft through winter's chilling woes,
Is all the warmth his little *cottage* knows. *Sheridan.*

And from the sheep-*cote* in the dell,
Soft tinkling chimes the wether's bell;
Accordant to the cheerful strain
Of milk-maid blithe, and whistling swain. *Huddesford.*

The roofless *cot* decayed and rent,
Will scarce delay the passer by;
The tower by war or tempest bent,
While yet may frown one battlement
Demands and daunts the stranger's eye:
Each ivied arch, and pillar lone,
Pleads haughtily for glories gone. *Byron. The Giaour.*

COT, or **COTT**, *n. s.* Old Fr. *coete*, *coite*, *coern*.
A small bed; a child's cradle; a hammock.

Their beds are *cots* of two feet height, on four low
posts, strengthened with girth-web. *Sir T. Herbert.*

COT, or **COTT**, *n. s.* Low Lat. *cota*. A little
boat.

Divers discourses in their way they spent;
Mongst which Cymochles of her questioned
Both what she was, and what that usage ment,
Which in her *cot* she daily practised?
Spenser. Faerie Queene.

COT, *n. s.* An abridgment of cotquean. See
COTQUEAN; also a cade lamb.

COT, } At the end of the names of places,
COTE, } come generally from the Sax. *cot*, a
COAT, } cottage.

COTABAMBA, a province of Peru, bounded
on the north by the province of Abancay, south
by that of Chilques y Masques, west by that
of Chumbivilcas, and north-west by that of Aima-
raez, being seventy-five miles long east and west,
and twenty-five wide from north to south. It
is of cold temperature, being largely occupied by
mountains covered with snow. In the valleys are

bred numerous herds of cattle; and wheat, maize,
and pulse are abundant. A plant is found here,
from the tendrils of which are fabricated cords,
and very strong ropes. Population 10,000.

COTANGENT, *n. s.* in geometry, the tan-
gent of an arch which is the complement of ano-
ther to ninety degrees.

COTE, *v. a.* Fr. *collé*. It seems to signify, says
Johnson, the same as to leave behind; to over-
pass. And so it does in some instances. But it
appears also to have the meaning of going side
by side with; for in the Return from Parnassus
we find, 'Marry, we presently *coted* and out-
strip them;' which implies, first, equalling, and
then overpassing.

Words her worth had proved with deeds,
Had more ground been allowed the race, and *coted*
far his steeds. *Chapman's Iliad.*

We *coted* them on the way, and hither are they
coming. *Shakespeare. Hamlet.*

COTE, *v. a.* The ancient mode of spelling, to
quote.

COTE, in coursing, the advantage one grey-
hound has over another, when he runs by the
side of it, and, putting before it, gives the hare a
turn.

CÔTE D'OR, a department of France, bounded
by those of Aube on the north, Upper Marne on
the north-east, Upper Saone on the east, Jura on
the south-east, Saone and Loire on the south, and
Nievre and Yonne on the west. It is chiefly
formed out of the *ci-devant* province of Burgundy.
Its form is an irregular oval, sixty-five miles long
from north to south; and from twenty-five to
fifty broad from east to west. Dijon is the
capital.

COTELERIUS (John Baptist), fellow of the
Sorbonne, and Regius Greek professor, was born
at Nismes in 1627. He made a collection of the
fathers who lived in the apostolic age, which he
published at Paris in two volumes folio, in 1673,
reviewed and corrected from several MSS. He
also published the first volume of Monumenta
Ecclesiæ Græcæ; a collection of Greek tracts out
of the libraries of the king and M. Colbert, which
had never been published before: to both these
works he added a Latin translation and notes.
He intended a farther prosecution of this work;
but his intense studies broke his constitution, and
deprived him of life in 1686.

COTEMPORARY, *n. s. & adj.* Lat. *con* and
tempus. One who lives at the same period.
Living at the same time; coetaneous; contem-
porary. See **CONTEMPORARY**.

What would not, to a rational man, *cotemporary*
with the first voucher, have appeared probable, is now
used as certain, because several have since, from him,
said it one after another. *Locke.*

We now find so much artifice among our *cotem-
poraries* who only follow rude and untaught nature. *Spens.*

COTERELLUS, and **COTARIUS**, both signify,
according to Spelman and Du Fresne, a servile
tenant; but in Doomsday and other ancient MSS.
there appears a distinction, as well in their tenure
and quality as in their name: for the cotarius
had a free socage tenure, and paid a stated firm
or rent in provisions or money, with some occa-

sional customary services; whereas the coterellus seems to have held in mere villenage, and his person, issue, and goods, were disposable at the pleasure of the lord.

COTERIE. Fr. *coterie*. This word has altered strangely in its meaning. Cotgrave and Sherwood define it to be, 'Companie, societie, association of county people.' It now means a select party, particularly of ladies; a fashionable select assembly; and the word is often used sarcastically.

But for the children of the 'mighty mother's,'

The would-be wits and can't-be gentlemen,

I leave them to their daily 'tea is ready,'

Sing coterie, and literary lady. Byron. *Beppo.*

Why then I'll swear, as poet Wordy swore,

(Because the world won't read him, always snarling)

That taste is gone—that fame is but a lottery,

Drawn by the blue-coat misses of a *coterie*.

Id. Don Juan.

COTES (Roger), an excellent mathematician of the eighteenth century. At seventeen years of age he was admitted a pensioner of Trinity College Cambridge. In 1706 he was appointed professor of astronomy in the professorship founded by Dr. Plume, being the first in that chair. In 1713 he published at Cambridge in 4to, a second edition of Newton's Principia, with all the author's improvements; to which he prefixed an excellent Preface. He prepared several useful books for the public; and wrote A Description of the Great Meteor which appeared on the 6th March 1716, published in the Philosophical Transactions. He died in 1716.

CÔTES DU NORD, or the NORTH COASTS, a department of France, so named from its situation; being bounded on the north by the British Channel, on the east by the departments of Isle and Vilaine, and on the south and east by those of Morbihan and Finisterre. It contains part of the ci-devant Brittany; and extends sixty-five miles from east to west, and between twenty-seven and forty-five from north to south. The superficial extent is about 2800 square miles, and the population 520,000. Its chief productions are hemp, flax, maize, and apples. The breed of cattle is excellent, and the butter much better than in the interior of France, but there are many barren spots. The mineral productions are lead and iron, and the manufactures linen and woollen stuffs, leather, thread, and hardware. St. Brieux is the capital.

COTHURNUS, a species of boot or buskin worn by hunters, and also by actors of tragedy, when they represented the characters of gods and heroes. They differed from the sandal, which was a mere sole tied about the toes and ankles with thongs and straps of leather, while the cothurnus covered the foot and leg as high as the calf, and was ornamented with gold, gems, and ivory. It is said to have been invented by *Eaehylus*.

COTICE, or *Covise*, in heraldry, is the fourth part of the bend; which with us is seldom or never borne, but in couples, with a bend between them. A bend thus bordered is said to be *cotised*.

COTILLON. Fr. *cotillon*, a petticoat. A lively dance, usually danced by eight persons.

And, wow! Tam saw an unco sight!

Warlocks and witches in a dance;

Nae *cotillion* brent new frae France,

But hornpipes, jigs, strathspeys, and reels.

Put life and mettle in their heels.

Burns.

COTOPAXI. See **ANDES**.

COTQUEAN, n. s. Probably from Fr. *coquin*, says Johnson; but this does not seem a very happy derivation. It is a corruption of *cuch-quean*, a woman whose husband is unfaithful to her bed, says Mr. Gifford. This guess, however, is more unfortunate than Dr. Johnson's. A *cotquean* is one who meddles too much with what is woman's peculiar business; and it is not easy to see what this has to do with *cornuing*, unless Mr. Gifford means to insinuate that a wife would be tempted to violate her faith to such a husband. Skinner is, perhaps, nearer to the truth, who thinks that it means a *cook-quean*, one who meddles with the cookery. The quotation from Shakspeare lends support to this supposition.

Look to the baked meats, good Angelica;

Spare not for cost.—

— Go, go, you *cotquean*, go;

Get you to bed.

Shakspeare. Romeo and Juliet.

And make a drudge of their uxorious mat

Who, like a *cot-quean*, freezeeth at the rock

While his breech doth dawe doth man the forren stock.

Hall.

You have given us a lively picture of husband; hen-pecked: but you have never touched upon one of the quite different character, and who goes by the name of *cotquean*.

Addison.

COTRONE, a town of Naples, in Calabria Citerior, on the site of the ancient Cróton, though not occupying the same extent of ground. It is fortified with walls, and a castle erected by Charles V. The streets are dismal and narrow. Cheese and corn are the principal commodities. The annual export of corn is considerable.

COTT, a sort of bed-frame, suspended from the beams of a ship for the officers to sleep in between the decks. It is much more convenient at sea than either the hammocks or fixed cabins; being a large piece of canvas sewed into the form of a chest, about six feet long, one deep, and from two to three wide. It is extended by a square wooden frame with a canvas bottom, equal to its length and breadth, to retain it in an horizontal position.

COTTAGE, in law, is properly a little house for habitation without lands belonging to it; stat. 4 Edw. I. By a later statute, 31 Eliz. c. 7, no man might build a cottage unless he laid four acres of land thereto; except in market towns or cities, or within a mile of the sea, or for the habitation of laborers in mines, sailors, foresters, shepherds, &c. This remained in force until 15 Geo. III. c. 32, by which it is repealed.

COTTIWAR, or *CATTIVAD*, a district in the province of Gujerat, Hindostan. The inhabitants called *Catties* are Hindoos, who adore the sun. They are governed by independent chiefs, frequently at war with each other; but all of whom are tributary to the Mahrattas. Their breed of cattle and horses is highly esteemed.

C O T T O N.

COTTON, *v. n.* & *n. s.* } Fr. *coton*. Cotton
 COTTONY, or } is the down of the
 COTTONOUS, *adj.* } cotton tree; the
 cloth made from that down. See the following
 article and GOSSIPIUM. To cotton means to rise
 with a nap; and, in familiar speech, to agree
 well with. Cottonous and cottony are, like cot-
 ton, full of cotton.

The pin ought to be as thick as a rowling-pin, and covered with *cotton*, that its hardness may not be offensive.

Wiseman.

A quarrel will end in one of you being turned off, in which case it will not be easy to *cotton* with another.

Swift.

Round, and round, and round they go: Mundell-box, that drives his *cotton*-mill, is their exact prototype—without an idea or wish beyond their circle; fat, sleek, stupid, patient, quiet, and contented. *Burns.*

So Arkwright taught from *cotton* pods to cull
 And stretch in lines the vegetable wool;
 With teeth of steel its fibre knots unfurled,
 And with its silver tissue clothed the world. *Darwin.*

COTTON. In our examination of this important subject, we shall, in the first instance, briefly notice its botanical character, and then proceed to a practical examination of its general properties and usefulness as an article of commerce.

The plant, or tree, that produces this important material, appears to be generally indigenous in the tropical regions. In the Linnæan classification of plants it is denominated *gossypium*, a genus of the class *monadelphia*; order *polyandria*; *cal.* double; and of which there are ten species. It seems to have been unknown in Europe till a comparatively recent period, none of the Latin vocabularies giving any definition of its nature or properties. It is adverted to by Herodotus, as growing in India. It was found in Mexico and in Peru at the time of the Spanish invasion, and its manufacture among the Peruvians was carried on to some extent.

The generality of the native West India species of the plant are annuals; whilst those of Asia are perennial, both in root and branch, rising in a straight line about eight feet high, with leaves in five palmate lobes; but the plants chiefly propagated are of the herbaceous species. The origin and progress of its culture in Asia is involved in great obscurity; but it was, doubtless, coeval with the origin of those ancient dynasties which excited the cupidity of Alexander of Macedon, and its manufacture progressively extended from the Indus to Cape Comorin.

Pliny describes the cotton-shrub as growing in the higher parts of Egypt, and 'of which,' he says, 'the Egyptian priests were wont to have surplices made, in which they took a singular delight.' He also tells us, that vestments of cotton were worn by the ancient Egyptians, and that too, more than a thousand years before the commencement of the Christian era. Moses speaks of robes of linen, and commands his people 'not to wear a garment of divers sorts,

as of woollen and linen together.' The dress of the ancient Babylonians consisted of a tunic of lawn, which they wore next to their skin. It descended, in the eastern mode, to their feet, and the Athenians wore long robes of fine cotton.

Three species of cotton are cultivated in Malta; one natural to the country, another from Siam, and the third of a cinnamon color, called Antilles cotton. These are all sown in the month of April, and the top of the plant is cut in the beginning of September, that the fruit may increase in size. It is gathered in October, when it begins to open, which is a sign that it is then sufficiently ripe. It is sown in the following manner: a hole, some inches deep, is made in the ground, which is afterwards filled with water, and when it is sufficiently soaked, the seed is put into it, and covered over, without being watered again until it begins to shoot out of the ground. The plant, when in perfection, grows to the height of from ten to fifteen inches, and blooms in the month of August.

In the year 1790 the planters, in the southern States of America, began to turn their attention to the raising of cotton-wool; and, besides carrying the cultivation of the article to a great extent, they produced qualities of cotton before unknown. In the year 1792 the quantity of cotton exported from the United States was only 138,328 pounds. At present, the annual export is supposed to be not less than 60,000,000 of pounds, and the amount is yearly increasing.

The American cotton-wool first brought to this country was very ill cleaned; and, in consequence, was for some time indiscriminately applied to the manufacture of the coarser species of goods. It was soon, however, perceived, that the cotton grown upon the coast, termed Sea Island cotton, had a finer and longer staple than that grown farther back in the country, and known by the name of upland cotton. But it was not for several years, and after a succession of trials, that this wool was ascertained to be of a quality, in every respect, superior to the cotton of the Isle of Bourbon. Indeed, it was not before the year 1796, that the finest description of it was applied to the purposes for which Bourbon wool had till then been used, and which it soon entirely supplanted; the second quality of it, in like manner, supplanting the Brasil wool in many kinds of goods for which it had been employed.

The upland cotton is a different species from the Sea Island, and is separated with such difficulty from the seed, that the expense of cleaning this wool must have put a stop to its farther cultivation, had not Mr. Whitney, a gentleman of the State of Massachusetts, in the year 1795, invented a machine by which the operation could be easily and successfully accomplished. There are two qualities of this cotton, the one termed upland Georgia, grown in the States of Georgia and South Carolina, and the other, a superior

quality, raised upon the banks of the Mississippi, and distinguished in the market by the name of New Orleans cotton. There was at first a strong prejudice against this wool; it was supposed that it was of an inferior quality, and did not receive a good color in dyeing; but being found suitable to different coarse fabrics, its cultivation was so rapidly extended, that, in the year 1807, 55,018,448 lbs. of upland cotton were exported from the United States.

Previous to the extended culture in North America, a very considerable portion of the annual supply was derived from Smyrna—say 6,000,000 to 7,000,000 lbs. The culture in Asia Minor, as well as Macedon and other parts of Turkey in Europe, is still considerable, but consumed chiefly for domestic purposes, and in the eastern parts of Europe; but the little that is now brought to England is used chiefly for candle-wicks. The quality cultivated in Egypt is good, and may be regarded as a new and important feature, should the career of the present enterprising pacha remain uninterrupted for a few years. In addition to the several kinds or growths already enumerated, the Isle of Bourbon, in the Indian Ocean, produces a very superior kind, limited in quantity, but equal in value, though somewhat different, to the American. It is probable also, from the delicacy of some of their fabrics, that a very superior kind is produced in India to any that is imported thence. China also, it is believed, produces a sort peculiar to itself, from which the nankeen cloths are supposed to be made.

But neither the extent of its growth in America, nor of its manufacture in England, is so much an object of surprise, as the very short period in which both have been accomplished. In point of extent, the comparison with the growth and manufacture of India, could it be ascertained, would probably be found trifling; the export of the raw material from Bengal and Bombay, in 1818, exceeded 600,000 bales, chiefly to China, or about 230,000,000 to 240,000,000 of lbs., whilst the internal consumption probably equalled, if not exceeded, that quantity.

It should be noticed, however, that the culture in the West Indies has not decreased in proportion to the apparent decrease of importation. It is true that the culture is very limited there, and the greater portion included under that head is from Demerara; it might also be inferred, from Portugal being included with the Brasils, that some plants are cultivated in Portugal, which is not the case; under the colonial regime the whole of the produce of the Brasils was carried to Portugal, and from thence re-exported: at the present time, however, nearly the whole growth comes direct to England from the Brasils; a comparatively trifling proportion goes direct to France and other parts of Europe. France is, however, the only other part of Europe where the spinning of cotton is carried on to any extent, being in that country about one-third what it is in England, with this difference, however, that whilst England indicates an increase, France indicates a decrease; the number of bags in France, in 1822, having been 190,000,

and only 166,000 in 1823; whilst the quantity in England, in 1822, was 541,000 bags, and 576,000 in 1823; the quantity spun in all the rest of Europe, collectively, not amounting to 60,000 bags.

Till within these few years the finest cotton, that was brought from India and the Isle of Bourbon, was comparatively of no use in England. Owing to its extreme delicacy and peculiarity of fibre, the carding engines then in use could not be brought to work it into a state fit for spinning. But the late improvements in that series of machinery which spinners call 'the preparation,' have obviated this difficulty, and, by enabling us to spin that cotton to the degree of fineness of which it is susceptible, have rendered our manufacture the wonder and envy of our rivals.

We shall now, however, proceed to our examination of the earliest stages of its manufacture.

The cotton, when collected from the pod, contains the seed, and pieces of the husk by which it was enveloped attached to it; it has, therefore, preparatory to being subjected to the operation of spinning, to undergo a process that will divest it of these superfluous parts. The ancient mode of effecting this was by what is termed bowing it; that is, exposing it to the action of a bow, about four feet long, such as is used at the present day by hatters. The process consisted merely in placing the cotton upon a square table, with horizontal crevices cut through it, and submitting it to the repeated action of the bow, until the dust, seeds, and superfluous parts had separated and fallen through the openings. This inconvenient and desultory mode has in modern times been superseded by a far more effectual and expeditious one, by the application of a machine called a *gin*. Gins are of two kinds, the one called the roller-gin, the other the saw-gin.

The *roller-gin* is represented in the annexed diagram. It consists of two shallow fluted rollers, *a* and *b*, placed so near to each other, that when the cotton is thrust against the line where they enter into contact, they immediately seize hold of it and draw it in between them, while the seeds and other particles, not being able to pass through, fall into the box *K*, and are, by the slanting direction of its bottom, delivered on one side. The motion is communicated by means of the treadle and crank, *C D*, and is equalised by the fly-wheel *E*. The cotton is presented to the rollers over the board *f g*, and is drawn between them, and delivered at *I, H*. In South America this kind of gin is much used, and a negro working with one of them can clean from 30 lbs. to 40 lbs. weight of cotton per day, which, however, is considered heavy work.

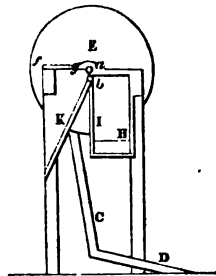

The *saw-gin* is given in section in the annexed figure. The cotton is thrown into the receptacle A B, on that side marked C D, which is formed of strong wires placed parallel to each other, to admit the circular saws E, fixed on the axis F, behind the grating, about an eighth of an inch apart, to pass between them. By this means, the teeth of the saws seize hold of the cotton, and draw it through the bars; and the seeds and other superfluous parts being too bulky to pass through, remain behind, and eventually fall through the aperture G. The cotton is brushed from the saws by a circular brush H, made to revolve rapidly on its axis. The motion is communicated by manual, or any other power applied to the axis F, upon one end of which is the wheel K, acting in a pinion, fixed to one end of the axis of the brush. When the cotton arrives in this country, it is again submitted to the action of machinery, for the further separation of the extraneous matter, unless it is to be spun into coarse yarn.

The first process the cotton undergoes in this country, is effected by means of an instrument called a *picker*; as represented in the annexed diagram:—

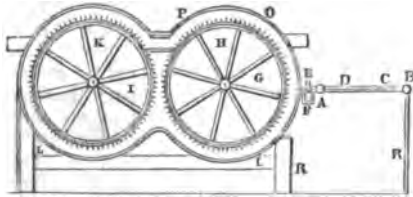

A and B are two rollers, having an endless cloth C D, stretched over them. This cloth is called the feeding-cloth, and its upper surface is, by the revolution of the rollers, always carried towards D. E and F are two fluted rollers, which nearly touch each other, and revolve, so that their touching surfaces pass towards G H. G H I K are cylinders, covered on their outer surfaces with long blunt pins, making about 250 revolutions, in the direction of the letters, per minute. L L is a grating of wires for the seeds to fall through, when the cotton carried by the feeding-cloth is delivered by the small rollers upon the face of G H. By the rapid revolution of G H, the cotton is thrown against the top O P, and is carried forward and delivered upon the cylinder I K, which in like manner carries it rapidly round, draws it over the grating, and delivers it back upon the lower face of G H, which after having drawn it over the remainder of the grating, and divested it of the remainder of the seeds and particles of dust, deposits it in the box R R.

This machine is liable to injure the staple of the cotton, and is therefore superseded by another called a *batter*, represented in fig. 1., plate I, COTTON MANUFACTURE. In this machine, the feeding-cloth upon the rollers A and B carries

forward the cotton to the rollers c and c, which deliver it upon the curved rack or grating d e, while a scotcher g h, revolving rapidly on its axis, strikes the cotton with its two edges g and h, and divides it; at the same time a draught of air, created by the revolution of the fan I, blows the cotton forward over the grating K K, divests it of the superfluous parts, and ultimately deposits it in a box at the end.

Having thus described the process of *batting*, we may now furnish a brief outline of the manipulations through which the material passes, and then examine the engines in detail.

Carding is that operation in which the first rudiments of the thread are formed. It is performed by cylinders covered with wire cards, revolving with considerable swiftness in opposite directions, nearly in contact with each other, or under a kind of dome or covering, the under surface of which is covered with similar cards, whose teeth are inclined in a direction opposite to those of the cylinders. By this means the separation of almost every individual fibre is effected, every little knotty or entangled part disengaged, and the cotton spread lightly and evenly over the whole surface of the last, or finishing cylinder.

For *jenny-spinning*, which is still in use for the coarser kinds of thread, the cardings are stripped off in separate lengths. The finishing cylinder is covered with the ordinary cards, nailed on in stripes across, and the cotton contained between the margins or intervals of each stripe, forms one carding, whose length of course depends on the width of the engine, or cylinder. When stripped off by the crank and comb, it forms a loose and shapeless film, which falling on the surface of a plain wooden cylinder, the lower half of which revolves within a hollow shell or casing, the cotton in its passage is rolled up and delivered at the other side in perfect and cylindrical cardings. For *mule* or *water-spinning*, the finishing cylinder is covered with spiral, or fillet-cards; and the cotton being taken off in one continued fleece, and contracted by passing through the funnel and rollers, forms one endless and perpetual carding, which is interrupted only, or broken, when the tin can that receives it is completely filled. In the *jenny-carding*, the fibres of the cotton are disposed across, or at right angles to the axis of the carding; in the perpetual carding they are disposed longitudinally, or in the direction of its length, and it is this circumstance which renders the carding destined for mule or water-spinning, inapplicable to the jenny, and vice versa.

Drawing and *doubling* is one of the preparatory processes for which we are indebted wholly to Sir Richard Arkwright, and belongs exclusively to the mule, or water-spinning. The doubling, or passing three or four cardings at once through a system of rollers, by which they are made to coalesce, is intended to correct any inequalities in the thickness of the cardings, and also to admit of their being frequently drawn out or extended, by passing through the rollers. The effect of this frequent drawing is to dispose the fibres of the cotton longitudinally, and in the most perfect state of parallelism. The operation of carding effects this in a certain degree; yet the fibres,

Fig. 7.

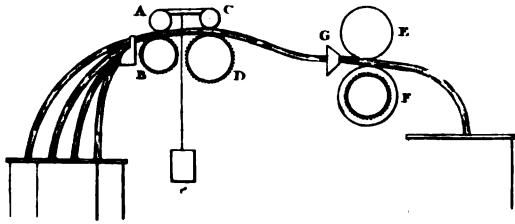

Fig. 4.



Fig. 6.

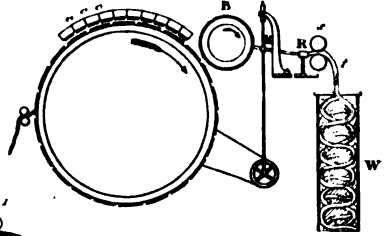

Fig. 5.

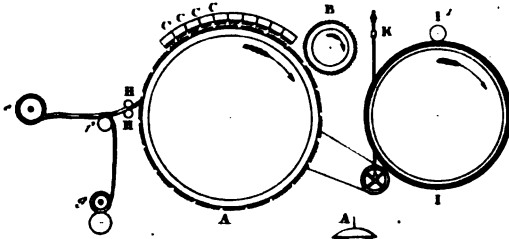

Fig. 9.

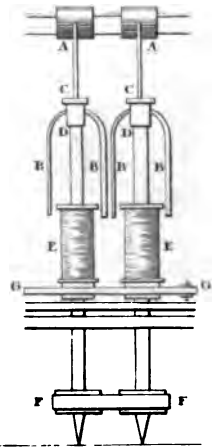

Fig. 10.

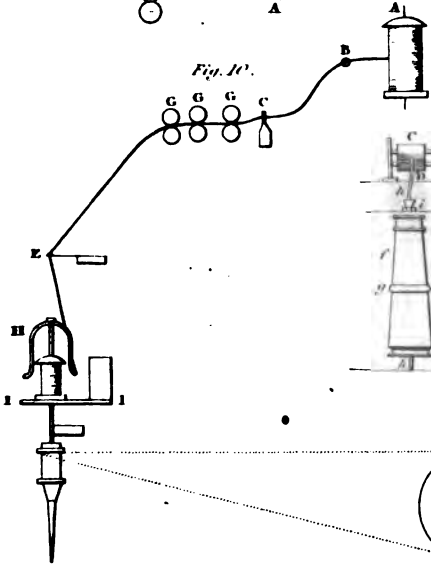

Fig. 8.

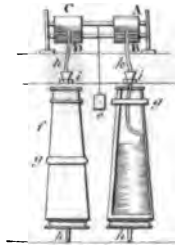
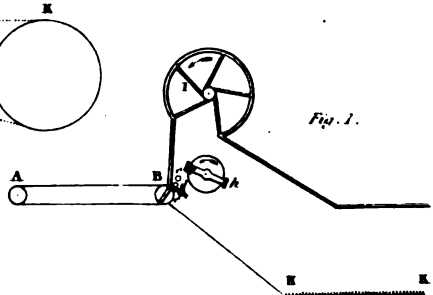

Fig. 1.



though parallel, are not straight, but doubled, as may easily be supposed from the teeth of the cards catching the fibres sometimes in the middle, which become hooked or fastened upon them. Their disposition is also farther disturbed by the taker-off, or comb, which strips them from the finishing cylinder; and though the general arrangement of the fibres of a carding is longitudinal, yet they are doubled, bent, and interlaced in such a way, as to render the operation we are now speaking of absolutely necessary. When the cardings have been passed four or five times through the drawing-frame, every fibre is stretched out at full length, and disposed in the most even and regular direction; and though the average length of a fibre of cotton is not two inches, yet the finished drawing, as these prepared cardings are now termed, has all the appearance of a lock of Jersey wool, whose fibres, six or eight times as long as those of cotton, have been carefully and smoothly combed.

Roving is that operation by which the prepared cotton, as it comes from the carding-engine, or drawing-frame, is twisted into a loose and thick thread, and wound upon a spindle or bobbin. In mule, or twist-spinning, the prepared carding or drawing, as it is termed, is again passed through a system of rollers, and is twisted, either by a rapidly revolving can, into which it is delivered from the rollers, or by a fly and spindle similar to those of the flax-wheel; in the latter case it is wound on the bobbin by the machine; in the former it is received in the conical can in which it acquires the twist, and is afterwards wound upon bobbins by children. Sir Richard Arkwright always employed the revolving can, and it is still employed in many of the first mills in the country. The roving-frame, with fly and spindle, which is in fact nothing more than the twist-frame of Sir Richard, is now however very generally in use, especially since later improvements have removed objections to the machine, which rendered its use previously inconvenient. The operations through which the thread passes after it has received the first twist are various, and depend greatly on the use it is intended for. The finer it is required, the oftener it is drawn out and twisted, till by degrees, as in the process of wire-drawing, it is brought down to the fineness required. The rovings are therefore distinguished into first, second, and third, according to the number of operations they have gone through.

Spinning is the last operation which the thread undergoes in the series of processes employed in converting it into thread, and is that in which it receives the final extension and twisting.

Carding, as we have already stated, is performed by two kinds of engines, one of which is called the breaker, and operates upon the cotton preparatory to its being submitted to the operation of the other, called the finisher. A card is a kind of brush, formed by making wires into the form of staples, as represented in fig. 4. The two legs of the staples are placed through holes in a flexible piece of leather, and present to the side view a form similar to that shown in the figure, where AB is the leather, and CD the wires forced through it. Cards are formed in

two ways; the one called sheet-card is made about four inches wide, and eighteen inches long, or of a length corresponding with the width of the main cylinder, which they have to cover; the other, called fillet-card, is made in one continuous band or fillet, and is used for covering the doffer cylinder. The teeth of the fillet-card are placed pointing in the direction of the length of the fillet, and completely cover the cylinder to which they are applied; whereas in sheet-cards a space is left behind every sheet.

Fig. 5 represents a sectional view of the immediate working parts of a breaker carding-engine. A is the main cylinder, covered with sheet-cards; B the doffer cylinder, covered with fillet-cards; CCC are the tops; *eg* is the feeding cloth supplied with cotton, which has been previously weighed, moving forward over the roller *f*, by means of the roller *g*, and delivering the cotton between the feeding-rollers H H, which carry it to the main cylinder. The main cylinder revolves rapidly in the direction of the dart, and carries the cotton upward between itself and the tops, which are covered with sheet-cards, about one inch and three-quarters to two inches wide, so that they may, as nearly as possible, follow the curve of the main cylinder. I is the lapping-cylinder, having wooden rollers Ii, lying upon its upper surface; and K is the doffer, or taker-off, having attached to it the steel comb called the doffing-plate.

The main cylinder, by its revolving motion, is soon covered with cotton, and is divested of it by the doffer-cylinder, which is placed so as nearly to touch it, and which moves at a much slower speed, in the direction of the dart. The effect of this engine would therefore be to distribute the cotton equally over the main cylinder, the top cards, and the doffer cylinder; but the doffing-plate, by the action already described, is continually clearing the doffer cylinder, whose points are consequently left bare to receive a fresh supply from the main cylinder. The doffing-plate continually strips the doffer cylinder of the carded cotton, which it delivers upon the lapping cylinder in one continuous web of about eighteen inches wide, which is the usual width of the engines for fine work. When the top cards are covered with cotton, an attendant is appointed to take them off, and to divest them of the loose cotton by means of a card nailed on a board, which he carries in his hand for that purpose. The quantity of work delivered to the engine is ruled by the speed of the cylinders, and quality of the cotton. When it has passed through the engine, and is wound upon the lapping cylinder (which is so adjusted as to contain about twenty laps), the attendant lifts up the large roller, makes a division in the circular web, and takes it off the roller. In this operation we are presented with the first act of plying or doubling, which is introduced in the process of spinning, in order to obtain equality in the strength and thickness of the yarn.

The cotton is in this state called a lap, and is immediately taken to a finisher-engine, which, in general, is disposed back to front, immediately after the breaker-engine, as may be seen in fig. 6. The construction of the finisher-engine is

exactly similar to that of the breaker-engine, except that instead of having a lapping cylinder, the cotton, when it leaves the doffer, is drawn through a mouth-piece R, formed like the end of a trumpet, by means of the rollers *s* and *t*, and is delivered into the can W. The rollers *s* and *t* are seen in section in this figure. Previously, however, to leaving this process, we shall make a few remarks, as it is, with much propriety, considered the very foundation of all good spinning. The breaker-engine for spinning fine cotton is generally covered with cards of a fineness that will admit 225 teeth, or 450 points in a square inch; and the finisher 275, or 550. But spinners are much divided on this subject, and in some mills the same work is performed with cards one-fifth coarser than it is in others. The top cards are in general one-tenth coarser, and those of the doffer cylinder one-tenth finer than those on the main cylinder: and in some manufactories, at the back part of the engines, where the cotton first arrives, coarser top-cards have been introduced, with a view of divesting the cotton of the largest particles of extraneous matter, and in some instances have been again laid aside as superfluous. Cards must be set easy in the leather, which should be thin and strong. The card-engine is driven by a strap passing from a drum over a fast and loose pulley, fixed on the shaft of the main cylinder.

The cotton having been transferred to the can from the card-engines, in the form of a *sliver*, is next submitted to the process of drawing, represented in fig. 7. In this process three or four card-ends are brought in tin cans, and passed between the rollers A B and C D, which revolve with different velocities; that is, the rollers C and D revolve much quicker than A B, and the top rollers A and C are made to press upon B and D, by means of the weight *e*. Now, supposing four slivers to be placed together, and passed through the rollers A B and C D, and that C D revolve so much quicker than A B, that the sliver will become four times its original length, the cotton will, by such elongation, be reduced in thickness three-fourths, that is, to the same thickness as the single sliver when first brought to the rollers. By this process the fibres of the cotton are laid more parallel to each other, in the direction of the length of the sliver, and the operation is repeated by plying the slivers which have passed the rollers, and passing them through a similar set. The sliver, when thus plied and reduced, is drawn through the mouth-piece G, by the rollers E and F, and delivered into another can. After the cotton has been plied and drawn as many times as the spinner, from the quality of the cotton, and the intended quality of the yarn, considers necessary, it is carried to the roving-frame.

This ingenious piece of apparatus, which is much used in mills where mule-spinning is carried on, is represented in fig. 8, and is termed the *can roving-frame*. A B, are two rollers, moving at a slower speed than C D; A and C, are pressed upon the rollers B and D, by the weight E, as may be seen in the accompanying section.



The cans are represented, the one shut and the other open; the latter opens by means of hinges, after raising the ring *g*. The cans are capable of revolving upon their spindles *h h*, and are supported in an upright position by the collars *tt*, and have at their upper extremities funnel-shaped pieces, *kk*. If two slivers of cotton are brought from the drawing-frame, and passed between the rollers A B, and C D, the processes of plying and drawing will again take place; and the rollers C D, will feed the end thus introduced into the can through the mouth-piece at *k*, which, by revolving rapidly upon its axis, will impart to the end, or sliver, a slight degree of twist. When the can is filled, the rollers are thrown out of gear, and the motion ceases; the can is then opened, and the cotton, or as it is now called, the roving, is taken out and wound upon a bobbin, and in that state is carried to a machine called a stretcher. Some objections exist against this species of roving; first, from the necessity of taking the roving out of the can for the purpose of winding it upon a bobbin, during which it is liable to sustain much damage from the fibres being in a very slight state of adhesion; and secondly, from the roving receiving its twist solely from the revolution of the can in which it rests, and by which the twist is not equally diffused over the whole length of the roving. The first objection was attempted to be obviated, by placing the can in a frame, and drawing the roving out through the mouth-piece at which it entered; and a remedy for the second was somewhat unsuccessfully attempted by Mr. Arkwright, who tried to introduce a pair of rollers upon the top of the roving-can, to seize hold of, and feed the roving into the can as fast as it was received from the drawing-rollers. This, undoubtedly, would have perfectly equalised the twist throughout; but the machinery necessary to produce the double rotatory motion was found to be inconvenient, and the plan was in consequence abandoned.

A roving-frame of a different construction, which obviates the preceding objections, and which in consequence, has received more general adoption, is represented at fig. 9. It is called the *bobbin and flier roving-frame*. The rollers for stretching are similar to those before described; and the plied and drawn roving is represented as coming from the rollers at A, whence it passes through an eye at C, over the top of the spindle D, and down one of the legs of the flier B B, which is for that purpose formed tubular. By the revolution of the spindle D, generated by a strap acting upon the pulley F, the fliers are carried swiftly round, and twist and deliver the thread upon the bobbin E, which is moved upwards upon the spindle by raising the board G G, upon which it rests, descending again as the board descends. The roving is, by this means, slightly twisted and wound upon a bobbin, in a fit state to be immediately carried to the stretching-frame, which, being very similar in its construction to the mule, we consider it necessary only to give a side view of one of the spindles of a mule.

It is shown in the annexed figure. A, is the place where the bobbin from the roving-frame

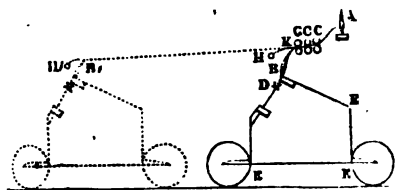

(not shown in this figure), would have been situate; and *ccc*, are three pairs of rollers, revolving at different speeds, for the future drawing of the roving. The roving, when it has been thus drawn, is brought to the spindle *B*, which is formed of polished steel, ground slightly tapering to the end, which is a round blunt point. The spindle receives its motion at the pulley *D*, by means of a band passing round a drum in the box *E E E*; which drum has bands passing in the same manner to several other spindles. When the motion commences, the carriage *E E E*, passes backwards to the position shown by the dotted lines, and carries with it the spindles to the position *B'*, during which the spindle revolves rapidly on its axis, and gives a certain degree of twist to the roving, which already has undergone a reduction in diameter by passing through the rollers *C C C*. The extent to which the frame recedes is about three yards, and when the spindles have given the requisite degree of twist to the yarn, it returns to its former place; while the attendant, by moving the bar *H*, upon its axis, presses the yarn downwards, by means of a piece of wire *K*, which causes it to be wound upon the spindles, so as to form a figure that may be represented by two cones, one having a more acute angle than the other, placed base to base as shown at *A B*, and *B'*. This form is termed a *cop*, and the act of so distributing the yarn, by the movement of *H K*, the *building of the cop*. It may here be observed, that although this is called the stretching-frame, the yarn is not stretched, but merely undergoes a further process of drawing and spinning, and that the stretching is not performed till the next operation, which is performed upon the mule, and termed spinning.

The yarn, delivered from the stretching-frame in the form of a cop, is taken to the mule, which is, though much lighter, both in form and action of the parts, very similar to the stretching-frame. The spindles also are of a smaller size, and are situated nearer to each other. The *mule spinning-frame* differs from that of the stretching-frame inasmuch as the act of stretching is added to the other operations; for when the frame *E E E*, (see diagram) has receded a certain distance, generally about one yard, the rollers *C C C*, cease to move, and the frame still continuing to recede, stretches the yarn. During this process the spindles on the frame *E E E*, move considerably quicker, in order to save time. The stretching is performed with a view to elongate and reduce those places in the yarn which have a greater diameter, and are less twisted than the other parts, so that the size and twist of the yarn may be more uniform throughout. When the cops are full, they are taken from the moving

spindles, and placed on stationary parts of other mules, as at *A*, and the yarn is again submitted to the same process until it is reduced and spun to the proper fineness, both as respects the diameter and the twist; during the whole of which process, the yarn can be continually joined, so that the cops, which are in separate pieces, can be added to each other in parts, or otherwise, as the continual elongation of the yarn in the course of the different operations of each mule may require. The pieces are joined by children, called *piecers*, who are in attendance on each mule, to join any yarn that may be broken in the act of stretching or twisting. The drums, which drive the spindles in those parts of the mule that recede, receive their motions from bands communicating with the moving power; but the advancement and recession of the carriage, for the purposes of receiving and stretching the yarn, as before described, is performed by means of a wheel moved by hand-labor. A spinner is enabled by experience to judge of and regulate both these operations, as also the building of the cop, which is a matter of very great nicety; for if the cop is not well built, the yarn will not run off even when it is to be used. The number of spindles on a mule amounts frequently to 300. The yarn produced by mule-spinning, being by far the most perfect, is employed in the fabrication of the finest articles, such as lace and hosiery; and when it is twisted in two, four, or six plies, is used for sewing-thread.

We may now briefly examine the process called *jenny-spinning*. This is of a much earlier date, and is on the whole a less perfect process than mule-spinning; consequently it is but little used, except in the manufacture of yarn for coarse goods. In this spinning, the cotton, after having been cleansed by some of the processes already described, is, preparatory to being exposed to the action of the jenny, immersed in a solution of soap and water, to divest it of the glutinous matter generally found on the surface of this and other vegetable fibres; it is then, after the soap and water has been pressed from it, put into a warm stove, and when dry is considered to be in a fit state to be exposed to the operation of the carding-engine. The carding-engine used in jenny-spinning is different in its construction to the one before described; for in mule and water spinning there is a breaker and a finisher engine; but the engine used in this process is called the double-engine; the first part, or breaker, is in the same frame with the second part, or finisher, and the doffer from the first part delivers the cotton upon the main cylinder of the second part, which, in like manner, delivers it upon the second doffer. The second doffer, instead of being covered with fillet-cards, as the doffer of the single engines, is covered with sheet-cards, like the main cylinder, but being of smaller dimensions, has generally only twelve cards upon it; therefore the web of cotton combed from such doffer by the doffing-plate is not in one continuous piece, but in several pieces or portions, equal to the quantity attached to each sheet-card upon the doffing cylinder. As the several small portions are delivered by the comb, they fall into the concave part of a smooth

arc that is equal to one-third of a circle. In this arc a cylinder of smooth mahogany slowly revolves in such direction that the lower surface in the arc passes from the engine. This cylinder has small cavities or flutes on its surface, in a parallel direction to its axis; the angles on the projections between the flutes are taken off, so that the several portions of web which fall from the doffer into the arc are seized by the flutes, and carried forward on the concave face of the arc, and formed into a sliver, about half an inch in diameter, and of a length corresponding with the breadth of the carding-engines, which is about from twenty-four to thirty-four inches. The portions thus rolled are called rows, rolls, or rowans.

In this state, the cotton may be considered in the same relative state of progress as a card-end in mule or water spinning; but it is evident that this mode of spinning is very deficient for the purposes of fine yarn, inasmuch as in the rowans the fibres of the cotton are laid across the longitudinal direction in which they are to be spun, so that the advantage derived in the other process of carding, from the fibres being placed in a direction parallel to the intended length of the yarn, is entirely lost. In this process, also, the advantage of plying, which we have noticed as taking place on the lapping cylinder is lost.

When the rowans are perfected by the mahogany cylinder, they are taken up by children, and placed upon the feeding-cloth of a machine called the *billy*, or *roving-billy*, the operation of which is called roving or stubbing; but the latter expression is now but seldom used, except in the manufacture of woollen. This machine is in its construction and action very similar to the mule, as is the feeding-cloth, to that described in the machine called the picker and batter.

The feeding-cloth lies in a slanting position, and the rowans are placed upon it so that they can pass lengthwise in the direction of its action, and be delivered over the upper roller between two pieces of board which possess a capability of clasping and again relieving them. The rowans are then attached to revolving spindles, which have an advancing and receding motion similar to the mule or drawing-frame. By this revolution and recession the spindles perform the operation of spinning and stretching; and at such intervals as the spindles are stretching and twisting, the feeding-cloth stops, and the clasps seize hold of the roving, and detain it till sufficiently spun and twisted, when it is relieved in order to allow a further portion of the rowan to be fed. The roving having by this means received a certain degree of twist, is built on the spindle in the form of a cop, as in mule-spinning, and is then taken to the machine called the jenny. The operation of the jenny is nearly the same as the *roving-billy*; the only material difference is, that the cops of roving to be spun are fixed upon a moving carriage, which has clasps to hold the roving while in the act of being stretched and spun into yarn.

Water-spinning differs both from the mule and jenny spinning; but the carding and drawing machines are the same as those used in the process of mule spinning. When the cotton has passed

through the carding and drawing machines, it is carried to the spinning-frame, which is upon a different principle to the mule, and, indeed, is more closely allied to the bobbin and flier roving frame. One of the spindles is represented in the engraving, fig. 10. A, the bobbin, brought from the roving-frame; B C, and E, guides for the yarn to pass through; G G G, three pairs of rollers to perform the office of drawing; and H, a flier, formed solid, and having at the end of one arm a small twist like a cork-screw, through which the yarn passes. By the revolution of the flier the yarn receives the requisite degree of twist, and is wound upon the bobbin, which, by the movement of the seat II, on which it rests, has an upward and downward motion, in order that the yarn may be received upon it regularly. The guide C has a slow reciprocating motion in the direction of the axes of the rollers G G G, by which the roving is moved over the surfaces of the rollers, so that the parts wear uniformly.

In water twist-spinning, the operation of stretching is not introduced. The motion is transmitted from the first mover to the drawing and roving frames by means of bevel-wheels, placed on the end of the frame. These wheels communicate motion to the rollers, which have spur-wheels upon their shafts, adapted to give motion to each other by intermediate wheels which give to the lower rollers motion in the proper direction. The spindles receive their motion from bands communicating with the drum K, represented by the dotted lines. This construction of a water spinning-frame is called a *throstle*, and the difference which characterises it from that properly called the water-frame is, that the cylinder K runs through the whole length of the frame, and gives motion to all the spindles at once; whereas in the water-frame the spindles are moved by an upright pulley, communicating motion to only one set of six spindles, which is an advantage, as the motion of one set can be stopped without stopping the motion of the whole. But as the water-frame is far more expensive than the other, it is a matter of doubt which ought to be preferred.

The several sorts of yarn have each their peculiar destination. The yarn from mule and jenny spinning is taken from the frame in the form of a cop; that from water-twist is wound upon a bobbin. The yarn from water-frames possesses much regularity and strength, and is mostly used for the warps of heavy goods, such as fustians and strong calicoes. If the yarn has to be packed for the market, it is reeled upon a frame consisting of six horizontal bars, supported on an axis parallel to each other.

The frame is represented in the accompanying diagram, A A A A A the horizontal bars, B the axis, and C the bobbin from the water-frame. The dotted lines represent the direction of the twist. These reels are of a sufficient breadth to wind off about fifty cops or bobbins, at the same time.

When the reel has made eighty revolutions, a small bell that is connected with the machinery rings, and warns the attendant to stop the motion of the reel. The portion thus wound is called a lay, and seven of these lays wound

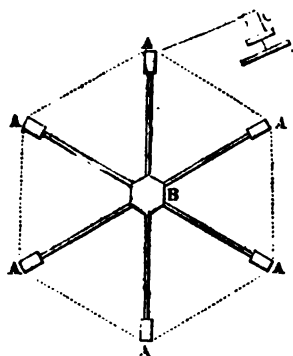

upon the same reel constitute a hank, which is taken from the reel by causing one of the horizontal bars, supplied with a hinge, to fall inwards. The circumference of the reel is a yard and a half, consequently the hank measures 840 yards. The size of the twist is expressed by stating how many hanks go to the pound weight: thus, the yarn called No. 100, is that which takes 100 hanks 840 yards each to weigh an avoirdupois pound. Yarn can be spun upon mules as fine as 200 hanks to the pound; but in water-twist and jenny-spinning it seldom exceeds sixty or seventy.

The last operation that we shall have occasion to describe, is that of warping. The machine on which this is performed is an octagonal prism, five or six feet high, and somewhat less in diameter, revolving vertically, and put in motion by a hand and pulley placed under the seat of the warper. The bobbins which furnish the thread are suspended horizontally in a frame on one side. Twenty-eight or thirty threads, forming together a system called a half beer, are wound round the prism in a spiral form from top to bottom. The machine is then turned the contrary way, and the thread wound round the prism upwards from bottom to top, and this is repeated backwards and forwards till a sufficient number of half beers have been wound to form a web of the breadth required. When finished, and the ends properly secured, the whole is wound off, and coiled upon the hand into a round ball, called the warp. If the thread has been previously sized in the hank, it is now ready for the loom; but if the warp is made of cop twist, that operation is next performed. The warps are boiled several hours in water till they are thoroughly penetrated and softened; after draining some time they are then uncoiled and worked in the size till fully impregnated, after which the superfluous size is squeezed out, and they are suspended on poles to dry: the warp is then ready for the loom.

Without this operation of sizing, which, as we have before observed, gives strength and tenacity to the thread, it would not support the friction of the loom. Two threads are passed between each dent of the reed, and at each stroke of the treadle one ascends whilst the other descends. There is, therefore, a constant friction of the threads upon each other, as well as against the teeth of the reed. The motion of the reed itself

also backwards and forwards, and of the healds, up and down, is very severe upon the warp, and unless it has been well penetrated by the size, and its fibres well cemented or glued together, this continual rubbing is sufficient to destroy its texture. Good sizing prevents this, but it is still further aided by another operation called dressing, which is performed by the weaver himself after the warp has got into the loom.

This consists first in applying with a brush a kind of paste made of wheat-flour well boiled, to which is often added a small portion of common salt, sometimes of potash, and sometimes even a little tallow. It is in fact a repetition of the operation of sizing, with this difference, that the dressing is applied chiefly to the surface of the thread, which is slightly coated with the paste, and brushed uniformly in one direction from the healds to the beam, by which means the loose fibres are all disposed evenly one way and firmly glued fast to the thread.

In summer the warp is dried simply by fanning it, but in winter, and in damp cold weather, a hot iron is lightly passed over it. It is then dressed again with a brush dipped in tallow or butter, with which it is slightly greased. This gives suppleness and smoothness to the thread, and greatly diminishes the friction of the healds and reed. As such a portion of the warp as is extended between the healds and beam can alone be dressed at one time, this is woven, and the dressing repeated again upon another portion, and so on alternately dressing and weaving, till the whole of the web is finished.

Messrs. Ratcliffe and Ross dress the whole of the warp before it is wound upon the beam; the labor of the weaver is therefore uninterrupted, and his attention directed solely to one object. This alone is a great point gained, but it is attended also by other, not less important, advantages. Great part of the intellectual skill required in weaving, is in the dressing and beaming of the warp; the mere mechanical part of throwing the shuttle, &c. is soon acquired, even by a boy. A more accurate division of labor, by reducing the beaming and dressing to a system by which they are better, more economically, and more expeditiously performed than before, has removed the great difficulty in the art of weaving, and rendered it in a great measure the employment of children. From what we have already said, it will appear that the object in dressing and sizing is nearly the same, and Messrs. Ratcliffe and Ross, by an improved mode of dressing, have succeeded in reducing these operations to one. They have gone still further; they have done away with the necessity of warping, by forming the web at once from the bobbin, and thus reduced the warping, sizing, dressing, and beaming, to one operation. A thousand bobbins and upwards supply the materials for the warp, which in its progress is properly disposed and arranged, sized, dressed, and finally wound upon the beam. See WEAVING.

Messrs. Hall's experiments on the stoving of cotton goods with sulphur, are of a new character, and well worthy of notice. To stove goods in the most advantageous way, they should be

exposed to the vapor of burning sulphur in a moistened state. But they are then rendered less saleable by the appearance of the spots or iron-moulds. The object of the experiments about to be detailed, was at once to combine the good effects, with regard to the appearance and feel of the goods, resulting from stoving, and to obviate the appearance of the spots. The probable conclusion from these experiments is, that small portions of iron are derived from the sulphur, as held in solution in the sulphureous acid gas formed, and are at length deposited in distinct nuclei on the goods exposed to its action, so as to form the spots above mentioned. With the view of preventing this formation of spots, the following experiments were made:—

The clearest and purest sulphur of commerce, called virgin sulphur, &c. was first employed. The spots produced were less numerous than those occasioned by the common kinds of sulphur; but the benefit was partial and inconsiderable only. Flowers of sulphur were then taken and sublimed to the third time; but still the experiment yielded no results of a decisive character. Sulphur precipitated from the alkaline and earthy sulphurets by means of pure acids, still induced the same appearance of spots as before. The same thing may be observed of sulphur purified by means of phosphorus; the phosphorus was first united under water with the sulphur, and then converted into phosphoric acid by continued boiling; much ferruginous matter was separated, and this experiment seemed to promise success; but the result, although the most favorable of all, was far from being perfect. Sulphurous acid gas, produced by the decomposition of sulphuric acid, by means of charcoal and of mercury, still induced the spots, in the same manner as when it resulted from the combustion of sulphur. Sulphurous acid gas expelled from the sulphates of the alkalis or earths, produced the same appearance of spots as before. Sulphurous acid gas passed through acids still retained the same property of spotting.

The usual mode of stoving, consists in burning sulphur in a close chamber, in which the goods to be stoved are hung. Beside this mode of experiments, many trials were made by exposing a little of the material of the goods to the action of the sulphurous acid in a glass jar, containing about six or eight pints of the gas. The cotton, in these experiments, was moistened with a decoction of galls. Rather more than the requisite quantity of sulphur was placed on a bit of tile, brought to a red heat, and placed within the jar. At first the sulphur burnt with its usual blue flame, but at length the flame became extinguished, and the sulphur was seen to sublime, the oxygen of the air being exhausted. After the cotton had remained about an hour exposed to the sulphurous acid gas, it was taken out free from spots; but the spots gradually began to make their appearance during an exposure to the air of about five or ten minutes.

The mode of bleaching cotton in Suabia is worth notice, especially as it is peculiar to that country. This operation is performed in two days, and does not require extensive premises.

An alkaline caustic lee is prepared, by taking two measures of quick-lime, and covering them with ten measures of good ashes; the heap is then to be sprinkled with water, and when the lime is slaked and the mass cooled, it is fit for making the lee, by the addition of cold soft water. The skeins of cotton, being untwisted and tied in parcels, are to be immersed in the lee, in which they are to be left six hours, and to be occasionally turned. They are then to be washed in a river, and afterwards boiled twelve hours in a bath of the same kind of lee, in which, for every sixty-six pounds of cotton thread, six pounds of soap have been dissolved. They are then to be boiled the same length of time in a solution of soap and water only, according to the former proportion; after which, they are to be again washed in the river, and hung up in the air, or laid on the grass to dry as quick as possible. The process for the hosiery is similar. The boiler must be made of copper, and always well cleaned after it has been used.

The manufacture of *Bandanas* has now become a very important branch of our cotton trade; and we cannot do better than furnish our readers with an account of the great Bandana gallery of Messrs. Monteith and Co. at Glasgow. This establishment has been long celebrated in the commercial world for the excellence and beauty of its cotton fabrics. Their madder-reds rival in brilliancy and solidity any ever produced at Adrianople; and the white figures distributed over the cloth, surpass, in purity, elegance, and precision of outline, the original Bandana designs.

Their new arrangement of hydrostatic presses was completed in 1818, under the direction of Mr. George Ridger, sen., manager of the works. It consists of sixteen of these engines beautifully constructed, placed in one range in subdivisions of four; the spaces between each set serving as passages to admit the workmen readily to the back of the press. Each subdivision occupies twenty-five feet; whence the total length of the apparatus is 100 feet. To each press is attached a pair of patterns in lead (or plates, as they are called,) the manner of forming which will be described in the sequel. One of these plates is fixed to the upper block of the press. This block is so contrived that it turns on a kind of universal joint, which enables this plate to apply more exactly to the under plate. The latter rests on the moveable part of the press, commonly called the sill. When this is forced up, the two patterns close on each other very nicely, by means of guide-pins at the corners, fitted with the utmost care. The power which impels this great hydrostatic range, is placed in a separate apartment, called the machinery-room. This machinery consists of two cylinders of a peculiar construction, having cylindrical pistons accurately fitted to them. To each of these cylinders three little force-pumps, worked by a steam engine, are connected. The piston of the larger cylinder is eight inches in diameter, and is loaded with a top-weight of five tons. This piston can be made to rise about two feet through a leather stuffing or collar. The other cylinder has a piston of only one inch in diameter, which

is also loaded with a top-weight of five tons. It is capable, like the other, of being raised two feet through its collar. Supposing the pistons to be at their lowest point, four of the six small force-pumps are put in action by the steam engine, two of them to raise the large piston, and two the little one. In a short time, so much water is injected into the cylinders, that the loaded pistons have arrived at their highest points. They are now ready for working the hydrostatic discharge presses, the water pressure being conveyed from the one apartment to the other under ground, through strong copper tubes of small caliber.

Two valves are attached to each press, one opening a communication between the large prime-cylinder and the cylinder of the press, the other between the small prime-cylinder and the press. The function of the first is simply to lift the under-block of the press into contact with the upper-block; that of the second is to give the requisite compression to the cloth. A third valve is attached to the press, for the purpose of discharging the water from its cylinder, when the press is to be relaxed, in order to remove or draw through the cloth. From twelve to fourteen pieces of cloth, previously dyed Turkey red, are stretched over each other, as parallel as possible, by a particular machine. These parallel layers are then rolled round a wooden cylinder, called by the workmen a drum. This cylinder is now placed in its proper situation at the back of the press. A portion of the fourteen layers of cloth, equal to the area of the plates, is next drawn through between them by hooks attached to the two corners of the webs. On opening the valve connected with the eight-inch prime-cylinder, the water enters the cylinder of the press, and instantly lifts its lower block, so as to apply the under plate with its cloth close to the upper one. This valve is then shut, and the other is opened. The pressure of five tons in the one inch prime-cylinder is now brought to bear on the piston of the press, which is eight inches in diameter. The effective force here, will therefore be $5 \text{ tons} \times 8^2 = 320 \text{ tons}$; the areas of cylinders being to each other, as the squares of their respective diameters. The cloth is, therefore, condensed between the leaden pattern-plates, with a pressure of 320 tons.

The next step, is to admit the blanching or discharging liquor (aqueous chlorine, obtained by adding sulphuric acid to solution of chloride of lime,) to the cloth. This liquor is contained in a large cistern, in an adjoining house, from which it is run at pleasure into small lead cisterns attached to the presses, which cisterns have graduated index tubes, for regulating the quantity of liquor according to the pattern of discharge. The stop-cocks on the pipes and cisterns containing this liquor, are all made of glass. From the measure-cistern, the liquor is allowed to flow into the hollows in the upper lead-plate, whence it descends on the cloth, and percolates through it, extracting in its passage the Turkey red dye. The liquor is finally conveyed into the waste pipe, from a groove in the under block. As soon as the chlorine liquor has passed through, water is admitted in a similar manner, to wash

away the chlorine, otherwise on relaxing the pressure, the outline of the figure discharged would become ragged. The passage of the discharge liquor, as well as of the water through the cloth, is occasionally aided by a pneumatic apparatus or blowing machine; consisting of a large gasometer, from which air, subjected to a moderate pressure, may be allowed to issue, and act in the direction of the liquids, in the folds of the cloth. By an occasional twist of the air stop-cock, the workman also can ensure the equal distribution of the discharging liquor, over the whole excavations in the upper plate. When the demand for goods is pressing, the air apparatus is much employed, as it enables the workman to double his product.

The time requisite for completing the discharging process in the first press, is sufficient to enable the other three workmen to put the remaining fifteen presses in play. The discharger proceeds now from press to press, admits the liquor, the air, and the water; and is followed, at a proper interval, by the assistants, who relax the press, move forwards another square of the cloth, and then restore the pressure. Whenever the sixteenth press has been liquored, &c., it is time to open the first press. In this routine, about ten minutes are employed; that is, 224 handkerchiefs (16×14), are discharged in ten minutes. The whole cloth is drawn successively forward, to be successively treated in the above method. When the cloth escapes from the press, it is passed between two rollers in front, from which it falls into a trough of water placed below. It is finally carried off to the washing and bleaching departments, where the lustre of both the white and the red is considerably brightened. By the above arrangement of presses, 1600 pieces, consisting of 12 yards each = 19,200 yards, are converted into Bandanas in the space of ten hours, by the labor of four workmen.

The patterns, or plates, which are put into the presses to determine the white figures on the cloth, are made of lead, in the following way:— a trellis-frame, of cast-iron, one inch thick, with turned-up edges, forming a trough rather larger than the intended lead pattern, is used as the solid ground-work. Into this trough, a lead plate, about half an inch thick, is firmly put by screw-nails passing up from below. To the edges of this lead plate, the borders of the piece of sheet-lead are soldered, which covers the whole outer surface of the iron frame. Thus, a strong trough is formed, one inch deep. The upright border gives at once great strength to the plate, and serves to confine the liquor. A thin sheet of lead is now laid on the thick lead plate, in the manner of a veneer on toilette-tables, and is soldered to it, round the edges. Both sheets must be made very smooth beforehand, by hammering them on a smooth stone table, and then finishing with a plane; the surface of the thin sheet, now attached, is to be covered with drawing-paper pasted on, and upon this the pattern is drawn. It is now ready for the cutter. The first thing which he does, is to fix down, with brass pins, all the parts of the pattern which are to be left solid. He now proceeds with the little tools generally used by block-cutters, which

are fitted to the different curvatures of the pattern, and he cuts perpendicularly quite through the thin sheet. The pieces thus detached are easily lifted out; and, thus the channels are formed, which design the white figures on the red cloth. At the bottom of the channels, a sufficient number of small perforations are made through the thicker sheet of lead, so that the discharging liquor may have free ingress and egress. Thus, one plate is finished, from which an impression is to be taken by means of printer's ink, on the paper pasted on another plate. The impression is taken in the hydrostatic press. Each pair of plates constitutes a set, which may be put into the presses, and removed at pleasure.

Fig. 1, plate II, is an elevation of one press; A, the top, or entablature; BB, cheeks of ditto, or pillars; C, upper block for fastening upper pattern to; D, lower, or movable block; E, the cylinder; F, the sole, or base; G, the water for the discharged cloth to fall into; H, cistern, or liquor-meter; *dd*, glass tubes for indicating the quantity of liquor in the cistern; *ea*, glass stop-cocks for admitting the liquor into the cistern; *ff*, stop-cocks for admitting water; *gg*, the pattern plates; *nn*, screws for setting the patterns parallel to each other; *mm*, stuffs perforated with a half-inch drill. The lower iron frame has corresponding pins, which suit these perforations; so that the patterns are guided into exact correspondence with each other; *hh*, rollers which receive and pull through the discharged cloth, from which it falls into the water-box; *k*, stop-cock for filling the trough with water; *iii*, waste tubes for water and liquor.

The plan of the buildings in which the cotton spinning machinery is placed, is generally in the form of a parallelogram, of a length proportionate to the extent of the manufacture carried on therein, and about thirty feet wide. In the best constructed mills, the carding and other preparatory machines are placed on the lowest floor; the mules and stretching frames on the next; and so on progressively as the machines improve the fineness of the yarn. The mules, jennies, and water-frames are placed with their line of spindles across the building; and the card engines have the axes of their cylinders parallel to the long wall of the building. Four or six rows, breakers, and finishers, are placed alternately.

The steam engine, or first mover, is placed at one end of the building, and the motion is communicated by a horizontal shaft running the whole length of the building, which transmits the motion to vertical shafts with bevel-wheels, which wheels transmit the motion to horizontal shafts in the upper floors. A better idea, however, may be procured of one of these mills by reference to plate II, COTTON MANUFACTURE, in which we furnish a view of the fire-proof premises erected by Messrs. Strutt.

The most important legislative enactment connected with the cotton manufacture, relates to the regulation of the mills, and is especially intended to preserve the health of the persons employed in those extensive works. The act was passed in the month of June, 1825, and

commenced its operation in August, and the result has been most satisfactory. It commences by enacting that no person, being under the age of sixteen years, shall be employed in any description of work whatsoever, in spinning cotton wool into yarn, or in the previous preparation of such wool, or in the cleaning of any mill, manufactory or building, for more than twelve hours in any one day, exclusive of the necessary time for meals, such twelve hours to be between the hours of five of the clock in the morning, and eight of the clock in the evening. And no person under the age above-mentioned shall be worked more than nine hours on a Saturday; such nine hours to be completed between the hours of five of the clock in the morning, and four of the clock in the afternoon.

There shall be allowed to every person, in the course of every day, not less than half an hour to breakfast, and not less than one full hour for dinner; such half hour for breakfast to be between the hours of eight of the clock, and nine of the clock, in the morning; and such hour for dinner to be between the hours of twelve of the clock in the forenoon, and two of the clock in the afternoon. If at any time, in any such mill, manufactory, or buildings, time shall be lost in consequence of the want of a dug supply, or of an excess of water, or any accident happening to the steam engine, water-wheels, or mill-gearing, then it shall be lawful for the proprietors of any such mill to extend the before-mentioned time of daily labor, after the rate of one additional hour in any one day during the week (except on Saturdays), in which it is lost, but no longer. The ceilings and interior walls of every such mill, manufactory, or building, shall be washed with quicklime and water once in every year.

Every person, whether proprietor, occupier, or foreman, of any such cotton mill, who shall offend against any of the provisions of this act, shall for every such offence forfeit and pay any sum not exceeding £20, nor less than £10, at the discretion of the justices before whom such offender shall be convicted.

We may now turn to the *foreign trade* as regards the manufacture of this important article. In the year 1806, 21,734,000 lbs. of cotton were imported into France, and manufactured into the following articles:—About 1,000,000 lbs. into velveteens; about 925,000 lbs. into nankeens, nankinets, crapes, and other small stuffs; about 1,155,000 into dimities; about 14,880,000 into fustians, calicoes, coverlets, simoises, and muslins. In twenty-two of the departments in France, in which this manufacture was carried on, there were, in 1806, 7,450 spinning mules, containing 800,724 spindles, and employing 28,460 persons; and there were in these departments 28,634 looms employed in weaving cotton fabrics, giving occupation to 31,107 persons. The number of machines, and of people engaged in this manufacture in the other parts of the country are not stated.

In the same year France imported (contraband) from England 2,000,000 of pieces of nankeens, 1,000,000 of pieces of cotton cloth for printing, and about 300,000 pieces of other de-

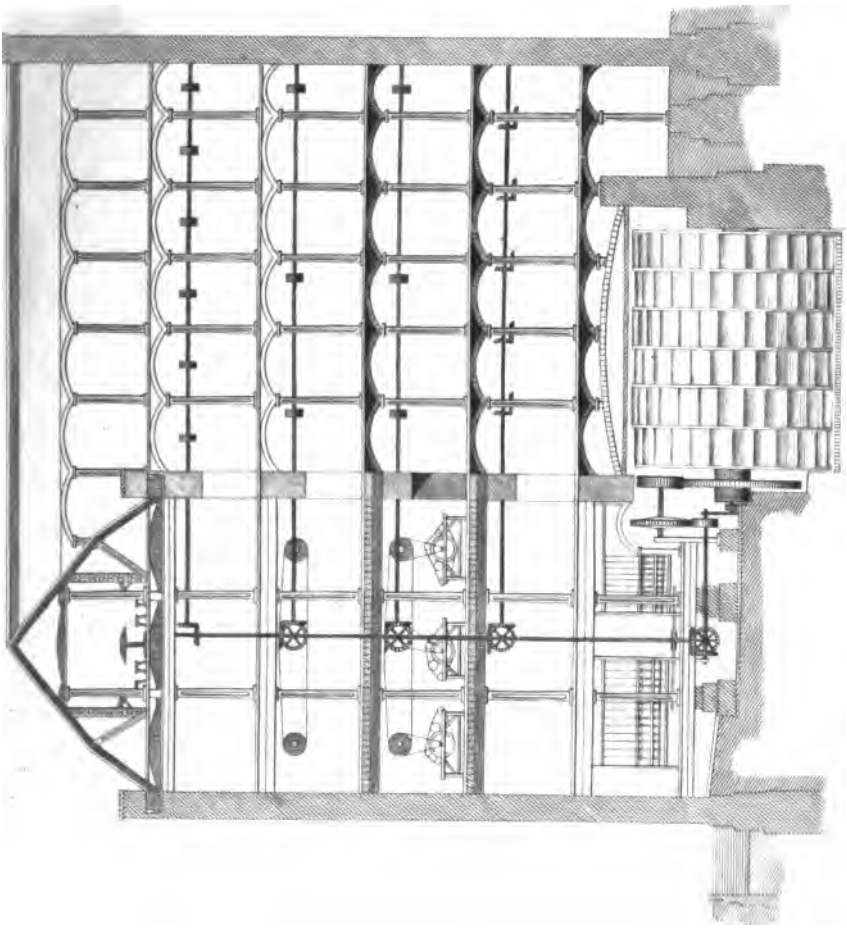
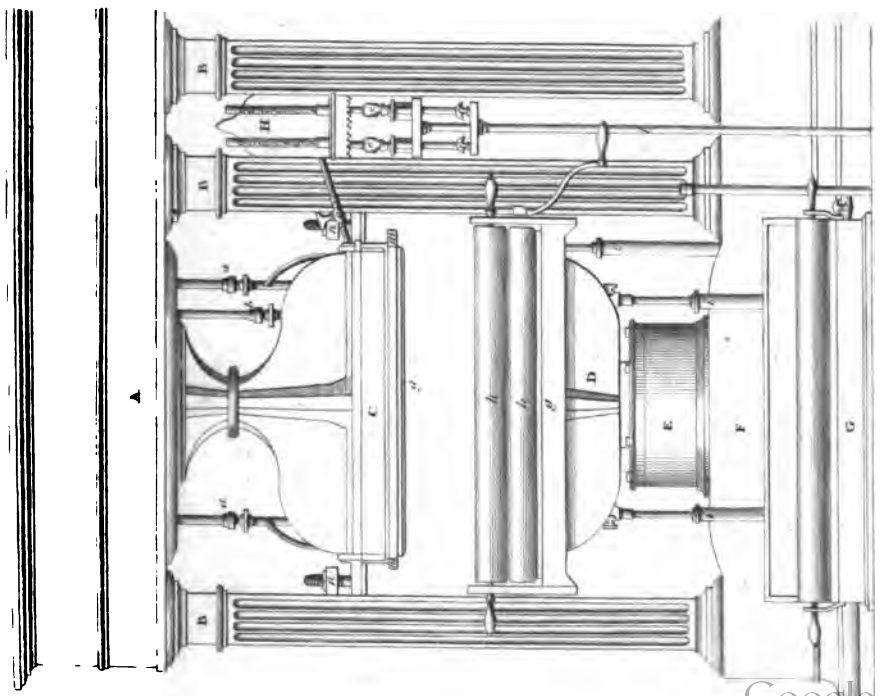

London, Published by Thomas Agnew & Sons, Manchester, Agents, 1857.

scriptions of cotton goods, such as muslins, cambrics, dimities, &c. valued at £3,000,000 sterling.

The cotton manufacture of Switzerland, whatever may have been the date of its commencement, has not proceeded so rapidly as the French. It was even many years after Sir Richard Arkwright's improvements before it began to make any considerable advance. It was not until the year 1798, that the Swiss had any spinning by machinery, at which time their first mill was erected at St. Gall. Before that period all their yarn was spun upon the one-thread wheel; and even still, about a tenth part of what they produce is spun in this manner. After the introduction of machinery, however, this article of manufacture made rapid advances, and spinning works were erected in all the manufacturing cantons of the republic. In these they now spin water-twist up to No. 40, and mule yarn up to No. 80; but they import from this country all the higher numbers required in their manufacture. A considerable proportion of their machinery is worked in the same manner as a part of the spinning machinery of France; that is, in small systems; and in Switzerland these little establishments are scattered over the country. In the manufacture of the goods, the weaver, in general, provides himself with the yarn, and sells the cloth, when woven, at the nearest weekly market, or exchanges it for a new supply of yarn.

The cotton manufacture is carried on also in Prussia, and there is in the temperament and habits of that people, what leads us to expect that they may become a manufacturing nation. At present, however, like the Austrians, Saxons, and other nations upon the continent who have attempted to carry on this manufacture, they are far behind in the knowledge of the means of economising labor, and in that readiness and precision of execution which the workmen of this country possess. But these they will soon acquire if the business continues to be prosecuted by them. In the mean time they have laborat a cheaper price than that at which we can generally command it; and in manufacturing for markets which lie near to themselves, they can, better than we at a distance, adapt the fashion and fabric of the goods to the changes of taste, and accommodate the supply to the exact measure of the demand. In Russia they have begun to manufacture cotton upon a small scale. At St. Petersburg there is one spinning work, carried on by the emperor, of course at a great expense. They also spin some cotton yarn upon the distaff. In addition to these supplies, they import annually from this country about 3,000,000 lbs. of yarn, of numbers from No. 18 to No. 46. The weaving is carried on in Moscow and its neighbourhood; and, latterly, along that line of country stretching towards the Caspian Sea, particularly about Sarapta, where a colony of Moravians has for some time been established. The goods produced are used chiefly for the garments of the peasantry.

The amazing increase that has taken place in the quantity of cotton goods manufactured in the United States, may be conceived by the follow-

ing facts connected with a district which had no: previously a manufacturing character.

In 1810 there existed in New Hampshire, altogether, twelve manufacturing establishments, which produced in a twelve-month, between 4,000,000 and 5,000,000 yards of cotton cloth. Whereas now there are, in the same county, no less than fifty manufactories, making up about 30,000,000 yards! Here there has been a direct increase of more than 500 per cent. It may be added, that the whole surrounding country has now put on a manufacturing aspect; that villages of sixty or seventy habitations have sprung up, where, a short time back, there were but one or two. And that at Lowell a company was incorporated in January 1825, with a capital of 600,000 dollars (£125,000 sterling), for jean, dimity, and twilled goods.

The progress of the Irish in the same line of industry must not be overlooked; and the laudable and spirited exertions of captain Robert Brooke deserve to be particularly noticed. In the year 1780 that gentleman established a cotton manufactory on his lands, situated on the great canal, about eighteen miles west of Dublin. In 1783 the government of Ireland, understanding that some of the manufacturers of Manchester intended to remove to America, and carry their machinery with them, found means to persuade them to go to Ireland, and gave captain Brooke about £3000 for settling them in his houses upon his lands; and they afterwards advanced him £32,000 upon interest and security, that he might give employment to a great number of weavers, who were then starving and riotous for want of employment in Dublin. By means of these, and other acquisitions of inhabitants, the manufacturing village, which was called 'Prosperous,' consisted afterwards of several hundred houses, erected on a spot where, in the year 1780, there stood one single hut; and the manufacture gave employment to about 3000 men, women, and children. Besides captain Brooke's, which was the principal one, there were at this time several other manufactures of cotton established in various parts of Ireland by the spirited exertions of individuals, and the liberal encouragement of parliament.

The quantity of cotton wool exported from Great Britain to Ireland, is very considerably increased during the past five years, as appears from the following parliamentary statement, printed in 1826.

	lbs.
1821 . . .	1,386,564
1822 . . .	1,716,395
1823 . . .	1,950,288
1824 . . .	2,177,703
1825 . . .	2,598,893.

The lightness, as well as cheapness, of the calico, has rendered it a chief article of dress amongst all classes of people, and annihilated the manufacture of many of the lighter kinds of woollen and worsted stuffs, formerly so much in demand. The trade of Halifax, and the surrounding country, which consisted almost wholly in such stuffs, has gone entirely to decay, and been replaced by the manufacture of calicoes and other

cotton goods: and such are the quantities now manufactured, more especially in the country round Colne, and thence to Bradford, that from 16,000 to 20,000 pieces are brought weekly to the Manchester market; the produce of those districts which adjoin or are included between these towns.

To the same improvements in spinning which gave birth to the manufacture of calicoes, we are indebted for that of muslin, a branch not less important to the country than honorable to our pride and industry as manufacturers. For this elegant article of dress all Europe had long been tributary to India, where the manufacture has, through the long lapse of ages, arrived at the greatest perfection. Muslins were first introduced into this country by the East India Company, about the year 1670, before which time cambrics and Silesia lawns were worn, and such fine linens from Flanders and Germany, as were brought back in exchange for our woollen manufactures of various kinds exported thither in considerable quantities. The manufacture was attempted at Paisley as early as the year 1700. A few looms were employed, but this trade was soon annihilated by the introduction of the goods of India. Eighty years afterwards a more successful rivalry commenced. British muslins were first successfully introduced in the year 1781, but were carried to no great extent till 1785, since which period their progress has been rapid beyond all example. In the year 1787 it was computed, that not less than 500,000 pieces of muslin, including shawls and handkerchiefs, were annually made in Great Britain. The manufacture has, from that time to the present, continued progressively to increase and improve, and bids fair to become the most lucrative and extensive of any in this country. The rapidity with which it approaches to perfection, and its surprising extent in the short space of twenty years, are amongst the many important consequences that have resulted from the improvements in the art of spinning. By the cheapness and superior quality of our yarn, we are enabled to employ thousands of looms in the production of this elegant and useful article of dress, to keep in this country millions of specie which was heretofore sent to the east to purchase this commodity, and to clothe ourselves with this fabric at one-third of the expense formerly required.

Some curious data connected with the state of the cotton trade in Manchester are furnished in the MS. notes of a tour made by their imperial highnesses the archdukes John and Lewis of Austria. They say, 'It is calculated, that 1,500,000 lbs. of raw cotton are worked up every week in the manufactories of Manchester; and in the same space of six days, a single house

pays £10,000 for the purchase of raw cotton. One single manufactory pays £1500 a week for wages. From these facts an idea may be formed of the active industry of this place, and of the riches which commerce must bring into it. The manufactories use so great a number of thermometers, that an Italian whom we know, (a Mr. Zanetti), who is settled in Manchester, sells ten or twelve dozen every week. Three hundred steam engines in constant motion produce all these wonders.'

The rapid increase of the cotton trade appears to have been owing, in a great measure, to the more liberal introduction of machinery into every branch of it, than into any other of our staple manufactures. The utility and policy of employing machines to shorten labor, has been a subject which has exercised the pens of several ingenious writers; while their introduction into almost every branch of manufacture has been attended, in the outset, with much riot and disorder. They are, undoubtedly, most wonderful productions of human genius, the progressive exertions of which neither can nor ought to be stopped: they enable the manufacturer to produce a better article than can be made by the hand, in consequence of the uniformity and certainty of their operations; and at a much lower price, in consequence of the vast quantities of goods they are capable of performing. They thus support the credit of our manufactures abroad; and enable us, under the vast load of taxes, and consequent increase in the price of every necessary of life, to meet our foreign competitors with advantage at market. They can even allow the goods to furnish, in their passage, a considerable revenue to the government. And although they do, undoubtedly, on their first introduction, throw some persons out of employ, by changing the nature and course of business, they almost immediately make up for the inconvenience by astonishingly multiplying the absolute quantity of employment. If they take away their work from carders and spinners, they return it them back ten-fold as winders, warpers, weavers, dressers, dyers, bleachers, printers, &c. &c.

We shall conclude our present article by subjoining a summary of the rise and progress of this important branch of British manufacture.

From 1770 to 1780 the importation of cotton wool averaged 5,735,575 lbs. per annum. From 1781 to 1790 about 18,000,000 lbs. weight; and from 1791 to 1801 about 32,000,000 lbs. weight; and the following is a statement of the quantity imported in each of the twenty-two years 1802—1823, distinguishing the several countries from whence imported, and the number of bags and bales from each respective country

COTTON WOOL, IMPORTED FROM

Years.	United States of America.	Brazil and Portugal.	East Indies.	West Indies, &c.	Total No. of Bags and Bales.	Total in lbs. weight.	Quantity in lbs. weight taken for spinning in each of the nine years 1815—1823.
1802	107,494	74,720	8,535	90,634	281,383	77,393,600	
1803	106,831	76,297	10,296	45,474	238,898	59,921,990	
1804	104,103	48,588	2,661	86,385	241,637	70,506,355	
1805	124,279	51,242	1,983	75,116	252,620	72,229,537	
1806	124,939	51,034	7,787	77,678	261,738	75,157,530	
1807	171,267	18,981	11,409	81,010	282,667	86,206,870	
1808	37,672	50,442	12,512	67,512	168,138	22,676,740	
1809	135,000	166,107	35,764	103,511	442,382	117,775,530	
1810	240,516	149,535	79,382	92,186	561,173	136,570,735	
1811	128,192	118,514	14,646	64,789	326,141	91,662,535	
1812	95,331	98,714	2,617	64,563	261,215	63,027,570	
1813	37,721	137,168	1,421	73,218	249,503	49,820,530	
1814	48,000	151,500	13,500	74,500	287,500	59,745,373	
1815	201,000	91,200	24,300	54,900	371,400	96,720,370	
1816	166,000	124,000	31,000	49,000	370,000	94,140,330	
1817	195,560	114,490	117,955	49,155	477,160	125,132,230	
1818	219,950	160,200	247,300	57,850	660,300	177,257,375	
1819	212,250	125,450	178,300	31,070	545,070	150,735,728	
1820	301,200	179,700	57,300	31,950	577,150	143,637,325	
1821	300,100	121,050	29,700	37,250	488,100	128,573,275	
1822	330,000	143,200	19,300	40,650	533,150	139,797,735	
1823	448,070	148,070	38,650	33,610	668,400	180,233,795	

The following is an account of the official value of the cotton wool imported; the number of bags and bales, and the official value thereof re-exported; and the official and declared real value of the quantity of cotton yarn and of cotton manufactures exported to all parts of the world (except Ireland), in each of the ten years 1814—1823.

The official values imply a fixed value assigned by the government, in 1694; and may or may not have a relation to the real value of the present time; but they are important and interesting as denoting an increase or decrease of quantity.

Years.	Official Value of Raw Imported.	EXPORTED.					
		Raw.		Value of Yarn.		Value of Manufactures.	
		Bags.	Value.	Official.	Real.	Official.	Real.
1814	2,030,862	. . .	366,270	1,119,850	2,791,248	16,690,366	17,393,796
1815	3,335,564	. . .	397,664	808,853	1,674,021	21,699,505	19,124,061
1816	3,160,075	30,000	343,768	1,380,486	2,628,448	16,335,124	13,072,758
1817	4,161,824	22,700	721,430	1,125,257	2,014,181	20,357,147	14,178,021
1818	5,767,547	60,000	1,245,781	1,296,776	2,385,305	21,627,936	16,643,579
1819	4,871,513	65,800	1,085,536	1,585,753	2,516,783	16,876,206	12,388,833
1820	4,957,057	27,500	370,610	2,022,153	2,826,643	20,704,600	13,843,569
1821	4,347,258	51,000	1,062,302	1,898,695	2,307,830	21,639,493	13,786,958
1822	4,731,252	58,700	1,279,263	2,353,217	2,700,437	24,566,920	14,534,253
1823	6,241,561	39,700	707,312	2,425,419	2,625,947	24,117,549	13,751,415

By the first of the above statements it appears that the total quantity of cotton wool imported, in the nine years 1814—1823, has amounted to about 1,235,000,000 of lbs. weight, and the stock on hand at the close of the year 1814, having been about 24,000,000 of lbs. it makes a total quantity of 1,260,000,000 lbs. weight in

the nine years to be accounted for: which has been disposed of in the following manner, viz. 1,062,000,000 of lbs. weight taken for spinning: 105,000,000 lbs. re-exported in a raw state; and 92,000,000 of lbs. remaining on hand at the close of the year 1823.

COTTON GRASS. See *ERIOPHORUM*.

COTTON, LAVENDER. See *SANTOLINA*.

COTTON, PHILOSOPHIC, a name given to the flowers of zinc, on account of their resemblance to cotton.

COTTON, SILK. See *BOMBAX*.

COTTON WEED, a species of filago.

COTTON (Charles), a burlesque poet, was descended from a good family, and lived in the reign of Charles II. and James II. His most celebrated piece is *Scarronides*, or *Travestie* of the first and fourth books of the *Æneid*. He also parodied several of Lucian's dialogues, in the same manner, under the title of the *Scoffer Scoff'd*; and published another poem of a more serious kind, entitled the *Wonders of the Peak*. An anecdote is told of him, that in consequence of a single couplet in his *Virgil Travestie*, wherein he made mention of a peculiar kind of ruff worn by a grandmother of his, he lost an estate of £400 per annum, which would otherwise have been left to him by that lady.

COTTON (Sir Robert), an English antiquarian, was descended from an ancient family, and born in 1570. In his eighteenth year he began to collect records, charters, and other MSS. Camden, Selden, and Speed acknowledged their obligations to him in their respective works. He was highly distinguished by queen Elizabeth, and also by James I. who created him a baronet. At his death in 1631 he left his valuable library, consisting of curious MSS. &c. to his family for public use. A large accession was made to it by private benefactions before the death of the founder, and afterwards by the purchases of his heirs, until in 1709 an act of parliament was obtained, at the request of Sir John Cotton, for preserving it to the public after his decease, under the denomination of the Cottonian Library, for public use. It is now in the British Museum.

COTTON (Nathaniel), M. D. also, an ingenious English poet, of the last century, studied medicine under the celebrated Boerhaave, at Leyden, and settled finally at St. Alban's; where for many years he kept an asylum for lunatics. The poet Cowper was under his care, and much attached to him. He died in 1788, aged eighty-one. He wrote, *Visions in Verse*, for the Instruction of Younger Minds.

COTTUS, the bull-head, in ichthyology, a genus of fishes belonging to the order of thoracici. The head is broader than the body, and the gill membrane has six rays. There are ten species, the most remarkable are—1. *C. cataphractus*, the armed bull-head, or pogge, very common on most of the British coasts. 2. *C. gobio*, the river bull-head, also very common in all our clear brooks. 3. *C. scorpius*, the father-lasher, is common on the rocky coasts of this island; it lurks under stones, and will take a bait. It seldom exceeds eight or nine inches in length. The head is large, and has a most formidable appearance, being armed with vast spines, which it can oppose to any enemy that attacks it, by swelling out its cheeks and gill-covers to a large size. This species is also common in the Newfoundland seas, where it is called *scolping*; and on the coast of Greenland, in deep water near the shore. It is a principal food of the natives, and wholesome soup is said to be made of it.

COTULA, in botany, May-weed; a genus of the polygamia superflua order, and syngenesia class of plants. The receptacle is almost naked; the pappus margined; the florets of the disc quadrifid; of the radius frequently none. There are twenty-two species, all herbaceous annuals, rising six or eight inches high, and adorned with yellow flowers. None of them are natives of Britain, and most of them require artificial heat.

COTULA, or COTYLA, a liquid measure in use among the ancients. Fannius says, the cotyla was the same thing with the hemina, which was half a sextary. Chorier observes, that the cotyla was used as a dry measure as well as a liquid one; from the authority of Thucydides, who in one place mentions two cotylæ of wine, and in another two cotylæ of bread.

COTYLA, or ? Fr. *coytle*; *κοτύλη*. The COTYLE, n. s. § socket in which the head of a bone moves; a liquid measure used by the ancients.

COTYLEDON, navelwort, a genus of the pentagynia order, and decandria class of plants; natural order thirteenth, succulentæ: cal. quinquefid: cor. monopetalous: there are five nectariferous scales at the base of the germen, and five capsules. There are twenty-four species, most of them hardy succulent perennials; though some require to be kept in a stove, being natives of warm climates. They rise from half a foot to a yard and a half high, and are adorned with yellow flowers growing in umbels. They are easily propagated either by seeds or cuttings. Two species are found in Britain: 1. *C. umbilicus*, common navelwort. 2. *C. lusea*, yellow navelwort.

COTYLEDONS, n. s. Lat. *cotyledon*; *κοτύλη*. Seed lobes (see BOTANY, Index); glandular bodies which adhere to the chorion of some animals.

Many are of opinion that even the placenta of the human fetus, and *cotyledons* of quadrupeds, are respiratory organs rather than nutritious ones. *Darwin*.

COTYTTO, the goddess of debauchery. Her festivals were celebrated by the Athenians, Corinthians, Thracians, &c. during the night. Her priests were called baptæ, and nothing but debauchery and wantonness prevailed at the celebration. See BAPTÆ. A festival was observed in Sicily, where the votaries of the goddess carried about boughs hung with cakes and fruit which it was lawful for any person to pluck off. It was a capital punishment to reveal whatever was seen or done at these sacred festivals. The goddess Cotytto is supposed to be the same as Proserpine.

COUCH, v. a., v. n., & n. s. } Fr. *coucher*:
COUCHANT, adj. } Dutch, *koets*:
COUCHEE, n. s. } Junius supposes
COUCHER, n. s. } it to be derived
COUCH-FELLOW, n. s. } 'à Gall. *couché*:
COUCHING, n. s. } Belg. *koetsæ*, desumptum ex Ital. *colcare*, pro collocare; nam *colcarsi* in Ital. est, *conferre se in cubitum, collocare se in lecto.* Skinner says, 'à Fr. Gall. *coucher*; Ital. *cor care, colcare, cubare*; à Lat. *culcita*, q. d. *culcitare*, i. e. *in culcitam se condere.*' To couch is, to lie down to rest; to lie down on the knees, as a beast does when it rests;

to lie hidden; to lie in a bed or stratum; to stoop; to repose; to lay any thing in a layer or layers; to bed in; to bend under; to include; to hide; to lay close to another; to fix the spear in the rest, in order to attack; to perform the operation for removing a cataract from the eye. A couch is a seat of repose; a sofa; a bed; a layer or stratum. Couchant signifies, lying down; squatting. Couchee is, bed time; the time of visiting late at night. Coucher is, a bed-fellow; a person who removes a cataract; a register book in monasteries. A couch-fellow is, one who shares the same bed; a familiar companion. Couching, as a noun, is the act of bending or bowing.

Isaachar is a strong ass *couching* down between two burdens. *Genesis* xlix. 14.

Blessed of the Lord be his land, for the dew, and for the deep that *coucheth* beneath. *Deut.* xxxiii. 13.

Grand mercy, quod the preest, and was full glad, And *coucheth* the coles as the chanon bad. *Chaucer. Cant. Tales.*

Let take a cat, and foster hire with milke And tendre fleash, and make hire *couches* of silke, And let hire see a mous go by the wall, Anon she weiveth milke and fleashe and all. *Id.*

The goddesse strait he knew, and by and by e peaste and *coucheth*, while that we passed by. *Sackville.*

And over all with brazen scales was armed, Like plated coat of steel, so *coucheth* near, That nought might pierce. *Spenser. Faerie Queene.*

The knight of the Red Crosse, when him he spide Spurring so hot with rage dispiteous, Gan fairly *couch* his speare, and towards ride. *Id.*

And him beside an aged squire there rode, That seemed to *couch* under his shield three-square, As if that age badd him that burden spare. *Id.*

About their lady first they flockt around, Whom having laid in comfortable *couch*, Shortly they reard out of her frozen snownd. *Id.*
His crest was covered with a *couchant* hownd. *Id.*

I have grated upon my good friends for three reprivies for you, and your *couchfellows*, Nim; or else you had looked through the grate like a geminy of baboons. *Shakespeare. Merry Wives of Windsor.*

If I court more women, you'll *couch* with more men. *Id. Othello.*

Doth not the gentleman Deserve as full, as fortunate a bed, As ever Beatrice shall *couch* upon? *Id. Much Ado about Nothing.*

We'll *couch* i' th' castle-ditch, till we see the light of our fairies. *Id. Merry Wives of Windsor.*

Let not the royal bed of Denmark be A *couch* for luxury and damned incest. *Id. Hamlet.*

These *couchings*, and these lowly courtieses, Might stir the blood of ordinary men. *Id. Julius Caesar.*

It is at this day in use at Gaza, to *couch* potsherds, or vessels of earth, in their walls, to gather the wind from the top, and to pass it down in spouts into rooms. *Bacon's Natural History.*

A sentence well *coucheth* takes both the sense and the understanding. I love not those cart-ropes speeches that are longer than the memory of man can fathom. *Feltham.*

Before each van

Prick forth the aery knights, and *couch* their spears, Till thickest legions close. *Milton's Paradise Lost.*

Dire was the tossing, deep the groans! despair Tended the sick, busiest from *couch* to *couch*. *Id.*

As a tiger, who by chance hath spy'd In some purlieu, two gentle fawns at play, Straight *couches* close; then rising, changes oft His *couchant* watch. *Id.*

None of her sylvan subjects made their court; Levees and *couches* passed without resort. *Dryden.*

When love's fair goddess *Coucheth* with her husband in his golden bed. *Id. Æneid.*

The former waved in air His flaming sword; Æneas *coucheth* his spear. *Id.*

Trees bent their heads to hear him sing his wrongs, Fierce tygers *coucheth* around, and lolled their fawn-tyng tongues. *Id.*

The foundation of all parables is some analogy or similitude between the topical or allusive part of the parable, and the thing *coucheth* under it and intended by it. *South.*

That great argument for a future state, which St. Paul hath *coucheth* in the words I have read to you. *Atterbury's Sermons.*

O ye immortal powers, that guard the just, Watch round his *couch*, and soften his repose! *Addison's Cato.*

Subtile wights (so blind are mortal men, Though satire *couch* them with her keenest pen) For ever will hang out a solemn face, To put off nonsense with the better grace; As pedlars with some hero's head make bold, Illustrious mark! where pins are to be sold. *Young.*

Whether the cataract be wasted by being separated from its vessels, I have never known positively, by dissecting one that had been *coucheth*. *Sharp.*

If the weather be warm we immediately *couch* malt about an inch thick; but if a hotter season require it, we spread it on the floor much thinner. *Mortimer's Husbandry.*

This heap is called by maltsters a *couch*, or bed, of raw malt. *Id.*

Nor less the alarm that shook the world below, Where marched in pomp of war the' embattled foe: Where mannikins with haughty step advanced, And grasp the shield, and *couch* the quivering lance. *Beattie.*

Go, prince, be virtuous, and be blest. The throne Rears not its state to swell the *couch* of Lust; Nor dignify Corruption's daring son, T' o'erwhelm his humbler brethren of the dust. *Id.*

Yes—thou mayst eat thy bread, and lick the hand That feeds thee; thou mayst frolic on the floor At evening, and at night retire secure To thy straw *couch*, and slumber unalarmed. *Cowper.*

When all did sleep, whose weary hearts did borrow One hour from love and care to rest, Lo! as I pressed my *couch* in silent sorrow, My lover caught me to his breast. *Sharidam.*

Let him who crawls enamoured of decay. Cling to his *couch*, and sicken years away, Heave his thick breath, and shake his palsied head; Ours—the fresh turf, and not the feverish bed. While gasp by gasp he falters forth his soul, Ours with one pang—one bound—escapes control. *Byron. Bride of Abydos.*

COUCHANT, in heraldry, is understood of a lion, or other beast, when lying down, but with his head raised, as in the diagram; which distinguishes the posture of couchant from dormant, wherein he is supposed quite stretched out and asleep.



COUCHE' in heraldry, denotes any thing lying side-ways, with the two ends on each side of the shield, which should properly rest on the base *as* or, a chevron couched azure.



COUCHGRASS, *n. s.* A weed.

The *couchgrass*, for the first year, insensibly robs most plants in sandy grounds apt to graze.

Mortimer's Husbandry.

COUCHING, in surgery, is a mode of curing a cataract in the eye. This disease is an affection of the crystalline lens, or of its capsule, by which the rays of light are prevented from falling upon the retina. The cure has been generally performed, either by couching, that is, removing the lens from its capsule, or by extracting it. It was long a matter of doubt which of these methods deserved the preference; but Sir Astley Cooper gives the preference to the former. He says, 'It is applicable to every species of the malady; it produces subsequently symptoms far less severe and dangerous, than those which frequently happen after extraction: it may be successfully repeated, when any accidental circumstance has rendered the primary attempts fruitless; that it is much the most easy operation of the two; that it is not so liable as extraction to be followed by the secondary membranous cataract; and that Pott, Callisen, Lucas, Scarpa, Hey, Latta, and many other eminent and unbiased surgeons have given it the preference.'

The best needles for couching, according to this great surgeon, are those employed by Scarpa, or Hey, the former in fig. 1, and the latter fig. 2, of the annexed diagram.

'If the curved couching-needle be made use of,' he says, 'it is to be held with the convexity of its curvature forward, its point backward, and its handle parallel to the patient's temple. The surgeon, having directed the patient to turn the eye towards the nose, is to introduce the instrument boldly through the sclerotic coat, at the distance of not less than two lines from the margin of the cornea, in order to avoid the ciliary processes. The exact place, where the point of the needle should next be guided, is between the cataract and ciliary processes, in front of the opaque lens and its capsule; but, as the attempt to hit this delicate invisible mark borders upon impossibility, and might even endanger the iris, it seems safer to direct the extremity of the instrument immediately over the opaque lens, and, in the first instance, to depress it a little downward with the convex flat surface

of the end of the needle. Thus room is made for the safe conveyance of the instrument, between the cataract and ciliary processes, in front of the diseased crystalline and its capsule. Care must be taken, in this latter step of the operation, to keep the marked side of the handle forward, so as to have the point of the instrument turned away from the iris. The needle will now be visible in the pupil, and its point is to be pushed in a transverse direction as far as the inner edge of the lens. Then the operator is to incline the handle of the instrument towards himself, by which means, its point will be directed through the capsule into the substance of the opaque lens; and, on inclining the needle downward and backward, the former will be lacerated, and conveyed, with the latter, deeply into the vitreous humor. It is deemed of great importance to lacerate the front layer of the capsule in the operation; for this plan renders the absorption of the opaque lens more certain and quick afterwards, and the occurrence of a secondary membranous cataract almost impossible. Such is Scarpa's excellent plan of operating for a firm cataract.'

'When the case is a fluid or milky one, the contents of the capsule flow out as soon as the little membranous sac is pierced with the needle, and they sometimes completely conceal the iris, the pupil, and the instrument, from the operator's view. The object is now to lacerate the capsule as much as possible. Both the fragments and the extravasation of the milky fluid in the two chambers of the aqueous humor are gradually absorbed after the operation, so as to leave the eye in a transparent state. When the cataract is soft, the particles of which it is composed will frequently elude all efforts made with the needle to depress them. This, however, is quite unnecessary. The operator may either be content with a free laceration, and disturbance of them, or he may imitate Scarpa in pushing the fragments of the capsule, and the particles of caseous matter, into the anterior chamber. In this cavity, absorption seems to be carried on with more vigor than behind the pupil. When the cataract is a secondary membranous one, the surgeon is to turn the point of the needle cautiously towards the pupil, and pierce the opaque capsule. This is to be broken, as far as it is practicable, at every point of its circumference; and the fragments may either be left in their situation, or pushed forward, through the pupil, into the anterior chamber, in the way which Scarpa practises. When the capsule is adherent to the iris, it may often be separated by skilful and delicate movements of the needle.

'If the operator should prefer the straight needle, he must be careful to depress the cataract a little in the first instance, before making any attempt to place the instrument in front of the cataract, in order to be able to depress it, downward and backward, in the most convenient manner. As the point of a curved needle is turned backward, it may evidently be brought forward with more safety than a straight one, which has a tendency to run directly against the iris. Whenever an operator prefers lacerating the front layer of the capsule, and pushing the



particles of soft and membranous cataracts forward, he will accomplish his objects with far greater safety by means of Scarpa's needle, than it is possible to effect with a straight one, provided he is well acquainted with the anatomy of the eye, the scientific mode of using the instrument, and has a tolerably steady hand, and a good eye of his own.' *First Lines of the Practice of Surgery.*

Under the article BLINDNESS, we referred our readers, for 'the first effects of sight on those who have been couched,' to the present article. The cases which we there had in view, and which are at once the best attested and the most interesting, are those recorded by Mr. Cheselden and Mr. Ware. The former is stated in the *Philosophical Transactions*, No. CCCCIII. p. 477. The youth on whom the operation was performed, seems to have been unusually intelligent. 'When he saw the light for the first time,' says the operator, 'he knew so little how to judge of distances, that he believed the objects which he saw touched his eyes (and this was his expression) as the things which he felt touched his skin. The objects which were most pleasant to him were those whose form was regular and smooth, though he had no idea of their form, nor could he tell why they pleased him better than the others. During the time of his blindness he had such an imperfect idea of colors, that he was then able to distinguish, by a very strong light, that they had not left an impression sufficient by which he could again recognise them. Indeed, when he saw them, he said the colors he then saw were not the same as those he had seen formerly; he did not know the form of any object; nor could he distinguish one object from another, however different their figure or size might be: when objects were shown to him which he had known formerly by the touch, he looked at them with attention, and observed them carefully in order to know them again; but as he had too many objects to retain at once, he forgot the greater part of them, and when he first learned, as he said, to see and to know objects, he forgot a thousand for one that he recollected. It was two months before he discovered that pictures represent solid bodies; until that time he had considered them as planes and surfaces differently colored, and diversified by a variety of shades; but when he began to conceive that these pictures represented solid bodies, in touching the canvas of a picture with his hand he expected to find in reality something solid upon it, and he was much astonished when, upon touching those parts which seemed round and unequal, he found them flat, and smooth like the rest; he asked, which was the sense that deceived him, the sight or the touch? There was shown to him a little portrait of his father, which was in the case of his mother's watch; he said that he knew very well it was the resemblance of his father; but he asked, with great astonishment, how it was possible for so large a visage to be kept in so small a space, as that appeared to him as impossible as that a bushel should be contained in a pint. He could not support much light at first, and every object seemed very large to him; but after he had seen larger things, he considered the

first smaller. He thought there was nothing beyond the limits of his sight. The same operation was performed on the other eye about a year after the first, and it succeeded equally well. At first he saw objects with his second eye much larger than with the other, but not so large, however, as he had seen them with the first eye; and when he looked at the same object with both eyes at once, he said that it appeared twice as large as with the first eye; but he did not see double, at least it could not be ascertained that he saw objects double, after he had got the sight of the second eye.'

The second case also is recorded by Mr. Ware in the *Philosophical Transactions*, and was read to the Society June 11th, 1801. It varies somewhat from Mr. Cheselden's. It was the case of a young gentleman, who, by a surgical operation, recovered his sight when seven years of age; after having been deprived of it by cataracts before he was a year old. Mr. Ware gives the following account of the facts in question: 'I performed the operation on the left eye, on the 29th of December last, in the presence of Mr. Chamberlayne, F.A.S., Dr. Bradley of Balliol College, Oxford, and Mr. Platt, surgeon in London. It is not necessary in this place, to enter into a description of the operation. It will be sufficient to say, that the child, during its performance, neither uttered an exclamation, nor made the smallest motion either with his head or hands. The eye was immediately bound up, and no enquiries made on that day with regard to his sight. On the 30th, I found that he had experienced a slight sickness on the preceding evening, but had made no complaint of pain, either in his head or eye. On the 31st, as soon as I entered his chamber, the mother with much joy informed me that her child could see. About an hour before my visit, he was standing near the fire with a handkerchief tied loosely over his eyes, when he told her that under the handkerchief, which had slipped upward, he could distinguish the table by the side of which she was sitting: it was about a yard and a half from him; and he observed that it was covered with a green cloth (which was really the case), and that it was a little farther off than he was able to reach. No further questions were asked him at that time; as his mother was much alarmed, lest the use thus made of his eye might have been premature and injurious. Upon examination I found that it was not more inflamed than the other eye; and the opacity in the pupil did not appear to be much diminished. Desirous, however, to ascertain whether he was able to distinguish objects, I held a letter before him, at the distance of about twelve inches, when he told me, after a short hesitation, that it was a piece of paper; that it was square, which he knew by its corners; and that it was longer in one direction than it was in the other. On being desired to point to the corners, he did it with great precision, and readily carried his finger in the line of its longest diameter. I then showed him a small oblong band-box covered with red leather, which he said was red and square, and pointed at once to its four corners. After this, I placed before him an oval silver box, which he said had a shining appear-

auce; and, presently afterwards, that it was round, because it had not corners. The observation, however, which appeared to me most remarkable, was that which related to a white stone mug; which he first called a white basin, but, soon after, recollecting himself, said it was a mug, because it had a handle. These experiments did not give him any pain; and they were made in the presence of his mother, and of Mr. Woodford, a clerk in his majesty's treasury. I held the objects at different distances from his eye, and enquired very particularly if he was sensible of any difference in their situation; which he always said he was, informing me, on every change, whether they were brought nearer to, or carried further from him. I again enquired, both of his mother and himself, whether he had ever before this time, distinguished by sight any sort of object; and I was assured by both that he never had on any occasion; and that when he wished to discover colors, which he could only do when they were very strong, he had always been obliged to hold the colored object close to his eye, and a little on one side, to avoid the projection of the nose. No further experiments were made on that day. On the 1st of January I found that his eye continued quite free both from pain and inflammation, and that he felt no uneasiness on the approach of light. I showed him a table knife; which at first he called a spoon, but soon rectified the mistake, giving it the right name, and distinguishing the blade from the handle, by pointing to each as he was desired. He afterwards called a yellow pocket-book by its name, taking notice of the silver lock in the cover. I held my hand before him which he knew, but could not at first tell the number of my fingers, nor distinguish one of them from another. I then held up his own hand, and desired him to remark the difference between his thumb and fingers; after which he readily pointed out the distinctions in mine also. Dark-colored and smooth objects, were more agreeable to him than those which were bright and rough. On the 3rd of January he saw, from the drawing-room window, a dancing bear in the street; and distinguished a number of boys that were standing round him, noticing particularly a bundle of cloths which one of them had on his head. On the same evening I placed him before a looking-glass, and held up his hand: after a little time he smiled, and said he saw the shadow of his hand, as well as that of his head. He could not then distinguish his features; but, on the following day, his mother having again placed him before the glass, he pointed to his eyes, nose, and mouth, and seemed much gratified with the sight.'

COVE, *v. a. & n. s.* Fr. *couver*; Ital. *covare*; Lat. *cubare*; Arm. *couf*; Isl. *kofe*; Ang.-Sax. *cofe*; Teut. *kove*. To cove is used by Holland, in his translation of Plutarch, in the sense of to incubate; but it now means to arch over. Cove is a small creek; a shelter; a cover; but the first of these meanings is the most in use.

The mosques and other buildings of the Arabians were rounded into domes and coved roofs. *Swinhurne*.

Or with fair Hope the brightening scenes improve,
And cheer the dreary wastes at Sidney cove. *Darwin*.

And many a summer flower is there,
And many a shade that love might share,
And many a grotto, meant for rest,
That holds the pirate for a guest;
Whose bark in sheltered cove below
Lurks for the passing peaceful prow.

Byron. Bride of Abydos.

As the fleet dove, who, on the mossy breast
Of a coved rock, broods fondling o'er her nest,
Scared by some sudden foe, in tumult springs
From her loved home, and loudly claps her wings.

Symonds' Aecis.

COVE, or CORK HARBOUR, the town of Cove, in the parish of Great Island, and in the barony of Barrymore, is about eight English miles south-west of Cork. During the last French war this village, from its local advantages, grew from comparative insignificance into its present importance; having now a population of 6,500 persons in the town alone, besides 3000 in the remaining part of the parish. The cove or harbour of Cork is probably the noblest natural basin in Europe: its entrance is deep, free, and open, and the harbour inside, where the whole British navy might ride at anchor, completely land-locked. There are three fortifications, one on Spike, one on Hawlboline Island, beside Carlisle Fort. Cove Town stands directly opposite to Hawlboline Island, has a southern aspect, enjoys a mild atmosphere, and is much frequented by invalids. The importance of Cove harbour to a nation like England, decidedly commercial, and exposed by her insular situation to foreign invasion, has long been acknowledged. There are at present steam vessels plying from Cork to Bristol, to Liverpool, to Dublin, and to London.

CO'VENABLE, *adj.* } Fr. *covenenable*. Suit-
CO'VENABLELY, *adv.* } able; fit; proper. Suit-
ably; fitly.

As yet unto this time ye han wel and covenably
taught me. *Chaucer. Cant. Tales.*

The covenable joyning of every of the sayd partes one
with another. *Palegrave.*

COVENANT, *v. a. & n. s.* } Fr. and Spaa.
COVENANTE'E, *n. s.* } *covenir*; Ital.
COVENAN'TER, *n. s.* } and Lat. *conve-*
CO'VENUOUS, *adj.* } *nire*, from *con*
CO'VENT, *n. s.* } and *venire*. To

agree; to stipulate; to bargain; to contract; to enter into an agreement with. A covenant, in law, is a contract; a stipulation; an agreement; the writing which contains the terms of an agreement. Covenantee signifies one who is a party to a covenant; one who bargains. He who takes a covenant, who makes himself a party to a covenant, is a covenanter. The word is chiefly applied to those who took the covenant in the reign of the misguided Charles I. Covenous is, fraudulent; collusive; trickish. Covent is the old spelling of convent.

They covenanted with him for thirty pieces of silver. *Matthew.*

And by his covenant yave he rekening,
Sin that his lord was twenty yere of age.
Chaucer. Prool. to Cant. Tales.

No wels keeping the covenant in Southwerk that
was made. *Id. Cant. Tales.*

His lord used commonly so to covenant with him,
which if at any time the tenant disliked, he might
freely depart at his pleasure. *Spencer's State of Ireland.*

I shall but lend my diamond till your return; let there be covenants drawn between us.

Shakespeare. Cymbeline.

I wish some means devised for the restraint of these inordinant and covencous leases of lands, holden in chief, for hundreds or thousands of years.

Boopn's Office of Alienation.

It had been covenanted between him and the king of England that neither of them should treat of peace or truce with the French king.

Hayward on Edward VI.

A covenant is a mutual compact, as we now consider it, betwixt God and man; consisting of mercies, on God's part, made over to man; and of conditions, on man's part, required by God.

Hammond's Practical Catechism.

He makes a covenant never to destroy
The earth again by flood; nor let the sea
Surpass his bounds. *Milton. Par. Lost.*

The covenanters shall have no more assurance of mutual assistance each from other, after the taking of the covenant, than they had before.

Oxford Reasons against the Covenant.

By words men come to know one another's minds; by these they covenant and confederate.

South.

Jupiter covenanted with him, that it should be hot or cold, wet or dry, calm or windy, as the tenant should direct.

L'Estrange.

Some men live as if they had made a covenant with hell: let divines, fathers, friends, say what they will, they stop their ears against them.

Id.

Pointing to a heap of sand,
For every grain, to live a year demand;
But ah! unmindful of the effect of time,
Forgot to covenant for youth and prime.

Garth's Ovid.

Both of them were respective rites of their admission into the several covenants, and the covenantees become thereby entitled to the respective privileges.

Ayliffe's Paragon.

COVENANT, in ecclesiastical history, denotes particularly a contract or convention agreed to by the Scots in 1638 for maintaining their religion free from innovation. In 1581 the general assembly of Scotland drew up a confession of faith, or national covenant, condemning episcopal government; which was signed by James I., and which he enjoined on all his subjects. It was again subscribed in 1590 and 1596. The subscription was renewed in 1638, engaging the subscribers by oath to maintain religion in the same state as it was in 1580, and to reject all innovations introduced since that time. This oath annexed to the confession of faith received the name of the covenant; as those who subscribed it were called covenanters.

The Solemn League and Covenant was established in the year 1643, and formed a bond of union between Scotland and England. (See ENGLAND.) It was sworn and subscribed by many in both nations, who thereby solemnly abjured popery and prelacy, and combined together for their mutual defence. It was approved by the parliament and assembly at Westminster, and ratified by the general assembly of Scotland in 1645. The Encyclopædia Metropolitana, in its high-church zeal, calls this transaction 'a compound of hypocrisy and fanaticism, to which may be justly charged much of the tragedy of the

succeeding years.' We are not the advocates of religious covenants imposed by the sword; but this writer seems to have no doubt of the sincerity of the prince and his ministers of whom the following facts are recorded.

King Charles II. disapproved of it when he surrendered himself to the Scots' army in 1646; but in 1650 he declared his approbation both of this and the national covenant, by a solemn oath; and in August of the same year made a farther declaration at Dumferline to the same purpose, which was also renewed on occasion of his coronation, at Scone, in 1651. The covenant was ratified by the parliament of Scotland in this year, and the subscription of it required by every member, without which the constitution of the parliament was declared null and void. But it produced a series of distractions in the subsequent history of that country, and was voted illegal by parliament, and provision made against it. Stat. 14, Car. II. cap. 4. Clarendon gives, at length, the document that was subscribed at Westminster in his History, book vii.

COVENANT, in law, is the agreement of two or more persons to do, or not to do, some act or thing contracted between them. Also it is the declaration the parties make, that they will stand to such agreement, relating to lands or other things; and is created by deed in writing, sealed and executed by the parties, or otherwise it may be implied in the contract thereto. And if the persons do not perform their covenants, a writ or action of covenant is the remedy to recover damages for the breach of them.

COVENANT, in theology, is much used in connexion with other terms; as, the covenant of grace, of redemption, &c. These phrases generally describe peculiar theological views of the ways of God, rather than any doctrine simply scriptural.

COVENANT, See SOLEMN LEAGUE.

COVENTRY, a city of great antiquity in Warwickshire, whose origin is involved in much obscurity: some suppose its name to have been derived from a convent which was destroyed by Edric the Traitor in 1016. It is more certain that, about the year 1043, Leofric, earl of Mercia, founded and endowed a convent of Benedictine monks here. It is said, however, that Leofric, receiving some provocation from the inhabitants of the town, loaded them with heavy taxes; and being importuned by his lady, Godiva, to remit them, he consented, upon condition that she should ride naked on horseback from one end of the town to the other. This condition, as it was stipulated by her husband, she is said to have complied with; and having enjoined the citizens not to venture out, or become the spectators of her progress on pain of death, proceeded through the city, concealing her person as well as possible with her fine hair. One citizen only, the legends state, a certain tailor, could not refrain from peeping: the lady's horse neighed, and the tailor paid dearly for his curiosity, being instantly struck blind! A figure of 'peeping Tom' is still preserved and to be seen in an opening at the upper part of a house at the corner of Hertford-street, adjoining the King's Head Inn. There was formerly a portrait of the countess and

Leofric exhibited in one of the windows of Trinity Church; the earl being represented as holding out a scroll or charter, inscribed,

'I, Luoricke, for the love of thee,
Do make Coventry toll-free.'

In commemoration of the circumstance above detailed, a most splendid procession occasionally takes place on the first day of the great fair, Friday in Trinity week, in which a female clad in a close dress of silk or linen of flesh color, and with long and flowing hair, rides through the city, preceded by guards in armor, and followed by the mayor, sheriffs, and corporation, in their robes, together with the masters of various trading companies, their followers, and magnificent streamers: several bands of music are interspersed through the procession. Its popularity is unabated, and thousands are attracted to witness the pageant whenever it takes place. The procession, as now conducted, commenced in the reign of Charles II. South of the town stood anciently the monastery of Gray Friars, celebrated for the mysteries performed in it on the day of Corpus Christi.

After the conquest, the lordship of Coventry devolved on the earls of Chester; subsequently it came into the hands of Henry III. and William de Albany, earl of Arundel; then of Robert de Montalt, and was granted, in default of issue, to Isabel, queen mother of Edward III. with remainder, first, to John of Eltham, afterwards earl of Cornwall, and then to king Edward II. and his heirs for ever. Soon after, 1337, Coventry was annexed to the earldom of Cornwall, and had various immunities granted to it. In 1344 the town was incorporated by Edward III. when a mayor and two bailiffs were chosen. In 1355 the building of the wall round the town commenced, which was not completed until forty years afterwards. Richard II., in 1377, confirmed privileges formerly granted, and in 1385 ratified the charter of Edward III. for building the stone walls, and permitted stone to be taken from his quarry at Cheylesmore for that and other purposes. Two parliaments have been held in this city, one in the great chamber of the priory in 1404, the other in 1459 by Henry VI.; the former acquired the name of parliamentum indoctorum, in consequence of its excluding all lawyers, or persons skilled in the laws: the latter was held in the chapter-house of the priory, and called parliamentum diabolicum, the parliament of devils, owing to the numerous attainders passed therein.

Coventry had at one time to boast a splendid cathedral, adorned in the most costly manner, and supposed to have been built on a similar plan to Litchfield cathedral, having two spires at the west end and one in the centre. The city then possessed a matchless group of churches, all standing within one cemetery. St. Michael's church is at this time, and most justly, are the boast of Coventry; its fine tower and spire are scarcely to be equalled in Europe, and are choice examples of English ecclesiastical architecture: the tower is 136 feet three inches high, from which ascends the spire 130 feet nine inches in height. Sir Christopher Wren is said to have spoken of it in the highest terms of admiration. The body of the church is worthy of its superb spire, and is

supposed to have been erected in the time of Henry VI.

Trinity Church is both handsome and capacious, but, being situated so near to St. Michael's, its importance and effect are lost in a great degree. St. Mary Hall is a building of singular interest, especially to the antiquary: it is situated in the immediate vicinity of St. Michael's Church, and was erected in the reign of Henry VI. as a place of meeting for the Trinity guild; it is now chiefly used for civic purposes. The Great Hall is a fine old room seventy-six feet six inches long, thirty feet broad, and thirty-four feet high. In consequence of a thorough reparation being necessary, it has very lately been restored, and judiciously altered in some respects, close attention having been paid to preserving its original character.

A handsome and very celebrated cross, considered one of the stateliest in England, stood in Cross-cheaping, and was taken down in 1771. The free-school was founded in the reign of Henry VIII. by John Hales, esq. and liberally endowed by him. Sir William Dugdale and other very eminent men received their education in this place. Coventry contains several hospitals, and many other buildings of considerable interest and antiquity. This city has, besides its churches, a Roman Catholic place of worship, two Independent chapels, a meeting-house for the Society of Friends, a Unitarian, a Baptist, and a Methodist chapel.

The trade of Coventry and the neighbourhood is chiefly confined to the manufacture of ribands and watches; 3000 looms, and 20,000 manufacturers are supposed to be employed in the former. It is governed by a mayor, ten aldermen, and twenty common-council men, and sends two members to parliament. The right of voting is vested exclusively in persons having served seven years apprenticeship to one and the same trade, within the city and county: the number of free men is nearly 4000. The population of Coventry has latterly very much increased, and is supposed to amount to 24,000. It lies eighteen miles south-east of Birmingham, forty-nine north-west of Oxford, and ninety-one north-west of London.

COVENTRY. There are five townships so called in the United States; one in Connecticut, one in Rhode Island with 2447 inhabitants, a third in New Hampshire, a fourth in Vermont, and a fifth in Pennsylvania.

COVER, *v. a. & n. s.*
CO'VERCLE, *n. s.*
CO'VERER, *n. s.*
CO'VERING, *n. s.*
CO'VERLET, *n. s.*
CO'VERT, *n. s. & adj.*
CO'VERTLESS, *adj.*
CO'VERTLY, *adv.*
CO'VERTNESS, *n. s.*
CO'VETURE, *n. s.*
CO'VER-CHIEF, *n. s.*
CO'VER-SHAME, *n. s.*
CO'VER-SLUT, *n. s.*
CO'VET-BARON, *n. s.*
CO'VET-FEME, *n. s.*
CO'VET-WAY, *n. s.*

Fr. couvrir; It. coprire; Span. cubrir; Lat. co-operire. So Junius positively affirms it to be. Yet we may, perhaps, be allowed to look to the north for the etymon; and there we shall find, Isl. & Goth. *kofe, cœvna; Suth. kofwa, kyffe, latibulum.* A thing, then, that is covered is as though it were hidden in a den or cave. To cover is, to spread one

thing over another; to conceal under a covering; to overwhelm with; to shelter, by interposing something above; to incubate; to couple with a female; to wear a hat as a privilege. Cover is any thing laid over another; a concealment; a shelter; a defence; a place where the fox or hare is supposed to be. As a noun, covert signifies a shelter; a thicket, or hiding place: as an adjective, sheltered; secret; insidious; and, in legal parlance, the state of a woman in marriage. The last of these meanings attaches to the word *coverture*; which also denotes shelter; defence. *Covertly* is secretly; underhandedly. *Covercle* is a lid. *Cover-chief*, which is obsolete, is the name of a covering for the head. For *covert-way*, see *FORTIFICATION*; for *covert-baron* and *covert-feme*, see *LAW*. *Cover-shame* and *cover-slit* are contrivances to conceal infamy and slut-tishness.

The women took and spread a *covering* over the well's mouth. 2 Sam. xvii. 19.

The pastures are clothed with flocks; the valleys also are *covered* over with corn. Psal. lxx. 13.

Let mine outcasts dwell with thee, Moab; be thou a *covert* to them from the face of the spoilers.

Isaiah xvi. 4.

There shall be a tabernacle for a shadow in the day-time from the heat, and for a place of refuge, and for a *covert* from the storm and rain. Id. iv. 6.

Charity shall *cover* the multitude of sins.

1 Peter iv. 8.

This false Arcite somwhat must he nede faine
When he was false to *cover*en his traitourie.

Chaucer. *Annelide and false Arvoite*.

A man shuld also think that God seeth and knoweth al his thoughtes, and al his workes, and to him may nothing be hid ne *covered*. Id. *Cant. Tales*.

A large *coverchief* of threde
She wrapped all about her hede.

Id. *Romanus of the Rose*.

Wel woste thou it will make anone
A lilyl roundil as a circle,
Para'venture as brode as a *covercle*.

Id. *The House of Fame*.

Some pleasant houres thy wo may wrap, and the de-
fend and *cover*. Wyal.

At last he came unto a gloomy glade,
Covered with boughs and shrubs from heaven's high
light. Spenser. *Faerie Queene*.

Enforat to seeke some *covert* nigh at hand,
A shadie grove not farr away they spide,
That promist ayde the tempest to withstand. Id.
Loe, loe! how brave she decks her bounteous
houre

With silken curtens and gold *coverletts*. Id.

Yet still Aragnol (so his foe was sight)
Lay lurking *covertly* him to surprise.

Id. *Musiopotmos*.

Go to thy fellows, bid them *cover* the table, serve in
the meat, and we will come in to dinner.

Shakspeare. *Merchant of Venice*.

Towards him I made; but he was 'ware of me,
And stole into the *covert* of the wood.

Id. *Romeo and Juliet*.

Bring some *covering* for this naked soul,
Whom I'll intreat to lead me. Id. *King Lear*.

How can'st thou cross this marriage!—Not hon-
estly my lord; but so *covertly*, that no dishonesty
shall appear in me. Id. *Much Ado about Nothing*.

Without the bed her other fair hand was,
On the green *coverlet*, whose perfect white
Shewed like an April daisy on the grass.

Id. *The Rape of Lucrece*.

The secundine is but a general *cover*, not shaped
according to the parts; the skin is shaped according
to the parts.

Bacon.

You are of either side the green to plant a *covert*
alley, upon carpenter's work, about twelve foot in
height, by which you may go in shade into the gar-
den.

Id.

It may be it is rather the shade, or other *cover-
ture*, that they take liking in, than the virtue of the
herb.

Id.

The infancy of king Edward VI. and the *cover-
ture* of queen Mary, did, in fact, disable them to
accomplish the conquest of Ireland. Davies on Ireland.

His calm and blameless life

Does with substantial blessedness abound,
And the soft wings of peace *cover* him round. Cowley.

Thence to the *coverts*, and the conscious groves,
The scenes of his past triumphs and his loves.

Denham.

Cover me, ye pines!

Ye cedars with innumerable boughs
Hide me, that I may never see them more. Milton.

The flaming mount appeared
In Dothan, *covered* with a camp of fire. Id.

It was the hour of night, when thus the Son
Communed in silent walk, then laid him down
Under the hospitable *covert* nigh
Of trees thick interwoven. Id.

By what best way

Whether of open war, or *covert* guile,
We now debate. Id.

He saw their shame, that sought
Vain *covertures*. Id.

In the mean time, by being compelled to lodge
in the field, which grew now to be very cold whilst
his army was under *cover*, they might be forced to
retire. Clarendon.

Sometimes Providence casts things so, that truth
and interest lie the same way; and when it is wrapt
up in this *covering*, men can be content to follow it.

South.

Or lead me to some solitary place,
And *cover* my retreat from human race.

Dryden.

That king had conferred the honour of grandee
upon him, which was of no other advantage or sig-
nification to him, than to be *covered* in the presence of
that king. Id.

Orestes' bulky rage,
Unsatisfied with margins closely writ,
Foams o'er the *covers* and not finished yet. Id.

Amongst the poets, Peraius *covertly* strikes at Nero;
some of whose verses he recites with scorn and indig-
nation. Id.

Instead of her being under *covert* baron, to be under
covert fems myself! to have my body disabled, and my
head fortified. Id.

This done, the host produced the genial bed,
Which with no costly *coverlet* they spread. Id.

Does he put on holy garments for a *cover-shame* of
lewdness? Id.

Whilst the hen is *covering* her eggs, the male gene-
rally takes his stand upon a neighbour bough within
her hearing, and by that means amuses and diverts
her with his songs during the whole time of her sitting.
Addison's Spectator.

The deer is lodged ; I've tracked her to her covert.
Be sure ye mind the word ; and when I give it,
Rush in at once, and seize upon your prey.

Id. Cato.

Together let us beat this ample field,
Try what the open, what the covert yield.

Pope's Essays.

Railery and wit serve only to cover nonsense with
shame, when reason has first proved it to be mere
nonsense.

Watts.

The fox is a beast also very prejudicial to the hus-
bandman, especially in places that are near forest-
woods and covert places.

Mortim. Husb.

By mixing with the concerns of state, he (Lanfranc)
did not lose his religion and conscience, or make them
the covers or instruments of ambition ; but, temper-
ing the fierce policy by the mild lights of religion,
he became a blessing to the country in which he was
promoted.

Burke.

Great Britain was not there. Almost in despair, I
hope she will never, in any rage and coverlets of in-
famy, be seen at such an exhibition.

Id.

Reason now
Takes part with Appetite, and pleads the cause
Perversely, which of late she so condemned ;
With shallow shifts and old devices, worn
And tattered in the service of debauch,
Covering his shame from his offended sight.

Cowper.

I had been for some days sculking from covert to
covert, under all the terrors of a jail ; as some ill-ad-
vised people had uncoupled the merciless pack of the
law at my heels.

Burns.

In short, she was a walking calculation,

Miss Edgeworth's novels stepping from their covers,
Or Mrs. Trimmer's books on education.

Or ' Coles's' Wife,' set out in quest of lovers.

Byron. Don Juan.

COVERDALE (Miles), a celebrated English
divine and reformer, was educated at Cambridge,
and became a canon of the order of St. Augus-
tine. On becoming a Protestant he went abroad,
and in 1532 assisted Tindale in his translation
of the Bible. The first complete English trans-
lation of the Scriptures appeared in 1535, with
his name in the title-page. A second version of
the New Testament was published by him in
1538. Queen Catherine Parr made him her
almoner ; and in 1551 he was promoted to the
see of Exeter. He went to Denmark on the ac-
cession of queen Mary, and afterwards to Geneva,
where he joined the other English refugees in
their celebrated version of the Bible. He came
home on the accession of queen Elizabeth, but,
instead of resuming his see, accepted the rectory
of St. Magnus, London Bridge. This he resigned
in 1566, and died May 20, 1567, and lies buried
in St. Bartholomew's church, by the Exchange.
Bishop Coverdale was also the author of The
Christen State of Matrymonye, wherein Hus-
bands and Wyfes maye lerne to keep House to-
gether with Love ; and other tracts.

COVET, *v. a. & n.*

COVETABLE, *adj.*

COVETING, *n. s.*

COVETINGLY, *adv.*

COVETISE, *n. s.*

COVETOUS, *adj.*

COVETOUSLY, *adv.*

COVETOUSNESS, *n. s.*

Fr. *convoliter*. Skin-
ner, Junius, and Me-
nage, agree in deriving
these words from low

Lat. *convolare*. Under
the word covetous, Le-
mon, who refers every-
thing to the Greek, says,
' *Orvus, coco, cupidus* ; under Ital. *covidiſia, quasi*

cupidigia ; greedy, eager, desirous : unless we
should prefer *coco*, to covet ; like the avaricious
man.' To covet is, to have an inordinate desire
of. Covetise, which is obsolete, is synonymous
with covetousness, in the sense of avarice ; lust
of money ; eagerness of gain. Shakspeare uses
covetousness with the meaning of eagerness, de-
sire, as will be seen in the quotation ; but in this
application of the word, I believe that he stands
alone. He also uses covetous in a good sense,
to express a laudable anxiety for ; and he is
not singular in so doing ; but this meaning is
nearly, if not quite, disused ; the general use of
the word being confined to inordinate, and con-
sequently, improper desire.

But covet earnestly the best gifts. 1 Cor. xii. 31.

The love of money is the root of all evil, which
while some coveted after, they have erred from the
faith. 1 Tim. vi.

An heart they have exercised with covetous prac-
tices. 2 Peter ii. 14.

Covetous is for to covet swiche thinges as thou hast not,
and avarice is to withhold and kepe swiche thinges as
thou hast without rightful nede.

Chaucer. Cant. Tales.

And if that she be foul, thou sayst that she
Coveteth every man that she may see. *Id.*
His blinde lust was all his coveting.

Id. Legends of Lucrece.

The charge thereof unto a covetous spright,
Commanded was, who thereby did attend,
And warily awaited day and night,
From other covetous fiends it to defend.

Spenser. Faerie Queene.

Most wretched wight, whom nothing might suffice,
Whose greedy lust did lack in greatest store ;
Whose need had end, but no end covetise. *Id.*

All things coveting as much as may be to like
unto God in being ever ; that which cannot hereunto
attain personally, doth seek to continue itself another
way, by offspring and propagation. *Hooker.*

If it be a sin to covet honour,

I am the most offending man alive.

Shakspeare. Henry VI.

I am yet

Unknown to woman ; never was forsworn ;

Scarcely have coveted what was mine own ;

At no time broke my faith. *Id. Macbeth.*

If he care not for't, he will supply us easily ; if he
covetously reserve it, how shall 's get it ?

Id. Timon of Athens.

When workmen strive to do better than well,

They do confound their skill in covetousness.

Id. King John.

Sheba was never

More covetous of wisdom and fair virtue ;

Than this fair soul shall be. *Id. Henry VIII.*

Then this desire of nature is not vain

She covets not impossibilities ;

Fond thoughts may fall into some idle brain,

But one assent of all is ever wise. *Dante.*

He that is covinous or angry at a virtue that is not his
own, at the perfection or excellency of his neighbour,
is not covetous of the virtue, but of its reward and re-
putation ; and then his intentions are polluted.

Taylor's Rule of Living Holy.

He that takes pains to serve the ends of covetousness,
or ministers to another's lust, or keeps a shop of in-
purities or intemperance, is idle in the worst sense. *Id.*

Let never so much probability hang on one side of a covetous man's reasoning, and money on the other, it is easy to foresee which will outweigh. *Locke.*

Covetousness, and the desire of having in our possession, and under our dominion, more than we have need of, being the root of all evil, should be early and carefully weeded out; and the contrary quality, or a readiness to impart to others, implanted. *Id.*

Covetousness debaseth a man's spirit, and sinks it into the earth. *Tillotson.*

O father! can it be, that souls sublime
Return to visit our terrestrial clime?
And that the generous mind, releas'd by death,
Can covet lazy limbs and mortal breath?

Dryden. Æneid.

While cumbered with my dropping clothes I lay,
The cruel nation, covetous of prey,
Stained with my blood the unhospitable coast. *Id.*

Whence has the world her magic power?
Why deem we death a foe?
Recoil from weary life's best hour,
And covet longer woe? *Cowper.*

O evenings worthy of the gods! exclaimed
The Sabine bard. O evenings, I reply,
More to be prized and coveted than yours,
As more illumined, and with nobler truths,
That I, and mine, and those we love, enjoy. *Id.*

Whate'er she saw and coveted was brought;
Whate'er she did not see, if she supposed
It might be seen, with diligence was sought,
And when 'twas found straightway the bargain
closed. *Byron. Don Juan.*

COVEY, *n. s.* Fr. *covée*; Ital. *covata*; Span. *covada*; Lat. *cubo*. A hatch; an old bird with her young ones; a number of birds together.

A flight of wasps and a covey of partridges went to a farmer, and begged a sup of him, to quench their thirst. *L'Estrange.*

A covey of partridges springing in our front, put our infantry in disorder. *Addison's Freeholder.*

There would be no walking in a shady wood, without springing a covey of toasts. *Id. Guardian.*

These are expensive joys, fit for the great,
Of large domains possessed; enough for me
To boast the gentle spar-hawk on my fist,
Or fly the partridge from the bristly field,
Retrieve the covey with my busy train,
Or with my soaring hobby dare the lark. *Somerville.*

The thundering guns are heard on every side,
The wounded coveys, reeling, scatter wide;
The feathered field-mates, bound by Nature's tie,
Sires, mothers, children, in one carnage lie. *Burns.*

COUGH, *v. n., v. a. & n. s.* } Arab. *gubhu*;
COUGHER, *n. s.* } Hin. *kuf*; Goth.

huof, kof; Swed. *quaf*; Dut. *kuch*. It has also been derived from *κωπος, levo, allevo*. To lighten or ease the breast and lungs by expectoration. Minshen and Skinner are of opinion that the word, like some others, is imitative of the sound produced by the act of coughing. Cough is a sonorous concussion of the thorax, produced by the sudden expulsion of the air through the fauces. It is occasioned by a violent and generally involuntary motion of the respiratory muscles. To cough is to have the lungs convulsed; to eject by a cough.

Ye should have coughed when ye com. Wher lern you curtesy?
Chaucer. Cant. Tales.

And still he stant under the shot window;
Unto his breast it rought, it was so low;
And soft he cougheth with a semisoun. *Id.*

The harbinger of death,
To me I see him ride,
The cough, the cold, the gasping breath
Doth byd me to provyde. *Songes and Sonettes.*

Thou didst drink
The stale of horses, and the gilded puddle
Which beasts would cough at.
Shakespeare. Antony and Cleopatra.

In consumptions of the lungs, when nature cannot expel the cough, men fall into fluxes of the belly, and then they die. *Bacon's Natural History.*

If any humour be discharged upon the lungs, they have a faculty of casting it up by coughing. *Ray on the Creation.*

If the matter be to be discharged by expectation, it must first pass into the substance of the lungs; then into the aspera arteria, or weasand; and from thence be coughed up, and spit out by the mouth. *Wiseman's Surgery.*

I cough like Horace, and tho' lean, am short. *Pope's Epistles.*

For his dear sake long restless nights you bore,
While rattling coughs his heaving vessels tore. *Smith.*

A frame so steeled
Dreads not the cough, nor those ungenial blasts
That breathe the tertian or fell rheumatism. *Armstrong.*

Love's a capricious power; I've known it hold
Out through a fever caused by its own heat,
But be much puzzled by a cough and cold,
And find a quinsy very hard to treat. *Byron. Don Juan.*

COUGH, in medicine, a convulsion of the lungs, generally occasioned, as a disease, by catarrh. As an accident, a drop of cold water, or a crumb of bread, passing to the tender coat of the wind-pipe, is sufficient to throw the muscles into the most violent agitation: but in catarrh it is generally the acrid serum collected in the lungs that is the immediate cause. See CATARRH and MEDICINE.

COVIN, or } Old Fr. *covin*. A deceitful
COVINE, *n. s.* } agreement between two or
more, to the hurt of another.

Wickid Tonge, whiche that the covine
Of every lovir can devine
Worste. *Chaucer. Romanes of the Rose.*

One covyn followeth another, and deceit is met with the lyke. *Knight.*

COVING, *n. s.* from *cove*. A term in building, used of houses that project the ground-plot, and the turned projecture arched with timber, lathed and plastered.

COULD. The imperfect preterite of *can*. See *CAN*. Was able to; had power to.

And if I have done well, and as is fitting the story,
It is that which I desired; but if slenderly and
meanly, it is that which I could attain unto. *2 Mac. xv. 38.*

Wel coude he sitte on hors, and fayre ride;
He coude songes make, and wel endite.
Chaucer. Prolog. to Cant. Tales.

Well mote ye wonder how that noble knight,
After he had so often wounded beens,
Could stand on foot now to renew the fight.
Spenser. Faerie Queene.

What if he did not all the ill he could?
Am I obliged by that t' assist his rapines,
And to maintain his murders?

Dryden's Spanish Friar.

COULOMB (Charles Augustus), an eminent French philosopher, was born at Angouleme in 1736. He was sent to Paris at an early age for his education, and, acquiring a partiality for the mathematical sciences, made great proficiency in his favorite study. The profession which his friends or his taste pointed out to him as the most eligible was that of the army; and the branch of the military service in which his previous acquirements could be employed to the greatest advantage, and could lead to the greatest distinction, was that of the engineers. He therefore entered that corps, and was sent out to the West Indies. After an absence of nine years, the unhealthiness of the climate compelled him to return to France, where he soon began to acquire celebrity by his philosophical labors. Before he was admitted into the Academy he submitted a memoir entitled *Sur les Moyens d'executer sous l'eau toutes sortes de Travaux Hydrauliques*, sans employer aucun Epuisement, which procured for him the title of corresponding member. His next memoir was on the theory of simple machines. Coulomb had divided with Sivinden the prize for the best construction of the magnetic needle; and, in the discussions to which some questions connected with the subject led him, his attention had been directed to the effects of torsion, or the resistance which is opposed to the force of magnetism, by the stiffness of the suspended wire. He applied himself, therefore, to the examination of this point, and invented an ingenious machine for measuring with precision the force of torsion. In 1781 he arrived at Paris; and the value of his works being already appreciated by the Academy, he was immediately elected a member. Before the era of the revolution Coulomb was appointed commissary to the king in Brittany, and was employed in examining all the canals and public works in that province. When the regal government was overthrown, and the civil troubles commenced in France, our author retired to an estate which he possessed near Blois. In 1798 he read to the national institute, which succeeded to the Academy, a paper containing the result of many experiments he had made, to determine the different quantities of work which the labor of a man can execute, according to the different modes in which his force is employed. In 1800 he contributed to the Transactions of the institute a valuable paper, entitled *Determination Theorique et Experimentale des Forces qui ramenant Differentes Aiguilles Aimentées a Saturation, a leur Meridien Magnetique*. His next, and his last paper of any importance, had for its object to determine the cohesion of fluids: it was published in the same volume of the memoirs of the institute with the preceding, and is reckoned among the most ingenious of his numerous speculations. After the elevation of Buonaparte to the head of the French government, Coulomb was recalled to Paris, and appointed one of the inspectors-general of studies; an office which, though undertaken with

reluctance, he filled with credit and usefulness. He died on the 23rd of August 1806.

CO'ULTER, or } Fr. *coultre*; Ital. *cultro*;
C'ULTER, n. s. } Ang.-Sax. *cultor*; Dutch,
kultor; Lat. *cultor*. The sharp iron of the plough, which cuts the earth perpendicular to the share.

The Israelites went down to sharpen every man his share, and his *coulter*, and his ax, and his mattock.

1 Samuel xiii. 20.

•He shoke of shere, and *coulter* off drove,
And hanged his harness on a pinne.

Chaucer. Cant. Tale

A smith man called Dan Gerveis,
That in his forge smithed plow harness;
He sharpeth share and *coultre* beasily.

Id.

Like damask roses' bud
Cast from the stalk, or like
In field to purple flowre,
Which languisheth, being shred
By *cultor* as it past.

Spenser. The Mourning Muse.

Literature is the grindstone to sharpen the *coulter*,
to whet their natural faculties.

Hammond on Fundamentals.

The plough for stiff clays is long and broad: and the *coulter* long, and very little bending, with a very large wing.

Mortimer.

With *coulters* bright the rushy sward bisect,
And in new veins the gushing rills direct.

Darwin.

COUNCIL, n. s.

CO'UNCILIST, n. s.

CO'UNCIL-BEARD, n. s.

CO'UNCIL-BOOK, n. s.

CO'UNCIL-CHAMBER, n. s.

CO'UNCIL-HOUSE, n. s.

CO'UNCIL-MAN, n. s.

CO'UN'IL-TABLE, n. s.

Fr. *conseil*; It.

and Sp. *concilio*;

Latin, *concilium*.

Council signifies

a body of persons

met together to

consult and deli-

berate; the act of

public deliberation; the body of privy counsellors. The council-board and council-table are synonymous, and mean the board, or table, in the council-chamber, or house, at which sit the persons in council, whose proceedings and resolves are entered in the council-book. Council-man is a member of a council. Milton uses the word councilist to denote a person well read in the acts of the councils. Our older writers used council and counsel indiscriminately; but the latter is now applied only to the advice given.

The chief priests, and all the *council*, sought false witness.

Matthew xxvi. 59.

Thus art thou of my *conseil* out of doute,
And now thou woldest falsly ben aboute
To love my lady whom I love and serve.

Chaucer. Cant. Tale.

Without the knowledge
Either of king or *council*, you made hold
To carry into Flanders the great seal.

Shakespeare. Henry VIII.

He hath commanded,
To-morrow morning to the *council-board*,
He be convened.

Id.

They being thus assembled, are more properly a *council* to the king, the great *council* of the kingdom, to advise his majesty in those things of weight and difficulty, which concern both the king and the people, than a court.

Bacon's Advice to Villiers.

The sceptered heralds call

To council in the city gates : anon
Grey-headed men and grave, with warriors mixed,
Assemble, and harangues are heard. *Milton.*

Wherewith he went at heaven's high council-table
To sit the midst of Trinal Unity. *Id.*

When ship-money was transacted at the council-board,
they looked upon it as a work of that power
they were obliged to trust. *Clarendon.*

Soon after, by my advice, he was put to the banker
in Lombard Street; is now a common-council-man,
will sordidly be deputy of the ward, and may in time
bid fair for the chair. *Tatler.*

In histories composed by politicians, they are for
drawing up a perpetual scheme of causes and events,
and preserving a constant correspondence between
the camp and the council-table. *Addison's Spectator.*

And Pallas, if she broke the laws,
Must yield her foe the stronger cause;
A shame to one so much adored
For wisdom at Jove's council-board. *Swift.*

Some borrow all their religion from the fathers of
the Christian church, or from their synods or councils. *Watts.*

We see the dame, in rustic pride,
A bunch of keys to grace her side,
Stalking across the well-swept entry,
To hold her council in the pantry. *Sheridan.*

COUNCIL AND SESSION, LORDS OF, the supreme
judges of the highest court in Scotland. See
SCOTLAND.

COUNCIL, AULIC. See AULIC.

COUNCIL, COMMON, in the city of London, is a
court wherein are made all by-laws which bind
the citizens. It consists, like the parliament, of
two houses; an upper one composed of the lord
mayor and aldermen, and a lower of a number
of common-council-men, chosen by the several
wards, as representatives of the body of the citi-
zens. See LONDON.

COUNCIL, OECUMENICAL, OR GENERAL, is an
assembly supposed to represent the universal
church. The Romanists reckon eighteen of them;
Bullinger, in his treatise *De Conciliis*, six; Dr.
Prideaux, and Bp. Beveridge, eight, which he
says are all the general councils which have ever
been held since the time of the first Christian
emperor. They are as follows:—1. The council
of Nice, held in the reign of Constantine the
Great, on account of the heresy of Arius. 2. The
council of Constantinople, called under the reign
and by the command of Theodosius the Great,
for much the same end that the former council
was summoned. 3. The council of Ephesus,
convened by Theodosius the younger, at the suit
of Nestorius. 4. The council of Chalcedon, held
in the reign of Martianus, which approved of the
Eutychian heresy. 5. The second council of
Constantinople, which was assembled by the
emperor Justinian, and condemned the three
chapters taken out of the book of Theodorus of
Mopsuestia, having first decided that it was law-
ful to anathematise the dead. Some authors
tell us, that they likewise condemned the several
errors of Origen about the Trinity, the plurality
of worlds, and the pre-existence of souls. 6. The
third council of Constantinople, held by the
command of Constantius Pogonatus, in which
they received the definitions of the first five

general councils, and particularly that against
Origen and Theodorus of Mopsuestia. 7. The
second Nicene council. 8. The fourth council
of Constantinople, assembled when Louis II.
was emperor of the West. Their regulations are
contained in twenty-seven canons, the heads of
which are set down by M. Dupin, to whom the
reader is referred.

COUNCIL OF WAR, an assembly of principal
officers of an army or fleet, occasionally called by
the general or admiral to concert measures for
their conduct, with regard to sieges, retreats, en-
gagements, &c.

COUNCIL, PRIVY. See PRIVY-COUNCIL.

CO-UNDERSTANDING, n. s. from *con* and
understanding. Mutual understanding.

Provided there be a reciprocal knowledge and co-
understanding between the parties. *Hocell.*

CO-U'NE, v. a. } From *con* and
CO-UN'ITE, v. a. & adj. } unite. To unite.
United.

CO'UNSEL, v. a. & n. s. } Fr. *conseiller* ;
CO'UNSELLABLE, adj. } Lat. *consilior*. To
CO'UNSELLING, n. s. } counsel is to give
CO'UNSELLOR, n. s. } advice. Counsel
CO'UNSELLORSHIP, n. s. } is, advice; consul-
CO'UNSEL-KEEPER, n. s. } tation; delibera-
CO'UNSEL-KEEPING, n. s. } tion; prudence ;
secrecy; formerly, purpose, design; a person
who pleads a cause in court for another. A
counsellor signifies, an adviser; confidant; one
of the king's privy council; one who gives ad-
vice and pleads in law cases. Counsellorship
denotes the office of a privy counsellor. He who
is willing to receive advice, or counselling, is
counsellable; and he who keeps a secret that is
confided to him is a counsel-keeper. Persons of
these two classes are less numerous than could
be wished. That which preserves secrecy is
counsel-keeping.

His mother was his counsellor to do wickedly.
2 Chron. xxiii. 3.

The counsel of the Lord standeth for ever, the
thoughts of his heart to all generations.

Psalms xxxiii. 11.

O how comely is the wisdom of old men, and un-
derstanding and counsel to men of honour.

Eccles. xxv. 5.

There is no wisdom, nor understanding, nor counsel,
against the Lord.

Prov. xxi. 30.

She would be a counsellor of good things, and a
comfort in cares.

Wisdom viii. 9.

Men may counseil a woman to ben on,
But counselling is no commendement.

Chaucer. Cant. Tales.

For troste wel that comunly these counsellours ben
flaterers, namely the counsellours of grete lordes, for
they enforcen hem alway rather to speken pleasant
wordes, enclining to the lordes lust, than wordes that
ben trewe or profitable. *Id.*

They all confess, therefore, in the working of that
first cause, that counsel is used, reason followed, and
a way observed. *Hoober.*

• Truth shall nurse her;
Holy and heavenly thoughts still counsel her.
Shakespeare. Henry VIII.

I hold as little counsel with weak fear
As you, or any Scot that lives. *Id. Henry IV.*

The players cannot keep counsel; they'll tell all.

Id. Hamlet.

Your hand, a covenant; we will have these things
get down by lawful counsel.

Id. Cymbel.no.

Death of thy soul! Those linen cheeks of thine
Are counsellors to fear.

Id. Macbeth.

And, look, whether the fiery Trigon, his man, be
not lisping to his master's old tables; his note-book,
his counsel-keeper.

Id. 2 Henry IV.

Curtained with a counsel-keeping care.

Id. Titus Andronicus.

There is danger of being unfaithfully counselled,
and more for the good of them that counsel than for
him that is counselled.

Bacon.

There is as much difference between the counsel that
a friend giveth, and that a man giveth himself, as
there is between the counsel of a friend and of a flatterer.

Id.

For the advocates and counsel that plead, patience
and gravity of learning is an essential part of justice;
and an overspeaking judge is no well-tuned cymbal.

Id.

Of the great offices and officers of the kingdom, the
most part are such as cannot well be severed from the
counsellorship.

Id.

He supports my poverty with his wealth, and I
counsel and instruct him with my learning and experi-
ence.

Taylor.

In such green palaces the first kings reigned,
Slept in their shades, and angels entertained;
With such old counsellors they did advise,
And by frequenting sacred groves grow wise.

Waller.

Bereave me not,

Whereon I live, thy gentle looks, thy aid,

Thy counsel, in this uttermost distress.

Milton.

Very few men of so great parts were more counsel-
lable than he; so that he would seldom be in danger
of great errors, if he would communicate his own
thoughts to disquisition.

Clarendon.

The less had been our shame,

The less his counselled crime which brands the Grecian
name.

Dryden's Fables.

A counsellor bred up in the knowledge of the muni-
cipal and statute laws, may honestly inform a just
prince how far his prerogative extends.

Dryden's Juvenal, Dedication.

If in a multitude of counsellors there is safety, we
ought to think ourselves the securest nation in the
world. Most of our garrets are inhabited by states-
men, who watch over the liberties of their country,
and make a shift to keep themselves from starving, by
taking into their care the properties of their fellow-
subjects.

Addison. Spectator.

What says my counsel learned in the law?

Pope.

There waiter Dick, with Bacchanalian lays,
Shall win his heart, and have his drunken praise,
His counsellor and bosom friend shall prove,
And some street-pacing harlot his first love.

Cowper.

Unknown to me the object of her grief—
I dare not counsel, did she ask relief;
Yet may the wish no vain intrusion prove,
To share her grief, for all who shared her love.

Shridam.

He died: and most unluckily, because
According to all hints I could collect
From counsel learned in those kind of laws,
(Although their talk's obscure and circumspect)
His death contrived to spoil a charming cause.

Egton. Don Juan.

COUNSEL, or ADVOCATES, in English courts of law, are of two degrees, BARRISTERS, and SERJEANTS. See those articles. From both these degrees some are usually selected to be his majesty's counsel, learned in the law; the two principal of whom are called his attorney-general, and solicitor-general. It is now customary to grant letters patent of precedence to such barristers as the crown thinks proper to honor with that mark of distinction: whereby they are entitled to such rank and pre-audience as are assigned in their respective patents; sometimes next after the king's attorney-general, but usually next after his majesty's counsel next being. These, as well as the queen's attorney and solicitor-general, rank promiscuously with the king's counsel; and, together with them, sit within the bar of their respective courts. The first king's counsel, under the degree of serjeant, was Sir Francis Bacon, who was made so, honoris causa, without either patent or fee. And all other serjeants and barristers, indiscriminately (except in the court of common pleas, where only serjeants are admitted,) may take upon them the protection and defence of any suitors, whether plaintiff or defendant, who are therefore called their clients,—like the dependents on the ancient Roman orators. These, indeed, practised gratis, for honor merely, or at most for the sake of gaining influence; and so likewise it is established that a counsel can maintain no action for his fees, which are given not as locatio vel conductio, but as quiddam honorarium; not as a salary, or hire, but as a mere gratuity, which a counsellor cannot demand without doing wrong to his reputation,—as is also laid down with regard to advocates in the civil law, whose honorarium was directed, by a decree of the senate, not to exceed in any case 10,000 sesterces, or about £80 of English money. And in order to encourage due freedom of speech in the lawful defence of their clients, and at the same time to check the unseemly licentiousness of prostitute and illiberal men, it has been holden that a counsel is not answerable for any matter by him spoken relative to the cause in hand, and suggested in the clients instructions, although it should reflect upon the reputation of another, and even prove absolutely groundless; but if he mentions an untruth of his own invention, or even upon instructions, if it be impertinent to the cause in hand, he is then liable to an action from the party injured. And counsel guilty of deceit and collusion are punishable by the statute Westm. 13 Edw. I. cap. 28, with imprisonment for a year and a day, and perpetual silence in the courts; a punishment still sometimes inflicted for gross misdemeanors in practice.

COUNSELLOR AT LAW, a person retained by a client to plead his cause in a public court of judicature. See **ADVOCATE, BARRISTER, COUNSEL, and SERJEANT**

COUNSELLOR, PRIVY. See **PRIVY-COUNSELLOR.**

COUNT, v. a., v. n., & n. s.

CO'UNTABLE, adj.

CO'UNTLESS, adj.

CO'UNTER, n. s.

CO'UNTING-HOUSE, n. s.

Fr. compter; It. contare; Sp. contar; Latm computare, from con and putare.

To number up ; to preserve a reckoning ; to calculate ; to compute ; to place to an account ; to estimate ; to found an account or scheme, in which case it takes upon after it. Count is, number ; the number summed up ; estimation : in law, a charge in an indictment, or a declaration in pleading. As a noun, counter signifies an imitative piece of money, used in reckoning ; contemptuously, money ; the long table on which goods are sold in a shop ; the part of a horse's fore hand that lies between the shoulder and under the neck ; the name of some prisons in London ; an auditor ; an abbreviation of encounter. For the adverb, see COUNTER. Counting-house is a room appropriated by merchants and traders to their books and accounts, and to the transaction of their business when they are at home.

He believed in the Lord, and he counted it to him for righteousness. *Genesis xv. 6.*

Count not thine handmaid for a daughter of Belial. *1 Sam. i.*

And let no wyght thy woe seekes to withhold : But countp thee wurthy (wretche!) of sorrowes store. *Sackville.*

For from the day that he thus did it leave, Amongst all knights he blotted was with blame, And counted but a recreant knight with endless shame. *Spenser. Faerie Queene.*

he to his closet went, where all his wealth Lay hid ; thereof she countlesse summes did reare, The which she meant away with her to beare. *Id.*

And fully setteth his felicity, Counting it fairer than it is indeed, And yet indeed her fairness doth exceed. *Id. Hymn in honor of Beauty.*

That we up to your palaces may mount, Of blessed saints for to increase the count. *Id. Epithal.*

The evils which you desire to be recounted are very many, and almost countable with those which were hidden in the basket of Pandora. *Id. Ireland.*

When once it comprehendeth anything above this, as the differences of time, affirmations, negations, and contradictions in speech, we then count it to have some use of natural reason. *Hooker.*

Here thro' this grate I can count every one, And view the Frenchmen. *Shakespeare. Henry VI.*

By my count, I was your mother much upon these years. *Id. Romeo and Juliet.*

When Marcus Brutus grows so covetous, To lock such rascal counters from his friends, Be ready, gods ! with all your thunder-bolts Dash him to pieces. *Id. Julius Caesar.*

Ay, tear for tear, and loving kiss for kiss, Thy brother Marcus tenders on thy lips : O were the sum of these that I should pay Countless and infinite, yet would I pay them. *Id. Titus Andronicus.*

Bear the sea's sand in memory, Earth's grass, and the stars in sky, The little moats which mounted Hang in the beams of Phoebus' eye, And never can be counted. *Davies.*

Nor shall I count it heinous to enjoy The public marks of honour and reward Conferred upon me. *Milton's Agonistes.*

Some modern sealots appear to have no better knowledge of truth, nor better manner of judging it, than by counting noses. *Shafesbury.*

Not barely the plowman's pains is to be counted into the bread we eat ; the labour of those who broke the oxen, must all be charged on the account of labour. *Locke.*

Men in trade seldom think of laying out money upon land, till their profit has brought them in more than their trade can well employ ; and their idle bags, cumbering their counting-houses, put them upon emptying them. *Id.*

All the virtues that have been ever in mankind are to be counted upon a few fingers ; but his follies and vices are innumerable, and time adds hourly to the heap. *Swift.*

I think it a great error to count upon the genius of a nation, as a standing argument in all ages. *Id.*

You would not wish to count this man a foe ! In friendship, and in hatred, obstinate *Philips's Britain.*

In half-whipt muslin needles useless lie, And shuttlecocks across the counter fly. *Gay's Trivia.*

And man, whose heaven-erected face The smiles of love adorn, Man's inhumanity to man Makes countlesse thousands mourn ! *Burns.*

Nor deems he wiser him, who gives his moon To miss, the mercer's plague, from shop to shop Wandering and littering with unfolded silks The polished counter, and approving none, Or promising with smiles to call again. *Id.*

A king sate on the rocky brow Which looks o'er sea-born Salamis ; And ships, by thousands, lay below, And men in nations ;—all were his ! He counted them at break of day— And when the sun set where were the *Byron. Juan.*

COUNT, *n. s.* } Fr. *comte* ; Ital. }
CO'UNTESS, *n. s.* } Sp. *conde* ; Lat. *comes*. A }
CO'UNTY, *n. s.* } foreign title of nobility, }
equivalent to that of earl. County was the old designation of a nobleman, as may be seen in our old writers ; but the term has long been obsolete. Countess is the feminine of count.

Wost thou (quod he) wber this be wife or maide, Or quene or countesse, or of what degree ? *Chaucer. Legend of Good Women.*

Princes and countesses ! surely a princely testimony, a goodly count comfect ! *Shakespeare. Much Ado about Nothing.*

The gallant, young, and noble gentleman, The county Paris. *Id. Romeo and Juliet.*

I take it, she that carries up the train, Is that old noble lady, the duchess of Norfolk.— It is, and all the rest are countesses. *Id. Henry VIII.*

He made Hugh Lupus county palatine of Chester, and gave that earldom to him and his heirs, to hold the same, its liberè ad gladium, stout rex tenebat Angliam ad coronam. *Davies.*

It is the peculiar happiness of the countess of Abingdon to have been so truly loved by you while she was living, and so gratefully honoured after she was dead. *Dryden.*

Shire is a Saxon word, signifying a division ; but a county, comitatus, is plainly derived from comes, the count of the Franks. *Blackstone.*

COUNT, as a title, properly signifies a nobleman who possesses a domain erected into a county. See VISCOUNT. English and Scottish counts we distinguish by the title of earls ; foreign ones still retain their proper name. The dignity of a count is a medium between that

of a duke and a baron. At one period, most plenipotentiaries and ambassadors assumed the title of counts; and anciently, all generals, counsellors, judges, and secretaries of cities under Charlemagne were called so; the distinguishing character of a duke and count being this, that the latter had but one town under him, but the former several. A count has a right to bear on his arms a coronet, adorned with three precious stones, and surmounted with three large pearls, whereof those in the middle and extremities of the coronet advance above the rest.

Counts were originally lords of the court, or of the emperor's retinue, and had their name *comites*, à *comitando*, or à *commeando*: hence those who were always in the palace, or at the emperor's side, were called counts palatine, or *comites à latere*. See *PALATINE*. In the times of the commonwealth, *comites*, among the Romans, was a general name for all those who accompanied the proconsuls and prætors into the provinces, there to serve the commonwealth; as the tribunes, præfects, scribes, &c. Under the emperors *comites* were the officers of the palace. The origin of what we now call counts seems owing to Augustus, who took several senators to be his *comites*, as Dion observes, i. e. to accompany him in his voyages and travels, to assist him in the hearing of causes, which were to be judged with the same authority as in full senate: but this title was rather a mark of office than of dignity; and Constantine was the first who converted it into an honorary name. The Franks, Germans, &c. passing into Gaul and Germany, did not abolish the form of the Roman government; and as the governors of cities and provinces were called *comites*, (counts), and *duces*, (dukes), they continued to be called so. Under the last or the second race of French kings, their dignity was made hereditary, and when Hugh Capet came to the crown his authority was not sufficient to oppose their encroachments. By degrees most of the counties were re-united to the crown. William the Conqueror, as Camden observes, gave the dignity of counts in fee to his nobles, annexing it to this or that county or province, and allotting for their maintenance a certain proportion of money, arising from the prince's profits in the pleadings and forfeitures of the provinces. In France at first, there was no clause in the patent of erection, intimating the reversion of the county to the crown in default of heirs male; but Charles IX., to prevent their becoming too numerous, ordained that duchies and counties, in default of heirs male, should return to the crown. The point of precedence between counts and marquises has been formerly much controverted: the reason was, that there were counts who were peers of France, but no marquises. But the point is now given up, and marquises take precedence; though anciently, when counts were governors of provinces, they were on a level even with dukes.

COUNT, in law, denotes the original declaration in a real action; as the declaration is in a personal one: the libellus of the civilians answers to both.—Yet count and declaration are sometimes confounded, and used for each other; as count in debt, count in appeal, &c.

COUNT-WHEEL, in the striking part of a clock, a wheel which moves round once in twelve or twenty-four hours. It is sometimes called the locking-wheel. See **CLOCK**.

CO'UNTENANCE, *v. a. & n. s.* } *Fr. contenance*; *Ital. contenza*;
CO'UNTENANCER, *n. s.* }
CO'UNTENANCING, *n. s.* }

Span. continente; *Lat. continere*. To encourage; to support; to patronise. The cast of the features; the look; composure of face; in which case it is preceded by the verb to *keep*; confidence of mien, generally with *in* or *out of* before it, as, in countenance, out of countenance; expression of the feelings, as visible on the face; support; patronage; superficial appearance; resemblance. Countenancer is one who affords countenance to; countenancing is the act of affording countenance to.

Neither shalt thou countenance a poor man in his cause. *Exodus xliiii. 3.*

A man came unto me, and his countenance was like the countenance of an angel of God, very terrible. *Judges xiii. 6.*

As I may best I wol my wo endure:
 Ne make no countenance of hevynesse.
 That folk of you may demen harme or gesse. *Chaucer. Cant. Tale.*

But yet her countenance was so gled,
 And she so fewe yeris hed,
 As any ladie that was there. *Id. Dream.*

Each to these ladies love did countenance,
 And to his mistress each himself strove to advance. *Spenser. Faerie Queene.*

Yet the stout fairy, 'mongst the midstest crowd,
 Thought all their glory vain in knightly view
 And that great princess too, exceeding proud,
 That to strange knight no better countenances allowed. *Id.*

The salvage nation feele her secret smart,
 And read her sorrow in her countenance sad. *Id.*

The election being done, he made countenances of great discontent therat. *Aecham's Schoolmaster.*

The church of Christ, which held that profession which had not the publick allowance and countenance of authority, could not use the exercise of the Christian religion but in private. *Hooker.*

The night beginning to persuade some retiring place, the gentlewoman, even out of countenance before she began her speech, invited me to lodge that night with her father. *Sidney.*

Malcolm! Banquo!
 As from your graves rise up, and walk like sprites,
 To countenance this horror. *Shakespeare. Macbeth.*

Well, Suffolk, yet thou shalt not see me blush,
 Nor change my countenance for this arrest:
 A heart unspotted is not easily daunted. *Id. Henry VI.*

Bianca's love
 Made me exchange my state with Tranio,
 While he did bear my countenance in the town. *Id. Taming of the Shrew.*

Now then we'll use
 His countenance for the battle; which being done,
 Let her who would be rid of him devise
 His speedy taking off. *Id. King Lear.*

We will not make your countenance to fall by the answer ye shall receive. *Bacon's New Atlantis.*

So spake our sire, and by his countenance seemed
 Entering on studious thoughts abstruse. *Milton.*

This conceit, though countenanced by learned men, is not made out either by experience or reason.

Browne.

Their best friends were out of countenance, because they found that the imputations which their enemies had laid upon them, were well grounded. *Clarendon.*

It is plain, that shaking off a power, which force, and not right, hath set over any one, though it hath the name of rebellion, yet is no offence before God, but is that which he allows and countenances, though even promises and covenants, when obtained by force, have intervened. *Locke.*

I do not remember that, in all my conversation with him, I ever saw him once angry, or to be so far provoked as to change colour or countenance, or tone of voice. *Id.*

To whom, with countenance calm, and soul sedate, Thus Turnus. *Dryden's Æneid.*

She smiled severe; nor with a troubled look,
Or trembling hand, the funeral present took;
Even kept her countenance, when the lid removed
Disclosed the heart unfortunately loved. *Id. Fables.*

If the outward profession of religion and virtue were once in practice and countenance at court, a good treatment of the clergy would be the necessary consequence. *Swift.*

If those preachers would look about, they would find one part of their congregation out of countenance, and the other asleep. *Id.*

The two great maxims of any great man at court are, always to keep his countenance, and never to keep his word. *Id.*

This national fault, of being so very talkative, looks natural and graceful in one that has grey hairs to countenance it. *Addison.*

This is the magistrate's peculiar province, to give countenance to piety and virtue, and to rebuke vice and profaneness. *Atterbury.*

Oppressed by thee (Poverty), the son of genius, whose ill-starred ambition plants him at the tables of the fashionable and polite, must see, in suffering silence, his remark neglected, and his person despised, while shallow greatness, in his idiot attempts at wit, shall meet with countenance and applause. *Burns.*

A father, whose authority, in show
When most severe, and mustering all its force,
Was but the graver countenance of love. *Cooper.*

The allies of ministry (those I mean who supported some of their measures, but refused responsibility for any) endeavoured to undermine their credit, and to take ground that must be fatal to the success of the very cause which they would be thought to countenance. *Sheridan.*

CRAFT. O to be sure! she has herself the oddest countenance that ever was seen; 'tis a collection of features from all the different countries of the globe. *Id.*

COUNTER, *adv.* Fr. *contre*; Lat. *contra*. Contrary to, in which case it generally has the verb run before it; the wrong way; contrariwise; the face, but this sense is obsolete. Counter is much used, both before nouns and verbs, to signify opposite to, as counter-plea, counter-petition.

How cheerfully on the false trail they cry,
Oh, this is counter, you false Danish dogs!

Shakespeare. Hamlet.

They hit one another with darts, as the other do with their hands, which they never throw counter, but at the back of the flyer. *Sandys' Journal.*

A man, whom I cannot deny, may oblige me to use persuasions to another, which, at the same time I am

speaking, I may wish may not prevail on him: in this case, it is plain, the will and the desire run counter. *Locke.*

That design was no sooner known, but others of an opposite party were appointed to set a counter-petition on foot. *Clarendon.*

Shall we erect two wills in God's, and make the will of his purpose and intention run counter to the will of his approbation? *South.*

The profit of the merchant, and the gain of the kingdom, are so far from being always parallels, that frequently they run counter one to the other. *Child on Trade.*

COUNTERACT, *v. a.* } From counter and
COUNTERACTION, *n. s.* } act. To hinder any thing from its effect by contrary agency.

In this case we can find no principle within him strong enough to counteract that principle, and to relieve him. *South.*

The counteraction of a false principle, or a stubborn partiality. *Johnson.*

Liberal, not lavish, is kind Nature's hand;
Nor was perfection made for man below.

Yet all her schemes with nicest art are planned,
Good counteracting ill, and gladness woe. *Beattie.*

Hence in respect to moving to the right or left these percussions counteract each other, but they coincide in respect to the progression of the fish. *Darwin.*

COUNTER-ATTRACTION, *n. s.* From counter and attraction. Opposite attraction.

Attractions of either kind are less perspicuous and less perceptible, through a variety of counter-attractions that diminish their effect. *Shenstone.*

COUNTERBALANCE, *v. a. & n. s.* To weigh against; to act against with an opposite weight; to reduce to an equilibrium. Opposite weight; equivalent power; that which holds another thing in equilibrium.

There was so much air drawn out of the vessel, that the remaining air was not able to counterbalance the mercurial cylinder. *Boyle.*

Few of Adam's children are not born with some bias, which it is the business of education either to take off or counterbalance. *Locke.*

Money is the counterbalance to all other things purchasable by it, and lying, as it were, in the opposite scale of commerce. *Id.*

But peaceful kings, o'er martial people set,
Each other's poise and counterbalances are.

Dryden's An. Mirab.

It may be asked,—whether the inconveniences and ill effects which the world feels, from the licentiousness of this practice, are not sufficiently counterbalanced by the real influence it has upon men's lives and conduct? that if there was no evil-speaking in the world, thousands would be encouraged to do ill, and would rush into many indecorums, like a horse into the battle, were they sure to escape the tongues of men. *Sterne.*

The English owed to the virtue of this stranger (Lanfranc), and the influence he had on the king, the little remains of liberty they continued to enjoy; and at last such a degree of his confidence, as in some sort counterbalanced the severities of the former part of his reign. *Burke.*

COUNTER-BOND, *n. s.* From counter and bond. A counter security.

COUNTER-BUFF, *v. a. & n. s.* From counter and buff. To impel a direction contrary to that which was given by the original impulse; to

strike back. A blow in an opposite direction; a stroke which makes an object recoil.

He at the second gave him such a *counterbuff*, that, because Phalantus was not to be driven from the saddle, the saddle with broken girths was driven from the horse. *Sidney.*

Go, captain Stub, lead on, and show
What house you come of, by the blow
You give Sir Quintin, and the cuff
You scape o' the sandbags *counterbuff*. *Ben Jonson.*

The giddy ship, betwixt the winds and tides
Forced back and forwards, in a circle rides,
Stunned with the different blows; then shoots amain,
Till *counterbuffed* she stops, and sleeps again. *Dryden.*

CO'UNCERCAST, n. s. } From counter, a
CO'UNCERCASTER, n. s. } sham piece of mo-
ney, and cast, to devise. Counter-
cast is a contemptuous designation of an arithmetician; a book-keeper; a keeper of accounts; a reckoner.

So as they past together on their way,
He gan devise this *countercast* of slight. *Spenser. Faeris Queene.*

I, of whom his eyes had seen the proof
At Rhodes, at Cyprus, must be led and calmed
By debtor and creditor, this *countercaster*. *Shakespeare. Othello.*

COUNTERCHANGE, v. a. & n. s. From counter and change. To give reciprocally. Exchange; reciprocation.

She, like harmless lightning, throws her eye
On him, her brothers, me, her master, hitting
Each object with a joy. The *counterchange*
Is severally in all. *Id. Cymbeline.*

That hearts can easily *counterchanged* be. *T. Hall.*

COUNTERCHARM, v. a. & n. s. From counter and charm. To disenchant; to destroy the effect of a charm. That which has the power of dissolving a charm.

Like a spell it was to keep us invulnerable, and so *countercharm* all our crimes, that they should only be active to please, not hurt us. *Decay of Piety.*

Now touched by *countercharms* they change again,
And stand majestick, and recalled to men. *Pope's Odyssey.*

COUNTERCHECK, v. a. & n. s. From counter and check. To oppose; to stop with sudden opposition. Stop; rebuke.

To *countercheck* that sword, else like to conquer all. *Drayton.*

If again I said his beard was not well cut, he would say I lye: this is called the *countercheck* quarrelsome. *Shakespeare.*

COUNTERDISTINCTION, n. s. From counter and distinction. Contradistinction.

I call it moral in *counterdistinction* to philosophical or physical. *H. More.*

COUNTERDRAW, v. a. From counter and draw. With painters, to copy a design or painting by means of a fine linen cloth, an oiled paper, or other transparent matter, whereon the strokes, appearing through, are traced with a pencil.

COUNTER-ERMINE, in heraldry, is the contrary of ermine, being a black field with white spots.

COUNTEREVIDENCE, n. s. From counter and evidence. Testimony by which the deposition of some former witness is opposed.

Sense itself detects its more palpable deceits by a *counter-evidence*, and the more ordinary impostures seldom outlive the first experiments. *Glass. Scops.*

We have little reason to question his testimony in this point, seeing it is backed by others of good credit; and all because there is no *counter-evidence*, nor any witness, that appears against it.

Burnet's Theory of the Earth.

CO'UNTERFEIT, v. a., n., n. s. } Fr. *contre-*
CO'UNTERFEITER, n. s. { & *adj.* } *faire*; Ital.
CO'UNTERFEITLY, adv. } *contrafarc*;
COUNTERFA'ISANCE, or } *barb. Lat.*
COUNTERFESSANCE, n. s. } *contrafactus.*

To copy with an intent to pass off the copy as an original; to forge; to imitate; to resemble; to feign. A counterfeiter is a person or thing which, with intent to deceive, takes the semblance of another; a forgery; formerly a likeness; a picture; a copy. The meanings of counterfeiter and counterfeitedly are obvious. Counterfaissance and counterfessance signify the act of counterfeiting; forgery; but they are both obsolete.

And pined her to *contresfetam* chere
Of court and ben estatelich of manere,
And to ben holden digné of reverence. *Chaucer. Cant. Tales.*

And *contresfetad* was ful subtilly
Another lettre, wrought ful sinfully. *Id.*

And all soche other *counter faitours*,
Chanons, canons, and soche disguised,
Ben Goddis enemies and traitours. *Id.*

Yet was not that same her owne native hewe,
But wrought by art and *counterfeted* skew. *Spenser, Faeris Queen.*

Such is the face of Falshood, such the sight
Of fowle Duessa, when her borrowed light
Is laid away, and *counterfessance* knowne. *Id.*

What art thou,
That *counterfeits* the person of a king? *Shakespeare. Henry IV.*

And, oh, you mortal engines! whose rude throats
The immortal Jove's dread clamours *counterfeit*,
Farewel! *Id. Othello.*

I am no *counterfeit*; to die is to be a *counterfeit*; for he is but the *counterfeit* of a man, who hath not the life of a man. *Shakespeare. 1 Henry IV.*

Since the wisdom of their choice is rather to have my cap than my heart, I will practise the insinuating nod, and be off to them most *counterfeitly*. *Id. Coriolanus.*

A man of easy profession never *counterfeits*, till he lays hold upon a debtor, and says he rests him; for then he brings him to all manner of unrest. *Ben Jonson. Every Man in his Humour.*

Henry the Second altered the coin, which was corrupted by *counterfeiters*, to the great good of the commonwealth. *Camden.*

There have been some that could *counterfeit* the distance of voices, which is a secondary object of hearing, in such sort, as, when they stand fast by you, you would think the speech came from afar off in a fearful manner. *Bacon.*

This priest, being utterly unacquainted with the true person, according to whose pattern he should shape his *counterfeit*, yet could think it possible for him to instruct his player, either in gesture or fashions,

or in fit answers to questions, to come near the resemblance.

Id.

O Eve! in evil hour thou didst give ear
To that false worm, of whomsoever taught
To counterfeit man's voice

Milton.

I learn

Now of my own experience, not by talk,
How counterfeit a coin they are, who friends
Bear in their superscription; in prosperous days
They swarm, but in adverse withdraw their head.

Id.

I think every one ought to contribute to the common stock, and to have no other scruple, or shyness, about the receiving of truth, but that he be not imposed on, and take counterfeit, and what will not bear the touch, for genuine and real truth.

Locke.

There would be no counterfeits but for the sake of something real; though pretenders seem to be what they really are not, yet they pretend to be something that really is.

Id.

But trust me, child, I'm much inclined to fear
Some counterfeit in this your Jupiter.

Addison's Ovid.

It happens, that not one single line or thought is contained in this imposture, although it appears that they who counterfeited me had heard of the true one.

Swift.

The counterfeited smile of pleasure in disagreeable company soon brings along with it a portion of the reality, as is well illustrated by Mr. Burke.

Darwin.

True modesty is a discerning grace,
And only blushes in the proper place;
But counterfeit is blind, and skulks through fear,
Where 'tis a shame to be ashamed to appear;
Humility the parent of the first,
The last by vanity produced and nursed.

Cowper.

COUNTERFERMENT, *n. s.* From counter and ferment. Ferment opposed to ferment.

What unnatural motions and counterferments must a medley of intemperance produce in the body! When I behold a fashionable table, I fancy I see innumerable distempers lurking in ambuscade among the dishes.

Addison's Spectator.

COUNTER-FLORY, in heraldry, is said of a treasure whose fleurs-de-lis are opposite to others.

COUNTER-FOIL, or **COUNTER-STOOK**, in the exchequer, that part of a tally which is kept by an officer of the court.

COUNTERFORT, *n. s.* From counter and fort.

Counterforts, battresses, or spurs, are pillars serving to support walls or terraces subject to bulge.

Chambers.

COUNTERGAGE, *n. s.* From counter and gage. In carpentry, a method used to measure the joints, by transferring the breadth of a mortise to the place where the tenon is to be, in order to make them fit each other.

COUNTERGUARD, *n. s.* From counter and guard. A small rampart, with a parapet and ditch, to cover some part of the body of the place.

COUNTER-INFLUENCE, *v. a.* From counter and influence. To prevent any thing by means of a counteracting influence.

COUNTER-LIBRATION, *n. s.* In astronomy, opposite libration.

COUNTERLIGHT, *n. s.* From counter and light. A window or light opposite to any thing, which makes it appear to a disadvantage.

COUNTERMAND, *v. a. & n. s.* Fr. *contramander*. To order the contrary of that which has been ordered; to revoke a command; to contradict orders given by another; to prohibit. Countermand is a contrary order.

For us to alter any thing, is to lift up ourselves against God, and, as it were, to countermand him.

Hooker.

Have you no countermand for Claudio yet,
But must he die to-morrow?

Shakespeare. Measure for Measure.

Avicen countermands letting blood in choleric bodies, because he esteems the blood a bridle of the gall.

Harvey.

In states notoriously irreligious, a secret and irresistible power countermands their deepest projects, and smites their policies with frustration and a curse.

South.

COUNTERMARCH, *v. n. & n. s.* from counter and march. To march back; to march in indirect ways. Retrograde march; march in a new direction; change of measures.

How are such an infinite number of things placed with such order in the memory, notwithstanding the tumults, marches, and countermarches of the animal spirits?

Collier on Thought.

They make him do and undo, go forward and backwards by such countermarches and retractions, as we do not willingly impute to wisdom.

Burnet's Theory of the Earth.

His host of wooden warriors to and fro
Marching and countermarching, with an eye
As fixed as marble, with a forehead ridged
And furrowed into storms, and with a hand
Trembling as if eternity were hung
In balance on his conduct of a pin.

Cowper.

COUNTER-MARCH, in military affairs, a change of the face or wings of a battalion, by which means those that were in the front come to be in the rear.

COUNTERMARK, *v. a. & n. s.* From counter and mark. For a definition of the verb, see the quotation from the *Farriers' Dictionary*. The noun has the following meanings. A second or third mark put on a bale of goods belonging to several merchants, that it may not be opened but in the presence of them all. The mark of the goldsmiths' company, to show the metal is standard, added to that of the artificer. An artificial cavity made in the teeth of horses that have outgrown their natural mark, to disguise their age. A mark added to a medal a long time after it is struck, by which the curious know the several changes in value which it has undergone.

A horse is said to be countermarked, when his corner teeth are artificially made hollow, a false mark being made in the hollow place, in imitation of the eye of a bean, to conceal the horse's age.

Farrier's Dictionary.

COUNTERMINE, *v. a. & n. s.* From counter and mine. To form a mine for the purpose of destroying that of the enemy; to counteract; to defeat by secret measures. A mine made to destroy an enemy; any thing that is calculated to defeat a hostile project.

He thinking himself contemned, knowing no countermine against contempt but terror, began to let nothing pass, which might bear the colour of a fault, without sharp punishment.

Sidney.

After this they mined the walls, laid the powder, and rammed the mouths; but the citizens made a *countermine*, and therein they poured such a plenty of water, that the wet powder could not be fired.

Hayward.

The matter being brought to a trial of skill, the *countermine* was only an act of self-preservation.

L'Estrange.

Thus infallibly it must be, if God do not miraculously *countermine* us, and do more for us than we can do against ourselves.

Decay of Piety.

COUNTERMOTION, *n. s.* } From counter
COUNTERMOVEMENT, *n. s.* } and motion.
Opposition of motion; motion in a contrary direction. The second of these words is principally used with reference to military manoeuvres.

That resistance is a *countermotion*, or equivalent to one, is plain by this, that any body which is pressed, must needs press again on the body that presses it.

Digby on the Soul.

If any of the returning spirits should happen to fall foul upon others which are outward bound, these *countermotions* would overset them, or occasion a later arrival.

Collier.

COUNTERMURE, *v. a. & n. s.* Fr. *contremur*. To fortify with a second wall. Countermure is a wall erected behind a breach or weak place.

Countermured with walls of diamond. *Kyd.*

The great shot flying through the breach, did beat down houses; but the *countermure*, new built against the breach, standing upon a lower ground, it seldom touched.

Knolles.

COUNTERNATURAL, *adj.* From counter and natural. Contrary to nature.

A consumption is a *counternatural* hectick extenuation of the body.

Harvey on Consumptions.

COUNTERNOISE, *n. s.* From counter and noise. A sound by which any other noise is overpowered.

They endeavoured, either by a constant succession of sensual delights, to charm and lull asleep, or else by a *counternoise* of revellings and riotous excesses to drown, the softer whispers of their conscience.

Calamy's Sermons.

COUNTEROPENING, *n. s.* From counter and opening. An aperture or vent on the contrary side.

A tent, plugging up the orifice, would make the matter recur to the part disposed to receive it, and mark the place for a *counteropening*.

Sharp's Surgery.

COUNTERPACE, *n. s.* From counter and pace. Contrary measure; attempts in opposition to any scheme.

When the least *counterpaces* are made to these resolutions, it will then be time enough for our malecontents.

Swift.

COUNTERPALED, in heraldry, is when the escutcheon is divided into twelve paies parted per fesse, the two colors being counterchanged; so that the upper are of one color and the lower of another.

COUNTERPANE, *n. s.* Fr. *contrepoint*. A coverlet for a bed, or any thing else woven in squares. It is sometimes written, according to etymology, counterpoint. It also formerly meant

one part of a pair of deeds, but this sense is become obsolete, and is replaced by counterpart.

Read, scribe; give me the *counterpane*.

Ben Jonson.

COUNTERPART, *n. s.* From counter and part. The correspondent part; the part which answers to another, as the two papers of a contract; the part which fits another, as the key of a cypher.

In some things the laws of Normandy agreed with the laws of England; so that they seem to be, as it were, copies or *counterparts* one of another.

Hale's Law of England.

An old fellow with a young wench, may pass for a *counterpart* of this fable.

L'Estrange.

Oh *counterpart*

Of our soft sex; well are you made our lords:
So bold, so great, so god-like are you formed,
How can you love so silly things as women?

Dryden.

He is to consider the thought of his author, and his words, and to find out the *counterpart* to each in another language.

H.

In the discovery, the two different plots look like *counterparts* and copies of one another.

Addison's Spectator.

COUNTER-PART, in music, denotes one part to be applied to another. Thus the base is said to be a counter-part to the treble.

COUNTER-PASSANT, in heraldry, is when two lions are in a coat of arms, and the one seems to go the contrary way from the other.



COUNTER-PETITION, *v. n. & n. s.* To petition against another petition, or against that which is prayed for by another petition. A petition in opposition to another.

The gentlemen and others of Yorkshire, who had *counter-petitioned*.

Rarity.

That design was no sooner known, but others of an opposite party were appointed to set a *counter-petition* on foot.

Clarendon.

COUNTERPLEAD, *v. a.* } From counter

COUNTERPLEA, *n. s.* } and plead. To

put in a counter-plea; to oppose. A counter-plea, says Cowell, in law, is a replication: as, if a stranger to the action begun desire to be admitted to say what he can for the safeguard of his estate, that which the demandant allegeth against this request is called a counterplea.

That as to *counterpleade* them, though ye wer my brother,

I wolde gyve yew no counsaill.

Chaucer. Cant. Tale.

And she answered, Let be thine arguing.

For Love ne will not *counterplead* be
In right ne wrong. *Id. Legende of Good Women.*

COUNTERPLOT, *v. a. & n. s.* } From coun-

COUNTERPLOTTING, *n. s.* } ter and plot.

To oppose plot by plot. One artifice opposed to another.

The wolf that had a plot upon the kid, was confounded by a *counterplot* of the kid's upon the wolf;

and such a counterplot as the wolf, with all his sagacity, was not able to smell out. *L'Étrange.*

Prudencia had counterplotted us, and had bespoken the same evening, the puppet show of The Creation of the World. *Tatler.*

COUNTERPOINT, *n. s.* A coverlet woven in squares, now called a counterpane; an opposite point or course; a trick; a contrivance; the art of composing harmony.

No counterpoint of cunning policy. *Spenser. Mother Hubbard's Tale.*

In cypress chests, my arras counterpoints. *Shakespeare. Taming of the Shrew.*

Fell suddenly into the very counterpoint of justifying bestiality. *Sir H. Sandys.*

COUNTER-POINT, in music, from Lat. *contra* against, and *pungere*, to point, is so named because the musical characters by which the notes in each part are signified are placed in such a manner, each with respect to each, as to show how the parts answer one another. See **COMPOSITION**.

COUNTER-POINTED, *contre-pointé*, in heraldry, is when two chevrons in one escutcheon meet in the points, the one rising, as usual, from the base, and the other inverted, falling from the chief; so that they are counter to one another in the points, as in the diagram. They may also be counterpointed when they are founded upon the sides of the shield, and the points meet that way, called counterpointed in fesse.



COUNTERPOISE, *v. a. & n. s.* From counter and poise. To keep in equilibrium; to act against with equal weight; to manifest an equal degree of power. Equiponderance; equivalence; the state of being placed to counterbalance something else; a counterbalance to.

It shall do us mochil gode,
And to our herte as moche availle
The counterpoise, ese and travaile. *Chaucer. The House of Fame.*

An huge great pair of ballance in his hand,
With which he boasted, in his surquedrie,
That all the world he would weigh equalle,
If ought he had the same to counterpoise. *Spenser. Faerie Queene.*

So many freeholders of English will be able to beard
and to counterpoise the rest. *Spenser on Ireland.*

Our spoils we have brought home
Do more than counterpoise a fall third part
The charges of the action. *Shakespeare. Coriolanus.*

Take her by the hand,
And tell her she is thine; to whom I promise
A counterpoise, if not in thy estate,
A balance more replete. *Id. All's Well that Ends Well.*

The second nobles are a counterpoise to the higher
ability, that they grow not too potent. *Bacon.*

The Eternal hung forth his golden scales,
Wherein all things created first he weighed,
The pendulous round earth, with balanced air
In counterpoise. *Milton. Par. Lost.*

The force and the distance of weights counterpoising
one another, ought to be reciprocal.

Digby. On the Soul.

The heaviness of bodies must be counterpoised by a
plummet fastened about the pulley to the axis. *Wilkins.*

Fastening that to our exact balance, we put a metal-
line counterpoises into the opposite scale.

Boyle's Spring of the Air.

Their generals, by their credit in the army, were,
with the magistrates and other civil officers, a sort of
counterpoise to the power of the people. *Swift.*

But royalty, nobility, and state,
Are such a dead preponderating weight,
That endless bliss (how strange soe'er it seem),
In counterpoise, flies up and kicks the beam. *Cowper.*

COUNTERPOISON, *n. s.* From counter and
poison. Antidote; medicine by which the effects
of poison are obviated.

Counterpoisons must be adapted to the cause; for ex-
ample, in poison from sublimate corrosive, and arsen-
nick. *Arbuthnot.*

COUNTER-POTENT, *contre potence*, in heraldry,
is reckoned a fur as well as vair and ermine;
but composed of such pieces as represent the
tops of crutches, called in French potences, and
in old English potents.

COUNTERPRACTICE, *n. s.* From counter
and practice. Practice in opposition to.

COUNTERPRESSURE, *n. s.* From counter
and pressure. Opposite force; power acting in
contrary directions.

Does it not all mechanick heads confound,
That troops of atoms from all parts around,
Of equal number, and of equal force,
Should to this single point direct their course;
That so the counterpressure every way,
Of equal vigour, might their motions stay,
And by a steady pause the whole in quiet lay?
Blackmore.

COUNTERPROJECT, *n. s.* From counter
and project. Correspondent part of a scheme.

A clear reason why they never sent any forces to
Spain, and why the obligation not to enter into a
treaty of peace with France, until that entire monar-
chy was yielded as a preliminary, was struck out of
the counterproject by the Dutch. *Swift.*

To **COUNTERPROVE**, *v. a.* From counter
and prove. To take off a design in blacklead, or
red chalk, by passing it through the rolling-press
with another piece of paper, both being moist-
ened with a sponge.

COUNTER-QUARTERED, *contre ecartelé*, in her-
aldry, denotes the escutcheon, after being quar-
tered, to have each quarter again divided into
two.

COUNTER-REVOLUTION, *n. s.* } From
COUNTER-REVOLUTIONARY, *adj.* } counter
and revolution. A revolution which reverses the
effects of a preceding revolution. That which
tends to bring about a counter-revolution.

COUNTERROLL, *v. a.* } From counter and
COUNTERROLLMENT, *n. s.* } roll. To preserve
the power of detecting frauds by another account.
This spelling is obsolete, and control is substi-
tuted instead. A counter account; controlment.

This manner of exercising of this office, hath many
testimonies, interchangeable warrants, and counterrol-
ments, whereof each, running through the hands, and

resting in the power of many several persons, is sufficient to argue and convince all manner of falsehood.

Bacon.

COUNTER-SALIENT, in heraldry, is when two beasts are borne in a coat leaping from each other directly the contrary way.

COUNTERSCARP, *n. s.* Sometimes written counterscarf by our old authors, from counter and scarp. That side of the ditch which is next the camp, or properly the talus that supports the earth of the covert-way; although by this term is often understood the whole covert-way, with its parapet and glacis; and so it is to be understood when it is said the enemy lodged themselves on the counterscarp.

COUNTER-SCUFFLE, *n. s.* From counter and scuffle. Mutual opposition.

A terrible *counter-scuffle* between them and their lusts.

Hewyt.

COUNTERSEAL, *v. a.* From counter and seal. To seal with others.

You shall bear

A better witness back than words, which we,
On like conditions, will have *countersealed*.

Shakespeare. Coriolanus.

COUNTERSECURE, *v. a.* To give additional security to any thing.

What have the regicides promised you in return, in case you should show what they call dispositions to conciliation and equity, whilst you are giving that pledge from the throne, and engaging parliament to *countersecure* it.

Burhe.

COUNTERSENSE, *n. s.* Contrary meaning.

There are some words now in French which are turned to a *countersense*.

Howell.

COUNTERSIGN, *v. a. & n. s.* From counter and sign. To sign an order or patent of a superior in quality of secretary, to render it more authentic. Thus charters are signed by the king, and countersigned by a secretary of state, or lord chancellor. In military affairs, the countersign signifies, the watch word of the day.

COUNTERSIGNAL, *n. s.* From counter and signal. A signal which answers to, or corresponds with, another.

COUNTERSNARL, *n. s.* From counter and snarl. A snarl in return.

If he bristle himself up and stand to it, give but a *countersnarle*, there is not a dog that dares meddle with him.

Burton.

COUNTERSTATUTE, *n. s.* From counter and statute. A contradictory statute.

His own antinomy or *counterstatute*.

Milton.

COUNTERSWAY, *n. s.* From counter and sway. Influence or power exercised in opposition to.

By a *countersway* of restraint curbing their wild exorbitance.

Milton.

COUNTERSTROKE, *n. s.* A stroke given in return.

He met him with a *countersstroke* so swift,
That quite smit'off his arme as he it up did lift.

Spenser. Faerie Queene.

COUNTERSURETY, *n. s.* From counter and surety. A counter bond to a surety.

COUNTERTALLY, *n. s.* From counter and tally. One of two tallies, on which any thing is scored; a check-tally.

COUNTERTASTE, *n. s.* From counter and taste. Vicious taste.

There is a kind of *countertastes*, founded on surprise and curiosity, which maintains a rivalry with the true.

Shenstone.

COUNTERTENOR, *n. s.* From counter and tenor. One of the mean or middle parts of music; so called, as it were, opposite to the tenor.

I am deaf: this deafness unqualifies me for all company, except a few friends with *countertenor* voices.

Swift.

COUNTERTIDE, *n. s.* From counter and tide. Contrary tide; fluctuations of the water.

Such were our *countertides* at land, and so

Presaging of the fatal blow,

In your prodigious ebb and flow.

Dryden.

COUNTERTIME, *n. s.* From counter and time; Fr. *contretemps*. The defence or resistance of a horse, that intercepts his cadence, and the measure of his manage. Defence; opposition.

Let cheerfulness on happy fortune wait,

And give not thus the *countertime* to fate.

Dryden's Aurengzebe.

COUNTERTURN, *n. s.* From counter and turn.

The *catastasis*, called by the Romans *statis*, the height and full growth of the play, we may call properly the *counterturn*, which destroys that expectation, embroils the action in new difficulties, and leaves you far distant from that hope in which it found you.

Dryden on Dramatic Poesy.

COUNTERVAIL, *v. a. & n. s.* To be equal to; to have equal influence. Equipoise; equal weight or value with something else.

Yet he (poor soule!) with patience all did beare,
For nought against their wills might *countervaille*.

Spenser. Faerie Queene.

In some men there may be found such qualities as are able to *countervail* those exceptions which might be taken against them, and such men's authority is not likely to be shaken off.

Hooker.

The outward streams, which descend, must be of so much force as to *countervail* all that weight whereby the ascending side does exceed the other.

Wilkins's Dedebe.

We are to compute that, upon balancing the account, the profit at last will hardly *countervail* the inconveniences that go along with it.

L'Estrange.

Surely, the present pleasure of a sinful act is a poor *countervail* for the bitterness of the review, which begins where the action ends, and lasts for ever.

South's Sermon.

COUNTERVIEW, *n. s.* From counter and view. Opposition; confronting; contrast.

Mean while, ere thus was sinned and judged on earth,

Within the gates of hell sat Sin and Death,

In *counterview*.

Milton's Paradise Lost.

I have drawn some lines of Linger's character, on purpose to place it in *counterview* or contrast with that of the other company.

Swift.

COUNTERVOTE, *v. a.* From counter and vote. To vote against; to outvote.

The law in our minds being *countervoted* by the law in our members. *Scott.*

COUNTERWEIGH, *v. n.* From counter and weigh. To weigh equal with; to weigh against.

If Wright had ten fellowships of St. John's, it would not *counterweigh* with the loss of this occasion. *Ascham.*

COUNTERWHEEL, *v. a. & n. s.* From counter and wheel. To wheel in an opposite direction; to wheel so as to oppose other movements. The movement made for that purpose.

Whose shoots the wary Heron beat
With a well *counterswheeled* retreat. *Lovelace.*

COUNTERWIND, *n. s.* A contrary wind. Is met of many a *counterswinds* and tyde. *Spenser.*

To **COUNTERWORK**, *v. a.* From counter and work. To counteract; to hinder any effect by contrary operations.

But heaven's great view is one, and that the whole: That *counterworks* each folly and caprice; That disappoints th' effect of every vice. *Pope.*

They were then only passengers in a common vehicle. They were then carried along with the general motion of religion in the community, and without being aware of it, partook of its influence. In that situation, at worst, their nature was left free to *counterwork* their principles. *Burke.*

COUNTRY, *n. s. & adj.* } *Fr. contrée*; *It. Contrada*; *Dutch, Kontraye*; *low Lat. contrata*. A region; the parts of a region distant from cities and courts; the place of a man's residence or birth; the inhabitants of any region. As an adjective, country signifies rustic; rural; of an interest in opposition to that of the court; peculiar to a region or people; rude; untaught. Countryman denotes, one born in the same country; a rustic; a husbandman. See **COUNTRY-DANCE**. Countrified, which means rustic, country-like, is a word of recent introduction into our language, and is not yet used in elegant composition or conversation.

She laughing the cruel tyrant to scorn, spake in her *country* language. *2 Maccabees vii. 27.*

And wedded the freshe queene Ipolita,
And brought hire home with him to his *contree*
With mechel glorie and great solempnitee. *Chaucer. Cant. Tales.*

Full many *countreyes* they did overrunne,
From the uprising to the setting sun. *Spenser. Faerie Queene.*

Yet was she certes but a *country* lasse,
Yet she all other *country* lasses farre did passe. *Id.*
Send out more horses, skirre the *country* round,
Hang those that talk of fear. *Shakespeare. Macbeth.*

See, who comes here?

My *countryman*; but yet I know him not. *Id.*

All the *country*, in a general voice,
Cried hate upon him; all their prayers and love
Were set on Hereford. *Id. Henry IV.*

'Tis the trial of a man to see if he will change his side; and if he be so weak as to change once, he will change --ain. Your *country* fellows have a way to

try a man if he be weak in the hams, by coming behind him and giving him a blow unawares; if he bend once, he will bend again. *Selden.*

They require to be examined concerning the descriptions of those *countries* of which they would be informed. *Spratt.*

A *countryman* took a boar in his scorn. *L'Estrange.*
Homer, great bard! so fate ordained, arise;
And, bold as were his *countrymen* in fight,
Snatched their fair actions from degrading prose,
And set their battles in eternal light. *Prior.*

I see them hurry from *country* to town, and then from the town back again into the *country*. *Spectator.*

I never meant any other, than that Mr. Trot should confine himself to *country-dances*. *Id.*

To live deprived of one's *country* is intolerable. Is it so? how comes it then to pass that such numbers of men live out of their *countries* by choice. *Bolingbroke.*

I fancy the proper means of increasing the love we bear our native *country*, is to reside some time in a foreign one. *Shenstone.*

We may have the same geographical situation, but another *country*; as we may have the same *country* in another soil. The place that determines our duty to our *country* is a social, civil relation. *Burke.*

In a free *country*, every violation of law is an attack upon the public liberty. The laws of God and our *country* are our best and only security against oppression; and therefore liberty can exist amongst us no longer than while those laws are obeyed. *Beattie.*

There lived in Gothic days, as legends tell,
A shepherd-swain, a man of low degree;
Whose sires, perchance, in Fairyland might dwell,
Sicilian groves, or vales of Arcady;
But he, I ween, was of the north *countree*. *Id.*

Can he love the whole,
Who loves no part? He be a nation's friend!
Who is in truth the friend of no man there?
Can he be strenuous in his *country's* cause,
Who slights the charities, for whose dear sake
That *country*, if at all, must be beloved? *Cowper.*
Or should the vulgar grumble now and then,
The Prompter might translate for *country* gentlemen. *Sheridan.*

Did not the Italian Musico Cazzani
Sing at my heart six months at least in vain?
Did not his *countryman*, Count Corniani,
Call me the only virtuous wife in Spain?

Byron. Don Juan.

COUNTRY DANCE, *Fr.* from *contree*, against, or opposite, a dance of English origin, though now transplanted into almost all the countries and courts of Europe. There is no established rule for the composition of tunes to this dance, because there is in music no kind of time whatever which may not be measured by the motions common in dancing; and there are few song tunes of any note within the last century, that have not been applied to country dances.

COUNTY, *n. s.* Old *Fr. counté*; *mod. Fr. comté*; *Lat. comitatus*. A shire, says Cowell, is a circuit or portion of the realm, into which the whole land is divided, for the administration of justice; so that there is no part of the kingdom but what lieth within some county. See **COURT**.

Discharge your powers unto their several *counties*,
As we will ours. *Shakespeare. Henry IV.*
He caught his death the last *county* sessions, where he would go to see justice done to a poor widow-woman, and her fatherless children. *Addison's Spectator.*

Leaving far behind him even Lord Camelford's generous design of bestowing Old Sarum on the bank of England, Mr. Benfield has thrown in the borough of Cricklade to reinforce the *county* representation.

Burke.

As petty-foggers' dirty wiles
Set John a Nokes on Tom a Stiles,
To prove, by desperate course of law,
His title to a barley straw;
Reckless of a whole *county's* curses,
So they can drain the loobies' purses.

Huddesford.

COUNTY, in geography, originally signified the territory of a count or earl, but now it is used in the same sense with shire. For the execution of the laws in the several counties, excepting Cumberland, Westmoreland, and Durham, sheriffs are appointed every Michaelmas. Other officers of counties are, a lord lieutenant, who has the command of the militia; custodes rotulorum, justices of peace, bailiffs, high constable, and coroner. See SHERIFF.

COUNTY CORPORATE is a title given to several cities, or ancient boroughs, on which our monarchs have thought fit to bestow extraordinary privileges; annexing to them a particular territory, land, or jurisdiction; and making them counties of themselves, to be governed by their own sheriffs and magistrates.

COUNTY COURT, in English law, is a court incident to the jurisdiction of the sheriff. It is not a court of record, but may hold pleas of debt or damages under the value of 40s. Over some of which causes these inferior courts have, by the express words of the statute of Gloucester, a jurisdiction totally exclusive of the king's superior courts. For in order to be entitled to sue an action of trespass for goods before the king's justices, the plaintiff is directed to make affidavit, that the cause of action does really and bona fide amount to 40s. which affidavit is now, however, disused, except in the court of exchequer. The statute also of 43 Eliz. c. 6. which gives the judges in many personal actions, where the jury assess less damages than 40s. a power to certify the same, and abridge the plaintiff of his full costs, was also meant to prevent vexation by litigious plaintiffs; who, for purposes of mere oppression, might be inclinable to institute such suits in the superior courts for injuries of a trifling value. The county court may also hold plea of many real actions, and of all personal actions to any amount, by virtue of a special writ called justices; which is a writ empowering the sheriff for the sake of despatch to do the same justice in his county court, as might otherwise be had at Westminster. The freeholders of the county are the real judges in this court, and the sheriff is the ministerial officer. The great conflux of freeholders, which are supposed always to attend at the county court (which Spelman calls forum plebeie justitie et theatrum comitive potestatis), is the reason why all acts of parliament at the end of every session were wont to be there published by the sheriff; why all outlawries of absconding offenders are there proclaimed; and why all popular elections, which the freeholders are to make, as formerly of sheriffs and conservators of the peace, and still of coroners, verderers,

and knights of the shire, must ever be made in pleno comitatu, or in full county court. By the statute 2 Edw. VI. c. 25, no county court shall be adjourned longer than for one month, consisting of twenty-eight days. And this was also the ancient usage, as appears from the laws of king Edward the elder: prepositus (that is the sheriff) ad quartam circiter septimanam frequentem populi concionem celebrato; cuique jus dicitur; litesque singulas dirimito. In those times the county court was a court of great dignity and splendor, the bishop and the ealdorman, or earl, with the principal men of the shire, sitting there to administer justice both in lay and ecclesiastical causes. But its dignity was much impaired, when the bishop was prohibited, and the earl neglected to attend it. And, in modern times, as proceedings are removable from hence into the king's superior courts, by writ of pone or recordare, in the same manner as from hundred courts and courts baron; and as the same writ of false judgment may be had, in nature of a writ of error; actions are rarely brought there.

COUNTY PALATINE. Of all the counties palatine Durham alone remains in the hands of a subject; for the earldom of Chester was united to the crown by Henry III. and has ever since given title to the king's eldest son. And the county-palatine or duchy of Lancaster, in the reign of Henry IV. was, by act of parliament, vested in the king and his heirs, kings of England, for ever. 1. Blackst. 118. There is a court of chancery in the counties palatine of Durham and Lancaster, over which there are chancellors; that of the latter is called chancellor of the duchy; and there is a court of exchequer at Chester, of a mixed nature, for law and equity, of which the chamberlain of Chester is judge. There is also a chief justice of Chester, and the other counties palatine have their justices, to determine civil actions and pleas of the crown. In none of these are the king's ordinary writs of any force; and the judges of assize, who sit within these franchises, sit by virtue of a special commission under the great seal of England. 3 Blackst. 79.

COUNTY-RATE. By the 12th Geo. II. c. 29, the justices at their general or quarter sessions, or the greater part of them (and by the 13th Geo. II. c. 18, justices of liberties and franchises not subject to county commissioners) shall have power to make one general county-rate, to answer all former distinct rates, which shall be assessed on every parish, &c. and collected and paid by the high constables of hundreds to treasurers appointed by the justices, which money shall be deemed the public stock, &c.; but appeal lies by the church-wardens and overseers against the rate of any particular parish, 22 Geo. III. c. 17. This rate is to be applied for the repairing of bridges and highways thereto adjoining, and to salaries for the surveyors of bridges; for building and repairing county gaols; for repairing shire-halls; for the salary of the master of the house of correction, and relieving the weak and sick in his custody; for the relief of the prisoners in the king's bench and marshalsea prisons, and of poor hospitals in the county, and of those who shall sustain losses by fire, water, the sea, or other casualties, and other charitable purposes for . . .

relief of the poor, as the justices in sessions shall think fit; for the relief of the prisoners in the county gaol; for the preservation of the health of the prisoners; for the salary of the chaplain of the county gaol; for setting prisoners to work; for salaries of persons making returns of the prices of corn; for charges attending the removal of any of the said general county-rates by certiorari; for money for purchasing lands at the ends of county bridges; for charges of rebuilding or repairing houses of correction, and for fitting up and furnishing the same, and employing the persons sent thither; for charges of apprehending, conveying, and maintaining, rogues and vagabonds; for charges of soldiers' carriages over and above the officer's pay for the same, by the several yearly acts against mutiny and desertion, and by the militia act; for the coroner's fee of 9d. per mile for travelling to take an inquisition, and 20s. for taking it; for charges of carrying persons to the gaol or house of correction; for the gaoler's fees for persons acquitted of felony or discharged by proclamation; for charges of prosecuting and convicting felons; for charges of prosecuting and convicting persons plundering shipwrecked goods; for charges of maintaining the militia-men's families by the several militia acts; for the charges of bringing insolvent debtors to the assizes, in order to their discharge, if themselves are not able to pay; for the charges of transporting felons, or conveying them to the places of labor and confinement; for charges of carrying parish apprentices, bound to the sea service, to the port to which the master belonged.

By the 12th Geo. II. c. 29, the church wardens and overseers shall, in thirty days after demand made, out of the money collected for the poor, pay the sums so assessed on each parish and place; and if they shall neglect or refuse so to pay, the high constable shall levy the same by distress and sale of their goods, by warrant of two or more justices residing in or near such parish or place. Where there is no poor-rate, the justices, in their general or quarter sessions, shall by their order, direct the sum assessed on such parish, township, or place, to be rated and levied by the petty-constable, or other peace-officer, as money for the relief of the poor is by law to be rated or levied. The high constables, at or before the next session respectively after they have received the money, shall pay the same to the treasurer; and the money so paid shall be deemed the public stock: and the said high constables shall deliver in a true account on oath, if required, of the money by them received, before the said justices at their general or quarter sessions. The treasurer shall pay so much of the money in his hands to such persons, as the justices in session shall from time to time appoint, for any uses and purposes to which the public stock of any county, city, division, or liberty, is or shall be applicable; and shall deliver in a true account on oath, if required, of his receipts and disbursements to the justices at every general or quarter session, and also of the proper vouchers for the same, to be kept amongst the records of the sessions: and the discharge of the said justices, by their order at the general or quarter session, shall be a sufficient discharge to the

treasurer: and no new rate shall be made until it appears by the treasurer's accounts or otherwise, that three-fourths of the money collected have been expended for the purposes aforesaid. If the church-wardens and overseers of any parish or place shall think such parish or place is over-rated, they may appeal to the next general or quarter sessions. A subsequent statute, 52 Geo. III. c. 110, amends 12 Geo. II. c. 29, and remedies defects in the laws relating to the repairing of county bridges, &c. By this the quarter sessions are empowered to appoint, annually at Easter, &c. two or more justices to superintend the repairs of bridges; who may incur any expenditure not exceeding £20 for such repairs, which shall be paid by the sessions on certificate of the justices. Justices at sessions may also contract with commissioners of turnpike roads for repair of bridges, &c. for any term not exceeding seven years.

Justices are also empowered, by 43 Geo. III. c. 59, amended by 54 Geo. III. c. 90, and 55 Geo. III. c. 143, to purchase land, houses, &c. for the widening, altering, and improving of county bridges; and also of bridges repaired by hundreds or general divisions of counties.

By 55 Geo. III. c. 51, additional provisions are made for the more equally and effectually making and levying the county rates. By this act, justices in general or quarter sessions are empowered to make a fair and equal county-rate in any county, whenever circumstances appear to require it. For this purpose they may require church-wardens and overseers of the several parishes to make returns to the justices of the respective divisions in petty sessions, of the annual value of all rateable property, which such justices must certify to the quarter sessions, who may make the county-rate thereon. By this act the treasurers of counties are required to publish an abstract of their receipts and expenditure yearly, as audited by the justices. And the high-constable employed in levying the rates, may be required by the quarter sessions to give security; and if he fails, the rates shall be paid directly to the treasurer. By 56 Geo. III. c. 49, extra parochial places are made rateable, and the sessions are empowered to ascertain boundaries, &c.; 57 Geo. III. c. 94, regulates the mode of appeal against rates, which are to remain in force until quashed on such appeal, &c.

COVOLO, a fortress and village of the Tyrol, formerly an important pass in the road from Germany to Italy. Here Buonaparte defeated the Austrians under general Wurmsser, September 8th, 1796. It lies near the Brenta, on the borders of the Veronese, twenty miles north of Vicenza, and twenty-three east of Trent.

COVORDEN. See **COEVORDEN**.

COUP-DE-MAIN, Fr. In military affairs, a sudden and violent attack, for the purpose of carrying a post. The phrase is applied to any prompt measure.

COUP-D'ŒIL, *n. s.* The first view; the first glance. In military affairs, a general who can instantly see in what manner the peculiarities of the ground may be turned to advantage is said to have a good coup-d'œil. Napoleon possessed this quality in perfection.

COUPED, in heraldry, is used to express the head, or limb, of an animal, cut out from the trunk, smooth, as in the diagram: distinguishing it from that which is called *erased*, that is, forcibly torn off, and therefore is ragged and uneven, it is also applied to such crosses, bars, bends, chevrons, &c. as do not touch the sides of the escutcheon, but are, as it were, cut off from them.



COUPE', *n. s. Fr.* A motion in dancing, when one leg is a little bent and suspended from the ground, and with the other a motion is made forwards.

COUPLE, *v. a., v. n., & n. s.*

COUPLEMENT, *n. s.*

COUPLABLE, *adj.*

COUPLING, *n. s.*

COUPLE-BEGGAR, *n. s.*

COUPLET, *n. s.*

to join in wedlock; to unite sexually. Couple signifies a chain by which dogs are held together; a pair; male and his female. Couplable is fit to be coupled with. Couplement is union; but both these words are disused; junction, sexual union, are the meanings of coupling. A couple-beggar is one who marries beggars. A couplet denotes a pair of rhymes; a pair, as of doves.

Put the taches into the loops, and couple the tent together that it may be one. *Exodus xxvi. 11.*

To the artificers and builders gave they it, to buy hewn stone, and timber for couplings. *2 Chron. xxxiv. 11.*

They behold your chaste conversation coupled with fear. *1 Peter iii. 2.*

Love that yhuittith lawe and companie,
And couplets doth in vertue for to dwel.

Chaucer. Troilus and Criseide.

There myght I see how ver hed every blossome
kent,

And eke the new betrothed byrdes y coupled how
they went. *Surrey.*

A schoolmaster, who shall teach my son and your,
I will provide; yea, though the three do cost me a
couple of hundred pounds. *Ascham.*

One day, as he forepassed by the plaine
With weary pace he far away espied
A couple seeming well to he his twayne.

Spenser. Faerie Queene.

After all which up to their steedes they went,
And forth together rode, a comely couplement. *Id.*

I shall rejoice to see you so coupled as may be
fit both for your honour and your satisfaction. *Sidney.*

He was taken up by a couple of shepherds, and
by them brought to life again. *Id.*

Then would they cast away their pipes, and hold-
ing hand in hand, dance by the only cadence of their
voices which they would use in singing some short
couplets, whereto the one-half beginning, the other
half should answer. *Id.*

Huntsman, I charge thee, tender well my hounds;
And couple Clowder with the deep-mouthed Brach.

Shakespeare. Introduction to Taming of the Shrew.

The orator, to deck his oratory,
Will couple my reproach to Tarquin's shame.

Id. The Rape of Lucrece.

I'll keep my stable-stand where
I lodge my wife; I'll go in couples with her,
Than when I feel and see no further trust her.

Id. Winter's Tale.

Oh! alas!

I lost a couple, that 'twixt heaven and earth
Might thus have stood, begetting wonder, as
You gracious couple do. *Id.*

Anon, as patient as the female dove,
Ere that her golden couplets are disclosed,
His silence will sit drooping. *Id. Hamlet.*

Waters in Africa being rare, divers sorts of beasts
come from several parts to drink; and so being re-
freshed, fall to couple, and many times with several
kinds. *Bacon.*

I have read of a feigned commonwealth, where
the married couple are permitted, before they contract,
to see one another naked. *Id. New Atlantis.*

That great variety of brutes in Africa, is by reason
of the meeting together of brutes of several species at
water, and the promiscuous couplings of males and fe-
males of several species. *Hale's Origin of Mankind.*

By adding one to one, we have the complex idea of
a couple. *Locke.*

It is in some sort with friends as it is with dogs in
couples; they should be of the same size and humour.

L'Estrange.

After this alliance,
Let tigers match with hinds, and wolves with sheep,
And every creature couple with his foe.

Dryden's Spanish Friar.

He said: the careful couple join their tears,
And then invoke the gods with pious prayers. *Id.*

That man makes a mean figure in the eyes of
reason, who is measuring syllables and coupling rhimes,
when he should be mending his own soul, and securing
his own immortality. *Pope.*

I am just going to assist with the archbishop, in
degrading a parson who couples all our beggars, by
which I shall make one happy man. *Swift.*

No couple-beggar in the land
E'er joined such numbers hand in hand. *H.*

In Pope I cannot read a line,
But with a sigh I wish it mine;
When he can in one couplet fix
More sense than I can do in six,
It gives me such a jealous fit,
I cry, Pox take him and his wit. *Id.*

Round her strewed room a frippery chaos lies,
A chequered wreck of notable and wise;
Bills, books, caps, couplets, combs, a varied mass,
Oppress the toilet, and obscure the glass. *Sheridan.*

While seated after dinner at his ease,
Beside his mistress in some soft abode,
Palace, or garden, paradise, or cavern,
Which serves the happy couple for a tavern. *Byron. Don Juan.*

COURAGE, *v. a. & n. s.* } Old Fr. *corage*;
COURAGEOUS, *adj.* } mod. Fr. *cowrage*;
COURAGEOUSLY, *adv.* } It. *coraggio*; Sp.
COURAGEOUSNESS, *n. s.* } *corage*; low Lat.

coragium, from *cor*, the heart. The verb, which
has the same meaning with to encourage, is, as Mr.
Todd truly observes, unjustly slighted and for-
gotten. The noun signifies, bravery; active
fortitude; spirit of enterprise; and formerly it
was used in the sense of heart or mind. Shaks-
peare ludicrously uses the word courageous in
the sense of outrageous.

And he that is *courageous* among the mighty, shall see away naked in that day. *Amos. ii. 16.*

Nicanor, hearing of the manliness and the *courageousness* that they had to fight for their country, durst not try the matter by the sword.

2 Maccabees, xiv. 18.

In Southwerk at the Tabard as I lay,
Redy to wenden on my pilgrimage
To Canterbury with devoute *courage*.

Chaucer. Prol. to Cant. Tales.

No length of time or deth may this deface,
Ne change my *courage* to an other place.

Id. Cant. Tales.

This Diomede, as bokis us declare,
Was in his medis preat and *courageous*.

Id. Troilus and Criseide.

And kind with *courage* so my corps had blent,
That lae on whom but me dyd she most smyle?

Sackville.

Whose warlike provelse and manly *courage*,
Tempred with reason and advisement sage,
Hathild sad Belgicke with victorious spoile.

Spenser.

Did counterfeit hynd pittie where was none,
For where's no *courage* there's no ruth nor moune.

Id. Faerie Queene.

The king-becoming graces,
Devotion, patience, *courage*, fortitude,
I have no relish of them. *Shakespeare. Macbeth.*

Their discipline

Now mingled with their *courage*. *Id. Cymbeline.*

He is very *courageous* mad about his throwing into the water. *Id.*

The king the next day presented him battle upon the plain, the fields there being open and champaign: the earl *courageously* came down, and joined battle with him. *Bacon's Henry VII.*

Courage, that makes us bear up against dangers that we fear, and evils that we feel, is of great use in an estate as ours is in this life, exposed to assaults on all hands: and, therefore, it is very advisable to get children into this armour as early as we can. *Locke.*

All *courageous* animals are carnivorous, and greater *courage* is to be expected in a people, such as the English, whose food is strong and hearty, than in the half-starved commonalty of other countries.

Sir W. Temple.

True *courage* has so little to do with anger that there lies always the strongest suspicion against it, where this passion is highest. The true *courage* is cool and calm. The bravest of men have the least of a brutal bullying insolence; and in the very time of danger are found the most serene, pleasant, and free.

Shaftesbury.

Hope arms their *courage*; from their towers they throw

Their darts with double force, and drive the foe.

Dryden.

Courage, that grows from constitution, very often forsakes a man when he has occasion for it; and, when it is only a kind of instinct in the soul, it breaks out on all occasions, without judgment or discretion. That *courage* which arises from the sense of our duty, and from the fear of offending him that made us, acts always in an uniform manner, and according to the dictates of right reason. *Addison's Guardian.*

Nothing but the want of common *courage* was the cause of their misfortunes. *Swift.*

There is a *courageous* wisdom: there is also a false reptile prudence, the result not of caution but of fear.

Burke.

But, more distinguished than the rest,
Was seen a wether ready drest,
That smoking, recent from the flame,
Diffused a stomach-raising steam.
Our wolf could not endure the sight,
Courageous grew his appetite:
His entrails groaned with tenfold pain,
He licked his lips, and licked again. *Beattie.*

Now from the dust of ancient days bring forth
The sober zeal, integrity, and worth;
Courage, ungraced by these, affronts the skies,
Is but the fire without the sacrifice. *Cowper.*

But now with pleasant pace a cleanlier road
I mean to tread. I feel myself at large,
Courageous and refreshed for future toil,
If toil await me, or if dangers new. *Id.*

Let your *courage* be as keen, but at the same time as polished, as your sword. *Sheridan.*

COURANT, in music, is a piece in triple time: the air of the courant is ordinarily noted in triples of minims; the parts to be repeated twice. It begins and ends when he who beats the measure falls his hand; in contradistinction from the saraband, which ordinarily ends when the hand is raised.



COURANT, in heraldry, an epithet for any beast represented in a running attitude, as in the diagram:—

COURAYER (Peter Francis), a Roman Catholic clergyman, born at Vernon, in Normandy, 1601. While canon regular and librarian of the abbey of St. Genevieve, at Paris, he addressed a letter to archbishop Wake in defence of the episcopal succession in England, and the validity of the English ordinations. This was afterwards published in Holland in 1727, and drew upon him the formal censures of the French church. Taking refuge in England, he was well received, and presented by the university of Oxford with the degree of D. D. In 1736 he translated into French, and published, Father Paul's History of the Council of Trent, in 2 vols. fol. dedicated to queen Caroline; who augmented to £200 a pension of £100 a year, which he had obtained before from the court. His works are numerous, and all in French; into which language he also translated Sleidan's History of the Reformation. He attended the service both of his own church and that of the church of England regularly. He died in 1776, after two days illness, at the age of ninety-five; and was buried in the cloister of Westminster Abbey.

COURB, *v. n. & adj.* To bend; to bow to; stoop in supplication; crooked.

Her neck is short, her shoulders *courb*. *Gower.*

In the fatness of these pury times,
Virtue itself of vice must pardon beg,
Yea, *courb* and woo, for leave to do it good.

Shakespeare. Hamlet.

COURIER, *n. s.* Fr. *courier*; Ital. *corriere*; Sp. *correo*; from Lat. *currere*, to run. A messenger sent in haste; an express; a runner, generally; a messenger.

I met a *courier*, one mine ancient friend.

Shakespeare. Timon.

This thing the wary Bessa well perceiving, by speedy couriers, advertised Solyman of the enemy's purpose, requesting him with all speed to repair with his army to Tauris. *Knolles' History.*

COURIER PIGEON. See COLUMBA.

COURIERS, ANCIENT. The ancients had two kinds of couriers, viz. 1. Those who ran on foot, called by the Greeks, Hemerodoromi, q. d. couriers of day. Pliny, Corn. Nepos, and Cæsar, mention some of these who would run twenty, thirty, thirty-six, and in the circus even forty leagues per day. 2. Cursores equitantes, who changed horses, as modern couriers do. Xenophon attributes the first couriers to Cyrus. Herodotus says they were very common among the Persians, and that there was nothing more swift than these kind of messengers. 'That prince,' says Xenophon, 'examined how far a horse would go in a day, and built stables at such distances from each other, where he lodged horses, and persons to take care of them; and at each place kept a person always ready to take the packet, mount a fresh horse, and forward it to the next stage: and thus throughout his empire.' But it does not appear that either the Greeks or Romans had any regular fixed couriers till the time of Augustus: under that prince they travelled in cars; though it appears from Socrates they afterwards went on horseback. Under the western empire they were called viatores; and under that of Constantinople, cursores: whence the modern name. See POST-OFFICE.

COURLAND, a duchy of Poland, situated between 21° and 60° E. long., and between 56° 30' and 57° 30' N. lat. It is bounded by the gulf of Riga and the river Dwina, which divide it from Livonia on the north; by Lithuania on the east; by Samogitia on the south; and by the Baltic Sea on the west: being 250 miles long and forty broad. It was formerly independent, but incorporated with the Russian empire in 1795. This country rises in gentle hills, and is fertile in corn, hemp, and flax. It also abounds in pine, fir, oak, and other timber, and has many neat villages and good inns. It is divided into Courland Proper and Semigallia. The chief towns are Mittau the capital, Goldengen, Groben, Libau, Winday, and Tacibstadt. It is said to contain 11,200 square miles, and 480,000 inhabitants.

COURSE, *v. a., v. n. & n. s.* } Fr. *course* ;
CO'URSER, *n. s.* } Latin, *cursus*,
CO'URSING, *n. s.* } from *currere*.

The shades of meaning in the verb and noun, particularly in the latter, are numerous. The verb signifies to hunt; to pursue; to chase with dogs that keep the game in sight; to compel to run; to run; to rove about. The noun denotes race; career; race ground; progressive motion; running in the lists; a ship's track; certain sails of a ship; process; order of succession; regular method, manner, or series of; conduct; manner of proceeding; method of life; train of actions; natural bent; catamenia; orderly structure; a continued layer of bricks or stones in a building; series of consequences; number of dishes set at once upon the table; settled rule; empty form. Of course, implies something that follows as a natural consequence from some other thing.

Courser is, a swift horse; a war horse; one who courses hares. Coursing is hunting with greyhounds. See COURSING.

And when we had finished our courses from Tyre, we came to Ptolemais. *Acts xxi. 7.*

If any man speak in an unknown tongue, let it be by two, or at the most by three, and that by course, and let one interpret. *1 Cor. xiv. 27.*

The tongue defileth the whole body, and setteth on fire the courses of nature. *James iii. 6.*

When Zephirus eke with his sots breathe
Enspired hath in every holt and hethe
The tender croppes, and the yonge sonne
Hath in the Ram his halfe course yronne.

Chaucer. Prolog. to Canto. Tale.

Ther was the hart ywont to heve his flight,
And over a brooke, and so forth on his wey,
This duk wol have a cours at him or twey
With houndes, swiche as him lust to commande. *Id.*

Wher as she many a ship and barge sie
Sailing hir cours wher as hem list to go. *Id.*

This gentil duk down from his *owser* sterte
With herte piteous when he herd hem speke. *Id.*

So fareth love when he hath tane a course,
Rage is his rayne, resistance vayleth none. *Wgat.*

So as they coursed here and there, it chaunst
That in her wheeling round, behind her crest
So sorely he her strooke, that thence it glaunst
Adowne her backe. *Spenser. Faerie Queene.*

He proudly prieketh on his courser strong,
And Atin ay him pricks with spurs of shame and wrong. *Id.*

But this hot knight was cooled with a fall, which,
at the third course, he received of Phalantus. *Sidney.*

A woman of so working a mind, and so vehement
spirits, as it was happy she took a good course; or
otherwise it would have been terrible. *Id.*

The big round tears
Coursed one another down his innocent nose
In piteous chase. *Shakspeare. As You Like it.*

The king is hunting the deer; I am courting myself.
Id. Love's Labour Lost.

The blood, before cold and settled, left the liver
white and pale, which is the badge of pusillanimity
and cowardice; but the sherris warms it, and makes
it course from the inwards to the parts extreme. *Id. Henry IV.*

The duke cannot deny the course of law. *Id.*
Worthy Sir, thou bleedest,

Thy exercise hath been too violent
For a second course of fight. *Id. Coriolanus.*

He that is disrespectful in his courses,
Oft sells his reputation at cheap market. *Ben Jonson.*

To the courses we have devised studding-sails, sprit-
sails, and top-sails. *Raleigh's Essays.*

It would be tried also in flying of hawks, or in cour-
sing of a deer, or hart, with greyhounds. *Bacon's Natural History.*

That worthy deputy, finding nothing but a common
misery, took the best course he possibly could to estab-
lish a commonwealth in Ireland. *Dorcas on Ireland.*

And some she arms with sinewy force,
And some with swiftness in the course. *Cowley.*

When they have an appetite
To venery, let them not drink nqr oat,
And course them oft, and tire them in the heat. *Mary's Virgil.*

— Rhyme the rudder is of verses,
With which, like ships, they steer their courses.
Beiler.

But if a right course be taken with children, there will not be so much need of common rewards and punishments.
Locke.

With a mind unprepossessed by doctors and commentators of any sect, whose reasonings, interpretation, and language, which I have been used to, will of course make all chime that way; and make another, and perhaps the genuine meaning of the author, seem harsh, strained, and uncouth to me.
Id.

It is best to leave nature to her course, who is the sovereign physician in most diseases.
Temple.

Men talk as if they believed in God, but they live as if they thought there was none; their vows and promises are no more than words of course.
L' Etrange.

The stoppage of women's courses, if not suddenly looked to, sets them undoubtedly into a consumption, dropsy, or some other dangerous disease.
Harvey on Consumptions.

Give willingly what I can take by force;
And know, obedience is your safest course.
Dryden's Aurengzebe,

Then with a second course the tables load,
And with full chargers offer to the god.
Dryden's Æneid.

Then to his absent guest the king decreed
A pair of courses, born of heavenly breed;
Who from their nostrils breathed æthereal fire,
Whom Circe stole from her celestial sire.
Id.

Ten brace and more of greyhounds, snowy fair,
And tall as stags, ran loose, and coursed around his chair.
Dryden.

I am continually starting hares for you to course;
we were certainly cut out for one another; for my temper quits an amour just where time takes it up.
Congreve's Old Bachelor.

Men will say,
That beautiful Emma vagrant courses took,
Her father's house and civil life forsook.
Prior.

Sense is of course annexed to wealth and power;
No muse is proof against a golden shower.
Garth.

The senate observing how, in all contentions, they were forced to yield to the tribunes and people, thought it their wisest course to give way also to time.
Swift.

When the state of the controversy is plainly determined, it must not be altered by another disputant in the course of the disputation.
Watts.

A leash is a leathern thong, by which a falconer holds his hawk, or a coarser leads his greyhound.
Hammer.

All at once
Relapsing quickly, as quickly re-ascend
And mix, and thwart, extinguish, and renew,
All ether coursing in a maze of light.
Thomson's Autumn.

Though vain the Muse, and every melting lay,
To touch thy heart, unconscious of remorse!
Know, monster, know, thy hour is on the way,
I see, I see the years begin their mighty course.
Beattie.

Is there a man, whose judgment clear
Can others teach the course to steer,
Yet runs himself life's mad career,
Wild as the wave;
Here pause—and through the starting tear,
Survey this grave.
Burns.

History, not wanted yet,
Leaned on her elbow, watching Time, whose course,
Eventful, should supply her with a theme.
Cowper.

O Love!—tormentor!—fiend!—whose influence,
like the moon's acting on men of dull souls, makes
idiots of them, but meeting subtler spirits, betrays
their course, and urges sensibility to madness!
Sheridan.

The morning watch was come; the vessel lay
Her course, and gently made her liquid way;
The cloven billow flashed from off her prow
In furrows formed by that majestic plough;
The waters with their world were all before;
Behind the South Sea's many an islet shore.
Byron. The Island.

COURSES, a name applied to the principal sails of a ship, viz. the main-sail, the fore-sail, and the mizen; the mizen-stay sail and fore-sail are also sometimes comprehended in this denomination; as are the main-stay sails of all brigs and schooners. When a ship sails under the main-sail and fore-sail only, without lacing on any bonnets, she is then said to go under a pair of courses.

COURSING, among sportsmen. There are three several sorts of courses with grey-hounds: 1. At the hare; 2. At the fox; and 3. At the deer. The best method of coursing the hare, is to go out and find a hare sitting; which is easily done in summer, by walking across the lands, either stubble, fallow, or corn grounds, and casting the eye up and down; for in summer they frequent those places for fear of the ticks, which are common in the woods at that season; and in autumn they dislike the shade of trees on account of the drops falling in time of rain. At other seasons it will be necessary to beat the bushes and thickets to rouse them, and oftentimes they will lie so close that they will not stir till the pole almost touches them; the sportsmen are always pleased with this, as it promises a good course. If a hare lie near any close or covert, and with her head that way, it is always to be expected that she will take to that immediately on being put up; all the company are therefore to ride up and put themselves between her and the covert before she is put up, that she may take the other way, and run upon open ground. When a hare is put up it is always proper to give her ground, or law as it is called, that is to let her run twelve score yards, or thereabouts, before the greyhounds are slipped at her, otherwise she is killed too soon, the greater part of the sport is thrown away, and the pleasure of observing the several turnings and windings that the creature will make to get away is lost. A good sportsman had rather see a hare save herself after a fair course, than see her murdered by the greyhounds as soon as she is up. In coursing the fox no other art is required than standing close, in a clear wind, on the outside of some grove where it is expected he will come out; and when he comes out he must have head enough allowed him, otherwise he will return back to the covert. The slowest greyhound will be able to overtake him, after all the odds of distance necessary; and the only danger is the spoiling the dog by the fox, which too frequently happens. For this reason no greyhound of any value should be run at this course, but the strong,

hard, bitter, dogs, that will seize any thing. For the deer, there are two sorts of courses; the one in the paddock, the other either in the forest, or the purlieu. For the paddock course there must be the greyhound and the terrier, and mongrel greyhound, whose business is to drive away the deer before the greyhounds are slipped; a brace or a leash are the usual number slipped at a time, seldom more than two brace. In-coursing the deer in the forest or purlieu, there are two ways in use; the one is coursing them from wood to wood; and the other upon the lawns close by the keeper's lodge. In the coursing from wood to wood, the way is to throw in some young hounds into the wood to bring out the deer; and if any deer come out that is not weighty, or a deer or antler which is buck, sore, or sorrel, then you are not to slip your greyhounds, which are held at the end of the wood, where the keepers, who can guess very well on these occasions, expect that the deer will come out. If a proper deer come out, and it is suspected that the brace or leash of greyhounds slipped after him will not be able to kill him, it is proper to waylay him with a couple of fresh greyhounds. The coursing upon the lawn is more agreeable than any of the other ways. When the keeper is warned before hand, he will lodge a deer for the course; and then, by coming under the wind, the greyhounds may be brought near enough to be slipped for a fair course.

The laws of coursing established by the duke of Norfolk in the reign of queen Elizabeth are still held binding. 1. He that is chosen festerer, or letter loose of the dogs, shall receive the greyhounds matched to run together into his leash as soon as he comes into the field; he is to march next to the hare-finder, or him who is to start the hare, until he come to the form; and no horse-man or footman is to go before or sideways, but all straight behind, for the space of about forty yards. 2. A hare ought never to be coursed with more than a brace of greyhounds. 3. The hare-finder is to give the hare three shoebes before he puts her up from her form or seat, to the end that the dogs may be prepared and attend her starting. 4. If there be not a particular danger of losing the hare, she should have about twelve score yards law. 5. The dog that gives the first turn, if after that there be neither cote, slip, or wrench, wins the wager. 6. A go-by, or bearing the hare, is counted equivalent to two turns. 7. If neither dog turn the hare, he that leads to the last covert wins. 8. If any dog turn the hare, serve himself, and turn her again, it is as much as a cote, and a cote is esteemed as much as two turns. 9. If all the course be equal, he that bears the hare shall win; and if he be not borne, the course shall then be judged dead. 10. If a dog take a fall in his course and yet perform his part, he may challenge the advantage of a turn more than he gave. 11. If a dog turn the hare, serve himself, and give divers cotes, and yet in the end stand still in the field, the other dog, if he turn home to the covert, although he gives no other, shall be adjudged to win the wager. 12. If by misfortune a dog be ridden over in the course, that course shall be adjudged void, and he that did the mischief is to make reparation to the owner. 13. If a dog give

the first and last turn, and there be no advantage betwixt them, he that gives the odd turn wins. 14. A cote is when a greyhound goes end ways by the side of his fellow, and gives the hare a turn. 15. A cote serves for two turns, and two trippings or jerkings for a cote; and if the hare turns not quite about, she only wrencheth in the sportsman's phrase. 16. If there be no cotes given by the greyhounds, but one serve the other at turning, then he that gives the most turns wins the wager. 17. Sometimes a hare does not turn, but wrenches, for she does not turn except she turns as it were round; in these cases two wrenches stand for one turn. 18. He that comes in first at the death of the hare takes her up, and saves her from breaking; he cherishes the dogs, and cleanses their mouths from the wool; he is adjudged to have the hare for his pains. 19. Finally, those who are judges of the leash, must give their judgment before they depart out of the field, or else it is not to stand as valid.

COURT, *v. n. & n. s.* Old French, *court*; mod. Fr. *cour*; Goth. *kurt*, civility of manners. Ang.-Sax. *cuþt*; Dut. *koert*; Lat. *curtis*.
 CO'URTEOUS, *adj.*
 CO'URTEOUSLY, *adv.*
 CO'URTEOUSNESS, *n. s.*
 CO'URTESY, *v. n. & n. s.*
 CO'URTEZAN, *n. s.*
 CO'URTIER, *n. s.*
 CO'URTING, *n. s.*
 CO'URTLIKE, *adj.*
 CO'URTLY, *adv. & adj.*
 CO'URTLINESS, *n. s.*
 CO'URTTLING, *n. s.*
 CO'URTSHIP, *n. s.*

To solicit; to flatter; to woo a woman. Court signifies a prince's residence; the retinue of a prince; the place where justice is administered; any jurisdiction, military, civil, or ecclesiastical; the art of insinuation; flattery; an open space before a house; a small opening enclosed with houses and paved with broad stones, through which, in general, carriages cannot pass. Courtier is one who follows the court; one who solicits a favor from another; but the latter meaning is disused. Courtly and courtliness mean having the manner of a court; being of gracious manners. Courtling is a contemptuous synonyme of courtier. Courtezan was formerly used in an inoffensive sense, but it is now confined to prostitutes. Courtesy denotes elegance of manners; an act of civility; the reverence made by women; a tenure, not of right, but by the favor of others. Courteous is elegantly mannered; polite; well bred. Courtlike is, refined; polite. Courting and courtship are the act of soliciting favor, chiefly that of a woman in order to obtain her hand. Donne uses the latter word in the sense of elegance of manners.

It shall be an habitation of dragons, and a court for owls. *Isaiah xxvi. 13.*

Friendship is more than is catell,
 For friends in courts are better is
 Than penny is in purse certis.

Chaucer. Romances of the Row.

His stede, which that shonne as sunne bright,
 Stant in the court as stille as any ston.

Chaucer. Cant. Tale.

For, brother min, take of me this motif,
 I have now ben a court-man all my lif. *16.*

Deus hic, quod he; O Thomas, friend, good day,
 Sayde this frere all courtly and soft. *16*

Curtis he was, lowly and servisable,
And carf before his father at the table.

Id. Prod. to Cant. Tales.

A knight there was, and that a worthy man,
That for the time that he firste began
To riden out, he loved chivalrie;
Trouthe and honour, freedom and *courtesie*.

Id.

Creseide fro it awoke

And all that *court* and conuocacioun
Vanished awaie.

Henderson. On Test. of Creseide.

A tong, that served in forein realmes his king,
Whose *courteous* talk to virtue did inflame
Each noble hart.

Surrey.

Myne owne John Poynes, sins ye delight to know
The causes why that homeward I me draw,
And flee the prease of *courts*.

Wyat.

The neat *courtier*

So serves for lease, than do these fatted swine. *Id.*
Him the prince with gentle *court* did board.

Spenser. Faerie Queene.

Forthwith to *court* of Gloriane I sped,
Of Gloriane, great queene of glory bright. *Id.*

What needs of dainty dishes to devise,
Of comely services, or *courtly* trayne? *Id.*

That nyght they pass in ioy and iollity,
Feasting and *courting* both in bowre and hall. *Id.*

And in the midst thereof, upon the floure,
A lovely bevy of faire ladies sate,
Courted of many a jolly paramour. *Id.*

'The first which then refused me,' said hee,
'Certes was but a common *courtisane*.' *Id.*

But to Duesse' each one himself did payne,
All kindnesse and faire *courtesie* to shew,
For in that *court* whylome her well they knew. *Id.*

Here do you keep a hundred knights and squires,
Men so disorderly, so debauched and bold,
That this our *court*, infected with their manners,
Shews like a riotous inn; epicurism and lust
Make it more like a tavern or a brothel,
Than a graced palace. *Shakespeare. King Lear.*

The archbishop

Of Canterbury, accompanied with other
Learned and reverend fathers of his order,
Held a late *court* at Dunstable.

Shakespeare. Henry VIII.

He hath been a *courtier*, he swears.—
If any man doubts that, let him put me to my purga-
tion. I have trod a measure; I have flattered a lady;
I have been politick with my friend, smooth with
mine enemy; I have undone three taylors; I have
had four quarrels, and like to have fought one.

Id. As You Like It.

You spurned me such a day; another time
You called me dog; and, for these *courtesies*,
I'll lend you thus much money.

Id. Merchant of Venies.

Be merry, and employ your chiefest thoughts
To *courtship*, and such fair osetens of love,
As shall conveniently become you there. *Id.*
He hath deserved worthily of his country; and his
ascent is not by such easy degrees, as those who have
been supple and *courteous* to the people.

Id. Coriolanus.

Sweet Cytherea, sitting by a brook,
With young Adonis, lively, fresh, and green,
Courted the lad with many a levely look,
Such looks as none could look but beauty's queen.

Id. The Passionate Pilgrim.

Courting, I rather thou shouldst utterly
Dispraise my work, than praise it frostily.

Ben Jonson.

Follow a shadow, it flies you;

Seem to fly it, it will pursue:

So *court* a mistress, she denies you;

Let her alone, she will *court* you. *Id. Forest.*

But when the cause itself must be decreed,

Himself in person in his proper *court*,

To grave and solemn hearing doth proceed

Of every proof, and every bye report. *Davies.*

You must have, before you come to the front, three
courts: a green *court* plain, with a wall about it; a
second *court* of the same, but more garnished, with
little turrets, or other embellishments, upon the wall;
and a third *court*, to square with the front, not to be
built but inclosed with a naked wall. *Bacon.*

With them there are no stews, no dissolute houses,
no *courtisanes*, nor any thing of that kind; nay, they
wonder, with detestation, at you in Europe, which
permit such things. *Id. New Atlantis.*

Our English tongue is, I will not say as sacred as
the Hebrew, or as learned as the Greek, but as fluent
as the Latin, as *courteous* as the Spanish, as *courtlike*
as the French, and as amorous as the Italian.

Camden's Remains.

There was not among all our princes a greater
courtier of the people than Richard III.; not out of fear,
but wisdom. *Suckling.*

The slightest part that you excel in, is *courtlinesse*.

Lord Digby to Sir Kenneth Digby.

Their wisdom was so highly esteemed, that some of
them were always employed to follow the *courts* of
their kings, to advise them. *Temple.*

Whilst Christ was upon earth, he was not only easy
of access, he did not only *courteously* receive all that
addressed themselves to him, but also did not disdain
himself to travel up and down the country.

Calamy's Sermons.

Hast thou been never base? Did love ne'er bend
Thy frailer virtue to betray thy friend?
Flatter me, make thy *court*, and say it did;
Kings in a crowd would have their vices hid.

Dryden's Awrenguebe.

They can produce nothing so *courtly* writ, or which
expresses so much the conversation of a gentleman, as
Sir John Suckling. *Id. on Dramatick Poetry.*

In short, a mere *courtier*, a mere soldier, a mere
scholar, a mere any thing, is an insipid, pedantic
character, and equally ridiculous. *Spectator.*

Every man, in the time of *courtship*, and in the first
entrance of marriage, puts on a behaviour like my
correspondent's holiday suit. *Addison's Guardian.*

If I should meet her in my way,

We hardly *court*'y to each other. *Prior.*

Ev'n now, when silent scorn is all they gain,

A thousand *court* you, though they *court* in vain.

Pope.

It is but to venture your lungs, and you may preach
against pride and dissimulation and bribery at White-
hall: you may expose rapine and injustice in the inns
of *court*; and in a city pulpit be as fierce as you please
against avarice, hypocrisy, and extortion. 'Tis but
a ball banded to and fro, and every man carries a
racket about him to strike it from himself among the
rest of the company. *Swift.*

A *courtier's* dependant is a beggar's dog. *Shenstone.*

Vanity bids all her sons to be generous and brave—
and her daughters to be chaste and *courteous*.—But
why do we want her instructions? Ask the comedian
who is taught a part he feels not. *Sterne.*

When was it that a king of England wanted where-
withal to make him respected, *courted*, or perhaps
even feared, in every state in Europe? *Burke.*

Though blest with wisdom and with wit refined,
She *courts* not homage, nor desires to shine;
In her each sentiment sublime is joined
To female sweetness, and a form divine. *Beattie.*

Admiring multitudes shall trace
Each patrimonial charm combined—
The *courtious* yet majestic mien,
The liberal smile, the look serene,
The great and gentle mind. *Id.*

Nymphs were Dianas then, and swains had hearts,
That felt their virtues; innocence, it seems,
From *courts* dismissed, found shelter in the groves. *Cowper.*

Courtier and patron cannot mix
These heterogeneous politics,
Without an effervescence,—
Like that of salts with lemon juice
Which does not yet like that produce
A friendly coalescence. *Id.*

There shall no vain pretender be,
To *court* thy smiles and torture me;
No proud superior there be seen;
But nature's voice shall hail thee queen. *Sheridan.*

YOUNG F. Hey-day! What the devil have we
here!—Sure my gentleman's grown a favorite at
court, he has got so many people at his levee! *Id.*

SNEER. Yes; and our prudery in this respect is
just on a par with the artificial bashfulness of a
courtisan, who increases the blush upon her cheek
in an exact proportion to the diminution of her mo-
desty. *Id.*

And now, Hidalgo! now that you have thrown
Doubt upon me, confusion over all,
Pray have the *courtsey* to make it known—
Who is the man you search for? how d'ye call
Him? What's his lineage? let him but be shown. *Byron. Don Juan.*

However, present remedy was none,
And no great good seemed answered if she staid;
Regarding both with slow and sidelong view,
She snuffed the candle, *curtied*, and withdrew. *Id.*

COURT, in law. As by our excellent constitu-
tion, the sole executive power of the laws is vested
in the person of the king, it follows that all courts
of justice, which are the medium by which he
administers the laws, are derived from the power
of the crown. For, whether created by act
of parliament or letters patent, or subsisting
by prescription, the only methods by which any
court of judicature can exist, the king's consent in
the two former is expressly, and in the latter
impliedly, given. In all these courts the king
is supposed, in contemplation of law, to be al-
ways present; but, as that is in fact impossible, he
is there represented by his judges, whose power
is only an emanation of the royal prerogative.
For the more speedy, universal, and impartial ad-
ministration of justice between subject and sub-
ject, the law has appointed a great variety of
courts, some with a more limited, others with a
more extensive jurisdiction: some constituted to
enquire only, others to hear and determine: some
to determine in the first instance, others upon
appeal and by way of review. See *Law*, and the
respective articles in the order of the alphabet.
One distinction runs throughout them all; viz.
that some of them are courts of record, others not
of record.

A court of record is that where the acts and
judicial proceedings are enrolled in parchment
for a perpetual memorial and testimony; which
rolls are called the records of the court, and are
of such high and supereminent authority, that
their truth is not to be called in question. For it
is a settled rule and maxim, that nothing shall be
averred against a record, nor shall any plea or ven
proof be admitted to the contrary. And if the ex-
istence of a record be denied, it shall be tried by
nothing but itself; that is, upon bare inspection
whether there be such record or not; else there
would be no end of disputes. But if there appear
any mistake of the clerk in making up such record,
the court will direct him to amend it. All courts
of record are the king's courts, in right of his
crown and royal dignity, and therefore no other
court hath authority to fine or imprison; so that
the very erection of a new jurisdiction with
power of fine or imprisonment, makes it instantly
a court of record. A court not of record is the
court of a private man, whom the law will not
intrust with any discretionary power over the for-
tune or liberty of his fellow-subjects. Such are
the courts baron, and other inferior jurisdictions;
where the proceedings are not enrolled or re-
corded, but as well their existence as the truth
of the matters therein contained, shall, if dis-
puted, be tried and determined by a jury. These
courts can hold no plea of matters cognizable by
the common law, unless under the value of 40s.
nor of any forcible injury whatsoever, not having
any process to arrest the person of the defendant.
In every court there must be at least three con-
stituent parts, the actor, reus, and judex; the
actor, or plaintiff, who complains of an injury
done; the reus, or defendant, who is called upon
to make satisfaction for it; and the judex, or ju-
dicial power, which is to examine the truth of the
fact, to determine the law arising upon that fact,
and if any injury appears to have been done, to
ascertain, and by its officers to apply the remedy.
It is also usual in the superior courts to have at-
torneys and advocates, or counsel, as assistants.
See **ATTORNEY**, and **COUNSEL**.

COURT, ARCHES. See **ARCHES COURT**.

COURT BARON, in English law, a court in-
cident to every manor in the kingdom, to be holden
by the steward within the said manor. This
court baron is of two natures: the one is a cus-
tomary court, appertaining entirely to the copy-
holders, in which their estates are transferred by
surrender and admittance, and other matters
transacted relative to their tenures only. The
other is a court of common law, and it is the
court of the barons, by which name the freehold-
ers were called: for that it is held before the
freeholders who owe suit and service to the
manor, the steward being rather the registrar than
the judge. These courts, though in their nature
distinct, are confounded together. The freehold-
ers' court was composed of the lord's tenants,
who were the pares of each other, and were
bound by their feudal tenure to assist their lord
in the dispensation of domestic justice. This was
formerly held every three weeks; and its most
important business is to determine, by writ of
right, all controversies relating to the right of
lands within the manor. It may also hold plea

of any personal actions, of debt, trespass on the case, or the like, where the debt or damages do not amount to forty shillings. Which is the same sum, or three marks, that bounded the jurisdiction of the ancient Gothic courts in their lowest instance, or fierding courts, so called because four were instituted within every superior district or hundred. But the proceedings on a writ of right may be removed into the county court by a precept from the sheriff, called a *tolt*, quia tollit atque eximit causam e curia baronum. And the proceedings in all other actions may be removed into the superior courts by the king's writs of *pone*, or *accedas ad curiam*, according to the nature of the suit. After judgment given, a writ also of false judgment lies to the courts at Westminster, to rehear and review the cause, and not a writ of error; for this is not a court of record: and therefore, in some of these writs of removal, the first direction given is to cause the plaint to be recorded, *recordari facias loquelam*.

COURT OF KING'S BENCH. See BENCH.

COURT MARTIAL, a court appointed for the punishing offences in officers, soldiers, and sailors, the powers of which are regulated by the mutiny-bill.

COURT-CHAPLAIN, *n. s.* From court and chaplain. One who attends the king to celebrate the holy offices.

The maids of honour have been fully convinced by a famous *court-chaplain*. *Swift*.

COURT-DAY, *n. s.* From court and day. Day on which justice is solemnly administered.

The judge took time to deliberate, and the next *court-day* he spoke. *Arbutnot and Pope*.

COURT-DRESSER, *n. s.* From court and dresser. One that dresses the court, or persons of rank; a flatterer. . .

There are many ways of fallacy; such arts of giving colours, appearances, and resemblances, by this *court-dresser*, fancy. *Locke*.

COURTENAY (John), an Irish gentleman, descended from the Devonshire family of this name; was originally in the army, and first appeared in public life as secretary to the marquis Townsend, lord-lieutenant of Ireland. He was returned at the general election in 1780, M. P. for Tamworth, and re-elected for that borough in 1784 and 1790. He came into administration with the whig party in 1783, as surveyor of the ordnance, and secretary to the master-general. During their administration in 1806 he was appointed one of the commissioners of the treasury. He sat in parliament for Appleby from 1796 to 1812. His speeches and conversation were always admired for their wit. His works are, 1. A Tract on the Duke of Richmond's Plan of Fortifications, 8vo. 2. A Poetical Review of Dr. Johnson's Character, 8vo. 3. Reflections on the French Revolution. 4. Poetical Epistles on the Manners of France, Italy, &c. 8vo. He died in 1816, aged seventy-five.

COURTESY OF ENGLAND. A tenure (says Cowell) by which, if a man marry an heiress, that is, a woman seized of land, and getteth a child of her that comes alive into the world, though both the child and his wife die forthwith, yet, if she were in possession, shall he keep the

land during his life, and is called *tenant per legem Angliæ*, or by the courtesy of England.

COURT-FAVOR, *n. s.* From court and favor. Favors or benefits bestowed by princes.

We part with the blessings of both worlds for pleasures, *court-favors*, and commissions; and at last, when we have sold ourselves to our lusts, we grow sick of our bargain. *L'Étrange*.

COURT-HAND, *n. s.* From court and hand. The hand or manner of writing used in records and judicial proceedings.

He can make obligations, and write *court-hand*.

Shakespeare.

COURT-LADY, *n. s.* From court and lady. A lady conversant or employed in court.

The same study, long continued, is as intolerable to them, as the appearing long in the same clothes or fashion is to a *court-lady*. *Locke*.

COURTRAI, or COURTRAY, a town of the Netherlands, with a castle; seated on the Lys. It is famed for its manufactures of woollen cloths, lace, diaper, and damask linens, &c. It was taken by the French under general Jarry, in the spring of 1792, but was soon after evacuated, and the suburbs burnt. It was retaken by them in 1792, and again evacuated in the spring of 1793; but surrendered a third time on the 28th of April, 1794, to general Pichegru; and was retained by France until the peace of 1814. Population 14,000. It lies fourteen miles east of Ypres, twenty-three south-west of Ghent, and twenty-four south of Bruges.

CO'USIN, *n. s. & adj.* } Fr. *cousin*; Ital. Co'USINAGE, *n. s.* } *cugino*; Lat. *consanguineus*.

Any one collaterally related—more remotely than a brother or sister. It is also a title of honor given by the king to noblemen, particularly to those of the council. Cousinage is an old word for kin.

Who was so welcome as my Lord Dan John,
Our dire *cousin*, full of curtesie? *Chaucer. Cant. Tales*.

Eke Plato sayeth, whose can him rede,

The wordes most ben *cosin* to the dede.

Id. Prol. to Cant. Tales.

By him lay heavy slepe, the *cosin* of death,
Flat on the ground, and still as any stone. *Sackville*.
Macbeth unseamed him.

Oh valiant *cousin*! worthy gentleman!

Shakespeare.

Tyhalt, my *cousin*! O my brother's child!

Unhappy sight! alas, the blood is spilled

Of my dear kinsman.

Id. Romeo and Juliet.

Thou art, great lord, my father's sister's son,

And *cousin*-german to great Priam's seed.

Id. Troilus and Cressida.

Your friends all wearie, and your spirits spent,
Ye may your fortunes seek, and be forwent,
Of your kind *cousins* and your churlish briers,
Left there alone, midst the fast folding briers, *Hall*.

Well, I never will join in ridiculing a friend; and so I constantly tell my *cousin* Ogle, and you all know what pretensions she has to be critical on beauty.

Sheridan.

They formed a very nymph-like looking crew

Which might have called Diana's chorus '*cousin*,'

As far as outward show may correspond;

I won't be bail for anything beyond.

Byron. Don Juan.

COUSIN is a term of relation between the children of brothers and sisters, who in the first generation are called *cousins-german*, in the second generation *second cousins*, &c. Theodosius the Great prohibited cousins from marrying under pain of death; on pretence that they were, in some sort, brothers and sisters to each other. Also a title often given to the nobility, particularly to those of the privy council, by the king.

COUSIN (John), a celebrated French painter, who excelled in painting on glass. His picture of the Last Judgment, in the vestry of the minims of the Wood of Vincennes, is much admired. He was also a good sculptor. He wrote several works on geometry and perspective; and died about 1689.

COUSU, in heraldry, signifies a piece of another color or metal, placed in the ordinary, as if it were sewed on, as the word imports.

COUTANCES, an old town of France, in Lower Normandy, having a population of 10,000. It is situated on the west coast of the department of La Manche, on the river Soule, five miles from its influx into the English channel, and contains several fine churches. Its manufactures are linen and lace; and its other articles of trade corn, flax, and wool. It is fifty miles west of Caen.

COUTANTIN, **COTANTIN**, or **COTENTIN**, a ci-devant territory of France, in Lower Normandy, containing the towns of Coutances, Carantan, Cherbourg, Barfleur, Granville, St. Sauveur, Valogne, Ville-Dieu, &c. It is now included in the department of the Channe!

COUTH, *adj.* Ang.-Sax. *cuð*. Known.

COUTH, **COUD**, or **COULD**. This is the past participle of *conne*, to know; to be able; but has long been obsolete in the original sense. *Could* is new used as a grammatical auxiliary.

Nor need he guide; the way right well he *could*.
Which leads to shady plains of Gaza old.

Fairfax. Tasso.

COUTHON (Georgé), a French revolutionist of the wildest character, was born in 1756 at Orsai, in the department of Puy de Dome. Brought up to the law, he practised as an advocate, and became president of the court of justice at Clermont. In September, 1791, he was chosen deputy from his native department to the Legislative Assembly; and in 1792 became a member of the National Convention. He spoke violently in the convention against the measure of granting the king a negative on public measures, and was one of the first to propose the trial of Louis XVI., for whose execution he voted. He wavered awhile between the parties of Brissot and Robespierre, but perceiving the latter to be the more powerful, closely connected himself with it, and all its atrocities. Being sent as commissioner from the convention to Lyons, and the deformity of his lower limbs rendering him incapable of walking, he ordered himself to be carried in a chair to the square of Belle-cour, where he gave a blow with a silver hammer to one of the buildings, exclaiming, 'I strike in the name of the law.' This was the signal for commencing the work of destruction; and the noblest edifices of the city were reduced to heaps of ruins. Couthon was most justly involved in the

fate of his party. When arrested, he is said to have exhibited the greatest pusillanimity; and his execution, which took place July 28th, 1794, was attended with great suffering, the distortion of his frame rendering it impossible to place him under the guillotine in the usual posture.

COUTTS (Thomas), a London banker, who, from a small commencement, raised himself to high rank in the mercantile class, was the fourth and youngest son of John Coutts, a merchant of Edinburgh; and in early life a junior partner in a house in St. Mary Axe, in correspondence with the firm to which his father belonged. He afterwards joined his brother's banking-house in the Strand, of which he became sole proprietor. He is remarkable principally for his matrimonial speculations, having married, first, Susan Starke, a female servant of his brother's, by whom he had three daughters—Susan, married in 1796 to lord Guilford; Frances, who married in 1800 John, marquis of Bute; and Sophia, married in 1793 to sir Francis Burdett, bart. He entered a second time into the marriage state in 1815, about three months after his first wife's decease, with Miss Mellon, an actress of some celebrity, whom he constituted at his death the sole legatee of his large fortune, sworn to be *under* £600,000 personals 'in the diocese of Canterbury,' besides real estates. He died February, 1821, aged eighty-seven.

COUVERT, in heraldry, a piece of hanging, or a pavilion falling over the top of a chief or other ordinary, so as not to hide, but only to be a covering to it.

COW, *v. a.* } Dr. Johnson unhesitatingly
Cowish, *adj.* } derives this verb from coward, of which he declares it to be a contraction. Mr. Tooke, with perhaps more plausibility, refers its origin to cower. Other lexicographers, however, trace it to the Swed. *kufwa*, to cheek, to curb, to suppress, to subjugate; meanings which also belong to the Isl. *kuga*. To cow signifies, to depress with fear; to break the spirits so as to render habitually timid. *Cowish* is timorous; mean; pusillanimous.

Macduff was from his mother's womb
Untimely ripped.

—Accursed be that tongue that tells me so,
For it hath cowed my better part of man.

Shakespeare. Macbeth.

It is the *cowish* terror of his spirit,
That dares not undertake: he'll not feel wrongs
Which tie him to an answer. *Id. King Lear.*

By reason of their frequent revolts, they have drawn upon themselves the pressures of war so often, that it seems to have somewhat cowed their spirits.

Howell's Vocal Forest.

For when men by their wives are cowed,
Their horns of course are understood. *Hudibras.*

Cow, *n. s.*
CO'W-BOY, *n. s.*
CO'W-HERD, *n. s.*
CO'W-HOUSE, *n. s.*
CO'W-KEEPER, *n. s.*
CO'W-LEECH, *v. n. & n. s.*
CO'W-LIKE, *adj.*
CO'WSLIP, *n. s.*

Per. *gau*; Sans. *gau*; Goth. *ku*; Ang.-Sax. *Eu*; Dut. *ke*; Ger. *kuhe*; Swed. *ko*. Junius supposes, 'cow vel *kuw*' to be the parent word. The

female of the bull. A cow-leech is one who professes to cure cows. *Cowslips*, says Dr. John-

son, are so called, 'as some think, from the resemblance of scent to the breath of a cow; perhaps, from growing much in pasture grounds, and often meeting the cow's lips.' Others suppose they derive their name from cows delighting in them, or from their similitude to the lips of a cow.

If that this bone be washe in any well,
If cow, or calf, or shepe, or oxe, swell
That any worm hath ete, or worm ystonge,
Take water of that well and washe his tonge
And it is hole anon. *Chaucer. Cant. Tales.*

How often would she flowers twine,
How often garlands make
Of cowslips and of columbine,
And all for Corin's sake. *Songes and Sonnettes.*
Streight downe she ranne, like an enraged cow
That is berobbed of her youngling dere.

Spenser. Faerie Queene.
And for her sake a cowheard vile became,
The servant of Admetus, cowheard vile,
Whiles that from heaven he suffered exile. *Id.*
Show me the ground with daffadownillies,
And cowslips, and king cups, and loved lillies.
Id. Shepherd's Calendar.

Where the bee sucks, there suck I;
In a cowslip's bell I lie. *Shakespeare. Tempest.*
We see that the horns of oxen and cows, for the most part, are larger than the bull's; which is caused by abundance of moisture, which in the horns of the bull faileth. *Bacon.*

Then, leaving in the fields his grazing cows,
He sought himself some hospitable house,
Good Creton entertained his godlike guest.
Dryden's Fables.
The terms cowkeeper and hogherd are not to be used in our poetry; but there are no finer words in the Greek language. *Broomer.*

Thy little sons
Permit to range the pastures; gladly they
Will mow the cowslip posies, faintly sweet. *Philips.*
You must house your milch-cows, that you give
hay to, in your cow-house all night. *Mortimer.*
Though there are many pretenders to the art of farriering and cow-leeching, yet many of them are very ignorant, especially in the country. *Id.*

Cowslip is also called pagil, grows wild in the meadows, and is a species of primrose. *Miller.*
Mourn, Spring, thou darling of the year!
Hk cowslip cup shall keep a tear:
Thou, Simmer, while each corny spear
Shoots up its head,
Thy gay, green, flowery tresses shear,
For him that's dead. *Burns.*

Who glide unseen, on printless slippers borne,
Beneath the waving grass, and nodding corn;
Or lay your tiny limbs, when noon-tide warms,
Where shadowy cowslips lay their golden arms.
Darwin.

In the *Adventurer*, a periodical paper, published by the ingenious Dr. Hawkesworth, I remember, indeed, a sort of humorous account of a dog that bit a hog in the streets; the hog bit a farmer, and the farmer bit a cow; and, what is very extraordinary, each conveyed his peculiar quality to the other; for the hog barked like a dog, the farmer granted like a hog, and the cow did its best to talk like the farmer. *Sheridan.*

Cow, in zoology. See Bos.
Cow, n. s. A moveable top to a chimney, to prevent it from smoking. The word is supposed to be corrupted from cowl.

COW, SEA. See TRICHECUS.

COWARD, v. a., n. s. & adj. } Fr. *coward*;
CO'WARDICE, n. s. } Ital. *codardia*;
CO'WARDIZE, v. a. } Sp. *cobardia*;
CO'WARDLIKE, adj. } Etymologists
CO'WARDLINESS, n. s. } differ greatly
CO'WARDLY, adj. & adv. } as to the deri-
CO'WARDIOUS, adj. } vation of cow-
CO'WARDSHIP, n. s. } ard. Junius
CO'WARDNESS, n. s. } and Skinner

refer it to cowherd; though why a man who watches cows should necessarily be a dastard, it is not easy to divine. Yet the manner in which some of our old writers speak the word, seems to afford some ground for this conjecture. Twisden, Somner, and Tyrwhitt consider it to be a corruption of *culum vertere*, to turn tail. Horne Tooke maintains, that coward is the past participle of the verb to cower; and with him agrees the *Encyclopædia Metropolitana*. Cowheart or cow-hearted have also been supposed to be the parent stock. Mr. Todd, however, reasons forcibly in favor of the derivation from the old Fr. *couard*, which itself springs from *coie*, Lat. *cauda*, a tail; allusively to animals depressing the tail between the legs when they are frightened. A coward is, a poltroon; a dastard; one who is habitually under the dominion of fear. The verb to cowardize, to make cowardly, is obsolete. The meaning of the subordinate words is obvious.

I cannot love a coward by my faith.
Chaucer. Cant. Tales.

Alas! she saith, that ever I was yshape
To wed a milkoop or a coward ape,
That wol ben overlodde with every wight. *Id.*

————— This compasse well marke
Not aye with full sailes the hye seas to beate,
Ne by coward dred, in shonning stormes darke,
On shallow shores thy keel in perill fret. *Survey.*
But loe my souldiers cowardly shrank away.
For such is fortune when she lyst to frowne. *Sacrille.*

That I alas in this calamitie
Alone was left, and to myself mought playne
This treason, and this wretched cowardlye. *Id.*

————— Why locest thou thy strokes
Cowardes among, turn thee to me, in case
Manhood there be so much left in thy heart.
Uncertain Authors.

Vile cowheard Dogge! now do I much repent
That ever I this life unto thee lent,
Whereof thou, Caytive! so unworthy art!
Spenser. Faerie Queene.

For all he taught the tender yonge was but
To banish cowardise and bastard feare. *Id.*

Pyrocles did such wonders, beyond belief, as was
able to lead Musidorus to courage, though he had
been born a coward. *Sidney.*

Having more man than wit about me, I drew;
He raised the house with loud and coward cries.
Shakespeare. King Lear.

I do find it cowardly and vile,
For fear of what might fall, so to prevent
The time of life. *Id. Julius Cæsar.*

A very paltry boy, and more a coward than a hare:
his dishonesty appears in leaving his friend here in
necessity, and denying him; and for his cowardship,
ask Fabian. *Id. Twelfth Night.*

He sharply reproved them as men of no courage, who had most cowardly turned their backs upon their enemies.

Knolles.

There was a soldier that vaunted, before Julius Cæsar, of the hurts he had received in his face. Cæsar, knowing him to be but a coward, told him, You were best take heed, next time you run away, how you look back.

Bacon.

An Egyptian soothsayer made Antonius believe that his genius, otherwise brave and confident, was in the presence of Octavius poor and cowardly.

Bacon's Natural History.

Gallant and fearless courage will turn into a native and heroic valour, and make them hate the cowardice of doing wrong.

Milton on Education.

Some are brave one day, and cowards another, as great captains have often told me, from their own experience and observation.

Temple.

Let all such as can enlarge their consciences like hell, and style a cowardly silence in Christ's cause discretion, know, that Christ will one day scorn them.

South.

None was disgraced ; for falling is no shame,
And cowardice alone is loss of fame.
The vent'rous knight is from the saddle thrown,
But 'tis the fault of fortune, not his own.

Dryden's Fables.

Invading fears repel my coward joy,
And ill foreseen the present bliss destroy.

Prior.

Tremble ye not, oh friends ! and cowards fly.
Doomed by the stern Telemachus to die !

Pope's Odyssey.

Rage, we know, can make a coward forget himself and fight. But what is done in fury or anger, can never be placed to the account of courage. Were it otherwise, womankind might claim to be the stoutest sex ; for their hatred and anger have ever been allowed the strongest and most lasting.

Shaftesbury.

To tell a man he lies, though but in jest, is an affront that nothing but blood can expiate. The reason, perhaps, may be because no other vice implies a want of courage so much as the making of a lie ; and therefore telling a man he lies, is touching him in the most sensible part of honour, and indirectly calling him a coward.

Addison.

It might, methinks, somewhat abate the insolence of human pride to consider, that it is but increasing or diminishing the velocity of certain fluids in the animal machine, to elate the soul with the gayest hopes, or sink her into the deepest despair ; to depress the hero into a coward, or advance the coward into a hero.

Melmoth.

The loose improvidence, the cowardly rashness of those who dare not look danger in the face, so as to provide against it in time, and therefore throw themselves headlong into the midst of it.

Burke.

O shun th' annoyance of the bustling throng,
That haunt with zealous turbulence the great ;
Their coward Office boasts th' unpunished wrong,
And sneaks secure in insolence of state.

Beattie.

Who will be a traitor knave ?
Who can fill a coward's grave ?
Who sae base as be a slave ?

Traitor ! coward ! turn and flee.

Burns.

— — — — — When

Thy sons are in the lowest scale of being,
Slaves turned o'er to the vanquished by the victors ;
Despised by cowards for greater cowardice,
And scorned even by the vicious for such vice

As in the monstrous grasp of their conception
Defy all codes to image or to name them.

Byron. The Dogs of Venice.

COWARD, in heraldry, a term given to a lion borne in an escutcheon with his tail doubled, or turned in between his legs, as in the annexed diagram :—



COWEL (Dr. John), a learned and eminent civilian, born about 1554. In 1607 he compiled a Law Dictionary, which gave great offence to Sir Edward Coke and the common lawyers : so that they first accused him to James I. as asserting that the king's prerogative was in some cases limited ; and when they failed in that attempt, they complained of him to the house of commons, as a betrayer of the rights of the people, by asserting that the king was not bound by the laws ; for which he was committed to custody, and his book publicly burnt. He also published *Institutiones Juris Anglicani*, in the manner of Justinian's Institutes ; and died of the operation for the stone, in 1611.

COWER, *v. a. & n.* Fr. *cower* ; Ital. *covare* ; Lat. *cupare* ; Goth. *kura* ; Welsh, *currian*. To sink by bending the knees ; to stoop ; to shrink from ; to cherish carefully : the latter meaning is obsolete.

Kingis mete to him knele and cower.
To the apostles that Christ frebode.

Chaucer. Cant. Tale.

Where finding life not yet dislodged quight,
He much rejoyest, and cowerd it tenderly,
As chicken newly hatcht, from dreading destiny.

Spenser. Faerie Queene.

The splitting rocks covered in the sinking sands,
And would not dash me with their ragged sides.

Shakespeare. 2 Henry VI.

Let the pail be put over the man's head above water, then he cower down, and the pail be pressed down with him.

Bacon.

As thus he spake, each bird and beast beheld,
Approaching two and two ; these covering low
With blandishment, each bird stooped on his wing.

Milton.

Our dame sits covering o'er a kitchen fire,
I draw fresh air, and nature's works admire.

Dryden.

Lo ! where the Giant on the mountain stands,
His blood-red tresses deepening in the sun,
With death-shot glowing in his fiery hands,
And eye that scorseth all it glares upon ;
Restless it rolls, now fixed, and now anon
Flashing afar,—and at his iron feet
Destruction covers to mark what deeds are done.

Byron. Child Harold.

A band of children, round a snow-white ram,
There wreath his venerable horns with flowers ;
While peaceful as if still an unweaned lamb,
The patriarch of the flock all gently covers
His sober head, majestically tame.

Id. Don Juan.

COWES, a sea-port town on the north coast of the Isle of Wight ; situated on the river Meden, which divides it into East and West Cowes each of which has a castle built by Henry VIII. It is a place of considerable trade, and much resorted to as a bathing place. The building,

rising one above another on the brow of the hill, command delightful views. The harbour is one of the safest and most commodious in the British Channel. During war large fleets of merchant ships are to be found waiting here for convoy or favorable winds. Genteel private lodgings abound, and there are two excellent inns. Passage boats ply regularly between Cowes and Southampton, a distance of sixteen miles, and afford, in favorable weather, a most charming sail. Distance from London eighty-four miles south-west, and from Portsmouth twelve W. S. W.

COWL, *n. s.*

COWLED, *adj.*

Old Fr. *coule*; Ital. *cuculla*; Sp. *capulla*; Wel. *cul*; Ang.-Sax. *cul*, *cugle*; Sw. *kufi*; Per. *koolah*; Lat. *cucullus*. A monk's hood; a vessel in which water is carried on a pole between two persons. Cowl-staff, usually written cole-staff, is the pole on which the vessel is suspended.

You may imagine that Francis Cornfield did scratch his elbow, when he had sweetly invented, to signify his name, saint Francis, with his friery cowl in a cornfield.

Camden.

Mounting him upon a cowl-staff,

Which (tossing him something high)

He apprehended to be Pegasus.

Suckling.

What differ more, you cry, than crown and cowl?
I'll tell you, friend, a wise man and a fool.

Pope.

Here the cowed zealots with united cries,

Urged the crusade.

Shenstone.

They will tell you that they see no difference between the idler with a hat and a national cockade, and an idler in a cowl or in a rocket.

Burke.

Dark and unearthly is the scowl

That glares beneath his dusky cowl.

Byron. The Giaour.

COWLS, worn by the Bernardines and Benedictines, are of two kinds; the one white, very large, worn in ceremony, and when they assist at the office; the other black, worn on ordinary occasions, in the streets, &c. F. Mabillon maintains the cowl to be originally the same thing in its origin with the scapular. The author of the Apology of the Emperor Henry IV. distinguishes two forms of cowls: the one a gown reaching to the feet, having sleeves, and a capuchin, used in ceremonies; the other a kind of hood to work in, called also a scapular, because it only covers the head and shoulders.

COWLEY (Abraham), an eminent poet, born at London in 1618. His father, who was a grocer, dying before he was born, his mother procured him to be admitted a king's scholar, at Westminster. His first inclination to poetry arose from his perusal of Spenser's Fairy Queen, when but just able to read: and he began at the age of thirteen to write poems; a collection of which was published in 1633. In 1636 he was elected a scholar of Trinity College, Cambridge, and removed to that University. He had taken his degree of M. A. before 1643, when, in consequence of the turbulence of the times, he, among others, was ejected from the college; and retiring to St. John's Oxford, published a satire, called the Puritan and the Papist. But he did not remain long at Oxford: his zeal for the royal cause engaging him in the king's service, whom he attended in many of his expeditions. During

one part of the civil war, he was settled in the earl of St. Albans' family; and when the queen mother retired into France, he accompanied her; labored strenuously in the affairs of the royal family, undertook several very dangerous journeys on their account, and was the principal instrument in maintaining an epistolary correspondence between the king and queen, whose letters he decyphered. His poems were published at London in 1647; and his comedy called the Guardian, (afterwards altered under the title of Cutter of Coleman-street), in 1650. In 1656 he came over to England, and, under pretence of retirement, gave information to lord Ormond of the posture of the public affairs. During his stay in England he wrote his Two Books of Plants, published first in 1662; to which he afterwards added four books more; all of which, with his other Latin poems, were printed in London, in 1678. He was created M. D. at Oxford, Dec. 2nd, 1657. Soon after the Restoration he became possessed of a very competent estate, through the favor of the duke of Buckingham and the earl of St. Albans; and, being now above forty years of age, he resolved to pass the remainder of life in studious retirement. His first rural residence was at Barn Elms; but he afterwards removed to Chertsey, where he died on the 28th of July, 1667, in the forty-ninth year of his age. He was interred in Westminster Abbey, near the ashes of Chaucer and Spenser. He was a man who united a very amiable character, with admirable genius. Charles II. on the news of his death, declared 'that Cowley had not left a better man behind him in England.' A monument was erected to his memory by George Villiers, duke of Buckingham, in 1675. Cowley's other works were, A Proposition for the Advancement of Experimental Philosophy; A Discourse by way of Vision concerning the Government of Oliver Cromwell; and several Discourses by way of Essays in prose and verse. A spurious piece, entitled The Iron Age, was published under his name during his absence from England, and, in Mr. Dryden's Miscellany Poems, we find a Poem on the Civil War, said to be written by him, but not extant among his works. An edition of his works was published by Dr. Spratt, afterwards bishop of Rochester, who prefixed to it an account of the author's life. Cowley's character as a poet has been variously estimated. Lord Clarendon has said he made a flight above all men; Addison, in his account of the English poets, that he improved upon the Theban bard. Dr. Johnson observes of his poetry, that 'he wrote with abundant fertility, but negligent or unskilful selection; with much thought, but with little imagery; that he is never pathetic, and rarely sublime, but always either ingenious or learned, either acute or profound.' Of his prose he says, 'no author ever kept his verse and his prose at a greater distance from each other. His thoughts are natural, and his style has a smooth and placid equability, which has never yet obtained its due commendation. Nothing is far-sought or hard labored; but all is easy without feebleness, and familiar without grossness.' He adds, 'that he was the first who imparted to English numbers the

enthusiasm of the greater ode and the gaiety of the less; that he was among those who freed translation from servility; and that, if he left versification yet improveable, he left likewise from time to time such specimens of excellence, as enabled succeeding poets to improve it.'

COWLEY (Hannah), a dramatic writer, was born at Tiverton in Devonshire in 1743. At the age of twenty-five she married Mr. Cowley, an officer in the East India Company's service, who died in 1797. She produced as her first play the comedy of the Runaway in 1776, which was followed the year after by the Belle's Stratagem, and some other popular pieces. Her best poems are the Maid of Arragon and the Siege of Acre. She died at Tiverton in 1809, and her works were published in 1813 in 3 vols. 8vo. with a memoir of her life.

CO-WORK, v. n. } From *con* and *worker*.
CO-WORKER, n. s. } A fellow-workman.

The power of God *co-working* within us. *Goodwin*.

And therefore in all acquired gifts and habits, such as those of philosophy, oratory, or divinity, we are properly *συμργου*, *co-workers* with God. *South*.

COWPER (William), one of the most distinguished of modern English poets, was the son of Dr. Cowper, rector of Berkhamstead, Herts, where he was born November 26th, 1731. His grandfather, Spencer Cowper, was a judge of the court of Common Pleas, and brother to lord Chancellor Cowper. From infancy his constitution was remarkably delicate, and his mind of a tender and timid cast. At six years of age he lost his excellent and 'most indulgent' mother, and was sent immediately to a large school in Bedfordshire. 'Here,' he says, 'I had hardships of different kinds to conflict with, which I felt more sensibly, in proportion to the tenderness with which I had been treated at home. But my chief affliction consisted in my being singled out from all the other boys, by a lad about fifteen years of age, as a proper object upon whom he might let loose the cruelty of his temper. I choose to forbear a particular recital of the many acts of barbarity, with which he made it his business continually to persecute me: it will be sufficient to say, that he had, by his savage treatment of me, impressed such a dread of his figure upon my mind, that I well remember being afraid to lift up my eyes upon him, higher than his knees; and that I knew him by his shoe-buckles, better than any other part of his dress. The cruelty of this boy, which he had long practised in so secret a manner that no creature suspected it, was at length discovered. He was expelled from the school, and I was taken from it.'

He was now placed for a year in the family of a surgeon and oculist, being in danger of losing one of his eyes, and from thence transferred to Westminster school. He praises its religious discipline at this time, and particularly the manner in which the boys were 'prepared for confirmation: but here he imbibed that strong aversion to public education, which he afterwards expressed so forcibly in one of his best poems, the 'Tirocinium.'

At the age of eighteen he was removed from

Westminster, 'being tolerably furnished,' as he informs us, 'with grammatical knowledge, but as ignorant of all points of religion as the satchel at my back; a curious result of the aforesaid discipline. Having spent about nine months at home, he was articled to an attorney of the metropolis, until he came of age, passing his leisure time ('pretty near all his time' he says) at an uncle's in Southampton-row. At twenty-one years of age he took possession of a set of chambers in the temple, with a view to the future practice of the law, as a barrister, but was soon afterwards attacked seriously with that wretched 'dejection of spirits,' which was the bane of his life. Its causes were evidently constitutional, and he mentions an early but short attack of the kind at Westminster school. Among the predisposing circumstances of this calamity, however, particularly at this period, we cannot but reckon the long continued *idleness* of his youth and early manhood. Had he been either by authority, by necessity, or by a sense of duty impelled to a real and steady exertion of his considerable powers for business, during the important years he trifled away at Southampton-row, the result we must believe would have been most salutary.

We shall not be expected to trace the ebbs and flowings of this unhappy complaint. He at first looked into Herbert's Poems, and books of devotion; was then advised to try a change of scene, and finding it relieve him, threw all his religious books aside, and renewed his school acquaintance with the profligate Churchill, with Lloyd, Thornton, and Colman; for the latter of whom he wrote two papers in the *Connoisseur*. His little patrimony being now well nigh spent, and a marriage being projected for him with a sister of Lady Hesketh's, he gladly accepted the offer of the places of reading clerk, and clerk of the committees to the house of lords. This satisfaction, however, was but momentary. In the course of a week his apprehensions of his own incompetence, and of his being publicly exposed before the assembled peerage, were overwhelming to his mind, and he wrote to the friend who had given him the choice of three places of this kind, relinquishing the two that were most profitable. His powers completely failed him, even in preparing for the less arduous post of clerk of the Journals. His agitation produced a nervous fever. 'The feelings of a man when he arrives at the place of execution,' he says, 'are probably much like mine, every time I set my foot in the office, which was every day for more than half a year together.' He in vain left London for a short refreshment of his health and spirits: on his return, the scene of preparation, and the idea of his public appearance before the house, became intolerable. 'To this dilemma was I reduced,' says he, 'either to keep possession of the office to the last extremity, and by so doing, expose myself to a public rejection for insufficiency; (for the little knowledge I had acquired, would have quite forsaken me at the bar of the house;) or else to fling it up at once, and by this means run the hazard of ruining my benefactor's right of appointment, by bringing his discretion into question. In

this situation, such a fit of passion has sometimes seized me, when alone in my chambers, that I have cried out aloud, and cursed the hour of my birth; lifting up my eyes to heaven, at the same time, not as a suppliant, but in the hellish spirit of rancorous reproach and blasphemy against my Maker. A thought would sometimes come across my mind, that my sins had perhaps brought this distress upon me, that the hand of divine vengeance was in it; but in the pride of my heart I presently acquitted myself, and thereby implicitly charged God with injustice, saying, 'What sins have I committed to deserve this?'

He hoped for madness, he tells us afterwards, and resolved on suicide; not, as some of his biographers have stated, in consequence of any distortion of some peculiar religious sentiments which he had now imbibed; but in a state of evident scepticism as to all religion. 'Perhaps, thought I, *there is no God*; or if there be, the Scriptures may be false; if so, then God has no where forbidden suicide.' His Calvinistic sentiments were clearly not imbibed until the latter part of his residence with Dr. Cotton. We will not transcribe the dismal narrative of his various wretched efforts to rid himself of life; he bought laudanum, took a coach resolving to throw himself into the Thames, and at last, on the morning on which he was to appear at the bar of the house of lords, hung himself over his bed-chamber door until he was totally insensible; but his garter providentially breaking, he was restored to the world at the very point of strangulation. His kinsman arriving was 'pointed to the broken garter in the middle of the room, and apprised of the attempts which he had been making.' Certainly, he observed, the office could not be held at that rate, asked for the deputation, and took it away with him; and thus ended all our poet's connexion with the house of lords.

His intellects completely sunk under the subsequent pressure of remorse and the fear of death, and in 1763 he was placed under the care of Dr. Cotton, with whom he remained eighteen months. His despair, according to Mr. Greathead, was at the latter part of this period 'effectually removed by reading in the sacred Scriptures that God hath set forth Jesus Christ to be a propitiation through faith in his blood, to declare his righteousness for the remission of sins that are past, through the forbearance of God. While meditating on this passage, he obtained a clear view of the gospel, which was attended with unspeakable joy. His subsequent days were (for awhile) chiefly occupied with praise and prayer, and his heart overflowed with love to his crucified Redeemer. The transports of his joy, which at first interrupted his necessary sleep, having subsided, were followed by a sweet serenity of spirit, which he was enabled to retain, notwithstanding reviving struggles of natural and habitual corruption.'

Cowper's own Memoirs of his Early Life prepare us in part for what may be called this sudden conversion, by a narrative of some conversation which he had with the Rev. Martin Madan prior to his illness. He also dwells on

the transports of joy with which it was accompanied. Its best effects were the serenity which seems to have followed, and which lasted for a period of upwards of eight years. A writer in the Quarterly Review (No. 59) presumes to pronounce without 'doubt', that the whole was 'the mere natural consequence' of high wrought feelings; and speaks of the 'flood of light which burst upon his mind as the false fire of insanity.' But Dr. Cotton was surely somewhat of a judge of this question, and his brother who concurred in his removal from that gentleman's care, was of different religious sentiments to those which Cowper now imbibed. What these were he thus informs us in a letter to a relative, dated October 20th, 1766:—'That Jesus is a present Saviour from the guilt of sin by his most precious blood, and from the power of it by his Spirit; that corrupt and wretched in ourselves, in Him, and in Him only, we are complete; that being united to Jesus by a lively faith, we have a solid and eternal interest in his obedience and sufferings, to justify us before the face of our heavenly Father, and that all this inestimable treasure, the earnest of which is in grace, and its consummation in glory, is given, freely given to us of God; in short, that he hath opened the kingdom of heaven to all believers;—These are the truths, which, by the grace of God, shall ever be dearer to me than life itself; shall ever be placed next my heart as the throne whereon the Saviour himself shall sit, to sway all its motions, and reduce that world of iniquity and rebellion to a state of filial and affectionate obedience to the will of the Most Holy.'

He declined to return to London, he says, as the scene of his former dissipation, and resigned from the conscientious motive of being thus unable to fulfil its duties, the office of a commissioner of bankruptcy, worth about £60 per annum. His brother procured for him a retreat at Huntingdon, where in November, 1765, he became an inmate in the family of the Rev. Mr. Unwin. On that gentleman's decease, in 1767, he continued to reside with his widow.

Some of the best fruits of the nine happy years of his life that followed, are preserved in his Private Correspondence, published in 1824, by his cousin, Dr. Johnson of Yaxley. We extract a playful letter of his, written at this period; and another containing one of the best gentle admonitions on a common, but serious topic, which we have ever seen.

TO THE REV. JOHN NEWTON

March 19th, 1785.

'My dear Friend,

'You will wonder no doubt when I tell you that I write upon a card table; and will be still more surprised when I add, that we breakfast, dine, and sup, upon a card table. In short, it serves all purposes except the only one for which it was originally designed. The solution of this mystery shall follow, lest it should run in your head at a wrong time, and should puzzle you, perhaps, when you are on the point of ascending your pulpit.

The round table, which we formerly had in use, was unequal to the pressure of my superincumbent breast and elbows. When I wrote upon it, it creaked and tilted, and by a variety of inconvenient tricks disturbed the process. The fly-table was too slight and too small; the square dining table too square and too large, occupying, when its leaves were spread, almost the whole parlour; and the side-board table, having its station at too great a distance from the fire, and not easily shifted out of its place and into it again, by reason of its size, was equally unfit for my purpose. The card table, therefore, which had for sixteen years been banished as mere lumber; the card table which is covered with green baize, and is therefore, preferable to any other that has a slippery surface; the card table, that stands firm and never totters, is advanced to the honor of assisting me upon my scribbling occasions; and because we choose to avoid the trouble of making frequent changes in our household furniture, proves equally serviceable upon all others. It has cost us, now and then, the downfall of a glass; for when covered with a table cloth, the fish ponds are not easily discerned; and, not being seen, are sometimes as little thought of. But having numerous good qualities which abundantly compensate that single inconvenience, we spill upon it our coffee, our wine, and our ale, without murmuring, and resolve that it shall be our table still, to the exclusion of all others. Not to be tedious, I will add but one circumstance more upon the subject, and that only because it will impress upon you as much as any thing that I have said, a sense of the value we set upon its escorial capacity. Parched and penetrated on one side by the heat of the fire, it has opened into a large fissure, which pervades not the moulding of it only, but the very substance of the plank. At the mouth of this aperture, a sharp splinter presents itself, which, as surely as it comes in contact with a gown or apron, tears it. It happens, unfortunately, to be on that side of this excellent and never-to-be-forgotten table, which Mrs. Unwin sweeps with her apparel almost as often as she rises from her chair. The consequences need not, to use the fashionable phrase, be given in detail; but the needle sets all to rights, and the card table still holds possession of its functions without a rival,' &c. vol. 1, p. 349.

TO JOSEPH HILL. ESQ

Jan. 21st, 1769.

'Dear Joe,

'I rejoice with you in your recovery, and that you have escaped from the hands of one from whose hands you will not always escape. Death is either the most formidable, or the most comfortable thing, we have in prospect, on this side of eternity. To be brought near to him, and to discern neither of these features in his face, would argue a degree of insensibility, of which I will not suspect my friend, whom I know to be a thinking man. You have been brought down to the sides of the grave, and you have been raised again by Him who has the keys of the invisible world; who opens, and none can shut,

who shuts, and none can open. I do not forget to return thanks to Him on your behalf, and to pray that your life, which He has spared, may be devoted to his service. 'Behold! I stand at the door and knock,' is the word of Him, on whom both our mortal and immortal life depend; and, blessed be his name, it is the word of one who wounds only that he may heal, and who waits to be gracious. The language of every such dispensation is, 'Prepare to meet thy God.' It speaks with the voice of mercy and goodness, for, without such notices, whatever preparation we might make for other events, we should make none for this. My dear friend, I desire and pray, that when this last enemy shall come to execute an unlimited commission upon us, we may be found ready, being established and rooted in a well-grounded faith in His name, who conquered and triumphed over him upon his cross.

Yours ever,
W. C.'

But we deeply lament, with the Christian Observer, the injudicious application of his time at this important period. It seems to have been wholly occupied with devotional exercises, and writing a few hymns and letters. It partook too much of the religion of the cloister to preserve a sound mind in a healthy state; but with his unhappy tendency to derangement it was most injudiciously associated. In 1773, the death of his brother brought on another paroxysm of his complaint, which rendered the following five or six years of his life an absolute blank. During its continuance he became highly indebted to the affectionate attention of Mrs. Unwin. On his recovery his friends engaged him as much as possible in literary composition. At the suggestion of the Rev. Mr. Bull, a dissenting minister of Newport-Pagnell, he produced his beautiful translation of Madame Guion's poems; and prepared for press in the same year (1780), his first volume of poems, containing Error, Truth, Expostulation, Hope, Charity, Retirement, and Conversation. The latter, published by Johnson, 1782, was declared by the sages of the Critical Review to be devoid of all poetry, and attracted little general attention.

In 1781 lady Austen came to reside at Olney. Her sprightly conversation and general accomplishments made her a most suitable and salutary companion at the vicarage; and, as Hayley, we believe, has said,

Sent the freed eagle in the sun to bask,
And from the mind of Cowper drew the Task.

The poet consulted her respecting a subject for his muse: 'You can write upon any thing,' she replied, 'write upon this sofa.' He adopted the suggestion, beginning, as it would seem, a species of mock heroic description of the origin of that useful and elegant seat, and led on by his genius into the most exquisite natural and moral associations. This piece appeared, accompanying the Tirocinium, as a second volume of his poems in 1783. His character as a genuine and highly favored son of the muses was now established. Dr. Johnson spoke highly of his poetic powers, and Mr. Fox quoted him in the house of com-

mons. Unhappily for his future life and occupations, his gratitude to Mrs. Unwin, to whom, though much his senior in years, he had promised marriage, induced him to resign in the following year the friendship of lady Austen.

At about this period he commenced his translation of Homer, which appeared in 1791, in 2 vols. 4to; and, immediately on its completion, accepted an engagement with Mr. Johnson to translate the Italian poetry of Milton, and write a commentary on all his works. He also projected a new original poem, called *The Four Ages*, a fragment of which appeared in Mr. Hayley's biographical volumes. But in 1792 a paralytic seizure, which Mrs. Unwin experienced, gave a fatal shock to his mind, and all his literary undertakings were relinquished the year following. In 1794, by the good offices of earl Spencer, a pension of £300 per annum was settled upon him by the crown; he manifested, however, no visible satisfaction at the communication of this fact. At this period, in the feeble state of Mrs. Unwin's health, his cousin lady Hesketh kindly undertook the management of his domestic concerns.

He was removed from Olney in 1795, together with Mrs. Unwin, to the house of his relative the Rev. Mr. Johnson, of Tuddenham, Norfolk. On the journey he walked with his young kinsman in the church-yard of Eaton, near St. Neot's, by moon-light, and talked of the poet Thomson with some composure. Soon after he visited another relation at Mattishall, where, seeing his own portrait by Abbot, he clasped his hands in an agony of grief, wishing that his present sensations could be what they were at the period when he sat to the artist.

He had short lucid intervals in the summer of 1796, and in the course of 1799; but the death of Mrs. Unwin once more threw him back into gloom at the close of the former year; and in the latter, he only made a few insignificant translations, and composed his *Castaway*. Symptoms of dropsy appeared in the beginning of 1800, and brought him to the grave the 25th of April in that year, at Dereham.

Few authors have had the facts of their history more amply detailed than Cowper. Mr. Hayley announces and spins them out to absolute tediousness; but he performed the great service to the public of establishing the claims of our poet to be also one of our ablest English letter-writers. In the choice selection of words he has been held to equal Pope; in wit and humour, Gray, and even Swift; while he is as free from all vulgarity as from all affectation, and utters the language of the heart in the most spirited and easy style. Of the influence of his peculiar religious sentiments on the latter part of his life, our readers will arrive at very different conclusions, perhaps, according to their own respective sentiments. As a poet he will rank to the latest posterity, we cannot doubt, with the first of our painters after nature; and, as eminently, the bard of social life. As a translator of Homer he is rugged, cold, and often repulsive; but faithful and correct. As compared with Pope, he has been well said to have all in this respect that his predecessor wants, and to want all that grace and spirit which he possesses.

COWRIES, the name of a species of cyprea, whose shell is of a fine white color and crimped, bearing a high polish. It is extensively used as money in India and Africa.

COWRY. The small shell commonly known by the name of blackamoor's tooth. See *CYPREA*.

It is curious that some of the most common fossil shells are not now known in their recent state as the *cornua ammonis*; and on the contrary, many shells which are very plentiful in their recent state, as limpets, sea-ears, volutes, *cowries*, are very rarely found fossil. Darwin.

COWSLIP. See *PRIMULA*.

COW-WHEAT. See *MELAMPYRUM*.

COX (Richard), a learned prelate, was born at Whaddon in Buckinghamshire, in 1499. He obtained a scholarship at King's College, Cambridge, of which he became a fellow in 1519: he was thence invited to Oxford by cardinal Wolsey, and made one of the junior canons of Cardinal College. In 1525 he was incorporated B. D. and in 1526 took the degree of M. A. But his attachment to the opinions of Luther soon rendered him hateful to his superiors, who threw him into prison on a suspicion of heresy. Being, however, soon released, he was chosen master of Eton school, which flourished under his care. In 1537 he took his degree of D. D. at Cambridge; in 1540 was made archdeacon, and in 1541 prebendary of Ely. In 1546 he was made dean of Christ Church, Oxford. By the recommendation of archbishop Cranmer, he was chosen preceptor to prince Edward; on whose accession to the throne he was sworn of the privy council, and made king's almoner. In 1547 he was elected chancellor of Oxford; in 1548 canon of Windsor; and 1549 dean of Westminster. Being appointed one of the commissioners to visit the University of Oxford, his zeal for reformation was so little under the guidance of knowledge, that he destroyed a number of curious and valuable books, because they were written by Roman Catholics. On the accession of queen Mary, he was stripped of all his preferments and committed to the Marshalsea. Being released, he immediately left the kingdom, and resided at Strasburg with his intimate friend Peter Martyr. On the death of queen Mary he returned to England, was appointed, with other divines, to revise the liturgy. In 1559 was preferred to the see of Ely, which he enjoyed upwards of twenty-one years. He died 22d of July 1581, aged eighty-one. His works are, 1. Two Latin Orations on the Dispute between Dr. Tresham and Peter Martyr, London 1549, 4to. 2. Liturgy of the Church of England; in compiling, and afterwards correcting which, he was principally concerned. 3. The Lord's Prayer in verse, commonly printed at the end of David's Psalms by Sternhold and Hopkins. 4. Translation of the four Gospels, the Acts of the Apostles, and the Epistle to the Romans, in the new translation of the Bible in the reign of Elizabeth. 5. Resolutions of some Questions concerning the Sacrament, in the Collection of Records at the end of Burnet's History of the Reformation. 6. Several Letters to the

queen and others, published in Strype's *Annals of the Reformation*.

CO'XCOMB,
CO'XCOMBLY, *adj.*
COX'COMICAL, *adj.*
COX'COMICALLY, *adv.*
COX'COMBRY, *n. s.*

From cock and comb. The top of the head; the distinctive ornament which licensed fools formerly wore in their cap; a fop; a superficial pretender to knowledge or accomplishments; a kind of red flower. Coxcomby is foolish; vain; in the manner of a coxcomb. Coxcomical is, foppish; conceited. A low word, unworthy of use, says Johnson; but in spite of his censure, the word is still in use, as well as its relation, coxcomically.

As the cockney did to the eels, when she put them i' the pasty alive; she rapt them o' th' *coxcombs* with a stick, and cried, Down, wantons, down!

Shakespeare. King Lear.

There, take my *coxcomb*; why, this fellow has banished two of his daughters, and did the third a blessing against his will: if thou follow him, thou must needs wear my *coxcomb*.

Id.

By this same *coxcomb* that we have i' th' wind, Tokens and letters which she did resend.

I scorn, quoth she, thou *coxcomb* ail'y, Quarter or council from a foe.

It is a vanity for every pretending *coxcomb* to make himself one of the party still with his betters.

L' Etrange.

They overflowed with smart repartees, and were only distinguished from the intended wits by being called *coxcombs*, though they deserved not so scandalous a name.

Dryden.

She is a most engaging creature, if she were not so fond of that damned *coxcomb* lord of hers.

Congrave.

Some are bewildered in the maze of schools, And some made *coxcombs*, nature meant but fools.

Pope.

Because, as he was a very natural writer, and they were without prejudice, without prepossession, without affectation, and without the influence of *coxcomical*, senseless cabal, they were at liberty to receive the impressions which things naturally made on their minds.

Dennis.

We should not deem a man a *coxcomb* for his dress, till, by frequent conversation, we discover a flaw in his title. If he was incapable of uttering a *boa mot*, the gold upon his coat would seem foreign to his circumstances. A man should not wear a French dress, till he could give an account of the best French authors; and should be versed in all the oriental languages before he should presume to wear a diamond.

Shenstone.

LORD F. Now, by all that's good and powerful, thou art an incomprehensive *coxcomb*—but thou makest good shoes, and so I'll bear with thee.

Sheridan.

You haven't been here, I believe, since I fitted up this room. Books, you know, are the only things in which I am a *coxcomb*.

Id.

One hates an author that's all author, fellows

In foolscap uniforms, turned up with ink,

So very anxious, clever, fine, and jealous,

One don't know what to say to them, or think,

Unless to puff them with a pair of bellows;

Of *coxcomby's* worst *coxcombs* s'en the pink,

Are preferable to these shreds of paper,

These unquenched snuffings of the midnight taper.

Byron. Beppo.

COY, *v. a. & adj.*
CO'YISH, *adj.*
CO'YING, *n. s.*
CO'Y'LY, *adv.*
CO'YNESS, *n. s.*

Old Fr. *coy* or *quoy*, a corruption of Lat. *quiescens*. The verb, which is now little, if at all in use, signifies, to behave reservedly; to make difficulty; to allure; to caress; to pat or stroke. The adjective *coy* means, modest; reserved; shrinking from notice; receding from familiarities. *Coying*, as a noun, is fondling, petting. The rest of the secondary words do not require elucidation.

There was also a Nonne, a *proresse*, That of hire smiling was ful simple and *coy*, Hire grettest othe n'as but by Seint Eloy.

Chaucer. Prol. to Cant. Tales.

Sire clerk of Ozenforde, our houte said, Ye ride as stille and *coy* as doth a maid, Were newe spoused, sitting at the bord.

Id. Cant. Tales.

Of Bialacoil she toke aie hede, That er he liveth in wo and drede, He kept him *coye* and eke privé.

Id. Romance of the Rose.

A fairer beaste, of fresher hue, beheld I never none, Save that her lookes were *coy*, and froward eke her grace.

Surrey.

Wherefore I woulde you wiste, that for your *coy* lookes,

I am no man that will be trapt, nor tangled with such hookes.

Id.

So forth they rode, he feining seemly merrh, And she *coy* lookes.

Spenser. Faerie Queen.

— For my sake hith learned to sport and dance, To *coy*, to wanton, dally, smile, and jest.

Shakespeare. Venus and Adonis.

Oh pity, gan she cry, flint-hearted boy! 'Tis but a kiss I beg, why art thou *coy*?

Id.

I'll mounbank their loves, *Coy* their hearts from them, and come home beloved Of all the trades in Rome.

Id. Coriolanus.

If he *coyed* To hear Cominius speak, I'll keep at home,

Id.

— In love, scorn is bought with groans; *coy* looks, With heart-sore sighs; one fading moment's mirth, With twenty watchful, weary, tedious nights:

Id. Two Gentlemen of Verona.

This said, his hand he *coyly* snatched away From forth Antinous' hand.

Chapman's Odyssey.

When the sun hath warmed the earth and water, three or four male carps will follow a female; and she putting on a seeming *coyness*, they force her through weeds and flags.

Walton.

Like Phœbus sung the no less am'rous boy: Like Daphne she as lovely, and as *coy*.

Waller.

When the kind nymph would *coyness* feign, And hides but to be found again.

Dryden.

What, *coying* it again! No more; but make me happy to my gust, That is, without your struggling.

Id. King Arthur.

Retire! I beg you, leave me.—

— Thus to *coy* it!

With one who knows you too!

Rowe's Jane Shore.

At this season every smile of the sun, like the smile of a *coy* lady, is as dear as it is uncommon.

Pope.

The Nile's *coy* source.

Cranger.

So pure, so soft, with sweet attraction shone
Fair Psyche, kneeling at the ethereal throne;
Wen with coy smiles the admiring court of Jove,
And warmed the bosom of unconquered love,
Darwin.

In vain delighted memory tries to raise
My doubtful song, and aid my will to praise!
In vain! nor fancy strikes, nor memory knows
Those little springs from whence those joys arose.
Yet come, coy fancy,—sympathetic maid!
Yes—I will ask, I will explore thy aid:—
Sheridan.

COYPEL (Anthony), an excellent French painter, born at Paris in 1661. Noel Coypel, his father, being chosen by M. Colbert to be the director of the academy at Rome, he took Anthony with him into Italy, where he formed his style on the works of the greatest masters, and on his return to France was made first painter to the duke of Orleans; who employed him in painting the grand gallery of the royal palace, and allowed him a pension. In 1714 he was director of the academy of painting and sculpture. In 1715 he was made first painter to the French king, and was ennobled. He died in 1722. M. Coypel, his son, also excelled in the same art.

COYSTREL, *n. s.* A species of degenerate hawk.

One they might trust, their common wrongs to
wreak:

The mascot and the *coystrel* were too weak,
Too fierce the falcon. *Dryden's Hind and Panther.*

COZ, *n. s.* A cant or familiar word, contracted from cousin.

Be merry, *coz*; since sudden sorrow
Serves to say thus, some good thing comes tomorrow.
Shakespeare.

COZEN, *v. n.* } Minshew says, 'to de-
COZENAGE, *n. s.* } ceive or beguile under the
COZENER, *n. s.* } name or show of kin-
COZENING, *n. s.* } dred.' This derivation
seems to be more ingenious than solid. It is rather too Swiflean. Junius refers to the Dutch *koosen*, to fawn upon, to soothe, or flatter. The Encyclopædia Metropolitana says, 'the primitive is probaby Ang.-Sax. *costnian*, to try, to tempt. Perhaps we may be allowed to go farther north, for the authority of Serenius, who says Goth. and Sueth. *kyusa*, fascinari; *kosen*, fascinator.' It will hardly be denied, that many of those who have been cozened, seem to have been fascinated, bewitched, by the cozener. To cozen is, to cheat; to trick; to defraud; to impose upon. Cozenage and cozening signify, fraud; trick; cheat; fallacy; the practice of cheating; the profession of a cozener.

For he was scholed by kind in all the skill
Of close conveyance, and each practice ill
Of *cozenage*, and cleanly knavery,
Which oft maintained his master's bravery.
Besides he used another slippery sleight,
In taking on in common sight
False personages, fit for every sted,
With which he thousands cleanly *cozined*.
Spenser. Mother Hubbard's Tale.

Let the queen pay never so fully, let the master-
view them never so diligently, let the deputy

or general look to them never so exactly, yet they can
cozen them all. *Id.*

Her lilly hand her rosy cheek lies under,
Cozening the pillow of a lawful kiss.
Shakespeare. The Rape of Lucrece.

Indeed, Sir, there are *cozeners* abroad, and there-
fore it behoves men to be wary. *Id. Winter's Tale.*

They say this town is full of *cozenage*,
As nimble jugglers that deceive the eye,
Disguised cheaters. *Id. Comedy of Errors.*

Wisdom without honesty is meere craft and *cozenage*;
and therefore the reputation of honesty must first be
gotten, which cannot be but by living well: a good
life is a main argument. *Ben Jonson's Discoveries.*

There's no such thing as that we beauty call,
It is mere *cozenage* all;
For though some long ag
Liked certain colours mingled so and so,
That doth not tie me now from chusing new.
Suckling.

Imaginary appearances offer themselves to our im-
patient minds, which entertain these counterfeitis,
without the least suspicion of their *cozenage*.
Glanville's Scepis.

Goring loved no man so well but that he would
cozen him, and expose him to publick mirth for having
been *cozened*. *Clarendon.*

He that suffers a government to be abused by care-
lessness or neglect, does the same thing with him that
maliciously and corruptly sets himself to *cozen* it.
L'Estrange.

Children may be *cozened* into a knowledge of the
letters, and be taught to read, without perceiving it to
be any thing but a sport. *Locke on Education.*

What if I please to lengthen out his date
A day, and take a pride to *cozen* fate.
Dryden's Aurengzebe.

Strange *cozenage*! none would live past years again,
Yet all hope pleasure in what yet remain!
And from the dregs of life think to receive
What the first sprightly running could not give. *Id.*

But all these are trifles, if we consider the fraud
And *cozenage* of trading men and shopkeepers. *Swift.*

COZUMEL, a fertile island of North America, forty miles long and from three to ten wide, near the east coast of Yucatan. It is inhabited by native Indians; and abundant in fowl and cattle. Cortes touched here in 1519 on his expedition to Mexico, and was the means of liberating Aguilar, a Spanish dean, who, in going from Darien to Hispaniola, had been taken prisoner a few years before by the Indians. He became the interpreter of this chief.

COZY, or **COSY**, *adj.* Snug; comfortable. The word is common in the Scotch dialect; and is sometimes used in the English, in familiar speech.

Thou saw the fields laid bare an' waste,
An' weary winter coming fast
An' *cozie* here, beneath the blast,
Thou thought to dwell,
Till crash! the cruel coultter past,
Out-thro' thy cell.
Burns.

CRAB, *v. a., n. s., & adj.* } Fr. *crabe*; Arm.
CRABBED, *adj.* } *crab*; Ang-Sax.
CRABBEDLY, *adv.* } *crabba*; Dut. and
CRABBEDNESS, *n. s.* } Germ. *krabbe*;
CRABBY, *adj.* } Swed. *krabba*;
CRAB'S-EYES, *n. s.* } Lat. *carabus*;
CRABER, *n. s.* } *καρὰβοσ*. The
verb signifies to sour; to render peevish or ma

rose. Crab is, a well-known crustaceous fish; a wild apple; a peevish morose person; an engine for lifting heavy weights; a sign of the zodiac. As an adjective it is expressive of something worthless or degenerate. Crabbed and crabby are, peevish; displeasing; difficult; perplexing. Crabbedness is, sourness of taste, of countenance, of manners; difficulty. For CRABS' EYES and CRABS' CLAWS see the following articles.

For thin husband armed be in maille,
The armes of thy *crabbed* eloquence
Shal perce his brest and eke his aventaille.
Chaucer. Cant. Tales.

And first of al Saturne gave his sentence,
Which gave to Cupide litle reverence,
But as a boistous chorle in his manere
Came *crabbedly* with austrine loke and chere.
Henderson. Testament of Creceide.

Therin a cauced *crabbed* carle does dwell,
Thot has no skill of court nor courtesie,
Ne cares what men say of him, ill or well.
Spenser. Faerie Queene.

A man of years, yet fresh as mote appear,
Of swarth complexion, and of *crabbed* hue,
That him full of melancholy did shew.
Id.
Noble stock
Was graft with *crab* tree slip, whose fruit thou art.
Shakespeare.

When roasted *crabs* hiss in the bowl,
Then nightly sings the staring owl.
Id.
Fetch me a dozen *crab* tree staves, and strong
ones; these are but *switches*.
Id. Henry VIII.

O, she is
Ten times more gentle than her father's *crabbed*;
And he's composed of harshness.
Id. Tempest.

That was when
Three *crabbed* months had soured themselves to death,
Ere I could make thee open thy white hand,
And clepe thyself my love.
Id. Winter's Tale.

Crabbed age and youth
Cannot live together;
Youth is full of pleasure,
Age is full of care.
Id. The Passionate Pilgrim.

Thus have I writ, in smoother cedar tree,
So gentle satires, penned so easily.
Henceforth I write in *crabbed* oak tree rynde,
Search they that mean the secret meaning find.
Hall.

Those that cast their shell are, the lobster, the *crab*,
the *crawfish*, the *hodmandod* or *dodman*, and the *tor-*
toise. The old shells are never found; so as it is
like they scale off and crumble away by degrees.
Bacon's Natural History.

How charming is divine philosophy!
Not harsh and *crabbed*, as dull fools suppose,
But musical as is Apollo's lute,
And a perpetual feast of nectared sweets,
Where no crude surfeit reigns.
Milton.

Beside, he was a shrewd philosopher,
And had read every text and gloss over;
Whate'er the *crabbedest* author hath,
He understood b' implicit faith.
Hudibras.

The poor fish have enemies enough, beside such
unnatural fishermen as otters, the cormorant, and the
crabber. which some call the water-rat.
Walton's Angler.

Several persons had, in vain, endeavoured to store
themselves with *crabs'-eyes*.
Boyle.

Then parts the Twins and *Crab*, the Dog divides,
And Argo's keel, that broke the frothy tides.
Cresch.

Better gleanings their worn soil can boast
Than the *crab* vintage of the neighbouring coast.
Dryden.

Lucretius had chosen a subject naturally *crabbed*.
Id.

Your *crabbed* rogues that read Lucretius
Are against gods, you know.
Prior.

The Heaven-taught Bards of whom I speak
When time was young, in *crabbed* Greek,
Th' achievements of celestial legions
Detailed among these lower regions.
Huddeford.

But if more deep the quarrel,
Why sooner drain the barrel
Than be the hateful fellow
That's *crabbed* when he's mellow.
Sheridan.

CRAB, of the genus Cancer, Linnæus, is thus described. Mouth usually furnished with six feelers; mandibles thick and horny; eyes two, distant, elongated, moveable, and commonly placed on peduncles; antennæ four, short, and filiform, or setaceous, the inner pair (or sometimes both) bifid at the last joint; legs eight or six, and two chelate claws; body somewhat ovate; tail short. The species are very numerous, and have been subdivided into three sections.

SECT. I.—Thorax smooth, sides very entire. These species are, 1. *Grapsus*.—Front retuse, deflected, and armed with four lobes; body variegated. (Fabricius, &c.) A native of the West India Islands, where it is not very common. The color whitish, most elegantly varied with red. The hand-claws are comparatively small and rough. 2. *Mutus*.—Thorax chestnut-brown transversely on the anterior margin. (Fabricius.) A native of the Mediterranean Sea. The posterior part of the body truncated; hand-claws smooth; arms denticulated beneath. 3. *Quadratus*.—Thorax square; sides crenated; hand-claws scabrous; Banksian Cabinet. (Fabricius.) A native of Jamaica. Size large. 4. *Ruricola*.—First joint of the legs spinous; second and third with tufts of hair.

This great land-crab of the Bahama Islands, the history of which has been largely detailed by Sloane, Catesby, and others, may be thus abridged. These animals regularly march from the mountains, their usual abode, to the sea-side in the months of April and May. At that time the whole ground is covered with this band of adventurers; and they direct their march with the utmost precision, never turning to the right or left for any obstacles they can possibly pass over. They are said to be commonly divided into three battalions, of which the first consists of the strongest and boldest males; but the main body of the army is composed of females, which never leave the mountains till the rain is set in, and then descend in regular order, being formed into columns of fifty paces broad, and three miles deep. Three or four days after this, the rear guard follows, a stragglung, undisciplined tribe, consisting of males and females, but neither so robust nor so vigorous as the former. The night is the chief time of proceeding, and if it rains by day they do not fail to profit by the occasion; but when the sun shines they halt. When they are terrified, they march back in a confused disorderly manner, holding up, and

clattering their nippers together, as if to threaten those that disturb them. They most commonly subsist on vegetables; but if any of them by accident are maimed in such a manner as to be incapable of proceeding, the rest fall upon and devour them upon the spot, and then pursue their journey.

After a march of sometimes two, or perhaps three months in this manner, they arrive at their destined spot on the sea-coast, on which they rush eagerly to the edge of the water, and let the waves wash over their bodies two or three times. This has been thought necessary by some to ripen the spawn in the ovaria, as the crab, appearing satisfied with this slight bathing, immediately retires, and seeks a lodging on the land. Before the last time the spawn may be seen under the tail in bunches the size of a hen's egg, which they shake off into the water, leaving them to the chance of fortune and accident to bring them to maturity. The eggs that escape the shoals of fishes gathered round the shore are hatched under the sand; and soon after the little crabs are seen slowly travelling up to the mountains. The old ones, however, have become so feeble and lean that they can hardly crawl along, and are obliged to continue in the flat parts of the country till they recover, making holes in the earth, which they cover at the mouth with leaves and dirt. They there throw off their old shells, and remain almost without motion, for six days together, when they become so fat as to be delicious food. It is said they have then under their stomachs four large white stones, which gradually decrease in proportion as the shell hardens, and when they come to perfection are not to be found. This animal, when in the mountains, subsisting only on vegetables, seldom ventures out; and its habitation being in the most inaccessible places, it remains for a great part of the season in perfect security. But when they descend into the flat country, the natives destroy thousands; disregarding their bodies, they only seek for the small spawn which lies on each side of the stomach, within the shell, of about the thickness of a man's thumb. They are much more valuable on their return, after they have cast their shells, for, being covered with a skin resembling soft parchment, almost every part except the stomach may be eaten. They are taken in the holes, by feeling for them with an instrument, and are sought after by night, when on their journey, by flambeaux light. Sometimes also they are caught when they take refuge in the bottoms of holes in rocks by the sea-side, by stopping up the mouth of the hole, and then the tide coming enters the hole, and the animal is drowned in its retreat. These crabs are of various colors; but those of a light color are esteemed most, and when full in flesh are well tasted. In some of the sugar islands they form no inconsiderable part of the food of the poor negroes. 5. *Paderus*.—Thorax oblong, with three teeth in front; eyes large and kidney-shaped. (Herbst.) Body size of a horse-bean, yellowish, with a ferruginous spot in the middle of the thorax. 6. *Residus*.—Thorax subround; front on both sides emarginate. (Herbst.) *Mus. Casar Viennens, &c. &c.*

SECT. II.—Thorax smooth and cut at the

sides. The principal species are, 1. *Corallinus*.—Thorax obovate, one toothed; front divided into three lobes. A native of India, and the largest known, being considerably bigger than *C. pagurus*, the great English crab. 2. *Xaiva*.—Thorax tridentate, front truncated, body hemispherical and about two inches and a half in breadth. A native of Chili. 3. *Strigotus*.—Thorax smooth, and streaked transversely on the sides; behind the eye a single tooth; snout deflected, with four tubercles before the tip. 4. *Pagurus*.—Thorax with nine plaits on each side, pincers of the claws black at the tip. Found on most of the rocky shores of Europe, and is in perfection at Christmas. The flesh is more palatable and wholesome than that of any other crab.

SECT. III.—Thorax spinous at the back. The chief species worthy of notice are, 1. *Germanus*.—Thorax rough, with a spine in the front and on the tail. Found in the German sea, and is very minute. 2. *Auritus*.—Thorax one spine in front, the back soft. Found in Iceland.

CRAB, in ship building, a sort of wooden pillar, whose lower end A, being let down through a ship's decks, rests upon a socket B, like the capstern; and having in its upper end three or four holes, at different heights, through the middle of it, into which long bars are thrust, whose length is nearly equal to the breadth of the deck. It is employed to wind in the cable, or to raise any other weighty matter which requires a great mechanical power. This differs from a capstern, as not being furnished with a drum head, and by having the bars to go entirely through it, reaching from one side of the deck to the other; whereas those of the capstern, which are superior in number, reach only about eight or twelve inches into the drum head, according to the size thereof.

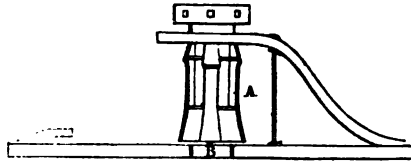

CRABS' CLAWS, in the materia medica, are the tips of the claws of the common crab broken off at the verge of the black part, so much of the extremity of the claws only being allowed to be used in medicine as is tinged with this color. The blackness, however, is only superficial; they are of a grayish-white within, and when levigated furnish a tolerably white powder. Crabs' claws are of the number of the alkaline absorbents; but they are superior to the generality of them in some degree, as they are found on a chemical analysis to contain a volatile urinous salt.

CRAB TREE, in botany. See PYRUS.

CRACATOA, the most southern of a cluster of islands lying in the entrance of the straits of Sunda in the East Indies. Its whole circumference does not exceed nine miles; and off its north-east extremity is a small island forming a road, in which Captain Cook anchored, when

visiting this island on his last voyage. The road where the Resolution anchored is in lat. 8° 6' south, and by observation, in 105° 36' long. east, by the time-keeper in 104° 48'. The variation of the compass 1° west. On the full and change days it is high water at seven o'clock A. M. and the tide rises three feet two inches perpendicular.

CRACK, or
CRAKE, *v. a. & n. s.*
CRA'CKER, *n. s.*
CRA'KER, *n. s.*
CRA'CKLE, *v. n.*
CRA'CKLING, *n. s.*
CRA'CKNEL, *n. s.*
CRA'CK-BRAINED, *adj.*
CRA'CK-HEMP, *n. s.*
CRA'CK-ROPE, *n. s.*

Fr. *croquer*; Ital. *crocchiare*; Sp. *crusir*; Dut. *kracken*; Ger. *kracken*; Goth. *krackia*; Ir. *crac*. To break into chinks; to split; to flaw; to do anything quickly; to destroy; to craze; to fall to ruin; to emit a loud sound suddenly; to boast of; to brag: in the last two senses it was formerly written *crak*. Crack is, an abrupt disruption, in which the parts recede but a little; the chink so produced; the sound made by a falling, or bursting body; any sudden and quick sound; the change of the voice on entering into the state of puberty; breach of chastity; craziness; a crazy man; a boast, vulgarly a boaster and a prostitute; out of hand, quickly, as, I will do it in a crack; a lad. Crackle signifies to make slight cracks; to decrepitate. Cracker, a noisy boaster; a kind of firework; that which makes any thing crack. Cracknel is a hard brittle cake, so called from the sound which it makes in being broken. Crack-brained denotes crazy; and crack-hemp and crack-rope, deserving of the gallows.

What say we of hem that belevon ou divinales, as by sight or by noise of briddes or of bestes, or by sorte of geomancie, by dremes, by chirking of dores, or cracking of houses, by gnawing of rattes, and swiche maner wretchednesse?
Chaucer. Cant. Tales.

The furious gonne, in his most raging yre,
 When that the boale is rammed in to sore,
 And that the flame cannot part from the fier,
Crackes in sunder. *Wyat.*
 'He lives,' quoth he, 'and boasteth of the fact,
 Ne yet hath any knight his courage crackt.'

Spenser. Faerie Queene.
 Leasings, hackbyttings, and vain glorious crackes. *Id.*
 So well she couth the shepherds entertain
 With cakes and cracknels, and such country cheer.

Id. Shepherd's Calendar.
 Of folded schedules had she many a one,
 Which she perused, sighed, tore, and gave the flood;
 Cracked many a ring of posied gold and bone,
 Bidding them find their sepulchres in mud.

Shakespeare. A Lover's Complaint.
 If I say sooth, I must report they were
 As cannons overcharged with double cracks.

Id. Macbeth.
 And let us, Polydore! though now our voices,
 Have got the manial crack, sing him to th' ground.

Id. Cymbeline.
 Love coole, friendship falls off, brothers divide: in
 cities, mutinies; in countries, discord; in palaces,
 treason; and the bond cracked 'twixt son and father.

Id. King Lear.
 Thou wilt quarrel with a man for cracking nuts,
 Having no other reason but because thou hast hazel
 eyes. *Shakespeare. Romeo and Juliet.*

And since her time are colliers counted bright,
 And Ethiops of their sweet complexion crack.

Id. Love's Labour Lost.
 What cracker is this same that deafs our ears
 With this abundance of superfluous breath?

Id. King John.
 Come hither, crack-hemp.
 —I hope I may chuse, Sir.

Come hither, you rogue!
 What, have you forgot me?

Id. Taming of the Shrew.
 I was ever of opinion, that the philosopher's stone,
 and an holy war, were but the rendezvous of cracked
 brains, that wore their feather in their heads.

Bacon's Holy War.
 Honour is like that glassy bubble,
 That finds philosophers such trouble
 Whose least part cracked, the whole does fly,
 And wits are cracked to find out why. *Hudibras.*

The bladder, at its breaking, gave a great report,
 almost like a cracker. *Bogle.*

The credit not only of banks, but of exchequers,
 cracks when little comes in, and much goes out. *Dryden.*

Caught her dishevelled hair and rich attire;
 Her crown and jewels crackled in the fire. *Id. Absid.*
 Pay tributary cracknels, which he sells;
 And with our offerings help to raise his vails.

Id. Juvenal.
 At length it would crack in many places; and those
 cracks, as they dilated, would appear of a pretty good,
 but yet obscure and dark, sky-colour.

Newton's Opticks.
 Vulcan was employed in hammering out thunder-
 bolts, that every now and then flew up from the anvil
 with dreadful cracks and flashes. *Addison.*

I have invented projects for raising millions, with-
 out burthening the subject; but cannot get the parlia-
 ment to listen to me, who look upon me as a crack
 and a projector. *Id.*

Marrow is a specifiick in that scurvy which occasions
 a cracking of the bones; in which case marrow per-
 forms its natural function of moistening them.

Arbuthnot on Aliments.
 We have sent you an answer to the ill-grounded
 sophisms of these crack-brained fellows. *Id. and Pope.*
 Sir Balaam now, he lives like other folks;
 He takes his chirping pint, he cracks his jokes. *Pope.*

Then furious he begins his march,
 Drives rattling o'er a brazen arch,
 With squibs and crackers armed to throw
 Among the trembling crowd below. *Swift.*

Since pulpits fall, and sounding boards reflect
 Most part an empty ineffectual sound,
 What chance that I, to fame so little known,
 Nor conversant with men or manners much,
 Should speak to purpose, or with better hope
 Crack the satiric thong? *Comper.*

Thus the slight wood engraved on glass untealed
 Runs in white lines along the lucid field;
 Crack follows crack, to laws elastic just,
 And the frail fabric shivers into dust. *Darwin.*

Piles the dry cedar round her silver urn,
 Bright climbs the blaze, the crackling faggots burn. *Id.*
 She's just like the French fruit one cracks for no-
 tes—made up of paint and proverb. *Sheridan.*

And giving up all notions of resistance,
 They followed close behind their sabbie guide,
 Who little thought that his own cracked existence
 Was on the point of being set aside. *Byron. Don Juan.*

CRACOW, a city and republic of Poland, situated at the confluence of the Vistula and Rudowa. Its castle, and the wide space covered by its buildings, convey to a stranger the impression of an extensive city; but the place is thinly inhabited, the streets crooked, and the pavements wretched. It has three suburbs, one of which lies on the opposite bank of the Vistula. It is the see of a bishop, who formerly bore the title of duke of Sivararia. The cathedral once contained the crown and regalia of Poland, and still possesses the tombs of the ancient Polish kings. This city was founded in the thirteenth century, and is said to have had in former times no less than 70,000 inhabitants: in 1810 only 25,736. The richer classes are principally German Jews. It is well situated for trade, the principal objects of which at this time are, wood, fish, Hungarian wine, honey, wax, and linen cloth. It is 128 miles S. S. W. of Warsaw, and 264 south of Koningsberg.

The latest British traveller who has given us any account of this neighbourhood is Mr. Jacob. He arrived in this part of Poland, in the latter part of 1825, with a view to ascertaining its resources as a corn-country. See our article **CORN LAWS**.

Around the city of Cracow, he found an independent republic of this name, very fertile, and extending on the Vistula about twenty miles. The whole territory contains above 500 square miles, or 320,000 English acres, with 100,000 inhabitants. The land is a clayey loam, requiring three or four horses to plough it, and yielding when well managed crops of excellent wheat and oats. Where they have adopted the practice of sowing clover between the corn crops, the produce is very abundant. Cracow is its capital.

CRA'DLE, *v. a., n., & n. s.* } Ang.-Saxon,
CRA'DLE-CLOTHES, *n. s.* } cradel. To lay
CRA'DLE-TIME, *n. s.* } in a cradle; to
 rock in a cradle; to lodge as in a cradle. A
 moveable bed for children; infancy; a case for
 a broken bone; a frame to assist in launching a
 ship; an instrument used by mezzotinto engra-
 vers; a part added to a scythe for the purpose
 of gathering the corn into swathes. Cradle-
 clothes are, the bed clothes of a cradle; cradle-
 time is, infancy.

The sow fretting the child right in the *cradel*;
 The cock ycalled for all his long ladel.

Chaucer. Cant. Tales.

— Or that the earth had rent in twaye,
 And swallowed thee in *cradles* as thou laye. *Sackville.*

There she beholds, with high aspiring thought,
 The *cradle* of her own creation,
 Amongst the seats of angels heavenly wrought.

Spenser's Colin Clout.

He knew them to be inclined altogether to war,
 and therefore wholly trained them up, even from their
swaddles in arms and military exercises.

Spenser's Ireland.

Hercules; whose famous acts
 We orderly shall tell,
 Whereof the first, but not the least,
 In *cradle-time* befel.

Warner.

She had indeed, Sir, a son for her cradle, ere she
 had a husband for her bed. *Shakespeare. King Lear.*

O could it be proved
 That some night-tripping fairy had exchanged,
 In *cradle-cloaths*, our children, where they lay,
 And call mine Percy, his Plantagenet;
 Then would I have his Harry, and he mine. *Id.*

His birth, perhaps, some paltry village hides,
 And sets his *cradle* out of fortune's way. *Dryden.*

The tears steal from our eyes, when in the street
 With some betrothed virgin's hears we meet;
 Or infant's funeral, from the cheated womb
 Conveyed to earth, and *cradled* in a tomb. *Id.*

If they are suffered from their *cradles* to treat men
 ill and rudely, because, by their father's title, they
 think they have a little power over them; at best it
 is ill-bred, and, if care be not taken, will, by degrees,
 nurse up their natural pride into an habitual contempt
 of those beneath them: and where will that probably
 end, but in oppression and *crudely*? *Locke.*

The *cradles* and the tomb, alas, so nigh!
 To live is scarce distinguished from to die. *Prior.*

Me let the tender office long engage,
 To rock the *cradle* of reposing age;
 With lenient arts extend a mother's breath,
 Make languor smile, and smooth the bed of death.

Pope.

He shall be *cradled* in my ancient shield, so famous
 through the universities: *Arbutnot and Pope.*

No gaudy wreath of flowers she weaves,
 But twines with oak the laurel leaves,
 Thy *cradle* to adore. *Beattie.*

Ah! what avails the *cradle's* damask roof,
 The eider bolster, and embroidered woof!—
 Oft hears the gilded couch unpitied plains,
 And many a tear the tasselled cushion stains!

Darwin.

Her brood delighted stretch their callow wings,
 As poised aloft their pendent *cradles* swings, *Id.*
 Fast by his hand one lipping boy she led;
 And one fair girl amid the loud alarm
 Slept on her kerchief, *cradled* by her arm. *Id.*

I pity kings, whom worship waits upon
 Obsequious from the *cradle* to the throne;
 Before whose infant eyes the flatterer bows,
 And binds a wreath about their baby brows;
 Whom education stiffens into state,
 And death awakens from that dream too late.

Cowper.

Alas! my babe, if thou wouldst peaceful rest,
 Thy *cradle* must not be thy mother's breast.

Sheridan.

CRADLE, in engraving, is the name of an instrument used in scraping mezzotintos and preparing the plate. It is formed of steel, resembling a chissel, with one sloping side, upon which are cut hollow lines very near each other and at equal distances. The acting part of this tool is made circular, and the corners are rounded. After being properly tempered, it must be sharpened on the whetstones. There are various sizes of this instrument.

CRADLE, in ship-building, is a frame of timber, as in the diagram, raised along the outside of a ship by the bulge, and is used to support the ship's weight, while she slides down the descent or sloping passage called the ways, which are for this purpose covered with soap and tallow.



CRAFT, *v. n.* & *n. s.* } Ang.-Sax. *craft*;
 CR'AF'TILY, *adv.* } Ger. and Swed. *kräft*.
 CR'AF'TINESS, *n. s.* } The idea conveyed by
 CR'AF'TLESS, *adj.* } the root of all these
 CR'AF'TY, *adj.* } words is that of power,
 CR'AF'TSMAN, *n. s.* } strength, excellence,
 CR'AF'TSMAS'TER, *n. s.* } and, formerly, craft
 and its congeners were used in a good as well
 as in a bad sense; they signified strength, skill.
 The verb, which is obsolete, means to play
 tricks; to practise artifice. Craft is, manual art,
 trade; ability; fraud; cunning; deception;
 cheating; small vessels employed in trade.
 Craftily and craftiness have now invariably a
 sinister meaning; they imply cunning; a want
 of fairness. Craftsman is, an artificer; a me-
 chanic; craftsman one who is skilful in his
 trade.

He taketh the wise in his own *craftiness*. *Job*.

For *craft* is all, who so that don it can.
Chaucer. Cant. Tales.

Though he can but lewdly
 On metres and on riming *craftily*. *Id.*
 A prentis whilom dwelt in our cite,
 And of a *craft* of vitailleurs was he. *Id.*
 How coude ye wepin so by *craft*? (quod she)
 Maie there soch teris evir fained be?

Id. Legends of Phyllis.
 o dearly had I boughte my grene and youthful
 yeres,
 If in myne age I coulede not fynde, when *craft* for
 love appeares. *Surrey.*

What man so wise, what earthly witt so were,
 As to descry the *crafty* cunning traine
 By which deceipt doth maske in visour faire?
Spenser. Faerie Queene.

The bashfull blood her snowy cheekes did dye,
 That her became, as poliaht ivory,
 Which cunning *craftsman* hand hath overlaid,
 With fayre vermillion or pure castory. *Id.*

You've made fair hands,
 Yov and your *crafts*! You've *crafted* fair.
Shakespeare. Coriolanus.

The offence is holy that she hath committed;
 And this deceit loses the name of *craft*,
 Of disobedience, or unduteous title. *Id.*
 Nay, you may think my love was *crafty* love,
 And call it cunning. *Id. King John.*

What reverence he did throw away on slaves,
 Wooing poor *craftsmen* with the *craft* of smiles. *Id.*
 He is not his *craftsman*, he doth not do it right.
Id.

A poem is the work of the poet; poesy is his skill
 or *craft* of making the very fiction itself of the work.
Ben Jonson.

Long as the *crafty* cuttle lieth sure,
 In the blacke cloude of his thicke vomiture,
 Who list complaine of wronged faith or fame,
 When he may shift it to another's name. *Hall.*

One would think that all mankind had bound them-
 selves by an oath to do all the wickedness they can;
 that they had all (as the scripture speaks) "sold
 themselves to sin:" the difference only is, that some
 are a little more *crafty* (and but a little, God knows)
 in making of the bargain. *Cowley.*

Before he came in sight, the *crafty* god
 His wings dismissed, but still retained his rod.
Dryden.

No body was ever so cunning as to conceal their be-
 ing so; and every body is shy and distrustful of *crafty*
 men. *Locke.*

There is art in pride: a man might as soon learn a
 trade. Those who were not brought up to it, seldom
 prove their *craftsmaster*. *Collier on Pride.*

What a resemblance this advice carries to the ora-
 tion of Demetrius to his fellow *craftsmen*.
Decay of Piety.

May he not *craftily* infer
 The rule of friendship too severe,
 Which chain him to a hated trust;
 Which make him wretched to be just? *Prior.*

This gives us a full view of wonderful art and *craft*
 in raising such a structure of power and iniquity.
Ayliffe.

But say, in country life can *craft* be learned,
 Where knowledge opens, and exalts the soul?
Beattie.

There sit, involved and lost in curling clouds,
 Of Indian fume, and guzzling deep, the boor,
 The lackey, and the groom: the *craftsman* there
 Takes a Lethæan leave of all his toil. *Cowper.*

CRA'G, *n. s.* } Wel. & Celt. *craig*;
 CRA'GGED, *adj.* } Ang.-Sax. *cræg*, which
 CRA'GGEDNESS, *n. s.* } mean a rock; Swed.
 CRA'GGINESS, *n. s.* } *kröge*, a collar. Cra'gs
 CRA'GGY, *adj.* } are, in the first place,
 rough, steep, rocks; the rugged protuberances
 of rocks, in which case, the Welsh seems to be
 the parent word. Crag, in the second place,
 denotes the neck, and here we may derive it from
 the Swedish and the kindred dialects. In the
 latter sense, however, it is now applied only to a
 neck of mutton, which is familiarly known by
 the name of a crag or scrag. All the derivatives
 from crag imply steepness; ruggedness; being
 filled with prominences.

Upon the whiche also stode
 Of squard stone a sturdy wall,
 Which on a *cragge* was found in all.
Chaucer. The Romances of the Rose.

Under *craggy* rocks they have barren plains.
Wylt.

Ere long they come where that same wicked wight
 His dwelling has, low in an hollow cave,
 Far undeneath a *craggy* cleft ypitch.
Spenser. Faerie Queene.

They looken bigge as bulls that been late,
 And bearen the *crag* so stiff and so state.
Id. Shepherd's Calendar.

And as mount Etna vomits sulphur out,
 With cliffs of burning *craggs* and fire and smoke.
Fairfax.

It was impossible to pass up the woody and *craggy*
 hills, without the loss of these commanders.
Raleigh's Essays.

On a huge hill,
Cragged and steep, truth stands. *Crashaw.*
 Who hath disposed but thou, the winding way,
 Where springs down from the steepy *craggs* do beat.
Wotton.

The *craggedness* or steepness of that mountain,
 maketh many parts of it in a manner inaccessible.
Beverwood.

A lion spied a goat upon the *crag* of a high rock.
L' Estrange.

Mountaineers that from Severus came,
 And from the *craggy* cliffs of Tetrica. *Dryden.*

The town and republic of St. Marino stands on the
 top of a very high and *craggy* mountain.
Addison on Italy.

Oft did the cliffs reverberate the sound
Of parted fragments tumbling from on high ;
And from the summit of that *craggy* mound
The perching eagle oft was heard to cry,
Or on resounding wings to shoot athwart the sky.

Beattie.

Round the dark *crags* the murmuring whirlwinds
blow,
Woods groan above, and waters roar below. *Darwin.*

And thus a moon rolled on, and fair Haidee
Paid daily visits to her boy, and took
Such plentiful precautions, that still he
Remained unknown within his *craggy* nook.

Byron. Don Juan.

CRAIG (John), a Scotch mathematician who settled at Cambridge about 1680, and about 1685 held a dispute with the celebrated Bernouilli on the method of the quadrature of curved lines, and curvilinear figures. He had afterwards another contest with that great mathematician on a question in algebra, but discovering that he was wrong, he candidly acknowledged it in the Philosophical Transactions. He wrote several able pieces on mathematical subjects; but the most extraordinary one is entitled, *Theologia Christianæ Principia Mathematica*, first printed in 1699, at London, and at Leipsic, with a learned preface, in 1756, 4to. The design of this singular tract is to apply mathematical calculation to the gospel history; and he maintains, on this principle, that the Christian religion must end, according to the doctrine of chances A. D. 3150, when our Lord will make his second appearance to judgment. The abbé Houteville answered this tract, in a work entitled, *The Christian Religion proved by Facts*. The time of Craig's death is not known.

CRAIL, or CARYLE, an ancient royal borough in the parish of the same name, situated on the Frith of Forth, near Fifeness, with a small harbour. This town is mentioned by historians so early as the middle of the ninth century; and a battle was fought here between the Danes and the Scots. It received a charter from king Robert I. which was confirmed by new grants from Robert II., queen Mary, James VI., and Charles I. In the beginning of the eighth century, it was the great rendezvous for the herring fishery, but for fifty years past has gradually declined. It consists of two parallel streets extending east and west along the shore; which is here steep and high. The houses are fallen into decay, and the whole town bears evident marks of having seen better days. It lies seven miles south-east of St. Andrews.

CRAM, *v. a. & n.* Goth. and Swed. *krama*; Dan. *kramme*; Ang-Sax. *cramman*. To stuff; to force in too large a quantity; to thrust in by force; to eat to excess.

With boxes *crammed* ful of lyes,
As evir vessel was with lies.

Chaucer. The House of Fame.

As much love in rhyme,
As would be *crammed* up in a sheet of paper,
Writ on both sides the leaf, margent and all.

Shakespeare.

Thou hast spoke as if thy eldest son should be a
fool, whose skull Jove *cram* with brains.

Id. Twelfth Night.

You *cram* these words into mine ears, against the
stomach of my sense. *Id. Tempest.*

Cram not in people by sending too fast company
after company; but so as the number may live well
in the plantation, and not by surcharge be in penury.

Bacon.

Yet must he haunt his greedy landlord's hall
With often presents at each festival :
With *crammed* capons every new year's morn. *Hall.*

Huffer, quoth Hudibras, this word
Shall down thy false throat *cram* that word. *Hudibras.*

Reading furnishes the mind only with materials of
knowledge: it is thinking makes what we read ours.
We are of the ruminating kind, and it is not enough to
cram ourselves with a great load of collections; unless
we chew them over again, they will not give us
strength and nourishment. *Locke.*

Fate has *crammed* us all into one lease,
And that even now expiring. *Dryden's Cleomenes.*

You'd mollify a judge, would *cram* a squire;
Or else some smiles from court you may desire.

King.

But Annius, crafty seer,
Came *crammed* with capon from where Pollio dines.

Pope.

As a man may be eating all day, and, for want of
digestion, is never nourished; so these endless readers
may *cram* themselves in vain with intellectual food.

Watts on the Mind.

When the whole trading interest of this empire,
crammed into your lobbies, with a trembling and anxious
expectation, waited, almost to a winter's return of
light, their fate from your resolutions. *Burke.*

Where it [emulation] is wanting, in vain shall we
preach up to children the dignity and utility of know-
ledge: the true appetite for knowledge is wanting;
and, when that is the case, whatever is *crammed* into
the memory will rather surfeit and enfeeble, than im-
prove the understanding. *Beattie.*

CRAMBE, or CRAMBO, *n. s.* A cant word,
probably without etymology. A play at which
one gives a word, to which another finds a rhyme;
a rhyme.

So Mævius, when he drained his skull
To celebrate some suburb trull,
His similies in order set,
And every *crambo* he could get.

Swift.

CRAMBE, sea cabbage, sea-beach kale, or
sea colewort, in botany: a genus of the siliquosa
order, and tetradynamia class of plants; natural
order thirty-ninth, siliquosæ. The four longer
filaments are forked at top, with an anthera only
on one point of each; the fruit a dry, globose,
and deciduous berry. There are eight species,
all herbaceous esculents with perennial roots,
producing annually large leaves resembling those
of cabbage, spreading on the ground, with strong
flower-stalks and yellowish flowers. Only one of
these is a native of Britain. It grows wild on
the shores of many of the maritime counties of
England, but is cultivated in many gardens as a
choice esculent. Its principal season for use is
in April and May.

CRAMER (John Andrew), a celebrated met-
tallurgist, born at Quedlinburgh, in 1710. He is
said to have been the first who formed the art of
assaying into a system; and he composed an in-
genious work on the subject, entitled *Elementa
Artis Docimasticæ*, published in 1739, 8vo. He
also wrote an introduction to the care and ma-

agement of Forests, with a particular description of the method of Burning Charcoal, 1766, fol. and the Elements of Metallurgy, in two parts fol. He died near Dresden, in 1777.

CRAMER (John Andrew), a German divine of some celebrity, was born in 1713. He studied at Leipsic, where he became a lecturer, and published a weekly paper, entitled The Guardian Spirit. He commenced preacher in 1748, and was removed to Copenhagen, as chaplain to the court, in 1754, where he was appointed professor of theology in 1765; but was deprived of his places upon the disgrace of Struensee, after which he retired to Lubec. In 1774 he was re-established in Denmark, and received the appointment of divinity professor at Keil: at which place he died in 1788. He translated into German several of Chrysostom's works; also Bossuet's Universal History, with Dissertations. He likewise published an animated poetic version of the Psalms; besides sermons, odes, the life of Gillert, and various miscellaneous pieces. His poems are held in great estimation.

CRAMERIA, in botany, a genus of the monogynia order, and tetrandria class of plants: CAL. none: COR. four petals; the superior nectary is trifid, the inferior biphyllous: SEED. is a dry, monospermous, and echinated berry. Species one, a native of Japan.

CRAMP, *v. a., n. s. & adj.* } Fr. *crampe* ;
 CRAMP-FISH, *n. s.* } Goth. *kram* ;
 CRAMP-IRON, *n. s.* } Dan. *krampe* ;
 CRAMP-RINGS, *n. s.* } Swed. & Ger. *krampe*.
 To pain with cramps or twitches; to restrain; to obstruct; to compress into uncomfortably narrow bounds; to fasten with cramp-irons. Cramp is, a spasm or sudden contraction of the muscles of the limbs; a restriction; a hindrance; a piece of iron bent at each end, for holding together two bodies, called also a cramp-iron: as an adjective, it signifies, difficult; hard to be understood. Cramp-fish is the torpedo. Cramp-ring is a ring worn as a remedy for the cramp. The kings of England were formerly believed to have the power of blessing these rings on Good Friday, so as to give to them medicinal virtue!

But wel he felte about his hertid croupe,
 For every tere which that Cresceide asterte,
 The cramp of deth to straine him by the herte.
Chaucer. Troilus and Cresceide.

Or beem thy bagpipes ren far out of frame?
 Or hath the cramp thy joints benumbed with ache?
Spenser. Shepherd's Calendar.

The aged man that coffers up his gold,
 Is plagued with cramps, and gouts, and painful fits;
 And scarce hath eyes his treasure to behold.
Shakespeare. The Rape of Lucrece.

The cramp cometh of contraction of sinews; which is manifest, in that it cometh either by cold or dryness.
Bacon's Natural History.

It is impossible to conceive the number of inconveniencies that will ensue, if borrowing be cramped.
Bacon.

To the uppermost of these there should be fastened a sharp grapple, or cramp of iron, which may be apt to take hold of any place where it lights.
Wilkins.

There are few but find that some companies benumb and cramp them, so that in them they can neither speak nor do any thing that is handsome.

Glaucille's Scopia.
 A narrow fortune is a cramp to a great mind, and lays a man under incapacities of serving his friend.
L'Étrange.

When the contracted limbs were cramped, even then
 A waterish humour swelled, and oozed again.

Dryden's Virgil.
 The antiquaries are for *cramping* their subjects into as narrow a space as they can, and for reducing the whole extent of a science into a few general maxims.
Addison on Italy.

No more
 The expansive atmosphere is cramped with cold,
 But full of life, and vivifying soul. *Thomson's Spring.*

The diversified but connected fabric of universal justice is well *cramped* and bolted together in all its parts.
Berk.

O that unwelcome voice of heavenly love,
 Sad messenger of mercy from above!
 How does it grate upon his thankless ear,
 Crippling his pleasures with the cramp of fear!

Croper.
 SERJ. What's here!—a vile *cramp* hand! I cannot see
 Without my spectacles.

ATT. He means his fee.
 Nay, Mr. Serjeant, good sir, try again. *[Gives money.]*
Sheridan.

CRAMPONEE, in heraldry, an epithet given to a cross which has at each end a cramp or square piece coming from it; that from the arm in chief towards the sinister angle, that from the arm on that side downwards, that from the arm in base towards the dexter side, and from the dexter arm upwards.

CRANE, *v. a. & n. s.* } Anglo-Sax. *cræan* ;
 CRANAGE, } Dut. *kraan* ; Sw. *kran* ;
 A bird. See ARDEA. An instrument made with ropes and pulleys, for raising great weights; a syphon for drawing liquor out of a cask. Cranage, from low Lat. *cranagium*, signifies a liberty to use a crane for drawing up wares from the vessels, at any creek of the sea or wharf, unto the land, and to make profit of it. It signifies also the money paid and taken for the same.

Like a crane, or a swallow, so did I chatter. *Isiah.*
 The crane, the geant, with his tromps' soun.

Chaucer. The Assemble of Fowles.
 And stalking stately like a crane did stryde
 At every step upon the tiptoes hie.
Spenser. Faerie Queene.

That small infantry warred on by cranes. *Milton.*
 In case the mould about it be so ponderous as not to be removed by any ordinary force, you may then raise it with a crane. *Martini.*

Then commerce brought into the public walk
 The busy merchant, the big warehouse built,
 Raised the strong crane. *Thomson's Autumn.*

Meanwhile they trim their plumes for length of flight,
 Whet their keen beaks, and twisting claws, for fight;
 Each crane the pigmy power in thought o'erturns,
 And every bosom for the battle burns. *Beattie.*

CRANE, in ornithology, see ARDEA.
 CRANES, in practical mechanics, are connected with their entire history. What other name can we give to those early triumphs of scientific mechanism, the engines of Archimedes? To him

has been attributed the theory of the inclined plane, the pulley, and the screw: while the machines alluded to, by which he annoyed the Roman army, astonish modern mechanics with regard to their power. Polybius represents them as composed of a balance and powerful levers, but we have no detailed description of them. In the ancient theatres the gods descended in clouds by means of some contrivances of this kind. Vitruvius is the earliest explicit writer on the subject. He mentions a species of crane used for the lading and unlading of vessels, as well as for raising the heavier stones of a building, which was moved by men walking within a wheel, to which were attached pulleys, and on some occasions the aid of the capstan was employed; but the jib, or arm of the modern crane, seems to have been wanting.

Until a comparatively recent date all the cranes in ordinary use in this country were constructed nearly as follows:—The principal member was a strong upright beam or arbor, firmly fixed in the ground, and sustained by eight arms, coming from the extremities of four pieces of wood laid across, through the middle of which passes the foot of the beam. About the middle of the arbor the arms met, and were mortised into it; its top ending in an iron pivot, which bore a transverse piece, advancing out to a good distance, something after the manner of a crane's neck, whence indeed the machine had its name. This projecting piece was commonly called the jib or gibbet. The middle and extremities of this were again sustained by arms from the middle of the arbor: and over it came a rope or cable, to one end of which the weight was fixed; the other was wound about the spindle of a wheel, which when turned (commonly by means of men walking upon the inside of the rim of the wheel) drew the rope, and *that* heaved up the weight; which might afterwards be applied to any side or quarter by the mobility of the transverse piece on the pivot.

These cranes were usually of two kinds: in the first, called the *rat-tailed crane*, the whole machine with the load, turned upon a strong axis; in the second kind, the gibbet alone moved on its axis. In both kinds, when the machinery was put in motion by men walking within the wheel, as was the almost universal practice, the laborers employed were exposed to extreme danger, and frequently met with the most shocking and fatal accidents. From this principle of their first movement, these machines have been generally called *walking cranes*.

The late Mr. Ferguson invented a crane, which has three trundles, with different numbers of staves, that may be applied to the cogs of a horizontal wheel with an upright axle; round which is coiled the rope that draws up the weight. This wheel has ninety-six cogs; the largest trundle twenty-four staves, the next twelve, and the smallest six; so that the largest revolves four times for one revolution of the wheel, the next eight, and the smallest sixteen. A winch is occasionally fixed on the axis of either of these trundles for turning it; and is applied to the one or the other, according as the weight to be raised is smaller or larger. While

this is drawing up, the ratch-teeth of a wheel slip round below a catch that falls into them, prevents the crane from turning backwards, and detains the weight in any part of its ascent, if the man who works at the winch should accidentally quit his hold, or wish to rest himself before the weight is completely raised. Making a due allowance for friction, a man may raise by such a crane, from three times to twelve times as much in weight as would balance his effort at the winch, viz. from ninety to 360 lbs., taking the average labor.

All cranes in which chains are used should be provided with barrels with a spiral groove cut in them, and the lower half of the chain run in the groove. This was applied in 1789 by Mr. John Smeaton, to a crane designed by him, and executed at the Wool-quay, Custom-house, and found to be a great advantage.

In 1792 Mr. James White, of Chevening, Kent, invented a crane for wharfs, for which he received the premium of the Society of Arts, and which was a decided improvement upon the walking crane. See plate CRANES, fig. 1. Its properties are these:—1. It is simple, consisting of a mere wheel and axle. 2. Its only friction, exclusive of the pulleys, is that on the two gudgeons of the shaft; and one of these supports the weight of the wheel, and of the man who works it, nearly in the direction of its point. 3. It is durable. 4. It is safe, for it cannot work but during the pleasure of the man, and while he is actually pressing on the gripe lever. 5. It admits of an almost infinite variety of different powers; and this variation is obtained without the least alteration of any part of the machine. If in unloading a vessel, there should be found goods of every weight, from a few hundreds to a ton and upwards, the man who does the work will be able so to adapt his strength to each, as to raise it in a time inversely proportionate to its weight; he walking always with the same velocity, as nature and his greatest ease may teach him. It is a great disadvantage in some cranes, that the smallest weight must be as long in raising as the largest, unless the man turn or walk on with a greater velocity, which tires him in proportion. In other cranes two or three different powers may be procured, to obtain which, some pinion must be shifted, or fresh handle applied. But in this crane, if the laborer find his load so heavy as not to permit him to ascend without turning, let him only move a step or two towards the circumference, and he will be fully equal to the task. Again, if the load be so light as scarcely to resist the action of his feet, and thus oblige him to run through so much space, as to tire him beyond necessity, let him move laterally towards the centre, and he will soon feel the place, where his strength will suffer the least fatigue, by raising the load in question. If left alone, this crane will reduce itself to a state of rest, even though a weight were suspended to it. The means are, the gripe or brake at the top, and its lever, which stretches across the diameter of the wheel, at the height of a man's breast, when in an attitude of treading the wheel. The frame of the crane may be considered as part of the house in which it is placed,

and is almost unnecessary where such a crane is to be erected in a house already built. In warehouses this crane would be extremely simple and cheap; as the wheel, though of considerable diameter, occupies but little room, from its thinness and inclination. A slit in a floor about two feet wide, with a support above and below for the axis, is all that is necessary to constitute and contain the crane: for goods may be stowed both under the whole wheel, and above nearly half of it; and there would be ample room to stow a large quantity of goods properly sheltered from the weather. Hence, the house would diminish the wharf room much less than many others. One man's weight alone, applied at the extremity of the wheel, would raise upwards of a ton; and a single-sheaved block would double that power: and this wheel will give as great advantage, at any point of its plane, as a common walking wheel of equal diameter; as the inclination can be varied at pleasure. A represents a circular inclined plane, moving on a pivot underneath it, and carrying round with it the axis E. A person walking on this plane, and pressing against the lever B, throws off the gripe D, by means of an iron rod C, and thus admits the plane and its axis to move freely, and raise the weight G, by the coiling of the rope F round the axis E. To show more clearly the construction and action of the lever and gripe, a plan of the circular inclined plane is added, fig. 2; where B represents the lever, D the spring or gripe. In this plan, when the lever B is in the situation it now appears in, the spring or gripe D presses against the periphery of the plane, as shown by the double line; and the machine cannot move but when the lever B is pressed out to the dotted line H. The gripe is also thrown off to the dotted line I, and the whole machine left at liberty to move. One end of a rope of a proper length is fixed near the end of the lever B, and the other end made fast to one of the uprights, serving to prevent the lever from moving too far, when pressed by the man.

In 1805 Mr. Gilbert Gilpin received the silver medal of the Society of Arts for the invention, in fact, of Mr. Smeaton, above alluded to; the society appearing ignorant that it had been used before. The pulleys were in this machine grooved to receive the lower half of the alternate links of the chain in the same manner as in Mr. Smeaton's. But Mr. Gilpin farther proposes, that the lower pivot on which the vertical arbor of the crane turns, instead of being fixed to that shaft, and turning in a bush or socket fastened in the nether block, shall be fixed in that block, while a socket in the lower part of the shaft shall be made to fit it, and turn about it.

Many practical and scientific men have thought highly of Mr. D. Hardie's crane, of St. James's Street. It will be seen to be on the very principle of the modern tread-mill.

This crane is in fact the same kind of walking-wheel as is used in China for working at the chain-pump, in raising water to the higher grounds employed in the culture of rice. The wheel is six feet in diameter, and may vary in length from six to twelve or more feet, according to the number of men intended to be employed

in working it; on the outside of the wheel are placed twenty-four equidistant steps, after the manner of float-boards in a mill water-wheel; these are for the men to tread upon, where the steps are found at a height rather exceeding that of the axis, or just above the position where the plane of the steps becomes horizontal. At one end of the wheel, and upon its axle, is the crane-ropes barrel, of a diameter suited to the draft of goods, and the number of men generally allowed. The men ascend by a flight of steps to a platform on the same horizontal plane as the axle of the wheel, and which reaches to within a few inches of its rim; on this platform is a seat, on which the men may rest themselves at the intervals between the operations. On the general framework which supports the wheel, there are placed above it, at suitable distances and convenient heights, both vertical and horizontal handles for the men to take hold of with both hands, when treading on the steps; sometimes both hands are applied to the vertical handles; at others, one hand to a vertical, and the other to a horizontal handle; at others, both hands to the horizontal handles; thus producing by either pushing or lifting, or both, a variety in the action, and, when necessary, a considerable augmentation to the force. There is a pawl which drops in at every step to prevent the wheel and its incumbent weight from overpowering the men at any time; it has at its lower part a cord with a loop to pass over one of the horizontal handles, near the extremity of which there is a notch sufficiently deep to retain the loop when drawn into it, for the purpose of raising the pawl to disengage it from the wheel preparatory to any operation of lowering. It is obvious, that by treading on the steps as they arrive at the position just above the horizontal plane passing through the axis, the men both ascend and descend nearly in the same vertical direction, of consequence the greatest possible velocity is produced without any unproductive labor; and the men are enabled to maintain the action by means of a hold of an upright handle in each hand, or occasionally to augment the action by pushing at these handles. Further, by taking hold of the horizontal handles, each man can, by an act similar to that of lifting, augment the force arising from his weight through all the degrees from about 150 to 300 lbs.; so that the same number of men can perform many operations of raising greater drafts than usual: such as with the common walking wheel or most other cranes could not be accomplished without additional men; and the pawl which drops in each step provides in the most effectual manner for the safety of the men; besides, that the distance between the edge of the platform and the revolving wheel is by no means large enough for a man to fall through.

Mr. Hardie has likewise contrived a method of operating without a gibbet, in which he places the crane at the top of the warehouse so as to allow the crane-ropes to drop directly down from the barrel of the crane in front of the loop-holes; and at the upper floors, where the shortness of the rope diminishes the swing of the goods in or out of the loop-hole, he has provided a sliding floor immediately under the floor of the ware-

CRANES.

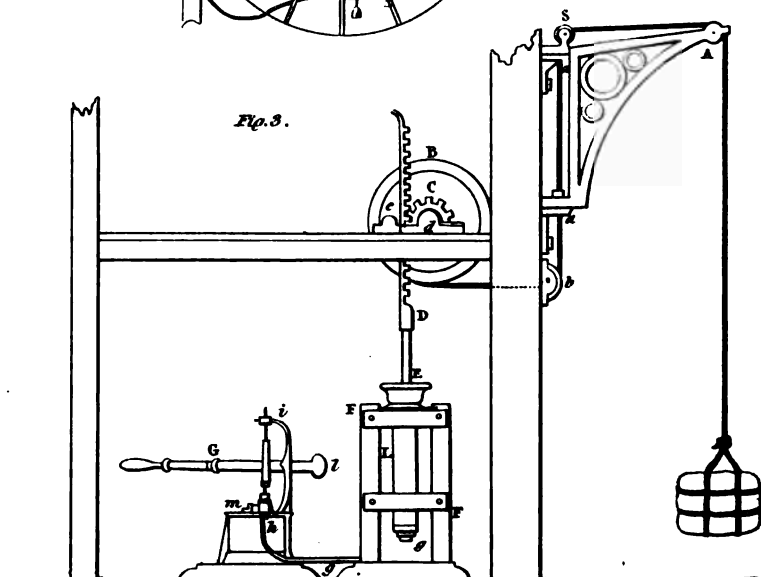
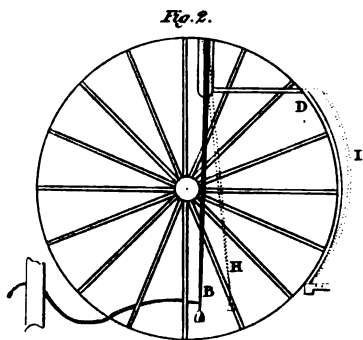
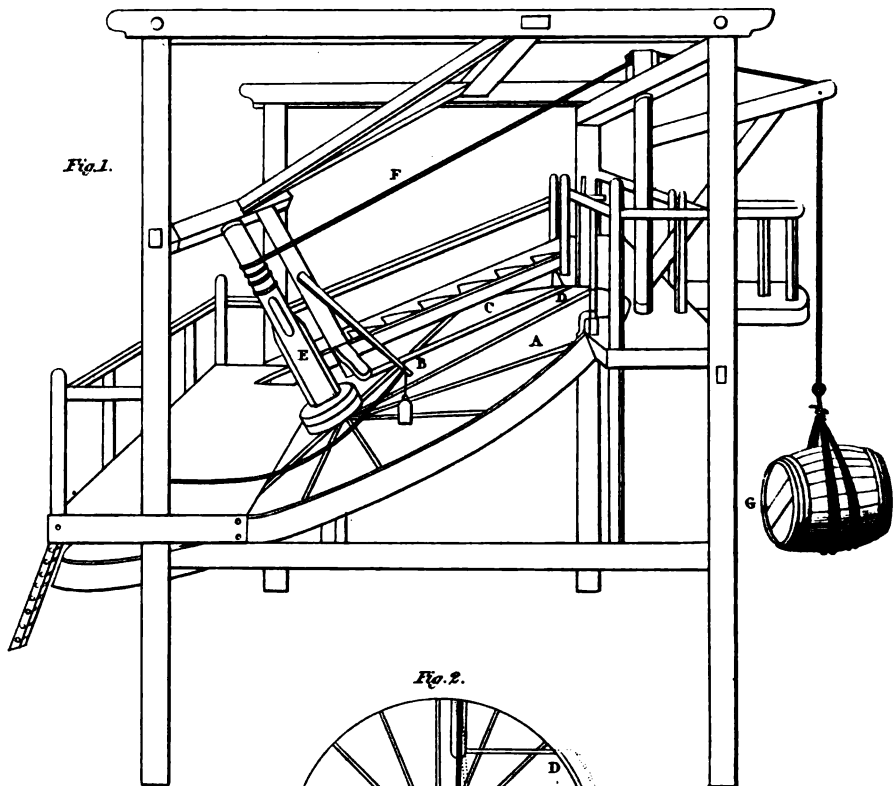

house, which one man draws out or in, by pulling a cord, with the greatest ease, to receive or deliver the goods by a truck at the loop-hole. The part of the warehouse floor which is immediately above the sliding-floor, consists of a thin plate of cast iron, which allows the truck to run off the one on the other, without any sensible obstruction. Thus more than one man's labor in five or six is saved by getting quit of the friction of the pulley of a gibbet; and a still greater saving of labor is effected by accelerating all the movements at the loop-holes.

Mr. Hardie's lowering regulator is invented for the special purpose of removing the evils and dangers attendant upon the usual practice of lowering goods by the brake and brake-wheel. The part essential to this invention is a cast-iron box, fixed firmly to a floor, and divided into two cylindrical compartments; each ten inches long, one of four inches diameter, and the other of two inches diameter: these are both filled with oil, a liquid not subject to any material change by frost; or they may be filled with water in summer and mild weather, and some spirituous liquor (gin for instance) in frosty weather. These two cylinders communicate by apertures at their top and bottom; the smaller compartment having a cock with its axle passing through the side of the iron box, guarded by a stuffing-box, and a quadrant with equidistant notches fixed at its end, to receive an iron claw which retains the cock in any proposed situation, and shows the extent of its apertures when opened. The larger compartment has a piston, with its rod passing through the top of the iron box (guarded here also by a stuffing-box), and passing through a guide; this rod is connected with a joint moved by a crank, which is turned by a pinion of about six teeth, and this pinion is moved by a wheel of a size suited to the diameter of the barrel of the crane, and the weight of the goods commonly lowered: this latter wheel is fixed to the axle of the crane by a simple mode of connexion, which admits of its being disengaged during the operation of raising; it is also provided with the barrel-rope and counter-weight, which are commonly used for the purpose of winding up the slack crane-rope on the barrel of the crane, to be ready to repeat the operation of lowering.

Now if the cock were quite shut, the oil or other liquid confined between it and the piston would prevent the piston from moving, and of course hinder the goods hanging from the wheel, &c. connected with the pinion from descending: but, if the cock were opened a very little, the oil would pass slowly through it, and would therefore allow the piston to move up and down slowly, and the goods to descend slowly also; and in like manner a farther opening of the cock, will permit the load to descend with a greater velocity; thus the cock, by being more or less opened, gives the precise velocity desired to the descent of the goods, whatever their weight may be.

The advantages resulting from these inventions are too obvious to require our dwelling upon them. Although the crane is a walking-crane, yet it is free from the dangers and disadvantages of the common walking-wheel; for as the men

walk on the outside of the wheel instead of inside of the rim, they are, in consequence of the adjoining platform, and the use of the pawl, free from danger; while, during the whole time of their labor, they can walk in an upright posture, well suited to free respiration; and farther, as they act at the extremities of horizontal levers, their weight and occasional muscular force act with all the advantages they can have; while the modifications they can make at pleasure in their action, will frequently supersede the necessity of calling in any more men, even when a double load is to be raised. Indeed, there can be no doubt that with a crane of this construction, any given number of men will raise at least twice as much in a day, as they could in a common walking wheel, or working at a capstan, or at a wheel and pinion. And as to the lowering apparatus, it possesses a much higher degree of perfection in lowering than any of the other cranes. The means afforded of regulating it to lower either small or great weights with facility, expedition, and safety, and without depending during the operation on the precarious attention and management of a man, render it in our opinion far preferable to the hazardous and limited mode of lowering goods by the brake; while, with respect both to safety and great saving of labor, it obviously surpasses the modes of lowering by the capstan and the walking-wheel, which require nearly the same number of men to lower that they take to raise any weight.

It appears that Mr. Ferguson, the late popular lecturer on mechanics, first suggested the application of the vertical rollers above the axis or upper gudgeon of the jib. These ought so to be placed, that, if the rope be stretched close by their outermost sides, the half thickness of the rope may be perpendicularly over the upper gudgeon of the jib; for then the length of the rope, between the pulley in the jib and the axle of the great wheel of the machine, will be always the same, in all positions of the jib; and the jib will consequently remain in any position to which it may be turned; and they thus let the rope bend upon them as the jib is turned to either side. Almost all the jibs of the London warehouse cranes are constructed in this manner, the wheel-work being in the interior of the premises.

A useful crane, connected with the action of a capstan is in much use; and has been thus described. At the extremity of a beam, supported horizontally ten or twelve feet from the ground, is the upper pivot of a jib supported, the lower pivot resting on a post fixed in the ground. The jib is formed of a triangular frame and perpendicular sides, moving upon pivots on a vertical axis of motion. At an angle of about 90° or upwards, a beam is projected from near the upper end of the perpendicular part of the jib, and forming the upper side of the triangle. The third side is formed by a strong brace projected from near the foot of the perpendicular post, towards the extremity of the upper beam. From this extremity the weight is suspended by a rope passing over a pulley: the other end of the rope is wound round a vertical roller or capstan turning on pivots, one of which

is supported by the horizontal beam first mentioned; the other on a post. Horizontal levers move this capstan capable of receiving as many men or horses as may be thought proper. The power is sometimes increased by the application at the jib of additional pulleys or blocks. For Mr. Heriot, of the Thames police office, has been claimed the original suggestion of applying the hydrostatic principle to cranes. Mr. Bramah, however, it is clear, first carried it into practice. The hydrostatic paradox, in fact, on which his machine is constructed, has been known for ages.

The simplest form of it is a machine to raise a heavy weight to a small height. A metallic cylinder, sufficiently strong, and bored cylindrical within, has a solid piston fixed into it, which is made perfectly watertight, by a leather or other packing, round its edge. In the bottom of the cylinder is inserted the end of a small tube, by means of which water, or any other fluid, may be introduced from a forcing pump. This pump is of course provided with valves to prevent the return of the water. If we suppose the diameter of the cylinder to be six inches, and the diameter of the piston of the small pump or injector only one quarter of an inch; the proportions between the two surfaces or ends of the pistons will be as the squares of their diameters, which are as 1 to 24; therefore the areas will be as 1 to 576; and supposing the intermediate space between them to be filled with water, or any other dense and incompressible fluid, any force applied to the small piston will operate on the other in the proportion of 1 to 576. Suppose the small piston, or injector, to be forced down, with a weight of 20 cwt., which can easily be done by means of a long lever, the piston of the great cylinder would then be moved up with a force equal to 1 ton multiplied by 576.

Figure 2, plate CRANES, represents a crane constructed upon the hydrostatic principle; that is by the injection of water from a small pump into a large cylinder, which is fitted with a piston, having a rack attached to it for the purpose of turning a pinion upon the axis of a large drum-wheel or barrel, round which the rope is coiled, and from thence passes to the jib. A represents the jib, made of iron, and supported upon two brackets *a, a*, projecting from the wall of the warehouse in which the crane is supposed to be erected. The rope passes over the pulley *S*, and down through holes in the brackets *a, a*, then turns under the pulley *b*, and comes to the lower side of the great drum-wheel *B*. The pinion *C* is fixed on the same axis with this, and its gudgeons turn in small iron frames *d*, bolted down to the floor of the warehouse. The pinion *C* is actuated by the teeth of the rack *D*; and a small roller, whose pivot is shown at *e*, presses against the back of the rack, to keep its teeth up to the pinion. The rack is attached to the piston *D*, of the cylinder *E*, in which the power for working the crane is obtained. The piston passes through a tight collar of leather on the top of the cylinder *E*, which does not admit of any leakage by the side of it; and, therefore, if any water is forced into the cylinder, it must protrude the piston from it. The cylinder is supported in a wooden frame *F, F*, and has a small copper pipe *g, g*, proceeding from the lower end of it.

communicating with a small forcing pump at *h*; this stands in an iron cistern, *H*, which contains the water, and sustains the standard *i*, for the centre of the handle *G*, with which the pump is worked by one or two men. The upper extremity of the standard, *i*, guides the piston rod of the pump to confine it to a vertical motion; *l* is a weight to balance the handle, *G*, of the pump. From what we have said before, the operation of this machine is evident; the power of the cylinder *D*, is in proportion to its size, compared with the size of the pump; but, as it only acts through short limits, the pinion and drum *B* are necessary to raise the weight a sufficient height. The operation of lowering goods by this crane is extremely simple, as it is only necessary to open a cock at *m*, which suffers the water to escape from the cylinder into the cistern *H*, and the weight descends, but under the most perfect command of the person who regulates the opening of the cock; for, by diminishing the aperture, he can increase the resistance at pleasure, or stop it altogether.

CRANES-BILL, *n. s.* From crane and bill. An herb. See GERANIUM. A pair of pliers terminating in a point, used by surgeons.

CRANGANORE, a town and district of India, in the country of Cochin, situated on the coast of Malabar, with an irregular fortress, built by the Portuguese. Jews are said to have been found in good circumstances at Cranganore so early as A. D. 490. In 1505 the Portuguese erected a fortress here, of which the Dutch obtained possession in 1663. The diocese of the Roman Catholic archbishop of Cranganore, extends from Mount Dilly towards Cochin. Most of the inland churches, formerly belonging to the Nestorian community, are included in it, and the see comprehends eighty-nine churches. In 1789 the Dutch sold Cranganore to the rajah of Travancore. But Tippoo disputing their right to dispose of it, a war ensued between him and the rajah; who being powerfully supported by the British and their allies, the nizam of the Deccan, and the Mahrattas, Tippoo was reduced to the necessity of ceding one half of his dominions to the confederate powers, and to pay, in 1792, above three crores of rupees towards the expenses of the war. Cranganore is twenty-four miles north by west of Cochin, and fifty-eight S. S. W. of Calicut.

CRANIOLARIA, in botany, a genus of the angiospermia order, and didynamia class of plants; natural order fortieth, perispermate: cal. double, the under one tetraphyllous, the upper one a monophyllous spathe: cor. of the tube very long: caps. almost the same with that of the martyria. There are two species, both natives of hot climates.

CRANIOLOGY. See PHRENOLOGY, its more modern, and said to be its more proper name. We only fear that, before the period of our arriving at that article, the science will have evaporated.

CRANIUM, *n. s.* Lat. The skull.

In wounds made by contusion, when the cranium is a little naked, you ought not presently to expose it in doasis; for if that contused flesh be well digested, the bone will incrust with the wound without much difficulty.

Wizeman's Surgery

CRANIUM, the skull. See **ANATOMY**. The word comes from the Greek *κρανιον*, of *κρανος*, galea, a helmet: because it serves to defend the brain like a head-piece. Pezron, however, derives *κρανιον* from the Celtic *cren*, because of its roundness.

CRANK, *v. n., n. s. & adj.* } Etymologists
CRA'NKLE, *v. n. & n. s.* } differ greatly as
CRA'NKLES, *n. s.* } to the etymon of
CRA'NKNESS, *n. s.* } crank, and some of their guesses are abundantly absurd. Perhaps the root of crank and crangle may be found in the Swedish verb *kranka*, to violate; to in-tringe. To crank and to crangle signify, to run in and out; to run into windings; to break into unequal surfaces or angles, which may be considered as a violating, or intringing upon, the circumjacent parts. Shakspeare makes Hotspur say,

See how this river comes me *cranking* in,
 And cuts me from the best of all my land
 A huge half moon, a monstrous castle out.

Shakspeare. Henry IV.

A crank is, any bending or winding passage; a conceit, formed by twisting a word in any manner; the end of an iron axis turned square down, and again turned square to the first turning down; so that on the last turning down a leather thong is slipt, to tread the treadle-wheel about. As an adjective, crank is, healthy; sprightly; from the Dutch *onkrank*, says Skinner, which means not sick, but Serenius refers it to Goth. *kranger*, bold, daring. A ship is also said to be crank, when by the form of its bottom, or from being too much loaded above, it is liable to be upset. Crankles are, inequalities; angular prominences.

And for the house is *crenelid* to and fro,
 And hath so quaint wayis for to go,
 For it is shapin as the mase is wrought,
 Therto have I a remedy in my thought.

Chaucer. The Legendes of Ariadne.

So many turning *crankes* these have, so many
 crookes. *Spenser. Faerie Queene.*

They looken bigge, as bulls that ben bate,
 And bearen the crag so stiff and so state
 As cocke on his dunghill crowing *cranks.* *Spenser.*

I send it through the rivers of your blood,
 Even to the court, the heart to the seat o' the brain;
 And through the *cranks* and offices of man,
 The strongest nerves, and small inferiour veins,
 From me receive that natural competency,
 Whereby they live. *Shakspeare. Coriolanus.*

Haste thee, nymph, and bring with thee
 Jest and youthful jollity,
 Quibs and *cranks*, and wanton wiles,
 Nods and becks, and wreathed smiles,
 Such as hang on Hebe's cheek,
 And love to live in dimple sleek. *Milton.*
 Old Vaga's stream,

Forced by the sudden shock, her wonted track
 Forsook, and drew her humid train aslope,
Crankling her banks. *Philips.*

In plying down the river, the Resolution was found to be very *crank*, which made it necessary to put into Sheerness in order to remove this evil, by making some alteration in her upper works. *Cook's Voyage.*

CRANMER (Thomas), a celebrated reformer and martyr of the Reformation, was the son of Thomas Cranmer, Esq., of Aslacton, in Notting-

hamshire, where he was born in 1489. At the age of fourteen he was admitted a student of Jesus College, Cambridge, of which he afterwards became fellow; but vacated his fellowship, and quitted the college, on his marriage. On the death of his wife he was re-admitted. In 1523 he took the degree of D.D. and was made theological lecturer and examiner. The plague being now at Cambridge, he retired to the house of a relation at Waltham Abbey, where, meeting with Fox the king's almoner, and Gardiner the secretary, he expressed an opinion concerning the great question of Henry VIII.'s marriage, which was reported to the king. This was, that, instead of disputing about the validity of the marriage with Catharine, they should reduce the matter to this simple question, 'Whether a man may marry his brother's wife or not?' When the king was told of it, he exclaimed, 'This fellow has got the right sow by the ear;' sent for him to court, and made him one of his chaplains. He was also directed to compose a vindication of the intended divorce; and sent to France, Italy, and Germany, to dispute the matter with the divines of those countries. At Nuremberg Cranmer married a second wife. Returning to England in March 1533, he was consecrated archbishop of Canterbury; in May following he pronounced the sentence of divorce between the king and queen; and soon after married the amorous monarch to Ann Boleyn. Being now at the head of the church, he exerted himself in the business of the Reformation. The Bible was translated into English, and monasteries were dissolved principally by his means. In 1536, the royal conscience again requiring his assistance, he divorced the king from Ann Boleyn. In 1537 he visited his diocese, and endeavoured to abolish the superstitious observation of holidays. In 1539 he and some of the bishops fell under the king's displeasure, because they would not give their consent in parliament that the monasteries should be suppressed for the king's sole use. He also strenuously opposed the act for the six articles in the house of lords, speaking three days against it; and, upon its passing, sent away his wife into Germany. In 1540 he was one of the commissioners for inspecting into matters of religion, and explaining some of its chief doctrines. The result of their commission was the book entitled *A Necessary Doctrine and Erudition for any Christen Man*. After Lord Cromwell's death (in whose behalf he had written to the king) he retired and lived in great privacy. In 1541 he gave orders for taking away superstitious shrines; and, exchanging Bishopsbourne for Bekebourne, united the latter to his diocese. In 1542 he procured the 'Act for the advancement of true religion and the abolishment of the contrary,' which moderated the rigor of the six articles. The king continued, afterwards to protect him from his enemies; and at his death appointed him one of the executors of his will, and one of the regents of the kingdom. In 1546 he crowned Edward VI. during whose short reign he promoted the Reformation to the utmost of his power; and was particularly instrumental in composing, correcting, and establishing the liturgy. He assisted also in compiling the thirty-

nine articles. In 1553 he opposed the settlement of the crown upon lady Jane Grey, though at last, through importunity, he was prevailed upon to consent to it. Upon queen Mary's accession, he was committed to the Tower; partly for his connexion with the attempt of lady Jane, and partly for the public offer he had made of justifying openly the late religious proceedings. Some of his friends advised him to fly, but he refused. In the ensuing parliament (November 3) he was attainted, and found guilty of high treason. In April, 1554, he was removed with Ridley and Latimer to Oxford, for a public disputation with the papists; in which, as in most similar cases, it was already decided by the higher powers who was to obtain the victory. On the 20th of April, two days after the close of these disputations, Cranmer and the two others were brought before the commissioners, and asked, Whether they would subscribe to popery? which they unanimously refusing, were condemned as heretics. From this sentence the archbishop appealed to the just judgment of the Almighty; and wrote to the council, giving them an account of the disputation, and desiring the queen's pardon for his treason, which it seems was not yet remitted. Some of his friends petitioned the queen in his behalf; reminding her that he had once preserved her in her father's time, by his earnest intercessions. All solicitations, however, were ineffectual; and the archbishop being degraded and most ignominiously treated, was at last flattered and terrified into an insincere recantation and renunciation of the Protestant faith. But this triumph was not sufficient to gratify the pious vengeance of the Romanists. On the 24th of February, 1556, a writ was signed for his being burnt at the stake; and, on the 24th of March, he was brought to St. Mary's church, and placed on a kind of stage over against the pulpit, where Dr. Cole was appointed to preach a sermon on the occasion. While Cole was haranguing, Cranmer evinced great inward emotion; frequently lifting up his hands and eyes to heaven, and shedding tears. At the end of the sermon, when Cole desired him to make an open profession of his faith, as he had promised he would, he first prayed in the most fervent manner; then made an exhortation to the people present, not to set their minds upon the world, to love each other, and to be charitable. After this he made a confession of his faith, beginning with the creed, and concluding with these words: 'And I believe every word and sentence taught by our Saviour Jesus Christ, his apostles and prophets, in the Old and New Testaments.—And now, added he, 'I come to the great thing that so much troubled my conscience, more than any thing I ever did or said in my whole life; and that is, the setting abroad a writing contrary to the truth, which I here now renounce, as things written with my hand contrary to the truth which I thought in my heart; and written for fear of death, and to save my life if it might be: that is, all such bills and papers which I have written or signed with my hand since my degradation, wherein I have written many things untrue. And forasmuch as my hand offended, writing contrary to my heart, my hand shall first be punished; for, may I come to

the fire, it shall be first burnt. As for the pope I refuse him, as Christ's enemy and antichrist with all his false doctrine. And as for the sacrament, I believe as I have taught in my book against the bishop of Winchester.' Thunder-struck with this unexpected declaration, lord Williams and the papists around admonished him not to dissemble. 'Ah!' replied he, 'since I lived hitherto, I have been a hater of falsehood, and a lover of simplicity, and never before this time have I dissembled,' and wept again. On this the party round the stage, being admonished by Cole from the pulpit to stop the heretic's mouth and take him away, pulled him down, and hurried him to the place of execution, near Baliol College. Here, being fastened with his shirt to the stake, and pressed to agree to his former recantation, he answered, stretching forth his right hand, 'This is the hand that wrote it, and therefore it shall first suffer punishment.' Fire being applied to him, he plunged his right hand into the flame, and held it there unmoved (except that he wiped his face with it once) till it was consumed; crying with a loud voice, 'This hand hath offended;' and often repeating, 'This unworthy right hand.' The fire increasing, he soon expired, never moving or crying out; but keeping his eyes raised towards heaven, and repeating more than once, 'Lord Jesus, receive my spirit.' His heart is said to have been found unconsumed among the ashes. Mr. Gilpin says, 'he left behind him a widow and children; but as he always kept his family in obscurity for prudential reasons, we know little about them. They had been kindly provided for by Henry VIII; who, without any solicitation from the primate, gave him a considerable grant from the abbey of Wulbeck, which his family enjoyed after his decease. King Edward VI. made some addition to his private fortune; and his heirs were restored in blood by an act of parliament in the reign of Elizabeth.' The same writer well observes, 'The character of the archbishop has been equally the subject of exaggerated praise, and of undeserved censure. The most indefensible parts of it are, the readiness with which he sometimes concurred in the unjustifiable proceedings of Henry VIII., and the instances wherein he showed himself to be actuated by intolerant principles. But the cause animated him. With the illegality of the king's marriage, he endeavoured virtually to establish the insufficiency of the pope's dispensation; and the latter was an argument so near his heart, that it seems to have added merit to the former. We cannot indeed account for his embarking so zealously in this business, without supposing his principal motive was to free his country from the tyranny of Rome, to which this step very evidently led. So desirable an end would in some degree, he might imagine, sanctify the means.' One of the most honorable actions of his life was the firm stand that he made against the six articles. This act was so strongly supported by the king, that even the Protestants in parliament made little opposition to it. But Cranmer opposed it with great zeal and steadiness. 'The good archbishop,' says Mr. Gilpin, 'never appeared in a more truly Christian light than on this occasion. In the midst of so general

a defection, he alone made a stand. Three days he maintained his ground, and baffled the arguments of all opposers. But argument was not their weapon, and the archbishop saw himself obliged to sink under superior power. Henry ordered him to leave the house. The primate refused: 'It was God's business,' he said, 'and not man's.' And when he could do no more, he boldly entered his protest. Such an instance of fortitude is sufficient to wipe off many of those courtly stains which have fastened on his memory. His behaviour in the case of the duke of Norfolk also was truly magnanimous. He was indeed remarkable for the placability of his temper, and for showing kindness to those by whom he had been greatly injured. Hence it is mentioned in Shakspeare's Henry VIII., as a common saying concerning him:

— 'Do my Lord of Canterbury
But one shrewd turn, and he's your friend for ever.'

Of the learning of archbishop Cranmer, Mr. Gilpin remarks that 'it was chiefly confined to his profession. He had applied himself in Cambridge to the study of the Greek and Hebrew languages; which, though esteemed at that time as the mark of heresy, appeared to him the only sources of attaining a critical knowledge of the Scriptures. And he had so accurately studied canon law, that he was esteemed the best canonist in England. He was a sensible writer, rather nervous than elegant. His writings were entirely confined to the great controversy which then subsisted, and contain the whole sum of the theological learning of those times.'

Dr. Southey says of his death, 'Of all the martyrdoms during this great persecution, this was in all its circumstances the most injurious to the Romish cause. It was a manifestation of inveterate and deadly malice towards one who had borne his elevation with almost unexemplary meekness. It effectually disproved the argument on which the Romanists rested, that the constancy of our martyrs proceeded not from confidence in their faith, and the strength which they derived therefrom; but from vain glory, the pride of consistency, and the shame of retracting what they had so long professed. Such deceitful reasoning could have no place here: Cranmer had retracted; and the sincerity of his contrition for that sin was too plain to be denied; too public to be concealed; too memorable ever to be forgotten. The agony of his repentance had been seen by thousands; and tens of thousands had witnessed how, when that agony was past, he stood calm and immovable amid the flames; a patient and willing holocaust; triumphant, not over his persecutors alone, but over himself, over the mind as well as the body, over fear, and weakness, and death.'

CRA'NNY, *n. s.* } Fr. *cren*; Latin *crena*;
CRA'NNIED, *adj.* } *κρηνη*. A chink; slit;
fissure. Full of chinks.

Revealing day through every *cranny* spies,
And seems to point her out where she sits weeping.
Shakspeare. The Rape of Lucrece.

A wall it is, as I would have you think,
That had in it a *crannied* hole or chink.
Id. Minsummer Nights Dream.

The eye of the understanding is like the eye of the sense; for as you may see great objects through small *crannies* or holes, so you may see great axioms of nature through small and contemptible instances.

Bacon's Natural History.

A very fair fruit, and not unlike a citron; but somewhat rougher chopt and *crannied*, vulgarly conceived the marks of Adam's teeth.

Browne's Vulgar Errors.

And therefore beat and laid about,
To find a *cranny* to creep out. *Hudibras.*

In a firm building the cavities ought not to be filled with rubbish, but with brick or stone, fitted to the *crannies*. *Dryden.*

Within the soaking of water and springs, with streams and currents in the veins and *crannies*.

Burnet's Theory.

He skipped from room to room, ran up stairs and down stairs, from the kitchen to the garrets, and he peeped into every *cranny*. *Arbutnot's John Bull.*

The light of the moon may gleam unexpectedly through a *cranny*, and, where it falls on the broken pavement, form an appearance not unlike a human face illuminated, or a naked human body, which the peasant, whose chance it is to see it, may readily mistake for a ghost, or some other tremendous being.

Beattie.

For 'tis a truth well known to most,
That whatsoever thing is lost,
We seek it, ere it come to light,
In every *cranny* but the right. *Cowper.*

CRANTARA, among the ancient Britons, was a sort of military signal used for collecting the distant and scattered warriors to the standard of their chief. It was generally a stick burnt at the end and dipped in the blood of a goat, which was sent by a swift messenger to the nearest hamlet, where, being delivered in silence, it was understood to denounce destruction by fire and sword to all who did not obey the summons, and was carried with great rapidity from village to village.

CRANTOR, a Greek philosopher and poet, born at Solos in Cilicia. He left his native country and went to Athens, and there studied with Polemon under Xenocrates. He was considered as one of the chief supporters of the Platonic sect; and was the first who wrote commentaries upon Plato's works. He flourished about A. A. C. 270.

CRANTS, *n. s.* Icel. *kranis*; Swed. *kranis*; Dutch *kranis*; Ger. *kranz*. Garlands carried before the coffin of a maiden, and suspended over her grave.

Yet here she is allowed her virgin *crants*,
Her maiden strewments, and the bringing home
Of bell and burial. *Shakspeare. Hamlet.*

CRAPE, *n. s.* Fr. *crêpe*, *crêpe*; Ital. *crispio*; low Lat. *crepa*. A thin stuff, loosely woven, of which the dress of the clergy is sometimes made, and which is also used in mourning dresses. In the quotation from Cowper, it signifies the mask, generally a piece of crape, worn by robbers, to prevent their being recognised.

And proud Roxana, fired with jealous rage,
With fifty yards of *craps* shall sweep the stage.
Swift.

To thee I often called in vain,
Against that assassin in *craps*. *Id.*

'Tis from high life high characters are drawn ;
A saint in *craps* is twice a saint in lawn. *Pope*.

O innocent, compared with hearts like these,
Crape, and cocked pistol, and the whistling ball
Sent through the traveller's temples ! *Cooper*.

CRAPE is made of raw silk gummed and twisted on the mill ; woven without crossing, and much used in mourning. *Crapes* are either *crapel* (i. e. *crisped*), or smooth. The silk destined for the first is more twisted than that for the second ; it being the greater or less degree of twisting, especially of the warp, which produces the *crisping* given it when taken out of the loom, steeped in clear water, and rubbed with a piece of wax for the purpose. *Crapes* are all dyed raw. The invention of this stuff came originally from Bologna ; but Lyons was long said to have had the chief manufacture of it. History tells us, that St. Bathilda, queen of France, made fine *crape* (*crepa*) of gold and silver, to lay over the body of St. Eloy. Binet says, this *crepa* was a frame to cover the body of the saint ; but others, with reason, take it to have been a transparent stuff, through which the body might be seen ; and that this was the *crepa* whence our word *crape* was formed.

CRA'PLE, *n. s.* Ger. *krappeln*, to seize ; Ang-Sax. grip-an, to gripe. An obsolete word, of the same family with *grapple*, signifying a claw.

Soone as they did the monstrous Scorpion wev,
With ugly *craples* crawling in their way,
The dreadfull sight did them so soro affray,
That their well known courses they forwent.

Spenser. Faerie Queene.

CRA'PULA, *n. s.* } Lat. *crapula* ; *κραπυλάη*.
CRA'PULENCE, *n. s.* } Intoxication ; sickness,
CRA'FULOUS, *adj.* } produced by intemperance. Drunken ; sick from drunkenness.

The drunkard now supinely snores,
His load of ale sweats through his pores,
Yet when he wakes, the swine shall find
A *crapula* remains behind. *Cotton*.

CRASH, *v. a., v. n. & n. s.* } Fren. *ecraser* ;
CRA'SHING, *n. s. & adj.* } Ger. *rauschen* ;
Goth. *kressa*. Dr. Johnson supposes the word to be formed from the thing, in which he agrees with Skinner. To make a loud, sharp, complicated noise, as if many things were falling or breaking at once ; to break or bruise. *Crash*, and *crashing*, are loud sudden mixed sounds, as of many things broken at the same time. Abrupt and dissonant sound is always implied by these words.

There shall be a great *crashing* from the hills.
Zeph. i. 10.

Senseless Plium,
Seeming to feel this blow, with flaming top
Stoops to his base ; and, with a hideous *crash*,
Takes prisoner Pyrrhus' car. *Shakespeare. Hamlet.*

Moralizing sat I by the hazard-table : I looked upon the uncertainty of riches, the decay of beauty, and the *crash* of worlds, with as much contempt as ever Plato did. *Pope*.

When convulsions cleave the labouring earth,
Before the dismal yawn appears, the ground
Trembles and heaves, the nodding houses *crash*.
Smith.

When sudden, darting down the depth of heaven.
Fierce on th' expecting fœe the cranes are driven,
The kindling frenzy every bosom warms,
The region echoes to the *crash* of arms. *Beattie*.

Now they reach thee in their anger :
Fire, and smoke, and hellish clangor
Are around thee, thou World's Wonder !
Death is in thy walls and under.
Now the meeting steel first clashes ;
Downward then the ladder *crashes*,
With its iron load all gleaming,
Lying at its foot blaspheming !

Byron. The Deformed Transformed.

CRASHAW (Richard), an English poet, the son of the Rev. William Crashaw ; was educated at the Charter-House, London, and afterwards sent to Pembroke Hall and Peterhouse, Cambridge. He was fellow of the latter college, and in both distinguished himself for his Latin and English poetry. He was afterwards ejected from his fellowship, with many others, for denying the covenant ; and, at last, became a Roman Catholic. He went to Paris, in hopes of recommending himself to some preferment there ; but, being a mere scholar, fell into great distress, which the poet Cowley relieved in 1646, and recommended him to queen Henrietta Maria, then residing at Paris. Obtaining her patronage, he travelled into Italy, became secretary to a cardinal at Rome, and at last one of the canons of the rich church of Loretto, where he died about 1664. Before he left England, he wrote some poems, entitled, *Steps to the Temple*, &c. ; afterwards others, called *The Delights of the Muses*, *Carmen Deo Nostro*, &c. He is said to have excelled in five languages, besides his mother tongue, viz. Hebrew, Greek, Latin, Italian, and Spanish.

CRA'SIS, *n. s.* *Κράσις*. Temperature ; constitution arising from the various properties of humors.

The fancies of men are so immediately diversified by the individual *crasis*, that every man owns something wherein none is like him. *Glanville*.

A man may be naturally inclined to pride, lust, and anger ; as these inclinations are founded in a peculiar *crasis* and constitution of the blood and spirits. *South*.

CRASS, *adj.* } Old Fr. *crasse* ; Lat.
CRA'SSIMENT, *n. s.* } *crassus*. Gross ; coarse ;
CRA'SSITUDE, *n. s.* } heavy ; thick ; dull ;
CRA'SSNESS, *n. s.* } stupid. That which is gross ; thick ; dull.

They must be but thin, as a leaf, or a piece of paper or parchment ; for, if they have a greater *crassitude*, they will alter in their own body, though they spend not. *Bacon*.

The Dead Sea, which vomiteth up bitumen, is of that *crassitude*, as living bodies, bound hand and foot, cast into it, have been borne up, and not sunk. *Bacon's Natural History*.

Iron, in aquafortis, will fall into ebullition, with noise and emication ; as also a *crass* and fœtid exhalation, caused from the combat of the sulphur of iron with the acid and nitrous spirits of aquafortis. *Brown's Vulgar Errors*.

Now, as the bones are principally here intended, so also all the other solid parts of the body, that are made of the same *crassiment* of seed, must be here included. *J. Smith*.

The ethereal body contracts *crassness* and impurity by the same degrees as the immaterial faculties abate in their exercise. *Glanville.*

The terrestrial matter carried by rivers into the sea, is sustained therein partly by the greater *crassitude* and gravity of the sea-water, and partly by its constant agitation. *Woodward.*

Metals are intermixed with the common terrestrial matter, so as not to be discoverable by human industry; or, if discoverable, so diffused and scattered amongst the *crasser* and more unprofitable matter, that it would never be possible to separate and extract it. *Id.*

Id. Natural History.

CRASSULA, lesser orpine, a genus of the pentagynia order, and pentandria class of plants; natural order thirteenth, succulentæ: CAL. pentaphyllous: the petals five, with five nectariferous scales at the base of the germen: CAPS. five. There are sixty-nine species, all natives of warm climates. Several of them are cultivated in this country, but require the assistance of artificial heat for their preservation. They rise from one foot to six or eight; and are ornamented with oblong, thick, succulent leaves, and funnel-shaped pentapetalous flowers of a scarlet, white, or greenish color. They are propagated by off-sets, or cuttings, and must be potted in light sandy compost, retained in a sunny part of the green-house all winter, and very sparingly watered. In summer they may be placed in the full air in a sheltered place, and in dry weather watered twice a-week.

CRASSUS (M. Licinius), a celebrated Roman, surnamed the Rich, on account of his opulence, which he is said to have obtained by educating slaves and selling them at a high price. The cruelties of Cinna obliged him to leave Rome, and he retired to Spain for eight months. After Cinna's death he passed into Africa and Italy, where he ingratiated himself with Sylla. When the gladiators, with Spartacus at their head, had spread universal alarm in Italy, and defeated some of the Roman generals, Crassus was sent against them. A battle was fought, in which he slaughtered 12,000 of the slaves, put an end to the war, and was honored with an ovation at his return. He was soon after made consul with Pompey, A. U. C. 682, and in this high office displayed his opulence, by entertaining the populace at 10,000 tables. He was afterwards censor, and formed the first triumvirate with Pompey and Cæsar. Crassus never imitated the ambitious conduct of his colleagues, but was satisfied with the province of Syria, which promised to be an inexhaustible source of wealth. He crossed the Euphrates, and hastened to make himself master of Parthia, but was betrayed in his march by the delay of Artavasdes, king of Armenia, and the perfidy of Ariamenes. Surena, the Parthian general, met him in a large plain, and a battle was fought, in which 20,000 Romans were killed, and 10,000 taken prisoners. The darkness of the night favored the escape of the rest; and Crassus, forced by the mutiny and turbulence of his soldiers, and the treachery of his guides, trusted himself to the general of the enemy, on pretence of proposing terms of accommodation, and was killed. His head was cut off, and sent to Orodes, who poured melted gold

down his throat. Though avaricious, he was attached to philosophy, and his knowledge of history is said to have been extensive.

CRASTINATION, n. s. From Lat. *cras*, tomorrow. Delay.

CRATÆGUS, wild-service tree, hawthorn, &c., in botany, a genus of the digynia order, and icosandria class of plants; natural order thirtieth, pomacæ: CAL. quinquefid: the petale five; the berry inferior, dispermous. There are twenty-three species, all of the tree and shrub kind, hardy and deciduous. Those most valuable for economical and ornamental purposes in gardening are the following: 1. *C. aria* theophracti, the white-leaf-tree, is a native of most of the cold countries of Europe. It grows to about twenty feet, and has, even in winter, though naked of leaves, a fine straight stem, with smooth branches, spotted with white. At the end of them are the buds, swelled for the next year's shoot. In spring, the oval leaves look delightfully, having their upper surface green, and the lower white. They are unequally serrated, about three inches long, and half as wide. Several strong nerves run from the mid-rib to the border, and they are placed alternately on the branches, which appear as if powdered with the finest meal. The flowers are produced at the end of the branches in May; they are white, grow in large bunches, having mealy foot-stalks, and are succeeded by red berries, which are ripe in autumn. 2. *C. coccinea*, the Virginia azarole, is a native of Virginia and Canada, and of about equal height. The stem is robust, and covered with a light-colored bark. Each separate flower is large, but, as few of them grow together, the umbels they form are rather small. They come out in May, and are succeeded by large dark-red-colored fruit, which ripens late in the autumn. The varieties of this species are, the pear-leaved thorn; the plum-leaved thorn, with very long strong spines, and large fruit; the plum-leaved thorn, with short spines and small fruit. 3. *C. crus galli*, the cockspur thorn, also a native of Virginia and Canada, and of similar appearance; rises with an upright stem, irregularly sending forth branches, which are smooth, and of a brownish color, spotted thinly with small white spots. It is armed with thorns that resemble the spurs of cocks. In winter the leaf-buds appear large and turgid. In summer the leaves are oval, angular, serrated, smooth, and bend backwards. The flowers are succeeded by a large bright-red fruit. The principal varieties are, the cockspur hawthorn with many thorns; the cockspur hawthorn with no thorns; the cockspur with eatable fruit. 4. *C. oxycanthus*, the hawthorn, or white-thorn, grows naturally all over Europe. In the state in which we usually see it, it is nothing better than a tall, uncouth, irregular shrub; but trained up as a standard, it swells to a large timber size, with a tall stem and a full spreading head. The standard hawthorn, whether we view its flowers in the spring, its foliage in the summer, or its fruit in the autumn and winter, is one of the most ornamental plants, standing singly, that can be scattered over a park or lawn. Of this species there are the following varieties: the

large scarlet, the yellow, the white, the maple-leaved, and the double-blossomed hawthorns: and the Glastonbury thorn. The scarlet hawthorn is exceedingly large, oblong, perfectly smooth, and of a bright scarlet. The yellow haw is a fine plant. The buds are of a fine yellow, and the fruit is of the color of gold. The tree retains its fruit all winter. It was originally brought from Virginia, is greatly admired, and no collection of hardy trees should be without it. White hawthorn hardly ever grows to the height of the common hawthorn, and the fruit is small. Maple-leaved hawthorns grow to nearly twenty feet high, and have very few thorns. The leaves are large, resembling those of the maple, and are of a whitish-green. The flowers are produced in large bunches in June, and are succeeded by remarkable fruit, of a shining red, which looks beautiful in winter. Double-blossomed hawthorn produces a full flower, and is one of the sweetest ornaments in the spring. These beautiful double flowers come out in large bunches in May, and the tree often appears covered with them. Glastonbury thorn differs in no respect from the common hawthorn, except that it sometimes flowers in winter. It is said to have been originally the staff of Joseph of Arimathea, who, according to tradition, attended by eleven companions, came over into Britain, and founded the first Christian church in this isle. As a proof of his mission, he is said to have stuck his staff into the ground, which immediately shot forth and bloomed. This tree is pretended to have blossomed on Christmas-day ever since; but Hanbury says, in fine seasons they will sometimes be in blow before Christmas, sometimes they afford their blossoms in February, and sometimes it so happens that they will be out on Christmas-day. 5. *C. tomentosa*, the gooseberry-leaved Virginia hawthorn, grows to about seven or eight feet. The branches are slender, and closely set with sharp thorns. The leaves are cuneiform, oval, serrated, and hairy underneath. The flowers are small, and of a white color; they are produced from the sides of the branches about the end of May, and are succeeded by yellow fruit, which ripens late in autumn. There is a variety of this called the Carolina hawthorn, which has longer and whiter leaves, larger flowers and fruit, and no thorns. 6. *C. viridis*, the green-leaved Virginia hawthorn, has the stem and branches altogether destitute of thorns. The leaves are lanceolate, oval, nearly trilobate, serrated, smooth, and green on both sides. The flowers are white, moderately large, come out the end of May, and are succeeded by a roundish fruit, which ripens late in autumn. All the different species are propagated by sowing the seeds in beds of fresh, light, rich earth; and the varieties are continued by budding them upon stocks of the white thorn. This latter method is generally practised for all the sorts; though, when good seeds can be procured, the largest and most beautiful plants are raised that way.

CRATCH, *n. s.* Fr. *crèche*; Lat. *crates*. The palisaded frame in which hay is put for cattle. The children's game called cratch-cradle, corruptly scratch-cradle, is meant to represent, by a

piece of string interwoven like hurdles, the cradle of our Saviour.

Begin from first, where he encradled was
In simple cratch, wrapt in a wad of hay.

Spenser. Hymns of Heavenly Love.

When, being expelled out of Paradise by reason of sin, thou wert held in the chains of death; I was inclosed in the virgin's womb, I was laid in the cratch, I was wrapped in swathing-cloaths.

Habswill on Providence.

CRATCH, *v. a.* Welsh *crach*, scabies. To scratch, to tear. This is our old verb for scratch.

Cratching of chekes, rendering eke of here.

Chaucer. Cant. Tales.

CRATCHES, in the manage, a swelling on the pastern, under the fetlock, and sometimes under the hoof; for which reason it is distinguished into the sinew cratches, which affect the sinew, and those upon the coronet called quitter-bones.

CRATE, *n. s.* Germ. *kraet*. A pannier, or vessel made of wicker, in which things are conveyed on a horse; a sort of case in which crockery ware is packed.

I have seen a horse carrying home the harvest on a crate.

Johnson.

CRATER, *n. s.* Lat. *crater*; *κράτηρ*. A vent or aperture. It is chiefly used to designate the mouth of a volcano.

CRATES, a famous philosopher of Thebes, a disciple of Diogenes the Cynic. It is said that he threw all his money into the sea, that he might the more freely apply himself to the study of philosophy. Others assert that he placed it in his brother's hands, with orders to give it to his children if they should happen to be fools: for, said Crates, if they should be philosophers, they will have no need of it; in which case it was to be given to the people. He flourished about A. A. C. 328.—Also the name of a famous academic philosopher, the disciple and friend of Polemon. He had Arcesilaus and other celebrated philosophers for his disciples; and flourished about A. A. C. 300.

CRATEVA, the garlic pear, in botany, a genus of the monogynia order, and dodecandria class of plants; natural order twenty-fifth, putamineæ: cor. tetrapetalous: cal. quadrifid: berry inferior dispermous. There are five species; natives of India, and chiefly distinguished by their fruit. All the species may be propagated in this country by seeds sown upon a hot-bed in the spring; and when the plants come up, they are to be treated in the manner directed for the annona.

The chief is *C. tapia*, the garlic pear, which has a smooth round fruit, about the size of an orange, with a hard brown shell or cover, which encloses a mealy pulp, filled with kidney-shaped seeds. It has a strong smell of garlic, and communicates the same to such animals as feed upon it. The tender buds from the young branches being bruised, and applied to the naked skin, will blister as effectually as cantharides. It rises to about thirty feet.

CRATINUS, an ancient comic poet, mentioned by Quintilian, Horace, and Persius, along

with Eupolis, and Aristophanes, as the three great masters of the ancient comedy. It is said that he died in the 87th Olympiad. Suidas tells us that he wrote twenty-one plays.

CRATIPPUS, a celebrated peripatetic philosopher, was a native of Mitylene, where he taught philosophy; but at length went to Athens, where Brutus and the son of Cicero were his disciples. Pompey, after the battle of Pharsalia, proposed to him some difficulties respecting the belief of a Providence, which he answered. He wrote some pieces respecting divination: and is supposed to be the Cratippus whom Tertullian, in his book *De Animâ*, has ranked among the writers upon dreams.

CRAVAN, or CRAVANT, a town of France, in the department of Yonne and ci-devant province of Burgundy, remarkable for its good wine, and for a battle between the English and French, in 1423. It is seated near the confluence of the rivers Cure and Yonne, nine miles south-east of Auxerre.

CRAVAT. Fr. *cravate*. Menage says, the word is derived from an appellation of the Croats, who were usually called Cravates; but Serenius deduces it from Goth *krafwa* for *krage*, the neck. Cravat is a neck-cloth; any thing that is worn round the neck.

Less delinquents have been scourged,
And hemp on wooden anvils forged;
Which others for *cravats* have worn
About their necks, and took a turn.

Hudibras.

When you draw him to do any thing that is fit by the offer of money, or reward the pains of learning his book by a precious morsel; when you promise him a lace *cravat*, or a fine new suit, upon performance of some of his little tasks; what do you by proposing these rewards, but allow them to be the good things he should aim at, and thereby encourage his longing for them, and accustom him to place his happiness in them?

Locks.

The restrictives were applied, one over another, to her throat: then we put her on a *cravat*.

Wise man's Surgery.

CRAVE, *v. a.* } Goth. *krefa*; Dan. *kra-*
CRÄVER, *n. s.* } *ve*; Swed. *krafwa*; Welsh,
CRÄVING, *n. s.* } *crefu*; Ang.-Sax. *crafan*.
To ask earnestly; to ask submissively; to beg, to entreat; to have an inordinate or unreasonable desire for; to be insatiable. Craver is an insatiable asker; and craving, an unreasonable desire.

Waste, what thing we may nat lightly have.
Thereafter wol we cry all day and crave.

Chaucer. Cant. Tales.

Such is the fortune that I have,
To love them most, that love me best,
And to my payne to seek and crave,
The thing that others have possess,

Wyatt.

To which the damzel, full of doubtfull thought,
Her mildly answered; ' Beldame, be not wroth
With silly virgin by adventure brought
Unto your dwelling, ignorant and loth,
That *crave* but room to rest while teapest overblo'th.

Spenser. Faerie Queene.

What one petition is there found in the whole Litany, whereof we shall ever be able at any time to say, that no man living needeth the grace or benefit therein *craved* at God's hands?

Hooker

As for my nobler friends, I *crave* their pardons;
But for the mutable rank-scented many,
Let them regard me as I do not flatter.

Shakespeare. Coriolanus.

Bid him with speed prepare to carry it,
The cause *craves* haste, and it will soon be writ.

Shakespeare. The Rape of Lucrece.

The poor people, not knowing where to hide themselves from the fury of their enemies, nor of whom to *crave* help, fled as men and women dismayed.

Knolles.

Once one may *crave* for love.

But more would prove

This heart too little, that too great.

Suchling.

The subjects armed, the more their princes gave,
The advantage only took the more to *crave*.

Denham.

I would *crave* leave here, under the word action, to comprehend the forbearance too of any action proposed.

Locks.

I will not say, high interest was the cause of it. For I rather think that our thriving trade was the cause of high interest, every one *craving* money to employ in a profitable commerce.

Id.

Levity pushes us on from one vain desire to another, in a regular vicissitude and succession of *cravings* and satiety.

L' Etrange.

He is actually under the power of a temptation, and the sway of an impetuous lust; both hurrying him to satisfy the *cravings* of it by some wicked action.

South.

Him dost thou mean, who, spite of all his store,
Is ever *craving*, and will still be poorer?

Who cheats for half-pence, and who doffs his coat
To save a farthing in a ferry-boat?

Dryden. Pericles.

Each ardent nymph the rising current *craves*,
Each shepherd's prayer retards the parting waves.

Prior.

Many a long-lingering year, in lonely isle,
Stunned with the eternal turbulence of waves,
Lo, with dim eyes, that never learned to smile,
And trembling hands, the famished native *craves*
Of Heaven his wretched fare.

Beattie.

CRÄVEN, *v. a., n. s. & adj.* Skinner, Horne Tooke, and Whiter, consider craven to be derived from the verb to *crave*, implying that the person bearing it has craved or craven his life from his antagonist. Dr. Johnson suggests, that 'perhaps it comes originally from the noise made by a conquered cock.' Mr. Todd, however, agrees with Dr. Jameson in deducing it from the old French, *creant*; a term of feudal jurisprudence, which was a promise of fealty. 'By the use of it therefore,' says Dr. Jameson, 'the vanquished person merely did homage to the victor as his superior.' A craven is a defeated and spirit-broken cock; a coward; a recreant; a chicken-hearted fellow; as an adjective, the word means cowardly; base; degraded. The verb, which seems to be a coinage of Shakespeare's, signifies to make recreant or cowardly.

In mighty armes he was yclad anon,
And silver shield; upon his coward breast
A bloody crosse, and in his *craven* crest
A bounche of heares discoloured diversly.

Spenser. Faerie Queene.

Yet if the innocent some mercy find,
From cowardice, not ruth, did that proceed;

His noble toes durst not his *craven* kind
Exasperate by such a bloody deed.

Fairfax.

'Gainst self-slaughter

There is a prohibition so divine,
That *cravens* my weak hand.

Shakespeare. Cymbeline.

What, is your crest a coxcomb? —

— A combless cock, so Kate will be my hen.

— No cocke of mine; you crow too like a *craven*.

Id. Taming of the Shrew.

Is it fit this soldier keep his oath?

— He is a *craven* and a villain else.

Id. Henry V.

Whether it be

Bestial oblivion, or some *craven* scruple,
Of thinking too precisely on the event;
A thought which, quartered, hath but one part wisdom,
And ever three parts coward. *Id. Hamlet.*

CRAUNCH, or } Dut. *scransen*. To crush
CRANCH, *v. a.* } between the teeth.

She cannot shoot at butts,
Or manage a great horse; but she can *cranch*
A sack of small coal, rat you lime and hair.

Ben Jonson.

She would *craunch* the wing of a lark, bones and
all, between her teeth. *Swift.*

CRAW, *n. s.* Ger. *kragen*; Swed. *krage*;
Dan. *kroe*. The crop or first stomach of birds.

In birds there is no mastication or comminution
of the meat in the mouth; but, in such as are not car-
nivorous, it is immediately swallowed into the crop
or *craw*, or at least into a kind of ante-stomach, which
I have observed in many, especially piscivorous birds.
Ray on the Creation.

CRA'WFISH, *n. s.* Sometimes written cray-
fish, properly crevice; in Fr. *ecrevisse*. A small
crustaceous fish found in brooks; the small
lobster of fresh water. See CANCER.

Those that cast their shell are the lobster, the crab,
the *crayfish*, the hodmandod or dodman, and the tor-
toise. *Bacon.*

Let me to crack live *crayfish* recommend. *Pope.*
The common *crayfish*, and the large sea *crayfish*,
both produce the stones called crab's eyes. *Hill.*

CRAWFORD (Adair), M. D., a medical
writer of considerable eminence, was born in
1749, and became physician to St. Thomas's
Hospital, London; professor of chemistry at
Woolwich; and fellow of the Royal Society.
His principal work is Experiments and Observa-
tions on Animal Heat, of which a second and
enlarged edition was published in 1784, 1 vol.
8vo. It was translated into German by L. F. F.
Crell, and into Italian by Vasalli; with Morgan's
Answer and Notes. Dr. Crawford also made
experiments on the matter of cancer, and was the
first writer who recommended muriate of barytes
as a remedy for scrofula. He died at Lynton,
July 29th, 1795. A posthumous tract of his
appeared in 1816, entitled An Experimental En-
quiry into the Effect of Tonics and other medi-
cinal Substances on the Cohesion of the Animal
Fibre, 8vo.

CRAWFURD, or CRAUFURD (David), a
Scottish historian, born at Dramsoy, near Glas-
gow, in 1665, is principally to be noted as a
wilful falsifier of history. Holding the place of
historiographer royal of Scotland to queen Anne,
he published, in 1706, Memoirs of Scotland
during the times of the Four Regents: a work
which had gone through two editions, had been

quoted by both Hume and Robertson and was held
in considerable estimation, until Mr. Laing pub-
lished, from the original MS., The Historie and
Life of King James Sext, when it was dis-
covered that Crawford had wretchedly inter-
polated and mutilated it, in all his alleged quotations
from it, to support his particular opinions as to
the character of Bothwell and queen Mary. He
was the author also of the two plays entitled
Courtship a la Mode, and Love at First Sight,
and died in 1726.

CRAWL, *v. n.* } Goth. *krafta*; Sw. *krala*;
CRA'WLER, *n. s.* } Dutch *krielen*. The Dutch
CRA'WLING, *adj.* } etymon Junius and Skinner
trace to the Lat. *grallari*, pro *gradulari*, i. e. gra-
datim seu pedetentim ire. To crawl is, to
creep; to move with a tardy motion; to move
with the lower parts on the ground like a worm;
to proceed onward tardily or timorously; to ad-
vance slowly and slyly; to move about hated and
despised. The meanings of the noun and ad-
jective are obvious.

And whylome by false Fairies stolen away,
Whyles yet in infant cradle he did *crall*.
Spenser. Faerie Queene.

'Tis our first intent
To shake all cares and business from our age,
While we unburthened *crawl* tow'rd death.
Shakespeare. King Lear.

Cranmer

Hath *crawled* into the favour of the king,
And is his oracle. *Id. Henry VIII.*

They like tall fellows crept out of the holes; and
secretly *crawling* up the battered walls of the fort, got
into it. *Kneller.*

I saw them under a green mantling vine,
That *crawls* along the side of yon small hill.
Milton.

Unarmed of wings and scaly oare,
Unhappy *crawler* on the land. *Locke.*

For the fleets of Solomon and the kings of Egypt,
it is very apparent they went with great leisure, and
crawled close by the shore-side. *Heylin.*

A worm finds what it searches after, only by feeling,
as it *crawls* from one thing to another.
Greus's Cosmologia.

That *crawling* insect, who from mud began;
Warmed by my beams, and kindled into man.
Dryden.

The streams, but just contained within their
bounds,

By slow degrees into their channels *crawl*;
And earth increases as the waters fall. *Id.*

The vile worm, that yesterday began
To *crawl*; thy fellow-creature, abject man. *Prior.*

Man is a very worm by birth,
Vile reptile, weak and vain!
Awhile he *crawls* upon the earth,
Then shrinks to earth again. *Pope.*

He was hardly able to *crawl* about the room, far
less to look after a troublesome business.
Archbishop's John Bull.

It will be very necessary for the threadbare gown-
man, and every child who can *crawl*, to watch the
fields at harvest-time. *Swift.*

An inadvertent step may crush the snail,
That *crawls* at evening in the public path;
But he that has humanity, forewarned,
Will tread aside, and let the reptile live. *Compton.*

Dark brinded hairs, in bristling ranks, behind,
Rise o'er his back, and rustle in the wind;
Clothe his lank sides, his shrivelled limbs surround,
And human hands with talons print the ground.
Silent in shining troops the courier throng
Pursue the monarch, as he *cravols* along. *Darwin.*

CRAX, in ornithology, the curassou, a genus of birds belonging to the order of gallinæ. The base of the beak of each mandible is covered with wax; and the feathers of the head are curled. There are five species, viz. 1. *C. alector*, the Indian hen of Sloane, is found in Berbice, Essequibo, Demerara, Brasil, and the warm parts of America. It is about the size of a small turkey, and is black, with a white belly. A yellow wax covers about one-half of each mandible; the tongue is entire; the temples are bare and black; the tail is roundish, and consists of fourteen prime feathers; the legs are strong and of a dusky brown color. These birds are common in Guiana; and are called *posewe* by the natives from their cry; are pretty numerous in the woods, and make no small part of the food of the planters, who are supplied by the Indian hunters: their flesh is reckoned as delicate as that of a turkey. They are easily brought up tame. 2. *C. globicera*, has a yellow protuberance between the nostrils, and is of a bluish-black color: the lower part of the belly is white. It is a native of Brasil. 3. *C. pauxi*, the Mexican pheasant of Brissonius, is of a bluish color, with blue wax, and the tip of the tail and belly white: it is a native of Mexico. 4. *C. rubra*, the Peruvian hen, is red, with a bluish head. These birds are natives of Mexico and Peru. They feed on fruits, and perch on trees: the flesh is white, and esteemed good food. They are frequently kept tame in our menageries in England, and readily mix with other poultry.

CRAY, **CRA**YER, or **CRA**RE, *n. s.* Old Fr. *crayer*; Sw. *krejare*; low Lat. *crayera*. A small maritime vessel; a bark.

Oh melancholy!

Whoever yet could sound thy bottom? find
The boze, to show what coast thy sluggish *crare*
Might easiest harbour in? *Shakespeare. Cymbeline.*

CRAYER (Caspar de), an eminent painter, born at Antwerp in 1585. He was a disciple of Raphael Coxis, whose father had studied under Raphael; but he soon far surpassed his master, and formed for himself a style that was exceedingly pleasing. The first work which established him in the favor of the court at Brussels, was a portrait of cardinal Ferdinand, brother to the king of Spain. Rubens, who went to Antwerp on purpose to visit him, after examining attentively his picture of the Centurion, in the abbey of Affteghem, declared that no painter could surpass Crayer. He had somewhat less fire in his compositions than Rubens, but his design is frequently more correct. There is a remarkable variety and simplicity in his draperies; and his coloring is admirable.

CRAYFISH, *n. s.* See **CRAW**FISH. The river lobster.

The cure of the muriatick and armoniack saltness requires slimy meats; as snails, tortoises, jellies, and *crayfishes*. *Floyer.*

CRAYFORD, or **CRE**CANFORD, a TOWN of England, in Kent, seated on the small river Cray, which serves to work a mill for slitting and rolling iron, and another for a cotton manufacture. This place is memorable for a great battle fought here in 457, between Hengist the Saxon, and Vortigern the British king; in which the latter lost 4000 men and four of his chief commanders. The rout was so general and decisive, that they left Hengist from that time in quiet possession of his Kentish kingdom. This town is two miles west of Dartford and fourteen E.S.E. of London.

CRAYON, *v. & n. s.* Fr. *craye, crayonner*. To delineate in dry colors; to sketch out the first lines of any thing. A kind of colored pencil; a drawing done with a crayon.

Let no day pass over you without drawing a line; that is to say, without working, without giving some strokes of the pencil or the *crayon*.

Dryden's Desdemona.

I wonder how any one can read the king's speech at the opening of that session, without seeing in that speech both the repeal and the declaratory act very sufficiently *crayoned* out. *Burke.*

CRAYON is a general name for all colored stones, earths, or other minerals and substances used in designing or painting in pastel; whether they have been beaten and reduced to a paste, or are used in their primitive consistence, after sawing or cutting them into long narrow slips. In this last manner are red crayons made of bloodstone, or red chalk, and black ones of charcoal and black lead. Crayons of all other colors are compositions of earths reduced to paste.

CRAYON-PAINTING. See **PAINTING**.

CRAZE, *v. a.* } Fr. *ecraser*. In this
CRAZEDNESS, *n. s.* } etymology Ihre, Lye,
CRAZINESS, *n. s.* } Skinner, and Dr. Johnson
CRAZY, *adj.* } agree. Minsheu on the
contrary derives *craze* from *ερασις, temperamentum*. To *craze* is, to break; to debilitate; to impair; to reduce to powder; to impair the intellect. *Crazy* signifies, broken down; decrepit; weak; shattered; broken-witted. *Crasedness*, and *crazines*, indicate the state of being weak, decrepit, or *crazy*.

I am right sicker that the pot was *crased*.
Be as be may, be ye no thing amazed;
As usage is, let sweeps the flore as awithe;
Plucke up your hartes, and be glad and blithe.
Chaucer. Cant. Tales.

For els my feeble vessel *crased* and cracht
Through thy strong buffets and outrageous blows,
Cannot endure. *Spenser. Faerie Queene.*

In this consideration, the answer of Calvin unto Farel, concerning the children of Popish parents, doth seem *crased*. *Hooker.*

The nature, as of men that have sick bodies, so likewise of the people in the *crasedness* of their minds, possessed with dislike and discontentment at things present, is to imagine that any thing would help them. *Id.*

Relent, sweet Herminia; and, Lysander, yield
Thy *crased* tide to my certain right.
Shakespeare. Midsummer Night's Dream.

I loved him, friend,
No father his son dearer, true, to tell thee,
That grief hath *crased* my wits. *Id. King Lear.*

Come, my lord,
We will bestow you in some better place,
Fitter for sickness and for *crasy* age.
Id. Henry VI.

For no *crased* brain could ever yet propound,
Touching the soul, so vain and fond a thought,
But some among these masters have been found,
Which in their schools the self same thing have
taught. *Davies.*

Like the vain bubble of Sherialan pride,
That overcroweth all the world beside,
Which reared to raise the *crasy* monarch's fame,
Strives for a court and for a college name. *Hall.*
The tin ore passeth to the *crasing* mill, which,
between two grinding stones, bruisseth it to a fine sand.
Carew's Survey.

Touching other places, she may be said to hold
them as one should do a wolf by the ears; nor will I
speak now of the *crasiness* of her title to many of them.
Howell's Vocal Forest.

Till length of years,
And sedentary numbness, *crasse* my limbs.
Milton.

Then through the fiery pillar, and the cloud,
God looking forth, will trouble all his host,
And *crase* their chariot wheels. *Id.*

The queen of night, whose large command
Rules all the sea, and half the land,
And over moist and *crasy* brains,
In high spring-tides, at midnight reigns. *Hudibras.*

Physick can but mend our *crasy* state,
Patch an old building, not a new create. *Dryden.*
When people are *crasy* and in disorder, it is natural
for them to groan. *L'Estrange.*

Wickedness is a kind of voluntary frenzy, and a
chosen distraction; and every sinner does wilder and
more extravagant things than any man can do that is
crased and out of his wits; only with this sad differ-
ence, that he knows better what he does. *Tillotson.*

Were it possible that the near approaches of eter-
nity, whether by a mature age, a *crasy* constitution,
or a violent sickness, should amaze so many, had they
truly considered? *Wake.*

How drooping, woeful wan, like one forlorn,
Or *crased* with care, or crossed with hopeless love!
Gray.

It was in vain to think of doing any more good at
school. The remaining week I staid, I did nothing
but *crase* the faculties of my soul about her, or steal
out to meet her; and the two last nights of my stay
in the country, had sleep been a mortal sin, the image
of this modest and innocent girl had kept me guiltless.
Burns.

The noblest friendship ever shown,
The Saviour's history makes known,
Though some have turned and turned it;
And whether being *crased* or blind,
Or seeing with a biassed mind,
Have not, it seems, discerned it. *Cowper.*

Ne'er may the *crasy* hand of pining care
Thy mirth and youthful spirits break!
Never come sickness, or love-crossed despair,
To pluck the roses from thy cheek! *Sheridan.*

CRAZE-MILL, or CRAZING MILL, a mill in
all respects like a grist mill to grind corn,
and so called by the tin-miners, who use it to
grind their tin, which remains too great after
trampling.

CREAGHT, v. n. & n. s. Irish. To pasture
cattle. A herd of cattle.

It was made penal to the English to permit the
Irish to *creaght* or graze upon their lands, or present
them to the ecclesiastical benefices. *Davies on Ireland.*

In these fast places, they kept their *creaghts*, or
herds of cattle, living by the milk of the cow, without
husbandry or tillage. *Id.*

CREAK, v. n. & n. s. } Old Fr. *criquer*;
CREAKING, n. s. } Dut. *krieken*; *spew*.
To make a stridulous protracted sound, such as is
made by dry shoes and oiled hinges; to make
a sharp cry, like some birds and animals.

Let not the *creaking* of shoes, nor the rustling of
silks, betray thy poor heart to women.

Shakespeare. King Lear.
No door there was the unguarded house to keep,
On *creaking* hinges turned, to break his sleep.
Dryden.

The *creaking* locusts with my voice conspire,
They fried with heat, and I with fierce desire. *Id.*

In a large and uninhabited building, like a church,
the wind may howl; the doors and windows may
clap; the *creaking* of rusty hinges may be heard: a
stone, or a bit of plaister, may drop with some noise
from the mouldering wall. *Beattie.*

Words learned by rote, a parrot may rehearse,
But talking is not always to converse;
Not more distinct from harmony divine,
The constant *creaking* of a country sign. *Cowper.*

So Juan stood, bewildered on the deck:
The wind sung, cordage strained, and sailors swore,
And the ship *creaked*, the town became a speck,
From which away, so fair and fast they bore.
Byron's Don Juan.

CREAM, v. a., v. n. & n. s. } Fr. *creme*;
CREAMY, adj. } It. *crema*; Goth.
CREAM-BOWL, n. s. } *kreima*; Ang-
CREAM-FACED, adj. } Sat. *ream*; Lat.
CREAMING-PAN, n. s. } *cremor*; *χρυσμα*.

To cream is to skim off the cream; to take the
quintessence of any thing; to gather on the sur-
face. Cream is the unctuous part of milk; the
best part of any thing.

— thee doth draine
Her *creaming* pannes, and frustrate all her paine.
Spenser. Faerie Queene.

There are a sort of men whose visages
Do *cream* and manple like a standing pond;
And do a wilful stiffness entertain,
With purpose to be drest in an opinion
Of wisdom, gravity, profound conceit.
Shakespeare. Merchant of Venice.

It is not your inky brows, your black silk hair,
Your bugle eye-balls, nor your cheek of *cream*,
That can entame my spirits to your worship.
Id. As You Like It.

Thou *cream-faced* lown,
Where got'st thou that goose-look?
Id. Macbeth.

I am as vigilant as a cat to steal *cream*.
Id. Henry IV.
Cream is matured and made to rise speedily, by
putting in cold water; which, as it seemeth, getteth
down the whey. *Bacon's Natural History.*

How the drudging goblin swet,
To earn his *cream-bowl* duly set;
When in one night, ere glimpse of morn,
His shadowy sail hath thrashed the corn. *Milton.*

Let your various *creams* incircled be
With swelling fruit, just ravished from the tree.

King.

Milk, standing some time, naturally separates into an oily liquor called *cream*; and a thinner, blue, and more ponderous liquor, called skimmed milk.

Arbutnot on Aliments.

We skim, from abstracted and translation,
The *cream* of classic information;
Like *cream* from London cows translated,
Or butter-milk sophisticated.

Huddesford.

And the small ripple split upon the beach
Scarcely o'erspass'd the *cream* of your champagne,
When o'er the brim the sparkling bumpers reach,
That spring dew of the spirit! the heart's rain!

Byron.

CREAM OF LIME is that part of the lime which had been dissolved in the water in its caustic state, but, having again attracted some fixed air from the atmosphere, becomes incapable of solution, and therefore separates from the water in the mild state of chalk or limestone.

CREAM OF MILK. Being naturally only mixed, and not dissolved in the rest it soon separates, being specifically lighter; after which it collects on the surface, from which it is generally skimmed, to complete the disengagement of the oily from the caseous and serous parts. Cream is not only an agreeable aliment when recent, but is also useful in medicine as a lenient, when applied to tetters and erysipelas, attended with pain and proceeding from an acrid humor.

CREAM OF TARTAR, the crystals of tartar pulverized. It is well known as a mild purgative, and of late years has been employed largely with advantage in dropsies.

CRE'ANCE, *n. s.* Fr. is, in falconry, a fine small line, fastened to a hawk's leash when she is first lured.

CREASE, *v. a. & n. s.* From Lat. *creta*, chalk, say Skinner and Dr. Johnson; but it is rather, as Herne suggests, from the old world creysed, crossed. To make a mark by doubling any thing. The mark made by a fold in something stiff.

Men of great parts are unfortunate in business, because they go out of the common road: I once desired lord Bolingbroke to observe, that the clerks used an ivory knife, with a blunt edge, to divide paper, which cut it even, only requiring a strong hand; whereas a sharp penknife would go out of the *crease*, and disfigure the paper.

Swift.

CREAT, in the manage, an usher to a riding master; or a gentleman bred in the academy, with an intent of making himself capable of teaching the art of riding the great horse.

CREATE, *v. a. & adj.* Fr. *creer*; Ital. *creare*; Sp. *criar*; Latin *creare*. To create is, to form out of nothing; to cause to exist; to produce; to beget; to invest with a new character or title; to give new qualities to any thing. As an adjective, create signifies, begotten; composed of; but it is

obsolete. Creation means, the act of calling into existence, or investing with new qualities or titles; the universe; any thing produced or caused. The power which does these acts is creative. Creator is the being that confers existence, especially the Supreme Being. A creature is, a being not self-existent; any created thing; an animal; a general term for man; a word of contempt or of endearment; a person who is indebted to another for his rise or fortune; or who acts the part of dependent or sycophant to another. Creaturely denotes having the qualities of a creature; and creatureship, the state of being a creature. Both these words are of unfrequent occurrence.

In the beginning God *created* the heaven and the earth.

Genesis.

And al be it so that God hath *create* all thing in right ordre, and nothing withouten ordre.

Chaucer. Cant. Tales.

No *creatyng* saw he that bare lif,
Save on the grene he saw sitting a wif,
A fouler wight ther may no man devise.

Id.

I think nature hath lost the mould
Where she her shape did take;
Or else I doubt if nature could
So fair a *creature* make.

Songes and Sonnettes.

For since the day that they *create* beene,
So many heavenly faces were not scene
Assembled in one place. *Sponsor. Faerie Queene.*
Yet crime in her could never *creature* find. *Id.*
Him long she so with shadowes entertained,
As her *creatress* had in charge to her ordained. *Id.*

And the issue there *create*
Ever shall be fortunate. *Shakespeare.*

Arise, my knights o' the battle: I *create* you
Companions to our person, and will fit you
With dignities becoming your estates. *Id. Cymbeline.*

Art thou not, fatal vision, sensible
To feeling as to sight? Or art thou but
A dagger of the mind, a false *creation*,
Proceeding from the heart-oppressed brain?

Id. Macbeth.

In many looks the false heart's history
Is writ, in moods and frowns and wrinkles strange,
But heaven in thy *creation* did decree,
That in thy sweet face love should ever dwell.

Id. Sonnet xciii.

I've heard that guilty *creatures*, at a play,
Have, by the very cunning of the scene,
Been so struck to the soul, that presently
They have proclaimed their malefactions.

Id. Hamlet.

And then, Sir, would he gripe and wring my hand;
Cry, Oh sweet *creature*! and then kiss me hard. *Id.*
The best British undertaker had but a proportion
of three thousand acres for himself, with power to
create a manor, and hold a court-baron.

Davies on Ireland.

Open, ye heavens, your living doors; let in
The great *Creator*, from his work returned
Magnificent; his six days' work, a world. *Milton.*
His abilities were prone to *create* in him great confidence of undertakings, and this was like enough to betray him to great errors and many enemies.

King Charles.

He sent to colonel Massey to send him men,
which he, being a *creature* of Essex's, refused.

Clarendon.

We having but imperfect ideas of the operations of our minds, and much imperfecter yet of the operations of God, run into great difficulties about free created agents, which reason cannot well extricate itself out of.

Locke.

Imperfect the world, and all the creatures in it must be acknowledged in many respects to be.

Tillotson.

Such was the saint, who shone with every grace,
Reflecting, Moses-like, his master's face :
God saw his image lively was expressed,
And his own work as his creation blessed.

Dryden's Fables.

The several parts of relatives, or creaturely infinities, may have finite proportions to one another.

Cheyne's Philosophical Principles.

A good poet no sooner communicates his works, but it is imagined he is a vain young creature given up to the ambition of fame.

Pope.

The design was discovered by a person whom every body knows to be the creature of a certain great man,

Swift.

Long abstinence is troublesome to acid constitutions, by the uneasiness it creates in the stomach.

Arbuthnot.

But come, ye generous minds, in whose wide thought,
Of all his works, creature beauty burns
With warmest beam.

Thomson's Spring.

Next to that which is due to the Creator, children owe to their parents the highest love, reverence, and gratitude; for to a good parent, in all ordinary cases, his child is more obliged than to any other fellow creature.

Beattie.

By thee inspired, O Virtue, age is young,
And music warbles from the faltering tongue ;
Thy ray creature cheers the clouded brow,
And decks the faded cheek with rosy glow.

Id.

Me oft has Fancy ludicrous and wild
Soothed with a waking dream of houses, towers,
Trees, churches, and strange visages, expressed
In the red cinders, while with poring eye
I gazed, myself creating what I saw.

Cowper.

So erst in Paradise creation's Lord,
As the first leaves of holy writ record,
From Adam's rib, who pressed the flowery grove,
And dreamt delighted of untasted love,
To cheer and charm his solitary mind,
Formed a new sex, the mother of mankind.

Darwin.

Before Creation peopled earth,
Its eye shall roll through chaos back ;
And where the furthest heaven had birth,
The spirit trace its rising track.

Byron. Hebrew Melodies.

CREATION, in its primary import, signifies the bringing into being something which did not before exist. The term is therefore most generally applied to the original production of the materials of which the visible world is composed. It is also used, in a secondary or subordinate sense, to denote those subsequent operations of the Deity, upon the matter so produced, by which the whole system of nature and all the primitive genera of things received their form, qualities, and laws.

It is certain that none of the ancient philosophers had the smallest idea of its being possible to produce a substance out of nothing, or that even the power of the Deity himself could work

without materials. Hence some of them, particularly Aristotle, asserted that the world was eternal, both as to its matter and form. Others, though they believed that the gods had given the world its form, yet imagined the materials of which it is composed to have been eternal. Indeed the opinions of the ancients, who had not the benefit of revelation, were on this head so confused and contradictory, that no thing of any consequence can be deduced from them.

Plato, in his Critias, mentions Atlantis as having been buried in the ocean about 9000 years before the age in which he wrote. He asserts it to have been well known to the Egyptian priests and to the contemporary inhabitants of Attica. But the learned generally agree in regarding his account of that island as a fiction, which the author himself did not design to be understood seriously. The Chinese represent the world as some hundreds of thousands of years older: and we are also told that the astronomical records of the ancient Chaldeans carried back the origin of society no less than 473,000 years. The Egyptian priests reckoned between Menes and Sethon 341 generations. But these accounts are so discordant, and so slenderly supported by evidence, that we cannot hesitate to reject them as false; the fables of historians scarcely merit so much attention as the hypotheses of philosophers.

From sacred history we may reasonably expect more accurate information concerning the antiquity of the globe; but it is evidently only a secondary object of the Scriptures to establish the era of creation. We need not, therefore, be surprised that they do not fix it with accuracy; or that they leave us at a loss whether to extend what they say concerning that era to the whole contents of space, or to confine it to our solar system, or to the earth and its immediate dependencies. Great varieties of dates have been assigned by close students of the Hebrew Bible as the epoch of the creation. The Samaritan Pentateuch fixes it at 4305 years before the birth of Christ. And the Greek translation known by the name of the Septuagint version gives—in the Vatican copy 5270, and in the Alexandrine 5508, as the number of the years which intervened between those two periods. See CHRONOLOGY. Archbishop Usher, on the other hand, makes out from the Hebrew Bible 4004 years as the term between the creation and the birth of Christ; and Josephus, according to Dr. Wills and Mr. Whiston, makes it 4658 years. We have entered, however, so much at large into the leading data of chronology under that article, that we feel it quite unnecessary to repeat our observations here.

Some difficulties occur in comparing the Mosaic account of the creation with the laws which appear at present to regulate the system of nature. It seems strange, for instance, to conceive how the earth, while yet a stranger to the influence of the sun, could experience the vicissitude of day and night. The condition of matter when the earth was without form and void, and the operation of the Spirit of God on the face of the waters, are equally mysterious. Some

ingenious men have eagerly labored to remove these difficulties. Among these is Dr. Thomas Burnet, who supposes all the celestial bodies, even the sun and all the other planets of the solar system, to have existed long before the earth. The chaos on which the spirit of God moved consisted, according to him, of the first principles from which all terrestrial bodies have been formed. When those laws by which the material world is regulated first began to operate on the mass, he supposes that its grosser and heavier parts would sink towards the centre, and there form a solid ball. Around this solid ball two species of particles would still float together in confusion. Of these he thinks one, being more volatile, would by degrees make its escape from the other, would leave it still recumbent on the solid centre, and spread around it in an atmosphere. The middle stratum he composes of aqueous and oleaginous fluids; and he makes no doubt, that after the air had made its escape, the levity of the oleaginous fluids would enable them to rise above the aqueous, and dispose themselves next the surface of the liquid mass. On them he supposes the impure atmosphere to have then deposited a quantity of terrene particles, sufficient to form, by intermixture with the oils, a thick crust of rich earth for the production of plants and herbage, and to afford an habitation to animals. This delicate shell he was careful not to furrow with seas or load with mountains; either of these would have reduced all to confusion. Such is his earth; and after moulding it with so much ingenuity, and into so happy a form, he contents himself, without venturing to use the same freedoms with the remaining part of Moses's account of the creation. We need not attempt to refute a theory which has long been justly condemned as equally unsupported by scripture and philosophy.

Whiston treats both the Scriptures and the laws of nature with greater reverence. Yet he certainly involves himself in no small difficulties in attempting to solve those of Moses. He supposes the sun, moon, and stars to be all more ancient than the earth. The chaos from which the earth was formed, he represents as having been originally the atmosphere of a comet. The six days of the creation he would persuade us to be equal to six of our years: for he is of opinion that the earth did not revolve daily round its axis, but only annually round its orbit, till after the fall. On the first day or year, therefore, the more ponderous parts of the chaos were according to this theory conglomerated into an orb of earth, the chinks and interstices over that orb filled up with water, and the exterior part or atmosphere rarefied, so as to admit some faint glimmering of the rays of the sun. On the second day, the atmosphere was diffused to its due extent around the earth, and reduced to a degree of rarity and purity which rendered it still more suitable for the transmission of light; the earth was still more consolidated; and the waters, being almost entirely excluded from the interstices which they before occupied, were partly spread over the surface of the earth, and partly raised in vapor into the atmosphere or firmament. On the third day the earth's surface became so irregular, in one

place rising into hills, in another sinking into valleys, as to cause the waters, which were before equally diffused, to collect into seas and lakes, leaving large tracts of ground unoccupied. And no sooner was a part of the earth's surface left bare by the waters, than the general influence of the sun produced on it a rich covering of herbage, and all the different species of vegetables. On the fourth day, the earth was rendered subject to the regular influence of the sun, moon, and stars. On the fifth day, or year, things were so far advanced, that fishes and fowls were now produced from the waters. On the sixth day the earth was furnished with animals; and the lord of all the other animals, man, was now created. Such is Mr. Whiston's account of the phenomena of the Mosaic creation. But he likewise assumes so much more than can be reasonably granted, that we need not attempt a formal refutation of his system. What appears to us the most natural way of understanding Moses's account of the creation is, that it was neither confined to the earth alone, nor extended to the whole universe. The relation which all the planets of the solar system bear to the same illuminating body countenances the conjecture, that they, together with the luminary by which they are enlightened, were all created at one period; but it would be conceiving too meanly of the benevolence, wisdom, and active power of the Deity, to suppose that before that period these had never been exerted in any work of creation. On the supposition, that the whole solar system was created at once, which has at least the merit of doing no violence to the narrative of Moses, the creation of the sun and the other planets may be understood to have been carried on at the same time with the creation of the earth. In that case, even in the course of the first day, though not longer than our present days, those bodies might be reduced to such order, and their relative motions so far established, as to begin the distinction between light and darkness, day and night. On the second day, we may naturally understand from Moses's narrative, that the atmosphere was purified, and the specific gravities of aqueous vapor and atmospheric air so adjusted, as to render the latter capable of supporting the former. On the third day the waters were first collected into lakes and seas; but in what manner, we cannot determine. Some call in the operation of earthquakes; others that of specific gravity, &c. But these are mere fancies; and we have not facts to offer in their stead. On the latter part of this day vegetables were caused to spring up over the earth. This growth must have been much more rapid than we ever behold it now; but by what supernatural power that might be effected, we should in vain enquire. On the fourth day, the sun, moon, and stars, were made to appear. But, according to the conjecture which we have mentioned as plausible, those heavenly bodies might be created before this day; though they had not till now begun to exert their full influence on the earth, as they have since continued to do. The creation of the inanimate world was now finished, and the earth prepared for the reception of animals. On the fifth day, therefore, were the living inhabitants

of the air and the waters created. On the sixth day the inferior animals inhabiting the earth were first created; and, after that, the whole work was crowned by the creation of a male and female of the human species. To the account of the creation of the animals, nothing can be added in explanation of Moses's narrative. As only one pair of the human species were at first created, the same economy might possibly be observed in the creation of the inferior animals.

St. Barnabas in the first century, speaking of the works of creation being finished by God in six days, says, 'This signifies that the Lord God will finish all things in six thousand years; as he himself testified, saying, Behold this day shall be as a thousand years. Therefore, in six days, that is, in six thousand years, shall all things be consummated. And he rested on the seventh day: this signifies, that when his Son shall come, and shall abolish the season of the wicked one, and shall judge the ungodly, and shall change the sun, and the moon, and the stars, then shall he rest gloriously on the seventh day.' And that the seventh day rest was symbolical, has been contended by many learned men since St. Barnabas. This is, however, purely a theological speculation, and we must be contented with suggesting it to our readers.

CREBILLON (Prosper Joliot de), a French tragic writer, usually ranked, in point of merit, after Corneille and Racine, was born at Dijon in 1674. He was originally destined to the law, and placed at Paris with that view; but he soon relinquished the bar for the drama. He at last obtained a place in the French Academy, and the employment of censor of the police, in which post he continued till his death. Being asked one day in company, which of his works he thought the best? 'I don't know,' replied he, 'which is my best production; but this (pointing to his son) is certainly my worst.' To this the son is said to have replied, 'That is, because no Carthusian had a hand in it,' alluding to a report that Crebillon was indebted to a monk of that order for some of his finest passages. His best works are, 1. *Idomeneus*, a tragedy; 2. *Atréus*; 3. *Electra*; and 4. *Rhadamistus*. He produced many other pieces, but they are all generally thought inferior to these. He was remarkably enthusiastic in his devotion to his task while composing. On one occasion some person entering his room during the concoction of a tragic plot, he cried out, 'Do not disturb me.—I am just going to bang a knavish minister, and turn out a stupid one.' On another, while in his favorite retreat, the *Jardin du Roi* at Paris, his friend Duvernet, the naturalist, who had given him a key of admission, was called out by the gardener, and told, that some maniac had made his escape, and was ranging the walks of the garden. The naturalist hastened to the place, and found his friend Crebillon without his coat, filled with poetical furor; and writhing like the Sybil, about to pour forth her predictions. He died at Paris, 1672.

CRE'BROUS, *adj.* } Lat. *creber*. Frequent;
 CRE'BRITUDE, *n. s.* } frequentness.
 CRE'DEN'DA, *n. s.* Lat. Things to be be-

lieved; articles of faith: distinguished in theology from agenda, or practical duties.

These were the great articles and *credenda* of Christianity, that so much startled the world. *South.*

CRE'DIT, <i>v. a., & n. s.</i>	} Lat. <i>credere</i> . To credit is, to believe; to confide in; to procure credit or honor to; to admit as a debtor. Credit is, belief; reputation; good opinion; the correlative to debt; influence; promise given. Creditor signifies, he to whom a debt is owed; one who credits what he hears: but this last sense is obsolete. Creditable denotes, reputable; estimable: creditably, without disgrace: credulous, too apt to believe, or give credit to: and credulity, easiness of belief; readiness of credit.
CRE'DITABLE, <i>adj.</i>	
CRE'DITABLENESS, <i>n. s.</i>	
CRE'DITABLY, <i>adv.</i>	
CRE'DITOR, <i>n. s.</i>	
CRE'DITRIX, <i>n. s.</i>	
CRE'DULENCY, <i>n. s.</i>	
CRE'DULITY, <i>n. s.</i>	
CRE'DULOUS, <i>adj.</i>	
CRE'DULOUSLY, <i>adv.</i>	
CRE'DULOUSNESS, <i>n. s.</i>	

When the people heard these words, they gave no credit unto them, nor received them. *1 Mac. x. 46.*

The things which we properly believe, be only such as are received upon the credit of divine testimony.

Hooker.

The poor Plangus, being subject to that only disadvantage of honest hearts, *credulity*, was persuaded by him.

Sidney.

Many sought to feed
 The easy creditors of novelties,
 By voicing him alive. *Shakespeare.*

Now I change my mind,
 And partly credit things that do presage.
Id. Julius Cæsar.

There came divers of Antonio's creditors in my company to Venice, that swear he cannot chuse but break.
Id. Merchant of Venice.

O hard believing Love! how strange it seems
 Not to believe, and yet too credulous!
Id. Venus and Adonis.

There is no decaying merchant, or inward beggar,
 hath so many tricks to uphold the credit of their
 wealth, as these empty persons have to maintain the
 credit of their sufficiency. *Bacon.*

Who now enjoys thee credulous, all gold,
 Who always vacant, always amiable,
 Hopes thee, of flattery gales
 Unmindful? hapless they,
 T' whom thou untried seemest fair. *Milton.*

May here her monument stand so,
 To credit this rude age; and show
 To future times, that even we
 Some patterns did of virtue see. *Walker.*
 They sent him likewise a copy of their supplication
 to the king, and desired him to use his credit that a
 treaty might be entered into. *Clarendon.*

Credit is nothing but the expectation of money
 within some limited time. *Locke.*

If you can once get into children a love of credit,
 and an apprehension of shame and disgrace, you have
 put into them the true principle, which will constantly
 work, and incline them to the right. *Id.*

At present you credit the church as much by your
 government, as you did the school formerly by your
 wit. *South.*

Many will chuse rather to neglect their duty safely
 and creditably, than to get a broken pate in the
 church's service, only to be rewarded with that which
 will break their hearts too. *Id.*

The contemplation of things, that do not serve to promote our happiness, is but a more specious sort of idleness, a more pardonable and *creditable* kind of ignorance.

Tillotson.

Among all these snares, there is none more entangling than the *creditable*ness and repute of customary vices.

Decay of Piety.

Some secret truths, from learned pride concealed, To maids alone and children are revealed :
What though no *credit* doubting wits may give,
The fair and innocent shall still believe.

Pope.

Yes, while I live, no rich or noble knave
Shall walk the world in *credit* to his grave.

Id. Horace.

He settled him in a good *creditable* way of living, having procured him by his interest one of the best places of the country.

Arbuthnot's John Bull.

The prejudice of *credulity* may, in some measure, be cured, by learning to set a high value on truth.

Watts's Logick.

The most trifling actions that affect a man's *credit* are to be regarded. The sound of your hammer at five in the morning, or nine at night, heard by a *creditor*, makes him easy six months longer; but if he sees you at a billiard-table, or hears your voice at a tavern, when you should be at work, he sends for his money the next day; demands it before he can receive it in a lump.

Franklin.

If this state of his country had been foretold to him, would it not require all the sanguine *credulity* of youth, and all the fervid glow of enthusiasm, to make him believe it? Fortunate man, he has lived to see it! Fortunate indeed, if he lives to see nothing that shall vary the prospect, and cloud the setting of his day.

Burke.

Not e'en the Sun, desirable as rare,
Could bend one knee, engage one votary there;
They were, what base *credulity* believes
True Christians are, dissemblers, drunkards, thieves.

Cowper.

There's monie a *creditable* stock
O' decent, honest, fawsont fo'k,
Are riven out baith root and branch,
Some rascal's pridefu' greed to quench,
Wha thinks to knit himsel the faster
In favour wi' some gentle master.

Burns.

Sir Peter, I do not expect you to *credit* me—but the tenderness you expressed for me, when I am sure you could not think I was a witness to it, has penetrated so to my heart, that had I left the place without the shame of this discovery, my future life should have spoken the sincerity of my gratitude.

Sheridan.

As for that smooth-tongued hypocrite, who would have seduced the wife of his too *credulous* friend, while he affected honourable addresses to his ward—I behold him now in a light so truly despicable, that I shall never again respect myself for having listened to him.

Id.

She hoped he would improve—perhaps believed;
A letter too, she gave (he never read it)
Of good advice—and two or three of *credit*.

Byron. Don Juan.

CREDIT was anciently a right which lords had over their vassals; consisting in this, that during a certain time they might oblige them to lend them money. In this sense, the duke of Brittany had *credit* during fifteen days on his own subjects, and those of the bishop of Nantes; and the bishop had the same *credit* of right among his subjects and those of that prince.

CREDIT, LETTERS OF, are those given to persons in whom a merchant, &c. can trust, to take money of his correspondent abroad, in case he happens to need it.

CREDITON, or **KIRKTON,** a town of England, in the county of Devon, formerly the see of a bishop, removed to Exeter in the year 1050. In the reign of Edward I. it sent members to the parliament then sitting at Carlisle. It was once a very flourishing town, but has suffered severely by fire. In 1743 no fewer than 460 houses were burnt down, besides the market-house, wool chambers, and other public buildings. The whole loss was estimated at between £50,000 and £60,000; and again, in 1772, the consequences of fire were nearly as disastrous. It is governed by a magistrate called a Portreeve. The principal manufacture is that of serges, which is carried on to a great extent. The church, which was the cathedral, is a noble Gothic structure, 150 feet long and forty-four wide; the altar-piece is a most exquisite piece of painting; the tower is 100 feet high, standing in the centre of the church, in a semicircular arch, supported by four pillars of uncommon magnitude; and containing eight bells, and a clock with chimes. The market is on Saturdays for provisions, wool, and yarn. It is eight miles south-east of Exeter; and 180 west by north of London.

CREE, a river of Scotland, which rises in the northern parts of the county of Wigton, and the stewarty of Kircudbright. It is very small for several miles, and runs through a bleak and dreary country; but is soon considerably increased by tributary streams. It now changes its appearance; and, instead of rocks and moors, it holds its course nearly south through a beautiful valley, till it empties itself into the bay of Wigton. It forms the boundaries between the counties of Wigton and Kircudbright. It abounds with salmon, and is navigable for vessels for several miles.

CREECH (Thomas), a translator of ancient authors, was born near Sherborne in Dorsetshire, in 1659. He was educated at Sherborne, and afterwards entered a commoner of Wadham College, Oxford. In 1683 he took the degree of M. A. and not long after was elected probationer fellow of All-souls College; to which his translation of Lucretius recommended him. He took the degree of B. D. on the 18th March 1696. In 1699, having taken holy orders, he was presented by his college to the living of Welwyn in Hertfordshire; but this he had not long enjoyed before he put an end to his own life. A letter presented to the Bodleian Library seems to prove that having frequently borrowed money of a fellow collegian, and repeating his applications too often, he met one day with such a cold reception, that he retired in a fit of gloomy disgust, and three days after was found hanging in his study. Creech's principal performances are, 1. A Translation of Lucretius. 2. A Translation of Horace; in which, however, he has omitted some few odes. 3. The Idylliams of Theocritus, with Rapin's Discourse of Pastorals. 4. A Translation of Manilius's Astronomicon. Besides translations of several parts of Virgil, Ovid, and Plutarch, printed in different collections.

CREED, *n. s.*
CR'EDENCE, *v. a. & n. s.*
CR'EDENT, *adj.*
CR'EDENTIAL, *n. s. & adj.*
CR'EDIBILITY, *n. s.*
CR'EDIBLE, *adj.*
CR'EDIBLENESS, *n. s.*
CR'EDIBLY, *adv.*
CREED-MAKER, *n. s.*

AN-SAX. *creþa*,
 from Lat. *credo*.
 A creed is a form
 of words which
 comprehends the
 articles of faith;
 any solemn profes-
 sion of principl-
 es or opinion;

A few persons of an odious and despised country could not have filled the world with believers, had they not shewn undoubted *credentials* from the Divine Person who sent them on such a message.
Addison on the Christian Religion.

any thing which a person firmly believes. See the next article. Credence signifies, belief; credit; that which entitles to be credited or believed, as letters of credence, which are synonymous with credentials. As a verb, credence is out of use; it means to believe. Skelton has, 'in credencing his tales.' Credent is, believing; unquestionable. Credible is that which is worthy of belief; credibleness, credibility, and credibly, of course participate in the same meaning.

I never heard of a man of learning, sense, or observation, that was favoured with any of them; a strong presumption against their *credibility*. *Burke.*

My *creed* (whatever some *creed-makers* mean By Athanasian nonsense, or Nicene)
 My *creed* is, he is safe that does his best,
 And death's a doom sufficient for the rest.

Cowper. [Satirically]

Such that can nat ysay ther *crede*
 With prayer shul be made prelates;
 Nothir can thei the gopell rede,
 Such shul now weldin high estates.

Chaucer. Cant. Tales.

For Solomon sayth, hereth me and yeveth *credence*
 to that that I shall say. *Id.*

Ne let it seem that *credence* this exceeds,
 For he that made the same, was known right well
 To have done much more admirable deeds;
 It Merlin was. *Spenser. Faerie Queene.*

No leasing new, nor grandames fable stale,
 But antient truth, confirmed with *credence* old.
Id. Colin Clout.

Things are made *credible*, either by the known condition and quality of the utterer, or by the manifest likelihood of truth in themselves. *Hooker.*

For me, my lords,
 I love him not, nor fear him; there's my *creed*.
Shakespeare.

Love and wisdom,
 Approved so to your majesty, may plead
 For ample *credence*. *Id.*

Then weigh what loss your honour may sustain,
 If with too *credent* ear you list' his songs. *Id. Hamlet.*
 They did not only underhand give out that this was the true earl; but the friar, finding some *credences* in the people, took boldness in the pulpit to declare as much. *Bacon.*

This, with the loss of so few of the English as is scarce *credible*; being, as hath been rather confidently than *credibly* reported, but of one man, though not a few hurt. *Id.*

Having now showed their *credential* letters on both sides. *Camden.*

The larger and fuller view of this foundation is set down in the *creeds* of the church.

Hammond on Fundamentals.

Thus we see how, amongst other good effects, *creed-making* always has, and always will necessarily produce and propagate ignorance in the world, however each party blame others for it. *Locke.*

The *credibleness* of a good part of these narratives has been confirmed to me by a practiser of physick. *Boyle.*

None can demonstrate to me, that there is such an island as Jamaica; yet, upon the testimony of *credible* persons, I am free from doubt. *Tillotson.*

The first of those opinions I shall shew to be altogether incredible, and the latter to have all the *credibility* and evidence of which a thing of that nature is capable. *Id.*

There stands the messenger of truth: there stands The legate of the skies!—His theme divine, His office sacred, his *credentials* clear. By him the violated law speaks out Its thunders; and by him, in strains as sweet As angels use, the Gospel whispers peace. *Id.*

Oh Love! how perfect is thy mystic art,
 Strengthening the weak, and trampling on the strong,

How self-deceitful is the sagest part
 Of mortals whom thy lure hath led along—
 The precipice she stood on was immense,
 So was her *creed* in her own innocence.

Byron. Don Juan.

CREED, APOSTLES'. See **APOSTLES.**

CREED, ATHANASIAN, and NICENE. These two, with the Apostles' Creed, are the most universal. They are used in the public offices of the church of England; and subscription to them is required of the clergy. See **ATHANASIAN, and NICENE.** Other ancient creeds are, 1. The form of apostolical doctrine, collected by Origen. 2. A fragment of a creed preserved by Tertullian. 3. A remnant of a creed in the works of Cyprian. 4. A creed composed by Gregory Thaumaturgus, for the use of his own church. 5. The creed of Lucian the martyr. 6. The creed of the apostolical constitutions. Besides these scattered remains of the ancient creeds, there are extant some perfect forms, as those of Jerusalem, Cesarea, Antioch, &c.

To **CREEK**, *v. a.* To make a harsh noise—
 See **To CREAK.**

Shall I stay here,
Creaking my shoes on the plain masonry?
Shakespeare.

CREEK, n. s. } AN-SAX. *crecca*; Dutch
CR'E'EKY, adj. } *kreke*. A prominence in a winding coast; a small port; a cove; familiarly, any turn or alley. Creek of day, from Teut. *krieke*, signifies the commencement of the dawn, Creeky is, full of creeks; unequal; winding.

Who, leaning on the belly of a pot,
 Poured forth a water, whose outgushing flood
 Run bathing all the *creaky* shore a-boat,
 Wheron the Trojan prince spilt Turnus' blood
Spenser.

A back-friend; a shoulder clapper; one that commands the passages of alleys, *creaks*, and narrow lands. *Shakespeare.*

As streams, which with their winding banks do play,
 Stopped by their *creaks*, run softly through the plain. *Darwin.*

A law was made here to stop their passage in every port and *creak*. *Id. on Ireland.*

They on the bank of Jordan, by a *creek*,
Where winds with reeds and eziers whispering play,
Their unexpected loss and plaints outbreathed.

Milton.

They have a petty traffic with known correspondents
in some little *creek*: within that they confine them-
selves, and are dexterous managers enough of the
wares and products of that corner with which they
contend themselves; but will not venture out into the
great ocean of knowledge.

Locke.

The wriggling fry soon fill the *creeks* around,
Poisoning the waters where their swarms abound;
Scorned by the nobler tenants of the flood,
Minnows and gudgeons gorge the' unwholesome food.

Cowper.

It was a wild and breaker-beaten coast,
With cliffs above, and a broad sandy shore;
Guarded by shoals and rocks as by an host,
With here and there a *creek*. *Byron. Don Juan.*

CREEKS, or MUSCOGEES, a nation of native
Indians, inhabiting the territory now included in
the Strait of Alabama in the neighbourhood.
They are reduced to about 20,000 in number.
See ALABAMA.

CREEP, *v. n.* } Goth. *kriepa*; Swed.
CREEPER, *n. s.* } *krypa*; Ang.-Sax. *creo-*
CREEPINGLY, *adv.* } *pan*; Dan. *krye*; Wel.
CREEPHOLE, *n. s.* } *croppian*; Lat. *reperere*;
iprw. To move like a worm; to grow along the
ground, or on supports; to move forward with
regularly slow progression; to move clandestinely;
to proceed timorously; to steal upon
unawares; to act with servility. A creeper is,
a plant that needs other support, like the ivy; an
iron to slide along a kitchen grate; a kind of clog
worn by women; an insect; a small bird, called
also the ox-eye; a small grapnel or drag, used
to recover things that have fallen into the sea.
A creephole is, a hole into which an animal may
creep to avoid danger; a subterfuge. Creepingly
signifies tardily; after the manner of a reptile.
To creep and to crawl are generally used syno-
nymously, and Johnson seems to sanction the
practice; but though both verbs denote slowness
of motion and proximity to the earth, creep, when
used with reference to animals, ought, perhaps,
in strictness, to be applied to such creatures as
have legs, and crawl to those which have none.

Of this sort are they which creep into houses, and
lead captive silly women. *2 Timothy, iii. 6.*

Thou makest darkness, and it is night, wherein all
the beasts of the forest do creep forth. *Psalms civ. 20.*

An hole he fond ful low upon the bord,
Ther as the cat was wont in for to crepe,
And at that hole he loked in ful depe.

Chaucer. Cant. Tales.

The flames upspring, and cruelly they crepe
From wall to roote, til all to cinders waste. *Sackville.*

And the old woman carefully displayed
The clothes about her round with busy ayd,
So that at last a little *creeping* sleepe
Surprised her sence. *Spenser. Faerie Queene.*

_____ like as a beare,

That *creeping* close amongst the dives to rear
An honey comb, the wakeful hogs espy. *Id.*

By those gifts of nature and fortune he creeps, nay
he flies, into the favour of poor silly women. *Sidney.*

The joy, which wrought into Pygmalion's mind,
was even such as, by each degree of Zelmane's words,
creepingly entered into Philoclea's. *Id.*

To-morrow, and to-morrow, and to-morrow,
Creeps in this petty pace from day to day,
To the last syllable of recorded time.

Shakespeare. Macbeth.

I'll *creep* up into the chimney.—

—There they always used to discharge their birding-
pieces: *creep* into the kiln-hole.

Id. Merry Wives of Windsor.

It seems, the marriage of his brother's wife
Has *crept* too near his conscience.—

—No, his conscience

Has *crept* too near another lady. *Id. Henry VIII.*

That jealousy itself could not mistrust
False *creeping* craft and perjury should thrust
Into so bright a day such black-faced storms.

Id. The Rape of Lucrece.

Plants that put forth their sap hastily, have bodies
not proportionable to their length; therefore they are
winders or *creepers*, as ivy, briony, and woodbine.

Bacon.

Then like the coward after neighbours' fray,
They *creep* forth boldly, and ask, Where are they?

Hall.

And every *creeping* thing that *creeps* the ground.

Milton.

It is not to be expected that every one should guard
his understanding from being imposed on by the so-
phistry which *creeps* into most of the books of argu-
ment.

Locke.

The grottos cool, with shady poplars crowned,
And *creeping* vines on arbours waved around. *Dryden.*
Ambition often puts men upon doing the meanest
offices; so climbing is performed in the same posture
with *creeping*.

Swift.

—They that *creep* and they that fly

Shall end where they began.

Gray.

If we have deserved this kind of evil fame from
any thing we have done in a state of prosperity, I am
sure that it is not an abject conduct in adversity that
can clear our reputation. Well is it known that ambi-
tion can *creep* as well as soar.

Burke.

Thus Heaven enlarged his soul in riper years,
For nature gave him strength, and fire, to soar
On Fancy's wing above this vale of tears;
Where dark cold-hearted sceptics, *creeping*, pore
Through microscope of metaphysic lore.

Beattie.

Error has no place;

That *creeping* pestilence is driven away;

The breath of heaven has chased it.

Cowper.

A gentle slumber, but it was not deep,

For ever and anon a something' shook

Juan, and shuddering o'er his frame would *creep*.

Byron. Don Juan.

CREEPER, in ornithology. See CERTHIA.

CREEPLE, *n. s.* Ang.-Sax. *crjppel*. Dut.
krepel. A cripple. This was the usual way of
spelling cripple till about the close of the seven-
teenth century.

A *crepill* he saw comyng with grete spede and haste
Oppon a stilt onder his kne bound wondrousfast.

Chaucer. Cant. Tales.

She to whom this world must itself refer
As suburbs or the microcosm of her,
She, she is dead, she's dead when thou knowest this,
Thou knowest how lame a *creepie* this world is.

Donne.

CREIGHTON (Robert), D. D., son of a bishop
of Bath and Wells of this name, was born in
1648. He accompanied Charles II. into his exile,
and prosecuted the study of music with great
success. An anthem of his, 'I will arise and go

to my father,' and a service in the key of E, are much admired, and constantly performed to this day in the cathedrals of England. Dr. Creighton died at Wells, 1736.

CRELLIUS (John), a celebrated Socinian writer, was born in 1590, in a village near Nuremberg. In 1612 he went into Poland, where the Unitarians had a school, in which he became professor of divinity, and minister at Cracow, where he died in 1632, aged forty-two. He was the author of, 1. A Treatise against the Mystery of the Trinity. 2. Commentaries on a part of the New Testament; and other works which are now very scarce.

CREMA, a town of Italy, a bishop's see, the *ci-devant* capital of Cremasco; and afterwards the biennial capital, alternately with Lodi, of the department of Adda. It is a fortified town, is well built, populous and commercial; containing five parish churches, several fine palaces, hospitals, and squares; and 8800 citizens. It now belongs to Austria, and is situated on the Serio, twenty miles north of Placentia, and twenty-two E. S. E. of Milan.

CREMASCO, a country of Italy, in the late Venetian territories, which took its name from Crema, the capital. It is seventy-four miles long, forty-six broad, and 230 in circumference; and contains one city, four villages, and fifty-three parishes. Its surface, except the Casta, is level, fertile in corn, wine, flax, and hemp.

CREMATION. Lat. *crematio*. A burning

And the Chinese, without cremation or urnal interment of their bodies, make use of trees and much burning, while they plant a pine-tree by the grave.

Brown.

CREMATION is particularly applied to the ancient custom of burning the dead. This custom is well known to have prevailed among most eastern nations, and continued with their descendants after they had peopled the different parts of Europe. It prevailed in Greece, Italy, Gaul, Britain, Germany, Sweden, Norway, and Denmark, till Christianity abolished it.

CREMONA, an ancient city of Italy, the *ci-devant* capital of the Cremonese, and now capital of the department of Upper Po, situated in a delightful plain, watered by the Oglio, about a quarter of a mile from the Po, over which is a bridge of boats protected by a fort. A Roman colony, with nunicipal rights, settled beyond the Po, below the confluence of the Addua, on the report of Hannibal's march into Italy. It was an opulent and mercantile city; but suffered greatly in the civil wars of Augustus. In the war with Vitellius, it was destroyed by the partisans of Vespasian; but was soon after rebuilt by the munificence of the citizens, by order of Vespasian. It is about five miles in circumference, and is defended by a castle. A canal passes through it which forms a communication between the Oglio and the Po. Its principal streets are broad and straight. It has forty churches, several squares, and a university. The population is about 30,000. The city with its fort was surrendered to Buonaparte, on the 12th May, 1796, and it has followed the fate of Lombardy in its ultimate subjection to the Austrians, during the late revolutionary wars. It

is thirty miles north-west of Parma, and thirty-eight south-east of Milan.

CREMONESE, a *ci-devant* territory of Italy, in the duchy of Milan, afterwards included in the department of the Upper Po. It was bounded on the east by the duchy of Mantua, on the north by Bresciano, on the west by Cremasco, and the Lodesau, and on the south by Parma. It is fertile in wine and fruit.

CREMOR, *n. s.* Lat. A milky substance; a soft liquor resembling cream.

The food is swallowed into the stomach, where, mingled with dissolvent juices, it is reduced into a chyle or cremor.

Ray.

CRE'NATED, *adj.* From Latin, *crena*. Notched; indented.

The cells are prettily *crenated*, or notched, quite round the edges; but not straited down to any depth.

Woodward.

CRENATUM FOLIUM. See **BOTANY**.

CRENELLE, in heraldry, one of the lines of partition representing the embattlements of towers, &c. as in the diagram, *argent*, party per fesse *gules*.



CREOLES, a name given to the families descended from the Spaniards, who settled at Mexico, in America. These are much more numerous than either the Spaniards properly so called, or the Mulattoes; which two other species of inhabitants are excluded from all considerable employments. The name throughout the rest of the West Indies is applied to all the natives who are descended from European parents.

CREON, king of Corinth, in fabulous history, the son of Sisypheus. He promised his daughter Glauce to Jason, who had repudiated Medea. To revenge the success of her rival, Medea sent her, as a present, a gown covered with poison. Glauce put it on, and was seized with sudden pains. Her body took fire; the house also was consumed with Creon and his whole family.

CREON, king of Thebes, in fabulous history, the son of Menotius, and father of Jocasta, the mother and wife of Oedipus. On the death of Laius, who had married Jocasta, Creon ascended the vacant throne of Thebes. As the ravages of the Sphinx were intolerable, Creon offered his crown and daughter in marriage to him who could explain the enigmas which the monster proposed. Oedipus explained the riddles, ascended the throne, and married Jocasta, without knowing she was his mother; and by her he had two sons, Polynices and Eteocles, and two daughters. The two sons agreed after their father's death to reign each a year alternately. Eteocles reigned first by right of seniority; but when once in power he refused to resign, and his brother led against him an army of Argives to support his right. The war was decided by single combat between the two brothers. They killed each other, and Creon again ascended the throne, till Leodamus the son of Eteocles should be of a sufficient age to assume the reins of government. He commanded that the Argives, and particularly Polynices, who was the cause of all the bloodshed, should remain unburied. Creon

was afterwards killed by Theseus, who made war upon him because he refused burial to the Argives.

CREPANCE, *n. s.* With farriers. An ulcer seated in the midst of the forepart of the foot.

CREPIS, hawk-weed, in botany, a genus of the polygamia superflua order, and syngenesia class of plants; natural order forty-ninth, composite. The receptacle is naked; *cal.* calyculated with deciduous scales; the pappus feathery and stalked. There are thirty-one species, most of them herbaceous annuals, rising to twelve or eighteen inches, and having their branches terminated by ligulated compound red and yellow flowers. These are very large, and consist of many flat florets spread over one another imbricatum, and when fully blown appear as if radiated. They are very beautiful; and appear in June, July, and August. They are succeeded by plenty of seeds, which, if permitted to scatter on the ground, will produce a number of young plants without further trouble.

CREPITATE, *v. a. &* Lat. *crepitare*. To **CREPITATION**, *n. s.* } make a small crackling noise.

CREPITATION, in chemistry, the noise which some salts make over the fire in calcination.

CREPITATION, in surgery, the noise made by the ends or pieces of bones, when the surgeon moves a limb to assure himself by his ear of the existence of a fracture.

CREPT, part. of creep.

There are certain men *crept* in unawares. *Juda.*

Some as that uncouth light upon them shone,
Into her mouth they *crept*, and sudden all were gone.
Sponser. Faeris Queens.

This fair vine, but that her arms surround
Her married elm, had *crept* along the ground. *Pope.*

CREPUSCULE, *n. s.* } Fr. *crepuscule*; Lat. *crepusculum*. }
CREPUSCULAR, *adj.* } }
CREPUSCULINE, *adj.* } light. }
CREPUSCULOUS, *adj.* } is, relating to the crepuscule: crepuscularous, and crepusculine, denote glimmering; belonging to the twilight; in a twilight kind of state; imperfectly elucidated.

A close apprehension of the one, might perhaps afford a glimmering light and *crepusculous* glance of the other. *Brown.*

The beginnings of philosophy were in a *crepusculous* obscurity, and it is yet scarce past the dawn. *Glanville's Scepis.*

He has made apertures to take in more or less light, as the observer pleases, by opening and shutting like the eye, the better to fit glasses to *crepusculine* observations. *Sprat.*

The *crepuscular* atmosphere, or the region where the light of the sun ceases to be refracted to us, is estimated by philosophers to be between forty and fifty miles high. *Darwin.*

CRESCENT, *v. a., n. s., & adj.* } Lat. *cre-*
CRESCENCE, *n. s.* } *scens*, pr. part.
CRESCIVE, *adv.* } of *creescere*.—

The verb is of modern introduction, and signifies to form into a crescent. The noun denotes the moon in her increasing state; any thing that resembles the moon in that state; the distinguishing emblem or sign of Mahomedanism: as an adjective, it means increasing; growing; in a

state of increase. **CRESCENCE** is, the state of growing; and **CRESCIVE**, increasing; growing.

My power's a *crescent*, and my auguring hope
Says it will come to the full.

Shakespeare. Antony and Cleopatra.
I have seen him in Britain; he was then of a *crescent* note. *Id. Cymbeline.*

So the prince obscured his contemplation
Under the veil of wildness, which no doubt
Grew, like the summer grass, fastest by night,
Unseen, yet *crecives* in his faculty. *Id. Henry V.*

Or Bactrian sophy, from the horns
Of Turkish *crescent*, leaves all waste beyond,
The realm of Alaudie, in his retreat. *Milton.*

With these in troop
Came Astoreth, whom the Phœnicians called
Astarte, queen of heaven, with *crescent* horns. *Id.*
Jove in dusky clouds involves the skies,
And the faint *crescent* shoots by fits before their eyes. *Dryden.*

And two fair *crescents* of translucent horn
The brows of all their young increase adorn. *Pope's Odyssey.*

From west to east by equal influence tend,
And towards the moon's attractive *crecences* bend. *Brooke.*

Now gliding remote, on the verge of the sky,
The Moon half-extinguished her *crescent* displays:
But lately I marked, when majestic on high
She shone, and the planets were lost in her blaze. *Beattie.*

There, shall broad streets their stately walls extend,
The circus widen, and the *crecens* bend. *Darwin.*

With the far mountain *crecens* half surrounded
On one side, and the deep sea calm and chill
Upon the other, and the rosy sky,
With one star sparkling through it like an eye. *Byron. Don Juan*

CRESCENT, in heraldry, is the figure of a half moon with the horns turned inwards toward the chief of the shield, in which latter respect it differs from *decrecens* and *increcens*. It is the prevailing badge among the followers of Mahomet, as the cross among Christians, but is sometimes borne in European shields, as *azure*, a *crescent*, *argent*, name Lucy. It is also the badge of the second son when on the crest, the second son of the second house when on another *crescent*, &c. See **HOUSE**, in heraldry.



CRESCENTED, in heraldry, a term applied to a cross that has at each end a *crescent*, as *argent*, a cross *crescented* gules, name, Wilkins.

CRESCENTIA, in botany, the calabash-tree, a genus of the angiospermia order, and didynamia class of plants; natural order twenty-fifth, putamineæ. *cal.* bipartite and equal; *cor.* gibbous; the **BERRY** pedicellated or stalked, unilocular, and polyspermous; the **SEEDS** bilocular. There are two species, viz.—1. *C. cujete*, with oblong narrow leaves and a large oval fruit, a native of Jamaica and the Leeward Islands. 2. *C. latifolia*, the broad-leaved calabash, seldom rises more than fifteen or twenty feet high, with an upright trunk, covered with a white smooth bark, sending out many lateral branches at the top, garnished with leaves three inches in length, and one and a quarter broad, ranged alternately. The flowers

are small, and of a deep yellow color. The fruit of this sort is sometimes round, sometimes oval, but of very unequal sizes. Both these species are easily propagated by seeds; but the plants are too tender to live in this country, unless they are constantly kept in a stove. The shells of calabashes are used for various purposes. The pulp is seldom eaten, except by cattle in time of drought. The wood, which is hard and smooth, is made into stools, chairs, and other furniture.

CRESCIMBENI (John Mario), an Italian poet, born at Macerata in Ancona, in 1663. He was the founder of the Arcadian Society, of which he was appointed director in 1690, and in which post he remained till his death, in 1728. He wrote, 1. A History of the Italian Poetry; much esteemed, and reprinted in 1731, at Venice in 6 vols. 4to. It is accompanied with a commentary, containing anecdotes of Italian poets. 2. A History of the Academy of Arcadia, together with the Lives of the most Illustrious Arcadians. He published also many other works, in prose and verse.

CRESS, *n. s.* Fr. *cresson*; Ital. *crecione*; Ang.-Sax. *carse* or *cerse*; Dut. *kerse*; Ger. *krasse*; Sw. *krassa*. Menage and Johnson give, as the etymon, Lat. *crecere*, to grow. A herb. See the following article.

His court, with nettles and with *creeses* stored,
With soups unbought, and sallads, blest his board.

Pope.

CRESS, a species of lepidium.

CRESS, INDIAN. See **TROPÆOLUM**.

CRESS, SCIATIC. See **IBERIS**.

CRESS, SPANISH. See **VELLA**.

CRESS, WALL. See **TURRITIS**.

CRESS, WATER. See **SISYMBRIUM**.

CRE'SSET, *n. s.* Fr. *croisette*. Because beacons had crosses anciently on their tops. So says Johnson; but Minshew derives the word from the Dutch *kearse*, *candela*. A great light set upon a beacon, light-house, or watch-tower; also, a torch or lamp. 'They still raise armies in Scotland by carrying about the fire-cross,' says Johnson. Happily, they have now lost this dangerous habit.

At my nativity

The front of heaven was full of fiery sparks,
Of burning *cressets*. *Shakespeare. Henry IV.*

From the arched roof,

Pendent by subtle magick, many a row
Of starry lamps, and blazing *cressets*, fed
With naphtha and asphaltus, yielded light
As from a sky. *Milton's Paradise Lost.*

CRESSY, or **CRECY**, a town of France, in the department of Somme, and in the ci-devant province of Picardy; memorable for a great victory obtained over the French by Edward III. of England, in 1346. Edward having encountered and overcome many difficulties in his expedition, was at last so closely followed and harassed by the French army, commanded by Philip VI. king of France in person, that he determined to make a stand at this place, and to give his pursuers a check. The king of France, dreading nothing so much as the escape of the English, began the march of his great army from Abbeville early in the morning, August 26, and

continued it several hours with great eagerness till he received intelligence that the English had halted at Cressy, and were prepared to give him battle. He was advised at the same time not to engage that day, when his troops were fatigued with their march, and in great disorder; and he was disposed to have taken this advice. But the discipline of these times was so imperfect, that the orders given for halting were not obeyed; and one corps of this mighty host impelling another, they continued advancing till they came into the presence of their enemies in much confusion. Edward had employed the forenoon of this important day in drawing up his army in the most excellent order, in three lines. The first line or battail was thus composed. The archers, 4000 in number, were drawn up in an oblong of about 200 in front and forty deep, at the bottom of which stood the prince of Wales among his men at arms drawn up in a solid square, and having on his left the earls of Arundel and Northampton commanding the second line, composed of 800 men at arms, 4000 halberdiers, and 2400 archers. The last line, or body of reserve, in which were 700 men at arms, 5300 billmen, and 6000 archers, was ranged along the summit of the hill, and conducted by the king in person, attended by the lords Moubray, Mortimer, and others. When the army was completely formed, Edward rode along the lines, and by his words and looks endeavoured to inspire his troops with the most ardent hopes of victory. He then commanded the cavalry to dismount, and the whole army to sit down upon the grass, in their ranks, and refresh themselves. As soon as the French army came in view, they sprung from the ground, full of strength and spirit, and stood ready to receive them. The king of France, assisted by the kings of Bohemia, and Majorca, the dukes of Lorraine and Savoy, and several other sovereign princes, with the flower of the French nobility, labored to restore some degree of order to his prodigious army, and drew it up also in three lines, but very indistinctly formed. The first line was commanded in chief by the king of Bohemia; the second by the earl of Alençon, the French king's brother; and the third by Philip in person; and each of these lines contained a greater number of troops than the whole English army. The battle was begun about three o'clock in the afternoon, by a great body of Genoese cross-bowmen, in the French service, who let fly their quarrels at too great a distance to do any execution, and were presently routed by a shower of arrows from the English archers. The earl of Alençon, after trampling to death many of the flying Genoese, advanced to the charge, and made a furious attack on that corps commanded by the prince of Wales. The earls of Arundel and Northampton advanced with the second line to sustain the prince, and Alençon was supported by as many troops as could crowd to his assistance. Here the battle raged for some time with uncommon fury; and the king of Bohemia, the earl of Alençon, and many other nobles, being slain, the whole first and second lines of the French army were put to flight. Philip, undismayed, advanced to the charge with the line under his immediate command. But this body soon

shared the same fate with the other two; and Philip, after having been unhorsed, and wounded in the neck and thigh, was carried off the field by John de Hainault, and fled with no more than five knights and about sixty soldiers in his company of all his mighty army, which at the beginning of the battle consisted of more than 120,000 men. Such was the famous victory of Cressy, the greatest ever previously gained by England. Edward continued with his army at Cressy three days, numbering and burying the dead. The French had left on this bloody scene the king of Bohemia, eleven other princes, eighty bannerets, 1200 knights, 1500 gentlemen, 4000 men of arms, and 30,000 other soldiers.

CRESSY (Hugh Paulin, or Serenus), a catholic divine, born at Wakefield, in Yorkshire, in 1605. He studied at Merton College, Oxford, where he became fellow, and took his degrees in arts. He afterwards became chaplain to lord Falkland, whom he attended to Ireland, and obtained the deanery of Leighlin, to which was added a canonry of Windsor. In 1644 he went to Rome, where he publicly renounced the Protestant religion; and afterwards entered among the Benedictines at Douay, on which occasion he changed his Christian name to Serenus. He returned to England at the Restoration, and was honored as chaplain to the queen of Charles II. He died at East Grinstead, in Sussex, in 1674. He was the author of several controversial pieces in defence of the Catholic faith, one of which lord Clarendon answered in an able manner. He also wrote *The Church History of Britanny*, fol. 1668; a work of great labor and learning, but abounding with legendary fables.

CREST, *v. a. & n. s.* } Fr. *creste*; Ital. and
 CRESTED, *adj.* } Sp. *cresta*; Lat. *crista*.
 CRESTLESS, *adj.* } To mark with streaks;
 CREST-FALLEN, *adj.* } to serve as a crest for.
 The plume or tuft on a helmet; the helmet itself; the comb of a cock; any tuft or ornament on the head; the ornament of the helmet in heraldry; figuratively, pride; spirit; loftiness of men. Crested is, adorned with a crest; wearing a comb. Crestless signifies, not having coat armour; not being of an eminent family. Crest-fallen is, spirit-sunk; cowed; degraded; out of heart.

Like as the shining sky in summer's night,
 What time the days with scorching heat abound,
 Is crested all with lines of fierce light.

Spenser. Faerie Queene.

Long tho it be, at last I see it gloom,
 And the bright evening star, with golden crest
 Appear out of the east. *Id. Epithalamion.*

When horses should endure the bloody spur,
 They fall their crests. *Shakespeare.*

His grandfather was Lionel duke of Clarence,
 Third son to the third Edward king of England,
 Sprung crestless yeomen from so deep a root. *Id.*

Over my altars hath he hung his lance,
 His battered shield his uncontrolled crest.
Id. Venus and Adonis.

The horn;

It was a crest ere thou wast born:
 Thy father's father wore it.

Id. As You Like It.

I warrant you, they would whip me with their fine wits, till I were as crest-fallen as a dried pear.

Id. Merry Wives of Windsor.

Of what esteem crests were, in the time of king Edward the Third's reign, may appear by his giving an eagle, which he himself had formerly borne, for a crest to William Montacute, earl of Salisbury.

Camden's Remains.

Nor hath some bribed herald first assigned
 His quartered arms and crest of gentle kind. *Hall.*

The bold Ascalonites

Then grovelling soiled their crested helmets in the dust. *Milton.*

They prolate their words in a whining kind of querulous tone, as if they were still complaining and crest-fallen. *Howel.*

At this, for new replies he did not stay;
 But laced his crested helm, and strode away. *Dryden.*

The crested bird shall by experience know,
 Jove made not him his master-piece below. *Id.*

Their crests divide,

And, towering o'er his head, in triumph ride. *Id. Virgil.*

No foe to man

Lurks in the serpent now: the mother sees,
 And smiles to see, her infant's playful hand
 Stretched forth to dally with the crested worm. *Cowper.*

Quick darts the scaly monster o'er the plain,
 Fold, after fold, his undulating train;
 And bending o'er the lake his crested brow,
 Starts at the crocodile that gapes below. *Darwin.*

CREST, in heraldry and armour, denotes the uppermost part of the armour; or that part rising over the casque or helmet. The ancient warriors wore crests to strike terror in their enemies, as the sight of the spoils of animals they had killed; or to give them the more formidable mien, by making them appear taller, &c. In the ancient tournaments, the cavaliers had plumes of feathers, especially those of ostriches and herons, for their crests; these tufts they called plumarts, and were placed in tubes, on the tops of high caps or bonnets. Some had their crests of leather; others of parchment, pasteboard, &c. painted or varnished, to keep out the weather; others of steel, wood, &c. on which were sometimes represented a member or ordinary of the coat; as, an eagle, fleur-de-lis, &c. but never any of those called honorable ordinaries, as pale, fesse, &c. The crests were changeable at pleasure; being reputed no other than as an arbitrary device or ornament. Herodotus attributes the rise of crests to the Carians, who first bore feathers on their casques, and painted figures on their bucklers; whence the Persians called them cocks. The Etruscans were also celebrated for their lofty crests, and modern artists have given similar additions to the helmets of the three-Horatii. The mane of horsehair which was appended to the crest, was called by the Greeks *λόφος*, and by the Romans *crista* and *juba*, and the part which upheld it, or the metallic crest, was called *πάλος* by the Greeks, and *conus* by the Romans. Antique helmets were sometimes divided from the base, spreading like two horns, while the interval was filled with the flowing mane of a horse, and a plume arose on either side. Such is the crest of Minerva on Mr. Hope's

fine antique vase, which has a painting of the expiation of Orestes.

CREST, in heraldry, is a figure placed upon a wreath, coronet, or cap of maintenance, above both helmet and shield, as for instance the crest of a bishop is the mitre. See **HERALDRY**. The crest is esteemed a greater criterion of nobility than the armour generally, as being borne at tournaments; to which none were admitted till they had given proof of their nobility. Sometimes it serves to distinguish the several branches of a family. It has also served, on occasion, as the distinguishing badge of factions. Sometimes the crest is taken from the device; but more usually it is formed of some piece of the arms: thus, the emperor's crest is an eagle; that of Castile, a castle, &c. Families that exchange arms, as the houses of Brunswick and Cologne have done, do not change their crests; the first still retain the horse, and the latter the mermaid.

CREST, in the menage, the upper part of a horse's neck.

CREST-FALLEN, in the menage, a fault of a horse, when the crest hangs to one side. The cure is to place it upright, clipping away the spare skin, and applying plasters to keep it in a proper position.

CRETA'CEOUS, *adj.* } Lat. *creta*. Chalk-
CRETA'TED, *adj.* } like; chalky; abounding
 in chalk. Cretated signifies, rubbed with chalk.

What gives the light, seems hard to say; whether it be the *cretaceous* salt, the nitrous salt, or some igneous particles. *Gross.*

Nor from the sable ground expect success,

Nor from *cretaceous*, stubborn and jejune. *Philips.*

CRETE, in ancient geography, one of the largest islands in the Mediterranean, according to Strabo 287 miles in length; according to Pliny 270; and according to Scylax 312. As to its breadth, it is not, as Pliny observes, above fifty-five miles where widest; whence it was styled, as Stephanus observes, the Long Island. It has the Archipelago to the north, the African Sea to the south, the Carpathian to the east, and the Ionian to the west. Anciently it was known by the names of Aeria, Chthonia, Curete, Idæa, Macaris, &c.; but its most common name was Crete. It is now called **CANDIA**, which see.

Homer, the celebrated Grecian bard, describes Crete, as it stood in his time, as an 'extensive island in the midst of the stormy main. The soil is rich and fertile: it contains an immense number of inhabitants: it is adorned with 100 cities, and its inhabitants speak in various languages.' The Cretan mythologists, quoted by Diodorus Siculus, relate that the first inhabitants of the island were the Dactyli Idæi, who dwelt around mount Ida; they were regarded as magicians, because they possessed a variety of knowledge, and were particularly skilled in religious mysteries. Orpheus, who distinguished himself so highly in poetry and music, was their disciple. They discovered the use of fire, iron, and brass, and invented the art of working these metals in Berecynthus, a mountain near Aptera. These discoveries procured them divine honors. One of them, named Hercules, rendered himself famous by his exploits. The Dactyli Idæi were

the ancestors of the Curetes, who at first inhabited the forests and caves of the mountains. They afterwards entered into domestic life, and taught men to collect flocks of sheep, to tame the ferocity of wild animals for domestic purposes, and to invite bees into hives, and gather their honey. They excited men to chase, taught the use of the bow, and were the inventors of swords and of military dances. The noise which they made by dancing in armour, hindered Saturn from hearing the cries of Jupiter, whose education Rhea had entrusted to them. With the assistance of the nymphs, they brought up that god in a cave in mount Ida, feeding him with the milk of the goat Amalthea, and with honey. To this period mythology assigns the origin of the Titans; their abode near Gnosus, where stood the palace of Rhea; their travels over the whole earth; their war against Animon, and his defence by Bacchus; the nuptials of Jupiter and Juno, celebrated near the river Therenus in Crete; the gods, goddesses, and heroes, who descended from them. The most illustrious of those heroes were Minos and Rhadamanthus. They are said to have been the sons of Jupiter and Europa, who was conveyed into the island on a bull. Minos, becoming king, built several cities; the most considerable of which were Gnosus, on that side of the island which faces Asia, Phœstus on the southern shore, and Cydon on the western, facing Peloponnesus. Rhadamanthus distinguished himself by the impartiality of his judgments, and by the inflexible severity with which he inflicted punishment on the impious and wicked. His empire extended over the chief isles of the Archipelago, and the inhabitants of the adjacent coasts of Asia submitted to him on account of his high reputation for probity and justice. Mythologists constituted him judge in the regions below, to determine the future state of the righteous and the wicked. They conferred on him the same honors which were bestowed on Minos, the justest of kings. Thus far have been followed the Cretan traditions as they are related by Diodorus; but historians differ about the truth of them.

Leaving mythology for the more certain records and monuments of history, we find that Crete received its name from Cres, the first of its monarchs; and, to distinguish the true Cretans from strangers, they were named Etecretes. A number of colonies, from different parts of Greece, settled on the island. Among the successors of Cres we find two Jupiters, and two of the name of Minos; but most writers confound them, and ascribe to one those transactions and exploits which should be shared between the two. Minos was esteemed the wisest legislator of antiquity. The office assigned him in the regions below, is a clear proof of his having gained an exalted reputation by his justice. His laws were engraven on tables of brass; and Talos, his chief minister, visited all the towns and cities in the island, three times a year, to observe in what manner they were executed and obeyed. The second Minos was the first of the Greeks who appeared in the Mediterranean at the head of a naval armament. He conquered the Cyclades, expelled the Carians, established Cretan colonies

in those islands, and committed the government of them to his son. Being informed, at Paros, that his son Androgeus was slain at Athens, he declared war against Ægeus, and imposed on him a disgraceful tribute; from the payment of which Theseus delivered his country. He took arms against Nisus, king of Megara, made him prisoner by the treachery of his daughter Scylla, and put him to death, together with Megarus, the son of Hippomanes, who had brought some forces to his assistance. Dædalus, who had incurred his displeasure, despairing of pardon from so severe and inflexible a prince, employed the resources of his inventive genius, to escape from his power. He fled to Sicily, gained the protection of king Cocalus, and obtained an asylum in his court. The Cretan monarch did not, however, give up his prey. He equipped a fleet, pursued the fugitive to Sicily, and fell before the walls of Camicum. But these two princes, are often confounded by the poets, and the epithets of the former applied to the latter.—See Ovid. *De Arte Amat.* lib. ii. The last king of Crete was Idomeneus, who conducted twenty-four ships (or according to Hyginus forty) to the assistance of Agamemnon; and at his departure from Crete committed the government to Leucus his adopted son. He having seduced the people from their allegiance, and gained over the nobles, sacrificed the wife and daughter of Idomeneus in the temple, and when Idomeneus, crowned with laurels, landed on the coasts, he attacked him with an armed force, and obliged him to embark. But the usurper did not long enjoy the fruit of his crimes, for soon after the departure of Idomeneus, monarchy was abolished, and Crete became a republic.

Soon after the expulsion of Idomeneus, the Cretan government became partly aristocratical. The power was divided between the nobles and the people: yet as the chief employments were occupied by the nobles, they directed the administration of affairs. Ten magistrates were annually elected by a majority of voices, in the national assembly. These were named *cosmoi*, and their public office and character were the same with those of the *ephoroi* at Sparta. They were the generals of the republic in time of war, and directed all affairs of any importance, and they had the right of choosing certain elders for counsellors, who, to the number of twenty-eight, composed the Cretan senate. They were chosen from among such as had discharged the office of *cosmoi*, or had distinguished themselves by extraordinary merit and blameless probity. These senators continued in office during life, possessed a weighty influence, and were consulted in every affair of importance. This body was a barrier against the ambition of the ten chief rulers, and another restraint on their power was the limiting of their administration to one year. All the Cretans were subjected to the power of their magistrates, and divided into two classes, the adults and the youth. Men arrived at maturity were admitted into the first. The second consisted of all the young men who were not below the age of seventeen. The society of adults eat together in public halls. There rulers, magistrates, poor and rich, seated together, par-

took, without distinction, of the same simple fare. A large bowl, filled with wine and water, which went round the company from one to another, was the only drink that they were allowed. None but the old men had a right to call for more wine. A female was appointed to preside at each table, who openly distributed the most exquisite meats to those who had distinguished themselves by their valor or wisdom. Near where the citizens sat, two tables were laid, which they named *Hospitable*: all strangers and travellers were entertained at these: and there was also a particular house set apart by the public, in which they might spend the night. To supply the public expenses, every citizen was obliged to bring a tenth part of his annual income into the treasury, and the chief magistrates took care that every person contributed his proportion. The Cretans were also celebrated throughout Greece for the education of their youth. At the age of seven the boy was permitted to handle the bow; from that time he was admitted into the society of the adults, where he continued till the age of seventeen. There, sitting on the ground, and clothed in a plain and coarse dress, he served the old men, and listened with respectful silence to their advice. He was early accustomed to arms and to fatigue, that he might learn to endure excessive heat or cold, to clamber and leap among hills and precipices, and to bear manfully the blows and wounds he might receive, amid the gymnastic exercises or in battle. He was also taught to sing the laws, which were written in verse, with a certain species of melody; that the charms of music might dispose him to learn them with pleasure, and might impress them deeply on his heart. He next learned hymns in honor of the gods, and poems in praise of heroes. When he reached his seventeenth year, he retired from the society of the adults, and became a member of that of the young men. Here his education was still carried on. He exercised himself in hunting, wrestling, and fighting with his companions. The lyre played tunes of martial music; and he learned to follow the measures of the musician. One dance, in which the youth aspired most ardently to excel, was the *Pyrrhic*, originally invented in Crete. The performers in that dance were arrayed in complete armour: they wore a light short coat, which did not fall below the knee, and was bound with a girdle twice round the waist: on their feet and legs were buskins; above these they bore their arms, and performed various military evolutions to the sound of musical instruments. When the youth had finished their exercises, and attained the legal age, they became members of the class of adults; were permitted to vote in the national assemblies, and were entitled to stand candidates for any public office. They were then obliged to marry; but did not take home their wives till they were capable of managing their domestic concerns. Friendship was in high estimation among the Cretans; but, says Strabo, the manner in which they conducted the intercourse of friendship was extraordinary. He who conceived an affection for a young man of his own age, formed a scheme for carrying him off by violence; which having effected, he loaded

his young friend with favors, carried him from feast to feast, procured him the pleasures of the chase, &c. and after using all possible means to gain his heart for two months, brought him back to the city, and gave him up to his parents; with presents of a suit of armour, an ox, and a drinking cup. The young man sacrificed the ox to Jupiter, and gave an entertainment to those who had assisted when he was carried off. He then declared his sentiments concerning a connection with his friend. If he had reason to complain of the treatment which he had received, the law allowed him to forsake a friend so unworthy of the name, and to demand his punishment. Those who had been thus carried off received public honors. Theirs were the first places in the halls and at the race. They were permitted to wear, during the rest of life, those ornaments which they owed to the tenderness of friendship; and that mark of distinction testified to all who saw them, that they had been the objects of some fond attachment.

Under these wise regulations, the republic rose to glory, opulence, and power; and was honored with the panegyrics of the most celebrated philosophers of Greece. It served Lycurgus as a model for the form of government which he established at Sparta, and continued to flourish till the age of Julius Cæsar; and it is very remarkable, that from the period at which that state assumed a republican form, till the time when they were attacked by the Romans, the nation was not once known to send an hostile force into the territories of any of their neighbours. But though the independent cities which flourished in Crete did not unite their arms to subjugate the neighbouring islands, yet they were not so wise as to live in peace among themselves. Gnosus and Grotynia sometimes marched with social banners against their neighbours, levelled their fortresses, and subjected them to their power; at other times they attacked each other with hostile violence, and saw their bravest youth perish amid the horrors of civil war. Lyctos and Cydon opposed an invincible barrier to their ambition, and preserved their own liberty. The last of these cities had acquired such strength and influence, that she held the balance between the rival powers of the island; but these incessant wars destroyed a number of the cities, and drenched the native country of Jupiter with blood. At length the time arrived when the warlike and victorious Romans would suffer none but their subjects or slaves to inhabit within the reach of their arms. 'If any person wish to know the reasons which induced us to attack Crete,' says Florus, 'the true reason was our desire to subdue so celebrated an island. The Cretans had appeared to favor Mithridates, and the Romans thought proper to declare war against them on that pretext. Marc Antony, father of the triumvir, attacked them with strong hopes of success, but was severely punished for his presumption and imprudence. The Cretans took a great part of his fleet, hung up his soldiers and sailors on the masts amid the sails and cordage, and returned in triumph into their harbours.' The Romans never forgot nor forgave a defeat. As soon as the Macedonian war was brought to

a conclusion, they took up arms against the Cretans to revenge their ignominy and loss; and Q. Metellus was sent to Crete with a powerful armament. He met with an obstinate and vigorous resistance. Panarus and Lasthenes, two experienced leaders, collecting a body of 40,000 young warriors, all eager for battle, and of determined courage, employed their arms successfully against the Romans, and protracted the fate of Crete for three years. Those conquerors, indeed, could not make themselves masters of the island till they had destroyed all its bravest warriors. They lost a great number of troops, and bought a bloody victory at the price of many a danger and much fatigue. However, their usual good fortune at length prevailed. The first care of the conqueror was to abolish the laws of Minos, and to establish those of Numa. Strabo complains of this act of severity, and informs us that, in his days, the original laws of Crete were no longer in force, because the Romans compelled the conquered provinces to adopt their civil code. To secure themselves still more fully in the possession of the island, they sent a powerful colony to Gnosus.

Since the conquest of Crete by the Romans, the Cretans have no longer formed a separate nation, nor made any figure among the states and kingdoms of the world: their noble and ingenious manners, their arts and sciences, their valor and their virtues, are no more. The island of Crete joined with the small kingdom of Cyrene, on the Lybian coast, formed a Roman province. It was at first governed by a proconsul; a quaestor and an assistant were afterwards sent there; at last, it was put under the government of a consul. It was one of the first islands that were favored with the light of the gospel. St. Paul introduced the Christian faith into it; and his disciple Titus, whom he left there to cultivate that precious plant, became the first bishop of the island. In the reign of the emperor Leo it had twelve bishops, all subject to the patriarch of Constantinople. Constantine separated Crete from Cyrene, in the new division which he made of the provinces of the empire; and left Crete, with Africa and Illyria, to his third son, Constantine. In the reign of Michael II., emperor of Constantinople, a rebellion, which lasted three years, caused him to neglect the other parts of the empire. The Saracens, who had conquered the finest provinces of Spain, seized that opportunity. They fitted out a considerable fleet, plundered the Cyclades, attacked the island of Crete, and made themselves masters of it without opposition. To secure their conquest, they built a fortress which they named Khandak, i. e. entrenchment. From that citadel they made inroads into the interior parts of the island, carrying havoc and devastation wherever they appeared. By repeated attacks, they subdued all the cities in Crete except Cydon. Michael made some ineffectual efforts to expel them from Crete. The emperor Basinius I. was not more successful. They defeated him in a bloody battle; but being vanquished by one of his generals, they were subjected to the payment of an annual tribute. At the end of ten years the Arabians refused the tribute. It was reserved for Nicephorus Phocas, afterwards em-

peror, to deliver this fine island from the yoke of the infidels. He landed on it with a numerous army, boldly attacked them, and routed them in various engagements. The Saracens, no longer daring to meet so formidable a general in the field, fled for protection to their fortresses. Phocas, being plentifully supplied with all the warlike machines necessary for a siege, levelled their walls, took their cities and fortresses, and drove them into Khandak, their metropolis. In nine months he subdued the whole island, took their king Curup, and his lieutenant Aremas prisoners, and reunited to the empire a province which had been 127 years in the hands of the infidels. It remained under the dominion of the Romans till the time when Baldwin earl of Flanders, being raised to the throne, liberally rewarded the services of Boniface marquis of Montserrat, by making him king of Thessalonica, and adding the island of Crete to his kingdom. That lord sold it to the Venetians, A. D. 1194; under whom it assumed the name of CANDIA. See that article.

CRETIC, *n. s.* *Κρητικός*. A foot used in Greek and Latin verse; it consists of a short syllable between two long ones: e. g. Căstītās.

CRETIO, in antiquity, a certain number of days allowed the heir, to consider whether he would act as heir to the deceased or not; after which time, if he did not act, he was excluded from the estate.

CREVELT, a town of Germany in the ci-devant duchy of Cleves, annexed to France, in December, 1797, and included in the department of the Roer, but since returned to Prussia. It was taken in October, 1794, by the French under general Jourdan. Near this town, the French were defeated by the Hanoverians, in 1758. It is ten miles south of Meurs; and has a manufacture of fine linen. Population 7450.

CREVICE, *v. a. & n. s.* Old Fr. *crevis*, from *crever*; Lat. *crepare*. To split into cracks; to make flaws in. A cleft; a chink; a crack; a very narrow opening.

The same harme do sometime the smial dropes of water that enteren thurgh a litle *crevis* in the thurroh, and in the bottom of the ship, if men ben so negli-gent that they discharge hem not by time.

Chaucer. Cant. Tales.

Till at the last I spide within the same,
Where one stood peeping through a *crevis* small.

Spenser. Faerie Queene.

I pried me through the *crevice* of a wall,
When for his hand he had his two sons heads.

Shakespeare. Titus Andronicus.

So laid, they are more apt in swagging down to pierce with their points, than in the jacent posture, and so to *crevice* the wall. *Wotton's Architecture.*

I thought it no breach of good manners to peep at a *crevice*, and look in at people so well employed.

Addison's Spectator.

CREVIER (John Baptist Lewis), a native of Paris, trained under the celebrated Rollin, and afterwards professor of rhetoric. Upon the death of that author, in 1741; he finished his Roman History. His death happened in 1765, at a very advanced age. Besides the continuation of

Rollin, he published, 1. An edition of Livius cum Notis, in 6 vols. 4to, 1748; and afterwards another for the use of his pupils, in 6 vols, small 8vo. 2. La Histoire des Empereurs de Romains Jusqu' a Constantin, 1749, 12 tom. 12mo. 3. Histoire de l'Université de Paris, 7 tom. 12mo. 4. Rhetorique Francoise, a just and useful work. 5. Observations sur l'Esprit des Loix.

CREUSA, a daughter of Priam, king of Troy, by Hecuba. She married Æneas by whom she had Ascanius. When Troy was taken, she fled in the night with her husband; but they were separated in the confusion, and Æneas could not recover her. Some pretend that Cybele saved her, and carried her to her temple, of which she became priestess.

CREUSE, a department of France, so named from the river. It is bounded by those of Allier and Puy de Dome on the east; Correze on the south, Upper Vienne on the west, and Indre on the north. It contains the ci-devant province of Marche. Gueret is the capital.

CREUSE, a river of France, which rises eight miles south of Felletin, crosses the department, and that of Indre; and separates that of Indre and Loire from that of Vienne, till it falls into the river Vienne, five miles east of Have.

CREUTZENACH, **CREUTZNACH**, or **KREUTZNACH**, a town of the Prussian states, in the circle of the Upper Rhine. It is situated on the Nahe, which divides it into the Old and New Town. The ancient kings of the Franks had a palace here; and it was defended by a castle, which stood on an adjoining mountain, but which was destroyed by the French in 1689. This town was taken by the French in October, 1794, and annexed to their dominions in December, 1797. The inhabitants carry on a trade in wine, salt, corn, wood, and tobacco. Population 3200. A quarter of a league from the town are two salt mines, said to let for £10,000 per annum. It lies six miles south of Bingen, twenty south-west of Mentz, thirty N. N. W. of Worms, and thirty-eight north of Deux Ponts.

CREUX, a promontory in Catalonia, which was fixed on as the boundary between France and Spain in 1660. Long. 3° 20' 50" E., lat. 42° 19' 35" N.

CREW. Goth. *grua*; Per. *guruh*, kurah; Ang.-Sax. *crud*, *cread*. Minsheu and Mr. Todd are disposed to derive it from old Fr. *crue*, or *creue*, growth, accession, augmentation. Skinner refers it to the Dutch *kroeghen*, to carouse, to drink. A number of people associated for any purpose; the company of a ship. Except in the latter sense, it is now generally used to signify an improper or despicable assemblage, though its inoffensive meaning is not entirely obsolete, as we still hear of a jovial crew, &c.

If all the world to seek I overwent,
A fairer crew, yet no where could I see,
Than that brave court did to the eye present.

Spenser.

Care we for all these bugs of idle feare:
For Tigel's grinning on the theatre?
Or scarce-babe threatenings of the rascal crew?
Or wind-spent verdicts of each ale-knight's view?
Hall.

One of the banished crew,
I fear, hath ventured from the deep, to raise
New troubles. *Milton's Paradise Lost.*

He, with a crew, whom like ambition joins
With him, or under him to tyrannize,
Marching from Eden towards the west, shall find
The plain. *Id.*

The anchors drooped, his crew the vessels moor.
Dryden's Æneid.

The last was he, whose thunder slew
The Titan race, a rebel crew. *Addison.*

There was no light in heaven but a few stars,
The boats put off ere crowded with their crews;
She gave a keel, and then a lurch to port,
And going down head foremost sunk in short.

Byron. Don Juan.

CREW, preterite of crow.
Immediately the cock crew. *Matthew xxvi. 74.*

It was about to speak when the cock crew.
Shakspeare. Hamlet.

CREW OF A SHIP. The sailors who are to work and manage a ship are regulated by the number of lasts it may carry; each last making two tons. The crew of a Dutch ship, from forty to fifty lasts, is seven sailors and a swabber; from fifty to sixty lasts, the crew consists of eight men and a swabber; and thus increases at the rate of one man for every ten lasts; so that a ship of 100 lasts has twelve men, &c. English and French crews are usually stronger than Dutch; but always in about the same proportion. In a ship of war there are several particular crews, or gangs; as the boatswain's crew, the carpenter's crew, the gunner's crew, &c.

CREWE (Nathaniel), an English bishop, the son of John lord Crewe was born at the family seat in Northamptonshire, in 1633. He was educated at Lincoln College, Oxford, where he took his degrees in arts, and joined the presbyterian party; but at the Restoration he took orders in the established church, and in 1669 was made dean of Chichester. He was preferred to the bishopric of Oxford in 1671, from whence he was translated to Durham in 1674, for which preferment he was indebted to James duke of York; upon whose accession to the throne the bishop supported all his measures, and was one of the commissioners appointed in the ecclesiastical commission in 1686. When, however, the prelate saw his master's ruin approaching, he began to change his conduct; and in the convention parliament, he gave his vote with others, that James had abdicated the throne; he was, however, excepted by name out of the pardon granted by William and Mary; and found it necessary to abscond for some time. But he at last, not only received his pardon, but the indulgence of retaining his dignity; and on the death of his brother, in 1691, he succeeded to the family title. He died in 1721, having held the see of Durham forty-seven years, a circumstance unparalleled in its history till the time of the late Hon. Shute Barrington, who held the same bishopric fifty-six years.

CREWEL, *n. s.* Dutch *klewel*. Yarn twisted, and wound on a knot or ball.

Take silk or crewel, gold or silver thread, and make these fast at the bent of the hook.

Watson's Angler.

CREWKERNE, a market town on the borders of Dorsetshire, a mile from the Parret. It contains about 3000 inhabitants who manufacture dowlas, sail-cloth, girth-web, and stockings. It has a market for corn and provisions on Saturday. It is twenty miles south-east of Taunton, and 132 west by south of London.

CRIB, *v. a. & n. s.* Ang.-Sax. crybbe; Dutch *krippe*, *krebbe*; Ger. *krippe*, *kruppe*. To shut up in a narrow or inconvenient space; to confine; to circumscribe. A rack or manger; the stall or cabin of an ox; a small habitation; a hut.

Now I am cabbined, cribbed, confined, bound in
To saucy doubts and fears. *Shakspeare. Macbeth.*

Let a beast be lord of beasts, and his crib shall stand at the king's messe. *Id. Hamlet.*

Why rather, sleep, lest thou in smoaky cribs,
Upon uneasy pallets stretching thee,
Than in the perfumed chambers of the great? *Id.*

The steer and lion at one crib shall meet,
And harmless serpents lick the pilgrim's feet. *Pope.*

In measure, as by force of instinct drawn,
Or by necessity constrained, they live
Dependent upon man; those in his fields,
These at his crib, and some beneath his roof. *Cowper.*

CRIB, *v. a.* Fr. *gripper*; Ger. *krippen*. To pilfer; to steal silyly. A low word.

CRIB, in the English salt-works, a name given to a sort of case, used in some places instead of the drab, to put the salt into as it is taken out of the boiling pan.

CRIBBAGE, *n. s.* A game at cards. See the next article.

A man's fancy world be summed up in cribbage. *J. Hall.*

CRIBBAGE, a popular game at cards. In this game the set must be sixty-one, and no cards are to be thrown out. It being an advantage to deal, on account of the crib, it is common to cut for it, and he that has the least cards deals. At this game there are only two players, and the cards are dealt out one by one, the dealer giving his antagonist the first, keeping the second to himself, and so on till each have five, when the rest are laid down in view upon the table. After this the dealer lays out the two best cards he can for his crib; and his antagonist lays down other two, the very worst he can, the crib being the property of the dealer. A card from the parcel left after dealing is then turned up, after which the game is counted thus: any fifteen by the cards is two; as king and five, ten and five, nine and six, eight and seven, &c. A pair is also two; a pair-royal, or three aces, kings, &c. six; a double pair-royal, or four aces, &c. twelve. Sequences of three cards, as four, five, and six, is three; sequences of four, four; five, five, &c. and the same holds of a flush. Knave-noddy, or of the suit turned up, is one in hand, and two to the dealer. If, after the cards for the crib are laid out, there remain in hand a nine and two sixes, that makes six, because there are two fiftens and a pair; and if a chance be turned up, then you have twelve in your hand, viz. the pair-royal and three fiftens. These are to be marked with pegs, counters, or otherwise. Should you happen to have sequents, as of four, five, and six, in your

hand, and six is the turned up card, they are counted thus: first the sequents in your hand make three; and the sequents of the four and five in your hand, added to the six turned up, make other three; there are likewise two fifteens, counting first with the six in your hand, and then with that turned up. After this the antagonist to the dealer plays first, suppose six; and if the dealer can make it fifteen, by playing nine, he gains other two; otherwise they play on, and whoever reaches thirty-one exactly or comes nearest under it gains two or one. Here also, in playing the cards you may make pairs, pairs-royal, flushes, &c. The crib being the dealer's, he may make as many as he can out of it, together with the card turned up, counted as above; if he can make none, he is said to be bilked. In this manner they play and deal by turns, till the game of sixty-one is up; and if this be reached by one gamester before the other reach forty-five, the latter is said to be lurchd, and the former gains a double game.

CRIBBLE, *v. a. & n. s.* } Old Fr. *crible* ;
CRIBRATION, *n. s.* } Lat. *cribrum*. To sift through a sieve. A corn sieve; coarse meal, a degree better than pollard. The act of sifting.

CRICELASIA, the driving a ring or hoop. Driving a hoop was one of the ancient gymnastics: this hoop was as high as the breast of the person who used it. It was commended for rendering the limbs pliable, and for strengthening the nerves.

CRICHTON (James), a Scots gentleman who lived in the sixteenth century, and who, on account of his extraordinary endowments of body and mind, obtained the appellation of the admirable Crichton. He was descended of the blood royal; and is said to have received his grammatical education at Perth, and to have studied philosophy in the university of St. Andrew's. In his seventeenth year he went to Paris, where he caused placards to be fixed on all the gates of the schools, halls, and colleges, belonging to the university, inviting those who were well versed in any art or science, to dispute with him in the college of Navarre, that day six weeks, by nine o'clock in the morning, where he would attend them, and be ready to answer to whatever should be proposed to him, in any art or science; and in any of these twelve languages, Hebrew, Syriac, Arabic, Greek, Latin, Spanish, French, Italian, English, Dutch, Flemish, and Slavonian: and this either in verse or prose, at the discretion of the disputant. During the time appointed he attended the various places of amusement, rather than the colleges or seats of learning, which so provoked the students, that under the placard which was fixed on the Navarre gate, they caused the following words to be placed; 'If you would meet with this monster of perfection, make search for him either in the tavern or stews.' Nevertheless when the day appointed arrived, Crichton appeared in the college of Navarre, and acquitted himself so well in the disputation, that he was presented by the president, with a diamond ring, and a purse full of gold, as a testimony of esteem. It is added, that he was so little fatigued with the dispute, that he went on the very next day to the

Louvre, where he had a match of tilting, and in the presence of some of the French princes, and many ladies, carried away the ring twenty-five times successively. About two years after this we find him at Rome, where he affixed a placard upon all the eminent places in the city, in the following terms: Nos Jacobus Crichtonus Scotus, cuicumque rei propositæ ex improviso respondebimus; and in the presence of the pope, many cardinals, bishops, doctors of divinity, and professors in all the sciences, he displayed such wonderful proofs of his universal knowledge, that he excited no less surprise than he had done at Paris. From Rome he went to Venice; where he contracted an intimate friendship with Aldus Manutius, Laurentius Massa, Speron Speronius, Johannes Donatus, and other learned men, to whom he presented several poems in commendation of the city and university. He held, likewise, disputations on theology, philosophy, and mathematics, before the most eminent professors, and multitudes of people. He next went to Padua, the university of which city was at that time in great reputation. Amidst the discourses which were occasioned by our young Scotchman's exploits, and the high applauses that were bestowed upon his genius and attainments, some persons endeavoured to detract from his merit. For ever, therefore, to confound these invidious impugnors of his talents, he caused a paper to be fixed on the gates of St. John and St. Paul's church, wherein he offered to prove before the university, that the errors of Aristotle, and of all his followers, were almost innumerable; and that the latter had failed both in explaining their master's meaning, and in treating on theological subjects; this he engaged to do, either in the common logical way, or by numbers and mathematical figures, or in 100 sorts of verses, at the pleasure of his opponents. According to Manutius, Crichton sustained this contest, without fatigue for three days; during which time he supported his credit, and maintained his propositions, with spirit and energy, and with the highest applause from an unusual concourse of people. From Padua, Crichton set out for Mantua; where there happened to be at that time a gladiator, who had foiled in his travels, the most famous fencers in Europe, and had lately killed three who had entered the lists with him in the city. This man Crichton challenged and slew, and divided the prize with the widows of the three whom the fencer had previously killed; in consequence of this and his other wonderful performances, the duke of Mantua appointed him preceptor to his son Vincentio di Gonzaga, who is represented as having been of a riotous temper and a dissolute life. One night, during the time of carnival, as he was walking along the streets of Mantua, and playing upon his guitar, he was attacked by six men in masks. In the issue, the leader of the company being disarmed, pulled off his mask, and begged his life, telling him that he was the prince his pupil. Crichton immediately fell upon his knees, and expressed his concern for his mistake; alleging that what he had done was only in his own defence, and that if his highness had any design upon his life, he might always be master of it. Then taking his own sword by

the point, he presented it to the prince, who was so irritated by the affront he had sustained, in being foiled with all his attendants, that he instantly ran Crichton through the heart. Thus died this celebrated man, in a drunken frolic, in the fifty-second year of his age. The following is the list of his works according to Dempster.

1. *Odæ ad Laurentium Massam plures.*
2. *Laudes Patavine, Carmen extempore effusum, cum in Jacobi Aloysii Cornelii domo experimentum ingenii, coram totâ Academiæ frequentiâ, non sine multorum stupore, faceret.*
3. *Ignorantionis Laudatio, extemporale Thema ibidem redditum, post sex horarum disputationes, ut, præsentibus somnia potius fovere quam rem se veram videre affirmarint, ait Manutius.*
4. *De Appulsu suo Venetias.*
5. *Odæ ad Aldum Manutium.*
6. *Epistolæ ad Diversos.*
7. *Præfationes solennes in omnes Scientias Sacras et Profanas.*
8. *Judicium de Philosophis.*
9. *Errores Aristotelis.*
10. *Alma an Literæ præstant? Controversia Oratoria.*
11. *Refutatio Mathematicorum.*
12. *A Comedy in the Italian language.*

CRICK, *n. s.* } Ital. *crick*; Ang.-Sax.
 CRICKET, *n. s.* } *crýce*; Dutch *krekel*. Crick
 CRICKETER, *n. s.* } is the noise made by a door, in which case it is derived from the Italian; unless, indeed, both words may be supposed to be imitative of the sound. It also means, a painful stiffness in the neck; and in that sense Junius thinks the Anglo-Saxon word for a stick or staff is the parent, because the neck is as stiff as a staff. Cricket is a noisy insect that haunts warm places (see GRYLUS); a well-known game, (see the next article); and a low seat or stool. Cricketer is one who plays at cricket.

Didst thou not hear a noise †—
 — I heard the owl scream, and the *crickets* cry.
Shakspeare. Macbeth.

Far from all resort of mirth,
 Save the *cricket* on the hearth. *Milton.*

The solemn death-watch clicked the hour she died,
 And shrilling *crickets* in the chimney cried. *Gay.*

The judge, to dance, his brother serjeant call;
 The senator at *cricket* urge the ball. *Pope.*

But come, thou genial son of spring,
 Whitsuntide! and with thee bring
Cricket, nimble boy and light,
 In slippers red and drawers white. *Hoddesford.*

'Yet, tho' 'tis too rural,—to come near the mark,
 We all herd in one walk, and that nearest the Park;
 There with ease we may see, as we pass by the wicket,
 The chimneys of Knightsbridge, and footmen at
cricket. *Sheridan.*

There's something cheerful in that sort of light,
 Even as a summer sky's without a cloud:
 I'm fond of fire, and *crickets*, and all that,
 A lobster-salad, and champagne, and chat.
Byron Don Juan.

CRICKET, in zoology. See GRYLUS.

CRICKET, the name of a manly English game in which one party endeavours to strike down one wicket with a ball thrown from the other, and which the other endeavours to strike in its course, with sufficient force to give time to change wickets before the ball can be again brought to them. Every change of wickets constitutes a notch, and the game is decided by the greatest number of

notches on either side. The full complement of players is twelve on each side and two umpires. The following are the principal laws of the game, as settled by the Mary-le-bonne club, and are universally acknowledged.

The ball must weigh not less than five ounces and a half, and not more than five ounces and three quarters.

The bat must not exceed four inches and a quarter in the widest part.

The stumps, which are three, must be twenty-four inches out of the ground, the bail seven inches in length.

The bowling mark must be in a line with the stumps, three feet in length, with a return mark.

The popping crease must be three feet ten inches from the wicket, and parallel to it.

The wickets must be opposite to each other, at the distance of twenty-two yards.

The wicket-keeper must stand at a reasonable distance behind the wicket, and not move till the ball is out of the bowler's hand.

The bowler must deliver the ball with one foot behind the bowling-crease, and within the return-crease, and bowl four or six balls before he changes wickets, which he is allowed to do but once in the same innings.

The striker is out; 1. if the bail be bowled off, or the stump bowled out of the ground; 2. if the ball, from a stroke over or under his bat, or upon his hand (but not wrists), is held before it touches the ground; 3. if in striking, or at any other time while the ball is in play, both his feet are over the popping-crease, and his wicket put down; except his bat be grounded within it; 4. if in striking the ball he hit down his wicket; 5. if the ball be struck up, and either wilfully strike it again; 6. if in running a notch, the wicket is struck down by a throw, or with the ball in hand, before his foot, hand, or bat, is grounded over the popping-crease; 7. if he stop the ball with his foot, when it would have hit the wicket.

If the players have crossed each other, he that runs for the wicket which is put down, is out; if they have not crossed, he that has left the wicket which is put down, is out.

When a ball is caught, or when a striker is run out, the notch run for is not to be reckoned. When the ball has been in the bowler's, or wicket-keeper's hand, it is considered as no longer in play, and the strikers need not keep within their ground till the umpire has called *play*; but, if the player go out of his ground with an intent to run before the ball is delivered, the bowler may put him out.

In single wicket matches, if the striker move out of his ground to strike the ball, he shall be allowed no notch for such stroke.

Not out if the striker hit the opposite wicket, and his partner be off his guard.

CRICKETING APPLE, *n. s.* A small species of apple.

CRICKHEATH, or CRICKIETH, a town of North Wales, in Caernarvonshire, on the coast of the Irish sea, with a castle said to have been built in the reign of king John, twenty-one miles south of Caernarvon, and 233 north-west of London. It has a weekly market on Wednesday, and three fairs.

CRICKHOWELL, a town of South Wales in Brecknockshire, situated near the Usk, much resorted to by invalids, for the purpose of drinking goats' milk and whey. The ruins of an ancient castle are yet visible. There is a weekly market on Thursday, well supplied with fish and provisions. It is six miles W. N. W. of Abergavenny, thirteen E. S. E. of Brecknock, and 154 W. N. W. of London.

CRICKLADE, a borough of Wiltshire, situated on the river Thames, anciently a place of considerable consequence. It contains about 250 houses, and sends two members to Parliament; but the electors having been convicted of corruption, the freeholders of several adjacent places were added to the number of voters. The river Thames is navigable to this town, and a canal is now made between the Thames and the Severn, which joins the former at this place. It has a weekly market on Saturday; and is thirty miles west of Oxford, and eighty-four W. N. W. of London.

CRICOIDES, in anatomy, a cartilage of the larynx, called also the annular cartilage. It occupies the lowest part by way of base to the rest of the cartilages, and to the lower part of it the *aspera arteria* adheres. See **ANATOMY**.

CRILLON (Louis de Berthon), a knight of Malta celebrated for his bravery, was born of a noble family in the court at Venaissin, in 1541. At the age of fifteen he served at the siege of Calais, and afterwards, in the battles of Dreux and Jarnac, distinguished himself against the Huguenots. He was also at the battle of Lepanto, and assisted in 1573 at the siege of Rochelle. Henry III., proposing to him to assassinate the duke of Guise, he resolutely refused but offered to fight him. In the reign of Henry IV. he repulsed the leaguers from before Boulogne, and in 1592 successfully defended Milleboeuf against the army of Villars. He was found, while able to keep the field, in every service of danger. The bad state of his health obliged him to retire early from active life, and he died at Avignon in 1615, in his seventy-fifth year.

CRIME, *n. s.*
CRIMEFUL, *adj.*
CRIMELESS, *adj.*
CRIMINAL, *n. s. & adj.*
CRIMINALITY, *n. s.*
CRIMINALLY, *adv.*
CRIMINALNESS, *n. s.*
CRIMINATE, *v. a.*
CRIMINATION, *n. s.*
CRIMINATORY, *adj.*
CRIMINOUS, *adj.*
CRIMINOUSLY, *adv.*
CRIMINOUSNESS, *n. s.*

Fr. *crime*; It., Sp. & Lat. *crimen*. Crime is, an act which is contrary to divine or human law; a heinous offence; an act of wickedness. It is also used by old writers to signify merely reproach; in which sense it is a Latinism. Criminal, as a noun, means, an accused person; a guilty person. As an adjective, it denotes, contrary to right, to duty, to law; tainted with crime; relating to penal as distinguished from civil legal proceedings. Crimeful, and criminous, indicate, a high degree of crime; enormous guilt. To criminate is to accuse of crime. The kindred words are so closely allied in meaning, that it is unnecessary to explain them.

I shal him tellen which a gret honour,
 It is to be a flattering limitour,

And eke of many another manor crime,
 Which nedeth not rehersen at this time.

Chaucer. Cant. Tales.

Nath lesse most heavenly faire in deed and wev
 She by creation was, till she did fall,
 Thenceforth she sought for helps to cloke her crime
 withall.

Spenser. Faerie Queene.

The tree of life, the crime of our first father's fall.
Id.

For on his backe a heavy load he bare
 Of nightly steths and pillage severall,
 Which he hed got abroad by purchase *criminall*. *Id.*
 Devise extremes beyond extremity,
 To make him curse this cursed *crimeful* night.

Shakspeare. The Rape of Lucrece.

My foes could not procure me any scathe,
 So long as I am loyal, true, and *crimeless*.

Id. Henry VI.

All three persons that had held chief place of
 authority in their countries; all three ruined, not by
 war, or by any other disaster, but by justice and sen-
 tence, as delinquents and *criminals*.

Bacon.

Of what is bad, a little's a great deale,
 Better is more: but best is nought at all,
 Lesse is the next, and lesser *criminal*.

Hall.

I could never be convinced of any such *criminos-
 ness* in him, as willingly to expose his life to the stroke
 of justice, and malice of his enemies.

King Charles.

Undergo with me one guilt, one *crime*
 Of tasting.

Milton.

The punishment that belongs to that great and
criminos guilt, is the forfeiture of his right and claim
 to all mercies, which are made over to him by Christ.

Hammond.

Some particular duties of piety and charity, which
 were most *criminosly* omitted before.

Id.

Was ever *criminal* forbid to plead?

Curb your ill-mannered zeal.

Dryden's Spanish Friar.

No *crime* was thine, if 'tis no *crime* to love. *Pope.*
 The neglect of any of the relative duties, renders us
criminal in the sight of God.

Rogers.

As our thoughts extend to all subjects, they may be
criminally employed on all.

Id.

Embracing in their arms the carcases of base *crimi-
 nals*, and promoting their relations on the title of their
 offences, they drive hundreds of virtuous persons to
 the same end, by forcing them to subsist by beggary or
 by *crime*.

Burke.

Lord Coke, the oracle of the English law, conforms
 to that general sense, where he says that 'those things
 which are of the highest *criminality*, may be of the
 least disgrace.'

Id.

It is no slight authority which shall persuade us
 (by receiving as proofs of loyalty the mistaken princi-
 ples lightly taken up in these addresses) obliquely to
criminate, with the heavy and ungrounded charge of
 disloyalty and disaffection, an uncorrupt, independent,
 and reforming parliament.

Id.

Shall he, nurst in the Peasant's lowly shed,
 To hardy Independence bravely bred,
 By early Poverty to hardship steeled,
 And trained to arms in stern Misfortune's field;
 Shall he be guilty of their hireling *crimes*,
 The servile, mercenary Swiss of rhymes.

Burns.

If killing birds be such a *crime*,
 (Which I can hardly see,)
 What think you, sir, of killing Time,
 With verse addressed to me?

Cowper.

Hear him, ye Senates! hear this truth sublime,
 'He who allows oppression, shares the *crime*.'

Darwin.

If he has transgressed the constitution with impunity, if his *criminality* is suffered to pass even without rebuke,—this is nothing less than a radical change of system.

Sheridan.

If now and then there happened a slight slip,

Little was heard of *criminal or crime*—

The story scarcely passed a single lip—

The sack and sea had settled all in time.

Byron. Don Juan.

CRIMES. The cognizance and admeasurement of crimes and punishments form, in every country, the code of criminal law; or, as it is more usually denominated in England, the doctrine of the pleas of the crown: so called, because the king, in whom the majesty of the whole community centres, is supposed, by the law, to be the person injured by every infraction of the public rights belonging to that community; and is, therefore, in all cases, the proper prosecutor for every public offence. However important this branch of jurisprudence may appear, either from the peculiar admixture of human passions, and its topics and subjects; from giving a lasting efficacy to sanctions that were intended to be temporary, and made, as lord Bacon expresses it, merely upon the spur of the occasion; or, lastly, from too hastily employing such means as are greatly disproportionate to their end, in order to check the progress of some very prevalent offence; from some, or from all of these causes, it has happened, that the criminal law is, in every country of Europe, more rude and imperfect than the civil. The student of law will find the general inhumanity and mistaken policy in the local constitutions of other nations, sufficiently pointed out by Montesquieu, Beccaria, and other ingenious foreign writers. In our own country, Mr. Bentham, Mr. Montague, Sir Samuel Romilly, and numerous modern authors, have called the public attention to this subject. Sir William Blackstone observes, b. iv. ch. 1, 'It is a melancholy truth, that among the variety of actions which men are daily liable to commit, no less than one hundred and sixty have been declared, by act of parliament, to be felonies, without benefit of clergy; or, in other words, to be worthy of instant death. So dreadful a list, instead of diminishing, increases the number of offenders.' And Mr. Wilberforce is reported to have said, in his place in the house of commons, 'that he well remembered, that a great and lamented public character, Mr. Pitt, at an early period of his life, had intended to have a digest made of the whole of our criminal code, with a view of lessening, in a great degree, the number of capital punishments which it contained, and the objections to which it was impossible to confute.' In England, indeed, we seem to have been, of late, imbibing better and more humane views of this interesting subject, while, on the continent, they have boldly carried into effect some striking and very admirable innovations. We have here only room to present the reader with the substance of the new Bavarian and French codes; hoping that our remaining article on the same subject, the PUNISHMENT OF CRIMES, may yet enable us to record some decided improvements in our own system.

The former was drawn up by M. Bexon, by

direction of the king of Bavaria, and published at Paris, in folio, in 1807. It professes to contain a complete system of criminal law, including punishments and police.

M. Bexon begins with a digest of police-laws, under the title of *Legislation de la Sureté*. In the subdivisions of his work, the principal heads are, 1. Principes généraux. 2. Des auteurs, des complices et des fauteurs, des délits et des crimes. 3. Des peines en général, et du mode de leur exécution. 4. De la récidive, de l'influence de l'âge sur le caractère et la durée des peines. 6. De l'autorité paternelle et de famille. 7. Du devoir des juges, dans l'application et la graduation des peines, de circonstances excusantes, atténuantes, et aggravantes. 8. Des actions et de leur prescription. 9. Des absens ou contumaces, et de la prescription des condamnations. 10. Des frais des procès criminels, et des dommages intérêt. 11. De la grace. 12. De la diminution de la durée des peines, pendant leur cours, ou de la remission que le coupable peut obtenir par son travail et son repentir. 13. De la réhabilitation. The arrangement of the matter of this part of the work is certainly neither clear nor convenient. Crimes, punishments, tribunals, and procedure, are mixed together, instead of being kept separate and distinct, as they ought to be.

In the penal code itself this writer has adopted the old classification of offences under the heads of, 1. Crimes against the public. 2. Crimes against persons. 3. Crimes against things. What is new in his work, is the distribution of these into three distinct classes, according to their supposed delinquency, and which he calls, 1. Contraventions et fautes. 2. Délits. 3. Crimes.

The modern French penal code was decreed the 12th February, 1810, and promulgated the 22nd of the same month. The whole penal code, including punishments, is comprised in 114 octavo pages. It begins by declaring, that a violation of the law, cognizable by the police, is a contravention; that a violation of the law, that is visited by correctional punishment, is an offence; and that a violation of the law, that is visited by an afflictive and infamous punishment, is a crime. The several species of punishments employed are, 1. Death. 2. Hard labor for life. 3. Transportation. 4. Hard labor for limited periods. 5. Seclusion. 6. The carcan, similar to our pillory. 7. Banishment. 8. Civil degradation. 9. Imprisonment, during a limited period, in a house of correction. 10. Suspension, temporary, of certain civil rights. 11. Making satisfaction to the party injured. To these are added, in specified cases, the drawing a ball, to be attached to the feet; imprinting on the right shoulder, by means of a red-hot iron, certain letters; standing on the carcan, having a writing, in large and legible characters, affixed to the head, &c. Some of the punishments are also attended with certain temporary, and others with perpetual, civil disabilities. Forfeiture of property, it is declared, shall not attach, in any case, as the necessary consequence of conviction, but is to have place only when expressly pronounced as part of the punishment, and, in the few instances in which it is used, the property

remains liable to all just incumbrances, and to the obligation of furnishing children, or other descendants, a half of such part of their portion as the criminal could not have deprived them of.

Offences are divided into two classes: 1. Those affecting the public. 2. Those affecting individuals. Under the first, the principal offences that are comprised are, offences against the exterior and interior of the state, levying war, counterfeiting the coin, and malversation on the part of public functionaries, ecclesiastical and civil. Under the second head, offences affecting particular assignable persons, such as murder and other personal injuries, perjury, and offences against property.

In the section relating to the administrative and judicial authority, it is declared, that, whenever any judge shall, after it has been notified to him that a cause has been removed before a superior tribunal, proceed to pronounce judgment notwithstanding, he shall be punished by a fine of not less than sixteen francs, nor greater than 150 francs; so again, wherever any judge shall enter the house of a citizen, in cases in which the law shall not have invested him with authority so to do, or in a manner not prescribed by the law, he shall be punished by a fine of not less than sixteen francs, nor greater than 200 francs; and there are several other cases in which the misconduct of judges renders them subject to penalties.

CRIMEA (The), a peninsula of European Russia, is situated between the parallels of 44° 40' and 46° 5' N., and the meridians of 32° 45' and 36° 39' E. It is of an irregular rhomboid shape, surrounded on all sides by the Black Sea and the Sea of Azof, except at its northern angle, where the isthmus of Perekop connects it with the continent. Its extent from north to south is about 124 English miles, and from west to east 208 English miles. Its superficies is computed at about 3,500,000 English statute acres, the greater proportion of which consists of desert plains, or steppes. This peninsula has been known under a variety of names; the ancients called it *Taurica Chersonesus*, also *Chersonesus Scythica*, and *Chersonesus Magna*; in the middle ages it was sometimes called the *Island of Caffa*; and, in more modern times, it has been known under the appellations of *Crim Tartary* and the *Crimea*.

The Crimea is naturally divided into three parts; *Crimea Proper*, the eastern subordinate peninsula of *Kertsch*, and the *Isle of Tamar*. Upwards of three-fourths of *Crimea Proper*, towards the north, is composed of steppes, and totally devoid of trees; but affording excellent pasturage, and abounding in salt lakes and marshes. The soil in this division is partly of a white sandy clay, and partly of black vegetable loam, mixed in some parts with chalk and limestone. The vast quantities of petrifications and marine productions which are found in this district, have given rise to the supposition that it was originally submerged by the Black Sea. The salt marshes are so productive, that upwards of 200 vessels are annually laden with salt from the single port of *Caffa*, besides which vast quantities are transported by land, to *Poland* and *Rus-*

sia, even as far as *Petersburgh* and *Riga*. The southern portion of the Crimea is mountainous: the principal ridges extending from east to west. Some of these mountains are said to be 1200 feet above the level of the Black Sea, and are covered with snow the greater part of the year. From the summit of *Ischadir-daghi*, or the pavilion mountain, the prospect stretches nearly over the whole peninsula. The union of the sublime and beautiful is nowhere more manifest than in the southern portion of *Crimea Proper*; where, while from a stupendous height the tops of the mountains glitter with silvery snow, their sides are covered with wide-spreading forests, and their bases with the blushing vine, the olive, the fig-tree, and the pomegranate. These mountains also enclose innumerable corn-fields, and verdant plains, refreshed with natural fountains and cascades.

The peninsula of *Kertsch* (anciently the kingdom of *Bosphorus*) presents a widely different aspect from the *Crimea Proper*. Its extent from west to east is about eighty-four English miles; its medium breadth from north to south twenty-four English miles. The isthmus which connects it with the Crimea, is a level plain, ten miles broad. The shores, both of the *Euxine* and the sea of *Azof*, which encircle this peninsula, are very steep and difficult of access. The interior is almost entirely destitute of wood, but abounds with fruit-trees; and the soil, excepting in the immediate neighbourhood of the salt-marshes, is very fertile. The strip of land which separates the *Mud Sea* from the *Sea of Azof*, is composed of sand and shells, and for the most part affords excellent pasture. On the leaves and stems of vegetables growing near a salt-marsh in this peninsula, is found what is supposed to be sulphur, or sulphuret of soda. Salt-springs, a spring of petroleum, or rock-oil, a mineral said to be prussiate of iron, and petrified shells, compose the remaining natural curiosities of this strip of land.

Tamar is included under the same government as the Crimea. This island is surrounded by the seas of *Azof* and the *Black Sea*; its length is forty miles, and its breadth twenty-six. The shores are remarkable for their steepness. The soil in some parts is fertile; but, owing to the prevalence of thick fogs, its humidity, and the bad quality of its water, the climate is unhealthy. In this island are found large quantities of petroleum, some saline springs, and many springs of fresh water, but no running streams. On the western extremity is a mud volcano, which the *Tchernomorski*, the present inhabitants, call *Prekla* (hell); its eruptions consist of disjections of vast masses of viscous mud, accompanied by smoke and fire. The *Salghir* is the only river of any importance in the Crimea. The *Bolbeck*, *Alna*, *Byak*, *Aithaddr*, *Badraka*, *Balganack*, *Katsha*, &c., are small streams, which are so very rapid after heavy falls of rain, as to be excessively dangerous; in the dry season, however, they are nearly destitute of water.

The climate of the Crimea is very variable. The winters are occasionally severe, whilst the springs are moderate and serene. The summer, for the most part, is very hot; and the autumn

saltry, moist, and unhealthy. Tertian fevers are the most prevalent complaints of the inhabitants. The Crimea is subject to the plague of locusts. Two species, the *gryllus tartaricus* and *migratorius*, are found here, which at certain seasons devastate the fields, the gardens, and the vineyards. Dr. Lyall mentions having seen as many as 200 Tartars, armed with branches of trees tied together, and clubs, occupied in destroying them, by beating them against the ground. Tarantulas, black, and of a tremendous size, infest this peninsula; also the *phalangium arachnoides*, a species of spider of a smaller size, the bite of which Pallas declares to be fatal. The *scelopendra morisians*, or centipede, is likewise very common; the bite of this insect is very terrible. In the mountainous districts, scorpions are not unfrequently found. A small kind of caterpillar, which is very destructive to the vines, is regarded by the celebrated Pallas as peculiar to this peninsula.

The present capital of the Crimea is Sympheropol, called by the Tartars *Ak-metchet* (white mosque) from an edifice of this description built by Ibrahim Bey. It is reported, that on the occasion of the Russian conquest, prince Potemkin threw up coin with his principal officers for the decision of a place for the seat of government, and it fell on this town. It is situated in a valley, watered by the Solghir, and presents a very picturesque appearance in summer, from the number of gardens, clumps of trees, and extensive fields, with which it is surrounded. It is 963 miles from Moscow, and 1408 from St. Petersburg. Like all Tartar towns, it consists of narrow unpaved streets, intersecting each other at irregular angles; the whole city is excessively dirty and confined. It contains no public buildings worthy of notice, with the exception of its cathedral, which Dr. Lyall considers the handsomest ecclesiastical structure in the Russian empire. There are within its compass four mosques, with minarets, an Armenian church, a Roman Catholic church, and a synagogue. Its population, consisting of Tartars, Greeks, Armenians, Moldavians, and Jews, is about 2000. This city was long the place of residence of the celebrated professor Pallas.

Bakhtchiserai (garden palace), the ancient capital, is situated thirty versts from Sympheropol. The view presented to the traveller, as he journeys to this city, is said to be very beautiful. The houses rise in terraces along the declivities of the hills, and are interspersed with vineyards, gardens, and clumps of Lombardy poplars, watered by numerous fountains and canals. The innumerable minarets, the ruins of the ancient palace of the khans, and a profusion of white chimneys rising amidst the richest foliage, produce a tout-ensemble of the most picturesque effect. The interior of the town, however, is no way corresponding with its external beauty. It is said to contain three churches, thirty-two mosques, a synagogue, and seventy-four fountains. The population in 1822 is stated by Dr. Lyall to have amounted to 10,212 souls, of whom 8200 were Mahomedans.

About four versts distance from this city is the Jewish colony of Ichufaut Kala (Jew's castle).

It contains about 200 houses and 1200 inhabitants, who so far differ from the usual character given to their brethren in other countries, that Dr. Clarke says their honesty in the Crimea is proverbial, the word of a Karaité Jew being considered equal to a bond. Adjoining to this village is a cemetery, called the field of the dead; a place, we are informed, most admirably calculated to inspire holy meditation. It is said the Jews hold this valley in such veneration, that when the khans wished to extort a contribution, they had only to threaten them with the destruction of these sacred trees, under the pretence of wanting timber or fuel, to ensure a speedy compliance.

Ak-yar, or Serastopol, is situated upon a neck of land interposed between two bays. Its harbour is one of the finest in the world; the largest vessels being able to lie within cable's length of the shore; it extends nearly four miles inland, and is only 200 yards wide at the entrance, which is well defended, and nine or ten fathoms deep. The houses in this town are extremely good, built principally after the Italian style of architecture; and the streets are wide, though not paved. Its principal public edifices are three churches, the admiralty, the hospital, the arsenal, the magazines, the barracks of the garrison, and the marine barracks. Its population was estimated at 22,000 in the year 1822; the number of its houses is said to be 1750. It is a rising town. Ak-yar is described by Dr. Clarke as the very centre of the most interesting antiquities of the Crimea; the Russians, however, have labored daily to annihilate every vestige of them. Within a short distance of this town stood the cities of Old and New Chersonesus, Eupatorium, the temples of Diana, and the promontory Parthenium, celebrated as the scene of the story of Iphigenia; the famous Chersonesian wall, with innumerable ramparts, tombs, canals, and other works, the memory of which has been embalmed in the writings of classical authors. The most remarkable curiosity in the Crimea is also situated in the neighbourhood of Ak-yar. The ruins of In-kerman (the town of caverns), consisting of innumerable chapels, cells, monasteries, sepulchres, and a variety of works, which, by their intricacy, astonish and confound the beholder. (See Dr. E. D. Clarke's Travels, vol. ii. p. 203). Bellaclara is situated to the south of the Herculæan Chersonesus; it contains about 1200 Greek inhabitants, and is particularly remarkable for its beautiful port (Bella Clara), from which it takes its name. This harbour is most accurately described by Strabo; it is about a mile in length, 200 fathoms in breadth, and from fifteen to twenty fathoms in depth in its shallowest part.

Karassa-bazaar (black water market), is the principal mart for the sale of fruit, wine, horses, and cattle, on the peninsula. The town is a straggling mass of mean buildings, containing about 5000 inhabitants. It is noted, however, for its tanneries, tile-works, candle and soap manufactories, and its manufactures of red and yellow morocco, and silks.

Sudak is built amongst the vineyards and groves of the vale which bears its name. This place was of such commercial celebrity at one

period of its history, that all the Greek possessions in the peninsula were denominated Sugdania (its ancient name). It is at present noted for its wines.

Caffa, in Crimea-*Proper*, was once the most splendid city in the peninsula; at present it presents but a few irregular streets, and the wrecks of its former magnificence. Whilst in the possession of the Genoese, it was termed *Krim Stambol*, or the Constantinople of the Crimea, and contained, inclusive of its suburbs, 44,000 houses; in 1800, fifty Tartar families formed the whole of its population! *Taman* is a fortress of considerable strength, and the only town worthy of mentioning in the island which bears its name.

Before the Crimea came under the power of the Russians, it is said to have contained a population of 1,500,000, consisting of Turks, Greeks, Armenians, and Tartars. At present there are no Turks; not many Armenians; and vast numbers of the Tartars have removed with their families and flocks to the steppes of the continent. Professor Pallas, whom we have already mentioned, divides the Tartars of the Crimea into three classes. The *Nogays*, the least mixed of the Mongolian race, devote their whole attention to agriculture and the rearing of cattle. A second race resembling the first, but not of so pure a descent from the Mongolians, who are chiefly scattered over the undulating steppes, from the borders of the mountainous country to the isthmus of *Perecop*. The third class occupy the valleys of the mountains; they are of a distinct physiognomy from the preceding two, having stronger beards and lighter colored hair; they are always stationary, and devote their whole attention to the cultivation of flax, hemp, and tobacco.

The native Tartars are divided into three distinct grades:—viz. the *moorzas*, or noblemen; the *mullahs*, or priests; and the peasantry. A *mullah* is always at the head of every settlement, and no measure is undertaken, which is likely to be important in its results, without first consulting with him. The *moorzas* amount to about 250; their dress for the most part resembles the *Circassians*; their manners are elegant, and they are excellent equestrians. The cottages even of the poorer sort of peasants are extremely clean; and the meanest Tartar has a double dwelling, one for himself and his guests, and the other for his wives. To every cottage is attached a garden, in which the mulberry, the fig, the vine, the olive, the pomegranate, the peach, the apricot, and the walnut, abound. These latter trees grow to a most amazing size. Pallas mentions one which annually produced from 80,000 to 100,000 nuts. The old Tartar nobles allow their beards to grow, whilst the young wear only whiskers. The general covering for the head in summer, is a turban; those who have been a pilgrimage to *Mecca* or *Medina*, wear white ones, as a badge of honor; in winter they wear a kind of helmet made of wool; and beneath both, at all times, even within doors, is worn a skull-cap. The peasants have the legs and feet bare in summer; but bandaged, after the manner of the Russians, during the winter. Their shirts are made very wide in the sleeves, and hang over their fingers'

ends. They wear a jacket of silk or cotton, with a small pocket, in which they keep the steel and flint for lighting their pipes. Their trowsers are large and loose, bound tight below the knee, but falling in thick folds round the legs. The women are generally diminutive, wearing drawers or long wide trowsers, shirts open before, an open silk gown with long narrow sleeves, ornamented according to the station of the wearer; and, over all, a great coat with short sleeves, and a band round the waist. They plait their hair, which is usually covered with a small cap; a long piece of cloth hangs down behind from the top of their heads, and tresses of hair, stained of a red color, fall down on their cheeks. They paint the nails of their hands and feet red, and stain their eyebrows black. Many of their customs display a taste for finery; thus, their pillows are covered with colored linen; the napkins which they use for their ablutions are fringed and gaily embroidered; and the stool which is used for supporting a tray during their meals, is often inlaid with mother-of-pearl. The food consists of mutton and lamb, boiled or roasted, eggs, butter, honey, milk, fruits, vegetables, &c. Their ordinary drink is water, or sour milk mixed with water, and a kind of beer called *barsa*. In every house is to be found one or more copies of the *koran*, which they teach their children to read and copy at a very early age. Like other oriental nations, they are excessively fond of ablutions, using them repeatedly during the day. The highest points of excellence, in the Tartar character, are their hospitality, sobriety, and chastity; for all of which they are universally distinguished. The Tartar law in cases of infidelity is very curious; the offender is placed in a grave, and the whole number of inhabitants for many *versts* round being assembled, each one flings a stone at the delinquent, who is thus at once stoned to death and buried. Since they have been governed by the Russian laws, however, they are no longer able to exercise their own customs, and this, like many others, is fast sinking into desuetude.

The *Cimmerians*, a tribe of the Thracians, are the most anciently known inhabitants of the *Taurica Chersonesus*. This warlike tribe, for a long time, defended the peninsula against the *Scythians*, but were at length driven into the mountainous parts by their more powerful adversaries, about 665 years before the birth of Christ. About 100 years after this, the Greeks formed colonies, and carried on a flourishing commerce on the southern shores; and the eastern peninsula was raised into the Greek kingdom of *Bosphorus*. About a century before the Christian era, *Mithridates*, king of *Pontus*, reduced the whole of the *Chersonesus* under his power. After the ruin of *Mithridates*, by the Romans under *Pompey*, who took possession of the Crimea, the kingdom of *Bosphorus* subsisted till the Christian era as a dependent power. The *Alani*, the *Goths*, the *Huns*, and other barbarous nations, successively overran the *Chersonesus*. The Crimea became a province of the western Tartar empire in 1237. But it is principally indebted to the *Venetians* and *Genoese* for its recovery from the desolated and impoverished state to which it was reduced under so many mas-

ters. The Genoese established large commercial cities on the coast of the Black Sea, and also opened a lucrative trade with China and the East Indies. In 1441 the Crimea, for a short period, became an independent monarchy; but the Turks destroyed this, and expelled the Genoese from the peninsula. In 1774 the empress, Catherine II. of Russia, stipulated for the independence of the Crimea under its own khans. In 1781 a civil war broke out, in which the Russians interposed; and, in 1783, Sahim Gheray, the reigning khan, abdicated his throne, and transferred his power to Russia. This acquisition was confirmed to the czar, by a treaty with the sultan, in 1784, since which time the Crimea has remained a province of the Russian empire.

CRIMP, *v. a., n. s. & adj.* } Ang.-Saxon
CRIMPLE, *v. a.* } ge-crympt; Ger.
krampen; Dut. *krimpen*; Swed. *krimpa*. To
crimp is to curl the hair, but this sense is obso-
lete; to cut fish while alive or very fresh, in order
to render the flesh firm; in cant phraseology,
to decoy persons to serve in the army. To
crimpe is, to contract; to corrugate; to cause to
shrink up. Crimp formerly was the name of a
game at cards; it is now the appellation of those
who enlist men by unfair means. That which is
friable, brittle, easily pulverisable, is crimp.
The adjective is also used to signify, not consis-
tent or forcible; but this usage was never elegant,
and is now obsolete.

Laugh and keep company at glee or *crimp*,
Ben Jonson.

He passed the cautery through them, and accord-
ingly *crimped* them up. *Wiseman's Surgery.*

Now the fowler, warned
By these good omens, with swift early steps,
Treads the *crimp* earth, ranging through fields and
glades. *Philips.*

The evidence is *crimp*; the witnesses swear back-
wards and forwards, and contradict themselves; and
his tenants stick by him. *Arbutnot's John Bull.*

From turkey poult transfix'd, and sirloins slash'd,
From marrow puddings mauled, and custards quash'd,
Crimpt cod, and mutilated mackerel,
And desolation of the turtle's shell,
Some alderman of giant appetite,
A surfeit sweeps to everlasting night. *Huddesford.*

CRIMSON, *v. a., n. s. & adj.* Fr. *cramoisi*;
It. *cramesioro*; Sp. *cremesin, cremesino*; Dutch,
kermesun; Per. *kermesy, kurmesy*; Ar. *kermex*.
It was formerly written *crimosin* and *cremosin*.
Crimson is red, with a tinge of blue; poetically,
red in general. To crimson is to tinge or dye
with crimson.

Upon her head a *cremosin* coronet,
With damask roses and daffedillies set.
Spenser. Shepherd's Calendar.

Still is he sullen, still he lowers and frets,
Twixt *crimson* shame, and anger ashy pale.
Shakespeare. Venus and Adonis.

Can you blame her, then, being a maid yet rosed
over with the virgin *crimson* of modesty, if she deny
the appearance of a naked blind boy, in her naked
seeing self? *Id. Henry V.*

Pardon me, Julius. Here wast thou bayed, brave
hart!
Here didst thou fall; and here thy hunters stand
Signed in thy spoil, and *crimsoned* in thy lethe.

Shakespeare.
As *crimson* seems to be little else than a very deep
red, with an eye of blue; so some kinds of red seem
to be little else than heightened yellow.

Boyle on Colours.
The *crimson* stream distained his arms around;
And the disdainful soul came rushing through the
wound. *Dryden's Æneid.*

Why does the soil endure
The blushing poppy with a *crimson* hue? *Prior.*
Mark, where Ambition leads the adverse band,
Each feature fierce and haggard, as with pain!
With menace loud he cries, while from his hand
He vainly strives to wipe the *crimson* stain. *Beattie.*

Tinged by the *crimson* sun, vast columns rise
Of eddying sands, and war amid the skies,
In red arcades the billowy plain surround,
And whirling turrets stalk along the ground. *Darwin.*

Her cheek with native *crimson* glows,
But *Crimson* softened by the rose:
'Twas Hebe's self bestowed the hue!
Yet Health has added something too:
But if an over-tinge there be,
Impute it to her modesty. *Kierdesen.*

And she was chill as they, and on her face
A slender streak of blood announced how near
Her fate had been to that of all her race;
For the same blow which laid her mother here
Had scarred her brow, and left its *crimson* trace
As the last link with all she had held dear. *Byron. Don Juan.*

CRINCUM, *n. s.* A cant word. A cramp;
a contraction; whimsy.

For jealousy is but a kind
Of clap and *crincum* of the mind. *Hudibras.*

CRINGE, *v. a., v. n., & n. s.* } Ger. *krickchen*.
CRINGER, *n. s.* } Ger. *krickchen*.

To bow servile-
ly; to fawn; to flatter; to act the sycophant; to
draw together; to contract: but in the last two
senses the verb is unusual. Cringe is servile
civility. A cringer is one who will bow to and
fawn upon another for the sake of interest, who
will even submit to a kicking if it will forward
the attainment of his purpose.

Whip him, fellows,
Till, like a boy, you see him *cringe* his face,
And whine aloud for mercy.

Shakespeare. Antony and Cleopatra.
Flatterers have the flexor muscles so strong, that
they are always bowing and *cringing*. *Arbutnot.*

The *cringing* knave, who seeks a place
Without success, thus tells his case. *Swift.*

Let me be grateful; but let far from me
Be fawning *cringes*, and false dissembling looks. *Philips.*

Purblind to poverty the worldling goes,
And scarce sees rags an inch beyond his nose,
But from a crowd can single out his grace,
And *cringes* and creep to fools who strut in lace. *Churchill.*

The pride of no person in a flourishing condition
is more justly to be dreaded, than that of him who is
mean and *cringing* under a doubtful and unprosperous
fortune. *Burke.*

Horatio's servant once, with bow and *crings*,
Swinging the parlour door upon its hinge,
Dreading a negative, and overawed
Lest he should trespass, begged to go abroad.

Cowper.

CRINGLE, a small hole made in the bolt rope of a sail, by intertwisting one of the divisions of a rope, called a strand, alternately round itself and through the strands of the bolt-rope, till it becomes threefold, and assumes the shape of a wreath or ring. The use of the cringle is generally to contain the end of some rope, which is fastened thereto for the purpose of drawing up the sail to its yard, or of extending the skirts by the means of bridles, to stand upon a side wind.

CRIN'GEROUS, *adj.* } Lat. *crinis*. Crinigerous, crinose, and crinite, signify, } hairy; abounding }
CRIN'NET, *n. s.* }
CRIN'ITE, *adj.* }
CRIN'OSE, *adj.* }
CRINO'SITY, *n. s.* } with hair. Crinosity is hairiness. Gascoigne gives the appellation of crinet to a lock of hair, and, as the word is pithy and well sounding, it deserves to be retained in the language.

How comete, *crinite*, caudate, stars are framed.

Fairfax.

CRINKLE, *v. a., v. n., & n. s.* } Dut *kron-*
CRIN'KLING, *n. s. & adj.* } *kelen*. To run into hendings; to wind in and out; to mould into inequalities. Crinkle, and crinkling, denote a wrinkle; a sinuosity; something moulded into small prominences, like the edge of a pie-crust. See **CRANKLE**.

Unless some sweetness at the bottom lie,
Who cares for all the *crinkling* of the pie?

King's Cookery.

CRINUM, asphodel lily, in botany, a genus of the monogynia order, and hexandria class of plants; natural order ninth, spathaceæ: cor. funnel-shaped, monopetalous, and sext partite, with three alternate segments having hooked appendages; the germen is covered in the bottom of the corolla, the stamina standing asunder. They are very beautiful green-house plants, rising two or three feet, each crowned by a large umbellate cluster of spathaceous, monopetalous, long funnel-shaped flowers, blue, white, or striped, having a very fragrant smell. They are propagated by off-sets.

CRIPPLE, *v. a., n. s. & adj.* } Goth. *krypil*;
CRIPPLENESS, *n. s.* } Ang.-Sax. *crypel*;
Dut. *krepel*. Mr. Whiter derives cripple from grapple, and Junius from *κραυραλη*; but Mr. Todd justly observes, that the root is clearly to be found in creep; and, indeed, our old authors wrote it in conformity with this derivation. See **CREEPLE**. A cripple is a man lame either by nature or by accident; a man who is obliged to creep, because he has not the full use of his limbs. To cripple is to deprive of the use of the limbs; figuratively, to deprive of the power of exertion. Crippleness is the state of being a cripple.

He, poor man, by your first order died,
And that a winged Mercury did bear;
Some tardy *cripple* had the countermand,
That came too lag to see him buried.

Shakespeare. Richard III.

But perhaps justice is denied, or I am *crippled* and cannot stir, robbed and have not the means to do it. If God has taken away all means of seeking remedy, there is nothing left but patience. But my son, when able, may seek the relief of the law, which I am denied: he or his son may renew his appeal, till he recover his right.

Locke.

I am a *cripple* in my limbs; but what decays are in my mind, the reader must determine.

Dryden.

Knots upon his gouty joints appear,
And chalk is in his *crippled* fingers found.

Id.

See the blind beggar dance, the *cripple* sing,
The sot a hero, lunatick a king.

Pope.

Tettyx, the dancing-master, threw himself from the rock, but was *crippled* in the fall.

Addison.

For he has wings, that neither sickness, pain,
Nor penury can *cripple* or confine,
No nook so narrow but he spreads them there
With ease, and is at large. The oppressor holds
His body bound; but knows not what a range
His spirit takes, unconscious of a chain.

Cowper.

CRISIS, *n. s.* Fr. *crise*; Ital. *crisa*, *crisi*; Span. and Lat. *crisis*; *epi-cris*. The critical moment at which a disease either becomes mortal, or changes to the better; the decisive point of time in any affair.

Wise leeches will not vain receipts obtrude;
Deaf to complaints, they wait upon the ill,
Till some safe *crisis* authorise their skill.

Dryden.

This hour's the very *crisis* of your fate;
Your good or ill, your infamy or fame,
And all the colour of your life, depends
On this important now.

Id. Spanish Friar.

The undertaking, which I am now laying down, was entered upon in the very *crisis* of the late rebellion, when it was the duty of every Briton to contribute his utmost assistance to the government, in a manner suitable to his station and abilities.

Addison's Freeholder.

Such men are raised to station and command,
When Providence means mercy to a land.
He speaks, and they appear; to him they owe
Skill to direct, and strength to strike the blow;
To manage with address, to seize with power
The *crisis* of a dark decisive hour.

Cowper.

Is there nothing that whispers to the right honourable gentleman that the *crisis* is too long, that the times are too gigantic, to be ruled by the little hackneyed and every-day means of ordinary corruption—or are we to believe, that he has within himself a conscious feeling that disqualifies him from rebuking the ill-timed selfishness of his new allies?

Sheridan.

CRISIS, in medicine, is used in different senses, both by the ancient and modern physicians. With some it means frequently no more than the excretion of any noxious substance from the body. Others take the word for a secretion of the noxious humors made in a fever. Others use it for the critical motion itself; and Galen defines a crisis in fevers, the point at which it changes finally for better or worse.

CRISP, *v. a. & adj.* } Old Fr. *crease*; Ital.
CRISPATION, *n. s.* } and Sp. *crease*; Ang.-
CRISPNESS, *n. s.* } Sax. *crypsian*; Latin,
CRISPY, *adj.* } *crispus*. To curl; to
CRISPING-IRON, *n. s.* } twist; to indent; to
CRISPING-PIN, } make wavy. Crispation
is, the act of curling; the state of being curled.

Crisp signifies, curled; indented; brittle; brisk, like liquor that sparkles. **Crispy**, and **crispness**, mean curled; curledness. **Crisping-iron**, and **crisping-pin**, are the ancient names of curling-irons.

The changeable suits of apparel, and the mantles, and the wimples, and the *crisping-pins*. *Isaiah* iii. 22.

His *crisps* here like rings was yronne,
And that was yelwe, and glittered as the sonne.

Chaucer. Cant. Tales.

Her tress also should be of *crisped* gold. *Wyatt*.
Her yellow lockes, *crisped* like golden wyre,
About her shoulders weren loosely shed.

Spenser. Faerie Queene.

You nymphs, called Naiads, of the winding brooks,
With your saged crowns, and ever harmless looks,
Leave your *crisp* channels, and on this green land
Answer your summons; Juno does command.

Shakespeare. The Tempest.

Severn, affrighted with their bloody looks,
Ran fearfully among the trembling reeds,
And hid his *crisped* head in the hollow bank.

Id. Henry IV.

So are those *crispy* snaky locks, oft known
To be the dowry of a second head.

Id. Merchant of Venice.

Young I'd have him too;
Yet a man, with *crisped* hair,
Cast in thousand snares and rings,
For love's fingers, and his rings.

Ben Jonson.

Friar, you must have
Your neat *crisp* claret.

Beaumont and Fletcher.

In frosty weather, musick within doors soundeth
better; which may be by reason, not of the disposition
of the air, but of the wood or string of the instrument,
which is made more *crisp*, and so more porous and
hollow.

Bacon.

Some differ in the hair and feathers, both in the
quantity, *crispation*, and colours of them; as he lions
are hirute, and have great manes; the she's are
smooth, like cats.

Id.

The Ethiopian black, flat-nosed, and *crisp-haired*.

Hale.

Along the *crisped* shades and bowers
Revels the spruce and jocund spring.

Milton.

From that saphire fount the *crisped* brooks,
Rolling on orient pearl and sands of gold,
Ran nectar, visiting each plant.

Id.

Spirit of wine is not only unfit for inflammations in
general, but also *crisps* up the vessels of the dura
mater and brain, and sometimes produces a gangrene.

Sharp's Surgery.

There, ranged in reverend majesty,
The taper shafts ascending high
To decorate the *crisped* roof
Their mingling branches shoot aloof:
Where, blazoned in projecting gold,
Flame the proud crests of Barons' bold.

Huddeford.

CRISPIANUS, and **CRISPINUS**, two legendary saints, whose festival is on the 25th of October. They are said to have been brethren, born at Rome; whence they travelled to Soissons in France, about A.D. 303, to propagate the Christian religion; and, that they might not be chargeable to others for their maintenance, they exercised the trade of shoemakers; but the governor of the town, discovering them to be Christians, ordered them to be beheaded: from which

time the shoe-makers have claimed them as their tutelary saints.

CRISPISULCANT, *adj.* Lat. *crispissulcatus*. Waved, or undulating, as lightning is represented.

CRISTA GALLI. See ANATOMY. This process is so named from its figure, which resembles a cock's comb. To it is fastened that part of the dura mater which divides the brain, called falx. In adults this process appears of a piece with the septum narium.

CRITERION, *n. s.* Κριτήριον. A mark by which any thing is judged of, with respect to its badness or goodness.

Mutual agreement and endearments was the badge of primitive believers; but we may be known by the contrary *criticon*.
Glassville's Scepia.

We have here a sure infallible *criticon*, by which every man may discover and find out the gracious or ungracious disposition of his own heart. *South.*

By what *criticon* do you eat, d'ye think,
If this is prized for sweetness, that for stink?

Pope's Horace.

To proceed in this manner, that is, to proceed with a presiding principle, and a prolific energy, is with me the *criticon* of a profound wisdom. *Burke.*

Saws of experience, sage and sound.

Say, man's true, genuine estimate,
The grand *criticon* of his fate,
Is not, Art thou high or low?
Did thy fortune ebb or flow?
Did many talents gild thy span?
Or frugal nature grudge thee one?

Burke.

Can any thing be of more consequence to man, than to know what is his duty, and how he may arrive at happiness? It is from the examination of his own heart that he receives the first intimations of the one, and the only sure *criticon* of the other. *Beattie.*

CRITHE, in surgery, commonly called the sty, a sort of tubercle that grows on the eyelids. See SURGERY.

CRITHMUM, samphire, in botany, a genus of the digynia order and pentandria class of plants; natural order forty-fifth, umbellate. The fruit is oval and compressed, the florets equal. There are two species, the principal of which is *C. maritimum*, the common maritime samphire, produced naturally on the sea-coast among the gravel and rocks. Its leaves are an excellent pickle for sauces, and are by many eaten raw in salads.

CRITHOMANCY, from κριθη, barley, and μαντευια, divination, a species of divination, by considering the dough or matter of the cakes offered in sacrifice, and the meal strewed over the victims to be killed. Barley meal was commonly used; whence the name.

CRITICK, *v. n., n. s., & adj.*

CRITICAL, *adj.*

CRITICALLY, *adv.*

CRITICALNESS, *n. s.*

CRITICISE, *v. n.*

CRITICISER, *n. s.*

CRITICISM, *n. s.*

CRITIQUE, *n. s.*

Fr. *critiquer*; *κριτικος*. To criticise and to critique are synonymous; but the former verb is now nearly superseded by the

latter. They signify, to examine; to investigate; to point out defects or beauties; to write remarks on any work; to play the critic. Critic,

criticism, and critique, are also equivalent terms, denoting critical remarks; the science of criticism; but the first of these words is disused in these senses. It now designates a man whose profession it is to judge of literary works; a man skilled in any art or science; a criticiser; a snarler; a censurer. Critical is, nicely judicious; relating to criticism; captious; important; momentous. Critically means, in a critical manner; at the exact point of time.

What wouldst thou write of me, if thou shouldst praise me?—
O, gentle lady, do not put me to 't;
For I am nothing, if not *critical*.
Shakespeare. Othello.

The moon is supposed to be measured by sevens, and the *critical* or secretory days to be dependent on that number.
Brown's Vulgar Errors.

This settles truer ideas in men's minds of several things, whereof we read the names in ancient authors, than all the large and laborious arguments of *criticks*.
Locke:

If ideas and words were distinctly weighed, and duly considered, they would afford us another sort of logic and *critick* than what we have hitherto been acquainted with.
Id.

Nor would I have his father look so narrowly into these accounts, as to take occasion from thence to *criticise* on his expences.
Id.

What you say about *criticks* and *critical* interpretations, particularly of the Holy Scriptures, is not only in my opinion very true, but of great use to be observed on reading learned commentators, who not seldom make it their business to show in what sense a word has been used by other authors; whereas the proper business of a commentator is barely to show in what sense a word has been used by the author in that place.
Id.

They do but trace over the paths that have been beaten by the ancients; or comment, *critick*, and flourish upon them.
Temple.

Virgil was so *critical* in the rites of religion, that he would never have brought in such prayers as these, if they had not been agreeable to the Roman customs.
Stillingsfleet.

I should be glad if I could persuade him to continue his good offices, and write such another *critick* on any thing of mine.
Dryden.

Criticism, as it was at first instituted by Aristotle, was meant a standard of judging well.
Id.

They who can *criticise* so weakly, as to imagine I have done my worst, may be convinced, at their own cost, that I can write severely with more ease than I can gently.
Id.

Difficult it is to understand the purity of English, and *critically* to discern good writers from bad, and a proper stile from a corrupt one.
Id.

Nor shall I look upon it as any breach of charity, to *criticise* the author, so long as I keep clear of the person.
Addison.

There is not a Greek or Latin *critick*, who has not shewn, even in the style of his *criticisms*, that he was a master of all the eloquence and delicacy of his native tongue.
Id.

Now learn what morals *criticks* ought to show, For 'tis but half a judge's task to know.
Pope.

What is every year of a wise man's life, but a censure and *critique* on the past?
Id.

Not that my quill to *criticks* was confined;
My verse gave ample lessons to mankind.
Id.

Thence arts o'er all the northern world advance,
But *critical* learning flourish'd most in France. *Id.*

Know well each ancient's proper character;
Without all this at once before your eyes,
Cavil you may but never *criticise*.
Id.

Criticism, contrary to all other faculties of the intellect, is ever held the truest and the best, when it is the first result of the *critic's* mind; as fowlers reckon the first aim for the surest, and seldom fail of missing the mark, if they stay not for the second.
Swift.

The people cannot but resent to see their apprehensions of the power of France, in so *critical* a juncture, wholly laid aside.
Id.

Where an author has many beauties consistent with virtue, piety, and truth, let not little *criticks* exalt themselves, and shower down their ill-nature.
Watts.

Gulliver's Travels are a sort of allegory, but rather satirical and political than moral. The work is in every body's hands, and has been *criticised* by many eminent writers.
Beattie.

This folio of four pages, happy work!
Which not e'en *critic* *criticise*; that holds
Inquisitive Attention, while I read,
Fast bound in chains of silence, which the fair,
Though eloquent themselves, yet fear to break;
What is it, but a map of busy life,
Its fluctuations, and its vast concerns?
Cowper.

Attend, ye virgin *critics*, shrewd and sage,
Ye matron censors of this childish age,
Whose peering eye and wrinkled front declare
A fixed antipathy to young and fair;
By cunning, cautious, or by nature, cold,
In maiden madness, virulently bold!
Sheridan.

DAN. Well, Sir Preful, I wish you may be able to get rid as easily of the newspaper *criticisms* as you do of ours.
Id.

They cannot read, and so don't lisp in *criticisms*;
Nor write, and so they don't affect the muse.
Byron. Beppo.

CRITICISM, is the art of judging with propriety, concerning any object or combination of objects. In a more limited sense, the science of criticism is confined to the fine arts. The principles of the fine arts are best unfolded by studying the sensitive part of our nature, and by learning what objects are naturally agreeable and what are naturally disagreeable. But the man who aspires to be a critic in these arts, must pierce still deeper: he must clearly perceive what objects are lofty, what low, what are proper and improper, what are manly, and what are mean or trivial. Hence a foundation for judging of taste, and for reasoning upon it; where it is conformable to principles, we can pronounce with certainty that it is correct; otherwise, that it is incorrect, and perhaps whimsical. Thus the fine arts, like morals, become a rational science; and, like morals, may be cultivated to a high degree of refinement. See BEAUTY.

CRITO, an Athenian philosopher, who flourished A. A. C. 400. He was one of the most zealous disciples of Socrates, and supplied him with whatever he wanted. Several pupils of his proved eminent men, and he composed some dialogues which are lost.

CRITOLAUS, a citizen of Tegea in Arcadia, who, with his two brothers fought against the three sons of Demostratus of Pheneus, to put an end to a long war between their respective

nations. The brothers of Critolaus were both killed, and he alone remained to withstand his three antagonists. He conquered them; and when at his return his sister deplored the death of one of his antagonists, to whom she was betrothed, he killed her in a fit of resentment. The offence deserved capital punishment; but he was pardoned on account of the services he had rendered his country. He was afterwards general of the Achæans; and is said to have poisoned himself because he had been conquered at Thermopylæ by the Romans, about A. A. C. 146.

CROAK, *v. n. & n. s.* } Old Fr. *croaquier*;
CROAKING, *n. s. & adj.* } modern Fr. *croasser*;
CROAKER, *n. s.* } Ital. *crocidare, crocicare*; Ang.-Sax. *crocettan*; Lat. *crocitare*; Sw. *kroaka*; *κρᾱνυς*. To make a hoarse dissonant noise, like a frog; to caw or cry, as a raven or crow; figuratively to make any unpleasant hoarse sound. Croak is the cry or voice of a frog or raven. A croaker is one who is perpetually complaining, starting difficulties, and anticipating evil.

Yield me an hostry mongst the *croaking* frogs,
And harbour here in safety from those ravenous dogs.
Spenser. Faerie Queene.
The raven himself is hoarse,
That *croaks* the fatal entrance of Duncan
Under my battlements. *Shakespeare. Macbeth.*
The subtle swallow flies about the brook,
And querulous frogs in muddy pools do *croak*.
Mary's Virgil.

Their understandings are but little instructed, when
all their whole time and pains is laid out to still the
croaking of their own bellies. *Locke.*

The hoarse raven on the blasted bough,
By *croaking* from the left, presaged the coming blow.
Dryden.

The swallow skims the river's watry face;
The frogs renew the *croaks* of their loquacious race.
Id.

Was that a raven's *croak*, or my son's voice?
No matter which, I'll to the grave and hide me. *Lee.*

At the same time the walk of elms, with the *croaking*
of the ravens, looks exceeding solemn and venerable.
Addison.

So when Jove's block descended from on high,
Loud thunder to its bottom shook the bog,
And the hoarse nation *croaked*. *Pope.*

Blood, stuffed in skins, is British christian's food;
And France robs marshes of the *croaking* brood.
Gay.

The raven *croaks* forlorn on naked spray:
And hark! the river, bursting every mound,
Down the vale thunders, and with wasteful sway
Uproots the grove, and rolls the shattered rocks away.
Beattie.

Thus kings were first invented, and thus kings
Were burnished into heroes, and became
The arbiters of this terraqueous swamp;
Storks among frogs, that have but *croaked* and died.
Cowper.

The *croaking* nuisance lurked in every nook;
Nor palaces, nor even chambers, escaped:
And the land stank, so numerous was the fry. *Id.*

There the hoarse stag his *croaking* rival scorns,
And butts and parries with his branching horns.
Darwin.

CROATIA, a country of Europe, and part
of the ancient Illyricum, bounded on the east by

Sclavonia and Bosnia, on the south and south-west by Morlachia, on the west by Carniola, and on the north by the Drave, which separates it from a part of Slavonia. It is about 160 miles long, and from sixty to 100 broad. In the eleventh century, Croatia and Dalmatia devolved to the king of Hungary; and has ever since continued under the dominion of that monarchy, except a small part subject to the Turks. It is divided into two parts, viz. that under, and that beyond the Save. In the wars between the empress queen and Frederic the Great, of Prussia, above 50,000 men were raised out of this small territory. Both horse and foot are good soldiers, especially the former. The soil, where cultivated is fruitful in wine and oil, &c. but being a frontier country, it is not so well cultivated as otherwise it might be. Carlstadt is the capital. Austrian Croatia is thus distributed.

	Sq. Mi.	Pop.
1. The Banat, or civil department, composed of the counties of Zagrao, Warasdin, and Creutz	3927	370,000
2. The Generalat, or military division, comprising the districts of Carlstadt, Warasdin, and the Banalgranze	5340	380,000
3. The Littorale (otherwise called Hungarian Dalmatia), being the maritime tract between Fiume and Carlopago	154	50,000
Total	9421	800,000

The first of these divisions has a government and provincial states similar to those of Hungary; the constitution of the second is entirely military; and the third has a separate governor. That part of Croatia, which belongs to the Turks, is seated on the Unna, and is about forty miles long and twenty broad.

CROATS, light irregular troops from Croatia. Their method of fighting is the same as the Pandours. They wear a short waistcoat, and long white breeches, with light boots, and a cap greatly resembling the hussar cap. Their arms are a long firelock with rifled barrel, and short bayonet, a crooked hanger, and a brace of pistols. The late empress queen of Austria had 5000 of these troops, the greatest part of which had no pay, but lived by plunder.

CRO'CEOUS, *adj.* Lat. *croceus*. Consisting of saffron; like saffron.

CROCITATION, *n. s.* Lat. *crocitatio*. The croaking of frogs or ravens.

CROCK, *n. s.* } Isl. *kro*; Swed. *kraks*;
CROCKERY, *n. s.* } Ang.-Sax. *crocca*; Germ. *krug*; Welsh, *crochan*. A cup; any vessel made of earth; a little stool; the soot on a kettle, or chimney stock. Crockery is earthenware.

And when that drunken was all in the *croaks*,
To bedde went the daughter right anon.

Chaucer. Cant. Tale.
Therefore the vulgar did about his *socke*,
And cluster thicke unto his leasings *vaine*,
Like foolish flies about an honey *croche*.
Spenser. Faerie Queene.

I bid her come out of the crowd, and seated her upon a little *crook* at my left hand. *Taylor.*

CRO'CKET, *n. s.* Fr. *croc.* An ornament with which, in Gothic architecture, the edges of gable ends, the angles of pinnacles, and other parts, are adorned.

CROCODILE, *n. s.* From *κροκος*, saffron, and *δελων*, fearing; because the animal was supposed to dislike or fear saffron. An amphibious and voracious animal, in shape resembling a lizard, and found in Egypt and the Indies. See **LACERTA** and **CROCODILE**, fossil.

By muddy shore of broad seven-mouthed Nile,
Unwetting of the perilous wandering wayes,
Doth meet a cruell craftie *crocodile*.

Spenser. Faerie Queene.

Gloster's show

Begiles him; as the mournful *crocodile*
With sorrow snares relenting passengers.

Shakespeare. Henry VI.

Crocodiles were thought to be peculiar unto the Nile.

Browne's Vulgar Errors.

Enticing *crocodiles*, whose tears are death;
Sirens, that murder with enchanting breath.

Glauville.

Cæsar will weep, the *crocodile* will weep. *Dryden.*

Crocodile is also a little animal, otherwise called stink, very much like the lizard, or small *crocodile*. It lives by land and water; has four short small legs, a very sharp muzzle, and a short small tail. It is pretty enough to look at, being covered all over with little scales of the color of silver, intermixed with brown, and of a gold color upon the back. It always remains little. *Trovous.*

In silent herds the wandering sea-calves lave,
Or nod their slimy foreheads o'er the wave;
Poised on still wing attentive vultures sweep,
And winking *crocodiles* are lulled to sleep. *Darwin.*

CROCODILE, in zoology. See **LACERTA**.

CROCODILE, in rhetoric, a name sometimes given to a captious and sophistical kind of argumentation, contrived to seduce the unwary, and draw them speciously into a snare. It has its name from the following fable, invented by the poets. A poor woman, begging a *crocodile*, that had caught her son walking by the river side, to spare and restore him, was answered, that he would restore him, provided she should give a true answer to a question he should propose; the question was, Will I restore thy son or not? To this the poor woman, suspecting a deceit, sorrowfully answered, Thou wilt not: and demanded to have him restored, because she had answered truly. Thou liest, says the *crocodile*; for if I restore him thou hast not answered truly; I cannot, therefore, restore him without making thy answer false. Under this head may be reduced the propositions called *mentientes* or *insolubiles*; which destroy themselves.

CROCODILINE, *adj.* Lat. *crocodilinus*. Like a *crocodile*.

CROCUS, *n. s.* A flower.

Fair handed Spring unbosoms every grace,
Throws out the snow-drop and the *crocus* first.

Thomson.

CROCUS, in botany, saffron, a genus of the *monogynia* order, and *triandria* class of plants; natural order sixth, *ensate*: *cor.* *sexpartite* and

equal; *stigmata* convoluted or rolled spirally inwards. Species three; of these *C. sativus* has a small roundish, brown, bulbous root, compressed at the bottom. Directly from the root issue many long narrow leaves, of a deep green color; and amidst them the flowers are protruded from a thin univalvular radical spatha; the tube of the flower is long, standing on the root, and serving as a foot-stalk to the limb or upper part, which is erect, six-parted, widens gradually upward, and grows from about three to five or six inches high. The varieties of the first are the *crocus officinalis*, or saffron of the shops; for the properties of which and its cultivation for sale, see **SAFFRON**. It has a long-tubed bluish-purple flower, with three *stigmata* of a fine golden color. Other varieties are the autumnal small blue *crocus*; deep blue, sky-blue, whitish blue, many flowered whitish blue, purple, large rush-leaved purple, autumnal white *crocus*, and autumnal yellow *crocus*. 2. *C. vernus*, the varieties of which are, the small and large, and golden yellow *crocuses*, and the yellow black striped, the yellow purple-striped and double cloth of gold ones; the white, white purple-striped, white purple-bottom, white black-striped, whitish cream-colored, whitish ash-colored, little narrow-leaved white, and white blue-striped *crocuses*. Besides these there are a great many others of a blue and purple color finely variegated. The autumnal *crocuses* flower about the beginning of October, but never ripen their seeds in this country. They are very beautiful if sown in patches in the front of borders, or in beds by themselves, and very proper ornaments for gardens of every extent, as coming up at a time when most other flowers are on the decay. They grow freely in any kind of soil, and may be propagated by off-sets. The vernal kinds flower in February, March, and April. They are also very ornamental, and are so hardy that they will grow almost any where. They are propagated by seeds, which are produced in plenty. 3. *C. nudiflorus* with three-cleft stigma enclosed in the corolla.

CROCUS, in chemistry, denotes any metal calcined to a red or deep yellow color.

CROCUS of **ANTIMONY**. See **ANTIMONY**.

CRÆSUS, the last king of Lydia, remarkable for his riches, his conquests, his temporary prosperity, and his sad reverse of fortune. He subdued the Phrygians, Mysians, Paphlagonians, Thracians and Carians; amassed together immense riches; and became one of the most powerful and magnificent princes in the world. Thales of Miletus, Pittacus of Mitylene, Bias of Priene, Cleobulus of Lindus, and most of the other wise men, as they are emphatically styled, who lived in that age, as well as Æsop the fabulist, and the elegant Greek poets of the times, were bountifully received at the court of Cræsus. There is still on record a memorable conversation between that prince and Solon, which seemed to predict the subsequent events of his reign, and which had a late but important influence on the character and fortune of the Lydian king. Cræsus having entertained his Athenian guest, according to the ancient fashion, for several days, ostentatiously showed him the magnificence of

his palace, and particularly the riches of his treasury. After all had been displayed to the best advantage, the king asked him, Whom of all men he esteemed most happy? expecting flattery rather than information. But Solon replied with manly freedom, 'Tellus, the Athenian, who was not conspicuous for his riches or his grandeur, being only a simple citizen of Athens; but was descended from parents who deserved the first honors of the republic, and was equally fortunate in his children.' Cræsus had little encouragement after this answer, to ask Solon, in the second place, Whom next to Tellus, he deemed most happy? Such, however, is the illusion of vanity, that he still ventured to make this demand; and still entertained hopes of being favorably answered. Solon replied with the same freedom as before, 'the brothers Cleobis and Biton; two youths of Argos, whose strength and address were crowned with repeated victory at the Olympic games.' 'And is the happiness of a king, then,' said Cræsus, 'so little regarded, that you prefer to it the mean condition of an Athenian or Argive citizen?'—'The life of man,' replied Solon, 'consists of seventy years, which make 25,550 days; an immense number: yet in the longest life, the events of any one day will not be found exactly alike to those of another. The affairs of men are liable to perpetual vicissitudes; and all human life, if not condemned to calamity, is at least liable to accident. Whoever has uninterruptedly enjoyed a prosperous tide of success may justly be called fortunate: but he cannot before his death be entitled to the epithet of happy.' The events, which soon followed this conversation, proved but too decidedly the wisdom of the sage. Victorious in war, unrivalled in wealth, and supreme in power, Cræsus felt his warmest affection centered in his son Atys, who had often fought and conquered by his side, and who was slain by a dart aimed at a boar, by Adrastus, a Phrygian prince, then in the court of his father. Cræsus had remained two years disconsolate for the loss of this son, when the growing greatness of Persia threatened the safety of his dominions. Being told by the Delphian oracle that if he crossed the Halys, a river between his country and that of Cyrus, it would be the destruction of a great empire, he marched against Cyrus with a vast army, but was defeated; and retreating to his capital Sardis, was there besieged; thus fulfilling in himself the double answer of the Pythian priestess. The city was taken by assault; and as a Persian soldier was going to kill Cræsus, that prince's only surviving son, who had hitherto been dumb, terrified at his danger, cried, 'Stop, soldier, and touch not Cræsus.' He seemed, however, only to be reserved for a harder fate. Dragged into the presence of his conqueror, he was loaded with irons; and the stern Cyrus ordered him, with his Lydian attendants, to be committed to the flames. An immense pile of wood and other combustibles was erected in the most spacious part of the city. The miserable victims, bound hand and foot, were placed on the top of the pyre. Cyrus, surrounded by his generals, witnessed the dreadful spectacle. Hearing his un-

fortunate captive, oppressed by the intolerable weight of his calamity, utter with a deep groan the name of Solon, Cyrus enquired by an interpreter, 'Who he was?' 'He,' replied Cræsus, 'whose words ought ever to speak to the hearts of kings.' Being desired to explain himself, he related the important discourse of Solon, of which his fate was the great moral. The words of a dying man make a strong impression on the heart. Those of Cræsus deeply affected the mind of Cyrus, who considered the speech as addressed to himself, and at once relenting in his intended cruelty towards Cræsus, gave orders that he should be seated by his side, and thenceforth treated him as a king. The kingdom of Lydia terminated in the person of this prince, the manner of whose death is unknown.

CROFT, *n. s.* Swed. *kraft*; Ang.-Sax. *craft*. A little close joining to a house, that is used for corn or pasture.

This have I learned,
Tending my flocks hard by, i' the hilly *crofts*
That brow this bottom glade. *Milton.*

CROIA, or **CROIA**, a town of European Turkey, in Albania, anciently the capital of the Albanian kings. It was fortified in the time of the celebrated Scanderbeg, who greatly harassed the Turks from it. They have since demolished the fortifications. It is a bishop's see, and seated near the Gulf of Venice; thirteen miles north-east, and thirty south of Scutari.

CROISA'DE, or } Fr. *croisade*; Ital. *cro-*
CROISA'DO, *n. s.* } *ciata*; Sp. *crusada*, from
CROISES, *n. s.* } *crur*, a cross. A holy war; a war carried on, under the banner of the cross, against infidels. Croises signify, pilgrims who carry a cross; soldiers who, under the banner of the cross, combat with infidels. See **CRUSADE**.

See that he take the name of Urban, because a pope of that name did first institute the *croisado*; and, as with an holy trumpet, did stir up the voyage for the Holy Land. *Bacon.*

The conquests of the *Croises*, extending over Palestine and a part of Syria, had been erected into a sovereignty, under the name of the kingdom of Jerusalem. *Burke.*

CROISES, or **CROIZES**, the knights of St. John of Jerusalem, instituted for the defence and protection of pilgrims, were particularly so called from a cross they wore as a badge.

CROISIERS, a religious order, founded in honor of the discovery of the cross by the empress Helena. They were, till of late, dispersed in several parts of Europe, particularly in the Netherlands, France, and Bohemia. Those in Italy were suppressed even before the late revolutions. These religious follow the rule of St. Augustine. They had in England the name of crouched friars.

CROIX. See **PETIS**.

CROIX (St.) LAKE, a lake of North America, commencing about 500 yards from the mouth of a river of this name, and is from one and a-half to three miles wide, and thirty-six miles in length. The river St. Croix communicates with Lake Superior by the Burnt River, by a reach of half

a mile only, and is by far the most preferable communication that can be had with that lake and the surrounding countries.

CROMACK WATER, a romantic lake of Cumberland, between Buttermere and Lowes-water, with both of which it is connected by the Cocker. It is four miles long, nearly half a mile broad, and has three small isles.

CROMARTY, from *Crom-Ba*, Gaelic, i. e. Crooked Bay, a county of Scotland, which comprehends part of a peninsula, bounded on the north by the bay of Cromarty; on the east and south by the Moray Frith, and on the west by Rosshire. It is only twelve miles long from east to west, and not above four broad. It is well cultivated and fertile. In the reign of James V. it was a forest, and abounded with wolves. It sends a member to parliament alternately with Nairn.

CROMARTY, the capital of the above county, seated on a narrow neck of land, which stretches out into the Moray Frith, at the mouth of Cromarty Bay. It has a considerable coasting trade in corn, thread, yarn, fish, and skins; and a good harbour. A manufacture of hempen cloth is carried on in it.

CROMARTY FRITH, a bay of Scotland, extending between the county of Ross on the north and west, and Cromarty and Ross on the south and east, nearly twenty miles. Its entrance is between the Sutor promontories, distant from one another about a mile and a half. It expands to more than four miles in breadth, but again contracts to less than two. This frith affords a good depth of water almost close to the shore, and the constant shelter of the surrounding country, renders it a most commodious resort for vessels from the northern and eastern seas.

CROMER, a town of England, on the north-east coast of Norfolk, chiefly inhabited by fishermen. It was formerly much larger, and had two churches; but one of these, together with many houses, were overflowed by the sea, which has encroached much on this coast. It has a harbour for fishing vessels, and considerable sums

have been expended, at different times, in attempting to raise a pier, but without success, the sea always washing it away. It is a place of resort for sea-bathing, and has a weekly market on Saturday. It lies twenty-three miles north of Norwich, and 129 N.N.E. of London.

CROMLECH. Welsh *cromlech*; Cornish *cromlech*. Celtic monuments, common in various parts of Europe, particularly in Great Britain. See the next article.

CROMLECH, or **CROMLEH**, in British antiquity, huge, broad, flat stones, raised upon other stones set up on end. They are common in Anglesey. See **ANGLESEY**. These monuments are described by Mr. Rowland, Dr. Borlase, &c. under the name of *Aræ*, or altars. Mr. Rowland, however, is divided in his opinion, supposing them to have been originally tombs, but that in after times sacrifices were performed upon them to the heroes deposited within. Mr. Keiller preserves an account of king Harold having been interred beneath a tomb of this kind in Denmark, and Mr. Wright discovered in Ireland a skeleton deposited under one of them. Mr. Toland mentions a cromlech in Nevern parish in Pembrokeshire, South Wales, having the middle stone eighteen feet high, and nine broad towards the base, but narrowing upwards: and by it there lay a broken piece ten feet in length, which seemed to be of a weight heavier than twenty oxen could draw. But at Poitiers in France, there is one supported by five lesser stones, much exceeding all in the British islands, as it is fifty feet in circumference. This he conceives to have been a 'rocking-stone.' At Bodouyr, in Anglesea, there is a noble cromlech; many of the stones being thirty tons in weight. The following is the appearance of some of the cromlechs of Anglesey.



CROMWELL.

CROMWELL. If we are not absolute converts to the opinion of a respectable modern writer, that 'there is no portion of history in which it so much behoves an Englishman to be thoroughly versed as in that of Cromwell's age,' we attach great importance to this part of our annals, and shall be found, in the article **ENGLAND**, to have considered the relative pretensions of every respectable narrative of its occurrences. The life and character of the Protector himself certainly occupy a large moral and political space, and they have had, therefore, a proportionable degree of attention bestowed upon them by writers of various parties, down to the present time. We shall fully avail ourselves of all the conflicting accounts of this great man with which we are acquainted.

The pedigree of his family is traced to Glothyan, lord Powys, who lived in the eleventh

century, and married Morveth, the daughter and heiress of Edwyn ap Tydwell. William ap Yevan, the head of the family in the fifteenth century, was in the service first of Jasper duke of Bedford, Henry VII.'s uncle, and afterwards in that of the king himself. His son, Morgan Williams, married a sister of the celebrated Thomas Cromwell, earl of Essex. (See **CROMWELL, THOMAS**.) The eldest son of this marriage was Richard Cromwell, *alias* Williams: the *alias* was long retained by the family in their deeds and wills. He was one of the six challengers who held a tournament in 1540 at Westminster against all comers, and who entered the field richly accoutred, and their horses trapped in white velvet; the knights and gentlemen who rode before them being apparelled in velvet and white sammet, and their servants in white doublets, and 'hosen cut in the Burgonian fashion.'

Sir Richard was knighted on the second day, and performed his part so well that the king cried out to him, 'Formerly thou wast my Dick, but hereafter thou shalt be my diamond;' and bade him bear a diamond ring in the fore gamb of the demy lion in his crest.

This Sir Richard Cromwell, being appointed one of the visitors of the religious houses, received for his reward upwards of £30,000 a year out of the church lands, besides which he had great estates in the counties of Cambridge, Bedford, Northampton, and Rutland.

Henry, his eldest son and heir, was knighted by queen Elizabeth, who esteemed him highly, and slept once at his seat, the Nunnery, at Hinchinbrook. From his wealth and liberality he was called the Golden Knight. The death of a second lady Cromwell being charged upon certain witches of Warboys, they were convicted and executed; their property, amounting to £40, being forfeited to Sir Henry, as lord of the manor; who gave it to the corporation of Huntingdon, on condition that a doctor or bachelor of divinity should be procured to preach annually in that town against the sin of witchcraft; a condition regularly fulfilled about thirty years ago.

Robert Cromwell, the father of the protector, was one of his younger sons, and left with an estate of about £300 a year, near the town of Huntingdon. The house in which he resided was either part of the original hospital of St. John, or built upon the site. He married Mrs. Elizabeth Lyne, formerly Steward, of the city of Ely, of a family said to be allied to the royal house of Stuart. Oliver Cromwell was the second of ten children, and the only one of three boys who lived to maturity. His father was in the commission of the peace, and member for the borough of Huntingdon in the parliament of the 35th of Elizabeth: he also entered into a considerable brewing business.

The protector was born 25th April, 1599; when an infant his life was endangered by a monkey kept at his grandfather's, who took him out of the cradle, and carried him upon the leads of the house, to the dreadful alarm of the family (who made beds and blankets ready, in the hope of catching him), but who, at last, brought him safely down. He was also saved from drowning in his youth by the Rev. Mr. Johnson, a curate in the neighbourhood.

During his education, at the grammar-school of his native town, he is said to have been an active and resolute boy, fond of exploits, and little inclined to study. Yet, according to the traditions respecting his youth, he was once excited to uncommon emotion in playing the part of Tactus, who finds a royal robe and a crown, in the old comedy of *Lingua*. In the height of his fortune he is said to have mentioned a gigantic figure which, when he was a boy, opened the curtains of his bed, and told him he should be the greatest person in the kingdom. There is another tale concerning his childhood; that being at his uncle's house at Hinchinbrook when the royal family rested there on their way from Scotland in 1604, he was brought to play with prince Charles, then duke of York, quarrelled with him, beat him, and made his nose bleed,

which was remembered as a bad omen for the king when Cromwell first began to distinguish himself. Mr. Noble relates this only as the tradition of the place, but adds that Hinchinbrook was well known as one of the royal resting-places on the north road. Cromwell was removed in his seventeenth year to Sydney Sussex College, Cambridge, where, though he acquired the name of 'a roister,' he seems to have made a respectable proficiency in the learning of the day. He had not been there more than a year when his father died, and he was placed at Lincoln's Inn. Why, specifically, he went thither seems to be as obscure a matter as when he left; but it seems he was but a short time; thus engaged, and, returning to reside upon his paternal property, is said to have led a low and dissolute life. He certainly offended his uncle, Sir Thomas Steward, by his conduct at this time; and wishing, we are told, to get possession of his estate, he petitioned for a commission of lunacy against him, which was refused. But he soon reformed his conduct, for Sir Thomas was reconciled to him, and left him his estate. When he came of age, he married Elizabeth, daughter of Sir James Bourchier, of Essex, a woman who was throughout life of irreproachable character. She brought him a small fortune, and, in the year 1625, he was returned for Huntingdon to king Charles's first parliament. He sat for the same borough in the parliament of 1628, and spoke severely against the promotion of Dr. Manwaring; complaining at the same time of persons who 'preached flat popery.' About this time he openly quitted the church of England, and, becoming a dissenter, occasionally preached among the puritans. A house was recently standing at Huntingdon, where he often 'exercised,' as it was called. Three years afterwards he stocked a grazing farm at St. Ives, and removed thither from Huntingdon. The barn which he built there was standing, and bore his name, when Mr. Noble published his *Memoirs of the Protectoral House*. His sheep-marking irons, having O. C. upon them, were also then in the farmer's possession who held the property. At this period he returned the sums of £30 and £120, which he had won some time before by gaming, thinking it sinful to keep them. The death of Sir Thomas Steward placed him, in 1635, in affluence; and he removed very soon after to the city of Ely. Taking an active share in the local business of the neighbourhood, he opposed an unpopular scheme for draining the fens of Lincolnshire and the Isle of Ely: a work, however, which proceeded when he was protector, and received his patronage.

But Cromwell became suddenly discontented and unsettled in his disposition; and the lords Say and Serle, and Brooke, with Mr. Pym and other distinguished persons, resolving to establish a colony in New England, he joined, after some hesitation, in the scheme. They had freighted eight vessels with emigrants and property, and were ready to sail from the Thames, when the king, by an order in council, forbade their departure, and compelled the intended passengers to come on shore; among these were Hampden, and Cromwell with all his family. We shortly

after find him re-settled in a quiet and pious life at Ely.

His appearance in the Long Parliament, to which he was returned for Cambridge, is thus described by Sir Philip Warwick. 'The first time,' says he, 'that ever I took notice of him, was in the beginning of the parliament held in November 1640, when I vainly thought myself a courtly young gentleman, for we courtiers valued ourselves much upon our good clothes. I came one morning into the house well clad, and perceived a gentleman speaking, whom I knew not, very ordinarily apparelled, for it was a plain cloth suit, which seemed to have been made by an ill, country taylor. His linen was plain, and not very clean; and I remember a speck or two of blood upon his little band, which was not much larger than his collar: his hat was without a hat-band; his stature was of a good size; his sword stuck close to his side, his countenance swoln and reddish, his voice sharp and untunable, and his eloquence full of fervor.' On one occasion upon which he spoke in this parliament, in opposition to lord Kimbolton, he behaved so intemperately, according to lord Clarendon, that the chairman of the committee found himself obliged to reprehend him, and to tell him 'if he proceeded in the same manner, he would presently adjourn the committee, and the next morning complain to the house of him.' On the question of the 'Remonstrance,' he declared to lord Falkland, that if it had not been carried, he would the next morning have sold all he had, and seen England no more.

One day when Cromwell had spoken warmly in the house, lord Digby asked Hampden who he was; the latter is said to have replied, 'That sloven whom you see before you, hath no ornament in his speech; that sloven, I say, if we should ever come to a breach with the king (which God forbid!) in such a case I say, that sloven will be the greatest man in England.'

Cromwell took no leading part during the proceedings which provoked the war, but was only one of those upon whom the leaders of the disaffected party could rely. He was at this time more sincerely a puritan than a politician: but when the war commenced, in 1642, he received a captain's commission, and raised in his own county a troop of horse. And now it was that he gave the first proof of that sagacity which afterwards governed him in every thing, and made him ultimate master of three kingdoms. 'I did labor as well as I could,' he said, 'to discharge my trust, and God blessed me as it pleased him. I had a very worthy friend then, and he was a very noble person, and I know his memory is very grateful to all, Mr. John Hampden. Your troops, said I, are most of them old decayed serving men, and tapsters, and such kind of fellows; and (said I) *their* troops are gentlemen's sons, younger sons, and persons of quality: do you think that the spirits of such base and mean fellows will ever be enabled to encounter gentlemen that have honor and courage, and resolution in them? Truly, I presented him in this manner conscientiously; and truly I did tell him, You must get men of spirit, and, take it not ill what I say (I know you will not), of a

spirit that is likely to go on as far as gentlemen will go, or else I am sure you will be beaten still; I told him so, I did truly. He was a wise and worthy person, and he did think that I talked a good notion, but an impracticable one. Truly I told him I could do somewhat in it; I did so; and truly I must needs say that to you, I raised such men as had the fear of God before them, and made some conscience of what they did; and from that day forward, I must say to you, they were never beaten, and wherever they were engaged against the enemy, they beat continually.'

Cromwell's troop, in fact, were mostly freeholders and freeholders' sons, thoroughly imbued with his own religious opinions, and engaging in the war 'upon matter of conscience,' they invited the celebrated Richard Baxter to be their chaplain. His first military exploit was to take possession of Cambridge for the parliament; and to secure the university plate. At the same time Cromwell paid a visit to his uncle and godfather, Sir Oliver Cromwell, and took away his arms and plate; but behaving towards him with the greatest personal respect. He also kept down the loyal party in Suffolk and Norfolk with great vigilance. At Peterborough his troop occupied themselves with demolishing the painted windows of the cathedral, breaking the organ, defacing tombs and statues, and destroying what they called superstitious books. In other places where the spirit of the party, as religionists, was not called forth, their conduct was more orderly than that of any other of the parliamentary troops. 'No man swears but he pays his twelvenpence,' says one of the journals of the day; 'if he be drunk, he is set in the stocks, or worse; if one calls the other round-head, he is cashiered; inasmuch that the countries where they come leap for joy of them, and come in and join with them.'

'But the relief of Gainsborough,' says White-lock, 'was the beginning of his great fortunes.' Cromwell speaks of having had 'the execution of the enemy' two or three miles, and that some of his soldiers killed two or three men each. When part of the marquis of Newcastle's army was defeated this year near Horncastle, he commanded under lord Manchester; his horse was killed under him, and as he rose he was again knocked down by the cavalier who charged him; he was, however, soon remounted, and by a good fortune, that never forsook him, without a wound. At the close of the year he took Hilsdon House by assault, and alarmed Oxford. The battle of Marston Moor occurred soon after. The Scotch, who were in the right wing, were completely routed by the royalists, and, flying in all directions, were taken or knocked on the head by the peasantry; but the fortune of the day was decided by the English horse under Fairfax and Cromwell. The troop of the latter in particular so distinguished themselves on this occasion, as to be afterwards surnamed 'ironsides.'

Cromwell was now the object of envy and jealousy with the other parliamentary leaders, and not a little elated with his own splendid success. Proposing something to lord Manchester, to which his lordship replied that the parlia-

ment would never approve it, he made answer, 'My lord, if you will stick firm to honest men, you shall find yourself at the head of an army that shall give the law to king and parliament.' A mutual dislike seems after this to have arisen between them. After the second battle of Newbury, Cromwell would have attempted to bring the conflict to a decided issue, by charging the king's army in their retreat; but Manchester thought the hazard too great, and that the evil consequences of a disappointment would be far greater than the possible advantage of a victory; 'for,' said he, 'if they should be routed before Essex's army is reinforced, there would be an end of their pretences; and they should be all rebels and traitors, and executed as such by law.' Cromwell repeated this to the parliament as a proof of lord Manchester's cowardice, when Manchester in return charged Cromwell with the above advice which he had given him, to despise both the king and parliament. This dispute occasioned considerable debate and alarm in the house, and Manchester soon retreated out of the storm. But Essex, the commander-in-chief, thought so fair an opportunity of displacing Cromwell was not to be slighted. To meet his hostile efforts, the self-denying Ordinance, as it was called, was proposed by Cromwell and his partisans. Essex was removed, and Fairfax appointed lieutenant-general. He was now induced to request that the Ordinance might be dispensed with in Cromwell's behalf, first for a limited, and then for an indefinite time.

The king had, at this period, struck a great blow by the taking of Leicester, and his fortunes began to appear still retrievable, when, after some unwise movements, the celebrated battle of Naseby drew on. Prince Rupert, who commanded the royal forces, was, as usual, in the onset irresistible, and Ireton was borne wounded from the field; on this the prince, having broken and routed the wing of the enemy opposed to him, pursued them as if the victory were secure. Charles, in person, was now about to charge Cromwell's horse, at the head of his reserve, when lord Carnewaith suddenly seized his bridle, and exclaimed, 'Will you go upon your death in an instant?' A cry ran through the troops from this interruption, that they should march to the right, in which direction the king's horse had been turned, and which, in the present situation of the battle, was bidding them shift for themselves. In vain the king, with great personal efforts, endeavoured to rally them. All was lost. On the royal side 700, it is said, were killed, and 5000 were taken prisoners together with all the artillery, the king's cabinet, and the baggage.

Cromwell wrote to the speaker of the house of commons: 'Sir, this is none other but the hand of God, and to him alone belongs the glory, wherein none are to share with him. The general served you with all faithfulness and honor; and the best commendation I can give him is, that I dare say he attributes all to God, and would rather perish than assume to himself, which is an honest and a thriving way; and yet as much for bravery may be given to him in this

action, as to a man. Honest men served you faithfully in this action. Sir, they are trusty, I beseech you in the name of God not to discourage them. I wish this action may beget thankfulness and humility in all that are concerned in it. He that ventures his life for the liberty of his country, I wish he trust God for the liberty of his conscience, and you for the liberty he fights for: so thus he rests who is your humble servant, Oliver Cromwell.' During the siege of Bristol, which followed, Fairfax and Cromwell narrowly escaped being killed by the same ball, when the latter declared none but an atheist could deny that their success was the work of the Lord. Cromwell next took Devizes, Winchester, and Basing House, and dispersed the club-men in Hampshire; after which he rejoined Fairfax in the west.

The king, it is well known, now fled towards the north, and delivered himself to the Scotch army, before Newark. In the bargain that afterwards resulted for the possession of his person, Cromwell was conspicuous as a commissioner. In the subsequent division of the public spoils, he received £2500 a year, charged on the estates of the marquis of Worcester.

Of the AGITATORS who rose to power at this time, we have already given some account. See that article. They were Cromwell's devoted creatures. Speaking of the parliamentarians, and the ascendant star of the lieutenant-general, Hollis says 'We fell as low as dust; all was dash: instead of a generous resistance to the insolencies of perfidious servants, vindicating the honor of the parliament, discharging the trust that lay upon them to preserve a poor people from being ruined and enslaved to a rebellious army, they deliver up themselves and kingdom to the will of their enemies; prostitute all to the lust of heady and violent men; and suffer Mr. Cromwell to saddle, ride, switch, and spur them at his pleasure.'

It is generally agreed that Cromwell was, at this period, desirous of making terms with the king, and that he stipulated for the title of the earl of Essex, now vacant by the death of the late general, to be made first captain of the guards, and vicar-general of the kingdom. He declared, with tears, that the interview between Charles and his children, was 'the tenderest sight that ever his eyes beheld; that never man was so abused as he in his sinister opinion of the king, who, he thought was the most upright and conscientious of his kingdom; and that he only wished that God would be pleased to look upon him according to the sincerity of his heart towards the king.' The republican party, however, prevailed; all he could actually do for the king was, as it seems, to instigate his escape from Hampton Court, with a view, it is probable, to his getting out of the kingdom; though others have supposed that he was directed to Carisbrook only because Cromwell knew he could rely on Hammond as a jailor. The zealots opposed to him, asserted that monarchy was in itself an evil; that the Jews had committed a great sin against the Lord in choosing it; and now, for the first time, avowed a desire of putting the king to death, and establishing a common-

wealth. Cromwell professed to be undecided; he concluded a conference on this solemn topic by flinging a cushion at Ludlow's head, and then running down stairs: the next day he told Ludlow he was convinced of the desirableness, but not of the practicability, of what his party proposed. He was soon, however, compelled to act a more decided part. An accusation was preferred against him in the house of lords by major Huntington, as having instigated the army to disobey and resist the parliament, and as having pledged himself to make the king the most glorious prince in Christendom. The charges passed off, but the general was evidently decided by them to proceed in the diligent way he now did in suppressing the insurrections that arose in favor of the king in Wales, and to resist the Scotch invasion. After defeating the Scotch, he passed to Edinburgh, where he was hailed as a deliverer, and settled the administration of that kingdom, for the parliament, in the hands of the duke of Argyll.

The part which Cromwell took in the ensuing tragedy of the death of the king, was, doubtless, like many of his later measures, forced upon him by others, to whom, and with whom, however, he had first voluntarily committed himself. On the second debate in the house of commons respecting appointing the high court of Justice (January 4th, 1649), he said, 'Should any one have voluntarily proposed to bring the king to punishment, I should have regarded him as the greatest traitor; but since Providence and necessity have cast us upon it, I will pray to God for a blessing on your counsels; though I am not prepared to give you any advice on this important occasion. Even I myself (said he), when I was lately offering up petitions for his majesty's restoration, felt my tongue cleave to the roof of my mouth, and considered this preternatural movement as the answer which heaven, having rejected the king, had sent to my supplications.'

We see in this speech neither the 'levity' nor 'hypocrisy' with which Cromwell has been often said to have acted on this occasion. He appears never to have fully approved the measure of the king's death; yet all the moral responsibility and guilt of the transaction he clearly partook, and that he *felt* it is as clear. We doubt, however, whether for that reason, it was ever a topic of levity with him, and whether, on this occasion he was not too entirely deluded by the canting habit of the times and of his associates, to be found chargeable within sincerity. He was deceived, we believe, far too much, and perhaps judicially, (because he loved the wages of the deceit), to be a hypocrite. It is remarkable to what a point he had screwed up his conscience at this time; that he went to look at the decollated king; opened the coffin himself; put his finger to the neck where it had been severed; and even, inspecting the inside of the body, observed in how healthy a state it had been, and how well made for long life.

It is well known that Cromwell accepted the command in Ireland at a critical period, but he reduced that kingdom to submission with more than his usual energy. Of the battle of Drogheda, which was garrisoned with 1500 men, he writes

with a kind of exultation. 'I do not believe,' he says, 'neither do I hear, that any officer escaped with his life, save only one lieutenant, who, going to the enemy, said he was the only man that escaped of all the garrison. The enemy were filled upon this with much terror, and truly I believe this bitterness will save much effusion of blood, through the goodness of God. I wish that all honest hearts may give the glory of this to God alone, to whom, indeed, the praise of this mercy belongs, for instruments they were very inconsiderable the work throughout.' Lord Clarendon accuses him of instigating all manner of cruelty here, and Ludlow says the slaughter continued two days, and that 'such extraordinary severity was used to discourage others.' It had at any rate this effect: he marched into Munster to receive the keys of Cork, almost without resistance, and in less than six months extinguished all the hopes of the Irish royalists. He returned to fight successively, and with his usual good fortune, the battles of Dunbar and Worcester; by the latter of which the Commonwealth was left without disturbance in its sovereignty. Cromwell called it his 'crowning mercy.'

The Long Parliament had now made themselves odious by their undisguised tyranny and desire to perpetuate their power, by the war which they had provoked with the Dutch, and the severities which they exercised in their high court of justice. Cromwell assembled certain members of parliament, and some of the chief officers, at the speaker's house, and told them it was necessary to come to a settlement of the nation, delivering his own opinion in favor of a settlement in 'some-what of a monarchical power.' The lawyers present were for a mixed monarchy; and some proposed choosing the duke of Gloucester king. Cromwell soon spoke out more plainly: 'Their pride,' said he to Whitelock, 'and ambition and self-seeking, ingrossing all places of honor and profit to themselves and their friends; and their daily breaking forth into new and violent parties and factions; their delays of business, and design to perpetuate themselves and to continue their power in their own hands; their meddling in private matters between party and party, contrary to the institution of parliaments; and their injustice and partiality in those matters, and the scandalous lives of some of the chief of them,—these things do give too much ground for people to open their mouths against them and to dislike them. Nor can they be kept within the bounds of justice and law or reason, they themselves being the supreme power of the nation, liable to no account to any, nor to be controlled or regulated by any other power; there being none superior or co-ordinate with them.' Whitelock, acknowledging the evil, said it would be hard to find a remedy. What, said Cromwell, if a man should take upon him to be king? To this Whitelock replied, that this remedy would be worse than the disease; that being general he had less envy and less danger than if he were called king; but no less power and real opportunities of doing good. He further represented to him that he was environed with secret enemies; that his own officers were elated with success; 'many of them,' said he, 'are busy and of turbulent spirits, and are

not without their designs how they may dismount your excellency, and some of themselves get up into the saddle,—how they may bring you down and set up themselves.' The memorable scene now followed (20th April, 1653), when Cromwell turned out the parliament, and locked the doors of the house of commons. To this succeeded the calling of Bare-bones' parliament: then the renewed dominion of the council of officers, and finally their declaration, called an Instrument of Government, by which they ordained that the government of the Commonwealth should reside in the single person of Oliver Cromwell, with the title of Lord Protector of the Commonwealth of England, Scotland, and Ireland, and a council of one-and-twenty to assist him.

It was further ordained, that the Protector should call a parliament once in every three years, and not dissolve it till it had sat five months; that the bills which were presented to him, if he did not confirm them within twenty days, should become laws without his confirmation; that his select council should not be more in number than twenty-one, nor less than thirteen; that with their consent, he might make laws which should be binding during the intervals of parliament; that he should have power to make peace and war; that immediately after his death, the council should choose another protector, and that no protector after him should be general of the army. He now addressed himself in good earnest to the business of the chief magistracy; made peace with the Dutch and with Portugal, upon terms highly advantageous to England, and caused his friendship to be courted by France and Spain. His first parliament assembled Sep. 3, 1654, and though orders were given that no persons should be chosen who had borne arms on the king's part, nor the sons of any such, and care was taken to return such members as were believed to be the best affected to his government, yet, in the first debate, his authority was questioned; and the assembly was dissolved Jan. the 22nd, 1655. He called his next parliament at the juncture when a war with Spain had made him master of Jamaica, and two well laden treasure-ships had been taken. Most of the members took the test of declared allegiance to the protector; an act was passed binding all men to renounce Charles Stuart and his family; they declared it high treason to attempt the life of the lord protector, and granted him larger supplies than had ever before been raised. Finally, they offered him the title of king. There was great opposition, however, to this; one member applied to him in the house the words of the prophet to Ahab, 'Hast thou killed, and also taken possession?' and after a long and painful struggle in the bosom of his own family, and with himself, he refused the crown on a plea of conscience.

He would now have governed constitutionally, mildly, and even liberally, if he could have done it in his situation. But self-preservation compelled him to a suspicious and severe system, and he was haunted by ten thousand fears. He wore armour under his clothes; would hardly ever sleep two nights together in one chamber; he went abroad surrounded by his guards, and never suffered it to be known which way he was going till he was

in his coach. His last were most miserable days. His final feelings of religion implied a misgiving, concerning his condition in the world on which he was about to enter—we mean the question proposed to his preachers, 'if the doctrine were true, that the elect could never finally fall?' Upon receiving a reply, that nothing could be more certain; 'Then am I safe,' said he, 'for I am sure that once I was in a state of grace.' He told his physicians boldly that he should not die, whatever they might think from the symptoms of his disorder, for 'God was far above nature, and had promised his people his recovery.' Thanks were even publicly given for the undoubted pledges of his recovery, which had been vouchsafed! His disease was a slow fever, which terminated in an intermittent, and he died in a lethargic state, 3d September, 1658.

The character of him drawn by lord Clarendon will never be exceeded for truth or beauty; and we transcribe it as most singularly the portrait also of a fortunate modern usurper. Posterity will often compare them. 'He was,' says this great writer, 'one of those men, quos vituperare ne inimici quidem possunt, nisi ut simul laudent; whom his very enemies cannot condemn without commending him at the same time: for he could never have done half that mischief without great parts of courage, industry, and judgment. He must have had a wonderful understanding in the natures and humors of men, and as great a dexterity in applying them; who from a private and obscure birth (though of a good family), without interest or estate, alliance or friendship, could raise himself to such a height, and compound and knead such opposite and contradictory tempers, humors, and interests into a consistence, that contributed to his designs, and to their own destruction; whilst himself grew insensibly powerful enough to cut off those by whom he had climbed, in the instant that they projected to demolish their own building. What was said of Cinna may very justly be said of him, *ausum eum, quæ nemo auderet bonus; perfecisse, quæ à nullo, nisi fortissimo, perfici possent*. He attempted those things which no good man durst have ventured on; and achieved those in which none but a valiant and great man could have succeeded. Without doubt, no man with more wickedness ever attempted any thing, or brought to pass what he desired more wickedly, more in the face and contempt of religion, and moral honesty: yet wickedness as great as his could never have accomplished those designs, without the assistance of a great spirit, an admirable circumspection and sagacity, and a most magnanimous resolution.' To this should be added, that as a chief magistrate, like Napoleon, he was generally inclined to be tolerant, and was liberal in his conduct to different religious parties; that he was a protector of literature and the arts; that his private character, unlike his, seems without a blemish; that he was a faithful husband and a good father; and that he boldly and consistently aided the persecuted Protestants of France.

CROMWELL (Richard), eldest son of Oliver, was by his father appointed successor to the protectorship, but soon deposed by the army, who

discharged his debts, and gave him a protection for six months, on which he retired. On the Restoration he went abroad; but returned in 1680 under the assumed name of Clark, and settled at Cheshunt in Hertfordshire, where he lived privately, and died in 1712, aged 86; leaving several children.

CROMWELL (Oliver), a gentleman recently deceased, was the great-grandson of Henry Cromwell. He practiced as a solicitor in Essex-street, London, for several years, and was clerk to St. Thomas's hospital. He succeeded to the estate of Theobalds, which descended to him through the children of the above Richard Cromwell; and died at Cheshunt Park, Hertfordshire, May 31st, 1821, aged seventy-nine. He wrote the Memoirs of the Protector, Oliver Cromwell, and his sons Richard and Henry, illustrated by Original Letters, and other Family Papers, 4to.

CROMWELL (Thomas), earl of Essex, was the son of a blacksmith at Putney, and born in 1498. Without a liberal education, but endowed with a strong natural genius, he became by degrees the confidential favorite, and prime minister of Henry VIII. and from the moment he acquired any authority in the cabinet, employed it in promoting the Reformation, to his zeal for which he became a victim; for, the more firmly to secure the Protestant cause, he contrived to marry the king to Anne of Cleves, whose friends were all Lutherans. Unfortunately Henry took a disgust to this lady, which brought on Cromwell's ruin: the king, with his usual cruelty and caprice, taking the opportunity to sacrifice this minister to the Roman Catholic party, to whom he seemed desirous of reconciling himself, when he had Catharine Howard in view. Cromwell was a great politician, and a good man; but, in his zeal for the new religion, he introduced the unjustifiable mode of attainer in cases of treason and heresy: and his enemies, who were numerous, having preferred many complaints against him, availed themselves of his own law. He was attainted of treason and heresy, convicted unheard, and beheaded in 1540. He was the chief instrument of the suppression of the abbeyes and monasteries, and the destruction of images and relics; to him also we are indebted for the institution of parish registers of births, marriages, and burials.

CRONE, *n. s.* } Anglo-Sax. *crone*; Dutch
CRONN, *n. s.* } *kronie*. *Crone* signifies an old ewe; contemptuously, an old woman. *Crony*, which is a word of familiar parlance, is one who is an old acquaintance; one with whom a person is very intimate.

Fresh herrings plenty Michel brings,
With fatted *crones*, and such old things. *Tusser.*

Take up the bastard,
Take 't up, I say; give 't to thy *crone*.

Shakspeare. Winter's Tale.

So when the Scots, your constant *crones*,
The espousers of your cause and monies.

Hudibras.

The *crone* being in bed with him on the wedding night, and finding his aversion, endeavours to win his affection by reason. *Dryden.*

To oblige your *crony* Swift,
Bring our dame a new year's gift. *Swift.*

Strange an astrologer should die
Without one wonder in the sky!
Not one of all his *crony* stars
To pay their duty at his herse! *Id.*

Your sage Belgic *crones*
Won't in this weighty point mislead ye,
Consult them and experto crede. *Huddesford.*

CRONEL, or **CORONEL**, in heraldry, the iron head of a tilting spear, often borne in coat armour, as sable, a chevron, ermine, between three cronels, argent; name, Wiseman.

CRONENBURG, or **CRONBORG**, a strong fortress of Denmark, in the isle of Zealand, situated on a point of land, on the west coast of the Sound, a little to the east of Elsinour and opposite to Helsingborg, in Sweden. It was built in 1577 by Frederick II. on piles of oak, and pillaged by the Swedes in 1658, who took away among the spoils, some statues of massy silver. It was restored to Denmark in 1660. Queen Matilda was imprisoned in it, before she was removed to Zell. About half a mile from it is a garden called Hamlet's Garden, which, tradition says, is the spot where that prince's father was murdered by his brother. It is flanked with four towers; contains extensive barracks; and is accounted one of the keys of the kingdom, being intended to guard the passage of the Sound; but the British fleet passed it on 29th March, 1801. Criminals are confined in this fortress. In the neighbourhood is a government manufactory of fire-arms. It is twenty-four miles north of Copenhagen.

CROWN, or **CORONET**, *n. s.* Fr. *couronne*; Dutch *kroon*. The hair which grows over the top of a horse's hoof.

CRONIUS, or **CRONIVS**, in chronology, the ancient name of the Athenian month Hecatombeon; which was the first of their year, and answered to the latter part of our June and beginning of July.

CRONSTADT, or the Crown City, a seaport town of Russia, situated on the island of Retusari, in the gulf of Finland. It was founded by Peter I. on account of its safe harbour, and as forming a strong bulwark by sea for the defence of his new metropolis. The greatest part of the Russian fleet usually lies here. The only passage by which ships of burden can approach Petersburg lies on the south side of Retusari, through a narrow channel; one side of which is commanded by Cronstadt, and the opposite by Cronslot and the citadel. All large vessels must sail between Cronstadt and these two fortresses, exposed to the fire of the opposite batteries; for the other parts of the gulf are only from one to eleven feet in depth. All these fortifications, when first built, were esteemed places of considerable strength; but they would offer feeble resistance to the attack of a powerful fleet. Cronstadt is built upon the south-east extremity of the island, and is defended towards the sea by wooden piers projecting into the water and towards the land by ramparts and bastions. It is a very straggling place, and occupies, like all the Russian towns, a larger space of ground than the number of inhabitants seems to require; their houses are mostly of wood, excepting a few fronting the harbour,

which are of brick stuccoed white. Among the latter are the imperial hospital for sailors, the barracks, and the academy for marines and officers of the navy. Cronstadt has a separate haven appropriated to the men of war, and another to merchant ships. The largest is the merchants' harbour, which is fitted to contain 600 vessels, and is touched at by most ships going to St. Petersburg, but is exposed, as well as the middle harbour, to the west wind. The war harbour, which is designed for ships of war which are on service, or stand in need of repairs, is of small size and depth, and the brackishness of the water often produces rot. The man of war's mole, as it is called, is a structure, enclosed by a strong rampart of granite, built in the sea, and containing a foundry for casting cannon, and a rope-work for manufacturing cables of all sizes, naval stores, &c. Close to the merchants' harbour is a canal, with several dry docks, begun in 1719 by Peter I. for the purpose of refitting the men of war. This useful work was neglected under his successors, and was not completed until the reign of his daughter Elizabeth. It has since been further improved, and is now used for building as well as careening ships of the line. At the extremity of these docks is a reservoir, constructed of granite, 568 feet in length, which contains water more than sufficient to supply all the docks, and is pumped into them by a steam engine. The length of this work, from the beginning of the canal to the end of the last dock, is 4221 feet. The sides of the docks are faced with stone, and the bottom is paved with granite. They are forty feet deep, and 105 broad; and are capable of containing nine men of war upon the stocks. A few miles below Cronstadt lie the guardships for the protection of the revenue, and the examination of passports. The number of vessels that entered the Neva, (and of course passed by Cronstadt), in 1817, was about 2000, and the departures were nearly as many. The principal exports are iron, flax, hemp, linseed, oil, and tar. Cronstadt is twenty miles west of Petersburg, and contains a population of about 40,000.

CRONSTEDT (Axel-Frederick), a Swedish mineralogist, born in 1722, and educated at the university of Upsal, where he paid particular attention to the study of natural history. In 1742 he was admitted into the college of mines, and in 1744 he was employed to inspect the mines of Sweden. In 1753 he became a member of the Royal Academy of Sciences at Stockholm; and in 1758 he was appointed inspector of all the western mines of the kingdom. He published *An Attempt towards an Arrangement of Minerals*, or of the different substances of the mineral kingdom; and several other tracts on mineralogy. He died in 1745, aged forty-three.

CROOK, <i>v. a.</i> , <i>v. n.</i> & <i>n. s.</i>	} Fr. <i>crocher</i> ; Goth. and Swed. <i>krok</i> , <i>kruka</i> ; Welsh <i>crucca</i> ; Dut. <i>krook</i> . To crook is to curve ; to be curved ; to deflect from the proper line.
CROOKED, <i>adj.</i>	
CROOKEDLY, <i>adv.</i>	
CROOKEDNESS, <i>n. s.</i>	
CROOKEN, <i>v. a.</i>	
CROOKBACK, <i>n. s.</i>	
CROOK-BACKED, <i>adj.</i>	
CROOK-KNEED, <i>adj.</i>	
CROOK-SHOULDERED, <i>adj.</i>	

Crook signifies, any crooked instrument; a sheep-hook; a meander; an artifice; a gibbet. To crooken is an obsolete verb, meaning, to make crooked. Crooked, crookedly, and crookedness, in their direct sense, of course denote curvature: and from this flows naturally the metaphorical sense, of perverse; obstinate; bad-tempered.

They have corrupted themselves: they are a perverse and crooked generation. *Deut. xxxii. 5.*

He made the peple pitouly to sing,
For er the bishop hent hem with his crook,
They weren in the arshedeakens book.

Chaucer. Cant. Tales.

Ful crokid were her bondis two,
For covetise is evir wode
To gripen other folkis gode.

Id. The Romant of the Rose

To grounde as ded she fallith as a stone,
She crampisheth her limmis crokidyly.

Id. Annetida and Pales Arcis.

For beauty with her band
These croked cares hath wrought,
And shipped me into the land
From whence I first was brought.

Songes and Sonettes.

His tyreling jade he fierly forth did peak
Through thicke and thin, both over banck and bush,
In hope her to attaine by houke or crooke.

Spenser. Faerie Queene.

At last, with creeping crooked pace forth came
An old, old man, with beard as white as snow,
That on a staffe, his feeble steps did frame. *Id.*
Whence he with crooked claws so long did crall,
That at the last he found a cave with entrance small. *Id.*

There fall those saphire-coloured brooks,
Which conduit-like, with curious crookes,
Sweet islands make in that sweet land. *Sidney.*

He that knoweth what is straight, doth even thereby
discern what is crooked; because the absence of
straightness, in bodies capable thereof, is *crookedness*. *Hobbes.*

Being moved, he strikes whatever is in his way,
And whom he strikes his crooked tushes slay. *Shakespeare. Venus and Adonis.*

Hence, heap of wrath; foul, indigested lump!
As crooked in thy manners as thy shape. *Id. Henry VI.*

Ay, crookback, here I stand to answer thee,
Or any be the proudest of thy sort. *Id.*

Whatever affairs pass such a man's hands, he
crooketh them to his own ends; which must needs be
often eccentric to the ends of his master or state. *Bacon.*

Their shoes and pattens are snouted and piked more
than a finger long, crooking upwards. *Camden.*

When the heathens offered a sacrifice to their false
gods, they would make a severe search to see if there
were any crookedness or spot, any uncleanness or
deformity, in their sacrifice. *Taylor's Worthy Communionist.*

If we walk perversely with God, he will walk
crookedly towards us. *Id. Rule of Living Holy.*

I sing the man who Judah's sceptre bore
In that right hand which held the crook before. *Conyng.*

A man shall never want crooked paths to walk in,
if he thinks that he is in the right way, wherever he
has the footsteps of others to follow. *Locke.*

There are millions of truths that a man is not, or
may not think himself, concerned to know; as whether
our king Richard III. was crookbacked or no. *Id.*

We were not born *crooked*; we learned those windings and turnings of the serpent. *South.*

A bell or a cannon may be heard beyond a hill which intercepts the sight of the sounding body; and sounds are propagated as readily through *crooked* pipes, as through straight ones. *Newton's Opticks.*

He left his *crook*, he left his flocks,
And wandering through the lonely rocks,
He nourished endless woe. *Prior.*

She that would raise a noble love, must find
Ways to beget a passion for her mind;
She must be that which she to be would seem;
For all true love is grounded on esteem:
Plainness and truth gain more a generous heart,
Than all the *crooked* subtleties of art. *Buckingham.*

It is highly probable, that this disease proceeds from a redundant acidity, because vinegar will soften and *crook* tender bones. *Arbuthnot on Diet.*

Among the *crooked* lanes on every hedge,
The glow-worm lights his gem. *Thomson's Summer.*

Unhappy they, confiding in the length
Of horny beak, or talon's *crooked* strength,
Who durst abide his rage; the blade descends,
And from the panting trunk the pinion rends. *Beattie.*

Yet is thy root sincere, sound as the rock,
A quarry of stout spurs, and knotted fangs,
Which *crooked* into a thousand whimsies, clasp
The stubborn soil, and hold thee still erect. *Cooper.*

Thus men go wrong with an ingenious skill;
Bend the straight rule to their own *crooked* will;
And with a clear and shining lamp supplied,
First put it out, then take it for a guide. *Id.*

CROOKED ISLAND, or rather a cluster of islands of the Bahama group, is known as, North Crooked Island, South Crooked Island, commonly called Acklin's Island, and Long Key, or Fortune Island. Castle Island is very small, and situated at the south end of Acklin's, which is the largest of the group, being about fifty miles in length. North Crooked Island is about twenty-one miles long, and from two to six broad; Long Key is about two miles in length, and very narrow. It contains a valuable salt pond. Long, of the middle of Crooked Island 74° W., lat. 22° 30' N.

CROOKED LAKE, a lake of North America, in the state of New York, eighteen miles in length. Forty miles south of Lake Ontario.

CROOKED LAKE, one of the chain of small lakes which connect the lake of the Woods with Lake Superior, on the boundary line between the United States and Upper Canada, remarkable for its rugged cliffs, in the cracks of which are a number of arrows sticking.

CROOKED REACH, a channel in the straits of Magellan, between the South American shore and an island in the strait. It is about four miles broad, and extends between Elizabeth Bay and Cape Quod.

CROOKED RIVER, a river of the United States n. Camden county, Georgia, which runs into the opposite Cumberland Island, twelve or fourteen miles north from the mouth of St. Mary's. Its banks are well wooded, and its course is east by north.

CROP, *n. s.* } Swed. *kropp*; Dut. *krop*,
CRO'PFUL, *adj.* } *kroppe*; Ang.-Sax. *crop*.
CRO'PSICK, *adj.* } The craw, or first stomach
CRO'PPER, *n. s.* } of a bird. Cropful is,

filled perfectly; cropsick, sick from repletion; cropper, a kind of pigeon which has a large crop.

He, stretched out all the chimney's length,
Basks at the fire his hairy strength;
And *crop-full*, out of door he flings
Ere the first cock his matin rings. *Milton.*

There be tame and wild pigeons; and of tame
there be *croppers*, carriers, runts. *Walton's Angler.*

In birds there is no mastification or comminution of the meat in the mouth; but in such as are not carnivorous, it is immediately swallowed into the *crop* or *craw*. *Ray.*

But fluttering there they nestle near the throne,
And lodge in habitations not their own,
By their high *croops* and corny gizzards known. *Dryden.*

Strange odds! where *crop-sick* drunkards must
engage
A hungry foe, and armed with sober rage. *Tate's Juvenal.*

So, stooping down from hawthorn top,
He thought to put him in his *crop*.
The worm, aware of his intent,
Harangued him thus, right eloquent. *Cooper.*

CROP, *v. a., v. n. & n. s.* } Ang.-Sax. *crop*
CRO'PPING, *n. s.* } from *ripan*, gery-
CRO'P-EAR, *n. s.* } pan, to reap. In
CRO'P-EARED, *adj.* } its primary sense
the noun *crop* means, that which is the highest part of any thing, as an ear of corn, the top of a tree; thence, the harvest; whatever is cut off. To *crop*, therefore, is to mow, reap, or lop the top off any thing; to gather a thing before it falls; and, in its neuter sense, to yield harvest. *Cropping*, as a noun, is the act of putting the future *crop* into the soil; the act of cutting off any thing. *Crop-ear* signifies a horse whose ears are cropped; and *crop-eared* that of which the ears have been cropped, or which is cut short about the ears.

I will *crop* off from the top of his young twigs a tender one, and will plant it upon an high mountain. *Baekiel*, xvii. 22.

When Zephirus eke with his sweete brethe
Enspired hath in every holte and heth
The tendre *croppes*. *Chaucer. Prol. to Cant. Tales.*

Or like the hell-borne hydra, which they faine
The greate Alcides whilome overthrew,
After that he had laboured long in vain
To *crop* his thousand heads. *Spenser. Faerie Queene.*

Whose shady boughs sharp steele did never lop,
Nor wicket beastes their tender buds did *crop*. *Id.*

And this of all my harvest hope I have,
Nought reaped but a weedy *crop* of care. *Id. Pastorals.*

All the budding honours on thy crest
I'll *crop*, to make a garland for my head. *Shakespeare. Henry IV.*

Cropped are the flower-de-luces in your arms;
Of England's coat, one half is cut away. *Id. Henry VI.*

He upon whose side
The fewest roses are *cropped* from the tree,
Shall yield the other in the right opinion. *Id.*

Royal wench
She made great Cæsar lay his sword to-bed;
He ploughed her, and she *cropt*. *Id. Antony and Cleopatra.*

What horse? a roan, a *crop-sar*, is it not?

Id. 1 *Henry IV.*

A *crop-eared* scrivener this.

B. Jonson.

Age, like ripe apples, on earth's bosom drops,
While force our youth, like fruits, untimely *crops*.

Denham.

Lab'ring the soil, and reaping plenteous *crop*,
Corn, wine, and oil. *Milton's Paradise Lost.*

O fruit divine!

Sweet of thyself, but much more sweet thus *cropped*.

Id.

No more, my goats, shall I behold you climb
The steepy cliffs, or *crop* the flow'ry thyme!

Dryden's Virgil.

Guiltless of steel, and from the razor free,
It falls a plenteous *crop* preserved for thee.

Id. Fables.

Death destroys

The parent's hopes, and *crops* the growing boys.

Creech.

The fountain which from Helicon proceeds,
That sacred stream, should never water weeds,
Nor make the *crop* of thorns and thistles grow.

Roscommon.

Nothing is more prejudicial to your *crop* than mow-
ing of it too soon. *Mortimer's Husbandry.*

The richest genius, like the most fertile soil, when
uncultivated, shoots up into the rankest weeds; and
instead of vines and olives for the pleasure and use
of man, produces to its slothful owner, the most
abundant *crop* of poisons. *Hume.*

The first year, from unfortunately buying seed, the
second, from a late harvest, we lost half our *crops*.
This overset all my wisdom, and I returned, 'like
the dog to his vomit, and the sow that was washed to
her wallowing in the mire.' *Burns.*

I saw him with that lily *cropped*

Impatient swim to meet

My quick approach, and soon he dropped

The treasure at my feet.

Cowper.

Shaggy, and lean, and shrewd, with pointed ears
And tail *cropped* short, half lurcher and half cur,
His dog attends him. Close behind his heel
Now creeps he slow; and now, with many a frisk
Wide-scampering, snatches up the drifted snow
With ivory teeth, or ploughs it with his snout;
Then shakes his powdered coat, and barks for joy. *Id.*

— Each young Hour its sickle fine employs,
And *crops* the sweet buds of domestic joys. *Darwin.*

Tombstones and monuments he took

For pills to cool his palate;

And *cropped* the church-yard yew-trees all—

They served him for a salad. *Huddesford.*

Make lords and *crop-eared* petit maitres

Their prowess prove on tavern waiters;

Challenge their corn-cutter and taylor

To arms, and catch contagious valour

From contact with each raggamuffin. *Id.*

Alas, thou hast no wings, oh Time!

It was some thoughtless lover's rhyme,

Who, writing in his Chloe's view,

Paid her the compliment through you.

For had he, if he truly loved,

But once the pangs of absence proved,

He'd *cropped* thy wings and in their stead,

Have painted thee with heels of lead. *Sheridan.*

Then the full flaxen wig, spread o'er the shoulders,

Concealed the shallow head from the beholders!

But now the whole's reversed—each fop appears,

Cropped and trimmed up, exposing head and ears. *Id.*

CRO'SIER, *n. s.* Fr. *croisse*; barbarous Latin, *crocia*, from *crux*, a cross. The pastoral staff of a bishop, which is surmounted by a cross.

When prelates are great, there is also danger from them; as in the times of Anselmus and Thomas Becket, who, with their *crozier*s, did almost try it with the king's sword. *Bacon.*

Grievances there were, I must confess, and some incongruities in my civil government; wherein some say the *crozier*, some say the distaff, was too busy. *Howel's England's Tears.*

Her front erect with majesty she bore,

The *crozier* wielded, and the mitre wore.

Dryden.

Crosiers for lordly priests provide,

Let warriors wield the truncheon;

I ask no implement beside

A tankard and a luncheon. *Huddesford.*

CROSIER, in astronomy, four stars in the southern hemisphere, in the form of a cross, serving those who sail in south latitudes to find the Antarctic Pole.

CROSIER, or **CROZIER**, the shepherd's crook, is a symbol of pastoral authority, consisting of a gold or silver staff, crooked at the top, carried occasionally before bishops and abbots, and held in the hand when they give the solemn benedictions. The custom of bearing a pastoral staff before bishops is very ancient, as appears from the Life of St. Casarea, of Arles, who lived about A. D. 500. Among the Greeks, none but the patriarchs had a right to the *crozier*. The *crozier*s were, at first, only simple wooden staves, in form of a T, used to lean upon. By degrees they were made longer, and at length arrived to their present form.

CROSLER, in heraldry, is when a cross is crossed again at a small distance from each of the ends. According to Lucholm, 'it is an honorable bearing, and is generally distributed at large in the field,' as *gules*, a saltire *argent*, between twelve cross-croslets, counter-changed, name, Pinkney.



CROSS, *v. a., v. n., n. s., adj. & prep.*

CROSSING, *n. s.*

CROSSLY, *adv.*

CROSSNESS, *n. s.*

CROSSWINE, *adv.*

CRO'SLET, *n. s.*

Fra.
crois;
Italian.
croce;
Gothic.
kross;

Sw. *kors*; Ang.-Sax. *cors*; Wel. *croes*; Lat. *crux*. The meanings of the noun, verb, and adjective are multifarious. A cross is primarily an instrument of punishment, composed of one straight body laid over another at right angles, on an instrument of which kind our Saviour suffered, and which thence became the ensign of the Christian religion. It also denotes a monument with a cross on it, to excite devotion; a line drawn through another; any thing that thwarts us, or puts our patience to the trial; intermixture of breed; figuratively, money, from its bearing the mark of a cross; Irish church lands. Cross, and pile, is a play, in which a piece of money is spun round into the air, and the player who has called 'cross' wins, in case of the cross

falling uppermost. The adjective signifies, transverse; falling athwart something else; oblique; adverse to; untractable; fretful; ill-humored; contrary to wish or expectation; unfortunate; interchanged. As a preposition it stands for athwart; over; from side to side. It forms compounds with many other words, as the succeeding articles will show. Crossing is, the act of signing with the cross; opposing; frustrating. Crossly, and crossness, are transversely; adversely; transverseness; peevishness. Cross-wise is in the manner of a cross. To cross is, to lay a body, or draw a line athwart another; to make the sign of the cross; to cancel; to pass from one side to the other; to pass from one place to another; to thwart; to defeat any purpose; to be inconsistent with; to contradict; to debar; to lie athwart another thing. A croslet is a small cross. The word is chiefly used in heraldry; but Chaucer employs it to designate a crucible.

He had a *cross* of laton ful of stones,
And in a glas he hadde pigges bones.

Chaucer. Prol. to Cant. Tales.

Of gentilwomen faire there were also
Disporting hem everiche aftir her gise,
In *crosses* aleis walking by two and two.

Id. The Assemble of Ladies.

Men's actions do not always *cross* with reason.

Sidney.

Wishing unto me many *crosses* and mischances in
my love, whensoever I should love.

Id.

Still do I *cross* this wretch, whatso he taketh in
hand.

Hooker.

In all this there is not a syllable which any ways
crosseth us.

Id.

And on his brest a bloodie *cross* he wore,
The deare remembrance of his dying Lord.

Spenser. Faerie Queene.

But he them spying, 'gan to turn aside,
For fear, as seemed, or for some feined loss;
More greedy they of news, fast towards him do *cross*.

Id.

Then Una 'gan to ask, if aught he knew,
Or heard abroad, of that her champion true,
That in his armour bare a *croslet* red.

Id.

No governour is suffered to go on with any one
course, but upon the least information he is either
stopped and *crossed*, or other courses appointed him
from hence.

Spenser. On Ireland.

It may make my case dangerous, to *cross* this in the
smallest.

Shakespeare. Measure for Measure.

Was this a face,

To stand against the deep dread-bolted thunder,
In the most terrible and nimble stroke
Of quick *cross* lightning?

Id. King Lear.

From his loins no hopeful branch shall spring,
To *cross* me from the golden time I look for.

Id. Richard III.

Thou ceaseless lucky to Eternity;
With some mischance *cross* Tarquin in his flight.

Id. The Rape of Lucrece.

She doth stray about

By holy *crosses*, where she kneels and prays.

Id.

From many men I do not bear these *crossings*.

Id. 1 Henry IV.

Heaven prepares good men with *crosses*; but no ill
can happen to a good man.

Ben Jonson's Discoveries.

Cross marriages, between the king's son and the
archduke's daughter; and, again, between the arch-
duke's son and the king's daughter.

Bacon's Henry VII.

The lighter sort of malignity, turneth but to a *cross-
ness* or aptness to oppose; but the deeper sort, to envy,
or mere mischief.

Bacon.

It is certain, howsoever it *cross* the received opinion,
that sounds may be created without air.

Id. Natural History.

They make a little *cross* of a quill, longways of that
part of the quill which hath the pith, and *crossways*
of that piece of the quill without pith.

Id.

The enemy had, in the woods before them, cut down
great trees *cross* the ways, so that their horse could not
possibly pass that way.

Knoles.

The absolute palatines made their own judges, so as
the king's writ did not run in those counties, but only
in the church lands lying within the same, which
were called the *cross*; wherein the king made a sheriff;
so in each of these counties palatines there was one
sheriff of the liberty, and another of the *cross*.

Sir J. Davies.

How his enraged ghost would stamp and stare,
That Cæsar's throne is turned to Peter's chayre;
To see an old shorne losell perched on high,
Crossing beneath a golden canopy.

Hall.

Your magical exorcisms; your clerical shavings;
your uncleanly unctions; your *crossings*.

Id.

You are first to consider seriously the infinite love
of your Saviour, who offered himself for you as a
sacrifice upon the *cross*.

Taylor's Guide to the Penitent.

A great estate hath great *crosses*, and a mean for-
tune hath but small ones.

Id. Rules of Living Holy.

He was said to make soldiers spring up out of the
very earth to follow him, though he had not a *cross* to
pay them salary.

Hovell's Vocal Forest.

This forced the stubbornest, for the cause,
To *cross* the cudgels to the laws;
That what by breaking them 't had gained,
By their support might be maintained.

Hudibras.

Whacum had neither *cross* nor pile;
His plunder was not worth the while.

Id.

He was so great an enemy to Digby and Colepeper,
who were only present in debates of the war with the
officers, that he *crossed* all they proposed.

Clarendon.

Then their wills clash with their understandings,
and their appetites *cross* their duty.

Locke.

They must not be *crossed*, forsooth; they must be
permitted to have their wills in all things; and they
being in their infancies not capable of great views,
their parents think they may safely enough indulge
their little irregularities, and make themselves sport
with that pretty perverseness, which they think well
enough becomes that innocent age.

Id.

A fox was taking a walk one night *cross* a yillage.

L' Estrange.

Friars

Resort to farmers rich, and bless their halls,
And exorcise the beds, and *cross* the walls.

Dryden.

Betwixt the midst and these, the gods assigned
Two habitable seats of human kind;
And *cross* their limits cut a sloping way,
Which the twelve signs in beauteous order sway.

Id. Virgil.

He conquered this proud Turk as far as the Helles-
pont, which he *crossed*, and made a visit to the Greek
emperor at Constantinople.

Temple.

The mind brings all the ends of a long and various
hypothesis together; sees how one part coheres with,
and depends upon, another; and so clears off all the
appearing contrarieties and contradictions, that seemed
to lie *cross* and uncouth, and to make the whole unin-
telligible.

South.

All *cross* and distasteful humours, and whatever else may render the conversation of men grievous and uneasy to one another, must be shunned. *Tillotson*.

He that provides for this life, but takes no care for eternity, is wise for a moment, but a fool for ever; and acts as untowardly and *crossly* to the reason of things, as can be imagined. *Id.*

The loxia, or *cross-bill*, whose bill is thick and strong, with the tips *crossing* one another, with great readiness breaks open fir-cones, apples, and other fruit, to come at their kernels; as if the *crossing* of the bill was designed for this service.

Derham's Physico-Theology.

Whatsoever penumbra should be made in the circles by the *cross* refraction of the second prism, that penumbra would be conspicuous in the right lines which touch those circles. *Newton.*

They help us to forget the *crossness* of men and things, compose our cares and our passions, and lay our disappointments asleep.

Collier of the Entertainment of Books.

I shall most carefully observe, not to *cross* over or deface the copy of your papers for the future, and only to mark in the margin. *Pope.*

Here an unfinished diamond *crosses* lay,
To which soft lovers adoration pay. *Gay's Fab.*

Her holy faith and Christian *cross* opposed
Against the Saxon gods. *Rowe.*

This I humbly conceive to be perfect boys' play;
cross, I win, and pile, you lose; or, what's your's is mine,
and what's mine is my own. *Swift.*

The ships must needs encounter, when they either advance towards one another in direct lines, or meet in the intersection of *cross* ones. *Bentley.*

Will ye one transient ray of gladness dart
Cross the dark cell where hopeless Slavery lies?
To ease tired Disappointment's bleeding heart,
Will all your stores of softening balm suffice? *Beattie.*

O Henderson! the man! the brother!
And art thou gone, and gone for ever!
And hast thou *cross* that unknown river,
Life's dreary bound!
Like thee, where shall I find another,
The world around! *Burns.*

By our blood in *Afric* wasted,
Ere our necks received the chain;
By the miseries that we tasted,
Crossing in your barks the main. *Cowper.*

Shrill cats, whom fierce domestic broils delight,
Cross cats, who nothing want but teeth to bite.
Huddesford.

See! through the grove a narrow lake extends,
Crosses each plot, to each plantation bends;
And while the fount in new meanders glides,
The forest brightens with refreshing tides. *Sheridan.*

Thou hast done a fearful deed
In falling away from thy father's creed:
But dash that turban to earth, and sign
The sign of the *cross*, and for ever be mine;
Wring the black drop from thy heart,
And to-morrow unite us no more to part.
Byron. Siege of Corinth.

This heathenish *cross* restored the breed again,
Ruined its blood, but much improved its flesh;
For, from a root, the ugliest in Old Spain
Sprung up a branch as beautiful as fresh.
Id. Don Juan.

Cross. The ancient cross was made with two pieces of wood, placed crosswise, either crossing

at right angles at the top, like a T, or in the middle of their length, like an X. The cross to which our Saviour was fastened is thus represented on old monuments, coins, &c.; and St. Jerome compares it to a bird flying, and a man swimming, or praying, with his arms extended. The punishment of the cross was common among the Syrians, Egyptians, Persians, Africans, Greeks, Romans, and Jews. It was the most dreadful of all others, both for the shame and pain of it; and so scandalous, that it was inflicted as the last mark of degradation upon the vilest of people. It was the punishment of robbers and murderers, provided that they were slaves too; for if they were free, and had the privilege of the city of Rome, it was thought too infamous a punishment for them, whatever might be their crimes. The body of the criminal was fastened to the upright piece, naked, by nailing the feet to it, and on the other transverse piece, generally by nailing the hands on each side. Sometimes he was fastened with cords to the fatal tree, with his head downwards. Nonnius thinks that our Saviour's arms were bound fast to the cross with chains; and St. Hilary speaks of the cords wherewith he was tied to it. Sometimes they who were fastened upon the cross lived a long time in that condition. St. Andrew is said to have continued three days alive upon it. Eusebius speaks of certain martyrs in Egypt who were kept upon the cross till they were starved to death. Pilate was surprised, we see, at our Saviour's dying so soon. Among some nations they were suffered to remain upon the cross a long time, even until they were devoured alive by birds and beasts of prey. Guards were appointed to observe that none of their friends or relations should take them down and bury them. The Roman soldiers, who had crucified Jesus Christ and the two thieves, thus continued near the crosses till the bodies were taken down and buried.

Crosses were usually, in former times, erected on the tops of houses, by which tenants pretended to claim the privileges of the Templars Hospitaliers, to defend themselves against their rightful lords. This was condemned by the statute William II. cap. 37. It was usual also, in those days, to set up crosses in places where the corpse of a nobleman rested as it was carried to be buried, that passengers might pray for his soul. Crosses, &c. are forbidden to be brought into England by 13th Eliz. cap. 2, on pain of a præmunire. &c.

Fables, in abundance, are connected with the alleged history of the true cross. An ancient feast was solemnised on the 3rd of May, in memory of the true cross of Christ being found by St. Helena, the mother of Constantine, deep in the ground on Mount Calvary, where she erected a church for the preservation of part of it, the rest being brought to Rome, and deposited in the church of the Holy Cross of Jerusalem. Theodoret mentions the finding of three crosses; that of Jesus Christ, and those of the two thieves; and that they distinguished between them by means of a sick woman, who was immediately healed by touching the true cross. The place is said to have been pointed out to her by St.

Quiriacus, then a Jew, afterwards converted and canonised.

The adoration of the cross appears to have been practised at a remote period; inasmuch as the Heathens, particularly Julian, reproach the primitive Christians with it; and we do not find that their apologetists disclaimed the charge. Mornay, indeed, asserted, that this had been done by St. Cyril, but could not support his allegation at the conference of Fontainebleau. St. Helena is said to have reduced the adoration of the cross to its just principle, as she adored in the wood, not the wood itself, but him who had been nailed to this wood. With such modifications some Protestants have been induced to admit the adoration of the cross. John Huss admitted of the phrase, provided it were expressly added, that the adoration was to the person of Christ. Imbert, the good prior of Gascony, was severely prosecuted, in 1683, for telling the people, that in the ceremony of adoring the cross, practised in that church on Good Friday, they were not to adore the wood, but Christ, who was crucified on it. The curate of the parish told them the contrary: it was the wood! the wood! they were to adore. Imbert replied, it was Christ, not the wood: for which he was cited before the archbishop of Bourdeaux, suspended from his functions, and even threatened with chains and perpetual imprisonment. It little availed him to cite the bishop of Meaux's distinction; it was answered, that the church allowed it not.

Cross, in coins, the right side or face, the other being called the pile, or reverse. It has been a common error that the reverse was meant by the cross; because at this time, with us, it is marked with figures disposed in that form; but the stamping the head of the prince in these kingdoms on the right side of the coin, was preceded by a general system of striking on that part the figure of a cross; while the pile contained the arms, or some other device.

Cross, in heraldry, is defined by Guillim, an ordinary composed of fourfold lines; whereof two are perpendicular, and the other two transverse; for so we must conceive of them, though they be not drawn throughout, but meet by couples, in four right angles, near the fess point of the escutcheon. See **HERALDRY**. This bearing was first bestowed on such as had performed, or at least undertaken, some service for the Christian profession; and is held by many to be the most honorable charge in all heraldry. It came into frequent use from the ancient expeditions into the Holy Land; the ensign of that war being the cross. In those wars, says M'Kenzy, the Scots carried St. Andrew's cross; the French, a cross *argent*, the English, a cross *or*; the Germans, *sable*; the Italians, *azure*; the Spaniards, *gules*. Leigh mentions forty-six several crosses; Sylvanus Morgan, twenty-six; Upton, thirty; Johannes de Bado Aureo, twelve. Upton owns he dares not presume to ascertain all the various crosses used in arms, for that they are at present almost innumerable; and, therefore, he only takes notice of such as he had seen used in his own time. See **HERALDRY**.

Cross, in law, instead of a signature to a deed, &c., is derived from the Saxon practice of

affixing the sign of the cross, whether they could write or not.

Cross (Michael), an English artist, famous for copying paintings in the reigns of Charles I. and Charles II. Of this talent, there is a story current, more to the honor of his skill than of his probity. He is said to have been employed by Charles I. to copy the celebrated Madonna of Raphael, in St. Mark's church, at Venice; and that, having obtained leave of the state for that purpose, he executed his piece so well, as to bring away the original, and leave the copy in the place of it.

Cross, MAIDS OF THE, a ci-devant community of young women, instituted in 1265, at Roye, in Picardy, and afterwards dispersed to Paris and other towns of France. They instructed young persons of their own sex. Some took the vows of poverty, chastity, and obedience; others retained their liberty. They were under the direction of a superior.

Cross, ORDER OF THE, or CROISADE, an order of ladies instituted in 1668, by the empress Eleonora de Gonzagna, wife of the emperor Leopold I., on occasion of the miraculous recovery of a little golden cross, wherein were enclosed two pieces of the true cross, out of the ashes of part of the palace. The fire is said to have burnt the case wherein it was enclosed, and melted the crystal, yet the wood remained untouched!

CROSSARMED, *adj.* From cross and arm. With arms folded across; melancholy.

Yet neither will I vex your eyes to see
A sighing ode, nor *cross-armed* elegy. *Denne.*

CROSSARROW, *n. s.* From cross and arrow. The arrow of a cross-bow.

Why I was run twice through the body, and shot
i' the head with a *cross-arrow*, and yet am well again.
Beaumont and Fletcher.

CROSS-BARRED, *adj.* From cross and bar. Barred with transverse bars.

Substantial doors,
Cross-barred and bolted fast.

Milton's Paradise Lost.

CROSS-BAR SHOT, *balle ramée*, Fr.; shot, with iron bars crossing through them, sometimes standing six or eight inches out at both sides; they are used at sea for destroying the enemy's rigging. At a siege they are of great service in demolishing the enemy's palisading, &c.

CROSS-BEARER, *porte-croix* cruciger; in the Romish church, the chaplain of an archbishop or primate, who bears a cross before him on solemn occasions. The pope used to have the cross borne before him everywhere; a patriarch any where out of Rome; and primates, metropolitans, and those who have a right to the pallium, throughout their respective jurisdictions. Gregory IX. forbade all patriarchs and prelates to have it borne in presence of cardinals. A prelate bears a single cross, a patriarch a double cross, and the pope a triple one on their arms.

CROSS-BEARERS also denote certain officers in the inquisition, who make a vow before the inquisitors, or their vicars, to defend the Catholic faith, though with the loss of fortune and life. Their business is to provide the inquisitors with necessaries.

CROSS-BILL, *n. s.* A bill brought by a defendant against the plaintiff in chancery.

CROSS-BILL, in ornithology. See *LOXIA*.

CROSSBITE, *v. a. & n. s.* From cross and bite. To circumvent by deception. A deception; a cheat.

The fox, that trusted to his address and manage, without so much as dreaming of a *cross-bite* from so silly an animal, fell himself into the pit that he had digged for another.

L'Étrange.

No rhetoric must be spent against *cross-biting* a country evidence, and frighting him out of his senses.

Collier.

That many knotty points there are,
Which all discuss, but few can clear;

As nature slyly had thought fit,

For some by-ends, to *cross-bite* wit. *Prior.*

CROSSBOW, *n. s.* } From cross and bow.

CROSSBOWER, *n. s.* } A missive weapon, formed by placing a bow athwart a stock, which has a groove for the reception of the arrow. One who shoots with a crossbow.

The master of the *cross-bows*, lord Rambures.

Shakespeare.

The French assisted themselves by land with the *cross-bowers* of Genoa against the English.

Raleigh's Essays.

Gentlemen suffer their beasts to run wild in their woods and waste ground, where they are hunted and killed with *cross-bows* and pieces in the manner of deer.

Carew of Cornwall.

Testimony is like the shot of a long bow, which owes its efficacy to the force of the shooter; argument is like the sho. of the *cross-bow*, equally forcible whether discharged by a giant or a dwarf.

Boyle.

Cross-Bow. See *BALISTA*, and *ARTILLERY*.

CROSSBUN, *n. s.* From cross and bun. A bun marked with the figure of the cross, which is sold on Good Friday.

CROSS-COUNTRY, *adj.* From cross and country. That which crosses the country.

These carpets, so soft to the foot,

Caledonia's traffic and pride!

Oh spare them ye knights of the boot,

Escaped from a *cross-country* ride! *Cowper.*

CROSSCUT, *v. a.* From cross and cut. To cut across.

CROSSEN, a town and duchy of Germany, in Upper Saxony, ceded in 1746 to the king of Prussia. It abounds in wine and fruits. The town was burnt down in 1708, and taken by Russia in 1757. It contains about 3500 inhabitants, and is sixty-eight miles E. S. E. of Berlin.

CROSS-EXAMINE, *v. a.* } From cross and

CROSS-EXAMINATION, *n. s.* } examine. To examine a witness, by putting catching and difficult questions to him. The act of cross-examining.

If we may but *cross-examine* and interrogate their actions against their words, these will soon confess the invalidity of their solemnest confessions.

Decay of Piety.

The judges shall, as they think fit, interrogate or *cross-examine* the witnesses.

Spectator.

CROSSFLOW, *v. a.* From cross and flow. To flow in an opposite direction.

The flood

That staid her flight with his *cross-flowing* course.

Milton. Comus.

CROSSGRAINED, *adj.* From cross and grain. Having the fibres transverse or irregular; perverse; bad tempered; fond of giving vexation.

If the stuff proves *crossgrained* in any part of its length, then you must turn your stuff to plane it the contrary way, so far as it runs *crossgrained*. *Moroe.*

We find in sullen writs,

And *crossgrained* works of modern wits,

The wonder of the ignorant. *Hudibras.*

The spirit of contradiction, in a *cross-grained* woman, is incurable. *L'Étrange.*

She was none of your *cross-grained*, termagant, scolding jades, that one had as good be hanged as live in the house with.

Arbutnot's John Bull.

But wisdom, peevish and *cross-grained*,

Must be opposed, to be sustained. *Prior.*

Sad strife arose, for they were so *cross-grained*,

Instead of bearing up without debate,

That each pulled different ways with many an oath,
'Arcades ambo,'—id est—blackguards both.

Byron. Don Juan.

CROSSEGGED, *n. s.* From cross and leg. Having the legs crossed, like tailors at work.

Crosslegged, and yet ungartered, hath been seen.

Messenger.

CROSSOSTYLUS, in botany, a genus of the polyandria order, and monadelphia class of plants: *CAL.* a quadrangular, quadridif, turbinate perianthium; *COR.* consists of four elliptical petals: *STAM.* are twenty filiform filaments, almost the length of the calyx; anthers small and roundish: *PERICARP.* an hemispherical, unilocular berry, with many striæ on its upper part: *SEED* numerous and roundish.

CROSS-PIECE, a rail of timber extended over the windlass of a merchant-ship, from the knight-heads to the belfry. It is stuck full of wooden pins, which are used to fasten the running-rigging as occasion requires. See *WINDLASS*.

CROSSPURPOSE, *n. s.* From cross and purpose. A kind of riddle; a contradictory system.

I see an eye of comfort in her case, and will take all proper measures to extricate her out of this unhappy game of *crosspurposes*.

Taylor.

To allow benefit of clergy, and to restrain the press, seems to have something of *crosspurpose* in it.

Shaftesbury.

CROSSPOST, *n. s.* From cross and post. A post across the country, by the cross roads.

Mr. Allen rose to great consideration by farming the *crossposts*.

Warburton.

CROSSQUESTION, *v. a.* To cross-examine; to embarrass by questions.

CROSSREA'DINGS, *n. s.* From cross and reading. Ludicrous sentences produced by reading across the newspaper, instead of from top to bottom.

Then strew all around it (you can do no less),
Crossreadings, ship news, and mistakes of the press.

Goldsmith.

CROSSROAD, *n. s.* From cross and road. A road across the country; a road connecting the main roads.

Be the plain track from henceforth mine,
Crossroads to Allen I resign.

Churchill.

CROSSROW, *n. s.* From cross and row. Alphabet; so named because a cross is placed at the beginning, to show that the end of learning is piety.

He hearkens after prophecies and dreams,
And from the *crossrow* plucks the letter G;
And says a wizard told him, that by G
His issue disinherited should be.

Shakespeare. Richard III.

CROSS-STAFF, *n. s.* From cross and staff. An instrument commonly called the fore-staff, used by seamen to take the meridian altitude of the sun or stars.

CROSSWAY, *n. s.* From cross and way. A small obscure path intersecting the chief road.

Neither shouldst thou have stood in the *crossway*.
Obadiah v. 14.

Damned spirits all,
That in *crossways* and floods have burial,
Already to their wormy beds are gone.

Shakespeare.

CROSSWIND, *n. s.* From cross and wind. Wind blowing from the right or left.

When lo
A violent *crosswind* from either coast
Blows them transverse ten thousand leagues away
Into the devious air.

Milton.

The least unhappy persons do, in so fickle and so tempestuous a sea as this world, meet with many more either *crosswinds* or stormy gusts than prosperous gales.

Boyle.

CROSSWORT, *n. s.* From cross and wort. A plant.

It hath soft leaves, like the ladies bedstraw, from which it differs in the number of leaves that are produced at every joint; which in this are only four, disposed in form of a cross.

Müller.

CROTALARIA, rattle-wort, in botany, a genus of the decandria order, and diadelphia class of plants; natural order thirty-second, papilionaceæ. The legume is turgid, inflated, and pedicellate; the filaments are coiled with a fissure on the back. There are eleven species, all natives of warm climates. They rise from eighteen inches to five feet in height, and are adorned with flowers of a blue or yellow color. The most remarkable species is the *C. retusa*, with simple oblong wedged leaves. It is a native of the island of Ceylon, and some other parts of the East Indies. The flowers are yellow, the pods smooth, cylindrical, inflated, and placed horizontally: they are filled with seeds, which when dried, and shaken by the slightest wind, emit a rattling noise: and this, by the rude inhabitants of the countries where the plant is a native, is attributed to the devil, who is thought to deliver his oracles in this whimsical manner.

CROTALO, an instrument in modern military music, resembling the ancient crotalum. The Turks were the first, among the moderns, who introduced the use of it for their troops. It has only one tone; but its effect in marking time may be distinctly heard through the noise of forty drums. It is the same with the ancient cymbalum.

CROTALUM, an ancient kind of musical instrument, found on medals, in the hands of the priests of Cybele. It differed from the sistrum, though authors frequently confound the two. It consisted of two little brass plates or rods, which were shaken in the hand, and in striking against each other made a noise. It was sometimes also made of a reed split lengthwise, one part whereof they struck against the other; and, as this made a noise somewhat like that of a crane's bill, they called that bird *crotalystris*, a player on the crotala: and Aristophanes calls a great talker a crotalum. Clemens Alexandrinus attributes the invention to the Sicilians; and forbids the use of it to the Christians, because of the indecent motions and gestures that accompany it.

CROTALUS, the rattle-snake, in zoology, a genus belonging to the order of amphibia serpentes; the characters of which are these: the belly is furnished with scuta, and the tail has both scuta and scales; but the principal characteristic of this genus is the rattles at the end of the tail. These rattles consist of several articulated, crustaceous, or rather horny bags, which make a considerable rattling noise when the creature moves, and serve to warn people of its approach. There are five species, and the bite of all of them is so highly poisonous, that it generally kills in a short time. Of these, the chief is *C. horridus*, the American rattle-snake. It grows sometimes to the length of eight feet, and weighs between eight and nine pounds. The color of the head is brown, and the eye red; the upper part of the body of a yellowish-brown color, transversely marked with irregular broad black lists. The rattle is of a brown color, composed of several horny, membranaceous cells, of an undulated pyramidal figure. These are articulated within one another in such a manner that the point of the first cell reaches as far as the basis of the protuberant ring of the third, and so on; which articulation, being very loose, gives liberty to the parts of the cells that are enclosed within the outward ring, to strike against the sides of them, and so to cause the rattling noise which is heard when the snake shakes its tail. This is the most inactive and slow moving of all the snakes, and is never the aggressor except in what it preys upon. Catesby is of opinion that no remedy is yet discovered for the bite of this animal. He had frequently access to see Indians bitten by it, and always thought that those who recovered were cured more through the force of nature, or by reason of the slightness of the bite, than by the remedies used. He says, the Indians know their destiny the moment they are bit; and if the bite happens to be on any of the large veins, they apply no remedies, knowing them to be entirely useless.

CROTCH, *n. s.*

CROTCHET, *v. n. & n. s.*

Fr. *croc, crotchet.*
A crotch is a hook
CROTCHETED, *part. adj.* } or fork. Crotch
signifies, one of the notes in music; a support or prop; [hooks in which words are included]; an instrument used in midwifery; a conceit; a whim; an odd fancy. To crotch is to play in a measured time of music; crotchetted is, marked by musical notation.

Save elme, ash, and crab tree for cart and for plough,
Save step for a style of the *croch* and the bough.

Tusser.

There is a tradition of a dilemma that Moreton used to raise the benevolence to higher rates; and some called it his fork and some his *croch*.

Bacon's Henry VII.

As a good harper stricken far in years,
Into whose cunning hands the gout doth fall,
All his old *crochets* in his brain he bears,
But on his harp plays ill or not at all. *Davies.*

All the devices and *croches* of new inventions,
which crept into her, tended either to twitch or enlarge the ivy. *Howel.*

The horse smelt him out, and presently a *crochet* came in his head how he might countermine him.

L'Estrange.

A stately temple shoots within the skies,
The *crochets* of their cot in columns rises. *Dryden.*

The third on four concordant lines
Prints the lone *crochet*, and the quaver joins;
Marks the gay trill, the solemn pause inscribes,
And parts with bars the undulating tribes. *Darwin.*

CROTO, or **CROTON**, in ancient geography, a city of the Brutii, in Italy, built by the Acheans; 150 stadia to the north of Lacinium, and in the neighbourhood of Metapontum. It was twelve miles in compass before the arrival of Pyrrhus in Italy; but, after the desolation produced by the war, scarcely half of it was inhabited. The citadel, on one side, hung over the sea, on the other towards the land. It was naturally strong from its situation, but afterwards walled round. It was taken by Dionysius, however, by stratagem, by means of the rocks behind it. Pythagoras, after his long peregrinations in search of knowledge, fixed his residence in this place, which some authors think his native one, or at least that of his parents. Of all the colonies sent out from Greece, this alone furnished succour to the mother-country when invaded by the Persians. By its avenging arms the Sybarites were punished for their shameful degeneracy; but victory proved fatal to the conquerors, for riches, and all their pernicious consequences, soon contaminated the purity of the Crotonites. Long after the Locrians, who were less corrupted, defeated them on the banks of the Sagra, and reduced the republic to distress and penury. This restored the remaining Crotonites to their pristine vigor of mind, and enabled them to make a brave, though unsuccessful resistance, when attacked by Dionysius of Syracuse. They suffered much in the war with Pyrrhus; and, by repeated misfortunes, decreased in strength and numbers, from age to age, down to that of Hannibal, when they could not muster 20,000 inhabitants. This small population being incapable of manning the extensive works erected in the days of its prosperity, Croton was taken by the Carthaginians, and its citizens transported to Locri. The Romans sent a colony hither 200 years before Christ. In the Gothic war, this city was conspicuous for its fidelity to Justinian, and Totila besieged it long in vain.

CROTON, in modern geography, a river of Connecticut, which rises in New Fairfield, and, running through Dutchess county, falls into

Tappan Bay. A bridge is thrown over the river three miles from its mouth, on the great road to Albany. It is a solid substantial bridge, 1400 feet long, piercing through a slate hill, and supported by sixteen stone pillars. Here is an admirable view of Croton Falls, where the water precipitates itself between sixty and seventy feet perpendicular, with high slate banks, in some places 100 feet, and the river spreading into three streams, as it enters the Hudson.

CROTON, in botany, wild ricinus, a genus of the monadelphia order and monœcia class of plants; natural order thirty-eighth, tricoceæ. Male, CAL. cylindrical and quinque-angled; COR. pentapetalous; the stamina from ten to fifteen. Female, CAL. polyphyllous; three bifid styles: CAPS. trilocular; one seed. There are twenty-one species, of which the most remarkable are, 1. *C. aromaticum*, with heart-shaped serrated leaves, and an arborescent stem. The bark of the tree is the same as the cascarilla and eluteria, though these have been considered by some as distinct barks, and sold in the shops as different productions. It is a hot, acrid, aromatic bitter, resembling in appearance the Peruvian bark, but more bitter and pungent, though not so rough and astringent. It was first introduced into Europe about the end of the seventeenth century. 2. *C. sebifera*, the tallow-tree, with rhomboidal egg-shaped leaves, pointed, smooth, and very entire. The Chinese make their candles of it, which would, doubtless, be as good as those in Europe, if they knew how to purify their vegetable tallow, as we do our animal kind, and to make their wicks as well. 3. *C. tinctorium*, the plant from which the French turnsole is made. See **TURNSOLE**. It grows naturally in the south of France; is an annual plant, rising about nine inches, with an herbaceous branching stalk, garnished with irregular or rhomboidal figured leaves, near two inches long and one and a quarter broad in their widest part. These stand upon slender foot-stalks near four inches long. The flowers are produced in short spikes from the sides of the stalks, at the end of the branches; the upper part is composed of male flowers, having many stamina, which coalesce at the bottom; the lower part has female flowers, which have each a roundish three-cornered germen. This afterwards becomes a roundish capsule, with three lobes, having three cells, each including one roundish seed. It flowers in July; but, unless the plants are brought forward on a hot-bed, they do not ripen seeds in this country.

CROTONA, an ancient city of Naples, in the province of Calabria Ultra, originally built by the Greeks. It is seated upon the mouth of the Essaro, at its influx into the gulf of Tarento, on the coast of the Ionian Sea, fifty miles east of Cosenza, and fifteen south-east of St. Severina.

CROTOPHAGA, in ornithology, a genus of birds belonging to the order of picæ; the characters of which are, the bill is thin, compressed, greatly arched, half oval, and cultrated at top; the nostrils are round; the tongue flat, and pointed at the end; the tail consists of ten feathers; and the toes are placed two and two.

The most remarkable species are, 1. *C. ani*, about the size of a blackbird; the color of the whole bird is black, in some parts glossed with purple, and about the neck faintly tinged with green on the margins; the base of the bill is furnished with black bristles, which turn forwards; the eye-lids have long hairs like eye-lashes; the tail is six inches long, and much cuneated; and the legs are black. This species is found in Jamaica, St. Domingo, and other islands in the West Indies; also, at Cayenne, and other parts of South America. Contrary to all other birds, they have the singularity of many laying in the same nest; to make which, they all unite in concert, and, after laying their eggs, sit on them close to each other in order to hatch them, each unanimously striving to do the best for the general good; and when the young are hatched, the parents, without reserve, do the best to feed the whole flock. It generally has two broods in a year, except accidents happen; in which case it has been known to make three nests. The eggs are about the size of those of a pigeon, of a sea-green color, spotted at the ends. Their food is various; worms, insects, fruits, and grain, according to the season. 2. *C. ani major*, is about the size of a jay, and is by some reckoned only a variety of the former, differing merely in size.

CROUCH, *v. a. & n. s.* } Fr. *crochu*; Isl. *kreika*; Ger. *kau-*
CROUCHED, *adj.* } *chen*. It is proba-
CROUCHING, *n. s. & adj.* } bly, says the Ency.
CROUCH-BACK, *n. s.* }

Met. by the common change of *k* into *ch*, merely. To crouch signifies to stoop low; to lie with the belly to the ground, as some beasts do; to cringe; to act servilely; anciently, to sign with the cross. Crouch-back is synonymous with crook-back.

Every one that is left in thine house, shall come and crouch to him for a piece of silver and a morsel of bread. *1 Sam. ii. 26.*

I crouche thee from elves and from rightes,
 Therwith the nightpel said he anon rightes
 On foure helves of the hous aboute
 And on the threswold of the dore withoute.

Chaucer. Cant. Tales.

I cannot crouche nor knele to such a wronge,
 To worship them like God on earth alone,
 That are as wolves these sely lambes among. *Wyatt.*

Kissing his hondes and crouching to the ground.
 For other language had he none nor speech.

Spenser. Faerie Queene.

At his heels,
 Leasht in like hounds, should famine, sword, and fire,
 Crouch for employment. *Shakespeare. Henry V.*

The crouching client, with low bended knee,
 And manie worships and faire flatterie,
 Tells on his tale as smoothly as him list,
 But still the lawyer's eye squints on his fist. *Hall.*

They fawn and crouch to men of parts, whom they
 cannot ruin; quote them when they are present; and,
 when they are absent, steal their jests. *Dryden.*

Too well the vigour of that arm they know;
 They lick the dust, and crouch beneath their fatal foe. *Id.*

When lo! the self-same lion from his cage
 Flies to devour him, famished into rage.
 He flies, but viewing in his purposed prey
 The man, his healer, pauses on his way,

And, softened by remembrance nto sweet
 And kind composure, crouches at his feet. *Cowper.*

He knew himself a villain—but he deemed
 The rest no better than the thing he seemed,
 And scorned the best as hypocrites who hid
 Those deeds the bolder spirits plainly did.
 He knew himself detested, but he knew
 The hearts that loathed him, crouched and dreaded
 toc. *Byron. Corsair.*

CROUP, *n. s.* Fr. *croupe*. The rump of a
 fowl; the buttocks of a horse. See CRUPPER.

The carter thakketh his hors upon the croupe.
Chaucer. Cant. Tales.

Away thou heedless boy! prepare the spear:
 Now is thy time, to perish, or display
 The skill that yet may check his mad career.
 With well-timed croup the nimble coursers veer;
 On foams the bull, but not unscotched he goes;
 Streams from his flank the crimson torrent clear.

Byron. Child Harold

CROUPA'DES, *n. s.* From croup. Higher
 leaps than those of corvets, that keep the fore
 and hind quarters of the horse in an equal height,
 so that he trusses his legs under his belly with-
 out yerking.

CROUSAZ (John Peter de), a learned philo-
 sopher and mathematician, born in 1663. Hav-
 ing made great progress in the mathematics and
 the philosophy of Des Cartes, he travelled to
 Geneva, Holland, and France; was successively
 professor in several universities, and at length
 was chosen governor to prince Frederick, of
 Heise Cassel, nephew to the king of Sweden.
 He wrote many works; the most esteemed of
 which are, 1. his Logic, in six vols. 8vo. in
 1741. 2. A Treatise on Beauty. 3. A Treatise
 on the Education of Children, two vols. 12mo.
 4. Several Treatises on Philosophical and Ma-
 thematical Subjects, &c. He died at Lausanne
 in 1748.

CROUTE, **SOUR CROUTE**, or **KROUTE**,
 saur kraut, German, i. e. sour herb; a preparation
 of cabbage, which has been found of sovereign
 efficacy as a preservative from the sea-scurvy in
 long voyages. The process for making it is as
 follows: the soundest and most solid cabbages
 are selected, and cut very small, commonly with
 an instrument made for this purpose, resembling
 the plain for slicing cucumbers. A knife is
 used when the preparation is made with great
 nicety. The cabbage, thus minced, is put into
 a barrel, in layers, hand high, and over each is
 strewed a handful of salt and carraway-seeds; in
 this manner it is rammed down with a rammer
 stratum super stratum, till the barrel be full,
 when a cover is put over it, and pressed down
 with a heavy weight. After standing some time
 in this state it begins to ferment, and it is not
 till the fermentation has entirely subsided, that
 the head is fitted to it, and the barrel is finally
 shut up and preserved for use. There is not a
 drop of vinegar employed in this preparation.

CROW, *v. n. & n. s.* } Goth. *krukjan*; Ger.
CROWING, *n. s.* } *kraechen*; Ang.-Saxon,
CROWS-FEET, *n. s.* } *crawan*; for the verb.
CROW-KEEPER, *n. s.* } For the noun, Per.
kro; Swed. *kraka*; Ang.-Sax. *crawe*; Latin,
corvus; *kopaξ*. To crow is, to make the noise
 which a cock makes for the purpose of express-

ing pleasure or defiance; to vaunt; to bluster; to swagger; to express triumph over. Crow is, a large black bird, that feeds on carcases. See *CORVUS*; the voice of the cock; a bar of iron with a beak, used as a lever. To pluck a crow with, is a trivial expression, which means, to have a dispute with; to reprimand for some offence. It is generally used with reference to trifling subjects. Crows'-feet are, the wrinkles which old age produces under the eyes. A crow-keeper is, a scare-crow.

When that the firste cock hath *crowe*, a non
Up rist this jolly lover Absolon.

Chaucer. Cant. Tales.

Wel sikerer was his *crowing* in his loge,
Than is a clok or any abbey orloge. *Id.*

As blake he lay as any cole or *crow*,
So was the blood yronnen in his face. *Id.*

So longe mote ye liven, and all proude,
Till *crowis-feete* growin under your eie.

Id. Troilus and Greeseide.

I am not he, such eloquence to boast,
To make the *crow* in singing, as the swanne.

Wyatt

And now the *crowing* cocke, and now the owle,
Lowd shriking; him afflicted to the very sowle.

Spenser. Faerie Queene.

That fellow handles his bow like a *crowkeeper*.

Shakspeare.

But even then the morning cock *crow* loud.

Id. Hamlet.

The *crow*s and choughs, that wing the midway air,
Show scarce so gross as beetles. *Id. King Lear.*

Diogenes called an ill physician, cock. Why?
saith he. Diogenes answered, Because when you
crow, men use to rise. *Bacon.*

Resolve, before we go

That you and I must *pull a crow*. *Hudibras.*

If you dispute, we must even *pluck a crow* about it.
L'Estrange.

To *crow*s he like imperial grace affords,
And choughs and daws, and such republick birds.

Dryden.

Within this homestead lived, without a peer
For *crowing* loud, the noble Chanticleer,
So high her cock. *Id. Fables.*

The *crow* is used as a lever to lift up the ends of
great heavy timber, and then they thrust the claws
between the ground and the timber; and laying some
stuff behind the *crow*, they draw the other end of the
shank backwards, and so raise the timber.

Moxon's Mechanical Exercises.

Selly is *crowing*, and, though always defeated by
his wife, still *crowing* on. *Richardson.*

How lonely every freeborn creature broods!

The sweetest song-birds nestle in a pair;

The eagle soars alone; the gull and *crow*

Flock o'er the carrion, just as mortals do.

Byron. Don Juan.

CROWD, *v. a. & n. s.* } Welsh *cruth. A*
CROWDER, *n. s.* } fiddle; a fiddler.

Hark how the minstrels 'gin to shrill aloud
Their merry musick that resounds from far,
The pipe, the tabor, and the trembling *crowd*,
That well agree withouten breach or jar.

Spenser's Epith.

Chevy-chase sung by a blind *crowder*. *Sidney.*
Fidlers, *crowd* on, *crowd* on; let no man lay a
block in your way *Massinger.*

His fiddle is your proper purchase,
Won in the service of the churches;
And by your doom must be allowed
To be, or be no more, a *crowd*. *Hudibras.*

CROWD, *v. a., v. n., & n. s.* } Ang.-Sax. *cruth*;
CROWDING, *n. s.* } Dutch *kruyden*.

To thrust in confusedly; to press into an incon-
venient space; to incumber by multitudes; to
throng together without order; to thrust among
a multitude. To crowd sail, is to hoist as much
sail as possible; to hurry on. A crowd is, a
promiscuous multitude, or medley of any thing;
the vulgar; the populace.

A rude disordered rout he did espay
Of men and women, that most spitefully
Did one another throng, and *crowd* so sore,
That his kind eye in pity wept therefore. *Dexter.*

Thus Love persuades, and all the *crowd* of men
That stands around doth make a murmuring. *Id.*

The time misordered, doth in common sense
Crowd us and crush us to this monstrous form,
To hold our safety up. *Shakspeare. Henry IV.*

A mighty man, had not some cunning sin
Amidst so many virtues *crowded* in.

Cowley's Davideis.

They follow their undaunted king;
Crowd through their gates; and, in the fields of light,
The shocking squadrons meet in mortal fight.

Dryden's Virg.

He went not with the *crowd* to see a shrine,
But fed us by the way with food divine. *Id. Fables.*
How short is life! Why will vain courtiers toil.
And *crowd* a vainer monarch for a smile? *Graville.*

He could then compare the confusion of a multi-
tude to that confusion he had observed in the Icarian
sea, dashing and breaking among its *crowd* of isles:
Pope.

A mind which is ever *crowding* its memory with
things which it learns, may cramp the invention itself.
Warton.

Trees produced without culture, here straggling
or single, and there *crowding* into little groves and
bowers. *Boswell.*

'Tis morning; and the sun, with ruddy orb
Ascending, fires the horizon; while the clouds,
That *crowd* away before the driving wind,
More ardent as the disk emerges more,
Resemble most some city in a blaze,
Seen through the leafless wood. *Comyn.*

Imperious man, who rules the bestial *crowd*,
Of language, reason, and reflection proud,
With brow erect who scorns this earthly sod,
And styles himself the image of his God. *Darwin.*

Amidst the barren sand and rocks so rude
She and her wave-worn love had made their bow.

Where nought upon their passion could intrude.
And all the stars that *crowded* the blue space,
Saw nothing happier than her glowing face.

Byron. Don Juan.

A *crowd* of shivering slaves of every nation,
And age, and sex, were in the market ranged. *Id.*

CROWFLOWER, *n. s.* From *crow* and
flower. A species of campion.

Fantastick garlands did she make
Of *crow-flowers*, nettles, daisies, and long purple.
Shakspeare. Hamlet.

CROWFOOT, *n. s.* From *crow* and foot; in
Lat. *ranunculus* A flower; the butter-flower,
or butter-cup.

CROWFOOT, n. s. From crow and foot. A caltrop, or piece of iron with four points, two, three, or four inches long; so that whatever way it falls, one point is up. It is used in war for incommoding the cavalry.

CROWFOOT. See **RANUNCULUS**.

CROWFOOT, on ship-board, a complication of small cords spreading out from a long block, like the smaller parts which extend from the back-bone of a herring. It is used to suspend the awnings; or to keep the top-sails from striking violently, and fretting against the tops.

CROWLAND, a small town of Lincolnshire, seated in the fens, and having formerly a market of some note. It consists of four streets, separated from each other by water-courses, and connected by a curious bridge, formed of three segments of a circle, meeting in a point at the top, but so steep that only foot-passengers can pass over; horses and carriages go underneath. On the south-west wing, which faces the London road, is an image of king Ethelbald, in a sitting posture, having a crown feury on the head, and a globe in the right hand. Its chief trade is in fish and wild ducks, which are in great plenty in the adjacent marshes.

The history of this place is involved in that of its far-famed abbey. It appears, from a charter of Ethelbald, that the lands belonging to the abbey comprehended 'the whole island of Croyland, formed by the four waters of Shepshoe on the east, Nene on the west, Southee on the south, and Asendyk on the north; in length four leagues, in breadth three, with the marshes adjoining on both sides the Weland; part of which, to the north, called Goggisland, is two leagues long from Croyland bridge to Aspath, and one league broad from the Weland south to Apenhall, and another part of the marsh south of the Weland, two leagues long, from Croyland bridge to South Lake; and two leagues broad from the Weland to Fynset, with fishery in the waters of Nene and Weland.' This charter is dated A. D. 716, and witnessed by Brithwald, archbishop of Canterbury; Winfred, archbishop of the Mercians; Iugwald, bishop of London; Aldwin, bishop of Litchfield; Tobias, bishop of Rochester; Ethelred, abbot of Bardney; Egbert, abbot of Medeshamsted; Egga, earl of Lincoln; Lurie, earl of Leicester, &c. &c. The monarch further gave towards the building of the monastery £300 in silver, and £100 a-year for ten years to come; he also authorised the monks to build, or enclose, a town for their own use, with a right of common for themselves and their servants.

The monastery was dedicated to the honor of St. Mary, St. Bartholomew, and St. Guthlac, who, 'by divine guidance, came in a boat to one of those solitary desert islands, called Crulande; on St. Bartholomew's day; and in an hollow, on the side of an heap of turf, built himself a hut in the days of Conrad, king of Mercia, when the Britons gave their inveterate enemies, the Saxons, all the trouble they could.' (Gough's History and Antiquities of Croyland). In the year 870 the Danes burned the monastery, and murdered the religious; it was, however, re-founded in the year 948 by king Edred,

VOL. VI.

out was afterwards destroyed by fire in the year 1091. It was rebuilt in the year 1112 by liberal contributions, and burnt and rebuilt again between the years 1142 and 1170. About the year 1720 the roof of the abbey-church fell in, and was found to consist of Irish oak, finely carved and gilt; pieces of which are to be found in almost every house in Crowland. The venerable remains of this once celebrated abbey are extremely magnificent, and consist chiefly of a portion of the conventual church, which is highly interesting to the architect and antiquary. The choir, central tower, transepts, and the whole of the east end are down; what portions are found standing, are the skeletons of the nave, with parts of the south and north aisles; the latter of which is covered over, pewed, and fitted up as [the parish-church. This edifice was made a garrison during the civil wars. Over the west gate are images of several kings and abbots; and among the rest of St. Guthlac, with a whip and knife, his usual symbols, and St. Bartholomew, with a knife.

Crowland is seven miles from Spalding, twelve N. N. E. of Peterborough, and ninety-three north by west of London.

CROWN, n. s. & v. a. } Goth. *krona* ;
CROWNER, n. s. } Dut. *kroone* ; Fr.
CROWN-GLASS, n. s. } *couronne* ; Lat. *co-*
CROWN-LESS, adj. } *rona*. 'Anciently
CROWN-PORT, n. s. } written *chorona*,
CROWN-SEAL, n. s. } says Selden, 'and
CROWN-THISTLE, n. s. } made Latin from
CROWN-WHEEL, n. s. } *χρονωστος*, which they
CROWN-WORKS, n. s. } civile (derive) from
χρονος or *χρονωσται*. i. e. the dancers or singers, and number of the solemnising sacrificers; and perhaps this from כְּרֹנָר, Hebrew, to dance around or in circles. The primitive idea seems to have been that of something surrounding the head. 'The antientest mention of a royal crown,' continues the above learned writer, 'is in the holy story, in that of the Amalekites bringing Saul's crown to David.' It was in the East more commonly a fillet circling the head, he adds. A diadem, the type of imperial, regal, or papal dignity; the authority of a king: as a verb, to invest with a diadem, or with such dignity; also the top or upper part of the head, or of a mountain; the upper part of the hat; a piece of money bearing royal ensignia; and, metaphorically, honor, reward, dignity in general; to confer honor or dignity; to complete, perfect, or praise. Crownet is the same with CORONET, which see. Crowner is a perfection, the old word for coroner, and still in use among the vulgar; and is also used by Shakspeare for the chief end or purpose; see the extract. The compounds denote severally; something large, superior, or excellent of their kind..

Now they do it to obtain a corruptible crown, but we an incorruptible. 1 Cor. ix. 25.

A seyn Stevenes day a non þe croune vorst he here. *Robert of Gloucester.*

Thou has maad him a litle lesse than aungelis, thou hast crowned him with glorie and onour, and thou hast ordeyned hym on the workis of thin hondis.

Wiclif. Ebrewis 2.

2 X

And *crowmed* were as kyngis,
With *crowis* wrought full of losynges.
Chaucer. The House of Fame.
O pale is whilom *crowne* of housis al!

Id. Troilus and Creseide.

Witnesse the guttleas blood pourd off on ground,
The *crowned* often slain, the slayer *crowmed*.
Spenser. Faerie Queene.

And like a Persian mitre on her hed
Shee wore, with *crownes* and *ouches* garnished. *Id.*

The wyfe came yet,
And with her fete,
She holpe to kepe him downe,
And with her rocke
Many a knocke
She gave him on the *crowne*.

Sir T. More.

The kings of England before his (Edward I.) time,
used to wear their *crowns* upon all solemne feast dayes :
he first omitted that custome, saying merrily that
crowns do rather ornerate than honour princes.

Camden's Remains.

If thou be a king where is thy *crowne* ?
—My *crowne* is in my heart, not in my head .
My *crowne* is called content :

A *crowne* it is that seldom kings enjoy. *Shakespeare.*

Upon my head they placed a fruitless *crowne*,
And put a barren sceptre in my gripe,
Thence to be wrenched with an unlineal hand,
No sort of mine succeeding. *Id. Macbeth.*

For within the hollow *crowne*,
That rounds the mortal temples of a king,
Keeps death his court ; and there the antick sits,
Scoffing his state, and grinning at his pomp.

Id. Richard II.

I'll have this *crowne* of mine cut from my shoulders,
Before I'll see the *crowne* so foul misplaced.

Id. Richard III.

Upon the *crowne* o' th' cliff, what thing was that
Which parted from you ?

Id. King Lear.

In his livery
Walked *crowns* and *crownets* ; realms and islands were
As plates dropped from his pocket.

Id. Antony and Cleopatra.

Oh, this false soul of Egypt ! this gay charm !
Whose eye becked forth my wars, and called them
home ;

Whose bosom was my *crownet*, my chief end ;
Like a right gipsy hath, at fast and loose,
Beguiled me to the very heart of loss. *Shakespeare.*

She shall be, to the happiness of England,
An aged princess ; many days shall see her,
And yet no day without a deed to *crowne* it. *Id.*

Trust not to your servants who may misinform you,
by which perhaps they may gain a few *crowns*.

Bacon.

He left behind him the reputation of a very fine
gentleman, and a most accomplished courtier ; and
after having spent in a very jovial life above four
hundred thousand pounds, which, upon a strict com-
putation, he received from the *crowns*, he left not a
house, nor acre of land, to be remembered by.

Clarendon.

The lasting and *crowning* privilege, or rather pro-
perty, of friendship, is constancy. *South.*

But he that can eat beef, and feed on bread which
is so brown,

May satisfy his appetite, and owe no man a *crowne*.

Suckling.

Black he stood as night ;
Fierce as ten furies ; terrible as hell ;
And shook a deadly dart. What seemed his head
The likeness of a kingly *crowne* had on. *Milton.*

An ounce of silver, whether in pence, groats, or
crowns pieces, stivers, or ducatoons, or in bullion, is,
and eternally will be, of equal value to another ounce
of silver. *Locke.*

Let merit *crowns*, and justice laurels give,
But let me happy by your pity live. *Dryden's Ep.*

All these a milk-white honeycomb surround,
Which in the midst the country banquet *crowned*.
Dryden.

While his head was working upon this thought, the
toy took him in the *crowne* to send for the songster.

L'Estrange.

Behold ! if fortune or a mistress frowns,
Some plunge in business, others shave their *crowns*.

Pope.

I once opened a remarkable atheroma ; it was about
as big as the *crowns* of a man's hat, and lay underneath
the pectoral muscle. *Sharp's Surgery.*

To conclude, my lords, if ministers thus persevere
in misadvising the king, I will not say that they can
alienate the affections of his subjects from the *crowns*,
but I affirm they will make the *crowns* not worth his
wearing. *Lord Chatham.*

They consider themselves as emancipated from
obedience, and as being no longer the subjects of the
British *crowns*. They leave us no choice but of yield-
ing or conquering, of resigning our dominion, or main-
taining it by force. *Johanson.*

King was a name too proud for man to wear
With modesty and meekness ; and the *crowns*,
So dazzling in their eyes who set it on,
Was sure to intoxicate the brows it bound. *Cowper.*

The castled crag of Drachenfels
Frowns o'er the wide and winding Rhine,
Whose breast of waters broadly swells
Between the banks which bear the vine,
And hills all rich with blossomed trees,
And fields which promise corn and wine,
And scattered cities *crowning* these. *Byron.*

The Niobe of nations ! there she (Rome) stands
Childless and *crownsless*, in her voiceless woe ;
An empty urn, within her withered hands,
Whose holy dust was scattered long ago.

Id. Child's Herald.

CROWN is also used to signify the possessions
and dignity of a king. The crown of England,
according to Sir William Blackstone, is, by
common law, and constitutional custom, heredi-
tary, and this in a manner peculiar to itself ;
but the right of inheritance may, from time to
time, be changed or limited by act of parlia-
ment, under which limitations the crown still
continues hereditary. See **SUCCESSOR**.

CROWN OFFICE, an office belonging to the
court of king's bench, of which the king's cor-
ner, or attorney, is commonly master. In this
office, the attorney-general and clerk of the
crown severally exhibit informations for crimes
and misdemeanors at common law, as in the
case of batteries, conspiracies, libelling, &c., on
which the offender is liable to pay a fine to the
king.

CROWN, PLEAS OF THE. See **ARRAIGNMENT**,
and **PLEA**.

CROWN, in commerce, is a general name for
coins, both foreign and domestic, of or near the
value of five shillings sterling. In its limited
sense, crown is only applicable to the British
coin of that name, which is worth 5s., and equi-
valent to six livres French money ; but, in its

extensive sense, it takes in several others; as the French ecu, which we call the French crown, struck in 1641, for sixty sols, or three livres; also, the patagon, dollar, ducatoon, rix-dollar, and piece of eight.

CROWN, in an ecclesiastical sense, is used for the clerical tonsure, the mark of the Romish ecclesiastics. This is a little circle of hair shaved off from the crown of the head, more or less broad, according to the quality of the orders received. That of a mere clerk is the smallest; that of priests and monks the largest. The clerical crown was anciently a round list of hair shaved off around the head, representing a real crown; this is easily observable in several ancient statues, &c. The religious of St. Dominic and St. Francis still retain it.

CROWNS, ANCIENT. The first crowns were no more than a bandelet drawn round the head, and tied behind, as we still see it represented on medals round the heads of Jupiter, the Ptolemies, and the kings of Syria. See our article **CORONATION**. Afterwards they consisted of two bandelets; by degrees they took branches of trees of divers kinds; at length they added flowers; inasmuch that, Claudius Saturninus says, there was not any plant whereof crowns had not been made. The Roman emperors had four kinds of crowns, still seen on medals, viz. a crown of laurel, a radial or radiating crown, a crown adorned with pearls and precious stones, and the fourth a kind of bonnet, or cap, something like the mortar. The Romans had also various kinds of crowns, which they distributed as rewards of merit, which were considered as marks of nobility to the wearers; and, upon competitions with rivals for rank and dignities, often determined the preference in their favor.

CROWNS, MODERN. See **HERALDRY**.

CROWNE (John), a celebrated dramatic writer, born in Nova Scotia, where his father was a minister. Impatient of the restraint under which he had been educated, he came to England, where he was reduced to enter into the service of an old lady. He then had recourse to his pen, which quickly procured him favor at court; but this kind of subsistence proving precarious, he ventured to solicit Charles II. for some establishment. Charles promised to provide for him; insisted, however, first on having another comedy; and suggested to him the plan of a Spanish play, from which Crowne produced the comedy of Sir Courtly Nice; but the sudden death of the king, on the last day of the rehearsal, disappointed his hopes. He died about 1703, and left seventeen tragedies and comedies, a romance called Pandion and Amphigeria, and a burlesque poem, 'Dæneids, partly imitated from Boileau's Lutrin. His merit lay chiefly in his comedies. Dryden was jealous of him, and used to compliment him when any of his pieces failed.

CROW-NET, an invention for catching wild fowl in winter, which may be used in the day-time. It is made of a fine pack-thread; the meshes should be two inches wide, the length about ten yards, and the depth three; it must be verged on the side with good strong cord, and stretched out very stiff on long poles prepared for that pur-

pose. At the proper place, open it, and lay it out at its full length and breadth; then fasten the lower end of it all along the ground, so as only to move it up and down; the upper end of the net must stand extended on the long cord; the further end thereof being staked first to the earth by a strong cord about five yards from the net. Place this cord in an even line with the lower edge of the net. The other end must be at least twenty-five yards distant to reach into some natural or artificial shelter, where one may lie concealed from the fowl, otherwise no success can be expected. The net must be placed in such exact order that it may give way to play on the fowl on the least pull of the cord, which must be done smartly lest the fowl should escape. This net may be used for pigeons, crows, or other birds, on corn-fields newly sown; also in stubble-fields provided the stubble conceal the net from the birds.

CROWNING, in architecture, is understood, in the general, of any thing that terminates or finishes a member or decoration. Thus, a cornice, a pediment, &c. are called crownings: the abacus is said to crown the capital; and any moulding is said to be crowned when it has a fillet over it; and a niche is crowned when it is covered with a capital.

CROWNING, in sea-language, denotes the finishing part of a knot made at the end of a rope. It is performed by interweaving the ends of the different stands artfully amongst each other, so as they may not become loosened or untwisted. They are useful in all kind of stoppers.

CROWN-POINT, a township of New York, in Clinton county, so called from the celebrated fortress in it, which was garrisoned by British troops, from the time of its reduction by general Amherst in 1759, till the late revolution. It was taken by the Americans on the 14th of May, 1775, and retaken by the British the year after. The point upon which it was erected by the French, in 1731, extends north into lake Champlain.

CROWTH, or **CRUTH**, a kind of musical instrument anciently in use among the common people of Wales.

CROWTOE, *n. s.* From crow and toe. A plant.

Bring the rathe primrose that forsaken dies,

The tufted crow-toe, and pale jessamine. *Milton.*

CROXALL (Samuel), an ingenious English divine, born at Walton-upon-Thames, in Surry, and educated at St. John's College, Cambridge. While at the University he wrote *The Fair Circassian*, a licentious imitation of Solomon's Song. On entering into orders he obtained the living of Hampton in Middlesex, with several preferments in Hereford Cathedral; and afterwards the united parishes of St. Mary Somerset, and St. Mary Mounthaw, in London; both which he held till his death in 1751. He was chaplain in ordinary to king George II. He published *Scripture Politics*, and various poems and translations, with an entire English edition of Esop's Fables. He was a zealous whig.

CROYDEN, a township of New Hampshire, in Cheshire county, adjoining Cornish, and about eighteen miles north-east of Charlestown. It was incorporated in 1763.

CRUYDON, a town of England, in Surry, near the head of the river Wandle. It is surrounded with hills, and was formerly a seat of the archbishop of Canterbury. It has a large handsome church, an hospital, and a free school. The trade of this town is considerably increased by means of a canal which communicates with the Grand Surry, previously to its falling into the Thames, and, by an iron rail-way, from Wandsworth to Croydon, thence extending forward to Mersham, near Reigate. The archbishop's palace was sold by act of parliament, in 1780, and has since been converted into a cotton manufactory: market day Saturday.

CRYLSTONE, *n. s.* Crystallised cauk or spar, found in Derbyshire. In this, says Woodward, the crystals are small.

CRUCIAL, *adj.* Lat. *crux, crucis*. Transverse; intersecting one another.

Whoever has seen the practice of the *crucial* incision, must be sensible of the false reasoning used in its favour. *Sharp's Surgery.*

CRUCIANELLA, petty madder, a genus of the monogynia order, and tetrandria class of plants; natural order forty-seventh, stellate. cor. monopetalous, and funnel-shaped, with the tube filiform and the limb unguiculated, or having an inflexed segment on the top of each segment; cal. diphylous, and there are two linear seeds. There are five species, natives of the southern part of Europe.

CRUCIATE, *v. a.* } Lat. *crucio*. To tor-
CRUCIATION, *n. s.* } ture; to torment; to
 excruciate. See EXCRUCIATION.

— Thinking—Why God would suffer his children and servants so vehemently to be cruciated.

Fox's Martyrs.

No man can be so insensate, to think there can be more dreadfulness in the place of those infernal tortures, than there is pleasure and joy in the height of that sphere of blessedness; since we know we have to do with a God, that delights more in the prosperity of his saints, than in the cruciation and howling of his enemies. *Bishop Hall.*

CRUCIBLE, *n. s.* Lat. *crucibulum*; Ital. *crocola*. A chemist's melting pot, made of earth; said to be so called, because they were formerly marked with a cross to preserve the operations of the chemist from the interference of infernal spirits.

Take a quantity of good silver, and put it in a crucible or melting cypse, and set them on the fire, well covered about with coals. *Peacham.*

Wit, like every other power, has its boundaries. Its success depends on the aptitude of others to receive impressions; and that as some bodies, indissoluble by heat, can set the furnace and crucible at defiance, there are minds upon which the rays of fancy may be pointed without effect, and which no fire of sentiment can agitate, or exalt. *Johnson.*

These calces therefore, when mixed with the enamel flux, are melted in crucibles, once or oftener, and the deep coloured opaque glass thence resulting is ground into impalpable powder, and used for enamel. *Darwin.*

CRUCIFY, *v. a.*

CRUCIFIX, *n. s.*

CRUCIFIXION, *n. s.*

CRUCIFIER, *n. s.*

CRUCIFEROUS, *adj.*

CRUCIFORM, *adj.*

CRUCIGEROUS, *adj.*

Lat. *crux, crucis*. To put to death by nailing on a Cross, which see. The instrument or cross on which the person crucified generally our Saviour, is represented.

Crucifixion is the punishment so inflicted, and crucifier, he who inflicts it. Cruciferous and crucigerous are explained by exactly the same phrase, 'bearing the cross,' by Dr. Johnson; but he gives no instance of their use. Cruciform is, having the form of a cross. Metaphorically, the verb is used for the infliction of extreme pain of any kind.

Thei crieden and seiden, take awei, take awei, crucifie him. Pila. seith to hem, schal I crucifie ghoure kyng? the bisshopis answeriden, we han no kyng but the emperour, and thanne Pilat bitook him to hem that he schulde be crucified. And thei token Iesus and ledden him out and he bar to himself a cross, and wente out into that place that is seid caluarie in ebrew golgatha, where thei crucifieden him. *Wiclif, Jon 19.*

They crucify to themselves the Son of God afresh, and put him to an open shame. *Heb. vi. 6.*

How scourged, how crowned, how buffeted, how bruised,

And, lastly, how twixt robbers crucified.

Spenser. Hymn of Heavenly Love.

The misbelieving Christian, therefore, crucifies Christ again. Each of his willing sins is a plain despite to his Redeemer. *Bishop Hall.*

He that prayed for his first crucifiers curseth his second: they crucified him in his weakness; these in his glory, fetched him from the garden to the cross; these pull him out of heaven. *Id.*

I believe that Jesus Christ was crucified, dead and buried, rose again the third day from the dead, and ascended into heaven. *Locke.*

But to the cross he nails thy enemies, The law that is against thee, and the sins Of all mankind, with him there crucified. *Milton.*

Visible judgments were executed on Christ's crucifiers. *Hammond.*

There stands at the upper end of it a large crucifix, very much esteemed. The figure of our Saviour represents him in his last agonies of death. *Addison on Italy.*

This earthquake, according to the opinion of many learned men, happened at our Saviour's crucifixion. *Id.*

The sight of Christ in glory, with his saints, will, in an inexpressible manner, torment the crucifiers of the one, and the persecutors of the others. *Bishop Horne, Psa. cxii. 10.*

Some were disguised in the skins of wild beasts, and worried to death by dogs. Some were crucified, and others wrapped in pitched shirts and set on fire when the day closed, that they might serve as lights to illuminate the night. *Paley's Evidences.*

He died as born, a Catholic in faith, Like most in the belief in which they're bred, And first a little crucifix he kissed, And then held out his jugular and wrist. *Byron. Don Juan.*

CRUCITA, in botany, a genus of the digynia order, tetrandria class of plants. Interior cal. tetraphyllous; exterior cal. triphyllous; corolla none; only one seed.

CRUDE, *adj.*
CRU'DELY, *adv.*
CRU'DENESS, *n.s.*
CRU'DITY, *n.s.*
CRU'DY, *adj.*

Lat. *crudus*; Gr. κρως;
 from κρως cold. Raw;
 harsh; unripe; uncon-
 cocted; immature.

A juice so *crude* as cannot be ripened to the degree of nourishment. *Bacon.*

While the body, to be converted and altered, is too strong for the efficient that should convert or alter it, whereby it holdeth fast the first form or consistence, it is *crude* and inconcoct; and the process is to be called *crudity* and inconcoction. *Id.*

Sherris sack ascends into the brain; dries me there all the foolish, dull, and *crudy* vapours which environ it. *Shakespeare.*

They are very temperate, whereby they prevent indigestion and *crudities*, and consequently putrescence of humours. *Brounne.*

Others, whom mere ambition fires, and dole Of provinces abroad, which they have feigned To their *crude* hopes, and I as amply promised. *Ben Jonson.*

In a moment up they turned Wide the celestial soil; and saw beneath The' originals of nature, in their *crude* Conception: sulphurous and nitrous foam They found, they mingled, and with subtle art, Concocted and adusted. *Milton's Paradise Lost.*

Deep versed in books, and shallow in himself, *Crude*, or intoxicate, collecting toys. *Id.*

Absurd expressions, *crude* abortive thoughts, All the lewd legions of exploded faults. *Roscommon.*

Common *crude* salt, barely dissolved in common aqua fortis, will give it power of working upon gold. *Boyle.*

Fermented liquors have quite different qualities from the point itself; for no fruit, taken *crude*, has the intoxicating quality of wine. *Arbutnot.*

A diet of viscid aliment creates flatulency and *crudities* in the stomach. *Id.*

The' advice was true; but fear had seized the most, And all good counsel is on cowards lost: The question *crudely* put, to shun delay, 'Twas carried by the major part to stay. *Dryden.*

Wisdom and power in God are absolutely necessary, because God himself is absolutely necessary: but we cannot *crudely* say, the curing in men their aversion to the true religion, is absolutely necessary. *Locke.*

Where *cruder* juices swell the leafy vein, Stint the young germ, the tender blossom stain; On each lopped shoot a foster scion bind, Pith pressed to pith, and rind applied to rind. *Darwin.*

Bowles—if some new-born whim, or larger bribe Prompt thy *crude* brain, and claim thee for a scribe, If chance some bard, though once by dunces feared, Now prone in dust, can only be revered, If Pope, whose fame and genius from the first Have foiled the best of critics, needs the worst, Do thou essay; each fault and failing scan; The first of poets was, alas! but man! *Byron. English Bards.*

CRUDEN (Alexander), M. A. principally known as author of a Concordance to the Holy Scriptures, was the son of Mr. William Cruden, merchant, and one of the magistrates of Aberdeen. He was born in 1701, and educated at the grammar school of that city. He studied divinity at Marischal College; but betraying symptoms of insanity, through disappointment in a love affair,

he was confined for some time after in a house for the reception of lunatics, at Aberdeen. He was afterwards a private tutor, and a corrector of the press in London, where his Concordance was first published in 1737, dedicated to queen Caroline. The details of his life in the metropolis embrace only a mournful exhibition of great mental weakness, united with much that was amiable and instructive. He was more than once confined, we believe; called himself Alexander the Corrector, and published *Adventures and Admonitions to the public* under that title; and died at Islington, Nov. 1770, possessed of some little property.

CRUDLE, *v. s.* } From **CURD**, which see.
CRU'DY, *adj.* } To coagulate, congeal, or make into curd. Congealed; concreted; coagulated.

His cruel wounds with *crudy* blood congealed, They binden up so wisely as they may. *Spenser.*

I felt my *crudled* blood Congeal with fear; my hair with horror stood. *Dryden. Virgil.*

The Gelons use it, when, for drink and food, They mix their *crudled* milk with horses' blood. *Id.*

CRUEL, *adj.* } Fr. *cruel*; Ital. *crudelis*;
CRU'ELLY, *adv.* } Lat. *crudelis*, from *crudens*.
CRU'ELNESS, *n.s.* } See **CRUDE**. Savage; barbarous; fierce; hard-hearted; inhuman.

Consider mine enemies; for they are many, And they hate me with *cruel* hatred. *Psalms xxv. 19.*

When he endured hed a yere or two This *cruel* torment, and this peine and wo, At Thebes, in his contree, as I said. *Chaucer. Cant. Tales.*

The *cruelties* of thee, Quene Medea, Thy litel children banging by the hals For thy Jason, that was of love so fals. *Id.*

Ones have the wyndes the trees dyspoled clene, And once agayne beginnes their *cruelness*, Synce I have hyd under my breast the harme That never shall recover healthfulnessene. *Survey.*

Use then my death, see shall your *crueltys* Spite of your spyte, rid me from all my smart. *Wyatt.*

But she more *cruel*, and more savage wild, Than either lion or the lioness, Shames not to be with guiltless blood defiled, She taketh glory in her *cruelness*. *Spenser.*

Wretched man! wretched tree! whose nature weake A *cruell* witch, her cursed will to wreake, Hath thus transformed, and plast in open plaines. *Id. Faerie Queene.*

The Scottish arrows, being sharp and slender, enter into a man or horse most *cruelly*, notwithstanding they are shot forth weakly. *Id. On Ireland.*

We beheld one of the *cruellest* fights between two knights, that ever had adorned the most martial story. *Sidney.*

REG. Wherefore to Dover?
GLO. Because I would not see thy *cruel* nails Pluck out his poor old eyes, nor thy fierce sisters In his anointed flesh stick boorish fangs. *Shakespeare. King Lear.*

The *cruelty* and envy of the people, Permitted by our dastard nobles, Have suffered me by the voice of slaves to be Whooped out of Rome. *Shakespeare.*

Who can express the savage *cruelty* of the enemies of the gospel? Look into the ancient story of the infancy of Christianity, ye shall see how men set their wits on the rack to devise torments. *Bishop Hall.*

Now hath the spider caught a wandering flye,
And drags her captive at her *cruell* thigh. *Id. Sat.*

He relies upon a broken reed, that not only basely fails, but also *cruelly* pierces, the hand that rests upon it. *South.*

If thou art that *gruel* god, whose eyes
Delight in blood, and human sacrifice. *Dryden.*

There were great changes in the world by the revolutions of empire, the *cruelties* of conquering, and the calamities of enslaved nations. *Temple.*

Jefferies, who wanted in *cruelty*, had already given a specimen of his character in many trials where he presided; and he now set out with a squalid joy, as to a full harvest of death and destruction. *Hume.*

Illusions vain! Can sacred Peace reside
Where sordid gold the breast alarms,
Where *cruelty* inflames the eye of Pride,
And Grandeur wantons in soft Pleasure's arms? *Beattie.*

I am a bending aged tree,
That long has stood the wind and rain;
But now has come a *cruel* blast,
And my last hold of earth is gane. *Burns.*

Why did they not then die?—they had lived too long
Should an hour come to bid them breathe apart;
Years could but bring them *cruel* things or wrong. *Byron. Don Juan.*

CRUENTATE, *adj.* Lat. *cruentatus*. Smeared with blood.

Atomical aporrhæas pass from the *cruentate* cloth or weapon to the wound. *Glanville.*

CRU'ET, *n. s.* Dutch *kruicke*; perhaps from Lat. *grus*. A crane or heron, from both the bird and the vessel having a long neck; a vial for vinegar or oil.

Within thy reach I set the vinegar;
And filled the *cruet* with the acid tide,
While pepper-water worms thy bait supplied. *Swift.*

CRUIKSHANK (William), F.R.S. an eminent surgeon and anatomist, was born at Edinburgh, and completed his medical education at Glasgow in 1771, when he became librarian to the celebrated Dr. William Hunter. He afterwards became also his assistant in his anatomical lectures. On the death of Dr. Hunter he associated himself as a lecturer with the late Dr. Baillie, and published, in 1786, *The Anatomy of the Absorbent Vessels of the Human Body*, 4to, of which an improved edition appeared in 1790. He was also the author of *Experiments on the Insensible Perspiration of the Human Body*, 1795, 8vo; and several scientific essays and papers in the *Transactions of the Royal Society*. He died in 1800.

CRUISE, *v. n.* Dutch *kruicke*; Teut. *krus*; Fr. *cruche*; Lat. *grus*. Derived as above. A small vessel or pitcher.

I have not a cake, but an handful of meal in a barrel, and a little oil in a *crucise*. *I Kings.*

Now shalt thou never see the salt beset
With a big-bellied gallon flagonet
Of an ebbe *crucise* must thirsty Silen sip,
That's all forestalled by his upper lip. *Ep. Hall's Sat.*

The train prepare a *crucise* of curious mould,
A *crucise* of fragrance, formed of br. nished gold
Pope's Odyssey

CRUISE, *v. n. & n. s.* } Fr. *crucisè*. Either
CRUI'SER, *n. s.* } from the croisaders, the
CRUI'SING, *adj.* } Christian pirates of the

twelfth century, or more directly from Lat. *crus*, *crucis*, as Skinner says, from their sailing up and down, or cross-ways, in quest of an enemy. To pass backward and forward, by sea; to rove; to sail in search of an enemy.

Amongst the *cruisers* it was complained, that their surgeons were too active in amputating fractured members. *Wiseman.*

Thy thoughts are vagabonds; all outward-bound
Mid sands, and rocks, and storms, to *cruise* for pleasure;
If gained, dear bought; and better missed than gained. *Young. The Complaint.*

Cruisers are small men of war, made use of to-and-fro in the Channel, and elsewhere, to secure our merchant-ships and vessels from the enemy's small frigates and privateers. They are generally such as sail well, and are commonly well manned. *Chambers.*

Thus she came often, not a moment losing,
Whilst her piratical papa was *cruising*. *Byron. Don Juan.*

Thus having settled his marine affairs,
Dispatching single *cruisers* here and there,
His vessel having need of some repairs,
He shaped his course to where his daughter fair,
Continued still her hospitable cares. *Id.*

CRUM, or
CRUMB, *v. n. & n. s.* } Goth. *krome*; Anz-
CRUMBLE, *v. a.* } Sax. *cruma*. A small part of a loaf or portion of bread; that which readily breaks off; the soft part of a loaf, as distinguished from the crust; a small portion of any thing.

It is not good to take the breed of children and gyve to houndis. An sche answerde and seyde to him, this lord, for litil whelpis eten undir the berd of the *crummys* of children. *Wiclif. Mark. v.*

Think on the woman Cananee, that saide
That whelpes eten som of the *crumes* alle
That from hir lordes table ben yfalle. *Chaucer. Cant. Tale.*

Take of manchet about three ounces, the *crumb* only thin cut; and let it be boiled in milk till it grow to a pulp. *Bacon.*

Flesh is but the glass which holds the dust
That measures all our time, which also shall
Be *crumbled* into dust. *Herbert.*

There is so hot a summer in my brain,
That all my bowels *crumble* up to dust. *Shakespeare. King John.*

He with his bare wand can unthread thy joints,
And *crumble* all thy sinews. *Milton.*

By frequent parcelling and subdividing of inheritances, in process of time they became so divided and *crumbled*, that there were few persons of able estates. *Hale's Law of England.*

At the same time we were *crumbled* into various factions and parties, all aiming at by-interests, without any sincere regard for the public good. *Attorney.*

The bill leaves three hundred pounds a year to the mother church; which they can divide likewise, and *crumble* as low as their will and pleasure will dispose of them. *Swift.*

If the stone is brittle, it will often *crumble*, and pass in the form of gravel. *Arbuthnot on Dist.*

Not is the profit small the peasant makes,
Who smooths with harrow, or who pounds with rakes,
The *crumbling* clods. *Dryden's Georgicks.*

Ambition sighed: she found it vain to trust
The faithless column, and the *crumbling* bust. *Pope.*

More familiar grown, the table *crums*
Attract his slender feet. *Thomson's Winter.*

On these principles he chooses to suppose (for he does not pretend more than to suppose) a naked possibility, that he shall draw some resource out of *crumbs* dropped from the trenchers of penury; that something shall be laid in store from the short allowance of revenue officers, overloaded with duty, and famished for want of bread. *Burke.*

Daily near my table steal,
While I pick my scanty meal;
Doubt not little tho' there be,
But I'll cast a *crumb* to thee. *Langhorne.*

The storied pyramid, the laurelled bust,
The trophied arch, had *crumbled* into dust. *Darwin.*

How numerous, at the tables there,
The sparrows beg their daily fare.
For there, in every nook and cell,
Where such a family may dwell,
Sure as the vernal season comes,
Their nests they weave in hope of *crumbs*. *Cowper.*

CRUMENAL, *n. s.* Lat. *crumena*; from Gr. κρημνω. To hang down as a purse, which was anciently borne at the girdle. A purse.

The fat ox, that woonat lye in the stall,
Is now fast stalled in her *crumenal*. *Spenser's Pastoral.*

CRUMP, *adj.* } Anglo-Saxon *crump*;
CRUMPLE, *v. a.* } Goth. *krome*; Dut. *rom-*
CRUMPLING, *n. s.* } *pelen*. Crooked; bent, or driven into folds; to make crooked; to wrinkle, or rumple. Crumpling is an apple of a rumpled appearance.

When the workmen took measure of him, he was *crump*-shouldered, and the right side higher than the left. *L' Estrange.*

Sir Roger alighted from his horse, and exposing his palm to two or three that stood by him, they *crumpled* it into all shapes, and diligently scanned every wrinkle that could be made. *Addison.*

On inspecting the locomotion of about thirty acres of earth with a small house, near Bilder's Bridge in Shropshire, about twenty years ago, from the foot of a mountain towards the river, I well remember it bore all the marks of having been thus lifted up, pushed away, and as it were *crumpled* into ridges, by a column of water contained in the mountain. *Darwin.*

CRUOR, sometimes signifies the blood in general; sometimes only the venous blood; and sometimes extravasated or coagulated blood; but is most frequently used for the red globules of the blood, in contradistinction to the limpid or serous part.

CRUPPER, *n. s.* Fr. *croupier*, probably from κρωπρω, to conceal. The leather of a saddle, which fastens it to the croup of a horse.

A male twifold on his *crupper* lay,
It seemed that he carried litel array. *Chaucer. Cant. Tales.*

But Guyon selfe, ere well he was aware,
Nigh a speare's length behind his *crupper* fell. *Spenser. Faerie Queene.*

Clitophon had received such a blow, that he had lost the reins of his horse, with his head well nigh touching the *crupper* of the horse. *Sidney.*

Where have you left the money that I gave you?
—Oh—sixpence that I had a Wednesday last,
To pay the saddler for my mistress' *crupper*. *Shakespeare.*

Full oft the rivals met, and neither spared
His utmost force, and each forgot to ward:
The head of this was to the saddle bent,
The other backward to the *crupper* sent. *Dryden.*

That with fishes and loaves loads his *crupper*
While sectaries squint at the bait,
And get nothing but kicks for their supper. *Huddesford.*

CRURÆUS, or **CRUREUS MUSCULUS**, in anatomy, a fleshy mass, covering almost all the fore-side of the os femoris, between the two vasti, which likewise cover the edges of this muscle on each side. See **ANATOMY**.

CRURAL, *adj.* Lat. *crus*, *cruris*, the thigh. Belonging to the leg.

The sharpness of the teeth, and the strength of the *crural* muscles, in lions and tygers, are the cause of the great and habitual immorality of those animals. *Arbuthnot.*

CRUSADE, *n. s.* } See **CRUISADE**. An
CRUSA'DO, *n. s.* } expedition against the in-
fidels; a coin stamped with a cross.

Believe me, I had rather have lost my purse
Full of *crusadoes*. *Shakespeare. Othello.*

CRUSADES, or **CRUISADES**, in modern ecclesiastical history, may be applied to any war undertaken on pretence of defending the cause of religion; but it has been chiefly used to designate certain expeditions of the powers of Europe against the infidels for the conquest of Palestine. These expeditions commenced A. D. 1096. The foundation of them was a superstitious veneration for those places where our Saviour performed his miracles, and accomplished the work of man's redemption. Jerusalem had been taken, and Palestine conquered, by Omar. See **KHALIFS**. This proved a considerable interruption to the pilgrims, who flocked from all quarters to perform their devotions at the holy sepulchre. They had however still been allowed this liberty, on paying a small tribute to the Saracen caliphs, who were not much inclined to molest them. But in 1065 this city changed its masters. The Turks took it from the Saracens; and being much more fierce and barbarous, the pilgrims now found they could no longer perform their devotions with the same safety. An opinion was at this time also prevalent in Europe, which made these pilgrimages much more frequent than formally. It was imagined that the 1000 years, mentioned in Rev. xx., were fulfilled; that Christ was soon to make his appearance in Palestine, to judge the world; and consequently that journeys to that country were in the highest degree meritorious, and even absolutely necessary. The multitude of pilgrims who now flocked to Palestine, meeting with a very rough reception from the Turks, filled all Europe with complaints against those infidels, who profaned the holy city, and derided the sacred mysteries of Christianity. even in the place where they were fulfilledf Pope Gregory VII. had formed a design o

uniting all the princes of Christendom against the Mahomedans; but his exorbitant encroachments upon the civil power of princes had created him so many enemies, and rendered his schemes so suspicious, that he was not able to make great progress in his undertaking. The work was reserved for a meaner instrument. Peter, commonly called the hermit, a native of Amiens, in Picardy, had made the pilgrimage to Jerusalem; and being deeply affected with the dangers, to which that act of piety now exposed the pilgrims, as well as with the oppression under which the eastern Christians now labored, formed the bold, and in all appearance impracticable, design of leading into Asia, from the farthest extremities of the West, armies sufficient to subdue those potent and warlike nations that now held the holy land in slavery. He proposed his scheme to pope Martin II., who, prudently resolving not to interpose his authority till he saw a probability of success, summoned, at Placentia, a council of 4000 ecclesiastics and 30,000 seculars. As no hall could be found large enough to contain such a multitude, the assembly was held in a plain. Here the pope himself, as well as Peter, harangued them, representing the dismal situation of their brethren in the east, and the indignity offered to the Christian name in allowing the holy city to remain in the hands of the infidels. These speeches were so agreeable to those who heard them, that the whole multitude suddenly and violently declared for the war, and solemnly devoted themselves to perform a service which they believed to be meritorious in the sight of God. But, though Italy seemed to have embraced the design with ardor, Martin thought it necessary, in order to ensure perfect success, to engage the greater and more warlike nations in the same enterprise. Having therefore despatched Peter to the chief cities and sovereigns of Christendom, he summoned another council at Clermont in Auvergne. The fame of this great and pious design, being now universally diffused, procured the attendance of the greatest prelates, nobles, and princes; and when the pope and the hermit renewed their pathetic exhortations, the whole assembly, as if impelled by immediate inspiration, exclaimed with one voice, 'it is the will of God!' These words were deemed so much the effect of a divine impulse, that they were employed as the signal of rendezvous and battle in all future exploits of these adventurers. Men of all ranks now flew to arms with the utmost ardor, and a cross was affixed to their right shoulder by all who enlisted in this holy enterprise. At this time Europe was sunk in the most profound ignorance and superstition. The ecclesiastics had gained the greatest ascendancy over the human mind; and persons who committed the most horrid crimes and disorders, knew of no other expiation than the observances imposed on them by their spiritual pastors. But amidst the abject superstition which now prevailed, the military spirit had also universally diffused itself; and, though not supported by art or discipline, was become the general passion of the nations governed by the feudal law. All the great lords possessed the rights of peace and war. They were engaged in continual hostilities with one

another; the open country was become a scene of outrage and disorder: the cities, still mean and poor, were neither guarded by walls nor protected by privileges. Every man was obliged to depend for safety on his own prowess or private alliances; and valor was the only excellence which was held in esteem, or gave one man the pre-eminence above another. When, therefore, all the particular superstitions were here united in one great object, the ardor for private hostilities took the same direction; 'and all Europe,' as the princess Anna Comnena expresses it, 'torn from its foundations, seemed ready to precipitate itself in one united body upon Asia.'

I. The nobles were moved, by the romantic spirit of the age, to hope for opulent establishments in the east, the chief seat of arts and commerce at that time. In pursuit of these chimerical projects, they sold at low prices their ancient castles and inheritances, which had now lost all value in their eyes. The infirm and aged contributed to the expedition by presents and money; and many of them attended it in person, being determined, if possible, to breathe their last in sight of that city where their Saviour died for them. Even women, concealing their sex under the disguise of armour, attended the camp. The greatest criminals were forward in a service which they considered as an expiation for all crimes; and the most enormous disorders were, during the course of these expeditions, committed by men inured to wickedness, encouraged by example, and impelled by necessity. The adventurers were at last so numerous, that their sagacious leaders became apprehensive lest the greatness of the armament should be the cause of its own disappointment. For this reason they permitted an undisciplined multitude, computed at 300,000 men, to go before them under the command of Peter the hermit, and Gautier or Walter, surnamed the Moneyless from his being a soldier of fortune. These took the road towards Constantinople through Hungary and Bulgaria; and trusting that heaven, by supernatural assistance, would supply all their necessities, they made no provision for subsistence in their march. They now, therefore, soon found themselves obliged to obtain by plunder what they vainly expected from miracles; and the enraged inhabitants of the countries through which they passed, attacked and slaughtered them without resistance. The more disciplined armies followed after; and, passing the straits of Constantinople, were mustered in the plains of Asia, and amounted in the whole to 700,000 men. The princes engaged in this first crusade were, Hugo, count of Vermandois, brother to Philip I. king of France; Robert, duke of Normandy; Robert, earl of Flanders; Raimond, earl of Toulouse and St. Giles; the celebrated Godfrey of Bouillon, duke of Lorraine, with his brothers Baldwin and Eustace; Stephen, earl of Chartres and Blois; Hugo, count of St. Paul's; with many other lords. The general rendezvous was at Constantinople. In this expedition, Godfrey besieged and took the city of Nice. Jerusalem was taken by the confederated army, and Godfrey chosen king. The Christians gained the famous battle of Ascalon against the sultan of Egypt, which put an end to

the first crusade; but not to the spirit of crusading. The rage continued for nearly two centuries.

II. The second crusade, in 1144, was headed by the emperor Conrad III., and Louis VII. king of France. The forces of the emperor were either destroyed by the enemy, or perished through the treachery of Mamiel, the Greek emperor; and the second army, through the unfaithfulness of the Christians of Syria, was forced to break up the siege of Damascus.

III. The third crusade, in 1188, immediately followed the taking of Jerusalem by Saladin the sultan of Egypt. The princes engaged in this expedition were, the emperor Frederick Barbarossa; Frederick, duke of Suabia, his second son; Leopold, duke of Austria; Berthold duke of Moravia; Herman, marquis of Baden; the counts of Nassau, Thuringia, Missen, and Holland; and above sixty other princes of the empire; with the bishops of Besançon, Cambrai, Munster, Osnaburg, Missen, Passau, Visburg, and several others. In this expedition the emperor Frederick defeated the sultan of Iconium: his son Frederick, joined by Guy Lusignan king of Jerusalem, in vain endeavoured to take Acre or Ptolemais. During these transactions, Philip Augustus king of France, and Richard I. king of England, joined the crusade; by which means the Christian army consisted of 300,000 fighting men; but, great disputes happening between the kings of France and England, the former quitted the holy land, and Richard concluded a peace with Saladin.

IV. The fourth crusade was undertaken, in 1195, by the emperor Henry VI. after Saladin's death. In this expedition the Christians gained several battles against the infidels, took a great many towns, and were in prospect of great success, when the death of the emperor obliged them to quit the holy land, and return into Germany.

V. The fifth crusade was published by pope Innocent III. in 1198. Those engaged in it made fruitless efforts for the recovery of the holy land; for though John de Neule, who commanded the fleet equipped at Flanders, arrived at Ptolemais a little after Simon of Montfort, Renard of Dampierre, and others; yet the plague destroying many of them, and the rest either returning or engaging in the petty quarrels of the Christian princes, there was nothing done; so that the sultan of Aleppo easily defeated their troops in 1204.

VI. The sixth crusade began in 1228; in which the Christians took the town of Damietta, but were forced to surrender it again. In 1229 the emperor Frederick made peace with the sultan for ten years. About 1240 Richard earl of Cornwall, brother to Henry III. king of England, arrived in Palestine at the head of the English crusade; but finding it most advantageous to conclude a peace he re-embarked, and steered towards Italy. In 1244 the Karasians, being driven out of Persia by the Tartars, broke into Palestine, and gave the Christians a general defeat near Gaza.

VII. The seventh crusade was headed, in 1249, by St. Lewis, who took the town of Damietta;

but, a sickness happening in the Christian army, the king endeavoured a retreat; in which, being pursued by the infidels, most of his army were miserably butchered, and himself and his nobility taken prisoners. A truce was agreed upon for ten years, and the king and lords set at liberty.

VIII. The eighth crusade, in 1270, was headed by the same prince, who made himself master of the port and castle of Carthage in Africa; but, dying a short time after, he left his army in a very ill condition. The king of Sicily coming up with a good fleet, and joining Philip the Bold, son and successor of Lewis king of Tunis, after several engagements with the Christians, in which he was always worsted, desired peace, which was granted upon conditions advantageous to the Christians; after which both princes embarked for their own kingdoms. Prince Edward of England, who arrived at Tunis at the time of this treaty, sailed towards Ptolemais, where he landed a small body of 300 English and French, and hindered Bendochar from laying siege to Ptolemais; but being obliged to return, to take possession of the crown of England, this crusade ended without contributing any thing to the recovery of the holy land. In 1291 the town of Acre, or Ptolemais, was taken and plundered by the sultan of Egypt, and the Christians quite driven out of Syria.

This, happily for the honor of the Christian name, was the last of the crusades, although various attempts were made by the popes to revive them, particularly by Nicholas IV. in 1291, and Clement V. in 1311. Voltaire computes the people who perished in the different expeditions at upwards of 2,000,000. Many there were, however, that returned; and these, having conversed so long with more civilized and magnificent races of people, began to entertain some taste for a refined mode of life. Thus the barbarism, in which Europe had been so long immersed, began soon after to wear off. The princes, also, who remained at home, found means to avail themselves of the frenzy of the people. By the absence of such numbers of restless adventurers, peace was established in their dominions. They also took the opportunity of annexing to their crowns many considerable fiefs, either by purchase or the extinction of the heirs; and thus the mischiefs which must always attend feudal governments were considerably lessened. Mr. Gibbon, in tracing the consequences and effects of the crusades, considers that the intercourse between Constantinople and Italy diffused the knowledge of the Latin tongue; and that several of the fathers and classics were thus at length honored with a Greek version. If we compare, he says, at the era of the crusades, the Latins of Europe with the Greeks and Arabians, their respective degrees of knowledge, industry, and art, our rude ancestors must be content with the third rank in the scale of nations. Their successive improvement and present superiority may be ascribed to a peculiar energy of character, to an active and imitative spirit, unknown to their more polished rivals, who, at that time, were in a stationary or retrograde state. With such a disposition, the Latins might have derived essen-

tial benefits from events which opened to them a long and frequent intercourse with the more cultivated regions of the east. Their first and most obvious progress was in trade and manufactures, in the arts, which are strongly prompted by the thirst of wealth, the calls of necessity, and the gratification of the sense of vanity. But the intellectual wants of the Latins were more slowly felt and supplied; and, in the age of the crusades, they viewed with careless indifference the literature of the Greeks and Arabians; nor did they derive any substantial advantage from it. The principle of the crusades was a savage fanaticism; and the most important effects were analogous to the cause. Each pilgrim was ambitious to return with his sacred spoils, the relics of Greece and Palestine; and each relic was preceded and followed by a train of miracles and visions. The active spirit of the Latins preyed on the vitals of their reason and religion, and if the ninth and tenth centuries were the times of darkness, the thirteenth and fourteenth were the ages of absurdity and folly. The embers of the arts of antiquity, as Mr. Gibbon conceives, were rekindled by the northern conquerors of the Roman empire; and after a long interval, from the reign of Charlemagne forward, the tide of civilisation began to flow, about the eleventh century, with a steady and accelerated course. During the two centuries of the crusades its increase was great, and its progress rapid; and some philosophers, as we have already stated, have applauded the propitious influence of these holy wars; but Mr. Gibbon thinks that they checked rather than forwarded the maturity of Europe. The lives and labors of millions, who were buried in the east, would have been more profitably employed in the improvement of their native country; the accumulated stock of industry and wealth would have overflowed in navigation and trade; and the Latins would have been enriched and enlightened by a free and friendly correspondence with the climates of the east. In one respect he perceives the accidental operation of the crusades, not so much in producing a benefit as in removing an evil. 'The larger portion of the inhabitants of Europe was chained to the soil, without freedom, or property, or knowledge; and the two orders of ecclesiastics and nobles, whose numbers were comparatively small, alone deserved the name of citizens and men. This oppressive system was supported by the acts of the clergy and the swords of the barons. The authority of the priests operated, in the darker ages, as a salutary antidote:—they prevented the total extinction of letters, mitigated the fierceness of the times, sheltered the poor and defenceless, and preserved or revived the peace and order of civil society. But the independence, rapine, and discord, of the feudal lords were unmixed with any semblance of good; and every hope of industry and improvement was crushed by the iron weight of the martial aristocracy. Among the causes that undermined that Gothic edifice, a conspicuous place must be allowed to the crusades. The estates of the barons were dissipated, and their race was often extinguished, in these costly and perilous expeditions. Their poverty extorted from their pride those charters of

freedom which unlocked the fetters of the slave, secured the farm of the peasant and the shop of the artificer, and gradually restored a substance and a soul to the most numerous and useful part of the community. The conflagration which destroyed the tall and barren trees of the forest gave air and scope to the vegetation of the smaller and nutritive parts of the soil.' See *Gibbon's History of the Roman Empire*, vol. ii.; *Robertson's History*, chap. 5. vol. i.; *Historical Disquisitions concerning India*, p. 131, &c.; *Smith's Wealth of Nations*, vol. i. chap. 3; *Mosheim's Ecclesiastical History*, vols. ii. and iii.; and *Hume's History*, vols. i. and ii.

The late lamented Mr. Mill is the last and not least interesting writer on this fruitful topic. He clothes a narrative full of romantic adventure and anecdote in a correct, clear, and energetic style. We cannot forbear extracting some of his closing reflections.

'A view of the heroic ages of Christianity, in regard to their grand and general results, is a useful and important, though a melancholy, employment. The crusades retarded the march of civilisation; thickened the clouds of ignorance and superstition; and encouraged intolerance, cruelty, and fierceness. Religion lost its mildness and charity; and war its mitigating qualities of honor and courtesy. Such were the bitter fruits of the holy wars! Painful is a retrospect of the consequences; but interesting are the historical details of the heroic and fanatical achievements of our ancestors. The perfect singularity of the object, the different characters of the preachers and leaders of the crusades, the martial array of the ancient power and majesty of Europe, the political and civil history of the Latin States in Syria, the military annals of the orders of St. John and the Temple, fix the regard of those who view the history of human passions with the eyes of a philosopher or a statesman. We can follow with sympathy both the deluded fanatic and the noble adventurer in arms, in their wanderings and marches through foreign regions, braving the most frightful dangers, patient in toil, invincible in military spirit. So visionary was the object, so apparently remote from selfish relations, that their fanaticism wears a character of generous virtue. The picture, however, becomes darkened, and nature recoils with horror from their cruelties, and with shame from their habitual folly and senselessness. Comparing the object with the cost, the gain proposed with the certain peril, we call the attempt the extremest idea of madness, and wonder that the western world should for 200 years pour forth its blood and treasure in chase of a phantom. But the crusades were not a greater reproach to virtue and wisdom, than most of those contests to which in every age of the world pride and ambition have given rise. If what is perpetual be natural, the dreadful supposition might be entertained that war is the moral state of man. The miseries of hostilities almost induce us to think, with the ancient sage, that man is the most wretched of animals. Millions of our race have been sacrificed at the altar of glory and popular praise, as well as at the shrine of superstition. Fanciful claims to foreign thrones, and the vanity of foreign do-

minion, have, like the crusades, contracted the circle of science and civilisation, and turned the benevolent affections into furious passions. But

They err, who count it glorious to subdue
By conquest far and wide, to overrun
Large countries, and in field great battles win,
Great cities by assault; what do these worthies,
But rob and spoil, burn, slaughter, and enslave
Peaceable nations, neighbouring, or remote,
Made captive, yet deserving freedom more
Than those their conquerors, who leave behind
Nothing but ruin wheresoe'er they rove,
And all the flourishing works of peace destroy!

We feel no sorrow at the final doom of the crusades, because in its origin the war was iniquitous and unjust. "THE BLOOD OF MAN SHOULD NEVER BE SHED BUT TO REDEEM THE BLOOD OF MAN. IT IS WELL SEED FOR OUR FAMILY, FOR OUR FRIENDS, FOR OUR GOD, FOR OUR KIND. THE REST IS VANITY, THE REST IS CRIME." vol. ii. pp. 373—376.

CRUSCA, Ital. i. e. bran, the title assumed by a celebrated academy established at Florence, for purifying and perfecting the Tuscan language. The academy took its name from its office and object, which were to refine the language, and, as it were, to separate the bran from it. Accordingly, its device is a sieve; and its motto, *Il piu bel fior ne coglie*; that is, 'It gathers the finest flour.' The vocabulary Della Crusca is an excellent Italian dictionary, composed by this academy.

CRUSH, *v. a. & n. s.* } *Mæso-Goth. krius-*
CRUSHING, *adj.* } *tan; Fr. ecraser.* To
break with violence, and perhaps originally, with a violent noise. To compress with force; to squeeze; drive together; press down; subdue; oppress.

The ass thrust herself unto the wall, and crushed Balaam's foot against the wall. *Numbers* xxii. 25.

They use them to plague their enemies, or to oppress and crush some of their own too stubborn freeholders. *Spenser on Ireland.*

Cold causes rheums and defuxions from the head, and some astringent plasters crush out purulent matter. *Bacon.*

He crushed treasure out of his subjects' purses, by forfeitures upon penal laws. *Id.*

Certainly virtue is like precious odours, most fragrant where they are incensed or crushed: for prosperity doth best discover vice, but adversity doth best discover virtue. *Id.*

Put in their hands thy bruising irons of wrath,
That they may crush down, with a heavy fall,
The usurping helmets of our adversaries!

Shakespeare. Richard III.

You speak him far—

—I don't extend him, Sir: within himself
Crush him together, rather than unfold
His measure fully. *Id. Cymbeline.*

This act

Shall bruise the head of Satan, crush his strength,
Defeating sin and death, his two main arms. *Milton.*

Bacchus, that first from out the purple grape
Crushed the sweet poison of misused wine. *Id.*

When loud winds from diff'rent quarters rush,
Yast clouds encount'ring one another crush. *Waller.*
Vain is the force of man, and heaven's as vain,
To crush the pillars which the pila sustain.

Dryden's Æneid.

I fought and fell like one, but death deceived me;
I wanted weight of feeble Moors upon me,
To crush my soul out. *Id. Don Sebastian.*

Thou shalt flourish in immortal youth,
Unhurt amidst the war of elements,
The wreck of matter, and the crush of worlds. *Addison's Cato.*

Dr. Merish has further observed, that many of the echini are crushed in their form, and yet filled with flint, which has taken the form of the crushed shell. *Darwin.*

No syeophant or slave, that dared oppose
Her sacred cause, but trembled when he rose;
And every vena! stickler for the yoke
Felt himself crushed at the first word he spoke. *Cowper.*

How profound
The gulf! and how the giant element
From rock to rock leaps with delirious bound,
Crushing the cliffs, which downward worn and rent
With his fierce footsteps, yield in chasms a fearful
vent. *Byron.*

Ye race of Frederic! Frederic but in name
And falsehood—heirs to all except his fame;
Who, crushed at Jena, crouched at Berlin, fell
First, and but rose to follow. *Id.*

CRUST, *v. & n.* } *Ital. crosta; Lat. crus-*
CRUSTACEOUS, *adj.* } *ta, from Gr. κρυσταλλος.*
CRUSTATION, *n. s.* } *See CRUSTAL. To con-*
CRUSTILY, *adv.* } *geal; to make hard, or*
CRUSTINESS, *n. s.* } *cover with a coat or*
CRUSTY, *adj.* } *case; the coat or case*
so produced; crustaceous is hard or covered with a spell.

For shepherds (said he) there doen lead
As lords doen elsewhere;
Their sheep han crust, and they the bread;
The chips and they the cheer. *Spenser. Shepherd's Calendar.*

Pretending, that the face of nature may be now quite changed from what it was; and that formerly the whole collection of waters might be an orbicular abyss, arched over with an exterior crust or shell of earth, and that the breaking and fall of this crust might naturally make a deluge. *Bentley.*

The 7th of December I put some very strong French brandy into a China cup, such as they drink coffee out of, and exposed it to the air; in three hours time it was turned into a crusty ice all about the sides of the cup, as if some cold blast had forced it abroad. *Boyle. On Cold.*

I contented myself with a plaster upon the place that was burnt, which crusted and healed in very few days. *Temple.*

Ye are liberal now, but when your turn is sped,
You'll wish me choaked with every crust of bread. *Dryden.*

It is true, that there are some shells, such as those of lobsters, crabs, and others of crustaceous kinds, that are very rarely found at land. *Woodward's Nat. Hist.*

The egg itself deserves our notice: its parts within, and its crusty coat without, are admirably well fitted for the business of incubation. *Derham's Physico-Theology.*

If your master hath many musty, or very foul and crusted bottles, let those be the first you truck at the alehouse. *Swift.*

He was never suffered to go abroad, for fear of catching cold; when he should have been hunting down a buck, he was by his mother's side, learning how to season it, or put it in crust. *Addison's Spectator.*

With thee to smile upon him as he eats his *crust*,
the swain is happier than his monarch, from whose
court thou art exiled. *Sterne.*

All else was hushed as Nature's closed ee ;
The silent moon shone high o'er tower and tree :
The chilly frost, beneath the silver beam,
Crept, gently *crusting*, o'wre the glittering stream.

From cliff to cliff, the liquid treasure falls ;
In beds of stalactite, bright ores among,
O'er corals, shells, and crystals, winds along ;
Crusts the green mosses, and the tangled wood,
And sparkling plunges to his native flood.

I praise you much, ye meek and patient pair,
For ye are worthy ; choosing rather far
A dry but independent *crust*, hard earned,
And eaten with a sigh, than to endure
The rugged frowns and insolent rebuffs
Of knaves in office, partial in the work
Of distribution. *Cowper.*

To this family party I do not wish to belong.
He may invite persons, if he please, to dinner, and, like
lord Peter, say, that this tough *crust* is excellent nut-
ton. He may toss a sceptre to the king of Etruria to
play with, and keep a rod to scourge him in the cor-
ner, &c. *Sheridan.*

CRUST is also applied, by naturalists and chem-
ists, to those bony coverings of which the
whole external surface of crabs, lobsters, and
other sea animals is composed. And, as these
consist of, 1. cartilaginous substance, possessing
the properties of coagulated albumen ; 2. car-
bonate of lime ; 3. phosphate of lime (the pre-
sence of which distinguishes them from bones),
they are considered as an intermediate substance
betwixt bones and shells, partaking of the prop-
erties and constitution of both. The shells of
eggs, though the animal cement is much less in
them, may likewise be considered in this class,
as they contain both carbonate and phosphate of
lime ; and it seems very probable, from the experi-
ments of Bernard and Hatchett, that the shells
of snails are composed of the same ingredients,
as these chemists detected phosphate of lime in
them. The last mentioned gentleman examined
the crust of crabs, lobsters, prawns, and crayfish.
Being immersed in diluted nitric acid, they effere-
vesced a little, and gradually assumed the ap-
pearance of a yellowish-white soft elastic cartilage,
each retaining its respective form. The solution
yielded a precipitate to acetate of lead, and am-
monia threw down phosphate of lime ; carbonate
of ammonia threw down a much more copious
precipitate of carbonate of lime. See CONCHO-
LOGY.

CRUSTACEOUS FISH have their shells usually
softer than those of the testaceous kind, which
consist of a single piece, generally much thicker
and stronger than the former ; such as those of
the oyster, scallop, cockle, &c. Dr. Woodward
observes, in his Natural History, that of all the
shells found in beds of all the different matters
dug out of the earth, there are scarce any of the
crustaceous kind : the reason he gives for it is,
that these being much lighter than the rest, must
have floated on the surface at the time of the de-
luge, when all the strata were formed, and there
have corrupted and perished.

CRUTCH, *n. s.* } Swed. *kruka* ; Teut.
CRUTCH-LIKE, } *krucke* ; Fr. *croce*, in all
probability from *σπαρος*, strength ; and *σπαρην*,
is to lay fast hold. A support or staff of age or
lameness.

My lymes been both hole and sound, me neede't
stilt ne *crutch*,
He cast asyde them both, and lepe oppon an huche.
Chaucer. Cant. Tales.

Ah, thus king Henry throws away his *crutch*,
Before his legs be firm to bear his body.
Shakspeare. Henry VI.

Hence, therefore, thou nice *crutch* ;
A scaly gauntlet now, with joints of steel,
Must glove this hand. *Id. Henry IV.*

On these new *crutches* let them learn to walk.
Dryden's Georgicks.

This fair defect, this helpless aid called wife,
The bending *crutch* of a decrepit life. *Dryden.*

The dumb shall sing, the lame his *crutch* forego,
And leap exulting like the bounding roe.
Pope's Messiah.

The broken soldier, kindly bade to stay,
Sate by his fire and talked the night away ;
Wept o'er his wounds, or, tales of sorrow done,
Shouldered his *crutch* and shewed how fields were
won. *Goldsmith.*

Halting on *crutches* of unequal size,
One leg by truth supported, one by lies ;
They sidle to the goal with awkward pace,
Secure of nothing but to lose the race. *Cowper.*

And Circumstance, that unspiritual god
And miscreator, makes and helps along
Our coming evils with a *crutch-like* rod,
Whose touch turns hope to dust—the dust we all have
trod. *Byron. Child's Harold.*

CRUZ, SANTA, one of the Caribbee Islands, in
the West Indies, about twenty-four miles in
length, and nine in breadth. It enjoys a good
air, but the water is not wholesome, until allowed
to settle in jars. Sugar-canes, oranges, citrons,
and various other fruits flourish here. It was
first discovered by Columbus, and possessed after-
wards by the English and Dutch. The latter
were then driven out by the English, who, in
their turn, were expelled by the Spaniards. At
last the French seized upon the island in 1650,
and sold it the following year to the knights of
Malta, from whom it was again purchased by
the French West India Company. It was finally
sold to the Danes, who held it until the year
1801, when it was taken by the British. The
value of the exports and imports for the years
1809 and 1810 :—

Imports.	Exports.
£435,378	£84,964
422,033	89,949

Long. 64° 35' W., lat. 17° 45' N.

CRUZ, SANTA, 1. A island in the straits of
Magellan, opposite Cape Monday. 2. The name
of a small island on the coast of Brasil. 3. A
small island in the gulf of California, situated
near the coast. 4. An island in the north Paci-
fic Ocean, about twenty miles from the coast of
New Albion, from which it is separated by the
straits of Santa Barbara. It is nearly fifty miles
in circumference.

CRUZ, SANTA, a river of South America, in the
province of Maracaiho, which falls into the great

lake of this name. Also a river of Patagonia, which runs into the Atlantic, in lat. 50° 25' S.

CRUZ, SANTA, DE LA SIERRA, a town and province of Peru, bounded on the north by Moxos, east and south by the territory of the Indians, south-west by the province of Tomina, and west by that of Mizque. It is eighty-four miles in length, and fifty-four in breadth. It is of a moist and hot temperature. Population 16,000.

CRY, *v. a. & n. s.* Fr. and Welsh, *crie*; CRYING, *n. s.* Germ. Span. and Port. CRYER, *n. s.* or CRIER, *n. s.* } *grita*; Gr. *εραυρη*. *Cri* and *gri* seem, in most languages, to signify a call or sharp hailing. The Scottish word *greit* is of similar origin. To utter a loud sound of distress or anxiety; to bewail; to deplore; this seems its primitive acceptance. It came then to indicate the loud expression of other passions; any noisy, sharp, or clamorous exertion of the voice.

Forsothe Jhesus oftsoone *crieds* with a greet voys and gaf up the goost. *Wiclif Matt. 27.*

At midnight a cry was maad: lo the spouse cometh, go ye out to meete him. *Id. Matt. 25.*

But swiche a *crie* and swiche a was they make, That in this world n'is creature living That ever herd swiche another waimenting.

Chaucer. Cant. Tales
What folk be ye that at min home coming
Perturben so my feste with *cryng*! *Id.*

With *cry* of houndes and merry blastes betwene,
Where we did chase the fearful herte of force. *Surrey.*

No other noyse, nor peoples troublous *cries*,
As still are wont to annoy the walled town
Might there be heard; but careless Quiet lyes,
Wrapt in eternal silence farre from enymies. *Spenser. Faerie Queene.*

Richely she fedes, and at the riche mannes cost.
And for her meate she nedes not crave nor *cry*. *Wyatt.*

By all means *cry down* that unworthy course of late times, that they should pay money. *Bacon to Villiers*

No comfortable star did lend his light,
No voice but owls' and wolves' death boding *cries*.
Shakespeare. The Rape of Lucrece.

Methought I heard a voice *cry*, Sleep no more!
Macbeth, doth murder sleep? the innocent sleep. *Shakespeare.*

You common *cry* of curs, whose breath I hate
As reek o' th' rotten fens; whose loves I prize
As the dead carcasses of unburied men,
That do corrupt my air. *Id. Coriolanus.*

What's the matter,
That in the several places of the city
You *cry* against the noble senate? *Id.*

Yet let them look they glory not in mischief,
Nor build their evils on the graves of great men,
For then my guiltless blood must *cry* against them. *Shakespeare.*

I'll to the king,
And from a mouth of honour quite *cry down*
This Ipswich fellow's insolence. *Id. Henry VIII.*

For ere vengeance begin, repentance is seasonable;
but if judgment be once gone out, we *cry* too late. *Bishop Hall.*

Cry out upon the stars for doing
Ill offices, to cross our wooing.

"The astrologer, if his predictions come to pass, is *cried up* to the stars from whence he pretends to draw them. *South.*

Actors I've seen, and of no vulgar name,
Who being from one part possessed of fame,
Whether they are to laugh, *cry*, whine, or bawl;
Still introduce the fav'rite part in all. *Churchill.*

He scorns the dog, resolves to try
The combat next; but if their *cry*
Invades again his trembling ear,
He strait resumes his wonted care. *Waller.*

When men are become accomplished knaves, they
are past *criing* for their cake. *Shaftesbury.*

Epiphanius *cries out* upon it, as rank idolatry, and destructive to their souls who did it. *Stillingfleet.*

The partial crowd their hopes and fears divide,
And aid, with eager shouts, the favoured side.
Cries, murmurs, clamours, with a mixing sound,
From woods to woods, from hills to hills rebound. *Dryden.*

The philosopher deservedly suspected himself of vanity, when *cried up* by the multitude. *Glanville's Suscepis.*

All the effect that I conceive was made by *criing up* the pieces of eight, was to bring in much more of that species, instead of others current here. *Temple.*

They slight the strongest arguments that can be brought for religion, and *cry up* very weak ones against it. *Tillotson.*

When any evil has been upon philosophers, they groan as pitifully, and *cry out* as loud, as other men. *Id.*

We are ready to *cry out* of an unequal management, and to blame the Divine administration. *Atterbury.*

In popish countries some impostor *cries out*, A miracle! a miracle! to confirm the deluded vulgar in their errors; and so the *cry* goes round, without examining into the cheat. *Swift.*

The child certainly knows, that the 'worm-seed or mustard-seed it refuses, is not the apple or sugar it *cries for*. *Loche.*

Tumult, sedition, and rebellion, are things that the followers of that hypothesis *cry out* against. *Id.*

I find every sect, as far as reason will help them, make use of it gladly; and where it fails them, they *cry out*, It is matter of faith, and above reason. *Id.*

Crying is a fault that should not be tolerated in children; not only for the unpleasant and unbecoming noise it fills the house with, but for more considerable reasons, in reference to the children themselves; which is to be our aim in education. *Id.*

To all my weak complaints and *cries*,
Thy mercy lent an ear,
Ere yet my feeble thoughts had learnt
To form themselves in prayer. *Addison.*

Mute was the wail of Want, and Misery's *cry*,
And grateful Pity wiped her lucid eye;
Peace with sweet voice the Seraph form addressed,
And virtue clasped him to her throbbing breast. *Darwin.*

Laugh when I laugh, I seek no other fame,
The *cry* is up, and scriblers are my game;
Speed Pegasus!—ye strains of great and small,
Ode! Epic! Elegy! have at you all. *Byron. English Bards.*

CRYOPHORUS, the frost-bearer, or carrier of cold, an elegant instrument invented by Dr. Wollaston, to demonstrate the relation between evaporation at low temperatures, and the production of cold. Take a glass tube, whose in-

ternal diameter is about one-eighth of an inch, with a ball at each extremity of about one inch diameter; and let the tube be bent to a right angle at the distance of half an inch from each ball. One of these balls should be somewhat less than half full of water, and the remaining cavity should be as perfect a vacuum as can readily be obtained; which is effected by making the water boil briskly in the one ball, before sealing up the capillary opening left in the other. If the empty ball be immersed in a freezing mixture of snow and salt, the water in the other ball, though at the distance of two or three feet, will be frozen solid in the course of a very few minutes. The vapor contained in the empty ball is condensed by the common operation of cold, and the vacuum produced by this condensation gives opportunity for a fresh quantity to arise from the opposite ball, with proportional reduction of its temperature.

CRYPISIS, a genus of the diandria digynia class and order: CAL. a glume, two-valved, one-flowered; COB. a glume, two-valved, and awnless. There is one species, a grass of Siberia.

CRYPT, *n. s.* Lat. *crypta*; Gr. κρυπ-
CRYP TIC, *adj.* τω, to hide; a secret or
CRYP TICAL, *adj.* hidden place; a cave;
CRYP TICALLY, *adv.* 'Et solitus mediæ crypt-
CRYP TOGRAPHY, *n. s.* tam penetrare Suburræ.'

Juven. sat. 5. v. 106. A part of ancient churches under the high altar. Secret; hidden; occult; unknown. Cryptography is a secret kind of writing, or writing in copper.

When Christian religion was most pure, and indeed golden, Christians had but low and poor conventicles, and simple oratories; yea caves under the ground, called *Cryptæ*, where they, for fear of persecution, assembled secretly together. A figure whereof remaineth in the vaults, which yet are builded under the great churches, to put us in remembrance of the old state of the primitive church. *Homilies.*

We take the word acid in a familiar sense, without cryptically distinguishing it from those sapers that are akin to it. *Boyle.*

The students of nature, conscious of her more cryptical ways of working, resolve many strange effects into the near efficiency of second causes. *Glanville's Apol.*

Speakers, whose chief business is to amuse or delight, do not confine themselves to any natural order, but in a cryptical or hidden method adapt every thing to their ends. *Watts.*

In consequence of the ardour which he expressed on this subject, it was thought proper to deposit his body in the crypt of that magnificent church. *Malone.*

CRYPTA, from κρυπτω, to hide, a subterraneous cell or vault, especially under a church, for the interment of particular families or persons. S. Ciampini, describing the outside of the Vatican, speaks of the cryptæ of St. Andrew, St. Paul, &c. Vitruvius uses the word for a part of a building, answering nearly to our cellar; Juvenal for a cloaca.

CRYPTO-CALVINISTS, a name given to the favorers of Calvinism in Saxony, on account of their secret attachment to the Genevan doctrine and discipline. Many of them suffered by the decrees of the convocation of Torgaw, held

in 1576. These Calvinists in their progress have divided into various lesser sects.

CRYPTOCEPHALUS, in entomology, a genus of insects of the coleoptera class. The antennæ are filiform; feelers four; thorax margined; shells immarginate; and the body somewhat cylindrical. This genus is very extensive, consisting of 268 species.

CRYPTOGAMIA, from κρυπτος, concealed, and γαμος, nuptials, the twenty-fourth class in the Linnæan system, comprehending those plants whose fructification is concealed, either through minuteness, or within the fruit. See BOTANY.

CRYPTOSTOMUM, a genus of the pentandria class and order; CAL. five-cleft: COB. tube inserted into the throat of the calyx; borders five-cleft; nectarium five-toothed; berry, seeds scarred. There is one species, a shrub of Guiana.

CRYSTAL, *n. s. & adj.* Fr. *crystal*;
CRYSTALLINE, *n. s. & adj.* Span. *crystal*; It.
CRYSTALLISE, *v. n.* *cristello*; Lat.
CRYSTALLISATION, *n. s.* *crystellus*; Gr.
CRYSTAL-COVERED, *adj.* κρυσταλλος, ice,
CRYSTAL-CRUSTED, *adj.* from Heb. קריש.
CRYSTAL-STREAMING, *adj.* to join; coalesce
as water when frozen. The Romans adopted the word for salts and minerals, as supposit: them permanent congelations. See the following article.

And he schewide to me a flood of quycke watr schynynge as *crystal* comynge forth of the sects of god and of the lombe. *Wiclif. Apocalips. 2.*

O cloist, gardin, voide of wedis wreke,
Crystallin well, of clereness clere consigned. *Chaucer.*
Alas the clear *crystal*, the bright translucent
glasse,
Doth not bewray the colours hid which underneath it
hase. *Wylst.*

Such seemed they, and so their yellow heere
Crystalline humor dropped down space. *Spenser. Faerie Queene.*

Furth from her iyen the *crystal* teares outbrast,
And syghing sore, her handes the wrong and folde. *Sackville.*

Water, as it seems, turneth into *crystal*; as is seen in divers caves, where the *crystal* hangs in stillicidie. *Bacon.*

Mount eagle to my palace *crystalline*.
Shakespeare. Cymbeline.

If *crystal* be a stone, it is not immediately concreted by the efficacy of cold, but rather by a mineral spirit. *Brewer.*

As earth, so he the world
Built on circumfusious waters, calm, in wide
Crystalline ocean, and the loud misrule
Of chaos far removed; lest fierce extremes
Contiguous might disemper the whole frame. *Milton.*

If you dissolve copper in aqua-fortis, or spirit of nitre, you may, by *crystallising* the solution, obtain a goodly blue. *Boyle.*

In groves we live, and lie on mossy beds,
By *crystal* streams that murmur through the meads. *Dryden.*

All natural metallick and mineral *crystallisations* were effected by the water, which first brought the particles, whereof each consists, out from amongst the matter of the strata. *Woodward's Nat. Hist.*

The parts of the eye are made convex, and especially the *crystalline* humour, which is of a lenticular figure, convex on both sides. *Ray on the Creation.*

Island *crystal* is a genuine spar, of an extremely pure, clear, and fine texture, seldom either blemished with flaws or spots, or stained with any other colour.

Hill.

High in the flood her azure dome ascends,
The *crystal* arch on *crystal* columns bends ;
Roofed with translucent shell the turrets blaze,
And far in ocean dart their coloured rays.

Darwin.

The colours of these siliceous vegetables are generally brown, from the iron, I suppose, or manganese, which induced them to *crystallise*, or fuse more easily.

Id.

How blest the Solitary's lot,
Who, all-forgetting, all-forgot,
Within his humble cell,
The cavern wild with tangling roots,
Sits o'er his newly-gathered fruits,
Beside his *crystal* well !

Burns.

A taste seen in the choice of his abode,
A love of music and of scenes sublime,
A pleasure in the gentle stream that flowed
Past him in *crystal*, and a joy in flowers,
Bedewed his spirit in his calmer hours.

Byron. Don Juan.

CRYSTAL is found, 1. Opaque, or semitransparent, and white, or of a milk color. 2. Opaque and red, or of a cornelian color, from Oran in Barbary. 3. Opaque and black, from the same place. 4. Clear. The specific gravity of these kinds of crystals is from 2650 to 2700. Professor Bergman extracted from them about six parts of argilla, and one of calcareous earth per hundred weight; but Mr. Gerhard found some so pure as to contain neither. 5. Clear and blackish brown, the smoky topaz, or Rauch topaz of the Germans. It is found at Egan in Norway, and at Lovisa in Finland. These crystals are said to become clear by boiling them in tallow. 6. Clear and yellow; found in Bohemia, and sold for topazes. 7. Clear and violet-colored; the amethyst, from Saxony, Bohemia, and Danemore in Upland. The most transparent of these are called false diamonds, Bristol, Kerry stones, Alençon diamonds, &c. 8. Colorless rock crystal, properly so called, found in Bohemia, the province of Jemtland, and many other places. 9. Pyramidal crystal with one or two points. These have no prismatic shape, but either stand upon a base in cavities of quartz veins; have only a single pyramid, and are of various colors; or they lie in a clayey earth, and have both pyramids, but no prism. They are found at Blackenburg upon the Hartz, and at Morserosh in the Silverland in Transylvania. The colored transparent crystals derive their tinge from an exceedingly small portion of metallic calces, but lose them entirely when strongly heated. They are called false gems; viz. the red from Oran in Barbary, false rubies; the yellow from Saxony, false topazes; the green from Dauphny, very rare, false emeralds or prases; the violet from Vil in Catalonia, false amethysts; the blue from Puy in Valley in France, false sapphires. There are likewise opal or rainbow

crystals, the various colors of which are thrown out in zones across the surface. They make a very fine appearance, though they never shine like the oriental opal. Crystal is also found in many parts of Britain and Ireland. About Bristol it is found of an amethystine tinge. In Silesia, and Bohemia, it is found stained with the colors of the ruby, sapphire, emerald, and topaz; in which case jewellers take great advantage of it, selling it under the name of occidental sapphire. Fourcroy makes a remarkable difference between the crystals and quartz, by affirming that the former are unalterable in the fire, in which they neither lose their hardness, transparency, nor color, while the quartz loses the same qualities, and is reduced by it to a white and opaque earth. He classes the rock crystals, I. According to their form, viz. 1. Insulated hexagonal crystals ending in pyramids of six faces, which have a double refraction, or show two images of the same object when looked through. 2. Hexagonal crystals united, having one or two points. 3. Tetrahedral, dodecahedral, flatted crystals; and which, though hexagonal, have nevertheless their planes irregular. 4. Crystals in large masses, from the island of Madagascar, which have a simple refraction. II. With regard to their color, as being either diaphanous, reddish, smoky, or blackish. III. With regard to accidental changes, some are hollow; some contain water within one or more cavities; some are cased one within the other; some are of a round form, as the pebbles of the Rhine; some have a crust of metallic calces or of a pyrites; some are found crystallised in the inside of a cavity, while some seem to contain amianthus or asbestos; and others contain shirls. M. Fourcroy reckons among crystals the oriental topaz, the hyacinth, the oriental sapphire, and the amethyst. Mr. Daubenton has always looked upon this last as a quartz of a crystal.

i. The forms or orders into which pure crystals have been divided are three: Perfect columnar crystals, with double pyramids, composed of eighteen planes, in an hexangular column, terminated by an hexangular pyramid at each end. ii. Perfect crystals with double pyramids, without a column, composed either of twelve or sixteen planes, in two hexangular pyramids, joined closely base to base, without the intervention of any column. iii. Imperfect crystals, with single pyramids, composed either of twelve or ten planes, in an hexangular or pentangular column, affixed irregularly at one end to some solid body, and terminated at the other by an hexangular or pentangular pyramid. Under these there are almost infinite varieties in the number of angles, and the length, thickness, and other accidents of the columns and pyramids. iv. When crystal is blended with metalline particles at the time of its formation, it assumes a variety of figures wholly different from these, constituting a fourth order, under the name of metalline crystals: when the metal is lead, the crystal assumes the form of a cube; when it is tin, of a quadrilateral pyramid, with a broad base; when iron, the crystal is found concreted in rhomboidal figures: these crystals are very common about mines; but the common spars;

which are liable to be influenced in the same manner by the metals, and to appear in the very same form, are to be carefully distinguished from them. There is one very easy test; viz. that all spars are subject to be dissolved by aqua-fortis, and effervesce violently only on its touching them: but it has no such effects on crystal. v. When crystals are found in the form of round pebbles, which is occasioned by their being tossed about and rubbed against one another by floods or by the sea, they are called by the English lapidaries pebble crystal. They come from the Indies, Siberia, and other places. vi. The pebble crystal is common in all parts of the world; but that which is formed of hexangular columns, affixed to a solid base at one end, and terminated by an hexangular column at the other, is infinitely more so: this is called sprig or rock crystal, and is the species described by most authors, under the name of crystal of the shops, or that kept for medicinal uses. When the rock crystals are semitransparent, or intermixed with opaque veins, they are called by the Swedish lapidaries milk crystals. According to Bomare, they are generally formed upon or among quartz, which shows their great affinity, and are to be found in all parts of the world. The greatest quantity of them is brought from mount Saint Gothard, in Switzerland. Large pieces of these, weighing from 500 to 800 pounds, were found there at Grimselberg; another of about 1200 pounds weight was found some years ago at Fisback in the Wallais; and a piece six feet long, four wide, and equally thick, was found in the island of Madagascar, where these natural productions are of the most extraordinary size and perfection. In the imperial collection at Vienna, there is a pyramidal crystal vase two ells in height, cut wholly out of one piece. It is usual with the largest crystals of the German mountains to be full of cracks and flaws, and to be so constructed internally as to show all the prismatic colors; but the above mentioned ones were quite free from these blemishes, and resembled columns of the purest glass, only much clearer than any glass can be made.

Natural crystal may be reduced by calcination into a state proper for making glass with alkaline salts, and thus becomes a very valuable fritt. The method is this: calcine natural crystal in a crucible; when it is red-hot, throw it into cold water. Repeat this eight times, covering the crucible that no dust or ashes may get in among the crystal. Dry this calcined mass, and reduce it to an impalpable powder.

Crystal is frequently cut; and lustres, vases, and toys, are made of it as of other beautiful stones. For this purpose it is to be chosen perfectly clear and transparent. It may be tried by aqua-fortis, or by drawing it along a pane of glass. The genuine crystal will not be affected by the acid, and will cut glass almost like a diamond. When any piece of workmanship of natural crystal is become foul and dark, the following method is to be used for recovering its brightness without hurting the polish:—Mix together six parts of common water and one part of brandy; boil these over a brisk fire, and let the crystal be kept in it, in a boiling state, a

quarter of an hour; then take it out and rub it carefully over with a brush dipped in the same liquor; after this wipe it with a napkin, and thus its surface will be perfectly cleaned, and rendered as bright as at first, without any injury to the points of the cutting, or the polish of the planes or faces, which would probably happen, were the cleaning attempted by mere rubbing with a cloth.

CRYSTALLISATION, (*κρυσταλλος*, ice,) is that process of nature by which the particles of a body are arranged systematically in passing from a liquid to a solid state. The Greeks first applied it to ice, as the most obvious transformation of this kind; and the Roman naturalists transferred it to rock crystal and similar bodies, which they considered as only mere permanent formations of the same description as ice. Then it being observed that nitre and certain other salts were capable, by particular management, of exhibiting a similar prismatic form, the word crystal assumed a more general meaning, and was finally applied to all such saline substances and metallic ores as exhibit this tendency to symmetrical arrangement. Crystallography is a term that has been used for the science which discourses of crystallisation. This process is in a vast number of cases completed by nature in the bodies presented to our view. Modern naturalists observe that 'most of the solids which compose the mineral crust of the earth, are found in the crystallised state. Thus granite consists of crystals of quartz, felspar, and mica. Even mountain masses like clay-slate, have a regular tabulated form.' It is also imitated by art. The chemist produces it both by igneous fusion, and by solution in a liquid. When the temperature is slowly lowered in the former case, or the liquid slowly abstracted by evaporation in the latter, the attractive forces resume the ascendancy, and arrange the particles in symmetrical forms. And, if few of the crystallisations that are performed by nature have been successfully accomplished by art, chemistry has been able on the other hand, to effect the crystallisation of a variety of substances, chiefly salts, which are not found crystallised naturally; and, by taking proper advantage of this circumstance, has succeeded in obtaining them in a state of greater purity than they can be procured in by any other method. M. Le Blanc in a paper in the *Journal de Physique*, gives instructions for obtaining crystals of large size. His method is to employ flat glass or China vessels: to pour into these the solutions boiled down to the point of crystallisation: to select the neatest of the small crystals formed, and put them into vessels with more of the mother-water of a solution that has been brought to crystallise confusedly; to turn the crystals at least once a day; and to supply them from time to time with fresh mother-water. If the crystals be laid on their sides, they will increase most in length; if on their ends, most in breadth. When they have ceased to grow larger, they must be taken out of the liquor, or they will soon begin to diminish. It may be observed in general, that very large crystals are less transparent than those that are small.

The crystals of metals may be obtained by fusing them in a crucible with a hole in its bottom, closed by a stopper, which is to be drawn out after the vessel has been removed from the fire, and the surface of the metal has begun to congeal. The same effect may be observed if the metal be poured into a plate or dish, a little inclined, which is to be suddenly inclined in the opposite direction, as soon as the metal begins to congeal round its edges. In the first method, the fluid part of the metal runs out of the hole, leaving a kind of cup lined with crystals; in the latter way, the superior part, which is fluid, runs off, and leaves a plate of metal studded over with crystals.

The phenomena of crystallisation have much engaged the attention of modern chemists, and a vast number of experiments have been made with a view to determine exactly the different figures assumed by salts in passing from a fluid to a solid form. It does not, as yet, however, appear, that any certain rule can be laid down in these cases, as the figure of saline crystals may be varied by the slightest circumstances. Thus, sal-ammoniac when prepared by a mixture of pure volatile alkali, with spirit of salt, shoots into crystals resembling feathers; but if, instead of a pure alkali, we make use of one just distilled from bones, and containing a great quantity of animal oil, we shall, after some crystallisations of the feathery kind, obtain the very same salt in the form of cubes. Such salts as are sublimable, crystallise not only in the aqueous way by solution and evaporation, but also by sublimation; and the difference betwixt the figures of these crystals is often very remarkable. In nature also we find frequently the same chemical substance crystallised in forms apparently very dissimilar. Thus, carbonate of lime assumes the form of a rhomboid, of a regular hexahedral prism, of a solid terminated by twelve scalene angles, or of a dodecahedron with pentagonal faces, &c. Bisulphuret of iron or martial pyrites produces sometimes cubes and sometimes regular octohedrons, at one time dodecahedrons with pentagonal faces, at another icosahedrons with triangular faces, &c. And while one and the same substance lends itself to so many transformations, we meet with very different substances, which present absolutely the same form. Thus fluat of lime, muriate of soda, sulphuret of iron, sulphuret of lead, &c. crystallise in cubes, under certain circumstances; and in other cases, the same minerals, as well as sulphate of alumina and the diamond, assume the form of a regular octohedron.

Linnæus, in his bold attempt to arrange the whole of nature's works, could not fail to observe a resemblance more or less perfect between the forms of various salts, and those of several crystallised minerals. He however, considered the faculty of crystallising to be peculiarly characteristic of saline substances, and hence concluded that all the crystallised earthy minerals were compounded of earth and some particular salt, which gave them outward form. Thus, because both nitre and quartz crystallise in the form of hexahedral prisms, terminated by hexahedral pyramids, he regarded the former as the type of

a whole genus, of which the latter was one of the species; observing again that alum and the diamond crystallise in pyramidal octohedrons, he arranged the latter as a species of the genus alum. Wallerius very soon proved that this hypothesis was untenable; nothing more correct, however, was offered as a theory of crystallisation until that of M. Romé de Lisle appeared. This able philosopher first arranged the study of crystallisation on the simple basis of facts. He examined all the crystalline forms that fell under his observation, delineated them with accuracy, ascertained the measurement of their principal angles, and arranged them with great sagacity, into species and varieties. Among the different forms belonging to each species, he chose one as the most proper, from its simplicity, to be regarded as the primitive form; and by supposing it truncated in different ways, he deduced the other forms from it, and determined a gradation or series of transitions between this same form and that of polyhedrons, which seemed to be still farther removed from it. In this way he discovered that the principal of the angles formed by the incidence of the circumscribing planes on each other, are always of the same dimensions, notwithstanding the truncatures and other modifications undergone by the primitive figure; and also that the dimensions of these angles vary in every different species, although the general figure of the crystals may be the same.

The illustrious Bergman followed the same line of observation; until he became convinced that the varieties in crystallisation are not owing to truncations of the primitive figure, but to the superposition of secondary laminae upon its faces, either in regular, or variable and decreasing proportions. According to this hypothesis, however, it would still follow, that if the external laminae of any crystals were taken off in regular succession, the remaining nucleus would be constantly approaching to the primitive form, and at last arrive at it. Bergman demonstrated this his principal discovery in the formation of the dog-tooth spar, by an actual dissection of the crystal. Removing the different crystalline laminae in succession, he arrived at a rhomboidal solid, divisible only by planes parallel to its surfaces, and therefore unsusceptible of undergoing any further change of form. In attempting, however, to apply this discovery to other varieties of calcareous spar, he was not equally successful.

It was reserved for M. Haüy, to unfold with mathematical accuracy, the profound but simple laws of nature on this subject. He has confirmed the general principles of de Lisle and Bergman with regard to the primitive formation of crystals; and has rendered it highly probable, that the integrant particles of crystallising substances always combine in the same body in the same way; or in other words, that the same faces, or the same edges, always attach themselves together; but that these differ in crystals produced from different substances; a fact which can scarcely be accounted for, without supposing that the particles of bodies are endowed with a certain polarity, which makes them attract one

part of another particle, and repel every other part. His next improvement in the study of the laws of crystallisation, however, was the submitting to regular calculation. He produced a mathematical theory, reduced to analytical formulæ, representing every possible case; and the application of which to known forms leads to the accurate valuations of angles, and has hitherto agreed with all the recorded observations and experiments upon this subject.

We cannot, therefore, better exhibit the present state of science with regard to this interesting part of nature, than by submitting to the reader, I. M. Haüy's Theory of the Structure of Crystals. II. Of the Laws of Crystallisation; and III. The Observations of Dr. Wollaston and more modern philosophers on the same subject.

SECT. I.—M. HAÜY'S THEORY OF THE STRUCTURE OF CRYSTALS.

This may be conveniently considered in three parts. 1. His theory of primitive forms: 2. Of secondary forms; and 3. Of integrant molecules, or constituent particles.

1. The *primitive form* is, according to this theory, the nucleus of the crystal; or a solid of a constant form, engaged symmetrically in all the crystals of one and the same species, and the faces of which follow the directions of the laminae which form these crystals. The primitive forms of all crystals which have been hitherto examined are six. 1. The paralleliped, bounded by six planes, the opposite planes being parallel. This includes the cube, and varieties of the rectangular prism, the oblique angular prism, and the rhomboid. 2. The octahedron. This is a double four-sided pyramid. When the triangular faces are equilateral, it is called a regular octahedron. There are, besides this, other varieties of the primitive octahedron, in which the pyramids are longer or shorter than the regular one, or have a rhomboidal base, or a rectangular base, longer in one direction than the other. 3. The regular tetrahedron bounded by four equilateral triangles. 4. The regular hexahedral prism, or equiangular six-sided prism. 5. The rhomboidal dodecahedron, bounded by twelve equal rhombs. 6. The pyramidal dodecahedron, consisting of two six-sided pyramids joined base to base.

The primitive forms which most frequently occur are, the paralleliped and the octahedron. The tetrahedron and dodecahedron are very rare as primitive forms, though common as the secondary forms of crystals.

By this mechanical division of minerals we ascertain their true primitive form, and prove that this is invariable while we operate upon the same substance; however diversified or dissimilar the forms of the crystals belonging to that substance may be. Two or three examples will suffice to demonstrate this. If we take a regular hexahedral prism of carbonate of lime (plate I. CRYSTALLISATION, figs. 1 and 2), and try to divide it parallel to the edges, from the contours of the bases, we shall find, that three of these edges taken alternately in the upper part, for instance, the edges *lf*, *cd*, *bm*, may be referred to this division: and in order to succeed in the same way with respect to the inferior base, we must choose

not the edges *l'f'*, *c'd'*, *b'm'*, which correspond with the preceding, but the intermediate edges *d'f'*, *b'c'*, *l'm'*. The six sections will uncover an equal number of trapeziums. Three of the latter are represented upon fig. 2; viz. the two which intercept the edges, *lf*, *cd*, and are designated by *ppoo*, *aakk*, and that which intercepts the lower edge *d'f'*, and which is marked by the letters *nnii*. Each of these trapeziums will have a lustre and polish; from which we may easily ascertain in general cases that it coincides with one of the natural joints of which the prism is the assemblage. We shall attempt in vain to divide the prism in any other direction. But if we continue the division parallel to the first sections, it will happen, that on one hand the surfaces of the bases will always become narrower, while, on the other hand, the altitudes of the lateral planes will decrease; and at the term at which the bases have disappeared, the prism will be changed into a dodecahedron, fig. 3, with pentagonal faces, six of which, such as *ooiOe*, *oIkii*, &c. will be the residues of the planes of the prism; and the six others *EAlOo*, *OA'Kii*, &c. will be the immediate result of the mechanical division.

Beyond this same term, the extreme faces will preserve their figure and dimensions, while the lateral faces will incessantly diminish in height, until the points *o*, *k*, of the pentagon *oIkii*, coming to be confounded with the points *ii*, and so on with the other points similarly situated, each pentagon will be reduced to a simple triangle, as we see in fig. 4. The points which are confounded, two and two, upon this figure, are each marked with the two letters which served to designate them when they were separated, as in fig. 3. And when new sections have obliterated these triangles, so that no vestige of the surface of the prism remains, fig. 1, we shall have the nucleus or the primitive form, which will be an obtuse rhomboid, fig. 5, the grand angle of which *EAl* or *EOI*, is $101^{\circ} 32' 13''$. It is observed, that each trapezium, such as *ppoo*, fig. 2, uncovered by the first sections, is very sensibly inclined from the same quantity, as well upon the residue *ppdebm* of the base, as upon the residue *ooj'l* of the adjacent plane. Setting out from this equality of inclinations, we deduce from it, by calculation, the value of the angles with the precision of minutes and seconds, which mechanical measurements are not capable of attaining.

If we try to divide a crystal of another species, we shall have a different nucleus. For instance, a cube of fluatate of lime will give a regular octahedron, which we succeed in extracting by dividing the cube upon its eight solid angles, which will in the first place discover eight equilateral triangles, and we may pursue the division, always parallel to the first sections, until nothing more remains of the faces of the cube. The nucleus of the crystals of sulphate of barytes will be a straight prism with rhombous bases; that of the crystals of phosphate of lime, a regular hexahedral prism; that of sulphureted lead, a cube, &c.; and each of these forms will be constant, relative to the entire species, in such a manner, that its angles will not undergo any appreciable variation.

2. *Secondary forms* are those in which the

Fig. 1.

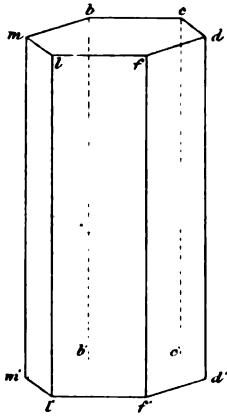

Fig. 2.

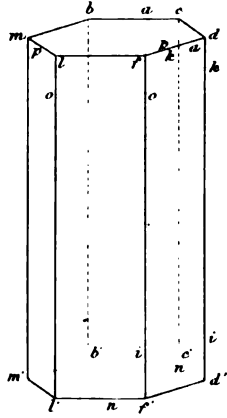

Fig. 3.

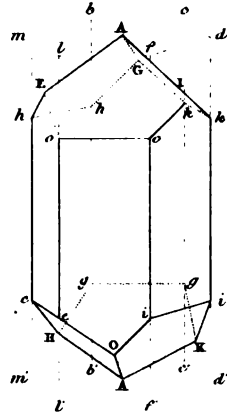

Fig. 4.

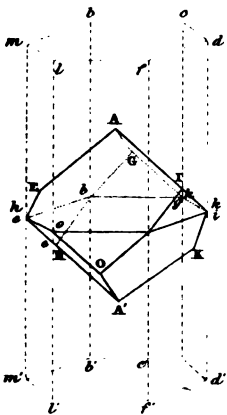

Fig. 5.

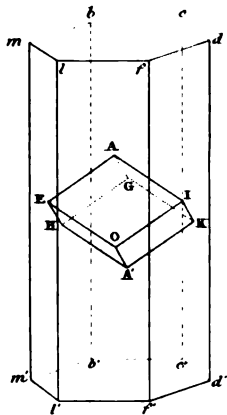

Fig. 6.

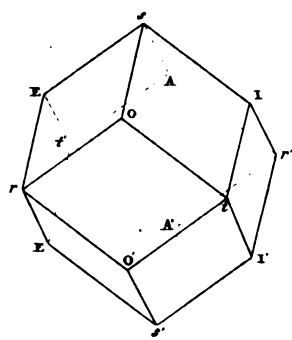

Fig. 7.

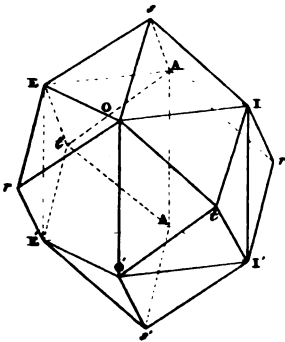
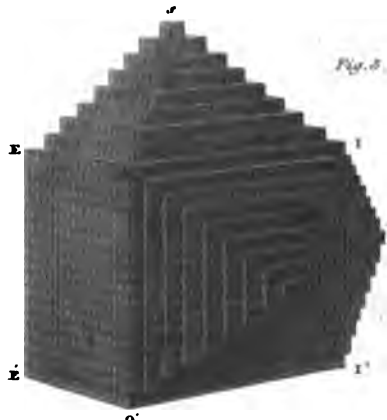

Fig. 8.



laminae of a crystal divide in any other direction than parallel to its faces; and are sometimes called secondary crystals. The division of secondary crystals by sections in the direction of the laminae is, in some cases, easily effected; in others, the joints are indistinct, and require the crystal to be heated and plunged into cold water to make them visible. The direction of the laminae is frequently rendered obvious by turning a mineral slowly round in the sunshine, when the reflections from the internal parts will show the structure. Where no joints are discoverable, Häuy determines their direction and the form of the primitive nucleus by conjecture, from the appearances offered by the secondary crystal.

3. *Of integrant molecules.* According to M. Häuy the nucleus of a crystal is not the last term of its mechanical division. It may always be subdivided parallel to its different faces, and sometimes in other directions also. The whole of the surrounding substance is capable of being divided by strokes parallel to those which take place with respect to the primitive form. If the nucleus be a parallelepipedon, which cannot be subdivided except by blows parallel to its faces, like that which takes place with respect to carbonated lime, it is evident that the integrant molecule will be similar to this nucleus itself. But it may happen that the parallelepipedon admits of further sections in other directions than the former.

The forms of the integrant molecules of all crystals may be reduced to three, the tetrahedron, or the simplest of the pyramids; the triangular prism, or the simplest of all the prisms; and the parallelepipedon, or the simplest among the solids, which have their faces parallel two and two. And since four planes at least are necessary for circumscribing a space, it is evident that the three forms in question, in which the number of faces is successively four, five, and six, have still, in this respect, the greatest possible simplicity.

To recapitulate.—The constituent particles of all crystals Häuy denominates their integrant molecules, and conceives them to be arranged in rows; a number of these rows forming thin laminae or plates. When these laminae are parallel with all the faces or planes of a crystal, they may be removed without changing the form of the crystal; but if the laminae divide in any other direction than that which is parallel to the faces, a change of form will be produced by every division, until at last we obtain a nucleus which is divisible in a direction parallel to its sides. In the former case, the primitive form is the form of the crystal itself. Hence if a cubic crystal be divisible only by laminae parallel to its six sides, we may continue diminishing the magnitude of the crystal, as long as mechanical division is possible without any change of form. When the laminae of a crystal divide in any other direction than parallel to its faces, it is called a secondary form or derivative crystal.

SECT. II.—OF THE LAWS OF CRYSTALLISATION.

'If,' says M. Häuy, 'we consider attentively the figures of the plates which successively cover again the nucleus of a crystal, and which we

shall call laminae of superposition, it will be perceived that proceeding from the nucleus they go on by a progressive diminution or decrement, sometimes on all sides at once, sometimes in certain parts only. But the difference between each lamina and that which precedes it, can only arise from the retrenchment of a certain quantity of integrant particles that are taken from the first till it is equal to the second; and, since the edges of the decreasing laminae are constantly right lines parallel one to another upon the different laminae, it results that the differences of which we have spoken are measured by the subtractions of one or many ranges of integrant particles. This, therefore, is the enunciation of the problem presented for solution: a secondary crystal being given, and the figure of its nucleus and of its integrant particles being likewise given—supposing, moreover, that each of the laminae that will be added to the nucleus does not project so far as the preceding, in certain parts, by a quantity equal to one, two, three, &c. ranges of molecules—to determine among the different laws of diminution those from which a similar form to that proposed will result, with respect to the number, the figure, and the disposition of its faces, and to the measure of both its plane and solid angles. This sort of problems can only be resolved by the aid of a rigid calculus.'

The decrement in question, then, is effected by regular subtractions of one or more rows of integrant molecules; and the theory, in determining the number of these rows by means of calculation, succeeds in representing all the known results of crystallisation, and even anticipates future discoveries, indicating forms which, being still hypothetical only, may one day be presented to the enquiries of the philosopher.

1. *Of Decrements on the Edges.*—Let s, s' , fig. 6, plate I. CRYSTALLISATION, be a dodecahedron with rhombic planes. This solid, which is one of the six primitive forms of crystals, also presents itself occasionally as a secondary form, and in this case it has, as a nucleus, sometimes a cube and sometimes an octohedron. Supposing the nucleus to be a cube:—In order to extract this nucleus, it is sufficient successively to remove the six solid angles composed of four planes, such as s, r, t , &c., by sections adapted to the direction of the small diagonals. These sections will display as many squares, $AE O I, E O O' E', I O O' I'$, fig. 7, &c., which will be the faces of the cube.

Now, let us conceive that each of these faces is subjected to a series of decreasing laminae solely composed of cubic molecules, and that every one of these laminae exceeds the succeeding one, towards its four edges, by a quantity equal to one course of these same molecules. Afterwards we shall designate the decreasing laminae which envelope the nucleus, by the name of laminae of superposition. Now, it is easy to conceive that the different series will produce six quadrangular pyramids, similar in some respects to the quadrangular steps of a column, which will rest on the faces of the cube. Three of these pyramids are represented in fig. 8, and have their summits in s, t, r' . As there are six quadrangular pyramids, we shall have twenty-four triangles, such as, $O s I, O t I$, &c. But because the de-

crement is uniform from s to t , and so on with the rest, the triangles taken two and two are on a level, and form a rhomb $s O t I$. The surface of the solid will therefore be composed of twelve equal and similar rhombs; i. e. this solid will have the same form with that which is the subject of the problem. This structure takes place, although imperfectly, with respect to the crystals called *boracic spars*. The dodecahedron now under consideration is represented by fig. 8 in such a way that the progress of the decrement may be perceived by the eye. On examining the figure attentively, we shall find that it has been traced on the supposition that the cubic nucleus has on each of its edges seventeen ridges of molecules; whence it follows, that each of its faces is composed of 289 facets of molecules, and that the whole solid is equal to 4913 molecules. On this hypothesis, there are eight laminae of superposition, the last of which is reduced to a simple cube, whose edges determine the numbers of molecules which form the series 15, 13, 11, 9, 7, 5, 3, 1, the difference being 2, because there is one course subtracted from each extremity. If instead of this coarse kind of masonry, which has the advantage of speaking to the eye, we substitute in our imagination the infinitely delicate architecture of nature, we must conceive the nucleus as being composed of an incomparably greater number of imperceptible cubes. In this case, the number of laminae of superposition will also be beyond comparison greater than on the preceding hypothesis. By a necessary consequence, the furrows which form these laminae by the alternate projecting and re-entering of their edges, will not be cognizable by our senses; and this is what takes place in the polyhedra which crystallisation has produced at leisure, without being disturbed in its progress.

2. M. Haüy calls *decrements in breadth*, those in which each lamina has only the height of a molecule; so that their whole effect, by one, two, three, &c., courses, is in the way of breadth. *Decrements in height* are those in which each lamina, exceeding only the following one by a single course in the direction of the breadth, may have a height double, triple, quadruple, &c., to that of a molecule: this is expressed by saying that the decrement takes place by two courses, three courses, &c., in height.

SECT. III.—OF SUBSEQUENT OBSERVATIONS ON CRYSTALLISATION.

Dr. Wollaston communicated to the Royal Society in 1813 some observations on the *ultimate* cause of crystalline forms, equally ingenious and profound.

Among the known forms of crystallised bodies, there is no one common to a greater number of substances than the regular octohedron, and no one in which a corresponding difficulty has occurred with regard to determining which modification of its form is to be considered as primitive; since in all these substances the tetrahedron appears to have equal claim to be received as the original from which all their other modifications are to be derived. The relation of these solids to each other is most distinctly exhibited to those who are not much conversant with crystallo-

graphy, by assuming the tetrahedron as primitive; for this may immediately be converted into an octohedron by the removal of four smaller tetrahedrons from its solid angles. Plate II. CRYSTALLISATION, fig. 1.

The substance which most readily admits of division by fracture into these forms, is fluor spar; and there is no difficulty in obtaining a sufficient quantity for such experiments. But it is not, in fact, either the tetrahedron or the octohedron, which first presents itself as the apparent primitive form obtained by fracture. If we form a plate of uniform thickness by two successive divisions of the spar, parallel to each other, we shall find the plate divisible into prismatic rods, the section of which is a rhomb of $70^{\circ} 32'$ and $109^{\circ} 28'$ nearly; and, if we again split these rods transversely, we shall obtain a number of regular acute rhomboids, all similar to each other, having their superficial angles 60° and 120° , and presenting an appearance of primitive molecule, from which all the other modifications of such crystals might very simply be derived. And we find, moreover, that the whole mass of fluor might be divided into, and conceived to consist of, these acute rhomboids alone, which may be put together so as to fit each other without any intervening vacuity.

But, since the solid thus obtained (as represented in fig. 2) may be again split by natural fractures at right angles to its axis, fig. 3, so that a regular tetrahedron may be detached from each extremity, while the remaining portion assumes the form of a regular octohedron; and, since every rhomboid that can be obtained must admit of the same division into one octohedron and two tetrahedrons, the rhomboid can no longer be regarded as the primitive form; and, since the parts into which it is divisible are dissimilar, we are left in doubt which of them is to have precedence as primitive. In the examination of this question, whether we adopt the octohedron or the tetrahedron as the primitive form, since neither of them can fill space without leaving vacancies, there is a difficulty in conceiving any arrangement in which the particles will remain at rest: for, whether we suppose, with the abbé Haüy, that the particles are tetrahedral with octohedral cavities, or, on the contrary, octohedral particles regularly arranged with tetrahedral cavities, in each case the mutual contact of adjacent particles is only at their edges; and, although in such an arrangement it must be admitted that there may be an equilibrium, it is evidently unstable, and ill adapted to form the basis of any permanent crystal.

With respect to fluor spar, and such other substances as assume the octohedral and tetrahedral forms, all difficulty is removed, says Dr. Wollaston, by supposing the elementary particles to be perfect spheres, which, by mutual attraction, have assumed that arrangement which brings them as near to each other as possible. The relative position of any number of equal balls in the same plane, when gently pressed together, forming equilateral triangles with each other (as represented perspectively in fig. 4), is familiar to every one; and it is evident that, if balls so placed were cemented together, and the stratum

Fig. 1.

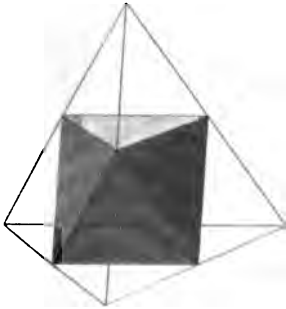

Fig. 2.



Fig. 3.



Fig. 4.



Fig. 5.



Fig. 11.



Fig. 8.



Fig. 6.

Fig. 16.

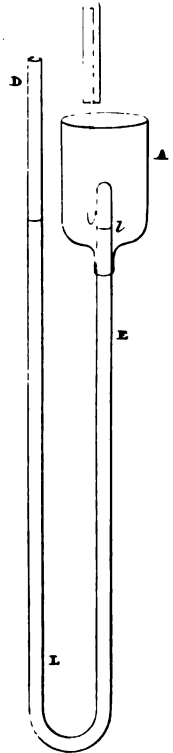

Fig. 12.

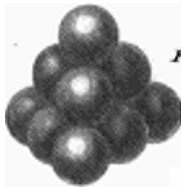

Fig. 7.

Fig. 10.



Fig. 9.



Fig. 13.

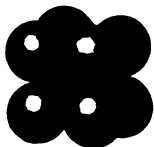

Fig. 14.

thus formed were afterwards broken, the straight lines in which they would be disposed to separate would form angles of 60° with each other. If a single ball were placed any where at rest upon the preceding stratum, it is evident that it would be in contact with three of the lower balls (as in fig. 5), and that the lines joining the centres of four balls so in contact, or the planes touching their surfaces, would include a regular tetrahedron, having all its equilateral triangles.

The construction of an octohedron, by means of spheres alone, is as simple as that of the tetrahedron. For, if four balls be placed in contact on the same plane, in form of a square, then a single ball resting upon them in the centre, being in contact with each pair of balls, will present a triangular face rising from each side of the square, and the whole together will represent the superior apex of an octohedron; so that a sixth ball similarly placed underneath the square will complete the octohedral group, fig. 6. There is one observation with regard to these forms that will appear paradoxical, namely, that a structure, which in this case was begun upon a square foundation, is really intrinsically the same as that which is begun upon the triangular basis.

But if we lay the octohedral group, which consists of six balls, on one of its triangular sides, and, consequently, with an opposite triangular face uppermost, the two groups, consisting of three balls each, are then situated precisely as they would be found in two adjacent strata of the triangular arrangement. Hence, in this position, we may readily convert the octohedron into a regular tetrahedron, by addition of four more balls (fig. 7). One placed on the top of the three that are uppermost forms the apex; and if the triangular base, on which it rests, be enlarged by addition of three more balls, regularly disposed around it, the entire group of ten balls will then be found to represent a regular tetrahedron.

For the purpose of representing the acute rhomboid, two balls must be applied at opposite sides of the smallest octohedral group, as in fig. 9. And if a greater number of balls be placed together, fig. 10 and 11, in the same form, then a complete tetrahedral group may be removed from each extremity, leaving a central octohedron, as may be seen in fig. 11, which corresponds to fig. 3.

We have seen that, by due application of spheres to each other, all the most simple forms of one species of crystal will be produced, and it is needless to pursue any other modifications of the same form, which must result from a series of decrements produced according to known laws. Since then the simplest arrangement of the most simple solid that can be imagined, affords so complete a solution of one of the most difficult questions in crystallography, we are naturally led to inquire what forms would probably occur from the union of other solids most nearly allied to the sphere. And it will appear, that, by the supposition of elementary particles that are spheroidal, we may frame conjectures as to the origin of other angular solids well known to crystallographers.

With respect to the obtuse rhomboid, if we suppose the axis of our elementary spheroid to

be its shortest dimension a class of solids will be formed which are numerous in crystallography. It has been remarked above, that by the natural grouping of spherical particles, fig. 10, one resulting solid is an acute rhomboid, similar to that of fig. 2, having certain determinate angles, and its greatest dimension in the direction of its axis. Now, if other particles having the same relative arrangement be supposed to have the form of oblate spheroids, the resulting solid, fig. 12, will still be a regular rhomboid; but the measures of its angles will be different from those of the former, and will be more or less obtuse according to the degree of oblateness of the primitive spheroid. It is at least possible that carbonate of lime and other substances, of which the forms are derived from regular rhomboids as their primitive form may, in fact, consist of oblate spheroids as elementary particles.

As to the hexagonal prisms, if our elementary spheroid be on the contrary oblong, instead of oblate, it is evident that, by mutual attraction, their centres will approach nearest to each other when their axes are parallel, and their shortest diameters in the same plane (fig. 13). The manifest consequence of this structure would be, that a solid so formed would be liable to split into plates at right angles to the axes, and the plates would divide into prisms of three or six sides with all their angles equal, as occurs in phosphate of lime, beryl, &c. It may farther be observed, that the proportion of the height to the base of such a prism, must depend on the ratio between the axes of the elementary spheroid.

And in regard to the cube: let a mass of matter be supposed to consist of spherical particles all of the same size, but of two different kinds in equal numbers, represented by black and white balls; and let it be required that, in their perfect intermixture, every black ball shall be equally distant from all surrounding white balls, and that all adjacent balls of the same denomination shall also be equidistant from each other. The doctor shows, that these conditions will be fulfilled if the arrangement be cubical, and that the particles will be in equilibrio. Fig. 14 represents a cube so constituted of balls, alternately black and white throughout. The four black balls are all in view. The distances of their centres being every way a superficial diagonal of the cube, they are equidistant, and their configuration represents a regular tetrahedron; and the same is the relative situation of the four white balls. The distances of dissimilar adjacent balls are likewise evidently equal; so that the conditions of their union are complete, as far as appears in the small group: and this is a correct representative of the entire mass, that would be composed of equal and similar cubes.

There remains one observation with regard to the spherical form of elementary particles, whether actual or virtual, that must be regarded as favorable to the foregoing hypothesis, namely, that many of those substances which we have most reason to think simple bodies, as among the class of metals, exhibit this further evidence of their simple nature, that they crystallise in the octohedral form, as they would do if their particles were spherical. But it must, on the

contrary, be acknowledged, that we can at present assign no reason why the same appearance of simplicity should take place in fluor spar, which is presumed to contain at least two elements; and it is evident, that any attempts to trace a general correspondence between the crystallographical and supposed chemical elements of bodies, must, in the present state of these sciences, be premature. Any sphere when not compressed will be surrounded by twelve others, and, consequently, by a slight degree of compression, will be converted into a dodecahedron, according to the most probable hypothesis of simple compression.

M. Beudant has lately made experiments to discover why a saline principle of a certain kind sometimes impresses its crystalline form upon a mixture in which it does not, by any means, form the greatest part; and also with the view of determining why one saline substance may have such an astonishing number of secondary forms as we sometimes meet with. The presence of urea makes common salt take an octohedral form, although in pure water it crystallises in cubes similar to its primitive molecules. Sal-ammoniac, which crystallises in pure water in octohedrons, by means of urea crystallises in cubes. A very slight excess or deficiency of base in alum, causes it to assume either cubical or octohedral secondary forms; and these forms are so truly secondary, that an octohedral crystal of alum, immersed in a solution which is richer in respect to its basis, becomes enveloped with crystalline layers, which give it at length the form of a cube. The crystalline form in muddy solutions acquires greater simplicity, losing all those additional facets which would otherwise modify their predominant form. In a gelatinous deposit, crystals are rarely found in groups, but almost always single, and of a remarkable sharpness and regularity of form, and they do not undergo any variations but those which may result from the chemical action of the substance forming the deposit. Common salt, crystallised in a solution of borax, acquires truncations at the solid angles of its cubes; and alum crystallised in muriatic acid takes a form which M. Beudant has never been able to obtain in any other manner. Thirty or forty per cent of sulphate of copper may be united to the rhomboidal crystallisation of sulphate of iron, but it reduces this sulphate to a pure rhomboid, without any truncation either of the angles or the edges. A small portion of acetate of copper reduces sulphate of iron to the same simple rhomboidal form, notwithstanding that this form is disposed to become complicated with additional surfaces. Sulphate of alumina brings sulphate of iron to a rhomboid, with the lateral angles only truncated, or what M. Haiiy calls his *variété unitaire*; and whenever this variety of green vitriol is found in the market, where it is very common, we may be sure, according to M. Beudant, that it contains alumina. Natural crystals mixed with foreign substances are in general more simple than others, as is shown in a specimen of axinite or violet schorl of Dauphiné, one extremity of which, being mixed with chlorite, is reduced to its primitive form; while the other end, which is pure,

is varied by many facets produced by different decrements. In a mingled solution of two or more salts, of nearly equal solubility, the crystallisation of one of them may be sometimes determined by laying or suspending in the liquid a crystal of that particular salt.

M. Le Blanc states, that on putting into a tall and narrow cylinder crystals at different heights, in the midst of their saturated saline solutions, the crystals at the bottom increase faster than those at the surface, and that there arrives a period when those at the bottom continue to enlarge, while those at the surface diminish and dissolve. Those salts which are apt to give up their water of crystallisation to the atmosphere, and of course become efflorescent, may be preserved by immersion in oil, and subsequent wiping of their surface. In the Wernerian language of crystallisation the following terms are employed: When a secondary form differs from the cube, the octohedron, &c. only in having several of its angles or edges replaced by a face, this change of the geometrical form is called a truncation. The alteration in the principal form produced by two new faces inclined to one another, and which replace by a kind of bevel, an angle, or an edge, is called a bevelment. When these new faces are to the number of three or more, they produce what Werner termed a pointing, or acumination. When two faces unite by an edge, in the manner of a roof, they have been called culmination. Replacement is occasionally used for bevelment.

Professor Mohs, successor to Werner in Freyberg; Dr. Weiss, professor of mineralogy in Berlin; and M. Brochant, professor of mineralogy in Paris, have each recently published systems of mineralogy. Pretty copious details, relative to the first, are given in the third volume of the Edinburgh Philosophical Journal.

For the instrument that measures the angles of crystals, see GONIOMETER.

CTESIAS, a native of Cnidos, who accompanied Cyrus, the son of Darius, in his expedition against his brother Artaxerxes, by whom he was taken prisoner; but curing Artaxerxes of a wound he received in the battle, he became a great favorite at the court of Persia, where he continued practising physic for seventeen years, and was also employed in several negotiations. He wrote the history of Persia in twenty-three books, and a History of the Indies: but these works are now lost, and all we have remaining of them is an abridgment compiled by Photius. Several of the ancients considered Ctesias as a fabulous writer; yet other historians, as well as some modern writers, have adopted in part his chronology of the Assyrian kings.

CTESIBIUS, a mathematician of Alexandria who flourished about A.A.C. 120. He was the first who invented the pump. He also invented a clepsydra, or water clock, which, by a continual supply of water and a waste pipe, was kept very regular. See CLEPSYDRA.

CTESIPHON, a celebrated Greek architect, who furnished the designs for the famous temple of Ephesus, and invented a machine for bringing thither the columns to be used in that noble structure. He flourished A.A.C. 544.—Also the

name of an Athenian, who advised his fellow-citizens to honor Demosthenes with a golden crown for his probity and virtue.

CRESIPRON, in ancient geography, a large city of Chalonitis, the most southern province of Assyria. It was situated on the east side of the Tigris, opposite to Seleucia: and built by the Parthians as a rival to that city. Here the kings of Parthia passed the winter, as they did the summer at Ecbatana.

CUB, *v. a. & n. s. ?* Minsheu is of opinion **CUBLESS**, *adj.* } that cub is derived from Lat. *cubo*, because it does not go out as the elder animals do, but lies close in its den. Cub is a young beast, particularly the offspring of a bear or fox; the young of a whale; contemptuously, a boy or girl; a stall for cattle. To cub is to bring forth; to shut up.

I would outstare the sternest eyes that look,
Pluck the young sucking *cube* from the she-bear.

Shakespeare.

O thou dissembling *cub*! what wilt thou be,
When time hath sowed a grizzle on thy case?
Or will not else thy craft so quickly grow,
That thine own trip shall be thine overthrow? *Id.*

This night, wherein the *cub*-drawn bear would couch,

The lion, and the belly-pinched wolf,
Keep their fur dry. *Id. King Lear.*

Was never fox but wily *cubs* begets;
The bear his fierceness to his brood besets. *Hall.*

To be *cubbed* upon a sudden, how shall he be perplexed?
What shall become of him? *Burton.*

Two mighty whales, which swelling seas had tost,
One as a mountain vast, and with her came
A *cub*, not much inferior to his dame. *Waller.*

In the eagle's destroying one fox's *cubs*, there's
power executed with oppression. *L'Ettrange.*

Cubbed in a cabin, on a mattress laid,
On a brown george with lousy swabbers fed:
Dead wine, that stinks of the Borrachio, sup
From a foul jack, or greasy maple cup.

Dryden's Persius.

O most comical sight! a country squire, with the
equipage of a wife and two daughters, came to Mr.
Swipwel's shop last night; but, such two unlicked
cubs! *Congreve.*

The love of offspring's nature's general law,
From tigresses and *cubs* to ducks and ducklings.

Byron. Don Juan.

The *cubless* tigress in her jungle raging
Is dreadful to the shepherd and the flock;
The ocean when its yeasty war is waging
Is awful to the vessel near the rock. *Id.*

CUBA, the most considerable of the West India islands, is situated opposite to the entrance of the Gulf of Mexico, extending from 19° 48' to 23° 15' N. lat.; and between 74° 2' and 84° 55' W. long. Its length, from east to west, is 764 miles, and its greatest breadth 134 miles; the superficial extent of the whole island being estimated at 56,000 square miles. A chain of lofty mountains traverses it from east to west, and divides it into two parts. These mountains are covered with the most luxuriant forests of cedar, mahogany, ebony, &c. and give rise to 158 rivers, which pour their liquid treasures into the plains below. They also abound in mines of copper, iron, loadstone, rock-crystal and gold; particles of the latter metal are often washed down by the

rapid mountain torrents. At the foot of these mountains the country spreads out into fertile plains and extensive meadows, which afford pasturage to innumerable herds of cattle, both tame and wild, thousands of which are killed annually for their skins, which are considered of a very superior quality, and furnish one of the principal exports of the island.

The climate of Cuba is hot and dry, but it is considered more healthy than that of St. Domingo, owing to the refreshing gales with which it is occasionally visited from the north and east. The rainy season commences in July, and continues till September, during which time the country is almost deluged with water. The winter, however, is unknown, the ground everywhere presenting a rich carpet of beautiful flowers and odoriferous plants, and the trees retaining all their foliage throughout the year. The soil, though but partially cultivated, produces, in abundance, ginger, long pepper, and a variety of other spices, maize, aloe, mastic cassia, manioc, fistula, sugar, coffee, cocoa, cotton, tobacco, &c. The tobacco of Cuba is considered superior to that grown in any other country, and is exported to Europe in the various forms of leaf, snuff and cigars. Tobacco has always been a royal monopoly in the Spanish transatlantic dominions; the planters here have been exposed to such vexatious restrictions, that the cultivation of it has greatly decreased. In the year 1794, the quantity produced was about 8,000,000 of pounds; but in 1803 it did not amount to 4,000,000. The cultivation of sugar, however, has greatly increased; from the commencement of the present century to 1810, the quantity exported amounted to an average of 644,000 cwt. per annum. Whilst St. Domingo remained in the possession of the Spaniards, coffee was principally cultivated in that island; on the destruction of their plantations there, however, they transferred this culture to Cuba, where it has risen to about 20,000,000 of pounds annually. Cotton is also profitably cultivated in this island. In 1764 a straggling band of emigrants from Florida introduced bees, and this useful insect has multiplied to such an extent, that the inhabitants not only receive an ample supply of honey and wax for their own consumption, but annually export great quantities of both. In some parts of the island mineral waters, possessing valuable medicinal properties, are found; and there are also many productive salt ponds. The rivers, none of which are navigable, abound with a variety of fish.

The Spaniards divided Cuba into two governments, viz. Cuba towards the eastern, and Havannah towards the western part of the island; and these are again subdivided into jurisdictions and districts. Cuba, or San Jago, is considered to be the capital; but the Havannah has long been the place of residence of the governor, and most of the principal officers of the island. The other chief towns are Puerto del Principe, Halquin, Trinidad, Bayamo, and Batabane. The island is indented with several bays, the principal of which visited by shipping, is Nueritas.

Cuba was discovered by the celebrated Christopher Columbus in his first voyage in the

year 1492. Yet so earnest was the voyager in his pursuit of gold, that although he admired the great beauty of the scenery, and the luxuriant fertility of the soil, he sailed on to Hayti, in the expectation of finding a greater abundance. The island of Cuba did not submit to the Spanish jurisdiction until 1511, when it was conquered by Valasquez. About eight years after this event, a pilot having discovered that the channel which flows between the northern part of Cuba and the continent, was the most convenient passage for vessels sailing from Mexico to Europe, the Havannah was built as a port for their reception. At first this town was an insignificant place, but its rapid increase in wealth and importance soon attracted the cupidity of the English and French pirates, who repeatedly pillaged it. The noted freebooter Morgan succeeded in taking the Havannah in the year 1669. In the year 1741 Admiral Vernon established a fort, &c., on the southern coast; but the heat of the climate soon obliged him to evacuate it. In 1762 the English, under admiral Pocock and lord Albemarle, again took the Havannah, and found vast quantities of booty in it; but it was restored to the Spaniards in the following year, since which time they have kept possession of it, and have endeavoured to render it impregnable. Of late this important part of the island has made a movement towards independence of the mother country; and has requested, we believe, to be placed under the protection of Colombia; but the progress and present hope of this result is not known at this time (1826) in England. See HAVANNAH. According to the latest estimates, the population of Cuba amounted to 423,000, which is about eight persons for every square mile. Humboldt considers that this population comprises 234,000 whites, 90,000 free people of color, and 108,000 slaves.

CUBA, a city in the island of the same name. It is situated in 76° 3' W. long., and 20° 1' N. lat. It has a good port, protected by a castle named the Morra. This city was once the capital of the island, and still retains that nominal honor. Since the commerce, however, has centered in the Havannah, Cuba has been deserted by its principal inhabitants, and is at present chiefly occupied by the proprietors of neighbouring estates. It contains no buildings worthy of notice.

CUBÆA, in botany, a genus of plants of the class decandria, and order monogynia: CAL-turbinate, five-parted, unequal: cor. five-petalled, nearly equal, with the stamens inserted into the calyx, the three upper ones being shorter; the legume villous and six or seven seeded; species two, (both natives of Guinea: one, a tree sixty feet high, with spiked terminal flowers.

CUBAGUA, an island of South America, eight miles long, near Cumana, between Margarita and Terra Firma, discovered by Columbus. It originally abounded with pearls; but in 1524 the pearl banks disappeared. The soil is dry, barren, and nitrous, without fresh water, and producing little else but rushes. Long. 63° 30' W., lat. 10° 42' N.

CUBAN. See KUBAN.

CUBATION, *n. s.* } Lat. *cubatio*. The act
Cu'BATORY, *adj.* } of lying down. Recumbent.

Cu'BATURE, *n. s.* From *cube*. The finding exactly the contents of any solid body.

CUBE, *n. s.* } *Kyβoc*, a die. A cube
CUBE-ROOT, *n. s.* } is a regular solid body,
Cu'BICK-ROOT, *n. s.* } consisting of six square
Cu'BICAL, *adj.* } and equal faces or sides,
Cu'BICK, *adj.* } and the angles all right,
Cu'BICALLY, *adv.* } consequently all equal.
Cu'BICALNESS, *n. s.* } Cube root and cubic
Cu'BIFORM, *adj.* } root signify a number,

by whose multiplication into itself, and again into the product, any given number is formed: thus two is the cube root of eight. See ARITHMETIC, and GEOMETRY. Cubical and cubic denote having the properties of a cube. These adjectives are also applied to numbers. Cubiform is cube-shaped.

The number of ten hath been as highly extolled, as containing even, odd, long and plain, quadrate and cubical numbers. *Brown's Vulgar Errors.*

The number of four multiplied into itself, produceth the square number of sixteen; and that again multiplied by four, produceth the cubick number of sixty-four. If we should suppose a multitude actually infinite, there must be infinite roots, and square and cubick numbers; yet, of necessity, the root is but the fourth part of the square, and the sixteenth part of the cubick number. *Hale's Origin of Mankind.*

All the master planets move about the sun at several distances, as their common centre, and with different velocities. This common law being observed in all of them, that the squares of the times of the revolutions are proportional to the cubes of their distances. *Greav's Cosmologia.*

A close vessel, containing ten cubical feet of air, will not suffer a wax candle of an ounce to burn in it above an hour before it be suffocated.

Wilkin's Math. Mag.

It is above a hundred to one, against any particular throw, that you do not cast any given set of faces with four cubical dice; because there are so many several combinations of the six faces of four dice.

Bentley's Sermons.

If urged by a stronger fire, salt fuses or forms large cubes. *Darwin.*

Of in wide lakes, around their warmer brims,
In hollow pyramids the crystals swim;
Or, fused by earth-born fires, in cubic blocks
Shoot their white forms, and harden into rocks. *Id.*

CUBE. See GEOMETRY.

CUBE ROOT. See ALGEBRA and ARITHMETIC.

Cu'BEB, *n. s.* A small dried fruit resembling pepper, but somewhat longer, of a grayish brown color on the surface. It has an aromatic smell, and is acrid to the taste. Cubebs are brought from Java.

Aromatics, as *cubebs*, cinnamon, and nutmegs are usually put into crude poor wines, to give them more oily spirits. *Floyer on the Humours.*

Cu'BICULAR, *adj.* } Old Fr. *cubiculaire*;
Cu'BICULARY, *adj.* } Lat. *cubicularis*. Belonging to the bed chamber. Fitted for the posture of lying down.

Custom, by degrees, changed their *cubiculary* beds into discombitory, and introduced a fashion to go from the baths unto these. *Brown's Vulgar Errors.*

Being the inseparable *cubicular* companion the king took comfort in, in the height of his troubles. *Howell*.

CUBIDIA; from *κῦβος*, a die; in mineralogy, a genus of spars, so named from their being of the shape of a common die, or of a cubic figure. These bodies owe this shape to an admixture of lead, and there are only two known species of the genus. 1. A colorless crystalline kind, with thin flakes, found in the lead mines of Yorkshire, and some other parts; and, 2. A milky white species, with thicker crusts, found in the lead mines of Derbyshire and Yorkshire, but usually small, and not very plentiful.

CUBIT, *n. s.* } Lat. *cubitus*; *κῦβιστρον*. A
CUBITAL, *adj.* } measure in use among the
ancients; which was originally, says Calmet, the distance from the elbow bending inwards, to the extremity of the middle finger. This measure is the fourth part of a well-proportioned man's stature. Some fix the Hebrew cubit at twenty inches and a half, Paris measure; and others at eighteen. Cubital signifies, that which is only the length of a cubit.

This proude king let make a statue of gold
Sixty *cubites* long and seven in brede.

Chaucer. Cant. Tales.

That like a litle lake it seemd to bee,
Whose depth exceeded not three *cubits* hight.

Spenser. Faerie Queene.

The watchmen of Tyre might well be called pygmies, the towers of that city being so high, that unto men below they appeared in a *cubital* stature.

Brownes's Vulgar Errors.

From the tip of the elbow to the end of the long finger, is half a yard, and a quarter of the stature; and makes a *cubit*, the first measure we read of, the ark of Noah being framed and measured by *cubits*.

Holder on Time.

Measured by *cubit*, length, and breadth, and height.

Milton.

The Jews used two sorts of *cubits*; the sacred, and the profane or common.

Arbutnot on Measures.

When on the goddess first I cast my sight,
Scarce seemed her stature of a *cubit* height.

Pope.

CUBIT, ENGLISH, according to Dr. Arbuthnot, is equal to eighteen inches.

CUBIT, JEWISH, one foot, 9.888 inches.

CUBIT, ROMAN, one foot, 5.406 inches.

CUBITUS, in anatomy, the same with *Ulna*. See **ANATOMY**. Some use the word for all that part of the arm between the elbow and the wrist, including the ulna or cubitus, properly so called, and the radius.

CUBOIDES OS, or **OS CUBIFORME**, in anatomy, the seventh bone of the foot, so called from its being in the form of a cube. See **ANATOMY**.

CUCKFIELD, a market town of Sussex, on the road from London to Brighton. It has a market on Friday, and fairs on Whit-Thursdays and September 16th. It is fourteen miles north of Brighton, and thirty-seven south by west of London.

CUCKINGSTOOL, *n. s.* Hicckes derives it from *coquina*, anciently *cockainga*, an idle jade, a base woman. Mr. Todd refers it to the Germ. *karche*, a sort of pillory. An engine invented

for the punishment of scolds and unquiet women, which, in ancient times, was called *tumbrel*.

We'll ship them out in *cuck-stools*, there they'll sail
As brave Columbus did. *Beaumont and Fletcher*

These mounted on a chair-curule,
Which moderns call a *cucking-stool*,
March proudly to the river's side. *Hudibras.*

CUCKINGSTOOL, an ancient instrument of punishment described in Doomsday book as *cathedra stercoris*; it was in use even in the Saxon time. The delinquents, consisting of scolds, cheating bakers or brewers, and other petty offenders, were led to this stool and immersed over head and ears in stercore, or stinking water. Some think it a corruption from ducking stool; others from choking stool, because the delinquents were nearly suffocated in the water.

CUCKOLD, *v. a. & n. s.* } Fr. *coçu*; Dut.
CUCKOLDLY, *adj.* } *kochoer*; Germ.
CUCKOLDOM, *n. s.* } *kuckcuck*; Icel.
CUCKOLD-MAKER, *n. s.* } *quonkall*. The

last of these words, which is derived from *quona*, a woman, and *kala*, to blemish, is considered by Serenius, to be the parent of the English word; and there is some plausibility in his conjecture. But the question as to the etymon seems to be set at rest by Horne Tooke: 'The Italian *ucolo*, a cuckow,' says he, 'gives us the word *ucol*, (without the terminating *d*) as the common people rightly pronounce it, and as the verb was formerly and should still be written. To *ucol* is to do as the cuckow does; and *ucol-ed*, *ucol'd*, *ucould*, its past participle, means cuckow-ed, i. e. served as the cuckow serves other birds.' A cuckold is one whose wife is false to his bed. To cuckold is to seduce a wife to be unfaithful to her husband; to wrong a husband by unchastity. A cuckold-maker is an habitual seducer of married women. Cuckoldom signifies the act of adultery; the state of being a cuckold. Cuckoldly is, cuckold-like; abject; sneaking; cowardly.

This drunken miller spake ful some again,
And sayde, Leve brother Osewold,
Who hath no wif he is no *cokewold*.

Chaucer. Cant. Tales.

If thou canst *cuckhold* him, thou do'st thyself a
pleasure, and me a sport. *Shakespeare. Othello.*

But for all the whole world; why, who would not
make her husband a *cuckold*, to make him a monarch?
I should venture purgatory for't. *Id.*

Poor *cuckoldly* knave, I know him not: yet I
wrong him to call him poor; they say the jealous
knave hath masses of money.

Id. Merry Wives of Windsor.

If I spared any that had a head to hit, either
young or old, he or she, *cuckhold*, or *cuckholdmaker*, let
me never hope to see a chine again.

Id. Henry VIII.

But suffer not thy wife abroad to roam,
Nor strut in streets with amazonian pace;
For that's to *cuckhold* thee before thy face.

Dryden's Juvenal.

She is thinking on nothing but her colonel, and
conspiring *cuckoldom* against me. *Id. Spanish Friar.*

One Hernando, *cuckholdmaker* of this city, contrived
to steal her away. *Id.*

It is a true saying, that the last man of the parish
knows of his *cuckoldom*, is himself.

Arbutnot's John Bull.

Cæsar and Pompey, Mahomet, Beliaricus,

Have much employ'd the muse of history's pen ;
Their lives and fortunes were extremely various,

Such worthies Time will never see again ;
Yet to these four, in three things, the same luck holds,
They all were heroes, conquerors, and *cuckolds*.

Byron. Don Juan.

CUC'KOO, or } Fr. *coucou*; Ital. *cuculo*;
CUC'KOW, n. s. } Span. *cuco*, *cucillo*; Ger.
cuckuk; Dut. *koekoek*; Dan. *kuckuk*; Sw. *kuku*;
Welsh *guccw*; Lat. *cuculus*; *κοκοῦς*. A bird
which appears in the spring, and is said to suck
the eggs of other birds, and to lay her own to be
hatched in their place: from which practice, it
was usual to alarm a husband, at the approach
of an adulterer, by calling cuckoo; and the warn-
ing became at last a name for the husband so
warned. See CUCULUS. Cuckoo is also a term
of contempt.

— Jalousie,
That wored of yelwe goldes a gerlond,
And hedde a *cuckow* sitting on hire hond.

Chaucer. Cant. Tales.

Finding Mopsa, like a *cuckoo* by a nightingale,
alone with Pamela, I came in. *Sidney.*

The merry *cuckoo*, messenger of spring,
His trumpet shrill hath thrice already sounded.

Spenser.

The pain song *cuckoo* gray,
Whose note full many a man doth mark,
And dares not answer, nay. *Shakespeare.*

Why, what a rascal art thou, then, to praise him so
for running!—A horseback, ye *cuckoo*;—but a-foot,
he will not budge a foot. *Id. Henry IV.*

Strives for a court and for a college name,
Yet nought within but lousy coules doth hold,
Like a scabbed *cuckow* in a cage of gold. *Hall.*

I deduce,
From the first note the hollow *cuckoo* sings,
The symphony of spring; and touch a theme
Unknown to fame; the passion of the grove.

Thomson.

They have no more notes in their song than the
cuckow. *Burke.*

Chides with her dulcet voice the tardy Spring,
Bids slumbering Zephyr stretch his folded wing ;
Wakes the hoarse *cuckoo* in his gloomy cave,
And calls the wondering dormouse from the grove.

Darwin.

CUC'KOO, or CUCKOW. See CUCULUS.

CUC'KOO-BUD, n. s. } Lat. *cardaminus*.
CUC'KOO-FLOWER, n. s. } The name of a flower.

When daisies pied, and violets blue,
And *cuckoo-buds* of yellow hue,
Do paint the meadows much bedight.

Shakespeare.

Nettles, *cuckoo-flowers*,
Darnel, and all the idle weeds. *Id. King Lear.*

CUC'KOO-SPITTLE, n. s. Cuckoo and spit-
tle.

Cuckoo-spittle, or woodsear, is that spumous dew or
exudation, or both, found upon plants, especially
about the joints of lavender and rosemary; observable
with us about the latter end of May.

Browne's Vulgar Errors.

CUC'QUEAN, n. s. From *cuck*, a *cuck*
old-maker, and *queen*, a wife, says Minsheu—
and, therefore, a *cucquean* is a *cuckold-maker's*
wife; a she *cuckold*. This derivation is borne
out by the authority of our old writers. Mr.
Todd, however, derives the word from French
coquette, and defines it, a vile woman; a prosti-
tute. Minsheu is clearly nearer to the mark.

He loves variety, and delights in change;
And I heard him say, should he be married,
He'd make his wife a *cucquean*. *Hayward.*

CUCUBALUS, berry bearing chickweed: in
botany, a genus of the trigynia order and de-
candria class of plants, natural order twenty-
second, caryophylleæ: CAL. inflated; petals five,
unguiculated, without a nectariferous corona at
the throat; CAPS. trilocular. There are thirteen
species, the most remarkable of which are: 1.
C. beher, Swedish *lychnis*, or gum *sepungar*, a
native of several parts of Europe. The em-
palement of its flower is curiously wrought like
network, and is of a purplish color. The leaves
have somewhat of the flavor of peas. The
Gothlanders apply the leaves to erysipelatos
eruptions. Horses, cows, sheep, and goats, eat
this plant. 2. C. noctiflora, the night flowering
lychnis, growing naturally in Spain and Italy.
It is a perennial plant, rising with an upright
branching stalk, a foot and a half high, garnished
with very narrow leaves placed opposite. The
upper part of the stalk branches very much:
3. C. otites, the catch-fly, a native of Britain and
other European countries. It has a thick, fleshy,
perennial root, which strikes deep into the
ground, from whence rises a jointed stalk three
or four feet high. At the joints there exudes
a viscous clammy juice, that sticks to the fingers
when handled; and the small insects which
settle upon those parts of the stalks are thereby
so fastened that they cannot get off. The flowers
are small, and of a greenish color. The plant is
propagated by seeds.

CUCULLARIA, in botany, a genus of plants
of the monandria class, and monogynia order,
CAL. four-parted: OOB. four petalled, unequal, and
spurred; filaments petal-like; anthers with dis-
tinct cells. Species one only; a tall tree of Gui-
ana, having pale yellow flowers.

CUCULLATE, *adj.* } Lat. *cucullatus*. Hood-
CUCULLATED, *adj.* } ed; covered, as with a
hood or cowl; having the resemblance or shape
of a hood.

They are differently *cucullated*, and capped upon
the head and back. *Browne's Vulgar Errors.*

CUCULUS, the cuckoo, in ornithology, a ge-
nus belonging to the order of picæ. The cha-
racters are: the bill smooth, and more or less
bending; the nostrils bounded by a small rim;
the tongue short and pointed; the feet and toes
formed for climbing. There are fifty-five species,
of which the following are the most remarka-
ble:—

1. C. canorus, the common cuckoo, weighs
about five ounces, and is in length fourteen
inches: in breadth twenty-five. The bill is
black, and about two-thirds of an inch in length.
The head, hind part of the neck, coverts of the
wings and rump, are of a dove color; darker on

the head and paler on the rump. The throat and upper part of the neck are of a pale gray; the breast and belly white, crossed elegantly with undulated lines of black. The tail consists of feathers of unequal lengths; the middle tail-feathers are black, tipped with white; the others are marked with white spots on each side their shafts. The legs are short, and the toes disposed two backwards and two forwards, like those of the wood-pecker, though it is never observed to run up the sides of trees. The female differs in some respects.—The neck before and behind is of a brownish red; the tail barred with the same color and black, and spotted on each side the shaft with white. The young birds are brown mixed with black, and in that state have been described by some authors as old ones. These birds appear in our country early in spring, and make the shortest stay with us of any bird of passage. The cuckoo is silent for some time after his arrival; his note is a call to love, and used only by the male, who sits perched generally on some dead tree or bare bough, and repeats his song, which he loses as soon as the amorous season is over. His note is so uniform, that his name in all languages seems to have been derived from it. The song of the female is widely different, and has been so little attended to, that few are acquainted with it. It resembles the cry of the dab-chick. Unlike the generality of birds, cuckoos do not pair. When a female appears on the wing, she is often attended by two or three males, who seem to be earnestly contending for her favors. She does not begin to lay till some weeks after her arrival. It is almost universally allowed, that the cuckoo does not hatch its own eggs. The hedge sparrow, the water wagtail, or the titlark, is generally the nurse of them. Buffon enumerates twenty sorts of nests at least in which they have deposited their eggs. When the hedge sparrow has sat her usual time, and disengaged the young cuckoo and some of her own offspring from the shell, her own young ones, and any of her eggs that remain unhatched, are soon turned out, the young cuckoo remaining possessor of the nest, and sole object of her future care. The young birds are not previously killed, nor are the eggs demolished; but all are left to perish together, either being entangled about the bush which contains the nest, or lying on the ground under it. A cuckoo, says Dr. Jenner, in a paper published in the Philosophical Transactions, laid her egg in a water wagtail's nest in the thatch of an old cottage. The wagtail sat her usual time, and then hatched all the eggs but one, which, with all the young ones except the cuckoo, was turned out of the nest. The young birds, consisting of five, were found upon the rafter that projected from under the thatch, and with them was the egg not in the least injured. The cuckoo was reared by the wagtails till it was nearly capable of flying, when it was killed by an accident. The same writer mentions a similar case of a hedge sparrow, in which the young sparrow, having returned alive, was a second and third time turned out. Cuckoos may be, and often are brought up tame, so as to become familiar. They will eat in this state bread and milk, fruits, insects, eggs, and flesh either cooked

or raw; but in a state of nature, chiefly live on caterpillars. When fat, they are said to be as good eating as a land rail. The French and Italians eat them, and the ancient Romans admired them greatly. Pliny says that there is no bird that can be compared to them for delicacy. In migrating, the major part of these birds are supposed to go into Africa, as they are observed to visit the island of Malta twice a year. They are well known also at Aleppo, and are said to be common in Sweden, but not to appear so early by a month as with us. Russia is not destitute of it, and Latham has seen a specimen of it brought from Kamptchatka, formerly in the possession of Sir Joseph Banks.

2. *C. honoratus*, or the sacred cuckoo, is somewhat less than our cuckoo; the general color is blackish ash on the upper parts, marked with two spots of white on each feather; beneath, white transversely spotted with ash-color: the quills are cinereous, transversely spotted with white: the tail is much cuneated, five inches and a half long, and of the same color as the quills; the outer feather only three inches long; the legs and claws are of a pale ash-color. This species inhabits Malabar, where the natives hold it sacred, as it feeds on reptiles.

3. *C. indicator*, or the honey-guide, is a native of Africa. This curious species of cuckoo is found at a considerable distance from the Cape of Good Hope, in the interior parts of Africa, being entirely unknown at that settlement. The Dutch settlers have given this bird the name of honiguyzer, or honey-guide, from its quality of discovering wild honey to travellers. Its color has nothing striking or beautiful. Its size is considerably smaller than that of our cuckoo in Europe; but in return, the instinct which prompts it to seek its food in a singular manner is truly admirable. Not only the Dutch and Hottentots, but likewise a species of quadruped named *ratel* (probably a new species of badger), are frequently conducted to wild bee-hives by this bird, which, as it were pilots them to the very spot. The honey being its favorite food, its own interest prompts it to be instrumental in robbing the hive, as some scraps are commonly left for its support. The morning and evening are its times of feeding, and it is then heard calling in a shrill tone, *cherr, cherr*; which the honey-hunters carefully attend to as the summons to the chase. From time to time they answer with a soft whistle; which the bird hearing, always continues its note. As soon as they are in sight of each other, the bird gradually flutters towards the place where the hive is situated, continually repeating its former call of *cherr, cherr*. At last the bird is observed to hover for a few moments over a certain spot, and then silently retiring to a neighbouring bush or resting place, the hunters are sure of finding the bees' nest in that identical spot; whether it be in a tree or in the crevice of a rock, or, as is most commonly the case, in the earth. While the hunters are busy in taking the honey, the bird is seen looking on attentively to what is going forward, and waiting for its share of the spoil. The bee-hunters never fail to leave a small portion for their conductor: but commonly take care

never to leave so much as would satisfy its hunger. The bird's appetite being whetted by this parsimony, it is obliged to commit a second treason, by discovering another bees' nest, in hopes of a better salary. It is about seven inches in length, and is of a rusty brown color on the back, with a white breast and belly. A nest which was shown to Dr. Sparrman for that of this bird, was composed of slender filaments of bark woven together in the form of a bottle; the neck and opening hung downwards, and a string, in an arched shape, was suspended across the opening fastened by the two ends, perhaps for the bird to perch on.

4. *C. vetula* is a little bigger than a blackbird; the bill above an inch and a half long: the upper mandible black, the lower whitish; crown of the head brown, the feathers of it soft and silky; the upper parts of the body and the quills cinereous olive; throat and forepart of the neck whitish; the rest of the under parts rufous; the tail is much cuneated; the two middle feathers cinereous olive, the others dusky black tipped with white; the outer feather very short; legs blue black. It feeds on seeds, small worms, and caterpillars, and is very tame. Besides insects, it will also eat lizards, small snakes, frogs, young rats, and sometimes even small birds. The snakes they swallow head foremost, letting the tail hang out of the mouth till the foreparts are digested. Its gait is that of leaping, like a magpie; being frequently seen on the ground; and its flight but short, chiefly from bush to bush. At the time when other birds breed, they likewise retire into the woods, but their nests have never yet been found. It has the name of rainbird, as it is said to make the greatest noise before rain. It is common all the year at Jamaica. In another variety, also, common in Jamaica, the feathers on the throat appear like a downy beard, whence probably the name of old man rain beard, given it there, and by Ray, Sloane, &c.

CUCUMBER, *n. s.* Fr. *concombre*; Ital. *cocomero*; Lat. *cucumer*. The name of a creeping plant, and also of its fruit.

How cucumbers along the surface creep,
With crooked bodies and with bellies deep.

Dryden's Virgil.

The southern wits are like cucumbers, which are commonly all good in their kind; but at best are an insipid fruit: while the northern geniuses are like melons, of which not one in fifty is good; but when it is so, it is an exquisite relish.

Berkeley.

Pardon then,

Ye sage dispensers of poetic fame,
The' ambition of one meaner far, whose powers,
Presuming an attempt not less sublime,
Pant for the praise of dressing to the taste
Of critic appetite, no sordid fare,
A cucumber, while costly yet and scarce.

Cowper.

CUCUMBER. See **CUCUMIS**.

CUCUMBER, WILD. See **MOMORDICA**.

CUCUMIS, in botany, a genus of the syngenesia order, and monœcia class of plants; natural order thirty-fourth, cucurbitaceæ. Male **CAL.** quinquepartite: **COR.** quinquepartite; the filaments three. Female **CAL.** quinquepartite: **COR.** quinquepartite, pistil trifid; the sides of the apple sharp-pointed. There are thirteen

species, of which the following are the most remarkable: 1. *C. chata*, the round-leaved Egyptian cucumber. According to Hasselquist, this grows in the fertile earth near Cairo, after the inundation of the Nile, and not in any other place in Egypt, nor in any other soil. It ripens with the water melons. The fruit is a little watery; the flesh almost of the same substance with the melons; it tastes somewhat sweet and cool; but is far from being as cool as the water-melons. This the grandees and Europeans in Egypt eat as the most pleasant fruit they find, and that from which they have the least to apprehend.

2. *C. colocynthis*, the colocynth, coloquintida, or bitter apple of the shops, is brought to us from Aleppo and the island of Crete; the leaves of the plant are large, placed alternate, almost round, and stand upon foot-stalks four inches long; the flowers white, and succeeded by a fruit of the gourd kind, of the size of a large apple, and which is yellow when ripe; the shelly or husky outside enclosing a bitter pulp interspersed with flatfish seeds.

3. *C. elaterium*, the wild, or ass's cucumber, affords the elaterium of the shops; which is the inspissated fœcula of the juice of this species.

4. *C. sativa*, the common cucumber, has roots, composed of numerous, long, slender, white fibres; long slender stalks, very branchy at their joints, trailing on the ground, or climbing by their claspers, adorned at every joint by large angular leaves on long erect foot-stalks, with numerous and monopetalous bell-shaped flowers of a yellow color, succeeded by oblong rough fruit. The principal varieties of this kind are, 1. The common rough green prickly cucumber; a middle-sized fruit, closely set with very small prickles; the plant is of the hardiest sort, but does not show its fruit early. 2. The early green cluster cucumber is a short fruit, remarkable for growing in clusters, and appearing early. 3. The long smooth green Turkey cucumber, is a smooth green-rinded fruit, growing from ten to fifteen inches in length, without prickles. The plants are strong growers with very large leaves. 4. The large smooth green Roman cucumber is a very large and long smooth green fruit, produced from a strong growing plant. 5. The long white prickly Dutch cucumber is a white fruit, eight or ten inches long, set with small black prickles; the plants are but bad bearers in this country. The first four varieties are those chiefly cultivated in this country. They are raised at three different seasons of the year: on hot-beds for early fruit; or under bell, or hand-glasses, for the middle crop; or on the common ground, which is for a late crop, or to pickle. The cucumbers which are ripe before April are unwholesome, being raised wholly by the heat of the dung without the assistance of the sun. Those raised in April are good, and are raised in the manner with which all our gardeners are well acquainted. The cucumber is chiefly used as a refrigerant, or condiment, to accompany animal food. They have a bland insipid juice, without acidity or sweetness, approaching, as appears by their ripening, to a farinaceous matter. When used green they have no nourishment, so they are only to be used in

the summer season, and only by the sedentary. Although cucumbers are neither sweet nor acid, yet they are considerably ascescent, and produce flatulency, cholera, diarrhœa, &c. Their coldness and flatulency may be likewise in part attributed to the firmness of their texture. Oil and pepper, the condiments commonly employed, are very useful to check their fermentation, The skin, which is bitter, may supply the place of aromatics; but should only be used when young.

CUCURBITA, the gourd, a genus of the syngenesia order, and monœcia class of plants; natural order thirty-fourth, cucurbitacæ. Male, CAL. quinquefentated: COR. quinquefid; the filaments three. Female, CAL. quinquefentated: COR. quinquefid: PIST. quinquefid; the seeds of the apple with a tumid margin. There are seven species: the chief are, 1. *C. lagenaria*, the bottle gourd, with thick trailing downy stalks, branching into many spreading runners, and extending along the ground sometimes fifteen or twenty feet in length. The leaves are large, roundish, heart-shaped, indented and woolly. The flowers are large and white, succeeded by long incurvated whitish yellow fruit, growing from about two to five or six feet in length, and from about nine to twenty-four inches in circumference, having a ligneous and durable shell. 2. *C. lignosa*, the ligneous shelled gourd, or calabash. It has trailing stalks, branching into runners, which extend far every way; the leaves are large, lobated, and rough; the flowers yellow, succeeded by roundish smooth fruit of a moderate size, with hard woody shells. 3. *C. melopepo*, or erect gourd, or squash. This rises with an erect strong stalk, several feet high, rarely sending forth side runners, but becoming bushy upward. It is adorned with large lobated leaves; and the flowers are succeeded by depressed knotty fruit, both white and yellow, commonly of a moderate size. 4. *C. papo*, the pompion, or pumpkin, has strong trailing, rough stalks, branching into numerous runners. These extend from ten to forty or fifty feet each way, and are garnished with large, roundish, lobated, rough leaves, and yellow flowers; succeeded by large, round, smooth fruit, of different forms and sizes; some as big as a peck or half-bushel measure; some considerably less, and others not exceeding the bulk of an orange; ripening to a yellow, and sometimes to a whitish color. This species is the most hardy of any, as well as the most extensive in their growth. A single plant, if properly encouraged, will overspread ten or fifteen roods of ground, and produce a great number of fruit, which, when young, are generally a mixture between a deep blue and a pale white, but change as they increase in bulk.

CUCURBITACEOUS, *adj.* From Lat. *cucurbita*, a gourd.

Cucurbitaceous plants are those which resemble a gourd; such as the pumpkin and melon. *Chambers.*

CUCURBITE, *n. s.* Lat. *cucurbita*. A chemical vessel, commonly called a body, made of earth or glass, in the shape of a gourd, and therefore called cucurbite. It is used in the place of a still for distillation. See the article **ALMBIC**.

Cucurbites and *alembikes* eke,

And other swiche ger. *Chaucer. Cant. Tales.*

I have for curiosity's sake distilled quicksilver in a *cucurbita*, fitted with a capacious glass head.

Boyle on Colours.

Let common yellow sulphur be put into a *cucurbita* glass, upon which pour the strongest aquafortis.

Mortimer.

CUCURBITIVE, *adj.* From *cucurbita*. An epithet applied to small worms shaped like a gourd-seed.

CUD, *n. s.* Ang.-Sax. *cu*. That food which is repositied in the first stomach in order to rumination, or to be chewed again.

Many times, when my master's cattle came hither to chew their *cud* in this fresh place, I might see the young bull testify his love. *Sidney.*

You range the pathless wood,
While on a flowery bank he chews the *cud*.

Dryden.

CUDBEAR, a dye-stuff, procured from the lichen *Tartarius*, thus named from Dr. Cuthbert Gordon the inventor, or rather the improver, of it; for it had been known and used in the Highlands of Scotland by the name of *croffel*, for several centuries before. The method there practised is this; after the moss is scraped from the rocks, and cleaned, it is steeped in urine for three months; then taken out and made into cakes, which are hung up in bags to dry. These cakes are afterwards pulverised, and the powder is used, with the addition of alum, to impart the beautiful red color which it gives. Dr. Gordon and his brother first set up this manufacture at Leith; but considerable improvements have been made in it, since its establishment in Glasgow, by Mr. George M'Intosh.

CUDDALORE, a town of Hindostan, in the Carnatic, on the west shore of the bay of Bengal, and district of Gingee. It is very near the place where Fort St. David once stood, and was possessed by the English so far back as 1681. It was reduced by the French in 1782; and in 1783 underwent a severe siege by the British forces commanded by general Stuart; nor did the enemy resign it until the peace of 1783. The neighbouring country suffered much during the wars with Hyder Ali. It is now rapidly recovering, and comprehended in the collectorship of Arcot. The factory is the residence of the commercial agent.

CUDDAPAH, **CURPA**, or **CRIPA**, a considerable district in the province of Golconda, Hindostan. It was once governed by a nabob, from the court of Dehly, but, falling under the dominion of the nizam of Deccan, it was ceded to the British in 1800, and is now subdivided into the two collectorships of Cuddapah and Bellary, or Balhary, under the Madras government. The valleys are fruitful in grain, sugar, cotton, &c. Its principal towns are Cuddapah, Combam, and Wandicotta. The first of them is the residence of the British judge and collector.

CUDDEN, *n. s.* } Without etymology, says
CUDDY, *n. s.* } Johnson; but Serenius refers it to the Islandic, *kutte*, a dwarf. Mr. Todd, on the other hand, derives it from Teut. *ku*, a herd of cattle, and also a pig; and this seems

the most likely etymon. A clown; a stupid rustic; a low dolt; a low bad word.

The slaving *cudden*, propped upon his staff, stood ready gaping with a grinning laugh. *Dryden*.

CUDDLE, *v. n.* Dr. Johnson calls it a low word, and believes it to have no etymology. Dr. Jamieson suggests that the parent may perhaps be found in the Ger. *kudden*, to meet, to come together. Mr. Todd suggests that 'it may be from the Welsh *cuddio*, to hide;' which, however, ought to be *cuddio*. His etymology is by no means an improbable one. The Welsh substantive, *cuddigyl*, which means a retreat, a private place, a private room, a bed-room, comes still nearer in sound to the English word. To lie close; to squat; to embrace closely.

Have you marked a partridge quake,
Viewing the towering falcon nigh?
She *cuddles* low behind the brake;
Nor would she stay, nor dares she fly. *Prior*.

They hopped from spray to spray,
They billed, they chirped all day,
They *cuddled* close all night;
To bliss they waked each morn,
In every bush and thorn,
Gay scenes of new delight. *Somerville*.

CUDDUM RUSOUL, or the Footstep of the Prophet, a town of Bengal, in the district of Chittagong. Here is a handsome cenotaph or dirga containing a stone, on which there is the impression, it is said, of Mahomet's foot, to visit which his followers come once a year from all parts of the district, thereby constituting a fair.

CUDDY, *n. s.* A fish which is found on the Scotch coast; the cole-fish.

The *cuddy* is a fish, of which I know not the philosophical name. It is not much bigger than a gudgeon, but it is of great use in these islands, as it affords the lower people both food and oil for their lamps. *Johnson*.

CRDDY, in a first-rate man of war, is a place lying between the captain-lieutenant's cabin and the quarter-deck; and divided into partitions for the master and other officers. It denotes also a kind of cabin near the stern of a lighter or barge of burden.

CUDGEL, *v. a. & n. s.* } Dut. *kudse*, *kod-*
CUDGELLER, *n. s.* } *se*; Scot. *cud*. A
CUDGELLING, *n. s.* } cudgel is any stick
CUDGEL-PLAY, *n. s.* } or staff, lighter than
CUDGEL-PLAYER, *n. s.* } a club, shorter than
CUDGEL-PLAYING, *n. s.* } a pole, carried for
CUDGEL-PROOF, *adj.* } the purpose of of-
fence or defence; a similar weapon, used by cudgel-players, in the exercise of cudgel-play, or cudgel-playing. To cudgel is, to beat with a stick; to drub; to beat in general. Cudgel-proof signifies being able to resist a beating given by a stick. To cross the cudgels means to forbear the contest, from the practice of cudgel players, to lay one over the other.

My lord, he speaks most vilely of you, like a foul-mouthed man as he is; and said he would *cudgel* you. *Shakespeare. Henry IV.*

Cudgel thy brains no more about it; for your dull ass will not mend his pace with beating. *Id. Hamlet.*

All we have seen, compared to his experience,
Has been but *cudgel-play* or cock-fighting. *Beaumont and Fletcher.*

Vine twigs, while they are green, are brittle; yet the wood, dried, is extreme tough; and was used by the captains of armies, amongst the Romans, for their *cudgels*. *Bacon.*

They were often liable to a night-walking *cudgeller*, or the emptying of an urinal. *Milton.*

Do not provoke the rage of stones
And *cudgels* to thy hide and bones:
Tremble and vanish. *Hudibras.*

His doublet was of sturdy buff,
And though not sword, yet *cudgel-proof*. *Id.*

This, if well reflected on, would make people more wary in the use of the rod and the *cudgel*. *Locke.*

It is much better to give way, than it would be to contend at first, and then either to cross the *cudgels*, or to be baffled in the conclusion. *L'Esrange.*

The ass courting his master, just as the spaniel had done, instead of being stroked and made much of, is only rated off and *cudgelled* for all his courtship. *South.*

The wise Cornelius was convinced, that these, being polemical arts, could no more be learned alone than fencing or *cudgel-playing*. *Arbuthnot and Pope.*

Three duels he fought, thrice ventured his life,
Went home, and was *cudgelled* again by his wife. *Swift.*

The *cudgel* in my niece did shake,
Each bristled hair stood like a stake,
When wi' an aldrithc stour, quick—quick—
Among the springs,
A wa ye squattered, like a drake,
On whistling wings. *Burns.*

CUDLE, *n. s.* A small sea-fish.
Of round fish there are britt, sprat, *cudles*, cels. *Ceres.*

CUDWEED, *n. s.* From cud and weed.
A plant. See **GNAPHALIUM**.

There is a plant which our herbalists call *herban impium*, or wicked *cudweed*, whose younger branches still yield flowers to overtop the elder. *Hall.*

CUDWORTH (Ralph), a learned English divine of the seventeenth century. He was one of the persons nominated in 1657 by a committee of the parliament, to be consulted about the English translation of the Bible. In 1678 he published his True Intellectual System of the Universe; a work which met with great opposition. He likewise published a treatise, entitled, *Deus Justificatus*, or The Divine Goodness of God vindicated against the Assertions of Absolute and Unconditionate Reprobation. He embraced the mechanical or corpuscular philosophy; but with regard to the Deity, spirits, geni, and ideas, he followed the Platonists. He died at Cambridge in 1688, and left several manuscripts, one of which bishop Chandlar published in 1731, with this title, *A Treatise concerning Eternal and Immutable Morality*. The rest, after having been plundered by Dodd, for his Commentary on the Bible, were purchased by the trustees of the British Museum.

CUE. Old Fr. *cove*; mod. Fr. *queue*; a tail. The tail or end of anything, as the long tail of a wig; the last words of a speech on the stage, which are the token for an entrance or answer; a hint; an intimation; the part which any man is to play in his turn; humor; temper of mind;

a mark denoting half a farthing, in the buttery books of Oxford and Cambridge; an instrument used in the game of billiards.

Pyramus, you begin : when you have spoken your speech, enter into that brake and so every one according to his cue.

Shakspeare. Midsummer Night's Dream.

What's Hecuba to him, or he to Hecuba,
That he should weep for her? What would he do,
Had he the motive and the cue for passion
That I have? He would drown the stage with tears.

Id. Hamlet.

Hold your hands,

Both you of my inclining, and the rest :
Were it my cue to fight, I should have known it
Without a prompter.

Id. Othello.

Neither is Otto here a much more taking gentleman : nothing appears in his cue to move pity, or any way make the audience of his party.

Rymer's Tragedies of the last Age.

Let him know how many servants there are, of both sexes, who expect vails ; and give them their cue to attend in two lines, as he leaves the house.

Swift.

CUENCA, or LA SIERRA DE CUENÇA, a province of Spain, forming the eastern part of New Castile. In the north and east it is mountainous, and fit only for sheep pasture, but in the west and north it is fertile in corn, hemp, pulse, saffron, fruit, and honey. The province exports large quantities of fine wool, and manufactures a kind of coarse camlet, in considerable request. The capital is Cuença, a bishop's see, situated on an eminence between two mountains, at the foot of which flow the rivers Huecar and Xucar. The walls rise from the valley to a great height ; and the streets are uncommonly steep and irregular. It is entered by six gates. The episcopal palace is a respectable edifice, and the city has five gates, thirteen parishes, six monasteries, and six nunneries, beside a seminary, three colleges, and an hospital. The cathedral is in the Gothic style, upwards of 300 feet long and 180 broad, and was founded in the twelfth century by Alphonso IX. A bridge across the Huecar consists of five arches, the pillars of which alone are said to have cost 63,000 ducats. The earl of Peterborough took this place for Charles III. in 1706. Population 6000. It is seventy-five miles east of Madrid, and 100 W. N. W. of Valencia.

CUENÇA, a district of the presidency of Quito, Colombia, bounded north by the province of Riobamba, south by that of Jaen de Bracamoros, east by that of Guayaquil, west by that of Quixos and Macas, north-east by that of Chimbo, and south-east by that of Loxa. It is of a mild temperature, but subject to dreadful storms ; and fertile in grain, sugar, and cotton. Its minerals are gold, silver, copper, quicksilver, and sulphur ; but the mines, for want of capital, are very partially worked. Cotton cloth is largely manufactured.

This district is subdivided into two departments, Cuença and Alausi ; the former including ten villages, and the latter, which borders on Riobamba, having four. Cuença is famed for the many remains of Peruvian architecture it contains, as the ruins of the Fort of Cannar, near the village of Atun-cannar, or Great Cannar, &c.

Alausi, the chief town of the grand department, is an inconsiderable place. In this district Atabalipa is said to have put to death 60,000 of the adherents of his brother Huascar.

CUENÇA, SANTA ANNA DE, the capital of the above district, is situated in a valley celebrated for its pleasantness and fertility. The streets run in parallel lines, and the city has a beautiful appearance, but the Indian huts of the suburbs are very mean. It is 180 miles south of Quito. Population 20,000.

CUERENHEBT (Theodore Van), a celebrated engraver, born at Amsterdam in 1522. Early in life he travelled into Spain and Portugal, but was afterwards obliged to have recourse to engraving for his support. His works are slight and hastily executed with the graver alone ; but in an open careless style, so as greatly to resemble designs made with a pen. He was established at Haerlem ; and there pursuing his favorite studies in literature, he was made secretary to that town, from whence he was sent several times as ambassador to the prince of Orange, to whom he addressed a famous manifesto, which that prince published in 1566. He at length openly avowed his opinion—deism, maintaining that all religious communions being corrupted, no person, without a supernatural mission, had a right to administer in any religious office. For these sentiments he was several times imprisoned, and at last sentenced to banishment. He died at Dergoude in 1590, aged sixty-eight. His works were published in 3 vols. fol. in 1630.

CUERPO, *n. s.* Span. To be in cuerpo is to be without the upper coat or cloak, so as to discover the true shape of the cuerpo or body

Exposed in cuerpo to their rage,

Without my arms and equipage. *Hudibras.*

CUFF, *v. a., v. n., & n. s.* Swed. *kuff*; Per. *kuffan*; Scot. *gouf*, from Icelandic, *kuffwa*. Skinner derives the word from *κόπρω*; Junius from *κόλαφος*; and Dr. Johnson from Ital. *xuffa*, a battle. To cuff is to strike with the fist, talons, or wings; to fight; to scuffle. Cuff, in its widest sense, signifies any stroke or blow; but is usually applied to a blow with the fist.

Now cuffing close, now chasing to and fro,

Now hurtling round advantage for to take.

Spenser. Faerie Queene.

The Sarazin, sore daunted with the buffe,
Snatcheth his sword, and fiercely to him flies,
Whom well it wards, and gyleth cuffs with cuffs. *Id.*

I'll after him again, and beat him.—
—Do, cuff him soundly ; but never draw thy sword. *Shakspeare.*

The priest let fall the book,

And as he stooped again to take it up,
The mad-brained bridegroom took him such a cuff,
That down fell priest and book, and book and priest.

Id. Taming of the Shrove.

Those lazy owls, who, perched near fortune's top
Sit only watchful with their heavy founts
To cuff down new-fledged virtues, that would rise
To nobler heights, and make the grove harmonious.

Otway.

Hovering about the coasts, they make their moan,
And cuff the cliffs with pinions not their own,

Dryden's Rucid.

He gave her *cuff* on the ear, and she would prick him with her knitting-needle. *Arbuthnot's John Bull.*

When a man's fancy gets astride on his reason, when his imagination is at *cuffs* with the senses; and common understanding, as well as common sense, is kicked out of doors; the first proselyte he makes is himself, &c. *Swift.*

CUFF, *n. s.* Ar. and Per. *kuff*; Goth. and Swed. *knuffe*; Ger. *kuff*. Johnson, however, derives it from Fr. *coeffe*. The cuff is that part of the sleeve which is next the hand. Byron uses the word in the sense of a handcuff.

With ruffs and *cuffs* and fardingales and things.

Shakespeare. Taming of the Shrew.

He railed at fops; and, instead of the common fashion, he would visit his mistress in a morning gown band, short *cuffs*, and a peaked beard.

Arbuthnot.

He had chained

His prisoners, dividing them like chapters
In numbered lots; they all had *cuffs* and collars,
And averaged each from ten to a hundred dollars.

Byron. Don Juan.

CUFF (Henry), the unfortunate secretary of the earl of Essex, was born at Hinton St. George in Somersetshire, about 1560, of an honorable and opulent family. In 1576 he was entered of Trinity College Oxford, where he soon acquired considerable reputation as a Grecian and disputant. He obtained a fellowship, but was expelled for speaking disrespectfully of the founder. He was, however, soon after admitted of Merton College, and in 1588 took the degree of M. A. Some time after he was elected Greek professor, and in 1594 proctor of the university. When the earl of Essex was made lord-lieutenant of Ireland, Mr. Cuff was appointed his secretary, and continued intimately connected with him until his confinement in the Tower. Before his execution the earl charged him with being the author of all his misfortunes, and Cuff was subsequently tried for high treason, and executed at Tyburn, 30th of March 1601. Lord Bacon, Sir Henry Wotton, and Camden, speak of him in very harsh terms; but he was certainly a man of learning and abilities. He wrote 1. The Differences of the Ages of Man's Life; published after his death. 2. De Rebus Gestis in Sancto Concilio Nicæno.

CUIABA, a town and river of Brasil, in the province of Mattogrosso, ninety-six leagues from its confluence with the Paraguay. The town is large, and computed to contain 30,000 inhabitants. It is well provided with fish, meat, and all sorts of vegetables. In the neighbourhood are some mines of the finest gold, which have yielded according to Mr. Mawe £500 annually. It is 288 miles east of Villa Batta.

CUJACIUS, or **CUJAS** (James), a celebrated civilian, born at Toulouse, in 1520. He studied polite literature and history; and acquired great knowledge in the ancient laws, which he taught at Toulouse, Cahors, Bourges, and Valence, in Dauphiné. Emanuel Philibert, duke of Savoy, invited him to Turin, and gave him singular marks of his esteem. Cujas afterwards refused very advantageous offers from pope Gregory XIII. who invited him to teach at Bologna, choosing rather to fix at Bourges, where he had a large number of scholars; whom he took great

pleasure in instructing, and was called the Father of his Scholars. He died at Bourges in 1590, aged seventy. His works are in high esteem among the civilians.

CUINAGE, *n. s.* The making up of twine into such forms as it is commonly framed into for carriage to other places.

CUIRASS, *n. s.* } Fr. *cuirass*, from *cuir*,
CUIRASSIER, *n. s.* } leather; Ital. *coraccia*. A breast-plate. A man at arms; a soldier in armour, or with a cuirass.

The picture of St. George, wherein he is described like a *cuirassier*, or horseman completely armed, is rather a symbolical image than any proper figure.

Brown's Vulgar Errors.

The field, all iron, cast a gleaming brown,
Nor wanted clouds of foot, nor on each horn
Cuirassiers, all in steel, for standing fight. *Milton.*

And pierced his *cuirass*, with such fury sent,
And signed his bosom with a purple tint. *Dryden.*

CUIRASS, a piece of defensive armour, made of iron plate, well hammered, serving to cover the body, from the neck to the girdle, both before and behind. It was not brought into use till about A. D. 1300, though it was known both to the ancient Greeks and Romans in different forms. The use of the cuirass has been lately revived in the British and French armies: the cuirassiers of the latter were very conspicuous in the battle of Waterloo.

CUISH, *n. s.* Fr. *cuisse*. The armour that covers the thighs.

I saw young Harry, with his beaver up,
His *cuishes* on his thighs, gallantly armed,
Rise from the ground like feathered Mercury.

Shakespeare. Henry IV.

But what had our author to wound *Aeneas* with at so critical a time? And how came the *cuishes* to be worse tempered than the rest of his armour? *Dryden.*

CULDEES, *n. s.* Lat. *colidei*. Monks in Scotland.

CULERAGE, *n. s.* The same plant with *arse-smart*.

CULEX, the gnat: in entomology, a genus of insects belonging to the order of diptera. The mouth is formed by a flexible sheath, enclosing bristles pointed like stings. The antennæ of the males are filiform; those of the females feathered. There are fourteen species. Before they turn to flying insects, they have been in some manner fishes, under two different forms. One may observe in stagnating waters, from the beginning of May till winter, small grubs with their heads downwards, their hinder part on the surface of the water; from which part arises sideways a kind of vent-hole, or small hollow tube like a funnel, and this is the organ of respiration. The head is armed with hooks, that serve to seize on insects and bits of grass on which it feeds. On the sides are placed four small fins, by the help of which the insect swims about, and dives to the bottom. These larvæ retain their form during a fortnight or three weeks, after which period they turn to chrysalides. After three or four days fasting they pass to the state of gnats. A moment before, water was its element; but now, become an aerial insect, he can no longer exist in it. He swells his head, and bursts his

enclosure. The robe he lately wore, turns to a ship, of which the insect is the mast and sail. He now seeks to pump the alimentary juice of leaves, or the blood of man and beasts. The sting which our naked eye discovers, is but a tube, containing five or six spicula of exquisite minuteness; some dentated at their extremity like the head of an arrow, others sharp-edged like razors. The insect injects a small quantity of liquor into the wound, by which the blood becomes more fluid, and is seen through the microscope passing through those spicula. The liquor it has injected causes by its fermenting that disagreeable itching which we experience; and which may be removed by volatile alkali, or by scratching the part newly stung, and washing it instantly with cold water; for if later, the venom ferments, and the tumor and the itching are only increased by friction.

C. pipiens, the musquito fly, is the most troublesome species of the whole genus; and swarms in South America, and the West Indies. In the day time or at night they come into the houses; and when the people are gone to bed they begin their disagreeable humming, approach always nearer to the bed, and at last suck up so much blood that they can hardly fly away. Their bite causes blisters in people of a delicate complexion. When the weather has been cool for some days, the musquitoes disappear; but when it changes again, and especially after rain, they gather frequently in such quantities about the houses, that their numbers are astonishing. In sultry evenings they accompany the cattle in great swarms, from the woods to the houses or to town; and when they are driven before the houses, the gnats fly in wherever they can. In the greatest heat of summer, they are so numerous in some places that the air seems to be quite full of them, especially near swamps and stagnant waters, such as the river Morris in New Jersey. The inhabitants therefore make a fire before their houses to dispel these disagreeable guests by the smoke.

CULIACAN, a province of Guadalajara, in Mexico, part of the intendancy of Sonora. It has Cinaloa on the north, New Biscay and the Zacatecas on the east. Chiametlan on the south, the gulf of California on the west. It abounds with all sorts of fruit, and has silver mines. The soil is fertile and the air healthy. It is about 200 miles long and 150 broad.

CULINARY, *adj.* Lat. *culina*. Relating to the kitchen; relating to the art of cookery.

Great weight may condense those vapours and exhalations, as soon as they shall at any time begin to ascend from the sun, and make them presently fall back again into him, and by that action increase his heat; much after the manner that, in our earth, the air increases the heat of a *culinary* fire. *Newton.*

To those who, by reason of their northern exposition, will be still forced to be at the expence of *culinary* fires, it will reduce the price of their manufacture. *Arbuthnot.*

Hard fare! but such as boyish appetite
Disdains not; nor the palate, undeprov'd
By *culinary* arts, unsavoury deems. *Cowper.*

CULL, *v. a.* } Fr. *cucillir*; Ital. *cogliere*;
CULLER, *n. s.* } Lat. *colligere*. To select from;
to make choice of the best. One who culls.

VOL. VI.

The best of every thing they had being *cull'd* out for themselves; if there were in their flocks any poor diseased thing not worth the keeping, they thought it good enough for the altar of God. *Hooker.*

Our engines shall be bent
Against the brows of this resisting town.
Call for our chiefest men of discipline,
To *cull* the plots of best advantage.

Shakespeare. King John.

I do remember an apothecary
In tattered weeds, with overwhelming brows,
Culling of simples. *Id. Romeo and Juliet.*

When the current pieces of the same denomination
are of different weights, then the traders in money
cull out the heavier, and melt them down with profit.
Locke.

When false flowers of rhetoric thou wouldst *cull*,
Trust nature, do not labour to be dull. *Dryden.*

The various offerings of the world appear:
From each she nicely *culls* with curious toil,
And decks the goddess with the glittering spoil. *Pope.*

To trim the ringlets of his scented hair;
To aim, insidious, Love's bewitching glance;
Or *cull* fresh garlands for the gaudy fair,
Or wanton loose in the voluptuous dance:
These were his arts; these won Enone's love,
Nor sought his fettered soul a nobler aim. *Beattie.*

Be silent, Conrad—dearest! come and share
The feast these hands delighted to prepare;
Light toil to *cull* and dress thy frugal fare. *Byron. The Corsair.*

CULLEN (Dr. William), one of the most celebrated physicians of his age and country, was born of a respectable family in Lanarkshire in 1712. After serving his apprenticeship to a surgeon at Glasgow, he went several voyages to the West Indies as a surgeon; but at last settled as a surgeon at the village of Shotts, where he became acquainted with Archibald duke of Argyll. About this period Mr. Cullen formed a connexion in business with William Hunter, afterwards a celebrated lecturer on anatomy in London. It was agreed that, in order to improve their medical knowledge, one of them should alternately be allowed to study in what college he should choose, during winter, while the other should carry on business for their common benefit. Accordingly Cullen was allowed to study first for one winter in the University of Edinburgh; but next winter, when it came to Hunter's turn, he preferred London, where his singular dexterity in dissecting, and making anatomical preparations, recommended him so effectually to Dr. Douglas, who then lectured upon anatomy and midwifery, and whose chair he afterwards filled, that he engaged him as his assistant. On hearing this Mr. Cullen freely gave up the articles, and the two partners ever after kept up a friendly correspondence. In September, 1740, Mr. Cullen took the degree of M. D. at Glasgow, and about the same time removed to Hamilton, with a view to practise as a physician; and a vacancy not long after occurring in the University of Glasgow, the duke of Hamilton procured Dr. Cullen the appointment. In 1746 he became professor of chemistry in that University; and his eminent abilities as a public lecturer now began to appear. His practice as a

physician also daily increased; and a vacancy occurring, in 1751 he was appointed by the king professor of medicine in that University. In 1756, on the death of Dr. Plumber, professor of chemistry in the University of Edinburgh, Dr. Cullen was unanimously called to the vacant chair; and removing to that metropolis continued a successful career there until his death. Among many useful reforms for which the students in Edinburgh are indebted to Dr. Cullen, the following has been noticed, that before he came to Edinburgh, it was the custom of the medical professors to accept of fees from the students; but Cullen would never take one from them. Dr. Cullen published his *First Lines of the Theory and Practice of Physic*; and his *Institutions of Medicine*, his *Lectures on the Materia Medica*, &c. are universally known. He was first physician to the king for Scotland; F. R. S. of London, Edinburgh, and Paris; Fellow of the Royal College of Physicians of Edinburgh and Madrid; Member of the American Philosophical Society at Philadelphia; of the medical societies of Dublin and Copenhagen; of the Royal Medical and Royal Physical Societies of Edinburgh, &c.

CULLEN, a royal burgh in a parish of the same name, which joins with Banff, Kintore, Elgin, and Inverary, in electing a representative to parliament. By the patriotic exertions of the late earl of Finlater, it carries on a considerable linen manufacture. It has a post-office, and several good schools.

CULLICE, or ? Fr. *coulis*. Broth; rich CULLIS, n. s. } jelly.

CULLODEN Moor, a heath in Invernesshire, memorable for a victory gained over the adherents of the house of Stuart, on the 16th of April 1746, by the royal army, commanded by the duke of Cumberland. A total defeat of the rebel forces took place, with the loss of 2500 killed, wounded, and prisoners; while the royalists did not lose above 200 men. Prince Charles had his horse shot under him during the engagement; and after the battle retired to the house of a factor of lord Lovat, about ten miles from Inverness, where he staid that night. Next day he set out for Fort Augustus, whence he pursued his journey, with great difficulty and distress, till at last he reached the coast and entered a vessel provided for him by the court of France. See ENGLAND.

CULLY, v. a., n. s. & adj. } Fr. *couillon*,
CULLYISM, n. s. } *coaille*; Ital. *cog-*
CULLIBILLITY, n. s. } *lione*; Lat. *coleus*.
CULLION, n. s. } To cully is, to
CULLIONLY, adj. } befool; to trick;

to impose on. A cully is one who is in a state of cullyism, that is, egregiously led by the nose by sharpers or a strumpet. A cullion is a scoundrel; a mean wretch. Cullionly is mean; despicable. Cullibility signifies credulity; facility of being imposed upon.

Such a one as leaves a gentleman,
And makes a god of such a cullion:
Shakespeare. Taming of the Shrew.

Up to the breach, you dogs; avaunt you cullions.
Shakespeare.

I'll make a sop o' th' moonshine of you: you
whoreson, cullionly, barber-monger, draw.

Id. King Lear.

Why should you, whose mother-wits
Are furnished with all perquisites,
Be allowed to put all tricks upon
Our cully sex, and we use none? *Hudibras.*

Yet the rich cullies may their boasting spare:
They purchase but sophisticated ware. *Dryden.*

He takes it in mighty dudgeon, because I won't let
him make me over by deed as his lawful cully.

Arbutnot.

What is this but being a cully in the grave? Sure
this is being hen-pecked with a vengeance! But
without dwelling upon these less frequent instances
of eminent cullyism, what is there so common as to
hear a fellow curse his fate that he cannot get rid
of his passion to a jilt, and quote an half line out of a
miscellaneous poem, to prove his weakness is natural?

Spectator.

Providence never designed Gay to be above two-
and-twenty, by his thoughtlessness and cullibility.

Swift.

CULLUMBINE, n. s. More properly spelt
COLUMBINE. The flowers of this plant are beau-
tifully variegated with blue, purple, red, and
white.

Her goodly bosom, like a strawberry bed;
Her neck, like to a bunch of columbines. *Spenser.*

CULM, or CHULM, a market town of Bohemia, in the circle of Saatz, belonging to the knights of the Red Star, near which the French army, under Vandamme, was attacked and routed by the allies on the 29th and 30th of August, 1813, and the general taken prisoner. Another engagement took place in the neighbourhood on the 16th and 17th of September, when the French found it necessary to retreat. It is eight miles north-east of Egtra.

CULM, in mineralogy, is thus distinguished by M. Magellan: 'It should be an easy matter for any person to distinguish culm from small caking coal, either by trying to make fire with it in a common grate, without interposing any other fuel between it; when if it kindles, it is a caking coal; if not it is culm: or by putting some of these small fragments of coal on an ignited iron shovel: if they melt and run together, they belong to the caking kinds; if not, they are culm. But it seems that coal merchants are now in the custom of calling culm the powdery parts of pit coal, of whatsoever kind they may happen to be. The reason of this is, that there is a difference in the duty payable by culm and by caking coals. There never was any difficulty, however, on the subject; nor would there be any difficulty in collecting the tax, were it not for the insufferable ignorance and love of despotic oppression, which generally pervades the underling officers of the revenue.'

CULMBACH, a town of the Bavarian states, situated on the river White Maine. Population 3700 Fifteen miles N. N. W. of Bayreath.

CULMEN, n. s. Lat. The summit.

At the culmen or top was a chapel. *Sir T. Herbert.*

CULMIFEROUS, adj. Lat. *culmus* and *fero*. See BOTANY.

Culmiferous plants are such as have a smooth jointed stalk, and usually hollow; and at each joint the stalk

is wrapped about with single, narrow, long, sharp-pointed leaves, and their seeds are contained in chaffy husks. *Quincy.*

There are also several sorts of grasses, both of the *Cyprus* and *culmiferous* kinds; some with broader, others with narrower leaves. *Woodward on Fossils.*

The properest food of the vegetable kingdom is taken from the farinaceous or mealy seeds of some *culmiferous* plants; as oats, barley, wheat, rice, rye, maize, panic, millet. *Arbuthnot.*

CULMINATE, *v. n.* } *Lat. culmen.* To be
CULMINATION, *n. s.* } vertical; to be in the
 meridian. Culmination is the transit of a planet through the meridian; the top or crown.

We upraid the end with the beginning, the harvest with the spring, and wonder how that which in its putting forth was a flower, should in its growth and *culmination* become a thistle. *Ferindon.*

Tar and wide his eye commands;
 For sight no obstacle found here, or shade,
 But all sunshine; as when his beams at noon
Culminate from the' equator. *Milton. Par. Lost.*

CULNA, a town in the district of Jessore, Bengal, standing on the north bank of one of the innumerable branches of the Ganges. Boats generally lay in a stock of fresh water and provisions here; and take a pilot to convey them through the navigation of the *Sunderbunds*.

CULPABLE , <i>adj.</i>	} Old. Fr. <i>coulpa-</i> <i>ble</i> ; Ital. <i>colpevole</i> ; Span. <i>culpable</i> ; Lat. <i>culpabilis</i> , from <i>cul-</i> <i>pa</i> , a fault. Culpa- ble is, criminal; guilty of; blamable.
CULPABLENESS , <i>n. s.</i>	
CULPABLY , <i>adv.</i>	
CULPARITY , <i>n. s.</i>	
CULPE , <i>n. s.</i>	
CULPRIT , <i>n. s. & adj.</i>	
CULPATORY , <i>adj.</i>	

Culpe is used, by Hall, to denote a fault. *Culpatory* is attributing blame. 'Adjectives in *osus*, as *famosus*, &c. (says Horace Walpole), were most commonly used by Latin authors in a *culpatory* sense.' The word is not in the dictionaries, but it deserves to be admitted. About *culprit* (says Johnson) there is great dispute. It is used by the judge at criminal trials, who, when the prisoner declares himself not guilty, and puts himself upon his trial, answers, 'Culprit, God send thee a good deliverance.' It is likely that it is a corruption of 'qu'il paroit,' 'May it so appear;' the wish of the judge being that the prisoner may be found innocent. Barrington agrees with Johnson in this derivation. Blackstone considers the word to have arisen from two abbreviations, *cul* for *culpable*, and the Fr. *pret*, ready to prove him so; others derive it from the first of these abbreviations, and Fr. *prist*, taken; Mr. Tyrwhitt looks for the origin in *cul*, the hind parts, and *prist*, one seized by the skirts; and, lastly, the Ency. Met. says, 'Culprit appears merely to be a compound and contraction of *culpe*, a fault; a crime; a transgression of the law; and Fr. *pris*, part. of *prendre*, to take; one taken; a prisoner, for a transgression of the law.'

And 'as Seint Gregory sayth, that precious clothing is *culpable* for the deth of it, and for his softnesse, and for his strangenesse and disguising, and for the superfluitee, or for the inordinate scantnesse of it. *Chaucer. Cant. Tales.*

These being perhaps *culpable* of this crime, or favourers of their friends. *Spenser's State of Ireland.*

The wisdom of God setteth before us in Scripture so many admirable patterns of virtue, and no one of them without somewhat noted wherein they were *culpable*; to the end that to Him alone it might always be acknowledged, Thou only art holy, Thou only art just. *Hooker.*

Proceed no straighter 'gainst our uncle Glo'ster,
 Than from true evidence of good esteem:
 He be approved in practice *culpable*. *Shakespeare. Henry VI.*

If we perform this duty pitifully and *culpably*, it is not to be expected we should communicate holily. *Taylor.*

Though prudence be reckoned among the cardinal virtues, yet I do not remember any professed treatise of morality, where it is treated in its full extent, and with that accuracy that it ought. For which possibly this may be a reason, that every imprudent action does not make a man *culpable* 'in foro conscientie.' *Locke.*

All such ignorance is voluntary, and therefore *culpable*; forasmuch as it was in every man's power to have prevented it. *South.*

The knight appeared, and silence they proclaim;
 Then first the *culprit* answered to his name;
 And, after forms of law, was last required
 To name the thing that woman most desired. *Dryden.*

An author is in the condition of a *culprit*; the publick are his judges; by allowing too much, and condescending too far, he may injure his own cause; and by pleading and asserting too boldly, he may displease the court. *Prior's Preface to Solomon.*

Like other *culprit* youths he wanted grace,
 But could have no self-interest in the case. *W. Whitehead.*

J. SURF. The license of invention some people take is monstrous indeed.

MARIA. 'Tis so; but, in my opinion, those who report such things are equally *culpable*. *Sheridan.*

CULPEE, a town in the district of Hoogly, Bengal, on the east bank of the Bhagarutty. It stands at the mouth of a creek, or small harbour, which gives shelter for boats from the impetuosity of the tides. Opposite the town is a place of anchorage for large vessels. It is said to be nearly certain death to an European to sleep on shore here, and coverings are recommended to be used during the night on all ships which anchor here, to keep off the heavy dews from the people.

CULROSS, a royal borough of Scotland, on the river Forth, about twenty-three miles north-west of Edinburgh. Its charter was granted by James VI. in 1588. The town is built on the abrupt ascent from the water, one street running direct north, while the other intersects it at right angles. The situation of the town gives it, especially on the approach from the harbour, a very picturesque and grand appearance. By two royal grants from James IV. and Charles II. the inhabitants of Culross possessed the exclusive privilege of making girdles (a kitchen utensil well known in Scotland for baking oat-cakes, &c.) It formerly carried on a very considerable trade in salt and coal, but this also has decayed; and at present it has no manufacture of any note. This borough joins with those of Stirling, Dun-

fermling, Innerkeithing, and Queensferry, in electing a representative in parliament.

CULTER, *n. s.* Lat. *cultor*. The iron of the plough perpendicular to the share. It is commonly written **COULTER**. See that word.

Her fallow lees

The darnel, hemlock, and rank fumitory,
Doth root upon; while that the *cultor* rusts
That should deracinate such savagery.

Shakspeare. Henry V.

CULTIVATE, *v. a.*

CULTIVABLE, *adj.*

CULTIVATION, *n. s.*

CULTIVATING, *n. s.*

CULTIVATOR, *n. s.*

CULTURE, *v. a. & n. s.*

Fr. *cultiver*; Ital. *coltivare*; Span. *cultivar*; Lat. *colere*.
To till the soil; to make the soil prolific; to improve; to meliorate.

These meanings are common to both verbs; to culture, however, seems to be of comparatively recent introduction. Cultivation is the art of improving soils, and forwarding and improving the growth of vegetables; generally, improvement. Culture is, the art of cultivation; tillage. Cultivable is a word of modern coinage, denoting that which has the capacity of being cultivated.

Give us seed unto our heart, and *culture* to our understanding, that there may come fruit of it.

2 Eodras viii. 6.

These three last were slower than the ordinary wheat of itself, and this *culture* did rather retard than advance.

Bacon.

Were we but less indulgent to our faults,
And patience had to *cultivate* our thoughts,
Our muse would flourish.

Waller.

He, who appropriates land to himself by his labour, does not lessen, but increases the common stock of mankind; for the provisions serving to the support of human life, produced by one acre of inclosed and *cultivated* land, are (to speak much within compass) ten times more than those which are yielded by an acre of land of an equal richness lying waste in common.

Locke.

It has been lately complained of, by some *cultivators* of clover grass, that from a great quantity of the seed not any grass springs up.

Boyle.

An innate light discovers the common notions of good and evil, which, by *cultivation* and improvement, may be advanced to higher and brighter discoveries.

South.

A foundation of good sense, and a *cultivation* of learning, are required to give a seasoning to retirement, and make us taste the blessing.

Dryden.

To make man mild and sociable to man,

To *cultivate* the wild licentious savage

With wisdom, discipline, and liberal arts,

The' embellishments of life, *Addison's Cato.*

One might wear any passion out of a family by *culture*, as skilful gardeners blot a colour out of a tulip that hurts its beauty.

Tatler.

Where grows?—Where grows it not? If vain our toil,

We ought to blame the *culture*, not the soil,

Fixed to no spot is happiness sincere.

Pope.

They rose as vigorous as the sun;

Then to the *culture* of the willing glebe.

Thomson.

In countries *cultured* high,

In ornamented towns, where order reigns,

Free social life, and polished manners fair.

Id.

It is therefore our business carefully to *cultivate* in our minds, to rear to the most perfect vigour and

maturity, every sort of generous and honest feeling that belongs to our nature.

Burke.

To a mind thus disposed no part of creation is indifferent. In the crowded city and howling wilderness; in the *cultivated* province and solitary isle; in the flowery lawn and craggy mountain; in the murmur of the rivulet, and in the uproar of the ocean; in the radiance of summer, and gloom of winter; in the thunder of heaven, and in the whisper of the breeze; he still finds something to rouse or to soothe his imagination, to draw forth his affections, or to employ his understanding.

Beattie.

Delights which who would leave, that has a heart susceptible of pity, or a mind *Cultured* and capable of sober thought, For all the savage din of the swift pack, And clamours of the field?

Cowper.

The beauties of the wilderness are his,
That makes so gay the solitary place,
Where no eye sees them., And the fairer forms.
That *cultivation* glories in are his.

Id.

CULVER, *n. s.* Ang.-Sax. *culfre*; Lat. *columba*. A pigeon. The word is almost disused.

Righte as the lambe that of the wolf is bitten,
Or as the *culcor* that of the eagle is smitten.

Chaucer. The Legend of Philomena.

Live as the *culcor* on the bare d bough
Sits mouraing for the absence of her mate.

Spenser. Sonnet lxxxviii.

Whence borne on liquid wing,

The sounding *culcor* shoots.

Thomson's Spring.

CULVERIN, *n. s.* Fr. *coulevrine*; Ital. *colubrina*; Span. *culebrina*, from Lat. *coluber*. A species of ordnance: originally a hawk.

As three great *culebrings* for batterie bent,
And leveld all against one certaine place,
Doe all attonee their thunders rage frith-vent.

Spenser. Faerie Queene.

Here a well polished mall gives us the joy
To see our prince his matchless force employ:

No sooner has he touched the flying ball;

But 'tis already more than half the mall;

And such a fury from his arm 't has got,

As from a smooking *culebrin* 'twere shot.

Waller.

A whole cannon requires, for every charge, forty pounds of powder, and a bullet of sixty-four pounds; a *culverin*, sixteen pounds of powder, and a bullet of nineteen pounds; a demy-*culebrin*, nine pounds of powder, and a bullet of twelve pounds.

Wilkins's Math. Magic.

CULVERIN, a long slender piece of ordnance or artillery, serving to carry a ball to a great distance. There are three kinds of culverins: the extraordinary, the ordinary, and the least sized.

1. The culverin extraordinary has 5½ inches bore; its length 32 calibres, or 13 feet; weight 4800 pounds; its load above 12 pounds; carries a shot 5½ inches diameter, weighing 20 pounds weight. 2. The ordinary culverin is 12 feet long; carries a ball of 17 pounds 5 ounces; calibre 5½ inches; its weight 4500 pounds. 3. The culverin of the least size, has its diameter 5 inches; is twelve feet long; weighing about 4000 pounds; carries a shot 3½ inches diameter, weighing 14 pounds nine ounces.

CULVERKEY, *n. s.* A flower.

Looking down the meadows, I could see a girl cropping *culverkeys* and cowslips to make garlands.

Walton's Angler.

CULVERTAIL, *n. s.* In carpentry, synonymous with dove-tail.

CUMÆ, or **CUMA**, in ancient geography, a city of Campania near Puteoli, founded by a colony from Chalcis and Cumæ of Æolia before the Trojan war. The inhabitants were called Cumæi. One of the Sibyls fixed her residence in a cave in the neighbourhood, and was called the Cumæan Sibyl. There is still a decayed town of this name on the spot, about four miles north-west of Pozzuolo.

CUMA, a small island in the Mediterranean, off the coast of Italy, five miles west of Naples.

CUMA, **ST. ANTONIO DE**, a town of Brasil, in the province of Maranhão.

CUMANA, a province in the department of the Oronoco, and state of Venezuela, Colombia. It is bounded by the Caribbean Sea on the north and east, the river Unara on the west, and on the south by the wide-spreading Oronoco. It thus includes New Barcelona, as well as New Andalusia, properly so called. The extent of the territory of Cumana, the fertile soil of the interior, and the nature of its boundaries, render it one of the most important divisions of the republic.

This province is extremely mountainous; a branch from the main chain of the Andes stretches across its whole extent to the gulf of Paria. It abounds in highly picturesque scenery, and gives birth to numerous rivers; some flowing towards the north and emptying themselves into the Caribbean Sea, others taking a southerly direction and discharging themselves into the broad expanse of the Oronoco. The principal of these are the Unara, the Neveri (on which Barcelona is built), the Manzanares, which encompasses the city of Cumana on the south and west, the Guarapiche, the Mamo, the Pao, and the Suara. These rivers are again joined by others of lesser importance, which intersect the territory in all directions, affording every possible facility to the erection of mills, and admirably adapted to the purposes of irrigation.

The province of Cumana presents every variety of soil: from the river Unara to the city of Cumana the land is moderately fertile; from the Point of Araya for about twenty-eight leagues to the east the coast is dry and sandy, the soil offering nothing but an inexhaustible mine of salt, both mineral and marine. The banks of the Oronoco consist chiefly of extensive commons, over which numerous herds of cattle are allowed to range. The remaining parts of the province are every where fertile. The guaiacum, anacardium, Brasil, and Campeachy woods flourish down to the coast of Paria, whilst their branches are thronged with innumerable flocks of birds of the rarest kinds and most brilliant plumage. Yet these regions are left so entirely to the inheritance of beasts of prey, that the panthers, tigers, and even the apes, evince little alarm or dread at the approach of man. Of the mountains in the interior, Tumeriquisi deserves particular mention. It is 935 toises above the level of the sea, and is the Hartz of the province, being associated with equally wild and superstitious ideas in the minds of the Cumanese. It contains an immense cavern, famous in the tradition of the country, which serves as a habitation for thousands of

nocturnal birds, from whose fat is procured a valuable oil. Its site is truly majestic; a river of considerable magnitude issues from its mouth, which is every where surrounded by the richest verdure; and the roar of the waters, joined to the mournful cries of the birds within, is believed by the natives to proceed from the souls of the dead, who are forced to enter this cavern as a vestibule to the other world. The climate of the territory of Cumana varies according to the situation of its districts; it may, in fact, be said to concentrate every variety of the habitable globe.

The city of Cumana, the most ancient of all the towns on this continent, is situated near the gulf of Cariaco, on an arid and sandy plain. No towering steeple or dome attracts the eye of the traveller from afar off; only a few trunks of tamarind, cocoa, and date trees rising above the flat roofs of the houses.

The river Manzanares separates it from the suburbs; the population is a European and mixed race. The appearance of the coast from the mouth of this river is thus described by Humboldt: 'We anchored opposite the mouth of the Manzanares at break of day. Our eyes were fixed on the groups of cocoa trees that border the river, and the trunks of which, more than sixty feet high, towered over the landscape. The plain was covered with tufts of cassias, capers, and those arborescent mimosas, which, like the pine of Italy, extend their branches in the form of an umbrella. The pennated leaves of the palms were conspicuous on the azure of a sky, the clearness of which was unsoftened by any trace of vapor. The sun was rapidly ascending towards the zenith; a dazzling light was spread through the air, along the whitish hills strewed with cylindrical cactuses, and over a sea ever calm, the shores of which were peopled with alcatras, egrets, and flamingoes. The splendor of the day, the vivid coloring of the vegetable world, the forms of the plants, the varied plumage of the birds, every thing announced the grand aspect of nature in the equinoctial regions.'

The castle of St. Antonio is built on the eastern extremity of a white, solitary hill of the same name, and forms the only bulwark to Cumana.

The city, as we have intimated, contains no remarkable buildings, the frequency of earthquakes obliging the inhabitants to sacrifice architectural beauty and elegance to personal security. There is a theatre constructed after the plan of the one at Caraccas. The pit, where the men are separated from the women, is uncovered, so that the audience may at once behold the actors and the stars. The heat of the climate precludes the possibility of these theatres being built in the European fashion; besides, rain is a greater rarity in this city than it even is at Caraccas. The other amusements of the Cumanese consist in bull-baiting, cock-fighting, and ropedancing. There is only one church and two convents. The suburbs are equally populous with the ancient city. They are three in number; the Serritos on the road to the Plaga Chica, on the north of the city, St. Francis on the south-east, and the great suburb of the Guayquerias. This latter one increases with great rapidity, there being no space for additional buildings on

the site of the old town, and also from the nature of the soil, which is supposed to be less exposed to the violent shocks of earthquakes. The population of Cumana has been variously estimated: M. Depons states it to have amounted to nearly 28,000 in the year 1802; other travellers have carried this number to 30,000; but Humboldt, who was favored with the sight of all the statistical memoirs of the country, pronounces it not to exceed 18,000 or 19,000.

The climate though excessively hot here is remarkable for its purity and healthiness. The town is only fifty-three feet above the level of the sea; but the breezes which have to pass over the lofty hills, which stretch along its whole eastern side, seem greatly to moderate the heat of the day. From June to the end of October Fahrenheit's thermometer usually rises to 90° and sometimes to 95°; and during these months it rarely descends to 80° during the night. The mean temperature of the whole year, according to observations on the centigrade thermometer, is 27·7°. The mean temperature of the hottest month at Paris is 19° or 20°, consequently several degrees less than the coldest day at Cumana. There is scarcely ever any rain in the plains of Cumana, whilst the storms are seen to accumulate and burst in torrents among the inland mountains. The hygrometer of De Luc is commonly at about 50° during the winter, and marks the utmost degree of dryness from the beginning of November to June. The sky contains 24° of blue, according to Saussure's cyanometer, whilst in Europe it seldom exceeds 14°. The arid and dusty plains of the neighbourhood are infested with thousands of gabinazo vultures, crocodiles, rattle-snakes, coral-vipers, centipedes, &c. A most singular phenomenon is presented on these plains after violent showers of rain:—the earth, drenched with moisture and heated again by the rapid rays of the sun, emits gaseous emanations, which are the vehicles of that musky odor, which, under the torrid zone, is common to the jaguar, tiger-cat, thick-nosed tapir and various other animals. These emanations are evolved in proportion as the mould, mixed with the remains of innumerable reptiles, worms, and insects, becomes saturated by the rain. Humboldt says he has 'seen Indian children, of the tribe of the Chaymas, draw out from the earth and eat millepedes, or scolopendras, eighteen inches long and seven lines broad. Whenever the soil is turned up we are struck with the mass of organic substances, which by turns are developed, transformed, and decomposed.' The Cumanese are represented as an economical, and industrious people; generally they cultivate the mechanical arts with success, while the fisheries and commercial pursuits unite them in intercourse with all the neighbouring colonies. The Creoles are distinguished by their penetration, judgment, and application to every thing they undertake. One of the most singular customs which prevail here is that of sitting on chairs placed in the river. Humboldt gives a very lively description of it.—He was one of a party comprising several very respectable inhabitants of the suburb of Guayquerias, who met in a

fine moonlight night in the water of Manzanares, to smoke cigars and discuss the news of the day. The ladies of his friends who accompanied them displayed not the least apprehension or fear of the baras or small crocodiles, and the troops of dolphins which spouted the waters around them. Indeed so frequently do they bathe that the whole of the inhabitants, even the women of the most opulent families, are expert swimmers. The Cumanese are said to be excessively polite sober, and abstemious.

The most dreadful scourge of the territory of Cumana is the earthquake. The natives have a tradition that the gulf of Cariaco was formed by an earthquake a short time previously to the third voyage of Columbus. They say that towards the end of the sixteenth century the whole coast was shaken, and the shores frequently inundated by the sea's rising fifteen or twenty fathoms above its usual level. As no record exists at Cumana, however, of an older date than 150 years (a species of the white ant entirely destroying all the treasures of the bibliomant) the precise date of these phenomena rests on mere hypothesis. On the 21st October, 1766, after a remarkable drought of fifteen months, the whole city was overthrown, and vast numbers perished. The oscillations of the earth continued hourly for fourteen months afterwards. The earth in many places ejected sulphureous waters; and a most singular feature of this earthquake is, that whilst the ground was externally oscillating the rain fell in torrents, and the harvest was unusually abundant. Another tremendous convulsion was experienced in 1794, and on the 19th December, 1797, four-fifths of the city were utterly destroyed. In this dreadful earthquake the ground was for the first time at Cumana felt to heave perpendicularly. About half an hour before the first shock there was a strong sulphureous smell near the castle, and a loud subterranean noise, resembling the explosion of a mine at a great depth: flames were also seen to rise from the banks of the river, and in several other places. Flames are not unfrequently observed near the city of Cumana; they do not burn the herbage, neither do they appear to issue from any crevices or fissures in the earth: the people call them the soul of the tyrant Aguirre, a tyrannical Spanish governor, who attempted to raise the standard of independence in this neighbourhood, in 1561. He was killed at Barquisimeto, after having been abandoned by his own men. At the moment he fell he plunged a dagger into the bosom of his only daughter, 'that she might not have to blush before the Spaniards at the name of the daughter of a traitor.' Ever since his death the above superstition has been connected with his memory, the natives believing that his soul wanders about the earth in the appearance of a flame which shuns the approach of man.

The port of Cumana is capable of containing all the navies of Europe: indeed the whole of the gulf of Cariaco, which is thirty-five miles long and sixty-eight broad, affords excellent anchorage. The West Indian hurricanes are never felt in these regions, the Caribbean Sea being as

calm and pacific as the great ocean which laves the coasts. The only danger in this part of Peru is a shoal called Morro Rexo, which is 900 toises broad, and so very steep that vessels are aground on it before they have the least warning. Immense flocks of fishing-herons and alcatras of a most unwieldy form frequent its shores. The principal exports from this harbour are cattle, smoked meat (tosajo), and salted fish. Of this latter commodity the Cumaneuse make large shipments to Caraccas, &c. and to the windward islands, in return for which they receive provisions, implements of husbandry, and contraband goods. Amongst the exports, cocoa-nuts and oil extracted from the pulp they contain deserve to be mentioned. The province contains innumerable medicinal plants and aromatics, which might become more important than they are in the list of their commercial articles. The retail trade of Cumana is vested almost entirely in the hands of the Biscayans, Canarians, and Catalans. These last-mentioned first established rape manufactories at Cumana, where they make excellent cobbles of the bark of the mahet (genus bombax), and cords and twine from the aloe, &c.

Seven nautical leagues to the south-west of the city of Cumana is the valley of Cupanacoa, celebrated for its plantations of tobacco. The principal other towns of Cumana are situated on the western coast, as Barcelona, Paritus, Clarinas, &c. On the coast, along the gulf of Paria, several villages have been established by the French and Spanish refugees who removed from Trinidad in 1797, when that island fell into the possession of the British. The progress which cultivation has made in this short time, induces the belief that this district will speedily become the richest in the province. The whole number of the inhabitants of this extensive territory, according to a recent official statement of the population, and distribution of the representatives at the congress of Colombia, amounts to 70,000 souls. But, as Colonel Hale says, the population is everywhere extremely disproportioned to the territory of the republic. 'In the time of its greatest prosperity,' he adds, 'the country was comparatively a desert, but this desolation has been fearfully augmented during the revolutionary war. The fertile provinces of Guiana, Cumana, and Barcelona, are almost abandoned, and the flourishing towns and villages of the plains reduced to a grass-grown wretchedness, which scarcely leaves room to conjecture their former prosperity. Could 20,000,000 of inhabitants be transferred from Europe, they would find land to cultivate, and abundance to recompense their labor.' He elsewhere observes that 'above half of the inhabitants of Venezuela are supposed to have perished in the late wars.' The city of Cumana is situated in 10° 27' 52" N. lat., and 64° 9' 47" W. long.

CUM'BENT, *adj.* Lat. *cumbens*, *cumbere*. Lying down; in a recumbent posture.

Too cold the grassy mantle of the marl,
In stormy winter's long and dreary night,
For cumbent sheep.

Dyer.

CUMBER, *v. a. & n. s.*
CUMBERSOME, *adj.*
CUMBERSOMELY, *adv.*
CUMBERSOMENESS, *n. s.*
CUMBRANCE, *n. s.*
CUMBROUS, *adj.*
CUMBROUSLY, *adv.*

Goth. *gaumbera* ;
Swed. *kymber*; Dan.
kommer; Dut. *kommern*. The ancient spelling was *cumber*. To embarrass; to obstruct; to impede by the addition of something useless; to involve in difficulties; to busy; to distract with multiplicity of cares; to harass; to crowd or load with something useless. The kindred words closely follow the various meanings of the primitive word.

How can I myself alone bear your *cumbrances*, and your burden, and your strife?
Deut. i. 12.

Martha was *cumbered* about much serving.
Luke x. 40.

Behold these three years I come seeking fruit on this fig-tree, and find none: cut it down; why *cumberest* it the ground?
Id. xiii. 7

The began Beryn to drede inwardlik sore,
And thought thus in his hert, shall I be *cumberid* more?
Chaucer. Cant. Tales.

Thus fade thy helps, and thus thy *cumbers* spring.
Spenser.

They waste bignesse but *cumbers* the ground,
And dirks the beauty of my blossoms round.
Id. Shepherd's Calendar

A cloud of *cumbrous* knattes do him molest,
All striving to infix their feeble stinges,
That from their noyance he can no where rest.
Id. Faerie Queene.

By the occasion thereof I was brought to as great *cumber* and danger, as lightly any might escape.
Sidney.

Domestick fury, and fierce civil strife,
Shall *cumber* all the parts of Italy.

Shakespeare. Julius Caesar
Let it not *cumber* your better remembrance.
Id. Timon.

The greatest ships are least serviceable, go very deep in water, are of marvellous charge and fearful *cumber*.
Raleigh.

Extol not riches then, the toil of fools,
The wise man's *cumbrance*, if not snare; more apt
To slacken virtue, and abate her edge,
Than prompt her to do aught may merit praise.
Milton

Wenceforth I fly not death, nor would prolong
Life much! Bent rather, how I may be quit,
Fairest and easiest, of this *cumbrous* charge.
Id.

There are scarce any of them that are not *cumbered* with some difficulties (such is the imperfection of human knowledge), which they have been fain to cover with obscurity of terms, and to confound the signification of words, which, like a mist before people's eyes, might hinder their weak parts from being discovered.
Locke

Hardly his head the plunging pilot rears,
Clogged with his clothes, and *cumbered* with his years
Dryden.

They reared him from the ground,
And from his *cumbrous* arms his limbs unbound;
Then lanced a vein.
Id.

Very long tubes are *cumbersome*, and scarce to be readily managed.
Newton's Opticks

What is a lordling's pomp? a *cumbrous* load,
Disguising oft the wretch of human kind,
Studied in arts of hell, in wickedness refined!

Burns.

Of late, with *cumbersoms*, though pompons show,
Edwin would oft his flowery rhyme deface,
Through ardour to adorn. *Beattie.*

So Time's strong arms with sweeping siths erase
Aur's *cumbrous* works, and empires, from their base.
Darwin.

CUMBERLAND, a county of England, situate between 2° 13' and 3° 30' W. long., and 54° 6' and 55° 7' N. lat. It is bounded on the west by the Irish sea, which washes its coasts for nearly seventy miles; on the north by the Solway frith, the river Liddel and Adrian's wall, which separate it from Scotland for thirty miles; on the south by Westmoreland and Lancashire for sixty-nine miles; and on the east by Northumberland and Durham for fifty-eight miles. Its greatest length is about seventy-three miles, but its mean extent is not more than sixty; its greatest breadth thirty-eight; and its circumference 224. Thus it includes 1516 square miles, or 970,240 acres, and of these about 342,000 comprise the mountainous districts. According to an agricultural survey, which was made in the latter end of the last century, this county was found to contain 470,000 acres of old enclosures; 150,000 of improvable common; and 8000 acres covered by lakes and waters. No county in England affords more instances of beautiful and sublime scenery than Cumberland; indeed every turn of the roads presents a new combination of the picturesque. Nature here indeed unites her most sublime with her most alluring appearances. Even the monotony of that level tract which stretches along the north and north-western borders of the county is frequently broken by the interesting scenery of the margins of the rivers. These, though very numerous, are but partially navigable; the names of the principal are, the Eden, Derwent, Esk, Eamont, Duddon, Greata, Cocker, Caldew, Irthing and Liddel; and almost every farm in the county enjoys the benefit of a clear spring. The rivers abound with salmon, trout, &c., and the smaller brooks with eels and a variety of other fish. But the chief attractions of Cumberland are its beautiful and extensive lakes. A lake poet very characteristically describes them: 'I know not,' says Mr. Wordsworth, 'how to give the reader a distinct idea of these more readily, than by requesting him to place himself with me in imagination on some given point; let it be the top of Great Garel or Scaw-fell; or rather let us suppose our station to be a cloud, hanging midway between these two mountains, at not more than half a mile's distance from the summit of each, and not many yards above their highest elevation; we shall then see stretched at our feet a number of valleys, not fewer than eight, diverging from the point on which we are supposed to stand, like the spokes from the nave of a wheel. First we note lying to the south-east the vale of Longdale, which will conduct the eye to the long lake of Windermere, stretched nearly to the sands of the vast bay of Morecomb, serving here for this imaginary wheel—let us trace it in a direction from the south-east towards the south, and we shall next fix our eyes upon the vale of Coniston, running up likewise from the sea, but, not as the other valleys do,' to the nave of the wheel, and

therefore it may not be unaptly represented as a broken spoke sticking in the rim. Looking again, with an inclination towards the west, immediately at our feet lies the vale of Duddon, in which is no lake, but a winding stream among fields, rocks and mountains, and terminating its course in the sands of Duddon. The fourth vale, that of the Esk, is of the same general character as the last, yet beautifully discriminate from it by peculiar features. Its stream passes under the woody steep on which stands Muncaster castle, the ancient seat of the Penningtons; and, after forming a short and narrow estuary, enters the sea below the little town of Ravenglass. Next, almost due west, we should look down into and along the deep valley of Wastdale, with its little chapel and a few neat dwellings, scattered upon a plain of meadow and corn ground, intersected with stone walls almost imperceptible. Beyond this fertile little plain, within its bed of steep mountains, lies the long, narrow, stern, and desolate lake of Wastdale, and beyond this a dusky tract of level ground conducts the eye to the Irish Sea. The stream, issuing from Wast-water, is called the Irt, and falls into the estuary of the river Esk, Ennerdale comes next in view, with its lake of bold and somewhat savage shores. Its stream, the Ehen, or Enna, flowing through a soft and fertile country, passes the town of Egremont, and the ruins of the castle; then, seeming to break through the barrier of sand thrown up by the winds on this tempestuous coast, enters the Irish Sea. The vale of Buttermere, with the lake and village of Crummock-water beyond, next present themselves. We will now follow the main stream, the Cocker, through the fertile and beautiful vale of Lorton, till it is lost in the Derwent, below the noble ruins of Cockermouth Castle. Lastly, Borrowdale, of which the vale of Keswick is only a continuation, stretching due north, brings us to a point nearly opposite to the vale of Windermere, with which we began. From this it will appear, that the image of a wheel, thus far exact, is little more than one-half complete; but the deficiency on the eastern side may be supplied by the vales of Wytheburn, Uls-water, Haws-water, Crasmere, and Rydal; none of these, however, run up to the central point between Great Garel and Scaw-fell. From this, hitherto our central point, if we take a flight, not more than three or four miles eastward, to the ridge of Helnellyn, we shall look down upon Wytheburn and St. John's vale, a branch of the vale of Keswick. Upon Uls-water, stretching due east, and not far beyond to the south-east, though from this point not visible, lie the vale and lake of Haws-water, and lastly the vales Grasmere, Rydal, and Ambleside, bring you back to Windermere; thus completing, though on the eastern side in a somewhat irregular manner, the representative figure of a wheel.

Besides the lakes mentioned above there are several others; and a multitude of taras. The only difference between a tara and a lake is, that the former is smaller or found in a circular recess. The loftiest of the English Appenines, which extend from Derbyshire to Linlithgow, separate the eastern from the western coasts, and bound the east side of this county. The mountains of

Cross-fell, Geltsdale forest, Spariadam Waste, and Hartside-fell, abound in limestone, slate, sandstone, clay, coal, and lead ore; but are no ways remarkable for their general appearance. The other range occupies the south-western part of the county; the majesty and grandeur of these mountains, some of them towering from 1100 to 3166 feet above the level of the sea, form the most striking features in the romantic scenery of the lakes. The valley bounded by this range, and extending from the Solway frith to Westmoreland, abounds with strata of red sandstone, mixed with beds of limestone, sandstone, coal, &c.

This county is rich, therefore, in mineral productions, the principal of which are, coal, lime, lead ore, black lead, copper, gypsum, lapis calaminaris, and excellent slate. Its copper-mines were formerly very productive, but of late years have sunk into neglect. The chief lead-mines are situate in Aldston Muir. This muir was vested in the hands of the commissioners and governors of Greenwich Hospital on the attainder of James, earl of Derwentwater (who was lord of the manor) in the year 1715. The number of mines in course of working and belonging to the hospital, in 1814, was 102, and the annual produce amounts to 4598 tons. On the eastern side of a mountain at the head of Borrowdale, the celebrated mines of black lead are situate: from the produce of these mines black lead pencils are made, known in France by the name of crayon d'Angleterre; these mines, however, are only opened occasionally to answer the demand, the quantity annually sold not amounting to more in value than £3000. The appearance of the mountains on which these mines are found, is excessively desolate and waste; the horrid projections of the vast promontories, the vicinity of the clouds, the thundering explosions in the mines and quarries, and their total nudity, inspiring the beholder with the idea that he is surveying the ruins of a world which he has survived. The principal coal-mines in the county are situated in the neighbourhood of Workington and Whitehaven. From the former place upwards of 300 tons are shipped every day: there are sixteen mines from forty to ninety fathoms deep. The collieries near Whitehaven are perhaps the most astonishing of any in the world. These mines are sunk to the depth of 130 fathoms, and extend under the sea, sufficient depth of water to bear the largest ships rolling over them. A steep descent leads down to the lowest vein of coal, through long galleries hewn out of the solid rock. Of its limestone, which abounds in various parts, nearly 700,000 bushels are yearly exported to Scotland. Its export of coal, which is sent principally to Scotland and Ireland, is said to amount to about 90,000 chaldrons.

The height of its mountains, and the great extent of its sea-coast, render the climate of Cumberland extremely variable. In the valleys, and low grounds, the snow seldom lies for more than twenty-four hours, whilst on the mountains it continues for six or eight months. Thus the lower parts of the county are mild and temperate, whilst the more elevated are extremely

severe. This county is also subject to heavy falls of rain, especially during the autumnal months, which render the harvest very precarious. Yet, as a proof of the general salubrity of the air, it may be stated, that no county in England affords more instances of remarkable longevity. The soil may be classed under the four following heads:—1. Rich loam and fertile clays, which extend over a very small portion of the county; 2. Dry loams, including the various degrees from bright brown loam to the light sandy soil which extend over the lower districts and the sides of some of the mountains; 3. Black peat earth; and 4. Wet loams. Till lately the Cumberland farmers attended rather to grazing than tillage; since the recent enclosure of 200,000 acres, however, considerable quantities of flour, oatmeal, &c., are exported. Cranberries are so plentiful in this county as to furnish an important branch of the export trade. The only fish exported hence are, cured cod for the Liverpool market, and salmon and potted shad for London. The principal manufactures of this county are calicoes, corduroys, ginghams, and various kinds of cotton goods; carpets, sail-cloth, paper, glass bottles, and pottery. Cumberland is deficient in harbours; its commerce, however, is rapidly improving, upwards of 300 vessels, from sixty to 120 tons burden, being employed in the coast trade alone. The chief ports are Workington, Whitehaven, Harrington, and Maryport.

Cumberland is divided into five wards, or hundreds, and 104 parishes. It contains one city, and eighteen market towns. Its only boroughs are Carlisle and Cockermouth. The city of Carlisle is beautifully situate in a forest near the confluence of the rivers Eden and Caldew. It is of very ancient date, and abounds with good buildings. Its distance from London is 306 miles. This city confers the title of earl on the Howard family; Whitehaven that of viscount and baron to the Lowthers. The village of Ellenborough gives the same to the Law family. Cumberland sends six members to parliament; two for the county, two for the city of Carlisle, and two for the borough of Cockermouth.

Its most interesting antiquities are a perfect Druidical circle, called by the country people Long Meg and her daughters, and the celebrated Picts' wall. The first of these is situated about two miles and a half distant from the village of Salkeld; it consists of a circle, about eighty yards in diameter, formed of sixty-seven rude, unhewn, and massy stones. What renders this vestige of the 'olden time' more astonishing, is the circumstance that no quarry of stone, similar to that of which it is constructed, is found within a great distance of this place, and how such immense masses could be moved is not easily determined when we reflect on the low state of mechanical knowledge in early ages. The celebrated Roman wall, begun by Adrian and repaired and rebuilt by Severus, extended from Tinemouth in Northumberland, to Solway frith in this county, dividing the kingdom from sea to sea. Its remains may easily be traced for upwards of seventy miles, in some places still entire to the height of five feet, and in others to the height of eight feet.

Cumberland derives its name from the Cimbri, or Cumbri, the aboriginal inhabitants. Ptolemy, however, calls the inhabitants of this county, in common with those of Yorkshire, Lancashire, Westmoreland, and Durham, Brigantes. They are supposed not to have been conquered by the Romans till the time of Vespasian, from which period their country was the constant residence of several Roman legions. When the Saxons subdued the Roman power, in Britain, Cumberland became part of the kingdom of Northumberland, and was then first called Lumbra-land or Lumer-land, the land or country of the Cumbri. From the time when the Danes broke the power of the Saxons, until 946, this country had petty kings of its own. About this time, however, Edmund, brother to king Ethelstane, in conjunction with Leontine king of South Wales, overran the country and, having subdued the inhabitants, granted it to Malcolm, king of Scotland, upon condition that he should defend the northern parts of England against all invaders. It was by virtue of this grant that the eldest sons of the Scottish kings were styled governors of Cumberland. The Saxons, subsequently to this, again reduced it under their government; but, at the time of the Norman conquest, it was so much impoverished that William the Conqueror remitted all its taxes. From this circumstance Cumberland is not rated in Doomsday Book, as all the other counties of England are.

CUMBERLAND, a county of North America, in New Brunswick, which comprehends the lands at the head of the bay of Fundy, on the basin called Chebecton, and the rivers which fall into it. It has several settled townships; as Cumberland, Sackville, Amherst, Hillsborough, and Hopewell; and is watered by the rivers Au Lac, Missiquash, Napan, Macon, Memramcook, Petcodia, Chepodie, and Ilerbert.

CUMBERLAND, a county of the United States, in the district of Maine, between York and Lincoln counties. It has the Atlantic ocean on the south, and Canada on the north. Its sea coast, formed into numerous bays and lined with a multitude of fruitful islands, is nearly forty miles in extent in a straight line. Cumberland is divided into twenty-four townships, of which Portland is the chief.

CUMBERLAND, a county of the United States, in New Jersey, bounded on the south by Delaware Bay, on the north by Gloucester county, on the south-east by Cape May, and on the west by Salem county. Fairfield and Greenwich are the chief townships.

CUMBERLAND, a mountainous county of Pennsylvania, bounded on the north and north-west by Mifflin; on the east and north-east by the Susquehanna, which divides it from Dauphin; or, the south by York, and on the south-west by Franklin county. It is forty-seven miles in length and forty-two in breadth, and has ten townships, of which Carlisle is the chief.

CUMBERLAND, a county of Virginia, on the north side of Appamatox River, which divides it from Prince Edward.

CUMBERLAND, a county of North Carolina, in Fayette district, containing, in 1816, 9382 inhabitants.

CUMBERLAND, a considerable fort of North America in New Brunswick, at the head of the bay of Fundy, on the east side of the northern branch.

CUMBERLAND, a harbour on the east side of Washington's Isles, on the north-west coast of North America. It lies south of Skittikiss, and north of Cummashawaa.—Also a bay on the south-east coast of the island of Cuba.

CUMBERLAND, an island and bay of the United States, on the coast of Camden county, Georgia, twenty miles south of the town of Frederica.

CUMBERLAND ISLANDS, a cluster of islands so called by captain Cook, in 1770, and situated near the north-east coast of New Holland. They form a passage, called, from the day of its discovery, Whitsunday Passage; in long. 211° 28' W., lat. 20° 36' S.

CUMBERLAND MOUNTAINS, a ridge of mountains in North America, about thirty miles broad, which extend from the Tennessee River, and join the Allegany Mountains in Virginia.

CUMBERLAND RIVER, a river of North America, rising in the Cumberland Mountains on the western borders of Virginia, and falling, after a course of 450 miles, into the Ohio, ten miles above the mouth of the Tennessee. It is navigable for loaded batteaux 800 miles without interruption, and at its mouth is 300 yards wide.

CUMBERLAND STRAIT, a strait in the North Sea, west of Davis's Straits, beginning in long. 65° 30' W., lat. 63° 35' N.

CUMBERLAND (Richard), D.D., a learned divine of the seventeenth century, was the son of a citizen of London, and educated at Cambridge. In 1672 he published his excellent *Treatise of the Laws of Nature*; and in 1686 *An Essay upon the Jewish Weights and Measures*. After the Revolution he was nominated by king William to the bishopric of Peterborough. At the age of eighty-three he applied himself to the study of the Coptic language, of which he made himself master. He was as remarkable for humility as for his extensive learning. He died in 1718, aged eighty-seven.

CUMBERLAND (Richard), a celebrated dramatic and miscellaneous writer, was born in 1732, in the master's lodge of Trinity College, Cambridge, under the roof of his grandfather Dr. Bentley. When about six years of age he was sent to the school of Bury St. Edmunds, where, at twelve years old, he produced a dramatic piece of some merit entitled *Shakspeare in the Shades*. He was next sent to Westminster, and at the age of fourteen removed to Trinity College, under the care of Dr. Morgan; who, however, entirely neglected him, as did also his second tutor, Dr. Philip Young. But Dr. Smith succeeding Dr. Bentley shortly after, and finding the little progress he had made, excited him to industry, and so far succeeded that young Cumberland soon obtained a bachelor's degree. A fellowship next presented itself to his hopes; but he was induced to decline it for the time, by a prospect of preferment which was offered him by lord Halifax, to become his private secretary in the colonial office. Here he found leisure to prosecute his academical studies with so much success, that, in the first recess after coming to town, he

repaired to Cambridge, and gained his college honors in competition with candidates of older standing. From his official services, which were never burdensome, he was, soon after the settlement of his father at Fulham, entirely released by the resignation of his patron. At the beginning of the reign of George III. brighter days of official dignity opened upon lord Halifax; and the beams of royal favor which shone upon the patron were as usual reflected upon his satellites. His lordship was appointed to the high office of representing Majesty in Ireland, and was required to open the king's first parliament in that kingdom. Now our author anticipated a reward for his long and faithful services, and that his golden dreams of advancement would be realised. He had adhered to the new lord-lieutenant when in an office of less importance, and when in no office at all; and hoped in return for the post of chief secretary. He was, however, obliged to content himself with the secondary post of Ulster-secretary; Single-Speech Hamilton, without the lord-lieutenant's interference or concurrence, having been appointed to the higher dignity. After remaining in this situation for some time, he returned from Ireland, and as the final reward for his long services, was appointed to £200 a year from the crown agency of Nova Scotia. Some benefit, however, accrued to his father from this Irish expedition, as he was soon after our author's return nominated bishop of Clonfert. The son now returned to his old office in the board of trade, and began to write for the theatre. His first attempt which met with approbation was a musical drama, in three acts, entitled *The Summer's Tale*. In the following winter he brought out the comedy of the *Brothers* at Covent Garden theatre; and its success encouraged him to proceed in a career thus auspiciously commenced. The *West Indian*, the most popular of all his plays, was the next offering he made to the stage. It was represented for twenty-eight successive nights to crowded houses, without an after-piece; and, when published, 12,000 copies of it were sold. To this succeeded the *Fashionable Lover*; a performance which he seems inclined himself to rate higher, in many respects, than the one which gave him such celebrity. It is needless to add that the public were of a different opinion. The comedy of the *Choleric Man* was brought forward soon afterwards, and was honored with a prologue by Garrick. In the meantime lord George Germain became chancellor of the board of trade, and by his influence, upon the resignation of Mr. Pownal, Cumberland was advanced to the post of chief secretary, which very considerably increased his income. In 1780 he went on a mission to Lisbon and Madrid, but was recalled the year following, having, as was said, exceeded his powers. He was also deprived of his situation at the board of trade, and from this time his circumstances were much embarrassed. He retired to Tunbridge Wells, where losing his wife, he came to London, and died at the house of Mr. Henry Fry, in Bedford Place, Russel Square, at the advanced age of nearly eighty. He was interred in Poets' Corner, Westminster Abbey, between the monuments of *Dryden* and *Addison*. He wrote, besides his

comedies above mentioned, a periodical work, entitled the *Observer*; *Memoirs of his own Life*; *Calvary*, and the *Exodiad*, epic poems; *Retro-spection*, a poem; some sermons, novels, &c.

CUMBRAY, GREAT, a small island on the Scottish coast, in the frith of Clyde, annexed to the county of Bute. It is separated from Little Cumbray by a strait three-fourths of a mile broad. Its length is two miles and a half, and breadth one and a half; its surface containing about 2500 acres, which produce grain, turnips and potatoes. There are few trees on the island, but abundance of freestone and limestone, the former of which is exported. On the east side are two remarkable basaltic rocks, called *Reppel Walls*, having seams like those of Staffa, but not columnar. Milnport, on the south-west shore, has safe anchorage, and a small manufacture of thread and coarse linens is carried on in the village.

CUMBRAY, LITTLE, also annexed to the county of Bute, contains a light-house, and on the south side the remains of an ancient castle, surmounted by a ditch and rampart. Here are also some singular caves. The floor of one of them is thirty-two feet square, and six feet in height; and the largest penetrates so far that it has never yet been explored. The general appearance of the islands is also remarkable; they are nearly horizontal, and rise above one another like stairs as they recede from the shore.

CUMFREY, *n. s.* A medicinal plant.

CUMIN, *n. s.* Lat. *cuminum*. A plant.

Rank smelling rue, and cummin, good for eyes.

Spenner. Musipotmos.

When a dove-house is empty, there is cummin-seed used to purloin from the neighbours.

Beaumont and Fletcher.

CUMIN, in botany. See **CUMINUM**.

CUMINUM, cummin, a genus of the digynia order, and pentandria class of plants; natural order forty-fifth, umbellatæ. The fruit is ovate and striated; there are four partial umbels, and the involucre are quadrid. There is but one species, viz. *C. cyminum*, an annual plant, perishing soon after the seed is ripe. It rises nine or ten inches in the warm countries where it is cultivated, but seldom rises above four in this country. The leaves are a deep green, divided into long narrow segments, like those of fennel, but much smaller, and generally turned backward at their extremity; the flowers grow in small umbels at the top of the stalks; they are composed of five unequal petals, of a pale bluish color, which are succeeded by long, channeled, aromatic seeds.

CUMLY, a small maritime district of the province of Malabar, in Southern India, situated between the twelfth and thirteenth degrees of north latitude. It was formerly subject to a rajah of the Khutrix tribe, who adopted the Nair custom of preferring to the succession the son of the eldest daughter.

CUMLY, the capital, is a small place, inhabited by Hindoos and Mahomedans, and very pleasantly situated between two rivers. Here the rajah still resides, but possesses no power.

CUMMAZEE, or **COOMASSIE**, a large town and district of Western Africa, the capital of the Ashantee territory. It has been made known to

Europeans, only by a British mission sent some few years ago from Cape Coast Castle, and of the results of which we have given an account in the article ASHANTEE, which see.

CUMULATE, *v. a.* } Lat. *cumulus*. To
 CUMULATION, *n. s.* } heap or pile together;
 CUMULATIVE, *adj.* } the act of heaping to-
 gether. Consisting of parts heaped together.

For *cumulation*, I must confess I never liked it.
Abp. Laud.
 A man that beholds the mighty shoals of shells, bedded and *cumulated*, heap upon heap amongst earth, will scarcely conceive which way these could ever live.
Woodward.

CUN, *v. a.* Ice. *kunna*; Goth. *kunnan*. To have knowledge of; to learn thoroughly; to direct the course of a ship. See COND and CUND.

CUNCTATION, *n. s.* } Lat. *cunctatio*. De-
 CUNCTATOR, *n. s.* } lay; procrastination.
 One who has a habit of procrastinating; an idler; a sluggard.

It is most certain, that the English made not their best improvements of these fortunate events; and that especially by two miserable errors, *cunctation* in prosecuting, and haste in departure.
Hayward.
 The swiftest animal, conjoined with a heavy body, implies that common moral, *festina lentè*; and that celerity should always be contempered with *cunctation*.
Browne.

Others, being unwilling to discourage such *cunctators*, always keep them up in good hope, that, if they are not yet called, they may yet, with the thief, be brought in at the last hour.
Hammond's Fundamentals.

To CUND, *v. n.* Dut. *kunnen*, to know. To give notice; a provincial or obsolete word. See COND.

They are directed by a balker or huer on the cliff, who, discerning the course of the pilchard, *cundeth*, as they call it, the master of each boat.
Carew's Survey of Cornwall.

CU'NEAL, *adj.* } Lat. *cuneus*. Relating
 CU'NEATED, *adj.* } to a wedge; of a wedge-
 CU'NEIFORM, *adj.* } like form.

CUNEIFORM BONES, *n. s.* The fourth, fifth, and sixth bones of the foot; thus called from their wedge-like shape, being large above and narrow below.

CUNDUS, in antiquity, a company of infantry drawn up in form of a wedge, the better to break through the enemy's ranks.

CUNICULUS, in mining, a term used by authors in distinction from puteus, to express the several sorts of passages and cuts in these subterranean works. The cuniculi are those direct passages in mines where they walk on horizontally; but the putei are the perpendicular cuts or descents. The miners in Germany call these by the names *stollen*, and *schachts*; the first word expressing the horizontal, and the second the perpendicular cuts.

CUNILA, in botany, a genus of the monogynia order, and monandria class of plants; natural order forty-second, verticillatæ: cor. ringent, upper lip erect and plain; there are two filaments, castrated, or wanting antheræ: SEEDS four. There are five species, none of which has any remarkable property.

CUNITZ (Mary), a lady of considerable genius of the sixteenth century, was born in Silesia. She acquired languages with amazing facility; and understood Polish, German, French, Italian, Latin, Greek, and Hebrew. She attained a knowledge of the sciences with equal ease; and was skilled in history, anatomy, and the fine arts. She more particularly applied herself to the mathematics, and was ranked amongst the most able astronomers of her time. Her Astronomical Tables acquired her great reputation: she printed them in Latin and German, and dedicated them to the emperor Ferdinand III. She married Elias de Lewin, M.D., and died at Pstehen in 1664.

CUNNER, *n. s.* Lepas. A kind of fish less than an oyster, that sticks close to the rocks.

CUNNING, *n. s. & adj.* } Goth. *kunnan*;
 CUNNINGLY, *adv.* } Ang.-Sax. *connan*;
 CUNNINGNESS, *n. s.* } Dut. *konnen*. These
 CUNNINGMAN, *n. s.* } words are among

those of our language which have gradually lost their good meaning, and acquired, or been confined to, a bad one. Anciently cunning, though also used in a sinister sense, was more frequently indicative of something praiseworthy. It implied superior skill; knowledge; proficiency in any thing; and in these meanings its derivatives, of course, participated. Now, this use of the word is nearly, if not quite, disused; and cunning denotes artifice; deceit; slyness; dissimulation; fraudulent dexterity; something meanly deceptive. Cunning is the vice and resource of a mean and dastardly mind. A cunning-man is a fortune-teller; one who deludes the vulgar by pretending to a knowledge of the future.

Send me now therefore a man *cunning* to work in gold and in silver, and that can skill to cut and to grave.
2 Chronicles.

If I forget thee, O Jerusalem, let my right hand forget her *cunning*.
Psalms cxxxvii. 5.

For wondring it semith me,
 Thus many fresh ladies to se
 So faire, so *cunning*, and so yong,
 And no man dwelling them among.

Chaucer's Dreame.

The queene her self full *cunningly*,
 With softe wordis in gode wise,
 Said to the helite yong and wise. *Id.*

The Memphite Zoroas, a *cunyring* clerke,
 To whom the heaven lay open as his booke.

Songes and Sonnetto.

And there beside of marble stone was built
 An altar, carved with *cunning* imagery;
 On which true Christians' blood was often spilt,
 And holy martyrs often done to die.

Spenser. Faerie Queene.

Faire Venus' sonne, that with thy cruell dart
 At that good knight so *cunningly* didst rove,
 That glorious fire it kindled in his heart. *Id.*

The more he protested, the more his father thought
 he dissembled, accounting his integrity to be but a
cunning face of falsehood,
Sidney.

What if I be not so much the poet, as even that
 miserable subject of his *cunning*, whereof you speak?
Id.

Schoolmasters will I keep within my house,
 Fit to instruct her youth.—To *cunning* men
 I will be very kind; and liberal
 To mine own children, in good bringing up,
Shakspeare.

Wherein is he good, but to taste sack and drink it?
Wherein *cunning*, but in craft? Wherein crafty, but
in villainy? *Id. Henry IV.*

I do present you with a man of mine,
Cunning in musick and the mathematicks,
To instruct her fully in those sciences. *Shakespeare.*

Once put out thy light,
Thou *cunning'st* pattern of excelling nature,
I know not where is that Promethean heat,
That can thy light relumine. *Id. Othello.*

We take *cunning* for a sinister or crooked wisdom;
and certainly there is a great difference between a
cunning man and a wise man; not only in point of
honesty, but in point of ability. *Bacon.*

These small wares and petty points of *cunning*
are infinite, and it were a good deed to make a
list of them; for nothing doth more hurt than that
cunning men pass for wise. *Id.*

Amongst other crimes of this nature, there was dilig-
ent enquiry made of such as had raised and dis-
persed a bruit and rumour, a little before the field
fought, that the rebels had the day, and that the
king's army was overthrown, and the king fled;
whereby it was supposed, that many succours were
cunningly put off and kept back. *Id. Henry VII.*

I must meet my danger, and destroy him first;
But *cunningly* and closely. *Denham's Sophy.*

He sent him for a strong detachment
Of beadle, constable, and watchmen,
T' attack the *cunningman* for plunder
Committed falsely on his lumber. *Hudibras.*

Discourage *cunning* in a child; *cunning* is the ape of
wisdom. *Locke.*

Or if confidence or *cunning* come once to mix with
vice, and support his miscarriages, he is only the surer
lost,—and you must undo again, and strip him of that
he has got from his companions, or give him up to ruin.
Id.

Men will leave truth and misery to such as love it;
they are resolved to be *cunning*: let others run the
hazard of being sincere. *South.*

When Pedro does the lute command,
She guides the *cunning* artist's hand. *Prior.*

When stock is high, they come between
Making by second-hand their offers;
They *cunningly* retire unseen,
With each a million in his coffers. *Swift.*

A proper secrecy is the only mystery of able men;
mystery is the only secrecy of weak and *cunning* ones.
Chesterfield.

Such fate to suffering worth is given,
Who long with wants and woes has striven,
By human pride or *cunning* driven
To misery's brink,
Till wrenched of every stay but Heaven,
He, ruined sink! *Burns.*

ANT. Hark ye, Isaac, do you dare to complain of
tricking?—Don Jerome, I give you my word, this
cunning Portuguese has brought all this upon himself,
by endeavouring to overreach you, by getting your
daughter's fortune without making any settlement in
return. *Sheridan.*

Oh! she was perfect past all parallel—
Of any modern female saints comparison;
So far above the *cunning* powers of hell,
Her guardian angel had given up his garrison:
Even her minutest motions went as well
As those of the best time-piece made by Harrison.
Byron. Don Juan.

CUNNINGHAM (Alexander), a Scotch
writer of some celebrity, was born about the
year 1654. His father was minister at Ettrick,
in Selkirkshire. He was educated in Holland,
where he lived amongst the English and Scottish
refugees before the Revolution, particularly with
the earls of Argyle and Sunderland. He came over
to England with the prince of Orange, and enjoyed
the confidence and intimacy of many leading men
of that period. He was travelling companion and
tutor; first to the earl of Hyndford, and his
brother; then to John lord Lorne, afterwards
duke of Argyle; and afterwards to lord viscount
Lonsdale. Sir Robert Walpole, on the access-
ion of George I., sent him as British envoy to
the republic of Venice, where he continued till
1720, when he returned, and died in London
1737. His History of Great Britain, from the
Revolution of 1688 to the accession of George
I., was published in two vols. 4to. in 1787. It
was written in Latin, but translated into English
by the Rev. William Thompson, LL.D.

CUNNINGHAM (John), an ingenious English
poet, was born in 1729 at Dublin, and educated at
Drogheda. At the age of seventeen he wrote a
farce, called *Love in a Mist*, on which Garrick
founded the *Lying Valet*. His success made him
so attached to the theatre that he now commenced
performer, and entered into various companies
of strolling players in England. In 1761 he
produced, at Edinburgh, his *Elegy on a Pile of
Ruins*; and, in 1762, published *The Contem-
platist*. This was succeeded by *Fortune*, an
Apologue, which contains many poetical beau-
ties; and the following year he published a
volume of his poems by subscription. He con-
tinued earning a scanty subsistence in his pro-
fession, until his death, which took place in 1773
at Newcastle-upon-Tyne. His *Landscape* is con-
sidered beautifully descriptive.

CUNOCEPHALI, in mythology, from *κυν*,
dog, and *κεφαλη*, head, a kind of baboons, or ani-
mals with heads like those of dogs, which were
wonderfully endowed, and were preserved with
great veneration by the Egyptians in many of
their temples. It is fabled that, by their assistance,
the Egyptians found out the particular periods
of the sun and moon; that one-half of the animal
was often buried, while the other half survived;
and that they could read and write!

CUNODONTES, a people mentioned by
Solinus and Isidorus, and by them supposed to
have had the teeth of dogs. They were probably
denominated, says Bryant, from the object of
their worship, the deity Chan-Adon, which the
Greeks expressed *Κυνόδον*, and thence called his
votaries *Cunodontes*.

CUNONIA, in botany, a genus of the digy-
nia order, and decandria class of plants: cor.
pentapetalous: cal. pentaphyllous: cap. bil-
ocular, acuminate, polyspermous; the styles
longer than the flower. Species, one only, a
Cape shrub.

CUP, v. a. & n. s. } Fr. *coupe*; It. *coppa*;
CUPBEARER, n. s. } Sp. *copa*; Ang.-Sax.
CUPBOARD, v. a. & n. s. } *cupp*; Welsh *cup*;
CUPPER, n. s. } Dut. *kop*; Isl. *kupp*;
CUPPING-GLASS. } Per. *kub, kubba*; *kûß-*
βα. To cup is, to supply with cups, but this

meaning is disused ; to fix a cupping glass on the skin, for the purpose of extracting blood: Johnson derives the verb, in the latter sense; from Fr. *couper*, to cut; but it seems rather to have its origin in the shape of the glass which is employed. Cup is, primarily, a small vessel to drink out of; thence, the liquor drank from it; a social entertainment, in which case the plural only is used; any thing cup-like; a glass to draw blood. Cup and can signify familiar companions, the cup being the necessary associate of the can. Cupper is one who performs the operation of cupping. Cupbearer is, an officer of the king's household; the attendant who carries round the cup to the guests at a feast. A cupboard is a case with shelves; and to cupboard is, to store in a cupboard; to treasure up.

Thou shalt deliver Pharaoh's *cup* into his hand, after the former manner when thou wast his butler.

Genesis.

Hire over lippe wiped she so clene,
That in her *cuppe* was no fething sene
Of gresse when she dronken hadde hire draught.

Chaucer. Proel. to Cant. Tales.

Pipen he coude, and fishe, and nettes bete,
And turnen *cuppes*, and wrastlen wel and shete.

Chaucer. Cant. Tales.

His drinke the running streame: his *cup* the bare
Of his palme closed: his bed the hard colde ground.

Sackville.

Which' when the vile enchantress perceived,
With *cup* thus charmed imparting she deceived.

Spenser.

Plumpy Bacchus, with pink eyne,
In thy vats our cares be drowned;
With thy grapes our hairs be crowned!
Cup us, till the world go round.

Shakespeare. Antony and Cleopatra.

Will 't please your lordship, drink a *cup* of sack?

Shakespeare. Henry IV.

Then shall our names,
Familiar in their mouth as household words,
Be in their flowing *cups* freshly remembered.

Id. Henry V.

The belly did remain
I' the' midst o' the body, idle and unactive,
Still *cupboarding* the viand, never bearing
Like labour with the rest.

Id. Coriolanus.

It was near a miracle to see an old man silent,
since talking is the disease of age; but, amongst
cups, makes fully a wonder. *Ben Jonson's Discoveries.*

Homer, to whom the Muses did carouse

A great deep *cup* with heavenly nectar filled
The greatest deepest *cup* in Jove's great house. *Davies.*

Some trees are best for planchers, as deal; some
for tables, *cupboards*, and desks, as walnut.

Bacon's Natural History.

They that never had the use
Of the grape's surprising juice,
To the first delicious *cup*
All their reason render up.

Waller.

Amidst his *cups* with fainting shivering seized,
His limbs disjointed, and all o'er diseased,
His hand refuses to sustain the bowl.

Dryden's Persius.

Codrus had but one bed; so short, to boot,
That his short wife's short legs hung dangling out:
His *cupboard's* head six earthen pitchers graced,
Beneath them was his trusty tankard placed.

Id. Juvenal.

The clotted blood lies heavy on his heart,
Corrupts, and there remains in spite of art;
Nor breathing veins, nor *cupping* will prevail;
All outward remedies and inward fail. *Id. Fables.*

A bubo, in this case, ought to be drawn outward
by *cupping-glasses*, and brought to suppuration.

Wiseman.

You have quartered all the foul language upon
me, that could be raked out of the air of Billingsgate,
without knowing who I am, or whether I deserve to
be *cupped* and sacrificed at this rate.

Spectator.

The best, the dearest favourite of the sky
Must taste that *cup*; for man is born to die.

Pope's Odyssey.

Hippocrates tells you, that in applying of *cups*, the
scarification ought to be made with crooked instru-
ments.

Arbutnot.

There is conveyed to Mr. Villiers an intimation of
the king's pleasure to wait and to be sworn his ser-
vant, and shortly after his *cupbearer* at large; and
the summer following he was admitted in ordinary.

Wotton.

Ye heavenly powers, that guard
The British isles, such dire events remove
Far from fair Albion; nor let civil broils
Ferment from social *cups*.

Philips.

You boasting tell us where you dined,
And how his lordship was so kind;
Swear he's a most facetious man;
That you and he are *cup* and can:
You travel with a heavy load,
And quite mistake preferment's road.

Swift.

Yet their wine and their victuals these curmud-
geon-lubbards

Lock up from my sight, in cellars and *cupboards*. *Id.*

Now stir the fire, and close the shutters fast,
Let fall the curtains, wheel the sofa round,
And, while the bubbling and loud hissing urn
Throws up a steamy column, and the *cups*,
That cheer but not inebriate, wait on each,
So let us welcome peaceful evening in.

Comper.

Each widening scaie and bursting film unfold,
Swell the green *cup* and tint the flower with gold.

Darwin.

Or conjures up aerial forms
To marshal all the fairy swarms
That quaff their acorn *cups*, and sing
And frisk, and dance in sportive ring,
Tinging, where'er their tracks are seen,
The circled sward with richer green.

Huddesford.

The virgin Nine in terror fly the bower,
And Matron Juno claims despotic power;
Soon Gothic hags the classic pile o'erturn,
A caudle *cup* supplants the sacred urn.

Sheridan.

A land of slaves shall ne'er be mine—
Dash down you *cup* of Samian wine!

Byron. Don Juan.

And with a stretch attaining
A certain press or *cupboard* niched in yonder,
In that remote recess which you may see—
Or if you don't the fault is not in me.

Id.

CUP, in botany, calyx. See BOTANY.
CUPANIA, in botany, a genus of the mono-
delphia order, and monœcia class of plants;
natural order forty-eighth, triloccæ. Male, CAL-
tryphyllous: cor. pentapetalous; stamina five.
Female, CAL. triphyllous: cor. tripetalous; the
style trifid: SEEDS two. There is but one spe-
cies, a native of America, which possesses no
remarkable property.

CUPAR OF FIFE, a royal borough in the
centre of a parish of that name, beautifully si-

tuated on the north bank of the Eden, on the spot where it joins the water of St. Mary. It boasts of very high antiquity. The Thanes of Fife, from the earliest times of which we have any account, held their courts in it. It is governed by a provost, three baillies, a dean of guild, and thirteen counsellors, who choose one, with eight deacons, who are elected by the incorporations. Here is an excellent grammar-school. In conjunction with Perth, Dundee, St. Andrew's, and Forfar: it sends a representative to parliament. It is a well-built town; and a considerable manufacture of coarse linen is carried on in the neighbourhood. It is eight miles north by east of Falkland, and seven south of Dundee.

CUPEL, in metallurgy, a small vessel, which absorbs metallic bodies when changed by fire into a fluid scoria; but retains them as long as they continue in their metallic state. One of the most proper materials for making a vessel of this kind is the ashes of animal bones; there is scarcely any other substance which so strongly resists vehement fire, which so readily imbibes metallic scorice, and which is so little disposed to be vitrified by them. The bones, burnt to perfect whiteness, so that no particle of coaly or inflammable matter may remain in them, and well washed from filth, are ground into moderately fine powder; which, to form into cupels, is moistened with just as much water as is sufficient to make it hold together, when strongly pressed between the fingers. The cupel is formed in a brass ring, from three-quarters of an inch to two inches diameter, and not quite so deep: the ring being filled with moistened powder, which is pressed close with the fingers, a round-faced pestle, called a monk, is struck down into it with blows of a mallet, by which the mass is made to cohere, and rendered sufficiently compact, and a shallow cavity is formed in the middle. The figure of the cavity is nearly spherical, that a small quantity of metal melted in it may run together into a bead. To make the cavity the smoother, a little of the same ashes levigated into an impalpable powder, and not moistened, is commonly sprinkled on the surface, through a small fine sieve made for this purpose, and the monk again struck down upon it. The ring or mould is a little narrower at bottom than at top; so that by pressing down on some of the dry powder spread upon a table, the cupel is loosened, and forced upwards a little; after which it is easily pushed out with the finger, and is then set to dry in a warm place, free from dust. See **ASSAYING**.

CUP-GALLS, in natural history, a name given by authors to a very singular kind of galls found on the leaves of the oak and some other trees. They are of the figure of a cup or drinking-glass, without its foot, being regular cones adhering by their point or apex to the leaf; and the too or broad part is hollowed a little way, so that it appears like a drinking-glass with a cover, made so small as not to close it at the mouth, but fall a little way into it. This cover is flat, and has in the centre a very small green protuberance; the rim round the top is of a scarlet color, and very beautiful. Besides this

species of gall, oak-leaves furnish several others, some of which are oblong, some round, and others flattened. They all contain the worm of some small fly; and this creature passes all its changes in this habitation, being sometimes found in the worm, sometimes in the nymph, and sometimes in the fly state.

CUPID, in pagan mythology, the god of love. There were two cupids; one the son of Jupiter and Venus, whose delight it was to raise sentiments of love and virtue; and the other the son of Mars and the same goddess, who inspired base and impure desires. The first of these, called eros, or true love, bore golden arrows, which caused real joy, and a virtuous affection; the other, called anteros, had leaden arrows, that raised a passion founded only on desire, which ended in satiety and disgust. Cupid was always drawn with wings, to represent his inconstancy; and naked, to show that he has nothing of his own. He was painted blind, to denote that love sees no fault in the object beloved; and with a bow and quiver of arrows, to show his power over the mind. Sometimes he is placed between Hercules and Mercury, to show the prevalence of eloquence and valor in love; and at others is placed near Fortune, to signify that the success of lovers depends on that inconstant goddess. Sometimes he is represented with a helmet on his head and a spear on his shoulder, to signify that love disarms the fiercest men; he rides upon the backs of panthers and lions, and uses their manes for a bridle, to denote that love tames the most savage beasts. He is likewise pictured riding upon a dolphin, to signify that his empire extends over the sea no less than the land.

CUPIDITY, *n. s.* Fr. *cupidité*; Lat. *cupiditas*. Concupiscence; unlawful or unreasonable longing.

Thus sharpens the curiosity, while he suggesteth the *cupidity*.
Ed. Montaigne.

CUPOLA, *n. s.* } Fr. *cupole*; Ital. *cupola*.
CUPOLAE, *adj.* } A dome; the semi-globe which crowns a building. Having a cupola.

Cupolae, compassed with walls, and open to the air.
Sir T. Herbert.

Nature seems to have designed the head as the *cupola* to the most glorious of her works; and when we load it with supernumerary ornaments, we destroy the symmetry of the human figure.

Addison's Spectator.

CUPPEL, *n. s.* See **COPPEL**.

There be other bodies fixed, as we see in the stuff whereof *cuppels* are made, which they put into furnaces, upon which fire worketh not.

Bacon's Natural History.

CUPREOUS, *adj.* Lat. *cupreus*. Coppery: consisting of copper.

Having by the intervention of a little sal ammoniac made copper inflammable, I took some small grains and put them under the wick of a burning candle, whereby they were with the melted tallow so kindled, that the green, not blue, flame of the *cupreous* body did burn.
Boyle.

Hard dies of steel the *cupreous* circles cramp,
And with quick fall his massy hammers stamp.
The Harp, the Lily, and the Lion, join,
And George and Britain guard the sterling coin.

Darwin.

The stalactites formed on the roofs of caverns are often coloured in concentric strata, by their coats being spread over each other at different times; and some of them, as the *cupreous* ones, possess great beauty. *Id.*

CUPREOUS STONES are the turquoise and lapis armenus. The latter has calcareous earth, or gypsum, for its base; whence it sometimes effervesces with acids, and sometimes not. It is used in painting, when ground to a fine powder, under the name of bice.

CUPRESSUS, in botany, the cypress-tree; a genus of the monadelphia order and monocæcia class of plants, natural order fifty-first, coniferæ. Male, CAL. a scale of the catkin: COR. none; the antheræ are four, sessile, and without filaments. Female, CAL. a scale of the strobilus, and uniflorous; instead of styles there are hollow dots; the fruit is an angulated nut. There are seven species, the most remarkable are the following, 1. *C. disticha*, the deciduous American cypress, has an erect trunk, retaining a large bulk, branching wide and regular; grows fifty or sixty feet high, fully garnished with small spreading deciduous leaves, arranged distichous or along two sides of the branches. All these species are raised from seeds, and will sometimes also grow from cuttings; but those raised from seeds prove the handsomest plants. 2. *C. sempervirens*, with an upright straight stem, closely branching all around, almost from the bottom upwards, into numerous quadrangular branches, rising in the different varieties, from fifteen to forty or fifty feet in height, and very closely garnished with small, narrow, erect, evergreen leaves, placed imbricatum; and flowers and fruit from the sides of the branches. The wood of this species is said to resist worms, moths, and putrefaction, and to last many centuries. The coffins in which the Athenians were wont to bury their heroes were made, says Thucydides, of this wood; as were likewise the chests containing the Egyptian mummies. The same tree is, by many eminent authors, recommended as improving and meliorating the air by its balsamic and aromatic exhalations; upon which account, many ancient physicians of the eastern countries used to send their patients, who were troubled with weak lungs, to the island of Candia, where these trees grew in great abundance; and where, from the salubrious air alone, very few failed of a perfect cure.

CUPROSE, *n. s.* A name given to the poppy in the north of England.

CUR, *n. s.* *Dut. korre*, A worthless degenerate dog; a **CURRISH**, *adj.* } *good-for-nothing man.*
CURRISHLY, *adv.* }
CURRISHNESS, *n. s.* } *Currish is brutal; quarrelsome; malignant; churlish; untractable. Curship is, dogship; meanness; scoundrelship.*

For lo the gentil kinde of the lion!
 For whan a fie offendeth him or biteth,
 He with his taile awaie the fie ysmither
 Al easly, for of his genèrie
 Him deimeeth not to wreke him on a fie,
 As doeth a curre or els another best.

Chaucer. The Legende of Good Women.

Like dastard curres, that having at a bay
 The salvage beast embost in wearie chace,
 Dare not adventure on the stubborne pray.

Spenser. Faerie Queene.

Yet would he not persued be for ought,
 Ne from his currish will a whit reclame. *Id.*
 Sweet speaking off a currish heart reclaim.

Sidney.

Currishly, without all order of law or honesty. *J. For.*

'Tis a good dog.

—A cur, Sir.

—Sir, he's a good dog, and a fair dog.

Shakespeare.

She says your dog was a cur; and tells you, currish thanks is good enough for such a present. *Id.*

What would ye have, ye cur,

That like not peace nor war? *Id. Coriolanus.*

O lawlesse paunch! the cause of much desight.
 Through raunging of a currish appetite. *Hall.*

Hell's porter, Cerberus,

That currishness into our heads dost put. *May.*

'How durst th' I say, oppose thy curship
 'Gainst arms, authority, and worship.

Hudibras.

Here's an old drudging cur turned off to shift for himself, for want of the very teeth and heels that he had lost in his maister's service. *L'Estrange.*

A cur may bear

The name of tiger, lion, or whate'er

Denotes the noblest or the fairest beast.

Dryden's Juvenal.

This knight had occasion to inquire the way to St. Anne's Lane; the person, whom he spoke to, called him a young popish cur, and asked him, who made Anne a saint? *Addison.*

Hidden as it is, and far remote

From such displeasing sounds as haunt the ear
 In village or in town, the bay of currs
 Incessant, clinking hammers, grinding wheels,
 And infants clamorous whether pleased or pained,
 Oft have I wished the peaceful covert mine.

Cooper.

CURA, *St. LEWIS DE*, a town of South America, in the Caracæe, surrounded by mountains. It is sixty-six miles south-west of Caracac. The temperature hot and dry. Population 4000.

CURACOA, an island in the Caribbean Sea, about seventy-five miles from the coast of the Caracac, South America. It has several excellent harbours, and is thirty miles long and ten broad. Its soil, in general, is not fertile, and it is almost entirely dependent on the rains for water; but it produces sugar and tobacco, and feeds a breed both of large and small cattle. Its ports were formerly much frequented by vessels from Carthage and Porto Bello, in the slave-trade. It is, in general, well supplied with the manufactures both of Europe and the East Indies. It was twice captured by the British during the late wars, but was restored to the Dutch at the peace of 1814. Its exports, in 1810, amounted, in value, to £263,996, and its imports to £236,181. Long. 69° 2' W., lat. 12° 6' N.

CURACOA, the capital of the above island, is a large and well-built city, has a good port, and is fortified by a castle.

CURATE, *n. s.*

CURATESHIP, *n. s.* } *Lat. curator.* A clergyman who performs for
CURACY, *n. s.* } hire the duties of another;
 a parish priest; one who holds a perpetual cu-

curacy. Curacy and curateship signify, employment of a curate; a benefice known by the name of a perpetual curacy

— he had power of confession,
As said himselfe, more than a *curat*,
For of his order he was a licentiat.

Chaucer. Prol. to Cant. Tales.

Bishops and *curates*, and all congregations.
Common Prayer.

I thought the English of *curate* had been an ecclesiastical hawking.—No such matter; the proper import of the word signifies one who has the cure of souls.

Collier on Pride.

He spared no pains; for *curate* he had none,
Nor durst he trust another with his care.

Dryden's Fables.

They get into orders as soon as they can, and, if they be very fortunate, arrive in time to a *curacy* here in town.

Swift.

And in truth to this *curate*, old Nick owed a grudge;
For—although in the pulpit as grave as a judge—
Yet folks, who his conduct have narrowly scanned,
Say he did not put quite enough starch in his band.

Huddeford.

CURATE, is an ecclesiastical term, sometimes applied to the incumbent of a parish, as having the care or cure of souls, but generally denoting the lowest degree of the clergy in the church of England, who represent the incumbent of a church, parson or vicar, and perform divine service in his stead. He is to be licensed and admitted by the bishop of the diocese, or by an ordinary having episcopal jurisdiction: and the bishop often appoints the salary; in such case, if he be not paid, the curate has a proper remedy in the ecclesiastical court, by a sequestration of the profits of the benefice; but if the curate is not licensed by the bishop, he is put to his remedy at common law, where he must prove his agreement, &c. A curate having no fixed estate in his curacy, or not being instituted and inducted, may be removed at pleasure by the bishop or incumbent. But there are perpetual curates as well as temporary, who are appointed where tithes are impropriate, and no vicarage endowed; these are not removable, and the impropiators are obliged to find them; some whereof have certain portions of the tithes settled on them. Every clergyman that officiates in a church, whether incumbent or substitute, in the liturgy is called a curate. Curates must subscribe the declaration according to the act of uniformity, or are liable to imprisonment, &c. It is provided by the canons that no curate shall remove from one diocese to another, without testimonials from the bishop or ordinary of his honesty, ability, and conformity to the ecclesiastical laws of the church of England; and that none should serve more than one church or chapel upon one day, except that chapel be a member of the parish church, or united thereto, and unless such church or chapel, where such minister should serve in two places be not able, in the judgment of the bishop or ordinary to maintain a curate. By the 12 Anne, cap. 12, the bishop or ordinary first had the power of appointing the curate's stipend at the time of granting his license, that is, admission to the curacy, such stipend not to exceed £50 per

Vol. VI.

annum, nor to be less than £20. By the 36 George III. cap. 18, this was increased to £75 per annum; and the curate was, in certain cases, to be allowed the use of the parsonage-house, or an allowance of £15 per annum instead. The 53 George III. cap. 149, much enlarged the powers of the bishops or ordinaries. They were authorised to appoint and license curates with salaries, in the event of non-resident incumbents neglecting to appoint, and the salary so made payable was not limited, as theretofore, to the sums of £50 or £75 per annum, but was to be in proportion to the value of the benefice and population of the parish.

CURATELLA, in botany, a genus of the di-gynia order and polyandria class of plants: CAL. is pentaphyllous; the petals four; the styles two: CAPS. bipartite, with the cells dispermous.

CURATOR, n. s. Lat. One who has the superintendence of any thing; a guardian appointed by law.

The *curators* of Bedlam assure us, that some lunatics are persons of honour.

Swift.

A minor cannot appear as a defendant in court but by his guardian and *curator*.

Ayliffe's Paerom.

CURATOR, in Roman antiquity, an officer under the emperors, who regulated the prices of all kinds of merchandise and vendible commodities, in the cities of the empire. They had likewise the superintendence of the customs and tributes; whence, also, they were called *logistæ*.

CURATOR, in the civil law, a trustee nominated to take care of the affairs of a person emancipated or interdicted. In countries where the Roman law prevails, between the age of fourteen and twenty-four years, minors have curators assigned them; till fourteen, they have tutors.

CURATOR OF AN UNIVERSITY, in the ci-devant United Provinces, was an elective office, to which belonged the direction of the affairs of the university; as the administration of the revenues, the inspection of the professors, &c. The curators were chosen by the states of each province; the university of Leyden had three, the burghermasters of the city a fourth.

CURB, v. a. & n. s. Fr. *courber*. A curb is, primarily, 'an iron chain made fast to the upper part of the branches of the bridle, in a hole called the eye, and running over the beard of the horse.' The purpose of it is, to check the horse; to restrain him in subjection. Hence, curb is, generally, restraint; opposition; hindrance. It is also the name of a hard callous tumor running along the inside of a horse's hoof; so called because it impedes his motion. To curb signifies, to guide a horse by means of a curb; to restrain; to hold back; to prevent from going beyond proper bounds. It sometimes takes *from* after it. In the quotation from Ray, Dr. Johnson thinks that the verb is used, as in French, in the sense of to bend.

Were not the laws planted amongst them at the first, and had they not governors to curb and keep them still in awe and obedience?

Spenser on Ireland.

His angry steede did clude his foaming bit,
As much disdainyng to the curbe to yielde.

Id. Faerie Queene.

Yet you are curbed from that enlargement by
The consequence of the crown. *Shakespeare. Cymbeline.*

3 A

The ox hath his bow, the horse his *curb*, and the falcon his bells; so man hath his desires.

Id. As You Like It.

The Roman state, whose course will on
The way it takes, cracking ten thousand *curbs*
Of more strong links asunder, than can ever
Appear in your impediment. *Id. Coriolanus.*

Shall the controller of proud Nemesis
In lawless rage upbraid each other's vice,
While no man seeketh to reflect the wrong,
And *curb* the range of his misruly tongue? *Hall.*

Then thou, the mother of so sweet a child,
Her false imagined loss cease to lament,
And wisely learn to *curb* thy sorrows wild. *Milton.*
Part wield their arms, part *curb* the foaming steed. *Id.*

We remain
In strictest bondage, though thus far removed,
Under the inevitable *curb*, reserved
His captive multitude. *Id. Paradise Lost.*

By these men, religion, that should be
The *curb*, is made the spur to tyranny. *Denham. Sophy.*

Though the course of the sun be *curbed* between the
tropics, yet are not those parts directly subject to his
perpendicular beams uninhabitable or extremely hot. *Ray.*

On the other side, if the mind be *curbed* and
humbled too much in children; if their spirits be
abashed and broken much, by too strict a hand over
them; they lose all their vigor and industry, and
are in a worse state than the former. *Loche.*

So four fierce coursers, starting to the race,
Scour through the plain, and lengthen every pace;
Nor reins, nor *curbs*, nor threatening cries they fear. *Dryden.*

Warm in the raptures of divine desire,
Bursts the soft chain that *curbs* the aspiring mind;
And fly, where Victory, borne on wings of fire,
Waves her red banner to the rattling wind. *Beattie.*
Honour and shame are much more liberal motives;
and experience proves, that they may, for the most
part, if not always, be more effectual. These indeed
may be employed, with good success, through the
whole of life, as a preservative from vice, and a *curb*
to every inordinate passion. *Id.*

Stretch the silk rein, and champ the silver *curb*. *Darwin.*

It seems as if we Britons were ordained,
By way of wholesome *curb* upon our pride,
To fear each other, fearing none beside. *Cowper.*

And from his chief withdrawn, he wandered lone,
Brief were his answers, and his questions none;
His walk the wood, his sport some foreign book:
His resting-place the bank that *curbs* the brook. *Byron. Lara.*

Yet again, ye shadowy heroes,
Yield not to these stranger Neros!
Though the son who slew his mother,
Shed Rome's blood, he was your brother:
'Twas the Roman *curbed* the Roman. *Id. The Deformed Transformed.*

CURB, in the menage, consists of these three parts; the hook, fixed to the eye of the branch; the chain of SS's, or links; and the two rings, or mailles. Large curbs, provided they be round, are always most gentle; but care is to be taken, that it rest in its proper place, a little above the beard, otherwise the bit-mouth will not have the effect that may be expected from it. English watering bits have no curbs; the Turkish bits, called genettes, have a ring that serves instead of a curb.

CURCULIO, in zoology, a genus of insects belonging to the order of coleoptera. The feelers are subclavated, and rest upon the front, which is prominent and horny. These insects are divided into the following families, 1. Those which have the rostrum longer than the thorax, and whose thighs are simple. 2. Those which have the rostrum longer than the thorax, and the thighs thicker and made for leaping. 3. Those which have the rostrum longer than the thorax, and the thighs dentated. 4. Those which have dentated thighs, and a rostrum shorter than the thorax. 5. Those whose thighs are without teeth or spines, and the rostrum shorter than the thorax. There are no less than ninety-five species, principally distinguished by their color. The larvæ of the curculiones differ not from those of most coleopterous insects. They bear a resemblance to oblong soft worms. They are provided anteriorly with six scaly legs, and their head is likewise scaly. But the places where those larvæ dwell, and their transformations, afford some singularities. Some species of them, that are dreaded for the mischief they do in granaries, find means to introduce themselves, while yet small, into grains of corn, and there make their abode. Other larvæ of curculiones are not so fond of corn, but fix in the same manner on several other seeds; and a species are lodged in the inside of plants. The heads of artichokes and thistles are often bored through and eaten away by the larvæ of large curculiones. Another species smaller, but singular, pierces and inwardly consumes the leaves of elms. It frequently happens that almost all the leaves of an elm appear yellow, and as it were dead, towards one of their edges, while the whole remainder of the leaf is green. Upon inspecting those leaves, the dead part appears to form a kind of bag or small bladder. The two laminæ, or outward pellicles of the leaf, as well above as below, are entire, but distant and separated from each other, whilst the parenchyma that lies between them has been consumed by several small larvæ of the curculio, that have made themselves that dwelling, in which they may be met with. After this transformation, they come forth, by piercing the kind of bladder, and give being to a curculio that is brown, small, and hard to catch, by reason of the nimbleness with which it leaps. The property of leaping, allotted to this single species, depends on the shape and length of its hinder legs.

CURCUMA, turmeric, in botany, a genus of the monogynia order, and monandria class of plants, natural order eighth, scitamineæ. It has four barren stamina, with a fifth fertile. The species are, 1. *C. longa*, with long fleshy roots, of a deep yellow color, which spread under the surface of the ground like those of ginger; they are about the thickness of a man's finger, having many round knotty circles, from which arise four or five large spear-shaped leaves, standing upon long foot-stalks. The flowers grow in loose scaly spikes on the top of the foot-stalks, which arise from the larger knobs of the roots, and grow about a foot high; they are of a yellowish-red color, and shaped somewhat like those of the Indian reed.

2. *C. rotunda*, with a round root. It has a fleshy jointed root like that of ginger, but round; and sends up several spear-shaped oval leaves, which rise upwards of a foot high, and of a sea-green color. From between these arises the flower-stalk, supporting a loose stalk of flowers of a pale yellowish color, enclosed in several different spathæ, or sheaths, which drop off. The flowers are never succeeded by seeds in this country. Both these species grow naturally in India, from whence the roots are brought to Europe for use. They are very tender, and will not live in this country unless kept constantly in a stove. They are propagated by parting the roots. The root communicates a beautiful but perishable yellow dye, with alum, to woollen, cotton, or linen. In medicine it is esteemed aperient, and emmenagogic; and of singular efficacy in the jaundice.

CURD, *v. a. & n. s.* } Thomson derives
CURDLE, *v. a. & v. n.* } curd from Fr. *cailler*,
CURDY, *adj.* } *caille*, a derivation which does not seem to be very plausible. Lemon, with his usual positiveness, says, 'by transposition evidently derived à *κρως*, quasi, *κρως*, frigus, et *κρως*, frigidus, unde *cruror*.' Skinner looks for its origin in the verb to crowd, whence crowdle. The old spelling, crudle, or cruddle, perhaps, suggested this etymology. To curd is to turn to curds; to cause to coagulate. To curdle is to coagulate; to shut together; to concreate; to force into coagulation, or concretions. Curd signifies, coagulated milk; the concretion the thicker parts of any liquor.

Which when as Una saw, through every vaine,
 The *cruddled* cold ran to her well of life.
Spenser. Faerie Queene.

For she would call him often heam,
 And give him *curds* and clouted cream.
Id. Shepherd's Calendar.

Maiden, does it *curd* thy blood,
 To say I am thy mother?
Shakespeare. All's Well that Ends Well.

Powder of mint, and powder of red roses, keep the milk somewhat from turning or *curdling* in the stomach.
Bacon.

Mixed with the sixth part of a spoonful of milk, it burnt to the space of one hundred pulses, and the milk was *curdled*.
Id.

Milk of itself is such a compound of cream, *curds*, and whey, as it is easily turned and dissolved.
Id.

My soul is all the same,
 Unmoved with fear, and moved with martial fame;
 But my chill blood is *curdled* in my veins,
 And scarce the shadow of a man remains.
Dryden's Virgil.

This night, at least, with me forget your care;
 Chesnuts, and *curds* and cream, shall be your fare.
Dryden.

Let Sporus tremble.—What! that thing of silk?
 Sporus, that mere white *curd* of ass's milk?
Pope.

Even now a fatal draught works out my soul:
 Even now it *curdles* in my shrinking veins
 The lary blood, and freezes at my heart.
Smith.

It differs from a vegetable emulsion, by coagulating into a *curdy* mass with acids.
Arbushnot on Aliments.

Some to the house,
 The fold, and dairy, hungry bend their flight,
 Sip round the pale, or taste the *curdling* cheese.
Thomson's Sum

CURDISTAN. See **KURDISTAN**.
CURDLING, the coagulating or fixing of any fluid body; particularly milk. See **CHEESE**. Pausanias says, that Aristæus son of Apollo, and Cyrene daughter of the river Peneus, were the first who found out the art of curdling milk. At Florence they curdle their milk for making cheese with artichoke flowers instead of rennet. The *Bisaltæ*, a people of Macedonia, Rochfort observes, live wholly on curds.

CURE, *v. a. & n. s.* } Lat. *cura*. Cure was
CU'RELESS, *adj.* } anciently synonymous
CU'RER, *n. s.* } with care, as will be
CU'RABLE, *adj.* } seen in one of the il-
CU'RABLENESS, *n. s.* } lustrations from Chau-
CU'RATIVE, *adj.* } cer, and it still retains
 this meaning in the 'cure of souls,' the charge committed to a clergyman. To cure is, to heal; to restore to health; to remedy; to recover; to prepare with antiseptics, so as to preserve from corruption. Cure signifies, remedy; act of healing; the benefice or employment of a curate or clergyman. Curable is that which may be cured; curative that which relates to curing.

I do *cures* to-day and to-morrow. *Luke viii. 32.*

Of studie toke he most *cure* and hede;
 Not a word spake he more than was neede.
Chaucer. Prolog. to Cant. Tales.

And will ye knowe that of a sursanure
 In surgerye is perileous the *cure*. *Id. Cent. Tales.*

But I wol leve it at this time, than Faunus also well
 Was afir sent in hert, of sekner to be *curyd*. *Id.*

Thus every way you see wythe absence how I
 burne,
 And for my wound no *cure* I fynde, but hoape of good
 returne. *Surrey.*

In depe wyde wound, the deedlystroke doth turns
 To *curseless* skarre that never shall returne. *Wyatt.*

For in yourself your only help doth lie
 To heale yourselves, and must proceed alone
 From your owne will to *cure* your maladie:
 Who can *cure* him that will be *cured* of none?
Spenser. Faerie Queene.

And being such, were now much more increast
 For want of taking heede unto the same,
 That now corrupt and *curseless* they became. *Id.*

It easeth some, tho' none it ever *cured*,
 To think their dolour others have endured.
Shakespeare. The Rape of Lærcæus.

O hateful, vaporous, and foggy night!
 Since thou art guilty of my *curseless* crime,
 Muster thy mists to meet the eastern light *Id.*

This league that we have made
 Will give her sadness very little *cure*;
 Brother of England how may we content
 This widow lady? *Id. King John.*

He is a *curer* of souls, and you a *curer* of bodies:
 if you should fight, you go against the hair of your
 professions. *Id. Merry Wives of Windsor.*

We study speech, but others we persuade;
 We leachcraft learn, but others *cure* with it. *Davies.*

The bones, in sharp colds, wax brittle; and there-
 fore all contusions of bones, in hard weather, are
 more difficult to *cure*. *Bacon's Natural History.*

The therapeutick or *curative* physick, we term that which restores the patient unto sanity.

Browne's Vulgar Errors.

A consumption of the lungs, at the beginning, herein differs from all other *curable* diseases, that it is not to be worn away by change of diet, or a cheerful spirit.

Harvey.

Cold, hunger, prisons, ills without a *cure*,
All these he must, and guiltless oft, endure.

Dryden's Fables.

If, said he,

Your grief alone is hard captivity,
For love of heaven, with patience undergo
A *curseless* ill, since fate will have it so. *Id.*

If his *cure* lies among the lawyers, let nothing be said against entangling property, spinning out causes, squeezing clients, and making the laws a greater grievance than those who break them.

Collier.

The beef would be so ill chosen, or so ill *cured*, as to stink many times before it came so far as Holland.

Temple.

Horace advises the Romans to seek a seat in some remote part, by way of a *cure* for the corruption of manners.

Swift.

Hear what from love unpractised hearts endure,
From love, the sole disease thou canst not *cure*. *Pope.*

There may be taken proper useful indications, both preservative and *curative*, from the qualities of the air.

Arbuthnot.

That certain bodily pains might be alleviated by certain sounds, was believed by the Greeks and Romans: and we have it on the best authority, that one species at least of madness was once *curable* by melody.

Beattie.

His unsuspecting sheep believe it pure;
And, tainted by the very means of *cure*,
Catch from each other a contagious spot,
The foul forerunner of a general rot. *Comper.*

Grief's *curseless* wounds with lenient balms assuage,
Or prop with firmer staff the steps of age. *Darwin.*

— their Politic Doctors assure her,

That they know where her malady lies,
And their grand panacea shall *cure* her.

Huddesford.

CURETES, in antiquity, ancient priests of the Isle of Crete, called also Corybantes. They are said to have been originally of Mount Ida, in Phrygia; for which reason they were also called Idæi Dactyli. According to Pezron, and others, the curetes were in the times of Saturn, &c. and in the countries of Crete and Phrygia, what the Druids were afterwards among the Gauls, &c. i. e. they were priests who had the care of what related to religion and the worship of the gods. Hence, as in those days it was supposed there was no communication with the gods but by divinations, auguries, and the operations of magic, the curetes passed for magicians; to these they added the study of the stars, of nature, and poesy; and so were philosophers, astronomers, &c. Vossius, de Idolatriâ, distinguishes three kinds of curetes, those of Ætolia, those of Phrygia, and those of Crete, who were originally derived from the Phrygians. The first, he says, took their name from *κῆρα*, tonsure, because from the time of a combat, wherein the enemy seized their long hair, they always kept it cut. Those of Phrygia and Crete he supposes were so called from *κῆρος*, young man, because they were young, or because they nursed Jupiter when he was young.

CURFEW. Old Fr. *couvre-feu*. An evening-peal, says Cowell, by which the Conqueror willed that every man should rake up his fire, and put out his light; so that in places, at this day, where a bell is customarily rung towards bed-time, it is said to ring curfew. The custom, however, appears to have been in existence, at least in the convents of the north, before the time of William the Conqueror: Curfew is also the name of a cover for the fire; a fire plate.

The dede slepe for very besinesse,
Fell on this carpenter, right as I gesse,
Abouten *curfew* time, or litle more.

Chaucer. Cant. Tales.

You, whose pastime
Is to make midnight mushrooms, that rejoice
To hear the solemn *curfew*.

Shakespeare. Tempest.

Who ever gives a pair of velvet shooes
To the Holy Rood, or liberally allows
But a new rope to ring the *curfew* bell,
But he desires that his great deed may dwell
Or graven in the chancel window glasse,
Or in the lasting tomb of plated brasse? *Hell.*

But now for pans, pots, *curfews*, counters, and the like, the beauty will not be so much respected, so as the compound stuff is like to pass.

Bacon.

Of on a plat of rising ground
I hear the far off *curfew* sound,
Over some wide-watered shore,
Swinging slow with sullen roar. *Milton.*

The *curfew* tells the knell of parting day. *Grey.*

Soothed by the lulling sound of grove and stream,
Romantic visions swarm on Edwin's soul:
He minded not the Sun's last trembling gleam
Nor heard from far the twilight *curfew* toll;
When slowly on his ear these moving accents stole. *Beattie.*

Till, summoned by the *curfew's* sound,
While falling dew embaths the ground,
Again I seek the friendly shade
From whence my devious steps have strayed,
Repass the lawn, and hawthorn dell,
Regain thy shelter, Lowly Cell! *Id.*

CURIA, among the ancient Romans, denoted a portion or division of a tribe. In the time of Romulus, a tribe consisted of ten curiæ, or 1000 men; each curia being 100. The legislator made the first division of his people into thirty curiæ. Afterwards curiæ became used for the place where each curia held its assemblies, as well as for the senate-house; and hence the moderns use the word curia, a court, for a place of justice, and for the judges, &c. there assembled. Varro derives the word from cura, care, q. d. an assembly of people charged with the care of public affairs. Others deduce it from the Greek; maintaining, that at Athens they called *κῆρα* the place where the magistrate held his assizes, and the people used to assemble: *κῆρα*, again, may come from *κῆρος*, authority, or power; because it was here the laws were made.

CURIA, or **DOMUS CURIALIS**, the place where the curiæ used to assemble. Each of the thirty curiæ of old Rome had a temple or chapel assigned to them for the common performance of their sacrifices, and other offices of their religion; so that they were not unlike our parishes. Some remains of these little temples seem to have subsisted many ages after on the Palatine hill,

where Romulus first built the city, and always resided.

CURIA, in our ancient customs. It was usual for the kings of England to summon the bishops, peers, and great men of the kingdom, to some particular place, at the chief festivals in the year, and this assembly is called by our historians curia; because there they consulted about the weighty affairs of the nation: whence it was sometimes also called solennis curia, generalis curia, augustalis curia, and curia publica, &c. See WITTENAGEMOT.

CURIA CLAUDENDA, in law, is a writ that lies against him who should fence and enclose the ground, but refuses or defers to do it.

CURIALITY, *n. s.* From Lat. *curialis*. The privileges, prerogatives, or perhaps retinue, of a court.

The court and curiality. *Bacon to Villiers.*

CURIATI, three brothers of Alba, who maintained the interest of their country against the Romans who had declared war against those of Alba. See HORATI.

CURIET, **CURET**, or **CURAT**. Old Fr. *cuirace*, from *cuir*, leather, because breast-plates were originally made of that material. A corslet; a breast-plate.

Instead whereof she made him to be dight
In woman's weeds that is to manhood shame,
And put before his lap an apron white,
Instead of *curiets* and bases fit for fight.

Spenser. Faerie Queene.

CURIO, in the Roman customs, the chief and priest of a curia. Romulus, upon dividing the people into curiæ, gave each division a chief, who was to be priest of that curia, under the title of curio and flamen curialis. His business was to provide and officiate at the sacrifices of the curia, which were called curionia: the curia furnishing him with a sum of money on that consideration, which pension was called curionium. Each division had the election of its curio; but all these particular curios were under the direction of a superior or general.

CURIO MAXIMUS, the head of the curios, elected by the whole body assembled in the comitia curialis. All these institutions were introduced by Romulus, and confirmed by Numa, as Dionysius Halicarnasseus relates.

CURIOSUS, an officer of the Roman empire during the middle age, appointed to take care that no frauds and irregularities were committed; particularly in what related to the posts, the roads, &c., and to give intelligence to the court of what passed in the provinces. This made the curiosi people of importance, and put them in a condition of doing more harm than they prevented, on which account Julian cashiered them; as did also Honorius, at least in some parts of the empire, A. D. 415.

CURIOSUS, *adj.* } Old Fr. *curios*, *cu-*
CURIOSUSLY, *adv.* } *curios*; mod. Fr. *curieux*;
CURIOSITY, *n. s.* } Lat. *curiosus*. Curious
CURIOSNESS, *n. s.* } signifies, inquisitive;
CURIO'SO, *n. s.* } anxious for information;
prone to enquiry; prying; attentive to, sometimes with *after*, and sometimes with *of*; careful to avoid error; fastidious; solicitous of perfec-

tion; exact; nicely diligent; elegant; highly finished; rigid; severe. Curiosity is, inquisitiveness; nicety; exactness; a nice experiment; an object particularly worthy of notice; a rarity. Curioso is synonymous with virtuoso.

Understanding to devise *curious* works to work in gold. *Exodus.*

Be not *curious* in unnecessary matters; for more things are shewn unto thee than men understand. *Ecclesi iii. 23.*

And for to fasten his hood under his chinne
He hadde of gold ywrought a *curious* pinne.
Chaucer. Prolog. to Cant. Tales.

Worship not Jove with *curious* fancies vaine,
Nor him despise; hold right atweene these twaine.
Songes and Sonnettes.

And therewithal came *curiousness*, and carpet out of frame. *Id.*

But he, to shifte their *curious* request,
Gan causen why she could not come in place.
Spenser. Faerie Queene.

He looked very *curiously* upon himself, sometimes fetching a little skip, as if he said his strength had not yet forsaken him. *Sidney.*

Till Arianism had made it a matter of great sharpness and subtlety of wit to be a sound believing Christian, men were not *curious* what syllables or particles of speech they used. *Hocher.*

For *curious* I cannot be with you,
Signior Baptista, of whom I hear so well.
Shakespeare.

When thou wast in thy guilt, and thy perfume, they mocked thee for too much *curiosity*; in thy rage thou knowest none, but art despised for the contrary. *Id. Timon.*

There hath been practised also a *curiosity*, to set a tree upon the north side of a wall, and at a little height to draw it through the wall, and spread it upon the south side; conceiving that the root and lower part of the stock should enjoy the freshness of the shade, and the upper boughs and fruit the comfort of the sun; but it sorted not. *Bacon's Natural History.*

A vaile obscured the sunshine of her eyes,
The rose within herself her sweetness closed;
Each ornament about her seemly lies,
By *curious* chance, or careless art, composed.
Fairfax.

Ee'n then to them the spirit of lies suggests
That they were blind, because they saw not ill,
And breathed into their incorrupted breasts
A *curious* wish, which did corrupt their will.
Davies.

A temperate person is not *curious* of fancies and deliciousness; he thinks not much, and speaks not often, of meat and drink. *Taylor.*

Our senses, however armed or assisted, are too gross to discern the *curiosity* of the workmanship of nature. *Ray.*

Curiosity in children is but an appetite after knowledge, and therefore ought to be encouraged in them, not only as a good sign, but as the great instrument nature has provided to remove the ignorance they were born with, and which without this busy inquisitiveness, will make them dull and useless creatures. *Locke.*

Nor is it the having of wheels and springs, though never so *curiously* wrought, and artificially set, but the winding of them up, that must give motion to the watch. *South.*

If any one too *curious* should enquire
After a victory which we disdain,
Then let him know the Belgians did retire
Before the patron saint of injured Spain.

Dryden.

Then thus a senior of the place replies,
Well read, and *curious* of antiquities. *Id. Fables.*

At first I thought there had been no light reflected
from the water in that place; but, observing it more
curiously, I saw within it several smaller round spots,
which appeared much blacker and darker than the
rest.

Newton's Opticks.

We took a ramble together to see the *curiosities* of
this great town. *Addison's Freeholder.*

It is pity a gentleman so very *curious* after things
that were elegant and beautiful, should not have been
as *curious* as to their origin, their uses, and their na-
tural history.

Woodward.

In proportion that credulity is a more peaceful pos-
session of the mind than *curiosity*, so far preferable is
that wisdom which converses about the surface, to
that pretended philosophy which enters into the depth
of things, and then comes back gravely with infor-
mations and discoveries, that in the inside they are
good for nothing.

Swift.

This, Sir, is *curious*; and what hardly would be
expected in so reduced a court as that of Charles the
Second, and in so improved a country as England
might then be thought. But so it was.

Burke.

His work on this last subject is the only one in
which that antique piece of *curiosity* has been pre-
served to us.

Id.

Meanwhile, whate'er of beautiful, or new,
Sublime, or dreadful, in earth, sea, or sky,
By chance, or search, was offered to his view,
He scanned with *curious* and romantic eye.

Beattie.

Then *Curiosity* with tracing hands
And meeting lips the line of form demands,
Buoyed on light step, o'er ocean, earth, and sky,
Rolls the bright mirror of her restless eye.

Darwin.

Oh, couldst thou speak,
As in Dodona once thy kindred trees
Oracular, I would not *curious* ask
The future, best unknown, but at thy mouth
Inquisitive, the less ambiguous past.

Cowper.

Books, for his volume heretofore was Man,
With eye more *curious* he appeared to scan,
And oft, in sudden mood, for many a day
From all communion he would start away.

Byron. Lara.

Vain was in fact question asked her for the past,
And vain e'en menace—silent to the last;
She told nor whence, nor why she left behind
Her all for one who seemed but little kind.
Why did she love him? *Curious* fool!—be still—
Is human love the growth of human will?

Id.

I loathe that low vice *curiosity*,
But if there's any thing in which I shine,
'Tis in arranging all my friends' affairs,
Not having of my own domestic cares.

Id. Don Juan.

CURISCH-HAFF, or the **GULF OF COUR-
LAND**, a lake or gulf of Prussia, alongside of
the Baltic, from which it is separated by the Cu-
risch-Nerung, extending from Memel to Lablau,
about seventy miles. The breadth is very un-
equal, being wide to the south and narrow to-
wards the north.

CURL, *v. a., v. n., & n. s.* } Dan. *krälle, knor-*
CURLINESS, *n. s.* } *la*; Dut. *krollen*;
CURLINGLY, *adv.* } Ang.-Sax. *cyran*;
CURLY, *adj.* } from Isl. *kra*, a
CURL-HEADED, *adj.* } crook, a turn; Ital.
CURLED-PATE, *adj.* } *ciurlo*; Lat. *circulo*;
CURLING-IRONS, *n. s.* } *Popow*. To curl is,

to form the hair into ringlets; to dress with curls;
to writhe; to twist; to raise into waves or undu-
lations; to shrink up into ringlets; to twist
round; to shrink back. Curl signifies, a ringlet
of hair; an undulation; a wave; a sinuosity.
Curliness, which means the state of being curled,
is a word of modern coinage, but has a legiti-
mate claim to form a part of the language, as no
other word expresses the same meaning. Of the
other words under this head, the meaning is ob-
vious.

Before the threshold dreadful Cerberus
His three deformed heads did lay along,
Curled with thousand adders venomous.

Spenser. Faerie Queene.

She apparelled herself like a page, cutting off her
hair, leaving nothing but the short curls to cover that
noble head.

Sidney.

If she first meet the curled Antony,
He'll make demand of her a kiss. *Shakespeare.*
His browny locks did hang in crooked curls,
And every light occasion of the wind
Upon his lips their silken parcels hurle.

Id. A Lover's Complaint.

The visitation of the winds,
Who take the ruffian billows by the top,
Curling their monstrous heads. *Id. Henry IV.*
Make curled-pate ruffians bald.

Id. Timon of Athens.

Letting them curl themselves about my limbs.
Beaumont and Fletcher.

The very thinking it
Would make a citizen start; some politic tradesman
Curl with the caution of a constable. *Id.*

They, up the trees
Climbing, sat thicker than the snaky locks
That curled Medæa. *Milton's Paradise Lost.*

Those slender aerial bodies are separated and
stretched out, which otherwise, by reason of their
flexibility and weight, would flag or curl. *Boyle.*

To every nobler passion of the town
The curling billows rowl their restless tide;
In parties now they straggle up and down,
As armies, unopposed, for prey divide. *Dryden.*

Then round her slender waist he curled,
And stamped an image of himself, a sovereign of the
world. *Id. Alexander's Feast.*

Just as in act he stood, in clouds enshrined,
Her hand she fastened on his hair behind,
Then backward by his yellow curls she drew;
To him, and him alone, confessed in view.

Id. Fables.

Thus it happens, if the glass of the prism be free
from veins, and their sides be accurately plain and
well polished, without those numberless waves or
curls, which usually arise from the sand holes.

Newton's Opticks.

While curling smoaks from village tops are seen.
Popo.

Here, on the sharp spear, mad with mortal pang,
The bird transfixed in bloody vortex whirle,
Yet fierce in death the threatening talon curls:
There, while the life-blood bubbles from his wound,
With little feet the pigmy beats the ground. *Beattie.*

With starting eyes, wide throat, and gaping teeth,
Curl his redundant folds, and writhe in death.

Darwin.

Love culls a flaming shaft of broadest string,
And rests the fork upon the quivering string;
Points his arch eye aloft, with fingers strong
Draws to his curled ear the silken thong;
Loud twangs the steel, the golden arrow flies,
Trails a long line of lustre through the skies. *Id.*

SEERJ. Full bottomed heroes thus, on signs, unfurl
A leaf of laurel in a grove of curl!
Yet tell your client, that, in adverse days,
This wig is warmer than a bush of bays. *Sheridan.*

Love shows all changes—hate, ambition, guile
Betray no further than the bitter smile;
The lips' least curl, the lightest paleness thrown
Along the governed aspect, speak alone
Of deeper passions, and to judge their mien,
He, who would see, must be himself unseen.

Byron. The Corsair.

And further on a group of Grecian girls,
The first and tallest her white kerchief waving,
Were strung together like a row of pearls;
Linked hand in hand, and dancing; each too
having
Down her white neck long floating auburn curls.

Id. Don Juan.

She came into the cave, but it was merely
To see her bird reposing in his nest;
And she would softly stir his locks so curly,
Without disturbing her yet alumbering guest,
Breathing all gently o'er his cheek and mouth,
As o'er a bed of roses the sweet south. *Id.*

CURLEW, *n. s.* Fr. *corlieu*. A kind of water fowl, with a large beak of a gray color, with red and black spots; a bird larger than a partridge, with longer legs, frequent in Spain and Sicily, and sometimes found in France.

Among birds we reckon crowsers, curlews and puffins. *Carow.*

I never hear the loud, solitary whistle of the curlew, in a summer moon, without feeling an elevation of soul like the enthusiasm of devotion or poetry.

Burns.

Mourn, ye wee songsters o' the wood;
Ye grouse that crap the heather bud:
Ye curlews calling through a clud;
Ye whistling plover;
And moarn, ye whirring patrick brood;
He's gane for ever!

Id.

CURLEW. See SCOLOPAX.

CURMI, a name given by the ancients to a sort of malt liquor or ale. It was made of barley, and was drunk by the people of many nations instead of wine, according to Dioscorides' account. He accuses it of causing pains in the head, generating bad juices, and disordering the nervous system. He also says, that in the western part of Iberia, and in Britain, such a sort of liquor was, in his time, prepared from wheat instead of barley.

CURMU'DGEON, *n. s.* } An unknown
CURMU'DGEONLY, *adj.* } correspondent
suggested to Dr. Johnson, that this word is probably derived from the Fr. *cœur mechant*. Dr. Johnson adopted the idea, and stated in what manner he obtained it. In Ash's Dictionary the ludicrous mistake was committed, of giving the words an 'unknown correspondent,' as a

translation of *cœur mechant*, and this blunder has afforded abundant food for laughter. Mr. Todd doubts the correctness of the derivation itself, and refers the origin of the word either to Ger. *curmede*, a sort of vassalage, or to *cur* and the Ang.-Sax. *mupnang*, a complaint, a murmuring; but he inclines to the former. Thomson says, Ang.-Sax. *car modig*, from *carc*, care, and *mod*, the mind. Curmudgeon means, an avaricious, churlish fellow; a close-fisted churl; a niggard; a griper.

And when he has it in his claws,
He'll not be hide-bound to the cause;
Nor shalt thou find him a curmudgeon,
If thou dispatch it without grudging.

Hudibras.

A man's way of living is commended, because he will give any rate for it; and a man will give any rate rather than pass for a poor wretch, or a penurious curmudgeon. *Locke.*

In a country where he that killed a hog invited the neighbourhood, a curmudgeonly fellow advised with his companions how he might save the charge.

L'Estrange.

CURRAH, a small district in the province of Allahabad, between the twenty-fifth and twenty-sixth degrees of north latitude, and bounded by the Ganges and Jumna. The country from Currah to Benares on the east side abounds with a species of earth called *sujee muttee*, impregnated with alkali, from one to three inches thick, which is sold at the close of the rainy season, to the soap manufacturers.

CURRAH, the chief place of the district of Allahabad, is situated on the south-west side of the Ganges, forty-five miles north-west from Allahabad, and extends a mile along the banks of the Ganges. Here is an old fort in ruins, and a new one with an unfinished stone gate-way. There are also many Hindoo temples.

CURRANT, *n. s.* Thomson says, 'crand, cranberry, and hindberry, seem to have included this fruit; which was afterwards confounded with the small raisins brought from Corinth.' The fruit of a species of *grossularia*; a small dried grape, now principally imported from Zante, but which takes its name from Corinth.

They buttered currants on fat veal bestowed,
And rumps of beef with virgin honey stewed;
Inspid taste, old friend, to them who Paris know,
Where rocombole, shallot, and the rank garlic grow.

King.

Lewenhoeck assures us, that in the bud of a currant tree he could not only discover the ligneous part, but even the berries themselves, appearing like small grapes.

Darwin.

CURRANTS, or CURRBANS, are the fruit of a species of *grossularia*. See *GROSSULARIA*. The white and red sort are mostly used; for the black, and chiefly the leaves upon first coming out, are in use to flavor English spirits, and counterfeit French brandy. Currants greatly assuage drought, cool and fortify the stomach, and help the digestion; and the jelly of black currants is said to be very efficacious in curing inflammations of the throat.

CUR'RRENT, *n. s. & adj.* } Fr. *courant*; Ital.
CUR'RRENTLY, *adj.* } *corrente*; Sp. *corri-*
CUR'RRENTNESS, *n. s.* } *ente*; Lat. *currens*,
CUR'RRENCY, *n. s.* } *currens*. That which

runs or flows onward continuously, is the idea which is here conveyed. Hence, current as a noun, signifies a running water; a particular direction of the waters of the ocean towards certain parts, of which the Gulf-stream affords an instance; course; progression. As an adjective, it means, that which passes from hand to hand; generally received; allowed to pass without contradiction; general; popular; fashionable; allowable; that which is now passing, as, the current year. Currency is, the mass of money in a country; power of passing from hand to hand; general belief and reception of; fluency of speech; constant flow; general esteem; the papers which were formerly stamped in the English colonies by authority, and which passed as money.

Shakels of silver, *current* money with the merchant. *Genesis* xxiii. 16.

O rodie rosier, flowering without spine,
Fountain filthlesse, as biril *current* clere! *Chaucer.*

Like as the tide that comes from the ocean mayne,
Flowers up the Shenar with contrarie forse,
And over-ruling him in his own rayne,
Drives back the *current* of his kindly course.

Spenser. Faerie Queene.

The very cause which maketh the simple and ignorant to think they even see how the word of God runneth *currently* on your side, is, that their minds are forestalled, and their conceits perverted beforehand. *Hooker. Preface.*

The *current*, that with gentle murmur glides,
Thou knowest, being stopped, impatiently doth rage;
But when his course is not hindered,
He makes sweet musick with the' enamelled stones.

Shakespeare.

Fouler than heart can think thee, thou canst make
No excuse *current*, but to hang thyself.

Id. Richard III.

When substantialness combineth with delightfulness, and *currentness* with stayedness, how can the language sound other than most full of sweetness?

Camden's Remains.

He that thinketh Spain to be some great overmatch for this estate, assisted as it is, and may be, is no good mintman, but takes greatness of kingdoms according to their bulk and *currency*, and not after their intrinsic value. *Bacon.*

Heaven her Eridanus no more shall boast,
Whose fame in thine, like lesser *current*, 's lost;
Thy noble streams shall visit Jove's abodes,
To shine among the stars, and bathe the gods.

Denham.

We are also to consider the difference between worth and merit, strictly taken: that is a man's intrinsic, this his *current*, value; which is less or more, as men have occasion for him. *Grew's Com.*

Not fabled Po more swells the poet's lays,
While through the sky his shining *current* strays.

Pope.

Oft leaving what is natural and fit,
The *current* folly proves our ready wit;
And authors think their reputation safe,
Which lives as long as fools are pleased to laugh. *Id.*

That there was *current* money in Abraham's time, is past doubt, though it is not sure that it was stamped; for he is said to be rich in cattle, in silver, and in gold. *Arbushnot.*

The *currency* of those half-pence would, in the universal opinion of our people, be utterly destructive to this kingdom. *Swift.*

They despaired of giving any very general *currency* to their opinions. They considered them as a reserved privilege for the chosen few. *Burke.*

Fain would I sing what transport storm'd his soul,
How the red *current* throbed his veins along,
When, like Pelides, bold beyond control,
Without art graceful, without effort strong,
Homer raised high to Heaven the loud, the' impetuous song. *Bentley.*

On the flood,
Indurated and fixed, the snowy weight
Lies undissolved; while silently beneath,
And unperceived, the *current* steals away. *Cooper.*

Four sparkling *currents* laved with wandering tides
Their velvet avenues, and flowery sides;
On sunbright lawn unclad the Graces strayed,
And guiltless Cupids haunted every glade. *Darwin.*

J. SURF. I' faith, that's true, lady Smeerwell:
whenever I hear the *current* running against the characters of my friends, I never think them in such danger as when candour undertakes their defence. *Sheridan.*

Before the mansion lay a lucid lake,
Broad as transparent, deep, and freshly fed
By a river, which its softened way did take
In *currents* through the calmer water spread
Around: the wild fowl nestled in the brake
And sedges, brooding in their liquid bed. *Byron. Don Juan.*

CURRENCY. See MEDIUM CIRCULATING.

CURRENTS, in navigation, are either natural and general, as arising from the diurnal rotation of the earth about its axis; or accidental and particular, caused by the waters being driven against promontories, or into gulfs and straits, where, wanting room to spread, they are driven back, and thus disturb the ordinary flux of the sea. Currents are various, and directed towards different parts of the ocean, of which some are constant, others periodical. Perhaps the most extraordinary current of the sea, is that of the Atlantic Ocean, which we have already noticed, and which extends from Guinea round by the coast of America. See ATLANTIC.

'This grand movement of the ocean from east to west,' says Mr. Tuckey, 'has a complicated origin; and the trade winds, so far from being the cause, as has been supposed by some, are probably in part the effect of this current. Buffon thought that the sun and moon advancing continually to the west, in regard to a fixed point on the earth, must draw the mass of waters after them, and occasion a constant movement of the ocean from east to west; but this explanation not being found satisfactory, the following has been offered:—The heat of the sun and the rotation of the earth constantly tend to diminish the density of the equatorial waters, and evaporation draws from that region a much greater quantity of the fluid than is restored to it by rivers or meteors; hence, as we have observed, the waters of the polar regions move towards the equator to restore the equilibrium; but these polar waters are specifically heavier than the tropical waters, and, besides, their rotative movement is infinitely slower, but their inertia prevents them from getting suddenly rid of their original movement, and there-

fore they cannot follow with equal velocity the increased rapidity of the rotatory movement of the globe in the equatorial regions. Heavy and motionless, they fall at once into a sphere of the most active movement, but preserve, for some time, their original character.

A variety of other shifting currents do not last, but return at certain periods; and most of these depend upon and follow the anniversary winds, which by blowing in one place may cause a current in another. Between the island of Celebes and Madura, when the western monsoons set in, viz. in December, January, and February, or when the winds blow from the north-west, or between the north and west, the currents set to the south-east, or between the south and east. At Ceylon, from the middle of March to October, the currents set to the south, and in the other parts of the year to the north, because at this time the southern monsoons blow, and at the other the northern. Between Cochin China and Malacca, when the western monsoons blow, viz. from April to August, the currents set eastward against the general motion; but the rest of the year they set westward, the monsoon conspiring with the general motion. They run so strongly in these seas, that unexperienced sailors mistake them for waves that beat upon the rocks, known usually by the name of breakers. So for some months after the 15th of February, the currents set from the Maldives towards India on the east, against the general motion of the sea. On the shore of China and Cambodia, in October, November, and December, the currents set to the north-west, and from January to the south-west, when they run with such rapidity about the shoals of Parcel, that they seem swifter than an arrow. At Pulo Condore, upon the coast of Cambodia, though the monsoons are shifting, yet the currents set strongly towards the east, even when they blow to a contrary point. Along the coasts of the bay of Bengal, as far as the Cape Romania, at the extreme point of Malacca, the current runs south in November and December. When the monsoons blow from China to Malacca, the sea runs swiftly from Pulo Cambi to Pulo Condore on the coast of Cambodia. In the bay of Sans-Bras, not far from the Cape of Good Hope, there is a current peculiarly remarkable, where the sea runs from east to west to the landward; and this more vehemently as it is opposed by winds from a contrary direction. This is undoubtedly owing to some adjacent shore which is higher than this. In the straits of Gibraltar, the currents almost constantly drive to the east, and carry ships into the Mediterranean: they are also found to drive the same way into St. George's Channel. The setting or progressive motion of the current may be either quite down to the bottom, or to a certain determinate depth. As the knowledge of the direction and velocity of currents is a very material article in navigation, it is highly necessary to discover both, in order to ascertain the ship's situation and course with as much accuracy as possible.

CURRICULE, *n. s.* Old Fr. *curicule*; Lat. *curriculum*. This word formerly meant a course: it is now the name of a two-wheeled open chaise, drawn by two horses abreast.

Upon a *curvide* in this world depends a long course of the next, and upon a narrow scene here an endless expansion hereafter. *Brown.*

CURRIE (Dr. James), was born at Kirkpatrick, in Scotland, in 1756. He received the rudiments of learning at the parish school of his native place, whence he was transferred to the grammar-school of Dumfries. His original destination was for a commercial life, and he passed some years of his youth in a mercantile station in Virginia. Disliking his profession, and unwilling to be a witness of the impending troubles in the American colonies, he quitted that country in 1776, and in the following year commenced a course of medical study at the university of Edinburgh. A prospect of an appointment in the medical staff of the army, which would not admit of the usual delay of an Edinburgh graduation, induced him to take the degree of doctor of physic at Glasgow; but, being disappointed in his hopes, he finally settled in Liverpool in 1781. In 1783 he married the daughter of W. Wallace, esq. a merchant of that town, by whom he had several children. His professional employment now rapidly increased, and he was elected one of the physicians of the infirmary. In 1790 he became a member of the London Medical Society, and communicated to it a paper On Tetanus and Convulsive Disorders, published in the third volume of its Memoirs. In 1792 he became a fellow of the Royal Society. A very curious and instructive Account of the Remarkable Effects of a Shipwreck, communicated by him to that body, was published in the Philosophical Transactions of that year. A pamphlet which appeared in 1793, under the title of A Letter, Commercial and Political, addressed to the Right Hon. William Pitt, by Jasper Wilson, Esq. on the subject of the war with revolutionary France, and which excited considerable attention, was also generally understood to come from his pen. In 1797 his reputation was further extended by a publication entitled Medical Reports on the Effects of Water, Cold and Warm, as a Remedy in Febrile Diseases, with Observations on the Nature of Fever, and on the Effects of Opium, Alcohol, and Inanition. The practice of affusion of cold water in fevers, which is the leading topic in this work, was suggested to the author by Dr. Wright's narrative in the London Medical Journal, of his successful treatment of a fever in a homeward-bound ship from Jamaica. Dr. Currie, however, greatly extended it, and investigated the principles by which its use should be directed.

On a visit to his native country, in 1792, he had become personally acquainted with that rustic son of genius Robert Burns. This extraordinary but unfortunate man having at his death left his family in great indigence, a subscription was made in Scotland for their immediate relief, and at the same time a design was formed of publishing an edition of his printed works and remains, for their emolument. Mr. Syme of Ryedale, an old and intimate friend of Dr. Currie, strongly urged him to undertake the office of editor. In 1800, therefore, he published in 4 vols., 8vo., The Works of Robert Burns, with an Account of his Life, and a Criticism on his

Writings; to which are prefixed some Observations on the Character and Conditions of the Scottish Peasantry. This work passed through repeated editions, and produced a balance of profit that formed a welcome assistance to the destitute family. Dr. Currie, though possessed of a frame naturally vigorous, was subject to violent pulmonary attacks, and, his health beginning to decline visibly in 1804, he was compelled to leave Liverpool. Spending the following winter alternately at Clifton and Bath, he thought himself in the month of March in a state of convalescence, and, taking a house in Bath, recommenced the practice of his profession. But his disease had now obtained a permanent hold on his constitution, and he was obliged to relinquish the attempt. As a last resource he went in August to Sidmouth, where, after much suffering, which he bore with manly fortitude and resignation, he expired August 31st, 1805, in the fiftieth year of his age. His disease was ascertained to be a great enlargement and flaccidity of the heart, accompanied with a remarkable wasting of the left lung, but without ulceration, tubercle, or abscess.

CURRIERS, COMPANY OF. This company was incorporated in 1438 by Henry I., and their arms are *sable*, a cross engrailed, or between four pair of shares in saltire *argent*. The crest, two arms embowed, holding a share: the motto, *Spes nostra Deus*



CURRITUCK, a county of North Carolina, on the sea-coast of Edenton district, forming the north-east corner of the state, being bounded on the east by Currituck Sound, north by the state of Virginia, south by Albemarle Sound, and west by Camden county; it contains upwards of 5000 inhabitants, and the celebrated Dismal Swamp, one of the best rice estates in America.

CURRITUCK, or **CARATUNK**, a township of the United States, in the district of Maine, twenty-eight miles above Norridgewalk.

CURRODREPANUS, from *currus*, a chariot, and *δρεπανον*, a scythe, in antiquity, a chariot armed with scythes. The driver of these chariots was obliged to ride on one of the horses, as there was no other seat for him. There were no scythes pointing down to the earth, either from the beam or axle-tree; but these were fixed at the head of the axle-tree in such a manner as to be movable by means of a rope, and thereby could be raised or let down, and drawn forward or let fall backward, by relaxing the rope.

CURRUCKDEAH, a hilly district of Hindostan, in the province of Bahar, covered generally with wood, and containing no important place except Curruckdeah, the capital; in long. 86° 13' E., lat. 24° 26' N.

CURRUCKPORE, also a district of the province of Bahar, in which are found hot springs, of no mineral taste, but keeping as well as the Bristol water. Curruckdeah is the capital.

CURRY, *v. a.* } Fr. *courroyer*; Lat. **CURRYCOMB**, *n. s.* } *corium*, leather. To dress **CURRYING**, *n. s.* } leather, so as to render it **CURRIER**, *n. s.* } fit for use; to drub; to rub a horse with a currycomb, which is an iron

instrument, consisting of several parallel ridges, indented with small teeth; to wheedle. To curry favor, is to become a favorite by petty officiousness, slight kindnesses, or flattery; it always implies meanness in the person who resorts to it; favor is a corruption of favel, a name anciently given to yellow-colored horses. Currier is one who dresses leather. Curryng is the operation of dressing leather; of rubbing down a horse with a currycomb.

So from her parting, she thenceforth did labour
By all the means she might to curry favour,
With the Elfin knight, her ladies best beloved.

Spenser. Faerie Queene.

If I had a suit to master Shallow, I would humour his men; if to his men, I would curry with master Shallow.

Shakespeare.

Frictions make the parts more fleshy and full; as we see both in men, and in the *currying* of horses: the cause is, for that they draw a greater quantity of spirits and blood to the parts.

Bacon.

He has a clearer idea from a little print than from a long definition; and so he would have of strigil and aistrum, if instead of a *currycomb* and cymbal, he could see stamped in the margin small pictures of these instruments.

Locke.

This humour succeeded so with the puppy, that an ass would go the same way to work to *curry* favour for himself.

L'Estrange.

A *currier* bought a bear-skin of a huntsman, and laid him down ready money for it.

Id.

Warned by frequent ills, the way they found
To lodge their loathsome carrion under ground;
For useless to the *currier* were their hides,
Nor could their tainted flesh with ocean tides
Be freed from filth.

Dryden's Virgil.

I may expect her to take care of her family, and *curry* her hide in case of refusal.

Addison's Spectator.

CURRY. Hind. *quorma*, to stew. An East Indian savoury powder, used in cookery.

CURRYING is the art of dressing or preparing leather for shoes, and a variety of other purposes, after it has undergone the process of tanning.

It is a trade conducted under a license which is taken out annually from the Board of Excise, and curriers are obliged to specify in the entry, every room in which leather is deposited, as well as the vats and tubs in which it is soaked. Their premises are, of course, subject to the inspection of excise-officers; and any hide or skin not having the tanner's duty-mark, is liable to seizure.

The premises of a currier usually consist of a shaving-shop, scouring-house, and rough leather warehouse, on the ground floor; above these are erected the drying sheds, which are weather-boarded, and calculated to admit a free draught of air, where the wet leather is hung on hooks fixed in rails, which are placed horizontally in rows. The stuffing-tables, which are of mahogany, are also fixed here; the lower floors are differently arranged by different persons, according to the extent of the premises, and the business to be carried on. Where a choice of situation offers, that will be preferred in which the air has free access to the sheds, and at a proper distance from foundries and steam-engines, the smoke

and smuts issuing from these buildings being a great annoyance to the currier, and injurious to saddle and boot-top leather in particular; the value of which depends much on the brightness and regularity of its color. An open yard is a useful appendage, and in extensive concerns cannot well be dispensed with. The coach and saddle currying is in many instances a distinct trade in London, but it is sometimes connected with the shoe trade, and in the country they are generally united.

The skin or shoe trade will come first under consideration, in which is comprehended the dressing of calf, seal, horse, and dog-skins, with the lightest ox and cow hides, for shoe upper-leathers; and to this is usually attached the business of a leather-cutter, which implies the cutting up heavy tanned hides, called crop leather, for soles, and curried goods for shoe upper leathers, welts, &c., for the retailer and consumer. It is a general practice to weigh the skins, and mark them singly before they are put into work, which enables the master to ascertain his profit on every lot of goods, or on every skin, if he wishes to be so particular; and also assists his judgment in buying and assorting the different kinds of goods, and in applying them to the particular purposes for which they are calculated. This requires as much experience as any part of the trade. In laying-in rough goods, the buyer should be well informed in the varieties of tannage, as well as the growth peculiar to different parts of the country, which are as readily distinguishable as the cattle themselves to an experienced dealer. Tanned goods are sold chiefly by weight, and the buyer must have in view the quality of the leather, pattern, and substance; the latter is unequal, and varies in the same lot of goods, and in different parts of the same skin. The proportion of thin loose leather to the middle or prime parts of the skin, is a principal consideration with the buyer, and he always finds the skin of the cow, or any other female animal more level, of a finer texture, and consequently more valuable than that of the male; the firmness and fineness of leather depends much on the treatment it has had in the tanner's pits. It is part of his duty to contract and fill the looser parts of the skin, which will be seen in its proper place; the gashing of the skin by the butcher is also a matter of much consequence to the buyer, and requires all his caution, as the extent of the mischief does not always appear, until the fibrous matter adhering to the flesh side, and which connects the skin to the carcase, is removed by the currier's knife.

An act was passed in the year 1800, inflicting certain penalties on the butcher, in proportion to the damage done to the skin; and persons have been appointed to the markets throughout the kingdom, to inspect the skins, and levy the fines by information before a magistrate, in proportion to the damage; but it has been found inefficient from the total negligence of the inspectors in some places, and more so from the good understanding the tanner finds it his interest to keep up with the butcher. Unfortunately, the currier, and not the tanner, who is the only

check on the butcher, is the principal sufferer by his negligence. A late repeal of statute 1st, James I., has relieved the trade from a vexatious tax, by abolishing the useless offices of searchers and sealers of leather. Until the year 1808, Leadenhall Market was subject to the troublesome interference of these officers, who were obliged to compromise a duty it was impossible to execute; and we believe the most strenuous among those who at that time assisted in supporting such a regulation, now consider their own judgment well substituted for the obnoxious statute. The country leather dealers had long before wisely relieved themselves of its restrictions. Experience soon teaches the buyer to discriminate between well-tanned and well-dried leather, and the contrary; and according as a deficiency in either deteriorates the value, so is the price given.

To return to practical currying: the dressing of a calf-skin for shoe upper-leathers will give a good general idea of the process; we will, therefore, take one as it is received from the tanner, and pursue the operation through the hands of the workman to its finished state. The offal parts, such as the face, tail, and shanks, being first taken off, which is called rounding the skin, it is delivered into the journeyman's hands, who throws it into a vat, or tub of water, to soak, preparatory to the operation of shaving, which is performed by a knife of a peculiar make, and it will be necessary to give a description of this tool, as well as the beam on which the leather is shaved.

The beam, so called by the curriers, is a post about three feet high, fixed in a slightly inclined position, on a firm stage or platform, which is raised eight or ten inches from the floor, for the man to stand upon; this post is about four inches thick and eight inches wide, and is faced with a board of lignum vitæ of the same breadth.

The knife has two edges; the blade is rectangular, about twelve inches long, and from four to six inches wide, and varies in size and weight, according to the work to be performed; one end has a straight, and the other a cross handle, in the plane of the knife. It is brought to a wire-edge, by rubbing on a stone of a coarse grit, which is afterwards taken off, and a finer grit produced by a finer and softer stone. The cross-handle of the knife is then firmly fixed between the workman's knees, and while in a kneeling posture he turns the edges to an angle with their former position, by means of a polished steel, similar in shape to a butchers' steel. They are kept in order, chiefly by a smaller steel, which the man holds constantly between his fingers, and passes along the knife, the point within, and the side without the groove, formed by the turned edge, as occasion requires, and, as often as the edges are worn, they are renewed in the same way. The name of Cox, of Gloucester, is known throughout Europe as the principal maker of curriers' knives. Mr. Bingley, of Birmingham, who has obtained a patent for an improvement in their manufacture, rivets a plate of steel, properly tempered, between two iron plates, instead of welding the whole together, which is the case with other makers;

and, thereby, as he properly observes, making the thicker and thinner parts unequal in temper, according to the unequal influences of the same degree of heat on the thicker and thinner parts of the knife.

Having prepared the knife, the wet skin is thrown over the beam, with the flesh-side outwards, and the man keeps it in its position by the pressure of his knees as he leans over the beam. The knife is then applied, horizontally, to the leather, and by repeated strokes downwards, it is reduced to the substance required. The angular edge does not merely scrape the skin; but, in the hands of a skilful man, takes off a shaving, the full breadth of the beam, at every stroke of the knife. The man's whole strength is exerted in shaving, and great care, as well as ingenuity, is necessary to avoid galling, or reducing the skin more in some parts than others. In order to keep the substance of the skin equal, the man frequently examines it, in every part, in the course of shaving, by passing it double through his fingers; and, when sufficiently reduced, he throws it, a second time, into a tub of fresh water, to be scoured and extended: for this purpose, it is laid on a stone table, to which the flesh-side adheres, and worked with the edge of a small square stone fixed in a stock or handle. Pumice-stone is used, but not so much as formerly. The skin is cleansed with a brush, from a whitish substance called the bloom, which all leather, tanned with bark, is found to contain. The natural folds of the grain disappear in the extension of the skin; and, to effect this completely, it is sometimes scoured a second time, for which the workman makes an extra charge. Changing the water has, of itself, a good effect in recovering dead, or stale leather, and the trifling additional expense is well laid out. The skin is then removed to the drying-shed, to be stuffed with a mixture of cod-oil and tallow, called dubbing, which is applied to both sides of the leather, but in larger quantities on the flesh than the grain side.

The dubbing is composed of about two parts of oil, and one part of tallow, melted and well stirred together in cooling, so as to be perfectly incorporated in a smooth, butter-like consistence. In conjunction with this mixture, sod-oil, which is a mixture of the cod-oil with the grease expressed from sheep-skins, &c., by the skimmers and felmongers, is sometimes used, but is never applied to bright-colored leather. Leather, lightly stuffed, will not wear so well as when it is rendered soft and flexible with the oil and tallow; and, on the other hand, if over stuffed, the color of the grain is darkened, and the oil itself, which, moderately used, is so great a preservative, becomes a cause of decay. The only motive for using more oil than adds to the quality of the leather is, to increase the weight; but, to admit of a good polish, less is usually applied than is really beneficial to the leather. The firmer and stronger parts of the skin require more than the looser parts to make them soft, which must be attended to in laying it on. In this state it is hung on the hooks to dry. In the course of drying, most of the oily

matter will be absorbed, and what remains on the surface, still feeds the leather, and is suffered to continue until the skin is wanted for finishing. Severe frosty weather will, of course, suspend the scouring, drying, and stuffing, and is apt to injure the texture of the leather, when frozen in the sheds, at the same time that it brightens the color; and the kinds of leather, which are valuable on account of color, are consequently improved. The shed-drying not being sufficient in winter, the leather is afterwards dried off in a stove, and then follows the boarding or bruising.

The board used for this purpose is toothed or grooved, similar to the crimping-board used by the ladies, and is slung on the hand by a leather strap. The skin is doubled and worked with a coarse board of this description, until well softened, and is then whitened, or lightly shaved over again, with a half-worn pair of edges, which leaves the flesh-side clean, and in a proper state to receive the color used in waxing. Before it is waxed, however, it is boarded a second time, and the impression of the board often remains, particularly if the leather be not perfectly dry. The skin is now said to be finished russet, in which state it keeps best; and, when wanted for sale, it is again given out to be waxed. In London, this work is chiefly done by apprentices, being the most simple, but the dirtiest part of the whole process. The blacking, usually termed color, is a composition of oil, lamp-black, and tallow, which is well rubbed into the flesh-side with a hard brush, great care being taken to keep the grain-side clean.

A coat of strong size and tallow is then laid on with a soft brush, and is afterwards rubbed with a smoothing-glass; and, lastly, it receives the finishing gloss from a little thin size laid on with a sponge. After the first coat of size, the skin is hung up a few hours to allow the size and color to dry and incorporate, and a lump of hard tallow is rubbed lightly over the surface. The skin is thus completely finished for the consumer, and leather so dressed is found superior in point of appearance and durability. Indeed, the blacking of the prime parts of calf-leather on the grain has almost entirely given way to waxing; an additional reason for which may be, that it is much better adapted for the polish it is afterwards to receive from the destructive shining blacking now in general use.

The middle and firmer part of the skin only is fit for the better purposes; the outer and thinner portion being thrown by and sold at inferior prices. These offal parts, indeed, are frequently cut off before the skin is put into work, and dressed separately from the butt or middle, and when that is the case, it is usually blackened on the grain-side. Horse, seal, and dog-skins are also blackened on the grain, which varies the latter part of the process materially. After shaving, the leather is well washed with urine, as a mordant, on the scouring stone, to prepare it for the first application of a solution of coppers, which is given it in the course of scouring, and communicates the black dye. It is then stuffed in the manner before described, but more plentifully than waxed leather, and hung in the shed to dry; when

taken down, the remains of the oily matter, adhering to the surface of the leather, are scraped off with a thin iron, formed and storked like the stone before-mentioned, and which is afterwards made use of to stone or set the leather smooth on the table. Here it receives a second application of copperas and bullocks' gall, which produces a complete black, and this part of the process is called seasoning. The copperas is applied with caution, lest by a too plentiful use of it the leather be injured. It should scarcely penetrate the cuticle or grain of the skin, and, if used too strong, the grain is burnt up and destroyed. While the leather is damp with this liquid, and in the course of seasoning, the graining-board is applied as before; only, as the grain is now to be worn outwards, the workman is more particular in giving that side a neat appearance, by raising the grain neatly and regularly. The coarser kinds of grain-leather are also, at this time, hardened with a tooth-slicker, called a dicing-iron, which leaves a lasting impression, or an artificial grain is imprinted by means of an engraved roller to imitate seal-skin, which is found to answer better than the board covered with fish-skin, formerly in use. This is not done so much with a view to increase its value, by imitating a better description of leather, as to harden and compress the looser parts of offal leather. It is now finished off with a little clear cod-oil, and is termed grained offal. The thin parts of the horse-hide are dressed in this manner, and are called cordovan, being probably in imitation of the manufacture of leather at Cordova, in Spain.

The act of James, already referred to, prohibited the use of horse-leather, clearly from ignorance of the legislators of that day, and the infant state of the manufactures of the country, horse-leather having been found quite as useful as some other descriptions of leather, and little inferior to calf-skin. It is now in very general use. The middle and stouter parts are cut out for boot-legs; and as leg-dressing is as curious, whether of calf or cordovan, as any part of the currying business, we shall be particular in describing the process.

The piece intended for a leg being cut of a proper length, and tapering a little towards the small, is first soaked and scoured, having been already shaved in the hide: it is then marked and numbered to match its fellow of a corresponding size and substance. The breadth of the small is measured, and the number of inches marked with a piece of copperas, which writes legibly on wet leather, as a guide for the boot-maker in fitting it to the leg. It is then blackened, if cordovan; but instead of again extending it on the scouring-stone, it is worked inwards with the slicker, and the width partially reduced in that part which is to form the small. The wet leather is then placed on a plain mahogany board, between two curved irons, approaching to a semicircle, the convex sides of which are made to approach to and recede from each other, and are screwed down at a distance, according to the size required for the small of the leg. The slicker is then employed to work the leather and contract it within the limits of the frame, by

which the breadth is reduced from two to four inches, and the leather thickened in proportion, or so much of the surface transferred to the substance; the leg, thus treated, will be elastic when dry; and, after giving out sufficiently to admit the foot, closes to the shape of the wearer. This, however, is not so much a matter of attention since the introduction of Hessian boots, which are cut out of the finished skin, and stand hollow without regard to shape; but though the other description of legs, called draft legs, are not so much taken in, they continue to be dressed in the same way. The advantage of this method is nothing more than as it regards the fitting of a new pair of boots; frequent exposure to wet will soon destroy the effects of the currier's ingenuity. Leg-dressing is the lightest and most profitable work to the journeyman in the shoe-currying; it requires superior workmanship, and generally is given to the man most distinguished as a complete and able currier. The leg is stuffed, dried, and finished in the usual manner. Some few years since cordovan legs were exported, in large quantities, to North America; but, from the recent improvements in the art of currying in that part of the world, the demand has entirely failed; and, cordovan having given way to calf legs for home consumption, the horse-hide is now used chiefly for ladies' shoes. The Spanish American horse-hides have lately been dressed thin and smooth on the grain, to imitate kid leather, for which, as far as respects durability, it is a good substitute.

There are several other processes in shoe currying, such as preparing binding, welt leather &c. &c. which we have not space to describe minutely; we pass on therefore to the hide trade, which includes the dressing of ox and cow hides, for coach, harness, saddle, and military purposes; this, as was before observed, forms a distinct branch of the currying trade.

Harness leather is dressed from the strongest and heaviest dressing hides, and the substance is not reduced in shaving, but merely the rough flesh taken off; for reins, the butt is reduced to a level with the thinner parts, and for both these uses the hide is first divided, or slit down the back, from head to tail, for the convenience of the workman; and, after being shaved and scoured, is blackened in the same manner as grain shoe leather. But before it is stuffed it is hung on the poles and semi-dried, and then stoned or set, in order to make the surface smooth, preparatory to receiving the dubbing, which is now laid on in quantities proportioned to the substance of the hide, which is then replaced on the poles until nearly dry. The grain being cleansed with the urine and ox galls, it receives the last application of copperas. A roll of hard tallow is then rubbed over the grain, which the man works into the leather with a stone, and after a second coat of tallow it hangs up till completely dry; it now only remains to be finished with a smoother stone, or a glass of the same form. Brown harness differs only in the omission of the copperas and the tallow in finishing, and, perhaps, is not quite so much stuffed in the first place.

Japan hides, for the roofs and bodies of

coaches, are shaved down to a thin substance, and carefully levelled, then stoned and set, and they are fit for the coachmaker's use; the japaning is the coachmaker's province, after the hide is fitted to the coach-body. Hides for the heads of open carriages are selected from light, roomy, and the least defective hides, and require the best of workmanship; they are blackened on the grain-side, and the leather is softened, and the grain is raised in the same manner as black grain shoe-leather. These hides, for the thinner purposes, being so very much reduced from their original substance, and the shavings of no other use than for fuel, an engine was invented, and has been many years in use, for splitting the hide into two parts, so as to divide the substance, and thereby obtain a useful piece of leather, which would otherwise be wasted in shavings.

The thinnest of all the hide-leather is that which is used for the lining of carriages; it is dressed bright russet, but the colored goat-skins, called Morocco-leather are more generally applied. The seats of army-saddles are cut out of thin hide-leather, of this description, as being less expensive, and quite as durable as hog-skins; but the hunting-saddles in general use are universally made of hog-skins; the skirts and flaps are cut out to pattern, usually from the rough tanned hide, and go through the top-skin process to improve the color. Bridle-leather is cut into pairs of butts and middlings, which signify the middle and butt of the hide; the neck and belly-parts being used for inferior purposes. The army consumes vast quantities of leather for harness, saddles, caps, and accoutrements, which all go through the curriers' hands; and the government contracts for accoutrements, &c., are great objects of contention in that line of business. The belts and straps are cut out of light cow-hides, which are curried much after the manner the same kind of hides are done for strong shoe-leather.

CURRYRURY, a frontier province of Bengal, on the eastern side of the Brahmapootra river, composed of lands formerly belonging to the territories of Assam and Bahar. It is mountainous and overrun with wood.

CURSE, <i>v. a., v. n. & n. s.</i>	} Swed. <i>korsa</i> ; Ang.-Sax. <i>cur-</i> sian. To wish evil to; to call down maledic- tions upon; to execrate; to de- vote; to do mis-
CURSED, <i>part. adj.</i>	
CURSEDLY, <i>adv.</i>	
CURSEDNESS, <i>n. s.</i>	
CURSER, <i>n. s.</i>	
CURSING, <i>n. s.</i>	
CURST, <i>adj.</i>	
CURSTNESS, <i>n. s.</i>	

chief to; to torment; to afflict; to imprecate; to deny or affirm with imprecation of divine vengeance. Curse is, malediction; torment; vexation. Cursed is, that which is deserving of a curse; hateful; wicked; blasted by a curse; vexatious; annoying. Cursedly is a vulgarism, signifying miserably; shamefully. Curst and curstness denote the quality, and the state, of being froward; shrewish; peevish; snarling; malignant.

Curse me this people, for they are too mighty for me. *Numbers.*

He read all the words of the law, the blessings and *curstings.* *Joshua viii. 36*

Thy silver about which thou *curstedst*, and spakest of also in mine ears, behold, the silver is with me. *Jud. xvii. 2.*

Neither have I suffered my mouth to sin, by wishing a *curse* to his soul. *Job.*

Ful loth were he to *cursen* for his tithes,
But rather wolde he even out of doute
Unto his poure parishers aboute
Of his offring, and eke of his substance.

Chaucer. Prol. to Cant. Tales.

Well may we *curse* our abbis and our place,
Our statutes sharpe to singe in copis wide.

Id. The Court of Love.

Hire thoughte hire *cursed* herte brast atwo;
She wolde not that hire sone hed do so.

Id. Cant. Tales.

The remenant were anhangd, more and lesse,
That were consentant of this *cursedness.* *Id.*

And first within the portche and jaws of hell,
Sate diepe Remorse of Conscience, al besprent
With teares; and to her selfe oft would she tell
Her wretchedness, and *cursing* never stent
To sob and sigh. *Sackville.*

The gold is good, and though she curse or banne
Yet where thee list thou mayst lye good and warme *Wyatt.*

Horribly then he gan to rage and rayle,
Curving his gods, and himselfe damning deep.

Spenser. Faerie Queene.

O piteous worke of mutabilitie!
By which we all are subject to that *curse*,
And death, instead of life, have sucked from our
nurse. *Id.*

After Solyman had looked upon the dead body,
and bitterly *curst* the same, he caused a great weight
to be tied unto it, and so cast into the sea. *Knolles.*

The untented woundings of a father's *curse*,
Pierce every sense about thee.

Shakespeare. King Lear.

Merciful powers!

Restrain in me the *curst* thoughts that nature
Gives way to in repose. *Id. Macbeth.*

I pray you, though you mock me, gentlemen,
Let her not hurt me: I was never *curst*;
I have no gift at all in shrewishness;
I am a right maid, for my cowardice;
Let her not strike me. *Id. Midsummer Night's Dream.*

Id. Midsummer Night's Dream.

Then, noble partners,
Touch you the sourest points with sweetest terms,
Nor *curstness* grow to the matter.

Id. Antony and Cleopatra.

Come, lady, while heaven lends us grace,
Let us fly this *curst* place,
Lest the sorcerer us entice
With some other new device. *Milton.*

The *curser's* punishment should fright the *curse.*

Dryden.

I never went from your lordship, but with a long-
ing to return, or without a hearty *curse* to him who
invented ceremonies, and put me on the necessity of
withdrawing. *Id.*

What, yet again! the third time hast thou *curst*
me?

This imprecation was for Laius' death,
And thou hast wished me like him. *Dryden and Lee.*

One day, I think, in Paradise he lived;
Destined the next his journey to pursue,
Where wounding thorns and *curst* thistles grew. *Prior.*

There are very few who can bear to grow old among the *curves* of a whole people. *Burke.*

O the supreme *curve* of making three guineas do the business of five! Not all the labours of Hercules; not all the Hebrews' three centuries of Egyptian bondage, were such an insuperable business. *Burns.*

But days, like this, with doubting *curved*,
I will not long endure—
Am I disdained—I know the worst,
And likewise know my cure. *Sheridan.*

But pause one moment more, and take
The *curve* of him thou didst forsake;
And look once more to heaven, and see
Its love for ever shut from thee.
Byron. Siege of Corinth.

CURSING and SWEARING. See SWEARING.

CURSOR, *n. s.* Lat. An officer or clerk belonging to the chancery, that makes out original writs. They are called clerks, of course, in the oath of the clerks of chancery. Of these there are twenty-four in number, which have certain shires allotted to each of them, into which they make out such original writs as are required. They are a corporation among themselves.—*Cowell.*

Then is the recognition and value, signed with the handwriting of that justice, carried by the *cursor* in Chancery for that shire where those lands do lie, and by him is a writ of covenant thereupon drawn, and ingrossed in parchment. *Bacon.*

CURSORY, *adj.* Lat. *cursorius.* **CURSORY,** *adj.* } sory signifies, hasty;
CURSORILY, *adv.* } transient; inattentive;
CURSORINESS, *n. s.* } not stationary. **Cursorily**, which seems of Shakspeare's coinage, has the same meaning. **Cursorily** is, hastily; without much heed: **cursoriness**, slight attention.

I have but with a *cursorary* eye
O'er glanced the articles. *Shakspeare. Henry V.*

Besides their *cursoris* men, as Gerrard, &c.
Proceedings against Garnet.

The first, upon a *cursorary* and superficial view, appeared like the head of another man. *Addison.*

This power, and no other, Luther disowns, as any one that views the place but *cursorily* must needs see. *Atterbury.*

Whoever takes a view of this kingdom in a *cursorary* manner, will imagine that he beholds a solid, compacted, uniform system of monarchy, in which all inferior jurisdictions are but as rays diverging from one centre. *Burke.*

CURT, *adj.* } Fr. *court*; Ital and
CURTAL, *n. s. & adj.* } Span. *corto*; Per. *kor*,
CURTLY, *adv.* } cord; Welsh, *cor*; Sw.
CURTAIL, *v. a.* } kort; Dan. *kurt*; Ang-
CURTAILER, *n. s.* } Sax. sceort; Dutch,
CURTAILING, *n. s.* } kortz; Lat. *curtus*.
CURTAIL-DOG, *n. s.* } Curt, curtly; short,
briefly. To curtail is, to cut off; to abbreviate: it has of before the thing cut off. A curtail-dog is a dog lamed, or mutilated according to the forest laws, whose tail is cut off, and who is therefore hindered from coursing. **Curtal**, as a noun, is a horse with a docked tail; as an adjective, brief, or abridged.

I, that am *curtailed* of all fair proportion,
Deformed, unfinished, sent before my time
Into this breathing world.
Shakspeare. Richard III.

My abepherd's pipe can sound no deal,
My wether's bell rings doleful knell;
My *curtail-dog*, that wont to have played,
Plays not at all, but seems afraid.
Id. The Passionate Pilgrim.

Hold my stirrup, my one lacquey, and look to my *curtal*, the other. *Ben Jonson.*
Yet pursy Euclis cheerly smiling prayed
That my sharp words might *curtail* their vile trade. *Hall.*

Neither are they to be determined here by essays and *curtal* aphorisms, but by solid proofs of Scripture. *Milton.*

Curtly, succinctly, and concisely. *Gayton.*
Then why should we ourselves abridge,
And *curtail* our own privilege? *Hudibras.*

Scribblers send us over their trash in prose and verse, with abominable *curtailings* and quaint modernisms. *Swift.*

This conduct of theirs served to show, that the Latins had not been interpolators of the breed, but that the Greeks had been *curtailers*. *Id.*

The count assured the court, that Fact his antagonist, had taken a wrong name, having *curtailed* it of three letters; for that his name was not Fact, but Faction. *Addison.*

Let the rule be general; let not the splendour of one be *curtailed*, while that of another is extended. *Sheridan.*

CURTAIN, *v. a. & n. s.* } Fr. *courtine*; It.
CURTAIN-LECTURE, *n. s.* } *copertino*; Lat. *cortina.* To enclose with curtains; to conceal as by curtains. A curtain is a cloth to be contracted or expanded at pleasure, to admit or exclude the light from a bed or room; in fortification, that part of the rampart between two bastions. To draw the curtain is either to close or uncloset it. A curtain-lecture signifies, a scolding given by a wife to her husband when they are in bed.

And Pandarus, that led her by the lappe,
Came nere, and gan in at the *curtein* pike.
Chaucer. Troilus and Creseide.

Now when as darksome Night had all displayd
Her cole blacke *curtein* over brightest skye,
The warlike youthes, on dayntie couches layd
Did chace away sweet sleepe from sluggish eye.
Spenser. Faerie Queene.

The governour, not discouraged, suddenly of timber and boards raised up a *curtain* twelve foot high, at the back of his soldiers. *Knolles.*

Now o'er one half the world
Nature seems dead, and wicked dreams abuse
The *curtained* sleep. *Shakspeare. Macbeth.*
Even so the *curtain* drawn, his eyes begun
To wink, being blinded with a greater light.
Id. Rape of Lucrece.

So soon as the all-cheering sun
Should in the farthest east begin to draw
The shady *curtain* from Aurora's bed.
Id. Romeo and Juliet.

What endless brawls by wives are bred!
The *curtain-lecture* makes a mournful bed.
Dryden's Jucenal.

I must draw a *curtain* before the work for awhile,
and keep your patience a little in suspense. *Burnet's Theory.*

But, in her temple's last recess inclosed,
On Dulness' lap the anointed head reposed:
Him close she *curtained* round with vapours blue,
And soft besprinkled with Cimmerian dew. *Pope.*

Thy hand, great Dulness ! lets the curtains fall,
And universal darkness buries all.

Now stir the fire, and close the shutters fast,
Let fall the curtains, wheel the sofa round,
And, while the bubbling and loud hissing urn
Throws up a steamy column, and the cups,
That cheer but not inebriate, wait on each,
So let us welcome peaceful evening in. *Cowper.*

He said ; and leading from her ivory seat
The blushing beauty to his lone retreat,
Curtained with night the couch imperial shrouds,
And rests the crimson cushions upon clouds.

Darwin.

CURTAIN, CURTIN, or COURTIN, in fortification, that part of the wall that lies between two bastions. It is bordered with a parapet, behind which the soldiers stand to fire upon the covered way and into the moat.

CURTATE DISTANCE, n. s. In astronomy, the distance of a planet's place from the sun, reduced to the ecliptic.

CURTATION, n. s. From Lat. *curto*, to shorten. The interval between a planet's distance from the sun and the curtate distance.

CURTAXE, CURTELASSE, or CURTELAX, n. s. See **CUTLASS**.

With *curtase* used Diamond to smite.

Spenser. Faerie Queene.

CURTSEY OF ENGLAND, Jus Curialitatis Anglim, in English law, is where a man taketh a wife seised in fee-simple, or fee-tail general, or as heitress in special tail, and hath issue by her, male or female, born alive, which by any possibility may inherit, and the wife dies: the husband in this case holds the lands during his life; and is called *tenens per legem Angliæ*, or tenant by the curtesy of England. This appears to have been also the established law of Scotland, where it was called *curialitas*. It is likewise used in Ireland, by virtue of an ordinance of Henry III.

CURTEYN, CURTANA, a name of Edward the Confessor's sword, or the first sword carried before the kings of England at their coronation: the point of which is broken or taken off as an emblem of mercy.

CURTYLAGE, n. s. Old Fr. *courtilage*. A garden, field, or piece of ground, in the vicinity of, or belonging to, a messuage.

CURTIS (William), a late distinguished botanist, was born in Hampshire in 1746. He was apprenticed to an apothecary of Alton, and at the age of twenty became assistant to a Mr. Talwin, in Gracechurch Street, London, whom he succeeded in business. His love of botany, however, attracted him from his professional duties, and he at length gave up his practice and became a public lecturer on that science. He engaged at this time a garden in Bermondsey, which he soon exchanged for one at Lambeth, and occupied finally still more extensive premises at Brompton. In 1771 he published, Instructions for collecting and preparing Insects; and, in the following year, a translation of the *Fundamenta Entomologiæ* of Linnæus, under the title of *An Introduction to a Knowledge of Insects*. These publications procured him considerable notice; but in 1777 the first number of

his *Flora Londinensis*, (which was completed in six fasciculi of seventy-two plates each), and shortly after his *Botanical Magazine*, raised him in the public estimation to the first rank of botanical authors. He wrote also a *History of the brown-tailed Moth*, *Practical Observations on the British Grasses*, and some papers in the *Transactions in the Linnæan Society*. He died the 7th of July; 1799. Since his death have appeared his *Lectures*, with coloured plates.

CURTIUS (Marcus), a Roman youth, who is said to have devoted himself to the gods' manes, for the safety of his country, about A. A. C. 360. A wide gap had suddenly opened in the forum, and the oracle had said that it never would close before Rome threw into it whatever it had most precious. Curtius immediately perceived that no less than a human sacrifice was required. He armed himself, mounted his horse, and leaped into the gulf, which it is said instantly closed over his head.

CURTIUS (Quintus), a Latin historian, who wrote the life of Alexander the Great, in ten books, of which the two first are not extant, but are well supplied by Freinshemius. When this writer was born, or even when he lived, is not known. By his style he is supposed to have flourished near the Augustan age; though some imagine the work of much later date, and that the name of Quintus Curtius was fictitiously prefixed. Cardinal du Perron was so great an admirer of this work, as to declare that one page of it was worth thirty pages of Tacitus.

CURTSY. See **COURT**.

CURVE, v. a. n. s. & adj. Latin, *curvus*.
To bend; to

CURVATED, adj. crook.

CURVATION, n. s. Any

CURVATURE, n. s. thing bent, or

CURVILINEAR, adj. crooked. Curvation

CURVILITY, n. s. is the act of

bending any thing; of making it curvated; of giving it curvature, or curvity; the state of being curvated. Curvilinear signifies, consisting of a crooked line; composed of crooked lines.

As for his session, we must not look upon it as determining any posture of his body, corresponding to the *curvation* of our limbs. *Pearson.*

And the tongue is drawn back and *curved*. *Haller.*

Flaccid it was beyond the activity of the muscle and *curvature* of the ossicles, to give it a due tension. *Id.*

The joined ends of that bone and the incus receding, make a more acute angle at that joint, and give a greater *curvity* to the posture of the ossicles. *Id.*

It is bent after the manner of the catenarian *curve*, by which it obtains that *curvature* that is safest for the included marrow. *Chyzer.*

The impulse continually draws the celestial body from its rectilinear motion, and forces it into a *curvilinear* orbit; so that it must be repeated every minute of time. *Id.*

Unless an intrinsic principle of gravity or attraction may make it describe a *curves* line about the attracting body. *Bentley.*

And as you lead it round, in artificial *curves*.
With eye intentive mark the springing game. *Thompson.*

Habit or custom, like a complex mathematical scheme, flows from a point, insensibly becomes a line, and unhappily, (in that which is evil,) it may become a *curvose*. *Robinson.*

In his ingenious work, entitled *The Analysis of Beauty*, Mr. Hogarth believes that the triangular glass, which was dedicated to Venus in her temple at Paphos, contained in it a line bending spirally round a cone with a certain degree of *curvature*, and that this pyramidal outline and serpentine *curvose* constitute the principles of grace and beauty. *Darwin.*

CURVE, in geometry, a line which, running on continually in all directions, may be cut by one right line in more points than one. See **FLUXIONS**.

CURVET, *v. n.* } Ital. *corvettare*. To leap;
CURVET, *n. s.* } to bound; to prance; to
 frisk; to be licentious. A leap; a bound; a
 prank.

Anon he rears upright, *curvets* and leaps,
 As who should say, lo! thus my strength is tried.

Shakespeare. Venus and Adonis:
 Cry holla! to thy tongue, I pry'thee, it *curvets* un-
 seasonably. *Shakespeare. As You Like It.*

Himself he on an earwig set,
 Yet scarce he on his back could get,
 So oft and high he did *curvet*,
 Ere he himself could settle. *Dryden.*

Seized with unwonted pain, surpris'd with fright,
 The wounded steed *curvets*; and, rais'd upright,
 Lights on his feet before: his hoofs behind
 Spring up in air aloft, and lash the wind.

Dryden's Æneid.
 B, Agreed. But would you sell or slay your horse
 For bounding and *curvetting* in his course?
 Or if, when ridden with a careless rein,
 He breaks away, and seek the distant plain;
 No. His high mettle, under good control,
 Gives him Olympic speed, and shoots him to the goal.
Cowper.

CURVET, or **CORVET**, in the manege, an air in which the horse's legs are raised higher than in the demi-volt; being a kind of a leap up, and a little forwards, wherein the horse raises both his fore-legs at once, equally advanced, (when he is going straight forward, and not in a circle), and as his fore-legs are falling he immediately raises his hind-legs, equally advanced, and not one before the other; so that all his four legs are in the air at once; and as he sets them down he marks but twice with them.

CURULE, *adj.* Lat. *curulis*. Belonging to magistracy; magisterial.

We that are wisely mounted higher
 Than constables in *curule* wit. *Hudibras.*
 And Tully's *curule* chair, and Milton's golden lyre.
Akenside.

Who deserves the civic wreath,
 Who to fill the *curule* chair?
 Feast from gold, rich perfumes breathe,
 And all that honour gives, to share?
 The brave, the brave, the patriot brave,
 Who arms his country's rights to save. *Leftley.*

CURULE CHAIR, in Roman antiquity, a chair adorned with ivory, wherein the magistrates of Rome had a right to sit and be carried. This chair was fitted in a kind of chariot, whence its name. The *curules* were carried to the senate-house in this chair, as were also those who triumphed, and such as went to administer justice, &c. See **ÆDILES**.

CURULES, the *curule* magistrates, were the *ædiles*, the *prætors*, *censors*, and *consuls*.

CURZOLA, an island of Dalmatia, separated from the peninsula of Sabionella by a narrow channel. It is thirty miles long and eight broad; having abundance of wood: besides which it produces excellent wine. It contains one city; and several villages, but is thinly inhabited.

CURZOLA, a town on the east end of the above island, is the see of a bishop, and residence of the governor. It was at one time well fortified, and has a good harbour. In 1507 the Turks attempted to take it, but were repulsed by the women, after the men had fled.

CUSA (Nicolas de), a learned cardinal, of mean parentage, so named from Cusa, the place of his birth. He was made a cardinal in 1448; and being appointed governor of Rome by Pope Pius II. during his absence at Mantua, he was the chief conductor of the war against the Turks. He founded a church, and a good library of Greek and Latin authors, at Cusa, and left many excellent works behind him, which were collected and published in three volumes at Basil in 1565. In these he has made no scruple to detect the traditions and sophistries of the Roman church.

CUSCO, an ancient city and intendency of Peru, and the see of a bishop, and once the capital of the Peruvian empire. In the centre was a large level place, from which four grand streets branched out towards the four quarters of the world. Each province of the empire had its peculiar quarter, in which the inhabitants were obliged to reside during life, without the liberty of changing. There was also a quarter allotted to the descendants of the Incas. They might preserve their distinct customs, but were compelled to worship the sun in a sumptuous temple, the walls of which were encrusted with gold and silver, and adorned with figures and idols of the different nations subdued by the Incas. The Spaniards under Pizarro, made themselves masters of this city in 1534, and that with a display of their usual barbarity. On a hill towards the north are the ruins of a fortress built by the Incas, which had a communication, by means of subterraneous passages, with three forts on the walls of Cusco. These walls, of an extraordinary height, were of stone cemented with astonishing neatness. The Spaniards found the houses also built of stone, and amongst them a great number profusely ornamented with gold and silver. Cusco is at present a large city: the houses are of stone, and covered with tiles. The cathedral is a stately stone edifice, and of elegant and noble architecture. There are nine parish churches, and several convents and hospitals. Cusco contains about 14,000 Indians, and 16,000 whites. The intendency contains 225,000 inhabitants, and is fertile in grain and fruit; and the air temperate, but cold. The city is well watered by the rivers Apurimak and Yukai. It is 380 miles E.S.E. of Lima.

CUSCUTA, in botany, dodder; a genus of the digynia order, and tetrandria class of plants: CAL. quadrifid: cor. monopetalous: caps. bilocular; species two, one of which is a native of

Britain, viz. *C. europæa*, dodder. This is a very singular plant, almost destitute of leaves, parasitical, creeping, fixing itself to whatever is next to it. It decays at the root, and afterwards is nourished by the plant which supports it. Hops, flax, and nettles, are its common support; but principally the common nettle. Its blossoms are white.

CUSH, the eldest son of Ham, and father of Nimrod, Seba, Havilah, Sabtah, Raamah, and Sabtecha. Gen. x. 6—8. We know of no other person who, in scripture, is called by this name, but there are several countries called by it.

CUSH, in ancient geography, is generally reckoned the same with Ethiopia, and is so translated in the Vulgate, Septuagint, and other versions, both ancient and modern: but there are various passages where this translation seems to obscure the sense, as Gen. ii. 13.

Bochart has shown very clearly that there was a country called 'the land of Cush,' in Arabia Petræa, bordering upon Egypt; and this country extended itself principally upon the eastern shore of the Red Sea, and at its extremity, to the point of this sea, inclining towards Egypt and Palestine.

CUSHION, *n. s.* } Fr. *coussin*; Dut. *kussen*.
CUSHIONED, *adj.* } A pillow for the seat; a
CUSHIONET, *n. s.* } soft pad placed upon a chair; a part of an electrical machine. Seated on, or supported by, cushions. A little cushion.

He bracyd hym by the myddil, and preyd hym sit adoun,

And lowly with much worship dressed his cushion.

Chaucer. Cant. Tales.

Call Claudius, and some other of my men;

I'll have them sleep on cushions in my tent.

Shakespeare. Julius Cæsar.

Upon these pretty cushionets did lie

Ten thousand beauties. *Beaumont.*

But, ere they sat, officious Baucis lays

Two cushions stuffed with straw, the seat to raise;

Coarse, but the best she had. *Dryden's Fables*

An eastern king put a judge to death for an iniquitous sentence; and ordered his hide to be stuffed into a cushion, and placed upon the tribunal, for the son to sit on. *Swift.*

Many, who are cushioned upon thrones, would have remained in obscurity. *Bolingbroke.*

There are two kinds of electric ether, which exist either separately or in combination. That which is accumulated on the surface of smooth glass, when it is rubbed with a cushion, is here termed vitreous ether. *Darwin.*

The velvet cushions—for a throne more meet—

Were scarlet, from whose glowing centre grew

A sun embossed in gold, whose rays of tissue, Meridian-like, were seen all light to issue.

Byron. Don Juan.

CUSHION, in engraving, is a bag of leather filled with sand, commonly about nine inches square, and three or four thick, used for supporting the plate to be engraved.

CUSHION, in gilding, is made of leather, fastened to a square board, from fourteen inches square to ten, with a handle. The vacuity between the leather and board is stuffed with fine tow or wool, so that the outer surface may be flat and even. It is used for receiving the leaves

of gold from the paper, in order to its being cut into proper sizes and figures.

CUSP, *n. s.* Lat. *cuspis*. A term used to express the points or horns of the moon, or other luminary.

CUSPATED, *adj.* } From Lat. *cuspis*. A
CUSPIDATED, *adj.* } word expressing the leaves of a flower ending in a point.

CUSTARD, *n. s.* Welsh *custard*. A kind of sweetmeat, made by boiling eggs with milk and sugar till the whole thickens into a mass. It is a food much used in city feasts.

He crammed them, till their guts did ake,
 With cawdle, custard, and plum-cake. *Hudibras.*

Now may'r's and shrieves all hushed and satiate lay;

Yet eat, in dreams, the custard of the day. *Pope.*

CUSPINIAN (John), a German, born at Sweinfurt, in 1473. He was first physician to the emperor Maximilian I. and employed by him in several negociations. He wrote in Latin, 1. A History of the Roman emperors from Julius Cæsar to the death of Maximilian I. Degory Wheare, in his *Methodus Legendæ Historiæ*, calls this *Luculentum sanè opus*, and omnium lectione dignissimum. 2. A History of Austria; being a kind of continuation of the preceding. 3. A History of the origin of the Turks, and of their cruelties towards Christians. Gerard Vossius praises Cuspinian as *magnum suo ævo historiæ lumen*. He died at Vienna, in 1529.

CUSTEE, a town of Bengal, in the district of Ranjeshy, situated on the western bank of the Corroi river, a branch of the Ganges, which communicates with the Sunderbunds. It is navigable at all seasons, on which account much of the traffic from the north-west provinces passes by this town during the winter months.

CUSTODY, *n. s.* Lat. *custodia*. Imprisonment; restraint of liberty; care; guardianship; charge; defence.

Under the custody and charge of the sons of Merari, shall be the boards of the tabernacle. *Numb. iii. 36.*

The third hed of their wardrobe custody,

In which were not rich tyres nor garments gay,

The plumes of Pride, and wings of Vanity.

Spenser. Faerie Queene.

We being strangers here, how darest thou trust
 So great a charge from thine own custody?

Shakespeare.

There was prepared a fleet of thirty ships for the custody of the narrow seas. *Bacon.*

The council remonstranced unto queen Elizabeth, the conspiracies against her life, and therefore they advised her, that she should go less abroad weakly attended; but the queen answered, she had rather be dead than in custody. *Id.*

For us enslaved, is custody severe,

And stripes and arbitrary punishment

Indicted.

Milton's Paradise Lost.

There is generally but one coin stampd upon the occasion, which is made a present to the person who is celebrated on it: by this means the whole frame is in his own custody. *Addison.*

CUSTOM, *v. a., v. n., & n. s.*
CUSTOMABLE, *adj.*
CUSTOMABLENESS, *n. s.*
CUSTOMABLY, *adv.*
CUSTOMARILY, *adv.*
CUSTOMARINESS, *n. s.*
CUSTOMARY, *adj.*
CUSTOMED, *adj.*
CUSTOMER, *n. s.*
CUSTOMARY, *n. s.*
CUSTOM-HOUSE, *n. s.*

Fr. coutume.
 To custom is, to pay duty at the custom-house; to accustom. Custom signifies, habit; common way of acting; practice of buying from certain persons; application from buyers; tribute; tax on goods exported or imported. In legal parlance, custom is a law or right not written, which, being established by long use, and the consent of our ancestors, has been, and is daily, practised. We cannot say, that this or that is a custom, except we can prove that it hath continued so 100 years; yet, because that is hard to prove, it is enough for the proof of a custom, if two or more can depose that they heard their fathers say, that it was a custom all their time; and that their fathers heard their fathers also say, that it was likewise a custom in their time. If it is to be proved by record, the continuance of 100 years will serve. Custom is either general or particular: general, that which is current through England; particular, is that which belongs to this or that county; as gavelkind to Kent, or this or that lordship, city, or town. Custom differs from prescription; for custom is common to more, and prescription is particular to this or that man; prescription may be for a far shorter time than custom. Customary, customed, and customizable, signify, according to established custom; habitual; usual. Customer is one who goes to a place of sale for the purpose of purchasing; one who habitually purchases from another; in old writers, a common woman; a collector of customs; but these senses of the word are disused. Customary is a book, or code, of laws and customs.

And the priest's custom with the people was, that when any man offered sacrifice, the priest's servant came; while the flesh was in seething, with a flesh-hook of three teeth in his hands. *1 Sam. ii.*

According to the custom of the priest's office, his lot was to burn incense when he went into the temple of the Lord. *Levit. i.*

Where archbishop and archdiacon
 Yeongin full out the service
 A'ter the customs and the gauge
 And holie churches' ordinaunce.

Chaucer's Dreams.

What ever he hath of any honest custome,
 Of her and me that holds he every whit. *Wyatt.*

For on a bridge he custometh to fight,
 Which is but narrow, but exceeding long
 And in the same are many trapfalls pight.

Spenser. Faerie Queene.

Blood and destruction shall be so in use,
 That mothers shall but smile when they behold
 Their infants quartered by the hands of war;
 All pity choaked with custom of fell deeds.

Shakespeare. Julius Caesar.

Even now I met him

With customary compliment, when he,
 Wafting his eyes to the contrary, and falling
 A lip of much contempt, speeds from me.

Shakespeare.

No nat'ral exhalation in the sky,
 No common wind, no customed event,
 But they will pluck away its nat'ral cause,
 And call them meteors, prodigies, and signs.

Id. King John.

I marry her!—What a customer? Pr'ythee bear
 some charity to my wit, do not think it so unwhole-
 some. *Id. Othello.*

— All the merchants, with other merchandise,
 Are safe arrived, and have sent me to know,
 Whether yourself will come and custom them.

Marlow.

Kingdoms have customably been carried away by
 right of succession, according to proximity of blood.

Hayward.

The residue of these ordinary finances be casual
 or uncertain, as be the eccheats and forfeitures, the
 customs, butlerage, and imposts. *Bacon.*

To call God to witness truth, or a lye perhaps, or
 to appeal to him on every trivial occasion, in common
 discourse, customarily without consideration, is one of
 the highest indignities and affronts that can be offered
 him. *Ray.*

To a fond parent that would not have his child
 corrected for a perverse trick, but excused it, saying
 it was a small matter, Solon very well replied, 'Ay,
 but custom is a great one.' *Locke.*

Those commodities may be dispersed, after having
 paid the customs in England. *Temple.*

We should avoid the profane and irreverent use
 of God's name, by cursing, or customary swearing;
 and take heed of the neglect of his worship, or any
 thing belonging to it. *Tillotson.*

A vice which for its guilt may justify the sharpest,
 and for its customariness the frequentest, inferences,
 which can be made against it.

Government of the Tongue.

You say he is assiduous in his calling, and is he
 not grown rich by it? Let him have your custom, but
 not your votes. *Addison.*

Lord Strut has bespoke his liveries at Lewis Baboon's shop: Don't you see how that old fox steals
 away your customers, and turns you out of your business
 every day? *Arbutnot.*

Some customhouse officers, birds of passage, and
 oppressive thrifty squires, are the only thriving people
 amongst us. *Swift.*

It was drawn from the old Germanick or Gothick
 customary; from the feudal institutions, which must
 be considered as an emanation from the customary. *Burke.*

Who know'st man's frailty; with a favouring eye,
 And melting heart, behold't a brother's fall;
 Who, unenslaved by custom's narrow tie,
 With manly freedom follow'st at reason's call. *Beattie.*

The volume closed, the customary rites
 Of the last meal commence. A Roman meal;
 Such as the mistress of the world once found
 Delicious, when her patriots of high note,
 Perhaps by moonlight, at their humble doors,
 And under an old oak's domestic shade,
 Enjoyed, spare feast! a radish and an egg.

Cowper.

For saddle-tree scarce reached had he,
 His journey to begin,
 When, turning round his head, he saw
 Three customers come in. *Id.*

People have a *custom* of excusing the enormities of their conduct by talking of their passions, and as if they were under the control of a blind necessity, and sinned because they could not help it. *Cumberland.*

But on my right hand and my left, instead
Of thee and Zames, and our *customed* meeting,
Was ranged on my left hand a haughty, dark,
And deadly face.—I could not recognise it,
Yet I had seen it, though I knew not where.

Byron. Sardanap.

Customs, in political economy, the duties, toll, tribute, or tariff, payable to the king upon merchandise exported and imported, forming a branch of the perpetual taxes. The consideration upon which this revenue, or the more ancient part of it, which arose only from exports, was invested in the king, were said to be two: 1. Because he gave the subject leave to depart the kingdom, and to carry his goods along with him. 2. Because the king was bound of common right to maintain and keep up the ports and havens, and to protect the merchant from pirates. Some have imagined they are called with us customs, because they were the inheritance of the king by immemorial usage and the common law, and not granted by any statute; but Sir Edward Coke has clearly shown, that the king's first claim to them was by grant of parliament, 3 Edw. I. And indeed this is in express words confessed by statute 25 Edw. I. c. 7, wherein the king promised to take no custom from merchants, without the common assent of the realm, 'saving to us and our heirs the customs on wool, skins, and leather, formerly granted to us by the commonalty aforesaid.' These were formerly called hereditary customs of the crown; and were due on the exportation only of the above three commodities, and none other: which were styled the staple commodities of the kingdom, because they were obliged to be brought to those ports where the king's staple was established, in order to be there first rated and then exported. In the barbarous Latin of our ancient records, they were denominated *custuma*, an appellation which seems to be derived from the French word *coutume*, or *coutume*, which signifies toll or tribute, and owes its own etymology to the word *coust*, which signifies price, charge, or as we have adopted it in English, cost; not *consuetudines*, which is the language of our law whenever it means merely usages. The duties on wool, sheep-skins, or wool-fells, and leather, exported, were called *custuma*, *antiqua sive magna*: and were payable by every merchant, as well native as stranger; with this difference, that merchant strangers paid an additional toll, viz. half as much again as was paid by natives. The *custuma parva* et *nova* were an impost of three-pence in the pound due from merchant strangers only, for all commodities as well imported as exported; which was usually called the alien's duty, and was first granted in 31st Edw. I. But these ancient hereditary customs, especially those on wool and wool-fells, were of little account, when the nation became sensible of the advantages of a home

manufacture, and prohibited the exportation of wool by statute 11 Edw. III. c. 1. Other customs payable upon exports and imports were distinguished into subsidies, tonnage, poundage, and other imposts. Subsidies were such as were imposed by parliament upon any of the staple commodities before mentioned, over and above the *custuma antiqua et magna*; tonnage was a duty upon all wines imported, over and above the prisage and butlerage aforesaid: poundage was a duty imposed ad valorem, at the rate of twelve-pence in the pound, on all other merchandise whatsoever: and the other imposts were such as were occasionally laid on by parliament, as circumstances and times required. These distinctions are now in a manner forgotten, except by the officers immediately concerned in this department: their produce being in effect all blended together, under the one denomination of the customs. By these we understand, at present, a duty or subsidy paid by the merchant at the quay upon all imported as well as exported commodities, by authority of parliament; unless where, for particular national reasons, certain rewards, bounties, or drawbacks, are allowed for particular exports or imports. But few commodities pay a duty upon exportation: where a duty is not specified in the tables, and the exportation is not prohibited, all articles may be exported without payment of duty, provided they are regularly entered and shipped; but on failure thereof, they are subject to a duty ad valorem. To prevent frauds in the representation of the value, a simple and equitable regulation is made, viz. the proprietor shall himself declare the value; and if this should appear not to be a fair and true estimate, the goods may be seized by the proper officer, and four of the commissioners of the customs may direct that the owner shall be paid the price, which he himself fixed upon them, with an advance of £10 per cent. besides all the duty which he may have paid. They may then order the goods to be publicly sold, and if they raise any sum beyond what was paid to the owner, and the subsequent expenses, one-half of the overplus shall be paid to the officer who made the seizure, and the other half to the public revenue.

By 27 Geo. III. c. 13, called the consolidation act, all the former statutes imposing duties of customs and excise were repealed with regard to the quantum of the duty; and the two former books of rates were declared to be of no avail for the future; but all the former duties were consolidated, and were ordered to be paid according to a new book of rates annexed to that statute. The like plan has been followed in subsequent acts, as 43 Geo. III. c. 68, 49 Geo. III. c. 98, and particularly 6 Geo. IV. c. 111, which contains the duties now in force. These are so important to the merchant and general trader, and bear so directly on the price of the numerous commodities specified, both at home and abroad, that we have conceived a complete table of the imports, exports, and coast imports of this description, would be acceptable to a large majority of our readers.

TABLE I.—DUTIES OF CUSTOMS, INWARDS.

A TABLE of the DUTIES of CUSTOMS payable on Goods, Wares, and Merchandise imported into the United Kingdom from Foreign Parts, and of the Drawbacks to be allowed on the Exportation of such Goods, Wares, and Merchandise.

INWARDS.		Duty.			INWARDS.		Duty.		
		£.	s.	d.			£.	s.	d.
Acacia, per lb.		0	2	0	Aloes, hepatica or Barbadoes aloes, the lb.		0	1	3
	Drawback	0	1	4		Drawback	0	0	10
Acetous Acid. See Vinegar.					— scotorina, the lb.		0	2	6
Acorns. See Seed.						Drawback	0	1	8
Acorus, the lb.		0	0	10	— Ditto, the produce of the Cape of Good Hope and imported direct from thence, the lb.		0	0	3
	Drawback	0	0	6		Drawback	0	0	2
Adiantum, the lb.		0	0	8	— of any other sort, the lb.		0	0	9
	Drawback	0	0	5		Drawback	0	0	6
Agaric, the cwt.		1	18	0	Alum, the cwt.		0	17	6
Agates or cornelians, set, for every £100 value		20	0	0	— Roch, the cwt.		0	11	8
— not set, for every £100 value		10	0	0	Amber, beads. See Beads.				
— beads. See Beads.					— oil of. See Oil.				
Alkali, not being barilla, viz. any article containing soda or mineral alkali, whereof mineral alkali is the most valuable part, (such alkali not being otherwise charged with duty, if not containing a greater proportion of such alkali, than 20 per cent. the cwt.		0	11	4	— rough, the lb.		0	1	8
	Drawback	0	5	8		Drawback	0	1	1
— Ditto, if containing more than 20 per cent. and not exceeding 25 per cent. of such alkali, the cwt.		0	15	0	— all other manufactures of		0	12	0
	Drawback	0	7	6	Ambergris, the produce of British fishing, the oz.		0	2	0
— Ditto, if containing more than 25 per cent. and not exceeding 30 per cent. of such alkali, the cwt.		0	18	4	— the produce of foreign fishing, the oz.		0	5	0
	Drawback	0	9	2	Ambrá liquida, the lb.		0	3	4
— Ditto, if containing more than 30 per cent. and not exceeding 40 per cent. of such alkali, the cwt.		1	3	4	Anacardium. See Cashew Nuts.				
	Drawback	0	11	8	Anchovies, the lb.		0	1	0
— Ditto, if containing more than 40 per cent. of such alkali, the cwt.		1	10	0	Angelica, the lb.		0	0	10
	Drawback	0	15	0		Drawback	0	0	6
Alkanet root, the lb.		0	0	10	Annotto or Rocou, flag, the lb.		0	0	5
	Drawback	0	0	6	— roll, or any other sort, not here described, the lb.		0	1	0
Alkermes, confection of, the oz.		0	1	8	Antimony, crude, the cwt.		0	15	0
Almond paste, for every £100 value		60	0	0	— regulus of antimony, the cwt.		2	0	0
Almonds, bitter, the cwt.		1	11	8	Apples, the bushel		0	4	0
	Drawback	1	8	0	— dried, the bushel		0	7	0
— bitter, the produce of any British possession, the cwt.		0	15	10	Aquafortis, the cwt.		0	14	3
	Drawback	0	14	0	Arangoes, for every £100 value		20	0	0
— Jordan, the cwt.		4	15	0	Archelia. See Orchal.				
	Drawback	4	4	0	Argol, the cwt.		0	2	0
— Jordan, the produce of any British possession, the cwt.		2	7	6	— the produce of and imported from any British possession, the cwt.		0	1	0
	Drawback	2	2	0	Aristolochia, the lb.		0	0	10
— of any other sort, the cwt.		2	7	6		Drawback	0	0	6
	Drawback	2	2	0	Arquebusade water. See Spirits.				
		2	7	6	Arrow root or powder, the lb.		0	0	2
		2	2	0	— the produce of any British possession, the lb.		0	0	1
		2	2	0	Arsenic, white, the cwt.		0	14	3
		2	2	0	— of any other sort, the cwt.		0	18	8
		2	2	0	Asafetida, the lb.		0	0	10
		2	2	0		Drawback	0	0	6
		2	2	0	Asarum root, the lb.		0	0	8
		2	2	0		Drawback	0	0	5
		2	2	0	Ashes, pearl and pot, the cwt.		0	6	0
		2	2	0	— Ditto, the produce of and imported direct from any British possession				Free.
		2	2	0	— soap and wood, the cwt.		0	1	8

INWARDS.		Duty.		INWARDS.		Duty.	
		£.	s. d.			£.	s. d.
Ashes, not otherwise described, for every £100 value		20	0 0	— Ditto, from the 5th January, 1829, to the 6th January, 1830, the ton		17	0 0
Asphaltum, the lb.		0	0 10	— Ditto, from and after the 5th January, 1830, the ton		13	0 0
— the produce of and imported from any British possession, the lb.	Drawback	0	0 6	Bark, Angustura, the lb.		0	2 0
Asses, each		0	10 0	— Cascarilla. See Eleutheria bark, in Bark.		0	1 4
Auripigmentum. See Orpiment.				— Cinchona. See Peruvian bark, in Bark.			
Bacon, the cwt.		1	8 0	— clove, the lb.		0	0 10
Balaustia, the lb.		0	0 10	— Drawback		0	0 6
Balsam, Canada, the lb.		0	1 3	— cork tree. See Oak bark, in Bark.			
— Cōpaiba or Capiwi, the lb.	Drawback	0	0 10	— eleutheria, or cascarilla, the lb.		0	0 6
— Drawback		0	2 0	— Drawback		0	0 4
— Riga, the lb.		0	1 0	— guaiacum, the cwt.		1	8 0
— and further as Foreign spirits, for every gallon		1	10 0	— Drawback		0	18 8
— balm of Gilead, balsam of Peru, of Tolu, and all balsams not otherwise described, the lb.		0	4 6	— Jesuits. See Peruvian bark, in Bark.			
Bandstring twist, the dozen knots, each knot containing 32 yards.		0	5 0	— oak, the cwt.		0	0 8
Barilla, if not containing a greater proportion of mineral alkali than 20 per cent. to the 6th of January, 1829, the ton		8	10 0	— solid vegetable extracts from oak. See Extract.			
— Ditto, from the 5th of January, 1829, to the 6th of January, 1830, the ton		6	10 0	— black oak, or quercitron, for dyeing, imported from any country not in Europe, the cwt.		0	2 0
— Ditto, from and after the 5th of January, 1830, the ton		5	0 0	— Ditto, otherwise imported, for every £100 value		20	0 0
— if containing more than 20 per cent. and not more than 25 per cent. of mineral alkali, to the 6th of January, 1829, the ton		11	5 0	— Peruvian or Jesuits', the lb.		0	2 0
— Ditto, from the 5th of January, 1829, to the 6th of January, 1830, the ton		8	12 6	— Drawback		0	1 4
— Ditto, from and after the 5th January, 1830, the ton		6	12 0	— extract or preparation of. See Extract.			
— if containing more than 25 per cent. and not more than 30 per cent. of mineral alkali, to the 6th January, 1829, the ton		14	10 0	— red mangrove, the cwt.		0	0 8
— Ditto, from the 5th January, 1829, to the 6th January, 1830, the ton		11	0 0	— sassafras, the lb.		0	0 8
— Ditto, from and after the 5th January, 1830, the ton		8	10 0	— Drawback		0	0 5
— if containing more than 30 per cent. and not more than 40 per cent. of mineral alkali, to the 6th January, 1829, the ton		18	10 0	— Simarouba, the lb.		0	1 0
— Ditto, from the 5th January, 1829, to the 6th January, 1830, the ton		14	0 0	— Drawback		0	0 8
— Ditto, from and after the 5th January, 1830, the ton		11	0 0	— winter's, the lb.		0	0 8
— if containing more than 40 per cent. of mineral alkali, to the 6th January, 1829, the ton		22	6 8	— Drawback		0	0 5
				— winter's, the produce of any British possession, the lb.		0	0 4
				— Drawback		0	0 3
				— not otherwise described, being for the use of dyers or tanners, for every £100 value		20	0 0
				— the produce of any British possession, for every £100 value		10	0 0
				— not particularly described, or otherwise charged with duty whether pulverised or not, the lb.		0	2 0
				Bar wood, the ton		0	7 0
				Basket rods, the bundle not exceeding three feet in circumference at the band		0	3 2
				Baskets, for every £100 value		20	0 0
				Bast ropes, the cwt.		0	10 0
				Bast or straw hats or bonnets. See Hats.			
				— plating, or other bast or straw, for making hats or bonnets. See Plating.			
				Bdellium, the lb.		0	1 8
				— Drawback		0	1 1

INWARDS.	Duty.		
	£.	s.	d.
Beads, amber, the lb.	0	12	0
— arango, for every £100 value	20	0	0
— coral, the lb.	0	15	10
— crystal, the 1000.	1	8	6
— jet, the lb.	0	3	2
— not otherwise described, for every £100 value	30	0	0
Beans, kidney, or French beans, the bushel	0	0	10
Beef wood, unmanufactured, imported from New South Wales, the ton	0	5	0
Beer, mum, the barrel, containing 32-gallons	3	1	1
— spruce beer, ditto	3	6	0
— or ale of all other sorts, ditto	2	13	0
Benjamin, or benzoin, the lb.	0	2	0
Drawback	0	1	4
Berries, bay, the cwt.	0	11	1
— juniper, the cwt.	0	11	1
— yellow, for dyers' use, the cwt.	0	14	0
— for dyers' use, not otherwise described, the cwt.	0	12	0
— not for dyers' use, not otherwise described for every £100 value	30	0	0
Bezoar stones, the oz.	0	2	6
Birds, viz. singing birds, the dozen.	0	8	0
Bitumen judaicum, the lb.	0	0	10
Drawback	0	0	6
Blacking, the cwt.	3	12	0
Bladders, the dozen	0	0	6
Blubber. See Train Oil, in Oil.			
Bole, Armenic or Armenian bole, the cwt.	0	8	0
Drawback	0	5	4
Bones of cattle, animals, or fish, except whale fins, for every £100 value	1	0	0
Bonnets. See Hats.			
Books, printed prior to 1801, bound or unbound, the cwt.	1	0	0
— printed in or since 1801, bound or unbound, the cwt.	5	0	0
Note.—For books prohibited to be imported, see the act for the regulation of the customs, and acts for securing copyrights.			
Boracic acid, the lb.	0	0	4
Borax or tincal, refined, the lb.	0	0	6
— unrefined, the lb.	0	0	3
Botargo, the lb.	0	1	0
Bottles of earth or stone, empty, the dozen	0	3	2
— Ditto, further, full or empty, for every cwt.	0	5	0
— of glass covered with wicker 12 quarts content.	1	2	0
— Ditto, further, for every cwt.	4	0	0
— of green or common glass, not less than one pint content, and not being phials,			
— Ditto, full, the dozen quarts content	0	4	0
— Ditto, empty, the dozen quarts content	0	2	0

INWARDS.	Duty.		
	£.	s.	d.
Bottles, of glass, not otherwise described, for every £100 value	25	0	0
— Ditto, further, for every cwt.	4	0	0
Note.—Flasks in which wine or oil is imported, are duty free.			
Boxes of all sorts, for every £100 value	20	0	0
Box wood, the produce of and imported from any British possession, the ton	1	13	4
— of any other place, or if otherwise imported, the ton.	7	18	6
Brass, manufactures of, not otherwise described, for every £100 value	30	0	0
— powder of, for japanning, the lb.	0	2	6
— wire. See Wire.			
Brasil wood, not otherwise described, the ton	5	0	0
Braziletto, or Jamaica wood, the ton.	0	16	8
Bricks or clinkers, the 1000	1	2	6
Brimstone, rough, the cwt.	0	0	6
— refined, the cwt.	0	6	0
— in flour, the cwt.	0	9	9
Bristles, dressed, the dozen lbs.	0	12	0
— rough, or undressed, the dozen lbs.	0	3	7
Brocade of gold or silver for every £100 value	30	0	0
— of silk. See Silk manufactures			
Bronze, all works of art made of			
— Bronze, the cwt.	1	0	0
— powder, for every £100 value	25	0	0
Buck wheat, the quarter	0	14	0
Bugles of all sorts, the lb.	0	4	0
Bullion and foreign coin, of gold or silver, and one of gold or silver, or of which the major part in value is gold or silver, duty free			
Bulrushes, the load containing 63 bundles	0	12	0
Burrachas. See Caoutchouc.			
Burrs for mill stones. See Stones.			
Butter, the cwt.	1	0	0
Buttons, for every £100 value	20	0	0
Cables, tarred or untarred, in use or otherwise, the cwt	0	10	9
Calaminaris lapis. See Lapis.			
Calamus aromaticus, the lb.	0	0	10
Drawback	0	0	6
Calves velves, the cwt.	0	11	6
Cambogium. See Gamboge.			
Cambrics. See Linen.			
Camomile flowers, the lb.	0	0	6
Drawback	0	0	4
Camphor, refined, the lb.	0	0	10
— unrefined, the lb.	0	0	5
Camwood, the ton	0	15	0
Cancrorum oculi, the lb.	0	1	3
Drawback	0	0	10
Candles, spermaceti, the lb.	0	2	6

INWARDS		Duty.		INWARDS		Duty.	
		£.	s. d.			£.	s. d.
Candles, tallow, the cwt.		3	3 4	Chillies. See Pepper.			
— wax, the lb.		0	2 6	China root, the lb.		0	1 3
Candlewick, the cwt.		4	8 8	— — — — — Drawback		0	0 10
Canella alba, the lb.		0	0 8	China or Porcelain ware plain, for every £100 value		15	0 0
	Drawback	0	0 5	— gilt, or ornamented for every £100 value		30	0 0
Canes, bamboo, the 1000		1	14 0	Chip, manufactures of, to make hats or bonnets. See Platting.			
— rattans, not ground, the 1000.		1	0 0	Chocolate and cocoa paste, the produce of and imported from any British possession, the lb.		0	1 9
— reed canes, the 1000		1	6 6	— — — — — the produce of any other place, or if otherwise imported, the lb.		0	4 4
— walking canes or sticks, mounted, painted, or otherwise ornamented, for every £100 value		30	0 0	Cider, the ton		21	10 0
— Whangees, Jumboo, ground rattans, dragon's blood, and other walking canes or sticks, the 1000		4	0 0	Cinders, the ton		2	0 0
Cantharides, the lb.		0	3 6	Cinnabaris nativa, the lb.		0	0 3
	Drawback	0	2 4	— — — — — Drawback		0	0 2
Caoutchouc, or elastic gum, the lb.		0	0 5	Cinnamon, the lb.		0	3 6
Capers, the lb.		0	1 0	— — — — — Drawback		0	3 2
Capita papaverum, the 1000		0	3 6	— the produce of and imported from any British possession, the lb.		0	2 6
	Drawback	0	2 4	— — — — — Drawback		0	2 3
Capsicum. See Pepper.				Citrate of lime, the lb.		0	1 6
Cardamoms, the lb.		0	2 0	Citron, preserved with salt, for every £100 value		20	0 0
— — — — — extract or preparation of. See Extract.		0	1 4	— preserved with sugar. See Succades.			
Cards, playing, the dozen packs		4	0 0	Citron water. See Spirits.			
Cariophyllorum cortex. See Clove bark, in Bark.				Civet, the oz.		0	4 9
— — — — — oleum. See Oil of Cloves.				Clinkers. See Bricks.			
Carminé, the oz.		0	4 0	Clocks, for every £100 value		25	0 0
Carrabe. See Succinum.				Cloves, the lb.		0	3 0
Carriages of all sorts, for every £100 value		30	0 0	— — — — — Drawback		0	2 7
Casks, empty, for every £100 value.		50	0 0	— the produce of and imported from any British possession the lb.		0	2 0
Cassia, buds, the lb.		0	1 0	— — — — — Drawback		0	1 9
— fistula, the lb.		0	0 10	Coals, the ton		2	0 0
	Drawback	0	0 6	Cobalt, the lb.		0	0 3
— lignea, the lb.		0	1 0	Cocculus Indicus, the lb.		0	2 6
Cis or, the lb.		5	0 0	— — — — — extract or preparation of. See Extract.			
	Drawback	0	3 4	Cochineal, the lb.		0	1 0
Casts of busts, statues, or figures, the cwt.		0	2 6	— dust, the lb.		0	0 5
Catechu. See Terra Japonica.				— the produce of any British possession, the lb.		0	0 4
Catlings, harpstrings, or lutestrings, the gross of 12 dozen knots		0	6 4	— Ditto dust the lb.		0	0 1½
Caviare, the cwt.		0	12 0	Cocoa nuts, the produce of any British possession in America, the lb.		0	0 6
Cedar wood, the ton		3	16 0	— the produce of any British possession within the limits of the East India Company's Charter, the lb.		0	0 9
— the produce of, and imported from any British possession (except the Cape of Good Hope), the ton		1	0 0	— the produce of any other place, the lb.		0	1 3
— the produce of the Cape of Good Hope, and imported direct from thence, the ton		0	10 0	Coccol nut husks, or cocoa shells, the lb.		0	0 2
Chalk, prepared or otherwise manufactured, and not otherwise described, for every £100 value		40	0 0	Cocoa paste. See Chocolate.			
— unmanufactured, and not otherwise described, for every £100 value		20	0 0	Cocus wood, the produce of any British possession, the ton		0	3 0
Charts. See Maps.				Codilla. See Flax.			
Cheese, the cwt.		0	10 6	Coffee, the produce of any British possession in America, the lb.		0	0 6
Cherries, the cwt.		0	18 8				
Cherries, dried the lb.		0	0 8				

INWARDS.	Duty.		
	£.	s.	d.
Coffee, the produce of any British possession within the limits of the East India Company's charter, the lb.	0	0	9
— the produce of any other place, the lb.	0	1	3
Coin of copper. See Copper.			
Coker or cocoa nuts. See Nuts.			
Coloquintida, or colocynth, the lb.	0	1	8
— Drawback	0	1	1
Columba root, the lb.	0	2	0
— Drawback	0	1	4
Comfits, the lb.	0	2	6
Copper ore, the cwt.	0	12	0
— old, fit only to be remanufactured, the cwt.	0	15	0
— in plates and copper coin, the cwt.	1	10	0
— unwrought, in bricks, or pigs, rose copper, and cast copper, the cwt.	1	7	0
— in part wrought viz. bars, rods, or ingots, hammered or raised, the cwt.	1	15	0
— wire. See Wire.			
— manufactures of copper not otherwise described, and copper plates engraved, for every £100 value	30	0	0
— the produce of any British possession within the limits of the East India Company's charter, viz. ore the cwt.	0	1	0
— Ditto old, fit only to be remanufactured, the cwt.	0	9	2
— Ditto in plates and coins, the cwt.	0	15	0
— Ditto unwrought, in bricks or pigs, rose copper, and all cast copper, the cwt.	0	9	2
— Ditto in part wrought, viz. bars, rods, or ingots, hammered or raised, the cwt.	1	11	3
— Ditto manufactures of copper, not otherwise described and copper plates engraved, for every £100 value	30	0	0
Copperas, blue, the cwt.	0	5	0
— green, the cwt.	0	5	0
— white, the cwt.	0	12	0
Coral, beads. See Beads.			
— in fragments, the lb.	0	1	0
— whole, polished the lb.	0	12	0
— Ditto unpolished, the lb.	0	5	6
— Ditto, ditto of British fishing or taking the lb.	0	0	6
Cordage tarred or untarred, whether in use or otherwise (standing or running rigging in use excepted), the cwt.	0	10	9
Cordial waters. See Spirits.			
Cork, the cwt.	0	8	0
Corks ready made, the lb.	0	7	0
Corn. See Act 3. Geo. IV. c. 60.			
Cornu Cervi Calcinatam, the lb.	0	0	8

INWARDS.	Duty.		
	£.	s.	d.
Costus, the lb.	0	1	0
— Drawback	0	0	8
Cotton, manufactures of, for every £100 value	10	0	0
— Ditto, and further, if printed, for every square yard	0	0	3½
— wool, or waste of cotton wool. See Wool.			
Couhage, or cowitch, the lb.	0	1	3
— Drawback	0	0	10
Cowries, for every £100-value	20	0	0
Cranberries, the gallon	0	0	6
Crayons, for every £100 value	40	0	0
Cream of tartar, the cwt.	0	4	8
Crystal, beads. See Beads.			
— rough, for every £100 value.	20	0	0
— cut, or in any way manufactured, for every £100 value	30	0	0
Cubebs, the lb.	0	2	0
Cucumbers, pickled, including the vinegar the gallon	0	3	0
— preserved in salt and water, for every £100 value	20	0	0
Culm, the ton	2	0	0
Currants, the cwt.	2	4	4
— Drawback	2	0	0
Cuttle shells, the 1000	0	12	6
Damask tabling, towelling, or napping. See Linen.			
Dates, the cwt.	4	10	3
— Drawback	4	0	0
Derelict. Foreign liquors, derelict, jetsam, flotsam, lagan, or wreck, brought or coming into Great Britain or Ireland, are subject to the same duties, and entitled to the same drawbacks, as liquors of the like kind regularly imported.			
Diagrydium. See Scammony.			
Diaper tabling, towelling, or napping. See Linen.			
Dice, the pair	1	6	2
Dittany, the lb.	0	1	0
— Drawback	0	0	8
Down, the lb.	0	1	3
Dragons' blood. See Sanguis Draconis.			
Drawings. See Prints.			
Drugs, not particularly described, nor otherwise charged with duty, for every £100 value	20	0	0
Dust, perfumed. See Powder.			
Earthenware, not otherwise described, for every £100 value	15	0	0
Eels. See Fish.			
Ebony, the produce of any British possession, and imported direct from thence, the ton	0	15	0
— the produce of any other country, or if otherwise imported, the ton	24	14	0
— green, the produce of and imported from any British possession, the ton	0	3	0

INWARDS.		Duty.	INWARDS.		Duty.
		£. s. d.			£. s. d.
Eggs, the 120		0 0 10	Fish, sturgeon, the keg, not contain- ing more than five gallons		0 9 0
Elastic gum. See Caoutchouc.			— turbots		Free.
Embroidery and needlework, for every £100 value		30 0 0	— fresh fish, of British taking, and imported in British ships or vessels		Free.
Emery stones. See Stone.			— cured fish, of British taking and curing		Free.
Enamel, the lb.		0 7 2	Fishing nets, old. See Rags.		
Essence, of bergamot or of lemon, the lb.		0 4 6	Flasks. See Bottles.		
— of spruce, for every £100 value		20 0 0	Flax, and tow or codilla, of hemp or flax, whether dressed or un- dressed, until the 6th of July, 1826, the cwt.		0 0 4
— not otherwise described, the lb.		0 4 6	— Ditto, from the 5th of July, 1826, until the 6th of July, 1827, the cwt.		0 0 3
Euphorbium, the lb.		0 0 8	— Ditto, from the 5th of July, 1827, until the 6th of July, 1828, the cwt.		0 0 2
	Drawback	0 0 5	— Ditto, from and after the 5th of July, 1828, the cwt.		0 0 1
Extract, cardamoms,	} Extract or pre- paration of, for every £100. value .	. 75 0 0	Flint stones for potters. See Stones.		
— cocculus Indictus,			Flocks, the cwt.		0 19 0
— grains, Guinea,			Flotsam. See Derelict.		
— ditto, of Paradise,			Flower roots, for every £100 value		20 0 0
— liquorice,			Flowers, artificial, not made of silk, for every £100 value		25 0 0
— nux vomica,					
— oak bark, solid vegetable extract from oak bark, or other vegetable substances, to be used for the purpose of tanning leather, and for no other pur- pose whatever, the cwt.		0 3 0	Fossils, not otherwise described, for every £100 value		20 0 0
— the produce of New South Wales and its dependencies, and imported direct from thence, until the 1st of January, 1833, duty-free.			— specimens of. See Specimens.		
	} Extract or prepa- ration of, for every £100 value .	. 25 0 0	Frames for pictures, prints, or draw- ings, for every £100 value		20 0 0
— opium,			Frankincense. See Olibanum.		
— pepper, Guinea			Furriers' waste, for every £100 value		20 0 0
— Peruvian or Jesuits' bark, extract or preparation of, the lb.		0 5 0	Furs. See Skins.		
— quassia, extract or prepara- tion of, for every £100 value		50 0 0	Fustic, the ton		0 4 6
— radix rhatania, extract or preparation of, the lb.		0 5 0	— the produce of any British possession in America, or on the West Coast of Africa, the ton		0 3 0
— vitriol, extract or prepara- tion of, for every £100 value		25 0 0	Galangal, the lb.		0 0 6
— extract or preparation of any article, not being particu- larly described, nor otherwise charged with duty, for every £100 value		20 0 0		Drawback	0 0 4
Feathers, for beds, in beds or not, the cwt.		2 4 0	Galbanum, the lb.		0 1 4
— ostrich, dressed, the lb.		1 10 0		Drawback	0 0 10
— Ditto, undressed, the lb.		0 10 0	Galls, the cwt.		0 11 2
— not otherwise described, dressed, for every £100 value		20 0 0	Gamboge, the lb.		0 1 8
— Ditto, undressed, for every £100 value		10 0 0		Drawback	0 1 1
Figs, the cwt.		1 1 6	Garnets, cut, the lb.		1 10 0
	Drawback	0 19 0	— rough, the lb.		0 10 0
Filtering stones. See Stones.			Gauze of thread, for every £100 value		30 0 0
Fish, eels, the ship's lading		18 1 3	Gentian, the lb.		0 0 6
— lobsters, duty-free.				Drawback	0 0 4
— oysters, the bushel		0 1 6	Ginger, the cwt.		2 13 0
— stock fish, the 120		0 5 0	— preserved, the lb.		0 3 2
			— the produce of any British possession, the cwt.		0 11 6
				Drawback	0 10 0
			— Ditto, preserved, the lb.		0 0 3
			Ginseng, the lb.		0 1 6
				Drawback	0 1 0
			Glass, crown, or any kind of window glass (not being plate glass or German sheet glass), the cwt.		8 6 8

INWARDS.	Duty.		
	£.	s.	d.
Glass, German sheet, the cwt.	10	0	0
— plate, superficial measure, not containing more than 9 square feet, from the 5th of January, 1826, to the 6th of January, 1827, the square foot	0	7	0
— Ditto, after the 5th of January, 1827, the square foot	0	6	0
— containing more than 9 square feet, and not more than 14 square feet, from the 5th of January, 1826, to the 6th of January, 1827, the square foot	0	9	0
— Ditto, after the 5th of January, 1827, the square foot	0	8	0
— containing more than 14 square feet, and not more than 36 square feet, from the 5th of January, 1826, to the 6th of January, 1827, the square foot	0	10	6
— Ditto, after the 5th of January, 1827, the square foot	0	9	6
— containing more than 36 square feet, from the 5th of January, 1826, to the 6th of January, 1827, the square foot	0	12	0
— Ditto, after the 5th of January, 1827, the square foot	0	11	0
— manufactures, not otherwise described, and old broken glass fit only to be re-manufactured, for every £100 value	20	0	0
— Ditto, further for every cwt.	4	0	0
Glovers' clippings, fit only to make glue, the cwt.	0	4	9
Gloves, habit, from the 5th of July, 1826, the dozen pair	0	4	0
— mens', from the 5th of July, 1826, the dozen pair	0	5	0
— or mitts, womens', from the 5th of July, 1826, the dozen pair	0	7	0
Glue, the cwt.	0	12	0
Grains, Guinea, the lb.	0	2	0
— ditto, extract or preparation of. See Grains, in Extract.			
— of Paradise, the lb.	0	2	0
— ditto, extract or preparation of. See Grains, in Extract.			
Granilla, the lb.	0	0	10
— the produce of any British possession, the lb.	0	0	5
Grapes, for every £100 value	20	0	0
— rape of. See Rape of grapes.			
Grease, the cwt.	0	1	8
Greaves for dogs, the cwt.	0	2	0

INWARDS.	Duty.		
	£.	s.	d.
Gum ammoniac, the lb.	0	1	3
— Drawback	0	0	10
— animi, rough, and in no way cleaned, the lb.	0	0	5
— Ditto, scraped, or in any way cleaned, the lb.	0	0	6
— Arabic, the cwt.	0	12	0
— cashew, the cwt.	0	7	6
— Drawback	0	5	0
— copal, rough, and in no way cleaned, the lb.	0	0	5
— Ditto, scraped, or in any way cleaned, the lb.	0	0	6
— elemi, the lb.	0	0	8
— Drawback	0	0	5
— guaiacum, the lb.	0	1	10
— Drawback	0	1	2
— juniper. See Gum Sandarack.			
— kino, or gum rubrum astringens, the lb.	0	1	6
— Drawback	0	1	0
— lac, cake } for every £100			
— lake } value	10	0	0
— dye } for every £100			
— seed } value	5	0	0
— stick } value			
— shell, for every £100 value	20	0	0
— opopanax, the lb.	0	3	6
— Drawback	0	2	4
— rubrum astringens. See Gum. Kino.			
— sagapenum, the lb.	0	0	10
— Drawback	0	0	6
— sandarack, or juniper, the cwt.	0	19	0
— Drawback	0	12	8
— sarcocolla, the lb.	0	0	10
— Drawback	0	0	6
— Senegal, the cwt.	0	12	0
— Tacamahaca, the lb.	0	2	0
— Drawback	0	1	4
— tragacanth, the lb.	0	1	0
— Drawback	0	0	8
— not particularly described, or otherwise charged with duty, for every £100 value	20	0	0
Gunpowder, the cwt.	3	0	0
Gypsum, the ton	1	11	8
— the produce of, and imported from any British possession, the ton	0	1	3
Hair, camels' hair or wool, the lb.	0	0	1
— Ditto, the produce of and imported from any British possession			Free.
— Cow, ox, bull, or elk hair, the cwt.	0	10	0
— Goats' hair. See Wool.			
— Hats made of hair. See Hats.			
— Horse hair, for every £100 value	20	0	0
— Human hair, the lb.	0	5	0
— not otherwise described, for every £100 value	20	0	0

INWARDS.		Duty.	INWARDS.		Duty.
		£ s. d.			£ s. d.
Hair, manufactures of hair or goats' wool, or of hair or goats' wool and any other material, not particularly enumerated, or otherwise charged with duty, for every £100 value		30 0 0	Hides, or pieces of hides, tanned tawed, curried, or in any way dressed, not particularly described, nor otherwise charged with duty, for every £100 value		75 0 0
Hams, the cwt.		1 8 0	Hones, the 100		1 3 0
Harp strings. See Catlings.			Honey, the produce of any British possession, the cwt.		0 5 0
Hats, bast, chip, cane, or horse hair hats or bonnets, each hat or bonnet not exceeding 22 inches in diameter, the dozen		1 0 0	— the produce of any other place, the cwt.		0 15 0
Ditto, each hat or bonnet exceeding 22 inches in diameter, the dozen		2 0 0	Hoofs of cattle, for every £100 value		20 0 0
— Straw hats or bonnets, each hat or bonnet not exceeding 22 inches in diameter the dozen		3 8 0	Hoops, of iron, the cwt.		1 3 9
— Ditto, each hat or bonnet exceeding 22 inches in diameter, the dozen		6 16 0	— of wood, the 1000		0 15 0
— made of, or mixed with felt, hair, wool, or beaver, the hat		0 10 6	Hops, the cwt.		8 11 0
Hay, the load containing 36 trusses, each truss being 56 lbs.		1 4 0	Horns, horn tips, and pieces of horns, not otherwise charged with duty, the cwt.		0 2 4
Head matter. See Train oil, in Oil.			Horses, mares, or geldings, each		1 0 0
Heath, for brushes, the cwt.		0 9 2	Hulled barley. See Pearl barley.		
Hellebore, the lb.		0 0 6	Hungary water. See Spirits.		
	Drawback	0 0 4	Jalap, the lb.		0 2 0
Hemp, dressed, the cwt.		4 15 0		Drawback	0 1 4
— rough or undressed, or any other vegetable substance of the nature and quality of undressed hemp, and applicable to the same purposes, the cwt.		0 4 8	Japanned ware, for every £100 value		20 0 0
— Ditto the produce of any British possession	Free.		Jet, the lb.		0 2 0
Hessen canvas. See Linen.			— beads. See Beads.		
Hides, horse, mare, gelding, buffalo, bull, cow, or ox hides in the hair, not tanned, tawed, curried, or in any way dressed, viz. dry, the cwt.		0 4 8	Jetsam. See Derelict.		
— Ditto wet, the cwt.		0 2 4	Jewels, emeralds, rubies, and all precious stones except diamonds, set, for every £100 value		20 0 0
— the produce of and imported from the west coast of Africa, each hide not exceeding 14 lbs. weight, the cwt.		0 2 4	— Ditto not set, for every £100 value		10 0 0
— tanned and not otherwise dressed, the lb.		0 1 0	Jews' pitch. See Bitumen Judaicum.		
— the produce of any British possession, dry, the cwt.		0 2 4	India rubbers. See Caoutchouc.		
— Ditto, wet, the cwt.		0 1 2	Indigo, the lb.		0 0 4
— tanned, and not otherwise dressed, the lb.		0 0 6	— the produce of any British possession, the lb.		0 0 3
— Tails. See Tails.			Ink for printers, the cwt.		1 1 0
— Losh hides, the lb.		0 1 8	Inkle, unwrought, the lb.		0 0 10
— Muscovy or Russia hides, tanned, or colored, the hide		0 15 0	— wrought, the lb.		0 5 2
— Hides, or pieces of hides, raw or undressed, not particularly described, nor otherwise charged with duty, imported from any British possession in America, for every £100 value		5 17 6	Iris root. See Orrice root.		
— Hides, or pieces of hides, raw or undressed, not particularly described, nor otherwise charged with duty, for every £100 value		20 0 0	Iron, in bars or unwrought, the produce of any British possession, and imported from thence, the ton		0 2 6
			— Ditto, the produce of any other country, the ton		1 10 0
			— slit or hammered into rods, and iron drawn or hammered less than $\frac{1}{4}$ of an inch square, the cwt.		0 5 0
			— cast, for every £100 value		10 0 0
			— Hoops. See Hoops.		
			— old broken, and old cast iron, the ton		0 12 0
			— ore, the ton		0 5 0
			— pig iron, the ton		0 10 0
			— Ditto the produce of, and imported from any British possession, the ton		0 1 3
			— wire. See Wire.		
			— wrought, not otherwise described, for every £100 value		20 0 0
			Isinglass, the cwt.		2 7 6
			— the produce of and imported from any British possession, the cwt.		0 15 10
			Juice of lemons, limes, or oranges, raw, the gallon, for every degree of specific gravity or strength		0 0 0

INWARDS.	Duty.		
	£	s.	d.
Juice of lemons, limes, or oranges, concentrated, the gallon, for every degree of specific gravity or strength	0	0	0½
— Ditto the produce of and imported from any British possession, whether concentrated or raw, the gallon, for every degree of specific gravity or strength	0	0	0½
Junk, old. See Rags, old.			
Kelp. See Alkali.			
Lac See Lac, in Gum.			
Lace, silk, for every £100 value, until the 6th July, 1826	40	0	0
— Ditto after the 5th July, 1826, See Silk manufacture.			
— thread, for every £100 value.	30	0	0
— plain silk, called net or tulle, until the 6th July, 1826, the square yard	0	2	0
— Ditto after the 5th July, 1826. See Silk manufacture.			
Lacquered ware, for every £100 value	30	0	0
Lagan. See Derelect.			
Lamp black, the cwt.	3	6	6
Lapis calaminaris, the cwt.	0	1	0
— lazuli, the lb.	0	3	2
— tutia, the lb.	0	0	8
Lard, the cwt.	0	8	0
Latten, black, the cwt.	0	14	0
— shaven, the cwt.	1	5	0
Lavender flowers, the lb.	0	0	10
Lawns. See Linen.			
Lead, black, the cwt.	0	4	0
— chromate of, the lb.	0	2	0
— ore, the ton	0	10	0
— pig, the ton	2	0	0
— red, the cwt.	0	6	0
— white, the cwt.	0	7	0
Leather, any article made of leather, or any manufacture of which leather is the most valuable part, not otherwise enumerated or described, for every £100 value	30	0	0
Leaves, of gold, the 100	0	3	0
— of roses, the lb.	0	0	10
Lemons. See Oranges.			
— peel of, the lb.	0	0	5
— preserved, in salt and water, for every £100 value	20	0	0
— preserved in sugar. See Succades.			
Lentiles, the bushel	0	0	10
Lichen Islandicus. See Moss.			
Lignum, quassia. See Quassia.			
— rhodium, the cwt.	1	0	0
— vitæ, the produce of and imported from any British possession, the ton	0	11	2
— Ditto, of any other place, or if otherwise imported, the ton	4	12	8

INWARDS.	Duty.		
	£	s.	d.
Limes, juice of. See Juice.			
Linen, or linen and cotton, viz. cambrics, and lawns, commonly called French lawns, the piece not exceeding 8 yards in length, and not exceeding 7-8ths of a yard in breadth, and so in proportion for any greater or less quantity,—plain	0	6	0
— Ditto, bordered handkerchiefs	0	5	0
— lawns of any other sort, not French, not containing more than 60 threads to the inch of warp, the square yard	0	0	9
— Ditto, containing more than sixty threads to the inch of warp, the square yard	0	1	0
— damasks, and damask diaper, from the 5th of January, 1826, to the 6th of January, 1827, the square yard	0	3	0
— One-eighth part of one shilling (part of the above duty) to cease on the 6th of January, 1827, and the like on every 6th of January for seven succeeding years.			
— Ditto, from the 5th of January, 1834, the square yd.	0	2	0
— drillings, ticks, and twilled linens, from the 5th of January, 1826, to the 6th of January, 1827, the square yard	0	0	11
— One-eighth part of threepence (part of the above duty) to cease on the 6th of January, 1827, and the like on every 6th of January for seven succeeding years.			
— Ditto, from the 5th of January, 1834, the square yard	0	0	8
— sail-cloth, the square yard	0	0	7½
— plain linens and diaper, not otherwise described, and whether chequered or striped with dyed yarn or not, not containing more than 20 threads to the inch of warp, from the 5th of January, 1826, to the 6th of January, 1827, the square yard	0	0	3
— One-eighth part of three farthings (part of the above duty) to cease on the 6th of January, 1827, and the like on every 6th of January, for seven succeeding years.			
— Ditto, from the 5th of January, 1834, the square yard	0	0	2½
— containing more than twenty threads, and not more than 24 threads to the inch of warp, from the 5th of January, 1826, to the 6th of January, 1827, the square yard	0	0	3½

INWARDS.	Duty. £ s. d
Linen, One-eighth part of a half-penny (part of the above duty) to cease on the 6th January, 1827, and the like on every 6th January, for seven succeeding years	
— Ditto, from the 5th of January, 1834, the square yard	0 0 3
— containing more than 24 threads, and not containing more than 30 threads to the inch of warp, from the 5th of January, 1826, to the 6th of January, 1827, the square yard	0 0 5
One-eighth part of a penny (part of the above duty) to cease on the 6th of January, 1827, and the like on every 6th of January, for seven succeeding years.	
— Ditto, from the 5th of January, 1834, the square yard	0 0 4
— containing more than 30 threads, and not containing more than 40 threads to the inch of warp, from the 5th of January, 1826, to the 6th of January, 1827, the square yard	0 0 6
One-eighth part of three-half-pence (part of the above duty) to cease on the 6th of January, 1827, and the like on every 6th of January, for seven succeeding years.	
— Ditto, from the 5th of January, 1834, the square yard	0 0 4½
— containing more than 40 threads, and not containing more than 60 threads to the inch of warp, from the 5th of January, 1826, to the 6th of January, 1827, the square yard	0 1 0
One-eighth part of fourpence (part of the above duty) to cease on the 6th of January, 1827, and the like on every 6th of January, for seven succeeding years.	
— Ditto, from the 5th of January, 1834, the square yard	0 0 8
— containing more than 60 threads, and not containing more than 80 threads to the inch of warp, from the 5th of January, 1826, to the 6th of January, 1827, the square yard	0 1 2
One-eighth part of fourpence (part of the above duty) to cease on the 6th of January, 1827, and the like on every 6th of January, for seven succeeding years.	
— Ditto, from the 5th of January, 1834, the square yard	0 0 10
— containing more than 80 threads, and not containing more than 100 threads to the inch of	

INWARDS.	Duty. £ s. d
warp, from the 5th of January, 1826, to the 6th of January, 1827, the square yard	0 1 4
One-eighth part of fourpence (part of the above duty) to cease on the 6th of January, 1827, and the like on every 6th of January, for seven succeeding years.	
— Ditto, from the 5th of January, 1834, the square yard	0 1 0
— containing more than 100 threads to the inch of warp, from the 5th of January, 1826, to the 6th of January, 1827, the square yard	0 2 0
One-eighth part of sixpence (part of the above duty) to cease on the 6th of January, 1827, and the like on every 6th of January, for seven succeeding years.	
— Ditto, from the 5th of January, 1834, the square yard	0 1 6
— or, and instead of the duties herein-before imposed upon linens of all sorts, at the option of the importer, for every £100 value	40 0 0
<i>Note.</i> —No increased rate of duty to be charged on any linen or lawns for any additional number of threads, not exceeding two threads, for such as are not of 30 threads to the inch, nor for any additional number of threads not exceeding five threads, for such as are of 30 threads and upwards to the inch.	
— printed linen, in addition to the rated duties thereon, for every square yard	0 0 3½
— sails, for every £100 value	30 0 0
— foreign made sails, on board any ship or vessel belonging to any of his majesty's subjects, whether in use or not, for every £100 value	30 0 0
— manufactures of linen, or of linen mixed with cotton or with wool, not particularly enumerated, or otherwise charged with duty, from and after the 5th of January, 1826, for every £100 value	25 0 0
— Ditto, further, if printed, for every square yard	0 0 3½
Linseed cakes, the cwt.	0 0 2
Liquorice juice, or succus liquoritæ, the cwt.	3 15 0
— powder, the cwt.	5 10 0
— root, the cwt.	3 3 4
— extract or preparation of.	
See Extract.	

INWARDS.	Duty.
£.	s. d.
Liquors. Foreign liquors, derelict, jetsam, flotsam, lagan or wreck, brought or coming into Great Britain or Ireland, are subject to the same duties, and entitled to the same drawbacks, as liquors of the like kind regularly imported.	
Litharge of gold or silver, the cwt.	0 2 0
Litmus, the cwt.	0 4 0
Liverwort. See Lichen Islandicus, in Moss.	
Logwood, the ton	0 4 6
the produce of any British possession in America, or on the west coast of Africa, the ton	0 3 0
Lupines, the cwt.	0 5 0
Lutestrings. See Catlings.	
Macaroni, the lb.	0 0 8
Mace, the lb.	0 4 6
Drawback	0 4 0
the produce of and imported from any British possession, the lb.	0 3 6
Drawback	0 3 2
Madder, the cwt.	0 6 0
root, the cwt.	0 1 6
Magna Græcia ware, for every £100 value	5 0 0
Mahogany, of the growth of Bermuda, or any of the Bahama Islands, and imported direct from thence respectively, and mahogany imported direct from the Bay of Honduras, in a British ship, cleared out from the port of Balize, ton	3 16 0
of the growth of the Island of Jamaica, and imported direct from thence, the ton	5 0 0
of the growth of any other place, or otherwise imported or cleared out, the ton	11 17 6
Mangoes, the gallon	0 6 0
Manna, the lb.	0 1 3
Drawback	0 0 10
Manuscripts, the lb.	0 0 2
Maps or charts, plain or colored, each map or chart, or part thereof	0 0 6
Marble. See Stone.	
Marbles for children. See Toys.	
Marmalade; the lb.	0 1 3
the produce of any British possession, the lb.	0 0 3
Mastic, the lb.	0 1 4
Drawback	0 0 10
Mats, of Russia, the 100	1 3 9
not otherwise described, for every £100 value	20 0 0
Matting, for every £100 value	20 0 0
Mattrasses, for every £100 value	20 0 0
Mead or metheglin, the gallon	0 6 7
Medals, of gold or silver	Free.
of any other sort, for every £100 value	5 0 0

INWARDS.	Duty.
£.	s. d.
Medlers, the bushel	0 5 0
Melasses, the cwt.	1 3 9
the produce of and imported from any British possession, the cwt.	0 10 0
Melting pots, for goldsmiths. See Pots.	
Mercury, prepared, for every £100 value	30 0 0
Metal, bell, the cwt.	1 0 0
leaf (except leaf gold), the packet, containing 250 leaves	0 0 8
Metheglin. See Mead.	
Mill boards, the cwt.	3 8 2
stone. See stone.	
Minerals, not otherwise described, for every £100 value	20 0 0
specimens of. See specimens.	
Models of cork or wood, for every £100 value	5 0 0
Morels, the lb.	0 2 9
Moss, lichen Islandicus, or liverwort, the lb.	0 0 8
rock, for dyers' use, the ton	0 15 0
not otherwise described, for every £100 value	20 0 0
Mother-of-pearl shells, for every £100 value	5 0 0
Mules, each	0 10 0
Mum. See Beer.	
Musical instruments, for every £100 value	20 0 0
Musk, the oz.	0 5 0
Drawback	0 3 4
Myrrh, the lb.	0 1 8
Drawback	0 1 1
Myrtle Wax. See Wax.	
Napkinning. See Linen.	
Nardus Celtica, the cwt.	1 0 0
Drawback	0 13 4
Indica. See Spikenard.	
Natron. See Alkali.	
Needlework. See Embroidery.	
Nets, old fishing, fit only for making paper, or paste-board. See Rags.	
Nicaragua wood, the ton	0 15 0
Nitre, cubic, the cwt.	0 0 6
Nutmegs, the lb.	0 3 6
Drawback	0 3 2
the produce of and imported from any British possession, the lb.	0 2 6
Drawback	0 2 3
Nuts, cashew, the lb.	0 2 0
Drawback	1 4 0
Ditto, the produce of any British possession, the lb.	0 0 1
Ditto, kernels, the lb.	0 0 2
castor, the lb.	0 0 4
coker, or cocoa nuts, the produce of any British possession, the 120	0 5 0
chestnuts, the bushel	0 2 0
pistachio, the lb.	0 0 10

* £1 4s. is the drawback stated in the act of parliament—we do not therefore alter it; although there can be little doubt that 1s. 4d. is the drawback intended.

INWARDS.		Duty.		INWARDS.		Duty.	
		£	s. d.			£	s. d.
Nuts, small, the bushel		0	2 0	or from any British possession, in a British ship, the tun		0	1 0
— walnuts, the bushel		0	2 0	— Ditto, of foreign fishing, the tun		26	12 0
— nuts, not otherwise described, for every £100 value		20	0 0	— of turpentine, the lb.		0	0 8
Nux vomica, the lb.		0	2 6	— of vitriol, the lb.		0	0 6
— extract or preparation of. See Extract.				— walnut, the lb.		0	0 6
Oakum, the cwt.		0	4 9	— whale. See Train oil, in Oil.			
Ochre or oaker, the cwt.		0	6 9	— not particularly described, nor otherwise charged with duty, for every £100 value		50	0 0
Oil of almonds, the lb.		0	0 10	Oker. See Ochre.			
— of amber or succinum, the lb.		0	5 6	Olibarium, the cwt.		2	0 0
— of aniseed, the lb.		0	4 0	Drawback		1	4 2
— of bay, the lb.		0	0 3	Olives, the gallon		0	2 0
— of cajaputa, the oz.		0	1 0	Olive wood, the produce of and imported from any British possession, the ton		0	12 4
— of caraway, the lb.		0	2 6	— of any other place, or if otherwise imported, the ton		8	9 6
— of cassia, the oz.		0	1 0	Onions, the bushel		0	3 0
— of castor, the lb.		0	1 0	Opium, the lb.		0	9 0
— Ditto, the produce of and imported from any British possession, the lb.		0	0 6	Drawback		0	6 0
— chemical, not otherwise described, the lb.		0	4 0	— extract or preparation of. See Extract.			
— of cinnamon, the oz.		0	1 0	Opopanax gum. See Gum.			
— of cloves, the oz.		0	2 0	Orange flower water, the gallon		0	3 9
— of cocoa nut, the cwt.		0	2 6	Oranges and lemons the chest or box, not exceeding the capacity of 5000 cubic inches		0	3 4
— of fennel, the lb.		0	4 0	— Ditto, exceeding the capacity of 5000 cubic inches, and not exceeding 7300 cubic inches		0	5 0
— fish. See Train oil, in Oil				— Ditto, exceeding the capacity of 7300 cubic inches, and not exceeding 14,000 cubic inches		0	10 0
— of hemp seed, the tun		39	18 0	— for every 1000 cubic inches exceeding the above rate of 14,000 cubic inches, and so in proportion for any greater or less excess		0	0 10
— of jessamine, the lb.		0	4 0	— loose, the 1000		1	0 0
— of juniper, the lb.		0	2 0	— or, and at the option of the importer, for every £100 value		100	0 0
— of lavender, the lb.		0	4 0	— juice of. See Juice.			
— of linseed, the tun		39	18 0	— peel of, the lb.		0	0 6
— of mace, the oz.		0	2 6	Orchal, orchelia, or archelia, the cwt.		0	6 0
— of marjoram, the lb.		0	4 0	Ore, not otherwise described, for every £100 value		20	0 0
— of neroli. See Oil of orange flower.				— of gold or silver. See Bullion.			
— of nutmegs, the oz.		0	2 6	— specimens of. See Specimens.			
— of olives, the tun		8	8 0	Orpiment, the cwt.		1	8 6
— of orange flower or neroli, the oz.		0	2 0	Orris, or Iris Root, the cwt.		1	8 6
— of palm, the cwt.		0	2 6	Orsedew, the lb.		0	1 3
— perfumed, not otherwise described, the lb.		0	4 0	Otto, or attar, or oil of roses, the oz.		0	6 0
— of pine, the lb.		0	0 8	Paddy. See Rice.			
— of rape seed, the tun		39	18 0	Painters' colors, not otherwise described, for every £100 value		30	0 0
— of rhodium, the oz.		0	5 0	Paintings on glass, for every £100 value		30	0 0
— of rock, the lb.		0	0 10	— Ditto, and further, for every cwt. of glass		4	0 0
— of rosemary, the lb.		0	4 0				
— of roses. See Otto of roses.							
— of rosewood, the oz.		0	5 0				
— sallad. See Oil of olives.							
— of sandal wood, the oz.		0	2 6				
— of saffras, the lb.		0	2 6				
— seal oil. See Train oil, in Oil.							
— seed oil, not otherwise described, the tun		39	18 0				
— of spermaceti. See Train oil, in Oil.							
— of spike the lb.		0	4 0				
— of succinum. See Oil of Amber.							
— of thyme, the lb.		0	4 0				
— train, blubber, spermaceti, and head matter, viz. the produce of fish or creatures living in the sea, taken and caught by the crews of British ships, and imported direct from the fishery,							

INWARDS.	Duty.		
	£.	s.	d.
Paper, brown, made of old rope or cordage only, without separating or extracting the pitch or tar therefrom, and without any mixture of other materials therewith, the lb.	0	0	3
— printed, painted, or stained, or paper hangings, or flock paper, the yard square	0	1	0
— waste, or paper of any other sort, not particularly described, nor otherwise charged with duty, the lb.	0	0	9
Parchment, the dozen sheets	0	10	0
Pasteboards, the cwt.	3	8	2
Pearl barley, the cwt.	0	17	6
Pearls, for every £100 value	5	0	0
Pears, the bushel	0	7	6
— dried, the bushel	0	10	0
Pellitory, the lb.	0	0	6
Drawback	0	0	4
Pelts. See Skins.			
Pencils, for every £100 value	30	0	0
— of slate, for every £100	20	0	0
Pens, for every £100 value	30	0	0
Pepper of all sorts, the produce of and imported from any British possession, the lb.	0	1	0
— Ditto of any other place, or if otherwise imported, the lb.	0	1	6
Perfumed dust. See Powder.			
Perry, the ton	22	13	
Pewter, manufactures of, not otherwise described, for every £100 value	20	0	0
Pickles of all sorts, not otherwise described, including the vinegar, the gallon	0	6	0
Pictures, under two feet square, the picture	3	8	0
— two feet square and under four feet square, the picture	6	16	0
— four feet square or upwards, the picture	10	4	0
Pimento, the produce of any British possession, the lb.	0	0	5
— the produce of any other place, the lb.	0	1	3
Pink Root, the lb.	0	0	10
Drawback	0	0	6
Pitch, the cwt.	0	0	10
— the produce of any British possession, the cwt.	0	0	9
— Burgundy, the cwt.	0	14	3
— Jews. See Bitumen Judaicum.			
Plants, shrubs, and trees alive	Free.		
Plaster of Paris, the cwt.	0	1	0
Plate, battered, fit only to be re-manufactured. See Bullion.			
— of gold, the oz. troy	3	16	9
— of silver, gilt, the oz. troy	0	6	4
— Ditto, part gilt, the oz. troy	0	6	0
— Ditto, ungilt, the oz. troy	0	4	6
Platina, the oz.	0	1	0
— ore of, for every £100 value	5	0	0

INWARDS.	Duty.		
	£.	s.	d.
Plating, or other manufactures to be used in or proper for making hats or bonnets, of bast, chip, cane, or horse hair, the lb.	1	0	0
— of straw, the lb.	0	17	0
Plums, dried, the lb.	0	1	3
Polishing rushea, for every £100 value	20	0	0
— stones. See Stones.			
Pomatum, for every £100 value	30	0	0
Pomegranates, the 1000	1	10	0
— peels of, the cwt.	0	15	0
Poppies, heads. See Capita papaverum.			
Porcelain. See China ware.			
Potatoes' the cwt.	0	2	0
Pots, melting, for goldsmiths, the 100	0	3	2
— of stone, for every £100 value	30	0	0
Powder, hair, the cwt.	9	15	0
— Ditto, perfumed, or perfumed dust, the cwt.	13	13	0
— not otherwise described, that will serve for the same uses as starch, the cwt.	9	10	0
Precious stones. See Jewels.			
Prints and drawings, plain, each	0	0	1
— colored, each	0	0	2
Prunelloes, the lb.	0	1	3
Prunes, the cwt.	1	7	6
Quassia, the cwt.	8	17	6
— extract or preparation of. See Extract.			
Quern stones. See Stones.			
Quicksilver, the lb.	0	0	6
Drawback	0	0	3
Quills, goose, the 1000	0	2	6
— swan, the 1000	0	12	0
Quinces, the 100	0	4	0
Quinine, sulphate of, the oz.	0	2	6
Radix, contrayerva, the lb.	0	1	8
Drawback	0	1	1
— enula campanæ, the cwt.	0	13	6
Drawback	0	9	0
— eryngii, the lb.	0	0	6
Drawback	0	0	4
— ipecacuanhæ, the lb.	0	4	0
Drawback	0	2	8
— rhatanis, the lb.	0	2	0
Drawback	0	1	4
— Ditto, extract or preparation of. See Extract.			
— senekæ, the lb.	0	1	9
Drawback	0	1	2
— serpentaria, or snake-root the lb.	0	1	9
Drawback	0	1	2
Rags, old rags, old ropes, or junk, or old fishing-nets, fit only for making paper or pasteboard, the ton	0	5	0
— woollen rags, fit only for manure, the ton	0	7	6
Raisins, denia or lexia, the cwt.	1	0	0
Drawback	0	18	0

INWARDS.			Duty.			INWARDS.			Duty.		
			£.	s.	d.				£	s.	d.
Raisins, of the sun, the cwt.			2	2	6	Sassafras, the cwt.			0	6	4
— Drawback			1	18	0	Saunders, red, the ton			0	12	0
— of any other sort, the cwt.			1	2	0	— white or yellow, the lb.			0	0	10
— Drawback			1	0	0	Sausages, or puddings, the lb.			0	1	3
— of all sorts, the produce						Scaleboards, the cwt.			3	8	2
of any British possession, the						Scammony, the lb.			0	6	4
cwt.			0	10	0	— Drawback			0	4	3
— Drawback			0	9	0	Scilla. See Squills.					
Rape, cakes, the cwt.			0	0	2	Seeds, acorns, the bushel			0	1	0
— of grapes, the ton			0	13	6	— ammi, or ammiosseed, the lb.			0	0	6
Ratafia. See Spirits.						— anniseed, the cwt.			3	0	0
Red wood, or guinea wood, the ton			0	15	0	— burnet, the cwt.			1	0	0
Rennett, the gallon			0	0	6	— canary, the cwt.			3	0	0
Resina Jalappæ, the lb.			0	6	9	— caraway, the cwt.			1	10	0
— Drawback			0	4	6	— carrot, the lb.			0	0	9
Rhatany root. See Rhadix rhatanice.						— carthamus, the lb.			0	0	6
Rhinehurst, the cwt.			0	14	3	— castor, the lb.			0	0	4
— Drawback			0	9	6	— cevadilla. See Sabadilla seed.					
Rhubarb, the lb.			0	4	0	— clover, the cwt.			1	0	0
— Drawback			0	2	8	— cole, from the 5th January,					
— the produce of any British						1826, to the 6th July, 1826,					
possession, the lb.			0	2	6	the last			5	0	0
— Drawback			0	1	8	— Ditto, from and after the					
Rice, not being rough, and in the						5th July, 1826, the last			0	10	0
husk, the cwt.			0	15	0	— coriander, the cwt.			0	15	0
— rough, and in the husk, or						— cummin, the cwt.			1	0	0
paddy, the bushel			0	2	6	— fennel, the lb.			0	0	9
— the produce of any British						— fennugreek, the cwt.			0	9	6
possessions,						— flax, until the 6th April, 1826,					
Ditto, not being rough, and in						the bushel			0	0	5
the husk, the cwt.			0	5	0	— Ditto, after the 5th April, 1826,					
— Ditto rough, and in the husk,						the quarter			0	1	0
or paddy, the bushel			0	0	7½	— forest, the lb.			0	0	6
Rocou. See Annotto.						— garden, not particularly de-					
Ropes, new. See Cordage.						scribed, nor otherwise charged					
— old. See Rags.						with duty, the lb.			0	0	6
Rosewood, the cwt.			1	0	0	— grass, of all sorts, the cwt.			1	0	0
Rosin, or colophonia, the cwt.			0	4	9	— hemp, the quarter			2	0	0
— the produce of any British						— Ditto, the produce of, and					
possession, the cwt.			0	3	2	imported from any British					
Rubies. See Jewels.						possession, the quarter			0	1	0
Sacharum saturni, the lb.			0	10	0	— leek, the lb.			0	1	6
— Drawback			0	0	6	— linseed, until the 6th April,					
Safflower, the cwt.			0	5	0	1826, the bushel			0	0	5
Saffron, the lb.			0	2	6	— Ditto, after the 5th April,					
Sago, pearl, the cwt.			1	10	0	826, the bushel			0	1	0
— common, the cwt.			0	15	0	— lucerne, the cwt.			1	0	0
— powder, the cwt.			1	10	0	— maw, the cwt.			3	0	0
Sails. See Linen.						— millet, the cwt.			0	11	6
Sal, ammoniac, the lb.			0	0	3	— mustard, the bushel			0	8	0
— gem, the cwt.			0	8	0	— onion, the lb.			0	1	6
— limonum, the lb.			0	4	9	— parsley, the lb.			0	0	1
— prunelle, the lb.			0	0	6	— peas, when prohibited to be im-					
— succini, the lb.			0	3	2	ported as corn, the bushel			0	7	6
Salep or salop, the lb.			0	1	3	— piony or peony, the lb.			0	0	6
— Drawback			0	0	10	— quince, the lb.			0	3	0
Salt					Free.	— rape, from the 5th of January,					
Saltpetre, the cwt.			0	0	6	1826, to the 6th of July 1826,					
Sanguis draconis, the lb.			0	1	8	the last			5	0	0
— Drawback			0	1	1	— Ditto, from and after the 5th of					
Santa Maria wood, for every £100						July 1826, the last			0	10	0
value			20	0	0	— sabadilla or cevadilla, the lb.			0	1	0
— sapan wood, the ton			0	15	0	— shrub or tree, not otherwise					
Sarsaparilla, the lb.			0	1	3	enumerated, the lb.			0	0	6
— the produce of any British						— trefoil, the cwt.			1	0	0
possession, the lb.			0	1	0	— worm, the lb.			0	1	6
						— Drawback			0	1	0

INWARDS.	Duty.		
	£	s.	d.
Seed, all seeds not particularly described, nor otherwise charged with duty, commonly made use of for extracting oil therefrom, from the 5th January 1826 to the 6th July 1826, the last	5	0	0
— Ditto from and after the 5th July 1826, the last	0	10	0
— all other seed not particularly described, nor otherwise charged with duty, for every £100 value	30	0	0
Segars. See Tobacco, manufactured. Sena, the lb.	0	1	3
Drawback	0	0	10
Shaving for hats. See Platting.			
Ships to be broken up, with their tackle, apparel, and furniture (except sails), foreign ships or vessels, for every £100 value	50	0	0
— British, or vessels, entitled to be registered as such, not having been built in the united kingdom, for every £100 value	15	0	0
Shrubs. See Plants.			
Shumach, the cwt.	0	1	0
Silk, knubs or husks, the lb.	0	0	3
— raw, the lb.	0	0	3
— thrown, dyed or not, the lb.	0	7	6
— waste or floss, not otherwise described, the lb.	0	0	3
— manufactures of, or of silk and any other material, not particularly charged with duty, from and after the 5th July, 1826, for every £100 value	30	0	0
Silk-worm gut, for every £100 value	20	0	0
Skates for sliding, for every £100 value	20	0	0
Skins, furs, pelts, and tails:—badger undressed, the skin,	0	1	6
Drawback	0	1	4
— bear, undressed, the skin,	0	4	6
— Ditto, undressed, imported from any British possession in America, the skin	0	2	6
— beaver, undressed, the skin	0	0	8
— Ditto, undressed, imported from any British possession in America, the skin	0	0	4
— calabar. See Squirrel skins.			
— calf, and kip skins in the hair, not tanned, tawed, curried, or in any way dressed, dry, the cwt.	0	4	8
— Ditto, wet, the cwt.	0	2	4
— Ditto, the produce of, and imported from the west coast of Africa, each skin, not exceeding 7lbs. weight, the cwt.	0	2	4
— Ditto, tanned and not otherwise dressed, the lb.	0	1	0
— cat, undressed, the skin	0	0	6
— Ditto, undressed, imported from any British possession in America, the skin.	0	0	3
— coney, undressed, the 100 skins	0	1	0

INWARDS.	Duty.		
	£	s.	d.
Skins, deer, undressed, the skin	0	0	2
— Ditto, undressed, the produce of, and imported from any British possession in America, the 100 skins	0	1	0
Drawback	0	0	6
— Ditto, Indian, half dressed, the skin	0	0	8
— Ditto, undressed or shaved, the skin	0	0	4
— dog, in the hair, not tanned, tawed, or in any way dressed, the dozen skins	0	0	10
— dog-fish, undressed, the dozen skins	0	5	2
— Ditto, undressed, of British taking, and imported direct from Newfoundland, the dozen skins	0	0	1
— elk, in the hair, not tanned, tawed or curried, or in any way dressed, the skin	0	1	0
— ermine, undressed, the skin	0	0	8
Drawback	0	0	7
— fisher, undressed, the skin	0	1	0
— Ditto, undressed, imported from any British possession in America, the skin	0	0	6
— fitch, undressed, the dozen skins	0	3	2
Drawback	0	2	10
— fox, undressed, the skin	0	0	8
— Ditto, undressed, imported from any British possession in America, the skin	0	0	4
— Ditto, tails, undressed, for every £100 value	20	0	0
— goat, raw or undressed, the dozen skins	0	2	10
— Ditto, tanned, the dozen skins	2	0	0
— hare, undressed, the 100 skins	0	1	0
— husse, undressed, the skin	0	0	6
— kid, in the hair, the 100 skins	0	1	6
Drawback	0	1	4
— Ditto, dressed, the 100 skins	0	10	0
— kip. See Calf skins.			
— lamb, undressed, in the wool, the 100 skins	0	1	6
— Ditto, tanned or tawed, the 100 skins	0	10	0
— Ditto, dressed in oil, the 100 skins	4	0	0
— leopard, undressed, the skin	0	9	6
Drawback	0	9	0
— lion, undressed, the skin	0	6	0
— martin, undressed, the skin	0	0	6
— Ditto, undressed, imported from any British possession in America, the skin	0	0	2
— Ditto, undressed, the produce of any British possession within the limits of the East India Company's charter, the skin	0	1	3
— Ditto, tails, undressed, the 100 tails	0	16	3
Drawback	0	15	6

INWARDS.				INWARDS.			
	Duty.				Duty.		
	£.	s.	d.		£.	s.	d.
Skins, mink, undressed, the skin . . .	0	0	4	Skins, and furs, or pieces of skins and furs, raw or undressed, not particularly described, nor otherwise charged with duty, for every £100 value . . .	20	0	0
— Ditto, undressed, imported from any British possession in America, the skin . . .	0	0	2	— or pieces of skins and furs, tanned, tawed, curried, or in any way dressed, not particularly described, nor otherwise charged with duty, for every £100 value . . .	75	0	0
— Ditto, dressed, the skin . . .	0	2	0	Slate. See Stone.			
— mole, undressed, the dozen skins . . .	0	0	6	Slick stones. See Stone.			
— Drawback . . .	0	0	5	Smalts, from the 5th January, 1826, to the 6th January, 1827, the lb. . .	0	0	8½
— musquash, undressed, the 100 skins . . .	0	1	0	— from the 5th January, 1827, to the 6th January, 1828, the lb. . .	0	0	7½
— nutria, undressed, the 100 skins . . .	0	12	6	— after 5th January, 1828, the lb. . .	0	0	6
— otter, undressed, the skin . . .	0	1	6	Snuff, the lb. . .	0	6	0
— Ditto, undressed, imported from any British possession in America, the skin . . .	0	1	0	Soap, hard, the cwt. . .	4	10	0
— ounce, undressed, the skin . . .	0	7	6	— soft, the cwt. . .	3	11	3
— panther, undressed, the skin . . .	0	9	6	— the produce of any British possession in the East Indies, hard, the cwt. . .	1	8	0
— pelts of goats, undressed, the dozen pelts . . .	0	3	0	— Ditto, soft, the cwt. . .	1	3	0
— Ditto, dressed the dozen pelts . . .	0	6	0	Soapers' waste, the ton . . .	0	3	2
— Ditto, of all other sorts, undressed, the 100 pelts . . .	0	17	0	Soda. See Alkali.			
— racoon, undressed, the skin . . .	0	0	2	Spa ware, for every £100 value . . .	30	0	0
— Ditto, undressed, imported from any British possession in America, the skin . . .	0	0	1	Specimens of such minerals, fossils, or ores, which are not particularly described, nor otherwise charged with duty, each specimen not exceeding in weight 14 lbs. . .			Free.
— sable, undressed, the skin . . .	0	8	4	— exceeding in weight 14 lbs. each, for every £100 value . . .	5	0	0
— Drawback . . .	0	7	6	— illustrative of natural history, not otherwise described . . .			Free.
— Ditto, tails or tips of, undressed, the piece . . .	0	1	3	Speckled wood, the produce of, and imported from any British possession, the ton . . .	0	16	3
— seal, in the hair, not tanned, tawed, or in any way dressed, the skin . . .	0	0	3	— of any other place, or if otherwise imported, the ton . . .	8	14	2
— Ditto, of British taking, and imported directly from Newfoundland, the skin . . .	0	0	1	Spelter, until the 6th July, 1826, the cwt. . .	0	14	0
— Ditto, taken in any foreign fishery by persons not being British subjects, the skin . . .	0	1	0	— from the 5th July, 1826, to the 6th July, 1827, the cwt. . .	0	12	0
— sheep, undressed, in the wool, the dozen skins . . .	0	1	0	— after the 5th July, 1827, the cwt. . .	0	10	0
— Ditto, tanned or tawed, the 100 skins . . .	2	0	0	Spermaceti, fine, the lb. . .	0	1	6
— Ditto, dressed in oil, the 100 skins . . .	4	0	0	Spikenard, or nardus Indica, the lb. . .	0	2	9
— squirrel or Calabar, undressed, the 100 skins . . .	0	11	6	— Drawback . . .	0	1	10
— Drawback . . .	0	10	4	Spirits or strong waters of all sorts, viz. for every gallon of such spirits, or strong waters of any strength, not exceeding the strength of proof by Sikes's hydrometer, and so in proportion for any greater strength than the strength of proof, and for any greater or less quantity than a gallon, viz. not being spirits or strong waters, the produce of any British possession in America, or any British pos-			
— Ditto, tawed, the 100 skins . . .	0	17	6				
— Ditto, tails, undressed, for every £100 value . . .	20	0	0				
— swan, undressed, the skin . . .	0	1	0				
— tiger, undressed, the skin . . .	0	9	6				
— Drawback . . .	0	8	6				
— weasel, undressed, the 100 skins . . .	0	4	9				
— Drawback . . .	0	4	3				
— wolf, undressed, the skin . . .	0	2	0				
— Ditto, undressed, imported from any British possession in America, the skin . . .	0	1	0				
— Ditto, tawed, the skin . . .	0	17	6				
— wolverings, undressed, the skin . . .	0	1	0				
— Ditto, undressed, imported from any British possession in America, the skin . . .	0	0	6				

INWARDS.	Duty.		
	£.	s.	d.
session within the limits of the East India Company's charter, and not being sweetened spirits, or spirits mixed with any article, so that the degree of strength thereof cannot be exactly ascertained by such hydrometer	1	2	6
Spirits or strong waters, for every gallon, &c., the produce of any British possession in America, not being sweetened spirits, or spirits so mixed, as aforesaid	0	8	6
— Ditto, spirits or strong waters, the produce of any British possession within the limits of the East India Company's charter, not being sweetened spirits, or spirits so mixed as aforesaid	1	0	0
— Ditto, spirits, cordials, or strong waters respectively (not being the produce of any British possession in America), sweetened or mixed with any article, so that the degree of strength thereof cannot be exactly ascertained by such hydrometer.	1	10	0
— Ditto, cordials, or strong waters respectively, being the produce of any British possession in America, sweetened or mixed with any article, so that the degree of strength thereof cannot be exactly ascertained by such hydrometer.	1	0	0
— Foreign liquors—derelict. See Derelict.	0	2	0
Sponge, the lb.	0	2	0
— the produce of any British possession, the lb.	0	0	6
— Drawback	0	1	4
Squills, dried, the cwt.	1	0	0
— not dried, the cwt.	0	5	0
Starch, the cwt.	9	10	0
Stavesacre, the cwt.	1	8	0
— Drawback	0	18	8
Steel, or any manufactures of steel, not otherwise described, for every £100 value	20	0	0
Stibium. See Antimony.			
Sticks, walking. See Canes.			
Stone, burrs for mill stones, the 100 dog, not exceeding four feet in diameter, above six, and under twelve inches in thickness, the pair	3	16	0
— emery, the cwt.	0	2	0
— filtering, for every £100 value.	50	0	0
— flint, for potters, the ton	0	2	6
— grave, of marble, polished, each not containing more than two feet square, the foot square superficial measure	0	2	6

INWARDS.	Duty.		
	£.	s.	d.
Stone, grave, of marble, unpolished, the foot square, superficial measure	0	0	10
— Ditto, not of marble, polished or unpolished, the foot square, superficial measure	0	0	6
— lime, for every £100 value	20	0	0
— marble blocks, the solid foot	0	3	0
— marble, in any way manufactured (except grave stones and paving stones, each not containing more than two feet square), the cwt.	0	3	0
— marble paving, polished, each not containing more than two feet square, the foot square superficial measure	0	0	10
— Ditto, rough, the foot square, superficial measure	0	0	6
— mill, above four feet in diameter, if twelve inches in thickness or upwards, the pair	11	8	0
— paving, not of marble, the 100 feet square superficial measure	0	12	0
— pebble, the ton	0	13	6
— polishing, for every £100 value	20	0	0
— pumice, the ton	1	13	4
— quern, under three feet in diameter, and not exceeding six inches in thickness, the pair	0	8	9
— Ditto, three feet in diameter, and not above four feet in diameter, and not exceeding six inches in thickness, the pair	0	17	6
— rag, for every £100 value	20	0	0
— slate, the produce of the Islands of Guernsey, Jersey, Sark, Alderney, or Man, and imported from those islands respectively, for every £100 value	26	8	0
— slates, the produce of any other country, not otherwise described, for every £100 value	66	10	0
— slates, in frames, the dozen	0	3	0
— slick, the 100.	0	8	0
— sculptured, or mosaic work the cwt.	0	2	6
— to be used for the purpose of lithography, the cwt.	0	3	0
— whetstones, the 100	0	8	9
— not particularly described, nor otherwise charged with duty, for every £100 value	66	10	0
<i>Note.</i> —If any statue, group of figures, or other stone or marble ornament, carved out of the same block, shall exceed one ton weight, the duty to be charged thereon shall be estimated at the rate payable for one ton weight and no more.			
Storax or Styrax, calamita, the lb.	0	2	0
— Drawback	0	1	4
— liquida, the lb.	0	3	4
— Drawback	0	2	2

INWARDS.	Duty.		
	£.	s.	d.
Storax, in the tear or gum, the lb.	0	8	4
Drawback	0	5	6
Succades, the produce of any British possession in America, the lb.	0	0	3
— the produce of any British possession, within the limits of the East India Company's charter, the lb.	0	0	6
— the produce of any other place, the lb.	0	3	2
Succinum, the lb.	0	1	8
Drawback	0	1	1
Sugar, brown or muscovado, or clayed, not being refined, the growth, produce, or manufacture of any British possession within the limits of the East India Company's charter, the cwt.	1	17	0
— the growth, produce, or manufacture of any British possession in America, the cwt.	1	7	0
— of any other place, the cwt.	3	3	0
— refined, the cwt.	8	8	0
Sugar candy, brown, the cwt.	5	12	0
— white, the cwt.	8	8	0
Sulphate of quinine. See Quinine.			
Sulphur impressions, for every £100 value.	5	0	0
— vivum. See Brimstone.			
Sumach. See Shumack.			
Sweep-washer dirt, containing bullion. See Bullion.			
Sweet wood, the produce of and imported from any British possession, the ton	0	16	3
— of any other place, or if otherwise imported, the ton	10	13	0
Tails, buffalo, bull, cow, or ox tails, the 100	0	6	0
— fox, martin, sable, squirrel, or calabar. See Skins.			
Talc, the lb.	0	0	8
Tallow, the cwt.	0	3	2
Tamarinds, the lb.	0	0	8
— the produce of any British possession within the limits of the East India Company's charter, the lb.	0	6	6
— the produce of any British possession in America, or on the West Coast of Africa, the lb.	0	0	9
Tapioca, or tapioca powder, the cwt.	1	10	0
Tar, the last, containing 12 barrels, each barrel not exceeding 31½ gallons	0	15	0
— the produce of any British possession, the last, containing 12 barrels, each barrel not exceeding 31½ gallons.	0	12	0
— Barbadoes, the lb.	0	0	5
Tares, the quarter	0	10	0
Tarras, the bushel	0	1	3
Tea,—subject only to the duty of Excise.			
Teasles, the 1000	0	1	0
Teeth, elephants', the cwt.	1	0	0

INWARDS	Duty.		
	£.	s.	d.
Teeth, sea cow, sea horse, or sea morse, the cwt.	3	4	0
Telescopes, for every £100 value	30	0	0
Terra Japonica, or catechu, the cwt.	0	3	0
— sienna, the cwt.	1	11	8
— umbra, the cwt.	0	12	0
— verde, the cwt.	0	16	0
Thread, Bruges, the dozen lbs.	0	15	0
— cotton. See Cotton manufactures.			
— Otnal, the dozen lbs.	0	15	0
— pack, the cwt.	0	15	0
— sisters, the lb.	0	4	0
— whited brown, the dozen lbs.	0	13	0
— not otherwise described, for every £100 value	25	0	0
Tiles of all sorts, for every £100 value	50	0	0
Fin, the cwt.	2	10	0
— manufactures of, not otherwise described, for every £100 value	20	0	0
Tinical. See Borax.			
Tin-foil, for every £100 value	25	0	0
Tobacco, of the growth or produce of the United States of America, or of any of the territories or dominions of the emperor of Russia, or of the Ottoman or Turkish empire, or from any port or place within the limits of the East India Company's charter, unmanufactured, the lb.	0	4	0
— of the growth or produce of any British possession in America, unmanufactured, the lb.	0	3	9
— of the growth or produce of any other place, unmanufactured, the lb.	0	6	0
— manufactured, or cigars, the lb.	0	18	
— manufactured in the United Kingdom, at or within two miles of any port into which tobacco may be imported, made into shag, roll, or carrot tobacco, the lb.	0	0	0
Drawback	0	3	6
Tobacco pipes, for every £100 value	30	0	0
Tongues, the dozen	0	3	0
Tooth-powder, for every £100 value	30	0	0
Tornal, or tumsols, the cwt.	0	5	
Tortoise-shell, unmanufactured, the lb.	0	2	
— Ditto, the produce of any British possession in America, or on the West Coast of Africa, the lb.	0	1	0
Touch-stones, for every £100 value	20	0	0
Tow. See Flax.			
Toys, for every £100 value	20	0	0
Treadle of Venice, the lb.	0	3	6
Trees. See Plants.			
Truffles, the lb.	0	2	6
Turbith, the lb.	0	2	6
Drawback	0	1	8
Turmerick, the lb.	0	6	3
— the produce of any British possession in America,			

INWARDS.		Duty.	
	£	s.	d.
or on the West Coast of Africa, the lb.	0	0	2
Turnery, not otherwise described, for every £100 value	30	0	0
Turnsole. See Torsal.			
Turpentine, not being of greater value than 12s. the cwt. thereof, the cwt.	0	4	4
— being of greater value than 12s. the cwt. thereof, the cwt.	1	6	2
— of Venice, Scio, or Cyprus, the lb.	0	0	10
			Drawback
Tutia lapis. See Lapis.			
Twine, the cwt.	1	11	0
Valonia, the cwt.	0	1	6
Vanilloes, the lb.	0	16	8
Varnish, not otherwise described, for every £100 value	30	0	0
Vases, ancient, not of stone or marble, for every £100 value	5	0	0
Vellum, the skin	0	7	2
Verdegria of all sorts, the lb.	0	2	0
Verjuice, the tun	73	12	9
Vermicelli, the lb.	0	0	8
Vermillion, the lb.	0	1	0
Vetches. See Tares.			
Vinegar, or acetic acid, the tun	18	18	0
Vinelloes. See Vanilloes.			
Wafers, the lb.	0	1	3
Washing balls, the lb.	0	1	8
Watches of gold, silver, or other metal, for every £100 value	25	0	0
Watch glasses, for every £100 value	20	0	0
— Ditto, further for every cwt.	4	0	0
Water, arquebusade, citron, cordial, Hungary, lavender. See Spirits.			
— Cologne, the flask, thirty of such flasks containing not more than one gallon	0	1	0
— mineral or natural, the dozen bottles or flasks, each bottle or flask not exceeding three pints	0	4	0
— strong. See Spirits.			
Wax, bees, unmanufactured, the cwt.	3	6	6
— Ditto, the produce of, and imported from, any British possession, the cwt.	2	6	6
— Ditto, white or manufactured, the cwt.	6	3	6
— myrtle, the lb.	0	1	0
— sealing, for every £100 of the value	30	0	0
Weld, the cwt.	0	1	0
Whale fins, taken and caught by the crew of a British ship, and imported direct from the fishery, or from any British possession, in a British ship, the ton	1	0	0
— of foreign fishing, the ton	95	0	0
Wheat, the produce of any British possession in North America, and imported directly from thence, the quarter	0	5	0

INWARDS.		Duty	
	£.	s.	d.
Whipcord, the lb.	0	1	0
Wine, the produce of his majesty's settlement of the Cape of Good Hope, or the territories or dependencies thereof, imported directly from thence, until the 6th of January 1830, the gallon	0	2	5
			Drawback
— Ditto, after the 5th of January, 1830, the gallon	0	3	0
			Drawback
— French, the gallon	0	7	3
			Drawback
— all wine, not otherwise described, the gallon	0	4	10
			Drawback
— lees, subject to the same duty as wine, but no drawback is allowed on the lees of wine exported	0	4	10
Wire, brass or copper, not otherwise described, the cwt.	2	10	0
— gilt or plated, for every £100 value	25	0	0
— iron, not otherwise enumerated or described, the cwt.	1	0	0
— latten, the cwt.	1	0	0
— silver, for every £100 value	25	0	0
— steel, the lb.	0	1	10
Wood, the cwt.	0	3	0
Wood, anchor stocks, the piece	0	8	4
— Ditto, of the growth and production of any British possession in America, and imported directly from thence, the piece	0	0	10
— balks, viz. under 5 inches square, and 24 feet in length, the 120	18	2	7
— Ditto, under 5 inches square, and 24 feet in length, or upwards, the 120	27	0	0
— Ditto, 5 inches square, or upwards, are subject and liable to the duties payable on fir timber			
— balks of the growth and produce of any British possession in America, and imported directly from thence, viz. under 5 inches square, and 24 feet in length, the 120.	3	5	0
— Ditto, under 5 inches square, and 24 feet in length, or upwards the 120	4	17	6
— Ditto, 5 inches square or upwards are subject and liable to the duties payable on fir timber			
— battens imported into Great Britain, viz. 6 feet in length, and not exceeding 16 feet in length, not above 7 inches in width, and not above 2½ inches in thickness, the 120	10	10	0
— Ditto, exceeding 16 feet in length, and not exceeding 21			

INWARDS.	Duty.			INWARDS.	Duty.		
	£.	s.	d.		£.	s.	d.
feet in length, not above 7 inches in width, and not exceeding 2½ inches in thickness, the 120	11	10	0	Wood, batten ends, imported into Great Britain, under 6 feet in length, not above 7 inches in width, and exceeding 2½ inches in thickness, the 120	6	0	0
Wood, battens, exceeding 21 feet in length, not above 7 inches in width, or if exceeding 2½ inches in thickness, the 120	20	0	0	— batten ends of the growth and produce of any British possession in America, and imported directly from thence into Great Britain, under 6 feet in length, not above 7 inches in width, and not exceeding 2½ inches in thickness, the 120	0	7	6
— battens of the growth and produce of any British possession in America, and imported directly from thence into Great Britain, viz. 6 feet in length, and not exceeding 16 feet in length, not above 7 inches in width, and not exceeding 2½ inches in thickness, the 120	1	0	0	— Ditto, under 6 feet in length, not above 7 inches in width, and exceeding 2½ inches in thickness, the 120	0	15	0
— Ditto, exceeding 16 feet in length, and not exceeding 21 feet in length, and not above 7 inches in width, and not exceeding 2½ inches in thickness, the 120	1	3	0	— batten-ends, imported into Ireland, under 8 feet in length, not above 7 inches in width, and not exceeding 3½ inches in thickness, the 120	4	14	5
— Ditto, exceeding 21 feet in length, not above 7 inches in width, or if exceeding 2½ inches in thickness, the 120	2	0	0	— Ditto, under 8 feet in length, if exceeding 3½ inches in thickness, the 120	9	3	1
— battens imported into Ireland, 8 feet in length, and not exceeding 12 feet in length, not above 7 inches in width, and not exceeding 3½ inches in thickness, the 120	8	6	3	— battens and batten-ends of all sorts, of the growth and produce of any British possession in America, and imported directly from thence, the 120	0	8	3
— Ditto, exceeding 12 feet in length, and not exceeding 14 feet in length, not above 7 inches in width, and not exceeding 3½ inches in thickness, the 120	9	14	0	— beech plank, 2 inches in thickness or upwards, the load, containing 50 cubic feet	2	8	9
— Ditto, exceeding 14 feet in length, and not exceeding 16 feet in length, not above 7 inches in width, and not exceeding 3½ inches in thickness, the 120	11	1	8	— Ditto, of all sorts, of the growth and produce of any British possession in America, and imported directly from thence into Ireland, the 120	0	8	4
— Ditto, exceeding 16 feet in length, and not exceeding 18 feet in length, not above 7 inches in width, and not exceeding 3½ inches in thickness, the 120	12	9	4	— beech quarters, under 5 inches square, and under 24 feet in length, the 120	4	10	8
— Ditto, exceeding 18 feet in length, and not exceeding 20 feet in length, not above 7 inches in width, and exceeding 3½ inches in thickness, the 120	13	17	2	— Ditto, 5 inches square, and under 8 inches square, or if 24 feet in length, or upwards, the 120	12	3	6
— Ditto, exceeding 20 feet in length, not above 7 inches in width, and not exceeding 3½ inches in thickness, the 120	34	6	1	— Ditto, of all sorts under 8 inches square, of the growth and produce of any British possession in America, and imported directly from thence, the 120	0	16	3
— batten-ends imported into Great Britain, under 6 feet in length, not above 7 inches in width, and not exceeding 2½ inches in thickness, the 120	3	0	0	— beech boards, under two inches in thickness, and under 15 feet in length, the 120	4	9	6
				— Ditto, under 2 inches in thickness, and if 15 feet in length, or upwards, the 120	8	19	0
				— clap boards, not exceeding 5 feet 3 inches in length, and under 8 inches square, the 120	6	2	0
				— Ditto, of the growth and produce of any British possession in America, and imported directly from thence, the 120	0	12	4
				— linn boards, or white boards for shoemakers, under 4 feet in			

INWARDS.	Duty.			INWARDS.	Duty.		
	£.	s.	d.		£.	s.	d.
length, and under 6 inches in thickness, the 120	6	16	6	Wood, deals to be used in mines.—			
Wood, linn boards, &c. 4 feet in length, or 6 inches in thickness or upwards, the 120	13	13	0	above 7 inches in width, being 8 feet in length, and not above 10 feet in length, and not exceeding 1½ inch in thickness, the 120	8	2	6
— oak boards, under 2 inches in thickness, and under 15 feet in length, the 120	18	1	0	— deals, imported into Great Britain :— above 7 inches in width, being 6 feet in length and not above 16 feet in length, and not exceeding 3½ inches in thickness, the 120	19	0	0
— Ditto, under 2 inches in thickness, and if 15 feet in length, or upwards, the 120	36	2	0	— Ditto above 7 inches in width above 16 feet in length and not above 21 feet in length, and not exceeding 3½ inches in thickness, the 120	22	0	0
— outside slabs, or paling boards, hewed on one side, not exceeding 7 ft. in length, and not above 1½ inch in thickness, the 120	2	0	0	— Ditto above 7 inches in width, above 21 feet in length and not above 45 feet in length and not above 3½ inches in thickness, the 120	44	0	0
— outside slabs, or paling boards, hewed on one side, exceeding 7 feet in length, and not exceeding 12 feet in length, and not above 1½ inch in thickness, the 120	4	0	0	— Ditto, above 45 feet in length, or above 3½ inches in thickness, not being timber 8 inches square, or upwards, the load containing 50 cubic feet	2	10	0
— outside slabs or paling boards, hewed on one side, exceeding 12 feet in length, or exceeding 1½ inch in thickness, are subject and liable to the duties payable on deals.				And further, the 120	6	0	0
— outside slabs or paling boards, hewed on one side, of the growth and produce of any British possession in America, and imported directly from thence, not exceeding 7 feet in length, and not above 1½ inch in thickness, the 120	0	5	0	— deals of the growth and produce of any British possession in America, and imported directly from thence into Great Britain :— above 7 inches in width, being 6 feet in length and not above 16 feet in length and not exceeding 3½ inches in thickness, the 120	2	0	0
— Ditto, exceeding 7 feet in length, and not exceeding 12 feet in length, and not above 1½ inch in thickness, the 120	0	10	0	— Ditto, above 7 inches in width, above 16 feet in length, and not above 21 feet in length, and not exceeding 3½ inches in thickness, the 120	2	10	0
— Ditto, exceeding 12 feet in length, or exceeding 1½ inch in thickness, are subject and liable to the duties payable on deals.				— Ditto, above 7 inches in width, being 6 feet in length, and not above 21 feet in length, and exceeding 3½ inches in thickness, the 120	4	0	
— pipe boards, above 5 feet 3 inches in length, and not exceeding 8 feet in length, and under 8 inches square the 120	9	3	0	— Ditto, above 7 inches in width, exceeding 21 feet in length, and not exceeding 4 inches in thickness, the 120	5	0	0
— Ditto exceeding 8 feet in length, and under 8 inches square the 120	18	6	0	— Ditto, above 7 inches in width, exceeding 21 feet in length and exceeding 4 inches in thickness (not being timber 8 inches square, or upwards, the 120	10	0	0
— Ditto of all sorts, exceeding 5 feet 3 inches in length, and under 8 inches square of the growth and produce of any British possession in America, and imported directly from thence, the 120	0	19	6	— deals imported into Ireland :— above 7 inches in width, and not exceeding 12 inches in width, and not exceeding 3½ inches in thickness, if 8 feet in length, and not exceeding 12 feet in length, the 120	12	9	5
— wainscot boards the foot, containing 12 feet in length, and 1 inch in thickness, and so in proportion for any greater or lesser length or thickness	0	4	0	— Ditto, exceeding 12 feet in length, and not exceeding 14 feet in length, the 120	14	11	0
— boards of all sorts, not otherwise described, of the growth and produce of any British possession in America, and imported directly from thence the 120	0	8	4				
— bowsprits. See Masts.							

INWARDS.		Duty.		INWARDS		Duty.		
		£.	s. d.			£.	s. d.	
Woods, deals, imported into Ireland, above 14 feet in length, and not above 16 feet in length, the 120.		16	12 6	ditional duties following:—If exceeding 12 inches in width, and not exceeding 15 inches in width, 25 per cent. or one-fourth of the aforesaid rates. If exceeding 15 inches in width, and not exceeding 18 inches in width, 50 per cent. or one-half of the aforesaid rates. If exceeding 18 inches in width, and not exceeding 21 inches in width, 75 per cent. or three-fourths of the aforesaid rates. If exceeding 21 inches in width, 100 per cent. or an additional duty, equal to the aforesaid rates respectively.				
— Ditto, exceeding 16 feet in length, and not exceeding 18 feet in length, the 120 .		18	14 1	— firewood, not fit or proper to be used other than as such: the fathom 6 feet wide and 6 feet high.		0	19 0	
— Ditto, exceeding 18 feet in length, and not exceeding 20 feet in length, the 120 .		20	15 7	— Ditto, of the growth and produce of any British possession in America, and imported directly from thence, the fathom, 6 feet wide and 6 feet high		0	0 10	
— Ditto, above 7 inches in width, and not exceeding 12 inches in width, and exceeding 3½ inches in thickness, viz. 8 feet in length, and not exceeding 20 feet in length, the 120 .		41	11 3	— Fir quarters, under 5 inches square, and under 24 feet in length, the 120 .		18	2 7	
— Ditto, above 7 inches in width, and not exceeding 12 inches in width, and not exceeding 4 inches in thickness, and exceeding 20 feet in length, the 120 .		51	9 2	— Ditto, under 5 inches square, and 24 feet in length, or upwards, the 120 .		27	0 0	
— Ditto, above 7 inches in width, and not exceeding 12 inches in width, and exceeding 4 inches in thickness, and exceeding 30 feet in length, the 120 .		100	6 1	— Ditto, 5 inches square or upwards are subject and liable to the duties payable on fir timber.				
— deal ends imported into Great Britain, viz. above 7 inches in width, being under 6 feet in length, and not exceeding 3½ inches in thickness, the 120 .		6	0 0	— fir quarters, of the growth and produce of any British possession in America, and imported directly from thence:—under 5 inches square, and under 24 feet in length, the 120 .		3	5 0	
— Ditto, above 7 inches in width, being under 6 feet in length, and exceeding 3½ inches in thickness, the 120 .		12	0 0	— Ditto, under 5 inches square, and 24 feet in length or upwards, the 120 .		4	17 6	
— deal ends of the growth and produce of any British possession in America, and imported directly from thence into Great Britain, viz. above 7 inches in width, being under 6 feet in length, and not exceeding 3½ inches in thickness, the 120 .		0	15 0	— Ditto, 5 inches square, or upwards, are subject and liable to the duties payable on fir timber.				
— Ditto, above 7 inches in width, being under 6 feet in length, and not exceeding 3½ inches in thickness, the 120 .		1	10 0	— fir timber. See Timber.				
— deal ends, imported into Ireland, viz. above 7 inches in width, and not exceeding 12 inches in width, and under 8 feet in length, viz. not exceeding 3½ inches in thickness, the 120 .		7	1 8	— handspikes, under 7 feet in length, the 120 .		2	0 0	
— Ditto, exceeding 3½ inches in thickness, the 120 .		13	14 8	— Ditto, 7 feet in length or upwards, the 120 .		4	0 0	
— deals and deal ends, of all sorts, of the growth and produce of any British possession in America, and imported directly from thence into Ireland, the 120 .		0	8 3	— Ditto, of the growth and produce of any British possession in America, and imported directly from thence, under 7 feet in length, the 120 .		0	2 6	
— Ditto, and further, on all deals and deal ends imported into Ireland of the aforesaid lengths and thicknesses, but of the following widths, the ad-				— Ditto, 7 feet in length or upwards, the 120 .		0	5 1	
				— knees of oak, under 5 inches square, the 120 .		0	10 0	

INWARDS.	Duty.		
	£.	s.	d.
Wood, knees of oak, 5 inches square, and under 8 in. square, the 120	4	0	0
— Ditto, 8 inches square or upwards, the load, containing 50 cubic feet	1	6	0
— Ditto, of the growth of any British possession in America, and imported directly from thence, under 5 inches square, the 120	0	2	0
— Ditto, 5 inches square, and under 8 inches square, the 120	0	15	0
— Ditto, 8 inches square or upwards; the load containing 50 cubic feet	0	5	0
— lathwood, in pieces, under 5 feet in length, the fathom 6 feet wide, and 6 feet high	4	5	0
— Ditto in pieces of 5 feet in length and under 8 feet in length, the fathom 6 feet wide and 6 feet high	6	16	0
— Ditto, 8 feet in length and under 12 feet in length, the fathom 6 feet wide and 6 feet high	10	4	0
— Ditto 12 feet long or upwards the fathom, 6 feet wide and 6 feet high	13	12	0
— Ditto, of the growth of any British possession in America, and imported directly from thence, in pieces under 5 feet in length, the fathom, 6 feet wide and 6 feet high	0	15	0
— Ditto, in pieces 5 feet in length or upwards, the fathom, 6 feet wide and 6 feet high	1	5	0
— masts, yards, or bowsprits, 6 inches in diameter, and under 8 inches, each	0	8	
— Ditto, 8 inches in diameter, and under 12 inches, each	1	2	0
— Ditto, 12 inches in diameter or upwards, the load, containing 50 cubic feet	2	15	0
— Ditto of the growth of any British possession in America, and imported directly from thence, 6 inches in diameter, and under 8 inches, each	0	1	6
— Ditto, 8 inches in diameter, and under 12 inches, each	0	4	0
— Ditto, 12 inches in diameter, or upwards, the load, containing 50 cubic feet	0	10	0
— Oak plank, 2 inches in thickness or upwards, the load containing 50 cubic feet	4	0	0
— Ditto of the growth of any British possession in America, and imported directly from thence, 2 inches in thickness or upwards, the load containing 50 cubic feet	0	15	0

INWARDS.	Duty.		
	£.	s.	d.
Wood, oak Timber. See timber.			
— oars, the 120	14	19	3
— Ditto, of the growth of any British possession in America, and imported directly from thence, the 120	0	19	6
— spars, under 22 feet in length, and under four inches in diameter, exclusive of the bark, the 120	2	8	0
— Ditto, 22 feet in length or upwards, and under four inches in diameter, exclusive of the bark, the 120	4	5	0
— Ditto, four inches in diameter, and under six inches in diameter, exclusive of the bark, the 120	9	0	0
— spars, of the growth of any British possession in America, and imported directly from thence, viz. under 22 feet in length, and under four inches in diameter, exclusive of the bark; the 120	0	9	0
— Ditto, 22 feet in length or upwards, and under four inches in diameter, exclusive of the bark, the 120	0	16	0
— Ditto, four inches in diameter, and under six inches in diameter, exclusive of the bark, the 120	1	15	0
— spokes for wheels, not exceeding two feet in length, the 1000	3	7	4
— Ditto, exceeding two feet in length, the 1000	6	14	8
— Ditto, of all sorts of the growth of any British possession in America, and imported directly from thence, the 1000	0	6	4
— staves, not exceeding 36 inches in length, not above three inches in thickness, and not exceeding seven inches in breadth, the 120	1	3	0
— Ditto, above 36 inches in length, and not exceeding 50 inches in length, not above three inches in thickness, and not exceeding seven inches in breadth, the 120	2	6	0
— Ditto, above 50 inches in length, and not exceeding 60 inches in length, not above three inches in thickness, and not exceeding 7 inches in breadth, the 120	3	0	0
— Ditto, above 60 inches in length, and not exceeding 72 inches in length, not above three inches in thickness, and not exceeding seven inches in breadth, the 120	4	4	0

CUSTOMS.

INWARDS.	Duty. £. s. d.	INWARDS	Duty. £. s. d.
staves, above 72 inches in length, not above three inches in thickness, and not exceeding seven inches in breadth, the 120	4 16 0	Wood, Ditto, not exceeding 1½ inch in thickness, shall be charged with one-third part of the duty herein proposed on such staves.	
— Ditto, above 3 inches in thickness, or above 7 inches in breadth, and not exceeding 63 inches in length, shall be deemed clap boards, and be charged with duty accordingly.		— Ditto, above 3½ inches in thickness, or above 7 inches in breadth, and not exceeding 63 inches in length, shall be deemed clap boards and be charged with duty accordingly.	
— Ditto, above 3 inches in thickness, or above 7 inches in breadth, and exceeding 63 inches in length, shall be deemed pipe boards and be charged with duty accordingly.		— Ditto, above 3½ inches in thickness, or above 7 inches in breadth, and exceeding 63 inches in length, shall be deemed pipe boards, and be charged with duty accordingly.	
— staves, being the growth of any of the United States of America, or of the growth of East or West Florida, and imported directly from thence respectively, not exceeding 1½ inch in thickness, shall be charged with one-third part only of the duties herein before imposed on staves.		— * teake, the load containing 50 cubic feet	1 10 0
— staves, being the growth of and imported directly from the Ionian Islands, shall be charged at the same rate of duty as staves of the growth of the United States of America, when imported directly from thence.		— Ditto, of the growth of any British possession in Africa, the load, containing 50 cubic feet	0 10 0
— staves of the growth of any British possession in America, and imported directly from thence, viz. not exceeding 36 inches in length, not above 3½ inches in thickness, and not exceeding 7 inches in breadth, the 120	0 2 0	— timber, viz. fir, eight inches square or upwards, the load, containing 50 cubic feet	2 15 0
— Ditto, above 36 inches in length and not exceeding 50 inches in length, not above 3½ inches in thickness, and not exceeding 7 inches in breadth, the 120	0 4 0	— Ditto, fir, of the growth of any British possession in America, and imported directly from thence, eight inches square or upwards, the load containing 50 cubic feet.	0 10 0
— Ditto, above 50 inches in length, and not exceeding 60 inches in length, not above 3½ inches in thickness, and not exceeding 7 inches in breadth, the 120.	0 6 0	— oak timber, 8 inches square or upwards, the load containing 50 cubic feet	2 15 0
— Ditto, above 60 inches in length, and not exceeding 72 inches in length, not above 3½ inches in thickness, and not exceeding 7 inches in breadth, the 120	0 8 0	— oak timber, of the growth of any British possession in America, imported directly from thence, 8 inches square or upwards, the load containing 50 cubic feet	0 10 0
— Ditto, above 72 inches in length, and not above 3½ inches in thickness, and not exceeding 7 inches in breadth, the 120 .	0 10 0	— timber of all sorts, not particularly described, nor otherwise charged with duty, being 8 inches square or upwards, the load containing 50 cubic feet	1 8 0
		— timber of all sorts, not particularly described, nor otherwise charged with duty, being of the growth of any British possession in America, and imported directly from thence, being 8 inches square or upwards, the load containing 50 cubic feet	0 5 0
		— ufers, under 5 inches square, and under 24 feet in length, the 120	18 2 7
		— Ditto under 5 inches square, and 24 feet in length, or upwards, the 120 .	27 0 0
		— Ditto 5 inches square, or upwards, are subject and liable to the duties payable on fir timber.	

INWARDS.	Duty.		
	£.	s.	d.
Wood, ufers of the growth of any British possession in America, and imported direct from thence, under 5 inches square, and under 24 feet in length, the 120 .	2	5	0
— Ditto under 5 inches square, and 24 feet in length, or upwards, the 120 .	4	17	6
— Ditto 5 inches square or upwards, are subject and liable to the duties payable on fir timber.			
— wainscot logs, 8 inches square or upwards, the load containing 50 cubic feet .	2	15	0
— Ditto of the growth of any British possession in America, and imported direct from thence, the load containing 50 cubic feet .	0	12	0
— unmanufactured, the growth of any British possession in America, not particularly described, nor otherwise charged with duty, for every £100 value .	5	0	0
— Ditto, not particularly described, and on which the duties due on importation are payable according to the value thereof, being of the growth of the British limits within the province of Yucatan in the bay of Honduras, and imported direct from the said bay, for every £100 value .	5	0	0
— Ditto not particularly described, nor otherwise charged with duty, for every £100 value .	20	0	0
—* teake, or other wood fit for ship-building, 8 inches square or upwards, the growth of any British possession within the limits of the East India Company's charter, the load containing 50 cubic feet .			Free.
Wool, beaver, the lb. .	0	1	7
— Ditto cut and combed, the lb. .	0	4	9
— bison or buffalo, the produce of, and imported direct from, any British possession, the lb. .	0	0	4
— Ditto of any other place, or if otherwise imported, the lb. .	0	0	6
— Carmania, the lb. .	0	0	1
— coney, the lb. .	0	0	2
— cotton, or waste of cotton wool, the produce of any British possession in America, and imported direct from thence .			Free.
— Ditto the produce of any British possession in America, not being imported direct from thence; and the produce of any other country or place, for every £100 value .	6	0	0
— goats', or hair, the lb. .	0	0	1

INWARDS.	Duty.		
	£.	s.	d.
Wool, goats', the produce of and imported from any British possession .			Free.
— hares', the lb. .	0	0	2
— lambs'. See Sheep's.			
— ostrich, the lb. .	0	0	6
— Polonia, the lb. .	0	0	6
— red, the lb. .	0	0	6
— sheep or lambs', the produce of, and imported from any British possession .			Free.
— Ditto the produce of, or imported from any other place: not being of the value of 1s the lb. thereof, the lb. .	0	0	0½
— Ditto, ditto, being of the value of 1s. the lb. thereof, or upwards, the lb. .	0	0	1
Woollens, manufactures of wool not being goats' wool, or of wool mixed with cotton, not particularly described, nor otherwise charged with duty, for every £100 value .	15	0	0
Wreck. See Derelect.			
Yarn, cable, the cwt. .	0	10	9
— camel, or mohair, the lb. .	0	0	3
— grogam, the lb. .	0	0	6
— raw linen, the cwt. .	0	1	0
— worsted, being of two or more threads, twisted or thrown, the lb. .	0	0	6
Zaffre, the lb. .	0	0	1
Zepoaria, the lb. .	0	1	3
Drawback .	0	0	10

Goods, wares, and merchandise, being either in part or wholly manufactured, and not being described nor otherwise charged with duty, and not prohibited to be imported into or used in Great Britain or Ireland, for every £100 value . 20 0 0

Goods, wares, and merchandise, not being either in part or wholly manufactured, and not being described, nor otherwise charged with duty, and not prohibited to be imported into or used in Great Britain or Ireland, for every £100 value . 10 0 0

Note.—All goods the produce or manufacture of the Island of Mauritius, are subject to the same duties as are imposed in this table on the like goods, the produce or manufacture of the British possessions in the West Indies.

All goods, the produce or manufacture of the Cape of Good Hope, or the territories or dependencies thereof, are subject to the same duties as are imposed in this table on the like goods, the produce or manufacture of the British possessions within the limits of the East India Company's charter, except when any other duty is expressly imposed thereon.

C U S T O M S .

TABLE II.—DUTIES OUTWARDS.

of Duties of Customs payable on Goods, Wares, and Merchandise, exported from the the United Kingdom to Foreign Parts.

OUTWARDS.		Duty.	OUTWARDS.		Duty.
		£. s. d.			£. s. d.
and cinders usually sold by measure, viz. exported to the Isle of Man, the chaldron, imperial measure		0 1 6	made use of as wool again, mat-trasses or beds stuffed with combed wool, or wool fit for combing or carding, the lb.		0 0 1
— exported to any British possession, the chaldron, imperial measure		0 1 6	The following duty is also payable on goods of the growth, produce, or manufacture of the United Kingdom exported from thence, whether subject to other export duty or not, viz. goods, wares, and merchandise, of the growth, produce, or manufacture of the United Kingdom, except as herein-after mentioned, exported to any port or place whatever, for every £100 of the true and real value		0 10 0
— exported to any other place, in a British ship, the chaldron, Newcastle measure		0 17 0	EXCEPT		
— in a ship, not British, the chaldron, Newcastle measure		1 10 3	Bullion.		
Coals and cinders usually sold by weight, viz. exported to the Isle of Man, the ton		0 1 0	Corn, grain, meal, malt, flour, biscuit, bran, grits, pearl barley, and Scotch barley.		
— exported to any British possession, the ton		0 1 0	Cotton yarn, or other cotton manufactures.		
— exported to any other place:— in a British ship, the ton		0 5 9	Fish.		
— Ditto, in a ship not British, the ton		0 10 0	Linen, or linen with cotton mixed.		
Any coals which shall have been screened through a riddle or screen, the bars of which not being in any part thereof more than three-eighth parts of an inch asunder, shall, on exportation from any part of Great Britain, be subject and liable to such and the like duties, and no other, as are or may be charged and payable on culm exported from Great Britain to Foreign parts.			Melasses.		
Culm, exported to the Isle of Man, the chaldron, imperial measure		0 0 6	Military clothing, accoutrements, or appointments, exported under the authority of the commissioners of his majesty's treasury, and sent to any of his majesty's forces serving abroad.		
— exported to any British possession, the chaldron, imperial measure		0 0 6	Military stores exported to India by the East India Company.		
— exported to any other place:— in a British ship, the chaldron, Newcastle measure		0 4 6	Salt.		
— Ditto, in a ship not British, the chaldron, Newcastle measure		0 8 0	Sugar, refined, of all sorts, and sugar candy.		
Skins, coney, the 100		0 1 0	Goods, wares, and merchandise, exported to the Isle of Man by virtue and under the authority of any licence which the commissioners of his majesty's customs are or may be authorised and empowered to grant.		
— hare, the 100		0 1 0	Any sort of craft, food, victuals, clothing, or implements or materials necessary for the British fisheries established in the island of Newfoundland, or in any of his majesty's colonies, islands, or plantations in North America, on due entry thereof, and exported direct to the said colonies, islands, or plantations.		
Wool, of hares and of conies, the lb.		0 0 1	Wool.		
— of sheep or lambs:—not being of the value of 1s. the lb. thereof, the lb.		0 0 0½	Woollen goods, or woollen and cotton mixed, exported to any port or place within the limits of the East India Company's charter.		
— Ditto, being of the value of 1s. the lb. or upwards, the lb.		0 0 1			
Woollen manufactures:—woolfels, mortlings, shortlings, yarn, worsted, woolflacks, cruels, coverlids, waddings, or other manufactures, or pretended manufactures, slightly wrought up or put together, so as that the same may be reduced to and					

TABLE III.—DUTIES COASTWISE.

A TABLE of the DUTIES of CUSTOMS payable on Goods, Wares, and Merchandise brought or sent COASTWISE, from one Port or Place to any other Port or Place in the United Kingdom, and of the Drawbacks to be allowed upon the Exportation of such Goods, Wares, and Merchandise.

COASTWISE.	Duty. £. s. d.	COASTWISE.	Duty. £. s. d.
Coals, culm, and cinders, except charcoal made of wood, viz. coals, except small coals otherwise charged with duty, brought coastwise from any port or place in the united kingdom into any port in England or Wales, in case they be such as are most usually sold by weight, the ton	0 4 0	phan's duty, and of all other rates, dues, and duties, payable to the corporation of London upon coal, culm, and cinders imported into the port of London, to be paid over to the said corporation at the end of every quarter.	
Drawback	0 3 8	Coals, shipped to be carried coastwise from the port of Newcastle-upon-Tyne to any other port in the united kingdom, the chaldron, imperial measure	0 0 6
— Ditto, in case they be such as are most usually sold by measure, the chaldron, imperial measure	0 6 0	— small, which have been screened through a screen or riddle, the bars of which not being in any part thereof more than 3-8ths of an inch asunder, or such coals mixed with ashes, shipped to be sent coastwise from the ports of Newcastle or Sunderland to any port in England or Wales, the chaldron, imperial measure	0 1 0
Drawback	0 5 6	— Ditto, not subject to the duty imposed upon coals brought coastwise.	
— brought coastwise from any port of the united kingdom into any port in Ireland, the ton	0 1 7½	— and culm carried from Ellenfoot to Bank End, in the county of Cumberland, or from any other Creek or place between Ellenfoot and Bank End aforesaid, provided bond be entered into, with a general condition for the due landing of such coals within the said limits;— coals and culm carried on the Monmouthshire canal, or on any of the railways or tram roads connected therewith, and afterwards carried from any port or place to the eastward of the islands called the Homes, to any other port or place in or upon the river Severn:—also to the eastward of the Homes without passing to the westward of the said islands, except in going to the port of Bridgewater, and without touching at any place to the westward of the said islands;—coals, culm, and cinders carried from any part of the Lancaster canal, or any of the branches thereof, or from any port or place within the hundred of Lonsdale, in the county of Lancaster, into the, Ul-	
— Ditto, and further, if brought into the harbour of Dublin, the ton	0 0 11		
Culm, viz. to be used for burning lime, sent from any place within the limits of the port of Milford, in the county of Pembroke, to any other place within the counties of Pembroke, Caermarthen, Cardigan, or Merioneth, the chaldron, imperial measure	0 0 6		
— Ditto, not having been so sent or charged with duty brought coastwise from any port in the united kingdom into any port in England or Wales, the chaldron, imperial measure	0 0 6		
Drawback	0 0 6		
Cinders, made of pit coal, brought coastwise from any port in the united kingdom, into any port in England or Wales, the chaldron, imperial measure	0 6 0		
Coals, culm, and cinders, brought by the Grand Junction or Paddington canals, nearer to London than the stone or post at or near the north-east point in Grove Park, in the county of Hertford, or brought down the river Thames nearer to London than the city's stone placed on the west side of Staines Bridge, in the county of Middlesex, the ton	0 1 0		
And a further duty of 1s. 3d. the ton payable to the proper officer of customs, in lieu of the duty called or-			

CUSTOMS.

COASTWISE.	Duty. £. s. d.	COASTWISE.	Duty. £. s. d.
<p>the canal, across or along any bay or estuary separating two canals;—coals, culms, cinders, or coked coals, burnt in any pit coal on which the proper duties shall have been paid, being again brought coastwise from any port or place in Great Britain to any other port or place in England or Wales; Duty free.</p>		<p>— Ditto, countesses, exceeding 16 inches in length and 8 inches in breadth, and not exceeding 20 inches in length and 10 in breadth, the 1000</p>	<p style="text-align: right;">1 2 6</p>
<p>Slates, brought coastwise from one port to another port in Great Britain, delivered by tale:—</p>		<p>— Ditto, duchesses, exceeding 20 inches in length and 10 inches in breadth, and not exceeding 24 inches in length and 12 inches in breadth, the 1000</p>	<p style="text-align: right;">1 15 6</p>
<p>— doubles, not exceeding 13 inches in length, or 7 inches in breadth, the 1000</p>	<p style="text-align: right;">0 6 0</p>	<p>— delivered by weight, queen or size rag slates, the ton</p>	<p style="text-align: right;">0 1 1</p>
<p>— Ditto, ladies', exceeding 13 inches in length, and 7 inches in breadth, and not exceeding 16 inches in length and 8 inches in breadth, the 1000</p>	<p style="text-align: right;">0 13 0</p>	<p>— Ditto, imperial or milled slates, the ton</p>	<p style="text-align: right;">0 15 6</p>
		<p>— Ditto, slab slates, the ton</p>	<p style="text-align: right;">0 13 0</p>
		<p>— Ditto, block slates, the ton</p>	<p style="text-align: right;">0 14 6</p>
		<p>— Ditto, Westmoreland rag slates, the ton</p>	<p style="text-align: right;">0 14 6</p>
		<p>— Ditto, slate or slates not otherwise described, for every £100 value</p>	<p style="text-align: right;">25 0 0</p>

Numerous acts of parliament have been passed to prevent frauds in this branch of the revenue; but a similar measure to that pursued by the consolidation act, respecting the quantum of the duties, is yet a desideratum, with regard to the acts restraining fraud.

Officers of the customs, 13 and 14 Car. II. cap. 11, sect. 4 & 6, may search ships; and having writ of assistance, may search houses; keepers of wharfs, quays, &c. landing or shipping goods, without the presence of some officer of the customs, shall forfeit £100. Where officers of the customs are hindered in the execution of their duty by persons armed to the number of eight, the offenders, by stat. 6, Geo. I. cap. 21, are to be transported for seven years.

If any goods are put into any vessel to be carried beyond sea: or be brought from beyond sea, and unshipped to be landed, the duties not being paid nor agreed for at the customs-house; the same shall be forfeited, one moiety to the king, the other to the seizer, &c.

It is also made felony for any persons to be assembled with fire-arms, &c., or to be assisting in the running of goods; to be found passing within five miles from the sea-coasts, with any horses, carts, &c., wherein are put above six pounds of tea, or five gallons of brandy, or other foreign goods of £30 value, not having permits; and suspected persons lurking near the coasts, not giving a good account of themselves, may be sent by a justice to the house of correction for a month; and informers to have

10s. for every offender so taken. Watermen, carmen, porters, &c. in whose custody run goods are found, shall forfeit treble value, or be committed for three months. Ships and vessels from foreign parts, having on board tea, or brandy, rum, &c., in casks under sixty gallons, except for the use of seamen, found at anchor, or hovering near any port, or within two leagues (increased to eight leagues by subsequent acts) of the shore, and not proceeding in their voyages, unless in cases of unavoidable necessity, all such tea, &c. shall be forfeited. Persons offering any bribe to officers of the customs, to connive at the running of goods, to forfeit £50; and obstructing such officer, in entering or searching ships, incurs a forfeiture of £100: and if an officer be wounded or beaten on board a ship, the offenders to be transported, &c., 9 Geo. II. cap. 35, &c. See SMUGGLING.

In the year 1822 a very important act, affecting the customs, called the warehousing act, was finally revised. The great feature of this act is deferring the payment of duties due to the king at the time of importation, and allowing goods to remain in warehouses and other places, under the king and the owner's key, until it may suit the parties to remove them for exportation or home consumption, according to certain regulations. In 1825 the benefits of this act were extended to the colonies of Great Britain, who are now treated in this respect as an integral part of kingdom. In 1824 prohibitions on imports, and bounties on exports were abolished.

The produce of the customs, for the last three years, are thus given in the official returns:

Year ending 5th Jan. 1824.	Year ending 5th Jan. 1825.	Year ending 5th Jan. 1826.
11,498,755	11,327,738	16,541,521

UNIVERSITY OF MICHIGAN



3 9015 06836 8565

Digitized by Google

B 484849

