

UMASS/AMHERST



312066005225954

Doc. # 23475
11023475

LIBRARY

OF THE



MASSACHUSETTS
AGRICULTURAL
COLLEGE

NO. 23475 DATE 9-1902

SOURCE College funds

SF
486
D37
1899

UNIVERSITY OF
MICHIGAN LIBRARY
ANN ARBOR
MICHIGAN

This book may be kept out

TWO WEEKS

only, and is subject to a fine of TWO CENTS a day thereafter. It will be due on the day indicated below.

FEB 4 1903

NOV 27 1907

~~NOV 17 1910~~

NOV 10 1910

NOV 4 1959

APR 1 1968

CARD

UNIVERSITY OF
MICHIGAN LIBRARY
ANN ARBOR MI 48106



Digitized by the Internet Archive
in 2009 with funding from
Boston Library Consortium Member Libraries

LOW COST POULTRY HOUSES.



PLANS AND SPECIFICATIONS FOR POULTRY BUILDINGS,
COSTING FROM \$25 TO \$100, WITH A CHAPTER
ON POULTRY HOUSE CONVENIENCES.

Second Edition.

A Valuable, Practical Treatise for Amateurs
on Poultry Buildings.

---BY---

J. WALLACE DARROW,

Editor of "The Fanciers' Review," and Publisher of "Five Hundred Questions and Answers in Poultry Keeping," "Art of Poultry Breeding," "A B C of Poultry Culture," "Pigeon Queries," "Farmers' Institute Question Box on Cattle and the Dairy," Etc., Etc.

[COPYRIGHT 1893.]

CHATHAM, N. Y.
THE FANCIERS' REVIEW,
1899.

636.57

D25

PUBLISHER'S PREFACE.



So cordially have our previous little books for poultrymen been received by both people and press, that we venture to send out another entitled, "Low-Cost Poultry Houses." For such a publication we believe there is an open field.

In this little work we have attempted nothing elaborate. The plans presented for poultry houses and poultry house fixtures and conveniences, have been for the most part drawn and engraved specially for this book, and the descriptions are those of buildings as they now stand, not imaginary "air castles." We have kept in mind the fact that the majority of poultrymen are not millionaires and they have no use for \$1,000 structures to house \$100 or \$200 worth of birds. The plans and specifications herein contained call for low-cost poultry houses, none exceeding \$100 we think, in cost; the most under \$50 or \$75. We have tried to make each description explicit so that, with the accompanying illustration, a poultryman may construct a building after the plan which pleases him best, or he may gather ideas from different plans from which he may formulate something yet more satisfactory than anything herein described.

To those who have assisted us in this little work by furnishing descriptions, plans and specifications, we tender our sincere thanks, and they will be otherwise remunerated, and also to "The Rural New Yorker" of New York city; the "American Farmer" of Washington, D. C.; the "Poultry Monthly" of Albany, N. Y., and to Mr. J. W. Russell of Vermillion, Dak., our thanks are likewise cordially extended for the loan of plates.

Our chief desire is that this book may be helpful to those who may desire to construct or re-model their poultry buildings after the plans and suggestions here presented. J W. DARROW.

Note to Second Edition.

So popular has been this little work, that we take pleasure in now presenting the Second Edition, with some new features added, and some of the less important old ones, omitted. An introductory article by Mr. J H. Davis, on the general work of building the poultry house, follows. We believe this book has been helpful to many; we trust this edition will also "go about doing good."

J. W. D.

Chatham, N. Y., January 1, 1899.

LOW-COST POULTRY HOUSES.



INTRODUCTORY.



Poultry Houses in General.



By J. H. Davis.

The poultry house should be built substantial, according to climate, and according to the means of its owner. In the Southern States, from the Tennessee line on toward the Gulf, the houses for winter need not be built more substantial than the ordinary stable or carriage house. Yet they should be made perfectly tight, but with plenty of means of ventilation.

In my book, "The A B C of Poultry Culture," will be found illustration of a house peculiarly adapted to the Southern States, inasmuch as it has my idea of ventilation, at the bottom, instead of at the top. We reproduce the illustration here, so that all may see what it is like.

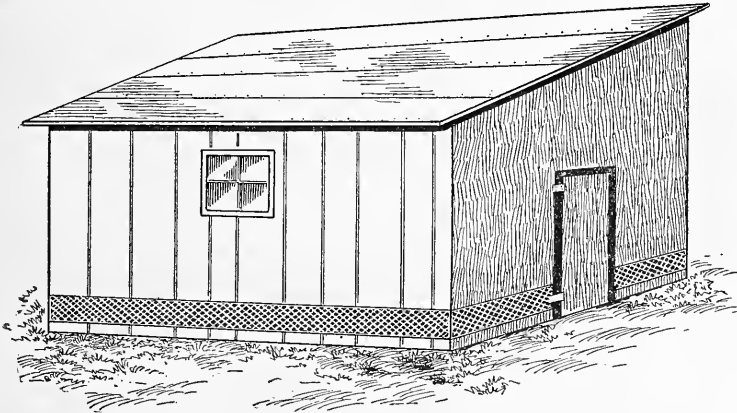

DAVIS' BOTTOM-VENTILATED POULTRY HOUSE.

The above house is 10x10 feet square, 5 feet high at back and 6 feet high at front, boarded up and down and battened, tar paper roof and lined with tar paper which is *white washed* on the inside and outside. The bottom ventilation consists of a strip of $\frac{1}{4}$ or $\frac{1}{2}$ inch mesh wire around the bottom of the house on all four sides. The

perches for roosts are wood, square, and placed in the centre of the house, thus: A dropping board slanting down the four sides with a

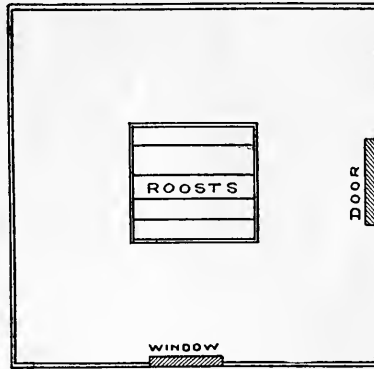

GROUND PLAN OF HOUSE.

strip at the ends to keep the droppings from falling to the floor and nest boxes under the dropping board, completes the interior arrangement, which is cheap, simple and will answer the purpose. The perches must be made to suit the number of fowls kept. And the house may be made larger or smaller as required. The merit of this house is its extreme simplicity and perfect cleanliness. Five minutes work will remove the droppings and sweep the house. And any person can build such a house in half a day.

At the North the poultry house, of necessity, must be built strong and warm. It must also have means to ventilate it thoroughly in warm weather. But the best plan to adopt is to roost the fowls all out of doors from May to November. The birds will be hardier for this treatment, and enjoy immunity from lice and mites that cause so much work when fowls roost in the house.

Grout houses are substantial and fairly cheap. Brick houses can also be built cheaply. A frame house, either boarded up and down and battened and lathed and plastered, or weatherboarded and plastered, makes a good house. Windows and doors may be put in at option of the builder. In the summer, doors and windows may be removed entirely and wire screens put over the openings to keep out "varmints." Of course these buildings are intended for people who can afford to construct them, and they may be made very plain or ornamental as the builder may desire.

Good houses may be made on a cheaper plan by simply boarding up and down and battening, the walls and ceiling being covered closely and well with tar paper. All should understand that in moderate or very cold weather, no ventilation at all is necessary. Do you want your window up when the mercury is hovering about zero?

No. Understand, then, that the poultry-house can not be too tight for cold weather, nor too open in hot weather.

For the comfort of the fowls, three rooms or apartments are required.

For roosts, you want just room enough to hold the fowls, as they are never on the roosts except at night, if they have other quarters. Adjoining the roosts should be the nest-room, and at the end of this, the scratching-room containing plenty of chaff or cut straw. The floors should be of earth, raised a foot above the outside, so as to insure dryness. Absolutely nothing is required in the roosting-place but the roosts, which should be low trestles, on which lay poles. I prefer poles to 2x4 scantling which many use. When a fowl roosts, it wants to grasp the perch with its foot. It cannot grasp a 2x4.

The nesting-room should be rather dark, as fowls prefer dark nests to light ones. But the scratching-room and the roosting-room should have plenty of light, the former more than the latter. Place the water, grit, and dust bath in the scratching-room in such a position that the birds cannot scratch the straw into the water fountain.

Build your house substantial, so as to last just as long as your dwelling lasts. Paint it, if you can afford to do so, every year. Whitewash, and clean the inside out twice a year. Make your nests permanent. Then you can take out the old straw, burn it, give the inside of the nest-boxes a coat of pine tar, replace the nests with new straw, and the thing is done.

The interior arrangements must be left to the builder. All have different ideas, and a little experience will help you to determine any necessary change. There are many plans of houses, and any one can build as his circumstances warrant and necessity demands.

Some have an idea that a poultry house should be moved occasionally; that the premises get foul if the house stands too long in one place. But such is not the case. The poultry house and premises can be kept just as clean and healthful as your own house and premises, during a lifetime, if you so will it. I have seen poultry houses in which fowls had roosted for fifty years, and they were clean and in good condition. The main thing in a poultry house is a good roof; light in roosting and scratching rooms; ventilation in summer; dirt floors, and rat proof.

I would not advise roosting over fifty fowls together. In hot weather, if you have no outside advantages to roost the birds, no trees, you may roost them in the scratching-room, which will not be used much in summer, if you have good runs, or free range.

Practically there is no use at all of ventilators in a poultry house.

In winter they are useless, and in summer they amount to nothing, as the open doors and windows will be sufficient to give the birds all the fresh air that can be got inside of a house, unless the bottom or wire ventilation is used, which allows the fresh air to come in, and the foul air to go out, as foul air is heaviest and sinks to the floor, while the pure or warmer air goes upward.

Build your house just where it will be the most convenient. If the ground is low, raise it up. If too high, level down. Make the house one story or two story, as you are inclined. Look over the buildings as shown in "Low-Cost Poultry Houses," and you will get what you want. If you can make any improvement on any of the houses herein, so much the better. I have merely given you the main points here, which you are at liberty to improve on or change at your option. Roosting-houses are only necessary in winter. The nesting, or laying-house, is necessary the year round.

COMFORTABLE POULTRY HOUSE.--COST \$34.



The poultry house illustrated on the next page is one in which convenience and comfort are the prime considerations. The roosting and laying-house, which constitutes the main building, is 10x20 feet, shown in rear side view at Fig. 1 in illustration. The front of the building is eight feet high, with space of two feet between ground run (H) and board floor above same, as seen in Fig. 2 of the illustration. The height of roof above the floor is, therefore, six feet. The rear posts of the building at point of junction with the shed are five feet high. The shed adjoining the rear of the main structure is 16x20 feet, making with the space beneath floor in main building a ground run of 20x26 feet.

At B is the passage way two feet wide extending the full width of the building with door shown at C entering the hennery proper. The outer entrance door is seen at A. The roosting perches are shown at E, drop boards at F, nests at G and located under the drop boards. In the partition back of the nests is a hinged board one foot wide, through which opening eggs are taken from the nests. At 7 is shown a trap door through floor to ground run.

The window in the shed roof is 3x3 feet and hinged to afford ventilation in summer. At S S in both figures are shown openings for ventilation four inches in diameter. The board floor in Fig. 2, as before stated, is two feet above ground and can be covered with tar

paper on which several thicknesses of newspapers are first laid, and on top of these another layer of tarred felt is tacked on with laths two feet apart. This floor should be kept covered with sand or dry dirt about three inches deep. Coal ashes may also be used on it to good advantage. Over the roosting drop boards tarred felt is also put and this is kept covered with ashes.

The inside walls of the house are sheathed with slate paper, over which is tacked a dozen layers or so of newspapers and then another layer of slate or tarred paper. This house is water and wind proof and so warm in winter that a pan of water will scarcely freeze over in it.

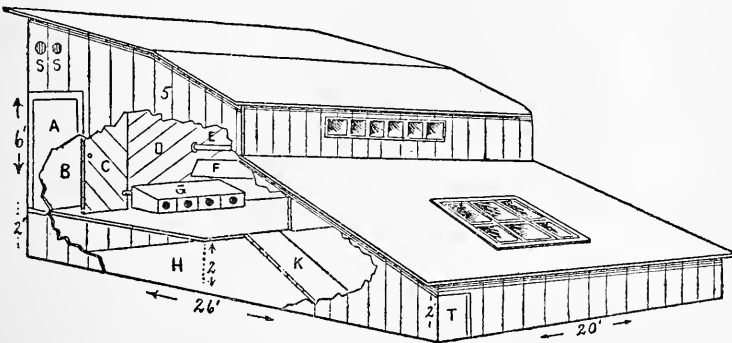

FIG. 1.

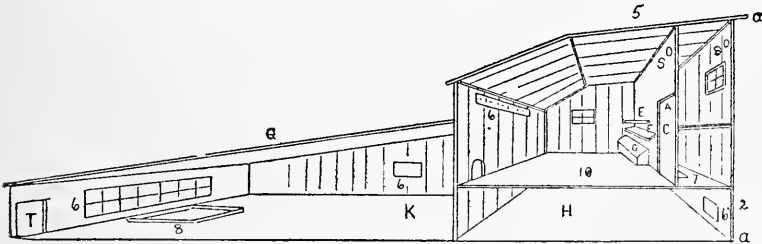

FIG. 2.

Comfortable Poultry House.

[Plans and Specifications by CAPT. W. A. PHILLIPS, Chicago, Ill.]

Capt. Phillips of Chicago, who furnished the description of this building for this book, says: "In building my house I bought hemlock lumber, paying \$9.50 per M. for 2x4s, and \$11.80 for common boards, and \$12.50 where they were tongued and grooved. The run under the house with the long shed run in addition, is an excellent place for fowls at all times of the year and it is especially warm in winter, giving also plenty of scratching room for the hens. In the summer it is thrown wide open and the ends taken down, making a

cool place and affording protection from rain and winds. In this house, divided into pens, were kept last winter sixty-three fowls with the loss of only one."

COST OF MATERIAL.

1,260 ft. matched boards, 100 2x2 in. scantling, 70 2x4 joists..	\$20 60
2 windows for covered run.....	1 50
5 small windows.....	1 20
15 lbs. nails, hardware, etc.....	1 25
Lath.....	40
5 squares roofing paper.....	5 00
3 squares tarred felt for floor.....	3 00
8 squares sheathing paper.....	1 00
Total cost.....	<u>\$33 95</u>

◆ ◆ ◆

A BUILDING COSTING ABOUT \$80.

The building shown at Fig. 1 of the accompanying engraving is 40 ft. front by 12 ft. in width, and same plans can be adapted to a lean-to structure if preferred. The arrangement of interior is simple. An alley 2 ft. 6 in. wide extends full length of building (see Fig. 4) with a cross alley 4 ft. wide from which entrance is had to the pens. Each pen is about 9 ft. square. The nests are so arranged as to be accessible for gathering the eggs from the long alley. At Fig. 2 a section of nest boxes and roosting perches is shown. The nests are one foot square with an opening to each box in alley-way. The location of the roosting perches and drop-boards may be seen at Fig. 3. The perches are on a hinged frame so that they may be turned up out of the way when drop-board is cleaned.

The house is sided with boards. The windows are 3x5 ft. 2 in. Partitions are boarded up 2 ft. from ground and above the boards there is 4 ft. wire netting. The inside doors are simply frames covered with wire. The following shows

THE COST OF MATERIAL.

1,300 sq. ft. matched boards, spruce.....	\$26 00
350 ft. 2x4 joist.....	4 00
300 ft. 2x3 scantling.....	3 50
4 windows.....	20 00
250 sq. ft. wire netting.....	3 75
300 sq. ft. tar roofing.....	6 00
Nails and hardware.....	1 00
Labor of carpenter.....	18 00
Total cost.....	<u>\$82 25</u>

Each additional running foot front will cost about \$2.25.

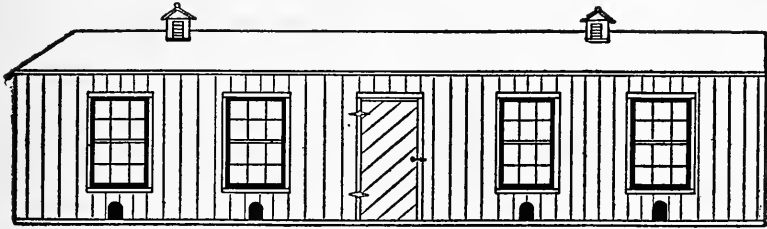

FIG. 1.

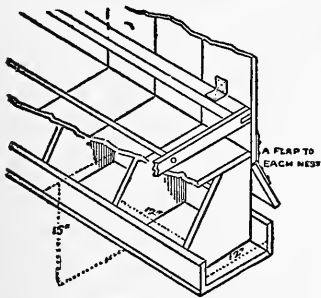

FIG. 2.

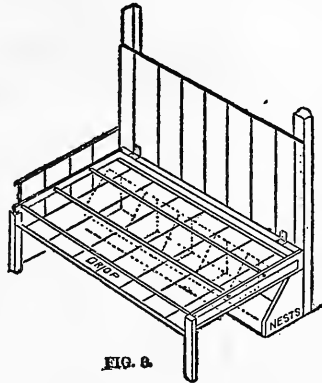

FIG. 3.

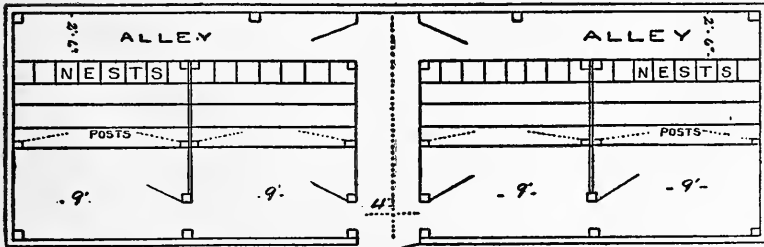

FIG. 4.

A Building Costing About \$80.

Plans and Specifications by FRANK LOSEE, Brooklyn, N. Y.]

A CHEAP HOUSE.--COST \$22.



The poultry house shown herewith at Fig. 1 front view and Fig. 2 rear view is 10x25 feet and contains three pens. Two of them are 7½x8¼ feet and the other 10x8½ feet. The north side is 6 feet high and the south side 4 feet. The material is \$12 lumber, matched pine 7-8 inch thick. Gravel is used for the floor. The nest boxes and nests are all in the hall so they can be easily reached. The roosts are made so as to clean from the hall by lifting a six-inch board off the back or pulling them out on a slide. There is one six-light window in each pen, which is all that is necessary. The doors are made so as to slide from one coop to another, except the last door, which is made to swing. There is a hallway 2½ feet wide, extending two-thirds of the length of the building. The last coop is full width. There will be required to construct this building:

700 feet of lumber.....	\$8 40
Nails.....	50
Labor.....	6 00
Screen.....	2 00
Three windows.....	3 75
Paint.....	1 00
Total cost.....	<u>\$21 65</u>

A PLAIN STRUCTURE FOR \$30.



The building here described is intended to accommodate thirty fowls. Its construction is simple and easily understood from the illustration. It is 30 ft. long, 10 ft. wide and 8 ft. high in front, 6 ft. in rear. Roof is of tarred paper. The hall is 4x4 ft., from which entrance is had to the pens. The light lines shown at either side of entrance are to represent sliding doors which may be lifted to admit a wheelbarrow into which the droppings may easily be swept from drop-boards under the roosts. At the letters A A, a 6-inch board is set up on edge and gravel is filled in from it to the outer side of pen. The plan should show two scratching pens, the partition between the two having been omitted in the drawing, however.

COST OF MATERIAL.

1,500 ft. common siding.....	\$18 00
300 ft. rafters, posts and plates.....	3 60
Windows.....	4 00
Tar paper for roof.....	3 80
Door fixtures, nails, etc.....	60
Total cost.....	<u>\$30 00</u>

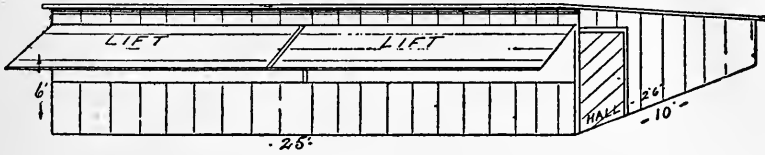

FIG. 1.

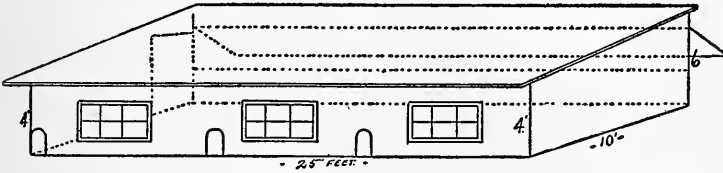

FIG. 2.

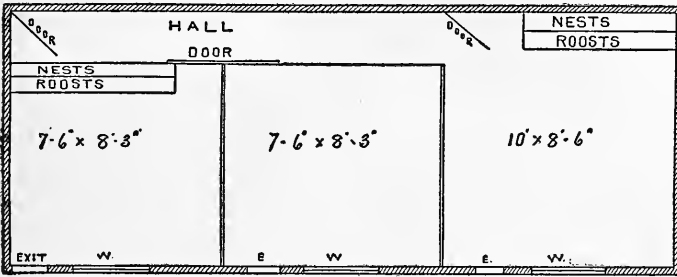

FIG. 3.

A Cheap House. [Plans and Specifications by J. B. JONES, Batavia, N. Y.]

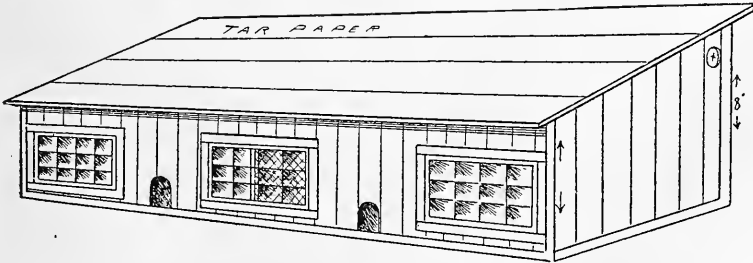

FIG. 1.

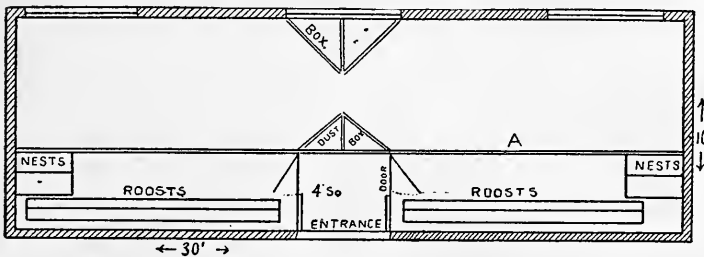

FIG. 2.

A Plain Structure. [Plans and Specifications by F. C. IELFIELD, Silver Creek, N. Y.]

A \$32 POULTRY BUILDING.



A plain structure is that shown on following page, but one that answers a good purpose for twenty-five or thirty fowls. It shows plans for two pens only, but these can be duplicated on same plan to the extent desired.

The building shown at Fig. 1 is 10x16 ft., and 9 ft. high in front, and 5 ft. in rear. It is sided up and down with common matched boards. Tar paper is used as sheathing, and the floor being double, the paper is also used between floor boards. The roof is covered with No. 1 shingles. Some may prefer ground floor, and if so, the cost will be still less.

COST OF MATERIAL.

400 ft. common boards.....	\$4 00
220 ft. for flooring.....	1 75
400 ft. common boards for lining.....	3 20
200 ft. spruce or hemlock.....	1 80
2 squares No. 1 shingles.....	4 00
Tar paper.....	2 10
200 ft. 2x4s, 10 ft. long.....	2 00
22 ft. 2x4s, 19 ft. long, for plates.....	22
96 ft. 4x6s, 16 ft. long, for sills.....	96
90 ft. 6x6s, 10 ft. long, mud sills.....	90
64 ft. 2x4s, 12 ft. long, for rafters.....	64
60 ft. common lumber for drop boards, nests, etc.....	48
Lath for partitions.....	60
Hardware.....	1 80
Windows.....	2 40
Labor of carpenter.....	5 00
Total.....	\$31 85

The cost of lumber is figured at \$10 per M for best grade; \$8 for second; \$9 for hemlock, and \$10 for scantling, etc.

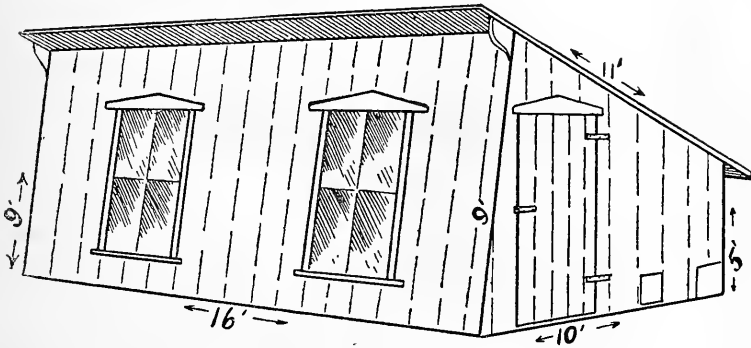

FIG. 1.

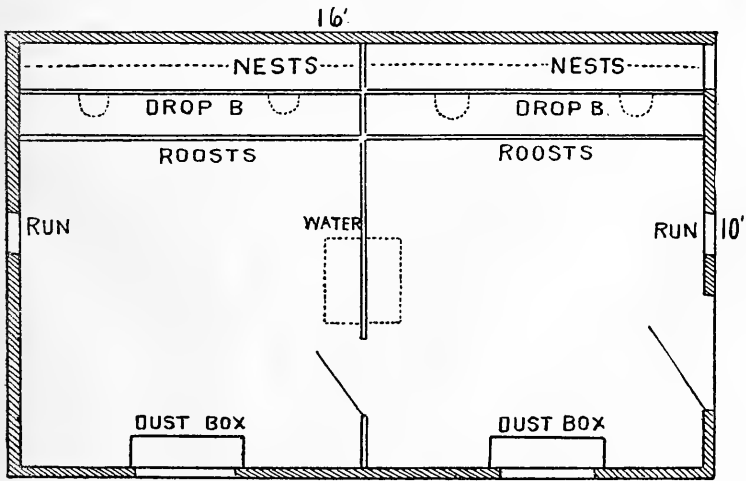

FIG. 2.

A \$32 Poultry Building.

[Plans and Specifications by D. L. SOMERVILLE, Stewarttown, Ont.]

SUNNYSIDE POULTRY HOUSE.--COST \$35.



The accompanying cut shows ground plan with dimensions of a poultry house with three apartments for three distinct breeds. The size of main building is 18x24, with one door entering into a hall-way which runs full length of building and is three feet wide, giving ample room to run a wheelbarrow in to clean out the various compartments. Also a drop door is left on the nests, the back part of which extends three inches into the hall and allows you to remove eggs or examine nests without entering into the compartment where the fowls are. The nests are to be made portable, so as to be easily taken out and cleaned when desired, giving them a thorough renovation at will. The roosts are suspended near the centre of each pen by wires at the four corners with a hook, making them portable and very easily taken out and renovated. A dusting place is shown on diagram in right hand corner of each pen, where the sun will keep it dry, being right under the large windows; the size of it is 2x2x3, being three-cornered. The dotted lines running lengthwise of the building represent a six-inch board stood on edge on ground, forming a litter or scratching apartment 4x8 feet. Soft-feed boards are shown on diagrams in each pen, which are made 2x6 and lathed 18 inches high, roof shape, all around; leaving lath wide enough so that the fowls can get their heads through to eat comfortably. This prevents them from trampling the feed and spoiling it; this is made portable and easy to clean. The doors to the various entrances are shown in cut by x x x x. The cross lines thus —||—||—||—|| are the partitions separating each pen and are boarded tight 18 inches high, then latticed with lath or wire netting. The water troughs are made to slide under the partition, which of itself forms a fence to keep fowls from getting any more than their heads in to drink. The height of front to eaves is 9 feet; the other one foot can be run up past and a board put on which adds to the appearance of outside. The back is 6 feet high, which allows a drop of 3 feet to 18, amply sufficient to run off

water. The two middle posts are shown in cut simply to give a plainer view of where the divisions are on inside.

COST OF MATERIAL.

480 ft. common boards for roof.....	\$7 68
600 ft. ship caps for sides and ends.....	10 80
40 pieces 2x4 12 ft., 10 pieces 2x4 18 feet.....	8 00
3 large windows.....	1 00
3 small windows.....	1 00
100 pounds tar felt.....	3 09
30 ft. wire netting 4 ft. wide.....	1 35
5 bunches lath.....	88
Nails and lock.....	1 00
Total cost.....	\$34 71

The above does not include cost of labor on building.

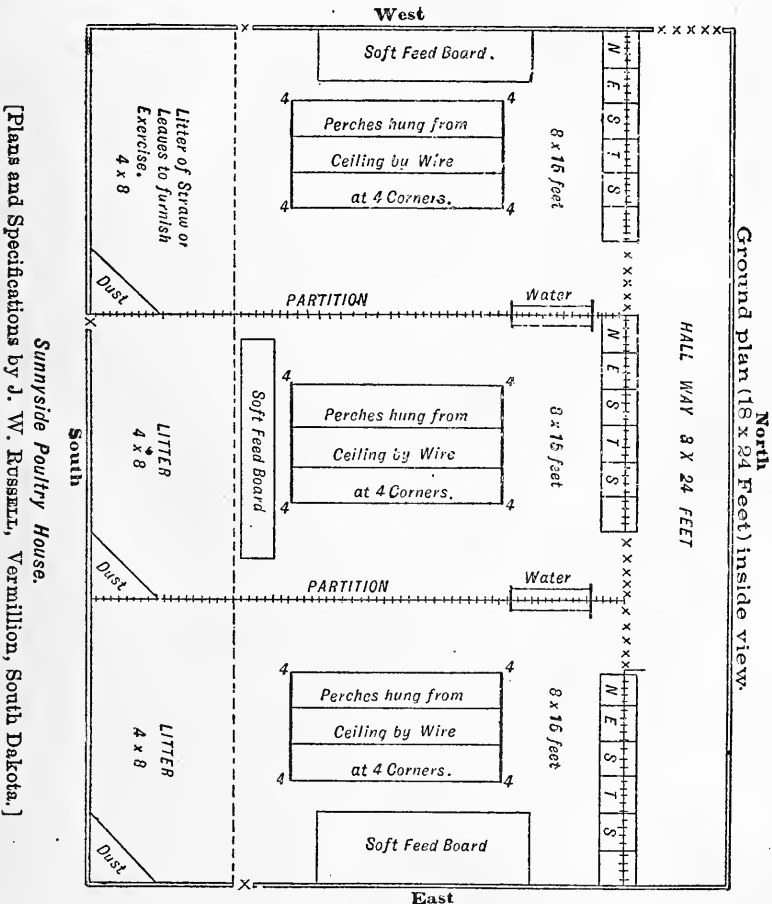

A HOUSE FOR FIFTY FOWLS.--COST \$22.



This building is 12 ft. long, 8 ft. wide, 7 ft. high in front with 2 ft. fall. Ordinary boxing lumber battened with tin strips is used for siding nailed to a base and top frame of 2x4 in. stuff. The roof is shingled. There are three openings (two windows covered with wire netting and one large door), one small window in the rear, a large window in the front side and the door in this end, as shown by the illustration. The small window in rear end is 2 ft. wide, 3 ft. long, 4 ft. from the floor running 1 ft. from the left-hand corner, not to extend over the platform; the window in front of building is 2 ft. wide, 10 ft. long, 4 ft. from floor, running 1 ft. from either corner; the door is 3 ft. wide, 5 ft. high and just opposite the rear window. In the bottom of the large door is an 8x12 in. slide door for the fowls to pass out and in when the large door is closed. Boxing lumber is used for flooring laid on 2x4 in. sleepers, the right-hand half of the floor being 1 ft. above the base or left-hand half, making a platform over which the roosting frame is placed, and under which the fowls may go for shelter from hot sun and bad weather. The roosting frame (C) is 9 ft. long, 3½ feet wide, made of 2x4 in. stuff with 1x3 in. perches every 1½ ft. apart crosswise of the frame, the same being suspended by wire from the rafters 3 ft. above the platform running lengthwise from the rear end, thus leaving 3 ft. of this end of the platform on which to set feed troughs, water vessels, etc., as the lower floor is for litter and the dust bath. The nest boxes (A) are made of boxing lumber and nailed to the siding of the building. The lower floor and platform (B) are divided by a 12-in. board running lengthwise of the building. The object of the platform floor under roosts is that it will be easier cleaned, and as the front part of the floor will be used to scatter litter on, the other end of platform will be used for feed troughs and water vessel.

COST OF MATERIAL.

350 ft. boxing lumber at \$1.60.....	\$5 60
150 ft. 2x4 in. plank at \$1.60.....	2 40
350 ft. 1x3 in. stuff at \$1.60.....	5 60
1½ M shingles at \$2.....	3 00
Hardware—nails, hinges, wire netting, etc.....	1 40
Labor—two men one day at \$2.....	4 00
Total cost.....	\$22 00

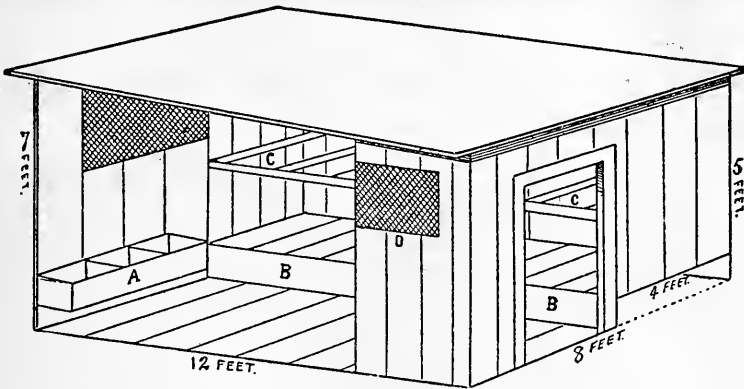

A House For 50 Hens. [See Previous page.]

[Plans and Specifications by W. A. THORP, Dallas, Tex.]

A HANDY POULTRY HOUSE---COST \$28.



The building shown on following page is 9x24 feet. Use for the frame 2x4 hemlock scantlings if they can be obtained. Get six large stones, four for the corners, and two to be placed 12 feet from the corners on each side. Lay two 12-foot scantling end to end for each side. Upon these on the ends and in the middle lay the three nine-foot cross-pieces and spike all together. Level carefully. Set up the six uprights upon the extremities of the cross-pieces, the front ones being four feet eight inches long, those at the back six feet eight inches. Then put on the plates (12 feet 2x4 scantlings.) Two pieces should be set in the frame at the back about three feet eight inches above the sill to help to support the platform and for nailing the siding to them. Then tack strips of tarred paper up and down outside the frame at the back, and nail on the siding over it. There are nine sets of rafters three feet apart. The scantlings are cut seven feet four inches and three feet eleven and one-half inches, the longest measure. Old fence boards can be used for the piece which binds them together, forming a truss. The rafters can all be framed before they are set up, if one set is put together for a pattern.

Now set up the rafters, put on tarred paper crosswise, then the roof boards. The ends are next sided, the tarred paper having been first applied as before. Next comes shingling; the front is finished last. Four windows 3x3½, are sufficient. A long scantling set in

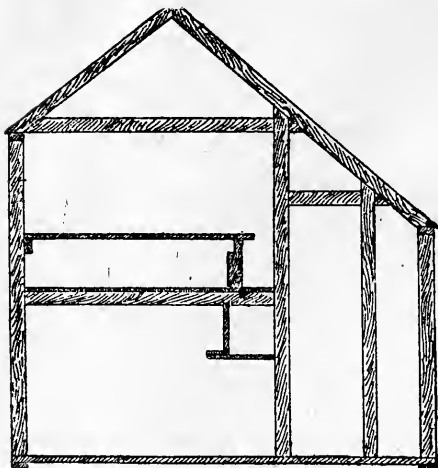

FIG. 1.

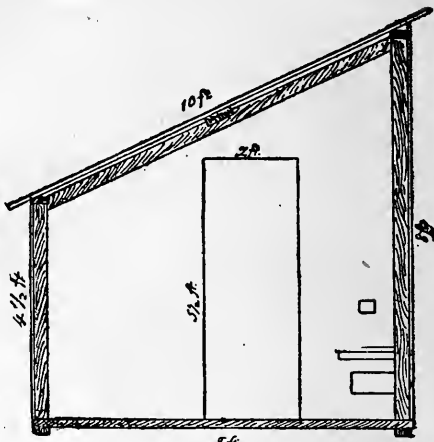

FIG. 2.

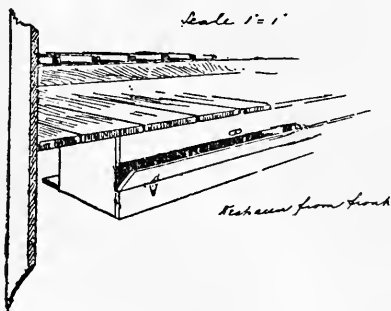

FIG. 3.

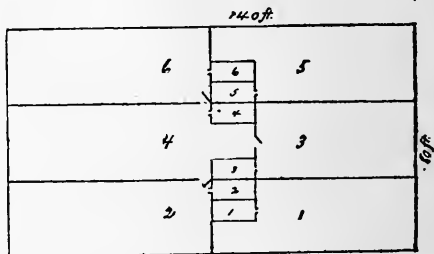

FIG. 4.

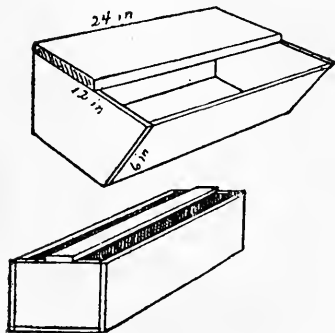

FIG. 5.

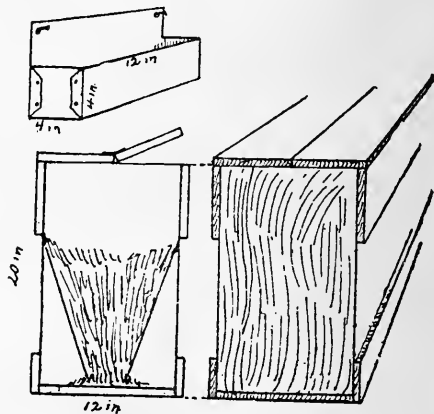

FIG. 6.

A Handy Poultry House.

[Plans and Specifications Furnished by THE RURAL NEW YORKER.]

the frame forms the window sill and pieces of the same set up make a frame for the window, which extends to the plate. The door frame is five feet wide and three feet eight inches high. A frame of 2x4 scantling is made in the building as for a stationary table or counter, and inch rough hemlock boards are nailed on lengthwise of the building.

Crosswise of the building, about eight inches apart, are thirty-four roost poles of 2x2 stuff with the corners shaved off. The poles are four feet long and fourteen inches above the platform.

Eighteen nests, 12 inches high and deep, and 14 inches wide are placed under the front of the platform. The hens go in from the back side at a hole 6x7 inches. A board shelf is put up on which they can walk along to the nests, and a short ladder reaches to the ground. The sides and bottom of the nests are of single boards 12 inches wide, with board divisions; but the front board is slit into three pieces of equal width; the middle one being hinged at the bottom and fastened with a button at the top, turns down, opening nine nests at a time. The ladders upon which the hens climb to the roosts are set out so that the turning down of the above pieces may not be interfered with. These are merely boards with cleats nailed across them. If a ventilator is put in it should open near the ground.

Figure 1 is a cross-section of the building. Figure 2 is a cross-section of a cheap three-section breeding-pen house (requiring about 400 feet of lumber.) Figure 3 shows the construction of the nests and roosts. Figure 4 is a convenient arrangement for six breeding-pens with yard (these are 26½x70 feet.) Figure 5 (5) is a wooden stationary feed box. Figure 6 (6) is a water trough of galvanized iron, which any tinner can make. Figure 5 (7) is a long box with slats across the top—a very convenient feeding box. Figure 6 (8) is a perpetual feeding box for use in fattening fowls, feeding dry bran or ground shells, bone, grit, etc.

COST OF MATERIAL.

400 feet matched pine, at \$18 per M.....	\$7 20
120 feet hemlock boards, at \$13 per M.....	1 50
230 feet 2x4 hemlock, at \$13 per M.....	3 00
Shingles	6 75
4 windows, at \$1.25.....	5 00
100 pounds tarred paper.....	2 50
Nails, hinges, etc.....	2 00
	<hr/>
Total cost.....	\$27 95

No estimate is made for roof boards, as old fence boards were utilized. One dollar's worth of oil and venetian red should paint the building twice over.

A HOUSE COSTING \$32.



The annexed sketch represents a poultry house suitable for a person keeping a small number of fowls. The size of house is 38 ft. long and 8 ft. wide, 8 ft. high in front and 6 ft. high in rear, in other words, a lean-to shed with sufficient slope to the roof to shed the water readily; 6 ft. on each side of this building is utilized as open sheds. The 16 ft. in centre is boarded tightly all around except a door in each end to admit to the shed on either end. In building the house use either 2x4 or 3x4 scantling for posts, sills and frame work of house; for weather boarding and roof use one-inch thick and 12-inch wide hemlock boards, same to be placed up and down and cleat with ordinary building laths to keep out draughts. The flat roof is covered with standard roofing paper properly cleated and then covered with two coats roofing paint. The house should front south, and in front make two windows of 9x12 glass. Sheds are closed in on all sides except front, where there is a wire-covered door 3 ft. wide, 6 ft. high, the balance of front to be covered with wire in order to admit sunlight.

In the sheds may be placed food and water for the fowls and also a box 3x6 ft. for dust bath; a box properly partitioned can also be placed in the sheds for bone and oyster shells. This shed will afford shade in the summer time and protection to fowls in the winter. The main house is divided into two rooms 8x8, partitioned off with wire, with 3 ft. hall on one side running the entire length of house, partitioned off with wires or laths. In each room there is a platform 2 ft. high and 7 ft. long, under which place nests, using nail kegs with part of one side cut out. In front of platform make a door 1 ft. wide and 7 ft. long through which to get the eggs from nests. In making platform 7 ft. long it will leave 1 ft. space in front for hens to go under platform to lay. The top to platform should be on hinges to raise up out of the way when it is necessary to clean behind it. Over top of platform place roosting poles 1½ ft. apart and 2 ft. above platform; these roosts should be on hinges so as to be thrown out of the way during day. The floor of house should be of dirt unless in damp locality where board floor is best. Ventilator is

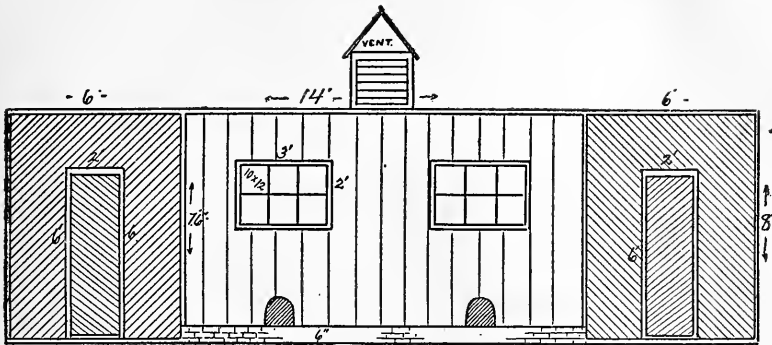

FIG. 1.

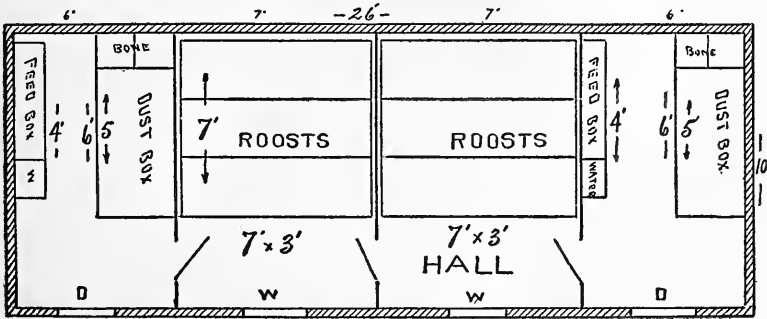

FIG. 2.

A House costing \$32.

[Plans and Specifications by J. G. LONGFELLOW, Clayton, Del.]

shown at top of house 2 ft. high and 1 ft. wide, and is to be closed in winter time. No further detailed explanation of drawings is necessary as they are self-explanatory.

COST OF MATERIAL.

850 ft. hemlock siding.....	\$13 60
262 ft. 3x4 scantling.....	4 32
2 windows, glasses 9x12.....	1 20
Roofing paper.....	2 50
Nails.....	50
Hardware.....	50
Wire netting.....	1 66
Laths.....	35
Labor.....	5 00
Paint.....	2 00
Total cost.....	\$31 63

AN \$18 HOUSE.



The accompanying figures illustrate a cheap and comfortable poultry house. The posts are seven feet and the distance from ground to ridge of roof is 10 feet. The dimensions of the building are 10x20 feet. The east side is covered by 1x3 inch strips two inches apart. The south side is boarded up three feet from bottom, stripped four feet, and then boarded to peak of roof. The north and west sides are boarded up tight. This gives protection for cold weather in a mild climate and is very cool in summer. In a colder climate it would probably be necessary to board all sides of building up tight.

The house is divided into four compartments by wire netting with two 12-inch boards at base, which is sufficient to keep cocks from fighting. For roosts, I use pine trees about five inches in diameter. The nest boxes are in the rear of each pen, as shown in illustration. In this house were kept four breeding-pens of fowls, one cock and ten hens to each yard. They thrive well and were seldom troubled with disease of any kind.

COST OF MATERIAL.

825 ft. 1x12 boards, at \$10 per M.....	\$8 25
200 ft. 1x3 boards, at \$10 per M.....	2 00
180 ft. 2x3 for framing.....	90
30 ft. 2-in. wire mesh six feet wide.....	50
Nails.....	50
Staples for wire netting.....	10
4 pairs hinges with screws.....	60
Labor of one man two days, at \$2.50.....	5 00

Total cost.....	\$17 85

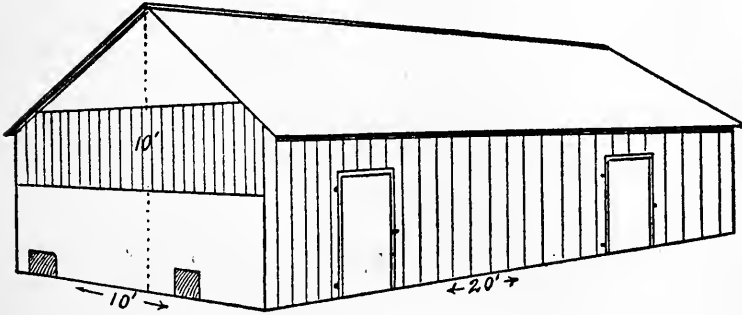

FIG. 1.

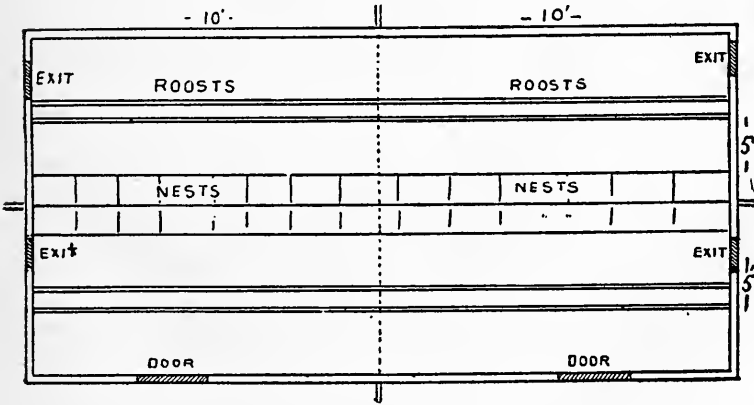

FIG. 2.

An \$18 House.

[Plans and Specifications by A. E. SHAW, Bay St. Louis, Miss.]

A \$100 POULTRY BUILDING.



The building, Fig. 1, is 16 feet wide and 32 feet long, with alley three feet wide near the centre, the floor of which is two feet above the floor of the house, thus giving a good, dark, quiet place for nests, which are located under floor at A, Fig. 2, and are easily reached through trap doors, B (shown at Fig. 4) in alley floor. The partition between the roosting and laying pen and the scratching pen below alley floor, is solid except a slide door 1 foot wide by 1½ feet high. The scratching pens are 7x12 feet each and are lighted by the window, C, (Fig. 1), hinged at top, fastened with cupboard catch by gravity and opened or closed from alley by cord. E, in Fig. 3, represents doors from alley into pens on either side. (The doors are made of lath.) One short board forms a step, F, making it easy to go from alley into pens. The dust bath boxes, G, are 2 feet wide and 6 inches deep and two feet above them are the platforms, H, to catch the droppings; one foot above these are the roosts, I.

By means of the lower windows, C, sufficient light is provided in the scratching pens and by the upper windows, K, good light is given for the dust baths, G, in the north part of the pen. In the summer, the sun being high, no direct sunshine enters either part of the pen and by keeping both sets of windows open it makes a very cool place for the fowls. The nests, below alley floor, are 1 foot deep and 1½ feet square, open at top and about two-thirds of the way down the south side. They have a small piece of narrow board nailed across the bottom and extending out on the south side for a step for the hens in going on and off the nest.

The building is constructed of hemlock lumber and covered entirely with roofing paper and cost complete about \$3 per running foot.

COST OF MATERIAL.

2,500 ft. hemlock, at \$15	\$37 50
1,500 ft. Neponset roofing	15 00
18 sash, 6 lights, 8x10	9 00
50 lbs. 8d wire nails	1 50
10 lbs. 2d wire nails	25
1 hasp, 2 hooks, 36 pair 2-in. butts, 2 pairs 6-in. T hinges...	2 00
500 laths	1 50
Carting	4 50
Carpenter work	25 00
Boxes for nests	50
Posts for foundation	1 50

Total cost

\$98 25

If a man happens to be handy with carpenters' tools and does the work himself, the \$25 then could be saved, thus reducing the cost to about \$70.

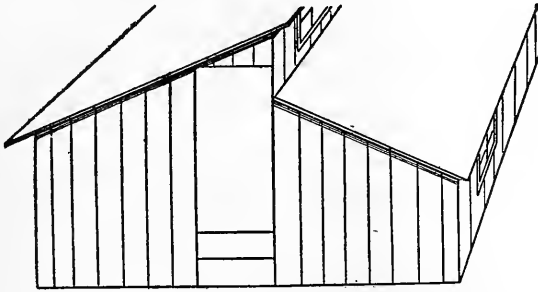

FIG. 1.

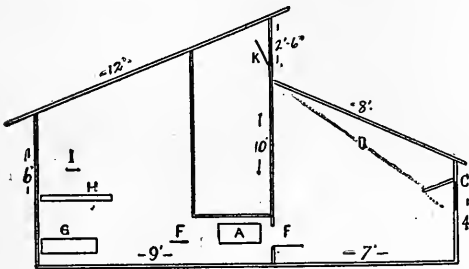

FIG. 2.

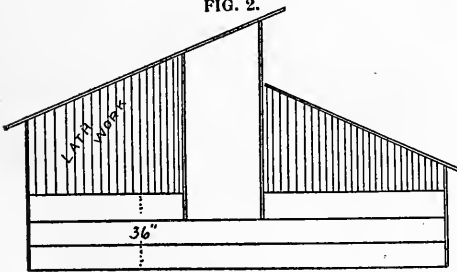

FIG. 3.

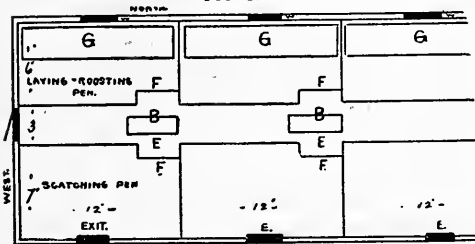

FIG. 4.

A \$100 Poultry Building.

[Plans and Specifications by F. A. RAPPLEYE, Farmer, N. Y.]

A CANADIAN POULTRY HOUSE.--COST \$55.



The accompanying sketch illustrates a convenient house for fowls, the cost of which, not including labor, was \$54.52. The building is 14x32, and 7 ft. high at front and 5 ft. at rear. Only a short section is shown in the cut. The roof is sheathed with inch hemlock covered with tar paper, over which No. 1 shingles are laid 5 inches to weather. Windows and doors are all double. Front and ends are sided with V joint matched stuff and painted; rear is covered with common rough lumber. This completes the outside.

There are two pens, 6x14, one at each end without floor, with ground dust box in each just in front of window. The other 20 ft. is divided into three pens, two of them are 11x8 ft. each, and one is 11x4 ft. There is a 3 ft. hall running full length of the 20 ft., and a door on each end to get into the exercise room. Fowls go through slide doors which are 8x10 in. All outside walls are grouted between outside siding and inside lining; grouting is made rich with lime. Lathing and plastering, one good heavy coat, completes the inside walls. Pens are divided 2 ft. up from bottom with $\frac{1}{2}$ in. base-boards. Then to ceiling there is lattice work. The doors into pens are lattice work also. Roost poles are 2x4 in. rounded on top corners and a groove ploughed down the centre 1-8 in. wide by $\frac{1}{2}$ in. deep to within 2 or 3 in. of either end for coal oil as lice preventive, bottom of same is well painted with pine tar. The perches rest on brackets at ends 2 $\frac{1}{2}$ ft. from floor; drop boards are under roosts and nests are under drop boards which form top of nest boxes.

The middle or small pen is used for sundry purposes. The 20x14 ft. is double floored with rough pine.

The expense is exclusive of labor, which might add \$15 to total cost if a carpenter were employed.

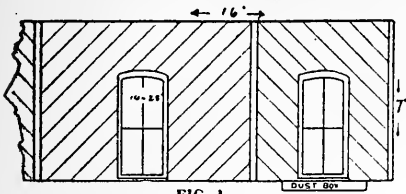

FIG. 1.

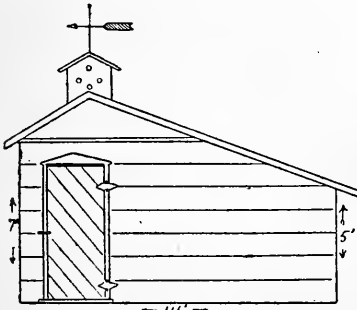

FIG. 2.

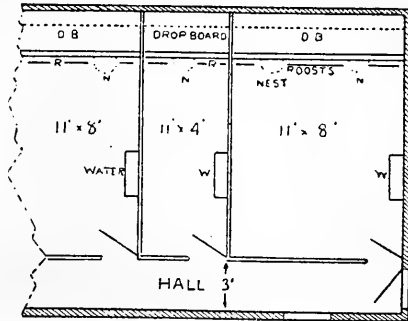

FIG. 3.

A Canadian Poultry House.

[Plans and Specifications by D. L. SOMERVILLE, Stewarttown, Ont.]

COST OF MATERIAL.

3 4x6 in. 20 ft.....	\$1 40
2 4x6 in. 32 ft.....	1 53
6 4x6 in. 14 ft.....	2 16
30 2x4 in.....	2 00
560 ft. common flooring.....	4 48
1,000 ft. good culls.....	6 00
400 ft. dressed siding.....	8 00
5 square No. 1 shingle.....	10 00
Windows.....	9 60
Hardware.....	1 50
Tar paper.....	3 00
Lath and plastering.....	4 75
Total cost.....	\$54.52



BLYTHECOTE POULTRY HOUSE.



These buildings are located on the farm of J. D. Tompkins, Brainard, N. Y., and are models of convenience. In size the structure is about 14x32 ft., divided into compartments 8x10 ft., with a hallway in rear of pens four feet wide. The figure of the ground plan herewith gives detailed information in itself. The partition along the hall is made of wire netting down to within 16 inches of the floor and below this are small rounds two and a half inches apart, through which the fowls feed and drink from a trough and dishes placed on hallway floor close to the partition. The pen partitions are of wire also down to within three feet of floor, then they are boarded up tight.

Ventilators, one for each pen, are provided in the shape of a chimney made of boards running from the floor up through and above the roof with an opening at the floor to ventilate in winter by drawing out the cooler air which lies near the floor, also with an opening in the ventilators near the top of the room for use in the summer to take out the hot air near the ceiling, one to be closed when the other is open according to the season or as occasion requires; each being operated by a cord from the hall.

The perches are arranged about three feet from the floor above a platform and on a level with each other. About one-third of the floor of this platform is something like sixteen inches above the floor of the building and then turned up at an angle of 45 degrees, making it an easy task to remove the droppings—which is done once each week, to an open shed provided with a bin for the purpose. Under the platform at the low side is arranged movable nest boxes, while under the inclined part a dust box is made, in which the fowls enjoy the great luxury of a dust bath in winter, located in front of a window that comes to the floor. The floor of the apartments occupied by the fowls is covered with fine gravel and sand to the depth of two or three inches, the feeding and watering being done from the hallway with only wire netting for partitions, the birds may be seen and cared for with neatness, pleasure and dispatch, while nothing is wasted or made unwholesome by getting into their dishes.

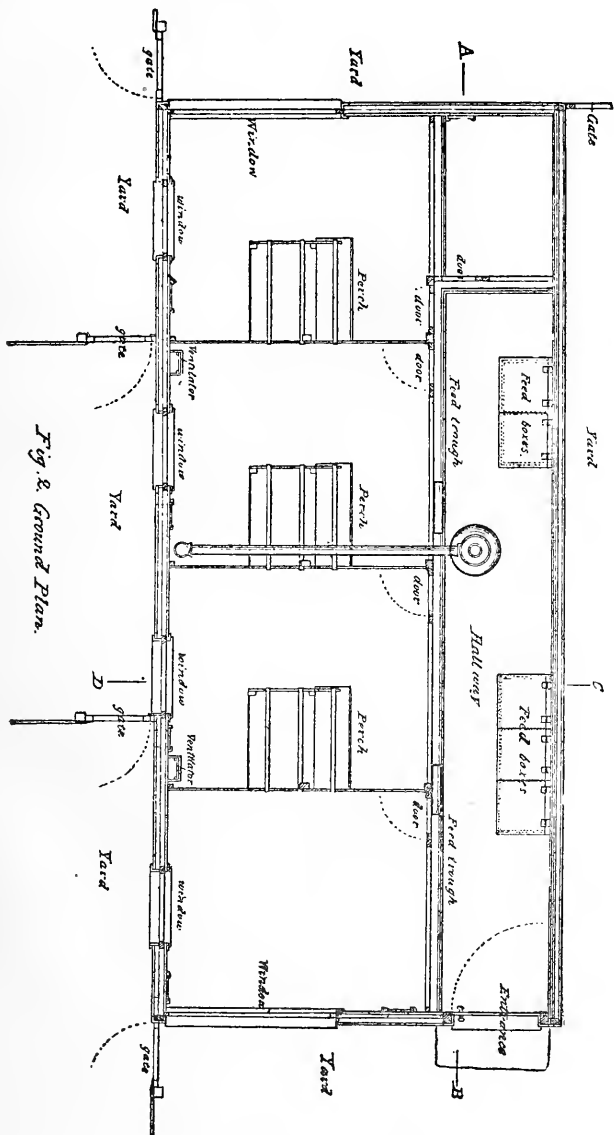

Blythecote Poultry House—Ground Plan.

At Fig. 3 is shown a transverse section of the building and at Fig. 5 is a section of the nests and perches, with drop board, all of which are self-explanatory in the cut. This structure is, of course, more expensive than most of those described in this book, yet the reader will gain many valuable hints and suggestions from a detailed study of these very excellent plans.

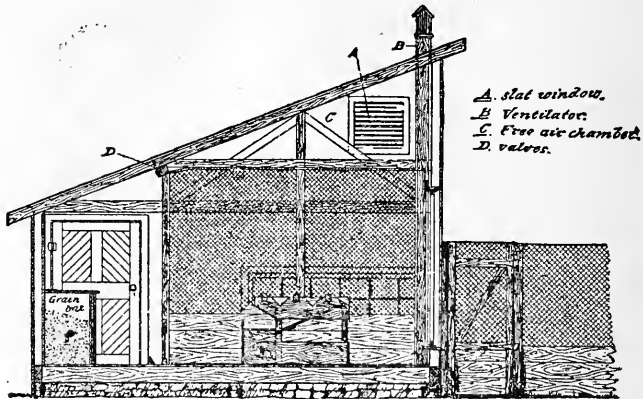

- A. Slat window.
- B. Ventilator.
- C. Free air chamber.
- D. Valves.

Transverse Section at C.D.

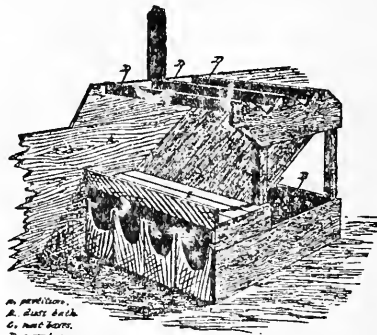

- A. Ventilator.
- B. Slat door.
- C. Nest door.
- D. Perches.
- E. Platform to receive droppings.

Blythecote Poultry House.

[Plans and Specifications Furnished by THE POULTRY MONTHLY, Albany, N. Y.]

A STRUCTURE COSTING ABOUT \$25.

The accompanying sketch shows general plan of a poultry house that need not cost over \$25. It is furnished by Mrs. John S. Newnam of Kent Co., Md. The first figure shows a cross section of building giving arrangement of nest boxes. The building is 24 feet long, 12 feet wide (See next page.) It is divided into three sections. A roost room 8x12, a scratch room 12x12, an egg room 4x12. The north side is boarded up. The door near the end opens from the yard into the egg room. The nests are boxes on shelves. The boxes can be drawn through, so as to take out the eggs without going into the next room. There is a door from the egg room to the scratch room, where the shelves are. There is a door from the scratch room to the roost room, also to yard. The door between roost and scratch room is a slat door; on the bottom of it is a smaller door, which can be lifted up; it has a little strap on it and hooks up on the large door.

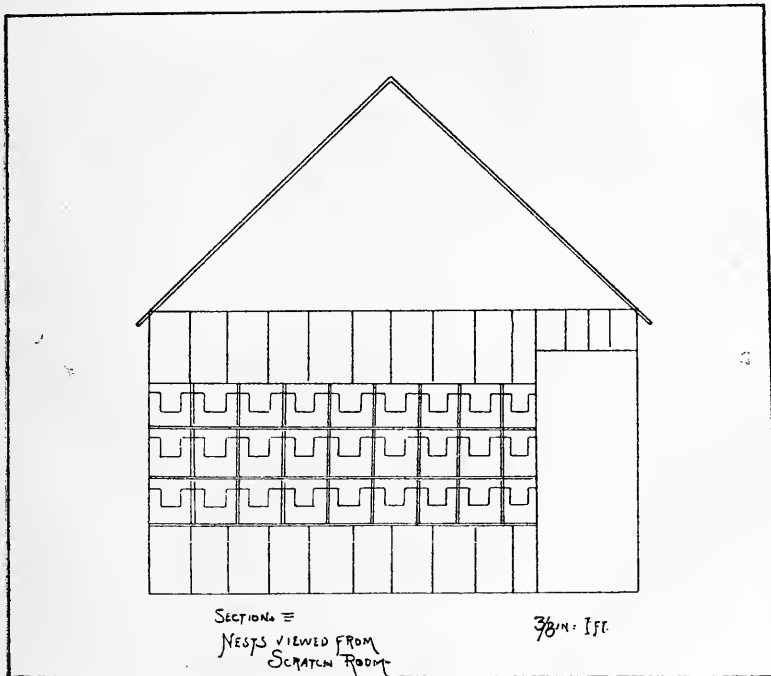

CROSS SECTION SHOWING ARRANGEMENT OF NEST BOXES.

There is a small door in the roost room for them to go in and out. The house faces to the south, has drop windows in each of the end sections eight feet long by two feet wide. They have wire netting over them on the inside, so that the doors only have to be up in extreme cold weather. The middle section has a door and a sash that admits light and sunshine when the others are closed.

The posts around the yard are chestnut and cedar. The bottom board is a foot wide, then a three-inch space, another board of cypress fence boarding; at the top of that is stretched a four-foot-wide wire netting. The frame of the building was made from trees

that grew on the farm. They were hauled to the saw-mill and sawed into sills, posts and weather-boarding. When it was finished and the expenses added up the whole cost was about \$20. Every one that has seen it pronounces it a very convenient hen-house. The plan was original with the Baltimore Weekly Sun.

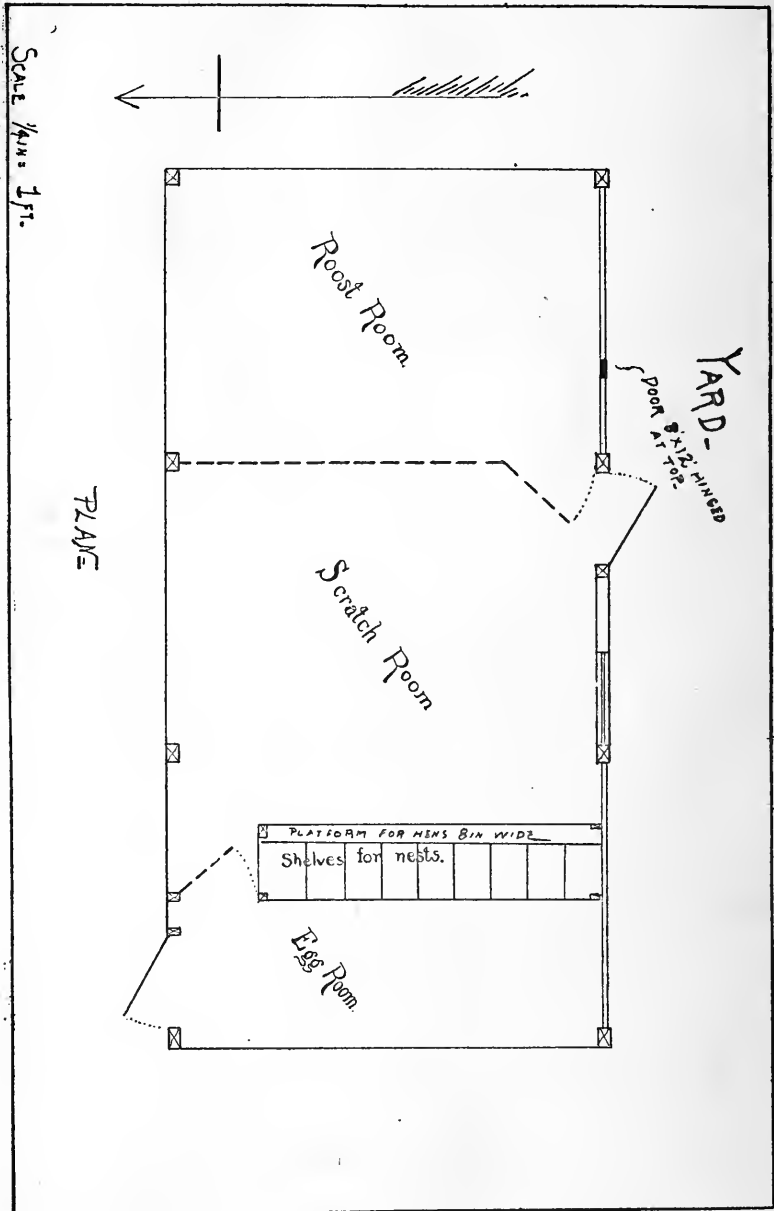

[Plan furnished by MRS. JOHN M. NEWN, M., Kent Co. Md.]

POULTRY HOUSES COSTING UNDER \$25.



The following Six Articles are Taken from "The Fanciers' Review" and are Without Illustrations.



To build a poultry house for 25 hens for \$25, I should build in size 10x16 ft; back 4½ ft., front 7½ ft. high, to be divided into two pens 8x10 ft., window in middle of each pen, 7x9, 12 lights, door in end south-east corner. It should be boarded with matched spruce 12 ft. long; it will take 700 feet. Walls to be boarded perpendicular, and roof in same way. Then a 12 ft. board will cut into two pieces, each for wall boarding. Schedule would be:

156 ft. spruce scantling \$17 per M.....	\$ 2 65
700 matched spruce, \$16	11 20
2 windows, 7x9, 12 lights.....	1 60
1 bunch lath.....	25
5 squares roofing	2 00
10 pounds 8d. nails.....	50
Hardware.....	50
Carpenter, two day's time.....	5 00
Total cost.....	\$23 70

Sills 2x9 are to be set up edgewise and filled with gravel inside to make a dry floor. There are two scantlings to nail roof boarding to, besides the plates. Drop boards are two feet wide and the same from floor, roosts one foot above drop boards, to be in back side of house, nest boxes under drop boards, partition in centre of house, making two 8x10 pens, each having a window in front.

LEWIS B. PAINE.



A model poultry house for 25 hens that need not cost over \$25, should be 13 feet wide by 14 feet long, with a hallway 3 feet wide running the entire length of the house. It should be 7 feet high at front and four feet high at back with flat felt roof. The hallway divided from the pens by a partition of wire netting down to within 2 feet of the floor below, which are lath two inches apart; leave as many holes in partition next to the floor as you want nests; for nest boxes use nail kegs with one side sawed out and when you gather eggs turn around the keg so the opening will be in the hall.

Do the same when the hen wants to sit, then the rest can't get to her; at the same time she can get feed and water. Do all feeding

and watering in troughs in the hall as the hens will eat through the slats and cannot foul the water or feed. This does away with going into the pen except to clean.

This house is divided into two pens, each pen 7x10, giving room for 12 hens and cock. In front of each pen put a window with shutters to close at night. For perches use 2x2's seven feet long, placed over a trough made of boards 14 inches wide running the entire length; under perches put sifted coal ashes. A. J. TOBY.

The ideal poultry house must cost little. Keep the fowls healthy and profitable, and save labor. It must stand on well drained or naturally dry soil, and surface water must at all times be kept out. Set cedar or chestnut posts deeply and cut off six inches above the ground. On these put sills 2x8 inches. Build a light frame the sides covered with boards over which heavy tarred felt is fastened by lath. The roof is boards covered with 2-ply prepared roofing, and is placed just high enough to walk under comfortably, and slopes gently. The entire length is 32 feet by 10 feet wide.

First comes an open shed six feet wide with door in outer wall at front. Next a felt covered board partition with door at front, then a 10x10 feet pen, a lath partition with door, another 10x10 feet pen and another felt covered partition and door, a six-foot shed at other end of building with door. The ends of building, enclosing sheds need not be felt covered. The open ends of sheds face the south. A 12-light 10x12 inch sash, with wire netting inside, must occur in each pen at the south side. Holes 6x8 inches are provided to let hens into the sheds on sunny days. Coarse wire netting covers the open fronts of sheds in winter to keep the hens off the snow. A scratching box seven feet long by four feet two inches wide by ten inches deep is set level against the inside partition and the back wall, twenty inches from the ground. Twenty inches above this a level platform, seven feet long and 25 inches wide with eight inch cleats at each end extending upwards and beveled both ways towards the ends, form a rest for a one and one-half by four inch by seven foot movable roost-bar. The other pen is furnished in the same way, against the opposite corner. Three nail kegs each with holes cut in sides, make good nests. Use pine saw dust in nests. Provide cut hay or straw in scratching boxes in which scatter grain often and change every two weeks. Put springs on all pen doors so they close quickly behind you. Dispense with all ventilators. In hot weather, fasten the doors open a trifle. Feed soft feed and oyster shells on sills. Drive a few four-inch wire nails through a narrow board and tack on a sill. On these stick beets and cabbage. Put corn in hoppers and arrange with windlass, rope and pulley to let hens eat in

evening, then elevate out of reach of rats. The whole ground floor is available to hens and is easily cleaned. Put a load of sand in the shed one fall and the next fall put it in the pen and draw in more.

This building need not cost over \$25 if you do the work. No better poultry house can be built at any price. Plymouth Rocks, Wyandottes and similar breeds will not freeze at 20 degrees below zero. In cold weather heat the drinking water two or three times a day. Put the timid and young fowls in a pen together. Birds of the same breed do best together. For a larger number of fowls, and at a greater expense, a house can be built to save a good deal of labor over this one, but limited space prevents a description.

J. H. NELLIS.

"How shall I build my poultry house?" is a question which every one who is about to embark in the poultry business asks himself. I shall answer: As eight feet of floor space is required by each fowl, the building must be built 12x16 feet to allow of enough room. Build the house of sod, if in the prairie states, or of stone if it is handy, as a frame building cannot be made warm enough to keep down diseases for \$25. if lumber costs \$25 to \$30 per M., as it does here in Kansas. Build the back or north side six feet and the south side four feet. The north roof should be one-half pitch and six feet long; the south roof three-eighths pitch and ten feet long. South roof to contain a hot-bed sash to provide plenty of light. This should be covered with a double blind at night to retain the heat. A double thickness of glass is better and answers the same purpose. Make the roof of shingles.

The frame now constructed, proceed to give the inside a good plastering so as to prevent lice from gaining a foothold, a point worthy our consideration. Now give all the inside of the building a good coat of whitewash. Make an opening large enough to give the fowls an opportunity for egress and ingress on the south side. Leave the doorway in the east or west end near the north side. Make ventilator in top of building so as to let out the once breathed air and let fresh air in at the bottom. Avoid the four-section tube ventilators, or you will regret it when you lose your best birds with roup, etc.

Make your perches of round poles from your woods, three inches in diameter, or of 3x4's rounded at the upper corners. Place these over a platform elevated one and one-half or two feet from the floor. Make four platforms of ten two-inch boards with 1x3 inches furring around the edge to prevent the waste of droppings and also to save labor as, if the hens walk on the droppings, some of them will stick to their feet and be daubed on the perches. The furring also assists

the heavy fowls in getting on and off the roost. Under this roost platform you can set your hens. Use wire nest boxes, as they can be burned when the house is fumigated. Make your dust box 2x3 feet and 9 inches deep. Provide a box to be filled with gravel, lime, charcoal and cut bone. Place them in the lightest part of the house and everything is ready for business. ORLEN A. LEWIS.

I have a poultry house 8x24 and keep 27 chickens in it. I have it divided into three pens 8x8 each, and eight hens and cock or cockerel in each pen. The coop can be built for \$25, or even less, as any one may wish. All it needs is two sticks 2x6, 24 feet long; 1, 2x6 and 16 feet long; 2 sticks 2x4, 24 feet long; 6 2x4 and 17 feet long for rafters and it won't take a thousand feet of lumber to make it seven feet in front and five behind, with three window sashes three feet square, one for every eight feet. I have the roof covered with felting and papered inside with vermin proof building paper, and it makes a cheap and warm coop for the size and money. CHARLES HURT.

Get six large dry goods packing boxes. Place them side by side fronting south, on timbers. Put glass window sash in east side of east box. Same in south front of next box, and of next also; make doors opening in south front of boxes four, five and six. Remove bottom from boxes 1, 2 and 3. Leave bottom in 4, 5 and 6. Fill bottom of 1, 2 and 3 with earth, gravel or coal ashes. Put three roost poles in 4 and 5. Six is the nest room. Cut 18 inch opening from 5 to 6. Remove partition between 4 and 5 to allow roost poles. Cut 18-inch openings between 1 and 2 and 2 and 3, and 3 and 4. Cover all the boxes with roofing paper. The doors will give access to nest boxes and for cleaning floor of roost rooms. Opening for hens may be in glass sash of No. 2 by taking out one glass and fixing slide in its place. This is an invention of my wife who also did all the work except the necessary sawing. Cost did not reach \$5 00. We kept 25 mixed Leghorns in this house. The small rooms retain nearly all the animal heat so that no comb froze during our very severe winters. The hens were allowed to run out during the day time. Snow shoveled away from south front so as to give exercise and feeding ground 10x20 feet upon which litter from horse stable was occasionally spread to give scratching exercise. We got eggs in plenty. These hens laid as well as did our choice stock in our \$100 house. We got from 10 eggs per day in December to 22 per day in March. This is as good a house as any one can make where results only are sought. GEORGE A. GOWDY.

Plan of Home-Made Incubator.



With the aid of the accompanying illustrations, but little difficulty need be experienced in making an incubator, and as the one here described is in general use, it has been fully tested and found to perform all that may reasonably be expected. Fig. 1 represents the *interior* of the incubator.

It will be noticed that there are an outer and inner box, with sawdust between them—chaff or any such material will answer. The outer box is 48 inches long, 44 wide and 36 high. The inner box is 40 inches long, 32 inches wide, 18 inches deep, and holds a tank 32x36 inches. The outer measurements are used in measuring boxes. A is the outer box and B the inner. C C are strips one inch wide and one inch thick, with iron rods $\frac{5}{8}$ of an inch thick (F F) upon which the tank rests. D D are similar strips (but no rods) for supporting the egg drawer. E is a $1\frac{1}{2}$ inch tin tube, two feet long, which admits air into the ventilator (space under egg drawer). The ventilator is five inches deep, and is of the same length and width as the tank. Fig. 2 shows a sectional plan. A is a tube extending through the incubator into the tank. B is a faucet for drawing off water. C is the egg drawer. D is the tin air tube. The egg drawer, Fig. 3, is four inches deep, outside measurement, and should be made of light material. It is 39 inches long and 30 inches wide, containing three movable trays, $1\frac{1}{2}$ inches deep, and of size to fit in the drawer. The bottoms are thin strips (one inch wide and one inch apart, to both drawer and trays) over which muslin is tightly drawn and tacked. The tank is seven inches deep. The faucet is detachable, and screwed in when desired, on a thread. The tube on top is seven inches high. The front of the egg drawer is also boxed off and filled with sawdust.

It requires about 115 feet of lumber (inch tongued and grooved boards), and the cost of the tank is about \$5. The plan of the tank is show at the sectional view given. When completed the incubator is simply a box, having this appearance—see Fig. 4.

In building, one may follow any plan that may be preferred, as it is not necessary to conform to any particular design. Have the floor close. All that is necessary is to make a *warm room* for keeping the eggs at a uniform temperature; but do not attempt to have any tubes for the escape of air. Opening the drawers to turn the eggs provides sufficient ventilation.

DIRECTIONS FOR OPERATING.

Each tray holds about 80 eggs, laid in promiscuously, the same as in a nest, making the total number for incubator 240 eggs. First fill

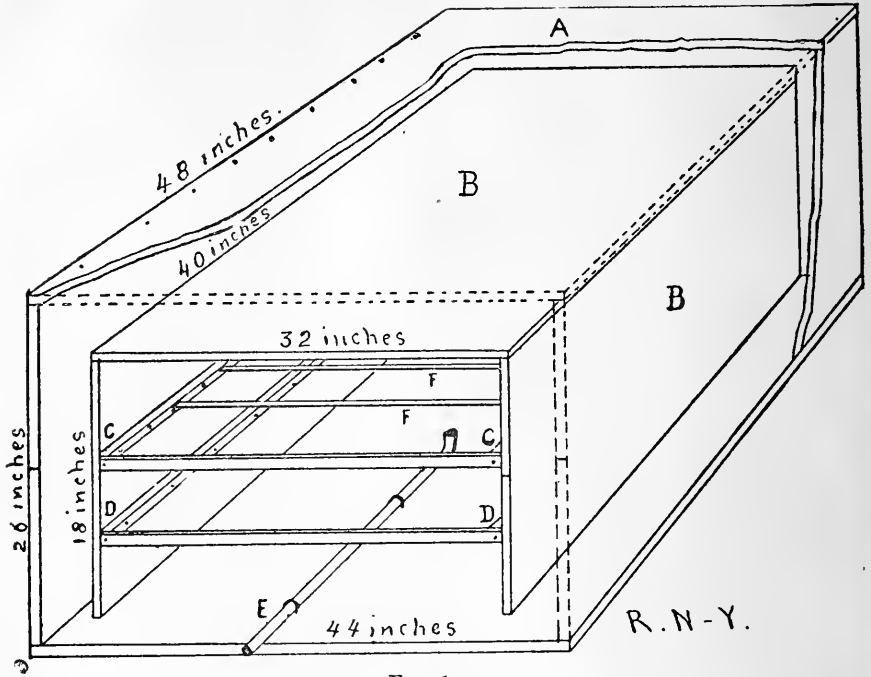
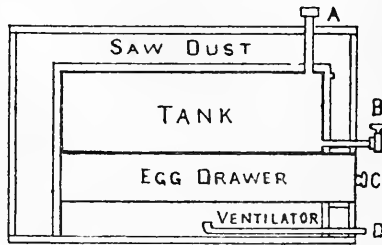

FIG. 1.



R.N.-Y.

FIG. 2.

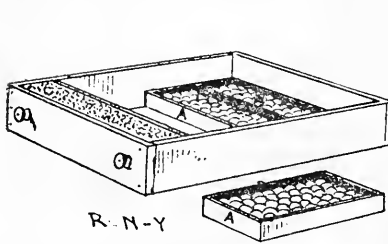

FIG. 3.

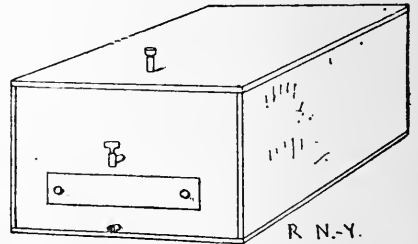

FIG. 4.

A Home-Made Incubator.

the tank with boiling water, but never allow it to remain in the tube on top, as it thus increases pressure; hence when the tank is full to top of tube, draw off a gallon of water. Fill it 48 hours before putting eggs in, and have heat up to 115° before they are put in. As the eggs will cool down the heat, do not open the drawers for six hours, when the heat should be 103°, and kept as near to that degree as possible, until the end of the hatch. It is best to run it a few days without eggs, to learn it thoroughly. Place incubator in a place where the temperature does not fall below 60°. As the heat will come up slowly, it will also cool off slowly. Should the heat be difficult to bring up, or the eggs be too cool, you can raise or lower the trays, using small strips under them. You can also stop up or open the air tube in the front opening of the ventilator whenever you desire. When the eggs are put in, the drawer will cool down some. All that is required then is to add about a bucket or so of water once or twice a day, in the morning and at night, but be careful about endeavoring to get up heat suddenly, as the heat does not rise for five hours after the additional bucket of water is added. The cool air comes from the ventilator pipe, passing through the muslin bottom of the egg-drawer to the eggs. Avoid opening the egg-drawer frequently, as it allows too much to escape of heat, and be careful not to open it when chicks are hatching, unless compelled, as it causes loss of heat and moisture at a critical time.

Cold drafts on the chicks at that time are fatal. Do not oblige visitors. Be sure your thermometer records correctly, as half the failures are due to incorrect thermometers, and not one in twenty is correct. Place the bulb of the thermometer even with the top of the eggs, that is, when the thermometer is lying down in the drawer, with the upper end slightly raised, so as to allow the mercury to rise, but the bulb and eggs should be of the same heat, as the figures record the heat in the bulb, and not in the tube.

Turn the eggs twice a day at regular intervals—six o'clock in the morning and six o'clock at night. Do not let them cool lower than 70 degrees. Turn them by taking a row of eggs from the end of the tray and placing them at the other end, turning the eggs by rolling them over with your hand. By removing only one row you can roll all the rest easily. Give no moisture the first week, very little the second, and plenty the third week. Do not sprinkle the eggs. For moisture, put a wet sponge, the size of an egg (placed in a flat cup), in each tray the second week, and two sponges in each tray the third week. Do not put in sponges until you are about to shut up the drawer, after turning. Wet the sponges by dipping in hot water. After the first ten days the animal heat of the chicks will partially assist in keeping up the temperature. Be careful, as heat always drops when chicks are taken out. You can have a small glass door in front of the egg drawer, to observe thermometer, if desired. Always change position of trays when the eggs are turned, putting the front one at the rear. After the fourteenth day spray the eggs twice a day with water warmed to 110 degrees, using an atomizer, and do it quickly.

[For the above article, written by P. H. JACOBS, with the illustrations, we are indebted to that excellent agricultural journal, THE RURAL NEW YORKER. While some may prefer to construct their own incubators, most poultrymen will find it more satisfactory to buy one of the many excellent machines now on the market.]

A HOME MADE BROODER.

The brooder herewith described is simple and cheap. The tank *A* in Fig. 1 consists of a three-inch iron pipe eight feet or more long screwed up with a cap on each end. Through one end is bored a hole, through which a one-inch pipe *B* runs up nearly to the other end of the tank. On this pipe *B* outside is screwed a T, standing upright. On top of this T is a small cock *E* and below the T is a one-fourth inch pipe with valve and union. A hole bored on the underside of the tank very near the cap has a one-fourth or three-eighths inch pipe screwed in for the backflow *F*; this also has a valve and union. Another hole bored on top of the tank for a piece of one-inch pipe *C* for pouring in the water; when filling the tank the cock *E* ought to be opened so as to let out the air. A small piece of one-fourth-inch pipe *D* connected by a rubber hose reaches a pan on

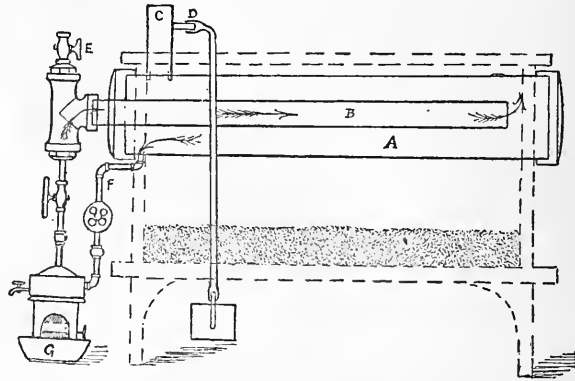

FIG. 1. SECTION OF BROODER BOILER.

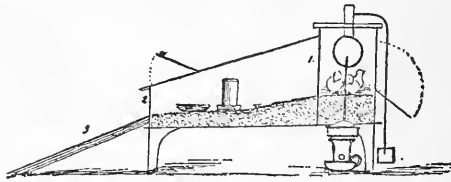

FIG. 2. SECTION OF THE BROODER.

the floor for the overflow. The oil stove or lamp *G* is for heating. This heater works very steadily, is cheap and will last a long while. Having built the boiler, the box is made around it. Each partition of the brooder is two feet long and seven or eight inches wide. In the back is a glass door sixteen inches long for convenience in cleaning out, and looking in. The front partition 1, as shown in Fig. 2, consists of three pieces of glass arranged to slide or to be taken out at will. The front box, or first run, 4, is covered with glass. It contains a pane to lift up for putting in the feed. After the chickens grow bigger partitions 1 and 2 are removed and the little ones allowed to run down on board 3. A fence two feet high of one-inch wire mesh separates each flock. It is not advised to put more than thirty chicks together, else they will crowd and kill each other.

Coops and Other Conveniences.



The variety in chicken coops is almost endless. Every poultryman has his own notions of the coop that will answer his purposes best, yet we take this opportunity to present a few illustrations of coops and other conveniences which may be used as patterns or may be taken as suggestive merely.

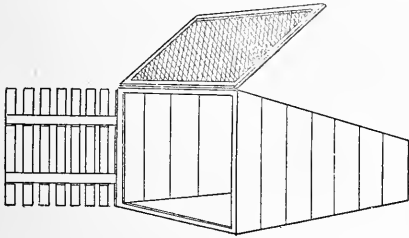

FIG. 1.

The screen admits air and does not allow the chicks to stray into "outer darkness" nor midnight prowlers to crawl within. It is cheaply constructed and the cut explains itself.

At Fig. 1, there is shown an improvement on the ordinary coop with fixed slats. Here the slats are made into a door which is hinged. It is to be closed during the day, and at night it is thrown open and the screen door, shown at top of coop, is thrown down. This door should be so hung as to allow it to lie flat on top of the coop when not

COOP WITH DRY RUN.

The coop shown at Fig. 2, is intended for small chicks. It is made of an ordinary size dry goods or boot box, the lath portion being intended for a dry run for the chicks when grass and ground is wet. It may be of any length desired, and may be constructed of scantling for corner parts and frame, with lath nailed to sides of box and extending out in front as far as necessary. The inner gate or lifting door, is to keep chicks within box during storms. Its construction is obvious. The run section can, of course, be extended to any desired length.

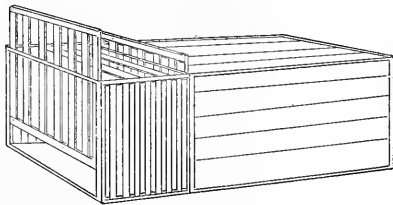

FIG. 2.

A COOL WEATHER COOP.

A coop for cool weather is shown at Fig. 3. It is something in which chicks will delight if they are hatched out so early in spring as to make out-door exercise impracticable. The general construction

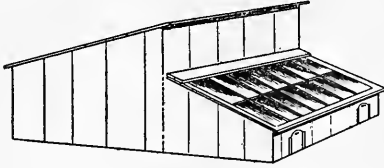

FIG. 3.

of the coop is obvious. It is, say, 4 feet long, 2½ feet wide with a glass covered run in front of about 2 feet. The highest part of roof should be about 30 inches, rear 14 inches. There should be a board partition between main coop and run, with openings in bottom to allow the chicks to enter the glass-covered run. Wire or even lath may be used for this partition, the idea being simply to keep the hen out of the run, which is intended for the sole use of the chicks. The sash in the annex should be moveable or hinged at upper part. It is well to construct the coop with a floor to be kept covered with sand or ashes, particularly in the chicken run, or if it is located on dry ground the floor is not necessary. Set the coop facing the sun so that its rays may fall on the glass and then watch your chicks disport themselves even when the temperature is low without.

A BROODING PEN.

At Fig. 4, a brooding pen is shown, or rather there are two pens in the illustration. These may be built in sections of two, and placed in the most convenient places in and about the poultry house or yard.

The size should be 4 feet square and three feet high. The lid is for convenience in attending to the sitting hen. The front of pen is a wire screen. The nest is at A in the illustration, the side of pen being removed to show it. The nest should be a box 16 or 18 inches square, open at one side, with a door to cover opening in case the hen becomes "cranky" about sitting quietly on nest. Each pen should, of course,

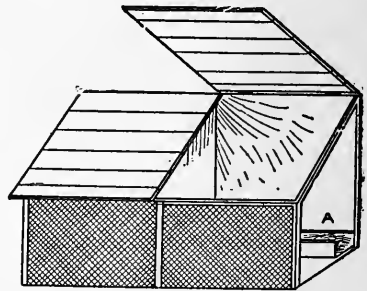

FIG. 4.

be supplied with feed and drinking vessels, and floor should be covered with sawdust. Much depends on the success you have in managing your hens when sitting on a clutch of valuable eggs, and you will find this contrivance a good one.

NEST BOXES FOR EGG-EATING HENS.

If a poultryman is troubled with egg-eating hens, we commend the style of nest boxes shown herewith at Fig. 5. The nests are dark inside, hence the hens cannot see to consume the eggs, and some claim that a dark nest is an inducement to laying. The box is about five feet long, 18 inches high in rear and eight inches front. At the right-hand corner is shown the entrance to the nests, and it should be about eight or ten inches wide.

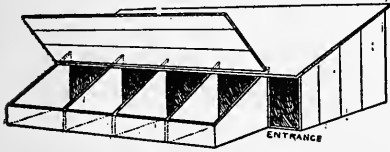

FIG. 5.

The cover is, of course, to be closed except when eggs are being gathered. Use common inch boards in the construction of the nests; no detailed description is necessary for anyone handy with hammer, saw and nails.

A LIGHT SHIPPING COOP.

In these days of high express charges, a light shipping coop is very desirable. A good one is shown at Fig. 6. It is easily and cheaply made. The bottom, which is of light matched boards, may be made about two feet by two and a half, and the top about one-quarter the width of the bottom and same length. If preferred, you can tack some cheese cloth over the crate before the slats are nailed on, and where good, strong cloth is used some of the slats may be dispensed with, thus lightening the coop. It ought not to weigh over 8 or 10 pounds when completed.

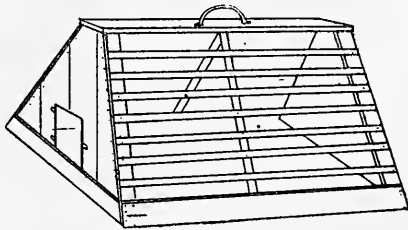

FIG. 6.

A FEEDING BOX OR RACK.

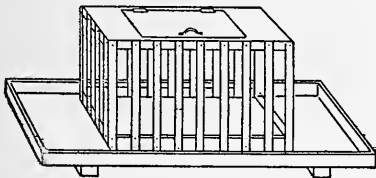

FIG. 7.

The box or crate is then set upon the platform, as shown in the illustration, the door in top of same being intended to admit the feeding and drinking vessels. This feeding box prevents waste of feed and keeps it and the water from being polluted. It is very serviceable.

Fig. 7 is a feeding box or rack for fowls. The bottom is a board say five feet long, or as much longer as is desired, with two cross pieces beneath to prevent warping. A two-inch strip is nailed around the edges to keep feed in place on the board.

CRATE FOR SHIPPING CHICKS.

While speaking of shipping fowls, let us call attention to the little basket (Fig. 8,) for shipping chickens. As it is not improbable that in the future chicks rather than eggs will be bought and sold, it will

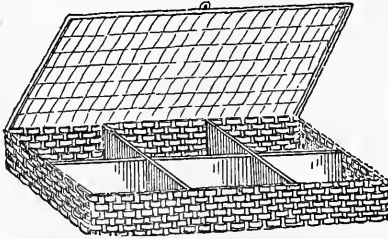

FIG. 8.

be necessary to have a convenient and well-adapted basket for that purpose. Here we have it. The basket is made of white oak splints, as they combine lightness and strength, and is 10 inches deep. Its other dimensions may conform to the needs of the shipper. The cover is of stout wire netting and handles on each end make it convenient of handling. With the six apartments quite a number of chicks can be shipped without overcrowding. Where it is not practicable to use splints for the sides and bottom of the crate, any light wood can be employed. Poultrymen will find this little contrivance a very practical one when in need of something to convey chicks, or even fowls if the depth of basket be a little greater.

A ROOST CONTRIVANCE.

There is, we believe, serious objection to having fowls roost within six inches or so of the accumulated droppings. Coupled with bad ventilation, disease is almost sure to follow. The illustration at Fig. 9 shows a contrivance intended to remedy this defect of most poultry houses. The roosting perches or main frame are to be as long as necessity demands, and should be about three or four feet from the floor. Some prefer a less distance, some a greater. Under the cross perches drop boards are placed (shown at A, A), which are about six inches wider than the cross perches and which convey the droppings into the boxes (B, B). These are easily removed each day, sand or sawdust being placed in the bottom of them before returning to their places. We consider this a decided improvement over the level drop board close under the roosting perches.

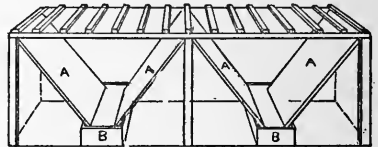

FIG. 9.

A FEEDING PLATFORM FOR FOWLS.

The cut at Fig. 10, shows a small platform upon which to feed fowls, and thus avoid the common and wasteful practice of throwing the grain or wet food upon the earth or snow. The platform may be

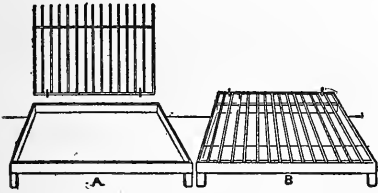

FIG. 10.

of any desired size, built by the side of the poultry house, and consists of a bottom-board raised a few inches from the ground, with a narrow border upon its three sides. A slatted "drop" is secured to the side of the building, as shown at A in the illustration. After the food is placed on the platform, the drop is lowered as shown at B, and prevents the fowls from crowding upon the board, soiling the feed with their feet, and causing waste.

A NEST CONTRIVANCE.

Are you ever troubled with several hens trying to get on the nest at the same time? If so, the illustration at Fig. 11 shows how to obviate the difficulty. You can make the box out of an old boot case.

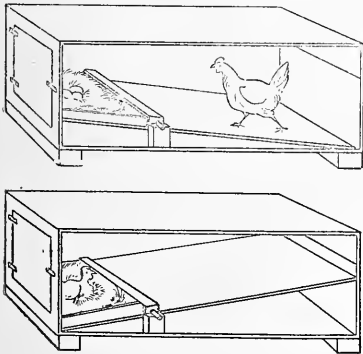

FIG. 11.

The board upon which biddy is walking in the upper figure of the illustration is two inches narrower than the box and is so pivoted that it can move up and down. The heaviest part of the platform should, of course, be toward the entrance so that the approach to the nest will be open when the hen isn't on it. When she steps over the pivot the nest end drops and closes the entrance. Simple, but effective.

A MOVABLE NEST BOX.

The two accompanying illustrations show a movable nest box. The advantage of having the nests so that they can be easily taken out and cleaned, is to every poultryman self-evident. These boxes

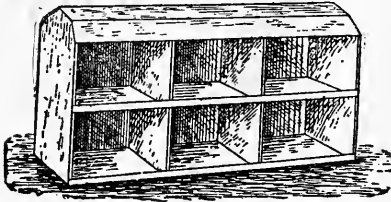

FIG. 12.

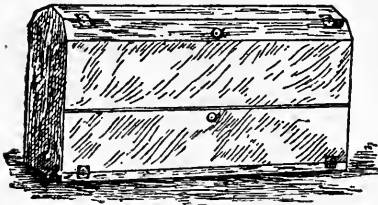

FIG. 13.

are in sections of six nests each and are about 4 feet long. Two of these are placed end to end and fitted loosely under the partition dividing hallway from pen, the boxes thus forming a part of partition. Fig. 12 shows the nests facing toward pen. Fig. 13 shows the side of box toward hallway, the hinged lid at top permitting the eggs to be removed from upper nests and the hinged back from lower nests without going into pen. They will be found very convenient. The boxes should be of inch stuff and anyone handy with carpenter's tools can easily make them.

A DRINKING FOUNTAIN.

Another convenience for the poultry house is the drinking fountain as illustrated at Fig 14. It represents a convenient arrangement for furnishing a steady supply of drinking water to fowls. The vessel is made by soldering a tin bottom to the lower part of the can, so as to form a trough on all sides. Several small holes are made in the can. The can may be filled by submerging it in water, or through a hole in the top provided with an air-tight cork. The trough will fill up above the holes and remain so until the water in the can is exhausted. The water flows from the can as fast as it is needed by the fowls. If properly constructed, the trough can never run over.

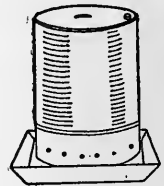

FIG 14.



