

# MAINTENANCE OF WAY STANDARDS

ON

...AMERICAN RAILWAYS...

AND



RULES AND INSTRUCTIONS  
GOVERNING ROADWAY DEPARTMENTS

Compliments of  
VERONA TOOL WORKS  
Pittsburgh, Pa.

GIFT OF

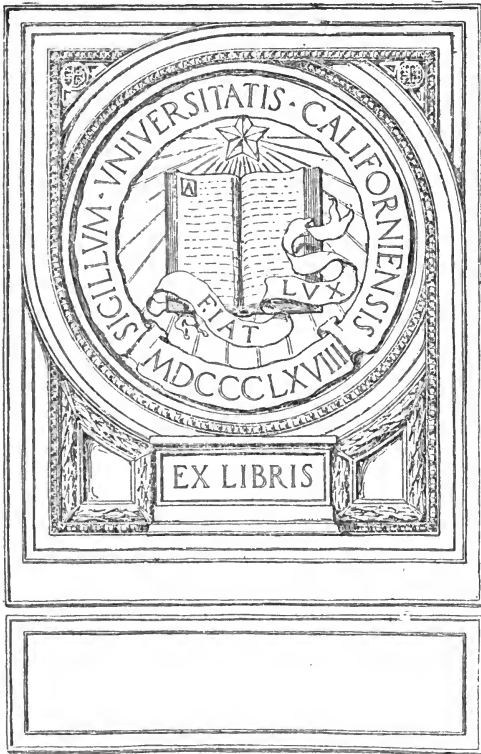

ENGINEERING LIBRARY  
OF  
**WILLIAM B. STOREY**  
A GRADUATE OF  
THE COLLEGE OF MECHANICS  
CLASS OF 1881  
PRESENTED TO THE UNIVERSITY  
1922

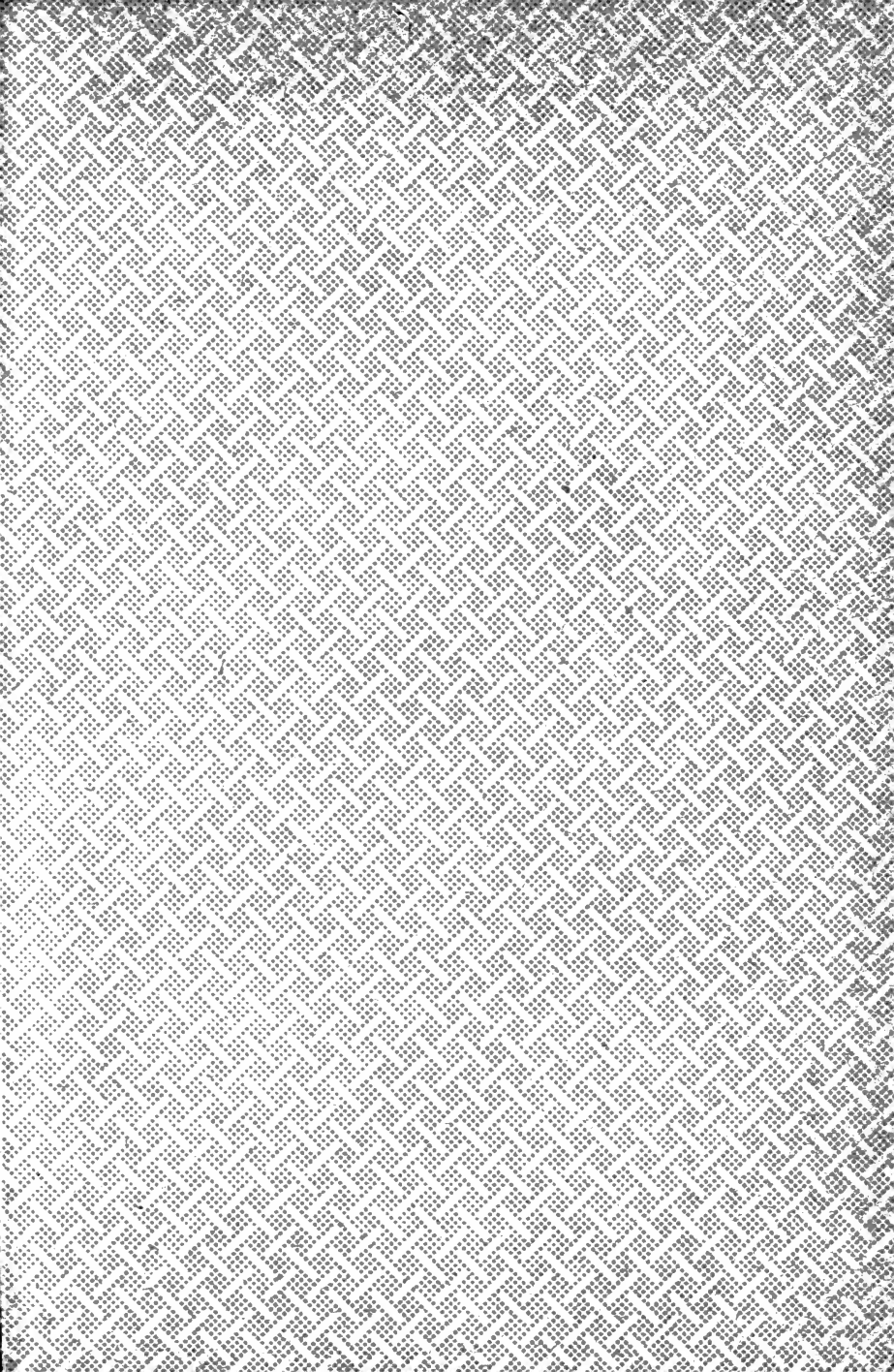



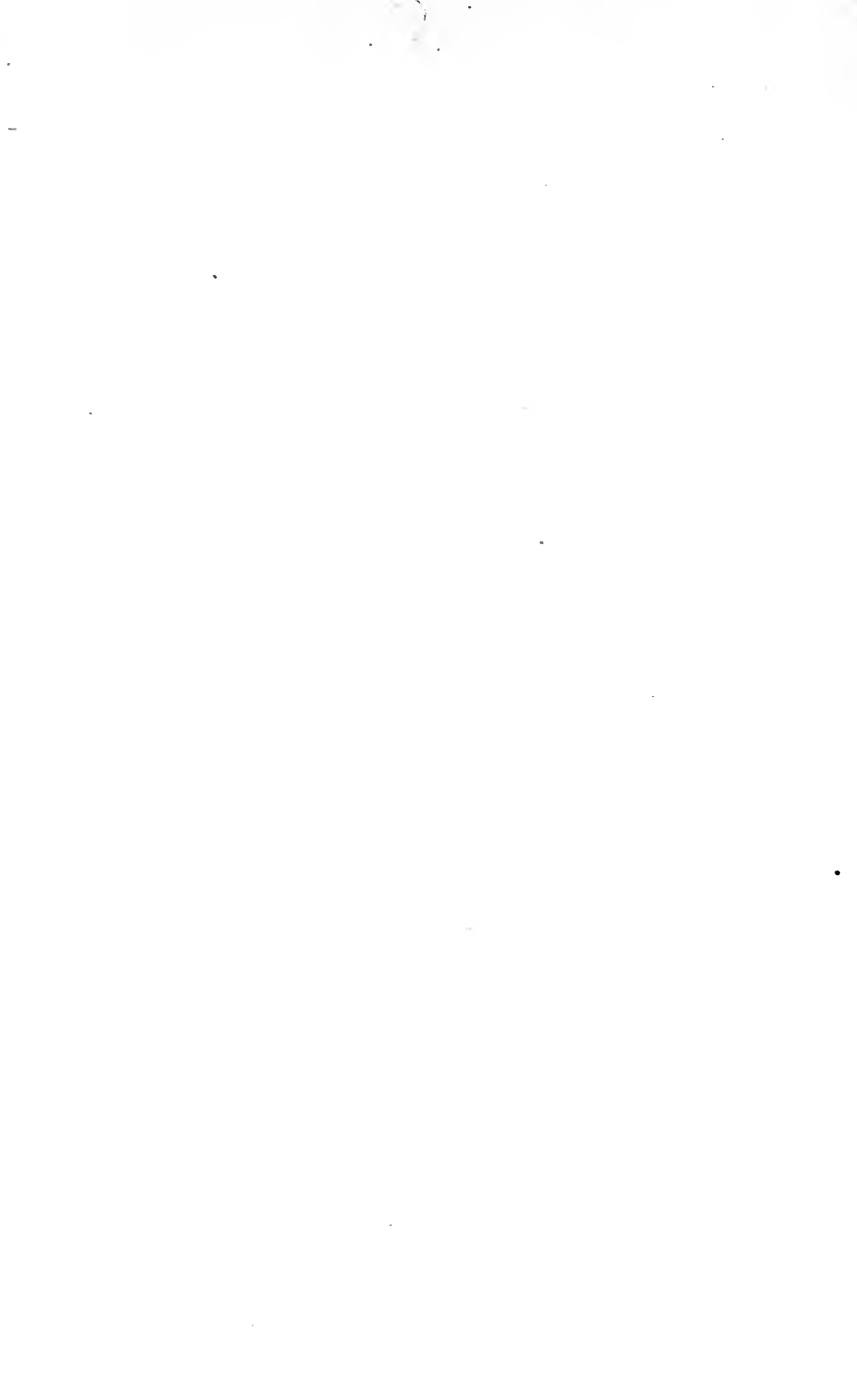

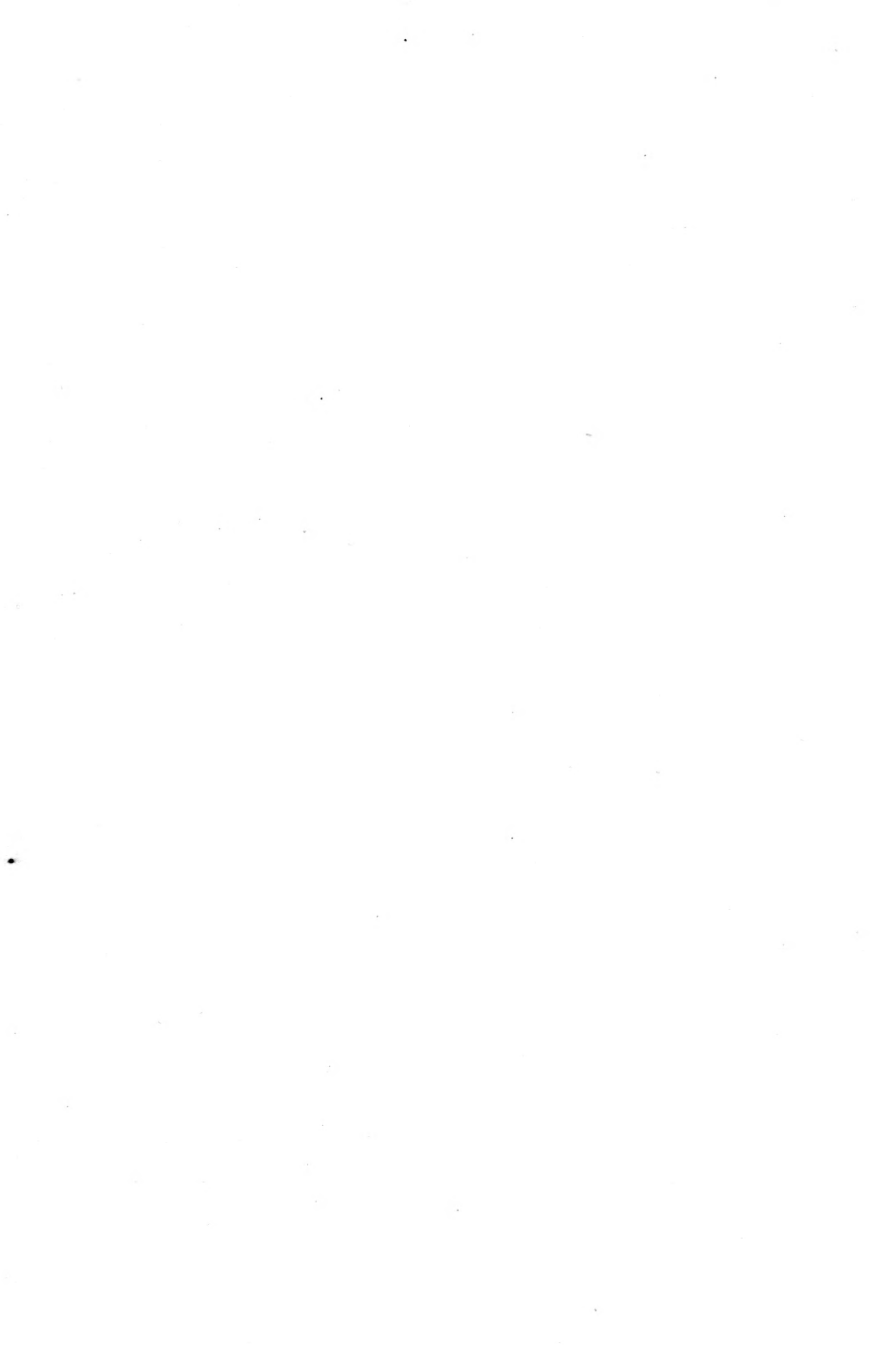







Library of  
Congress

**MAINTENANCE OF WAY  
STANDARDS**

ON

**AMERICAN RAILWAYS**

AND

**Rules and Instructions**

**GOVERNING ROADWAY  
DEPARTMENTS**



CHICAGO  
ROADMASTER AND FOREMAN, Publishers,  
87-93 S. Jefferson St.  
1896.

TO THE  
LIBRARY OF CONGRESS

TF530  
S6

417

Entered According to Act of Congress, in the Year 1896,  
By B. S. WASSON & CO.,  
In the office of the Librarian of Congress, at Washington.



## **INDEX TO RAILROADS.**

### **SECTION I.—EASTERN ROADS.**

- Boston and Albany Railroad—Pages 1 to 24.
- Baltimore and Ohio Railroad—25 to 110.
- Philadelphia and Reading Railroad—111 to 123.
- Pennsylvania Railroad—124 to 171.
- New York Central and Hudson River Railroad—172 to 204.
- New York, Lake Erie and Western Railroad—205 to 215.
- Michigan Central Railway—216 to 281.

### **SECTION II.—SOUTHERN ROADS.**

- Cincinnati, New Orleans and Texas Pacific Railroad—282 to 303.
- Louisville and Nashville Railroad—304 to 348.
- Illinois Central Railroad—349 to 397.

### **SECTION III.—WESTERN ROADS.**

- Atchison, Topeka and Santa Fe Railroad—398 to 443.
- Chicago, Burlington and Quincy Railroad—444 to 451.
- Great Northern Railway Line—452 to 457.

### **SECTION IV.—MISCELLANEOUS ROADS.**

- Union Pacific Railway—457 to 467.
- Central Railroad of Georgia—468 to 475.
- Southern Railway—476 to 481.
- Lake Shore and Michigan Southern Railway—482 to 483.
- Chicago and Northwestern Railway—484 to 492.
- New York, New Haven and Hartford Railroad—493 to 499.

## **INDEX TO ILLUSTRATIONS.**

- Angle Bars—18, 58, 60, 139, 212, 213, 214, 243, 309, 358, 417, 418, 450, 466, 467, 474, 476, 494, 496, 497, 499.
- Block Signal Towers—95, 163 to 171, inclusive.
- Bolts, Track—59, 61, 103, 139, 212, 213, 214, 243, 309, 358, 417, 418, 450, 466, 467, 476, 494, 496, 497, 499.
- Cattle Guards—87, 228.
- Car Stop (bumper)—102.

## IV

## CONTENTS.

- Frogs Spring—68, 69, 72, 73, 140, 233, 295, 321, 356, 490, 491.  
 Frogs, Rigid—62, 63, 64, 65, 66, 67, 70, 71, 141, 357, 416, 465, 488.  
 Guard Rails—248, 314, 317, 367, 464, 472.  
 Hand-Car Houses—96.  
 Joints—18, 58, 60, 139, 212, 213, 214, 243, 309, 358, 417, 418, 466, 467,  
 474, 476, 494, 496, 497, 499.  
 Mail Bag Cranes—100, 101.  
 Nut Locks—212, 213, 214, 358, 466.  
 Penstocks—98, 99.  
 Rail Sections—18, 19, 59, 61, 139, 191, 212, 213, 214, 243, 309, 357, 358,  
 417, 418, 450, 466, 467, 474, 476, 494, 496, 497, 499.  
 Relay Box—433, 436.  
 Roadbed Sections—11, 28, 29, 34, 35, 40, 41, 113, 114, 115, 120, 132,  
 133, 138, 175, 176, 187, 207, 209, 211, 221, 286, 289, 306, 352, 353,  
 402, 403, 404, 446, 447, 454, 455, 456, 457, 459, 460, 461, 462,  
 468, 469, 470, 471.  
 Road Crossings—88, 182, 183, 198, 199, 325, 330, 463, 475.  
 Signals—149 to 161, inclusive.  
 Signs—89, 90, 91, 434, 435, 436, 437.  
 Switch Stands—49, 50, 51.  
 Switches, Split—45, 46, 47, 48, 239, 292, 314, 367, 473, 482, 485, 486.  
 Switch Ties, bills of—85, 86, 397.  
 Tell-Tales—92, 93.  
 Tie Plates—192, 478, 552, 553.  
 Track Spikes—104, 139, 466.  
 Tools—105 to 110, inclusive, 555, 556.  
 Watch Boxes—94.  
 Water Tanks—97.

---

◆ ◆ ◆

## *GENERAL ALPHABETICAL INDEX.*

---

**A.**

- Accidents—77, 324, 373.  
 Addresses—246.  
 Alignment of Track—203, 260.  
 Angle Bars—38, 501 to 511.

**B.**

- Ballast, Handling of—25, 206, 304, 350.  
 Bolts, Specification of—103.  
 Bolts, Standard—501 to 511, inclusive.  
 Bridges, general information—277, 301, 303, 385 to 394, inclusive,  
 438 to 444, inclusive.  
 Bumpers, Standard—512.

**C.**

- Cars, Hand, Regulations for—74, 222, 230, 231, 326, 374, 405, 406.  
Car Houses, Specification—513.  
Carpenters, Rules for—122, 129, 130.  
Cars, Push, Regulations for—74, 230, 231, 326, 374, 405, 406.  
Cattle Guards—277, 513.  
Clearance—250, 254.  
Construction Trains—82, 83, 84, 299, 332 to 335, inclusive, 380, 381.  
Crossings—253.  
Culverts—210.  
Curves—297, 362, 363, 364, 365, 452, 453.

**D.**

- Danger Signals—219 to 229, inclusive, 320, 322, 370, 371, 401, 448.  
Ditching—31, 259, 304, 349, 420.

**E.**

- Electrical Apparatus—22.  
Elevation of Curves—55, 56, 57, 312, 313, 314, 364, 365, 410, 452, 453.

**F.**

- Fences—222, 251, 400.  
Freight, Found—251.  
Frog Blocking—275.  
Frogs, proper condition of—274.  
Frogs, Rigid, Standard—514, 515, 516, 517, 519, 521, 522, 523.  
Frogs, Spring, Standard—516, 517, 518, 519, 520, 521, 522, 523.

**G.**

- Gage, Regulations for—205.  
Gates, Regulations for—250.  
Guard Rails, Care of—365, 366.  
Guard Rails, Standard—523, 524.

**I.**

- Inspection of Track—14.

**J.**

- Joints, Care of—205, 269, 360.  
Joints, Standard—501 to 511, inclusive.

**M.**

- Mail Bag Crane—101, 524.  
Material Shipments—22, 259, 279, 323.  
Material, Use of—215, 280, 323, 372, 373.

**O.**

- Obstructions to Trains—220, 252, 254, 406.

**P.**

Penstocks—524, 525.

Policing, Rules for—79, 80, 81, 82, 215, 327, 328, 375, 421.

**R.**

Rails, Renewal of—280, 310, 311, 312, 359.

Rail Sections, Standards—501 to 511 inclusive, 525, 526.

Records—172 to 204 inclusive, 232 to 244 inclusive.

Regulations for Roadway Employees—7 to 14 inclusive, 25 to 84 inclusive, 111 to 123 inclusive, 216 to 281 inclusive.

Reports—172 to 204 inclusive, 232 to 244 inclusive, 329, 376, 377, 378, 424 to 429 inclusive.

Requisitions—232.

Road Bed, Care of—25, 205.

Road Bed, Standard Sections—529 to 541 inclusive.

Road Crossings, Care of—210, 253, 419.

Road Crossings, Standard—527, 528, 529.

Roadmasters, Rules for—283, 339, 340, 341, 342, 343, 436, 440, 441, 445.

Rubbish, Rules for Handling—254.

**S.**

Scrap Material—407, 408.

Section Foremen, Rules for—115, 116, 117, 130, 131, 245, 287, 331, 378, 398 to 443, 447 to 451.

Signals and Electrical Apparatus—22, 142 to 148, 258, 278, 257, 256, 284.

Signals, Position of—17, 18, 142 to 148.

Signal Men, Rules for—122, 123.

Signs, Care of—90, 91, 250.

Signs, Standard—541, 542, 543, 544.

Shims, Rules for Using—16, 17, 261, 359.

Snow Trains and Shoveling—21, 276.

Spikes, Standard—38, 268.

Supervisors, Rules for—21, 111, 112, 128, 129, 284, 335, 336, 337, 338, 339, 382, 383, 384, 385.

Switches, Tables and Rules—210, 52, 53, 208, 271, 272, 273, 250, 316, 344, 345, 346, 347, 348, 365.

Switches, Standard—544, 545, 546, 547.

Switch Tenders—121, 137, 301.

Station Grounds—215.

Stock Reports—250.

Surfacing—260.

Switch Stands, Standards—547, 548, 549.

Supplies—75.

**T.**

- Tamping, Rules for—262, 420.  
Telegraph Line—215, 254, 222.  
Tell-Tales—277, 512.  
Ties, Renewal of—264, 265, 266, 267.  
Ties, Spacing of—208, 267, 395, 396, 397, 423.  
Ties, Specifications for—17, 32, 85, 86, 307, 354, 355, 423.  
Tie Plugs—308.  
Tie Plates—549, 550, 551, 552, 553.  
Trespassers—20.  
Track Scales—271.  
Tools, Care of—75.  
Tools, Standards—553, 554, 555, 556, 557.

**W.**

- Washouts, Regulations for—246, 247, 249.  
Watching, Regulations for—76, 119, 121, 136, 137, 280, 246, 247, 300,  
303, 318, 368.  
Water Column, Standard—524, 525.  
Water Stations—326, 375.  
Weeds—Cutting of—254, 421.

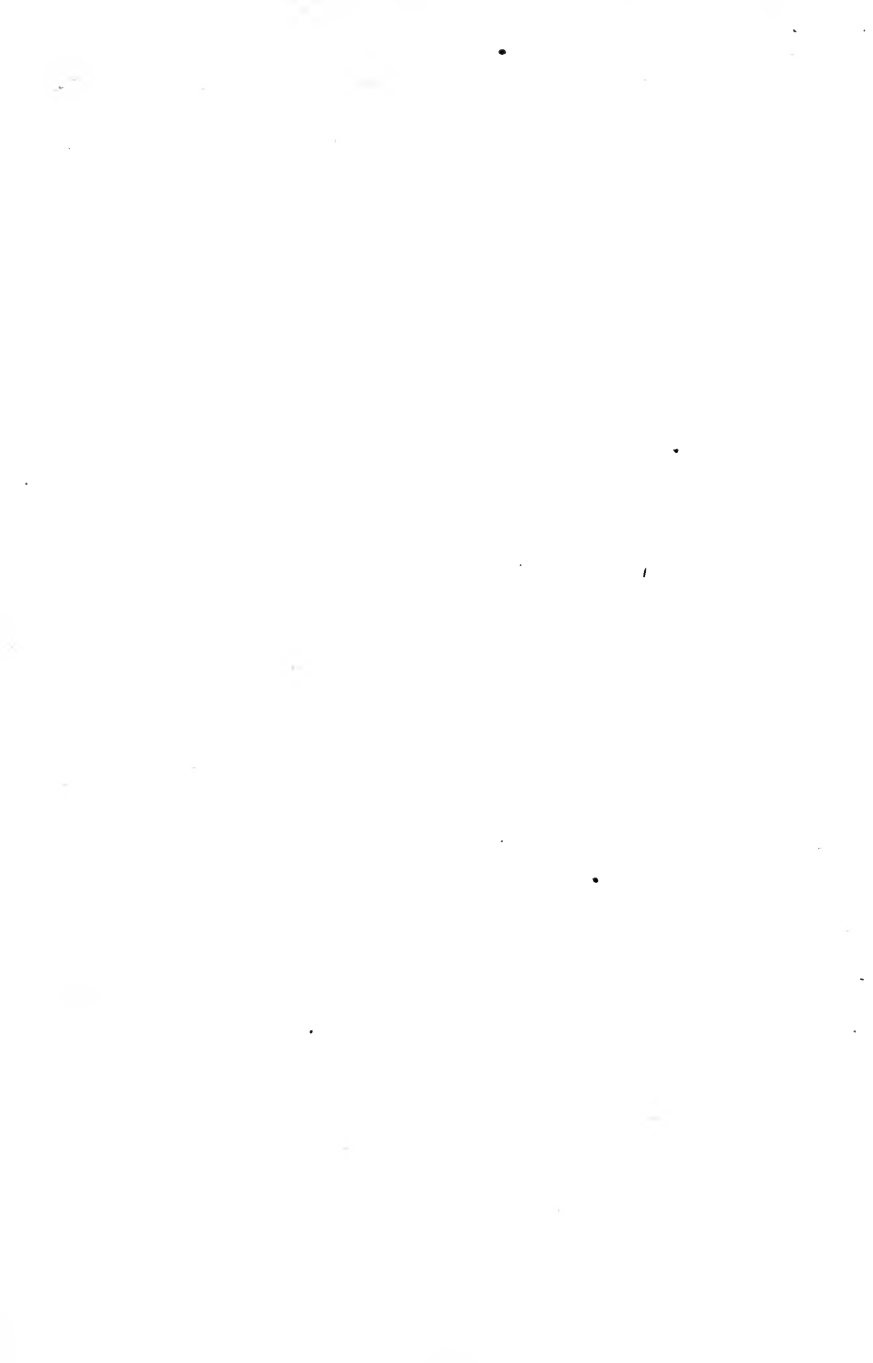



## PREFACE.

There is no branch in the railway service in which there is less uniformity in the mode of operation than in the Roadway Department. While physical conditions are naturally vital factors which affect the methods of doing track work, they do by no means preclude the possibility of creating standards for certain classes of work which might be advantageously adopted by all roads, thereby securing the all-important element of uniformity in the Road Department, which feature has wrought such excellent results in the traffic and other branches of the railway service.

In presenting this work to the railway public in general, and officers interested in roadway affairs in particular, we aim to pave a road which will ultimately lead to the promulgation of an official code of Maintenance of Way Standards and Rules which will be adopted by all roads. It will be seen that we have carefully compiled the codes governing trackmen of American roads, from the Atlantic to the Pacific; thus all conditions under which track work must be carried on are represented.

It may also be of interest to note that but a very small percentage of roads have any definite form of rules for the government of their Maintenance of Way forces. For such roads, we believe, this volume will prove of great value, as it furnishes them a most ex-

cellent variety of matter from which to select suitable rules for their own roads.

While the subject is not exhausted, the ground is sufficiently covered to give, in convenient book form, much valuable matter relating to existing Standards and Rules which has not heretofore been published, and which, we trust, will be a help to all who are seeking information in regard to current practice on American roads.

F. A. SMITH, C. E. M. E.

We beg to return thanks to the Chief Engineers of the various roads for material forwarded, and also for drawings of standards received too late for insertion, but which will appear in the second edition.





## SECTION 1.

### CHAPTER I

#### BOSTON AND ALBANY RAILROAD.

##### MAINTENANCE ACCOUNTS.

Each Foreman will keep a careful record of all the labor done under his charge, in the time book or on the individual time sheets; and also such additional memoranda as are necessary to enable him to show at the end of each month the exact portion of his time report in dollars and cents, which should be charged to each of the accounts named in the list or to any other work which he was authorized to do. He will report such distribution of charges on the proper blank, as is provided, to his Division Master, and report the same total on the regular time report to the Springfield office.

##### ROADWAY.

The first ten accounts on the list are the roadway accounts, which are presumed to exhibit the regular expense of maintenance with some degree of uniformity per mile of road. Each of these roadway accounts must show separate amounts for main line and each branch.

1. Main Tracks.—To this account, or to any sub-

division of this account for each branch—which should always be distinctly expressed—charge all the expense of keeping the main track or tracks in repair, together with the cost of labor on renewal of rails, ballast, sleepers, fastenings, switches, and frogs in the main tracks, timbers, &c., ditching, surfacing, policing, and care of the right of way and general work on the section.

2. Side Tracks.—Charge to this account in the same manner as above directed, the expense applied to all the other tracks on the section, but not to include the care of right of way unless the side track is on a separate right of way branching outside of the location, or the outside areas of the large yards. New side tracks will be reported separately.

3. Snow and Ice.—Charge to this account only the immediate expense of getting rid of the snow and ice.

4. Accidents, Fire Damages and Washouts.—Charge the extra work at wrecks, cost of combatting fires that may damage railroad property, or woodland, &c., outside of location, but not including cost of burning right of way, also charge cost of extra work at washouts.

5. Fences and Highway Crossings.—Charge expense of fence repairs, including stone fences. Report entirely new fences separately, with the length of the same. Charge cost of cattle guards, planking crossings, and crossing signs and gates.

6. Masonry.—Includes cost of repairing bridge abutments, arches, culverts, retaining walls, &c., not including cattle guards, or walls built only for a fence, or masonry which belongs to some building, or regular or special account mentioned below. It will

include work done by the masons on drainage or sewerage, which ought not to be included in any of the following accounts.

7. Iron Work on Iron Bridges.—Refers to the repairs of riveting, and parts of iron bridges already completed, with painting, inspection, &c., of the same, but not including any of the expense of the repairs of the wooden floor, which expense may be charged to the bridge account. Keep separate account of all expense, including cost of floor, cleaning the ground, false work, &c., of each new bridge built of iron, reported as work on New Iron Bridge, No.

8. Bridges.—This account includes all the general work of bridge repairs, excepting masonry and iron work on iron bridges, and includes the wooden parts of the floors of iron bridges.

9. Water Works, Tank Houses, &c.—Refers to the expense of maintaining all the apparatus belonging to the water supply for railroad purposes.

10. Railroad Buildings.—Refers to the maintenance of railroad buildings and structures not mentioned below.

Take particular care not to include in the above accounts any expense which belongs to the following regular accounts, or to any expense of a special account, for such new work as may be ordered from time to time.

#### COST OF SHIPPING SLEEPERS.

Includes the expense of loading and transportation of sleepers from the piles to where inspected, but does not include the cost of handling when on the section where they are to be used, such expense

belongs to the main or side track repair account, or new track account, as the case may be.

#### WOOD AND CHARCOAL.

Includes cost of handling and producing wood and charcoal, with delivery of the same. When construction trains are collecting old ties, &c., it properly is part of the cost of cleaning up the right of way, and should be charged to track repairs, according to the locality. When odd car loads of such are sent to the pit, and the expense of loading charged to track work, the Section Foreman who simply goes to the pit to unload the car may charge such expense to wood and charcoal.

#### WHARVES AND DOCKS.

Includes dredging expense—unless it is for the Ferry—and repairs of sea walls, wharves, &c., but not any expense on the buildings which may cover it.

\* \* \* \* \*

#### WORCHESTER UNION DEPOT.

All expense of repairs, renewals, changes, &c., including cost of removing snow from the roofs, and track used by the connecting roads between Grafton street and a line 50 feet east of the train house.

#### EAST ALBANY FERRY AND SLIPS.

Including boat, dredging, piling, bridge drops, cutting ice, winter bridge, and all belonging to the business of the apparatus for crossing the Hudson River.

#### GRADING.

This is the general account, to include all expenses where land is laid out and graded and cultivated.



Each locality will be considered separately, and so reported.

Ordinary grading and smoothing of the right of way will not be charged to this, as these belong to main track work.

## BOSTON SHOPS.

Includes maintenance of Machine Shops, blacksmiths, Boiler Room, Slide table, and the fixed plant for heating; but not the engine or machinery.

## ALLSTON SHOPS.

Same items as mentioned above, but not including the outside standing or switching tracks.

\* \* \* \* \*

## HALL SIGNALS.

Includes also the mast, chain, house, and all the incidental expense. Report each branch separately.

Towers	20	} Are to be reported as separate maintenance accounts.
	28	
	35	
	45	

## INTERLOCKING IN GENERAL.

Includes maintenance expense at all the other towers.

Hall Signals.	} All the expense of maintenance and operation.
Union “	
Electric Light, Boston.	
“ “ East Boston.	
“ “ Worcester.	
“ “ Springfield.	

## GRAVEL AND CONSTRUCTION TRAINS.

The Foreman on this train will report all his help as a unit charged to this account, also the number of engine-days' work. Then report on what work each

engine-day or part of a day was spent, and if gravel is being hauled, give a detailed report of the number of car loads. If sleepers are handled, report how much time of the train should be credited to this account and charge the cost of shipping sleepers.

#### STEAM SHOVEL AND ITS TRAINS.

Charge to this account all the expense of work done at the shovel or pit on the temporary tracks for the same, on the trains or on the dumps. Report daily, on the proper blanks, every item of work done.

Gravel or temporary tracks are not included in the account of side tracks, belonging either to one or the other of the accounts of construction train or steam shovel.

Always keep such memoranda that a detail account can be furnished showing number of days' work at each rate per day for each of the above accounts, or any new work that may be ordered.

Foremen having any work to do on account of rentals will make out a detail statement monthly, showing labor amounting to the sum charged as above, as directed, also material used, which statement shall show the different sums expended on each house.

When material used is taken from stock on hand, it should be so reported.

In filling out the blanks used by the Track Foremen, showing material used, specify whether that used in repairs was for main track or side tracks.

The popularity of a railway with the public, and its consequent prosperity, depends in a great measure upon the courtesy and attention which its employees pay to its patrons. Every servant of the company

will be expected to treat every person with whom he may come in contact with respect and courtesy.

Every person in the employ of the company is to devote himself exclusively to its service. He must obey promptly all instructions he may receive from persons placed in authority over him, and conform to all the regulations of the company. He will be liable to immediate dismissal for disobedience of orders, negligence or incompetency. No one, whatever his rank, will be allowed to absent himself from his duty without permission of the head of the department in which he is employed.

All persons in places of trust in the service of the company must report any misconduct or negligence, affecting the interest or safety of the road, which may come within their knowledge.

Perfect familiarity with the following Rules, as well as with all Special Regulations, which may accompany the Time Table, or which may be issued at any time separately, by the proper officers, will be expected of all employees of this company.

In case the instructions are not understood, necessary explanations must be asked of the heads of Department.

Smoking in or about the shops, at the depots, or on the passenger engines or trains of the company, while on duty, is prohibited.

The regular compensation of employees covers all risk of accident.

A Red Flag by day, or a Red Light by night, shown upon the track, is a signal of danger, and requires every train to stop as soon as possible

Torpedoes must be used in addition to flags or

lights whenever there is a doubt that the flag or light may not be seen by reason of fog, storm, or other emergency.

A Red Flag by day, or a Red Light by night on an engine, indicates that another train is following, and no train or engine shall move in either direction over that portion of track where this signal has been carried, until the train or engine for which this signal was carried has passed.

No train or engine shall carry a Red Flag or Light without orders from the General or Division Superintendent's office. Conductors and enginemen or extra trains must know that the proper signal has been carried.

In all cases where the signal is at all earnest, the train must be stopped so that the person giving it may be conversed with, and the facts ascertained, even if the person making it is not provided with the proper danger signals.

Section Foremen will see that all track instruments are in position—half an inch from and a quarter of an inch higher than the rail.

Trackmen with hand-cars will use the jumping iron, so as not to operate the track instruments; they will avoid disturbing the apparatus and report by telegraph any needed repairs.

In moving a switch to which the signals are attached, it must be thrown clear over before being set back to position on main track. Track instruments must be kept clear of snow and water.

In case of accident to a train, or the track is obstructed, the flagman shall go back instantly with danger signals to stop any train or engine which may

be following. At a point 900 yards from the rear of the train or obstruction, he shall place an explosive cap on the rail. He shall then proceed 900 yards further to the rear—making 1800 yards in all from the obstruction, and place two explosive caps on the rail, five yards apart; he may then return to a point 1200 yards from the rear of his train where he must remain until called in by the whistle of the engine; but if the signal of recall is given within twenty minutes of the time of a passenger train, he must remain at his post until it arrives. When recalled, the flagman will remove the explosive cap nearest to the train or obstruction, but the two explosive caps must be left on the rail as a caution signal to any following train. If the accident occurs upon single track or both tracks of the double line are blocked, the fireman shall go forward and protect the head of the train, in the manner prescribed for the brakeman to protect the rear. The conductor, as well as the engineer, is required to know that the fireman performs this duty; if he is unable to go, the front brakeman shall be sent in his place. When a torpedo is exploded by an engine passing over it, the train must be stopped immediately. Torpedoes are supplied from the Mechanic's office.

For the maintenance of the permanent way, the road is divided into four Divisions:

#### Divisions Described.

\* \* \* \* \*

Each one of these Divisions is subdivided into sections of about four miles in length, under the immediate care of a Section Foreman, who will report to

and receive instructions from the Division Road Master. They are required to pass over the entire length of their sections daily in person and make careful inspection of the track, sidings, permanent way, bridges, switches, frogs and ties, and make repairs sufficient to keep the line in the highest state of efficiency. They have charge of the repairs of their respective sub-division, and will be held responsible for the condition of the road and the watching necessary to secure the safety of trains at all times.

They must never allow the track to be obstructed in any way without first displaying a danger signal in a conspicuous position, far enough from the work in progress or obstruction to stop any approaching train. Any work which will render the passage of trains unsafe will be considered an obstruction, and must not be attempted without first displaying the necessary danger signal.

A track jack within the limits of the track, will be considered an obstruction, and in no case will be used or brought upon the track without first protecting approaching trains.

During heavy rains, storms and thaws, extraordinary precaution must be taken to prevent accident. All hands must be on duty day and night until the danger is past. At such times the track must be constantly patrolled and examined with great care. They will pick up everything which may fall from passing trains, and send it to the nearest Station Agent.

They will report to the Division Roadmaster all animals killed or injured by trains, and all fires set by

STANDARD ROAD VIEW.

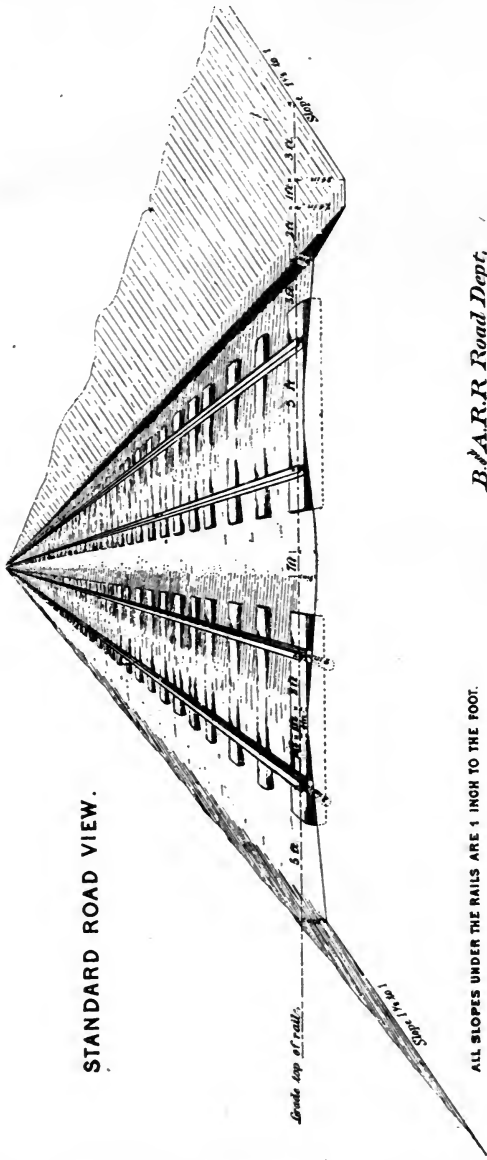

ALL SLOPES UNDER THE RAILS ARE 1 INCH TO THE FOOT.

*B.A.R.R. Road Dept.*

sparks from the engines, if there is any damage to property.

Section Foreman will report on the cards prepared for that purpose all fires occurring on their sections which are caused by sparks from the locomotives.

They will report, also, all cases of damage by fire to buildings belonging to the Railroad Company, whether caused by sparks from the locomotives or otherwise.

Section Foremen will not allow any person not in the employ of the Railroad Company to enter upon the Railroad Company's location for the purpose of digging under the tracks on account of the lying or repairing of any drain, water, sewer or gas pipe of any description, or for the purpose of constructing or repairing any bridge or other structure, either over or under the tracks, without first obtaining permission from the Chief Engineer or the Assistant Engineer.

The use of hand-cars on Sunday is prohibited except for the necessary work of the Company.

The telegraph lines must be watched, especially after storms, and when found broken the Trackmen will, in the absence of the line repairers, unite the wires so as to render them temporarily effective.

Each division is in charge of a Division Roadmaster, who has control of the Section Foremen and their men, and whose duty it is to see that instructions to the Section Men are faithfully executed, and that the sections are supplied with men and materials, sufficient to keep the line in the highest state of efficiency. They are required to pass over the whole length of their respective divisions at least once a



week, and make careful inspection of the work in progress.

They will be held responsible for the Section Foremen, and must see that none but competent careful men are employed. They will also see that the work is done in a proper and economical manner.

All requisitions for men and materials will be made on the Roadmaster in chief.

Each division has a Master Bridge Carpenter, whose duty it is to make careful and minute examination in person of all the bridges on his division, as often as once each month.

He shall also have in charge the repairs of buildings, water tanks, platforms and crossing signs, and keep them in proper repair. All requisitions for men and materials shall be made on the Roadmaster in chief.

There is one Master Mason for the whole line, whose duty it is to make careful examination of all culverts, arches, abutments, and walls of masonry. If any signs of weakness are discovered report it immediately to the Roadmaster.

The Engineer and Roadmaster in chief will have the general supervision of the permanent way, tracks, bridges, masonry and buildings.

He shall pass over the road as often as once a month, from end to end, making careful inspection of the property intrusted to him.

He shall see that the Division Roadmasters, Carpenters and Masons are diligent in the discharge of their duties, and that good discipline is maintained.

All Division Roadmasters, Master Bridge Builders, Master Mason and men under them, are subject to

the Roadmaster in chief, and are subordinate to him

No new work, other than repairs incidental to the proper maintenance of the track, will be undertaken without orders from him.

#### INSPECTION OF TRACK.

CLASS A, 1—*Alignment*. The body of the rails should be in a true line or vertical plane—such as sighting by a plumb line would give—without either short jogs or long swings for the straight parts of the location.

On curves the perfect alignment would be a true curve without unevenness or variations as staked out. Curves should not be swung outside of the line of the tangent extended, as may often be observed near the ends of curves.

A condition of bad joints may exist on what could be fairly termed a good line.

2—*Surface*. This is the same kind as alignment, only surface refers to the horizontal view of the rails, and alignment as before explained.

The two rails of each track should compare at all opposite points. If on a tangent, exactly level; if on a curve, exactly inclined according to the rule. The surfacing should be adjusted to the grade, and the ballast to the surfacing.

CLASS B, 3—*Joints*. Those on one rail should be nearly opposite midway between those on the other

They should be accurately in conformity with balance of the track, both as pertains to alignment and surface; marks on both these points are to be made under the head of joints.

The fish pieces and bolts ought always to be complete, and kept well screwed up.

The rail ends should be double spiked so as to prevent kicking out.

The proper space between the rail ends ought to be maintained.

4—*Spikes*. Two spikes at least are necessary at each rail bearing.

Any looseness or movement up and down under the spikes is a defect. Spikes should be plumb, entire and driven well home.

CLASS C, 5—*Switches*. These, as all the other parts of the connections, should receive constant and particular attention. Head blocks should be firm; and lines, gauges and spaces truly adjusted.

The gate ought to stand plumb, and the targets kept well painted.

6—*Frogs*. All possible service should be gotten out of a frog, but one badly worn or showing signs of weakness, or a broken one, should be promptly removed.

The condition of the timbers should be observed, as well as the guard rails and castings.

CLASS D. 7—*Ballast*. Good gravel is the best, but the Foreman cannot be held directly responsible for its quality. It should be distributed as far as it will go, in conformity to the standard cross-section. Care might be taken not to get too much ballast deposited; where this occurs and the track cannot be raised, the spare material should be used on the edges of the shoulder, making a line parallel with the rail.

8—*Sleepers*. They should be spaced and lined according to the rule. Decayed and badly cut ties should be promptly removed. They will wear best if sorted, so that the dimensions will run evenly.

CLASS E. 9—*Ditches*. Ditches should be dug as nearly as possible to the full dimensions, and at proper locations. The bottom should have a considerable grade. They should be kept clean and free from obstructions. Avoid digging the ditch and throwing the material on the slope in a cut.

10—*Cleanliness*. Under this head may be criticised the depot grounds adjoining the tracks, the surroundings of the tool houses. Arrangements should be maintained with the mechanics and employees of the transportation departments, regarding the care of tools and material frequently left in the yards or on the road. Also, the disposition and orderliness of spare material and scrap heaps—the entire appearance of the location and in some instances the fences. The timber or wood growth should be kept from impending the observation of the enginemen. Brush should be removed at stated intervals; grass and dry stuff on the location burned over as often as necessary, to prevent fires; and no growth at all permitted on the surface of the road-bed. The condition of the crossings should be regarded under this head, excepting what pertains to line or surface.

Particular attention should be given to remarks under Class B, in relation to bolts and nuts; also the condition of the spikes, and the connections for switches and frogs. When rails are cut into the track, both ends must be drilled and bolted, except at a chair-rail joint.

#### RULES FOR USING SHIMS.

When laying 30 feet rails. The bars will expand  $\frac{1}{4}$  of an inch for 100 degrees.

Particular care must be used to lay them according to the following table:

When the day is

Very hot,	100	degrees,	allow	for	3-16	inch	space	at	every	joint.
Warm,	75	"	"	"	1-4	"	"	"	"	"
Medium,	50	"	"	"	5-16	"	"	"	"	"
Frosty,	25	"	"	"	3-8	"	"	"	"	"
Very cold,	0	"	"	"	7-16	"	"	"	"	"

Take care to see that the proper Shims are used when the rails are put in place, and have them removed just as soon as it is certain that the work ahead will not drive the rails together, say five or six joints back of the new work.

Report each case of a broken rail on the blanks provided for that purpose; also say if the rail is mended and kept in the service or taken out.

When inspecting sleepers, be guided by the following

#### SLEEPER SPECIFICATIONS.

The Boston & Albany Railroad Company will pay the following prices for sleepers, delivered upon the line of their road.

For a sleeper having a	7	inch	face,	7	inches	thick,	8	feet	long,	50	cents	each.
"	"	"	6	"	7	"	"	8	"	40	"	"
"	"	"	5	"	7	"	"	8	"	35	"	"
"	"	"	5	"	6	"	"	8	"	20	"	"

The sleepers must be of chestnut, free from decay, shakes and rotten knots; to be faced straight on two parallel sides; the ends to be sawed square, and the bark removed; and must not be hewed or split on more than two sides.

#### THE FOLLOWING ARE THE RULES FOR SETTING SWITCH TARGETS AND LIGHTS.

Quarter-turn switch gate should face approaching trains with green light.

When wrong for main track, show red to approach-

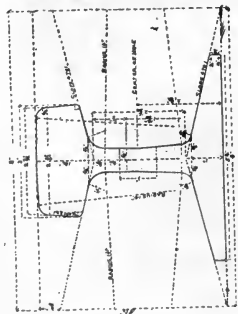
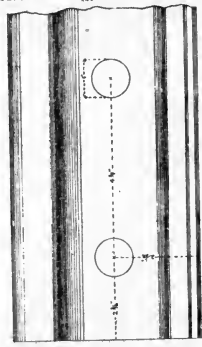
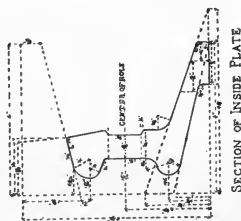
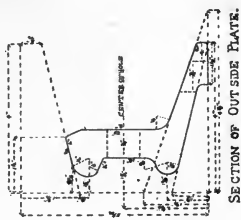

ELEVATION  
OF  
OUTSIDE PLATE

ELEVATION  
OF  
INSIDE PLATE

**STANDARD  
95 LB RAIL  
&  
ANGLE PLATES  
B. & A. R. R.**

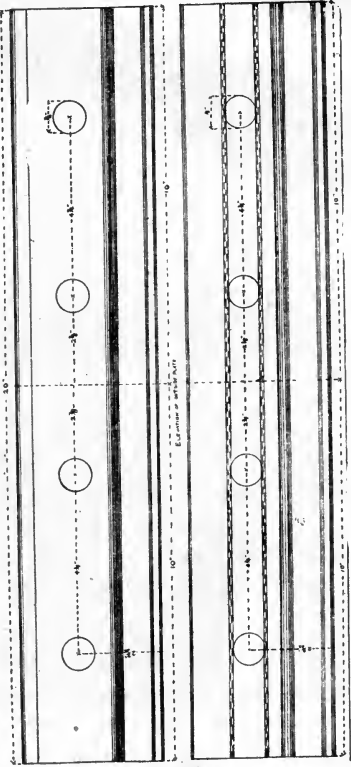

*Actual  
100/100*

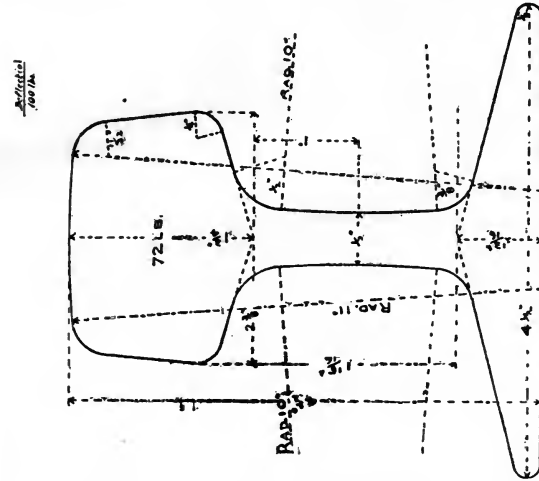

SECTION OF 72 LB. RAIL LAID IN 1886 TO 1890, INCLUSIVE.

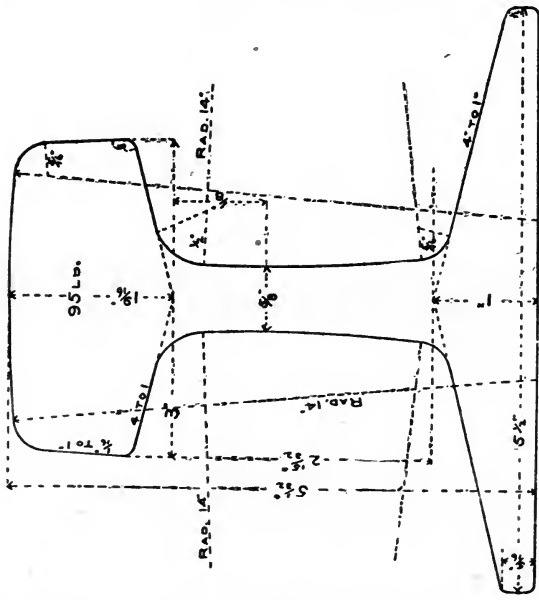

SECTION OF STANDARD 95 LB. RAIL LAID IN 1891, AND TO DATE.

ing trains, and white opposite the red for the train which may be switching behind it. In no case show red to an approaching train on opposite track.

Target square, white to match green light; black behind.

When turned, red target under red light and black behind, pointer set so as to point to the side to which switch is thrown, so that switching train behind can see it.

When point switches are being put in, the outside turnout rail should have a decided angle about two feet ahead of the switch-point, so that the point of the switch may lay up close to that rail without being forced or sprung by moving switch. The outside rail and also the main straight rail should have the guards and bearing plates put in and spiked before trains are allowed to pass, as the tread of the wheel when trailing out may force the outer rail when the switch is not properly supported.

Set the guard rails  $1\frac{3}{4}$  inches from the main rail.

Report each case, when a frog or switch, or either rail of a switch, is changed. Use the frog and switch report blanks for that purpose.

#### TRESPASSERS

Are forbidden to deposit ashes or rubbish of any kind upon the tracks or other premises of the Boston & Albany Railroad Company. Foremen will use all proper means to prevent such abuse, and report such cases as they cannot control.

Foremen will collect any lanterns lost by trainmen on the road, and send them to the freight train dispatcher at Boston, Springfield or Greenbush, as the case may be.

Each Section Foreman will report on the accident



report cards all trouble with, extra work for, or accidents to or on account of telegraph poles and wires.

Any person in charge of a hand car should provide protection whenever the car has to be lifted across a track, or whenever the car may obstruct any main track on which the view is limited.

When a hand-car is left on a siding, or hand-car bridge, or plank crossing, so that it can be pushed out and obstruct the main track, the wheels should be chained and locked, or else the car should be derailed in a position to prevent any careless or malicious obstruction.

Hand-cars will be controlled and protected as trains when under the interlocking.

#### SNOW TRAINS.

##### TO DIVISION ROADMASTERS.

Make arrangements annually, in November, for cleaning the track of snow and ice as follows

1. Examine the plows and scrapers, see that all are provided with necessary tools, lanterns, flags, &c., and are in order for service.

2. Have them conveniently located, ready for use.

3. Have a list, including the call men, made of all who are to go on the train. If necessary, apply to the Division Superintendent to detail a conductor, &c.

4. When you think the plow or scraper ought to be run, apply to the Division Superintendent for an engine and the right of way for your train.

5. Arrange for necessary night watch and prompt reports.

6. Leave the list of men, with the number of the scraper or plow and portions of road allotted to them,

with the Division Superintendent, for use, in case you cannot be heard from.

7. Send a copy of the list to the Engineer's office, also report the mileage of each car.

#### SHIPPING OF MATERIAL TO DIVISION FOREMEN.

1. Provide each of your men who has to send out supplies of tools or materials with a book of the blank notices.

See that he understands how to use it, as follows:

2. Always use the notice when anything of value is to be sent out.

3. Ship the articles to some individual, at the place where they are wanted, so that the agent will know whom to notify; and send the notice to the place where the individual lives.

4. Describe the articles, so that he may know when he gets the whole, and state on what train or car number.

5. Write your own name after the printed words—"promptly to"—and fill out the stub before you tear off the notice to send.

6. If the notice is not signed and returned within reasonable time, ascertain the reason, and report.

7. On receiving the returned notice, note it on the stub that belonged to it.

8. If the material was for new work or any special account other than regular main track repairs, send the returned notice to this office.

\* \* \* \* \*

#### SIGNALS AND ELECTRIC APPARATUS.

Trackmen will avoid disturbing any of the apparatus connected with the automatic signals, and when

by accident any part is disarranged they will report the fact at once by telegraph, if necessary, to the Assistant Engineer at Boston. They will also advise of any needed repairs to signal apparatus.

Where there are rail circuits, Trackmen will be careful not to disturb or break any of the wires attached to the rails, and when any are found broken the Section Foreman will replace them with new ones as soon as possible.

When any of the rails, switches or frogs included in a track circuit are disconnected or removed the new work must be drilled and new wires immediately put in. No holes are to be left over night without wires.

Take particular care at switches not to drive spikes so as to touch both the main and the switch rails on the side where these rails are separated.

Section Foremen are to see that insulated joints are kept in good order, the ties under them well tamped, and bolts tight. They will renew the insulations when requested by signal men. When work is to be done which will interfere with any of the signal apparatus, or a track or switch instrument is to be moved, notify the signal man to be present.

All interlocking appliances, signals and electric apparatus are placed under the control of the Road Department.

Employees, whose duties relate to the use or care of any of the above, will regard the rules and instructions of the Engineer, and report as required.

This order will not affect the duty of any person to give the proper attention to the train service, according to the general or special instructions.

Requisitions for men to operate the appliances will be made on the Division Superintendent. Requisitions for material will be made on the Road Department.

All material required on the Road, in the Shops, or at Stations and offices of the company, will be purchased only under direction from the office of the General Superintendent.

On or before the 28th of each month, Heads of Departments and Division Superintendents will make requisition for all supplies needed for their use during the coming month. They will instruct subordinates to make requisition on them for whatever may be required in their departments.

The necessary requisitions, accompanied by estimates of the cost for material that is needed for repairs or new work for the following month, will be made on the Head of the Department on or before the 25th of each month, and no material is to be purchased until the requisition is granted. Section Foremen will communicate their needs to the Division Roadmaster in time for the above.

## CHAPTER II

### BALTIMORE AND OHIO RAILROAD.

#### ROAD-BED AND BALLAST.

The object of a ballast is to secure a solid bearing for the cross-ties and hold them in position; to distribute the train load over a large surface; to carry off water during rains; to prevent, as far as possible, the freezing of the road-bed and to give elasticity to the track.

The material in all cases must be stone, gravel or furnace slag, clear and hard, so as not to pack in a solid mass and thus prevent the passage of water from the track. Ashpan cinder may be used on branches where other material cannot be obtained.

Stone or rock ballast must be broken evenly in pieces that will pass through a two and one-half inch ring. There must be a uniform depth of at least twelve inches of broken stone under the ties, and the space between the ties must be filled level with, but not above, the tops of the ties. From the end of the ties the ballast must be sloped evenly to the sub-grade.

Gravel ballast must be clean and placed to the same uniform depth under the ties as stone ballast. The filling between the ties must be the same as pre-

scribed for rock ballast, except that the sloping to subgrade should commence at the rail instead of at end of the tie.

Where the ballast is very thin, or where there is none at all, the filling should be two inches above the ties at the center of the track, sloping uniformly to one inch below the bottom at the ends of the cross-ties, and thence out to the bottom of ditch. An inch space must be left under the rails for the passage of water from the tracks.

Before ballast is distributed the subgrade must be prepared in accordance with the standard diagram, and the banks widened so that the ballast will not be wasted or washed away.

Between main track and sidings, large coarse stone must be placed at the bottom, but not at the ends of the cross-ties.

In raising the track the tamp must be used on each tie from a point one foot on each side of the rail and ballast simply shoveled in at middle. Special attention must be given that the tie is tamped directly under the rail, which, because it is a difficult point to reach, is apt to be neglected by the men. Tamp all ties as evenly as possible, and always tamp the joint ties last.

In using track jacks they must always be set on the outside of the rail. Serious accidents have resulted from trains striking them when set on the inside of rail, and no excuse will be accepted for this practice.

Road crossing planks, where used, must be securely spiked. The planking should be one half of an inch below the top of the rail, and two and one-half



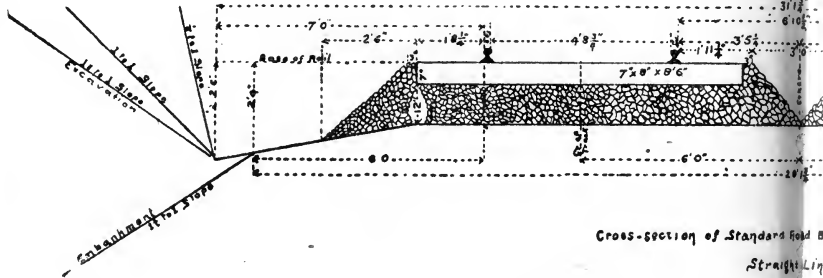

Cross-section of Standard Road B  
Straight Line

# STANDARD ROAD BALTIMORE

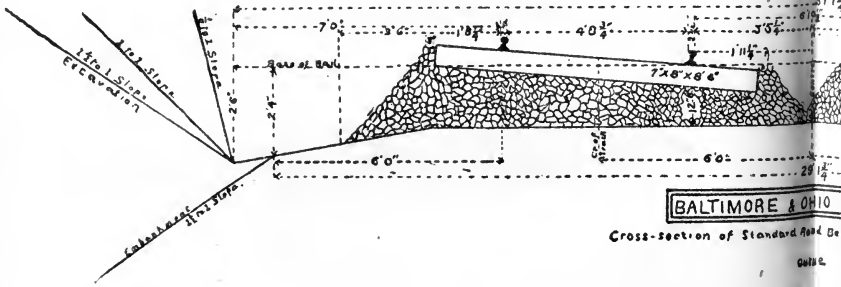

**BALTIMORE & OHIO**  
Cross-section of Standard Road B

cut 2.



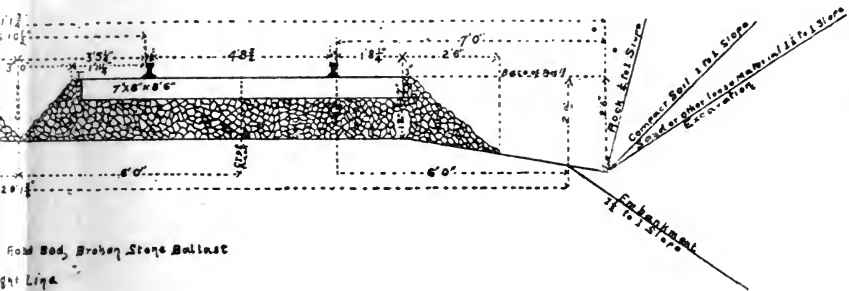

# D BED SECTIONS

## RE & OHIO R.R.

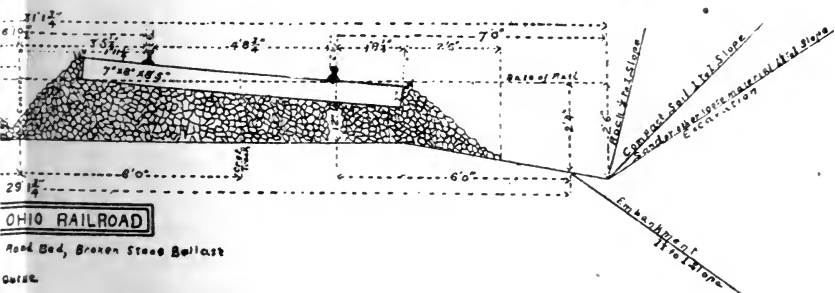

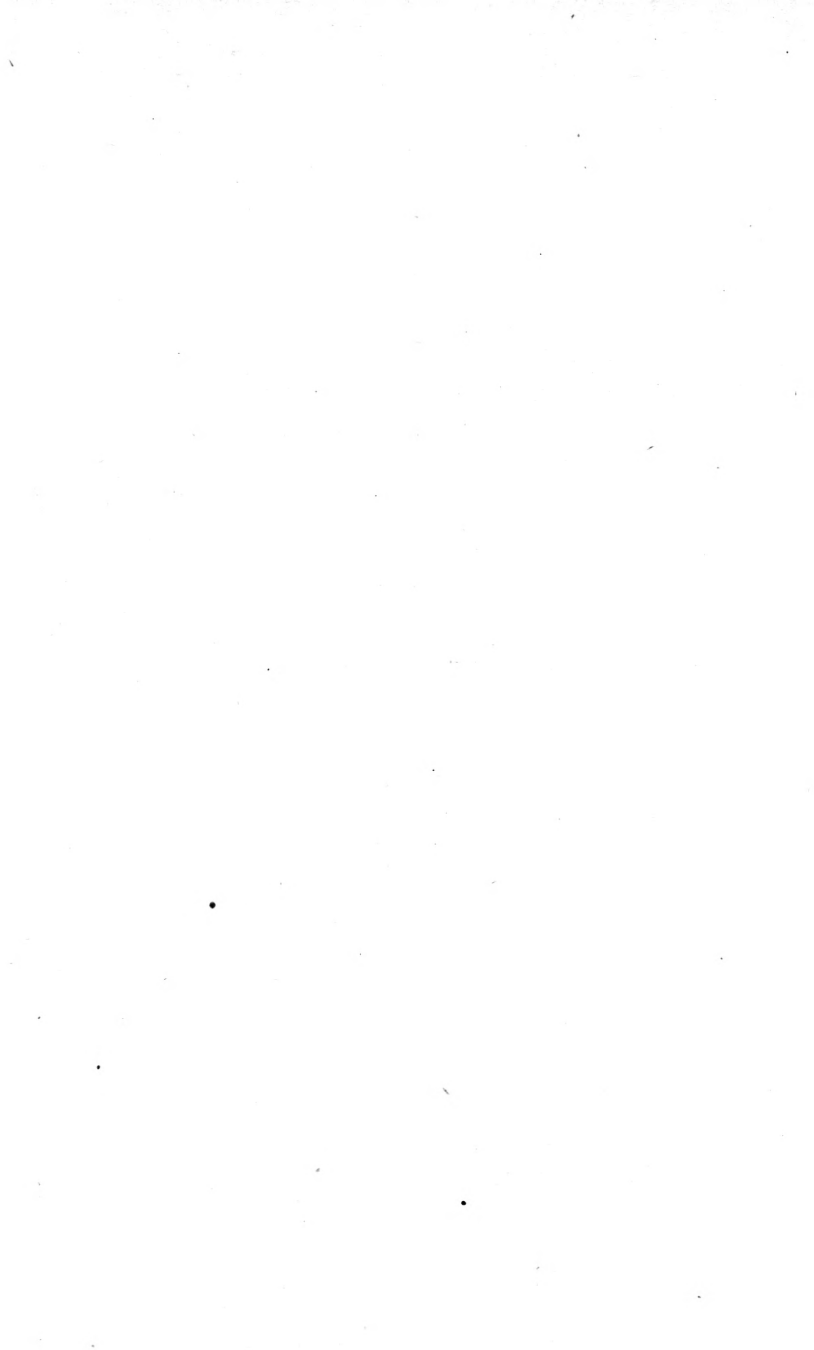

inches from the gauge line. The ends and inside edges of planks should be bevelled.

#### DITCHING.

Embankments and ditches must, as rapidly as possible, be brought to the designated standards. Where the standard cannot be attained, owing to a scarcity of earth or the narrowness of cuts, the banks and ditches must conform to the standard pattern as far as practicable, and all work should be performed with a view to ultimately reaching the standard.

The standard widths of banks for single track is not less than 17 feet on top, and for double track 29 feet, which should be kept free from grass; but on the slopes the growth should be encouraged to prevent washing.

Where the cuts will admit, the cross section of all ditches must be made to conform to the standard diagram. The ditches must be graded parallel with the rails so as to pass water freely during the heaviest rains and thoroughly drain the road-bed. The outlines must be clearly defined, and all earth taken from ditches or elsewhere must, in all cases, be dumped over the bank and leveled off to allow complete drainings. Under no circumstances must the earth be so placed that it will be washed back and obstruct the ditches.

Cross drains must be put in wherever they are necessary.

All new ditches must be dug and all old ditches cleaned for the winter season if possible before the first day of November.

Ditches, box drains and culverts must be frequently examined and cleaned of all obstructions to the free

passage of water. Masonry that has been washed or undermined must receive prompt attention, and serious cases reported to the Supervisor.

Frequent examinations should be made of all channels and streams on each side of the road, and all drift, brush and movable obstructions removed. This is as essential below the road as above, as damage may result as much from back water as moving obstructions.

In addition to the ordinary care bestowed upon culverts and drains, each Section Foreman must during the month of October make a special and careful examination of every culvert and drain in his section, and remove all brush and other obstructions to the channel for some distance, both above and below, and make a report of each culvert to the Supervisor.

#### CROSS-TIES.

All cross-ties used in the main track must conform strictly to the following specifications: Material—sound, white, chestnut, burr or rock oak, free from wind shakes, length  $8\frac{1}{2}$  feet on lines east of Ohio River, and 8 feet on lines west of Ohio River, with the ends sawed square. Thickness, 7 inches. Face nowhere less than 7 inches; if split ties are furnished, not less than 8 inches.

Ties must be hewed to the exact thickness with parallel faces throughout. All bark must be entirely removed. Accepted ties must be distinctly marked "B. & O." in red. Special attention must be given to the length of ties, and none accepted which do not conform to specifications.

Cross-ties should, as far as possible, be laid early in season, so that all track work in the summer will be



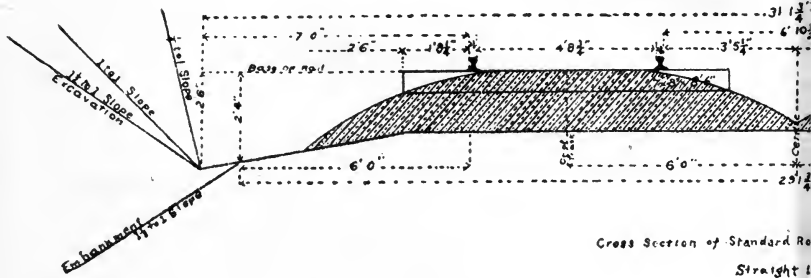

Cross Section of Standard Road  
Straight

# STANDARD ROAD BALTIMORE

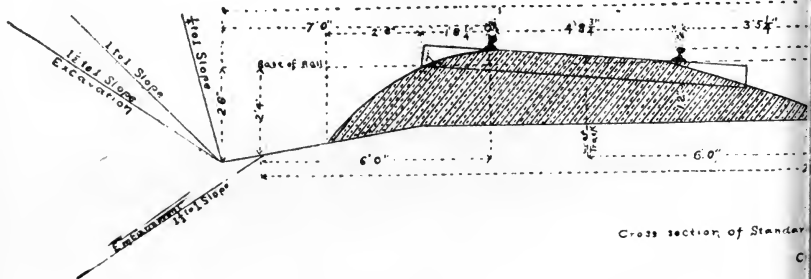

Cross section of Standard Road

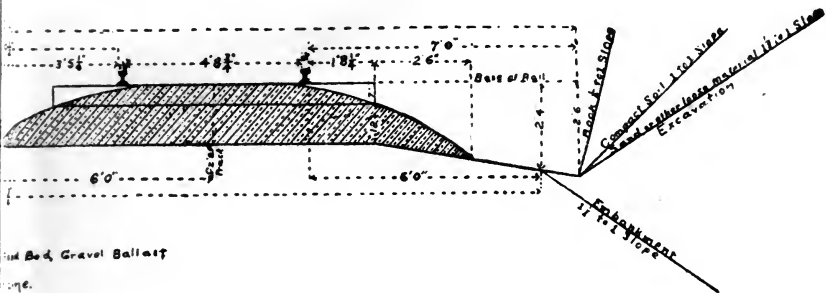

# BED SECTIONS

## & OHIO R.R.

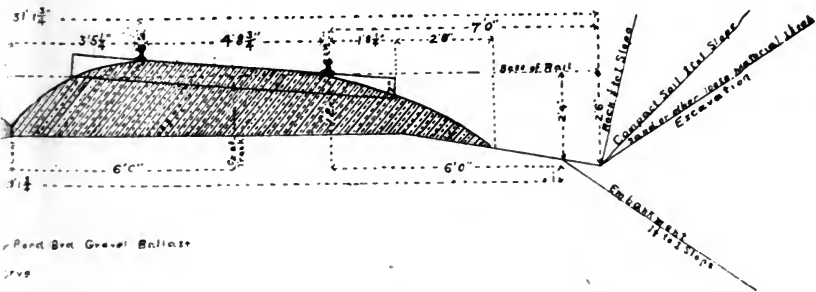

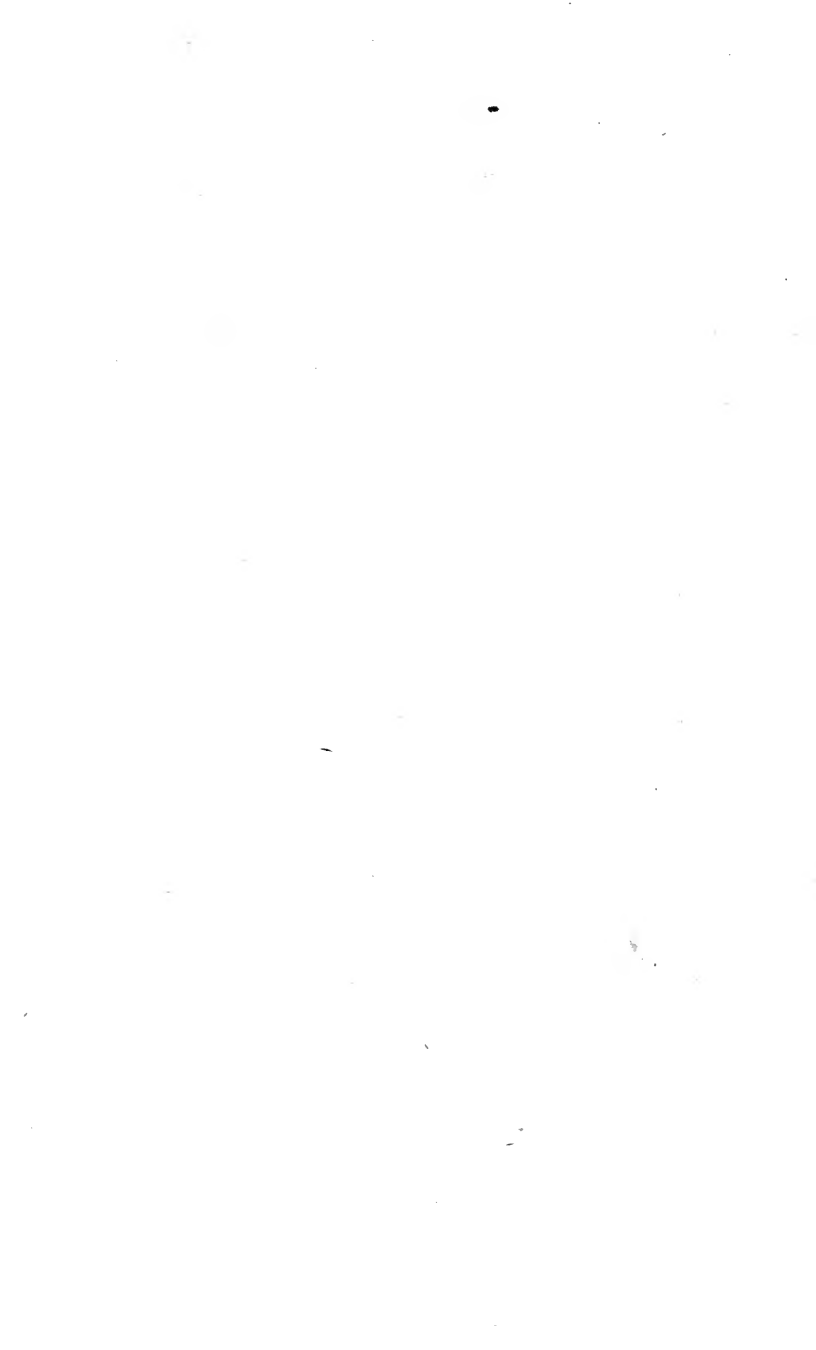



on sound timber. To effect this the Section Foreman must, during the month of September, determine by actual count, and not by estimate, the number of cross-ties he will need on each mile of his section during the ensuing season and report to the Supervisor, who will make requisition on the Division Engineer.

The ends of all cross-ties must be lined parallel with the rail on the right-hand side going west on single track and on the two outside ends on double track.

In all new work not less than sixteen ties must be placed under each thirty-foot sixty-seven pound rail, spaced evenly. Under heavier rail the number may be reduced as instructed by the Division Engineer. The largest and best ties, if there be any variation in width, must be placed at the joints, and the ties next to the joints should be as nearly as possible of the same size. When repairing old work any previous improper spacing must be corrected according to these instructions.

The proper spacing of cross-ties for the suspended angle joint is ten inches in clear between the edges of the two joint ties, and not more than fourteen inches between the edges of the intermediate ties.

The proper spacing for the supported joint is nine inches from the edge of the joint tie to either of the shoulder ties. The other ties must not be placed more than fifteen inches apart.

All the ties must be laid at right angles to the track, and no ties must be placed obliquely to suit irregular joints.

Cross-ties must never be notched; the adz must

be used to secure a true and uniform bearing for the base of the rail.

To prevent foul joints at switches and protect switch rods in case of derailment, all rods for stub switches must be confined between two cross-ties placed three inches apart.

Good serviceable cross ties must not be removed from the track, as economy demands that the full value of the timber be secured; at the same time sound judgment requires that rotten or defective ties be taken out.

Foremen must keep a supply of wooden spikes in the tool house and with gang, and whenever a spike is drawn from a sound tie the hole must invariably be plugged.

#### RAIL SPLICES AND SPIKES.

The distribution of rails must be made carefully, and rails must never be unloaded while cars are in motion.

Crooked or bent rails must be carefully straightened before they are laid in the track.

Before laying new rails all defective and decayed ties must be removed and new ones laid. The track must be surfaced so the new rail will not be bent or battered, and on all straight lines the tops of the rails must be made to strictly conform to the track level. The alignment must also be perfect, and no imperfections will be permitted.

Iron shims and not wooden chips must be used in all instances to separate the rails at the joints when laying track. When the rails are of uniform length the proper thicknesses are: During the coldest weather five-sixteenths of an inch; during spring



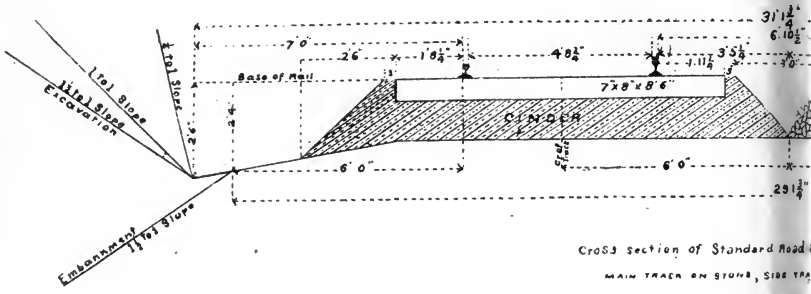

Cross section of Standard Road B  
 MAIN TRACK ON STONE, SIDE TRACK  
 . Straight Line

# STANDARD ROAD BALTIMORE &

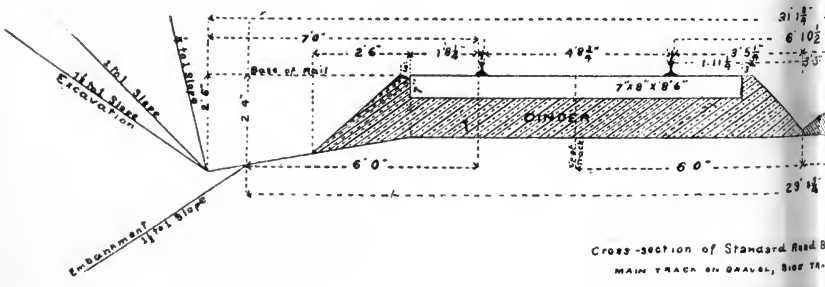

Cross-section of Standard Road B  
 MAIN TRACK ON GRAVEL, SIDE TRACK  
 . Straight Line

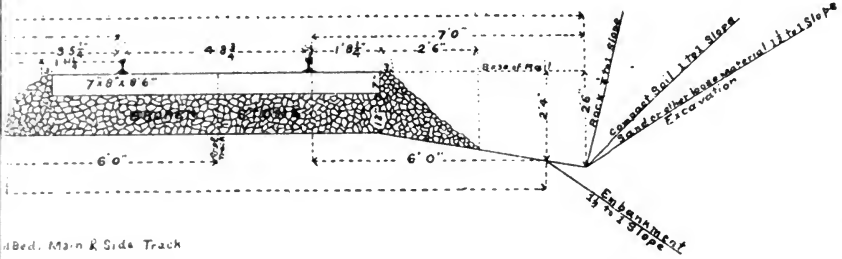

Bed, Main & Side Track  
taken on existing track

# D BED SECTIONS OHIO R.R

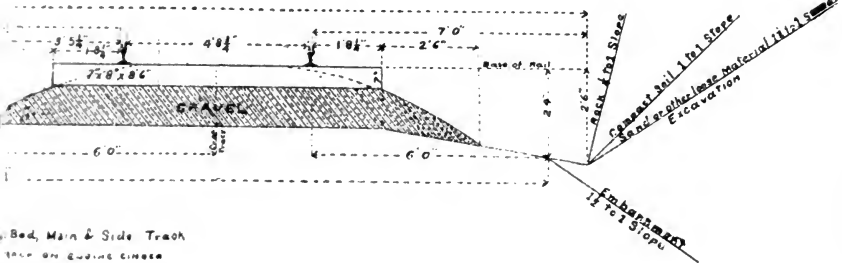

Bed, Main & Side Track  
taken on existing track

Line



and fall, one-eighth of an inch. During very warm weather one-sixteenth of an inch. This rule must be carefully observed.

When new rail displaces worn rail that is sufficiently good to be used in repairs again, it must be used where the same pattern of rail is laid, so that each kind of rail will be together.

When rails of different patterns join each other great care must be taken to get the upper surfaces and inside edges accurately matched by using step-chairs or other devices. All rails joined to others of different punching must have fish plates made to suit the different punchings.

The most fruitful source of laminations, breakage and damage to rails is low joints, and they must not be permitted to remain any longer than the time necessary to put them up. As soon as one is seen Trackmen must stop and raise it on stone, even if it has to be hauled a considerable distance on a push car. A few minutes timely work of this kind will often save many dollars in damage to rails and rolling stock.

In putting up low joints on rock, break the stone to the proper size, then cut out and cast away all the dirt and mud under the tie and tamp the rock under firmly and well, until a rock bed is made for that end of the tie. Whenever this sort of work is done the dirt must not be piled back over the rock, but the tie left open until such time as the point is reached in the regular course of ballasting the section.

The joints of the rails, in suspended or supported joints, must be as nearly as practicable opposite the centre of the rail on the other line of the same track; that is, the track must be laid with broken joints

Splices must be put on properly with the full number of bolts, nuts and nut locks. Nuts must be put on with the flat side put in and kept screwed tight to prevent rattling.

All rails must be spiked full on the main track, four spikes to each tie, and every spike must be driven home close, with a full hold on the rail. The last few blows should be given lightly, so as not to strain or break the head of the spike. The outside spike of one rail must be opposite the outside spike of the other rail, and the inside spike of one rail must be opposite the inside spike of the other rail. This rule must be observed on straight lines as well as curves. On sidings, between the clearance posts, only half spiking is premitted. Spikes must be driven perpendicularly, as the under side of the head of the spike is formed with a view to driving it straight and no spiker must lean the spike inward or outward to suit the swing of his maul. Neither must the attempt be made to draw rails to gauge with a spike. Throw the rail to gauge with a bar and drive the spike straight.

Spikes must be driven in the slots cut in the angle splice bar, which causes the splice to be closely confined between the spikes.

Switches and frogs must be kept well lined and free from snow and ice. They must work easily, have no lost motion, and be supplied with latches and locks. All spring frogs must have iron rail braces not more than two inches from the fly rail. All switches must be put in with the proper lead as shown in the attached table, and rails must be cut when necessary to make exact length.







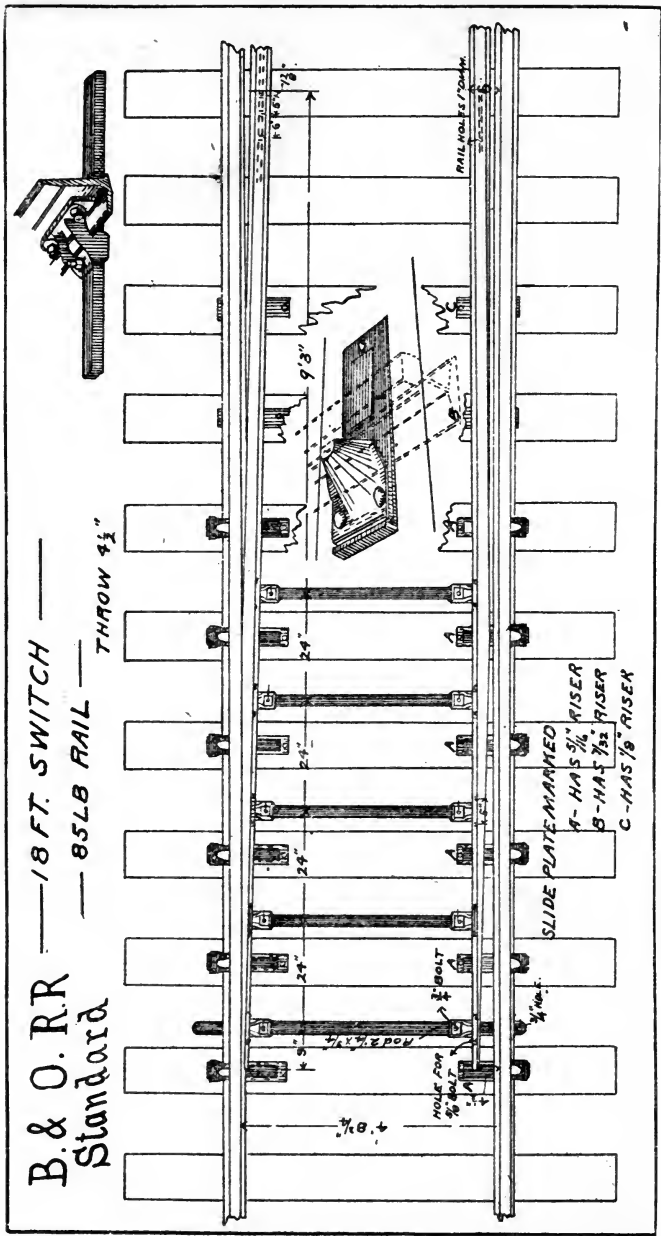

**B. & O. R.R.**  
Standard  
— 18 FT. SWITCH —  
— 85 LB RAIL —  
THROW 4 1/2"

SLIDE PLATE MARKED  
A - HAS 5 1/8" RISER  
B - HAS 7 1/2" RISER  
C - HAS 8" RISER

1/2" BOLT  
NUT FOR 5/8" BOLT  
1/4" W.A.S.

RAIL NOLLS FROM

7/8"

9 3/8"

24"

24"

24"

24"

24"

24"

24"



HIGH SIGNAL  
GROUND STAND

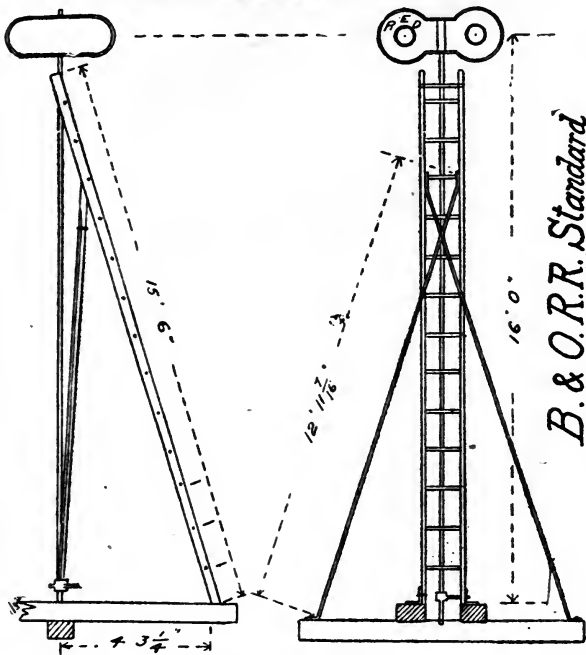

*B. & O. R. R. Standard*

LOW SIGNAL  
GROUND STAND

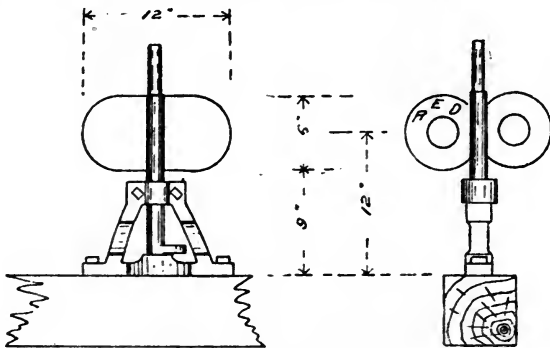

# B. & O. R.R. Standard

## SWITCH STAND

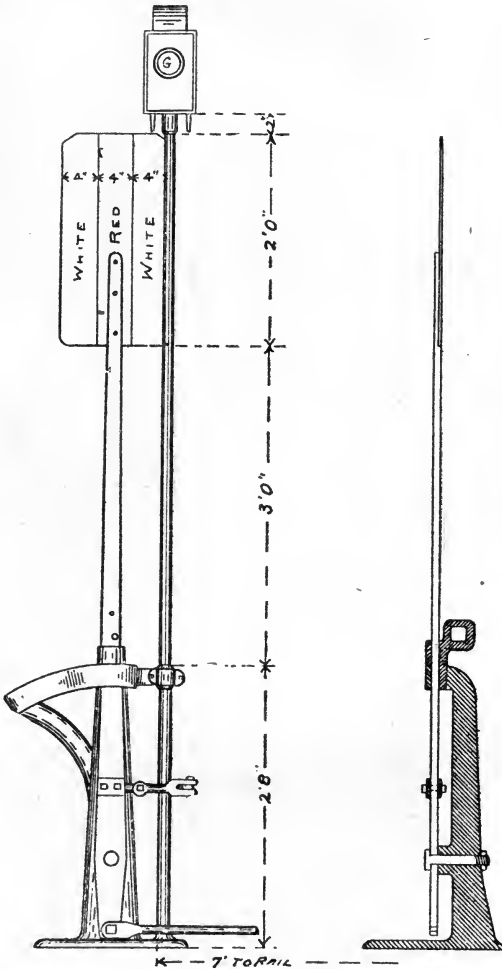

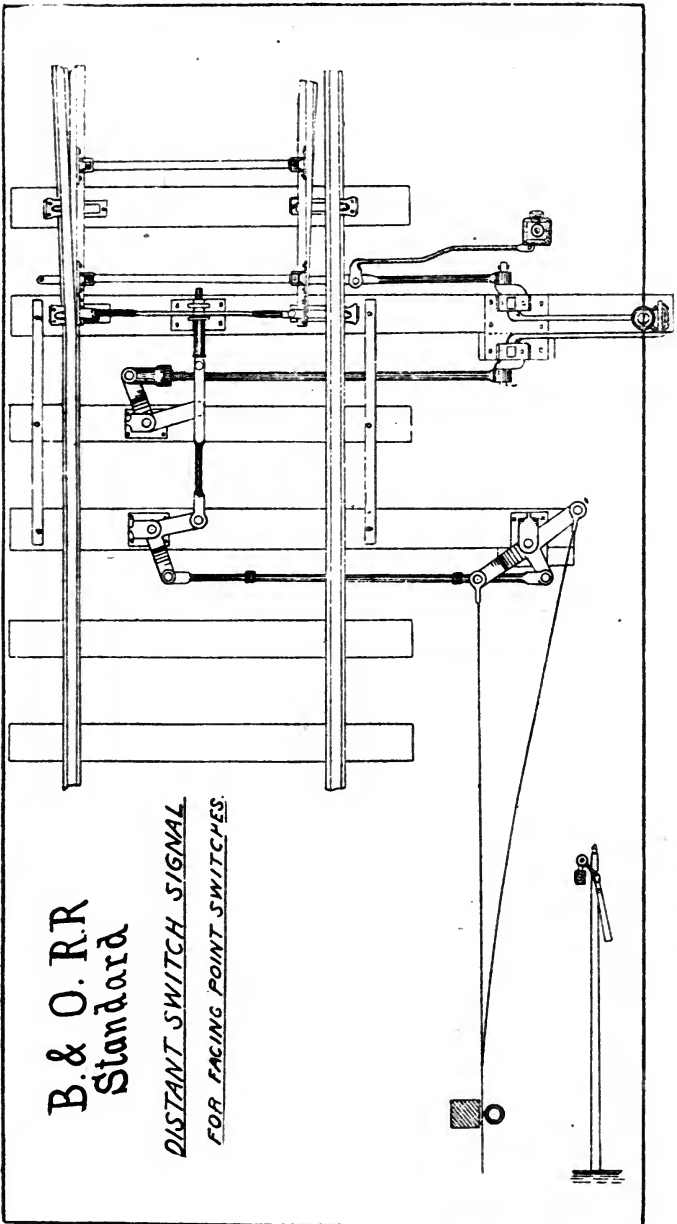

**B. & O. R.R.**  
**Standard**

*DISTANT SWITCH SIGNAL  
FOR FACING POINT SWITCHES.*

TABLE OF STANDARD SWITCHES.

Frog. No.	Frog. Angle.	Length of Split Switch.	Angle of Switch.	"E" Straight Wing of Frog.	"A" Distance on Straight Track from point of Frog to point of Switch.	Radius of Outside Rail.
1	53°.08'	7'.6"	3°.11'	2'.0"	13.7	6.80
2	28°.04'	"	"	"	21.2	29.0
3	18°.56'	"	"	"	28.1	69.7
4	14°.16'	10'.00"	2°.23'	"	37	129.5
5	11°.26'	15'.00"	1°.35½'	"	51.3	200.1
6	9°.33'	"	"	"	57.8	295.2
7	8°.10'	"	"	"	64.3	412.7
8	7°.10'	"	"	"	70.0	548.0
9	6°.21'	"	"	"	75.7	708.1
10	5°.44'	"	"	"	80.8	885.1
11	5°.12'	"	"	"	86.3	1102.5
12	4°.46'	"	"	"	91.3	1343.4
13	4°.24'	"	"	"	96.1	1616.9
14	4°.06'	"	"	"	100.4	1908.2
16	3°.35'	"	"	"	109.2	2653.4

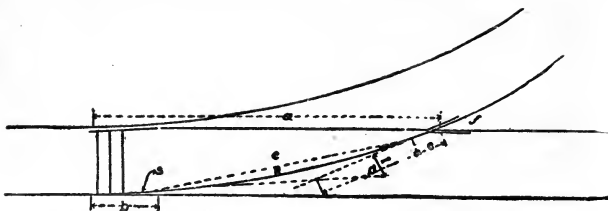

*a*—Distance on straight rail from point of frog to point of switch.

*b*—Length of split switch.

*S*—Angle between switch rail and main track rail.

*f*—Frog angle.

*e*—Distance from point of frog to point of curve.

*d*—Distance from *P. C.* to intersection.

*R*—Radius of outside rail.

*I*—Angle of intersection.

*g*—Gauge.



## FORMULÆ.

$$d = \frac{g - (\sin f e + \sin S b)}{\sin f + \sin S}$$

$$R = \frac{d}{\tan \frac{1}{2} I}$$

$$a = Co \sin S (b + d) + Co \sin f (d + e).$$

$$I = f - s.$$

$$c = Co \sin \frac{1}{2} I, 2 d.$$

New steel rails must not be cut or slotted under any circumstances. All closures must be made of pieces of steel rail. Foremen must use the drills to make holes when closures are made. No joint must permanently remain without the full number of bolts to each joint.

Guard rails in main track must be at least fifteen feet long, placed not more than two inches from the main rail, and must be braced with not less than three braces. All "point on" switches must have a guard rail not less than ten feet long placed on front of switch on side of continuous rail.

As rails are removed from the track, place at once all those that are good for future use on the north or east side of the track, and all those that are un-serviceable on the south or west side, and as far as practicable these piles should be made near mile posts.

The track must be laid to a perfect gauge, four feet eight and three-quarter inches, on straight lines, and on sharp curves the gauge may be widened not to exceed four feet nine inches.

Every Section Foreman, in the absence of special instructions, must determine by the following rules the amount of elevation required by each and every

curve on his section, making a note of same for future reference and guidance and apply the elevation determined.

It is a difficult matter to give one set rule for the elevation of the outer rail of curves that will suit under all conditions, hence the strict letter of the rule given cannot always be followed and the best results secured. As for example, when curvature occurs on double track and on steep grades, the trains passing in the direction of the ascent will necessarily move slower than if going in the opposite direction on the other track, hence the rule that would apply to the one track would not to the other, for curves with a great elevation offer at low speed a greater resistance than those of less elevation at same speed. Whereas, the alignment of both tracks being the same and the conditions exactly opposite, the rule for the elevation of the outer rail should be modified. Therefor two rules are given, one applying to single track lines where trains move in opposite directions, and for double track on descending and light ascending grades, where trains always move in the same direction. In order to determine the elevation required by a curve it will first be necessary to ascertain the degree of curvature or radius, which can be readily done by stretching a fifty-foot line along the inner or gauge side of the outer rail of the curve, letting the line touch the inner edge of the rail at the two points exactly fifty feet apart, and be stretched straight and taut between them. While two men are holding the line in this position the Foreman will measure with his rule the distance from the center of the line to the gauge line of the rail, which will give

what is known as the middle ordinate for fifty feet of the curve. Should the curve be on a single track line or on a descending or light ascending grade on double track, he will find in the following table the ordinate which corresponds nearest with the distance measured by the rule, and on the same line in the second column of the table will be found the proper elevation for the curve.

TABLE OF ORDINATES AND ELEVATIONS.

Table of Ordinates and Elevations for Curves to be used on Single Track Lines or Descending and Light Ascending Grades on Double Track.

Speed 40 miles per hour for curves to 5; over 5, 35 miles per hour.

Middle Ordinate for Fifty Feet of Curve.	Elevation of Outer Rail.	Degree of Curve.
$\frac{5}{16}$ inch	$\frac{1}{2}$ inch	$\frac{1}{2}$
1 "	$1\frac{1}{8}$ "	1
$1\frac{1}{8}$ "	$1\frac{1}{4}$ "	$1\frac{1}{2}$
$1\frac{1}{4}$ "	$2\frac{1}{8}$ "	2
2 "	$2\frac{1}{4}$ "	$2\frac{1}{2}$
$2\frac{1}{8}$ "	$3\frac{1}{8}$ "	3
$2\frac{1}{4}$ "	$3\frac{1}{4}$ "	$3\frac{1}{2}$
$2\frac{3}{8}$ "	$4\frac{1}{8}$ "	4
$3\frac{1}{4}$ "	5 "	$4\frac{1}{2}$
$3\frac{3}{8}$ "	$5\frac{1}{4}$ "	5
$3\frac{1}{2}$ "	$5\frac{1}{2}$ "	$5\frac{1}{2}$
$4\frac{1}{4}$ "	$5\frac{3}{4}$ "	6
$4\frac{3}{8}$ "	6 "	$6\frac{1}{2}$
$4\frac{1}{2}$ "	$6\frac{1}{4}$ "	7
$5\frac{1}{4}$ "	$6\frac{1}{2}$ "	$7\frac{1}{2}$
$5\frac{3}{8}$ "	$6\frac{3}{4}$ "	8
$5\frac{1}{2}$ "	7 "	$8\frac{1}{2}$
$6\frac{1}{4}$ "	$7\frac{1}{4}$ "	9
$6\frac{3}{8}$ "	$7\frac{1}{2}$ "	$9\frac{1}{2}$
$6\frac{1}{2}$ "		10

Where the middle ordinate of a fifty foot cord of any curve exceeds 6 9-16 inches, special instructions

must be obtained from the Division Engineer or Supervisor to suit the exigencies of the case, but in no instance on the main tracks must the elevation of the outer rail exceed  $8\frac{1}{2}$  inches.

Should a curve be on a steep ascending grade, on double track, where trains always move in the same direction, the elevation of the outer rail of the curve will be obtained by finding the middle ordinate for a cord of fifty feet of the curve as per instructions previously given and referring to the following table:

TABLE OF ORDINATES AND ELEVATIONS.

Table of Ordinates and Elevations for Curves to be used on Steep Ascending Grades on Double Track where Trains always move in the same direction:

Middle Ordinate for Fifty Feet of Curve.	Elevation of Outer Rail.	Degree of Curve.
$1\frac{5}{8}$ inch	$1\frac{5}{8}$ inch	$1\frac{1}{2}$
1 " "	1 " "	1 $\frac{1}{2}$
$1\frac{5}{8}$ " "	$1\frac{5}{8}$ " "	2
$1\frac{5}{8}$ " "	$1\frac{5}{8}$ " "	2 $\frac{1}{2}$
2 " "	2 " "	3
$2\frac{5}{8}$ " "	$2\frac{1}{4}$ " "	3 $\frac{1}{2}$
$2\frac{5}{8}$ " "	$2\frac{1}{2}$ " "	4
$2\frac{5}{8}$ " "	$2\frac{3}{4}$ " "	4 $\frac{1}{2}$
$3\frac{1}{4}$ " "	3 " "	5
$3\frac{1}{4}$ " "	$3\frac{1}{4}$ " "	5 $\frac{1}{2}$
$3\frac{1}{4}$ " "	$3\frac{1}{2}$ " "	6
$4\frac{1}{4}$ " "	4 " "	6 $\frac{1}{2}$
$4\frac{1}{4}$ " "	$4\frac{1}{4}$ " "	7
$4\frac{1}{4}$ " "	$4\frac{1}{2}$ " "	7 $\frac{1}{2}$
$5\frac{1}{4}$ " "	$4\frac{3}{4}$ " "	8
$5\frac{1}{4}$ " "	5 " "	8 $\frac{1}{2}$
$5\frac{1}{4}$ " "	$5\frac{1}{4}$ " "	9
$6\frac{1}{4}$ " "	$5\frac{1}{2}$ " "	9 $\frac{1}{2}$
$6\frac{1}{4}$ " "	$5\frac{3}{4}$ " "	10

NOTE.—The above table must be applied in determining the elevation of the outer rail for all curves on the main line. Should the schedule time of trains exceed forty miles per hour the elevation must be proportionally increased on instructions from the Division Engineer or Supervisor. For all yards and sidings use one-half the elevation given above.

In determining the degree of a curve ordinates should be taken at several different points, so that any especially sharp or flat places in the curve (which should be corrected when discovered) do not mislead in determining the true elevation for the curve. Some curves known as compound curves are purposely made sharper for a portion of their lengths, and some very long curves may change their degree several times in their entire length, but with a little care this can readily be detected in taking the ordinate and the proper elevations be applied to the several parts. At the point where the curve compounds it should have the full elevation of the sharper branch. Example: If a curve is a six degree curve for a portion of its length and a three degree curve for the remainder, the first branch, as it is called, will require an elevation corresponding to a six degree curve, and the second branch an elevation corresponding to a three degree curve.

All curves must have full elevation at their ends, which elevation must be carried uniformly around the curve, except in the case of a compound curve, and run down to a level on the straight lines at each end as soon as practicable. Ordinarily they should drop one inch to each thirty-foot rail, but where curves reverse, one directly to the other, with no straight line between them, no elevation can be given to either until the curves are entered; and when the straight line between them is very short it may be practicable to give the curves only a part of the elevation at their ends and the balance as soon as possible after entering them.

The elevation of curves is one of the most import-

Baltimore & Ohio R.R. Standard

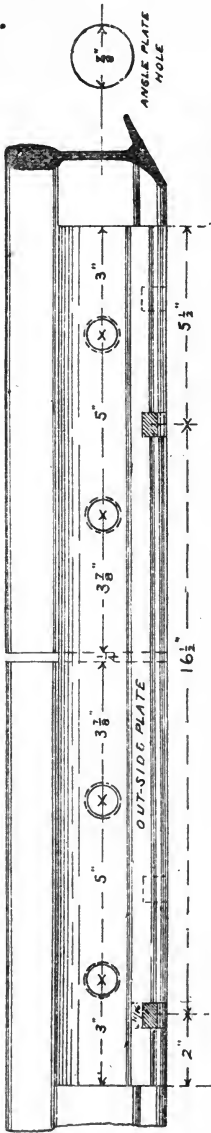

ANGLE "SPlice" — 67LB RAIL

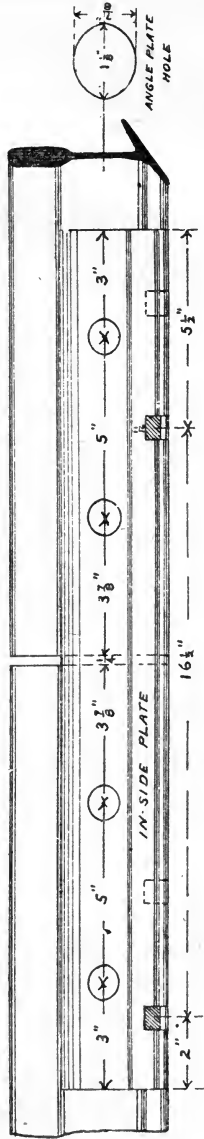

# B. & O. R.R. Standard

## 67 LB. RAIL

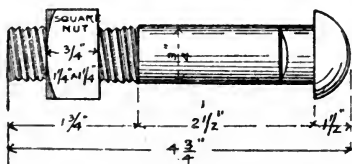
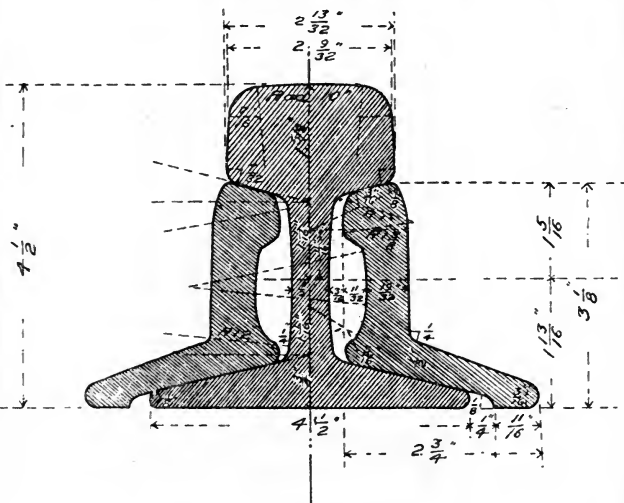
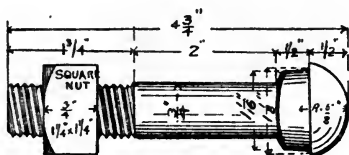

Baltimore & Ohio R.R. Standard  
 ANGLE SPLICE — 85 LB RAIL

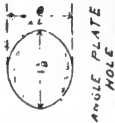

ANGLE PLATE HOLE

RAIL HOLES — 1" DIAM.

OUT-SIDE PLATE

IN-SIDE PLATE

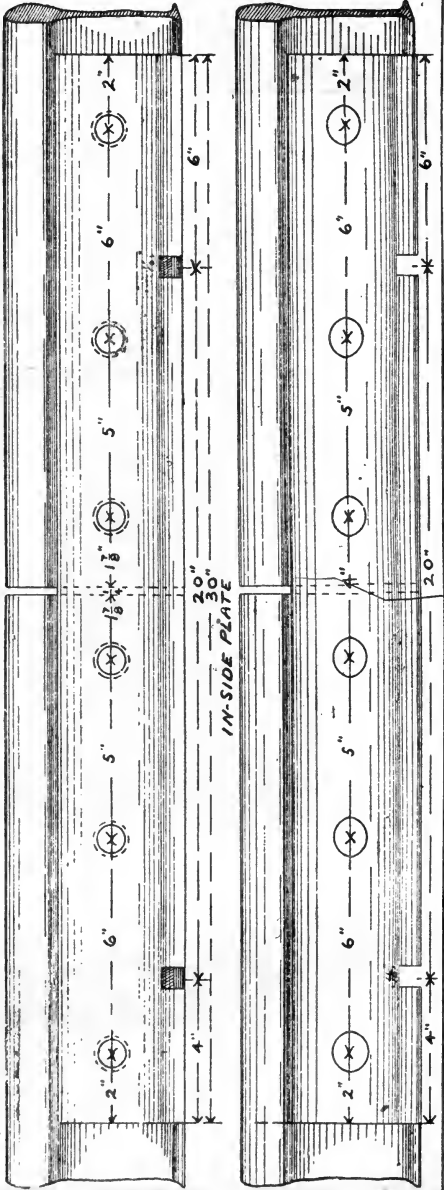



# B. & O. R.R. Standard

## 85 LB. RAIL

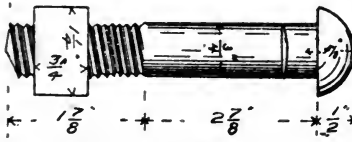
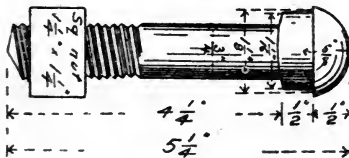
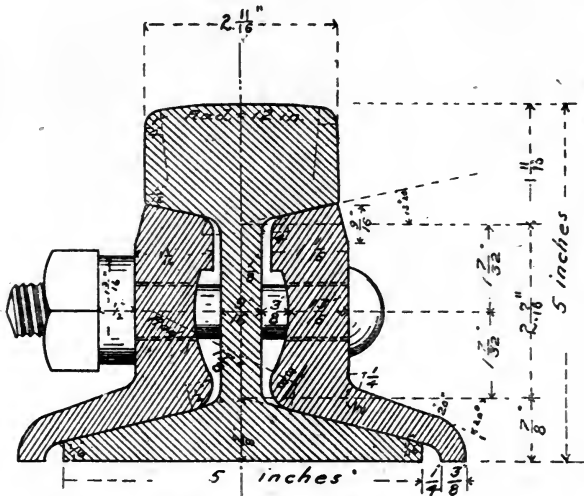

B. & O. R.R.  
Standard

NO. 6 CROSSING  
60 OR 67 LB RAIL

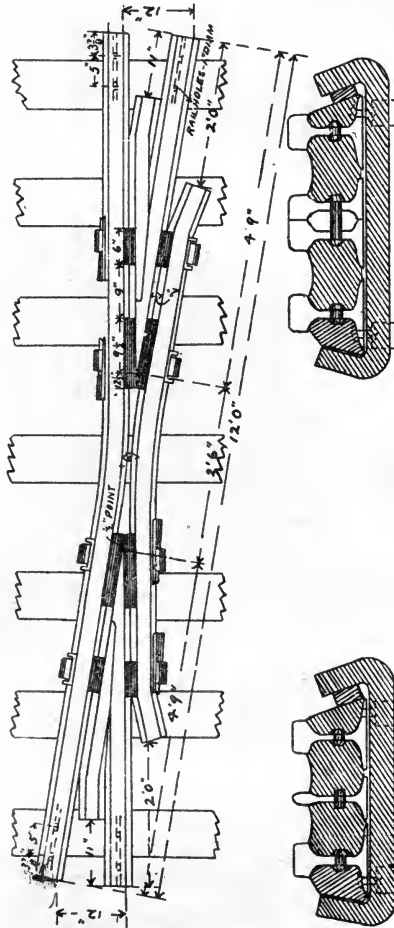







STANDARD FROGS BALTIMORE & OHIO R.R.

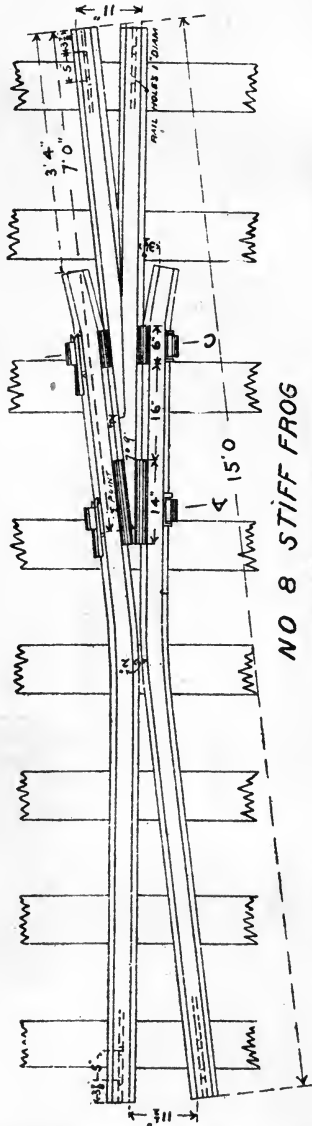

NO 8 STIFF FROG  
60 OR 67 LB RAIL  
THEORETICAL POINT TO HEEL — 7' 4"

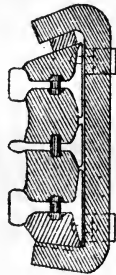

SECTION A-B

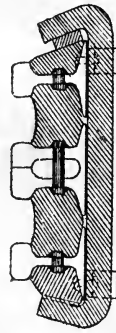

SECTION C-D

# STANDARD FROGS BALTIMORE & OHIO R.R.

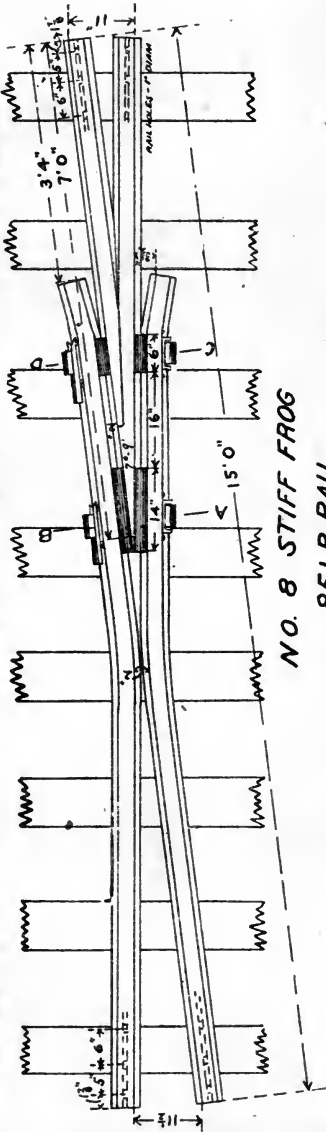

NO. 8 STIFF FROG  
85 LB. RAIL

THEORETICAL POINT TO HEEL — 7' 4"

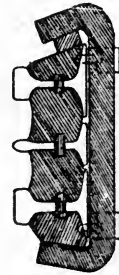

SECTION A-A-B.

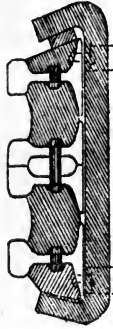

SECTION C-C-U.

**NO. 8 FROG — 60 OR 67 LB RAIL**

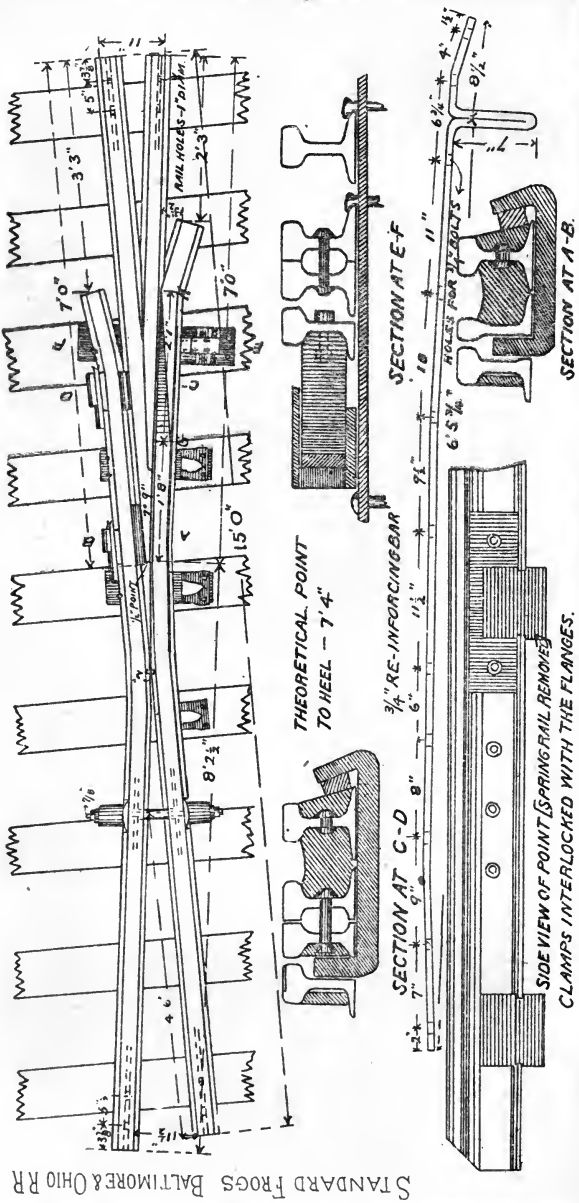

STANDARD FROGS BALTIMORE & OHIO RR

SIDE VIEW OF POINT (SPRING RAIL REMOVED)  
CLAMPS INTERLOCKED WITH THE FLANGES.







STANDARD FROGS BALTIMORE & OHIO R.R.

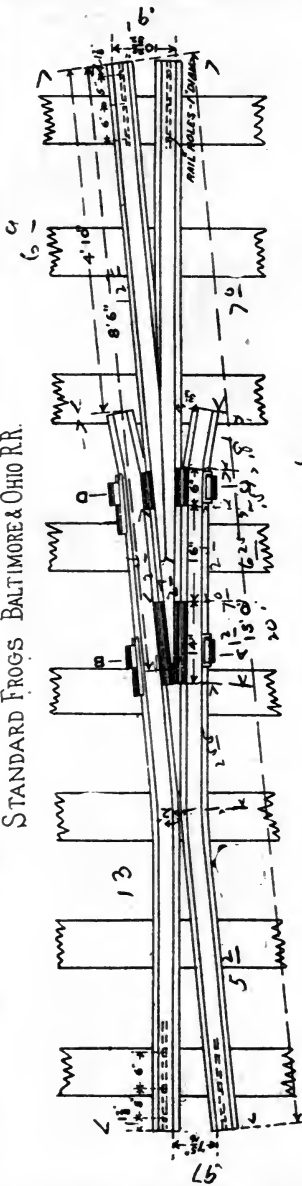

**NO. 10 FROG**  
**85LB. RAIL**

THEORETICAL POINT TO HEEL — 8'11"

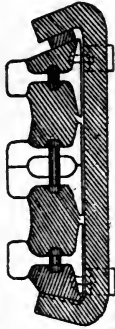

SECTION AT C-D

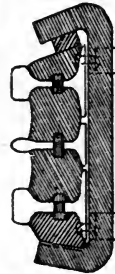

SECTION AT A-B

**STEEL SPRING**

FREE HEIGHT - 4" INSIDE DIAM - 1 1/2"  
SOLID HEIGHT - 2 1/2" DIAM. OUTSIDE BAR - 3/8"  
OUTSIDE DIAM - 2 1/4" DIAM. INSIDE BAR - 1/4"  
CAPACITY 1000 LBS WITH 1/8" MOTION LEFT

**NO 10 SPRING RAIL FROG**

600 R 67 LB RAIL

NOTE:-

MOVABLE WING RAIL TO BE PLAINED FROM 1' 8" TO 3' 9" [FOR 2 1/2"] FROM ACTUAL POINT OF FROG - COMMENCING AT 0 AT 1' 8" FROM POINT AND RUNNING DOWN TO 1/2" BELOW TOP OF RAIL AT 3' 9" FROM POINT AS SHOWN BY SPACING-G-H

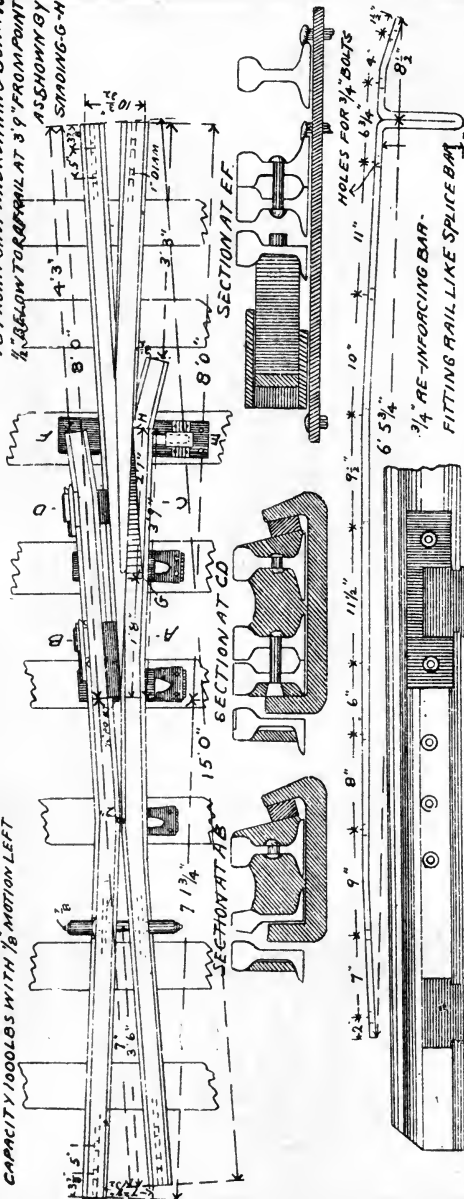

BALTIMORE & OHIO R.R.

STANDARD FROGS

**STEEL SPRING**

FREE HEIGHT - 4" IN VOID DIAM. - 1/2"  
 SOLID HEIGHT - 2 3/4" DIAM. OUTSIDE BAR - 3/8"  
 OUTSIDE DIAM. - 2 1/4" DIAM. INSIDE BAR - 1/4"  
 CAPACITY 1000 LBS WITH 1/8" MOTION LEFT

**NO 10 SPRING RAIL FROG**  
**85 LB. RAIL**

MOVABLE WING RAIL TO BE PLANED FROM  
 1' 8" TO 3' 9" [FOR 2' ] FROM ACTUAL POINT OF  
 FROG - COMMENCING AT 0 AT 1' 8" FROM POINT  
 AND RUNNING DOWN TO 1/2" BELOW TOP OF RAIL  
 AT 3' 9" FROM POINT AS SHOWN BY SHING G-H

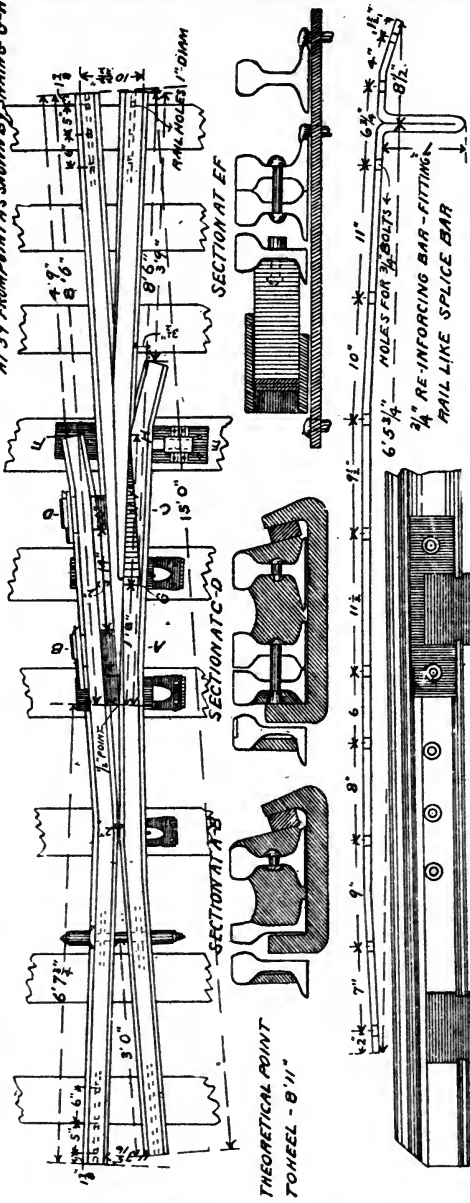

STANDARD FROGS BALTIMORE & OHIO R.R.

SIDE VIEW OF POINT (SPRING RAIL REMOVED)  
 CLAMPS INTERLOCKED WITH THE FLANGES.

ant matters connected with track adjustment, and should receive the closest attention of Section Foremen, for if neglected, besides endangering the trains, will result in the rapid wear of the rails and wheel flanges and the great discomfort of passengers.

Rail braces of the standard pattern must be used on both inside and outside rails at centers and quarters on all curves where an elevation of seven inches of the outer rail is required, and at such other places as may be found necessary, and then under special instructions from Division Engineers and Supervisors.

Keeping the track on straight lines, perfectly level crosswise, is of great importance, and will aid materially in preserving the alignment. Every Section Foreman should be provided with a level board for determining this and the elevation on curves.

#### HAND AND PUSH CARS.

When hand or push cars are not in actual use they must be lifted off the track and placed entirely clear of passing trains. When not within sight of the men they must be locked, and no car shall be used without the knowledge of the Section Foreman.

In no case shall a hand car be attached to a train in motion.

Rails must never be carried on hand cars except in case of an emergency.

Great care must be exercised when it is necessary to use hand or push cars during foggy weather or in the night. Foremen must always accompany the car.

No car will be run at night or on Sunday except in case of actual necessity. Cars must be kept under

lock and key, and in no case be used for personal purposes.

#### TOOLS AND SUPPLIES.

Foremen and all gangs will be held responsible for all material and tools placed in their custody, and must report promptly any loss to their Supervisor or superior officer.

The Supervisor will furnish each Foreman with a list of all the tools necessary for their section or gang, and will supply the tools according to their list. These tools must always be on hand and subject to inspection which may be made at any time. When a tool wears out or is broken in use, the Foreman must make requisition for a new one, which may be issued only upon the return of the old tools to the Supervisor.

Small tools and loose track supplies must be kept under cover and locked at night, and must be carried to the work as required and returned each night to the tool house.

Foremen will have the care of, and be responsible for, all loose property, such as cross-ties, lumber, ballast, scrap, etc., and must take every precaution to prevent its loss by the elements or theft.

All material, as far as practicable, must be kept locked or under the eye of the Foreman, and under no circumstances must tools or materials belonging to the company be loaned or given to any person whether employed or not.

All spikes must be carefully drawn with the view of using them again, and no old ties must be thrown aside with spikes remaining in them. All old spikes which cannot be used again must be collected and

kept at the tool house for shipment as directed by the Supervisor.

Mill rails should be piled at the side tracks convenient for shipment, iron and steel rails being piled separately. Repair rails must be likewise assorted and piled upon old ties or other rough platform free from the ground.

At water stations where the supply is taken from penstocks, Foremen must have fires kept burning in the penstock pits when necessary, and take every precaution to keep the penstocks free from ice and in good working order.

Pumpers must not unnecessarily call on the Foremen for assistance, but must do all in their own power to prevent their tanks and connections from freezing.

#### WATCHING.

Every morning the Foreman must send a reliable and experienced man to walk over such portion of the section as will not be seen by the foreman during the day. This track walker should carry a few bolts, nut locks, spikes and nails and a wrench and tamping pick. He must replace missing bolts and nut locks, replace broken spikes, examine all joints and rails, raise low joints, look for broken rails and burnt joint ties, examine closely all frogs, switches and switch locks, pick up all spikes, bolts, nuts, etc., and place them where the Foreman can get them. Watch for and extinguish fires, replace fences, close farm gates, and do anything and everything in his power to protect the road from accident and loss, and stock from wandering on the tracks.



Night watchmen, in addition to the foregoing, must see that all cars left on sidings fully clear the main track; that the doors of loaded cars are locked; examine buildings and other property of the company and protect them from fires and theft, and before going off duty notify the Foreman of any delayed trains that have not passed, and of any other matters requiring his attention.

During heavy rains and storms Foremen must take ever precaution to prevent accidents; every man, if necessary must be placed on duty and the entire section watched. Torpedoes and the necessary signals to stop trains must be distributed, and all culverts and drains examined and all drift wood immediately removed.

Bridge watchmen must keep a supply of water on the bridge at close intervals and follow every train, and extinguish any hot cinders that may have fallen from the engine. They must keep the coping of the abutments and piers clean, and remove all combustible matter from the vicinity of the bridge; frequently examine the iron work and timber of the bridges and report to the Foreman any decay or defect; observe the speed of passing trains and report to the Foreman any violation of the rules, and, as far as possible, prevent all persons except employees from crossing the bridges. When not wholly occupied watching they will attend to such duties as the Foreman may direct.

#### ACCIDENTS.

In case of accident to trains the nearest Section Foreman must at once take the entire force to the relief of the train even if it be off his own section.

Train men always send to the nearest Section Foreman for assistance, and section men must respond at all times, day or night, to calls from the conductors or enginemen of trains in distress. When notified of broken rails on adjoining sections they must go at once and make the track safe for the passage of trains.

When assisting a train delayed by an accident, Section Foreman will act under the direction of the senior Track Foreman until the arrival of the conductor of the construction train, the Supervisor or the Division Engineer.

In case of wreck, Foremen must at once appoint the necessary watchmen to prevent freight or the Company's property from being stolen, and the watchmen must remain on duty until relieved or the goods are removed.

Foremen must report all accidents occurring on their sections to the Supervisor by telegraph as soon as possible, giving briefly and without exaggeration the nature of the accident. The telegram must be followed by a full report on the proper blank. When serious accidents occur, requiring a collection of forces and material, Foremen must notify the Supervisor and the Division Engineer.

When repairs have been made, after an accident has occurred, and the different gangs are about to separate, each Foreman must carefully gather up the tools of his gang, which should always have some distinguishing mark. Any foreman or laborer who conceals or takes away a tool that belongs to another gang will be at once dismissed from the service.

A prompt report must be made to the Supervisor

by the Foreman of an injury to any person, caused by the operation of the road, so the proper officer may be notified.

Foremen must report to the Supervisor in writing all fires on their sections occasioned by sparks from the locomotives, whether damage was done to the Company or private parties. The report must state the location, the extent of the damage and the owner's name, together with the number of the engine and the train causing the fire.

When stock is crippled or killed on his section, the Foreman must make a report on the proper form and furnish all the information possible to obtain. Any particulars not asked for in the report should be mentioned, and the report sent to the Supervisor as soon as possible after the occurrence.

#### POLICING.

Policing is a term employed by railroad men to express the preservation of good order along its lines, such as cleaning right of way of undergrowth and piling material in proper shape, and in general, keeping the line in good order.

Foremen are responsible for the proper policing of the sections, and they and all other employees must in all cases be polite and obliging to the farmers and patrons of the road along the line. Foremen must treat the men under them with the consideration due to men, and must never use abusive or profane language toward them. Laborers who habitually fail to give satisfaction should be discharged and others employed in their places.

All old cross-ties taken from the track must be gathered daily, if practicable, and piled or disposed

of in such a manner as may be directed by the Supervisor. All other old and light material must be carried to the hand car house.

All material dropped from engines and cars, such as drawbars, car doors, brakes, bolts, etc., belonging to the company, must be gathered up daily and taken to the tool house for shipment as directed. Any package or articles of freight that may fall from trains must be taken to the nearest station agent, who will forward the same to the Superintendent.

Foremen must, if possible, make themselves familiar with all the boundary lines of the Company's property on their respective sections, and permit no one to encroach thereon without special permission. They must report in writing to the Supervisor the name and residence of any person who attempts to erect fences or buildings, or otherwise occupy the Company's grounds.

Foremen must observe that occupants of Company's houses keep them in respectable repair and that the grounds are kept neat and free from rubbish.

Briars and undergrowth on the right of way must be kept close to the ground, except where the growth is a benefit in preventing slides and washouts; all weeds, etc., which it is desired to destroy must be cut down and burned before seeding time, but great care must be taken that adjoining fences and grounds are not injured by fires.

Wherever fires are seen on the track or adjoining grounds they must be extinguished, and an effort made to discover the cause of the fire; if from a locomotive the number and train must be reported to the Supervisor. All combustible material must be

removed from the vicinity to the track, bridges and buildings. Farm and highway crossings must be kept in the best possible repair and free from obstructions, and hand or push cars must not be left unnecessarily on such crossings.

Foremen must watch closely all points where obstructions to the road are likely to occur. The slope of cuts should be examined, and any rocks, stumps or masses of earth removed that are likely to slide or fall; all dead trees or unsound trees which are in danger of falling on the track during high winds, or which obstruct the view of the track or endanger the telegraph line, should be cut down, and if not on the Company's grounds and the owner should object, the fact should be reported to the Supervisor and instructions asked.

Whenever wood, cross-ties, lumber or other material is piled along the track, notice must be taken by Section Foremen that it is at least six feet from the rail. If found nearer it must be at once removed to the proper distance. Signal or mile posts must not be placed nearer the rail than six feet.

The telegraph poles must be kept in proper position, and trees near the wires must be kept trimmed to prevent the branches touching the wires during high winds, and all vines growing up the poles must be removed.

Station platforms and grounds about stations must be kept clean and in good order, and immediately after snow storms switches and platforms must be cleaned.

Postal cranes, clearance posts, whistle boards,

crossing signs and switch lights must be kept in good order.

Foremen must report to the Supervisor all freight trains that pass at the higher rate of speed than the schedule permits, as well as any other carelessness or misdemeanor of trainmen.

#### CONSTRUCTION TRAINS.

Construction or ballast trains must occupy the main track only by special orders. They must in every case be clear of the main track between 7 o'clock p. m., and 6 o'clock a. m., and throughout the entire day on Sunday unless specially directed otherwise. In cases of emergency, when they cannot clear the main track as above, flagmen must be sent in both directions to protect the train until orders can be obtained. They must report by telegraph each evening, when they are in for the night, and where they wish to work the next day. After they once report "In" for the night they must not occupy the main track again that night without special orders to do so.

From the first day of December to the first day of March they must spend the night, if possible, at a telegraph station and observe the same rule during the remainder of the year when it can be done without losing time.

Foremen of construction trains are appointed by the Division Engineer, and are responsible for the safety and proper care of their trains, and for the good conduct of all the men employed therein, and for any material, tools or supplies entrusted to their care.

They must obey all orders for the safe move-

ment of their trains from the Train Dispatcher and faithfully observe all the card rules. They must also make themselves familiar with the rules and instructions issued to track and bridge men, and make themselves acquainted with all kinds of work pertaining to the maintenance of road.

They must report at once in writing to the Division Engineer whenever inadequate motive power or incompetent enginemen are furnished them.

On Monday of each week they must send to the Division Engineer a written report of all delays experienced during the preceding week, on account of not receiving orders promptly, or from other causes.

Whenever they experience delays at stations, either in writing for orders or from other causes, they must keep the entire force employed. No time must be wasted, and at every point on the road some kind of work will be found to do. Whenever delays occur (and some cannot be prevented) the men must be put to work cleaning the station grounds, weeding, ditching, ballasting, etc.

Train foremen must remember that they are placed on the road to assist the Track Foremen and not embarrass them, and therefore the wishes of foremen should be complied with as much as possible in the distribution of material, as they are supposed to be the best judges of where the supplies are to be placed.

The greatest care must be exercised in unloading material; rails must never be unloaded when cars are in motion, and skids must be used to prevent bending and breaking. Cross-ties must not be thrown over the bank or in the ditches to obstruct the waterway, nor must any condemned or uninspected ties be

loaded or unloaded without special orders. Ballast should be unloaded as evenly as possible on both sides of the road, and so distributed that no thin places will be left between the ends of the successive train loads.

No one but an officer of the road will be permitted to ride on construction trains.

Foremen must not give fuel or material to any one without an order from the Division Engineer.

In cases of accidents to trains foremen must render assistance as soon as notified by the Train Dispatcher or Division Superintendent, and must do everything in their power to secure the safe and speedy passage of trains. They will have full charge of any wreck until the arrival of the Supervisor, Division Engineer or Train Master.

Whenever it is necessary for train foremen to leave their trains permission must be obtained from the Division Engineer, and under no circumstances must they leave their men without such permission. Such absence must be communicated to the Train Dispatcher, so that in case of accident the Supervisor can take the train or make another appointment.

Train foremen must make such reports of labor and material as may be directed by the Division Engineer.



**BILL OF TIES**  
**STANDARD. TURNOUT NO. 6 FROG**  
**B. AND O. R. R.**

NO. OF PIECES	THICK- NESS	FACE	LENGTH	NO. OF PIECES	THICK- NESS	FACE	LENGTH.
2	7"	8"	18' 0"	1	7"	8"	11 1
4	7"	8"	8' 6"	1	7"	8"	11 4
1	7"	8"	8' 8"	1	7"	8"	11 8
1	7"	8"	8' 9"	1	7"	8"	12 0
1	7"	8"	8' 10"	1	7"	8"	12 4
1	7"	8"	8' 11"	1	7"	8"	12 8
1	7"	8"	9' 0"	1	7"	8"	13 0
1	7"	8"	9' 2"	1	7"	8"	13 3
1	7"	8"	9' 4"	1	7"	8"	13 6
1	7"	8"	9' 6"	1	7"	8"	13 9
1	7"	8"	9' 8"	1	7"	8"	14 0
1	7"	8"	9' 10"	1	7"	8"	14 3
1	7"	8"	10' 0"	1	7"	8"	14 7
1	7"	8"	10' 2"	1	7"	8"	14 11
1	7"	8"	10' 4"	1	7"	8"	15 3
1	7"	8"	10' 7"	1	7"	8"	15 8
1	7"	8"	10' 10"	1	7"	8"	15 11
				1	7"	8"	16 0

**BILL OF TIES**  
**STANDARD TURNOUT NO 10 FROG**  
**B. AND O. R. R.**

NO. OF PIECES	THICK- NESS	FACE	LENGTH	NO. OF PIECES	THICK- NESS	FACE	LENGTH
1	7"	8"	8' 8"	1	7"	8"	11' 4"
1	7"	8"	8' 9"	1	7"	8"	11' 6"
1	7"	8"	8' 10"	1	7"	8"	11' 8"
2	7"	8"	8' 11"	1	7"	8"	11' 10"
2	7"	8"	9' 0"	1	7"	8"	12' 0"
1	7"	8"	9' 1"	1	7"	8"	12' 2"
1	7"	8"	9' 2"	1	7"	8"	12' 4"
1	7"	8"	9' 3"	1	7"	8"	12' 6"
1	7"	8"	9' 4"	1	7"	8"	12' 9"
1	7"	8"	9' 5"	1	7"	8"	13' 0"
1	7"	8"	9' 6"	1	7"	8"	13' 2"
1	7"	8"	9' 7"	1	7"	8"	13' 4"
1	7"	8"	9' 8"	1	7"	8"	13' 7"
1	7"	8"	9' 9"	1	7"	8"	13' 10"
1	7"	8"	9' 10"	1	7"	8"	14' 0"
1	7"	8"	9' 11"	1	7"	8"	14' 2"
1	7"	8"	10' 0"	1	7"	8"	14' 4"
1	7"	8"	10' 2"	1	7"	8"	14' 6"
1	7"	8"	10' 4"	1	7"	8"	14' 9"
1	7"	8"	10' 6"	1	7"	8"	15' 0"
1	7"	8"	10' 8"	1	7"	8"	15' 2"
1	7"	8"	10' 10"	1	7"	8"	15' 5"
1	7"	8"	11' 0"	1	7"	8"	15' 8"
1	7"	8"	11' 1"	1	7"	8"	15' 10"
1	7"	8"	11' 2"	1	7"	8"	16' 0"
				2	7"	8"	18' 0"

B. & O. R.R. Standard

CATTLE GUARD

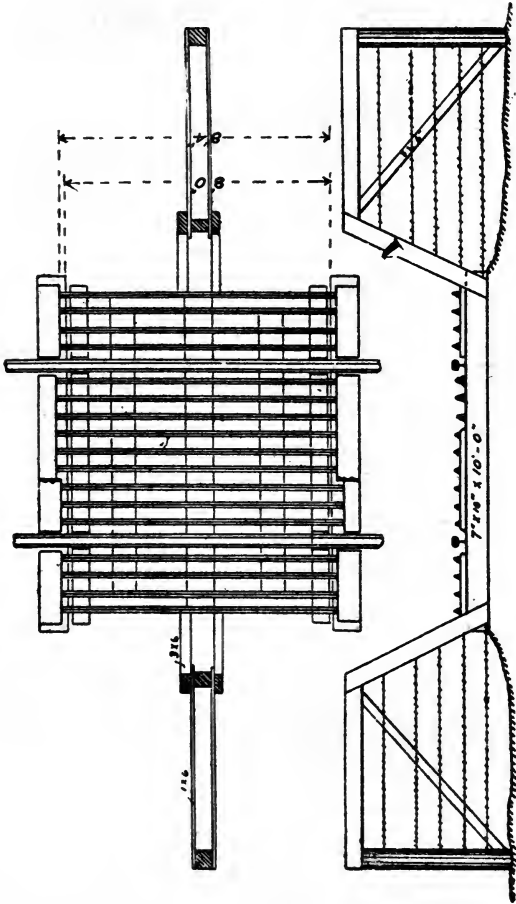

# B. & O.R.R. Standard

## ROAD CROSSING

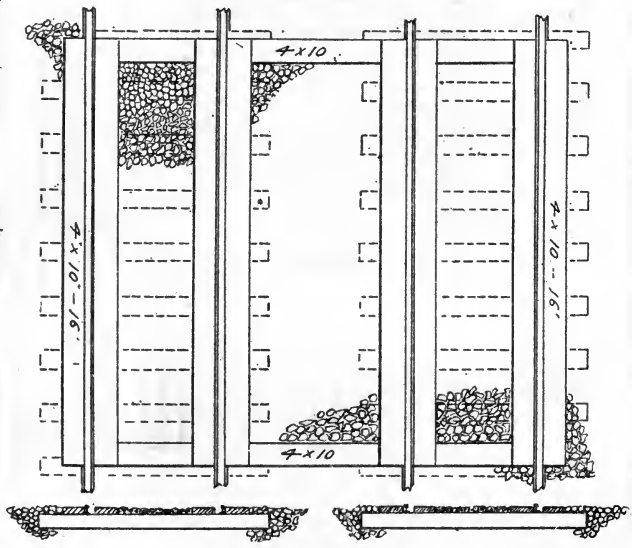
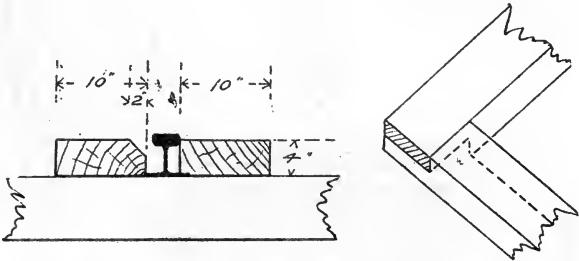

## B. & O. R. R. Standard

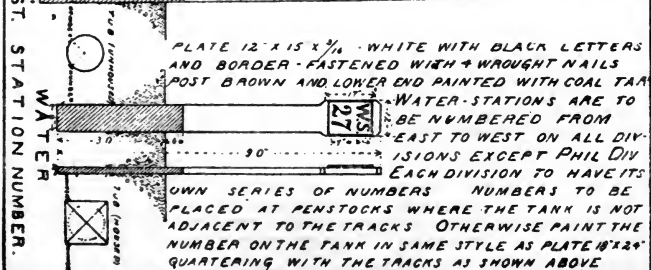
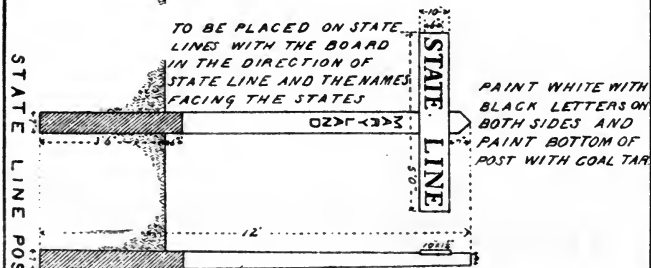
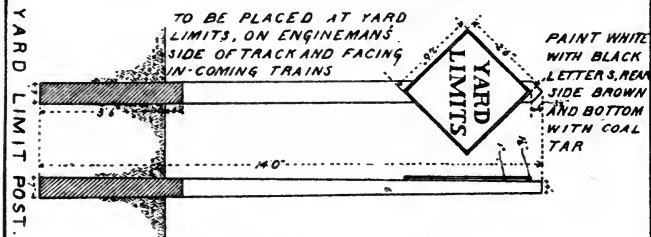
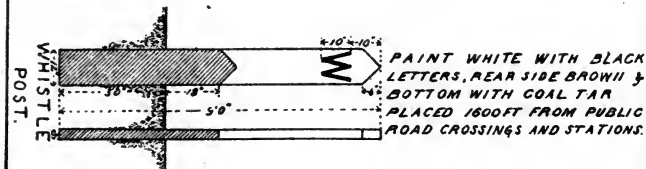
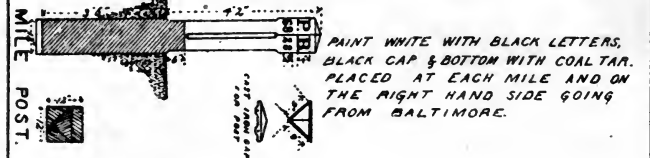

# B. & O. R.R. Standard

SECTION POST.

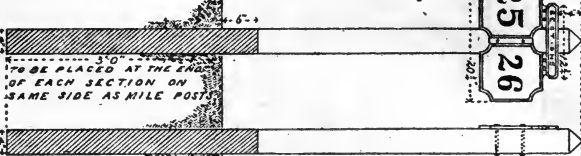

TO BE PLACED AT THE END OF EACH SECTION ON SAME SIDE AS MILE POST.

BRIDGE NUMBER.

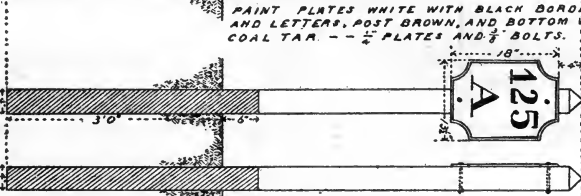

PAINT PLATES WHITE WITH BLACK BORDER AND LETTERS, POST BROWN, AND BOTTOM WITH COAL TAR. --  $\frac{1}{2}$ " PLATES AND  $\frac{1}{2}$ " BOLTS.

## BRIDGE NUMBERING.

THE BRIDGES ARE TO BE NUMBERED SO AS TO INDICATE THE FULL MILES ON THE DIVISION OR BRANCH ON WHICH THEY ARE LOCATED AND IN ACCORDANCE WITH THE DISTANCES GIVEN IN THE TIME-TABLE AND LETTERED ALPHABETICALLY TO THE NEXT MILE POST. EACH DIVISION AND BRANCH WILL HAVE ITS OWN SERIES OF NUMBERS. EXAMPLE :- HARPERS FERRY BRIDGE AND HARPERS FERRY TRESTLE, BOTH BEING SEVENTY TWO AND A FRACTION MILES FROM RELAY, THEIR NUMBERS WILL BE 72 A & 72 B, 1<sup>ST</sup> DIV.; AND NORTH BRANCH BRIDGE & THE CANAL BRIDGE, BOTH BEING SEVENTY TWO & A FRACTION MILES FROM MARTINSBURG, THEIR NUMBERS WILL BE 72 A & 72 B, 2<sup>ND</sup> DIVISION, &c.

CLEARANCE POST.



USED AT ALL TURN OUTS AND PLACED BETWEEN TRACKS AT A POINT  $3\frac{1}{2}$  FT. FROM EACH RAIL.



PAINT WHITE. BOTTOM WITH COAL TAR.

PROPERTY POST.

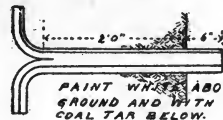

PAINT WHITE ABOVE GROUND AND WITH COAL TAR BELOW.

TOTAL LENGTH 5'0" OF IRON 'T' RAIL (BEFORE SPLITTING)

STOP POST.

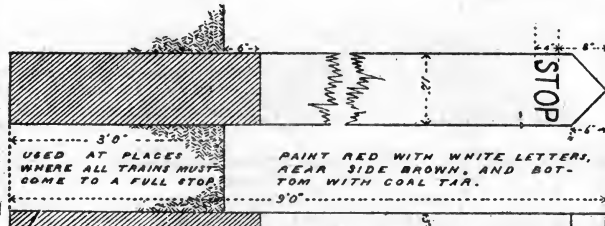

USED AT PLACES WHERE ALL TRAINS MUST COME TO A FULL STOP.

PAINT RED WITH WHITE LETTERS, REAR SIDE BROWN, AND BOTTOM WITH COAL TAR.

# B. & O. R. R. Standard

ROAD CROSSING SIGN

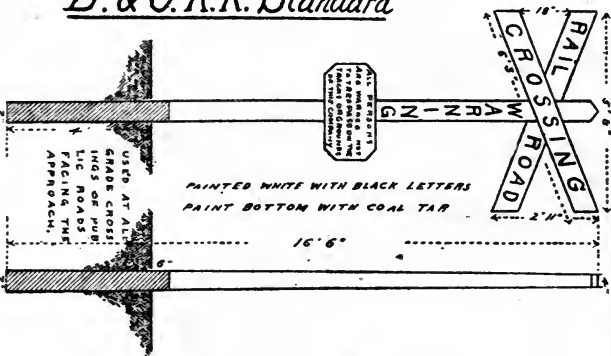

TRESPASS SIGN

## CAST IRON TRESPASS. SIGN

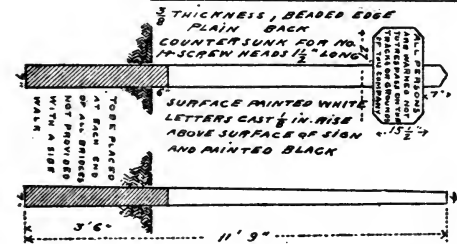

RAILROAD CROSSING SIGN

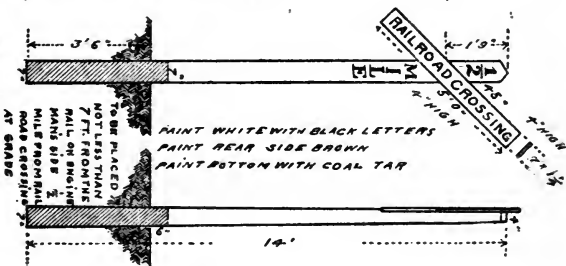

STATION SIGNAL

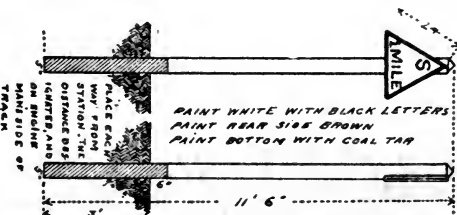

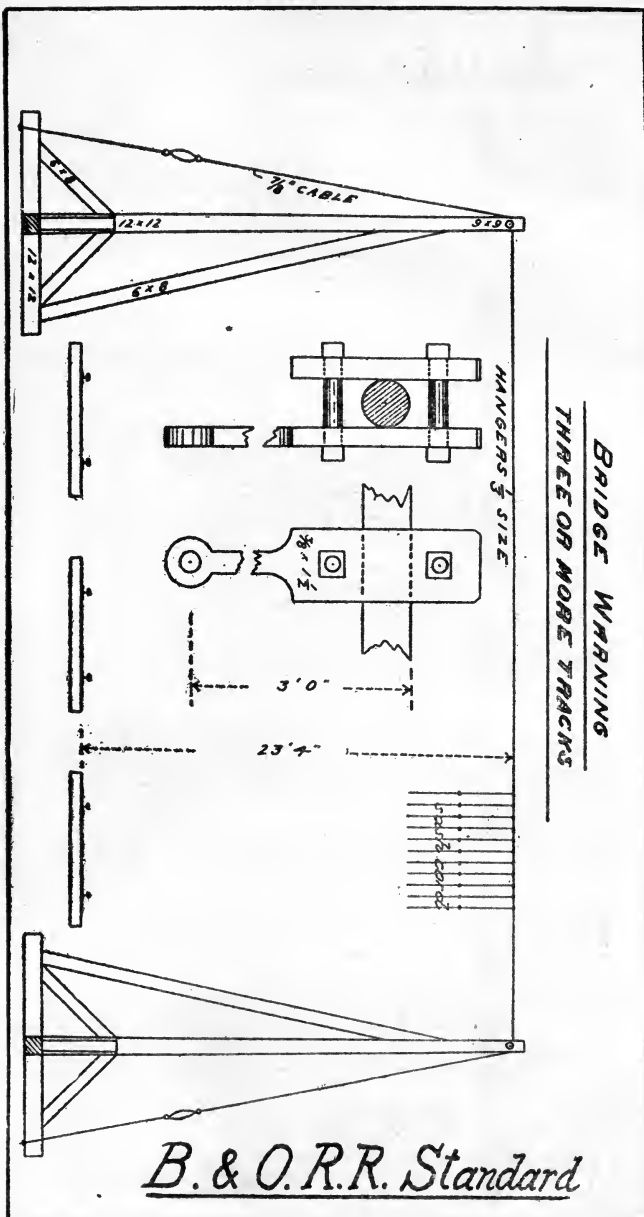

BRIDGE WINCH  
THREE OR MORE TRACKS

B. & O.R.R. Standard



BRIDGE WARNING  
ONE OR TWO TRACKS

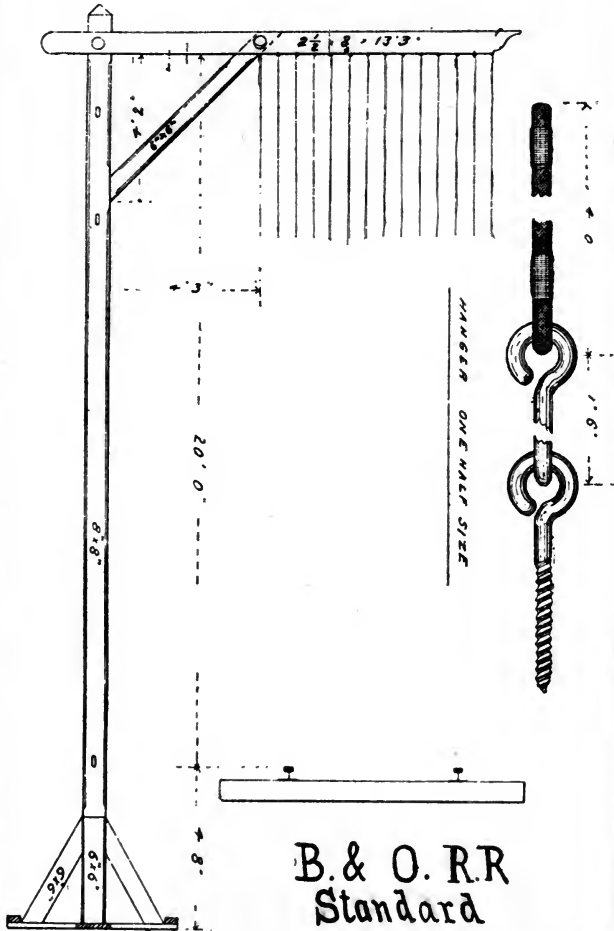

B. & O. R.R.  
Standard

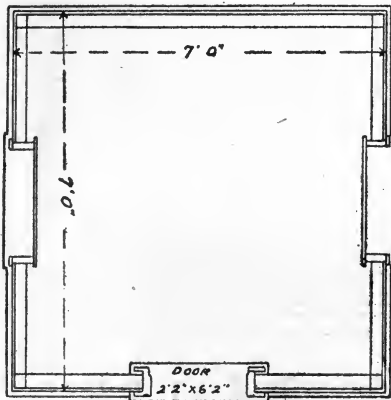
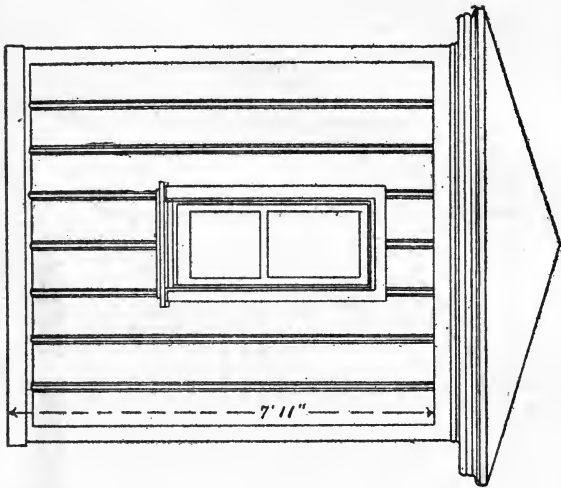

WATCH BOX

*B. & O.R.R. Standard*

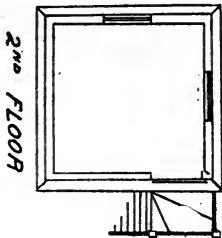
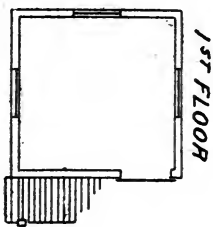
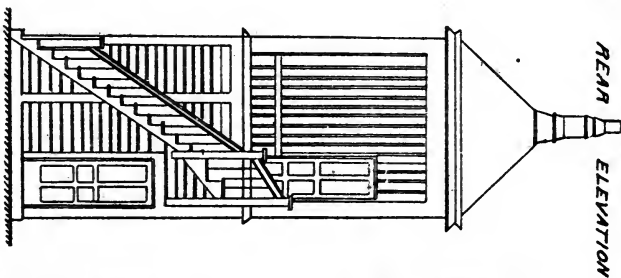
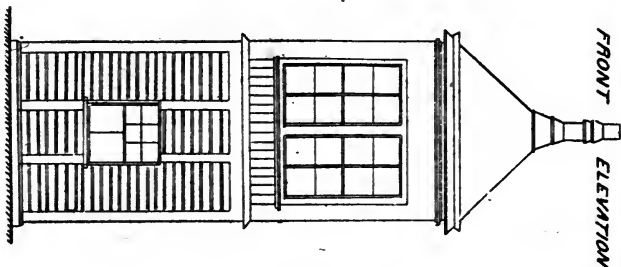
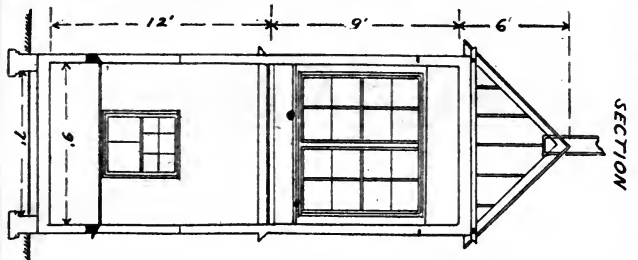

*BLOCK SIGNAL TOWER  
B. & O. R. R. Standard*

# B. & O. R.R. Standard

HAND CAR HOUSE

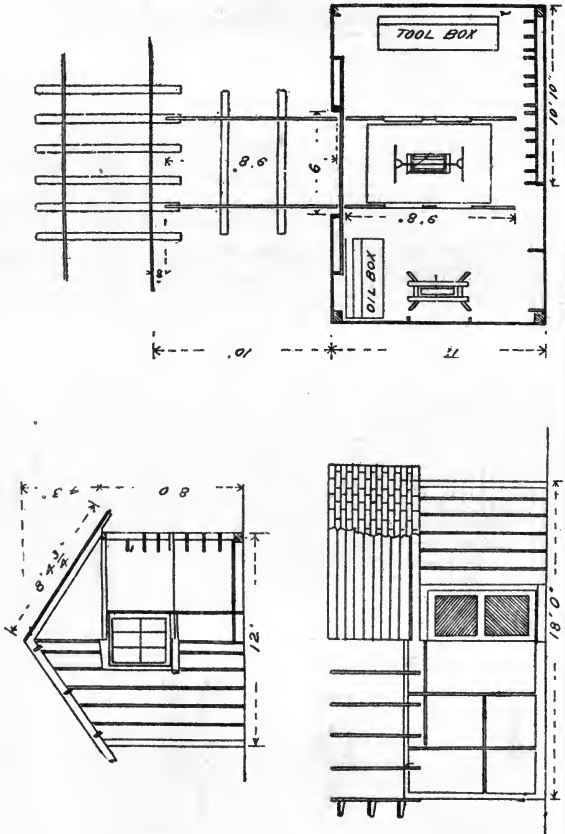

# WATER TANK

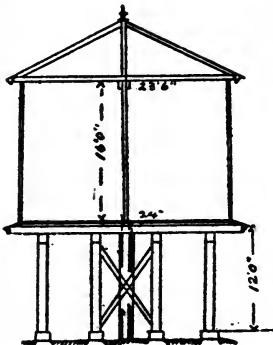

ELEVATION

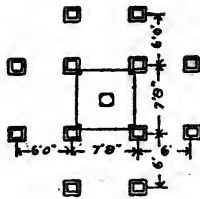

FOUNDATION

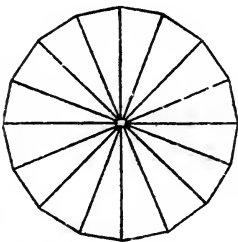

ROOF

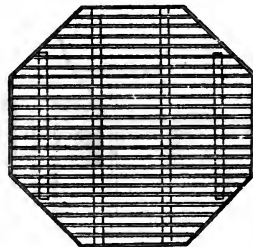

TIMBERS UNDERTANK

B. & O.R.R. Standard

PENSTOCK

*B. & O. R. R. Standard*

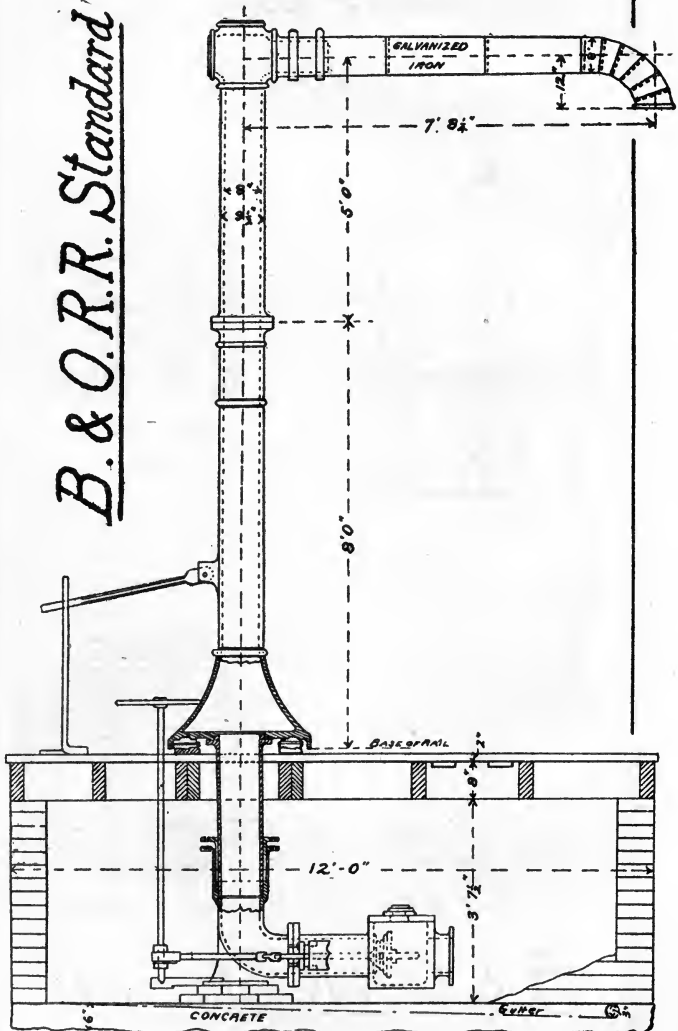

B. & O.R.R. Standard.  
**PENSTOCK**

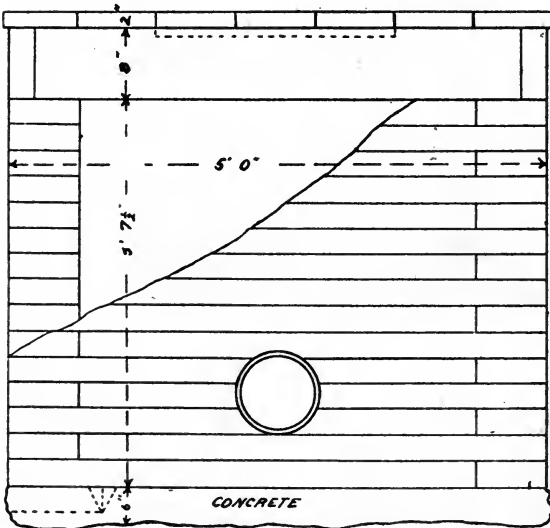
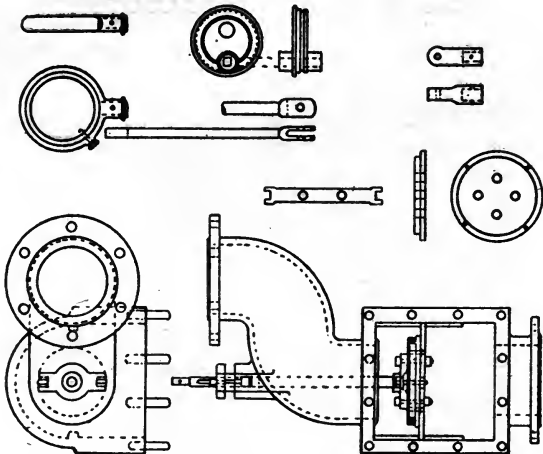

*MAIL BAG CRANE*  
*POST OFFICE DEPARTMENT*

*B. & O. R.R. Standard*

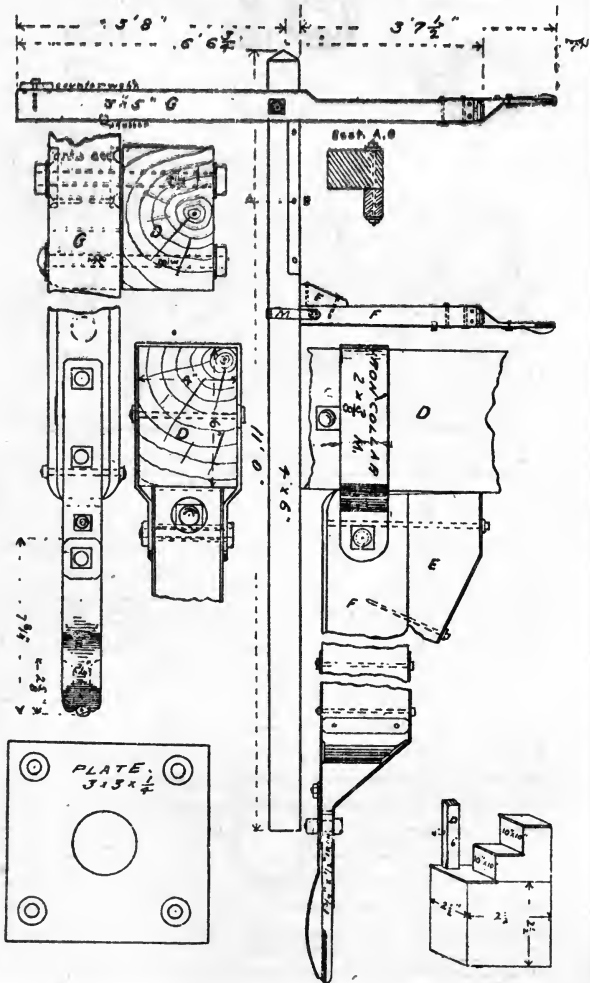



## MAIL-BAG CRANE

### SPECIFICATIONS OF CONSTRUCTION

THE TOP CROSS-ARM IS PIVOTED TO THE OUTSIDE OF THE VERTICAL POST. THE PIVOT IS A THREE-FOURTHS INCH BOLT PASSING THROUGH A SLEEVE OF GAS PIPE; THIS IS USED IN SCREWING UP THE BOLT TO PREVENT DRAWING THE CROSS-ARM TIGHT AGAINST THE POST. THE GAS PIPE SLEEVE PASSES THROUGH TWO PLATES OF IRON ONE-FOURTH INCH THICK, THREE BY THREE INCHES, LET INTO EACH SIDE OF THE CROSS-ARM, AND MADE FAST BY FOUR ONE AND ONE-QUARTER INCH NO. 14 SCREWS THROUGH EACH PLATE. AT THE SMALL END OF THIS ARM, UNDERSIDE, IS A BRACE OF IRON, ONE AND THREE-FOURTHS BY ONE-FOURTH INCHES; A PIECE OF IRON SAME SIZE ON TOP. ALSO ON TOP OF THIS IS A SPRING MADE OF STEEL, ONE AND THREE-FOURTHS BY ONE-EIGHTH INCHES, AND BETWEEN THE BRACE AND THE SPRING IS A PIECE OF IRON ONE AND THREE-FOURTHS BY ONE-HALF INCHES WITH THE OUT END DRAWN TO THREE-FOURTHS INCH WIDE, THE UNDER SIDE MADE HALF ROUND. THIS PIECE IS MADE LOOSE, AND HELD IN PLACE BY THE ONE-HALF INCH BOLT BACK AND THE CURVED FORM OF THE END OF THE SPRING FORWARD; SO THAT WHEN THE MAIL-BAG IS CAUGHT BY THE CATCHER THIS IRON MOVES FORWARD WITH THE BAG AND ALLOWS THE BAG TO DISENGAGE. THE LARGE END OF THE CROSS-ARM IS WEIGHTED, SO THAT WHEN THE MAIL-BAG IS TAKEN FROM THE FRONT, THIS ARM SWINGS IN A VERTICAL POSITION ALONGSIDE OF THE PIECE THAT IS BOLTED TO THE VERTICAL POST. THIS PIECE SERVES A DOUBLE PURPOSE: IT FORMS A REST FOR THE CROSS-ARM WHEN HORIZONTAL, AND A STOP FOR THE SAME WHEN VERTICAL. UNDER SIDE OF BOTH THE CROSS-ARMS A PIECE OF RUBBER SHOULD BE INSERTED, AS SHOWN.

THE CONSTRUCTION OF THE LOWER CROSS-ARM IS VERY PLAINLY SHOWN BY THE DRAWING. THE OUT END IS A DUPLICATE OF THE TOP ARM, ONLY THE BRACE AND THE SPRING BEING PLACED ON THE REVERSE EDGES.

### BILL OF LUMBER

THE LUMBER USED IN THE CONSTRUCTION OF THE CRANE MUST BE EITHER SEASONED OAK OR SOUTHERN PINE, FREE FROM SAP AND KNOTS, AND OF THE FOLLOWING DIMENSIONS, NAMELY

1 PIECE VERTICAL POST	6 X 4 INCHES	11 FEET
1 PIECE TOP CROSS-ARM	3 X 5 INCHES	6 FEET 6 $\frac{3}{4}$ IN.
1 PIECE BOTTOM ARM	3 X 3 $\frac{1}{2}$ INCHES	2 FEET 8 $\frac{1}{2}$ IN.
1 PIECE BLOCK ON BOTTOM ARM	3 X 3 $\frac{1}{8}$ INCHES	8 IN.
1 PIECE STOP FOR TOP CROSS-ARM	2 X 3 INCHES	2 FEET 6 IN.

B. & O. R.R.  
Standard

CAR STOP

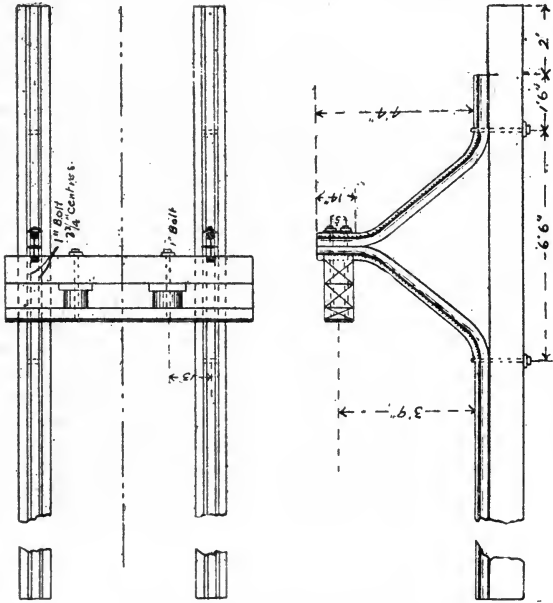

**SPECIFICATIONS—IRON AND STEEL TRACK BOLTS:**

1. SPECIFICATIONS OF PREVIOUS DATE FOR THIS MATERIAL ARE HEREBY ANNULLED.
2. TRACK BOLTS AND NUTS MUST CONFORM ACCURATELY TO DIMENSIONS ON BLUE PRINT.
3. IRON MUST BE TOUGH, FIBROUS AND OF UNIFORM QUALITY. STEEL MUST BE SOFT, DUCTILE, SHOULD HAVE A TENSILE STRENGTH OF 60000 LBS PER SQ. IN. AND AN ELONGATION OF 18 PER CENT IN 8 INCHES.
4. THREADS TO BE U. S. STANDARD [PRATT AND WHITNEY'S GAUGES BEING USED FOR REFERENCE], CUT CLEAR AND FULL; THE MATERIAL WILL BE REJECTED SHOULD IT FAIL TO CONFORM TO THE STANDARD GAUGES.
5. NUTS MUST FIT BOLTS NICELY AND MUST SCREW DOWN EASILY, BUT NOT LOOSELY, TO THE END OF THREAD.
6. THE LARGEST DIAMETER OF BODY OF BOLT MUST NOT BE MORE THAN  $\frac{1}{32}$  IN LARGER THAN THE NOMINAL DIAMETER OF BOLT; THE BOLTS MUST BE FREE FROM PROJECTING FINS, ETC., FORMED BY THE JUNCTION OF THE DIES, AND THE UNDER SIDE OF THE HEAD OF THE BOLT MUST BE AT RIGHT ANGLES TO THE BODY.
7. IRON BOLTS MUST STAND BENDING COLD THROUGH 180 DEGREES TO A CURVE OF THE SAME DIAMETER AS THE DIAMETER OF THE BOLT WITHOUT FRACTURE. STEEL BOLTS MUST STAND BENDING OVER THEMSELVES AND HAMMERING DOWN COLD WITHOUT FRACTURE. BENDING TO TAKE PLACE IN BODY OF BOLT AND NOT IN THE THREADED PORTION.
8. ONE BOLT FOR EVERY FIVE KEGS OR FRACTION THEREOF WILL BE TAKEN FROM EACH LOT AND TESTED, AND AS MANY WILL BE EXAMINED FOR CONFORMITY TO DIMENSIONS AS THE INSPECTOR THINKS NECESSARY.
9. SHOULD 20 PER CENT OF THE BOLTS TESTED OR EXAMINED FAIL, THE SHIPMENT WILL BE REJECTED.
10. MANUFACTURERS MUST NOTIFY THE GENERAL SUPERINTENDENT MOTIVE POWER SIX DAYS BEFORE THE MATERIAL IS READY FOR INSPECTION, AND FURNISH THE NECESSARY APPARATUS AND ASSISTANCE FOR MAKING THE ABOVE TESTS FREE OF COST TO THIS COMPANY.

B. & O. R.R.  
Standard  
SPIKE

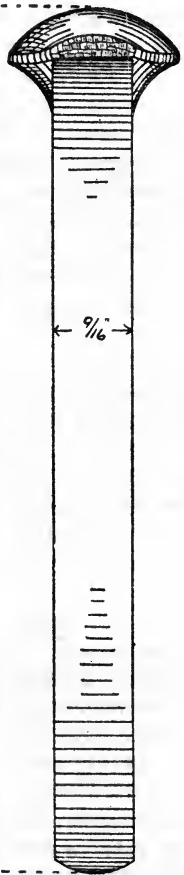
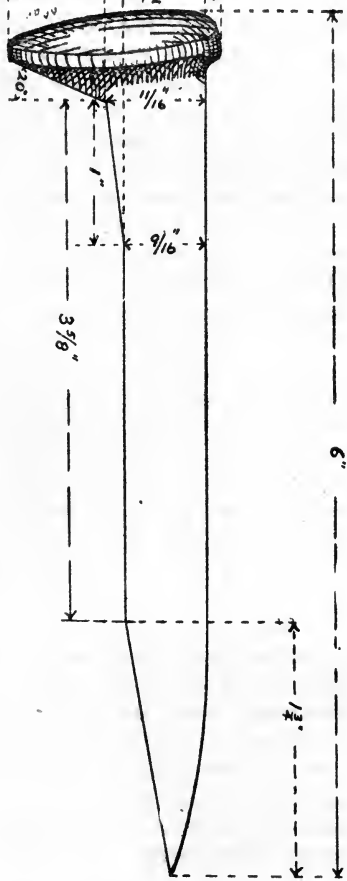
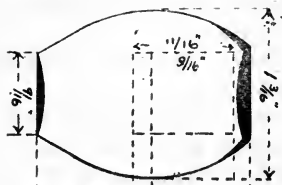

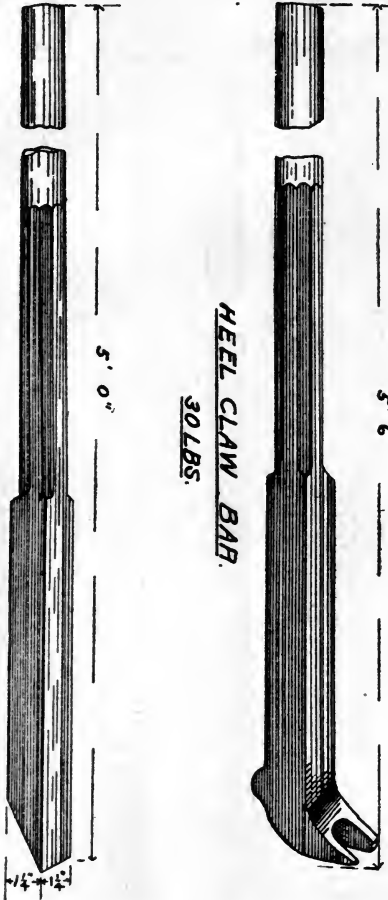

**STRAIGHT WRENCH**  
*B. & O. R.R. Standard*

B. & O. R.R.  
Standard

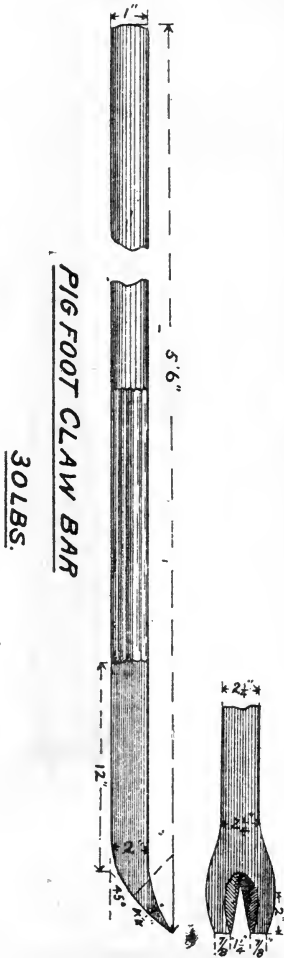

B. & O.R.R. Standard

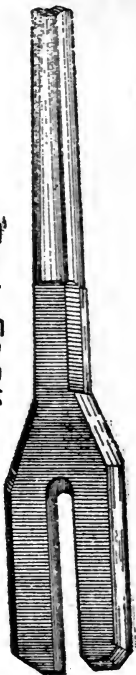

TRAIL FORK

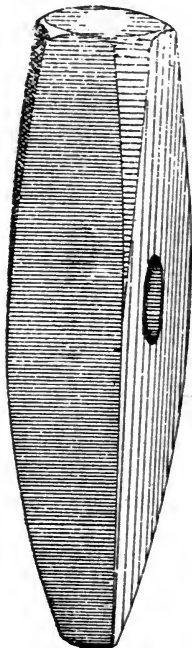

TRACK CHISEL  
4 LBS.

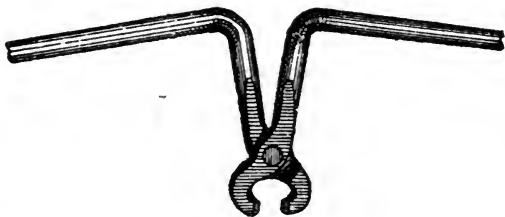

RAIL TONGS

B. & O. R.R. Standard

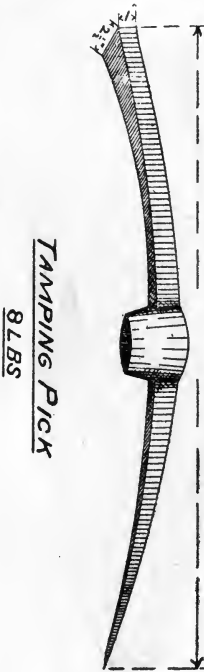

TAMPING PICK  
8 LBS

SPIKE MAUL  
10 LBS

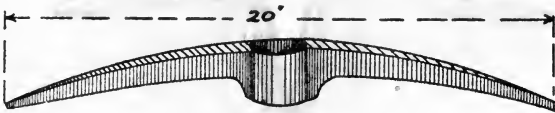
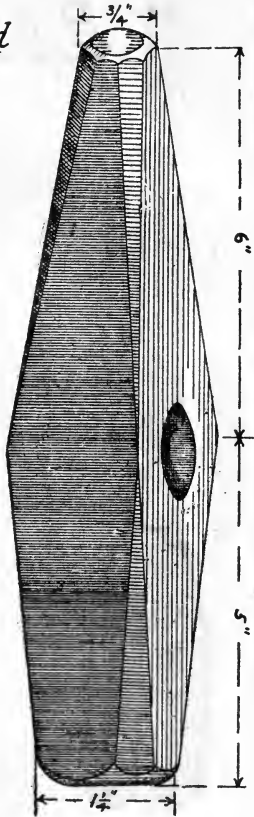

CLAY PICK  
7 LBS



*B. & O. R. R. Standard*

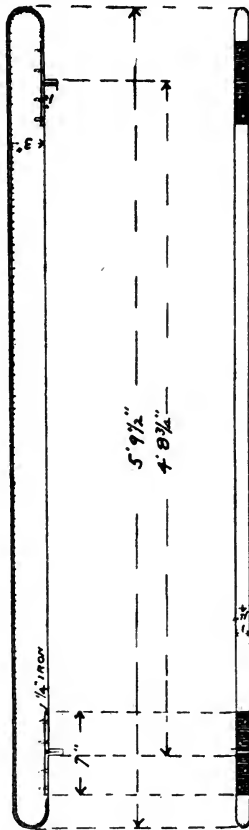

TRACK GAUGE

— TRACK LEVEL —

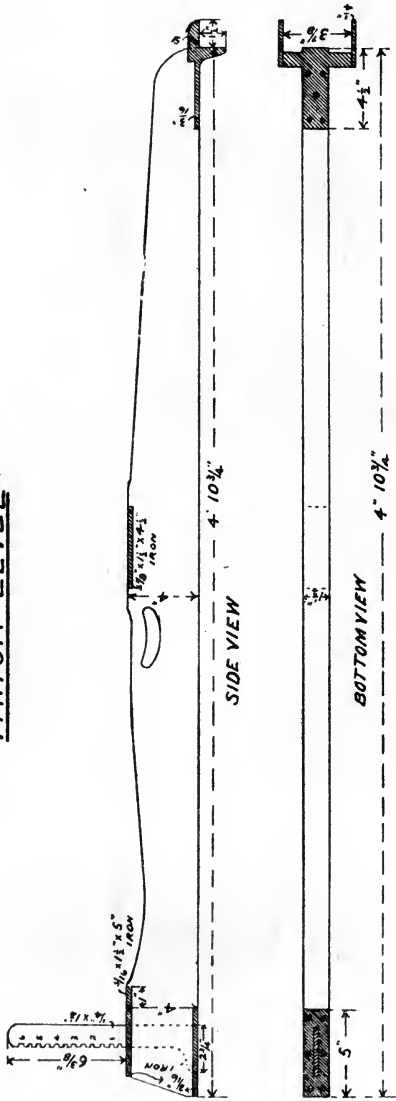

B. & O. R. R. Standard

## CHAPTER III

### PHILADELPHIA AND READING RAILROAD.

#### RULES FOR SUPERVISORS.

Supervisors report to and receive their instructions from the Division Engineer.

They will have general charge of Section Foremen and men, as well as Crossing and Tunnel Watchmen, seeing that they perform their respective duties, and must keep accurate record and make prompt report of the time of such men.

They may, with the approval of the Division Engineer, suspend any employe in their charge, for neglect of duty.

They must see that employes in their charge are supplied with the current Time-tables and with the Rules and Instructions pertaining to the maintenance and operation of the road, and must examine them in such Rules and Instructions to see that they are qualified for their respective positions.

They must provide themselves with, and see that each Section Foreman carries a reliable watch, which must always indicate Standard Time.

They must keep general oversight of all contractors or others doing work on their respective sections, and

see that the safety of the tracks is not endangered by them.

They must keep the right of way; track, and road-bed in the best possible condition, and see that all ties removed from the track, as well as old materials and scrap, are properly collected at least once a week.

They must frequently pass over their sections, giving special attention to the condition of bridges and trestles; see that culverts and drains are safe and in thorough repair, particularly after severe storms, and that all slopes and ditches are properly preserved; examine carefully all road crossings, cattle-guards, switches, and frogs; have everything removed that may obstruct the track, and do everything necessary to secure and maintain the safety of the road.

They must maintain proper clearance on sides of track, allowing no material whatever to be placed within seven feet of main track, and within four feet of sidings.

They must carefully examine water stations, plugs, and dams, and report any defect or damage thereto, as well as deficiency of water supply.

In case of accident or of any obstruction to the road, they must immediately go to the place, taking with them such force as may be required to clear the road as quickly as possible. They must ascertain and report full particulars in connection with all accidents upon their respective portions of road.

They must make such monthly reports as are prescribed, and will be responsible for the proper distribution and use of all materials in their charge.

They must familiarize themselves with the rules for the movement of trains, and with the duties of Train-

# STANDARD ROAD BED SECTIONS P. & R.R.R.

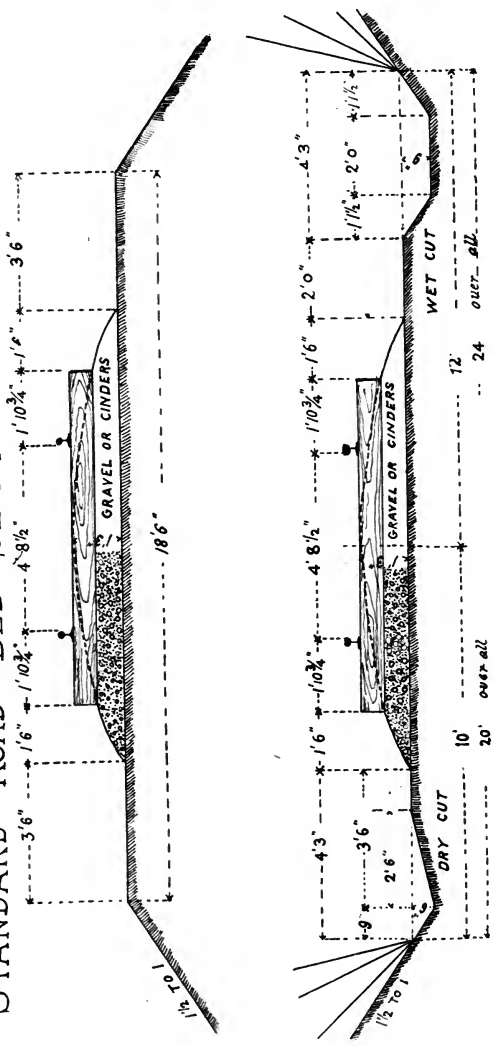

# STANDARD ROAD BED SECTIONS . P. & R. R. R.

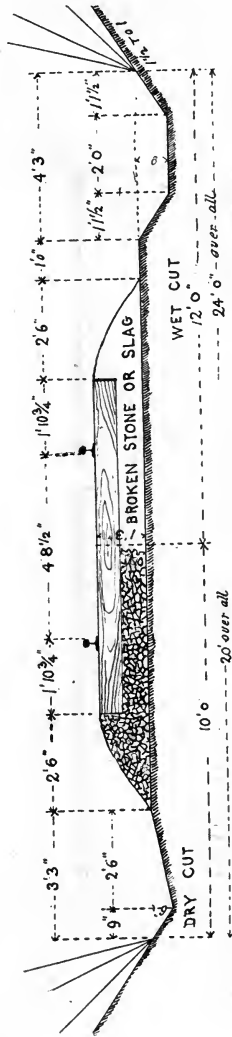
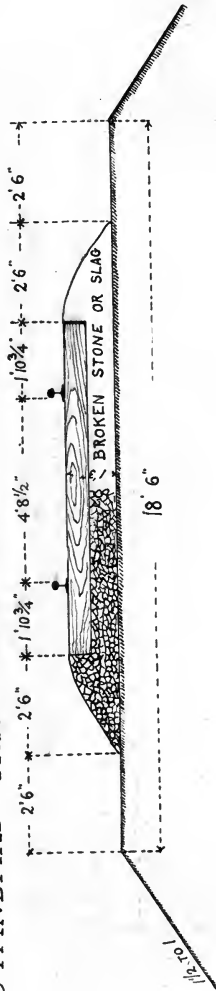

men, reporting any neglect of duty coming under their notice.

#### RULES FOR SECTION FOREMEN.

Section Foremen report to and receive their instructions from Supervisors.

They must carefully examine main tracks and keep them in safe conditions also sidings, switches, bridges, culverts, road-crossings, ditches and road-bed.

They must give special attention to the surface and line of their tracks, particularly at joints; see that all plates have the necessary bolts and nuts in place, that the track is properly spiked and gauged and cross-ties evenly spaced and tamped to a uniform bearing.

They must see that all tracks are safe for the passage of trains; keep all waste material clear of the road-bed, and see that ditches afford thorough draining.

They must see that the grounds in the immediate vicinity of stations are kept as free as possible of rubbish, and of material not immediately required for use.

Cross-ties removed from the track must be neatly piled until burnt, and other track materials must be taken to the tool houses.

They must remove all combustible materials from the vicinity of tracks, bridges, and buildings, and promptly extinguish any fires that may occur along the line of road.

They must keep abutments of bridges free from rubbish, and see that water barrels on bridges are at all times kept filled with water.

They must frequently examine the source of water supply to pipes feeding water stations, keeping the

head of pipes clear of anything that tends to a stoppage of the pipes.

They must promptly repair to, and render all assistance possible at any wreck that may occur, using every effort to clear the tracks and make the necessary repairs thereto as soon as possible.

They must use extra precaution during heavy storms by day or night, to prevent accident, and all employes under them must, when necessary, be detailed to closely watch the road at points specially exposed.

They may make track repairs within twenty minutes of the time of passenger trains, and within ten minutes of the time of other trains, but must never obstruct the track before displaying a danger signal at least 900 yards (18 telegraph poles) in both directions on single and double track.

Extra trains may be run at any time without previous notice and all employes must be continually on the watch for them.

It may be found necessary on double track to run trains on the opposite track, and it may not be possible to give notice to the Trackmen in each particular case.

Anything that interferes with the safe passage of trains at full speed is an obstruction and must not be attempted without using the above precautions.

When possible Track Foremen must notify the Superintendent when they intend to renew frogs, switches or rails, so that every precaution can be taken to avoid accident. This notice, however, will not relieve the Trackmen from displaying danger signals.

They must run hand-cars cautiously, continually



STANDARD ROAD BED SECTIONS PHILADELPHIA & READING RAIL ROAD.

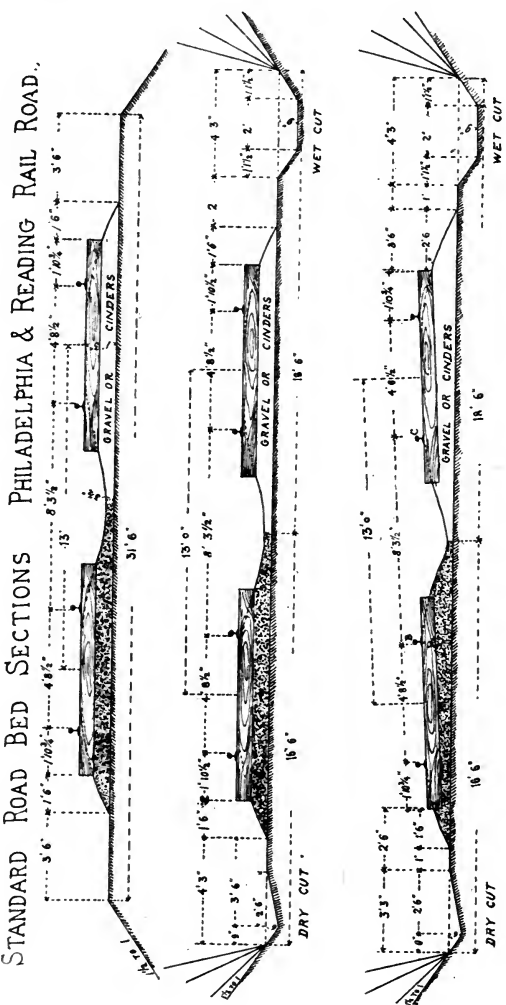

watching for trains and protecting themselves at dangerous points by proper signals. Hand-cars must not be run within twenty minutes of the time of a passenger train, nor moved in the opposite direction on double track, and before placing such cars upon the main track, Foremen must ascertain, if possible, from the nearest telegraph station, where the trains, next due, are. Hand-cars must not be attached to trains in motion, and when not in use, must be kept locked and in such position that they cannot be moved so as to endanger trains. Under no circumstances must hand-cars be run upon the road unless accompanied by Foremen; nor must they be run on Sunday or after dark without permission from the Division Superintendent.

They must carefully note signals displayed by trains, and before obstructing the track, must be sure that all trains running on the same signal have passed.

They must keep record of, and report to the Supervisor, the time of the respective Trackmen and Crossing and Tunnel Watchmen in their charge, as well as material received and used.

They may for good cause, suspend from duty any employe in their charge, reporting such action promptly, but must not employ more than the regular force without proper authority.

They must personally engage in all work and see that the men employed under them faithfully perform their duties.

They must see that watchmen attend to their duties, and must frequently visit them at night, promptly suspending them if found negligent.

They must carry a reliable watch which must at all times be kept so as to indicate the correct time.

#### RULES FOR ROAD AND BRIDGE WATCHMEN.

Road and Bridge Watchmen report to and receive their instructions from the Section Foreman.

Road Watchmen must pass over their respective portions of road, doing so in advance of passenger trains when possible, to carefully examine the rails and observe that switches, particularly, Point Switches, are set and locked for the main track; to try switch locks, and see in general that the road is safe for the passage of trains. They must examine stations and other property of the Company to protect them from theft and fire.

If any obstruction to the track arises, they must immediately display proper danger signals in the direction of the nearest approaching train. Should the obstruction be removed before a train reaches the torpedoes farthest from the place of danger, they must gather up and preserve the torpedoes so placed. Information as to the obstruction must be promptly reported.

Bridge Watchmen must keep a supply of water on wooden bridges, at short intervals, and immediately after the passage of an engine or train, must pass over the bridge with a bucket of water so as to extinguish any live coals or sparks that may have lodged thereon. This examination must be made at intervals of not more than half an hour even should no engine or train have passed during that time.

They must keep the tops of bridge piers and abutments clean, and remove all combustible matter to a safe distance from the bridge.

STANDARD ROAD BED SECTIONS PHILADELPHIA & READING RAIL ROAD

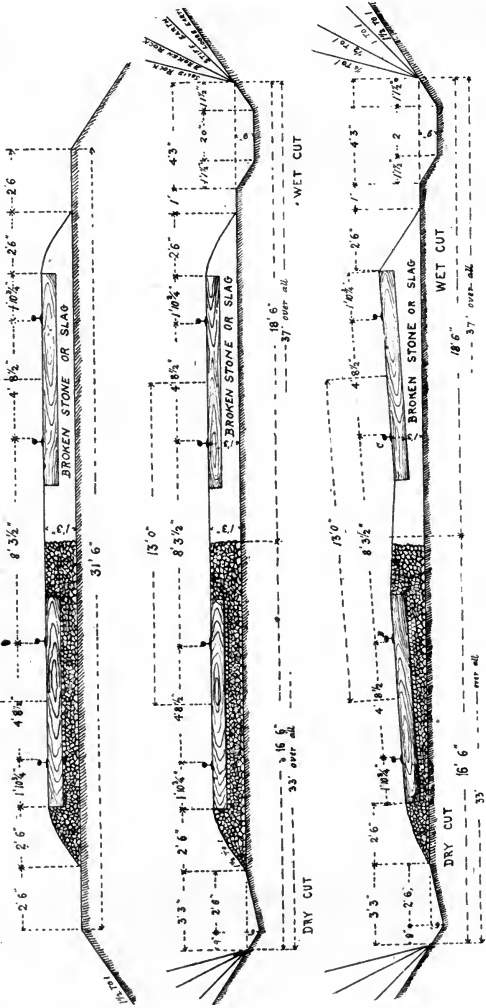

They must frequently examine into the condition of bridges, and promptly report any evidence of decay or danger.

They must allow no one, except employes, to walk across bridges, and must report any violation of rules governing the speed of trains passing over them.

Night Watchmen, before going off duty, must notify the Section Foreman of any extra trains, or of trains over-due.

When not occupied in watching bridges, they must perform such other duties as the Section Foreman may assign to them.

#### RULES FOR SWITCH-TENDERS.

Switch-tenders report to and receive their instructions from the Yard Master.

They are responsible for the safe condition of switches in their charge, as well as for the safe passage of trains over them, and must give undivided attention to their duty in order to prevent accident.

They must carefully and frequently examine into the condition of switches, keeping them clear of snow or other obstruction, and immediately report to the Supervisor or Section Foreman any defects.

They must keep switches set for the main track, except when passing trains to or from a branch track or siding.

They must be continually on the watch for approaching trains so as to give them proper signals.

Where both day and night Switch-tenders are employed, they must not leave their posts of duty until relieved by each other, and the one going off duty

must fully inform the one coming on of any trains over-due.

#### RULES FOR FOREMEN CARPENTERS.

Foremen Carpenters report to and receive their instructions from the Division Engineer.

They have charge of repairs to bridges, buildings, and permanent structures, any defects in which must be promptly reported when coming under their observation.

They must make frequent examinations of bridges, culverts, and buildings, and see that they are properly maintained, and must report their condition at least quarterly.

When repairing bridges and other structures, the main track must always be right for the passage of trains, and, when necessary to obstruct it, they must see that danger signals are displayed in the right direction at a distance of at least 1200 yards (24 telegraph poles.)

They must arrange with the Supervisor for the distribution of materials, and will co-operate with him in all work.

They must be familiar with the use of all signals, and also see that their subordinates understand and properly use the signals.

#### RULES FOR SIGNALMEN OPERATING INDEPENDENT BLOCK SIGNALS.

Signalmen report to and receive their instructions from the Train Master.

They must obey the orders of the Signal Inspector.

They must keep the green signal displayed if track

is clear, and no train in sight. The white signal to the train provided the track is clear for its passage.

Immediately upon the passage of the engine of a train they must set the red signal and not change it to the green or white until the train has passed.

When trains follow each other closely, they must hold the green and red signals long enough to prevent any danger of rear-end collisions.

When the track is obstructed they must give a red signal and hold it until the obstruction has been removed.

They must not leave their towers until relieved.

They must make themselves especially familiar with the meaning and use of the various color signals.

They must make themselves familiar with the meaning and use of train signals and train rules.

## CHAPTER IV

### PENNSYLVANIA RAILROAD COMPANY.

#### SUPERVISORS.

Supervisors report to and receive their instructions from the Assistant Engineer.

Supervisors have charge of the repairmen and other laborers employed on their respective divisions, and must see that they perform their duties properly; discipline them for neglect of duty; and keep account of and report their time in the manner prescribed. They are responsible for keeping the track and road bed, bridges, culverts, telegraph line and everything pertaining to the roadway, in repair.

They must frequently pass over their divisions; observe the condition of the track and bridges; see that the proper slopes and ditches are preserved, and that culverts and drains are kept open; note anything liable to obstruct the track, and have it removed; and do everything necessary to secure the safety of the road.

They must know that the persons under their charge understand and obey the rules and understand the use and meaning of signals: see that materials are safely kept and economically used; attend in person to the removal of slides, snow or other obstruc-





# STANDARD GUARD RAIL

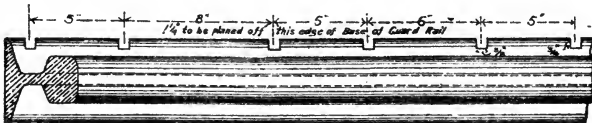
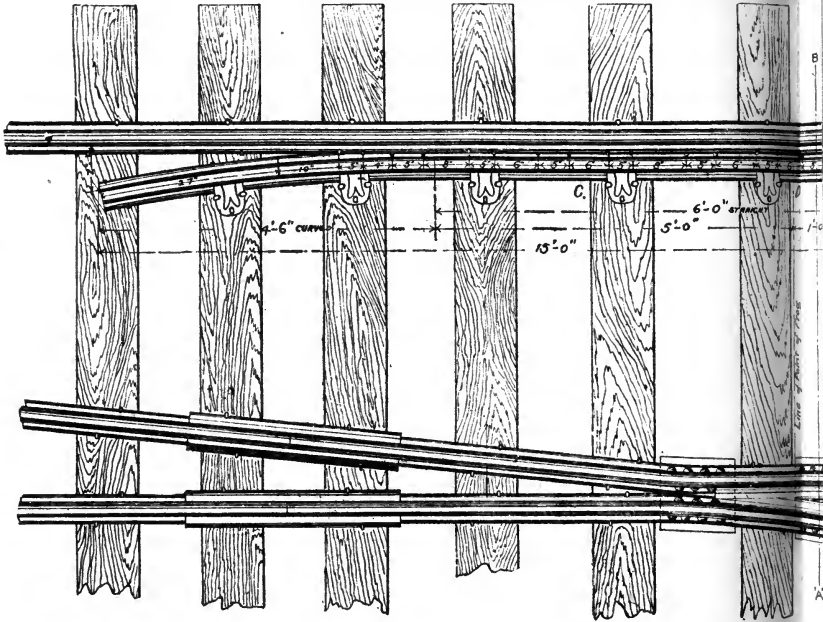

EXPLANATORY  
PLAN OF GUARD RAIL C.T.D.

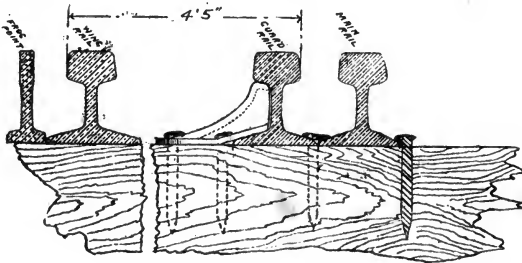

SECTION AT A.B.

# RAIL PENNSYLVANIA R.R.

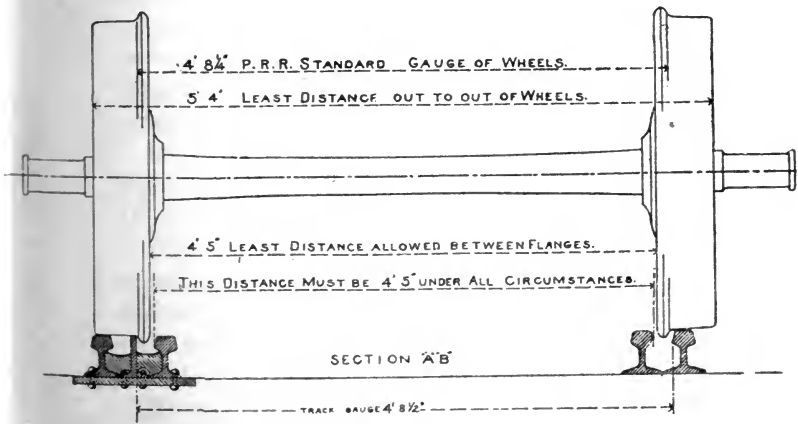
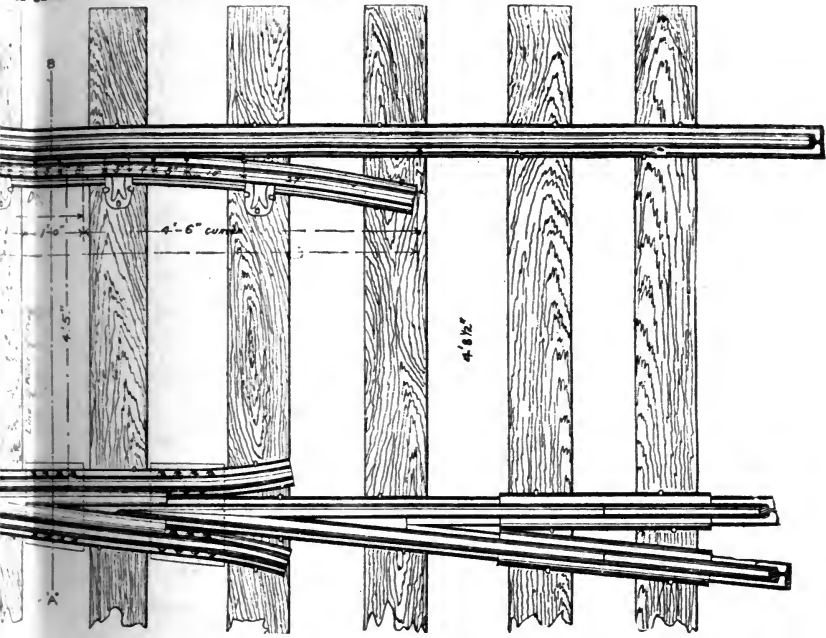

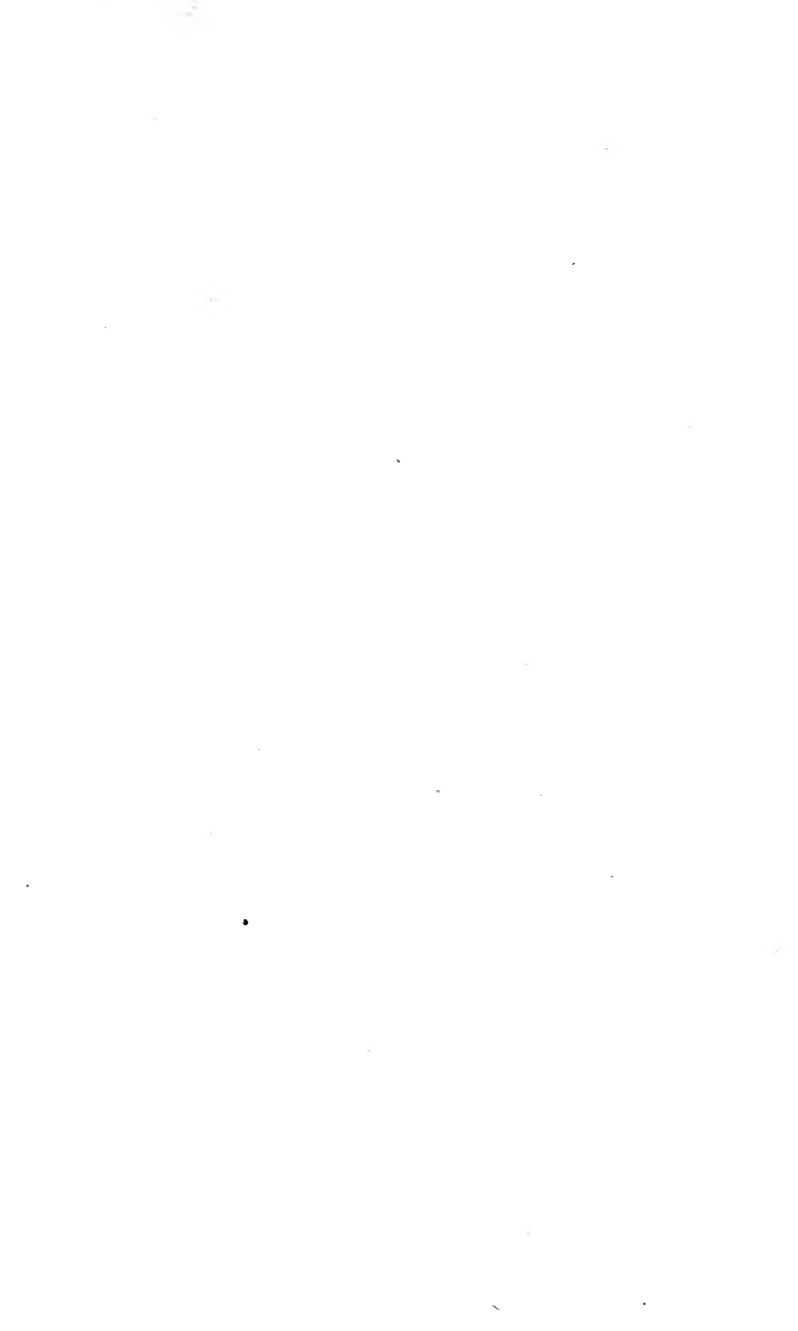

tions; in case of accident take the necessary force to the place, and use every effort to clear the road; have the standard time, and compare with each Foreman once a week or oftener; give attention to the water supply, and report any defect or deficiency; keep an oversight of work performed by contractors or mechanics, and see that they do not endanger the safety of the road; and make careful inquiry and report fully in writing, respecting any accident, or cases of personal injury to passengers, employees and others, on their divisions.

Supervisors must be familiar with the instructions issued for the government of trains and trainmen, and report any neglect of duty or violation of the rules that comes under their notice.

#### MASTER CARPENTERS.

The master carpenter reports to and receives his instructions from the Assistant Engineer.

He has charge of the repairs of bridges and other structures, and will promptly report any defects observed. He will employ such workmen as may be necessary, subject to the approval of the Assistant Engineer, and see that they perform their duties properly.

He must be familiar with the use and meaning of signals, and see that they are understood and properly used by the persons employed under him.

When repairing bridges or other structures, he must keep the main track safe for the passage of trains, and when necessary to obstruct it, see that danger signals are displayed at a distance of at least 900 yards in either direction from which trains may come.

He will arrange with the Supervisor for the dis-

tribution of material and for assistance he may require.

#### TRACK FOREMEN.

Track Foremen report to and receive their instructions from the Supervisor.

They have charge of the repairs on their respective sub-divisions, and are responsible for the proper inspection and safety of the track, bridges and culverts.

They must see that the track is in good line and surface, and properly spiked; that it is in true gauge; that cross-ties are properly spaced, lined and tamped; that the road-bed is in good order; that the proper slopes and ditches are preserved, and that the drainage is not interfered with.

They must engage in work personally, and see that watchmen and other workmen faithfully perform their duties, and suspend any one for neglect or misconduct, and report the same to the supervisor.

They must compare time each day with the clock at the nearest telegraph office, or with the conductor of a train; carefully observe signals displayed by trains; and be sure, before obstructing the track, that all trains and sections of trains that are due have passed.

They must watch points where obstructions are likely to occur; examine the slopes of cuts, and remove anything liable to fall or slide; remove combustible material from the vicinity of the track, bridges and buildings; extinguish fires that may occur along the road; watch the telegraph line and keep the poles in proper position; reset poles and unite wires when necessary; report promptly any derangement of the



# PENNSYLVANIA R. R.

CROSS-SECTIONS  
OF

## STANDARD - ROAD - BED

SINGLE TRACK  
TO BE USED ONLY FOR HEAVY TRAFFIC  
SLOPE 1 1/2 TO 1  
EXCAVATION

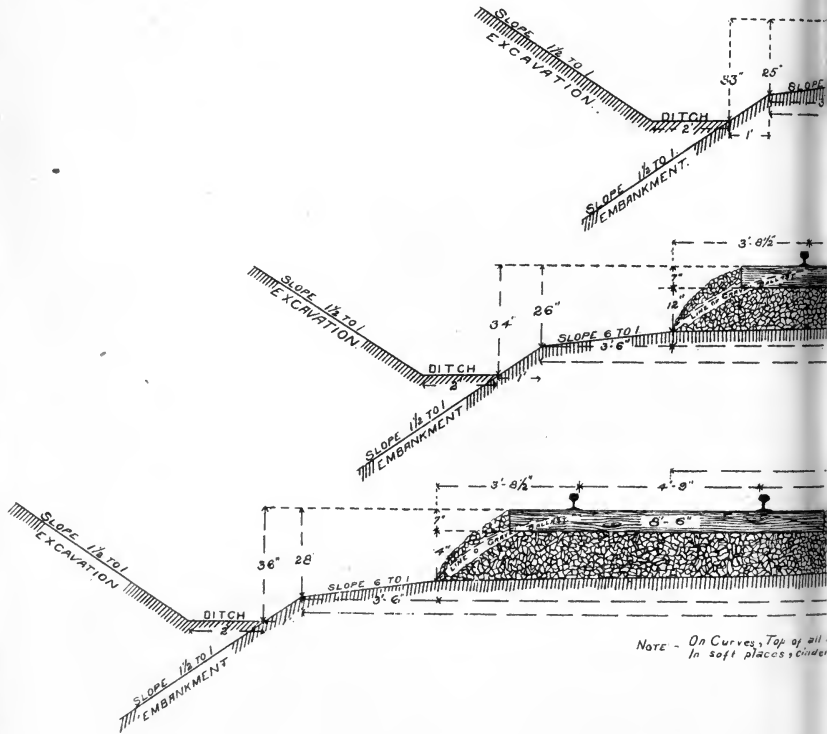

Note - On Curves, Top of all  
In soft places, consider



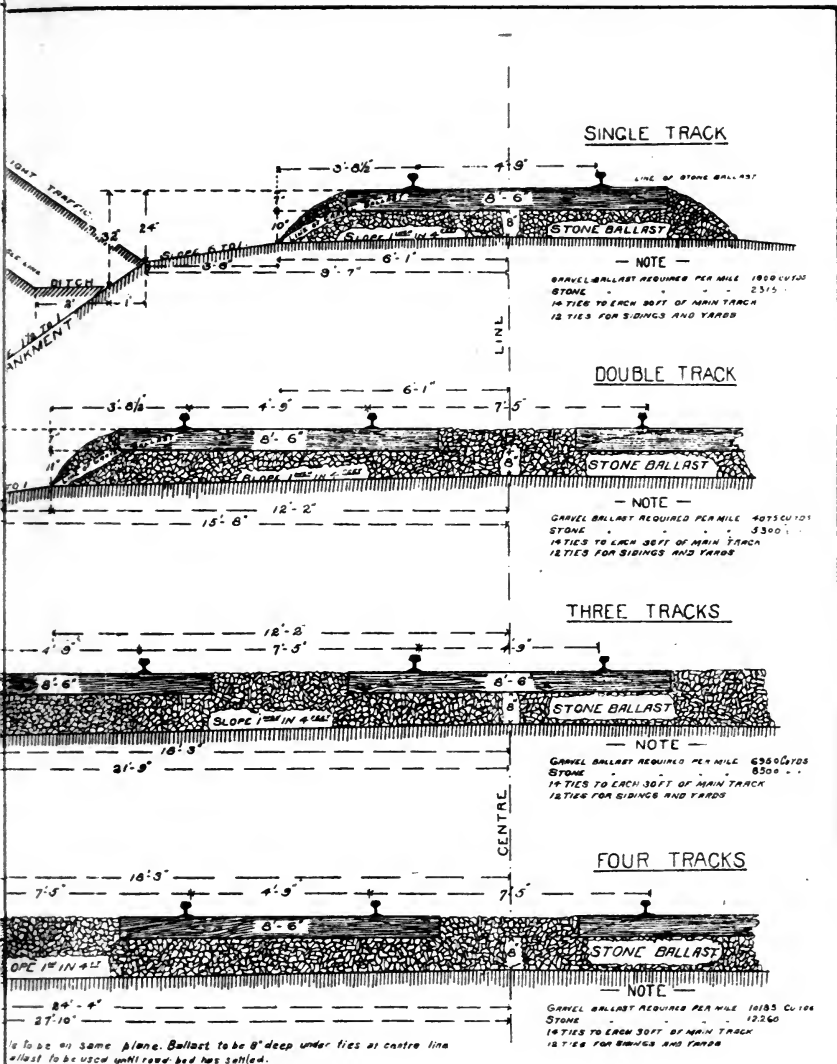



wires; assist the telegraph repairmen when necessary; see that water stations are kept in order and report any failure in the water supply; render prompt assistance in case of accident, or delay to trains; and see that old material is gathered up, and that their subdivisions are kept in neat and proper condition. During heavy storms they must detail all hands to watch the road and take every precaution to prevent accident.

They must run their hand-cars and trucks with great caution, always keeping a lookout for extra trains, and fully protect themselves by signals where necessary.

They must not run within twenty minutes of the time of any regular train, nor in the wrong direction on double track. They must not permit their hand-cars or trucks to be used, unless they accompany them, nor to be run on Sunday or after dark, without special authority from the Superintendent, nor to be attached to trains in motion; and when they are not in use they must be kept locked, and so secured that they cannot be so moved as to endanger the safety of trains.

They are permitted to use the track in making repairs to within ten minutes of the time of a regular train, but must never so use or otherwise obstruct the track without first displaying a danger signal at least 900 yards in either direction from which trains may come, and if the signal cannot be seen by the Foreman at the point where he is at work, a man must be placed in charge of it. They must always be prepared for the arrival of extra trains. Anything that interferes with the safe passage of trains at full speed

is an obstruction, and must not be attempted without using the above precaution.

#### ROAD AND BRIDGE WATCHMEN.

Watchmen report to and receive their instructions from the Track Foreman.

Road watchmen must carefully examine the track, and see that it is in safe condition; that the switches are set and locked for main track; that cars left on sidings fully clear the main track; and that the doors of loaded cars are secured. They must examine buildings and other property of the company, and protect them from theft and fire.

Should an obstruction to the track occur, the watchman must at once display a danger signal in either direction from which trains may come and immediately send word, if possible, to the Track Foreman. Night watchmen, before going off duty, must notify the Track Foreman of the trains due which have not passed, and of any other matters requiring attention.

Bridge watchmen must keep a supply of water on bridges and follow each train with a bucket of water to extinguish fire or hot cinders, that may have fallen from the engine; keep the coping of the abutments and piers clean; remove combustible matter from near the bridges; frequently examine the timber and iron work of their bridges and report any decay or defect; and prevent all persons, except employees, from crossing the bridges.

Watchmen must observe the speed of passing trains and report any violation of the rules. When their time is not wholly occupied with watching, they

will attend to such other duties as may be directed.

#### SWITCHMEN.

Switchmen report to and receive their instructions from the supervisor. In yards they report to and are under the direction of the Yard Master or Station Master.

It is the duty of the Switchmen to operate the switches under their charge, for trains using them; to keep the switches in good condition and clear of snow or other obstruction, and promptly report defects.

They must keep the switches locked for the main track, except when passing trains to or from another track, and must watch for approaching trains and give the safety signal if all is right.

When day or night switchmen are employed, they must not leave their posts until relieved by each other, and the one going off duty must inform the one coming on, of trains due which have not passed.



**Standard**  
**Track Material**  
**for**  
**100 lbs. Rail.**  
**Pennsylvania**  
**R.R.**

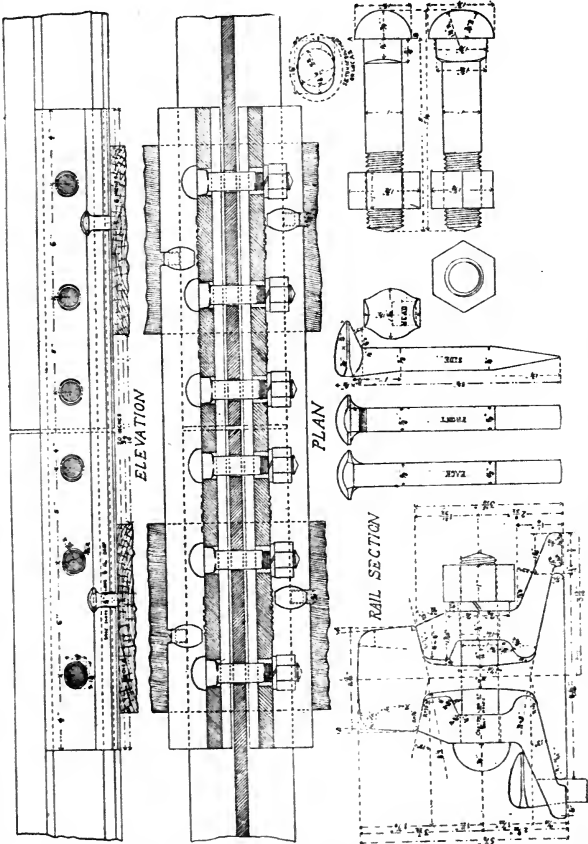

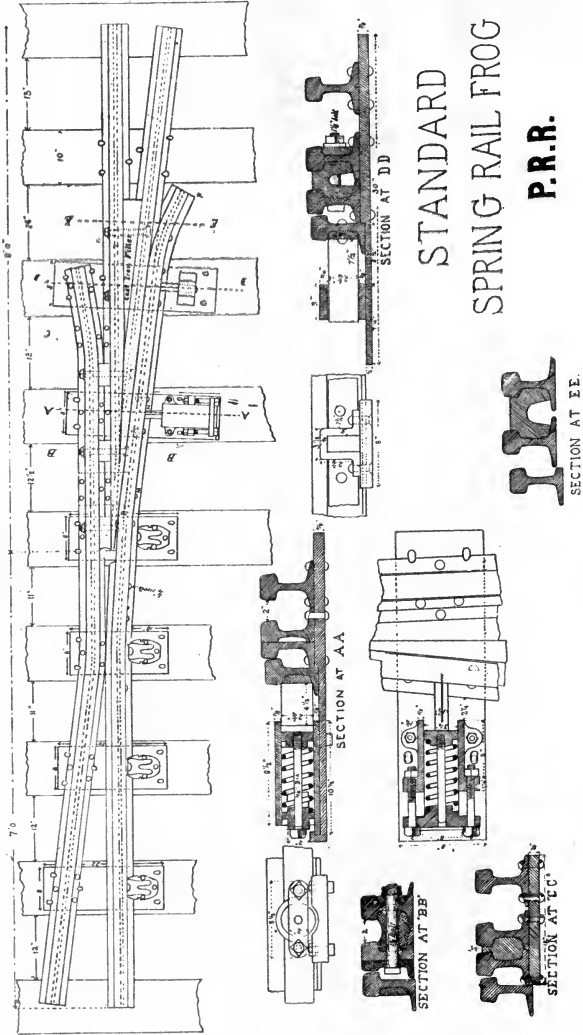

STANDARD  
SPRING RAIL FROG  
P.R.R.



# Standard Stiff Rail Frog

DISTANCE FOR NO. 4 FROG

26	4
24	4
22	4
20	4
18	4
16	4
14	4
12	4
10	4
8	4
6	4
4	4
2	4

NO. 4 STIFF FROG - 70'

NO. 4	70'
NO. 4	60'
NO. 4	50'
NO. 4	40'
NO. 4	30'
NO. 4	20'
NO. 4	10'

NO. 4 STIFF FROG

NO. 4	70'
NO. 4	60'
NO. 4	50'
NO. 4	40'
NO. 4	30'
NO. 4	20'
NO. 4	10'

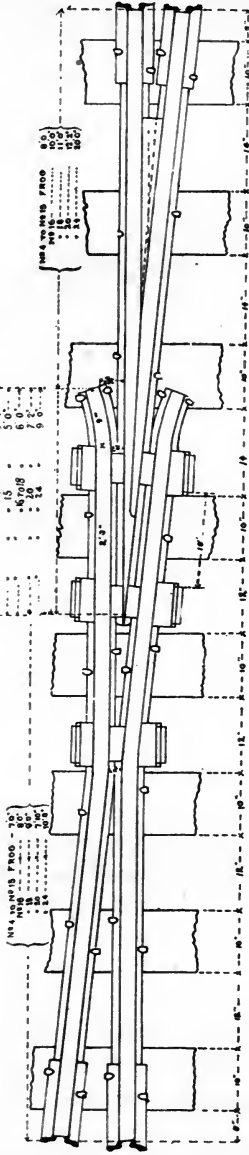

# Pennsylvania R.R.

## CHAPTER V.

### PENNSYLVANIA LINES WEST OF PITTSBURG.

#### SIGNAL DEPARTMENT.

##### SIGNAL ENGINEER.

There shall be a Signal Engineer, who shall report to the General Superintendent of each system for the work done on that system, and act under his direction.

He shall have charge of the erection work connected with Interlocking and Fixed Signals, and, after completion, it shall be his duty to inspect them from time to time, to the end that a proper adherence to standards may be observed in their maintenance.

He shall prepare plans for signaling (consulting fully with the Division Superintendent), and specifications and estimates for the same; and when approved shall superintend the erection.

##### SUPERVISOR OF SIGNALS.

The maintenance of the Interlocking and Fixed Signals on each division shall be in charge of a Supervisor of Signals, who shall report to and receive his instructions from the Engineer of Maintenance of Way, of the division. He shall report weekly to the Signal Engineer the condition of the work in his charge, on forms provided for that purpose. Until the signal work on a division has been developed to an extent sufficient to require the exclusive attention of one man, the duties

of Supervisor of Signals may be combined with those of some other office.

He will be responsible for the proper working of all interlocking apparatus and other signals in his charge.

He must make all necessary and ordinary repairs, but must not make any change in the locking, or in any part of the apparatus or appliances, without proper instructions from the Signal Engineer.

He must make examinations, as often as may be necessary, of all interlocking apparatus and signals in his charge, and see that lamps are kept in good condition.

When switches are disconnected from the machine it must be done under the supervision of the Track Foreman; they must be protected by a flagman, and all movements over them made according to instructions.

#### LEVERMEN.

Levermen report to and receive their instructions from the Supervisor of Signals, concerning the manual operation and the maintenance of the signal apparatus.

#### LAMPMEN.

Lampmen report to and receive their instructions from the Supervisor of Signals.

### GENERAL PRINCIPLES OF SIGNALING, WITH DIAGRAMS ILLUSTRATING THEIR APPLICATION.

---

#### SIGNALS AND THEIR POSITIONS.

The signals used must be of the semaphore pattern, and consist of a post with a movable arm pointing to the right; the arm having either a square or forked end. The shape and position of the arm indicate how trains shall proceed, as follows:

(a) An arm with a square end is a "Home Signal." In a horizontal position it indicates "danger, stop."

Inclined at an angle of 45 degrees to the horizontal, it indicates "caution, proceed carefully."

Inclined at an angle of 75 degrees or more to the horizontal, it indicates "safety, proceed."

At night these positions may be shown by illuminating the arm, or indicated by colored lights:

Red, for horizontal.

Green, for an angle of 45 degrees.

White, for an angle of 75 degrees or more.

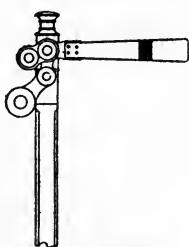

**DANGER.**

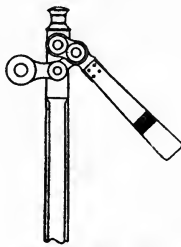

**CAUTION.**

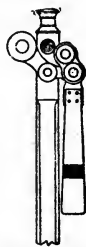

**SAFETY.**

(b) An arm with a forked end is a "Distant Signal." It is used in connection with the "Home Signal" for a high speed route, and regulates the approach thereto.

In a horizontal position, its indication is to approach its "Home Signal" prepared to stop.

Inclined at an angle of 75 degrees or more to the horizontal, its indication is "safety, proceed."

At night these positions may be shown by illuminat-

ing the arm, or indicated by colored lights:

Green, for horizontal.

White, for an angle of 75 degrees or more.

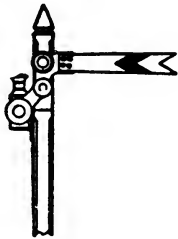

**CAUTION.**



**SAFETY.**

All semaphore arms must point to the right.

A separate post must be used for each track to be governed.

Each signal must be placed, whenever practicable, on the right hand side of the track it governs, except where a bridge is used, when it must be placed over the right hand rail. Where practicable, the tracks should be spread so as to allow each signal to stand directly at the right of the track it governs.

Semaphores may be of the high or low pattern. High semaphore arms stand not less than 25 feet above base of rail; they may be on single posts, bracket posts or bridges over the tracks. They govern main running tracks in their right direction. On single track both directions are right directions. Low semaphore arms stand not more than  $2\frac{1}{2}$  feet above base of rail; they govern main running tracks in their reverse direction, and movements from side tracks to main tracks, or side tracks to side tracks. They may be used to govern running tracks in their right direction at terminal points.

High home signals will have two arms on the same post, the top arm indicating safety, directs the train to main or high speed track; the bottom arm indicating safety, directs the train to any other track, to which it must proceed at reduced speed. If it is desired to specify to which track the switches are set, it will be done by an indicator showing the number of the track placed under the arm.

When two parallel tracks are to be governed, the posts carrying the signals governing them stand in the same relative positions as the tracks governed. Arms for exclusive passenger tracks stand 7 feet higher than arms for exclusive freight tracks.

Where a bridge is used, tracks are governed by the signals standing over the right hand rail.

A high semaphore signal is used as a distant switch signal, at points where the signal at switch cannot be seen a sufficient distance. The signal showing caution indicates that the switch is open.

If a signal is not properly displayed it indicates danger, and the train must stop, and not proceed until every precaution has been taken to insure safety.

#### HIGH SIGNALS.

High semaphore signals must be used to govern running tracks in their right direction. On single track both directions are right directions.

#### LOW SIGNALS.

Low semaphore signals may be used to govern running tracks in their right direction at terminal points. They must be used to govern running tracks in their reverse direction, and all other tracks in either direction.

#### NUMBER OF ARMS.

Excepting for train order and switch signals, two

arms must be used on all high home signal posts, the top arm to govern the main or high speed route, the bottom arm to govern all diverging routes. Where there are no diverging routes, the bottom arm must be fixed in the horizontal position, and show a red light at night. No more than two arms shall be used on a home signal post, nor more than one arm on a distant signal post.

#### BACK LIGHTS.

All signals, with the exception of interlocking signals which face the tower, must be provided with back lights.

#### HOME SIGNALS.

Home signals must be placed at the first fouling point, or point of danger, which they govern.

#### ADVANCE HOME SIGNALS.

Advance home signals will be used when necessary.

#### BLOCK SIGNALS.

Block signals may be made a part of an interlocking system, and when so arranged, a clear distant interlocking signal will also indicate that the block signal is either at clear or caution.

#### DISTANT SIGNALS.

Distant signals must be used only where the speed of trains is not limited by local conditions, and must indicate safety for high speed route only.

Distant signals for a tower in advance must never be located at a distance less than six hundred (600) feet in advance of a home signal of the tower in the rear,

and in no case shall any interlocking signal be located between a home signal and its distant signal.

#### DISTANT SWITCH SIGNALS.

A high semaphore signal may be used as a distant switch signal at points where the signal at the switch cannot be seen a sufficient distance. This signal in a horizontal position indicates that the switch is open.

#### COLOR OF SIGNAL ARMS.

All semaphore arms must be painted uniformly and of a color which will show most conspicuously against the surrounding background.

#### ILLUMINATED SIGNALS.

Illuminated arms may be used in new work and renewals.

The construction must be such that any failure of parts directly controlling a signal shall cause the arm to return to the horizontal position.

#### TOWER LIGHTS.

Lights in the tower must be so placed as not to be directly seen from approaching trains.

Interlocking machines must be of the latch-locking type, in which the first movement of the latch of any lever locks all conflicting levers.



# STANDARD ARRANGEMENTS FOR LOCATION OF FIXED SIGNALS PA. LINES WEST OF PITTSBURGH

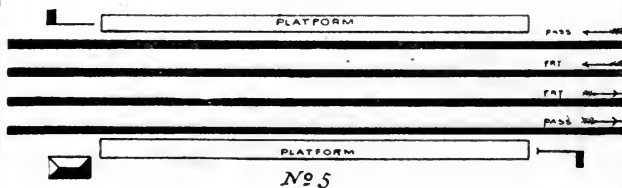
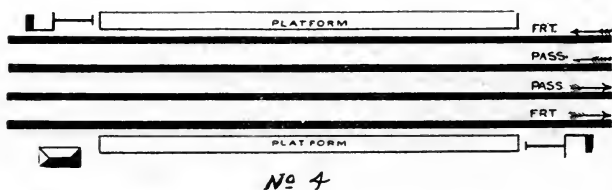
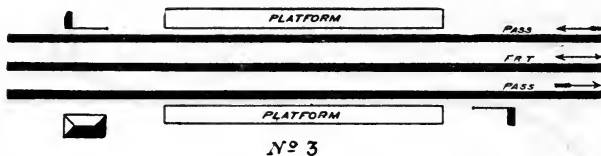
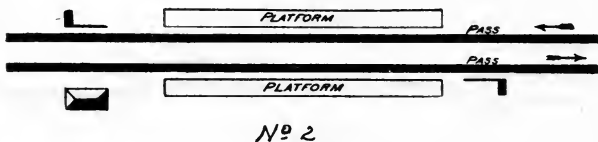



No 6.



No 7

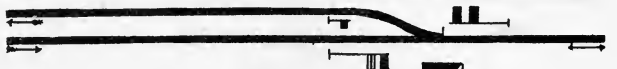

No 8.

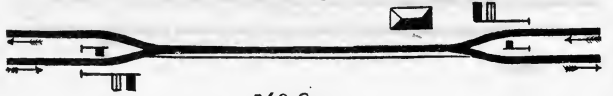

No 9

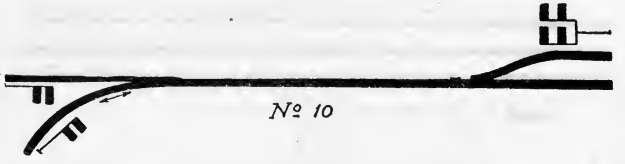

No 10

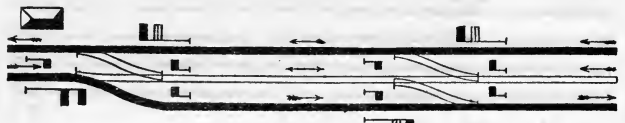

No 11

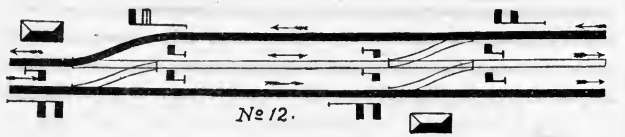

No 12.

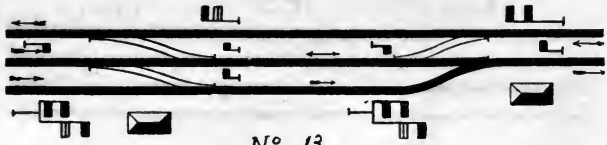

No 13

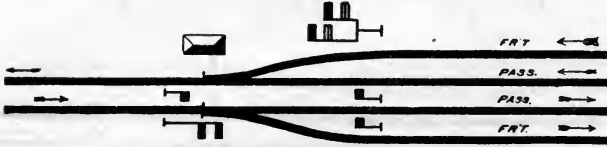

No 14.

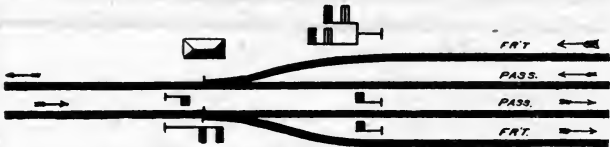

No 15

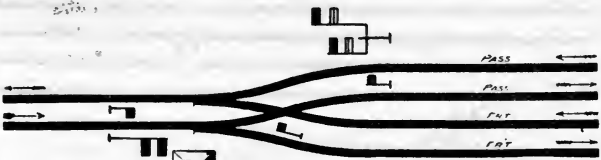

No 16.

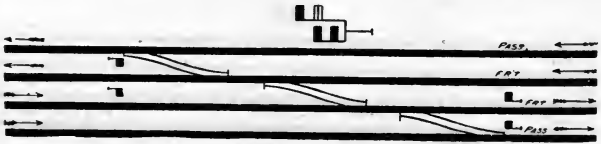

No 17

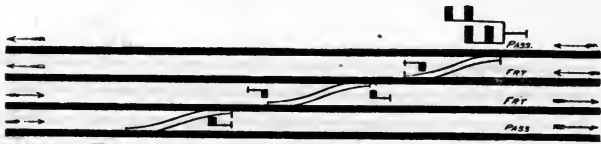

No 18

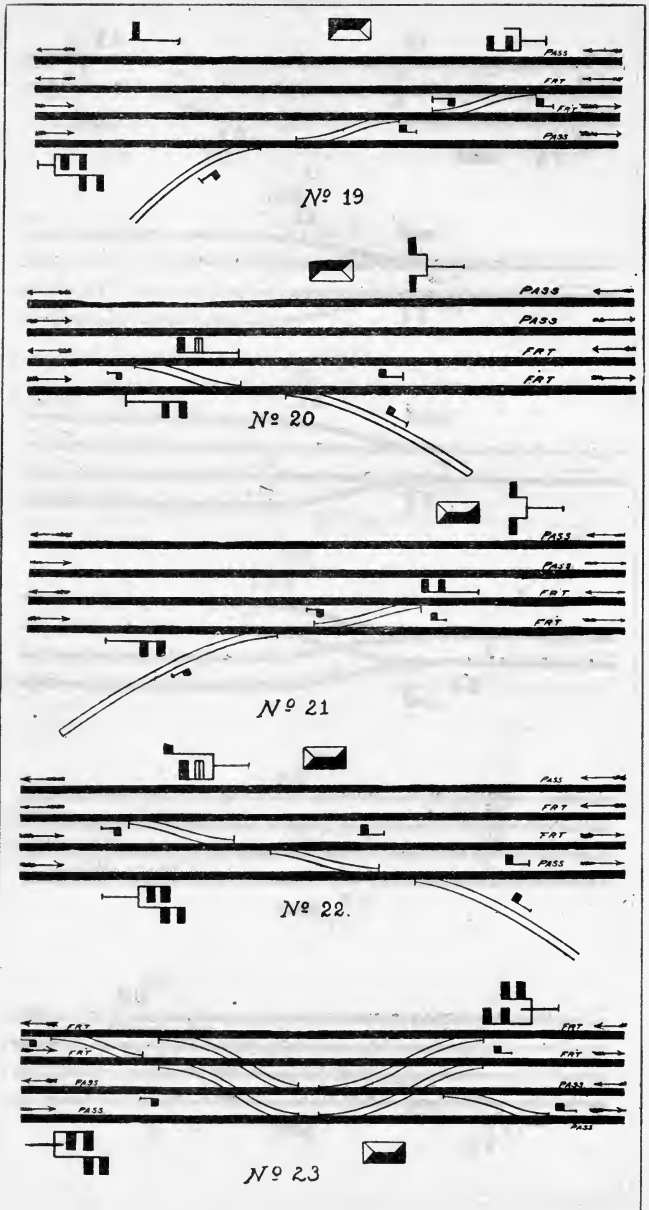

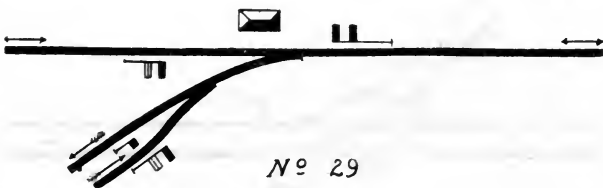
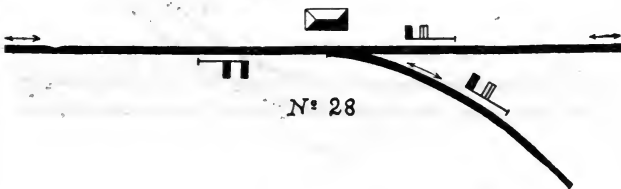
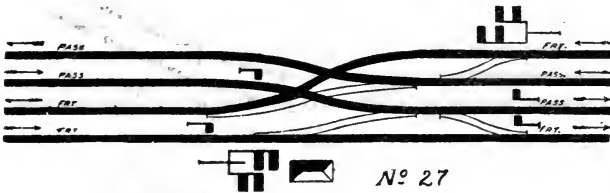
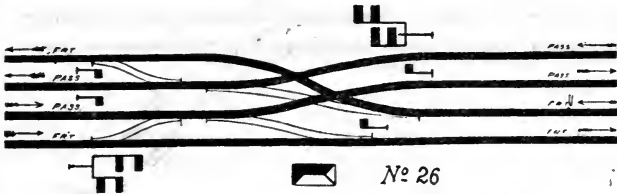
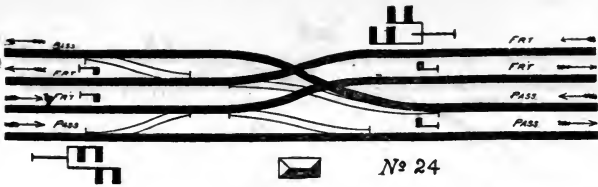

—154—  
PLATE LXXI.

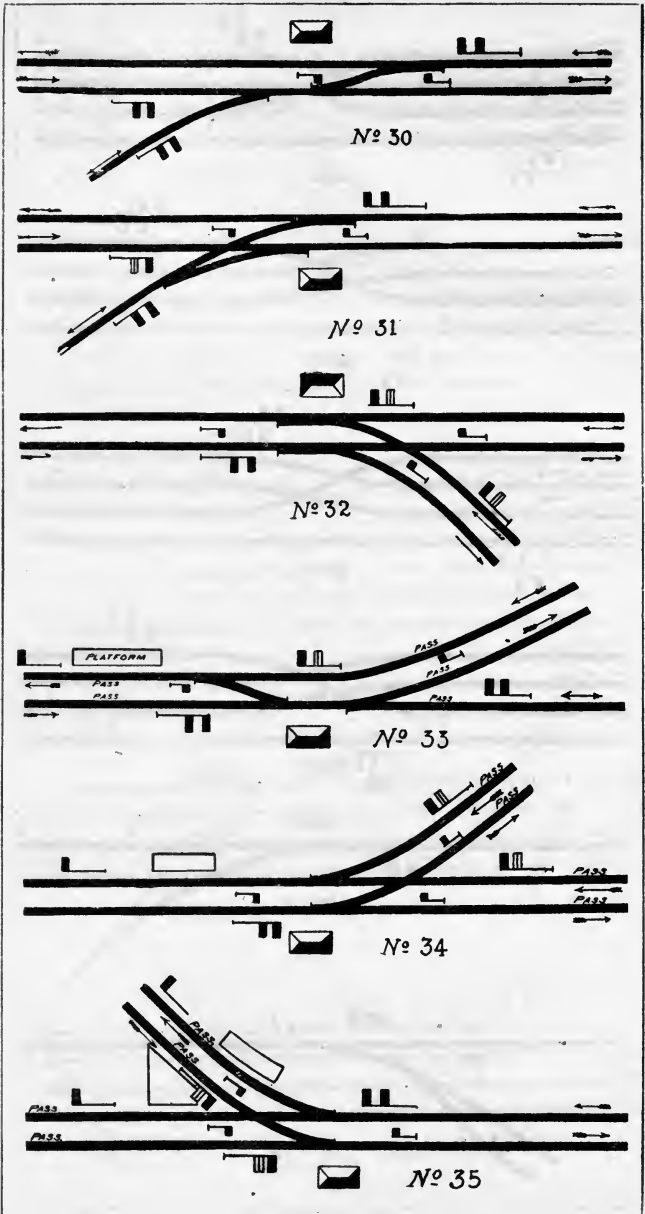

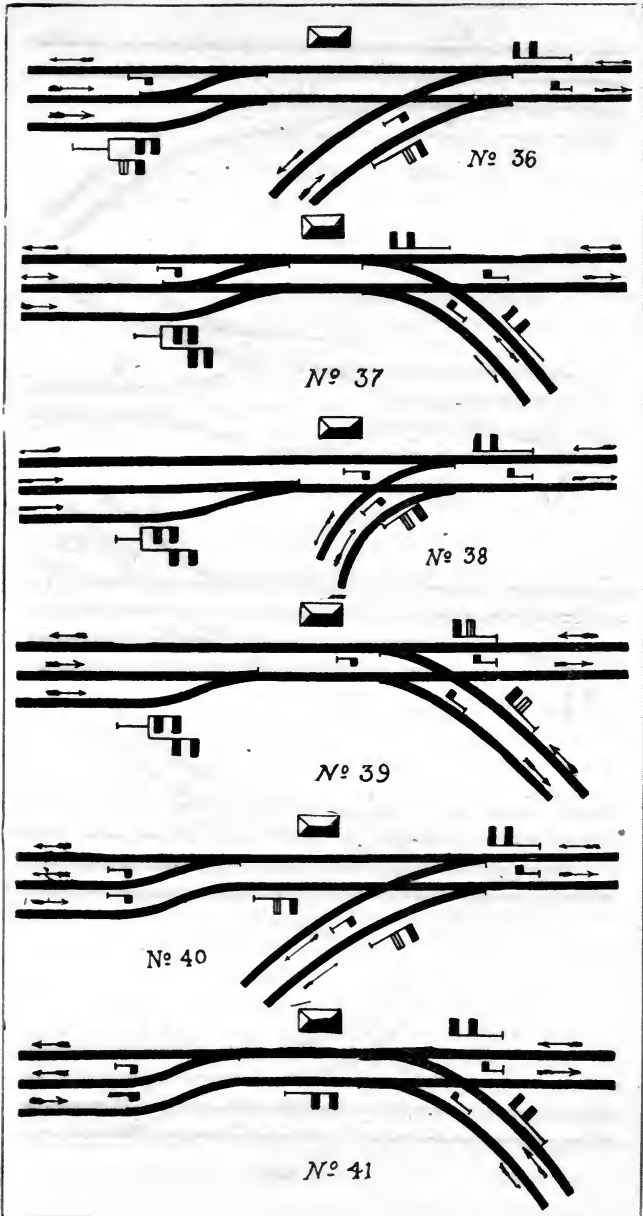

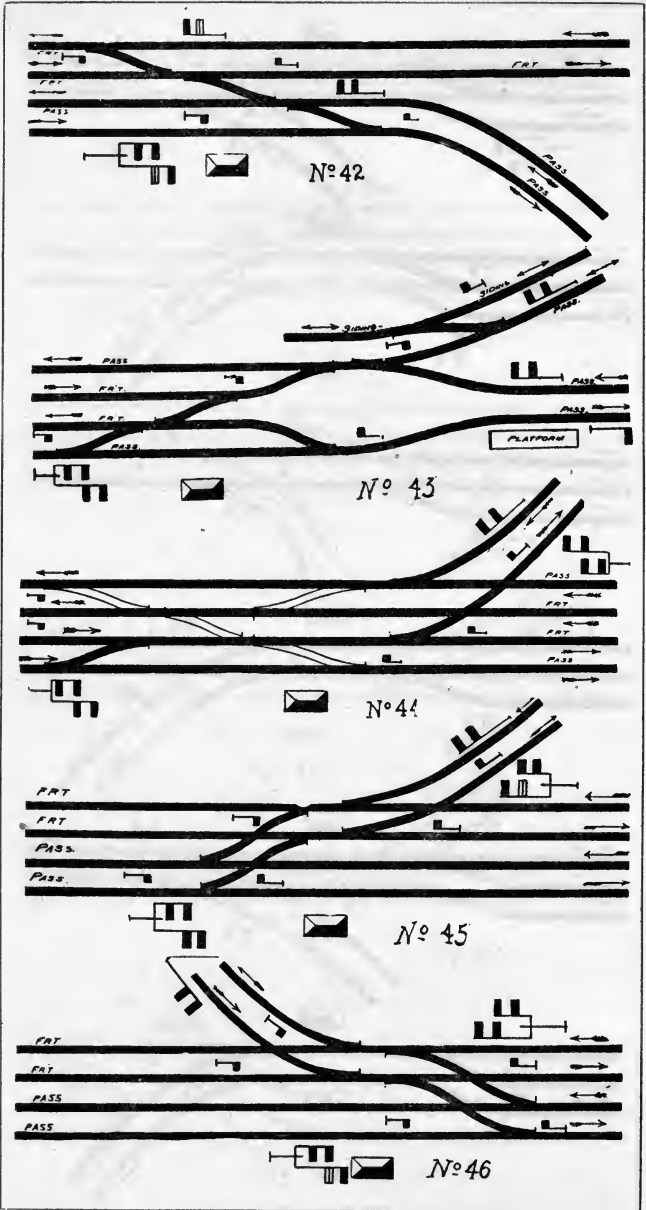



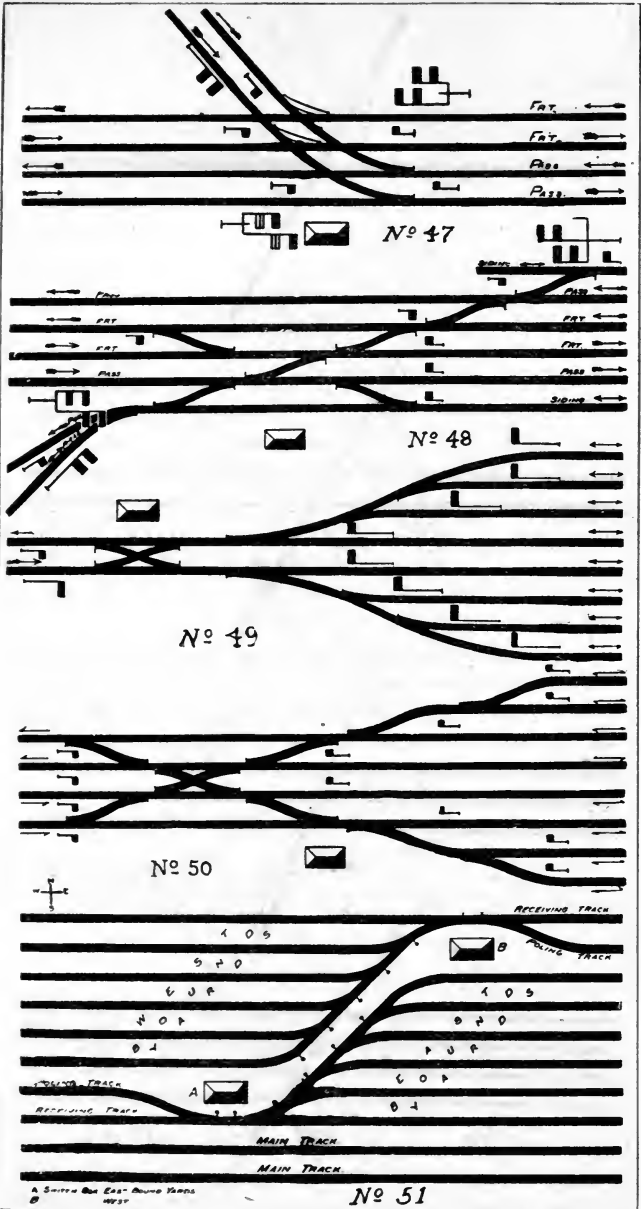

A Switch Box East-Going Yards  
1893

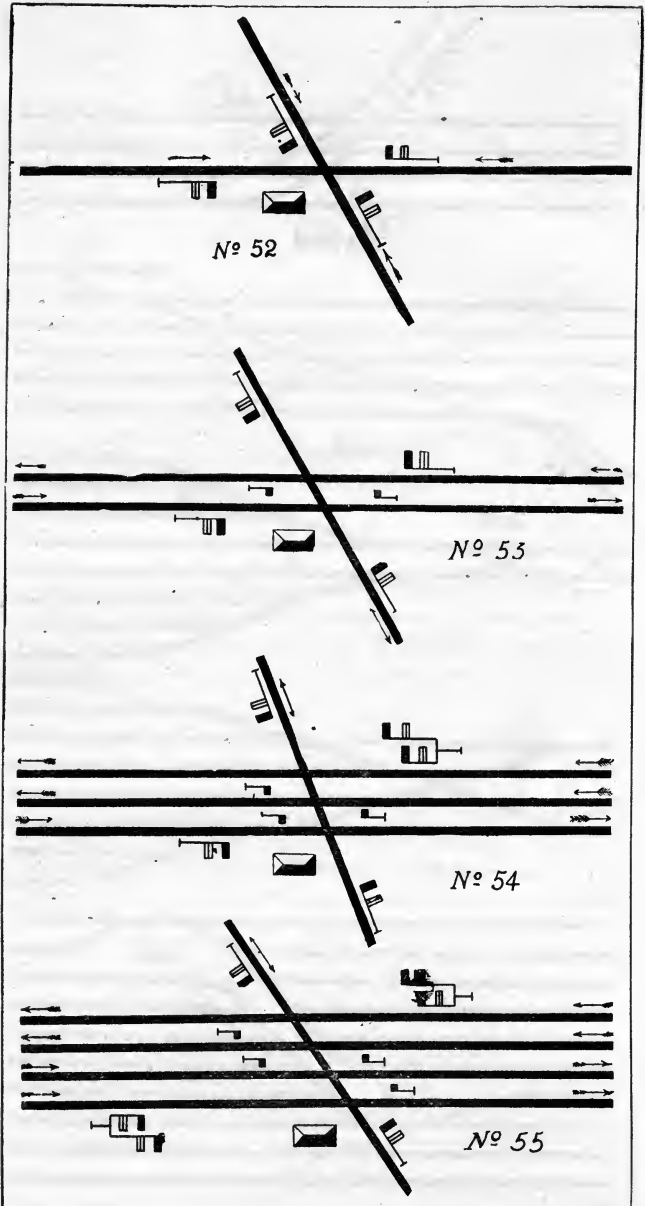

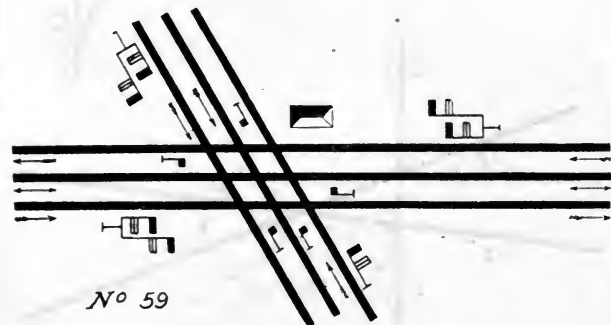
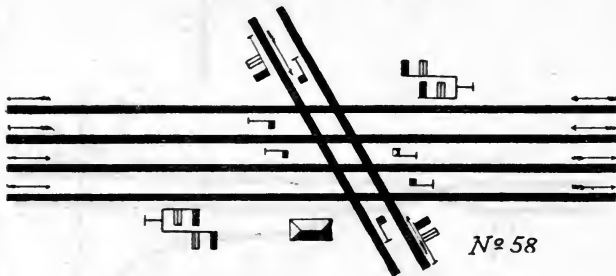
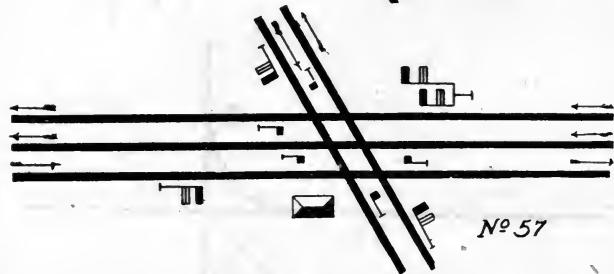
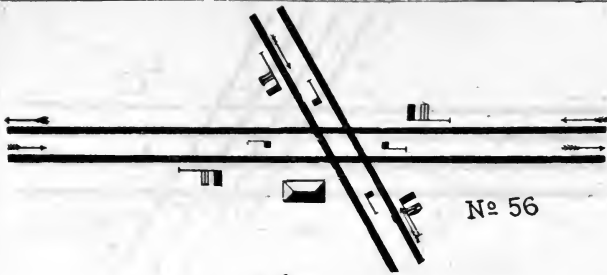

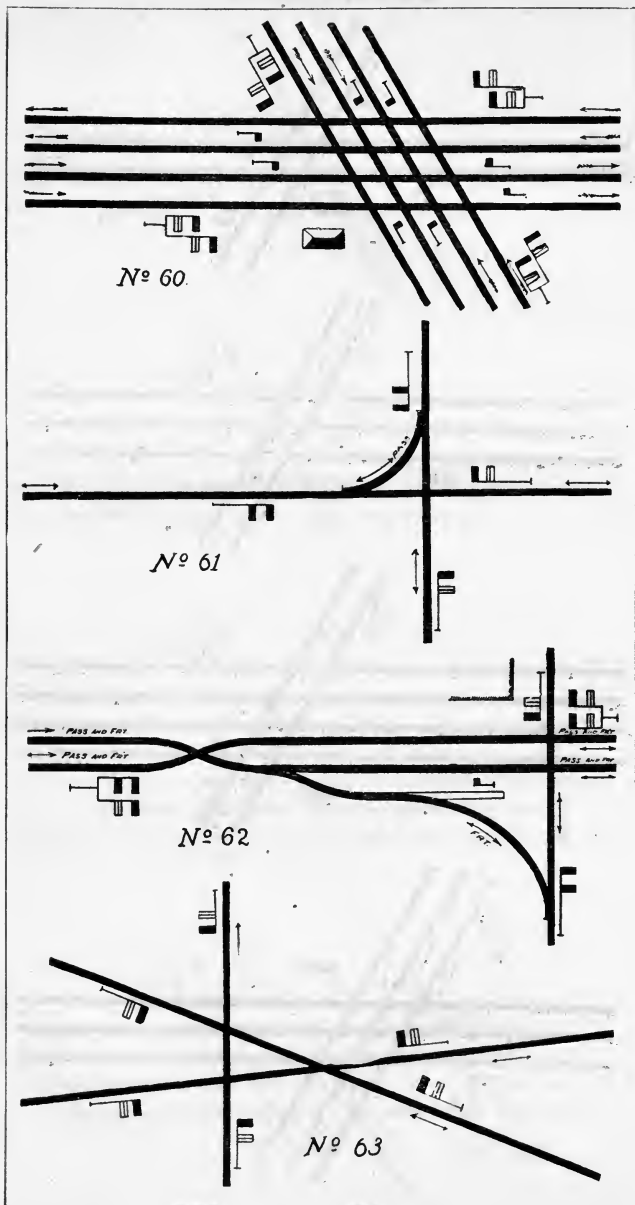

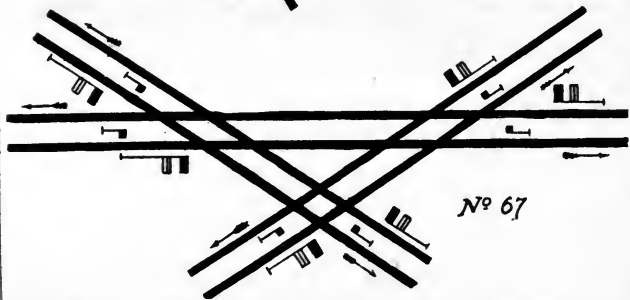
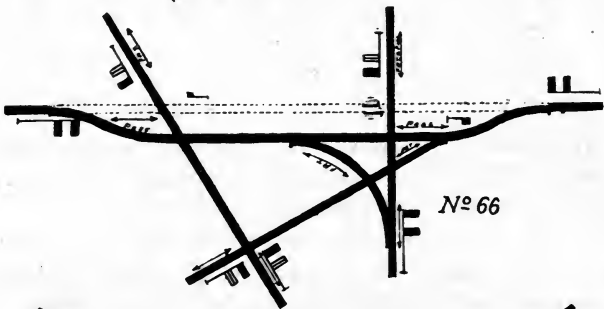
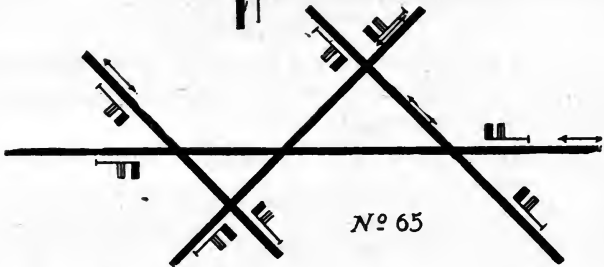
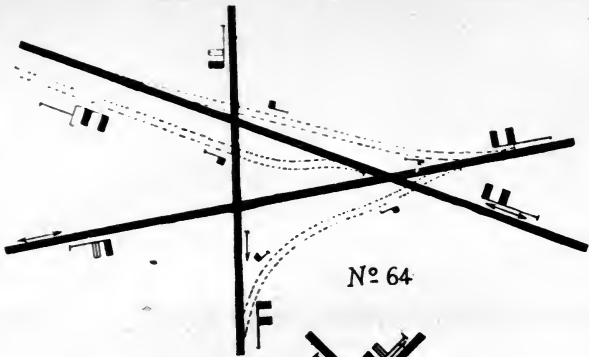

## STANDARD TOWER FOR INTERLOCKING APPARATUS.

1. For the several sizes of interlocking machines the minimum dimensions, from out to out of framing timbers, must be as follows:

For machines from	4	to	12	levers,		12 ft. by 12 ft.
"	"	"	16	"	24	" 12 ft. by 17 ft.
"	"	"	28	"	36	" 12 ft. by 22 ft.
"	"	"	40	"	48	" 15 ft. by 27 ft.
"	"	"	52	"	60	" 15 ft. by 32 ft.
"	"	"	64	"	72	" 15 ft. by 37 ft.
"	"	"	76	"	84	" 18 ft. by 42 ft.
"	"	"	88	"	100	" 18 ft. by 49 ft.

2. Tower foundations, including all timbers built into the foundation walls, will be furnished and put in place by the Railroad Company.

3. Where water and sewer connections can be had, the water closet must be built in the tower; without these essentials, separate building must be provided.

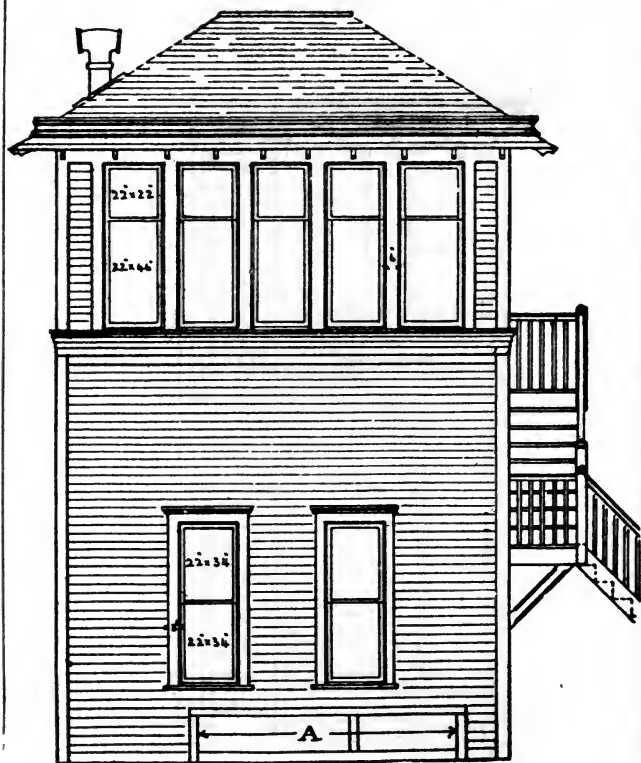

FRONT ELEVATION

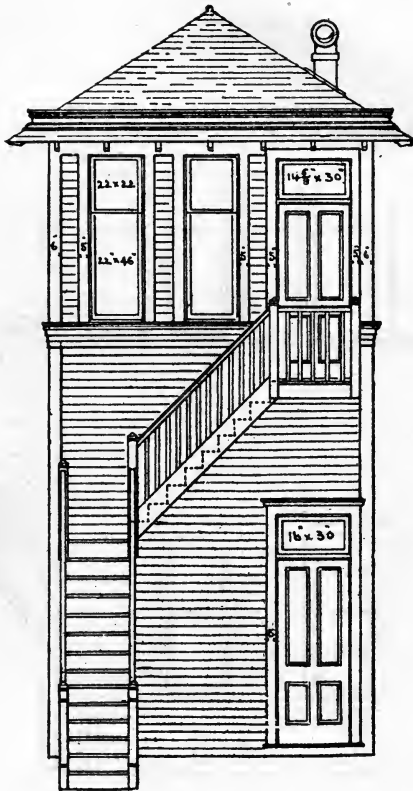

END ELEVATION



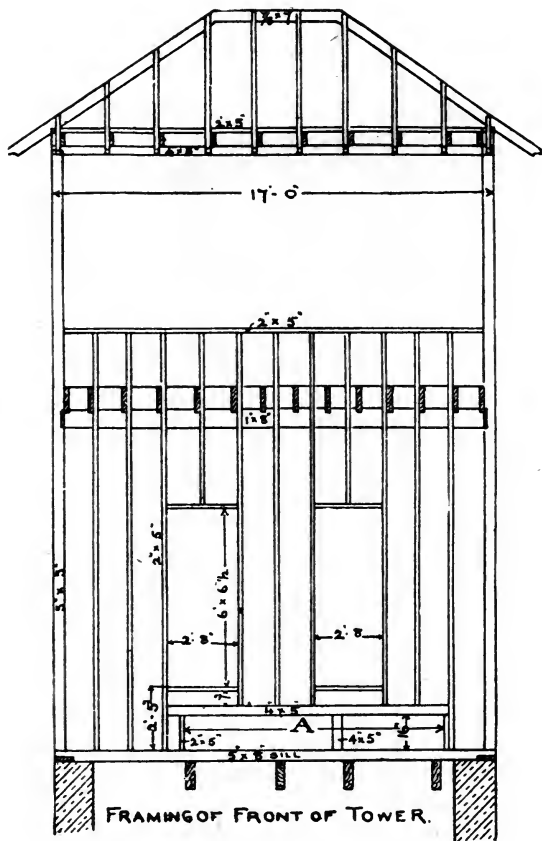

FRAMING OF FRONT OF TOWER.

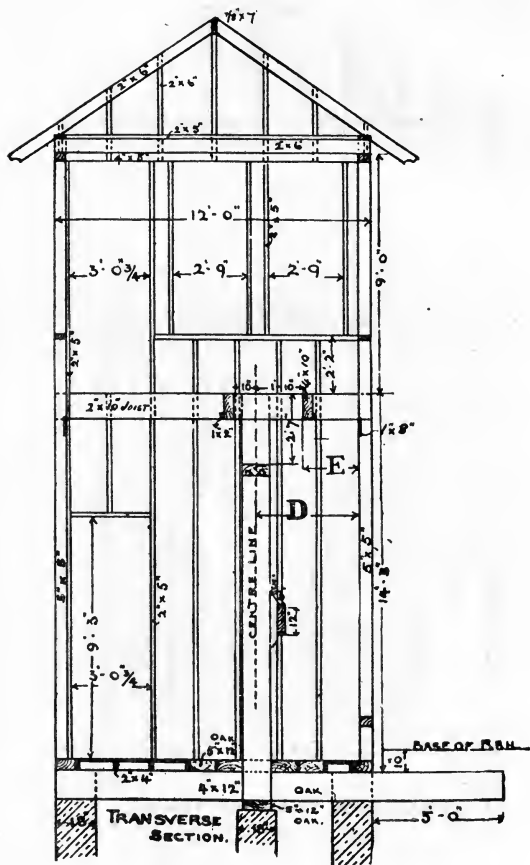

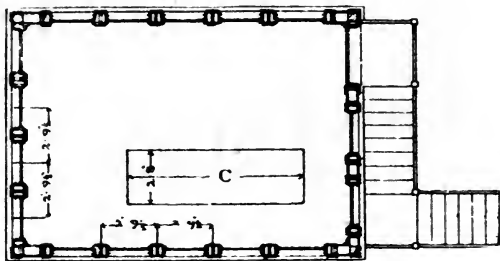

2<sup>ND</sup> STORY PLAN.

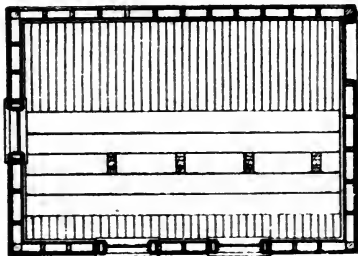

1<sup>ST</sup> STORY PLAN

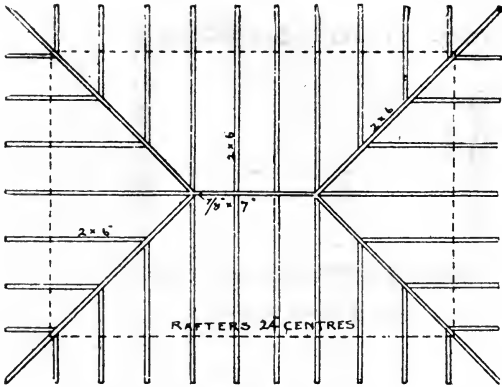

PLAN OF ROOF FRAMING

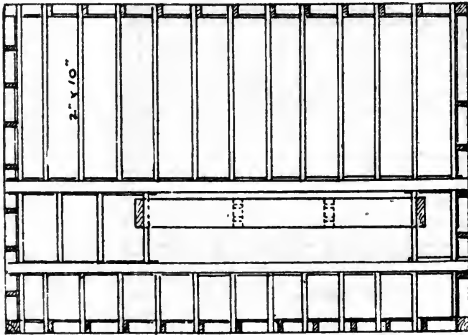

PLAN OF SECOND FLOOR FRAMING

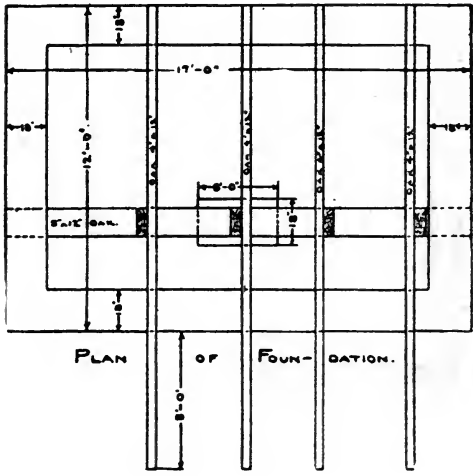
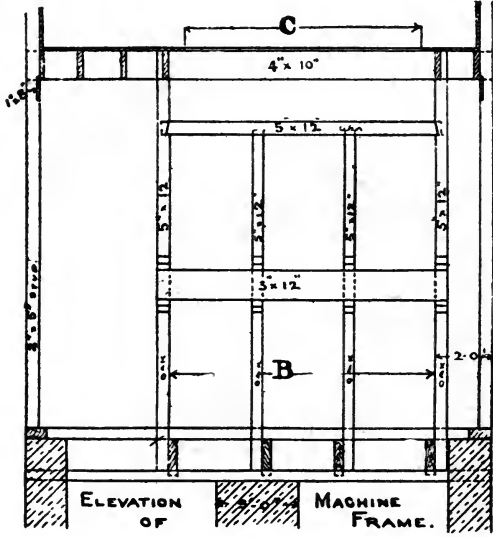

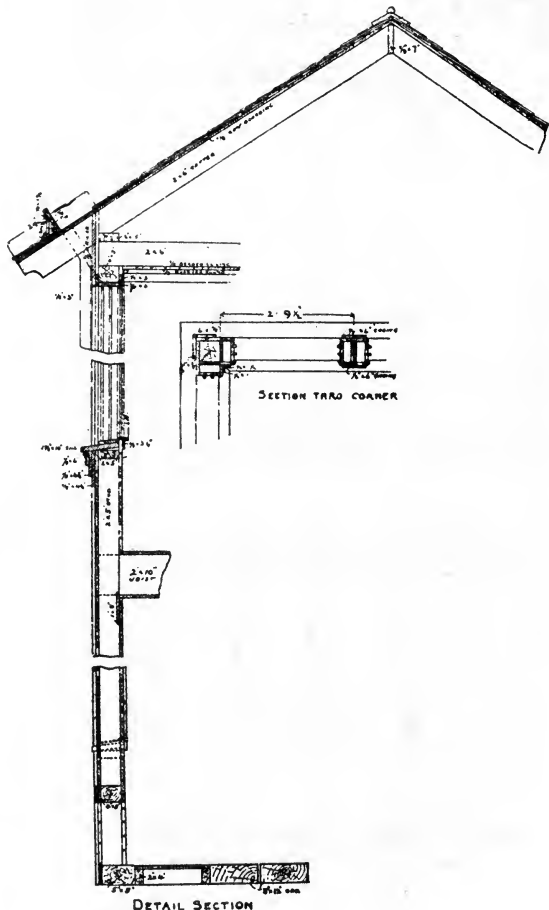

DETAIL SECTION

VARIABLE DIMENSIONS OF TOWERS FRAMED FOR SAXBY & FARMER MACHINES							NO OF INTER- MEDIATE FOUND- ATION PIERS.	BARS IN BRACKET	NO OF INTER- MEDIATE UP- RIGHTS	NO OF SUPPORT FOR LEAD OFF TIMBERS
NO OF LEVELS	SIZE OF TOWER	A	B	C	D	E				
4	12.0x12.0	3.3	3.0	2.0	3.0	1.2	1	8	0	2
8	" "	4.11	4.8	3.8	"	"	"	"	"	"
12	" "	6.7	6.9	5.8	3.3	1.5	"	12	1	3
16	12.0x17.0	8.3	8.0	7.0	3.6	1.8	"	16	-	-
20	" "	8.11	9.8	8.8	4.0	2.2	"	20	2	4
24	" "	11.7	11.4	10.4	"	"	"	24	"	"
28	12.0x22.0	13.3	13.0	12.0	4.6	2.8	2	28	3	5
32	" "	14.11	14.8	13.8	4.9	2.11	"	32	"	"
36	" "	15.7	16.4	15.4	"	"	"	"	4	6
40	15.0x27.0	18.3	18.0	17.0	5.0	3.2	"	36	"	"
44	" "	19.11	19.8	18.8	5.3	3.5	"	40	5	7
48	" "	21.7	21.4	20.4	6.0	4.2	"	"	"	"
52	15.0x32.0	23.3	23.0	22.0	"	"	3	48	6	8
56	" "	24.11	24.8	23.8	6.6	4.8	"	"	"	"
60	" "	26.7	26.4	25.4	7.0	5.2	"	56	7	9
64	15.0x37.0	28.3	28.0	27.0	"	"	"	60	"	"
68	" "	29.11	29.8	28.8	7.3	5.5	"	"	8	10
72	" "	31.7	31.4	30.4	7.9	5.11	"	64	"	"
76	18.0x42.0	33.3	33.0	32.0	"	"	4	72	9	11
80	" "	34.11	34.8	33.8	8.6	6.8	"	"	"	"
84	" "	36.7	36.4	35.4	"	"	"	80	10	12
88	18.0x47.0	38.3	38.0	37.0	"	"	5	"	"	"
92	" "	39.11	39.8	38.8	"	"	"	"	11	13
96	" "	41.7	41.4	40.4	"	"	"	"	"	"
100	" "	43.3	43.0	42.0	"	"	"	"	12	14

## CHAPTER VI.

### NEW YORK CENTRAL AND HUDSON RIVER RAILROAD.

#### ROADMASTER'S LABOR REPORT.

Time books, forms 1\* and 2, are to be used by Section Foremen and Foremen of other Gangs.

Form 1 provides a monthly account to each double page for a force of 10 men; Form 2 provides for a force of 20 men. The Foreman must enter the time of each employee under his charge in hours in the proper date column, and totalize at the close of each day the number of hours worked by his force. The time of the Foreman, and any other employee receiving a monthly salary, must also be entered on the time-book in hours, calling ten hours to the day.

At the close of each day the Foreman must enter a description of labor performed on blank 3 or 4, noting thereon the number of hours devoted to each kind of labor, as described in the blank, in the proper date column. He must write in any of the spaces provided the nature of the work if there is no printed description that will answer the purpose. The total hours thus entered must agree with total hours worked on the corresponding date, as shown by the time book 1.

Form 4 is designed for the use by Foremen of

---

\*The N. Y. C. & H. R. R. Maintenance of Way Accounting forms are not surpassed by any American road. The Form Numbers are given in this chapter but fac-simile of blanks cannot be reproduced on account of limited space of this work.



bridge, carpenter and other gangs. They will be required to write in daily the description of labor performed, giving definite location and description of each piece of work, as well as the hours of labor thereon.

At the close of the month each Foreman must extend the total time worked by each person, as shown on 1 and 2 (Time Book), entering rate of pay and extending the value. He must also extend the time as shown on Forms 3 and 4 into the "total time worked column," and must see that the total of the hours in the column "total time worked" agrees with the total hours worked, as shown by his time book.

After complying with these instructions the Foreman must forward his time book 1 or 2 and report of "Description of Labor Performed" to the Roadmaster.

The Roadmaster, after examination of rates and the extension in the various time books of his division, must make up the pay rolls therefrom on Form 46.

The Roadmaster must classify the description of labor performed as reported by his Foremen on Form 3 or 4, and note such classification on backs of forms referred to, giving time, average rate, and amount to each distribution. The total value thus extended must agree with the total amount of pay roll as per time book. \*

---

\* To ascertain the total value of labor chargeable to each class of work, divide total hours worked into the total value of time worked for an average rate. Multiply the number of hours for each class of work by this average rate.

The time and rate returned in Foreman's time books for Watchmen, Flagmen, Switchmen, etc., should not be included in ascertaining the average rate.

The whole time as returned on the time books of those employed in special service should be distributed direct to the proper Disbursement Accounts.

Foremen are to be provided with extra time books before close of the month, so that they can start their time for succeeding month while their time books for previous month are in the hands of the Roadmaster. These time books are to be returned to the Foremen from month to month until they are filled up, when they will be filed permanently with the Roadmaster.

After the Roadmaster makes up his rolls and has forwarded them to the General Roadmaster, he must make up and forward to the General Roadmaster a pay roll report on Form 5, which is a transcription and consolidation of amounts as distributed to the several disbursement accounts, etc., on Forms 3 and 4. The total of this pay roll report must agree with the total of the pay rolls of the Road Division.

The consolidation of the pay roll reports as returned on Form 5, referred to above, must be made by the General Roadmaster on Form 6, and rendered to the Auditor of Disbursements. The total of this report must agree with the total amount of the pay rolls approved by the General Roadmaster.

There are other labor reports tributary to those cited above, referred to under head of "Material Reports," as they are made in connection with material transactions.

#### ROADMASTERS' MATERIAL REPORTS.

Section Foremen and Foremen of other Gangs will be provided with a "Material Diary" (Form 7), in which they are to make each day a record of material received from all sources (including the rails and other material taken out of the track) under head of "Material Received." They must also enter each day under head of "Material used or disposed of"





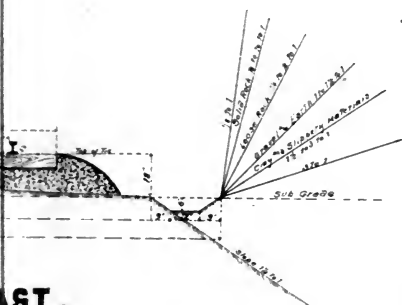

**STANDARD  
ROAD BED  
SECTIONS.**



**N.Y.C.&H.R.R.R.**

**AST.**

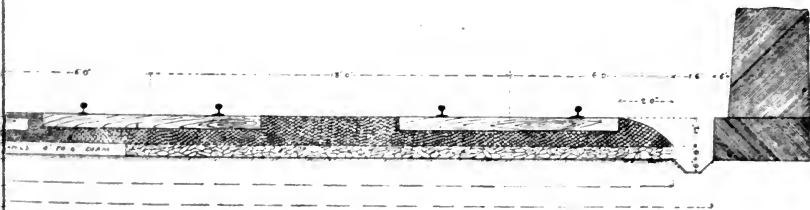

**YORK CITY; STONE BALLAST.**



the material used in repairs of track and in new work, or otherwise disposed of.

By the aid of his "Material Diary" the Foreman must make up and render to his Roadmaster on the 25th of each month a report of material used in repairs or taken away during the previous month, on Form 8, and report of material used in "New Work" during the previous month on Form 9.

Only material used in repairs or sent away from the section is to be reported on Form 8, except that the quantity of material taken out of track must be reported on this blank in spaces provided.

Form 9, must be used only to report material used in "New Work." This report must also be made by the Foreman of a special gang or work train whose force is engaged in constructing a new side track; in which case Foreman of the section on which the side track is constructed must not render a report. If 9 report is made by other than Section Foreman, the Foreman so reporting must state under "Remarks" from what section or point the "Material used" was taken.

Form 10, "Report of Tools," is a report to be made at the close of the month by each Section Foreman. This report will show the condition of tools in his charge; the various track tools received during the month, worn out during the month, and balance on hand at end of the month. Before the end of the month the Roadmaster must send one of these blank reports to each of his Foremen, with quantity on hand on the last day of previous month filled in; the Foremen must then fill in the required data opposite each printed description of tools, and forward report,

after certification, to the Roadmaster on the last day of the month.

Track and other tools included in these reports must not be considered as stock on hand. Their values are to be charged out by General Roadmaster on report of Division Roadmasters of actual distribution to Foremen.

Each Section Foreman must be required to furnish an inventory of material on hand on his section at least each quarter, or more frequently if required. These inventories are to be rendered on Form 11, and must be made up from actual count, weights or measurements.

When material is taken away from his section or delivered to outside parties the Section Foreman must at once notify the Roadmaster on form 12. He must give such explanation as is necessary under head of "Remarks," and include in his advice to the Roadmaster the amount of labor, in hours and rates, performed by his force in connection with such disposition of material.

Foremen must also use this blank to notify the Roadmaster of labor done for outside parties as soon as the work is performed.

The material named in this notice must also be included in the Foreman's report of material used, Form 8.

Foremen of work trains must make daily reports to the Roadmaster of movements, etc., on Form 14. They must report on this blank the location and quantity of materials "picked up" and "unloaded." On the fourth page of the report they must describe explicitly the nature of the work done during the day.





*Duggan Chair at Joint*

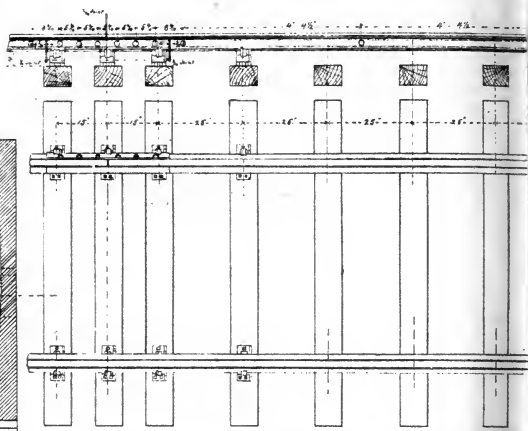
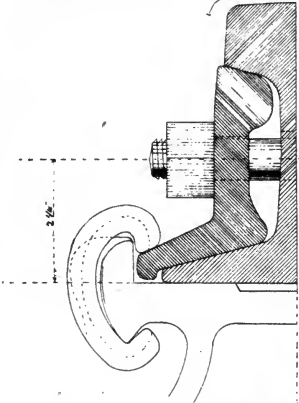

*Elevation & Plan, showing Arrangement*

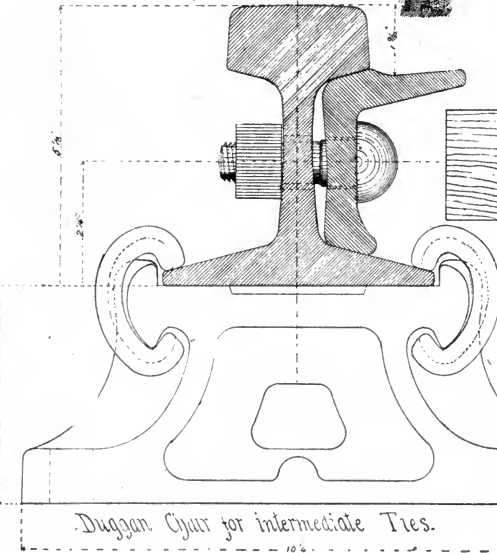

*Duggan Chair for intermediate Ties.*

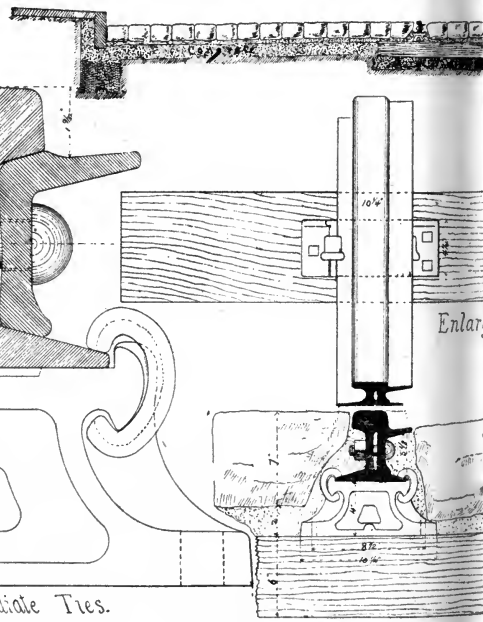

*Enlarged*

# Standard Track in Stone Paved Street. N. Y. C. & H. R. R. R.

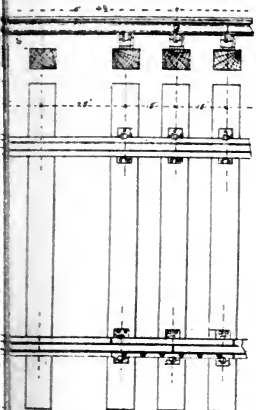

*of Duggan Chairs*



Section.

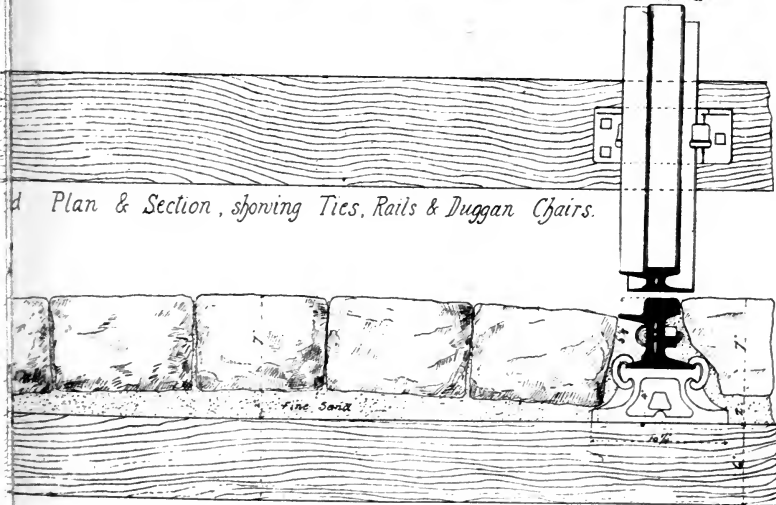

*Plan & Section, showing Ties, Rails & Duggan Chairs.*



These daily reports must be entered by the Roadmaster each day on Form 3, or 4, and at the end of the month he is to carry the consolidated totals to the back of blank opposite proper classification as instructed.

Section Foremen must report all broken rails as soon as practicable after the breakage, giving full information in regard thereto as required on Form 13.

The foregoing instructions embody all the requirements from Section Foremen as regards material and labor. It shall be the duty of the Roadmaster to impress upon his Foremen a sense of accountability for material placed in their charge and the importance of rendering correct and full reports as explained herein.

#### ROADMASTERS' RECORDS.

Upon receipt of material the Roadmasters must advise the General Roadmaster on Form 54 as soon as the exact quantities are ascertained. They must also state in these advices the month in which the quantities so reported will be taken up on reports Form 26.

The "Material Received" advices (Form 54) must be consecutively numbered through the calendar year, and copied in an impression book.

The quantities as represented by the "Material Received" advices must be consolidated on Form 20, and carried to the "Received" column in the monthly "Material Report," Form 26.

Roadmasters must be particular and forward advices, Form 54, for all material received on their Divisions from all sources, and they must see that the material reported as "Received" on Form 26 agrees

with the quantities reported in "Material Received" advices, Form 54.

Each Roadmaster shall also keep a book record of material received on his division (Form 50). In this book he must register in full detail the quantities and values of material received on his division—an exact transcript of all the bills and invoices certified by him. On each bill or invoice so certified the Roadmaster shall note the number or numbers of his advices (Form 54) to the General Roadmaster.

The number of such advices must also be noted opposite the record of the invoice on Form 50, and on the impression copies of such advices (Form 54) should be noted "Invoice Received—see Material Record. Page—."

Bills and invoices for material received must be forwarded promptly to the General Roadmaster. Roadmasters are required to see that they get bills for material received, and they must advise the General Roadmaster when such bills do not come to hand; but under all circumstances they must report such material as "Received" on their monthly reports to the General Roadmaster, as instructed.

Upon receipt of reports from Foremen of sections and other gangs (8, 9, and 15) the Roadmaster must first make up therefrom reports to the General Roadmaster as follows:

- Form 21, "Steel" and "Iron Rails" Accounts.
- “ 22, "Angle and Fish Plates" Account.
- “ 23, "Spikes" and "Bolts" Accounts.
- “ 24, "Frogs" Account.
- “ 25, "Cross Ties," "Switch and Bridge Timber," and "Fence Posts" Accounts.

# STANDARD ROAD BED SECTION

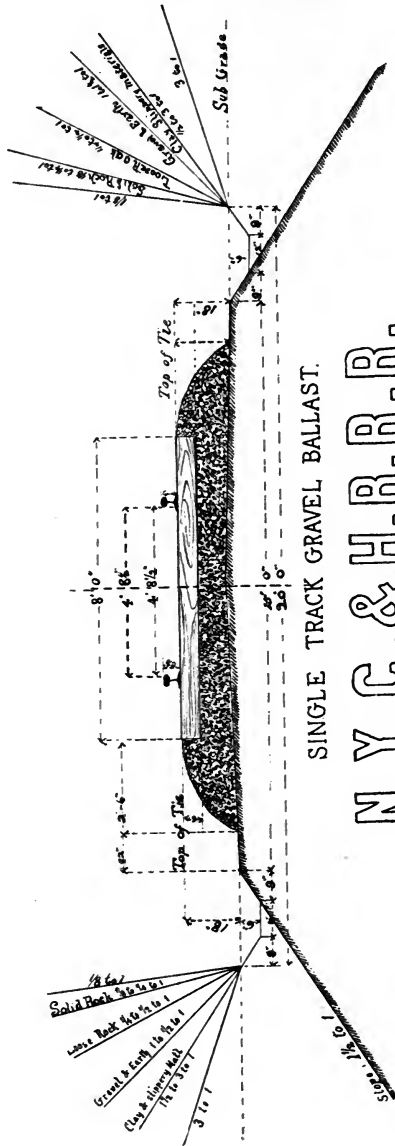

SINGLE TRACK GRAVEL BALLAST.

# N.Y.C. & H.R.R.R.

These reports must be sent to the General Roadmaster as soon as completed, and in advance of the "Material Report," Form 26. The quantities "Received," "Used" and "On Hand" named in these reports must also be included in the "Material Report," Form 26.

The Roadmaster must then, by aid of Form 20, consolidate the quantities of "Miscellaneous Material" used and disposed of as returned by Foremen of Section and other gangs. The total quantities of of each class of material so consolidated must then be entered on the "Material Report," Form 26, in the "Used" column. The balance of each kind of material must then be extended into the "Balance on Hand" column.

The quantity of material entered in the "Used" column, Form 26, represents the entire amount of material consumed or transferred off the division. How it is used is stated in full on Forms 21, 22, 23, 24, 25 and 27.

Form 27 is supplemental to Form 26, and represents the quantities of "Miscellaneous Materials" used or otherwise disposed of as entered on Form 26, arranged according to the proper "Classification of Disbursement Accounts," or as delivered to Outside Parties and to other departments. This report must agree exactly with the quantities stated in the "Used" column of Form 26, and the General Roadmaster must check it for that purpose.

The Roadmaster will be obliged to enter the class of material used when the same is not printed in the blank under classification. He must refer to his Foremen's "Material Reports" to aid him in stating the quantities under proper heads, and should bear



in mind that this report, Form 27, is intended to classify the miscellaneous material for which he claims credit according to its actual disposition, and according to the "Classification of Disbursement Accounts." For instance, if crossing plank is used to repair a station platform, the quantity so used should be reported under head of "Traffic Expenses, Station Buildings Repairs of," and not to "Maintenance of Way, Road Crossings, Repairs of." He must also use care in reporting quantities of material transferred to other divisions or to other departments and to outside parties, and must see that the General Roadmaster is promptly advised of such transfers

The Roadmaster shall keep in his office accounts with his Section Foremen of material placed in their charge. He shall charge them with track material shipped to the Section, and shall credit them with the quantities used in repairs and otherwise disposed of.

These accounts shall be kept on Form 17, "Material Ledger," and balances must be compared and adjusted to inventories rendered from time to time on Form 11.

When a Roadmaster furnishes material of any kind to outside parties or to other departments, he must at once advise the General Roadmaster of such disposition on Form 28. He must also use this blank for reporting charges for labor to outside parties or to other departments.

Deliveries to other departments of material must be invoiced by Roadmaster on Form 1255, which must be sent to the consignee when shipment is made.

When a Roadmaster transfers material to another division in the Maintenance of Way Department he must, as soon as shipment is made, send to the consignee a shipper's invoice, Form 1255. The Roadmaster to whose division the material is consigned must acknowledge receipt of the material by detaching the acknowledgment from the blank and returning it to the Roadmaster who made the shipment, properly filled out. The upper part of the blank Form 1255 must then be sent by the Roadmaster receiving the material, after record on Form 50, to the General Roadmaster, noting thereon his Material Received Advice Number as instructed.

Form 19 is to be used by the Roadmasters in notifying their Foremen of material shipped to them. As soon as the material is received the Foreman must sign and detach the acknowledgment and forward it to the Roadmaster.

In connection with their monthly reports the Roadmasters must render on Forms 29 and 30 reports of Labor and Material included therein for New Work, New Side Tracks and Extensions, and Extraordinary Repairs.

Each Roadmaster must render to the General Roadmaster on the last day of the calendar quarters a report of the "Condition of Rails in the Main Tracks." This report must show the actual condition of the tracks at different locations on his division in accordance with instructions on the blank, Form 53.

Roadmasters shall make requisitions for all supplies and material required (except stationery) direct to General Roadmaster on Form 18. Requisi-

# STANDARD RAIL SECTIONS.

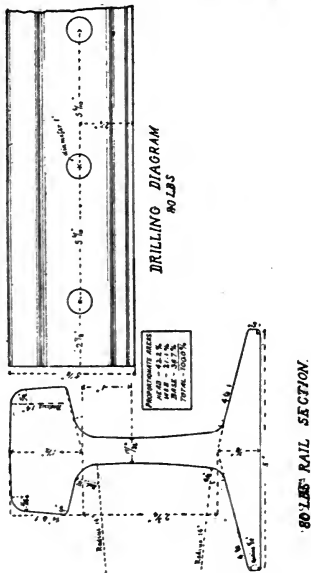
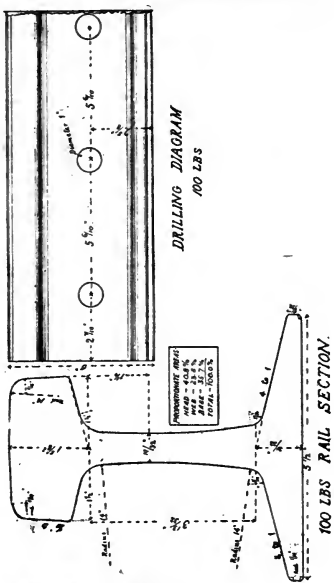

## N. Y. C. & H. R. R. R.



tions for Stationery must be made on Form 311, and sent to the General Roadmaster.

#### MASTER BUILDERS.

The Master Builder on each division must report direct to the General Roadmaster.

Master Builders shall promptly forward advices of receipts of material to the General Roadmaster, Form 54, and shall keep book records of "Material Received," Form 50.

Foremen under Master Builders are to use time books, Form 1 and 2, and make daily entries on Form 4, describing specifically the work performed.

Foremen under Master Builders will be provided with a "Material Diary," Form 7. They shall make reports to the Master Builders of all material used in each piece of work on Form 15. These reports are to be forwarded to the Master Builder through the month upon completion of each piece of work, and on the 25th of the month reports must be rendered for all material used on work unfinished at that date.

The reports of Foremen (Form 15) shall be compiled through the month by the Master Builders on Form 16, on which will appear the same detail and description as shown on the Foreman's reports. There must be separate reports of material used in "Repairs" and material used in "New Work."

The report of material used in "Repairs" and "New Work," Form 16, must agree in quantities as expressed on "Material Report," Form 26, and must be sent with the latter report to the General Roadmaster.

Master Builders must notify the General Roadmas-

ter promptly of all material delivered to outside parties and to other departments.

Master Builders must make requisitions for all supplies and material required (except stationery) on the General Roadmaster on Form 18. Requisitions for stationery must be made on Form 311, and sent to the General Roadmaster.

#### OIL AND WASTE RECORDS.

Special forms are provided for keepers in charge of oil and waste on road divisions, to wit:

Form 31, Record of Oil and Waste Received.

“ 32, Record of Oil and Waste Delivered.

“ 33, Storekeeper's Oil and Waste Report.

Inspection of forms will indicate how the records are to be kept and the reports rendered. The keeper will not be required to furnish receipts for his deliveries, but he must refuse to furnish oil to parties when their requisitions are in excess of the apparent requirements, without orders from the Roadmaster.

Trains-shipment of oil and waste to outside parties or to other departments must be treated in same manner as other material. The keeper must advise the Roadmaster on Form 12 of such deliveries.

Section and other Foremen will not be required to report quantity of oil used, but the Roadmaster shall distribute direct to proper expense accounts the quantities of oil issued covering these ordinary and regular supplies as per report Form 33.

#### EAST ALBANY STOREHOUSE.

All Roadway and Bridge Material on hand at East Albany Storehouse and East Albany Road Shop

shall be in charge of a Storekeeper, who shall report direct to the General Roadmaster.

All such material shipped to East Albany shall be consigned to the "Storekeeper, East Albany."

All such material shipped from East Albany shall be made under the direction of the Storekeeper.

Upon receipt of material the Storekeeper must advise the General Roadmaster on Form 54 as soon as the exact quantities are ascertained. He must also state in his advise the month in which the quantities so reported will be taken up on report Form 34.

The "Material Received," advice 54 must be consecutively numbered through the calendar year and copied in an impression book.

The quantities as represented by the "Material Received" advices 54 must be consolidated on Form 20 and carried to the "Received" column in the monthly "Material Report," 34.

The Storekeeper must be particular and forward advices, Form 54, for all material received at East Albany from all sources, and he must see that the material reported as "Received" on Form 34 agrees with the quantities reported in "Material Received" advices, Form 54.

The Storekeeper shall also keep a book record of material received at East Albany (Form 50.) In this book he must register in full detail the quantities and values of material received at East Albany—an exact transcript of all the bills and invoices certified by him. On each bill or invoice so certified the Storekeeper shall note the number or numbers of his advices, Form 54, to the General Roadmaster.

The numbers of such advices must also be noted

opposite the record of the invoice on Form 50, and on the impression copies of such advices 54, should be noted "Invoice Received.

All deliveries of material by the Storekeeper must be covered by orders from the General Roadmaster, Form 36, or by requisitions from Foremen of East Albany Road Shop, Form 35, for material to be used in filling "Shop Orders," and for current supplies necessary for operation of the shop.

Requisition of Foreman of shop for material to be used in filling "Shop Orders" must bear the General Roadmaster's order numbers. Requisitions for current supplies for shop must be regularly invoiced by the Storekeeper on Form 1255, the Foreman to return the acknowledgement to the Storekeeper, and to send the upper part of the blank to the General Roadmaster, who will charge values out to the proper expense accounts.

The Foreman of East Albany Shop, upon request of Storekeeper, shall furnish such labor as is necessary for loading and unloading and hauling material at the storehouse.

#### EAST ALBANY ROAD SHOP.

All Roadway and Bridge Material at East Albany Road Shop must be considered as part of the stock of East Albany Storehouse under charge of the Storekeeper.

The Foreman of the shop shall make requisitions on the Storekeeper for material required in filling "Shop Orders" from the General Roadmaster, and for material required for current use at shops.

With the exception of such unskilled labor as is necessary for incidental purposes, the work at the



shops must be done on shop orders to be issued by the General Roadmaster on Form 37.

Shop Orders (Form 37) shall be issued by the General Roadmaster direct to the Foreman of the shop. Upon receipt of the order the Foreman must fill in on the "Shop Order Card" (Form 38) the number, date, and nature of the order. The material used and labor performed in filling the order must be entered daily on the card by the Foreman of each gang as the work progresses.

The manufactured material shall be turned over to the Storekeeper as fast as completed who must acknowledge receipt on the card, take into account, and forward advice to the General Roadmaster, Form 54. Upon entire completion of order and delivery to the Storekeeper the Foreman shall enter date of completion, certify and deliver the card to the Storekeeper, who must fill in the value of labor and material used, certify as to receipt, and then forward the card to General Roadmaster.

The time of employees at East Albany Road Shop shall be kept by a Timekeeper on Form 2. It shall be his duty to see that "Shop Order" cards are properly filled in, and that the labor and material used in filling the orders are noted thereon.

The Timekeeper must foot daily the time of force and enter the total hours worked on Form 4 opposite distribution to the different order numbers, or to such incidental labor as may be done. The time of the General Foreman, Timekeeper, Engineer, Fireman, etc., must be distributed to the several orders in proportion to labor performed. This proportion must be entered on the order card upon completion

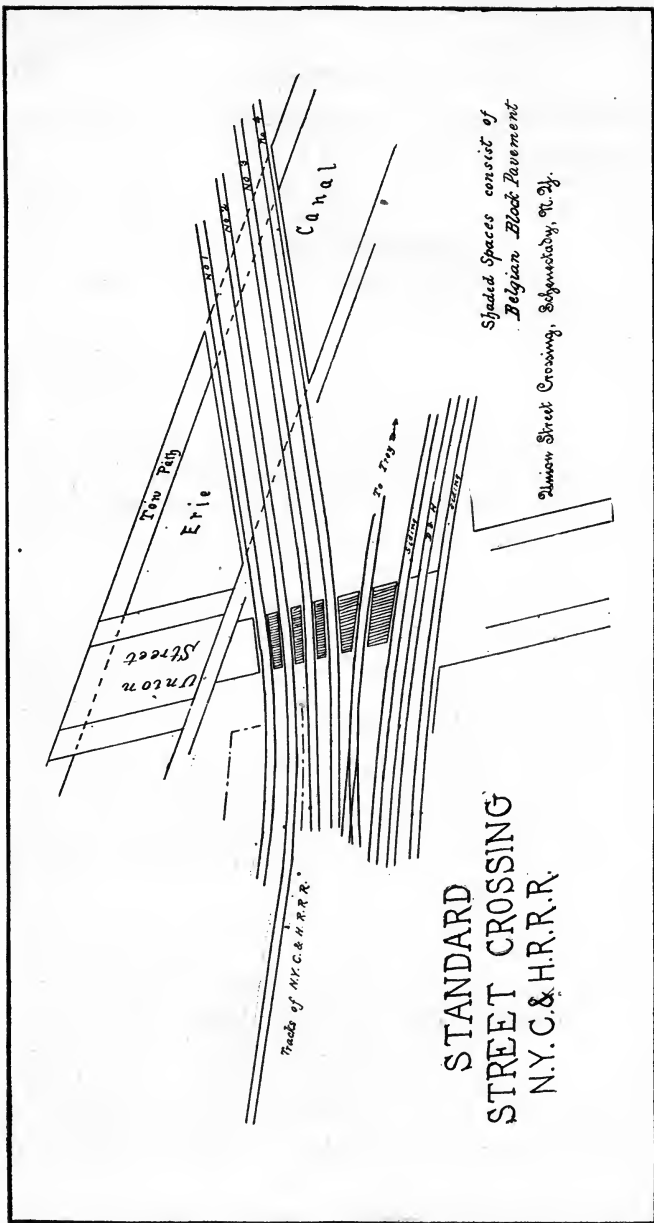

**STANDARD  
STREET CROSSING  
N.Y.C. & H.R.R.R.**

*Shaded Spaces consist of  
Belgian Block Pavement  
Union Street Crossing, Schenectady, N.Y.*



of the order, and at the end of the month on all unfinished orders.

The Timekeeper shall make up the Pay Rolls of the Shop at the end of the month and forward them to the General Roadmaster, duly certified by the Foreman, with the distribution, Form 4.

#### GENERAL ROADMASTER'S RECORDS.

All Vouchers and Pay Rolls covering expenditures for material and labor made under the supervision of the General Roadmaster shall be approved by him and properly accounted for under instructions from the Accounting Department.

The General Roadmaster shall be responsible for the economical distribution of material, and he must hold his Roadmasters and other subordinates, to a strict accountability for material placed in their charge.

The General Roadmaster shall keep the following special material accounts:—

Steel Rails,	Frogs,
Iron Rails,	Cross Ties,
Angle and Fish Plates,	Switch and Bridge Timber,
Spikes,	Fence Posts,
Bolts,	Miscellaneous Material,

with such additional special accounts for material as may be deemed advisable.

The principal record books of the General Roadmaster shall be:

- Form 50. Material Received.
- “ 51. Material Journal.
- “ 52. Material Ledger.

In Form 50 must be entered a complete abstract of all bills for charges against the Maintenance of Way

Department coming under the supervision of the General Roadmaster. All such charges shall be posted in Form 52, "Material Ledger," in values. The quantities must also be posted in the Ledger covering special accounts. The "Material Received" record must also show the particular Road Division of stock point chargeable. The "Material Journal" is to be used in making necessary entries after closing the accounts at the end of the month, representing the values, and in special accounts the quantities, as summarized on the "Material Received" register. The Journal is also to be used for entering the values, etc., of the material consumed during the month after consolidation of all the material reports from the several divisions and stock points; also for such entries as may be necessary in adjusting differences with general offices, etc.

The "Balance" account for entries of totals of vouchers, pay rolls, and material consumed shall be designated "General Office Ledger," and such general account shall be credited the amount of vouchers and pay rolls certified by the General Roadmaster, and shall ultimately be charged with the value of labor and material expended.

The General Roadmaster's books shall also show under proper account headings the entire results of the operation of his department, and in each month entries must be made thereon which will show, properly distribution under account headings, the value of material received and disbursed, the amount of labor expended, and the value of material on hand.

Such accounts are as necessary for tributary records may be opened in the Ledger. After the close

of a month's accounts a balance sheet must be rendered to the Accounting Department which will show the status of the General Roadmaster's books at the end of the month. There must also be a statement showing the details of debits and credits to the several material accounts, Form 1281, with the resulting balances as shown on the balance sheet.

The accounts of material kept by the General Roadmaster with the several Road Division Roadmasters, Master Builders, Storekeepers, etc., shall be kept in quantities and not values, and all material received by his department shall be taken up by the proper Division Roadmaster, etc., in quantities. Each Division Roadmaster shall report, as instructed herein, during, and at the end of each month the quantities of each kind of material received, consumed and on hand, and also show under head of "Classification of Disbursement Accounts" for what purpose the material was used

During the month the General Roadmaster shall have posted on Form 39 the quantities of the different classes of material chargeable to each division and stock point. This will comprise the quantities reported received for the current month by Roadmasters, Master Builders, and Storekeepers, on Form 54.

From this compilation on Form 39 he shall check the quantities reported as "Received" in the various "Material Reports" rendered by Roadmasters, etc. He must also see that balances brought forward as "On Hand" from previous month are correct, and balances "On Hand" at close of month are properly extended.

The General Roadmaster shall also check the "Ma-

terial Received Advices," Form 54, against the bills certified by the Roadmasters, etc., and ascertain whether the advices agree with the bills; also for the purpose of hastening bills for material for which he has advices, Form 54, but for which no bills have been received.

The quantities of material reported as "Used" in the "Material Reports" must also be compared with the quantities as reported on the distribution reports, Forms 21, 22, 23, 24, 25, and 27.

Having checked the material "Used," as above instructed, the quantities of material reported as "Used" must be consolidated under the proper account headings on Form 40, and then carried to Form 41 under like classification and the values extended.

The reports having been examined and material consolidated and values extended, the General Roadmaster shall then make out his Roadway and Bridge Material Report to the Accounting Department on Form 42.

Supplemental to report Form 42 the General Roadmaster shall render the following reports, viz:

Form 43, entitled "Distribution of Steel and Iron Rails, Cross Ties, etc." This report furnishes required data in regard to special materials as to how the amounts charged to expense accounts are made up.

Form 44, for reporting the expenditures each month for New Work, New Side Tracks and Extensions, and Extraordinary Repairs.

Form 1268, for detail of charges to material accounts, outside parties, etc., the gross amounts of which are entered on report Form 42.

The General Roadmaster shall also render monthly a report of labor and material expended in Maintenance of Way, Form 45, which shall be an epitome of the expenses charged for the month, arranged by Divisions, and showing the average cost of maintenance per one mile of single track.

The General Roadmaster shall also render quarterly to the Chief Engineer a report of the "Condition of Rails in the Main Tracks," compiled from reports of Roadmasters, Form 53.

If material is transferred to another Department upon receipt of advice from a Roadmaster, etc., on Form 28, the General Roadmaster must bill against the Department, Form 1266, for amount of labor and material chargeable, or on Forms 1312 and 1313 if material was furnished on Purchasing Agent's order.

He must also render promptly accounts against outside parties for labor and material delivered on "Collection Vouchers," Forms 185 and 1222. These bills are not to be delayed until close of month, but must be rendered as soon as the service is performed or the material is furnished.

Requisition for material required by Roadmasters, etc., must be made to the General Roadmaster on Form 18, for material, and on Form 311 for stationery. If the material can be supplied from supply stock or from other divisions the General Roadmaster shall give necessary instructions as to transfer.

For material which cannot be thus supplied the General Roadmaster shall make necessary requisitions on the Purchasing Agents on Forms 48 and 49.

Increase of Force will not be allowed unless previously authorized by approval of application therefor, Form 47.



## CHAPTER VII.

### NEW YORK, LAKE ERIE AND WESTERN RAILROAD.

#### ALIGNMENT.

The track must be in good line and surface, and all rails laid with the dates and maker's mark on the outside of track.

On tangents the rails must be on the same level.

On curves the proper elevation must be given to the outer rail as shown by figures painted on a stake placed at each end of the curve on a single track railroad, and at the beginning of each curve going with the trade on a double track railroad.

#### GAUGE.

The rails must be properly spiked to gauge.

On straight lines, and on all curves up to and including 3 degrees, 4 feet 8½ inches will be the gauge used.

From 3 degrees to 5 degrees, 4 feet 8 5-8 inches; from 5 degrees to 7 degrees, 4 feet 8 3-4 inches; from 7 degrees to 9 degrees, 4 feet 8 7-8 inches; and from 9 degrees to 11 degrees, 4 feet 9 inches, must be the gauge used.

#### JOINTS.

Where the short angle plate is used the joints of the rails must be exactly midway between the joint

ties, and the joint on one side opposite the center of the rail on the other side of the same track.

Where the long angle plate is used, the joint must be over the center of the tie, accurately spaced between two other ties, so that the angle splice plates reach over three ties.

Iron shims must be used to separate the joints in laying rails. Shims of the following thickness will be provided, viz.: 1-4, 1-8 and 1-16 inch. In cold weather use the largest size, in moderate weather the medium, and in hot weather the smallest.

The splices must be properly put on with the full number of bolts, nuts, and nut locks, and nuts screwed up tight. Spikes must be driven in the slots in both the outside and the inside bars to prevent the track from creeping.

The rails must be spiked both on the outside and the inside on each tie, and the spikes must be driven in such a position as to keep the tie at right angles to the rails.

#### BALLAST.

There must be a uniform depth of at least twelve inches of clean, broken stone, gravel or slag under the ties. The ballast must be filled up evenly between, but never above the top of the ties, and slope outside of the ties according to standard cross section.

Where stone is used it must be broken evenly and not larger than a cube that will pass through a two and one-half inch ring.

On double track the space between tracks should be filled with coarse stone to the bottom of the ties,

STANDARD ROAD BED SECTIONS. NYLÉ & W.R.R.

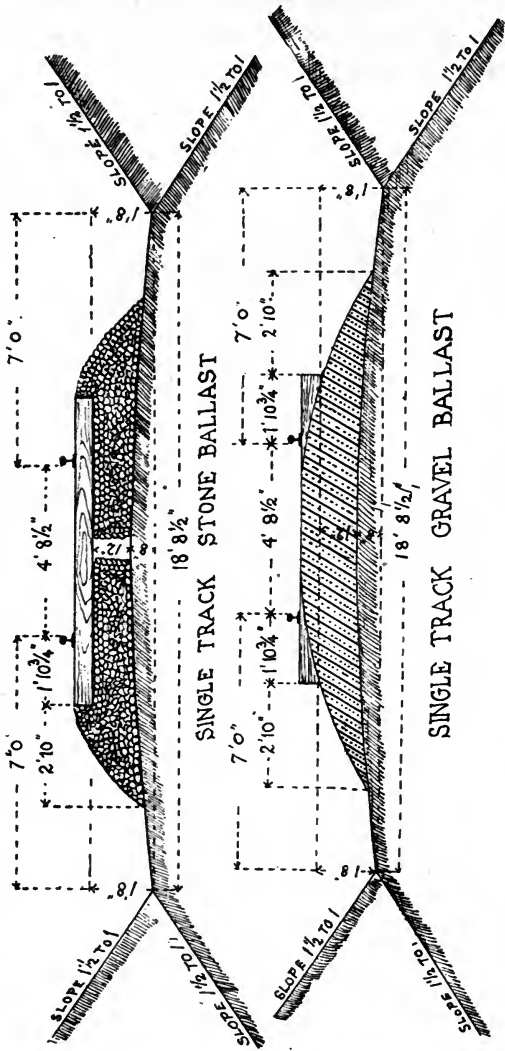

and then leveled up to the top of the ties with stone broken according to specifications.

#### CROSS-TIES.

The cross-ties must be properly spaced with ten inches between the edges of bearing surfaces at the joints, and with an equal distance from center to center of all intermediate ties.

The ends of the ties on the outside of double track, and on the right hand side going north or west on a single track, must be lined up parallel with the rails.

Ties must not be notched, but must be made true with the adze, so that the rail may have an even bearing over the whole width of the tie.

For each 30 foot rail sixteen cross-ties must be used on all main tracks; on branch roads and third tracks of main lines, fourteen ties and on sidings and tracks used for standing cars only, not exceeding twelve ties for every 30 foot rail are to be used.

On all main tracks of the main line where the long angle plate is used, or the joint is supported, fifteen ties for each 30 foot rail must be placed at equal distances between the end ties supporting the joints. On branch roads and third track of the main line thirteen ties only will be used under the same circumstances

#### SWITCHES.

Switches and frogs must always be well lined up and maintained in good order; switch signals must be kept clean and well painted.

All guard rails at frogs must be braced and carefully spiked, and the standard distance of two inches between the heads of the guard rail and the main rail must always be maintained.

STANDARD ROAD BED SECTIONS NEW YORK LAKE ERIE & WESTERN R R

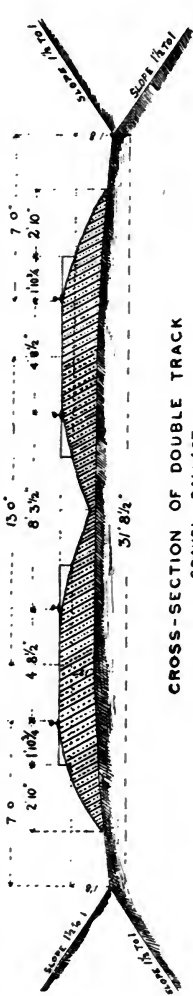

CROSS-SECTION OF DOUBLE TRACK  
 GRAVEL BALLAST

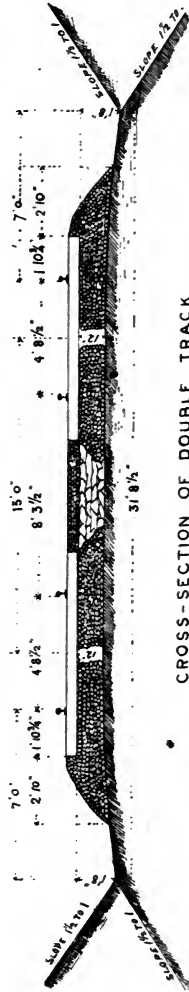

CROSS-SECTION OF DOUBLE TRACK  
 BROKEN STONE BALLAST

All switches and frogs must be put in according to dimensions given on drawings in the hands of the Roadmaster

#### SIDINGS.

All Company sidings should be kept in as good order as practicable, using for this purpose second-class rails and ties or the partly worn materials taken from main tracks, using engine cinders for ballast according to standard cross section.

Owners of private sidings must be required to keep their sidings in safe condition for use at all times.

Private, local and all sidings used for standing cars or handling freight must be provided with blind switches to prevent cars from being run out on main track by accident.

The line of the bottom of the ditches must be seven feet from and parallel with, the rails. They must be kept clean and of sufficient depth to carry the water

#### CULVERTS.

Culverts and drains must be kept clear of all obstructions. All dirt and rubbish of any kind likely to wash down and obstruct the inlet must be burned or removed.

#### ROAD CROSSINGS.

The road crossing plank must be securely spiked, always using the spike specified for that purpose; the planking should be three-quarter of an inch below the top of the rail, and two and one-half inches from the gauge line. The ends and inside edges of the planks should be beveled and filled in between with broken stone or slag.

STANDARD ROAD BED SECTIONS NEW YORK LAKE ERIE & WESTERN R.R.

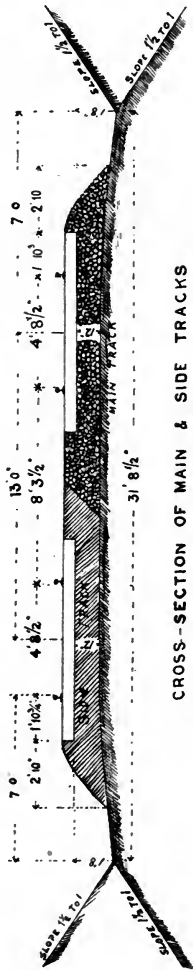

CROSS-SECTION OF MAIN & SIDE TRACKS  
MAIN TRACK ON STONE CINDER SIDE TRACK ON ENGINE CINDER

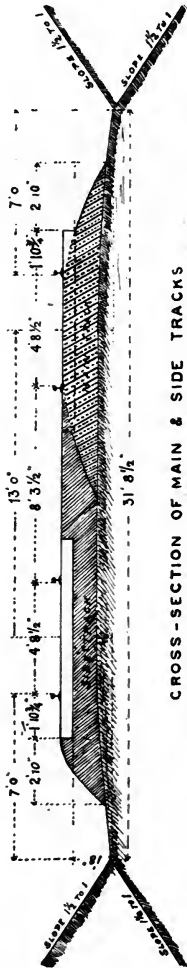

CROSS-SECTION OF MAIN & SIDE TRACKS  
MAIN TRACK ON GRAVEL SIDE TRACK ON ENGINE CINDER.

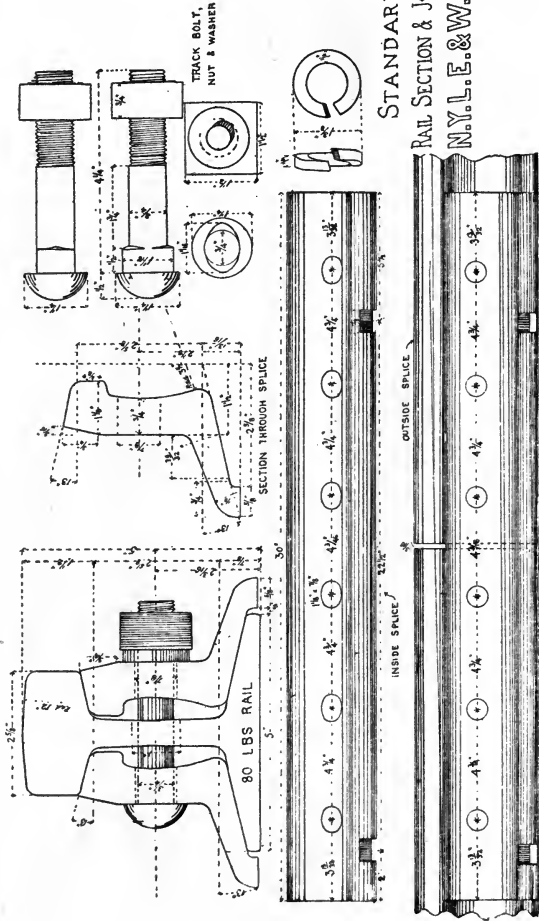

**STANDARD**  
**RAIL SECTION & JOINT**  
**N.Y.L.E.&W.R.R.**



STANDARD  
RAIL SECTIONS  
&  
JOINT FASTENINGS  
N.Y.L.E. & W.R.R.

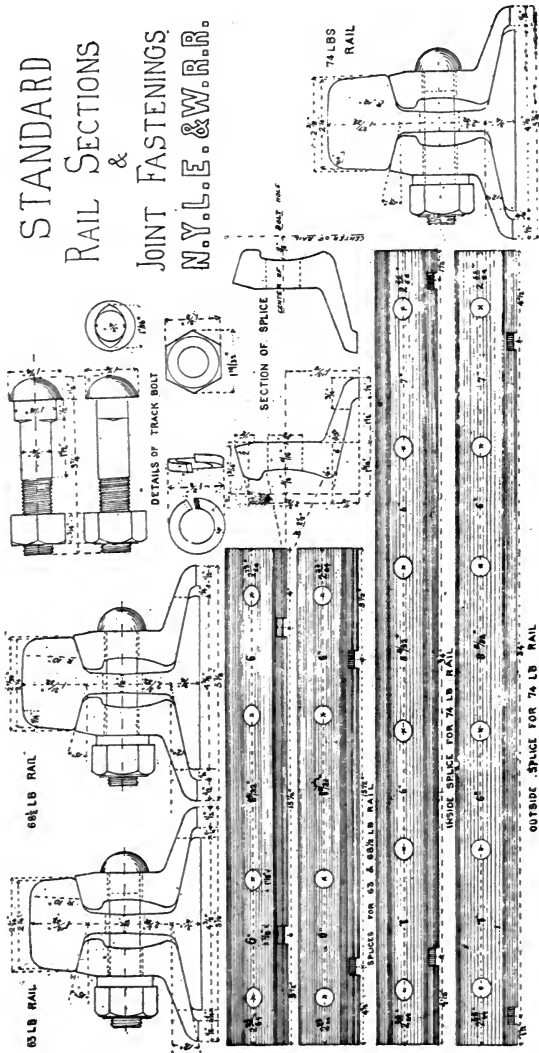



All public crossings must be provided with standard crossing signs, placed so as to be readily seen by persons approaching in both directions.

Whistling posts must be placed at least 80 rods in each direction from all crossings.

#### STATION GROUNDS.

Platforms, fences and grounds at stations must be kept clean and in good order.

#### TELEGRAPH.

The telegraph poles must be kept in proper position and placed far enough from the road to prevent obstruction in case of falling. Trees near the telegraph line must be kept trimmed to prevent the branches touching the wires during high winds.

#### POLICING.

All old material, such as old ties, old rails, chairs, car material, etc., must be gathered up at least once a week and neatly piled at proper points. Briers and undergrowth on the right of way must be kept cut close to the ground.

#### USE OF MATERIAL.

Proper judgment and caution must be exercised to avoid extravagant use of material, and old tools must be held and accounted for before new ones are received.

All injuries to bridges or other structures, water stations, depot buildings, platforms and Company's houses must be properly repaired, or reported by wire to the Division Superintendent and Roadmaster.

All encroachments or supposed encroachments upon Company's property must, if possible, be prevented, and in every case reported promptly.

## CHAPTER VIII.

### RULES AND INSTRUCTIONS. MICHIGAN CENTRAL RAILWAY.

Roadmasters, Foremen and all other employes of the Track Department, who are in any way concerned by the following rules and regulations, are expected to make themselves familiar with the contents of this book.

The following general rules, as shown on the Time Schedule of this Company, are hereby confirmed as setting forth requirements made upon all employes of the Track Department.

Time Card Rule No. 22.—“The use of intoxicating liquors is forbidden under any circumstances.

“All persons employed by the Company are to devote themselves exclusively to the Company’s service; residing at whatever place may be appointed; attending at such hours as may be required; and paying prompt obedience to persons in authority over them.

“They are not allowed to absent themselves from duty without first obtaining leave from their Division Superintendent or head of their department. Their pay, while absent, will be stopped.”

Time Card Rule No. 24.—“No employes of the Company are allowed to engage in trade, either directly or indirectly, for themselves or others, without special permission from the General Superintendent or Assist-

ant General Superintendent. They are strictly forbidden to receive any fee or reward from the public under any pretense whatever."

Latter Part of Time Card Rule No. 26, viz.—“At many of the stations on the road there are cattle-guards within station limits. Trainmen and switchmen working about yards or at such stations are required to exercise great care to avoid injury in passing over such cattle-guards.

“Attention is also called to the necessity of equal care in working about switches at stations and in yards to avoid injury by having feet caught in frogs, switches and guard-rails.

“Jumping on or off cars or engines in motion, entering between cars in motion to couple or uncouple them, and all similar imprudences, are forbidden.

“Every employe is required to exercise the utmost caution to avoid injury to himself or fellow employes, especially in coupling, switching, or other movements of cars or trains.

“Car repairers and other employes who have occasion to work on or about cars are strictly forbidden to commence work on any car the nature of which requires them to place themselves in a position on, under or about the car, whereby its movement on the track could result in injury to them, without first properly protecting themselves with a red flag or flags by day, or red lights by night.

“All employes must bear in mind that under the Telegraph System of working the road, a train may be expected at any moment, and thus the necessity of the strictest watchfulness on the part of all.”

The following General and Special Rules, as shown

on the Time Schedules of this Company, are hereby confirmed as setting forth requirements made upon roadmasters and all foremen of track work.

The term "Foremen of Track Work" in this book of instructions applies to all foremen subordinate to Roadmasters.

First Part of Time Card Rule No. 21, viz.—"All persons, upon entering the service of this Company, will be furnished with a copy of the Time Tables in force and of the Rules and Regulations, with which it will be their duty to make themselves fully acquainted, and they must also make themselves thoroughly familiar with all special instructions issued by the heads of departments from time to time. Strict compliance with the Time Table and strict obedience to the Rules and Regulations and special instructions, in every particular, will be required.

Time Card Rule No. 23.—"Heads of departments must know that all their subordinates are furnished with each issue of the Time Table before the same shall have effect, and will require receipt from them for the same. Due notice of the issue of a new Time Table must be given by special notice posted upon bulletin boards, as required by Rule No. 21, and the Chief Despatcher of each Division must advise all telegraph offices by telegraph of the new Time Table being used, before the same shall take effect.

"Each Time Table, from the moment it takes effect, supersedes the preceding Time Table, and trains shall be run as directed thereby, subject to the rules. All regular trains on the road, running according to the preceding Time Table, shall unless otherwise directed,

assume the times and rights of trains of corresponding numbers on the new Time Tables.

“No trainmen, enginemen or yardmen must leave terminal stations or go on duty without a copy of this Time Table, with Rules and Regulations.”

Time Card Rule No. 29, Amended to apply to whole Michigan Central System.—On Main, Air Line and Fort Erie Divisions, between Buffalo and Chicago, where the track is impassable, or before a rail is taken out of track, or when it is necessary to repair any portion of the roadway that will render the road impassable for a train; or where the track is out of order and must be run over slowly, a flagman must be sent out in each direction with a red flag and torpedoes by day and red light and torpedoes by night, to flag approaching trains, as per Rule No. 46.

On other Divisions, when the track is out of order and must be run over slowly, blue and white flag by day and a red light by night must be placed by the side of the track, on engineer's side, at a distance of twenty-five telegraph poles in each direction from the defective track. When the track is impassable, or before a rail is taken out of the track, or when it is necessary to repair any portion of the roadway that will render the road impassable for a train, a red flag by day and red light by night must be placed in the center of the track in each direction from the impassable point, at a distance of not less than twenty-five telegraph poles from it, and two torpedoes must also be placed on the rail, ten telegraph poles beyond the flag, at a distance of fifty feet from each other.

When culverts or bridges are being repaired, or any work done upon the track, making it necessary for

trains to run slowly over such culvert, bridge or portion of track, for an extended length of time, Division Superintendents must first be notified and orders will be issued by them for trains to run slowly until otherwise directed. In such cases, a blue and white flag by day and a red light by night, as a marker, must be placed by the side of the track, on the engineer's side, at a distance of twenty-five telegraph poles in each direction from the defective track.

Time Card Rule No. 30.—“Upon Main and Air Line, double track, flagmen must be sent out, as provided above, in both directions from the impassable point. Upon other Divisions flagmen must be sent out, or flags and torpedoes placed as provided above, in both directions from impassable point.”

Time Card Rule No. 31, Amended to apply to whole Michigan Central System.—At night, when track is impassable or must be run over slowly, section foreman must, in addition to placing flags and torpedoes as provided by Rule 29, notify Division Superintendent as soon as possible.

Time Card Rule No. 32.—“Track and bridgemen are forbidden to set track jacks inside of rails. When tracks are to be raised, jacks must be set outside of rails. See that sand does not wash down upon the track at road crossings. During very wet nights foremen must watch places in the track likely to be damaged.”

Time Card Rule No. 33.—“Rails and other materials must not be left scattered about depot grounds. Pile them up together outside of all tracks.

“Hand-cars must not be left standing on highway



STANDARD ROAD BED SECTION  
MICHIGAN CENTRAL RAIL ROAD  
DOUBLE TRACK

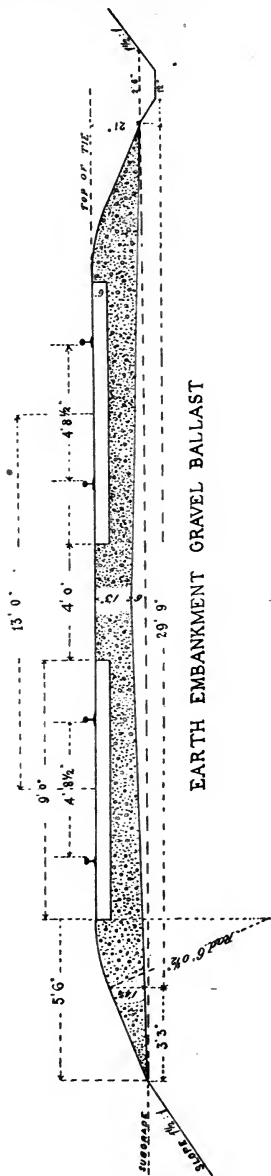

or private crossings except for the purpose of letting trains pass.

“Section foremen must not leave their handcars standing upon double or single main track while their men are working on track.

“When two or more handcars are running in the same direction, they must keep at least two telegraph poles apart. No one except employes will be allowed to ride on handcars.”

Time Card Rule No. 34.—“No cordwood, lumber or other articles must be piled along the track within a less distance than five feet from the rail.”

Time Card Rule No. 35.—“Telegraph Line.—Trackmen will pay particular attention to the telegraph wires, and see that they are not obstructed or down upon the ground. In case they are found broken, or on the ground, or crossed, or in any way obstructed, they must be repaired in a temporary manner immediately, and notice given to the telegraph office. When the wires are crossed, or in contact with each other, and the break or obstruction is of such a nature as not to admit of temporary repair, immediate notice must be sent by special messenger to the nearest telegraph office.”

Time Car Rule No. 36.—“Fences.—Constant attention must be given to see that fences on each side of the road and at crossing are in good order, and that cattle-guards are kept in repair; a break in the fence must in no case be passed by without being repaired when it is possible to mend it. When a break in the fence cannot be repaired for want of material, it is the duty of the foreman of the section to give the Roadmaster immediate notice of it, stating what material is

required. When fences are taken down to haul wood on to the right of way, have them replaced."

Time Card Rule No. 37.—"Foremen of repair parties will be held responsible for the strict observance of the above requirements. It is the duty of each one to see that his party is always supplied with the proper signal lamps, flags and torpedoes; but should he at any time, from accident or otherwise, be deficient, he must post a man at a safe distance to warn approaching trains."

Time Card Rule No. 38.—"Any employe observing any obstruction or damage to the road or bridges, or observing any circumstance that indicate danger in any way, will leave at nearest telegraph station a written report of the same, and will take such further steps as will insure safety. All such reports must be telegraphed by the agent or operator to Division Headquarters, and notice of the obstruction or danger must be given to conductors of all trains, until orders are received from Division Headquarters to discontinue such notice."

Time Card Rule No. 39.—"Foremen of Repairs, and men in their employ, must at all times hold themselves in readiness to aid the passage of trains, and in case of accident or delay, will obey the orders of conductors."

Time Card Rule No. 46.—"When the track is obstructed, the Conductor will immediately send back a flagman with danger signals (a red flag and torpedoes by day and a red light and torpedoes by night), placed as per Rules 13 and 14, not less than twenty-five telegraph poles, and until he has reached a point where his danger signals can be seen the distance of not less than ten telegraph poles, by the engineer of the approaching train; and the flagman must remain in such position until the train that is due has arrived, or until

he is recalled by the whistle of his own engine. The engineer of the approaching train, on preceiving the flagman's signals, will immediately sound the whistle as per Rule 3. Passenger flagmen, when protecting their trains at night, will leave a lighted fusee in addition to torpedoes, as per Rule 14, when recalled.

"When any train runs over red flags or torpedoes placed upon the track or bridges by bridge or section men, as per Time Table Rule 29, conductors will see that such flags and torpedoes are replaced before proceeding."

Time Card Rule No. 13.—"A torpedo is an extra danger signal. It is fastened to the rail by clamps, and explodes by the engine passing over it. The explosion of a torpedo is a signal to stop the train immediately. They are to be used in all cases of accident and emergency, and must be used in addition to the regular day and night signals.

"A fusee is an extra danger signal to be lighted and placed on the track at night in cases of accident, foggy or stormy weather. Fusees will burn five or ten minutes. Passenger trains will use ten-minute fusees; freight trains five-minute fusees. A train finding a fusee burning on the track will come to a stop and wait until it burns out, and then proceed with caution, expecting to find the track obstructed, until information is received that the track is clear."

Time Card Rule No. 14.—"Flagman will place a torpedo on the rail on engineer's side, at a distance of ten telegraph poles from the place where track is obstructed, a second torpedo at a distance of twenty telegraph poles, and a third torpedo at a distance of twenty-five telegraph poles from the train, or until he

has reached a point where his signal can be seen a distance of ten telegraph poles by the approaching train, and will at once place a torpedo on the rail at that point. If the following train has not arrived when he is recalled, he must leave on the rail the last torpedo placed, and also place one fifty feet from it as a caution to the following train, and take up the other torpedoes.

“A single explosion will indicate that the train has passed the flagman, with his red flag or light, without observing him, and it will wait for him to retrace his way to give information of the obstruction. If the explosion is double, it will indicate that the flagman has been recalled; and, in this case, the train will move slowly forward until it shall be learned that the obstruction is removed.

“When any train has been stopped by a preceding train, in the manner above mentioned, the conductor of the last train will use the same precautions with regard to any following train as those heretofore described.”

In order that there may be no possible misapprehension of the intent and scope of the “Time Card Rules” cited above, the following explanatory matter is put in the form of rules, which are to be rigidly observed:

Rule No. 1.—Roadmasters and Foremen of track work shall make their men acquainted with the Time Card Rules first quoted as requirements made upon all employes of the Track Department, and are required to point out to their men the necessity of looking out for their personal safety in the performance of their work.

Rule No. 2.—Referring to Time Card Rules Nos. 21

and 23: Roadmasters are expected to make themselves acquainted with all the requirements set forth in the Time Tables. Foremen of track work are required to make themselves familiar with the parts of the Time Card Rules specified in this book of instructions; to study each new issue of Time Table sufficiently to know the time of trains which may affect the work they have to do, and to have at hand a copy of the latest issue of Time Table when upon duty.

Rule No. 3.—Foremen of track work, in carrying out Time Card Rule No. 29, are required to give particular instructions in each case to the men they send to flag, and will be held responsible for the proper display of flag and use of other signals designated in Time Card Rules.

Although the requirements of Time Card Rule No. 29 do not contemplate that flagmen remain with the signals on divisions other than the Main Line, Air Line and Fort Erie, Foremen of track work are hereby directed to locate the signals that are to be left alone for impassable track within view of the point of obstruction, if they can be so located, and be at or beyond the point which is the specified distance of twenty-five telegraph poles from point of obstruction.

In case such signals cannot be seen from point of obstruction, Foremen of track work must take such precautions as are necessary to a clear display of these signals, and are made responsible that the flags stand and that the red lights burn.

In case of impassable or unsafe track, flagging is the first duty and repairs must wait, if necessary, until signals have been placed.

The signal for caution and for slow speed of trains by

day is a blue and white flag, the staff of which is to be set firmly in the ground, three feet outside the rail, on engineer's side, and to lean away from the track. At night a red lamp is to be left on the ground on same side of rail, and at same distance therefrom, additional to the blue and white flag.

If a display of the caution signal is required in foggy weather, and the imperfect state of the track has not been announced to Division Superintendent, as provided in Time Card Rule No. 29, one torpedo must be placed on rail on engineer's side 100 feet in advance of the blue and white flag, and another on same rail 50 feet nearer to flag. Having placed such torpedoes to call attention to the blue and white flag in foggy weather, Foremen of track work must not assume that trainmen will replace exploded torpedoes as provided in Time Card Rule No. 46, but are required, unless the Division Superintendent is notified of the location of the trouble, to see that torpedoes remain upon the track in advance of the signal during the continuance of the fog or until track is in perfect condition.

Rule No. 4.—In flagging an obstruction which occurs on the double track of Main or Air Line, as per Time Card Rule No. 30, in case only one track is obstructed, Foremen of track work will not stop or slow down a train running on the unobstructed track unless, in their judgment, the safety of the men employed at the obstruction demands such caution. It is to be borne in mind, however, that a train may be approaching the obstruction from either direction on either track, and no chances must be taken in view of such uncertainty. In case the obstruction exists in both tracks, the torpedoes specified for flagging must

STANDARD CATTLE GUARD & FENCE · M. C. R. R.

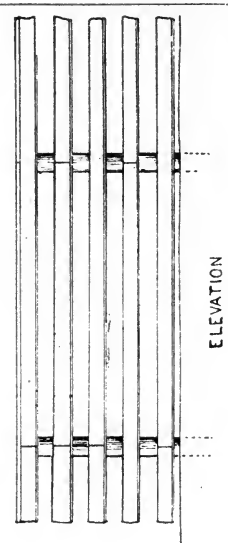
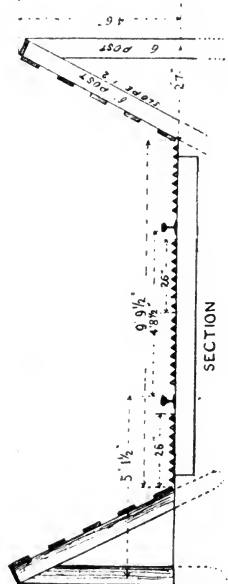
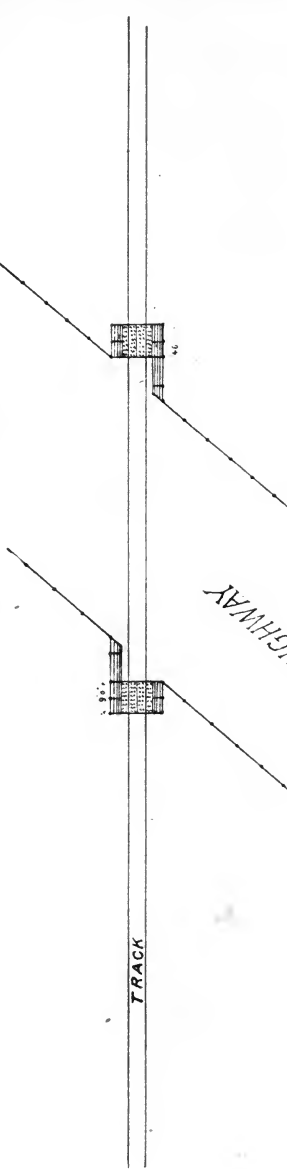



be placed on the rails of both tracks in both directions from the point of obstruction, and the flagmen must stop trains approaching on either track.

On the double track of divisions where attendants are not required with the flags, and trains on one track only are to be stopped, the flags and other signals are to be placed in both directions on the obstructed track only. If both tracks are obstructed, flags and torpedoes are to be placed each way, as specified, upon the tracks on which trains approach the obstruction by right hand running, and one torpedo is to be placed on the other track opposite each flag.

Rule No. 5.—All Foremen of track work are instructed to report at once by wire to the Division Superintendent and to the Roadmaster any impassable or unsafe track they may observe, and are further instructed to report at frequent intervals by wire to the Division Superintendent and to the Roadmaster the condition of track which has been reported by themselves or by others as impassable or unsafe. These latter reports are to be sent as often as can be done consistently with the speedy restoration of the track, and may often be of the greatest utility in arrangements for detours of trains.

Rule No. 6.—Each Foreman of track work must keep himself provided with the following signals for use in case of danger or necessity of caution, viz.: One case of torpedoes, two red flags mounted on staffs four feet long, two red lanterns, and two blue and white flags mounted on staffs four feet long. When he has less than twenty-four torpedoes he must immediately order more from his Roadmaster in writing.

He must report to his Roadmaster any instance of disregard of danger or caution signals by trainmen.

Rule No. 7.—Loaded push-cars on the track are to be considered as obstructions and must be protected by danger signals.

Rule No. 8.—Torpedoes found on the track must not be removed. If any are exploded or damaged in any manner by hand-cars or push-cars, they must be replaced.

Rule No. 9.—Except in cases of emergency, no work that will obstruct the track shall be done during fogs or storms.

Rule No. 10.—Every Foreman of track work must provide himself with a reliable watch, and compare time daily with the clock at a telegraph office or with conductors.

Rule No. 11.—Foremen of track work must not carry any person (except the head of a department) on their hand-cars, velocipedes or push-cars without written permission from Roadmaster or other superior officer of the Track Department.

They will also stop any person other than employes of Track, Bridge, Telegraph or Building Departments, from running hand-cars, velocipedes or push-cars on the track without written permission to do so from the Roadmaster.

Rule No. 12.—Hand-cars and push-cars, when not in actual use, must be lifted from the track and placed at least four feet from nearest rail. Such cars must not be allowed to stand on highways, station walks nor private crossings except during the passing of a train. When they are left out of the sight of trackmen they must be kept locked.

Rule No. 13.—When two or more hand-cars or push-cars are running in the same direction, they must be kept at least two telegraph poles apart, and in no case must they be attached to engines or trains in motion.

Rule No. 14.—Foremen of track work must see that the boxes of the gear wheels and axles of their hand-cars and push-cars are kept in line and properly oiled.

Rule No. 15.—Hand-cars and unloaded push-cars must be passed from main line to side track, or vice versa, by lifting car. Switches are to be turned for loaded push-cars only under supervision of the foreman, who will be held responsible for the proper replacing of switches.

Rule No. 16.—Hand-cars or push-cars must not be left standing upon side-tracks.

Rule No. 17.—At least one man on a hand-car on track shall face the rear and keep a lookout for trains approaching from that direction. Extreme care must be taken in the use of hand-cars or push-cars in the vicinity of curves and in stormy or foggy weather.

When a hand-car or push-car has to be taken from track to avoid an approaching train, it must never be set upon the adjoining track of a double track when in the vicinity of a curve. Extreme care must be taken in the running of hand-cars in the vicinity of highway crossings, and hand-cars must be under full control when approaching crossings at which the view of the track is obstructed. Hand-cars must not be used for any other purpose than the inspection and care of the track, and when not in such use must be kept locked in the car-house. Push-cars when not in use must be kept at a safe distance from track with their wheels secured by a chain and lock.

Rule No. 18.—Foremen of track work are expressly forbidden to handle switches for trainmen.

Rule No. 19.—All Foremen of track work, in passing over the track, are expected to notice its condition and report any slight defects to the foreman of repairs of the section where such defects exist. They are required to protect, and repair if possible, any unsafe track they may observe, and are to be guided in their observation and work by the directions given further on in this book for the care of the track.

Rule No. 20.—Foremen or other employes of the Track Department are not authorized to lend, sell or give away any tools or material, new or old, belonging to this Company.

Rule No. 21.—Foremen of track work must be vigilant to prevent the theft of any material, or disfigurement or damage to any structure or grounds belonging to this Company, and must do all in their power to secure the punishment of any such damage or theft.

Rule No. 22.—Orders for tools and materials must be sent to the Roadmaster. Old and worn out tools must be sent to the Roadmaster on receipt of the new tools. All tools and material for repairs must be sent to the Master Mechanic. A tag must be securely fastened on each lot of tools or material, plainly addressed. The number and kind of materials sent, and the number of section or name of station they are from must be written on the tag. At the same time a letter must be written to the Master Mechanic, stating number and kind of tools or material sent, and what repairs are needed. If tools or material sent as above to the Master Mechanic for repairs are not returned in ten days, the Roadmaster must be notified of such shipment, and



the date and number of train it was made on must be specified.

Rule No. 23.—Foremen of track work will be furnished with ordinary memorandum time books to keep notes of time they and their laborers are employed. To secure uniformity in the recording of such time, foremen are instructed to enter their own names on the top line of page, and the names of their men on succeeding lines, one man's name to each line. Every day on which each man is employed all day is to be marked opposite his name, and in the column corresponding to the day of the month, by one vertical line. When a man is employed only a part of a day, that part of the day is to be marked in the proper column. When a man not discharged is absent from duty on a working day, the day on which he is absent is to be marked with an X. Sundays are to be marked with an S opposite the names of the men who are not employed on Sunday. No time must be entered for laborers except such time as they are employed in doing the Railroad Company's work. Unless discharged or directed otherwise by Roadmaster, they are considered to be so employed when on hand for duty, but prevented from actual work by storms too severe, in the foreman's opinion, to do the work in hand to advantage. In this connection it is to be understood that all laborers are subject to their foreman's order to do any kind of work appertaining to the care of the Company's property, and the foremen are instructed to so employ them when the weather is unsuitable for a particular class of work.

With the exception of the patrolling or watching of the track alluded to in this Book of Instructions under "Instructions to Foremen of Repairs," in Rule

No. 46, no regular work for the company is to be done on Sundays or on general holidays. In case of an emergency, any foreman whose services can be useful, and any laborer that the foreman calls upon, is expected to give the service demanded, whether the emergency arises at night, on Sunday, holiday or on regular working days. In case of mere expediency, foremen or laborers having scruples as to Sunday work may decline to give their services without any prejudice to their regular employment. No work of mere expediency is to be done on Sunday except under specific direction of the Roadmaster.

Work done at night, on Sunday and on general holidays by other employes than Foremen of Repairs, will be paid for at the same rate as regular daily work, and no extra time will be allowed on account of such work being done at irregular hours, except to laborers who run the car for the Sunday and holiday trip, and who will receive one-half day's pay for such service, and for other service due to emergency they may be called on to render in the first five hours of the day.

Foremen of Repairs, being paid by the month, will not receive any compensation on account of the Sunday and holiday inspection trip, but will be allowed additional compensation at their regular rate of pay for work done at irregular hours other than the first hours of Sunday or holiday, as cited above.

Rule No. 24.—The following is a list of blank forms required for the use of Foremen of track work. In ordering these blank forms, both the name and number of form shall be given and the quantity required of each kind shall be stated:

- Form No. 1040.—Time Books.  
 “ “ 281.—Time Sheets.  
 “ “ 315.—Work Train Reports.  
 “ “ 844.—Report of Stock Killed or Injured.  
 “ “ 845.—Report of Damage Done by Fire.  
 “ “ 849.—Report of Personal Injury.  
 “ “ 887.—Report of Broken Rails.  
 “ “ 695.—Identification Cards for Extra  
 Gangs.

Rule No. 25.—Form No. 1040. In addition to the memorandum time books referred to in Rule No. 23, Time Books of the Form No. 1040 will be furnished to all Foremen of track work, in which they are required to make the proper distribution of the labor performed under their supervision. All entries in these books are to be made with ink, and are to be made at the close of each day's work. These time books must contain not only the correct report of the time actually worked by each man in a gang, but must show the description of work upon which the foreman and each laborer was engaged each day. The first pages of the books are for the distribution of the time of foremen, and each succeeding page for the distribution of the time of one man. The full name, the month and year are to be entered at the top of the page. The column of "Days Work" is to be filled as per instructions in Rule No. 23. The number of hours devoted to any particular class of work is to be entered in its proper column, and their sum must equal the amount of time shown in column headed "Day's Work." If any class of work is engaged in for which there is no heading in the time book, that class of work and the number of hours devoted to it are to be entered in the column headed "Re-



marks." In case a discharge check is given, the fact is to be noted in the column of "Remarks," and the number of days' work and amount of check stated. One page of each book is to be used as a general diary by each foreman, and in it is to be noted the character of the weather during each day, stating "Clear," "Foggy," "Wet" or "Snowing;" also if calm or windy, giving direction from which wind blows. This latter page is to have the foreman's name entered at the top of the page.

Great care in making the distribution of time correctly is required. The books for the preceding month are to be sent to the Roadmaster on the first day of each month.

In the Time Books will be found blanks designated "Tie Reports for 8 ft. and 9 ft. track ties and for switch ties." All Foremen of track work will make entries in the proper column of such reports, of the number and kind of ties used for any purpose, on the day they are so used, and will fit out the lower portion of the blank reports when they send in their Time Books. The number of ties entered in the lower portion of the blank as the balance on hand at the end of the month shall be the number found by the Foreman of track work by actual count, and must in no case be entered to make an apparent balance of figures in the other columns.

Rule No. 26.—Form No. 281. Time sheets are to be made out and sent to the Roadmaster by all Foremen of track work in accordance with the following directions:

Foremen in making out time returns for the month must show each man's name correctly spelled on time sheet, the number of days he has been employed, and his rate per day. If any laborer has been paid by time

check during the month, his name must be placed on the time sheet, as above, and opposite his name must be written the words, "Paid by time check."

Time checks will be issued only to employes leaving the service of the Company either voluntarily or by discharge or suspension for cause. They will not be issued to an employe who expects to return to the Company's service within the month.

A time check will be issued by the Roadmaster upon a statement by the foreman that a man is entitled to it under the above conditions.

The time sheets must be at the Roadmaster's office one day before the close of each month, and the foreman, unless he knows to the contrary, is to assume that the men employed on the day that time is sent in will continue to be employed throughout the month. If the foreman finds that any of the men reported by him as above are not employed on the last day or days of the month, he must wire the Roadmaster, stating the number of days to be deducted from each man failing to be employed.

In case minors are employed, foremen are instructed to ascertain whether they are entitled to receive their pay personally or whether it is due to their parents or guardians. In the latter case the name of the proper recipient is to be entered opposite the minor's name on the time sheet with the word "Guardian" annexed.

Any foreman returning for himself or any laborer time, which has not been employed for the Company, is dishonest and will be dishonorably discharged from the Company's service.

At the bottom of the time sheet will be found columns headed by the names of several classes of material. On

STANDARD SPLIT SWITCH MICHIGAN CENTRAL RY.

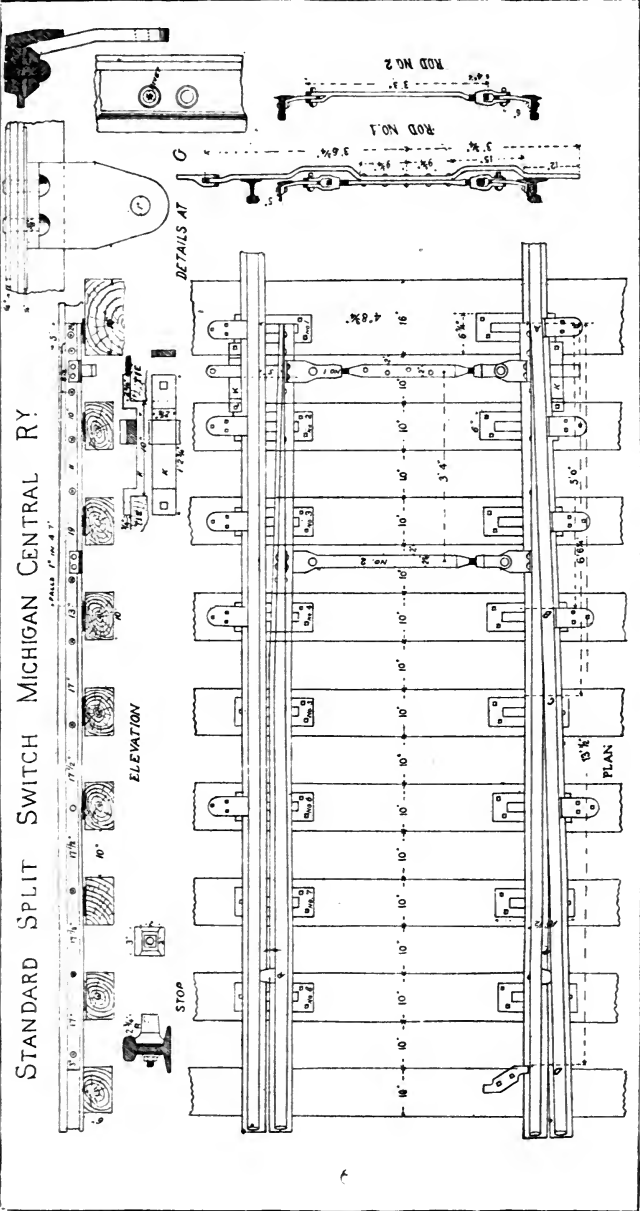

the first line below these headings, and in the left-hand column, are to be written the words "On hand." In the line below, the words "Used during month." In the next line, the words "Received during month." The proper entries in the columns of material are also to be made. All entries upon time sheets are to be made with ink, and all time sheets are to be signed by the foremen with ink.

Rule No. 27.—Form No. 315. Work train reports are to be used by the conductor of work or construction trains. The report showing all the details specified on the blank form is to be made with ink and sent immediately after the close of each day's work to the office of the Car Accountant at Detroit.

Rule No. 28.—Form No. 844. Report of Stock Killed or Injured. When stock of any description has been killed or injured by a passing train, or from any cause connected with the operation of the railroad, the Foreman of the section on which the accident occurred will immediately obtain all the information possible in connection therewith, and make a full report of the same with ink upon the blank form according to the instructions printed upon the blank form. This report must immediately be sent to the Roadmaster.

Rule No. 29.—Form No. 845. Report of Damage Done by Fire. This blank form must be properly filled out with ink and sent to Roadmaster as soon after the extinguishment of the fire as possible. A report upon this form is to be made of fires occurring in the vicinity of the right-of-way, whether started by engines or by employes of this Company, or by causes not connected with the care and operation of the road. In the reports of fires originating from causes foreign to the operation

or care of the road, some of the details on the printed form are evidently not to be filled out. In all cases the date, hour and location of the fire and the cause, if known, are to be reported, as well as a description of the property destroyed or damaged, whether the property belongs to this Company or to owners of adjoining lands; and in cases where this Company's operation or care of its road is the evident or probable cause of the fire, the report is to be made in full.

Foremen of track work are required to report to their Roadmaster the number or name of any engine which they know to have set fire along or adjacent to the right-of-way, whether the fire results in damage or not.

Rule No. 30.—Form No. 849. Report of Personal Injuries. In case of any accident resulting in injury to employes or others, Foremen of track work are instructed to telegraph the facts, briefly and at once, to the Division Superintendent and to the Roadmaster. As soon as possible after the occurrence a report upon the blank form is to be made with ink and sent to the Roadmaster. Even if the injury is apparently of little importance, all information necessary to a complete knowledge of the case must be given. One blank form is to be used for the case of each individual injured.

Rule No. 31.—Form No. 887. Report of Broken Rails. This report must be filled out with ink by Foremen of track work and sent to the Roadmaster as soon as practicable after the removal of the broken or defective rail.

Rule No. 32.—Form No. 695. Identification cards will be furnished to each Foreman of extra gangs, who

will fill them out with ink and give one to each man in the gang with instructions to deliver the card to the Paymaster, when pay is drawn.

Rule No. 33.—Foremen of track work are instructed to make a written report of any derailment to a train occurring within the territory of which they have charge. Full details of the accident are to be given, and in giving such details foremen are cautioned to state only facts, and not to color the facts by their wish to escape censure in regard to condition of track or appliances which are in their care. This report is to be made with ink and sent to the Roadmaster as soon after the accident as possible.

Rule No. 34.—All Foremen of track work are instructed to report to the Roadmaster any failure they may observe by the trainmen of this Company or of a company whose tracks cross the tracks of this Company, to stop before passing a grade crossing, where a stop is required. They are also instructed to report to the Roadmaster any failure by the trainmen of this Company to stop before passing over a draw-bridge, where a stop is required, and any failure to give the proper signals when approaching a highway crossing at grade. In such reports the time of the failure and the number of the engine are to be stated.

Rule No. 35.—All Foremen of track work are instructed to report to the Roadmaster any failure they may observe by the men in charge of street cars to stop before crossing the tracks of this Company. In such reports the time of the failure and the number of the car are to be given.

Rule No. 36.—Foremen of track work are instructed

# STANDARD RAIL SECTION & ANGLE BAR JOINT MICHIGAN CENTRAL RAIL ROAD

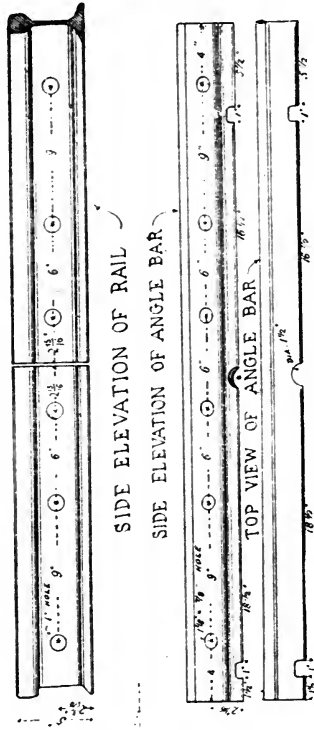
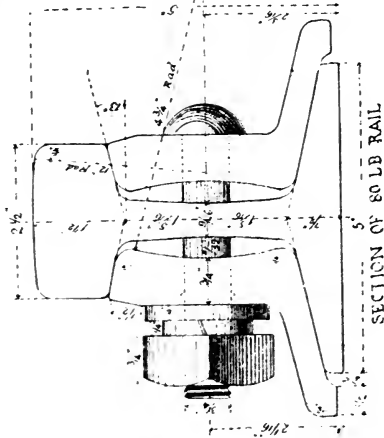

to watch all trains which pass them. If anything is seen to be wrong with the running gear, or to be dragging along the track the Division Superintendent is to be notified at once by the foreman from the nearest telegraph station.

Rule No. 37.—All Foremen of track work are instructed to get their men out of the way of a moving train, before the train is dangerously near. The nerves of the engineers are worth more than the few seconds' work which may be saved by exposing the men to needless danger.

Rule No. 38.—Foremen of track work, who have occasion to send their men on this Company's trains from one station to another on business connected with the work they have in charge, may send them on passenger trains by display of their time passes to the conductors of such trains. If it is not convenient to send time pass with the men who are to be carried on a passenger train, such transportation must be requested by wire or otherwise from the Roadmaster. In a contingency, which makes the use of a freight train for such purpose desirable, foremen are instructed to wire the Roadmaster, who will provide free transportation on such trains by authority of the Division Superintendent. Foremen are forbidden to pass their men on this Company's trains except on the Company's business.

Rule No. 39.—Foremen of extra gangs will receive specific instructions from the Roadmaster as to the details of work they are to supervise.

They are to make daily report, by letter, to the Roadmaster, as to the progress of the work put into their hands, and their attention is called to Rule 105 of this



book showing kind of report required of the movement of ties.

INSTRUCTIONS TO FOREMEN OF REPAIRS, CONCERNING THE  
DETAILS OF TRACK WORK.

Rule No. 40.—Foremen of Repairs will have charge of a section of roadway, generally about five miles in length, marked by a stake at each end of the section. For the safety and good condition of this part of the roadway the foreman is held responsible. The number of men he may employ will be designated to him by the Roadmaster from time to time, and the foreman may discharge from such employ any man he finds incompetent or insubordinate. The fact and occasion of such discharge must be communicated to the Roadmaster at once. While the following rules are given him for guidance and direction as to the duties he is to fulfill, it is manifest that no set of rules can be prepared, which shall meet every contingency, and the foreman is expected to follow implicitly all general orders from the head of the Track Department, and all general and specific orders from his Roadmaster. He is to post all general orders in his hand-car house.

Rule No. 41.—Foremen of Repairs are to remain with their men and personally superintend all work of the gang. They are to participate in the labor, when they can do so without interference with its supervision.

Rule No. 42.—Foremen of Repairs on divisions in the United States are to go on regular duty with their men at 6:30 central standard time in the morning, and are through with their regular duty at 5:30 central standard time in the afternoon. In Canada the hours for regular duty are between 6:00 central standard time in the morning and 5:00 central standard time in the

afternoon. From April 1 till November 1 they and their men are to carry lunches, and may use an hour in the middle of the day for lunch and rest. From November 1 till April 1 of the next year they may go home to mid-day meal and be away from the neighborhood of their work for one hour, it being expressly understood that no such absence from the work is allowable in case of unsafe track, that can be made safe by a few hours' work; and it also being understood that men detailed for flagging are on duty until relieved.

Rule No. 43.—Foremen of Repairs will at all times keep posted in the telegraph or ticket office nearest their headquarters the names of themselves and of their men, and also the address of each, so that the force can be summoned at any time.

Rule No. 44.—Foremen of Repairs will stop at such telegraph offices as they may have occasion to pass, and inquire for dispatches.

Rule No. 45.—In cases of severe storms or violent winds Foremen of Repairs are required to make thorough examination of their sections and see that all is safe. This examination must be made during the storm, whether it occurs at night, on Sunday or on other days, and the amount of time consumed in such examinations and consequent extra work must be reported at once to the Roadmaster.

Rule No. 46.—Foremen of Repairs must pass over their sections daily and see if the track and all pertaining to it is in safe condition. When possible, this daily inspection shall be made on the hand-car, and the ordinary track repair tools and danger signals must be loaded on the car. When it is not practicable to run the hand-car, Foremen of Repairs and their men must

walk over the section of which they have charge, and take with them one spike maul, one track wrench, some spikes and bolts, two red flags and some torpedoes, so that trains can be stopped for defective track and slight repairs be made with the least delay possible. This inspection should be made the first thing in the morning, unless some emergency requires immediate attention. On the Sunday trip only such men shall be called out as are necessary to run the car and do flagging, if it should be necessary.

Rule No. 47.—Foremen of Repairs are instructed to watch closely all points where obstructions are liable to occur, carefully examine the slopes of cuts and remove promptly any rocks, stumps, masses of earth or trees that are liable to fall or slide so as to endanger the passage of trains. Trees outside the right-of-way which are liable to fall upon the track must be reported to the Roadmaster.

Rule No. 48.—Foremen of Repairs are instructed to see that all bridges, culverts or other openings in the roadway for the passage of water are at all times kept free from drift-wood or other obstructions, and that all pit cattle-guards, trestles, open culverts or other structures, which would be injured by fire, are kept free from accumulation of weeds, leaves or other combustible material.

To ensure this safety from fire the sod must be removed and the weeds kept cut within a distance of ten feet from such structures. During the winter, when a thaw approaches, the ice in streams is to be cut away from the walls and piles of culverts and pile bridges.

Water barrels are to be put and maintained at all timber bridges and trestles. They are to be sunk into



the embankment and supplied with reasonably tight detachable covers. At short bridges or trestles of a single span a water barrel at one end will be sufficient. At long timber bridges of a single span and at all timber bridges or trestles of two spans or more, a water barrel at each end of the bridge is required. These barrels are to be filled with water on April 1 of each year and kept full until such time in autumn or early winter as cold weather and snow set in, when they are to be baled out and left empty till the following April.

Rule No. 49.—Foremen of Repairs are instructed to examine all structures for the passage of water after every rain storm or extraordinary flow of water, and if any undermining of foundation has occurred to report same at once to the Roadmaster. They are also instructed to report at once to the Roadmasters any erosion of the banks of streams or ditches, which may affect the stability of the roadway.

Rule No. 50.—Foremen of Repairs are instructed to watch the condition of the right-of-way and station fences, and to repair immediately any insecurity or breaches of them. Where the inequalities of the ground are such that the lower wire or board of the fence is more than six inches above a hollow, such opening is to be closed by driving boards or pickets into the ground and fastening the tops of them to the wires or bottom board of fence.

Rule No. 51.—Foremen of Repairs are instructed to watch the gates of private crossings, and if a gate is found open to close it and notify the owner of the adjoining land that such gate must remain closed except when in actual use. If the same gate is frequently left open by the user of it, a report of such practice must

be sent to the Roadmaster, and the dates of failures of user to close it must be specified.

If station ground gates are found open they must be closed and reported the same as gates at private crossings.

Rule No. 52.—Foremen of Repairs are instructed to remove at once from the right-of-way any stock which may have intruded there, and to report to the Roadmaster any attempt made by unauthorized persons to enter the right-of-way with teams or stock.

Rule No. 53.—Foremen of Repairs are instructed to see that all street and railway crossing signs, whistling posts, mile posts, siding signs, bridge guards, etc., are maintained in their proper positions, and that they are always in good repair.

Rule No. 54.—Foremen of Repairs are instructed to notice if cars upon side tracks fully clear the main track. If any are found which do not clear the main track properly, they must be put clear, if possible, by the section gang. If the section gang is unable to move the cars within a short time, the obstruction must be flagged and the matter must be reported at once to the Division Superintendent.

Rule No. 55.—Foremen of Repairs are instructed to notice the position of all main track switches, and if any are found set for side track without an attendant, the foreman is to set same for main track and notify the Roadmaster, giving date of such discovery. Foremen of Repairs are also to notice the position of all cut-out switches in sidings. If any are found closed with cars on side-track and not in use by trainmen, they are to be opened and the matter fully reported at once to the Roadmaster.

Rule No. 56.—Foremen of Repairs are instructed to carry any small package or article of freight which may be found on the right-of-way to the nearest station as soon as practicable, and take a receipt therefor from the agent. Any article of freight discovered which is too large to be carried conveniently on the hand-car or push-car must be promptly reported to the nearest station agent, and a full report of the discovery and care taken of such lost article sent to the Roadmaster, together with the station agent's receipt for same.

All car doors, links, pins and other car scrap and light track scrap of all kinds must be picked up and taken to car house, when returning from work each night.

Rule No. 57.—Foremen of Repairs are not allowed to grant permission to any one to make an opening in the highway, right-of-way or station fences for the purpose of delivering material for shipment, or for company use. In case requests for such permission are made, they are to be referred to the Roadmaster, who will issue instructions in the matter.

When the purpose of an authorized opening in the fence has been served the fence must be immediately replaced. If legitimate use of the opening is to be made at other times than in the months of December, January and February, a suitable gate must be erected by the Foreman of Repairs and maintained during the use of the opening.

Rule No. 58.—Foremen of Repairs are instructed to prevent, and refer to the Roadmaster, any attempt by persons not employes of the Company, to string wires of any description in highway and elsewhere over the tracks or along the right-of-way. They are also in-

structed to make frequent measurements of the height of existing wires above the main or side tracks, and to report to the Roadmaster any such wires which come to a less height than twenty-two feet above the top of the rail.

Rule No. 59.—Foremen of Repairs are instructed to prevent any person from cultivating any ground belonging to the Company, unless such person has written permission from the Roadmaster to do so, or holds a lease of such land from the Company.

Rule No. 60.—Foremen of Repairs are instructed to prevent any person from using the track or roadway in their charge for developing or testing any appliance whatever, unless such person has written authority from the Roadmaster to make such test.

Rule No. 61.—Foremen of Repairs are instructed to prevent any person from attaching advertising cards or posters to, or painting signs of any kind upon fences or structures belonging to this Company, unless such person has written authority from the Roadmaster. Any unauthorized signs, posters, cards or similar disfigurements must be detached or obliterated from the fences or buildings by the foremen as soon as discovered.

Rule No. 62.—Foremen of Repairs are instructed to be vigilant to prevent or report any kind of unauthorized occupation of the premises of this Company, whether at station grounds or elsewhere.

Rule No. 63.—Foremen of Repairs are instructed to report to the Roadmaster any obstruction which is put nearer than five feet to the rail at any height less than twenty-two feet above the top of the rail, upon grounds not owned by the Company.



Rule No. 64.—Foremen of Repairs are instructed to make frequent inspection of such track crossings, "Y" tracks, joint tracks and roadways as are used by this Company in common with another company, but in the immediate charge of the other company, and report promptly to the Roadmaster of this Company any defect in such tracks or track appliances. The Foremen of Repairs of this Company will be held responsible in the same degree for reports of unsafe condition of such joint tracks, as for the safe condition of this Company's tracks. The responsibility of this Company's Foremen of Repairs in the matter of tracks used jointly will extend over such tracks only as are laid within the station grounds of the two companies at the crossing or junction.

Rule No. 65.—Foremen of Repairs are instructed to pay particular and regular attention to the condition of the planking and approaches of highway crossings at grade. These are always to be preserved in a safe and commodious condition within the limits of the right-of-way and station fences. The gravel adjoining the plank outside the rails must be kept level with the top of the crossing plank.

The highway crossing sign must stand at least thirty feet from the nearest rail and in such a position as to be prominently visible to any one approaching the crossing from either direction.

The sidewalks upon and along the Company's lands are also to be frequently inspected by Foremen of Repairs; dangerous places are to be repaired at once and any defects to be reported promptly to the Roadmaster.

Rule No. 66.—Foremen of Repairs are instructed to remove at once any accumulation of papers, straw

or other combustible waste material from the proximity of the Company's buildings or cars, and to burn such rubbish in a safe place. They are instructed to remove and bury accumulations of rubbish which will not burn, and which originated from the operation of the road, or are deposited upon the Company's property by outsiders. Foremen of Repairs are responsible for the neat condition of the station grounds and right-of-way.

Rule No. 67.—Foremen of Repairs are instructed to see that no material of any kind is piled alongside any main, side or spur track nearer than five feet to the nearest rail of such track and that piles of material of any kind are so made as not to fall toward the track.

Rule No. 68.—Foremen of Repairs are instructed to watch for breaks in the telegraph line and make temporary repairs to broken wires when found. All breaks or insecurities of the line or of the posts are to be reported to the Roadmaster at once.

When a line is rebuilt or repaired by the Telegraph Department, such old poles as are not reserved by that Department and are suitable for fence posts, are to be cut to the proper lengths and piled up for such use. The refuse portions of piles are to be burned by the section men.

Rule No. 69.—Foremen of Repairs are instructed to erect snow plow markers on October 15 of each year, and take them down on April 15 of each year. When not in use they are to be laid alongside fence opposite their winter location. These markers are required at about twenty-five feet beyond each end of every permanent obstruction on the main track (except cross fences leading to cattle guards at highways, private

ways and station limits), which is at a greater height than three inches below top of rail and within a distance of two and one-half feet from either rail.

The wooden splices used at insulated joints of track are evidently obstructions of this nature and require the erection of snow plow markers. The snow plow markers are constructed by nailing two fence boards eighteen inches long to the top of a fence post with the edges touching and horizontal. They are to be set not less than six feet from the nearest rail in any case. They are to be set nine feet from the nearest rail when in such position they will be clearly seen by an approaching engineer. They are to be set on the engineer's side of the track and in such positions as not to be hidden from him by intervening object nor to hide the view of signals.

Rule No. 70.—Foremen of Repairs are instructed to cut all the grass, weeds and other undergrowth upon their sections, beginning such work July 1 of each year, unless otherwise instructed by the Roadmaster, and making such work the principal occupation until it has been completed. The rubbish, when dry, is to be burned under the supervision of the foremen, who are cautioned to do such burning with the greatest care to prevent damage to property.

Rule No. 71.—Foremen of Repairs are instructed to remove the bark from all fence posts furnished to them for repairs on their sections, before such posts are set, and to remove the bark from posts in fences already built.

This bark is to be burned the same day as it is removed.

Rule No. 72.—Foremen of Repairs are instructed

to cut all stumps on their sections to the ground level; as time for such work is found in the winter, and to gather up and burn all old logs, chunks of wood and other refuse which may have been left in the construction of the road.

Rule No. 73.—Foremen of Repairs are instructed to bury any dead animals which may be found upon the right-of-way, at least one-half mile outside the limits of any city or village.

Rule No. 74.—Foremen of Repairs are instructed to notify their Roadmaster of necessity of occupation by them of the main track for renewals of culverts or for the execution of other work which will prevent the passage of trains, and which can be done as well in a few days as at once, and they will proceed with such work only after notice from the Roadmaster when to do it.

Rule No. 75.—Foremen of Repairs will attend to the care and lighting of such switch and signal lights only as are designated to be in their charge by their Roadmaster. They are required to keep such lamps clean, to fill them every morning, and to keep them lighted at all times except when attending to them.

The care of lamps is to be subject to the following instructions quoted from those issued by the Signal Engineer:

“1. Lamps must not be filled higher than one-half inch below the top of the font.

“2. The wick must reach the bottom of the font and fit properly in the burner. A wick that will not move freely when acted upon by the ratchet wheel is apt to clog inside of the burner, thereby preventing the free flow of oil to the flame. When the oil does not flow fast enough to feed the flame, the burner overheats, the

wick encrusts, smoke is produced and an explosion sometimes occurs.

"3. When the ratchet wheel will not work, the wick must be drawn up through the burner with the fingers, and moved back to place by turning the ratchet wheel. If the wick is too thick, reduce it by removing a few threads.

"4. The wick must be kept below the top of the burner when the lamp is not lighted, to prevent oil flowing from the wick over the outside of the font.

"5. Once a week all oil must be removed from the font before filling with new oil.

"6. Oil fonts and cans must be thoroughly rinsed with clean hot water at least once a month. Soap or soda must not be used in the water, as either will leave a residue in the can that is injurious to the oil.

"7. Lamps must be cleaned and filled daily. Special attention must be given to the lenses and to the top of the lamp where soot is most likely to collect. All vents must be kept open so that the lamp will receive the proper amount of draft. The gas escape vent in the burner must never be allowed to clog.

"8. If the ventilating holes in the burner become clogged with dirt they can be opened by putting the burner in boiling hot water.

"9. The lamp must be lighted a short time before turning the flame to its full height, and an examination must be made to see if the lamp smokes after the font is put in place.

"10. The sulphur must be burned off the match before lighting the lamp, to avoid crusting the wick with sulphur.

"11. No alterations must be made in lamps. If they do not give satisfaction the trouble must be reported.

"12. A report must accompany a requisition for a new lamp, stating the trouble with the lamp that is to be replaced.

"13. In taking down or replacing lamps at semaphores, the glasses in the semaphore arm castings must be inspected to see if they are clean and in good condition. A broken glass must be reported by telegraph to the Division Superintendent."

Particular attention to the tamping of the head block must be given, as an undue amount of vibration of the switch may put out the light. The springs in the sockets of the switch lamp into which the fork of the mast fits, may become set and fail to relieve the jar of the stand. In such event the lamp must be replaced. A report must be sent to the Roadmaster of every occasion where the lamp is found not to be burning, and the cause specified if known.

Rule No. 76.—Foremen of Repairs are instructed to build such hand-car run-offs as are necessary on their sections, with a fall from the track of four inches in twelve feet.

These run-offs must be excavated, if necessary, or made of earth embankment, and must be at least thirteen feet long and ten feet wide. One such run-off must be built in the vicinity of every highway crossed by single track, and one such run-off must be built for each track of double track close to every highway crossing.

Rule No. 77.—Foremen of Repairs are not allowed to use stoves in their hand-car houses. In inclement weather, when shelter is imperatively necessary, they

may use the station building for such shelter. While in the station building for shelter, or for other reasons, they and their men are expected to be orderly and are forbidden to smoke.

Rule No. 78.—Foremen of Repairs will see that no stone, gravel or earth is left nearer either rail than three feet at height greater than three inches below the rail, during the time snow plow markers are standing, as per Rule 69, unless such material has been deposited in such proximity to track by direction of the Roadmaster, who may be presumed by the Foremen to be taking care of its disposal.

Rule No. 79.—Foremen of Repairs will not attend to loading or unloading any material for use of any other department than the Track Department, unless under express order of the Roadmaster or in observance of Time Card Rule No. 39. When loading or unloading is done by such order, Foremen of Repairs are instructed to report to the Roadmaster the number and initials of the car loaded or unloaded, the kind of freight, number and condition of pieces, the point of shipment and the destination. In case such freight is handled from a disabled car, this information is to be sent to the Roadmaster by wire.

Rule No. 80.—Foremen of Repairs are instructed to attend to the drainage of the roadbed as the first essential factor in the maintenance of good track. All ditches in cuts are to be kept clear of accumulations which obstruct the flow of water. Where conditions of traffic do not interfere, these accumulations are to be taken out of the cuts by the use of push-cars, unless such material can be cast beyond the top of the slopes. Ditches leading to and from culverts are to be kept

clear within the limits of the Company's property. Ditches are to be cut through snow banks where a sudden thaw would be likely to flood the track in the absence of such ditches.

Rule No. 81.—Foremen of Repairs are instructed to keep the track in the best possible surface. In surfacing track care must be taken not to raise the track in general off its bed. The lower places are to be raised to conform to the higher places, which latter are not to be disturbed as to surface. To secure a proper bearing of the rail on the tie, it is necessary that such bearing be examined on each tie, and if the rail has cut into any but the joint ties more than one-half inch, the tie is to be adzed down outside and inside of the rail to the level of the bearing, and the spike driven home. The joint ties under angle splice are to be examined with particular care, and the splice is never to come into contact with the tie. The use of the track level is insisted on to bring opposite rails to the same or to the required height, and the track level is to be tested every morning before use.

The test of the level is to be made by placing the board on the rails square to the line of the track and bringing the center of the bubble to the center marked on the glass, by a shim if necessary. When, in this first position of the board, the bubble has been found to be or has been brought to be in the center of the glass the board is to be turned end for end and put on the same supports as before. If in this last position of the board, the center of the bubble stands at the center marked on the glass, the level is correct, but if the bubble fails to do so, the level is out of order and must be sent to the Roadmaster for repairs.



Upon all straight track, excepting near curves, the opposite rails are to be maintained at the same level. Upon curves and the approaches thereto the outer rail is to be higher than the inner rail by an amount specified by the Roadmaster at each curve.

The shimming of track to preserve its good surface will be allowed only in winter weather, unless otherwise ordered by the Roadmaster. Foremen are directed to use shims up to one inch in thickness, if necessary, rather than to adze down ties which have heaved. Foremen are directed to give as prompt notice as possible to the Roadmaster of the use, or of the necessity to use, shims of greater thickness than one inch, and in such notice to mention the location and approximate number of such shims. Foremen are directed to be very particular to secure a uniform bearing on all shims used, both under rail and on tie. White oak shims eight inches long and four inches wide are to be used, and they are to be driven under the rail from the outside. Shims three-quarters inch thick, and over, on straight track, and one-half inch thick and over, on either rail of a curve, must be accompanied by a wooden rail brace extending at least one foot from the neck of the rail and securely held by spike.

Foremen are directed to remove all shims from the track as early in the spring as possible, and store the uninjured shims in their car house. Particular attention should be given to the drainage of such portions of the track as heaved badly during the previous winter. At points where the heaving has required the use of shims exceeding one inch in thickness for two consecutive winters, foremen are directed to drive stakes to

mark the location, and consult with the Roadmaster as to proper means to reduce such tendency to heave.

The tamping of ties is to extend throughout the length of the tie. If the character of the ballast admits of using tamping bars, the men using them are to stand opposite each other and strike the ballast at the same time. If the nature of the ballast requires the use of puddles, one space only at adjacent ties is to be dug out at a time. Both ties are to be tamped on the sides exposed by such removal of ballast, and the space is to be filled back before the other sides of the ties are tamped. Shovel tamping is permitted only in case of a general lift of three inches or over with any kind of material.

Rule No. 82.—Foremen of Repairs are instructed to allow no ballast above the top of the tie; to keep the ballast level with the top of tie throughout the length of the tie, and to conform the shoulder of the roadway to the standard bank gage. The exceptions to this shape of the roadway on account of inferior ballast will be made only under specific orders from the Roadmaster.

Rule No. 83.—Foremen of Repairs are instructed to keep their track in the best possible line. Track cannot be maintained in good line unless the surface is reasonably good, and the finer points of lining must follow surfacing. Any stakes which may be given to establish the line of track must be carefully preserved in the necessary work, and the accidental disturbance of such a stake or monument must be immediately reported to Roadmaster. When ballasted track is to be moved to conform to the line as given by stakes, the ballast in the vicinity of each stake is to be removed to the level of the bottom of the tie so that the stake shall

not be disturbed by ballast moving with the ties. Whenever the line of track is in any way impaired by accident, or by work done on the track, it must be relined at once. Track which has been surfaced during the day must be left at night in perfect line.

Rule No. 84.—Foremen of Repairs are instructed to keep the track always in correct gage. The only variation from a gage of 4 feet 8½ inches which is allowed, except at switches, will be designated by a specific order from the Roadmaster. The gage must be placed at right angles to the track. The shorter prongs of the gage must be placed at the joints, in track laid broken-jointed, and care must be taken that the splice does not keep the longer prong from touching the side of the head of the rail in track laid even-jointed. In regaging track, the spikes of not more than four ties are to remain withdrawn at one time. In case track is found out of gage it may be due to the fact that the rail has worn the tie so that the bearing of the rail is not parallel to the face of the tie. This is particularly liable to be the case on curves, and it is frequently the inner rail of the curve which has worn a tie unequally under the two edges of the rail. When ties are cut by the rail in such a way as to materially change the gage of the track under the passage of a train, new bearings which will hold the rail at right angles to the tie are to be adzed. The flange wear on the outer rail of a curve will also widen the gage. The track is not to be altered to restore gage changed by this cause alone. When such flange wear has reached the top edge of the splice, a report of such condition of the rail is to be made to the Roadmaster. The use of rail braces to preserve the gage or line of track which is in immediate contact

with the ties is permitted only at switches, guard rails and such curves as are specified by the Roadmaster. It is to be borne in mind that the line of track is the line of both rails; that however true the line of one rail may be, the line of the other rail is just as important and depends upon the accuracy of the gage.

Rule No. 85.—Foremen of Repairs are instructed to give the matter of tie renewals particular attention. In determining the necessity of replacing a tie under main or passing tracks, its condition as to decay and wear, its position in the track and the condition of the neighboring tie are all to be considered. A tie in straight track not under or next to a joint, not cut by the rail more than one inch and with adjacent ties in fair condition, is not to be replaced unless broken by the test specified below or sufficiently decayed alongside the rail to allow a pick or a sharp-pointed bar to enter the heart wood three inches with one blow. The tie under a joint, or either of the two ties immediately adjoining it, is to be replaced when showing enough decay alongside the rail to allow a pick or a sharp pointed bar to enter the heart wood two inches with one blow, or when it is broken under test specified below. Sap rot alone is not to condemn the tie for service. A requirement similar to that given above for joint ties is made for renewal of ties under curved track. If two ties with only one year's safe service according to the foregoing standard are adjacent, one of them must be renewed, and a group of ties with only one year's safe service must be so renewed as to leave each doubtful tie with a fairly good neighbor. The requirement made upon the foremen is first that condition of the tie gives safe track, and it is equally required that the utmost

safe service is afforded by the ties. In testing ties for decay, the bar or pick is to be driven into the tie toward the center, and is to be withdrawn without prying. In testing ties for transverse strength, a bar is to be used as a pry, the point to be applied under the extreme end of the tie to be tested and the nearest tie to be used as a fulcrum. If the tie will not break by one man's weight on the end of the bar, it may be considered safe as to strength. The tie renewals to be made in standing tracks of yards, and such tracks as are used for traffic of small importance, are determined by a lower standard, and no tie in such tracks is to come out until its safe service is past.

On September 1 of each year the Foremen of Repairs are instructed to send to the Roadmaster estimates of the number and kind of ties required for tie renewals for the next year, stating in such estimate the number of ties distributed on their sections which may be applied in such renewal. When the ties are received Foremen of Repairs are instructed to pile them neatly alongside the track, and as time can be spared are to see that the bark is removed and burned. No tie with bark on is to be put in tracks.

Ten ties are to be put in each pile. The pile is to be three-cornered or triangular, with one corner toward the track and one side parallel with the track. The first, fourth, seventh and tenth ties are to be put in the parallel side, and the other sides are to be of three ties each. The piles must be so constructed that the ties are not in contact with each other at points where the rail bearing will be.

This arrangement of piling is to be preserved as far as practicable and scattered ties brought into piles of

this description. In distributing ties from the piles for renewals, only such number of ties is to be put alongside track as can be put in during one day. The ties of smaller width are to be placed alongside ties of greater width. Ties are to be put in square to the line of the track, and each tie is to be full spiked as soon as it is put under the rails and before it is tamped. The gage is to be applied to the track over each tie which is renewed and the track brought to exact gage at the time of first spiking.

A tie with a waney edge is to be put in track with its wider face in contact with the rail. A 9-foot tie is to be so placed under rails that one end of it is 22 inches outside of and north or east of the edge of the flange of north or east rail. An 8-foot tie is to be so placed under rails that one end of it is 16 inches outside of and north or east of the edge of the flange of north or east rail. Care must be taken in the renewal of ties to replace in a safe and substantial way such planking as had to be removed. Ties taken out of track which may be suitable for docking are to be piled together. The remains of useless ties are to be placed at a safe distance from track and burned, when order for such burning has been given by Roadmaster. All spikes and stubs of spikes are to be taken from the ashes and either put in scrap pile or used again.

A statement of the number of sound ties taken out on account of being cut by the rails is to be sent to the Roadmaster each month.

A weekly report of the number and kind of ties used for any purpose whatever, destroyed or taken, is to be sent to the Roadmaster.

A Foreman of Repairs taking charge of a new section

must determine how many ties are distributed on that section by an actual count, and must report the number and kinds to the Roadmaster.

Rule No. 86.—Foremen of Repairs are instructed to space ties as follows: In all track a wide tie is to be under the joint between rails, extending an equal distance under each rail. In case of track laid with six bolt splice, the ties adjacent to the joint tie are to be so spaced as to have their centers equally distant from the spike slots in the angle plates. In such main track laid with 80-lb. rail and broken joints, between these ties adjacent to joints there are to be five ties spaced equal distance from center to center. In such main track laid with 80-lb. rail and even joints, between the ties adjacent to joints there are to be thirteen ties, spaced equal distance from center to center. In such main track laid with 65-lb. rail and broken joints, between the ties adjacent to joints there are to be six ties spaced equal distance from center to center. In such main track laid with 65-lb. rail and even joints, between the ties adjacent to joints there are to be fifteen ties spaced equal distance from center to center.

All main track with four bolt splice is to be laid even jointed and seventeen ties spaced equal distance from center to center are to be put between joints.

The above spacing applies to track laid with 30-ft. rail.

In all passing and switching tracks, the ties are to be spaced 24 inches from center to center. In standing tracks of yards and tracks on which the traffic is unimportant, the ties are to be spaced 30 inches from center to center.

Switch ties are to be spaced 20 inches from center to center, as shown upon diagrams of switch layouts.

Rule No. 87.—Foremen of Repairs are instructed to keep all ties fully spiked. The spike must be driven square to the top surface of the tie, and this square driving will be accomplished only by strict watchfulness on the part of the foreman. The last blow which brings the head of the spike to the rail must be given lightly so as not to injure head. If a spike is not brought up to flange of rail, or is twisted round so as to touch the flange only with an edge it is to be drawn and re-driven. When a spike has to be drawn and re-driven, the hole made by the first entry of the spike must be plugged, if the tie is in a state of reasonably good preservation. Plugs for this purpose will be furnished by the Roadmaster on demand. The spikes on the inner side of each rail must be opposite, and the spikes on the outer side of each rail must be opposite and staggered at least three inches from the position of the inner spikes, provided such amount of stagger will leave both spikes two inches or more from the edge of sound timber in the tie. One obvious exception to this requirement of stagger in spiking is at joints where angle plates are used.

Spikes are to be driven through all slots of angle plates except on bridges. On bridges the spikes at joints are to touch the edges of the angle plates, as far from the slots as the ties will allow, leaving freedom of movement for the rail lengthwise.

All bent spikes, suitable for re-driving, must be straightened. It will be found that the heads of spikes will break off, especially during the winter months. The stubs are not equivalent to spikes and are to be



driven flush with tie and replaced with new spikes. The spikes are to be driven so that the heads are in contact with the flanges of the rail.

Rule No. 88.—Foremen of Repairs are instructed to keep the joints of all main, passing and switching tracks full bolted, and to keep the joints of all other tracks which are laid with steel rail full bolted also, even if drilling is needed for such full bolting.

In tracks laid with iron rail one bolt through each end of the rail will be considered sufficient if drilling of the rail would be required to secure full bolting. The nuts of all bolts are to be kept tight. If this requirement cannot be followed without frequent use of the track wrench, it is generally because of wear in the bolt or splice, and new material is to be ordered of the Roadmaster. A cracked splice is about equivalent to a broken splice for supporting the joint, and must be replaced when discovered.

If the angle plates at a joint are bent either sidewise or vertically the result will be bad line and bad surface till such bent plates are replaced. Track should be frequently examined for this defect and the bent splice replaced on discovery and sent to the Roadmaster to be straightened.

Particular attention is called to joints in planked crossings, at stations and other points where plank is laid alongside the rails. These joints are as important as any, and although the expense of looking after them is greater, the requirements as to their condition is the same. In such parts of the track as are laid with 65-lb. or 80-lb. rail, the bolts are to be put into joints which come in planking from the outside of the rail so that the nuts will be in the flangeway.

The same method of entry of bolts is to be used at the heels of switches, derails and frogs, to facilitate blocking. This method of entry of bolts is contrary to the usual practice. In lower rails than those specified the bolts are to be put into all joints with the nuts outside the rails. The only exception allowed to the condition of absolutely tight nuts on track bolts is in the six bolt joint in summer. If the Foreman of Repairs notices slight kinks in the rail thus laid, due to expansion of the metal, the nuts may be relaxed slightly during extremely hot weather to allow freer expansion, but such nuts must be set tight after the rail has straightened.

Rule No. 89.—Foremen of Repairs are instructed to keep close watch of the condition of the track in hot weather, as to facilities of proper expansion at the joints. If a trip over the section at mid-day is required for absolute knowledge of this condition, the trip is to be taken. When more than twenty joints have closed tight because of expansion of the rails, an expansion space in the center of such tight section is to be made by driving the rails each way from the center of it. A chisel must never be inserted between the rail ends to drive rails apart. The bolts through the end of one rail must be removed and one section of tight rail be driven back by striking the splice bar. If the tight section is too long for such driving, enough rails are to be cut to leave the ends of not more than ten consecutive rails in contact.

Rule No. 90.—Foremen of Repairs are instructed to watch closely the creeping of the track under traffic on grades or under one-way running of traffic. If this creeping is frequent and of any considerable amount,

special instructions as to treatment of that part of the track are to be sought from the Roadmaster.

The open spaces at the ends of track scales must be examined frequently and maintained at not less than one inch and not more than one inch and one-half.

Rule No. 91.—Foremen of Repairs are instructed to remove from the track as soon as discovered, any rail broken or so damaged as to be dangerous in the remotest degree for traffic. If the rail is removed from a curve, its substitute must be bent to the same curve before it is spiked in position. If the stock of extra rails for repairs on any section is limited, full length rails must be made by splicing the good parts of damaged rails. Any length of rail sufficient to afford full bolting of the splices may be utilized and the stock of full length spare rails thus kept sufficient for emergencies. These spliced rails are to be removed from main tracks when full length rails can be furnished to replace them.

Rule No. 92.—Foremen of Repairs are instructed to make a critical inspection of all main line switches every day. Switch rods must be adjusted so that the point shuts tight against stock rail throughout the length of the planing of the point. The bolt which connects the No. 1 switch rod to the main connection must be put in from the bottom, the end of the bolt must be upset above the nut and a piece of white oak tie spiked to the side of the head block, under the bolt, of sufficient dimensions to form a shelf just below the bolt in all positions of the switch. A fish plate must be spiked to the head block near the switch stand in such a way as to make a shelf under the outer end of the main connection in all its positions, to hold it in connection with the crank arm of the stand, if the nut should

come off. Cotter pins of bolts and pins must always be in position and all nuts and rivets kept tight. The gage at the point is to be maintained at just 4 feet  $8\frac{3}{4}$  inches unless by special instruction from the Roadmaster. The banners of switch stands are to be maintained parallel with the main track rails. Special attention must be given to this point when it is necessary to skew the stand for change of throw. The cause of lost motion must be carefully looked into, and any material unduly worn must be replaced.

Switch stands used on this road, when new, give a five-inch throw when properly set up. This amount of throw gives five inches space between the main line rail and the idle point. The lost motion which results from the use of the switch gradually makes this available throw somewhat less, and the lost motion is to be compensated by skewing the switch stand. Great care must be taken, however, that such skewing of switch stand is never carried to a point where there is less than four inches opening between the idle point and the main line rail. At interlocking plants the original throw is generally less than five inches, but when by reason of wear of parts, it would be less than four inches, such condition of switch must be reported to the Roadmaster. The handling of the switch necessary for its proper examination must be done personally by the foreman, and in such handling he must observe the rule of the time card requiring men to stand away from a switch while train is passing over it.

The heels of both points must be kept level with the rails opposite, either by tamping or shimming to allow the points to shut in under the stock rails with facility.

The switch stand of a facing point switch must be put and maintained on engineer's side of track.

Some switches are equipped with automatic cut-outs. The proper condition and working of these cut-outs is as essential a feature of a switch as the points are, and if for any reason they must be put out of service temporarily, the fact must be telegraphed to the Roadmaster and to the Division Superintendent.

The switches leading from other tracks than the main track are subject to the rules cited for main track switches, and are to be sufficiently inspected to insure their perfect condition.

All switch stands of switches leading from main track must have switch locks.

Rule No. 93.—Whenever split switches have been run through or have been rendered unsafe in the remotest degree for service, Foremen of Repairs are instructed to make the track safe at once for main track movements. If circumstances do not allow such immediate repairs to include the use of the switch for side track movements, the facts are to be telegraphed at once to the Roadmaster and the Division Superintendent, and the message to the Roadmaster is to include an order for the necessary material for complete repair of the switch. The rods between the points of a split switch are known as "Rod No. 1," "Rod No. 2," etc., "Rod No. 1" being that at the point of the switch. The rod connecting "Rod No. 1" with the switch stand is known as the "main connection." A switch point is known as "right hand" or "left hand" by its position to the right or left of an observer standing between rails and facing the points of the switch. As soon as a disabled switch has been completely repaired, the Road-

master and Division Superintendent are to be advised by wire, and a written report of the nature of repairs and cost of labor is to be sent to the Roadmaster. If the Foreman of Repairs has positive knowledge of the cause of disability, a full statement of the facts is to be included in the report.

Rule No. 94.—Foremen of Repairs are instructed to make critical inspection of all main line frogs every day. The guard rail braces holding either the guard rails or the loose wing of guard rail frogs must be maintained in their proper position. The flange-way at guard rails must be maintained at two inches unless otherwise directed by Roadmaster. The loose wings of spring rail frogs must shut tight against frog points and must move freely through the stop-boxes. Occasional driving back of the loose wing may be required to secure such free movement. The nuts of bolted frogs must be kept tight. If the rivets of frog points or plates become loose, such looseness of parts must be reported to Roadmaster. If the wing rails, points or other parts of a frog become worn so much as to cause rough riding on main track, or be in any degree unsafe on main tracks or inferior tracks, its condition must be reported to the Roadmaster, who will determine the necessity for renewal. A broken wing rail is equivalent to any other broken rail in track and demands immediate renewal of frog.

All frogs must be maintained in perfect line. The frogs in other tracks than the main tracks and all crossing frogs are subject to the requirements cited for main track frogs, and are to receive sufficient inspection to insure perfect condition.

Rule No. 95.—Foremen of Repairs are instructed

to maintain suitable blocking at the ends of guard rails, at frogs, at switches and at other points between rails where the feet of men are liable to be caught. The condition of this blocking must be at all times unquestionably good and the blocking must be firmly secured to the ties. Material for it will be furnished by Roadmasters upon receipt of order. No material of any kind must be left at night nearer to any track than five feet without proper notice. All tools must be taken to car-house or tool box at night. When repairs are to be made in a yard which require the distribution of material within the above limits, the Division Superintendent must be notified that such dangerous conditions exist. Foremen of Repairs may assume that material for renewals of main track and gravel for lifting main track are within the limits stated above, with the knowledge of the Division Superintendent, but are instructed to remove any loose rail that is nearer the fixed rail than the ends of the ties.

Cinders dumped from engines are to be removed from the vicinity of the tracks whenever found there by Foremen of Repairs.

Rule No. 96.—Foremen of Repairs are instructed to keep the flange-ways of all switches, frogs, guard rails, planked crossings and other narrow spaces along gage side of rails and all switch rods or other movable track appliances at all times free from snow, ice, mud or other obstruction. The men engaged at such work will be in a dangerous position, especially in winter and at night. Foremen will consequently give them particular instructions to look out for their personal safety whenever they are detailed for such work.

Rule No. 97.—Foremen of Repairs are instructed

to keep the snow shoveled away from switch stands, the drifts shoveled away from highway crossings, and the snow piles arising from the use of plows or flangers shoveled out of private crossings. Foremen of Repairs are responsible for the removal of snow and ice from track scales and wagon scales, and are required to give such scales such attention throughout the winter as will insure their proper condition at all times. Platforms and walks about stations are to be kept clear from snow by the Operating Department, but Foremen of Repairs are instructed to furnish such help toward this work as can be done without interference with the proper fulfillment of their other duties.

Any knowledge Foremen of Repairs may gather as to the formation of drifts likely to impede traffic must be telegraphed in full to Roadmaster.

Rule No. 98.—Foremen of Repairs are instructed not to slot the flange or web of any rail. The necessary holes in flange or web of rail for insertion of bolts or passage of rods are to be drilled, and no hole of greater diameter than one inch is to be drilled in a rail without explicit directions from the Roadmaster.

If any rail in track is discovered which has a piece broken or cut from the flange, such rail must be drilled at the point where the defect exists and angle plates put on to preserve the safety of traffic.

Rule No. 99.—Foremen of Repairs are instructed to watch closely the condition of all bridges, culverts, pit cattle-guards and other openings in and under the roadway. In case any weakness of these structures is discovered, affecting in the remotest way their stability, such weakness is to be reported at once to the Roadmaster. They are further instructed to keep the nuts



tight on all packing, bond timber and other bolts in the floor system of bridges, and to report any looseness, chafing or rattling of rods, rivets or other parts of such structures. They are also instructed to keep the expansion rollers under the free ends of iron bridges free from gravel, cinders or other obstructions.

Rule No. 100.—Foremen of Repairs are instructed to notice closely the condition of all surface cattle-guards. The ballast filling between the ties under such guards is to be maintained at the height of about two inches below the tops of the ties. The sections of the guards are to be so secured to the ties as to leave the openings near the rails as safe for foot travel as any other part of the guard is. The guards are to be secured to the ties in such a way by staples or otherwise as to prevent rattling under the passage of a train. Any broken section of guard must be renewed as soon as discovered. A report of the failure of any guard to keep stock from the right-of-way must be made to the Roadmaster promptly.

Surface cattle-guards must be put and maintained within the limits of the Company's right-of-way and the cross fences leading to the guards must be as near as possible to the line of the highway. At a very oblique crossing the guards must not be located except under direction of the Roadmaster.

Rule No. 101.—Foremen of Repairs are instructed to notice the condition of bridge guards at overhead obstructions. The ropes must always be of the same length and hang free. If the binding of the ropes becomes detached, it must be replaced before the rope end frays. The posts and other combination of the

bridge guard must always be of sound material and properly secured.

Rule No. 102.—Foremen of Repairs are instructed to render such aid as is required by the Foremen of interlocking plants in keeping the tracks and switches in condition for operation, and are to do the necessary work of maintenance of track between distant signals only with the knowledge and subject to the supervision of the foremen of the plants.

The levermen have instructions to throw interlocked switches at the request of Foremen of Repairs for the proper examination of the working of the switches and derails, when such movements will not interfere with the traffic at the interlocker.

Any failure or unwillingness to do so on the part of the levermen is to be reported to the Roadmaster.

Rule No. 103.—Foremen of Repairs are instructed to run their hand-cars slowly over track instruments connected with crossing alarm bells or block signals, and if the hand-cars are heavily loaded, foremen must pass the cars by such track instruments without touching the instruments by wheels of the car.

Rule No. 104.—Foremen of Repairs are instructed to use great care in maintenance of track where track circuit is in use for bells or signals. Any necessary interruption to the circuit must be made as short as possible, and the accumulations of dirt or cinders must not be allowed under the rails nor around the connecting wires.

If a rail has to be replaced notice of such fact must be wired to the Roadmaster as soon as is consistent with safe condition of track. The joints supported by

wooden splices in such track must receive critical attention and be frequently tamped.

The splices must be renewed as soon as wear has begun.

Change from the standard form of roadbed in track where track circuit is in use must be made only under explicit orders from the Roadmaster.

Rule No. 105.—Foremen of Repairs when loading ties for shipment are instructed to lay them lengthwise on the car, and to secure each tier with two stakes firmly set in the stake pockets of the car. If a flat car is fully loaded with rails, stakes must be put in all side pockets and the ends of the rails must be held by end boards consisting of three-inch plank, fastened securely to the floor of the car or to stakes in the end pockets, provided such fastening to stakes in the end pockets will permit only a few inches movement to the rail.

If a flat car is partly loaded with rail the rail must be laid in the center of the car and held from side and end movement by three-inch planks securely nailed to floor of car. If a flat car is loaded with scrap or other loose material, such material must be kept from side or end movement by three-inch planks securely fastened to stakes or floor of car. Care must be used not to load any car beyond the capacity marked on it.

A particular report of the loading of ties to be shipped on freight cars or moved on push cars is to be made on a blank which will be sent to the Foreman by the Roadmaster on his application. Upon this blank is to be entered the location of the ties to be loaded, the date on which they are loaded, the number of ties, and the mark of the pile which is loaded, and the balance on hand at that locality by actual count. Except in

case of an emergency, ties which have been loaded at an inspection point and delivered to a Foreman of Repairs for use on his section, must not be taken from that section unless special order for such movement and clear directions as to its method shall be received from the Roadmaster.

Rule No. 106.—Foremen of Repairs are instructed to keep their supplies of bolts, spikes, nut-locks and similar material inside the car-house, which must be kept locked. Such old spikes as can be straightened, and such other old track appliances as can be used, must also be kept in the car-house, and all scrap material piled in the scrap box.

Rule No. 107.—Foremen of Repairs are instructed to see that men detailed to watch bridges, to patrol unsafe or imperfect track, or to perform other duties of day or night watchmen, are supplied with the necessary danger signals and the necessary equipment for performing such duties as are assigned to them. Foremen are instructed to visit these men at such intervals by day or night as will determine whether or not their duties are faithfully performed.

Rule No. 108.—Rail renewals of any magnitude will be made under direct supervision of Roadmaster. The care of such renewed track will immediately devolve upon the Foremen of Repairs, who are instructed to remedy any imperfections in work done by extra gangs.

Rule No. 109.—Any general lift of the main track will be made under direct supervision of the Roadmaster. The care of such newly ballasted track devolves immediately upon the Foremen of Repairs, who are instructed to give it particular attention, as without such attention it will soon get into uneven surface.

Rule No. 110.—A Foreman of Repairs must not be absent from his work except with the consent of his Roadmaster. If unavoidable absence occurs without the knowledge of the Roadmaster, one of the men must be put in temporary charge of the gang until return of the foreman, or appointment of another by the Roadmaster, who must be notified promptly of the foreman's absence and of the name of the man in temporary charge. The pay of Foremen of Repairs will be stopped during their absence, and foreman's rate of pay will be given to the man in charge of the section.

Rule No. 111.—While in the foregoing rules an attempt has been made to set forth the special duties trackmen are to perform, Foremen of track work are intrusted with their positions in the belief that the attendant responsibilities are appreciated, and that the sense of responsibility will be a guide in such contingencies as the rules may not reach. In such unprovided-for contingency as does not demand immediate action, the counsel of the Roadmaster is always to be sought. In such unprovided-for contingency as does demand immediate action, the safe side is always to be taken when there is any ground for doubt.

## SECTION 2.

### CHAPTER IX.

CINCINNATI, NEW ORLEANS & TEXAS PACIFIC RY.

#### SIGNALS.

Conductors, Enginemen, Firemen, Brakemen, Station Agents, Telegraph Operators, Switchmen, Switch-tenders, Track Foremen, Road and Bridge Watchmen, and all other employes whose duties may require them to give signals must provide themselves with the proper appliances, and keep them in good order and always ready for immediate use.

Flags of the proper color must be used by day, and lamps of the proper color by night, or whenever from fog or other cause the day signals cannot be clearly seen.

Red signifies Danger, and is a signal to stop.

Green signifies Caution, and is a signal to go slowly.

White signifies Safety, and is a signal to go on.

Green and white is a signal to be used to stop trains at flag stations for passengers or freight.

Blue is a signal to be used by car inspectors.

An explosive cap or torpedo, placed on the top of the rail, is a signal to be used in addition to the re-

gular signals.

The explosion of one torpedo is a signal to stop immediately; the explosion of two torpedoes is a signal to reduce speed immediately, and look out for a danger signal.

A fusee is an extra danger signal, to be lighted and placed on the track at night, in case of accident or emergency.

A train finding a fusee burning upon the track must come to a stop, and not proceed until it is burned out.

A flag or lamp swung across the track, a hat or any object waved violently by any person on the track, signifies danger, and is a signal to stop.

#### RULES FOR ROADMASTERS.

Roadmasters report to and receive their instructions from the Superintendent.

They have charge of and are responsible for the maintenance in good repair, of the road-bed, culverts, masonry, tracks, sidings, yards, depot-grounds, road-crossings at grade and telegraph line; also for the safe keeping of the right of way and other lands belonging to the railway, and of all materials and supplies on hand.

They must personally inspect and receive all materials, supplies and tools delivered, rigidly enforce the specifications, keep an exact record of the stock on hand, and see that it is properly used. Their requisitions must be addressed to the Purchasing Agent, and approved by the Superintendent.

They have full control and authority over the Track Supervisors, Section Foremen, Trackmen, Watchmen, Laborers, and construction trains on their divisions.

They must supervise and direct their work by constant and careful inspection of the line. They must check their reports and see that all instructions are properly understood and carried out.

They must send to the Superintendent on the first day of each month:

1st. Certified time-rolls of all the men employed on their divisions, made up from the time-books.

2nd. A classification on the proper blanks, of all the work done and material used during the month.

They must send to the Superintendent on the 1st of January, 1st of April, 1st of July and 1st of October, a statement, on the proper blank, showing materials and tools received and used during the preceding quarter, and the quantity of each on hand.

They must, upon receiving notice of an accident, proceed at once to the place, and render all the assistance necessary in clearing the track, and will supervise the work of repairing it.

A full report, giving the cause of the accident and the amount of damage done, must be sent to the Superintendent as soon as possible.

#### INSTRUCTIONS TO SUPERVISORS.

Supervisors report to and receive their instructions from the Roadmaster. They will supervise the work on their respective divisions, and will be held responsible for their safe keeping.

They have immediate charge over the Section Foremen and watchmen. They are authorized to discharge them for neglect of duty, subject to the approval of the Roadmaster.

They must walk over and carefully examine in all its parts, their entire division, every week. They



must spend all their time on the road, see that the Foremen and men fully understand and perform their duties, and that all materials are economically used.

They must examine and correct the time-books of the Foremen on the last day of every month and forward them to the Roadmaster with their certificates. They will countersign all discharge tickets given by the Foremen, and see that the proper memorandum in such cases is made on the time-book. They must see that an inventory of all tools and materials on hand is taken by actual count, the last days of every month, on all the sections of the division, and sent to the Roadmaster. It must check with the account of tools and materials received and used during the month and on hand at the beginning of the month.

They must familiarize themselves with the boundary lines of the right of way and other land owned by the Company on their divisions, and keep out all trespassers.

They must make requisitions for materials and supplies to the Roadmaster, and give him receipts for the same.

They must see that each Foreman is supplied with one switch-key, for which they will take a receipt. When a Foreman leaves the service of the Company, the Supervisor must take an inventory of all tools and material on hand, and report to the Roadmaster all tools and materials not accounted for. They will see that the switch-key is transferred by the departing Foreman to his successor, and if it is not returned, will make a note of it on the discharge ticket.

They will have charge of construction trains while

STANDARD ROAD BED SECTIONS  
C. N. O. & T. P. RY.  
ROCK CUTS

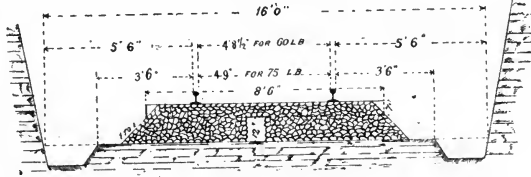

STONE BALLAST

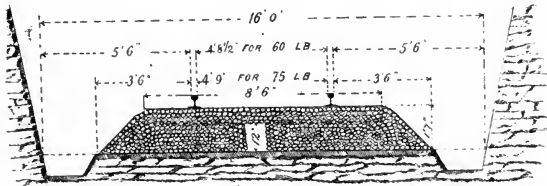

SLAG BALLAST

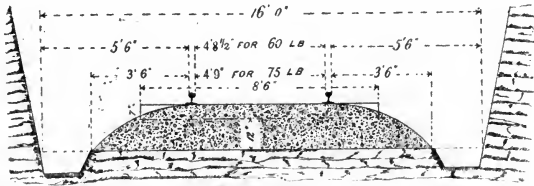

GRAVEL OR EARTH BALLAST

at work on their respective divisions, and will personally see to the proper distribution of all material, and that no time be lost.

They will report at once to the Roadmaster, if an accident occurs on their division, and will proceed immediately to the place of the accident. They will render all the assistance necessary in clearing the track, and, in the absence of the Roadmaster, will supervise the work of repairing it.

They will inquire and examine carefully into the cause of every accident, and write a full report thereof to the Roadmaster.

They must explain all circulars and instructions to the Foremen and Watchmen, see that they understand them correctly, and that they are supplied with time tables and watches. They will compare time with their Foremen as often as practicable.

#### RULES FOR SECTION FOREMEN.

Section Foremen report to and receive their instructions from the Supervisor.

They have charge of the repairs on their respective sections, and will be held responsible for the condition of the road and the watching necessary to insure its safety at all times.

They are required to pass over the whole extent of their section at least twice a week, observe the condition of the main track, sidings, road-bed, bridges, culverts, road-crossing, cattle-guards, etc., and execute such repairs as may be necessary to keep the track in perfect order.

They will engage in all work personally, and see that the laborers employed under them faithfully perform their duty.

They may discharge or suspend from duty any employe under their control, and must not engage, without special order from the Supervisor, more than the regular force allowed.

They will not allow rails, cross-ties and other material to be scattered along the road, but will gather them in regular piles along the track.

They must keep a good watch, and compare time daily, or as often as practicable, with the Supervisor or Conductors.

They must, when at work so as to obstruct the track, invariably display danger signals in both directions.

Anything that interferes with the safe passage of a train is an obstruction. All obstructions must be removed from the track fifteen minutes before the time of a passenger train, and ten minutes before the time of a freight train.

They must always have with them a copy of the current time-table, and know the time of all trains at the point where they are at work.

They must carefully examine the signals carried by trains, and be sure that all following trains have passed, before obstructing the track. Under the telegraph system of working the road a train may be expected at any moment. No notice whatever will in any case be given of the passage of extra trains, and Foremen must always be prepared for them.

They will under no circumstances allow their hand cars to be used unless they accompany it, and then only in accordance with the instructions issued by the Roadmaster and Supervisor. Hand cars must not be used in foggy weather, at night, or on Sundays, ex-

STANDARD  
ROAD BED SECTIONS  
CNO & T. P. RY

EARTH FILLS OR CUTS

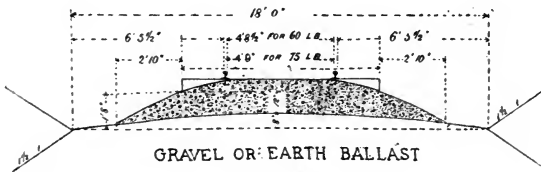
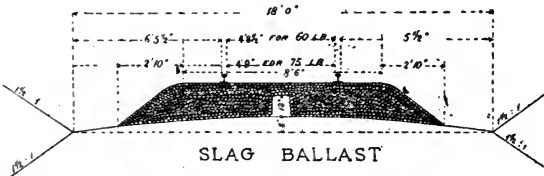
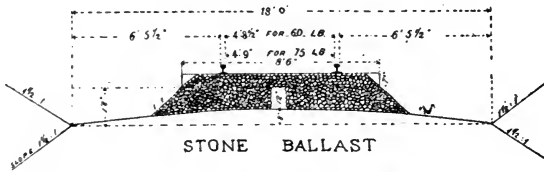

cept in case of absolute necessity. They must not be used for personal purposes.

When not in use, hand cars and trucks must be housed or kept locked and secured in such position that they cannot drift on the main track. Attaching a hand car or a truck car to a train in motion is not allowed under any circumstances. Hand cars running at night, or in dark tunnels, must be provided with a front and back light.

They must see that a clear space of at least seven feet is preserved on either side of the main or side track, and that nothing is piled near sidings within four feet of the rail. They will remove all combustible material from the vicinity of the track, and will not allow rubbish to accumulate near bridges and buildings. They will promptly extinguish any fire that may occur along the line of the road. The right of way must be kept clear of trees, bushes and rubbish, and weeds cut down before seed-time and burned. Station grounds must be kept clean.

All materials dropped from engines and cars, such as draw-bars, car doors, breaks, coupling-pins and links, bolts, nuts, etc., must be picked up, stored away, and shipped as may be directed by the Roadmaster, giving him the number of the train from which it has been dropped.

They must keep telegraph poles in proper position, and trees near the telegraph line must be kept trimmed, to prevent the branches touching the wires during high winds. They will watch the telegraph line, especially after storms, keep the wire up, repair it temporarily, and promptly report any damage to the line.

They shall not allow any person to erect fences or buildings upon or occupy in any way, the right of way without a special permit from the Company.

They will watch the Railway Company's fences and gates, repair them temporarily, and promptly report all damage. Gates at crossings must be kept closed.

They must keep all highway and farm crossings in good repair and unobstructed, and all bridge and trestle-work approaches in good surface and line at all times.

They must frequently visit the watchmen on their sections, and see that they attend to their duty.

They must keep close watch at points where obstructions are likely to occur, and promptly remove them.

They must take every precaution to prevent accidents during heavy storms and rains. All hands must be placed on duty, and every part of the entire section closely watched.

They must keep the road-bed well drained and shaped in accordance with the standard diagrams.

They must keep ditches clean, and of sufficient depth to pass all the water in the heaviest rains without everflow. They must be of a uniform grade, and parallel to the rails throughout the cut, diverging at the lowest end, so as to lead the water away from the slopes of the embankment.

They must put in cross-drains where they will facilitate the drainage.

They must frequently examine and clean the ditches and drains under road-crossings. The openings must be sufficient to pass all the water in the ditches without overflow.

STANDARD SPLIT SWITCH  
 C.N.O. & T.P.R.Y.

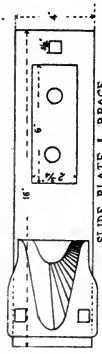

SLIDE PLATE & BRACE

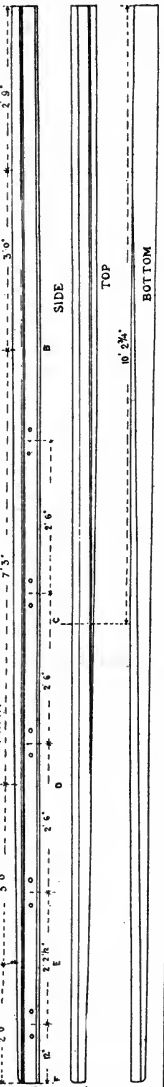
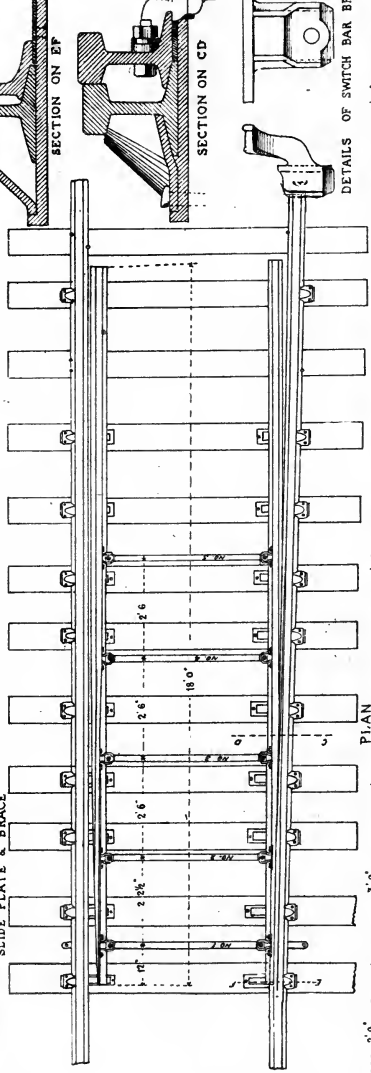
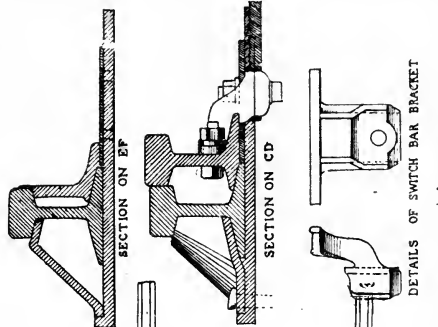



They must keep surface ditches on hillsides open, so as to protect thoroughly the slopes of excavations and embankments. No water must be allowed to stand against the slopes of embankments, except where special provisions have been made for a pond.

They must frequently examine, and keep open and clear of obstructions, all water outlets, ditches, channels, culverts, drains, bridges, etc. They must be examined immediately after every heavy rain, and where a wash has occurred at the lower end of culverts or near the base of piers and abutments, it must be immediately filled up with rock to avoid undermining.

They must pile up and burn the brush and drift taken out of channels, ditches and culverts. The dirt taken out of ditches or slides in cuts must be dumped on the slopes of embankments below grade. It must not be thrown on the road-bed nor on the slopes and edges of cuts.

They must keep cattle-guards well drained, and on true grade and line. Water-tank foundations must be kept well drained.

They must preserve the regular slopes of cuts and banks. No rock or other material must be dug out of the slopes of cuts unless to remove or to avoid a slip or fall. Material borrowed for surfacing or filling must be excavated in a regular shape, and at such a place as to avoid drainage of the borrow-pit into a cut.

They must, when good dry earth or cinder cannot be had to temporarily maintain the track over a slide in embankments, place a longitudinal sill under the ties, and see that it is supported by a sufficient number of

cross sub-sills. When longitudinal sills cannot be procured, cross-ties must be used instead—rock must not be used.

They must put in ballast as shown in the standard diagrams for rock and gravel ballast.

No rock or gravel ballast must be placed on or allowed to remain above the top of the cross-ties.

They must see that rock ballast is of hard and durable limestone, sandstone or shale, that will wear and stand the weather without crushing or disintegrating. It must be broken into pieces which can be passed through a ring two and one-half inches in diameter, and put in from the top to a depth of six inches under the cross ties. Under the depth of six inches the space may be filled up with rock of larger size.

They must, before distributing ballast material, see that the sub-grade is properly prepared, banks extended to the proper width, and ditches in cuts cleaned, so that the ballast will not be wasted or mixed with mud.

They must, when there is no rock ballast available, surface the track with dry earth, according to the standard diagram for gravel ballast.

They must uniformly space the cross-ties between rail-joints (fifteen cross-ties to a rail of thirty feet) and place them at right angles to the rails. The two joints must be as nearly as possible of the same size. They must be spaced according to the standard diagrams of "joints." Every tie must be well tamped, and have full bearing on its entire length.

They must not notch cross ties; if necessary, they



must be adzed to obtain a true and uniform bearing for the the rails.

They must space switch ties according to the standard diagram.

They must not unload rails while the cars are in motion. Skids must be used in unloading, and the rails handled with care to avoid bending or breaking.

They must straighten crooked rails, and properly bend rails for curves, before putting them in the track, as provided in table of ordinates for bending rails on curves.

They must use iron instead of wooden shims, to separate the rails at the joints, when laying the track. The shims must vary in thickness from one-sixteenth to five-sixteenths of an inch, according to the temperature, and must all be removed after the track is laid.

They must see that all the splices have the full number of bolts and spikes, in accordance with the standard diagram, and that all nuts are kept tight. Where the end of the rail is not properly slotted, it must be drilled to fit the splice bar or chair.

They must spike the rails full, with four spikes to each tie, two inside and two outside, in such a manner as to keep the cross ties at right angles with the rails. On sharp curves an additional spike will be put on the outside of the outside rail on each tie. Spikes must be driven where there are slots in the iron; in cold weather, place the spike against the edge of the slot nearest the end of the rail, in hot weather against the other side of the slot. All spikes must be driven home close.

They must see that the clear distance between in-

side of rails is exactly four feet, eight and one-half inches on straight lines and on curves less than two degrees. On curves of two degrees and over, it must be widened as follows:

2 degrees.....	$\frac{1}{8}$ inch.
4 " .....	$\frac{1}{4}$ "
6 " .....	$\frac{3}{8}$ "
8 " .....	$\frac{1}{2}$ "

They must see that the top of both rails, on straight lines, is on a true level at right angles with the track. On curves, the outside rail must be elevated according to the following scale:

1 degree.....	1 inch.
2 " .....	2 "
3 " .....	3 "
4 " .....	4 "
5 " .....	5 "
6 " .....	6 "

Tables will be furnished showing the point at which the elevation for curves should commence. In yards the curves should be laid without elevation.

They must see that the track is in perfect alignment. Every rail must be kept true to the proper line, in a horizontal and vertical direction, and every joint on a true grade. Large rocks must not be used under the cross-ties in surfacing the tracks.

They must lay switches and frogs in accordance with the standard diagram. Every guard-rail opposite frogs must have two wrought-iron brackets. Rails adjoining others of a different height must have a stepchair to bring the top of both rails on the same level.

They must keep switches and frogs clear of snow

and ice. Working parts must be frequently oiled, and must work easily without lost motion. The space between ends of rails at closures and at the "throw-end" of stub-switches must not exceed three-quarters of an inch; the clear space between rail and guard-rail must be two and one-quarter inches.

They must immediately replace broken or otherwise unsafe cross-ties and rails. Every Section Foreman must keep on hand for that purpose at least fifty cross-ties and a half dozen rails. Worn out and broken rails must be gathered up and piled near the car-house. Rotten and broken cross-ties must be burned. Old spikes must be saved and used again if good, otherwise they must be put in the scrap pile.

They are responsible for all tools and materials in their charge. They must keep an exact account of them, and report as directed to the Supervisor. They must not sell nor loan them under any circumstances, and must see that they are not lost or stolen. All damage or loss caused by the negligence of the Foremen will be paid for by them.

They must keep under lock in the tool-house all tools and all portable material, such as bolts, spikes, washers, chairs and light scrap.

They must box up and ship scrap-iron with old rails, on regular freights, as may be directed by the Roadmaster.

They must make requisition in writing to the Supervisor, and give receipts for the material and tools furnished to them.

They will assist, in case of accident, with their whole force at all times, day or night, whether on their own section or not, and work under the direc-

tion of the Conductor until the arrival of the Supervisor or Roadmaster, or other superior officers.

They must report immediately in writing to the Supervisor:

1st. All accidents occurring on their section, with all the facts relating to them.

2nd. All injuries to persons or stock, on the proper blank.

3rd. All damage by fire, giving the cause of the fire, nature and extent of the damage done, exact locality, and the name of the owner of the property damaged.

4th. All failures of trainmen to respect their signals, giving the number of train and engine.

5th. All broken rails, on proper blank.

They must keep a record of the time of the men and the materials used; and must hand or send to the Supervisor, on the first day of every month, the time-books and monthly report of materials and tools. The time-books must be written up every night.

#### INSTRUCTIONS TO CONDUCTORS ON CONSTRUCTION TRAINS.

Conductors on construction trains report to and receive their instructions from the Roadmaster and Supervisor. They must obey all orders for the safe movement of their train from the Train Dispatcher, and observe strictly all time-table rules.

They have charge of all the men employed on their train.

They must take good care of the cars in their train, and see that the brakes, couplings and journal-boxes are kept in good running order. Cars must not be run with defective brakes, wheels or boxes.

They must use skids in unloading steel and iron

rails, frogs and crossings, and handle them with care, to avoid bending or otherwise injuring them. In unloading all material, proper care must be used to avoid injuring it or rolling in down embankments.

They must follow the direction of the Supervisor in regard to the proper distribution of all track and ballast material, so as to avoid unloading more or less than is needed in each place.

They must keep the men employed while waiting on sidings for the right of track, and will not leave the train under any circumstances without permission from the Roadmaster.

They will promptly report to the Train and Roadmaster all accidents to their train, all damage done, and necessary repairs to their cars, caboose, or engine, and all violation of rules by Section Foremen.

They will report weekly, on the proper blank, the work done by their train and the time of their men.

They shall not allow any one, except an officer or properly authorized employe of the Railroad Company, to ride on construction trains.

#### RULES FOR ROAD WATCHMEN.

Road Watchmen report to and receive their instructions from the Section Foremen and Supervisor.

Road Watchmen must carefully examine the rails; observe that switches are set and locked for the main track; see that cars left on sidings fully clear the main track, and that the doors of loaded cars are locked; also examine buildings and other property of the Company, and protect them from theft and fire. Should an obstruction to the track occur, they must at once display danger signals in both directions, and immediately send word, if possible, to the Section



Foreman. Night watchmen, before going off duty, must always notify the Section Foremen of the trains due which have not passed, and of any other matters requiring attention.

#### RULES FOR SWITCH TENDERS.

Switch Tenders report to and receive their instructions from the Supervisor; in yards they are under the direction of the Station or Yard Master.

They are responsible for the safety of trains passing the switches under their charge, and this duty requires the closest attention, as any neglect may cause serious accident.

They must keep the switches locked for the main track, except when passing trains to or from the branch track or siding.

They must always be on the watch for the approaching trains, and give the safety signal if all is right.

They must carefully examine the condition of the switches, keep them clear of snow or other obstructions, and promptly report to the Section Foreman any defects.

When day and night switch tenders are employed, they must not leave their posts until relieved by each other, and the one going off duty must inform the one coming on, of the trains due which have not passed.

#### INSTRUCTIONS TO GENERAL FOREMEN OF BRIDGES AND BUILDINGS.

General Foremen of Bridges and Buildings report to and receive their instructions from the Superintendent.

They have charge of all bridges, viaducts and tres-

ties, including stringer bridges over open culverts and highway bridges. Also of all buildings, including depots, platforms, cattle-pens, engine-houses, shop turn-tables, water-tanks, coal-shutes and track scales. They are responsible for their maintenance in a perfect state of repair and adjustment. They must employ the laborers and mechanics.

They are responsible for the safe keeping and economical use of all material and tools. Their requisitions for the necessary material and tools must be addressed to the Purchasing agent, and approved by the Superintendent.

They must receive and inspect personally all material and tools delivered to them, and reject all such as are not in accordance with specifications.

They must return, on the first day of every month, to the Superintendent, the time rolls for the month preceding, prepared from the time-books of the Foremen of the gangs, and a classification of the labor and material used during the month for each structure.

They must inspect personally, at least every three months, every structure on the line, and report on their general condition to the Superintendent at the end of the quarter.

They must thoroughly inspect and adjust every bridge on the line during the months of April and October of every year. All the rivets of iron bridges must be tried every year, and the loose ones replaced.

They must personally supervise all important work of repair and adjustment, and never allow a gang to leave a structure before being satisfied by personal examination that the work assigned to it has been properly done.

They must instruct watchmen and bridge-tenders on the more important structures as to their special duties, and see that the rules governing the lighting of bridges and the signals for trains and boats are strictly observed.

#### RULES FOR BRIDGE WATCHMEN.

Bridge watchmen report to and receive their instructions from the General Foreman of Bridges and Buildings.

They must keep a supply of water upon the bridges at close intervals, and follow every train with a bucket of water, to extinguish any hot cinders that may have fallen from the engine.

They must keep the coping of the abutments and piers clean, and remove all cumbustible matter from the vicinity of the bridge.

They must frequently examine the timber and iron work of their bridges, and report promptly to the general Foreman any decay or defect.

They must prevent all persons except employes from crossing the bridges.

They must observe the speed of passing trains, and report to the general Foreman any violation of the rules.

When their time is not wholly occupied with watching, they will be required to attend to such other duties as the general Foreman may direct.

## CHAPTER X.

### LOUISVILLE AND NASHVILLE RAILWAY.

#### RULES FOR SECTION FOREMEN.

##### DITCHING.

It is expected that all new ditches will be dug, and all old ditches cleaned for the winter season, before the first day of November of each year.

The direction of ditches must in general be parallel with the rails.

The outlines of ditches must be clearly defined, and in determining their shape and depth at highest point, where the descent of the ditch begins, Section Foremen must be guided by the standard diagram, of which they are furnished a copy. The ditches must be graded so as to pass all water freely during the heaviest rains, and to thoroughly drain the road-bed.

All earth taken from ditches, or elsewhere, must be dumped over the banks, and leveled off so as to allow complete drainage of water from under the cross-ties.

Cross-drains must be put in wherever they are necessary.

Ditches, box-drains, and culverts must be often inspected and cleared of all obstructions. Masonry which has been washed or undermined must receive

prompt attention, and serious cases be reported to the Supervisor or Roadmaster.

Channels and streams for a considerable distance to the right and left of the road must also be frequently examined and cleared of brush, drift and other movable obstructions.

#### BALLAST.

The object of ballast is to get a solid bearing for the cross-ties on a bed of gravel or finely broken rock, uniform throughout, to distribute the applied load over a large surface, to hold the cross-ties firmly in position, to prevent freezing in winter, to carry off water during rains, and to give elasticity to the track. The material in all cases should be clear and hard, so as not to pack in a solid mass, and thus prevent the passage of water from the track.

Before distributing any kind of ballast, whether rock or gravel, the subgrade must be properly prepared, and banks widened so that none of the ballast will be wasted or washed away.

Rock ballast must be broken evenly in pieces, which can be passed through a ring two inches in diameter.

Gravel ballast should be of a clear gravel.

Places where the ballast is very thin, or where there is none at all, the filling should be two inches above the ties at center of track, sloping uniformly to one inch below the bottom at the ends of cross-ties, and thence out to the bottom of ditch. Foremen should take care to leave an inch space under the rails for the passage of water from the track.

There should be a uniform depth of at least twelve inches of gravel ballast under the ties. The space

STANDARD ROAD BED SECTIONS  
L. & N. R. R.

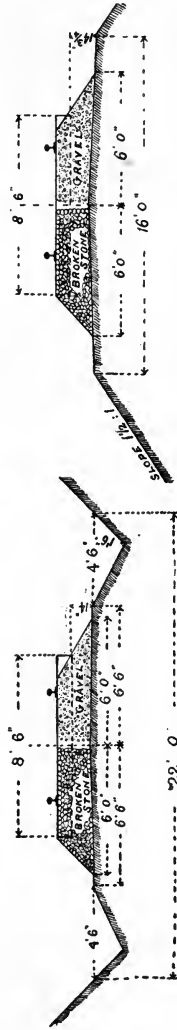

EMBANKMENT

EARTH CUT

between the ties should be filled up evenly with, but never above, the top of ties. From the rail the ballast should be sloped uniformly to subgrade.

There should be a uniform depth of at least twelve inches of clear, fine broken stone under the ties. The space between the ties should be filled up evenly with, but never above, the top of ties. From the ends of the cross-ties the ballast should be sloped evenly at the rate of one to one to subgrade.

Foremen, when preparing subgrade or ballasting track, must be guided by the standard diagram.

When a good bearing is obtained on gravel or finely broken rock, the cross-ties must not be raised until a new bed of gravel or rock is needed.

Between main track and sidings large, coarse stones may be placed at the bottom, but not at the end of cross-ties.

#### CROSS-TIES.

The best quality of cross-ties must be used for the main track, either of post or white oak, yellow pine, or black cypress, perfectly sound and straight. In all cases they must be hewed to the exact thickness, with parallel face throughout, and both bark and sap wood entirely removed.

Sawed cross-ties must only be used where it is impossible to get the required number of hewed ones.

With rock or gravel ballast the size will be 7"×9" by 8½ feet long.

On those parts of the line where ballast is not to be obtained the size of the cross-tie should be 7"×9" by 9 feet long except on the N. O. & M. Division, where they will be 10 feet long.

Where suspended joint with angle splice is used

the proper spacing of ties is ten inches in clear between the edges of the two joint ties, and not more than fourteen inches between the edges of the intermediate ties. Where supported joint is used, the distance in the clear from the joint-tie to either of the shoulder ties is nine inches; the rest of the ties are to be spaced not more than fifteen inches apart.

In all new work the cross-ties must be uniformly spaced, with hearts turned down, and while surfacing old work any previous improper spacing must be corrected. The largest and best ties, if there is any variation in width, are to be placed at joints, and the ties next to the joints should be as nearly as possible of the same size.

Ties made from different kinds of timber should be laid in track separately from each other.

The ends of all cross-ties must be lined true on the east side of the track, except on curves, where the inside of curve shall be the line side for ties, and on double track, where ties will be lined to the outside of both tracks.

Cross-ties should never be notched, but if necessary must be adzed, in order to obtain a true and uniform bearing for the base of the rail.

In order to prevent foul joints in switches, and to protect switch-rods in cases of derailment, all rods for stub switches must, in every case, be confined between two cross-ties laid three inches apart.

Every foreman will keep a supply of wooden spikes in his hand car house and with his gang. While at work the invariable rule must be to plug every hole wherever a spike is drawn.

Each Section Foreman will be supplied with wooden



STANDARD RAIL SECTION & JOINT    LOUISVILLE & NASHVILLE RAIL ROAD CO

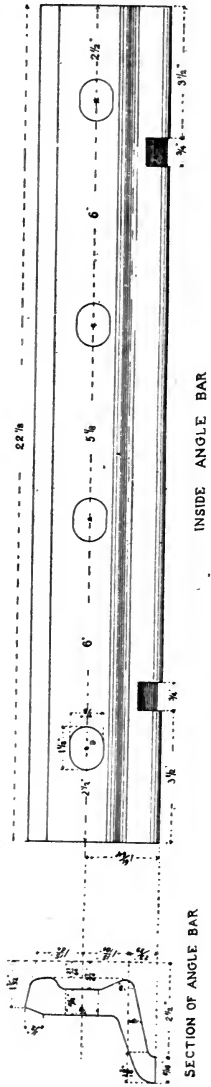
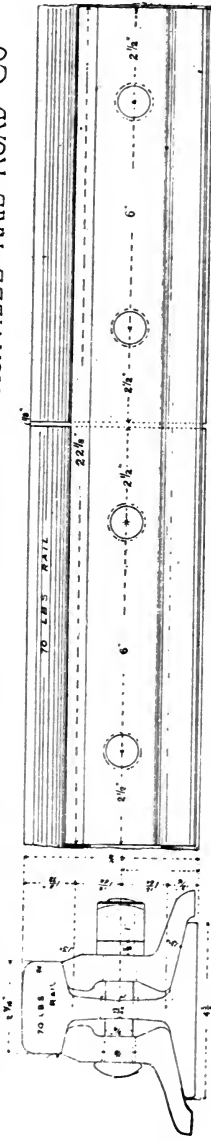

spikes made by machinery, and supervisors will see that none are without them. In case the stock is exhausted, and new ones do not arrive, foremen will have them made by hand when no other work can be done.

When laying new steel all old decayed ties must be removed and new ones substituted. All ties must be put in at right angle to the track, and no tie should be put in obliquely to suit irregular joints. The track must be surfaced so that the new rail will not be battered or bent.

#### RAILS.

Steel or iron rails must never be unloaded while cars are in motion. The distribution of bars over the section must be made carefully.

All crooked and bent rails be carefully straightened before they are laid in the track.

All rails for curves must be bent before they are laid in the track.

Steel rails will be neither punched nor slotted under any circumstances. Foremen must use drills in making holes for bolts whenever a closure is made. No joint must permanently remain without the full number of four bolts to each joint.

In laying new steel rails the old rails that are good enough to repair the track must be used again where the same pattern of rail has been laid, so that each kind of steel or iron may be kept by itself. If not needed for immediate use, it will be neatly stored at convenient places, and not left lying in the ditches.

Iron shims, to separate the rails at the joints, must always be used in laying track. Wooden chips will not answer, and must not be used. The proper thick

ness for coldest weather is five-sixteenths of an inch; during spring and fall use one-eighth of an inch, and in the very hottest weather one-sixteenth of an inch should be allowed; the rails supposed to be of uniform length.

This rule must be carefully observed, as many serious accidents have occurred by neglecting this simple method of making proper allowance for expansion. Any rail or fastening is weak compared with the powerful expansive force of the sun's rays.

The ends of the rails in suspended joints must be exactly midway between the two joint-ties, and the joint on the line of one rail must be even with the center of the opposite rail. In other words, the track is to be laid with broken joints.

In supported joints the joint must be exactly over the center of the cross-tie underneath, and the track laid with broken joints.

All rails adjoining others of a different height must have a step-chair to bring the top of the rails to the same level, and be connected with offset splices.

All rails joined to others of different punching must have splices made to fit the different punching.

The splices must be properly put on with the full number of bolts, nuts, and washers, or nut locks. Nuts must always be kept screwed up tight, and must be put on with the flat side turned in and resting on washer.

Short rails are admissible only as a temporary expedient on tangents and on inside of curves, but never, under any circumstances, on the out side of curves. No piece shorter than fifteen feet should be used at all.

All rails must be spiked full on both main and side tracks—four spikes to each tie—and every spike must be driven home close, with a full hold upon the rail. Spikes should be driven perpendicularly, as the under side of the head of spike is formed with the view of driving it straight, and no spiker must lean spike inward or outward to suit the swing of his maul.

In suspended joints with flange splice the inside splice-bar is slotted, and spikes must be driven in slots. But the outside splice-bar is not slotted, and spikes must be driven close to the rail, and at each end of the splice bar, taking a firm hold of the base of the rail. The splice is thus closely confined between the spikes driven into the joint-ties. This rule is not to be observed, however, on bridges or trestles, where spikes must never be placed in the slots or at the ends of splice-bars.

When new steel is laid it must be perfectly lined. No imperfection in the alignment will be permitted.

On all straight lines the top of the rails must be level transversely.

On all curves the outer rail must be elevated. The amount of this elevation is governed by the degree of curvature, the speed of the train, and local conditions which regulate the traffic. As an illustration, a 6 degree curve at the top of a grade should have less elevation than a 6 degree curve at the foot of a grade. On double track the track on which trains run against grade should have less elevation than the track which runs with the grade, etc.

In future Foremen will elevate curves in accordance with the following table, adapting the elevation as a

rule to a speed of 35 miles per hour, varying, however, in accordance with local conditions under authority from the Supervisor or Roadmaster:

DEGREE OF CURVE.	SPEED IN MILES PER HOUR.				
	25	30	35	40	45
1	$\frac{1}{2}$ inch	$\frac{5}{8}$ inch	$\frac{7}{8}$ inch	$1\frac{1}{8}$ inch	$1\frac{3}{8}$ inch
2	$\frac{7}{8}$ "	$1\frac{1}{4}$ "	$1\frac{3}{4}$ "	$2\frac{1}{4}$ "	$2\frac{3}{4}$ "
3	$1\frac{1}{4}$ "	$1\frac{7}{8}$ "	$2\frac{1}{2}$ "	$3\frac{1}{4}$ "	$4\frac{1}{4}$ "
4	$1\frac{3}{4}$ "	$2\frac{1}{2}$ "	$3\frac{3}{8}$ "	$4\frac{3}{8}$ "	$5\frac{1}{2}$ "
5	$2\frac{1}{8}$ "	$3\frac{1}{8}$ "	$4\frac{1}{4}$ "	$5\frac{1}{2}$ "	
6	$2\frac{5}{8}$ "	$3\frac{3}{4}$ "	$5\frac{1}{2}$ "	6 "	
7	3 "	$4\frac{1}{4}$ "	$5\frac{7}{8}$ "		
8	$3\frac{1}{2}$ "	$4\frac{7}{8}$ "			
9	$3\frac{7}{8}$ "	$5\frac{1}{2}$ "			
10	$4\frac{1}{4}$ "	6			
11	$4\frac{5}{8}$ "				
12	$5\frac{7}{8}$ "				

NOTE.—No curve to be elevated more than 6 inches.

To determine the degree of a curve Foremen should have with them at all times a cord 62 feet in length, with a small knot exactly in the middle. When this cord is stretched so that each end touches to gauge side of the outer rail of a curve, each inch of distance from the knot at the center to the gauge side of the rail represents a degree of curve. Thus, if the distance is two inches, the curve is a two-degree curve; if six inches, a six-degree curve.

The elevation of the beginning of a simple curve should be as great as at any other part of it. To insure smooth running, especially for trains at fast speed the elevation must commence back on the straight line, and continue gradually until the curve is reached. The following table shows how far from the beginning of the curve the elevation should commence:

STANDARD SPLIT SWITCH & GUARD RAILS L. & N. R. R. CO.

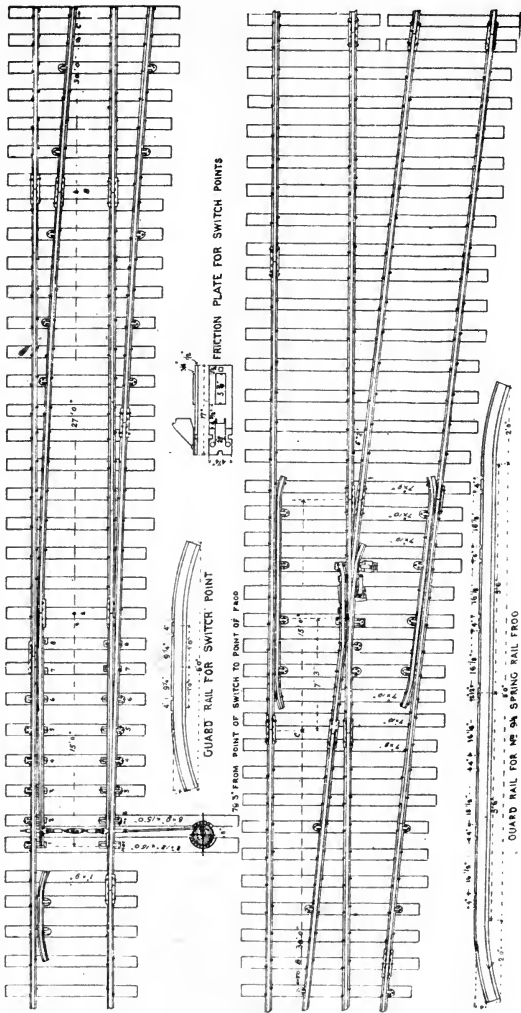

For 1 inch elevation go back on straight line	60 feet.
“ 2 “ “ “ “ “	120 “
“ 3 “ “ “ “ “	180 “

and so on at the rate of 60 feet for each inch of elevation. Where the elevation is in fractions of an inch the distance to be measured back will of course be proportional. For instance, the distance to be measured back when the elevation is  $1\frac{1}{8}$  inches is  $67\frac{1}{2}$  feet.

Where transition or spiral curves are used the Foreman will be furnished with a diagram showing the exact amount of elevation for each curve.

Track-gauges in the possession of Foremen will from time to time be compared by Roadmaster and Supervisors with the standard in the engineer's office.

The track must be laid to a perfect gauge on straight lines, and also on curves of 4 degrees and under. For curves over 4 degrees and under 7 degrees the gauge should be one-quarter of an inch wide; above that, and under 10 degrees, one-half inch wide, and over 10 degrees the gauge should be widened one-quarter of an inch for each additional  $2\frac{1}{2}$  degrees of curvature.

On main line rail braces should be used on curves of four degrees and over as follows:

On 4° degree curve,	2 braces on every fifth tie.
“ 5° “ “ “ “ “	fourth tie.
“ 6° “ “ “ “ “	third tie.

the braces being used also in pairs, two on one tie, and on the outside of the rails.

#### SWITCHES.

Switches must be laid in strict conformity with standard plans:

Split switches will be used on all sidings turning out from the main track, except where turnouts are from the outside of curves, in which case Wharton switches will be used. As a rule, where sidings turn out from side tracks, and in small yards, stub switches may be used.

No 9½ spring rail frogs will be used in the main track except in yards, or at other places where switch engines are constantly employed. In such cases stiff frogs will be used.

In yards and other places where tracks diverge from side tracks, No. 7 stiff frogs will always be used when practicable.

Where rail of a heavier pattern is used in the main track than in the side track, the main line pattern must extend at least as far on the side-track as the switch extends. In other words, compromise chairs and splices must not be placed on switch ties.

The most careful attention should be given to switches by foremen and track-walkers. They should work easily, and have no lost motion. The tongue-rails should fit snugly up to the stock-rail. The timbers should be sound, well lined and properly spaced. Guard-rails in main tracks should be used in front of splits and opposite frogs in strict accordance with the standard plan.

In yards, where practicable, guard-rails will be omitted on account of danger to switchmen. When used they must invariably be filled with cinders and screenings.

High switch-stands will be used in turnouts from the main track. Where two stands are close together on the same side of the track the target-rod of one





should be shortened, so that engine-men can plainly see both lights.

Safety switches must be used on all sidings when the grade descends toward the main track.

Targets must be exactly at right angle to the track, and the color kept clean and bright. Lamps must be cleaned and filled every day; they must be lit by sun-down and not put out until sunrise.

Track-walkers must never pass a switch without examining it carefully to see that all bolts are tight and in good order, and keeper-pins (if there be any) in place.

The head blocks of switches must be kept firmly tamped at all times, or lamps will be shaken out.

Foremen must report promptly by telegraph to the Superintendent and Roadmaster when new switches are put in, when switches are spiked down, or when switches which have been out of order are repaired and ready for use.

#### WATCHING.

During heavy rains and storms Section Foremen must take every precaution to prevent accidents; all hands must be placed on duty, and every part of the section watched. They must be supplied with the necessary signals and torpedoes to stop trains. After every freshet culverts and drains must be inspected, and all drift-wood immediately removed.

The importance of the track walker is next to that of the Foreman. The Foreman will send an experienced and reliable man every morning to walk over the whole section. This man must start on his trip of inspection in a direction opposite to that in which

the section force goes out. The track-walker should carry with him a few bolts and spikes, a wrench and a tamping pick. He is expected to put in missing bolts, tighten loose nuts, replace broken spikes, and raise low joints; to examine carefully all joints and rails, and to look for broken rails and burned joint ties, and to examine all bridges and trestles where there is no watchman, and switches, switch-locks and frogs closely. He must look for and pick up all spikes, bolts, nuts, washers, etc., and put them where Foremen can get them. He must look for and put out all fires that are burning, and put up all fences that are down, close farm gates, and do everything he can to prevent stock from wandering on the track. He must be provided with the proper flags, torpedoes, etc., for use in stopping trains, and must be instructed how to use them.

Foremen are required to pass over the whole of their sections at least twice every week, between the first day of April and the first day of November, and every alternate day between the first of November and the first of April, and to observe particularly the condition of the main track, sidings, culverts, cattle guards, bridges, and fences. They must always have with them the latest time table, for the movement of trains, and must understand its use, and know the time of all trains at whatever point they may stop to work.

Foremen of repair gangs, as well as bridgemen and construction trains, must never obstruct the track in any way whatever without protecting themselves with the proper signals.

Red signifies danger, and is a signal to stop trains, and must be used for no other purpose.

Green signifies caution, and is a signal to run slowly. Green signals will be used when the track is unsafe for trains at full speed, but in sufficiently good condition for trains to run slowly over.

An explosive cap or torpedo, placed on the top of the rail, is a signal to be used in addition to the regular signals. The explosion of one torpedoe is a signal to stop immediately. The explosion of two torpedoes is a signal to reduce speed immediately. These signals will be used by Section Foremen when necessary.

Special trains or engines may pass over the road at any time without previous notice, and Foremen must be prepared for them. Anything that interferes with a safe passage of trains is an obstruction, and must not be attempted without using the proper precaution. Employes are permitted to use the track for making repairs to within twenty minutes of the time of passenger trains, but always under cover of the proper signal.

Signals must be placed at least fifteen telegraph poles in both direction from place where track is obstructed, or unsafe for fast running of trains. They must be firmly and conspicuously planted in the ground on the side of enginemen of approaching trains. On heavy grades and sharp curves the distance will be increased to allow trainmen more time in stopping trains. In all cases the staff with horizontal arm must be used, so as to display fully the whole flag even in the calmest weather.

If danger signals be required, a red flag by day and a red lamp by night will be used. Under no circumstances must a red signal be left without a man in



charge. This man in daylight should be provided with track tools, in order that he may work in the near vicinity of the flag.

If cautionary signal be required, a green flag by day and a green lamp by night will be used.

Foremen must carefully observe the signals carried by trains, and be sure that all following trains, running on the same schedule, have passed before obstructing the track. They must also watch all passing trains closely for messages that may be thrown off.

Section Foremen must notice whether special watchmen attend to their duties by frequently visiting them at night, and reporting them if found negligent.

Watchmen must be provided with the proper lamps, flags, and torpedoes for stopping trains and must be instructed how to use them.

All sound and unsound trees which are in danger of falling on the track during high winds, should be cut down. If not on the company's property, the owner of the land should be consulted, and if he objects the facts should be reported and instructions asked.

Whenever wood, cross-ties, lumber, or other material is piled along the track, notice must be taken by Section Foremen that it is at least seven feet out from the rail. If found nearer it must be at once removed to the proper distance. Signals or mile posts must not be placed nearer the rail than six feet.

Every Foreman will engage in his work personally,

and must require all laborers under him to faithfully perform their duties.

#### MATERIAL.

Section Foremen, as well as Supervisors and Roadmasters, will make requisitions in writing for all necessary material, such as cross-ties, spikes, chairs splices, bolts, nuts, washers, and tools, and will hand them to their immediate superior officer.

Section Foremen will be held strictly responsible for all tools and material left in their charge. They must report promptly any loss of the same to their immediate superior officer. They will not be permitted to lend the tools or material of the company to any person under any circumstances.

All material new or old, must be kept locked up in tool houses as far as possible, or under the eye of the Section Foreman.

Section Foremen will have care of and be responsible for all loose property of the company, such as wood, ties, lumber, scrap iron, etc., and will notice that none of it is lost or stolen.

All spikes in the track, must be carefully drawn, with the view to use them again. No old ties are to be thrown aside with spikes left in them. All old spikes which can not be used again must be carefully gathered up and well boxed, or put in kegs securely fastened. The Section Foremen will ship them by regular freight, with bill of lading, to headquarters, as may be directed for each division of the road.

Each Foreman is charged with the amount of new spikes furnished him, and the accounts at the end of

every six months should show nearly the same amount of new spikes furnished and old ones returned, provided no new tracks are laid.

In uncoupling rail no tight nuts or bolts must be knocked off with the hammer. They must be oiled and properly taken off with wrench.

All scrap rail should be piled up at side tracks ready for shipment by freight. All the iron on hand for the repairs of tracks must be well assorted, and neatly piled.

#### ACCIDENTS.

In case of accidents to trains the nearest Section Foreman will at once take his whole force to the assistance of the train, even if it is not on his own section. Conductors always send for assistance to the nearest section-house, and section men must obey at all times, night or day, any call from conductors or engineers of trains in distress. If notified of broken rails on adjoining sections, they will at once go and make the track safe for passage of trains.

When assisting a train delayed by an accident Section Foremen will act under the direction of the conductor until the arrival of the Supervisor or Roadmaster.

In case of a wreck, foremen must at once appoint the necessary watchmen to prevent freight or company's property from being stolen. Said watchmen are to remain on duty until the goods are removed.

In case of injury to any person, caused by the operation of the road, an immediate report must be made by the Section Foreman to the Supervisor or Road-



STANDARD ROAD CROSSING  
E & N. R. R.

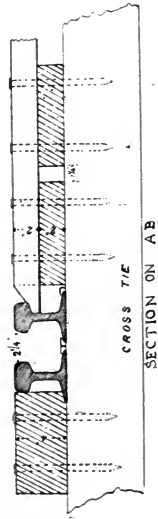
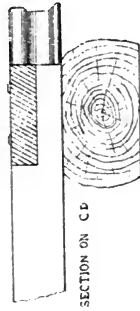
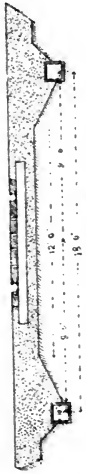
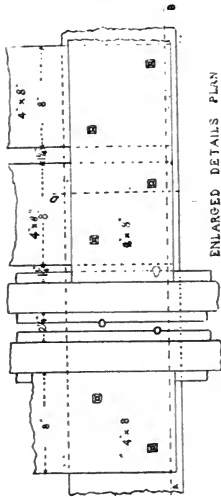

master, so that the office whose duty it is to take action in such matters can be notified.

#### HAND AND PUSH-CARS.

When hand or push-cars are not in actual use they must be lifted off the track, and placed entirely clear of passing trains. When not within sight of the men they must be locked, and no car shall be used without the knowledge of the Section Foreman.

In no case is it allowed to attach a hand or push-car to a train in motion.

Rails must never be carried on hand-cars, except in case of an emergency.

Great care must be exercised when it is necessary to use hand or push-cars during foggy weather or in the night. Foremen must always accompany the car.

Push-cars must not be run on main track, except under protection of red flags.

No car will be run at night or on Sunday, except in case of actual necessity. All damages to cars, or to company's material or tools in charge of the Foreman, caused by his own neglect, will be paid for by him. Cars must be kept under lock and key and in no case be used for personal purposes.

#### WATER STATIONS DURING FREEZING WEATHER.

During extreme cold weather, when water-stations are likely to suffer by frost, Foremen on whose section a water-station is located, if called upon by the pumper, will send a man to the tank who shall keep up a fire in the stove during the night, and see that everything is in working order during the absence of the pumper. The Section Foreman will put the ex-

pense of this in his time-book, properly classified, and charged to the respective water-station.

#### POLICING.

Too much stress can not be laid with Foremen upon the necessity of preserving a neat and orderly appearance about their sections. A few hours work each week devoted to cleaning up and putting things in order around section houses, station grounds, etc., will give an appearance of order and attention to his duties on the part of a Foreman that will meet with quick appreciation from his superior officers.

Foremen will make themselves familiar with all the boundary lines of the company's property on their respective sections, and see that no person encroaches upon them.

No person is allowed to erect fences and buildings or otherwise occupy the company's grounds without special permit. Any such action must be reported in a written statement to the Supervisor or Roadmaster, giving the name and residence of the party, and all facts bearing upon the subject.

Cross-ties partly burned by fire dropped from engines must be at once replaced.

All the old ties which are taken from the track must be gathered up at the close of each day, and put in some convenient place for burning, fuel, or fencing. When stumps are close by pile around them, and thus get rid of both at one burning.

Foremen will pay particular attention to the telegraph wires, and see that they are not obstructed or down on the ground. If broken or crossed they must

be repaired at once in a temporary manner, and notice sent to the nearest office by special messenger.

All highway and farm crossings must be kept in the best possible repair, and not obstructed by any material. Foremen are specially directed not to leave hand or repair cars unnecessarily on crossings.

All side tracks must be maintained in good order, and the platform and station grounds should always present a cleanly appearance.

All switch signals must be kept bright and in good order.

Weeds, bushes, trees and grass growing on the right of way must be cut down close to the ground over the entire section before seed time. They must be collected and burned promptly during the month of August. In burning rubbish so gathered, care is to be taken that the adjoining fences are not injured by fire.

The sod line should be neatly and accurately cut seven feet from and parallel with the rail on each side of the track.

Section forces must pick up each day any material dropped from engines and cars, such as draw bars, car doors, brakes, bolts, nuts, or other property belonging to the company, and take it to the tool-house, from whence it will be shipped as directed.

All packages or articles of freight that may fall from any train must be taken to the nearest station agent, who will forward to the Superintendent.

Foremen must pay attention to the condition of the wood yards on their respective sections. They must see that the wood-platforms are properly filled for the

trains; that no pieces are left in the ditches; and that the yards are neat and clean.

#### REPORTS.

The time-books must be written up every night of of the day which has closed. The time of Foremen and men must be given for each kind of work under the proper heading in the book.

Time books, as well as monthly reports of all tools and material on hand, whether good or bad, and reports of new tools and materials received during the month, must be handed by the Foreman to his superior officer on the last day of each month, together with requisition for such new tools and material as may be required.

When an employe is discharged the Foreman will make out and hand to him a discharge check for his time, and write on the page of the time book containing the employe's name: "Discharged, and time given."

Section Foremen will promptly report in writing to their immediate superior officer, any failure of trainmen to respect their signals, giving the number of train and engine.

Section Foremen must report all freight trains which they may notice passing by at a higher speed than schedule time allows; and also report promptly to their immediate superior any other carelessness or misdemeanor of trainmen.

They will report all accidents occurring on their sections by telegraph to the Roadmaster and Superintendent, as soon as possible, according to special instructions, giving in brief the nature of the accident.

STANDARD STREET CROSSING  
L. & N. R. R.

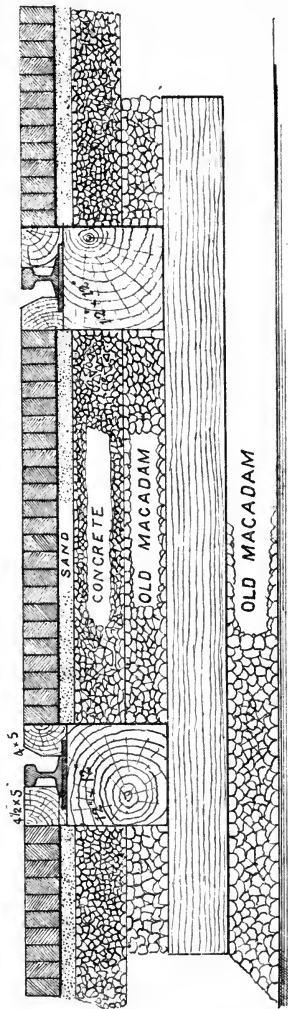

SECTION OF STREET CROSSING LOUISVILLE KENTUCKY

The telegram must be followed by a full report on the proper blank, and given or sent by the Foreman to his superior officer.

In cases of very serious accidents, requiring a collection of forces and material, Foremen must immediately report by dispatch in full to both the Superintendent and Roadmaster.

Foremen will promptly report all horses, cattle, sheep and hogs killed or crippled by a train on their sections, on proper blanks furnished them.

An immediate report in writing must be made by the Section Foreman to his superior officer of all fences burnt, or other property and material—whether belonging to the company or to private parties—destroyed by fire from the sparks of passing locomotives. The report should state the location, the exact damage done, the lineal feet of fencing destroyed, if any, and the owner of the property.

#### GENERAL RULES.

Section Foremen must remember that while their particular duty is to look after their own sections, to keep them in safe running order, and to steadily improve their condition, they must not fail to do everything to make the road secure; and to prevent accidents, even though they may have to perform the duty of some other man.

Section Foremen are not at liberty to excuse any neglect of their men in the performance of duty, but are required to discharge them in all cases upon the first evidence of unfaithfulness.

Section Foremen may discharge or suspend from duty any employe under their control.

They must not engage more than the regular force allowed.

Employes of this department who leave the service of the company of their own accord will not receive pay for their service until the regular pay-day in the month following that in which they leave the service. Foremen must so inform men before engaging them.

Each Foreman will be provided with one switch key, for which a receipt will be taken. In case he does not return key when leaving the service of the company, fifty cents will be deducted from the amount due him. The same deduction will be made should the Foreman lose his key and still continue in the service.

Trackmen must not wear red shirts as outer garments, as they may be mistaken for danger signals.

Foremen must compare their watches at least each alternate day, and daily when practicable, with the watches of conductors, enginemen, or supervisors. Once in three months Foremen should endeavor to send their watches to the Division Inspector for examination, or, at least, note carefully the variation of their watches on the pocket rate card (which will be supplied by the supervisor upon request), and forward it to the Inspector.

#### FOR CONDUCTORS OF CONSTRUCTION TRAINS.

The conductors of all work trains are appointed by the Roadmaster, subject to the approval of the Division Superintendent, and are responsible for the safety and proper care of their trains, for the good conduct of all the men employed thereon, and for any material intrusted to their care.



They must obey all orders for the safe movement of their trains from the train dispatcher or division superintendent, and they must faithfully observe all time-card rules.

Any violation of the existing time-card rules is at once followed by suspension from the charge of directing the movement of the train, but the conductor will still remain in charge of all the men, and will be responsible for the proper execution of all construction work, until investigations are made, and he is reinstated or dismissed. In such cases the division superintendent will immediately appoint a man to have temporary charge of the safe movement of the train only until the case is decided, and a new appointment made by the Roadmaster. Under no circumstances should a delay in the construction work occur.

No one except an officer of the road is permitted to ride on construction trains.

Conductors of all work trains must see that all the ditching and boarding-cars are in good running order; that the boarding-cars are neat and clean at all times; and that good substantial food is furnished to the men.

They must study the rules and instructions issued to all track and bridgemen, and fully familiarize themselves with all kinds of work pertaining to the maintenance of track.

Ditches must be cut as per direction to Section Foremen.

The greatest care must be taken in unloading material. Steel and iron rails must never be unloaded

while cars are in motion; and skids must be used to prevent bending and breaking the rails. In unloading new rail, car initial and number must be written down in memorandum book, and number and lengths of all rail on each car carefully recorded and reported.

Conductors must always notify the proper supervisor when ordered by the Roadmaster to distribute material, such as cross-ties, iron and ballast, so that the supervisor can in all cases be with the train when it is distributing material on his own division.

Conductors must not give or sell any employe wood or material without the proper order from the Roadmaster.

Conductors must make such monthly reports as are directed.

On Monday of each week they must send to the Roadmaster a written report of all the delays experienced during the past week on account of not receiving orders promptly, or from other causes.

From the first day of December to the first day of March they must always spend the night at a telegraph station; and observe the same rule during the rest of the year, when it can be done without losing time.

Whenever conductors of construction trains have delays at a station, whether in waiting for orders or from other causes, they must keep the whole force employed. There is no place on the line where some kind of work is not needed, and no time will be wasted by a good conductor. When delays occur, the men should be set to work on sidings at cleaning

station grounds, weeding, ditching, ballasting, or whatever other work is mostly needed.

In case of accidents to trains they will hasten to give assistance as soon as called upon by the division superintendent or train dispatcher, and they must do everything in their power to facilitate the quick and safe passage of trains. They will take full charge of any wreck until the arrival of the Supervisor or Roadmaster. When wrecked cars are burned the numbers and initials must be carefully noted and reported to the Roadmaster.

Conductors must report at once in writing, to Roadmasters whenever inadequate motive power or incompetent enginemen are furnished them.

Whenever it is necessary for them to leave the train they must ask permission to do so from the Roadmaster, and also notify the train dispatcher, so that in case of accident the Supervisor or Roadmaster can take the train or make another appointment. Under no circumstances will they leave their men without permission from the Roadmaster.

#### FOR TRACK SUPERVISORS.

Supervisors are held responsible for the safe-keeping of their divisions, and will have immediate charge of all the Foremen of sections and road watchmen on their respective divisions, and are authorized to discharge any employe governed by these instructions for neglect of duty. They will, however, in case an accident results from the negligence of an employe, report the case to Roadmaster.

They will carefully see that the time of the men

and the rate of pay are correctly reported and properly classified on the time-books.

They will note the time each Foreman is absent from work, and make proper deductions on time-books.

On the last day of each month they will go over the entire division, collect time books, make notes and explanations, approve each man's time by indorsing his own name on the page allotted to it, and forward the time-books to the proper person as may be directed.

They will countersign all discharge tickets given by their Foremen, and see that the proper memorandum in such cases is made in the time-book.

Each supervisor must walk over a portion of his division every day, covering his whole division once a month. Passenger trains must be used by them only in case of necessity.

They must spend all their time on the road, and see that Foremen and laborers fully understand and perform their duties.

They must pay strict attention to the proper adjustment and alignment of the track, and to the economical use of all material.

They must personally observe the alignment and super-elevation of outer rail on curves and must instruct Foremen as to the super-elevation of every curve on each section of their respective division.

They must see that Foremen show great precision in the use of iron shims in laying rail. It must be constantly borne in mind that too small a space between the ends of rails for expansion is a source of

great danger, and that at the same time too great a space is ruinious to good riding.

They should frequently examine the track gauges, and compare with the standard.

They should be thoroughly posted in regard to the right of way and other land boundaries on their respective divisions, and keep constant watch against encroachment by adjoining occupants.

They should keep a memorandum of the number of men at work on each section, and compare with the reports returned by the Section Foremen.

All requisitions for materials, such as cross-ties, spikes, chairs, splices, bolts, nuts, washers, tools, etc., must be made in writing to the Roadmaster, and sent in on the first day of each month.

When material is ready for delivery to the Section Foreman, the supervisor must make out a written statement of the amount received and of its condition, and send the same to the Roadmaster as soon as possible.

Supervisors will see that each Foreman is supplied with one switch-key and gives a written receipt for the same.

In case the key is not returned when the Foreman leaves the service of the company, fifty cents will be deducted from the amount then due the Foreman. Supervisors will make the proper remark respecting the switch-key on the discharge ticket.

When the Foreman is discharged or leaves the service of the company, supervisors must make out a correct list of tools on hand. They will note all tools

missing or not accounted for, and send such reports at once to the Roadmaster, so that the proper settlement can be made. In all such cases they will write on the discharge tickets "tools not accounted for as per report."

They will have charge and control of all construction trains while at work on their respective divisions, and will personally see to the proper distribution of all material for the use of their Foremen. They must always be with construction trains when distributing material on their division, especially when unloading steel rails, and see that no time is lost in so doing.

In case of accidents on their divisions they will send the reports of the Section Foremen certified, corrected by themselves, to the Roadmaster. On being notified of a wreck they will immediately proceed to it and take charge of all trackmen. They will superintend the work of clearing the wreck in the absence of the Roadmaster.

All printed circulars, instructions, and orders to Section Foremen or watchmen must be delivered in person by the supervisor who will read and explain the same to all his Foremen.

Supervisors of track must see that all the rules for signals, with flags and torpedoes, and other instructions are understood and obeyed by every man in their employ; and that all their foremen and watchmen are supplied with time-tables and watches while on duty. They must have their watches inspected, once in three months, if practicable, keep stand-

dard time, and compare time with their Foremen as often as possible.

Where there is no supervisor of track the above duties will be executed by the Roadmaster in addition to the following:

#### FOR ROADMASTERS.

Roadmasters must pass over a part of their division every day, and over their whole division—walking or on a hand-car or velocipede, at slow speed—once every month. They must see that the track and culverts are in safe condition and in good order. They must require supervisors of track, Foremen, and all employes in their charge to make proper use of material furnished for the repair and good maintenance of road-bed, track, and other portions of the railroad committed to their charge.

Roadmasters as well as supervisors of track, conductors of construction trains, and Section Foremen, must at all times be ready, both night and day, to render any assistance that may be called for by the train dispatcher, master of trains, or division superintendent, in case of accident or detention to trains, and to provide facilities for the safe and quick movement of trains.

On receiving notice of a wreck or accident, they must at once proceed to the place, and take full charge and control of all track forces and construction trains; put the track in condition for the safe passage of trains, and remove the wreck with the quickest possible dispatch. When cars are burned, they must note the number and initials of the cars

so destroyed and send a written report of the same to their superior officer.

In all cases, a written report in full, giving the amount of damage done, must be sent in.

They must inquire carefully in regard to every accident that may occur upon the road, to ascertain the cause of it, and they will write a full report thereof to their superior officer.

They must reserve such material as broken rails, cross-ties, axles, or other debris which may be of value in determining fully the cause of the accident.

Roadmasters must have full charge of all construction trains on their divisions; lay out the work for them on each subdivision as may be required. They must also see that the ditching cars are kept in good order, and that boarding cars are clean and tidy. They will often examine into the boarding arrangements of all their men, and see that wholesome and sufficient food is furnished them.

It is also the duty of the Roadmaster to see that each construction train is supplied with a good engine and competent engineer. In case insufficient motive power is furnished to his train he must at once report the matter to his superior officer. Construction trains, being very expensive, require the best kind of motive power for their economical working.

Roadmasters must personally receive all material contracted to be delivered on their divisions, such as cross-ties, wood, and ballast. They must in all cases enforce strictly the printed specifications.



Cross-ties must be raised from the ground, and symmetrically cross piled, not higher than six feet, so that each tie can be properly inspected and marked with hammer and brush.

When wood is taken up the measurement is to be put down in the book, after making proper deductions for undersize, bad piling or other deficiencies. All wood received is to be cross-piled on the top, and each rick is to be profusely marked all around with lampblack or whitewash. Marking in this manner will prevent dishonest parties from disturbing the pile and appropriating wood already paid for, to repile again for measurement.

Ricks should never be over sixty feet in length, and six feet high; a space of five feet is to be left between the ricks, in order to give free access all around in inspecting and marking it.

In receiving rock or gravel ballast, Roadmasters must see that the stone is piled closely, and that the ballast is of the proper size and quality as contracted for. Deductions must be made for loose piling or other deficiencies.

Roadmasters must see that nothing is piled nearer than six feet from the rail of main track and sidings.

They will keep a general oversight of all work performed on their divisions by contractors or bridge carpenters, lest anything should interfere with the safety of the track.

They must make such monthly reports to their superior officer as may be directed.

They are authorized to discharge any supervisor

of track, conductor of construction train, Section Foreman, road watchman, or other subordinate for neglect of duty; but should an accident result from such negligence they will suspend him from duty, and report the case to their superior officer, so that an investigation can be made.

They must make themselves acquainted with all the instructions issued for the government of trains and trainmen, and must report to their superior officer in writing any neglect of duty or violation of rules, that may come under their notice.

They must take pains to instruct supervisors and Section Foremen in regard to their duties, and satisfy themselves that every employe fully understands all the instructions issued for him.

Roadmasters will often make careful investigations into the wear of rails, fish-plates, spikes, washers, nuts, and cross-ties, and will encourage supervisors and Section Foremen to make the same observation

They must carefully mark on their steel profiles all the new steel laid from time to time, giving the year, brand, and exact location with reference to the nearest mile-post. This must be done in addition to a detailed written report, made every month, of all new steel rails laid.

In this way a correct account of the wear with reference to tonnage can be kept in the chief engineer's office.

They should keep a careful account of all new sidings built, and old sidings extended, shortened, or taken up, making full report of same at the end of

each calendar year, at which time they should send in also a corrected copy of the condensed profile giving all necessary information to date regarding section houses, water stations, sidings, etc.

TABLE I.

## LEAD OF MAIN TRACK TONGUE SWITCH.

Two rails, thirty feet long, should be used on main track, between the heel of tongue and the toe of frog, when fifteen foot tongue switch and No. 9½ stiff frog are used.

Two rails, one twenty-seven, and one thirty feet long, should be used on main track, between the heel of tongue and the toe of frog, when No. 9½ spring-rail frog is used.

Roadmasters and Supervisors should see that Section Foremen putting in tongue switches in main track, conform as near as possible to the lead of switch and the location of switch and frog ties, shown on plan furnished from the Chief Engineer's office.

The following is the bill of switch ties for No. 9½ main track tongue switch, with rotary stand, when cross ties are 8½ feet long.

DESCRIPTION.	No. of Pieces.	Size.	Length.	Feet B. M.
Headblock.....	1	8"x12"	15' 0"	120
".....	1	8"x9"	15' 0"	90
Switch-ties.....	9	7"x9"	9' 0"	425
".....	6	"	9' 6"	299
".....	5	"	10' 0"	263
".....	4	"	10' 6"	220
".....	3	"	11' 0"	173
".....	3	"	11' 6"	182
".....	3	"	12' 0"	189
".....	3	"	12' 6"	197
".....	3	"	13' 0"	205
Frog-ties.....	3	7"x10"	13' 6"	236
".....	2	"	14' 0"	163
".....	2	"	14' 6"	169
Switch-ties.....	3	7"x9"	15' 0"	236
".....	3	"	15' 6"	244
".....	3	"	16' 0"	252
".....	2	"	16' 6"	173
".....	2	"	17' 0"	178
<b>Totals.....</b>	<b>61</b>	<b>.....</b>	<b>.....</b>	<b>4,014</b>

TABLE II.

BILL OF SWITCH-TIMBERS FOR NO. 9½ THREE-THROW  
SPLIT SWITCH.

DESCRIPTION.	No. of Pieces.	Size.	Length.	Feet B. M.
Headblocks.....	2	8"x10"	21' 0"	280
Switch-ties.....	7	7"x10"	9' 0"	367
".....	2	"	9' 6"	111
".....	3	7"x9"	9' 6"	150
".....	3	"	10' 0"	158
".....	2	"	10' 6"	110
".....	3	"	11' 0"	173
".....	2	"	11' 6"	121
".....	2	"	12' 0"	126
".....	1	"	12' 6"	66
".....	2	"	13' 0"	136
".....	2	"	13' 6"	142
".....	2	"	14' 0"	147
".....	1	"	14' 6"	76
".....	2	"	15' 0"	158
".....	1	"	15' 6"	81
".....	2	"	16' 0"	168
".....	1	"	16' 6"	87
".....	1	"	17' 0"	89
Frog-ties.....	2	7"x10"	17' 6"	204
".....	1	"	18' 0"	105
".....	2	"	18' 6"	216
".....	1	"	19' 0"	111
".....	1	"	19' 6"	114
Switch-ties.....	2	7"x9"	20' 0"	210
".....	1	"	20' 6"	108
".....	1	"	21' 0"	110
".....	1	"	21' 6"	113
".....	1	"	22' 0"	116
".....	1	"	22' 6"	118
".....	1	"	23' 0"	121
".....	1	"	23' 6"	123
".....	1	"	24' 0"	126
".....	1	"	24' 6"	129
".....	1	"	25' 0"	132
Totals.....	60	.....	.....	4,602

TABLE III.

BILL OF SWITCH TIMBERS FOR NO. 7 SINGLE-THROW SPLIT  
SWITCH.

DESCRIPTION.	No. of Pieces.	Size.	Length.	Feet B. M.
Headblock .....	1	8"x12"	15' 0"	120
" .....	1	8"x9"	15' 0"	90
Switch-ties .....	7	7"x9"	9' 0"	331
" .....	5	"	9' 6"	249
" .....	4	"	10' 0"	210
" .....	3	"	10' 6"	165
" .....	3	"	11' 0"	173
" .....	2	"	11' 6"	121
" .....	2	"	12' 0"	126
" .....	1	"	12' 6"	68
Frog-ties .....	1	7"x10"	13' 0"	76
" .....	2	"	13' 6"	157
" .....	2	"	14' 0"	163
" .....	2	"	14' 6"	169
Switch-ties .....	2	7"x9"	15' 0"	157
" .....	2	"	15' 6"	163
" .....	2	"	16' 0"	168
" .....	2	"	16' 6"	173
" .....	2	"	17' 0"	178
Totals .....	48	.....	.....	3,188

TABLE IV.

BILL OF SWITCH TIMBERS FOR NO. 7 THREE-THROW SPLIT  
SWITCH.

DESCRIPTION.	No. of Pieces.	Size.	Length.	Feet B. M.
Headblocks.....	2	8"x10"	21' 0"	280
Switch-ties .....	4	7"x10"	9' 0"	210
" .....	3	"	9' 6"	165
" .....	1	7"x9"	9' 6"	50
" .....	3	"	10' 0"	158
" .....	2	"	10' 6"	110
" .....	2	"	11' 0"	115
" .....	1	"	11' 6"	60
" .....	2	"	12' 0"	126
" .....	1	"	12' 6"	66
" .....	2	"	13' 0"	136
" .....	1	"	13' 6"	71
" .....	1	"	14' 0"	73
" .....	2	"	14' 6"	152
" .....	1	"	15' 0"	79
" .....	1	"	15' 6"	81
" .....	1	"	16' 0"	84
" .....	1	"	16' 6"	87
Frog-ties .....	1	7"x10"	17' 0"	99
" .....	1	"	17' 6"	102
" .....	1	"	18' 0"	105
" .....	1	"	18' 6"	108
" .....	1	"	19' 0"	111
" .....	1	"	19' 6"	114
" .....	1	"	20' 0"	117
Switch-ties .....	1	7"x9"	20' 6"	108
" .....	1	"	21' 0"	110
" .....	1	"	21' 6"	113
" .....	1	"	22' 0"	116
" .....	1	"	22' 6"	118
" .....	1	"	23' 0"	121
" .....	1	"	23' 6"	123
" .....	1	"	24' 0"	126
" .....	2	"	24' 6"	258
Totals .....	48	.....	.....	4,052





## CHAPTER XI.

### ILLINOIS CENTRAL RAILROAD.

#### RULES AND INSTRUCTIONS FOR SECTION FOREMEN.

##### DITCHING.

The stability of the track depends upon the strength and permanence of the road-bed and structures upon which it rests; whatever will protect them from damage or prevent premature decay should be carefully observed. The worst enemy is water, and the further it can be kept away from the track, or the sooner it can be diverted from it, the better the track will be protected. Cold is damaging only by reason of the water which it freezes; therefore, the first and most important provision for good track is drainage.

It is expected that all new ditches will be dug, and all old ditches cleaned for the winter season before the first day of November of each year.

The direction of the ditches must in general be parallel with the rails.

The outlines of the ditches must be clearly defined, and in determining their shape and depth at highest point where the descent of the ditch begins, section foremen must be guided by the standard diagram, of which they are furnished a copy. The ditches must be graded so as to pass all water freely during the heaviest rains, and to thoroughly drain the road-bed. When the ditch-

es as shown in diagram are too small, they must be enlarged to the necessary size outside the line of lowest point in ditch shown in diagram, and must have a slope of not less than one and one-half feet to one on the side nearest the track. Surface ditches must be made outside the slopes of cuts, leaving a sufficient berme between the slope and the ditch, wherever the general drainage of the ground is toward the cut.

Earth taken from the ditches or elsewhere must be deposited upon the slopes of embankments, and spread so as to preserve the general inclination from the ballast and ties shown on the standard sections.

Cross-drains must be put in wherever necessary.

Ditches, box-drain and culverts must be often inspected and cleared of all drift-wood and trash. Masonry which has been washed or undermined must receive prompt attention and be reported at once to the Road Supervisor.

Channels and streams for a considerable distance to the right and left of the road must be frequently examined and cleared of brush, drift and other movable obstructions.

Wherever the water washes the soil so as to approach too near the track, at the ends of cuts or other places, special efforts must be made by dams of brush, old ties or other necessary methods, to stop such wash and to fill up the washed places, so the banks will be of full width, and have a slope of not less than one and one-half feet to one from top to bottom.

#### BALLAST.

Ballast is used to give perfect drainage, to prevent upheaval by frost, to distribute the bearing of the ties

and to secure as uniform support of the track as possible.

Before distributing any kind of ballast, whether rock or gravel, the subgrade must be properly prepared and banks widened so as to secure good drainage and retain ballast. The banks should never be thrown up above the bottom of the ballast. Cuts should have ditches carefully shaped to the proper section, and always below the bottom of the old ballast, if there be any, so as to give proper drainage.

Foremen, when preparing the subgrade for ballasting track, must be guided by the standard diagram, and stakes will be set for line and surface by an engineer when practicable.

Rock ballast must always be broken outside of the track, thrown in with forks and firmly tamped with tamping picks. Shovels must never be used for handling the broken stone, as dirt will invariably get mixed with the stone and start the ties churning, and also start vegetation. The greatest care should be observed to keep all ballast, gravel as well as stone, clean and free from earth. The shoulder ballast should be picked down to the bottom when necessary and when clean thrown back with forks.

There should be a uniform depth of at least ten inches of clear broken stone under the ties. The space between the ties should be filled up even with, but never above the tops of the ties. From six inches beyond the ends of the cross-ties the ballast should be sloped evenly to subgrade at the rate of one and one-half to one. See Standard Sections.

Gravel ballast should be of clear gravel, free from

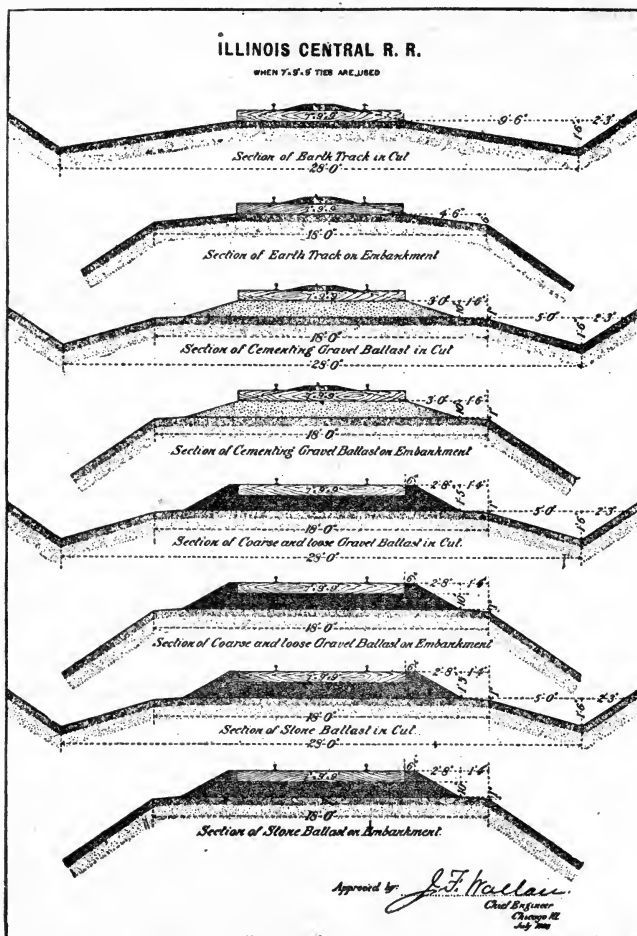

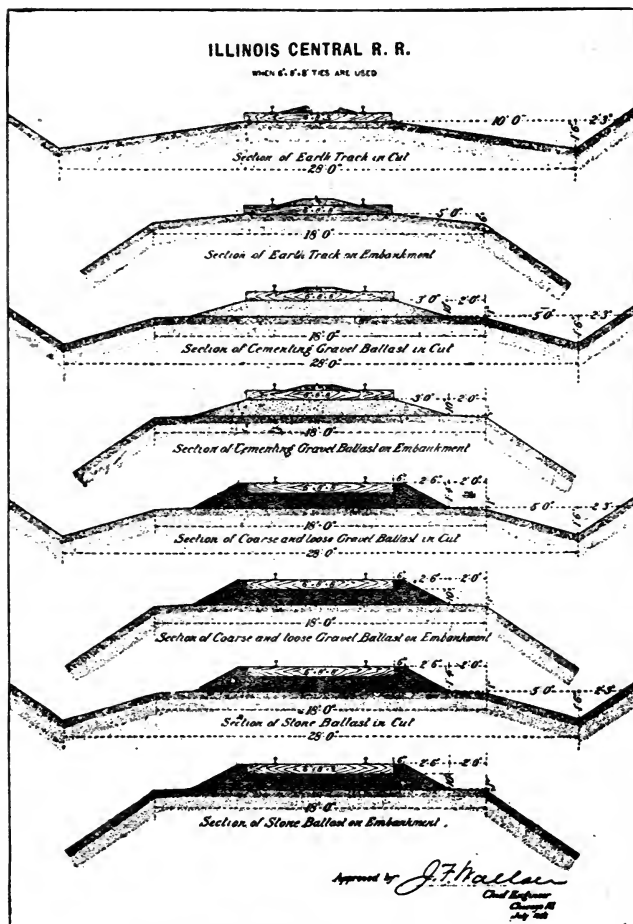

loam or earth, and must be carefully handled to prevent mixing with the earth of the roadbed.

There should be a uniform depth of at least ten inches of gravel ballast under the ties. With coarse clean gravel the ballast must be put in in the same manner as stone described in section 13. With other gravel the ballast must be put in with uniform slope from the bottom of the end of tie to subgrade. See Standard Sections.

When a good bearing is obtained on gravel or finely broken rock the general surface must not be raised until a new bed of gravel or rock is needed; and where ties are removed the ballast should be carefully taken out and put back, instead of raising on it. Foremen must never raise the general surface of the track in tunnels when surfacing.

The use of track jacks on the inside of rail is absolutely prohibited, and no excuse will be accepted for a violation of this rule.

#### CROSS-TIES.

Foremen will, under no circumstances, use ties from piles which have not been inspected and marked, except where necessary in case of a wreck. In this event they will report promptly to their Road Supervisor the location of the pile, and the number of uninspected ties used. Nor will foremen be allowed to use from inspected tie piles on their section, except in case of a wreck, or by direction of the Road Supervisor, and such use must be at once reported to the Supervisor.

On lines where supported joints\* are used a tie must be placed under the joint, and shoulder ties must be

---

\*The I. C. Ry. has modified its system of joints, some lines being laid with suspended and others with broken joints.

placed not more than ten inches distant from the joint tie; the remaining ties should be spaced evenly between the shoulder ties.

On lines where suspended joints are used joint ties must be placed eight inches apart, or four inches from the end of the rail to the inner edge of the joint tie; the and the shoulder ties should be as nearly as possible joint ties.

The largest and best ties are to be used as joint ties, and the shoulder ties should be as nearly as possible of the same size.

All ties must be laid at right angles to the track and not put in obliquely to suit irregular joints.

Cross-ties will be spaced as follows: Eighteen ties to each thirty-foot rail and seventeen ties to each twenty-eight foot rail in the main track.

On side tracks 2,640 ties per mile, or two feet between centers. Special instructions modifying this rule upon branch lines may be given.

The ends of all cross-ties must be lined true on the South and East side of the track; except on curves, where the line side will always be on the inside of the curve. If the inside is the North or West side, the line side will immediately change to the South or East side of the track when the straight line is reached. Ties eight feet long should be so placed in the track that the distance from the lined end of the tie to the outer flange of the rail shall be sixteen and one-quarter inches. For ties nine feet long the distance from lined end of tie to outer flange of rail should be twenty-two and one-quarter inches. On double tracks the ties will be lined on the outside of both tracks regardless of curves.

Cross-ties should never be notched; but if necessary







# STANDARD RAIL SECTION AND ANGLE BAR.

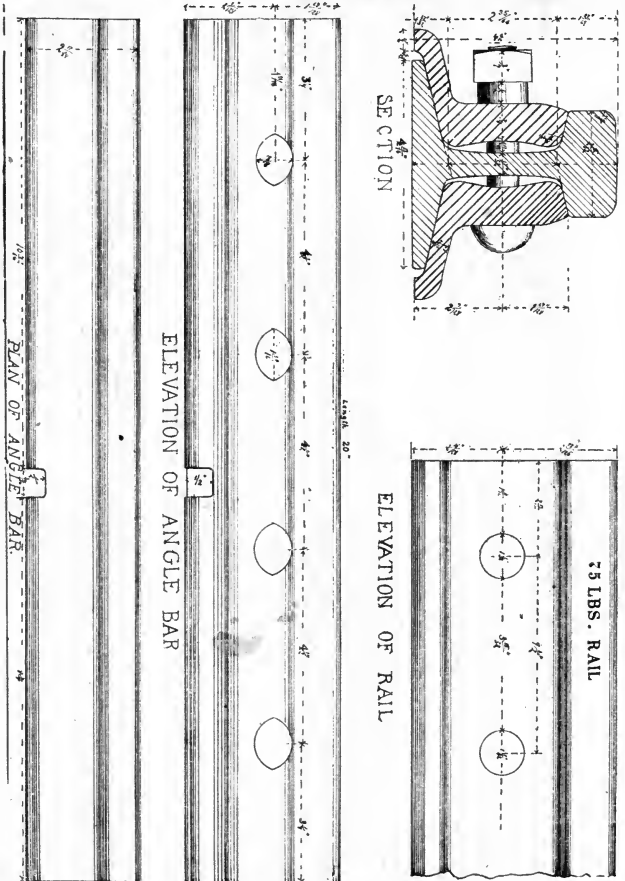

I. C. R. R.

must be adzed, in order to obtain a true and uniform bearing for the base of the rail.

Heart sides of ties must always be turned down.

Every foreman will keep a supply of wooden spikes in his hand-car house and with his gang. The invariable rule must be to plug every hole wherever a spike is drawn.

Shims. In case the action of frost or mud makes it necessary to shim the track, it is to be done in all cases on the tops of the ties. The placing of lumber under the ties is forbidden except in cases of accident, and in such cases must be removed as soon as possible. If shims more than one inch in thickness are used, holes must be bored in them and spikes of extra length used. When shims are removed such long spikes must be preserved in the tool-house for future use.

Shims must be of same thickness throughout, and not wedge-shaped.

#### RAILS.

Rails must never be unloaded while cars are in motion, except when an approved unloading device is used. The distribution of bars over sections must be made carefully.

Iron shims, to separate the rails at the joints, must always be used in laying track. Wooden chips will not answer, and must not be used. The proper thickness for coldest weather, upon northern and western lines, is five-sixteenths of an inch; during Spring and Fall use one-eighth of an inch, and in very hottest weather one-sixteenth of an inch should be allowed. Standard iron shims will be furnished by the Chief Engineer upon requisition.

This rule must be carefully observed, as many serious

accidents have occurred by neglecting this simple method of making proper allowance for expansion.

The rail must be laid with square joints on straight track and with broken joints on curves. The joint must be placed on the center of the tie.

All rails adjoining others of different section must have a step-chair to bring the tops of the rails to the same level, and the rails should be joined together with compromise splices made to fit the different sections and punchings.

The joint fastening must be properly put on with the FULL number of bolts, nuts and washers. Nuts must always be kept screwed up tight, and must be put on with the flat side turned in and resting on washer. A spike must be driven in each slot, inside and out, if angle bars are so slotted, except on bridges and trestles.

Where plain bars are not used on bridges and trestles, spiking in slots or against the flanges of rails, at the ends of angle bars, will be carefully avoided.

All rails must be spiked full on main track—four spikes to each tie—and every spike must be driven home close, with a full hold upon the rail. Spikes should be driven perpendicularly, as the underside of the head of the spike is formed with a view to driving it straight; and no spiker must lean a spike inward or outward to suit the swing of his maul. Spikes must be driven straight and snug up against the rail base. This should be accomplished by driving carefully, and not by a last blow on the spike to bend it over against the rail and give it the appearance of a fit. The outside spikes should be opposite each other and inside spikes the same, and neither of them less than two inches from the edge of tie.

Steel rails must not be punched or slotted, but when necessary to make holes for bolts they must be drilled with the proper tools furnished for that purpose.

Short rails are admissible only as a temporary expedient on tangents, and on inside of curves, but never, under any circumstances, on the outside of curves. No piece shorter than fourteen feet should be used at all.

When new steel is laid it must be perfectly lined and surfaced. No imperfection in the alignment will be permitted.

Track-gauges in the possession of foremen will from time to time be compared by Road Supervisor with the standard furnished by the Roadmaster.

The track must be laid to a perfect gauge on straight lines, and also on curves of four degrees and under. For curves over four degrees and under six degrees the gauge should be one-eighth of an inch wide. For curves of six degrees and under eight, the gauge should be one-fourth of an inch wide. For curves of eight degrees and over, the gauge should be one-half inch wide.

On all straight lines the tops of the rails must be level with each other, except the approaches to curves, as provided in rule 40.

Curves of the same degree should not always be given the same elevation. For instance: A four-degree curve at the top of a long grade should not be elevated for the same speed as a four-degree curve at the bottom of a long grade, as the speed of trains is almost invariably faster over the latter than the former.

The foreman, therefore, should consult the Road Supervisor about the elevation of each curve on his sec-

tion, and get from him the proper speed for which to elevate each curve.

To determine the degree of a curve, stretch a sixty-two foot line, with a small knot at the center (which is thirty-one feet from either end), on the running side of a well lined curve. Measure the distance from the knot to running side of rail, and every inch of this distance indicates one degree of curvature. Thus, if the distance is two inches, the curve is a two-degree curve; if it be four inches, the curve is a four-degree curve, etc. The degree of curve can also be determined by use of the table on the following page.

TABLE FOR FINDING CURVATURE OF TRACK.

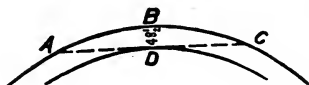

WM. A. PRATT, C. E.

Degree of Curve.	Radius of Centre Line.	No. of 30ft. Rails in Arc "ABC."	Length of Arc "ABC." in feet.	Length of Chord "AC." in feet.	Central Angle
1°	5730	15 $\frac{1}{2}$	463.5	463.4	4° 38'
2°	2865	11	328.6	328.4	6° 34'
3°	1910	9	268.1	267.9	8° 02'
4°	1433	8	232.5	232.2	9° 17'
5°	1146	7	208.0	207.7	10° 24'
6°	955.4	6 $\frac{1}{2}$	190.0	189.7	11° 22'
7°	819.0	5 $\frac{3}{4}$	175.8	175.5	12° 16'
8°	716.8	5 $\frac{1}{2}$	164.8	164.5	13° 08'
9°	637.3	5 $\frac{1}{4}$	155.2	154.8	13° 54'
10°	573.7	4 $\frac{3}{4}$	147.5	147.1	14° 40'
11°	521.7	4 $\frac{3}{4}$	140.5	140.1	15° 22'
12°	478.3	4 $\frac{3}{4}$	134.8	134.3	16° 04'
13°	441.7	4 $\frac{3}{4}$	129.5	129.0	16° 42'
14°	410.3	4 $\frac{1}{2}$	124.8	124.3	17° 20'
15°	383.1	4	120.6	120.1	17° 56'
16°	359.3	3 $\frac{3}{4}$	116.8	116.3	18° 30'
17°	338.3	3 $\frac{3}{4}$	113.3	112.8	19° 04'
18°	319.6	3 $\frac{7}{8}$	110.3	109.8	19° 38'
19°	302.9	3 $\frac{6}{8}$	107.4	106.8	20° 10'
20°	287.9	3 $\frac{5}{8}$	104.7	104.1	20° 40'

To find Degree of Curve of Track, stand at joint on outside curve, sight across gauge side of inside rail to where line strikes outer rail and count joints back, or measure chord AC, or arc ABC; degree of curve in table opposite either of these distances is the one sought.

Consult the table shown below for the elevation of outer rail for each degree of curvature for various speeds.

DEGREE OF CURVE.	Speed in Miles Per Hour.			
	30	40	50	60
1°	$\frac{1}{2}$ inch	1 inch	$1\frac{1}{2}$ inches	2 inches
2°	1 "	2 "	$2\frac{2}{3}$ "	$3\frac{3}{4}$ "
3°	$1\frac{1}{2}$ "	$2\frac{7}{8}$ "	$4\frac{1}{3}$ "	$5\frac{1}{4}$ "
4°	2 "	$3\frac{3}{4}$ "	$5\frac{1}{2}$ "	$6\frac{1}{2}$ "
5°	$2\frac{1}{2}$ "	$4\frac{1}{2}$ "	$6\frac{1}{4}$ "	
6°	3 "	$5\frac{1}{2}$ "		
7°	$3\frac{1}{2}$ "	6 "		
8°	4 "			
9°	$4\frac{1}{2}$ "			
10°	5 "			
11°	$5\frac{1}{2}$ "			
12°	6 "			

The elevation at the beginning of a curve should be as great as at any other part of it, except at reverse points and where short tangents occur between curves of opposite directions. To insure smooth running, especially for trains at fast speed,\* the elevation must commence back on the straight line and continue gradually until the curve is reached. The following table shows how far from the beginning of the curve the elevation should commence:

For 1 inch elevation, 50 feet back on the straight line.

"	2	"	"	100	"	"	"
"	3	"	"	150	"	"	"
"	4	"	"	200	"	"	"
"	5	"	"	250	"	"	"
"	6	"	"	300	"	"	"

—increasing thus fifty feet for each inch of elevation.

In reverse curves rails must be level with each other



at the reversing points; from the reversing point the elevation must be carried in either direction at the rate of one inch in fifty feet. Where short tangents of insufficient length to apply the foregoing table intervene between curves of opposite direction the middle of the tangent shall be the neutral point at which the elevation in either direction shall begin.

Old steel rail, which has been replaced by new rail, will, if it is sufficiently good, be used again in the main track, but as far as practicable with other rail of the same pattern. If it be not needed for immediate use, it will be neatly stored at convenient places and not left lying in the ditches.

All curves of three degrees and over will be braced. Rail-braces will be used on both inside and outside rails of curves to be braced and will be placed on the same tie for both rails.

Curves of from three to four degrees will have three rail-braces to each rail; curves from four to five degrees will have four rail-braces to each rail; from five degrees to six degrees will have five rail-braces to each rail; from six to eight, six braces; curves over eight degrees must have rail-braces on every other tie.

#### SWITCHES.

Switches must be laid in conformity with the standard plans furnished by the Chief Engineer.

Where rail of a heavier pattern is used in the main track than in the side track, the main line pattern must extend at least as far up the side track as the switch ties extend. In other words, no compromise chairs or angle bars must be placed on rails whose ends are on switch ties.

Every guard rail opposite a frog will be of the length

shown on the standard drawings, and it should be spiked parallel to and one and seven-eighths inches distant from the rail in the main track throughout its entire length, except four feet at each end, which will be curved inward six inches.

Every guard rail should have three braces, one at each end of the straight portion and one in the center—all of which is plainly shown on the standard drawings.

The most careful attention must be given to the switches by the foremen and track-walkers. All switches should work easily and have no lost motion, and must be kept lined up and to perfect surface at all times. Foremen must notify supervisors at once when new switches are put in, or old switches taken out; also whenever switches are spiked for any cause, and when switches that have been spiked have been reopened.

Keeper pins must always be used in connecting rod bolts.

Track-walkers must never pass a switch without examining every part of it carefully, to see that all bolts are tight and in perfect order, keeper pins in place, and that everything about the switch is in perfect order. Switches and frogs must be kept free from snow and ice.

Safety switches must be put on all sidings where the grade does not descend from main track, and on every track where there is no agent to see that proper clearance is left. This rule does not apply to regular passing tracks.

Switch lamps must be thoroughly cleaned every day and filled with oil. A supply of clean waste must be kept for the purpose of cleaning lamps. Lamps must

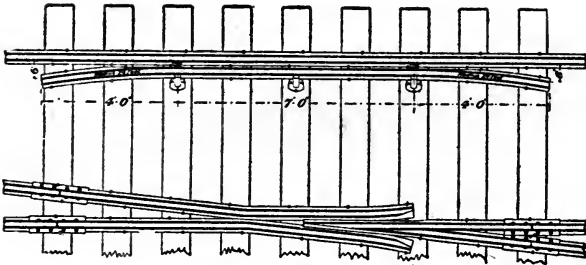

*Guard Rail and Rail Braces.*

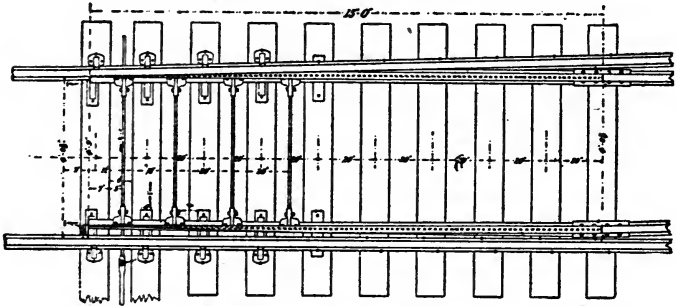

*Switch Points and Rail Braces.*

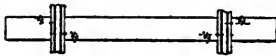

*Position of Splines.*

be lighted by "sun down" and not put out until "sun rise." On very foggy evenings they must be lighted earlier and be left burning later on such mornings; but this must be watched carefully and no unnecessary oil consumed.

The head blocks of switches must be kept firmly tamped at all times, or lamps will be shaken out.

When lamps are placed on switches they should not be left until the lighter is satisfied that the wicks are at proper height to give a good light and not to smoke.

Do not trim the wicks with scissors, but simply rub the finger over them and remove the crust. This will give much better results.

In filling lamps care must be used not to fill them too full, or when they are lighted the oil will run down on the switch targets.

Lamp lighters must be careful and not put their greasy hands on switch targets and disfigure them.

#### WATCHING.

During heavy rain and wind storms, every precaution must be taken to prevent accidents. Each Section Foreman must be out, and have with him a sufficient number of men, to insure safety to trains. It may occur that washouts cannot be prevented, but, by proper watching on the part of Section Foremen and men, trains can be kept from running into washouts. Men going out to watch track, either in storms or for ordinary track walking, must have with them the necessary signals and torpedoes to stop trains. During heavy rain storms, culverts and drains must be inspected, and all drift material removed from them.

The duties of the Track Walker are next in importance to those of the Foreman. Section Foremen will

be held responsible for seeing that their section is walked and examined every morning. When a full force is being worked, the Track Walker should start on his trip of inspection in a direction opposite to that in which the remainder of the force go. He must carry proper signals and torpedoes to stop trains when necessary, and tools to properly secure the safety of the track. He must also carefully examine switches, frogs, bridges and fences, and report promptly to his Foreman any defects that he cannot fully repair. He must drive stock off the right-of-way, and close farm gates.

Foremen are required to pass over the whole of their sections at least every alternate day, and to observe particularly the condition of the main track, switches, sidings, culverts, cattle-guards, bridges, trestles and fences.

They must always have with them the latest timetable for the movement of trains, and must understand its use, and know the time of all trains at whatever point they may stop to work.

Foremen must remove from bridges, cattle-guards and trestles all combustible matter, examine particularly the tops of piers and abutments, and remove all chips.

When necessary the sod must be removed from around the base of trestles, sign and mile posts and other wooden structures so that the dry grass may not carry fire to them.

The grass, weeds and brush on the right-of-way must be burned as early in the season as they become dry enough, and the right-of-way must be kept clear of all rubbish, especially old ties. Special care must be exer-

cised to prevent fires from extending to fences and adjoining property.

Foremen of repair gangs, as well as bridgemen and construction trains, must never obstruct the track in any way whatever, without protecting themselves with the proper signals.

Red signifies danger, and is a signal to stop. Red signals must be used when the track is obstructed so trains cannot pass. A red flag by day and a red light by night must be placed in the center of the track when trains cannot pass the obstruction.

A green flag by day and a green light at night placed beside the track, on the engineer's side, indicates that the track is not in perfect order and should be run over slowly. A white flag or light denotes that the track is clear and in perfect order. If red or green signals are required they must be placed at least twenty-four telegraph poles in both directions from the obstruction, and firmly and conspicuously planted.

When a curve, the grade or condition of weather makes it doubtful whether the train can be stopped in running the distance covered by twenty-four telegraph poles, the signals must be displayed enough further to insure sufficient distance to stop the train before reaching the obstruction.

If an obstruction of the track occurs on curves or grades so the danger signal cannot be seen by the Foreman from the point where he is working, a man must be left with the signal.

In all cases the signal staff must be so placed as to fully display the whole flag in windy or calm weather.

If from any cause the track becomes impassable for trains, and the Section Foreman cannot promptly re-

pair the damage, he will at once, after placing danger signals in both directions, telegraph the Train Master and Road Supervisor, giving the nature and location of obstruction, materials needed, etc.

An explosive cap or torpedo placed on the top of the rail is a signal to be used in addition to the regular signals. The explosion of one torpedo is a signal to stop immediately; the explosion of two torpedoes is a signal to reduce speed immediately. These signals will be so used by Section Foremen when necessary, and at the same distance from obstructions as the flag and light signals.

A sufficient number of torpedoes must be carried at all times upon hand-cars to be used in case torpedoes placed upon the track are exploded by hand-car passing over them, and as an additional precaution as prescribed by the Standard Transportation Rules.

Special trains or engines may pass over the road at any time without previous notice, and Foremen must be prepared for them. Anything that interferes with the safe passage of trains is an obstruction, and must not be attempted without using the proper signals. Employes are permitted to use the track for making repairs to within twenty minutes of the time of passenger trains and ten minutes of the time of freight trains; but always under the protection of the proper signal.

Foremen must carefully observe the signals carried by trains, and be sure that all following trains, running on the same schedule, have passed, before obstructing the track. They must also watch all passing trains closely for messages that may be thrown off, and signal trainmen if they see anything wrong with the running gear.

All trees which are in danger of falling on the track during high winds should be cut down. If not on the Company's property the owner of the land should be consulted, and if he objects, the facts should be reported and instructions asked.

Watchmen must be provided with the proper lamps, flags and torpedoes for stopping trains, and must be instructed how to use them.

Whenever wood, cross-ties, lumber or other material is piled along the track, notice must be taken by Section Foremen that it is at least seven feet from the rail. If found nearer, it must be at once removed to the proper distance. Signal or mile-posts must not be placed nearer the rail than twelve feet.

Every Foreman having fewer than five men will engage in his work personally, and must require all laborers under him to faithfully perform their duties.

#### MATERIAL.

Section Foremen, as well as Road Supervisors, will make requisitions in writing for all necessary material, such as cross-ties, spikes, chairs, splices, bolts, nuts, washer, and tools, and will hand them to their immediate superior officer, together with their time-books, on the night of the 27th of each month.

Section Foremen will be held strictly responsible for all tools and material left in their charge. They must report promptly any loss of the same to their immediate superior officer. They will not be permitted to lend the tools or material of the Company to any person under any circumstances.

All material, new or old, must be kept locked up in tool-houses, as far as possible, or under the eye of the Section Foreman.



Section Foremen will have care of and will be responsible for all loose property of the Company, such as wood, ties, lumber, scrap-iron, etc., and will see that none of it is lost or stolen, nor will they on their own responsibility give anything away.

All spikes in the track must be carefully drawn with the view to use them again. No old ties are to be thrown aside with spikes left in them. All old spikes which cannot be used again must be carefully gathered up and taken to scrap pile. In uncoupling rails no tight nuts or bolts must be knocked off with hammer. They must be oiled and taken off with a wrench.

Tools needing repairs will be shipped to the Company repair shop. Place a tag on each article showing to whom it is to be returned, and send note giving advice of shipment.

Foremen will not ship their hand-cars to shops for repairs until the Road Supervisor has inspected them and decided they need shop work. But no Foreman, either before or after advising the Road Supervisor of the bad condition of a hand-car, will use the same, if to do so involves the risk of accident.

All scrap rails should be piled up at side tracks ready for shipment.

#### ACCIDENTS.

In case of an accident to a train the nearest Section Foreman will at once take his whole force to the assistance of the train, even if it is not on his own section. If notified of broken rails or anything else needing immediate attention on an adjoining section, he will at once go and make the track safe for the passage of trains.

When assisting a train delayed by an accident, Sec-

tion Foremen will act under the direction of the Conductor until the arrival of the Road Supervisor.

In case of a wreck, Foremen must at once appoint the necessary watchmen to prevent freight or Company's property from being stolen. Said watchmen are to remain on duty until the goods are removed.

In cases of injury of any kind, no matter how trivial, to any one in their employ, Foremen must immediately make a report by wire to the Road Supervisor, and follow this as soon as possible with a written report. No Foreman shall exercise his discretion as to what injury is, or is not, important enough to be reported.

#### HAND AND PUSH CARS.

When hand or push-cars are not in actual use they must be lifted off the track and placed entirely clear of passing trains. When not within sight of the men they must be locked, and no car shall be used without the knowledge of the Section Foreman.

Loaded push-cars will not be run around curves on main track, or where there is not a tangent of at least half a mile, except under protection of red flags.

Hand or push-cars must never be attached to a train in motion.

Rails must not be carried on hand-cars, except in cases of emergency.

Great care must be exercised when it is necessary to use hand or push cars during foggy weather or in the night. Foremen must always accompany the cars.

No car will be run at night or on Sunday, except in case of actual necessity. Cars must be kept under lock and key, and in no case be used for personal purposes, except by special permission of the Supervisor, and then only when accompanied by the Foreman.

Parties claiming to be officers of the road cannot be taken on hand-cars without an order signed by the proper officer.

#### WATER STATIONS DURING FREEZING WEATHER.

During extremely cold weather, when water stations are likely to suffer by freezing, Foremen on whose section a water-station is located, if called upon by the Supervisor of Water-Works, will send a man to the tank, who shall keep the station in such condition that trains can take water at all times.

In all cases where called upon for aid by foremen of telegraph line repairs, Section Foremen will render prompt and cheerful assistance.

#### POLICING.

Nothing is more commendable in a Foreman than neatness and order on his section. A few hours devoted each week to cleaning up and putting things in order around section tool-houses, station grounds, etc., will give an air of order to the section which will be complimented by officers and travelers.

Foremen will make themselves familiar with all the boundary lines of the Company's grounds on their respective sections, and see that no person encroaches upon them.

No person is allowed to erect fences and buildings or otherwise occupy the Company's grounds without special permit. Any such action must be reported in a written statement to the Road Supervisor, giving the name and residence of the party, and all facts connected with the encroachment.

Cross-ties in track partly burned by fire, so that they are unsafe, must be at once replaced.

All old ties, which are taken from the track, must

be gathered up at the close of each day and put in some convenient place for burning, or use as fuel or fence posts. When there are stumps close by, pile around them and thus get rid of both at one burning.

Foremen will pay particular attention to the telegraph wires, and see that they are not obstructed or down on the ground. If broken or crossed they must be repaired at once and notice sent to the nearest office by special messenger.

All highway and farm crossings must be kept in the best possible repair, and not obstructed by any material. Foremen are specially directed not to leave hand or push-cars on crossings.

All side-tracks must be maintained in good order, and the platforms and station grounds should always present a cleanly appearance.

All switch signals must be kept bright and in good order.

The sod line will be neatly and accurately cut nine feet from and parallel with the center of the track on each side thereof.

Section forces must pick up each day any material dropped from engines or cars, such as draw-bars, car-doors, brakes, bolts, nuts, or other property belonging to the Company, and take it to the tool-house, from whence it will be shipped as directed.

All packages or articles of freight that may fall from any train must be taken to the nearest station agent, who will forward them to the Superintendent.

#### REPORTS.

The time roll book (form 1142) must be written up every night for the day just closed. The time of Foremen and men must be given and the same distributed

to each kind of work performed, under the proper heading. Time roll books (form 1142) as well as monthly reports of all tools and materials received during the month, must be handed by the Foreman to the Supervisor on the night of the 27th of each month.

When an employe is discharged, the Foreman will make out and forward to the Road Supervisor an application (form 1140) for a time-check, and indorse on the page of the time-roll book opposite the name of the employe, "Discharged, time given." Upon receipt of application for time-check, Road Supervisor will certify to its correctness and forward at once to the Roadmaster, who will issue time-check and forward to the agent at the station nearest the section for payment to the employe, who must be identified by the Section Foreman.

In case the employe has not received pay for work done in the previous month, the Roadmaster will request the Paymaster, by wire, giving the number of roll upon which the name appears and the month, to forward the amount due the discharged employe to the agent nearest the section for payment to him. Time-checks must never be issued by the Roadmaster after the rolls have left his hands.

Section Foremen will promptly report in writing to Supervisor, any failure of trainmen to respect their signals, and to answer the same with the whistle, giving the number of train and engine.

Section Foremen will report all accidents occurring on their sections, by telegraph to the Road Supervisor, as soon as possible, according to special instructions, giving in brief the nature of the accident. The tele-

grams must be followed by a full written report, given or sent by the Foreman to the Road Supervisor.

In cases of very serious accidents, requiring a collection of forces and material, Foremen must immediately report by wire in full to the Superintendent and Roadmaster.

Foremen will promptly report all stock killed or crippled by a train on their sections, on proper blanks furnished them.

An immediate report on proper form must be made by the Section Foreman to the Road Supervisor of all fences burnt, or other property and material—whether belonging to the Company or to private parties—destroyed by fire originating from passing locomotives or otherwise. The report should state the location, the exact damage done, the linear feet of fencing destroyed, if any, and the name of the owner of the property.

Broken rails must be at once reported to the Road Supervisor. State manufacturers' marks on the rail, when laid, and when broken, the nature of the break and its cause, and at what part of the rail it occurred, and between what mile posts, and whether on curve or tangent, and what disposition is made of broken rail, also condition of the road bed where break occurred.

#### GENERAL RULES.

Section Foremen must remember that while their particular duty is to look after their own sections, to keep them in safe running order and to steadily improve their condition, they must not fail to do everything to make the road secure and to prevent accidents, even though they may have to perform the duty of some other man.

The responsibility for the safe condition of bridges and trestles rests upon the Section Foremen, as well as upon the bridge department. They will look after the lining and spiking of the track on all bridges, as well as the condition of the bank sills. They must also frequently inspect the general condition of their bridges and trestles, and if work is needed, report same at once to their Road Supervisor.

Section Foremen may discharge or suspend from duty any employe under their control.

Section Foremen are not at liberty to excuse any neglect of their men in the performance of duty.

Foremen must not engage more than the regular force allowed without permission from the proper officer.

Employes of this department who leave the service of the Company of their own accord will not receive pay for their service until the regular pay-day in the month following that in which they leave the service. Foremen must so inform them before engaging them.

Each Foreman will be provided with one switch key, for which a receipt will be taken. In case he does not return key when leaving the service of the Company 50 cents will be deducted from the amount due him. The same deduction will be made should the Foreman lose his key and still continue in the service.

Trackmen must not wear red shirts as outer garments, as they may be mistaken for danger signals.

No Foreman or employe must take coal from the cars in transit or from coal-bins. Foremen will see that

this rule is obeyed, and promptly report any violation of it.

FOR CONDUCTORS OF CONSTRUCTION TRAINS.

The Conductors of all work trains are selected by the Roadmaster, subject to the approval of the Superintendent, and are responsible for the safety and proper care of their trains, for the good conduct of all the men employed thereon, and for any material entrusted to their care, except when a separate foreman is employed to work the men.

Conductors of work trains will be under the immediate direction of the Road Supervisor on whose section they are at work.

They must obey all orders for the safe movement of their trains from the Train Master or Superintendent, and they must faithfully observe all time-card rules.

No one except men employed on the trains, or an officer of the road, will be permitted to ride on construction trains.

Conductors of work trains must see that all the ditching and boarding cars are in good running order; that the boarding cars are neat and clean at all times, and that good, substantial food is furnished to the men.

They must study the rules and instructions issued to all track and bridge men, and fully familiarize themselves with all kinds of work pertaining to the maintenance of track.

The greatest care must be taken in unloading material. Steel or iron rails must never be unloaded while cars are in motion, except when approved unloading devices are used. In unloading new steel rails, car initials and numbers must be written down in memoran-



dum book, and number and lengths of all rails on each car carefully recorded and reported.

Conductors must not give or sell any employe or other person coal or material without a proper order.

Conductors must make such daily reports as are directed by the Roadmaster, and wire him daily the number of men employed and amount of work done.

On each day they must send to the Road Supervisor a report of all the delays experienced during that day on account of not receiving orders promptly, or from other causes.

From the first day of December to the first day of March they must always spend the night at a telegraph station; and observe the same rule during the rest of the year when it can be done without losing time.

Whenever Conductors of construction trains have delays at a station, whether in waiting for orders or from other causes, they must keep the whole force employed. There is no place on the line where some kind of work is not needed, and no time will be wasted by a good Conductor. When delays occur the men should be set to work on sidings, at cleaning station grounds, weeding, ditching, ballasting, or whatever work is mostly needed.

In case of an accident to a train they will give assistance as soon as called upon by the Superintendent or Train Master, and they must do everything in their power to facilitate the quick and safe passage of trains.

A natural eagerness to get the track clear must not lead to unnecessarily rough or careless handling of freight at wrecks.

When wrecked cars are burned the numbers and

initials must be carefully noted and reported to the Roadmaster and Train Master.

Conductors must report at once in writing to the Road Supervisor whenever inadequate power or incompetent enginemen are furnished them.

FOR ROAD SUPERVISORS.

Road Supervisors are held responsible for the safe-keeping of their sections, and will have immediate charge of all the Foremen and road watchmen, and are authorized to discharge such employes for neglect of duty. They will, however, in case an accident results from the negligence of an employe, report the case, before discharging him, to the Roadmaster.

In reporting the discharge of a Foreman, they will give the cause of same, so that a record of the man's standing may be kept for future reference. A discharged Foreman is not to be re-employed on another division of the road without permission from the Chief Engineer. Should a discharged Foreman desire an investigation, he can present his case to the general office, through the Road Supervisor, and it will be considered.

They will carefully see that the time of the men and the rate of pay are correctly reported and properly classified on the check-rolls.

They will note the time each Foreman is absent from work, and make proper deductions on check-rolls.

Each Road Supervisor must walk over a portion of his section every day, and go over the whole section on a hand-car or on foot, at least once a month. Passenger trains must be used by them during working hours only in case of necessity.

They must spend most of their time out on the road,

and see that Foremen and laborers fully understand and perform their duties.

They must also carefully examine every switch upon their respective sections at least once every month, and make a written report of the condition of each switch to the Roadmaster after each examination.

They must pay strict attention to the proper adjustment and alignment of the track, and to the economical use of all material.

They must personally observe alignment and elevation on curves, and must instruct the Foremen about the proper elevation for every curve on their sections.

They must also frequently examine the track-gauges, and compare them with the standard furnished by the Roadmaster.

They should be thoroughly posted in regard to the right-of-way and other land boundaries on their respective sections, and keep constant watch against encroachment by adjoining occupants.

They should keep a memorandum of the number of men at work on each section, and compare with the reports returned by the Section Foremen.

All requisitions for materials, such as cross-ties, spikes, chairs, splices, bolts, nuts, washers, tools, etc., must be made in writing to the Roadmaster, and receipts for material received must be sent to the Roadmaster.

Supervisors will personally examine their track in the month of October each year and ascertain the number of cross-ties required on each mile, and the number of cross-ties and switch-ties required in each siding for the ensuing year, and make report of same, before the fifteenth of November, to the Roadmaster.

Each year during the month of November, Supervisors will personally examine all rails in main track and make a report to the Roadmaster, giving the number of perfect rails, number of rails fit for cutting and drilling for future use in main track, and number of rails worn out and fit only for mill, on each mile.

Road Supervisors will see that each Foreman is supplied with one switch-key and gives a written receipt for the same. In case the key is lost or not returned when the Foreman leaves the service of the Company, fifty cents will be deducted from the amount then due the Foreman. They will make the proper indorsement respecting the switch-key on the discharge ticket.

When the Foreman is discharged or leaves the service of the Company, the Road Supervisor must make out a correct list of tools on hand. He will note all tools missing or not accounted for, and send such report to the Roadmaster, so that the proper settlement can be made. In such a case he will write on the discharge ticket: "Tools not accounted for as per report."

Road Supervisors will have charge and control of all construction trains while at work on their respective sections, unless otherwise arranged, and will personally see to the proper distribution of all material for use of their Foremen.

In case of accidents on their sections, they will send the reports of the Section Foreman and their own reports to the Roadmaster. On being notified of a wreck they will immediately proceed to it and take charge of all trackmen. All wrecked freight must be carefully handled, and initials and numbers of wrecked cars noted and reported to the Roadmaster and Trainmaster.

Supervisors must keep their Roadmasters advised of their whereabouts and probable movements.

Houses furnished for laborers will be occupied by those employed on the road, and no one else will be permitted to use them without authority from the proper office. Road Supervisors must give close attention to this.

All printed circulars, instructions, and orders to Section Foremen or watchmen must be delivered in person by the Road Supervisor, who will read and explain the same to all his Foremen, and then tack up in a conspicuous place in the tool-house of the section.

Road Supervisors must see that all the rules for signals with flags and torpedoes, and other instructions, are understood and obeyed by every man in their employ; and that all their Foremen and watchmen are supplied with time-tables and watches while on duty. They must compare time with their Foremen frequently.

Road Supervisors will instruct their Foremen to avoid all unnecessary use of the Company's telegraph, especially for material. The telegraph is only to be used in cases of emergency, or when delay would involve a loss to the Company.

Telegraphing for material can usually be avoided if the Foremen will inform themselves ahead as to what material they will need, asking for same by letter.

#### RULES AND INSTRUCTIONS FOR THE BRIDGE DEPARTMENT.

The Foreman of each gang will report to the Supervisor of Bridges in general charge of the Division or District—the Bridge Supervisor reporting to the Roadmaster. The Roadmaster shall report to the Division Superintendent, and the Division Superintendent to the Assistant General Superintendent. The Assistant Gen-

eral Superintendents will report to the Chief Engineer in all matters pertaining to bridge structures. The Superintendent of Bridges and the Engineer of Bridges will act immediately under the directions of the Chief Engineer; they will have special charge of all truss bridges, and will keep records of the condition of all trestle and pile bridges and minor structures, and will have general charge of all renewals and repairs.

All renewals of pile and trestle bridges, culverts, etc., shall be made in accordance with standard plans approved by the Chief Engineer.

All renewals and repairs of truss bridges shall be made in accordance with plans prepared by the Engineer of Bridges, approved by the Chief Engineer, and will generally be executed by the Superintendent of Bridges with forces directly under his control. Minor repairs will be made in accordance with rules hereinafter specified

Directions for Renumbering Bridges: The system of renumbering bridges on the Illinois Central System, including all branches, will be as follows:

An individual number shall be given to each bridge—including under the general term of "bridge" all truss bridges, trestle and pile bridges, cattle passes and open culverts, arch, pipe and box culverts, all overhead bridges, either for wagon roads or railroads, and generally all structures of the nature of bridges which have to be maintained by this Company, whether in or adjacent to the track; excluding cattle guards, drains in ditches and small stringer bridges for farm crossings.

But one number shall be given to any structure, no matter how many spans or openings it may have, or what may be the character or length of its approaches.

Where there are two or more bridges in adjacent tracks over the same stream or passage-way, but one number shall be used; but if the tracks are separated and the structures are distinct, a distinguishing letter, such as A, B, C, if there are several tracks, or the initial letter of the proper point of the compass, E. or W., N. or S., shall be used to distinguish the structures.

The numbers to be given shall be the same as those on the mile posts on the Division or District. These numbers, except on the main line from Chicago to New Orleans, shall be prefixed by certain letters, generally those which are given in the Official List, to distinguish the stations on the several Divisions or Districts. In addition to these letters and numbers, there shall be added two figures indicating the distance from the last mile post to the center of the structure in hundredths of a mile, these last two figures being separated from the number indicating the mile post by a hyphen, instead of a decimal point.

Whenever it is possible, the numbers shall be painted in black on a white ground in the style shown by standard blue prints. These shall be painted on short ties placed between the regular ties and extending about two feet beyond them, held in place by the rail and by a small bolt fastening them to the guard rail. The projecting ends of these ties shall be beveled on each face and the numbers painted thereon, so as to read from either direction along the track.

Where the above method of numbering cannot be used, a 6x6 post about 6 feet long shall be set on the same side of the track as the mile posts, and about 6 to 8 feet from the rail, with one corner of the post toward the track, and the numbers shall be painted on the two

faces of this post next the track, so as to read from the top downward.

Truss bridges may have the numbers painted on the end posts, or on number boards or plates to be attached thereto. In all cases the style of the numbering shall be uniform, all letters and figures being four inches long by approximately two inches wide, and of style illustrated on blue prints above referred to.

The initial letters and mile post numbers to be used on the several divisions, districts and branches are as follows:

DIVISION OR DISTRICT.	INITIAL TO BE USED.	MILE POST NUMBERS TO BE USED READ FROM	NUMBERS ON MILE POSTS.
Amboy Division	A.	Chicago to New Orleans	0 to 912
South Chicago Branch	B.	New Orleans to Freeport	661 to 934
Mona District	C.	67th St. to South Chicago	0 to 5
Springfield Division	D.	Mona Jct. to Lyle	0 to 75
Bloomington District	E.	Gilman to Springfield	0 to 112
Pontiac District	F.	Chicago to Bloomington	60 to 139
Tracy District	G.	Chicago to Pontiac	85 to 127
Aberdeen District	H.	Buckingham to Tracy	0 to 10
Mound City Branch	J.	Aberdeen Jct. to Aberdeen	0 to 105
Tchula District	K.	Mounds to Mound City	0 to 4
Yazoo District	M.	Durant to Tchula	0 to 25
Havana District	N.	Jackson to Parsons	0 to 115
Decatur District	P.	Champaign to Havana	0 to 101
Rantoul District	Q.	White Heath to Decatur	0 to 31
Madison District	R.	LeRoy to West Lebanon	0 to 74
Sioux Falls District	S.	Freeport to Madison	0 to 62
Onawa District	T.	Cherokee to Sioux Falls	0 to 96
Dodgeville District	V.	Onawa Jct. to Onawa	0 to 59
Chicago to Sioux City	W.	Red Oak to Dodgeville	0 to 57
Memphis Division	X.	Chicago to Sioux City	0 to 510
Cedar Rapids District	Z.	Memphis to Memphis Jct.	0 to 100
Blue Island Branch	AA.	Manchester to Cedar Rapids	0 to 42
Addison Branch	BB.	Blue Island Jct. to Blue Island	0 to 4
		South Addison to Addison	0 to 4

Note.—When mile posts are already set on branches and are numbered from either of the termini of the main line, bridges shall be numbered to correspond to the existing mile post numbers, and not as noted above.

Each Bridge Foreman shall be assigned to a given district, having defined limits, and shall be held responsible for the condition of the structures on his district. He shall make personal examination of all the structures on his district at least once every thirty days,



and shall report in writing, on proper blanks, all structures needing repairs.

Each Bridge Foreman is authorized to make necessary immediate repairs on any structure which he may find to be in a dangerous condition, reporting the same promptly to his immediate superior.

Each Supervisor of Bridges shall make a complete examination of all structures on his district once in six months, and shall make thereafter a complete report to his superior, giving a careful estimate of the work necessary to be done during the next six months, stating the quantity of each kind of material necessary for each structure. This report and estimate shall cover the regular work on each district, and, when requisitions are duly made and approved for the work, the ordinary repairs shall be carried on without further directions from superiors, the work being done in accordance with the standard plans furnished from the Chief Engineer's office.

All material shall be carefully checked, and errors in shipments promptly reported, so that no delay to the work shall be occasioned by lack of necessary material. One piece of work shall be completed before going to another, except in cases of emergency, when work left unfinished must always be put in a perfectly safe condition for the passage of trains.

Worthless material removed from structures undergoing repair shall be burned (all fire being extinguished before leaving the work), or it shall be placed on the down-stream side of the opening from which it was removed. Sound material, together with all bolts, washers, etc., shall be piled conveniently for shipment.

In case of storms, Bridge Foremen shall be on duty,

and shall, where possible, place themselves in communication with telegraph stations. They must assure themselves that the structures on their several districts are not being damaged, and shall take all needful precautions for the safety of trains.

In case of damage by storm or by fire, which may endanger or prevent the passage of trains, each Bridge Foreman shall promptly notify his superior officer, and also the Local or Division Trainmaster, and shall at once take measures to stop trains, if necessary, and to repair the damage.

In case of two or more bridge gangs being called to repair a damaged structure, in the absence of a superior, the Foreman on whose district the work is being done shall have general charge of the same, unless orders are given to the contrary.

The Division Roadmaster, or Bridge Supervisor, shall take personal charge of the more important repairs in case of wrecks or damage by storms, fire, etc., and shall notify the Chief Engineer of the same, and call to his aid any of the district bridge gangs he may see fit.

Examine masonry for signs of settlement or of bulging or tipping over. Examine pedestal stones for crushing or splitting. See if masonry needs pointing.

Take soundings, and compare with former records, to note scouring around piles or abutments. Bridge watchmen should do this, when there are any.

See that nuts on floor beam hangers are screwed to a bearing, and check the threads to prevent loosening.

See that laterals are not loose, but do not put heavy strains on them.

Do not attempt to adjust the other members of a

truss bridge, either of wood or of iron, without being directed by the Superintendent of Bridges, personally.

Keep the roller ends of spans free from anything that would hinder the movement of the rollers. Watch the action of truss spans under moving trains, and report any undue lateral or vertical movement.

Examine timber and piles for decay by boring. Test the latter at the ground line for evidences of rot. Tighten nuts on trestle work, and pay special attention to replacing missing guard rail bolts and nuts.

Barrels filled with water shall be kept on all long trestle and bridge spans. Buckets also shall be kept in the same.

Grass and weeds shall be cut away from around pile and trestle bents.

Drift shall be removed from all trestles, bridges and culverts.

Tunnels shall be examined for loose rocks, linings, etc. Signal rules and time-cards shall be studied and strictly observed.

Have signal flags and torpedoes for warning trains of dangerous structures or work under repair.

Handle work so as to delay regular trains as little as possible, and pay attention to signals they may carry for extras.

Check time frequently with train men and at telegraph stations.

In addition to the regular inspection reports already referred to, each Bridge Foreman shall report in writing any accident or failure of any structure under his charge, giving date and cause of same.

In case of detention of traffic he shall report the date

and hour when traffic was stopped, and also when same was restored, with cause of detention.

Each Foreman shall make a "Completion Report" of every piece of work, giving list of material used, cost of labor performed, and general description of the work done. This report shall be made immediately after the job is completed.

Certain forms kept in stock by the Stationer shall be used for bridge reports; they are as follows:

Form 1170 is a bridge foreman's daily report, in postal card style.

Form 1171 is a weekly time report.

Form 1172 is a foreman's completion report.

Form 1184 is a monthly inspection report of bridges and culverts.

In addition to the above, two large blank forms, numbered 1180 and 1182, have been prepared for bridge records, instructions for using which are as follows:

Form 1180 is designed for records of frame and pile trestles, and form 1182 is designed for records of culverts, tunnels, overhead bridges, etc.

Roadmasters will order these blanks from the Stationer in such quantities as may be required, identifying them by the form number.

As soon as possible after receiving these blanks, each Roadmaster will cause to be made out a complete list of all bridge structures on his division, giving to each the new number, with its proper initial prefixed in accordance with the instructions recently sent out from this office for renumbering bridges. In making this list, the new numbers are to be placed in the marginal space at the left, and the old numbers at the right in the column headed "Remarks." Enter up under

each column the information called for by the printed headings, occupying space enough for each structure on the blank report to give all desired information, using several lines if necessary.

These blanks are punched with holes on the left-hand margin, by means of which they can be filed in a binder. Each Roadmaster will be furnished with one of these binders, and will make requisition on the Stationer for sufficient blanks so that he may keep a record of the bridge structures on his division. For this record, one sheet may be used for each bridge. For the report to the Chief Engineer, as many structures may be entered upon a single sheet as can be done distinctly, as the record will be transcribed in the Chief Engineer's office into similar record books to those which are to be kept in each Roadmaster's office.

In this report to the Chief Engineer, it is essential to know as nearly as possible the age and present condition of each structure, and the year when the structure was built or rebuilt should be stated in the column headed "Date repairs were completed."

These blanks are also designed for periodical reports, that is, either quarterly, semi-annually, or annually as may be hereafter required; in this case the columns under the heading "Inspection and Estimates," and the note in red under "Remarks" are to be observed and used.

At least once in each year, or oftener if required, a complete statement shall be made of the bridges needing repairs, giving in each column, under the proper printed heading, the number of pieces of each kind needing renewal, and, in the proper columns, an estimated cost of the work for labor and materials.

At the end of every quarter, namely, March 31, June 30, September 30, and December 31, each Roadmaster shall make a complete report of all work done during the quarter, stating as nearly as may be the material of the several kinds used, and the actual cost of labor and materials. The blank forms described are designed to be used for these completion reports.

Each Roadmaster shall enter up on his office record, all inspection reports and estimates of renewals needed, and also all completion reports and statements of the actual cost of work done, thus keeping in his office a copy of all reports sent to the Chief Engineer.

All such reports sent to the Chief Engineer will be entered up in the records which are to be kept in the office of the Chief Engineer, so that the result should be that the Chief Engineer's record should correspond in all respects to the individual records kept by each Roadmaster.

Roadmasters and Supervisors of Bridges may issue such further rules for the government of their subordinates as they may deem necessary, provided they do not conflict with the foregoing rules.

### Bills of Switch Ties for Double Throw Split Switches.

All Oak Switch Ties 6" x 10"; Cypress 7" x 10"  
Headblocks are included in Bills.

SWITCH TIE LENGTHS.	No. 10, No. 10 and No. 7 FROGS.		No. 8, No. 8 and No. 6 FROGS.	
	TRACK TIES.		TRACK TIES.	
	8 Feet.	9 Feet.	8 Feet.	9 Feet.
	Number.	Number.	Number.	Number.
8' 6"	8	..	10	
9'	4	8	3	4
9' 6"	4	4	4	8
10'	3	4	2	4
10' 6"	2	3	2	3
11'	2	3	2	1
11' 6"	3	1	2	2
12'	3	3	1	2
12' 6"	1	3	3	1
13'	2	1	3	3
13' 6"	2	2	4	3
14'	2	2	3	4
14' 6"	3	2	3	3
15'	4	1	3	3
15' 6"	4	2	4	3
16'	8 <sup>H</sup>	2	7 <sup>H</sup>	4
16' 6"	3	9 <sup>H</sup>	1	7 <sup>H</sup>
17'	1	3	1	2
17' 6"	2	4	1	2
18'	1	3	1	1
18' 6"	2	1	1	1
19'	1	2	1	1
19' 6"	1	1	1	1
20'	2	1	1	1
20' 6"	1	2	1	1
21'	1	1	..	1
21' 6"	1	1	..	..
22'	2	1	..	..
22' 6"	1	2	..	..
23'	..	1	..	..
23' 6"	..	2	..	..
24'	..	1	..	..
Total,	74	76	65	66
B.M.-Cypress	6049.0	6641.2	4955.4	5305.4
Oak,	5185.0	5692.5	4247.5	4547.5

## Bills of Switch Ties for Single Throw Split Switches.

All Oak Switch Ties 6" x 10": Cypress 7" x 10".

Headblocks are included in bills.

SWITCH TIE LENGTHS.	No. 6 FROG		No. 7 FROG		No. 8 FROG		No. 9 FROG		No. 10 FROG	
	TRACK TIE.		TRACK TIE.		TRACK TIE.		TRACK TIE.		TRACK TIE.	
	8 Ft.	9 Ft.	8 Ft.	9 Ft.	8 Ft.	9 Ft.	8 Ft.	9 Ft.	8 Ft.	9 Ft.
8'	No.	No.	No.	No.	No.	No.	No.	No.	No.	No.
8' 6"	5	..	4	..	4	..	2	..	4	..
9'	5	..	4	..	5	..	5	..	4	..
9' 6"	4	5	5	4	5	4	6	2	7	4
10'	3	5	3	4	4	5	6	5	6	4
10' 6"	2	4	3	5	3	5	3	6	4	7
11'	2	3	3	3	3	4	4	6	3	6
11' 6"	2	2	2	3	2	4	3	3	4	4
12'	1	2	2	3	3	2	3	4	3	3
12' 6"	2	2	3	2	3	2	2	3	2	4
13'	1	1	1	2	2	3	3	3	2	3
13' 6"	2	2	2	3	2	3	2	2	3	2
14'	2	1	2	1	1	2	2	3	2	2
14' 6"	2	2	2	2	2	2	3	2	3	3
15'	1	2	1	2	2	1	2	2	2	2
15' 6"	2	2	2	2	2	2	2	3	3	3
16'	1	1	2	1	2	2	2	2	3	2
16' 6"	4 H	2	4 H	2	2	2	4 H	2	5 H	3
17'	..	3 H	..	4 H	4 H	4 H	..	4 H	..	4 H
17' 6"	..	2	..	2	..	2	..	5	..	3
	..	2	..	2	..	4	..	..	..	3
	..	2	..	2	..	4	..	..	..	8
<b>Total,</b>	<b>41</b>	<b>43</b>	<b>45</b>	<b>47</b>	<b>51</b>	<b>53</b>	<b>54</b>	<b>57</b>	<b>60</b>	<b>62</b>
<b>B. M.</b>										
Cypress,	2701	3138	3004	3465	3453	3940	3614	4220	4045	4600
Oak,	2315	2690	2575	2970	2960	3378	3098	3618	3468	3943

Numbers followed by H include two headblocks, 16' or 16.5' long.



TIE BILLS FOR  
#9 SLIP SWITCHES  
TIES 6" x 10"

LENGTH	TO GO WITH TRACK TIES	
	8 FEET LONG	9 FEET LONG
	N <sup>o</sup>	N <sup>o</sup>
10'6"	9	-
11'	6	-
11'6"	6	9
12'	10	5
12'6"	7	10
13'	11	11
13'6"	4	9
14'	4	4
14'6"	4	4
15'	-	4
15'6"	-	4
TOTAL	60	60

B.M. 3683 3945

SAME FOR  
MOVABLE POINTS

10'6"	8	-
11'	5	-
11'6"	6	8
12'	10	5
12'6"	7	10
13'	11	10
13'6"	4	10
14'	5	5
14'6"	4	4
15'	-	4
15'6"	-	4
TOTAL	60	60

B.M. 3702 3960

FOR INTERLOCKING  
PLACE A, B, C, D  
ON EDGE.

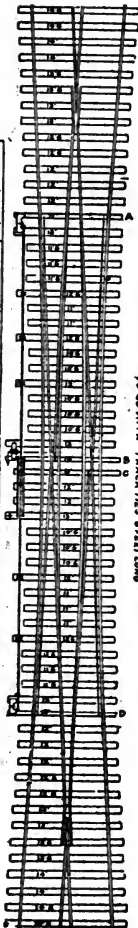

DOUBLE OR SINGLE SLIP SWITCH TIES.

MOVABLE POINTS - TRACK TIES - 1/4 SCALE.  
TO GO WITH TRACK TIES - 1/4 SCALE.

TIE BILLS FOR  
#7 SLIP SWITCHES  
TIES 6" x 10"

LENGTH	TO GO WITH TRACK TIES	
	8 FEET LONG	9 FEET LONG
	N <sup>o</sup>	N <sup>o</sup>
10'6"	9	-
11'	4	-
11'6"	2	9
12'	8	4
12'6"	6	6
13'	11	8
13'6"	4	9
14'	4	4
14'6"	2	4
15'	-	4
15'6"	-	2
TOTAL	50	50

B.M. 3072 3285

SAME FOR  
MOVABLE POINTS

10'6"	8	-
11'	4	-
11'6"	2	8
12'	8	4
12'6"	6	6
13'	11	7
13'6"	4	10
14'	5	5
14'6"	2	4
15'	-	4
15'6"	-	2
TOTAL	50	50

B.M. 3092 3300

FOR INTERLOCKING  
PLACE A, B, C, D  
ON EDGE.

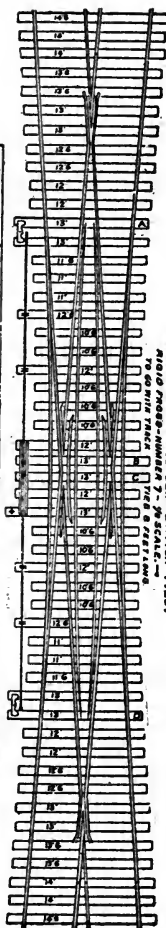

DOUBLE OR SINGLE SLIP SWITCH TIES.

MOVABLE POINTS - TRACK TIES - 1/4 SCALE.  
TO GO WITH TRACK TIES - 1/4 SCALE.

## SECTION III.

### CHAPTER XII.

ATCHISON, TOPEKA, & SANTA FE R. R. CO.

1. The following rules, as shown on the time schedules of this company, are hereby confirmed:

*A.* Section Foremen, or reliable men, must pass over and examine their sections daily, and ascertain that the track slopes, cuts and bridges are safe. This should be done in the morning.

*B.* They must see that no lumber, wood, stone, or other material is piled within six feet of the rail.

*C.* Before a rail or frog is taken out, or any obstruction is caused to the main track, or when any break or obstruction is discovered, the danger signal must be sent out in both directions, at least twenty telegraph poles from the point of danger, and a competent man must remain and keep it displayed until he is recalled by the Foreman, which must not be done until the track is known to be safe.

*D.* In stormy weather, Section Foremen must be out with their men (day or night) with proper signals, and watch those places most liable to wash or be disturbed.

*E.* It is also the duty of Trackmen and Bridgemen to put out fires set by engines, and to guard the property of others, as well as that of the railroad company, exposed to such fires, whether responsibility attaches to the Company or not.

*F.* Trackmen and Bridgemen will pay particular attention to the telegraph lines. In case the wires are found broken or on the ground, crossed or in any way obstructed, they must be repaired in a temporary manner immediately, and where such repairs are impracticable, notice must be given to the nearest telegraph office by messenger or the earliest means practicable.

*G.* At all times when work is going on which renders it necessary for trains to reduce speed, a green flag must be set at side of track at least twenty telegraph poles from the spot, on engineman's side, in each direction, as a caution to approaching trains to run slowly. After a severe storm of rain, wind or snow, or a thaw, a hand-car must be sent over the road before the passage of regular trains.

*H.* Hand-cars or other property belonging to the Company must not be used except for the business of the Company.

*I.* Trackmen and Bridgemen must at all times, hold themselves in readiness to aid in the passage of trains, and in case of accident must obey the orders of the conductor of the delayed train.

*J.* Every man at work on the track or bridges must bear in mind that in operating the road under telegraph orders a train may pass at any moment.

*K.* All Foremen must see that their gangs are supplied with the proper signal flags, lanterns, etc., and they are thoroughly instructed as to their use.

*L.* Trackmen must see that fences on each side of the road and at crossings are in good order, and that the cattle guards are in repair. A break in a fence should not be overlooked, and when it can not be repaired for want of material, the Section Foreman must give the Roadmaster immediate notice of it, stating what material is required. When fences are taken down for any purpose, they must be replaced without unnecessary delay.

In addition to the above, and in order to make some points clearer or more emphatic, the following must be observed.

Referring to Rule 1—*A*. At times when there is no apparent danger of damage to track from freshets or other special causes, the Foreman may send a track-walker to examine those parts of his section, which he does not personally examine on that day, but in this case as in all similar cases, the Foreman will be held personally responsible for the acts of the track walker or of any person to whom he intrusts the supervision of any of his work.

Special attention is called to Rule 1—*C* above. It is not sufficient to set a danger signal in the track, but in all cases a man must remain and keep the signal displayed. A red light or flag, when used as a danger signal, must never be out of the hands of a reliable man.

Referring to Rule 1—*D*. When any break or ob-

struction is discovered, the Foreman must first see that danger signals are properly placed as directed in Rule 1—*C*. At night or during storms and fogs, a red signal must not alone be depended on for stopping a train, but two torpedoes must be placed upon the rail on the Engineman's side of the track, at points one rail length apart and at a distance of not less than one quarter of a mile from the signalman, in the direction of the approaching train. Another torpedo should be placed on the rail near the stand of the signalman, and in case the engineman fails to take notice of the first two torpedoes the signalman must be prepared to secure his attention by throwing a clod of earth or some similar substance at the cab window of the engine. The Foreman, after having gone over his section, and having seen that all unsafe places are protected, must take steps to repair the damage, and if, with his force he is not able to do this promptly, he must at once report by telegraph to the Roadmaster.

Referring to Rule 1—*G*. A green flag, when used as a signal for caution, should not be set upright in the ground, but should be attached to a short post, set eight feet from the rail on the engineman's side of the track. The top of the post should be four feet above the top of the rail, and the flag stick should be fastened to the post in a horizontal position so that the flag will hang free and not be obstructed by weeds or grass and be in plain view of the engineer.

When a caution signal is used for a considerable length of time, as during the erection of a bridge, a

# STANDARD ROAD BEDS.

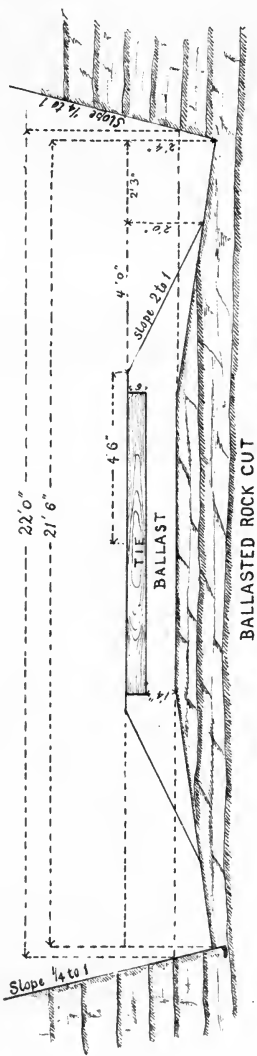
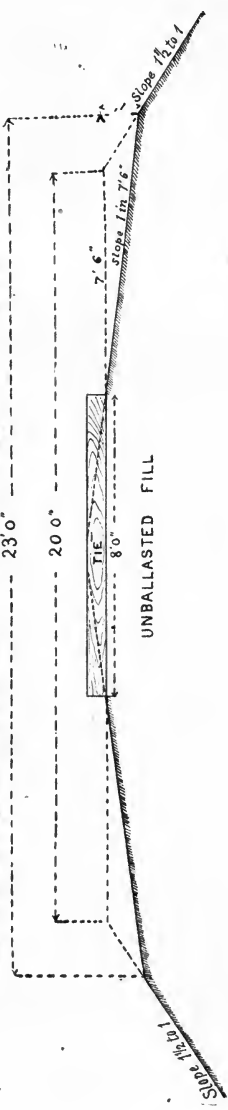

## A. T. & S. F. R. R.

# STANDARD ROAD BEDS.

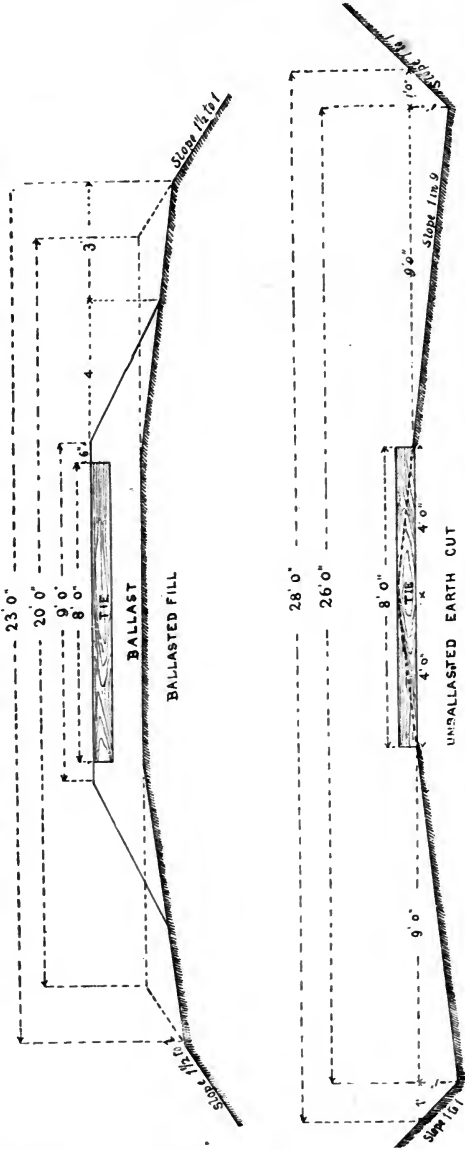

# A.T. & S.F.R.R.





sign board with the word "slow" painted in large letters should be used instead of a green flag. Any case of disregard of either danger or caution signals on the part of the engine or trainmen, or any instance of reckless or dangerous speed of trains over bad track, should be immediately reported to the Roadmaster, with a full written statement of the facts and circumstances.

Referring to Rule 1—*H*. Neither hand cars nor any other tools or materials belonging to the railroad company are to be lent to persons not in the company's service, nor to be used except for the company's work.

Hand-cars and push-cars, when not in actual use, must be lifted from the track and placed entirely clear of passing trains, and of all highway crossings, and when out of sight of the men, they must be locked.

The use of hand-cars or push-cars on the track at night, or during fogs or storms, is extremely hazardous and is not allowed except in cases of emergency, and in those cases the greatest care must be used to prevent accidents. At night lanterns must be displayed on each end of the car, and during fogs and storms the caution should, if necessary, extend even to the length of having flagmen out in each direction, and running the car no faster than these flagmen can walk.

When more than one hand-car is used by a gang or when gangs under different foremen are running over the track in the same direction, the cars must be kept at least two telegraph poles apart.

In no case must a hand-car or push-car be attached to a train or engine in motion.

Loaded push cars on the track are to be considered as obstructions, and must be protected by danger signals.

Except in cases of emergency, no work which will obstruct the track should be done during fogs or storms. During such weather, after going over his section to see that everything is safe, the Foreman should employ his men at the section tool house, cleaning, repairing and grinding tools, fitting up old bolts, spikes, etc., for use, and such other work of like character as he may find to do.

Track Foremen, when at work on their sections, must have their time cards with them, and must carefully observe the time of all schedule trains.

All culverts must be kept free from accumulations of mud, brush, driftwood or logs, and ditches of the full width of the openings of culverts must be cut both at the inlet and outlet, down to a level with the top of the paving in the culvert. Constant care should be used in this matter, but special attention should be given it in the spring, and in the first week in April of each year is here appointed as a time during which all culverts must be carefully examined and cleaned.

Where the track is fenced, foremen must see that the gates at farm road crossings are kept closed and if these are frequently left open by owners of land, the Foreman must make a written report of the fact to the Roadmaster.

A. All combustible material must be removed a

safe distance from all company buildings, bridges and cattle guards, and all company's material such as cross ties, telegraph poles and bridge material piled on the right of way.

*B.* The tops of all piers and abutments must be kept clean, and water barrels on bridges at all times kept full of water.

*C.* When for any reason it is necessary to build a fire on or adjacent to the right of way, the Foreman must personally see that it is completely extinguished before leaving the scene of the fire.

All tools and material, in small pieces, such as bolts, spikes, etc., when not in actual use must be kept inside the tool houses, and all material, such as rails, frogs, cross-ties, etc., when not in track must be kept in neat piles. All car doors, bolts, links, pins, etc., found along the track must be picked up and taken without delay to the section tool house. Any package or articles of freight that may fall from any train must be taken to the nearest station and delivered to the station agent, from whom a receipt will be obtained, or in case the article is too heavy to be loaded or carried upon the push-car it must be promptly reported to the nearest station agent. A full report of the material should be sent to the Roadmaster without delay.

On the first Monday in alternate months, beginning with January in each year, all old material, such as broken car links, draw bars, brake beams, broken or unserviceable wheels and axles, and refuse track material, or any useless or unsightly material, will be

loaded on cars, under the direction of Roadmasters, and forwarded to destination as directed from time to time. Foremen must prepare for this periodical cleaning up by gathering together all such material as described above, and piling it beside the track convenient for loading. This work must be completed on the Saturday previous to the day for loading the material, new or old, belonging to the railroad Company, and Foremen must be vigilant and energetic to prevent the theft of material by vicious persons, and must do all in their power to secure the punishment of persons guilty of such theft.

Requisitions for new tools will not be honored unless those broken or worn out are returned to the Roadmaster or satisfactory reason given for those missing.

All Foremen are expected to remain with their men and personally superintend all work. When gangs are small the Foreman must, himself, assist in the work.

No time must be returned for laborers except they are actually at work for the Railroad Company, and Foremen are cautioned against detailing men out of their gangs to do work such as cutting firewood or assisting in the kitchen of the section house or work trains.

It must be distinctly understood that for a Foreman to return time on the Company's books for any work done for himself, or other persons, is dishonesty, which will be followed by his discharge from the Company's service and by criminal prosecution.

The borrowing or lending of money between an employe and his superior, and the soliciting or contributing of money for the purchase of testimonials to be presented to superior officers, is positively forbidden, and any officer or employe of this department who asks or receives money or any valuable thing whatever in consideration for, or on account of, employment or place given, will be immediately and dishonorably dismissed.

Collections on account of the A. T. & S. F. Hospital Association will be made from all employes whether working a full month or a fractional part thereof, and upon the basis of the total gross earnings, for the month in each case, at the following rates:

From all employes earning during the month \$30.00 or less.....	25 cents
More than \$30.00 and less than \$60.00.....	35 cents
More than \$60.00 and less than \$100.00....	50 cents
\$100.00 or over.....	\$1.00

Persons temporarily employed during emergencies, or performing labor under contract, shall be exempted from assessments and excluded from all benefits of the Association.

#### RULES AND INSTRUCTIONS TO TRACK FOREMEN CONCERNING THE DETAILS OF TRACK WORK.

Perfect track must have the following essential characteristics:

1. Good surface.
2. Good drainage.
3. Good line.
4. Accurate gauge.
5. Tight joints.

In surfacing track the use of the track level is of primary importance. No foreman is allowed to trust his eyes to decide when track is level, but must keep his track-level and sighting boards in constant use when surfacing track.

Upon all straight track, except when approaching curves, the track must be level.

Upon all curves the outer rail must be higher than the other and the amount of this super-elevation of the outer rail is proportioned to the "degree or rate" of the curve.

In approaching a curve it is necessary to pass gradually from level track to that having the full super-elevation required on the outer rail of the curve, and for convenience we will call the gradual change the easement or "run-off." The length of the easement will be 120 feet for each curve.

TABLE SHOWING AMOUNT OF SUPER-ELEVATION AND LENGTH OF EASEMENT FOR DIFFERENT CURVES.

Degree of Curve.	Amount of Super-Elevation	Length of Easement.
1	$\frac{3}{4}$ inches	120 feet
2	$1\frac{1}{2}$ "	"
3	$2\frac{1}{4}$ "	"
4	3 "	"
5	$3\frac{3}{4}$ "	"
6	$4\frac{1}{2}$ "	"
7	$5\frac{1}{4}$ "	"
8	$5\frac{1}{4}$ "	"
9	$5\frac{1}{4}$ "	"
10	$5\frac{1}{4}$ "	"

In case of compound curves the super-elevation called for in the table will be given to the curve of greatest degree throughout its entire length. The

easement shall then be used on the curve of less degree until the proper super-elevation for that curve is reached.

In case any tangent is too short to provide for the length of easement given in the table, the tangent shall be divided into two parts in proportion to the degree of the curves which it connects, the greater part being next to the curve of greater degree. At the dividing point so found make ninety (90) feet or nearest three rail lengths of the tangent level, then use easements in each direction for 120 feet, using so much of the curve as is necessary for that purpose.

In case of doubt as to the degree or rate of any particular curve, the following rule will enable the Foreman to determine the degree for himself.

Take a cord or small line  $213\frac{1}{2}$  feet long, having a knot tied at the middle point, stretch the line tight and place the ends against the gauge side of the outer rail of the curve. Measure the distance from the knot at the middle of the line to the gauge of the outer rail and the number of feet in this distance will be the degree of the curve.

No curves will have a super-elevation greater than  $5\frac{1}{4}$  inches, because curves sharper than those shown in the above table are only found at places where trains and engines can not run at a high rate of speed. The table above must not be applied to curves in yards, for which the proper super-elevation can not be specified in general instructions, but must be governed by circumstances, and it will be the subject of special instructions from the Roadmaster to the Track Foreman.

Special attention must be given to secure good drainage of the roadbed and to this end the cross section of the road-bed and ballast must be made to conform to the standard diagrams, which will be furnished to all Roadmasters and Track Foremen.

In no case must earth be heaped against the side of stone or gravel ballast, but the earth roadbed must be cut away so as to give perfect drainage from the bottom of the ballast.

In many places the drainage of the roadbed is of the first importance, because without it the other essentials of good track cannot be maintained.

When landslides occur they should be opened by cross drains, which should be filled with rock.

In adjusting the line of track, foremen must be careful to keep the general line made in the original construction of the road, unless under special instructions to make changes, in which case the proper stakes for the guidance of the Foreman must be set by the resident engineer.

The adjustment of the line of track should be confined to removing short bends and deviations from the general line, and the Foreman should remember that track can not be maintained in good line unless the rails themselves are free from "kinks" and unless they are properly bent to fit the curves upon which they are used.

Track can not be properly lined unless it is uniformly and accurately gauged.

The correct gauging of track is of great importance, and in order to secure accuracy in this matter each superintendent is furnished with test gauges,



and is required from time to time to test the track gauge used by each Foreman and to see that this tool is in proper condition and also to test the track upon each section to see that proper care is taken in gauging.

On straight lines, except at turnouts and in yards, the gauge of the track should be 4 feet 8½ inches.

On all curves the gauge should be wider than on straight lines. The following table shows the gauge of track to be used upon curves of different degrees:

DEGREE OF CURVE.	Gauge of Track.	Increase from Standard Gauge.
1	4' 8½"	½ inch
2	4' 8½"	⅛ "
3	4' 8½"	¼ "
4	4' 8¾"	¼ "
5	4' 8¾"	⅓ "
6	4' 8¾"	⅓ "
7	4' 8¾"	⅓ "
8	4' 8¾"	⅓ "
9	4' 9"	⅓ "
10	4' 9"	⅓ "
11	4' 9"	⅓ "
12	4' 9½"	⅓ "
13	4' 9½"	⅓ "
14	4' 9½"	⅓ "
15	4' 9½"	⅓ "
16	4' 9½"	⅓ "
17	4' 9½"	⅓ "
18	4' 9¾"	⅓ "
19	4' 9¾"	⅓ "
20	4' 9½"	1 "

For securing accuracy in gauging curves, a gauge with adjustable end will be used. These gauges will be painted red, and when using the red gauge the Foreman must give careful attention to see that it is properly adjusted for the curve upon which it is being used.

The nuts of track bolts must be kept tightly screwed up and every joint must be full bolted. Track can not be maintained in good shape if the joint fastenings are allowed to get loose. If allowed to remain loose for any considerable length of time the bolts become so much worn that they are no longer fit for service.

The work of tightening bolts must be done under the personal supervision of the Foreman, who is expected to see not only that all nuts are tight, but that any nut lock device which may be in use on his section is properly applied and adjusted.

Loose joints are not only inconsistent with good track but by their rattling they advertise the bad condition of the track—an advertisement which injures the character of the road.

Switches, frogs and turnout leads must be carefully laid in accordance with standard diagrams, which will be furnished whenever needed.

Turnouts from main track must be ballasted to a depth of one foot below the bottom of the switch ties.

Tracks at turnouts must be laid level except when turning out from curved main track, in which case special instructions will be given.

Gauge of tracks at all turnouts, whether on straight or curved line, will be 4 feet 9 inches, which is  $\frac{1}{2}$  inch wider than standard gauge. This 4 feet 9 inch gauge shall extend clear through the switch, including the frogs and point rails, or slide rails, and outside of these limits the gauge shall be narrowed to 4 feet  $8\frac{1}{2}$  inches in a distance of 30 feet in each direction.

In large yards where many leads turn out from one track, the guage of this track should be 4 feet 9 inches for its whole length.

Guard rails at frogs and switches shall be spaced 2 inches from main rail, measured  $\frac{1}{2}$  inch below top of rails, and braced in that position.

Guard rails shall be of same height as main rails, and the flange of each guard rail shall be planed off on main rail side as follows, to allow for spiking both main and guard rails:

71	pound	rails,	$1-\frac{1}{2}$	inches.
66	"	"	$1-\frac{1}{2}$	"
61	"	"	$1-\frac{1}{4}$	"
56	"	"	1	inch
52	"	"	1	inch

At frogs, guard rails and switches the spaces between rails in which the feet of switchmen are liable to be caught shall be filled with wooden blocks (or as otherwise ordered) so as to prevent, as far as possible, this cause of accident.

Three sizes of frogs are standard and no other size will be used without special permission. Number 9 (1 in 9) angle 6 deg. 22 min. This frog is the main frog in nearly all main line turnouts and requires a 7 deg. 30 min. curve for lead. Number  $6\frac{1}{2}$  (1 in  $6\frac{1}{2}$ ) angle 9 degrees 00 min. This is the crotch frog in all 7 degree 30 min. main line double throw turnouts. It is also used as a main line frog in turnouts where curve of lead is 15 degrees. Number  $4\frac{1}{2}$  (1 in  $4\frac{1}{2}$ ) angle 13 deg. 00 min. This is the crotch frog where number  $6\frac{1}{2}$  frogs are used in a double throw switch.

Slide rails of stub switches should generally be 30



# STANDARD RAIL SECTION, A.T. & S.F.R.R.

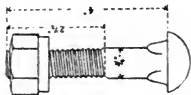
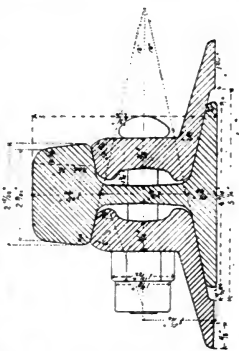
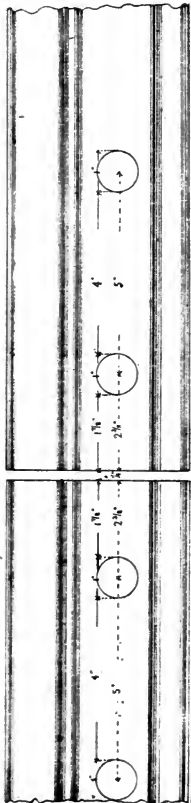
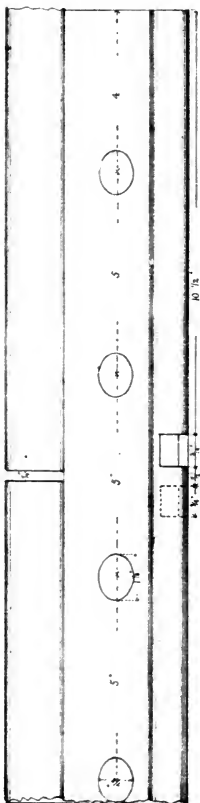

SECTION & SPLICE

71 LBS. RAIL.



feet long, spiked for five feet at fixed end if on 7 deg. 30 min. curve, and 12 feet if on a 15 deg. curve.

Track foremen must give careful attention to putting in and maintaining street and road crossings. Street crossings in cities and towns will consist of a plank outside of each rail and the space between the rails fully planked, except for the flange groove between each rail and the nearest plank. Country road crossings and private farm crossings will consist of four planks—one on each side of each rail, and the space between the two inner planks must be well filled with broken stone or earth. All the planks in a crossing must be cut to an even length and laid evenly. Planks must be secured to tie by a sufficient number of 8 inch boat spikes—common track spikes must not be used. The inside plank next to the rail should be laid so as to leave 3 inches between the head of the rail and the edge of the plank. On the outside of the track the under edge of the plank should be notched to set over the spikes and the planks laid close to the rail. The ends of the plank shall be rounded and beveled off as shown on drawing.

In surfacing track care must be taken not to raise the track in general off its bed, but to raise the low places only so much as is necessary to bring them up to the general surface of the track. When track is raised it is necessary to give special attention to the tamping of earth, or ballast under the ties. Tamping should extend from a point twelve inches inside each rail, outward to the ends of ties. The tamping should be hard and uniform and joint ties should be tamped last.

In widening cuts, or in cleaning out ditches in cuts the earth should not be cast out of the cut and left near the edge of the slope where the first rain will wash it back into the cut. Whenever practicable, material taken out of cuts should be loaded on push cars and carried to the adjacent embankment, where it will always be needed. We shall thus secure a double result from the labor of removing the material.

The cross-ties in track must be laid with the middle of the tie at the center of the track, so that the ends of the ties will project an equal amount on each side of the rails.

All spikes must be driven perpendicular to the face of the tie. Each end of each tie must be spiked to the rail by two spikes, one on the inner or gauge side and one on the outside of the rail. The outside spike of one rail must be opposite the outside spike of the other rail and the inside spike of one rail must be opposite the inside spike of the other rail. This rule must be observed on straight lines as well as on curves.

Where track is laid with good oak ties rail braces must be used both on inside and outside rails at centers and quarters on all curves of six degrees and over. When track is laid with cedar or other soft wood ties rail braces must be used on inside and outside rails on all curves of three degrees and over, by placing them at centers and quarters on curves from three degrees to five degrees, and at centers, quarters and at one end of each rail near the joints, on all curves of six degrees and over.

Foremen will be expected to keep their sections neat and clean by picking up all material not in the



track and either carrying it to the tool house or piling it in convenient places by cutting the weeds and brush within the limits of the Railroad Company's right of way, by burning all useless and valueless rubbish; by keeping ditches cleaned out, &c., &c., &c.

All weeds upon the top of the road-bed on embankments which are within two feet of the ends of the cross-ties, and in excavations, all weeds to the outside of the ditches must be cut close to the ground with a shovel and in all other places weeds will be cut with a scythe. Weeds cut with a shovel should be left to lie where they fall, because throwing them out of the track or off the roadbed removes earth which must be replaced at extra cost.

Foremen in charge of section houses must see that they are kept neat and clean and the section house yards free from rubbish.

An untidy section will be considered as evidence of an incompetent Foreman.

In relaying or renewing track, foremen will observe the following:

Rails must not be thrown from a car in unloading but must be "skidded" to the ground so as to avoid the danger of bending or breaking.

Rails having bad "kinks" or surface bends should not be laid, but should be thrown out until they can be straightened. All rails for use on curves of two degrees or sharper, must be curved before being laid. The curving must not be done with a sledge, but "rail benders" will be furnished which are to be used both for curving rails and for straightening those which are too crooked for use.

The following table shows the amount of curve to be given to rails of different lengths for curves of different degrees. The middle or dinate of a curved rail is the distance from a line or cord drawn between the ends of the rail to the corresponding part of the rail at its middle:

DEGREE OF CURVE.	MIDDLE ORDINATES.			
	24 Feet Rail.	26 Feet Rail.	28 Feet Rail.	30 Feet Rail.
	Inches.	Inches.	Inches.	Inches.
1	$\frac{1}{4}$	$\frac{1}{4}$	$\frac{1}{4}$	$\frac{1}{4}$
2	$\frac{1}{2}$	$\frac{1}{2}$	$\frac{1}{2}$	$\frac{1}{2}$
3	$\frac{3}{4}$	$\frac{3}{4}$	$\frac{3}{4}$	$\frac{3}{4}$
4	1	1	1	1
5	$1\frac{1}{8}$	$1\frac{1}{8}$	1	$1\frac{1}{4}$
6	$1\frac{1}{4}$	$1\frac{1}{4}$	$1\frac{1}{4}$	$1\frac{1}{2}$
7	$1\frac{1}{2}$	$1\frac{1}{2}$	$1\frac{1}{2}$	$1\frac{3}{4}$
8	$1\frac{3}{4}$	$1\frac{3}{4}$	$1\frac{3}{4}$	1
9	$1\frac{7}{8}$	$1\frac{7}{8}$	$1\frac{7}{8}$	$1\frac{1}{2}$
10	$1\frac{1}{2}$	$1\frac{1}{2}$	$2\frac{1}{4}$	$2\frac{1}{8}$
11	$1\frac{5}{8}$	2	$2\frac{1}{4}$	$2\frac{3}{8}$
12	$1\frac{3}{4}$	$2\frac{1}{8}$	$2\frac{1}{2}$	$2\frac{5}{8}$
13	2	$2\frac{3}{8}$	$2\frac{5}{8}$	$3\frac{1}{8}$
14	$2\frac{1}{8}$	$2\frac{1}{2}$	$2\frac{7}{8}$	$3\frac{3}{8}$
15	$2\frac{1}{4}$	$2\frac{5}{8}$	$3\frac{1}{8}$	$3\frac{5}{8}$

The ordinate at the quarter shall be three-fourths of the middle ordinate.

The allowance for contraction and expansion of rails must be gauged by iron "shims" and not by wooden chips nor "by guess." Shims  $\frac{1}{8}$  inch thick will be used in hot summer weather,  $\frac{1}{4}$  inch shims for moderately cool weather, and  $\frac{3}{8}$  inch shims for cold weather in winter.

When any extensive renewal of track is made the old rails which are taken out must, as soon as possible, be loaded and sent to division headquarters, where

they are to be cut, drilled, sorted and piled, so as to be ready for use in side tracks or elsewhere. No pieces of rail less than fifteen feet in length will be considered fit for use in main track. All shorter pieces of iron rails and all battered iron rails will be considered as scrap iron. Broken or worn out steel rails will be disposed of under special instructions.

#### TIES.

The uniform and accurate spacing of ties must be carefully attended to, and foremen must see that where slots are punched either in the base of rails or in the base of angle splices that a tie is placed under and a spike driven in the slot.

Hardwood, pine or cedar ties will be used, and will be laid at the rate of 2,640 to 3,168 per mile of main track, as ordered from time to time. On siding 2,640 ties per mile will be laid. The ties must be carefully bedded before the rails are laid, so as to have a firm and solid bearing for at least two feet from each end, and so as to conform to the true grade line as indicated by the stakes of the engineer. Straight edges must be used in surfacing ties, and must be kept in such repair as to bring the ties to a true surface.

The ties must be adzed not only so as to take them out of wind, but so as to give a horizontal face of at least five (5) inches.

Special care must be taken to select large ties for the joints and shoulder ties, and the shoulder tie must be so spaced as to give 8 inches between the joint and shoulder ties. Ties must be laid at right angles to the center line of track, and must be so

placed that the center of the ties will come on the said center line of track. The ties in each rail-length between the shoulder ties must be evenly spaced over the intervening distance.

Good serviceable cross-ties must not be removed from the track, and when inserting new ties the Foreman must exercise the greatest care and judgment and see that they are so distributed that all portions of the track shall be made equally safe.

Foremen must keep a supply of wooden plugs always on hand, and whenever a spike is drawn from a sound tie the whole must be immediately plugged.

Spikes must be drawn from all old cross-ties removed from the track. The old ties shall then be piled so that they can be inspected by the Roadmaster, after which they shall be disposed of as he directs.

Old spikes, splices, bolts and other track material unfit for use, shall be collected and kept at the tool house and subject to the Roadmaster's disposal.

Track Jacks, when in use, must always be placed on the outside of the rail.

No employe of this department must be discharged to make room for another except for good cause.

#### RULES AND INSTRUCTIONS CONCERNING REPORTS AND THE USE OF BLANK FORMS.

The following is a list of all the blank forms required for the use of foremen. In ordering these blank forms, both the name and consecutive number shall be given also the quantity of each required:

##### TRACK BLANKS.

Form 643. . . . . Discharge Tickets

“ 650. . . . . Board Bills.

- Form 952.....Track Material Report.  
 " 954.....Report of Rails worn out and taken  
                   from track.  
 " 955.....Broken Rail Report.  
 " 956.....Fire report.  
 " 957.....Work Train Report.  
 " 963.....Report of Accidents to Trains.  
 " 964.....Report of New Side Tracks.  
 " 1001.....Monthly Time Book.  
 " 1003.....Foreman's Tool Report.  
 " 1407.....Report of Stock Killed.  
 " 1428.....Report of Accidents to Persons.

## BRIDGE AND BUILDING BLANKS.

- Form 640.....Discharge Tickets.  
 " 650.....Board Bills.  
 " 956.....Fire Report.  
 " 963.....Report of Accident to Trains.  
 " 1001.....Monthly Time Book.  
 " 1003.....Foreman's Tool Report.  
 " 1428.....Report of Accidents to Persons.

## WATER SERVICE BLANKS.

- Form 650.....Board Bills.  
 " 652.....Discharge tickets.  
 " 1001.....Monthly Time Book.  
 " 1024.....Monthly Water Report.  
 " 1026.....Daily Water Report.  
 " 1028.....Tool Report Pump Engineer.  
 " 1033.....Oil and Waste Receipt.  
 " 1034.....Fuel Receipt.  
 " 1428.....Report of Accidents to Persons.

## USE OF FORMS.

Discharge tickets must never be issued except to

employes actually leaving the service of the Company, either voluntarily or by discharge for cause. No person receiving a discharge ticket will be again employed until after the expiration of thirty days from the date of discharge.

Board bills must be written up to the end of each month, signed personally by both the boarding boss and Foreman, and sent in with the time book.

It must be for board only, and cover no other time than that of the current labor month. It must not be returned in favor of any person not actually engaged in boarding employes of the Company. If sanctioned by the Foreman an allowance of not to exceed one dollar per week for the time worked, may be added to the board bill to cover tobacco, etc., furnished by the boarding boss. In case board bills have accumulated by sickness of the employe, a special order must be procured of the Roadmaster, to increase the amount for collection on board bill.

The time book must contain, not only the correct report of the time actually worked by each man in a gang, but must show the description of work upon which each man was engaged each day.

Foremen will note daily in their time books the general character of the weather during each day, stating weather clear, foggy, wet or snowing; also if calm or windy, giving direction from which the wind blows.

The time books furnished by the Railroad Company, and which are to be returned to headquarters at the end of each month, must be used for the original entries of time. Foremen must not keep time in a

separate book and copy into the regular time book at intervals.

In order to make a correct distribution of the labor accounts at the close of each month, it is imperatively necessary that great care should be taken in making the entry to the proper account, as hereafter explained. Foremen must carefully read and observe the following

#### GENERAL DIRECTIONS:

Enter the full name, occupation and rate of wages of every man under your charge, in the proper place at the head of the page, and be careful to write plainly and spell the name correctly to guard against error in making out the pay roll.

The first page of each time book is for the Foreman, and runs from the 1st to the 31st day, showing the full calendar month for which the book is returned; the succeeding pages are for the laborers, and the time commences with the first day of the month and runs to the last day of the calendar month for which the book is returned.

Make the check-mark for each day, or part of a day's work, in the square under the day of the month, and on the line opposite the printed description of work done. Make no mark of any kind under a date when no work was done.

Make the proper check-mark for each day or part of day's work in the line of "totals," at the bottom of the page, as well as opposite the account, but make no mark or figure in the columns headed "time" and "amount," except the total number of days worked in

the month, which you will enter at the bottom of the column headed "Time."

Should a discharge ticket be given, note the fact under the head of "Remarks," and under the same head give the number of days worked and the amount of the discharge ticket.

#### SPECIAL INSTRUCTIONS.

1. All labor of every description not particularly described in the time book, must be entered upon a blank line of the time book, and a description of the work, with its location fully set forth in the margin.

2. All foremen are required to study the time book directions and become familiar with the same, that no doubt can arise as to the absolute correctness of the distribution of labor as it may appear in the time books.

3. All foremen are expected to make a correct distribution of their own time to the several labor accounts in the same manner as that of the laborers under their charge.

#### Track Material Report:

This blank should correctly show the amount of track material received and used by each Foreman during the month. In this report the quantities of each article must be verified by actual measurement of all rails and pieces of rails, and a correct count of all other material. This report must be made out the first day of each month and immediately forwarded to the Roadmaster.

#### Foreman's Tool Report:

This blank must show the number and condition of



all track tools in charge of each Foreman. Make a correct statement of the tools in your possession and in the column headed "Remarks" note the general condition of the same. This report must be made out and forwarded to the Resident Engineer or Roadmaster the first day of each month.

**Report of rails worn out and taken from track:**

This form must accurately show the location of each worn out rail taken from the track during the month; also in the proper column notation must be given showing what part of each rail removed was defective. This report to be made the first of every month and sent to the Roadmaster.

**Broken Rail Report:**

This report must be made out and sent to the Roadmaster by the first passenger train following the discovery of the accident.

**Fire Report:**

This blank form must be properly filled up and sent to the Roadmaster by first passenger train following the extinguishment of the fire.

**Work Train Report:**

This report showing all the details of the day's work, must be made daily, immediately after the close of work, and sent to the Roadmaster by first passenger train thereafter.

**Report of Accidents to Persons:**

In case of any accident, to any person, happening on your section, a full report of the same must immediately be made and sent to the Roadmaster. Even if the injury is apparently of little importance all information necessary to a full knowledge of the case

must be given. Under the head of "Remarks" give all the details not particularly suggested in the blanks above. Use one blank for each individual case.

#### Report of Accidents to trains:

In case of any accident to a train occurring on your section, no matter of how seemingly small importance, make a full report of all information you may be able to obtain connected with the matter. Particularly note if engine or cars leave the track. Make out this report immediately after the occurrence of the accident and send to roadmaster by first passenger train.

#### Report of New Side Track:

This form is for the use of Roadmasters only, and is intended to show all changes made in side tracks, either the construction of new tracks, or changes in the length of those previously constructed. This report the Roadmaater will send to the Superintendent.

#### Report of Stock Killed:

When stock of any description has been killed or injured by a passing train, or from any other cause connected with the operation of the railroad, the Foreman of the section on which the accident occurred will immediately obtain all the information possible in connection therewith, and make a full report of the same according to the instructions printed upon the blank form. This report must be immediately sent to the claim Agent at Topeka.

NOTE.--The track time book, and all reports required of track foremen must be sent to the Roadmaster; the bridge and building time book and all

time reports made by bridge and building foremen will be sent to the resident engineer; the water service time book and all reports made by foremen or pumping engineers, must be sent to the Superintendent or Resident Engineer, as directed.

#### RULES GOVERNING BRIDGE INSPECTION.

In order that our bridge inspection may be thorough and uniform on all divisions, the following rules will be observed:

A Bridge Inspector shall be appointed by and report to the General Foreman of Bridges and Buildings on each operating division. He shall be a competent and experienced bridge carpenter, and shall be selected with regard to his peculiar fitness for the work. He shall be provided with the following tools:

50-foot tape line.

Plumb bob and line.

2-foot rule.

Hatchet.

Brace and bit.

Monkey wrench.

Small broom.

Necessary paint pots, brushes and stencils.

Velocipede car.

Also note book, for inspection notes in the field.

It shall be his duty to carefully examine all bridges trestles, culverts, cattle guards, stock yards and buildings, taking the main line of the division first, and branch lines in the order of their importance, He shall begin on or about the first day of the month, and complete the inspection on or about the last day

of the month, the idea being to have a thorough inspection once a month. In addition to the above, the General Foreman of bridges and buildings, Roadmaster and Resident Engineer, in company with the Bridge Inspector, shall make a combined inspection in the month of April. In the month of October of each year the Superintendent, Resident Engineer, General Foreman, Roadmaster and Bridge Inspector, shall make a special inspection, and all important repairs and renewals for the coming year be at that time considered and determined upon, and a full and complete report of the same made to the General Superintendent.

#### RULES.

Rule 1. The day and hour shall be noted when inspection is made of each particular bridge or structure.

Rule 2. All timber and piling shall be carefully examined, and its condition as to soundness, cracks or flaws noted. The condition of piles or posts near the surface of the ground or water line will be particularly observed.

Rule 3. See if bents are plumb, and if the stringers have a full bearing on the caps, and the caps on the piles or posts.

Rule 4. See if the bridge is in good line and surface, and if the foundations or supports are solid and unyielding.

Rule 5. See if sway bracing is well bolted and spiked.

Rule 6. See if bank walls and supports are in

# STANDARD SIGNS

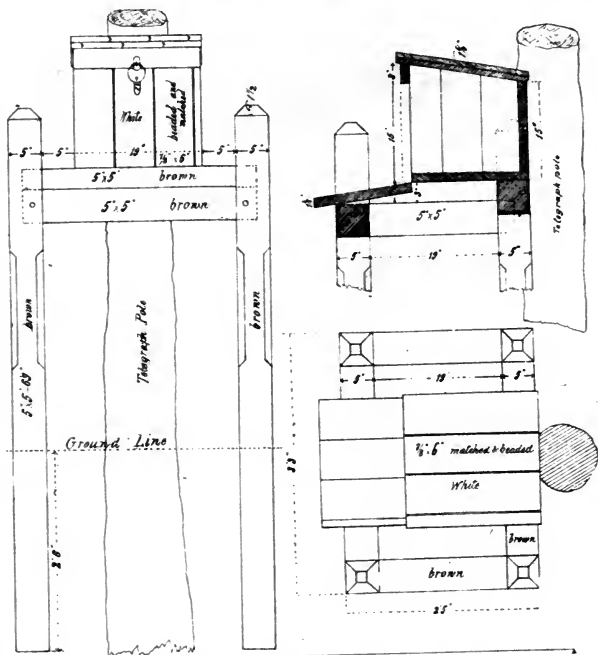

RELAY BOX AND GUARD

**A.T.&.S.F.R.R.**

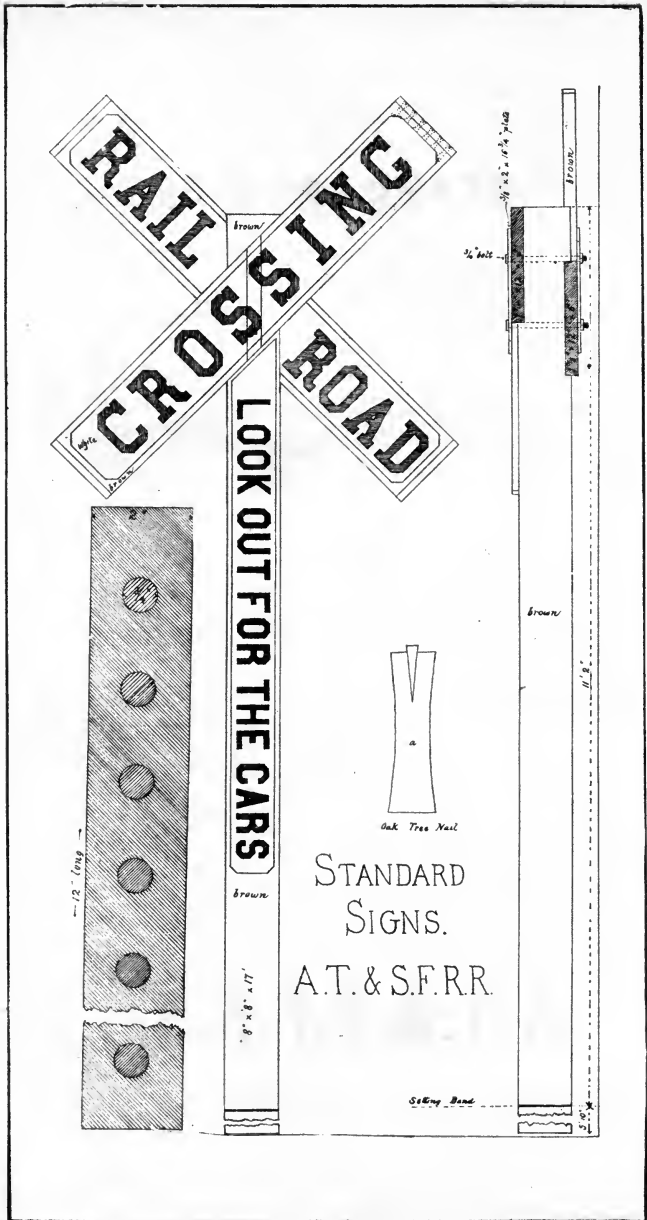

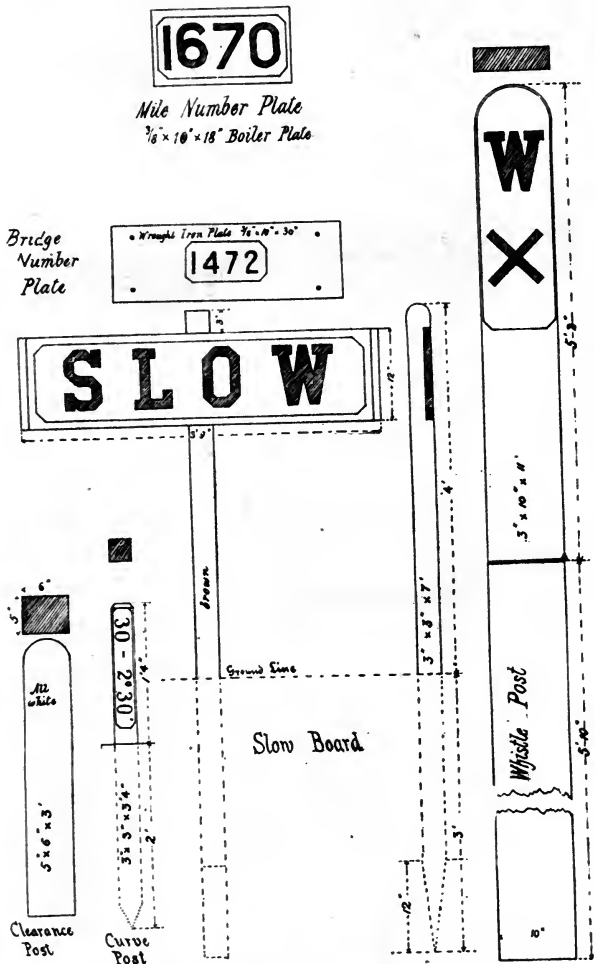

STANDARD SIGNS.  
A.T. & S.F.R.R.

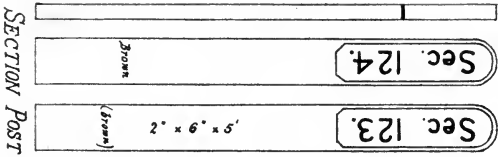
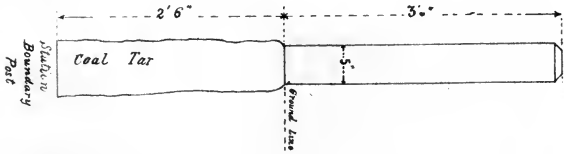

TELEGRAPH SIGNAL STATION SIGN.

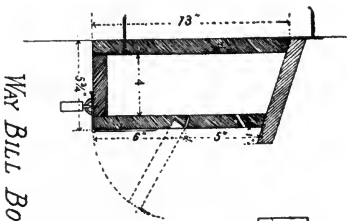

WAY BILL BOX

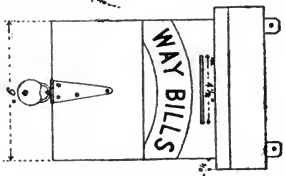

STANDARD  
SIGNS.  
A. T. & S. F. R. R.



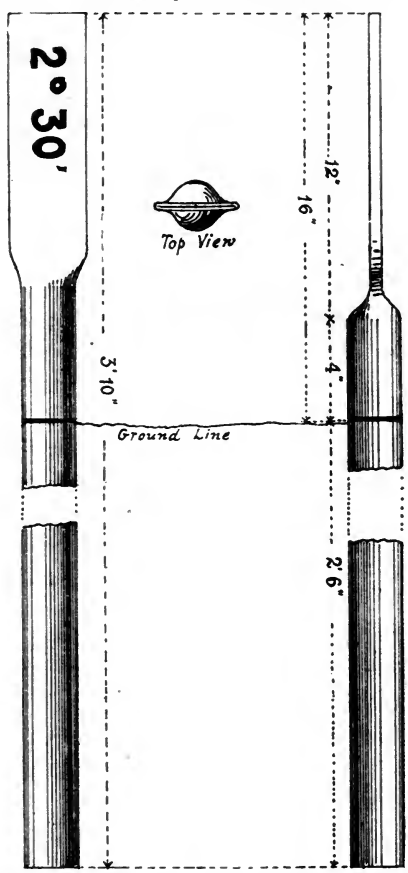

Curve Post of old Boiler Flue.

STANDARD SIGNS

A.T.&S.F.R.R.

good condition, and if earth or ballast is kept away from ends of stringers and wall plates.

Rule 7. See that no waste or other material liable to burn is allowed to accumulate on or about the bridge, notifying the General Foreman, when necessary, that he may cause to be removed from underneath the trestle or bridge, any undergrowth or drift.

Rule 8. See that bolts, nuts and washers are in their proper places.

Rule 9. See that bridge numbers are properly repaired and painted, it being intended that bridge numbers be painted when necessary, without removing the number board from the bridge.

Rule 10. Give the same care and attention to the woodwork of iron bridges as is given wooden bridges and see that the rollers and bed plates of iron bridges are kept free from dust, cinders or other materials.

Rule 11. Give a list of all material needed for repairs.

Rule 12. Report holes or defects in platforms, broken glass (with size,) condition of stock yard fences, gates, chutes, mail cranes, section houses and other buildings.

Rule 13. At the close of each day report by mail to the General Foreman of Bridges and Buildings the territory covered during the day, the route intended for the following day, with such information from daily notes as may be necessary to enable the General Foreman to order prompt repairs.

Rule 14. At the end of each week return to the General Foreman note book, properly filled out and signed. This note book shall be examined by the

General Foreman, signed by him personally, and passed to the Resident Engineer to be examined, labeled and filed for reference.

#### TO ROADMASTERS AND BRIDGE AND BUILDING FOREMEN.

Roadmasters must give personal attention to instructing track Foremen in regard to the best and most economical methods of doing their work, and they must see to it that their instructions are strictly carried out. It is not sufficient to tell a foreman how to do work; you must see that he does as he is told.

They must see that each Foreman is fully provided with the tools needed in his work and with the flags, lanterns and torpedoes which may be needed as danger signals, and that all these tools and signals are kept in good condition and ready for use at any time; that they are carefully used and well cared for, and properly accounted for when broken or worn out.

They must know that each Foreman has a copy of the proper time schedule; that he has time books for keeping the time of his men, and that he is never without one of these books besides the one which he uses daily; also that he has a copy of this book of rules and instructions and all of the blank forms in the list given, which are designed for his use, and that all the blanks are promptly, correctly and conscientiously filled out and returned as required.

Roadmasters must give personal attention to the Foreman's use of his time book, and must know that the book is used strictly as directed in the previous chapter, and that the distribution of labor is correctly and conscientiously made.

Particular attention must be given to filling up the blanks of casualty reports.

The Roadmaster must see that the Foremen understand how to make up these reports and that full and complete information is given regarding all accidents, no matter how small or insignificant. These reports must cover accidents to trains, track, bridges or persons coming within the knowledge of Roadmasters or Foremen.

Whenever a car is turned accidentally or intentionally, as in the case of cars too badly wrecked to be worth picking up, it is the duty of the Roadmaster to ascertain the number, initial and description of the car and to make a written report of the same, as soon as possible, to the Superintendent.

It is very important that reports should be made of any and every case of disregard of danger signals or caution signals on the part of enginemen or trainmen and these reports are made the duty of Roadmasters as well as Foremen.

The attention of Roadmasters is called to that part of these rules which prohibits the lending, selling or giving away of tools or material belonging to the Railroad Company. It is their duty to be watchful to prevent any theft or misappropriation of Company property.

Roadmasters must not give letters of recommendation of certificates of good character to Foremen or employes who have been dishonorably discharged from service, and a Foreman dishonorably discharged from one division of the road must not be employed by the Roadmaster of another division.

When a Foreman, from any cause is relieved from the charge of his section, the Roadmaster must see that all keys, books, blanks, tools or material which have been in the Foreman's care or possession are properly accounted for or turned over to his successor.

Roadmasters will be provided with memorandum books, which are to be used as a journal or diary, in which they will record all the important work done on other divisions, giving dates when begun and when completed. They will also record the dates when they go over their divisions and whether the trip is made on train, hand car, or on foot. In making a record of these trips any items of interest concerning the work of foremen or the needs of any particular section of the track should be entered.

These journals must at the end of each month be returned to the Resident Engineer or Superintendent, as directed.

Roadmasters must make themselves familiar with all the instructions in this book, and will be held responsible if they retain in service foremen who persistently fail to carry out the instructions.

Bridge and Building Foremen are responsible to Resident Engineers for the condition of bridges and other structures under their charge. They must give personal attention to the work which they have to do, and must know that all carpenters and laborers employed under their direction are competent, sober, industrious and honest.

When doing a work which makes the passage of trains at ordinary speed dangerous, and in all cases

when the work breaks or obstructs the track, Bridge and Building Foreman must be governed by the same rules as Track Foremen in regard to placing signals of caution or danger.

Bridge and Building Foremen are expected to know all the foregoing rules and to be governed by them.

Bridge and Building Foremen must make all general reports required upon blank forms which will be supplied for the purpose, according to instructions. Special attention must be given to the prompt making of casualty reports for all accidents to persons or property in any way connected with their work, giving full and detailed information in case of wrecks, freshets, fires, &c., by which any Company property has been destroyed or personal injury sustained.

The following rules must be observed in the location and construction of buildings and platforms:

The tops of all platforms adjacent to the main track should be 12 inches above the top of the rail (conforming to the grade of the track) and the nearest edge of the platform 2 feet 9 inches from the gauge side of the nearest rail.

The top of all freight platforms on side tracks for general use should be 3 feet 8 inches above the top of rail on side track (conforming to the grade of track) and the edge of platform 3 feet 3 inches from the gauge side of the nearest rail.

All passenger platforms must be finished up with an incline at both ends on the main track. The incline must run to the level of the base of rail and

have a slope of one in ten for the full width of the platform.

No building should be located nearer than 7 feet in the clear from the center of the main track.

No building should be nearer than 6 feet from the center of any side track which is used for meeting and passing trains or for general purposes.

On side tracks to be used for special purposes, such as coaling engines from elevated coal chutes and similar uses, the demand must establish the distance, provided no building or structure is placed nearer than 5 feet 6 inches from the center of any track.

All buildings, corn cribs, or other structures erected by corporations or private parties, and all stone, tie or timber piles for Company use should not be located nearer than six feet from the nearest rail.

Telegraph signals at stations should if practicable be so located that the lever shaft inside the building will be at the right hand of the telegraph operator as he sits at his desk or table, and so near him that he can turn the signal without leaving his seat. The bottom of the signal vane should not be less than 7 feet 6 inches nor more than ten feet above the platform.

The center of the vane shaft should be 8 feet 6 inches from the center of the track.

## CHAPTER XIII.

CHICAGO, BURLINGTON & QUINCY RAILROAD.

SUPERINTENDENT'S BRIDGES AND BUILDINGS.

Superintendents Bridges and buildings report to and receive their instructions from the Superintendent.

They will have charge of the maintenance, repairs and renewals of all buildings, water tanks, coal sheds, bridges, track scales, etc., and will promptly report to the Superintendent any defects that may come under their observation.

They will be required to examine frequently all bridges, etc.; and assure themselves of the condition of all structures affecting the safety of trains and make prompt report to the Superintendent of defects therein

They must make themselves fully acquainted with use of signals, and see that they are understood by their subordinates. and that the danger and caution signals are used strictly in accordance with the rules.

They will co-operate with the Roadmaster in regard to the distribution of material, and will call upon him whenever they require assistance.



They must give particular attention to the supply of water, and promptly report any defects or deficiencies.

## ROAD MASTERS.

Roadmasters report to and receive their instructions from the Superintendent.

They have charge of the repair men and other laborers employed on their divisions, and must see that they perform their duties properly; discipline them for neglect of duty and keep account of and report their time in the manner prescribed. They are responsible for keeping the track and road-bed, bridges, culverts, telegraph line and everything pertaining to the roadway in repair.

They must frequently pass over their division, observe the condition of the track and bridges, see that the proper slopes and ditches are preserved, and that culverts and drains are kept open, note anything liable to obstruct the track and have it removed, and do everything necessary to secure the safety of the road.

They must know that the persons under their charge understand and obey the rules and understand the use and meaning of signals; see that materials are safely kept and economically used; attend in person to the removal of slides, snow or other obstructions; in case of accident take the necessary force to the place, and use every effort to clear the road; have the standard time and compare with each Foreman once

# STANDARD ROAD BED SECTIONS C. B. & Q. R. R.

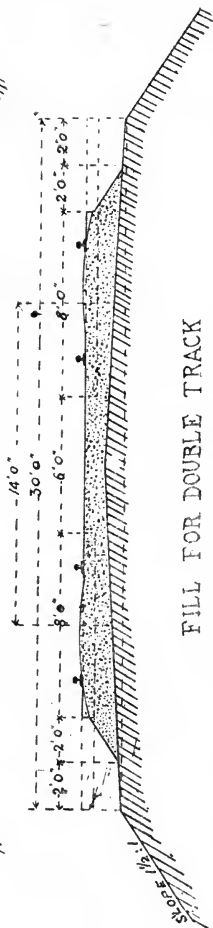
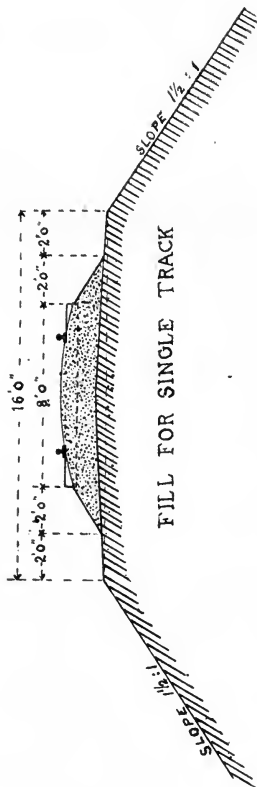

a week or oftener; give attention to the water supply and report any defect or deficiency; keep an oversight of work performed by contractors or mechanics, and see that they do not endanger the safety of the road and make careful inquiry and report fully in writing respecting any accident or cases of personal injury to passengers, employes and others on their divisions.

They must be familiar with the instructions issued for the government of trains and trainmen, and report any neglect of duty or violation of the rules that come under their notice.

#### SECTION FOREMEN.

Section Foremen report to and receive their instructions from the Roadmaster.

They have charge of the repairs on their respective sections, and are responsible for the proper inspection and safety of the track, bridges, and culverts.

They must see that the track is in good line and surface and properly spiked; that it is in true gauge; that the cross-ties are properly spaced, lined and tamped; that the road-bed is in good order; that the proper slopes and ditches are preserved, and that the drainage is not interfered with.

They must engage in work personally, and see that watchmen and other workmen faithfully perform their duties, and suspend anyone for neglect or misconduct, and report the same to the Roadmaster.

They must compare time each day with the clock at the nearest telegraph office, or with the Conductor of a train; carefully observe signals displayed by trains, and be sure that all trains and sections of

trains that are due have passed, before obstructing the track.

They must watch points where obstructions are likely to occur; examine the slopes of cuts, and remove anything liable to fall or slide; remove combustible material from the vicinity of the track, bridges and buildings; extinguish fires that may occur along the road; watch the telegraph line, and keep the poles in proper position; reset poles and unite wires when necessary; report promptly any derangement of the wires; assist the Telegraph Repairman when necessary; see that water stations are kept in order, and report any failure in the water supply; render prompt assistance in cases of accident or delay to trains, and see that old material is gathered up, and that their sections are kept in neat and proper condition. During heavy storms they must detail all hands to watch the road, and take every precaution to prevent accident.

They must run their hand-cars and trucks with great caution, always keeping a lookout for extra trains, and fully protect themselves by signals where necessary. They must not permit their hand-cars or trucks to be used, unless they accompany them, nor to be run on Sundays or after dark, without special authority from the Roadmaster, nor to be attached to trains in motion; and when they are not in use they must be kept locked, and so secured that they can not be so moved as to endanger the safety of trains.

The track must never be obstructed in any way whatever without first conspicuously displaying a danger signal. When Foremen are changing rails, or in any way working on the track, rendering it impas.





sable, they must first put out a red flag in the hands of a reliable man (which must be kept in his hands), twenty (20) telegraph poles in each direction from the impassable point, and the flagman must also place one torpedo at a distance of four telegraph poles beyond the flag. On double as well as single track, red flags must be placed, as above, in both directions.

In foggy weather, or on heavy grades or curves, the flags must be placed twenty-four (24) telegraph poles from the impassable point, and one torpedo (8) eight telegraph poles beyond the flag, as above directed.

Foremen disobeying this rule will be promptly discharged.

When sectionmen are working between a steel or extra gang and the latter's flagman, a red flag should be placed in the center of the track about 100 feet beyond the sectionmen and between them and the steel or extra gang, to warn approaching trains that there is another gang at work.

Sectionmen, bridgemen and all other employes whose duties require them to be near the tracks, are cautioned and warned that it is dangerous to remain near the tracks when engines or trains are passing. Coal, stone, car doors and other articles are liable to fall from engines and trains. All are required for their own protection, to retire to a safe distance from the track on the approach of an engine or train and to remain there until the engine or train has passed. All such employes are further warned that they must not rely on others to warn them of the approach of an engine or train, but must themselves keep a proper lookout.

## CHAPTER XIV.

### THE GREAT NORTHERN RY.

#### ELEVATION OF OUTER RAIL ON CURVES.

The outer rail on curves should be elevated as follows:

On a 1 degree Curve.....	$\frac{3}{4}$ inch.
On a 2 degree Curve.....	$1\frac{1}{2}$ inches.
On a 3 degree Curve.....	2 inches.
On a 4 degree Curve.....	$2\frac{1}{2}$ inches.
On a 5 degree Curve.....	3 inches.
On a 6 degree Curve.....	$3\frac{1}{2}$ inches.
On a 7 degree Curve and on any curve sharper than a 7 degree Curve.....	4 inches.

No elevation to exceed 4 inches.

At the point of beginning and ending of curves, get the full elevation according to the above table and decrease it gradually, so as to run into the perfect level of the straight track, at the rate of one-half an inch for each 30 foot rail.

To determine the degree of any curve, take two points on the inside of the outer rail 62 feet apart, and stretch a string tight between these points, and measure the middle ordinate, or distance from inside of said rail to the string at the middle. Each inch of



this distance equals one degree of curve. That is, if the distance is one inch, it is a one degree curve; if it is two inches, it is a two degree curve, and so on.

TABLE OF MIDDLE ORDINATES, IN INCHES, FOR  
CURVING RAILS.

DEGREE OF CURVE.	Length of Rail.		
	30	28	26
1° .....	1 4 7 16 "	3 6 "	1 8 "
2° .....	1 7 16 "	3 8 "	1 5 16 "
3° .....	1 18 "	5 8 "	1 5 16 "
4° .....	1 16 "	13 16 "	3 4 7 8 "
5° .....	1 13 16 "	1 "	1 7 8 "
6° .....	1 13 3 8 "	1 4 7 8 "	1 1 16 "
7° .....	1 1 7 8 "	1 1 7 8 "	1 1 4 7 8 "
8° .....	1 1 7 8 "	1 5 8 7 8 "	1 1 6 8 "
9° .....	2 2 3 8 "	1 1 7 8 "	1 1 6 8 3 4 "
10° .....	2 2 3 8 "	2 1 6 "	1 1 3 3 4 "
11° .....	2 2 3 8 7 8 "	2 1 4 1 2 "	1 1 6 8 "
12° .....	2 2 "	2 "	2 1 8 "

## GREAT NORTHERN RAILWAY LINE. CROSS SECTION OF DOUBLE TRACK WITH GRAVEL BALLAST.

*EXCAVATION.*



*EMBANKMENT.*

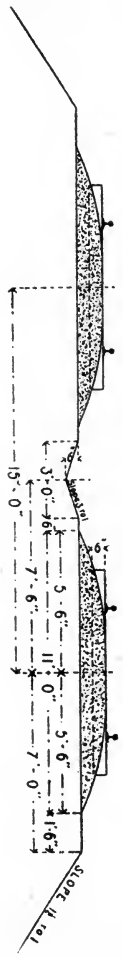



# GREAT NORTHERN RAILWAY LINE.

CROSS SECTION OF SINGLE TRACK WITHOUT GRAVEL.

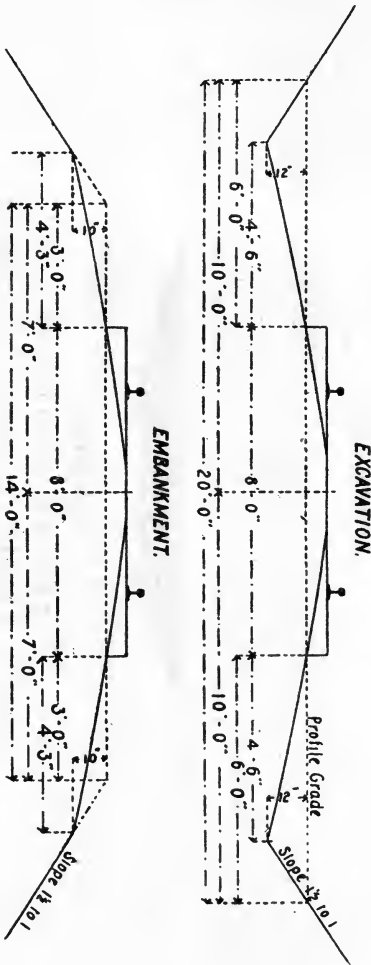

CROSS SECTION OF DOUBLE TRACK WITHOUT GRAVEL.

EXCAVATION.



EMBANKMENT.



**MISCELLANEOUS ROADS.**

# STANDARD ROAD BED SECTIONS UNION PACIFIC RY.

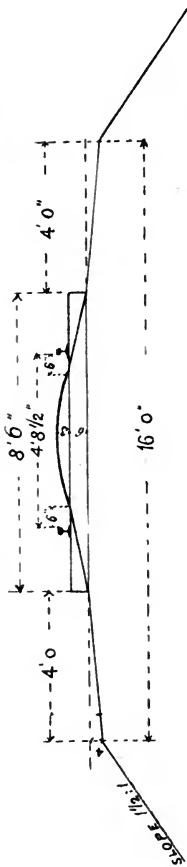

EARTH ROAD BED  
FILL

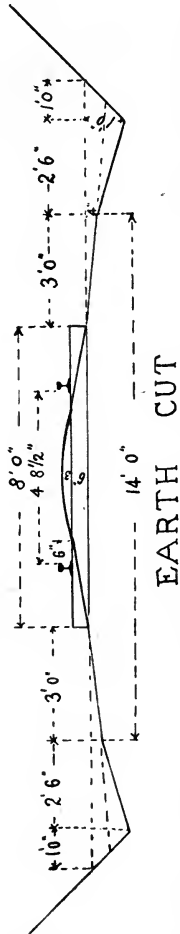

EARTH CUT

STANDARD ROAD BED SECTIONS UNION PACIFIC R.R.

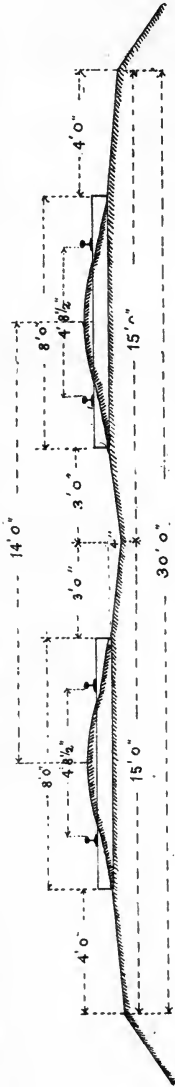

EARTH FILL DOUBLE TRACK

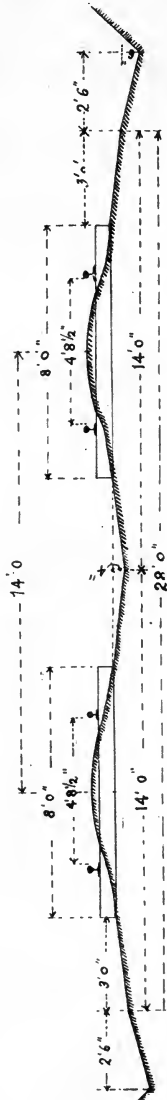

EARTH CUT DOUBLE TRACK



# STANDARD ROAD BED SECTIONS UNION PACIFIC R.R.

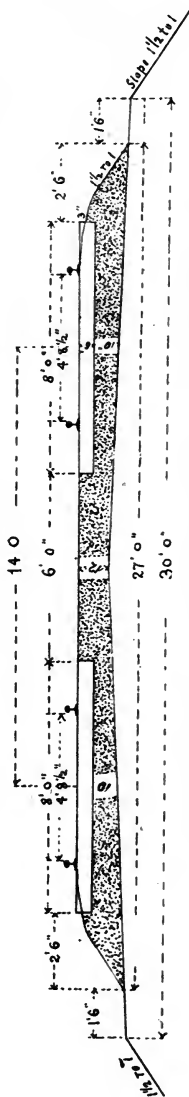

DOUBLE TRACK FILL. GRAVEL, CINDER OR ROCK BALLAST

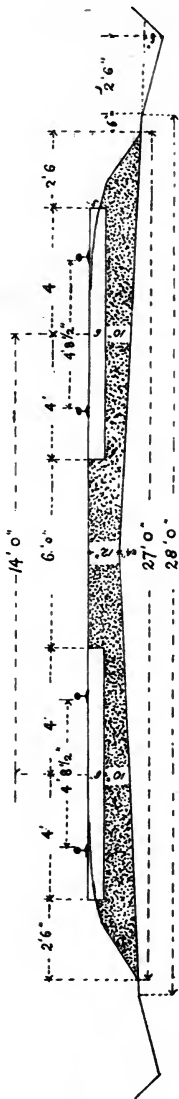

DOUBLE TRACK CUT. GRAVEL, CINDER OR ROCK BALLAST.

# STANDARD ROAD BED SECTIONS UNION PACIFIC RY.

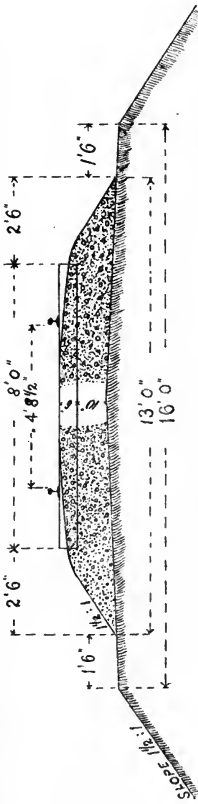

BALLAST OF GRAVEL, CINDER, BURNT CLAY OR BROKEN STONE

FILL

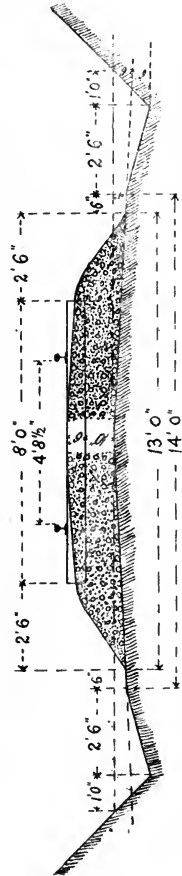

BALLAST OF GRAVEL, CINDER, BURNT CLAY OR BROKEN STONE

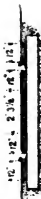

CROSS SECTION

NO. 1

STANDARD GAGE



LONGITUDINAL SECTION

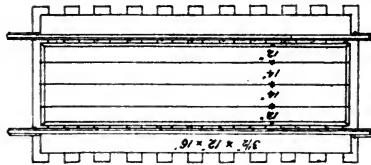

NO. 2

STANDARD GAGE



CROSS SECTION  
NO. 3

NO. 3

NARROW GAGE

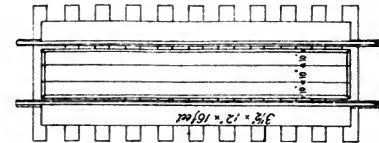

CROSS SECTION  
NO. 4

NO. 4

THREE RAIL TRACK

STANDARD  
ROAD CROSSINGS  
UNION PACIFIC RY.

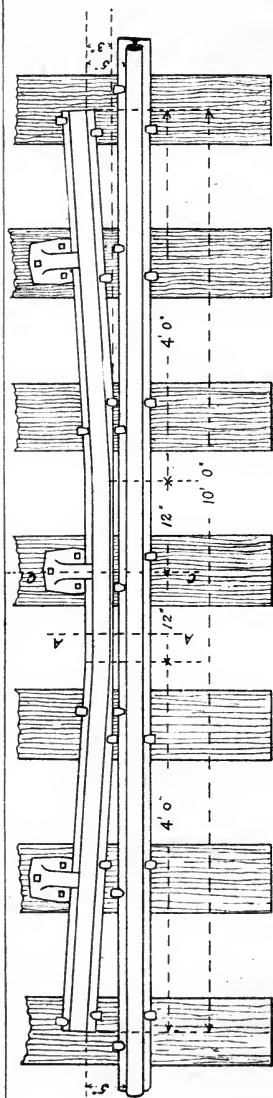

PLAN

STANDARD GUARD RAIL  
UNION PACIFIC RY.

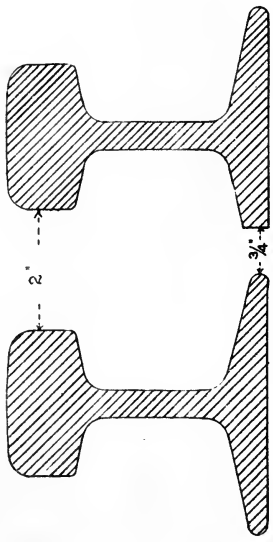

SECTION ON AA

Standard Frogs Union Pacific Railway.

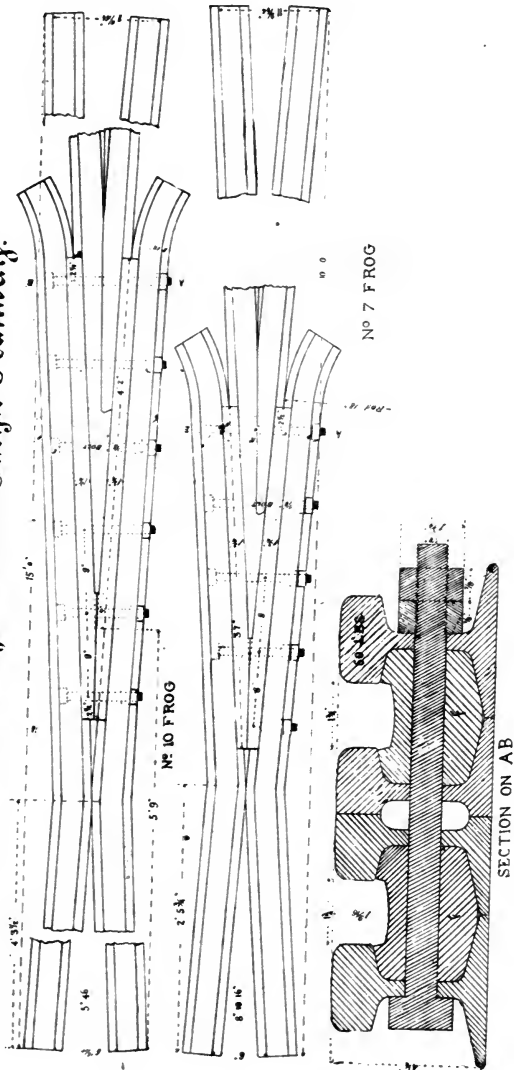

STANDARD RAIL SECTION & TRACK JOINT. UNION PACIFIC SYSTEM

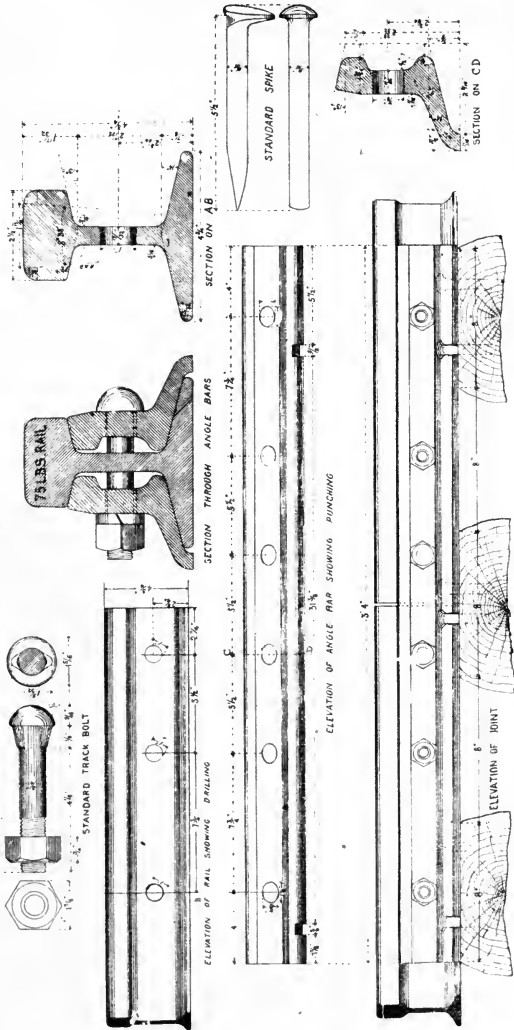

STANDARD RAIL SECTION & TRACK JOINT. UNION PACIFIC SYSTEM

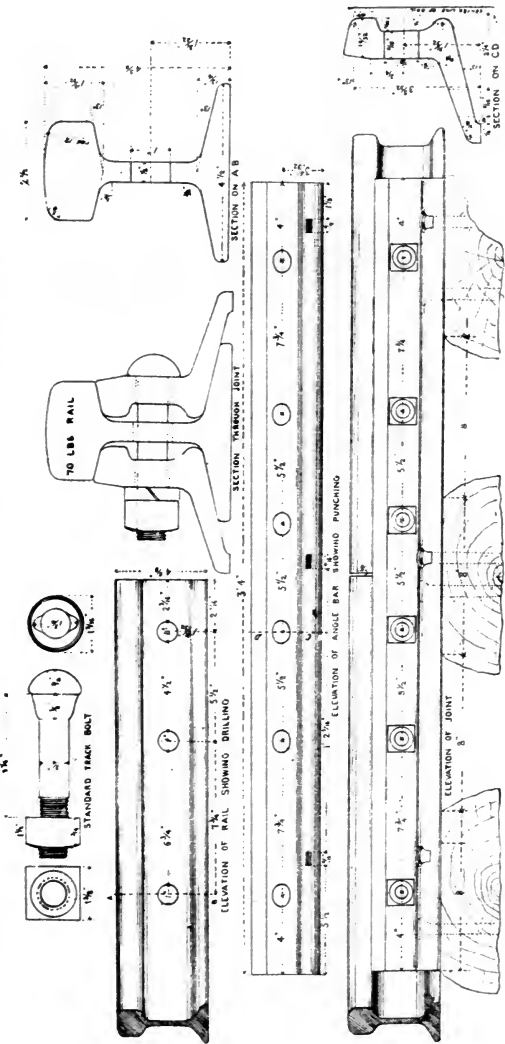

STANDARD ROAD BED SECTIONS CENTRAL R.R. OF GA.

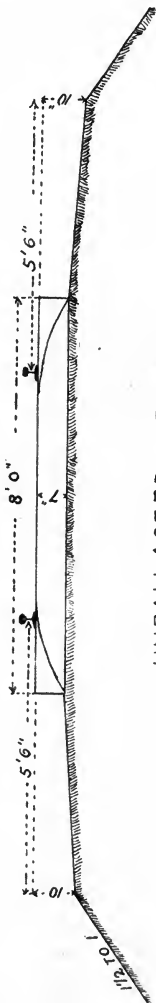

UNBALLASTED TRACK

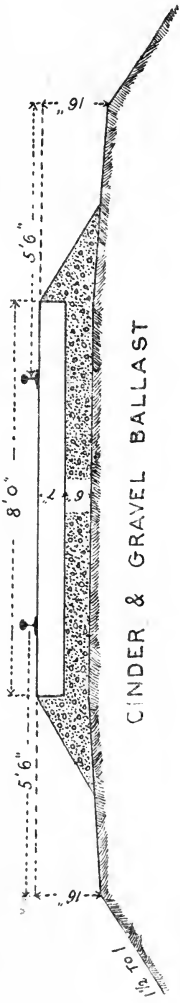

CINDER & GRAVEL BALLAST



STANDARD ROAD BED SECTIONS CENTRAL R.R. OF GEORGIA

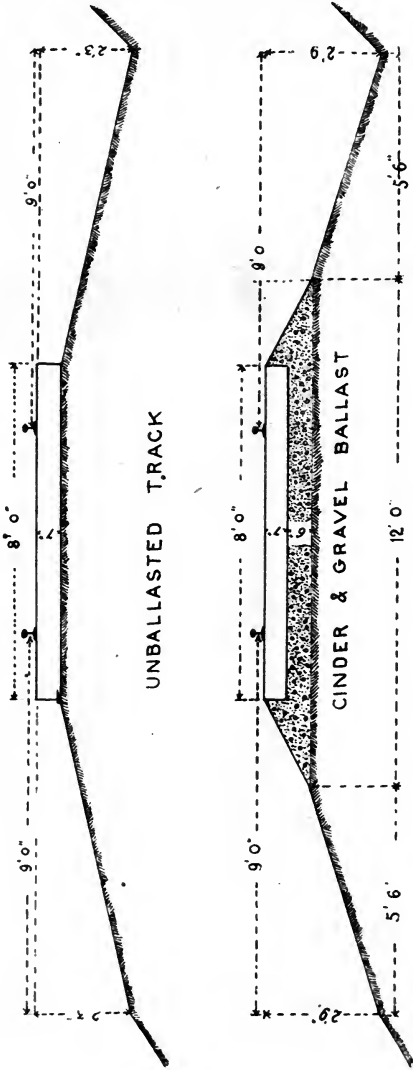

# STANDARD ROAD BED SECTIONS CENTRAL RR OF GA

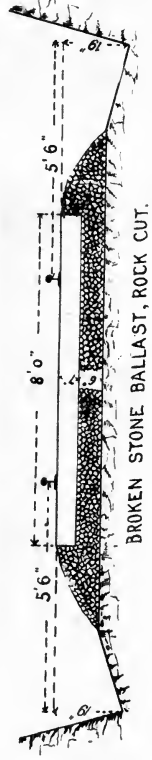
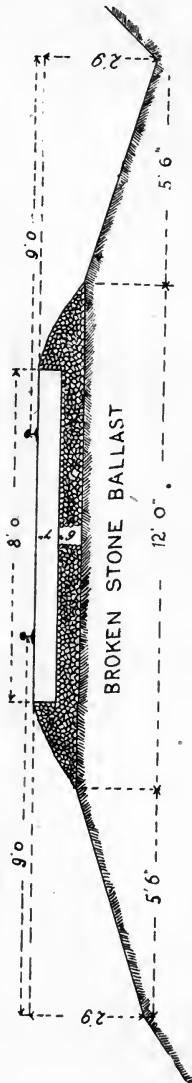

STANDARD ROAD BED SECTIONS CENTRAL R.R. OF GA

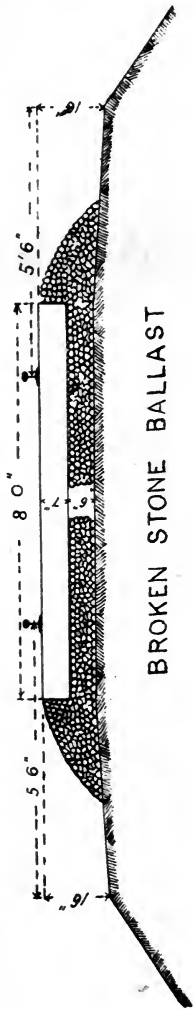

BROKEN STONE BALLAST

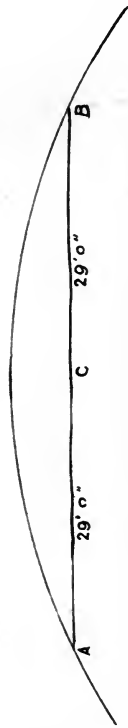
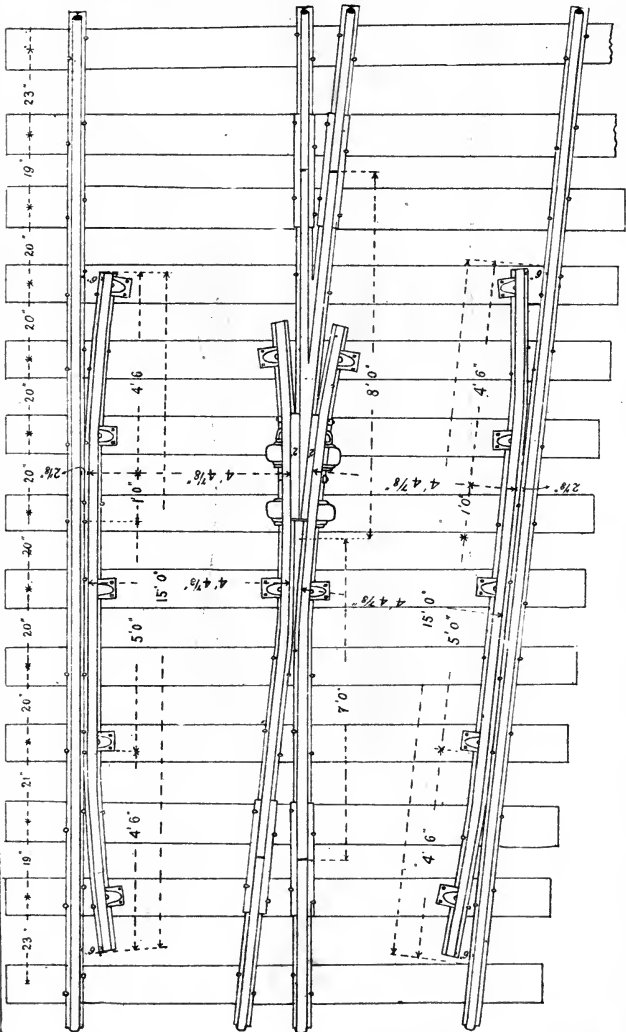
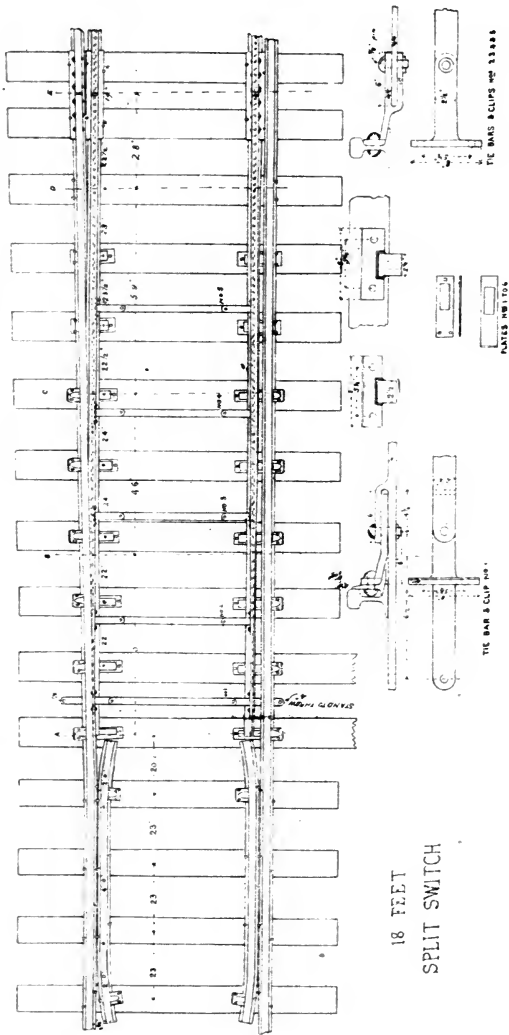

DIAGRAM FOR ELEVATING CURVES.

# STANDARD GUARD RAIL CENTRAL RAIL ROAD OF GEORGIA



STANDARD SPLIT SWITCH CENTRAL RAIL ROAD OF GEORGIA



18 FEET  
SPLIT SWITCH

TIE BAR & CLIP NO. 1

TIE BAR & CLIP NO. 2

TIE BAR & CLIP NO. 3



STANDARD  
ROAD CROSSING  
CENTRAL R.R. OF GA.

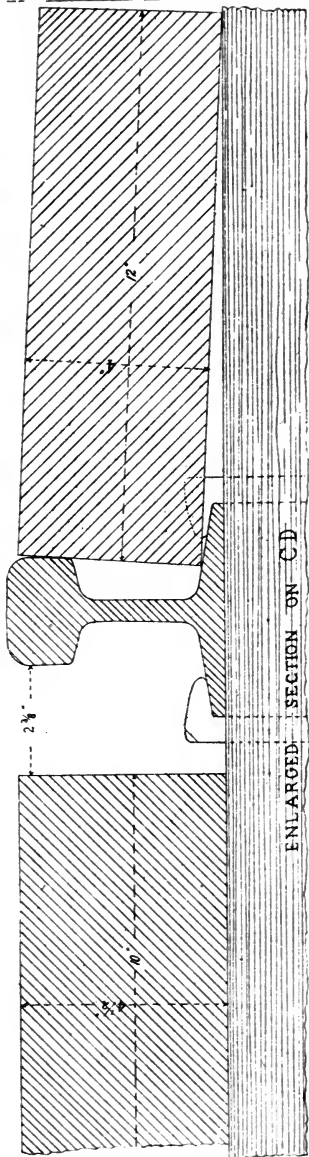
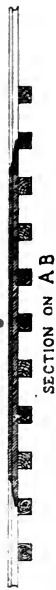
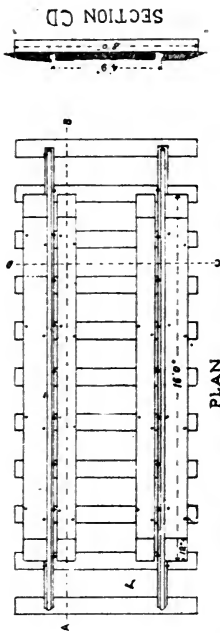

STANDARD RAIL SECTIONS & JOINTS SOUTHERN RAILWAY

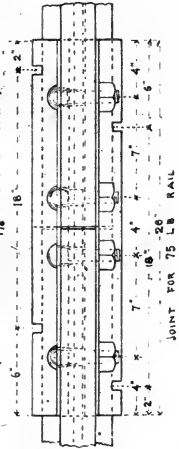
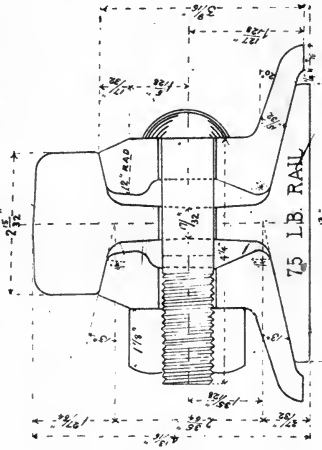
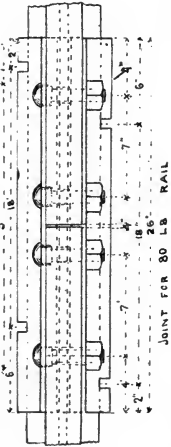
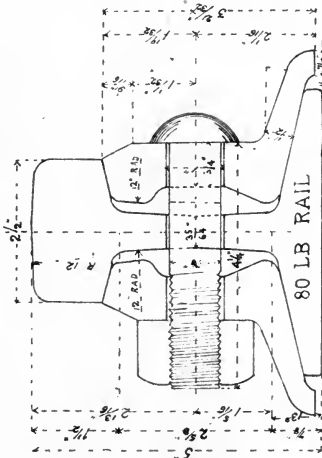



STANDARD ROAD BED SECTIONS SOUTHERN RY.

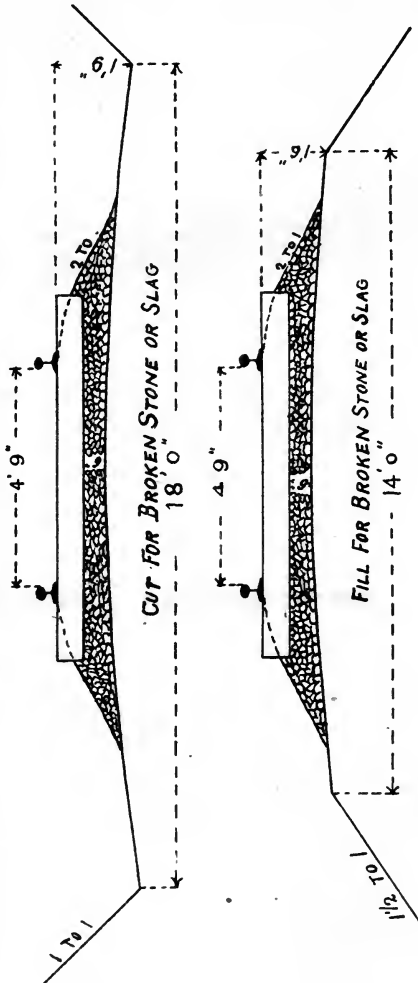



STANDARD ROAD BED SECTIONS. SOUTHERN RY.

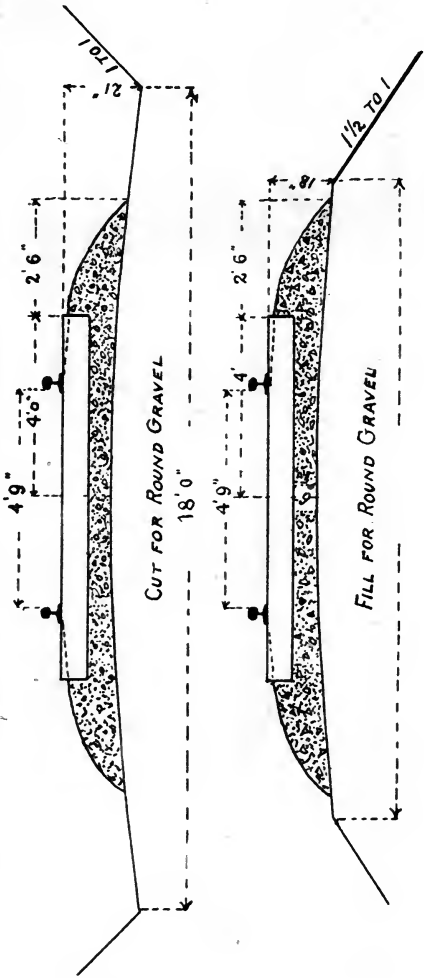

STANDARD ROAD BED SECTIONS SOUTHERN RY.

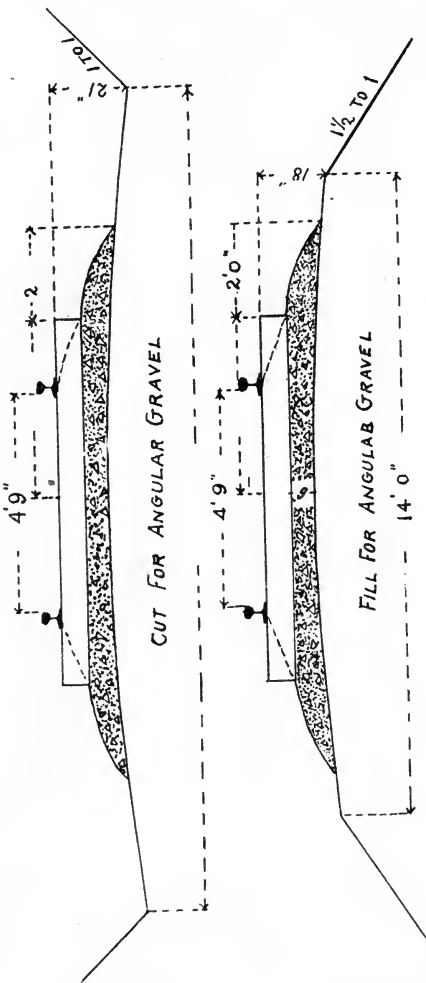



# STANDARD SPLIT SWIT

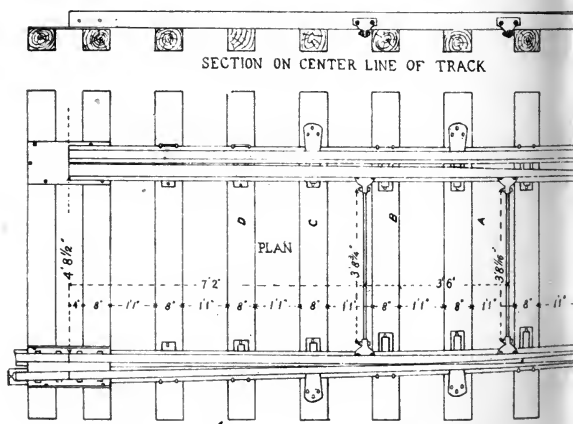
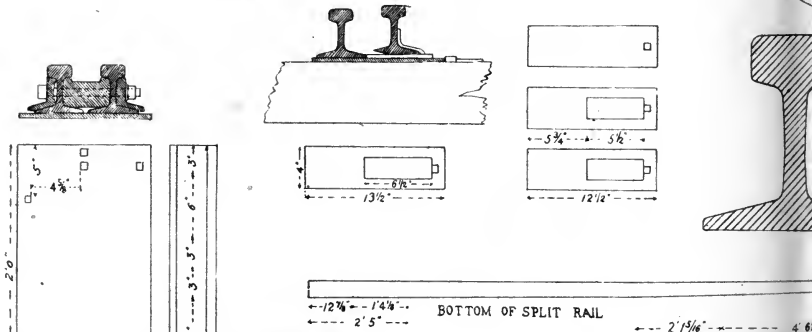
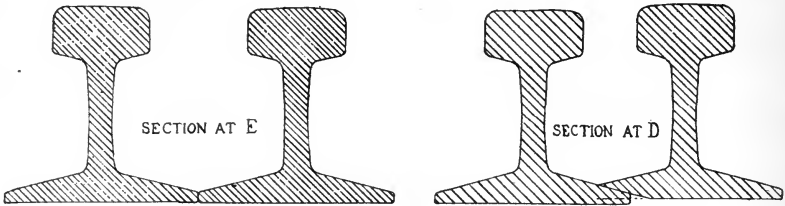

# CH. C. & N-W RY.

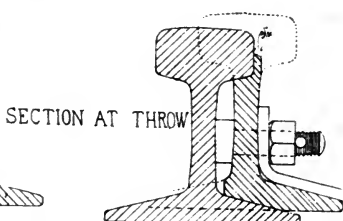
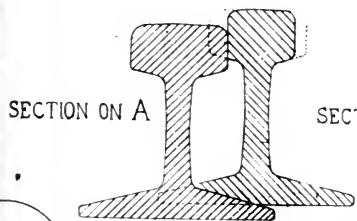

NO. 1 TIE ROD & CONNECTING ROD

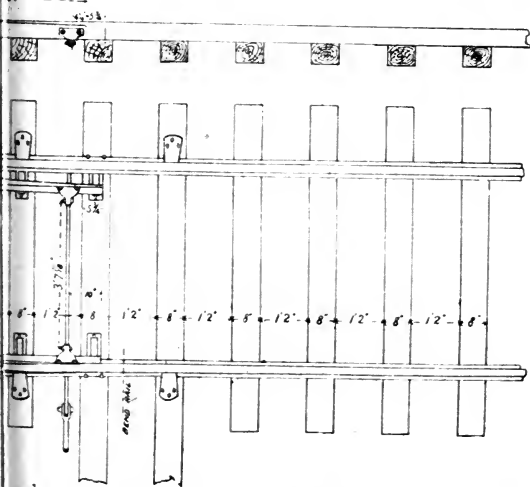
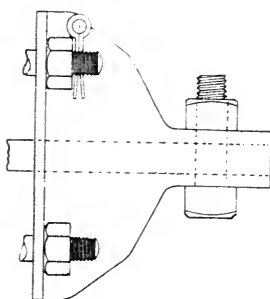
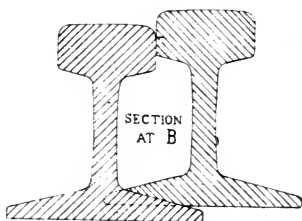
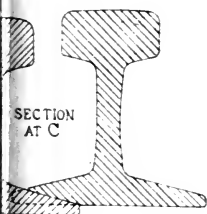

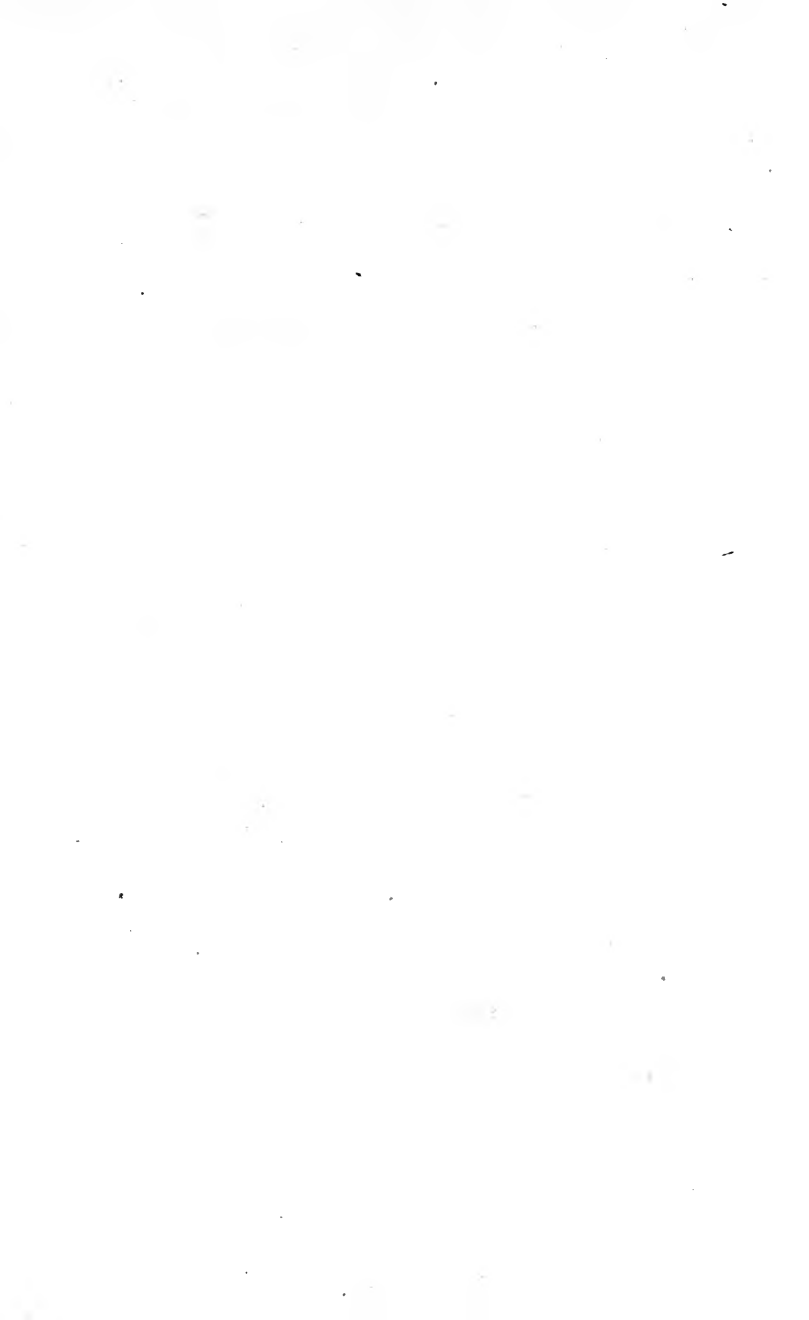



STANDARD ROAD BED SECTIONS SOUTHERN RY.

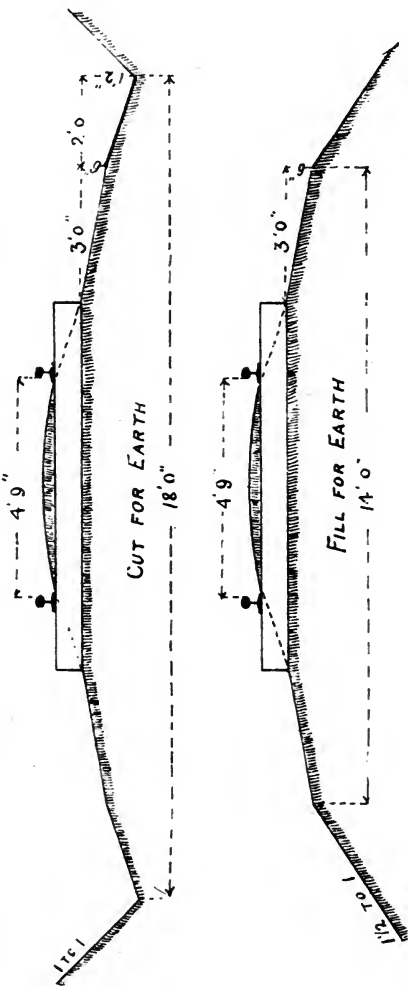



STANDARD ROAD BED SECTIONS

**F. S. & M. S. N.Y.**

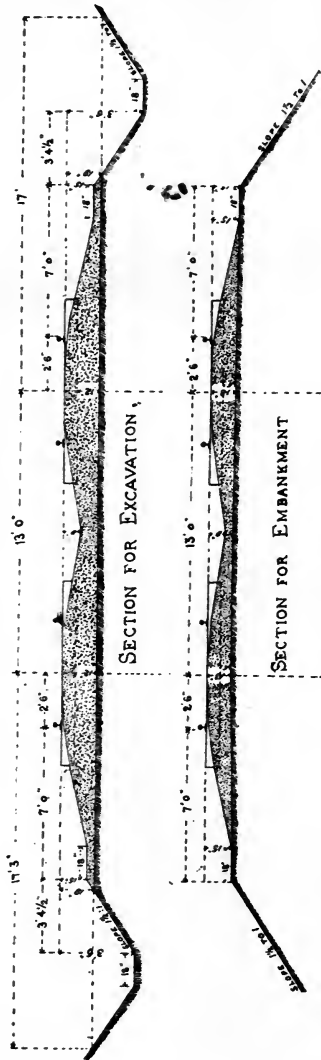

STANDARD FROG  
 C. & N.-W. RY.

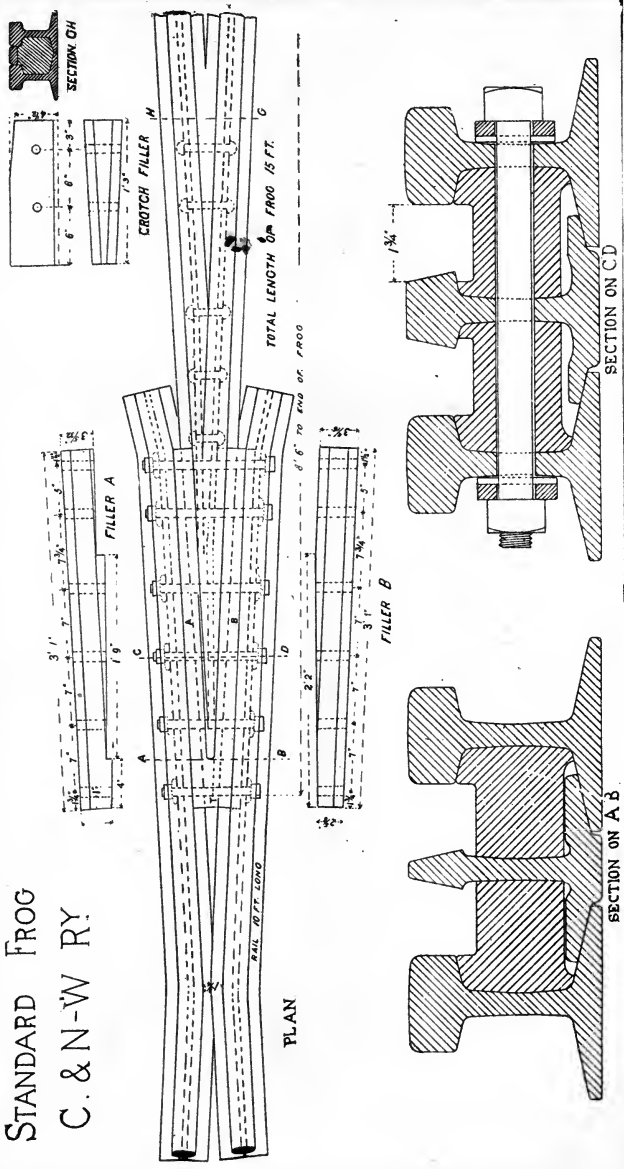

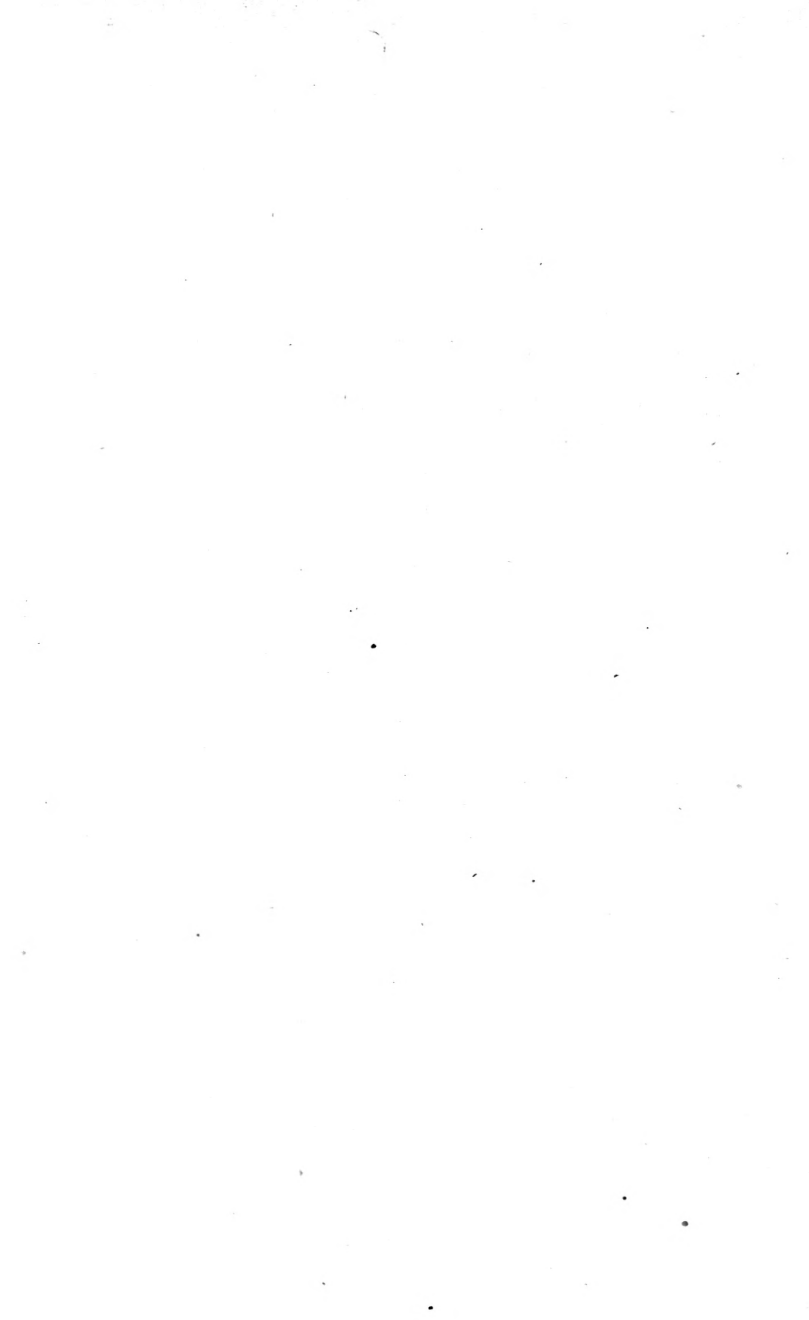





















STANDARD  
 RAIL SECTION  
 &  
 ANGLE BAR JOINT  
 OLD COLONY SYSTEM

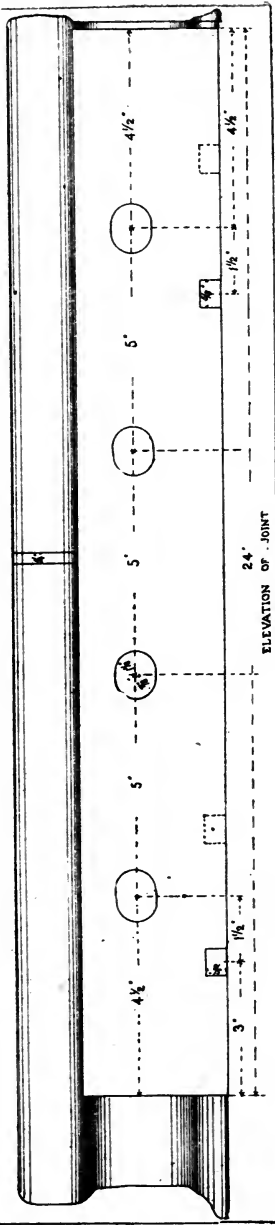
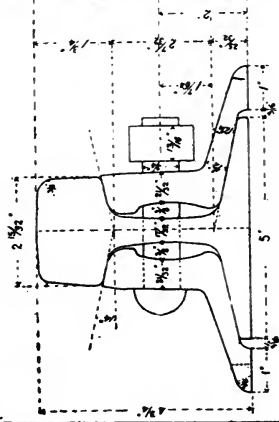
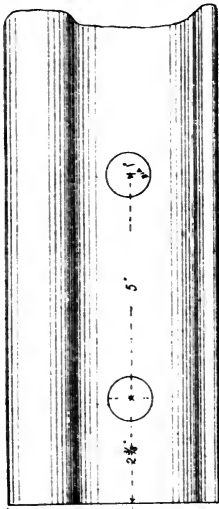





DESCRIPTIVE TEXT AND SPECIFIC INFORMATION RELATING TO PRECEDING ILLUSTRATIONS.

---

STANDARD ANGLE BARS, JOINTS AND RAIL SECTIONS.

BALTIMORE AND OHIO R. R.

We present a considerable collection of joint fastenings as used on the more prominent roads. The upper figure on plate XIV., page 58, shows an elevation of the outside and the lower figure the elevation of the inside angle bar of the Baltimore and Ohio Railroad standard joint for 67-pound rail. The bars are twenty-four inches long; the outer bar has four circular holes, seven-eighths inches in diameter, while the inner plate has oblong holes,  $\frac{3}{4} \times 1\frac{1}{8}$  inches; the holes in the rail are one inch in diameter; the first hole is  $3\frac{3}{8}$  inches from end and 5 inches distant from next hole, center to center; both angle bars and rails are punched for spikes, the shaded portion showing the slots in the angle bars, while the dotted lines show those in the rail; the arrangement shows clearly that the joint is of the suspended type, there being no tie directly under the joint.

The middle figure on plate XV., page 59, shows a cross section through the joint and rail of the joint described above, giving dimensions and geometrical form of its parts. It is seen the rail has a height of  $4\frac{1}{2}$  inches and a base of  $4\frac{1}{2}$  inches; the width of ball varies from 2 9-32 inches to 2 13-32 inches, being rounded by a radius of ten inches in the center, while the two corners turn down with a seven-sixteenths inch radius; the web is

one-half inch thick in the narrowest place, curving with a radius of twelve inches to ball and base. The height of angle bar is  $3\frac{1}{8}$  inches, the center of hole 1 13-16 inches from base of rail; the bar fits snugly under base of rail and on base of rail, but keeps clear of the web, allowing the joint to be tightened without straining either rail or angle bars.

JOINT FOR EIGHTY-FIVE POUND RAIL—BALTIMORE AND OHIO R. R.

The upper and lower figures on plate XVII. show details of track bolt used for this joint; it is  $4\frac{3}{4}$  inches long over all,  $\frac{3}{4}$  inches in diameter, round head  $1\frac{1}{4}$  inches in diameter, with an oblong shoulder 1 1-16x $\frac{3}{4}$  inches, fitting the oblong hole in the inside angle bar to prevent it from turning while being tightened. The nut is square,  $1\frac{1}{4}$ x $1\frac{1}{4}$  inches,  $\frac{3}{4}$  inch thick. The specifications for this bolt are given in detail on plate XLVIII.

The upper figure on plate XVI., page 60, shows an elevation of the outside angle bar, the lower figure is an elevation of the inside bar. The splices are thirty inches long, with six bolt holes placed, as shown in cut, the holes having the same size as in the preceding joint; the plates are slotted for spikes, four and six inches respectively from end of bar.

Plate XVII., page 61, shows a section of the rail and joint. The rail has a height of 5 inches and a base of 5 inches, the width of ball measures 2 11-16 inches, its upper surface is curved to a radius of 12 inches and the upper corners to a radius of  $\frac{1}{4}$  inch; the web is straight, 9-16 inch thick, curving to the base and ball under an angle of 13 degrees 20 minutes.

The angle bar has a thickness of 13-16 inch through center of bolt holes, and fits snugly under the ball and on top of flange of rail; it is reinforced above and below the bolt, but tapers to the ball to prevent wheel flanges from striking top of splice. The center of bolt hole is 2 3-32 inches above the base of rail.

The two lower figures on plate XXI. show the bolt used in this joint; it is  $5\frac{1}{4}$  inches over all,  $\frac{3}{4}$  inch in diameter, but otherwise of the same dimensions as described

for the 67-pound rail joint; it is threaded for  $1\frac{3}{8}$  inches, to provide room for a  $\frac{1}{4}$  inch washer or nut lock. The specifications for this bolt conform to those given on plate XLVIII.

JOINT FOR NINETY-FIVE POUND RAIL—BOSTON AND ALBANY R. R.

This joint is shown on plate II., page 18; the angle bars are 20 inches long over all, having a rectangular hole punched near the center for a spike. The rail is 5 1-32 inches high by  $5\frac{1}{2}$  inches base, extreme width of ball 3 inches; thickness of web in narrowest place  $\frac{5}{8}$  inch; top surface is curved to a radius of 14 inches, corners to a radius of 5-16 inch; web joins ball with a curve of  $\frac{1}{2}$  inch radius and joins base with 5-16 inch radius; the under faces of ball and top faces of base incline to the horizontal in the proportion of 1 to 4; the extreme corners of the base curve to a radius of 1-16 inch and the web faces to a radius of 14 inches; the center of bolt hole is 2 9-32 inches from lower base line. The center of first hole is 2 3-16 inches from end of rail, from center of first to center of second  $4\frac{3}{4}$  inches; diameter of hole 1 inch.

The holes in the angle bars are both round and  $\frac{7}{8}$  inch in diameter; it is noticed that the inside plate has a rectangular groove for the reception of the square bolt head, preventing the bolt from turning when being tightened.

The inner plate is  $\frac{5}{8}$  inches and the outer plate  $\frac{3}{4}$  inch thick in narrowest place; the expansion of rail is allowed for by the inch hole in rail.

JOINT FOR ONE HUNDRED POUND RAIL PENNSYLVANIA R. R.

Plate LXIII., page 139, shows an elevation, plan and section of the 100-pound pattern rail and angle bars, also bolts and spikes used on this joint. The rail is  $5\frac{1}{2}$  inches high and  $5\frac{1}{2}$  inches wide at base, extreme width of ball 2 13-16 inches; upper face of ball curves to a radius of 10 inches; upper corners of ball are rounded to a 7-16 inch radius, while lower corners have a radius of  $\frac{1}{8}$  inch; the lower faces of ball, also upper

faces of base, incline under an angle of 13 degrees to the horizon; ball joins web with a  $\frac{1}{4}$  inch radius; web is formed by an arc of a circle of 8-inch radius, joining base with a  $\frac{1}{4}$ -inch radius curve; thickness of web  $\frac{5}{8}$  inches in narrowest place. The cross section area is divided as follows: Head, 47.77 per cent.; web, 17.80 per cent., and base, 34.43 per cent.; the bolt holes are drilled 1 3-16 inches in diameter, with center of hole just 2 9-32 inches above base.

The angle bars are 34 inches long and weigh 72 $\frac{1}{2}$  pounds per pair; they are punched for six 1-inch bolts, distanced 4, 5 and 6 inches, respectively, from the middle of joint toward end, the center of last hole being just 4 inches from end. The height of splice is 3 15-16 inches from tie, fitting closely the lower face of ball and upper face of base; its thickness is  $\frac{3}{4}$  inch in narrowest place, clearing the web at the middle 11-16 inch and  $\frac{1}{8}$  inch near top and bottom; at the base the splice clears the rail 3-16 inch. Each splice has two slots 11-16 inch wide for spikes, 20 inches from center to center; joint ties are spaced 10 inches apart.

The bolts are 5 $\frac{3}{4}$  inches over all, 1 inch in diameter, having a round head 1 $\frac{1}{2}$  inch in diameter; bolt is threaded for 2 inches, hexagonal nut 1 inch thick, with a long diameter of 1 $\frac{7}{8}$  inches. The section of the shaft near the head is oblong, 1 inch by 1 $\frac{3}{8}$  inches. The bolt is designed to leave room for  $\frac{1}{4}$  inch spring nut lock.

The views shown of the track spike are easily understood; its cross section is square,  $\frac{5}{8} \times \frac{5}{8}$  inch; length over all 6 inches, wedge pointed, beginning 1 $\frac{3}{4}$  inches from point; the upper part of spike becomes gradually wider sideways, beginning 1 inch below lower face of head, and reaches  $\frac{3}{4}$  inch at top of spike; the length of head 1 $\frac{1}{2}$  inches and is 1 5-16 inches wide; the under face of head slopes upward under an angle of 23 degrees.

SEVENTY-FIVE POUND STEEL RAIL AND ANGLE BAR—ILLINOIS  
CENTRAL R. R.

Plate CXX., page 358, shows the 75-pound rail of the Illinois Central Railroad, together with angle bars

and bolts; this is their standard, adopted in 1894. The rail has a height of 4 13-16 inches and a base of 4 13-16 inches; upper face of ball curves to a radius of 12 inches, the upper corners of ball to a radius of 5-16 inches; the vertical faces of ball stand perpendicular to the horizontal, making the ball 2 15-32 inches wide; the lower corners of ball turn under a radius of 1-16 inch to the bottom faces, which incline under an angle of 13 degrees to the horizon and join the web with a curve of a  $\frac{1}{4}$ -inch radius; the web is described by arcs of 12-inch radii, approaching to 17-32 inch in narrowest place and joining the base with a radius of  $\frac{1}{4}$  inch. The upper faces of base form angles of 13 degrees, while the horizontal and extreme edges are rounded off with 1-16 inch radius; the depth of ball at center line is 1 27-64 inches and thickest place of base is 27-32 inch. The elevation shows drilling diagram; bolt holes are round, 1 1-32 inches in diameter; center of first hole is 2 13-64 inches from end of rail and  $4\frac{1}{2}$  inches from center of second hole; the center line of holes is 2 15-128 inches from base line of rail.

The angle bars are perfectly symmetrical in form, except that one is punched with oval holes,  $\frac{7}{8}$  inch by 1 3-16 inches for the head end of bolt and the other has punched round holes of  $\frac{7}{8}$  inch in diameter, to accommodate the  $\frac{3}{4}$ -inch track bolt. The inner faces of splices are curved to a 4-inch radius, giving a clearance of 17-16 inches in the center, which reduces near ball and base to  $\frac{1}{4}$  inch; the vertical sides of angle bars are  $\frac{7}{8}$  inch, and the angles 7-16 inch thick; the weight of one angle bar is 19 pounds; the lowest point of angle bar is 1-16 inch higher than base line of rail and gives a vertical clearance of 5-24 inch. The elevation of angle bar shows total length 20 inches, center of first hole from end of bar  $3\frac{1}{4}$  inches, from center of first to center of second hole  $4\frac{1}{2}$  inches, and same distance from center of second to center of third, also from third to fourth, last hole being again  $3\frac{1}{4}$  inches from end of bar. A slot for spike  $\frac{1}{2} \times 11-16$  inch is in each plate  $8\frac{1}{2}$  inches from one end of bar. The total height is 3 19-32

inches, while the width of flange is 2 17-24 inches, as shown on plan of plate.

The track bolt is  $\frac{3}{4} \times 4$  inches, having a square nut  $\frac{3}{4}$  inch thick, giving room for a  $\frac{1}{2}$ -inch nut lock.

SEVENTY-ONE POUND RAIL SECTION AND JOINT—ATCHISON,  
TOPEKA AND SANTA FE RY.

The section shown on plate CXXV., page 417, gives a total height of rail of 4 9-16 inches and a width of base of 4 9-16 inches; top of ball is curved by a 15-inch radius, upper corners by a  $\frac{3}{8}$ -inch radius; extreme width of ball, 2 15-32 inches; the vertical faces join the lower faces with a curve of 3-16-inch radius, the lower faces forming angles of 12 degrees with the horizontal, and join the web with a  $\frac{3}{8}$ -inch radius. The faces of web are perpendicular to where they curve to upper base faces, with a curve of  $\frac{3}{8}$ -inch radius. The extensions of the lower faces of ball and upper faces of base intersect in the horizontal center line of bolt hole, forming equal angles of 12 degrees therewith. Extreme thickness of ball is 1 45-64 inches, and of base 47-64 inches; center of bolt hole, 1 51-64 inches from base.

The angle bars fits snugly below ball and on top of flange of rail; the vertical sides are  $\frac{3}{4}$  inch thick in narrowest place, and the angles are  $\frac{1}{2}$  inch thick; total length of bar is 23 inches. The upper elevation on plate LV. shows punching diagram, from end of bar to center of first hole 4 inches, then 5 inches from center to center to last hole, and 4 inches from center of last hole to end of plate; there is a slot for a  $\frac{3}{4}$ -inch spike in each plate, 10 $\frac{1}{2}$  inches from end of plate. The lower elevation shows drilling of rail; each end has two holes 1 inch in diameter; the center of first is 2 $\frac{3}{8}$  inches from end of rail, and distance from center of first to center of second is 5 inches; this allows a maximum variation of  $\frac{1}{4}$  inch for expansion. The angle bars do not quite reach the tie, their lowest points being 3-64 inches higher than the base line of rail. The cross section of bar has an area of 3.22 square inches, making the 23-inch bar weigh about 21 pounds.

The bolt has a diameter of  $\frac{3}{4}$  inch, a length of 4 inches, threaded  $2\frac{1}{2}$  inches, round head and oval shank near the head; the nut is  $\frac{3}{4}$  inch thick.

Plate CXXVI., page 418, shows standard Heath rail joint.

STANDARD RAIL SECTIONS, ANGLE BARS AND JOINTS—NEW YORK, NEW HAVEN AND HARTFORD RY.

Plate CLXVIII., page 494, shows standard rail section and angle bar for 73.66 pounds steel. The height of rail is 4 11-16 inches and the base  $4\frac{3}{4}$  inches; top of ball is curved to a radius of 12 inches, upper corners to a radius of  $\frac{3}{8}$  inches; greatest width of ball is 2 7-16 inches; the under corners are curved to a radius of  $\frac{1}{4}$  inch and lower faces form angles of 17 degrees with the horizontal, joining web with a curve of 5-16-inch radius; the web is curved to a 15-inch radius and joins the base with a curve of  $\frac{1}{4}$ -inch radius; the upper faces of base incline under an angle of 13 degrees to the horizon; greatest thickness of ball is  $1\frac{3}{4}$  inches and of base  $\frac{3}{4}$  inches; thickness of web through center of bolt hole 9-16 inch.

The angle bars are constructed to fit perfectly under ball and on top of base of rail, clearing the web on inside  $\frac{3}{8}$  inch and on outside 19-32 inch on center line; thickness of plates at center of bolt holes 9-16 inch; the angle bars are 24 inches in length; the outer bar has 4 round holes of 15-16 inch in diameter, and the inside bar has 4 oblong holes  $\frac{7}{8} \times 1\frac{1}{8}$  inches, punched as shown on cut. Each rail end has two round holes, 1 1-16 inches in diameter, the first hole  $2\frac{3}{8}$  inches from end of rail, allowing  $\frac{1}{4}$  inch for expansion.

Plate CLXIX., pages 496 and 497, shows two different rail sections and angle bar joints, for 78-pound and 100-pound rails; the arrangements are very clear in the cut; the 78-pound rail is  $4\frac{1}{2}$  inches high and has a  $4\frac{1}{2}$ -inch base; the 100-pound rail is 6 inches high, with a  $5\frac{1}{2}$ -inch base; the holes in the 78-pound rail are 1 inch in diameter, while the holes in the 100-pound rail are 1 1-16 inches in diameter, bolts for the former rail be-

ing  $\frac{3}{4}$  inch and for the latter  $\frac{1}{8}$  inch in diameter; the angle bars are 24 inches long for both kinds of rail, but are punched differently. A pair of angle bars for the 100-pound rail weighs 48 pounds.

The 78-pound rail is used on the Old Colony system, except on the Stonington and Worcester divisions.

Plate CLXX., page 499, shows another variety of rail section and joint in use on the Old Colony system of the N. Y., N. H. & H. R. R. It is a 70-pound rail,  $4\frac{1}{2}$  inches high, with a  $4\frac{1}{2}$ -inch base; the various dimensions are plainly given in cut, requiring no further explanations. It is seen that the joint is arranged for suspension upon two ties; rail ends have two holes of 1 inch in diameter and  $\frac{3}{4}$  inch track bolts are used; angle bars are 24 inches long and interchangeable, having oblong holes  $\frac{7}{8} \times 1\frac{1}{8}$  inches.

STANDARD RAIL SECTION, ANGLE BAR AND JOINT—MICHIGAN  
CENTRAL RY.

Plate CV., page 243, shows the Michigan Central standard 80-pound rail, with angle bars and fastenings. The rail is 5 inches high and has a 5-inch base; top of rail and faces of web are curved to a radius of 12 inches; the inner faces of angle bars are curved to a radius of  $4\frac{1}{2}$  inches; the ball is  $2\frac{1}{2}$  inches wide on top and has vertical sides; the lower faces of ball and upper faces of base form angles of 13 degrees with the horizontal; on center line through bolt hole web is 9-16 inch and angle bars are  $\frac{3}{4}$  inch thick; track bolt is  $\frac{3}{4}$  inch in diameter and long enough to accommodate a  $\frac{1}{4}$  inch washer,  $\frac{1}{4}$  inch nut lock and a  $\frac{3}{4}$  inch nut. There are 6 bolts to the joint, spaced as shown in cut, drilling in rail is 1 inch in diameter, the angle bars are 44 inches long and foot of angle does not touch tie by  $\frac{1}{8}$  inch.

STANDARD RAIL SECTIONS AND JOINTS—SOUTHERN RAILWAY.

Plate CLVI., page 476, illustrates two patterns of rails and joints in use upon the Southern Railway, one for 80-pound and one for 75-pound rail.

The 80-pound rail has a height of 5 inches and a



base of 5 inches; the 75-pound rail is 4 13-16 inches high and its base is 4 13-16 inches long. The principal dimensions show plainly in cut; holes in web of rail are 1 inch in diameter; slotted holes in angle bars for spikes are  $\frac{5}{8} \times 11-16$  inch, and the holes in angle bars are oblong,  $1 \times 1\frac{1}{4}$  inch in both styles of joints. Track bolts have square nuts  $1\frac{1}{2} \times 1\frac{1}{2}$  inches and  $1\frac{1}{8}$  inches thick; diameter of bolt is  $\frac{3}{8}$  inch and total length of bolt is  $4\frac{1}{4}$  inches; the joints are designed to be suspended upon two ties 18 inches apart.

STANDARD RAIL SECTION AND JOINT—CENTRAL RAILROAD  
OF GEORGIA.

Plate CLIV., page 474, shows a section of a 68 $\frac{1}{2}$ -pound steel rail, with angle bar as used on the Central Railroad of Georgia. The rail is  $4\frac{3}{4}$  inches high and has a base of  $4\frac{5}{8}$  inches wide. The joint is suspended, 30 inches long, with 6 track bolts. At center line of bolts angle bar is 9-16 inch and web of rail 7-16 inch thick; holes in angle are oblong,  $\frac{7}{8} \times 1\frac{1}{8}$  inches, and holes in rail are round, 1 inch in diameter; the spacing is shown plainly in cut; the radius of rail web is 16 inches and for rail top 15 inches. Joint ties are spaced so as to leave 10 inches clear space between adjacent faces.

STANDARD RAIL SECTION AND JOINT—LOUISVILLE AND NASH-  
VILLE RY.

Plate CXII., page 309, shows details of the 70-pound rail and angle bar joint as used on the L. & N. Railroad. The rail is  $4\frac{5}{8}$  inches high and  $4\frac{5}{8}$  inches wide and has a web 33-64 inch thick through center of bolt hole; the angle bars are 11-16 inch through bolt holes and fit ball and base of rail. The joint is suspended and connected by 4 bolts spaced as shown; the holes in rail are circular, 1 inch in diameter; the holes in outside splice are circular,  $\frac{3}{8}$  inch in diameter, but the holes in inside angle bar are oblong,  $\frac{7}{8} \times 1\frac{1}{8}$  inches; the inside splice is slotted  $3\frac{1}{2}$  inches from end for spikes. The

angle bars are  $22\frac{1}{8}$  inches long and one pair weighs  $40\frac{1}{2}$  pounds. The track bolts are  $\frac{3}{4}$  inches in diameter.

STANDARD RAIL SECTIONS AND JOINTS—NEW YORK, LAKE  
ERIE AND W. RY.

Plate XCVIII., page 212, shows the 80-pound rail section, angle bars and joint fastenings on the N. Y., L. E. & W. R. R. The principal dimensions of the rail are: Height, 5 inches; base, 5 inches; width of ball,  $2\frac{5}{8}$  inches; thickness of web, 17-32 inch. The angle bars are 30 inches long, with 6 bolts; the holes in outside splice are circular and have a diameter of  $\frac{7}{8}$  inch; the holes in inside splice are oblong,  $\frac{7}{8} \times 1\frac{1}{8}$  inches; the holes in rail are round, 1 inch in diameter; thickness of splices  $\frac{3}{4}$  inch through hole. The track bolts are  $\frac{3}{4} \times 4\frac{1}{4}$  inches.

Plate XCIX., page 213, shows the 63-pound,  $68\frac{1}{2}$ -pound and 74-pound rail, with their joint fastenings for the same road. The angle bars for the 63 and  $68\frac{1}{2}$ -pound rails are 25 inches long and have four bolt holes, while the angle bars for the 74-pound rail are 40 inches long and have 6 bolts. The drilling and punching of holes in rails and angle bars are similar as described above, and is plainly shown on cut, the outside splices having round and inside splices oblong holes.

Plate C., page 214, shows their 90-pound rail, with joint fastenings. This rail has a height of  $5\frac{3}{8}$  inches and a base  $5\frac{3}{8}$  inches wide; the ball is  $2\frac{5}{8}$  inches wide, and thickness of web 9-16 inch; the splices are 30 inches long, with 6 bolt holes; diameter of holes in rail 1 inch, in outside splice  $\frac{7}{8}$  inch and in inside splice the holes are oblong,  $\frac{7}{8} \times 1\frac{1}{8}$  inches.

STANDARD RAIL SECTIONS AND ANGLE BARS—CHICAGO, BUR-  
LINGTON AND QUINCY RY.

Plate CXXXIV., page 450, shows two styles of rails and splices as used on the C., B. & Q. R. R.; the upper section is the 65-pound rail, the lower section the 75-pound rail; the dimensions, both of rails and angle bars, are plainly shown and need no further explanation. The angle bars are 38 inches long and rest on three ties, one

tie directly under joint. There are six bolts; the first is  $6\frac{1}{2}$  inches from end and the others are evenly spaced, 5 inches from center to center, and last bolt is  $6\frac{1}{2}$  inches from end. Angle bars are slotted and spiked to the two shoulder ties.

STANDARD JOINT AND ANGLE BARS—UNION PACIFIC RY.

Plate CXLVI., page 466, shows the U. P. standard 75-pound rail, angle bar and joint. The rail is  $4\frac{3}{4}$  inches high and has a base  $4\frac{3}{4}$  inches wide; the ball is  $2\frac{1}{2}$  inches wide and web 17-32 inch thick. Angle bars are 40 inches long and joints rest on three ties, one tie directly under joint. Angle bars are interchangeable, having oblong holes  $\frac{5}{8} \times 1\frac{1}{8}$  inches. The holes in rail are circular, 1 inch in diameter; track bolts are  $\frac{3}{4} \times 4\frac{1}{8}$  inches; joint ties are spaced 16 inches from center to center.

Plate CXLVII., page 467, shows the 70-pound rail, with joint fastenings. This rail is  $4\frac{3}{8}$  inches high and  $4\frac{1}{2}$  inches wide; the ball is  $2\frac{1}{2}$  inches wide and web is  $\frac{1}{2}$  inch thick. There are three holes in each rail end, 1 inch in diameter, and spaced as shown in the cut. The section on C. D. shows form of angle bars, which are 40 inches long, having 6 oblong bolt holes  $\frac{5}{8} \times 1\frac{1}{8}$  inches; they are slotted for three ties, spaced 16 inch centers. The track bolt is  $4\frac{1}{8}$  inches long,  $\frac{3}{4}$  inches in diameter, with nut lock and square nut.

BLOCK SIGNAL TOWER—BALTIMORE AND OHIO RY.

Plate XL., page 95, shows working drawings for a two-story block signal tower, 27 feet high, with a ground area of 10 feet by 10 feet. The structure is framed of timber; the lower story is 12 feet and the upper story 9 feet high. The room on the ground floor can be utilized for storage of supplies. A stairway built outside on the rear of tower affords easy communication with the upper story; plenty of light is provided for the signal man by two double windows, facing directions which he is expected to guard.

(See also Standard Towers for Interlocking Signals, Pennsylvania Lines, west of Pittsburg, Plates LXXIX.

to LXXXVII., pages 162 to 171, for diagrams and descriptions.)

BUMPER (CAR STOP)—BALTIMORE AND OHIO RY.

The upper figure on plate XLVII., page 102, shows a plan and the lower figure an elevation of the standard bumper on the B. & O. R. R. The principal features are two stringers, 12x12 inches, to each of which are bolted two rails, the ends bent up, so their bases meet, forming a triangle with the stringer as a base; the bent-up rails reach 4 feet 4 inches above the top of rails and to them are bolted the bumping timbers, which are 3 feet 9 inches above the surface of rails; these are reinforced by blocks set between them, 3 inches inside of gage and bolted to the inner and outer timber by 1 inch bolts.

The device is inexpensive and effective.

BRIDGE WARNINGS (TELL-TALES)—BALTIMORE AND OHIO RY.

Plate XXXVII., page 92, shows a bridge warning, to be used for 3 or more tracks. It consists of two simple timber standards 23 feet 4 inches high above top of ties, to which is fastened the cord carrying the tell-tale ropes, made of sash cord, from 4 to 6 feet long. The construction is simple; the foundation for standards is a cross of 12x12 inches timber, carrying the center pole, 12x12 inches, at the bottom, gradually battering to 9x9 inches at the top. This is braced to the bottom cross by four pieces, 6x8 inches, and an additional long brace, 6x8 inches, is used from inside the tracks to stiffen the structure against being pulled inward toward tracks.

For one or two tracks the construction of bridge warnings is still simpler and is shown on plate XXXVIII., page 93. A single upright, 8x8 inches, carrying a cross arm 20 feet high above top of rail, are the main features. The cross arm is  $2\frac{1}{2}$ x8 inches by 13 feet 3 inches, braced by a piece 6x6 inches to the upright, and carries the tell-tale cords. The details of the hanger are shown on a larger scale. The upright reaches 4 feet 8 inches below top of rail, being braced by 4 pieces of 6x6 inches and buried in the ground, giving

the structure the necessary solidity. For double tracks the cross arm must be made correspondingly longer.

CATTLE GUARD—BALTIMORE AND OHIO RY.

Plate XXXII., page 87, illustrated a cattle guard as used on parts of this system. It is a very simple arrangement of triangular slats of hardwood, nailed to the ties, parallel with the rails both inside and outside of track up to a juncture of the cattle guard wings connecting with the right of way fence.

STANDARD CATTLE GUARD—MICHIGAN CENTRAL RY.

Another design for cattle guard is shown on plate CII., page 228, and is used on the M. C. R. R. The guard proper consists of four sections of corrugated metal, 9 feet long and 26 inches wide, spiked directly to the ties. The cattle guard wing fences are 4 feet 6 inches high, sloping 1 in 2 with 5 fence boards nailed to the sloping post. The arrangement of parts is plainly shown in cut.

HAND CAR HOUSE—BALTIMORE AND OHIO RY.

Plate XLI., page 96, shows an excellent design for a section hand car and tool house. The first figure shows the gable end and lower figure is an elevation facing track, one-half of which shows the building as finished, and the other half shows framing arrangement; the right half of plate shows the ground plan. The structure covers an area of 12 by 18 feet and gives a clear height of 8 feet; the nearest wall is 10 feet from nearest track rail. A 6-foot sliding door, facing track and placed in the middle of building, gives sufficient room for bringing hand car in and out; a short track 9 feet 8 inches long bringing it to within 8 inches of main track, and a similar track inside car house gives the very best facilities of handling the hand car. On one side of hand car in tool house is sufficient room for grind stone frame, which is placed next the window, giving light while tools are being sharpened. Near the grind stone is a stationary oil box, while on the other side a tool box

is placed. There is plenty room for racks for the proper storing of tools and supplies.

### STANDARD FROGS.

#### NO. 6, CROSSING FROG—BALTIMORE AND OHIO RY.

This frog is shown on plate XVIII., page 62, and is the standard pattern on the B. & O. R. R. for 60 and 67-pound rail. The upper figure shows in plan the general construction, which is self-explanatory. The frog is 12 feet long over all, giving a spread of 12 inches on the gage line at each end; the points are blunted to  $\frac{1}{2}$  inch, and are 30 inches apart, leaving 4 feet 9 inches each way from point to heel. The section on A. B. shows cut across frog near point, and section on C. D. is a cut through frog on second clamp and filling; both views explain fully the fastening of the cast iron filling to the rails and the clamps binding all together. The ties are necessarily so placed that the clamps come between them.

#### NO. 6, STIFF FROG—BALTIMORE AND OHIO RY.

This frog is plainly shown on plate XIX., page 63, and is of the 67-pound rail pattern. It is 8 feet long, spreading 5 11-32 inches at the toe and 10 21-32 inches at the heel measured on gage lines. The flange way is 2 inches and the wings curve slightly at the ends to  $3\frac{1}{2}$  inches away from running rails; the theoretical point is 5 feet 4 inches from heel and the blunt point 5 feet 1 inch, showing the point to be  $\frac{1}{2}$  inch thick. Section on A. B. shows a cut through point and section on C. D. is a cut through second clamp and filling, giving a concise idea of the fastenings. The frog rests on five ties, the cast filling surrounding the point is 12 inches long and the second filling starts 9 inches from first, being 6 inches in length. The wing rails terminate 2 feet 3 inches from heel of frog.

#### NO. 6, STIFF FROG—BALTIMORE AND OHIO RY.

This frog differs mainly from the one just described, that it is of a heavier section, being for 85-pound steel, having joints of 6 bolts, which necessitates a greater

spread at the ends. Plate XX., page 64, shows this clearly. The frog is 10 feet long over all, having a spread of 8 inches at the toe and a spread of 12 inches at the heel. It is supported on 7 ties. The wings curve  $3\frac{1}{2}$  inches from running rails and extend to within 2 feet 9 inches of heel. Otherwise the construction is perfectly similar to the frog described on plate XIX. The sections shown on A. B. and C. D. are of the same character, except that the rail sections are heavier, making the filling and clamps heavier accordingly.

**NO. 7, STIFF FROG—BALTIMORE AND OHIO RY.**

Plate XXI., page 65, shows a plan and two sections of a No. 7 frog of 67-pound rail. It is 11 feet long over all, spreading 77-16 inches at toe and 117-16 inches at heel between gage lines. Flange way is 2 inches wide and wings curve  $3\frac{1}{2}$  inches from running rails, reaching to within 3 feet 5 inches of heel. The theoretical point is 6 feet 8 inches and the blunt point 6 feet  $4\frac{1}{2}$  inches from heel. It rests on 7 ties and is connected to track rails by four bolts, suspended joints. Section on A. B. and C. D. shows fillings and clamps and method of fastenings.

**NO. 8, STIFF FROG—BALTIMORE AND OHIO RY.**

This frog is 15 feet long over all, is made of 60-pound or 67-pound rail and has a spread of  $11\frac{1}{2}$  inches at toe and 11 inches at the heel. It rests on 8 ties and has a flange way of 2 inches. The upper figure on plate XXII., page 66, shows a plan; the two lower views are sections of the frog; it will be observed that the filling around the point is 14 inches long and that 16 inches clear space intervenes to the filling on C D, which is 6 inches long. The wings curve  $3\frac{1}{2}$  inches from running rails, the theoretical point is 7 feet 4 inches, and the blunt point 7 feet from heel. The sections show arrangement of cast filling and clamps.

**NO. 8, STIFF FROG—BALTIMORE AND OHIO RY.**

This is another variety and differs from the preceding one chiefly in being made of 85-pound rail and for

having 6 bolt joints. The top figure on plate XXIII., page 67, shows a plan of this frog. It is 15 feet over all, spreading  $11\frac{1}{2}$  inches at the toe and 11 inches at the heel. It rests on 8 ties and has a flange way of 2 inches. The arrangement of filling and clamps is the same as in the frog just described, only heavier to conform to the rail section. Wings curve  $3\frac{1}{2}$  inches away from running rails and reach within 3 feet 4 inches to heel; the frog point is 7 feet from heel and the theoretical point 7 feet 4 inches, making  $\frac{1}{2}$  inch bluntness.

NO. 8, SPRING RAIL FROG—BALTIMORE AND OHIO RY.

Plate XXIV., page 68, shows a plan and details of a No. 8 spring rail frog for 60 or 67-pound rail. The total length is 15 feet, spreading  $11\frac{1}{2}$  inches at toe and 11 inches at heel; spring is placed 4 feet 6 inches from toe and 3 feet  $8\frac{1}{2}$  inches from frog point. The fixed wing reaches to within 3 feet 3 inches and the spring rail to within 2 feet 3 inches of heel of frog. Point and stationary wing are fastened together like the rigid frogs, as shown in section AB and CD; the spring rail is free to move out 2 inches under the pressure of a wheel flange, until it strikes the stops provided by the four slide plates. A bar  $\frac{3}{4}$  inches thick and 6 feet  $5\frac{3}{4}$  inches long is bolted to the spring rail, bent double opposite extreme slide plate EF, projecting 7 inches, as shown in section on EF. This plate serves as a reinforcement of the spring rail and insures uniform bearing against the stops on the plates; it is shown on cut as looking down upon it and is fastened to the spring rail by eleven  $\frac{3}{4}$ -inch bolts, spaced as shown in diagram. Another view represents a side elevation of point, with the spring rail removed, which shows the flanges of rails interlocked with the clamps.

NO. 8, SPRING RAIL FROG—BALTIMORE AND OHIO RY.

This design is in all respects the same as the one just described on plate XXIV.; the only difference is in the weight of rail used, being made of the 85-pound pattern. The description of this frog shown on plate XXV., page



69, is therefore identical with that given for frog on page 68.

NO. 10, STIFF FROG—BALTIMORE AND OHIO RY.

This frog belongs to the type shown on plate XXII. It has a length of 15 feet and spreads on heel 10 3-32 inches and toe 7 29-32 inches, and is made for 60 and 67-pound rail. The main difference is in the angle of frog, bringing the theoretical point 8 feet 5 inches from heel. A plan and two sections are shown on plate XXVI., page 70.

NO. 10, STIFF FROG—BALTIMORE AND OHIO RY.

This frog, shown on plate XXVII., page 71, corresponds in most all particulars to the one described on preceding plate. It is 15 feet long, spreads 7 5-16 inches at toe and 10 11-16 inches at heel; theoretical point is 8 feet 11 inches and blunt point 8 feet 6 inches from heel; the wings curve  $3\frac{1}{2}$  inches from running rails and reach to within 4 feet 10 inches of heel. The sections shown are cuts on the lines AB and CD, and illustrate mode of fastenings. The frog is made of 85-pound steel.

NO. 10, SPRING RAIL FROG—BALTIMORE AND OHIO RY.

On plate XXVIII., page 72, a No. 10 spring rail frog for 60 or 67-pound rail is shown. Its general construction resembles that of the No. 8 spring rail frog shown on page 68 and described above; total length of frog is 15 feet, spreading 7 27-32 inches at toe and 10 3-32 inches at the heel. The spring is placed 3 feet 6 inches from toe and 3 feet  $7\frac{3}{4}$  inches from point, and has the following dimensions: Free height, 4 inches; solid height,  $2\frac{3}{4}$  inches; outside diameter,  $2\frac{1}{4}$  inches; inside diameter,  $1\frac{1}{2}$  inches; diameter of outside bar,  $\frac{3}{8}$  inch; diameter of inside bar,  $\frac{1}{4}$  inch. The movable wing rail is to be planed as shown by shaded portion in plan and in section at CD, beginning opposite point of frog for 1 foot 8 inches full width of ball, thence triangular a distance of 2 feet 1 inch to point H. The reinforcing bar, which fits the spring rail like a fish plate, is applied in the same way as described on plate XXIV.

NO. 10, SPRING RAIL FROG—BALTIMORE AND OHIO RY.

The frog shown on plate XXIX., page 73, is almost

identical with the preceding one, with the following exceptions: It is made of 85-pound steel rail, spring is placed 3 feet from toe of frog, and movable wing reaches to within 3 feet 9 inches of heel. The dimensions of spring are exactly the same as described above; spread at toe is 7 5-16 inches and at heel 10 11-16 inches. Reinforcing bar and other fastenings, also planing of spring rail agrees perfectly with the preceding frog.

STANDARD SPRING RAIL FROG—ILLINOIS CENTRAL RY.

Plate CXVIII., page 356, shows a No. 10 spring frog, which is standard on the Illinois Central Railroad. It is 14 feet long over all, bringing the point just midway between heel and toe and spreads 7 27-32 inches at toe and 8 15-16 inches at heel, between gage lines. Spring is placed 4 feet 3 inches from toe and 2 feet 9 inches from point, fixed wing is 10 feet 7 inches and spring rail is 12 feet 3 inches long; fixed wing and point are fastened by 6 1-inch bolts, passing through solid wrought iron filling 30 inches long; the flange way is 2 inches. The frog rests on 9 ties 10 inches face;  $\frac{1}{2}$ -inch plates of wrought iron 6 inches wide are placed on the four ties just beyond the spring, to facilitate the movement of the spring rail and to stop it the proper moment, as shown on the sections. A reinforcing bar, similar to the one shown on the B. & O. standards, is bolted to the spring rail, having 2 vertical projections, which slide in the hollow brackets marked 2 and 4. The piece marked Y is a piece of rail planed so as to fit between the rails forming frog point and is fastened to them by 2 bolts  $\frac{3}{4}$  inches diameter. The fixed wing curves away from running rails with a radius of 3 feet, while the spring rail curves with a radius of 4 feet, giving a clearance of 4 inches between balls of rails.

SPRING RAIL FROG—PENNSYLVANIA RY.

The type of spring rail frog shown on plate LXIV., page 140, is entirely different from the preceding ones, length of frog, 15 feet over all, resting on 9 ties and 6 plates  $\frac{3}{4}$ x8 inches and of varying length. Spring is

placed in a box on tie, marked AA, the details of which are shown enlarged in section at AA, the upper one being a vertical and the lower one a horizontal section through the spring and box. The frame is made of  $\frac{5}{8}$ -inch malleable iron  $9\frac{1}{2}$  inches long and 4 inches high. The spring has 6 turns of  $\frac{1}{2}$ -inch diameter steel, one end resting against the back of the box and the other end fastened to a circular malleable iron disc, against which the loop of the reinforcing bar presses. Thus, when the flange of a wheel moves the spring rail, the loop compresses the spring until reinforcing bar rests against spring box, and as soon as the wheel has passed the elasticity of spring pushes the movable rail back to its normal position. The frog is well fastened together; the fixed portions are riveted to the 6 plates and bolted together by  $1\frac{1}{8}$ -inch diameter bolts through the cast filling; the filling in the heel, shown in section at EE, slopes 1 inch from top of rails; the flange way is 2 inches; reinforcing bar is riveted to the spring rail by  $\frac{3}{4}$ -inch rivets and has two projecting loops, one at AA and one at DD, at the latter place sliding through a rectangular open bracket, which forms another stop to spring rail and relieves the spring box of excessive strain. The spring rail falls from point marked M to point N  $\frac{3}{4}$  inches, which is accomplished by reducing the  $\frac{7}{8}$ -inch plate under fixed frog to  $\frac{1}{2}$  inch under the moving rail. (See sections at AA and DD.) This is an excellent arrangement, as it makes the planing of spring rail unnecessary. The other plates are provided with brackets, fitting exactly the reinforcing bar when spring rail is forced out, thus giving uniform lateral support to the moving rail. The ties are 10 inches wide and spaced as shown in plan.

#### STANDARD STIFF FROGS—PENNSYLVANIA RY.

On plate LXV., page 141, is shown a plan of the standard construction of stiff frogs, as used on the P. R. R. system. The flange way is 2 inches; ties up to point are spaced 22 inches, and between point and heel 24 inches from center to center; dimensions of parts are as follows:

From toe to point of frog:

For No. 4 to No. 15, inclusive, 7 feet.

For No. 16 frog, 8 feet.

For No. 18 frog, 9 feet.

For No. 20 frog, 9 feet 10 inches.

For No. 24 frog, 10 feet.

From point of frog to end of wing:

For No. 4 frog, 2 feet 6 inches.

For No. 6 frog, 2 feet 10 inches.

For No. 8 frog, 3 feet.

For No. 9 frog, 3 feet.

For No. 10 frog, 3 feet.

For No. 12 frog, 3 feet 11 inches.

For No. 15 frog, 5 feet.

For No. 16 frog, 6 feet.

For No. 18 frog, 6 feet.

For No. 20 frog, 7 feet 2 inches.

For No. 24 frog, 9 feet.

From point to heel of frog:

For No. 4 to No. 15, inclusive, 8 feet.

For No. 16 frog, 10 feet 10 inches.

For No. 18 frog, 11 feet.

For No. 20 frog, 12 feet 2 inches.

For No. 24 frog, 20 feet.

The ends of wings curve  $3\frac{1}{2}$  inches away from running rails.

**STANDARD STIFF FROG—ATCHISON, TOPEKA & SANTA FE RY.**

The frog shown on top of plate No. CXXIV., page 416, is a No. 6 $\frac{1}{2}$  frog, as used on the A., T. & S. F. R. R. It is 9 feet long over all, spreads 53-32 inches at toe and 103-32 inches at heel; flange way is 2 inches, theoretical point lies 38 inches from toe and blunt point is 2 $\frac{3}{4}$  inches beyond, angle of frog being 9 degrees. It is bound together by 5 bolts 1 inch in diameter, placed 8 inches apart, passing through all the rails and solid cast filling. The wing rails run parallel to running rail beyond point for a distance of 23 inches and then curve away until their inner ball faces are 14 inches apart. The section shows position of the four frog rails at the points EF.

The lower plan shows a No. 9 frog as used on the same road. The total length is 12 feet, spread at toe 5 31-32 inches and at heel 10 1-32 inches. It is bound together by 6 bolts 1 inch in diameter and 6 $\frac{3}{4}$  inches from center to center; the theoretical point is 4 feet 5 $\frac{3}{4}$  inches from toe and blunt point lies 4 inches beyond; flange way is 2 inches and extreme ends of wings are 13 inches apart between inner flanges. The cast filling is 3 feet 3 inches long and a hardwood block 12 inches long is placed in the throat of frog. Both of these frogs are made of 52-pound rail 4 inches high and 3 $\frac{3}{4}$  inches base.

STANDARD STIFF FROG—ILLINOIS CENTRAL RY.

The design on plate CXIX., page 357, represents a No. 10 frog for 75-pound steel and is the standard on the Illinois Central Railway. The frog is 14 feet over all, has a spread of 7 $\frac{3}{4}$  inches at the toe and 8 $\frac{3}{8}$  inches at the heel; it is a typical plate frog, setting on a  $\frac{5}{8}$ -inch plate 40 inches long, tapering from 16 inches to 12 inches, to which rails are secured by  $\frac{3}{4}$ -inch rivets. The flange way is 1 $\frac{3}{4}$  inches and the throat is 5 feet 2 inches from toe of frog. The two rails marked C and D, forming the point, are planed as shown in enlarged views and section on AB shows position of frog rails near end of plate. The section of rail shown, although of the same weight as that described on plate CXX., is of different form. Its height is 4 $\frac{3}{4}$  inches and its base 4 $\frac{3}{4}$  inches; upper face of ball is curved to a radius of 10 inches and upper corners to a radius of  $\frac{3}{8}$  inches; lower faces of ball form angles of 15 degrees to the horizontal and meet the web in a curve of 5-16 inch radius; the web is curved to radius of 10 inches, is 9-16 inch thick in narrowest place and joins the upper faces of base under a curve of 5-16 inch radius. The upper faces of base form angles of 12 degrees 30 minutes, while the horizontal and extreme corners are curved to a radius of 5-48 inch.

STANDARD SPRING RAIL FROG—MICHIGAN CENTRAL RY.

Plate CIII., page 233, shows a No. 11 bolted spring rail frog, as used on the M. C. R. R. It is 15 feet long over all and made of 80-pound steel; point of frog is

cut where it is  $\frac{1}{2}$  inch wide; flange way for 80-pound rail is 2 inches and for lighter rails  $1\frac{3}{4}$  inches, and the stops have to be placed so as to give these throat openings at F. The re-enforcing bar is bolted to the spring rail by 8 bolts  $\frac{3}{4}$  inch diameter; the plates for the stops are  $\frac{1}{2}$  inch by 7 inches, made of wrought iron; the rigid wing is fastened to the point by 6 bolts  $\frac{7}{8}$  inch diameter.

STANDARD SPRING RAIL FROG—LOUISVILLE & NASHVILLE RY.

Plate CXV., page 321, shows the construction of a keyed spring rail frog, with anti-creeping device, as used on the L. & N. R. R. It is 15 feet over all. There is a double spring; the outer coil is of  $\frac{1}{4}$  inch round steel  $1\frac{3}{4}$  inches in diameter, the inner one of 3-16 inch steel  $1\frac{1}{8}$  inches in diameter; the flange way at AA is  $1\frac{7}{8}$  inches, and at DD  $2\frac{1}{8}$  inches; clamps are  $1\frac{1}{4}$  inches thick and 4 inches wide; the reinforcing bar is  $\frac{3}{8}$  inches thick, 5 feet  $1\frac{1}{2}$  inches long and fits web of rail like a fish plate. The spring rail has a maximum movement of  $2\frac{1}{2}$  inches. The anti-creeping device is shown between CC and DD.

STANDARD SPRING RAIL FROG—C., N. O. & T. P. RY.

Plate CX., page 295, shows arrangement of a 75-pound spring rail frog, as used on the C., N. O. & T. P. R. R. It is 16 feet 11 inches long over all and is partly bolted and partly riveted, the construction of which is plainly shown. Reinforcing strap is 7 feet 7 inches long and fastened to the spring rail by 10 bolts; the holding down device rest upon a wrought iron plate  $\frac{3}{4} \times 20 \times 30$  inches; the point is  $3\frac{3}{4}$  inches beyond the theoretical point, and point rails extend 7 feet  $3\frac{1}{2}$  inches to heel of frog; flange way is 2 inches at the throat and stops are arranged so as to give same flange way when spring rail is pushed out; the position of the various parts are shown in the different cross sections on a larger scale.

STANDARD FROGS—CHICAGO AND NORTHWESTERN RY.

Plate CLXV., page 488, shows a No. 10 stiff frog for 80-pound steel. It has a total length of 15 feet and is bolted together by 6 bolts  $\frac{7}{8}$  inch in diameter. The flange way is  $1\frac{3}{4}$  inches and the two wing rails are 10 feet long each; two large size sections are shown, which

illustrate the binding together of the different parts; also the details of the cast iron fillers A and B are given, as well as the crotch filler.

Plate CLXVI., pages 490 and 491, shows the standard spring rail frog of the C. & N. W. R. R. It is a No. 10 frog for 72-pound rail. It is a bolted frog, having a throat flange way of 2 inches. The rigid wing rail is 10 feet long; top of reinforcing bar is  $\frac{1}{4}$  inch below top of spring rail from opposite the theoretical point to toe; the plates Nos. 1, 2, 5 and 7 are  $\frac{3}{8} \times 4$  inches, with ends turned up to form stops for base of spring rail. The springs for these frogs are furnished by the railroad company; enlarged sections show further details of frog. The same general dimensions given for this frog are also used for the 80-pound rail.

#### NO. 7 AND NO. 10, STIFF FROGS—UNION PACIFIC RY.

Plate CXLV., page 465, shows two styles of stiff frogs as used on the U. P. R. R. The upper one is a No. 10 and the lower one a No. 7 frog. The No. 10 has a total length of 15 feet and the No. 7 is 10 feet long. They are for 60-pound steel rail and are bolted together, the details of which are plainly given in cut; the section on AB shows flange ways  $1\frac{3}{4}$  inches, also arrangement of cast iron fillers and bolts; the wings are curved to a radius of 18 inches and bolts are  $\frac{1}{2}$  inches in diameter.

### STANDARD GUARD RAILS.

#### GUARD RAIL FOR SPRING FROG—MICHIGAN CENTRAL RY.

Plate CVI., page 248, illustrates the standard guard rail in use on the M. C. R. R. The plan shows how it is set. It is 15 feet over all, giving a clear flange way of 2 inches for 5 feet opposite frog point; then flange way increases from 2 inches to  $2\frac{3}{4}$  inches in 3 feet and from here to end it curves abruptly for 2 feet, until end of guard rail is 8 inches from main rail. The upper figure shows a section of main and guard rail through the center.

#### GUARD RAIL FOR FROGS AND SWITCHES—LOUISVILLE AND NASHVILLE RY.

Plate CXIV., page 317, shows three styles of stand-

ard guard rails as used on the L. & N. system. The upper one is a guard rail for split switch point, the middle one for stiff frogs and the lower one for spring rail frogs; the first is 6 feet, the second 10 feet and the third 15 feet in length. They all run parallel with main rail to within 2 feet from end and then curve 4 inches away from gage line of guard rail.

GUARD RAIL FOR FROGS—CENTRAL RY. OF GEORGIA.

Plate CLII., page 472, shows the standard guard rail for frogs on the C. R. R. of Georgia. The flange way is 2 inches for 5 feet opposite throat of frog, then widens out to  $2\frac{1}{8}$  inches in 1 foot, and then curves away for 4 feet 6 inches until end is 6 inches away from main rail. The length of guard rail in all is 15 feet. The cut shows both guard rails in their relative position in track.

GUARD RAIL FOR FROGS—UNION PACIFIC RY.

Plate CXLIV., page 464, shows the standard guard rail in use on the U. P. system. It is 10 feet long and has a flange way of 2 inches for 12 inches both sides from center. It then is bent outward so that in 4 feet it departs 5 inches from main rail. It is protected by 3 rail braces placed as shown. The flange of guard rail is cut so as to clear base of main rail  $\frac{3}{4}$  inch, to provide room for spiking main rail.

MAIL BAG CRANE—BALTIMORE AND OHIO RY.

Plate XLV., page 100, shows an elevation and details of a mail crane as used on the B. & O. system. The post is 11 feet high, 6x4 inches and the cross arm is 6 feet  $6\frac{3}{4}$  inches long, 3x5 inches. The details show method of fastening and plate XLVI. gives full instructions as to its construction, as well as a bill of lumber.

PEN STOCK (WATER COLUMN)—BALTIMORE AND OHIO RY.

Plates XLIII. and XLIV., pages 98 and 99, show details of penstock as operated on the B. & O. R. R. The center line of spout is 13 feet above base of rail, is made of galvanized iron and curves 90 degrees at delivery end, so that the water flows out vertically. The stand pipe has an inner diameter of 8 inches and is  $\frac{3}{4}$  inches



thick. It can readily be swung into position for taking water, and after it has been used, turned back parallel to tracks. The valve admitting the water is placed below the floor, as shown in section. Drainage is provided by a gutter terminating in a 3-inch pipe. Plate XLIV. shows details of construction.

## STANDARD RAIL SECTIONS.

(SEE ALSO ANGLE BARS.)

FOR EIGHTY AND ONE HUNDRED POUND RAIL—NEW YORK  
CENTRAL AND HUDSON RIVER RY.

The two rail sections and elevations shown on plate XCI., page 191, are standards upon the N. Y. C. & H. R. R. R. The left hand section and elevation is an 80-pound and the right hand section and elevation a 100-pound rail. The 80-pound rail has a base of 5 inches and a height of  $5\frac{1}{2}$  inches; top of ball is curved to a 14-inch radius, upper corners to a 5-16 inch radius; vertical faces of ball slope 1-16:1, and lower faces 1:4; intersecting center line of rail  $1\frac{1}{2}$  inches below highest point of ball; vertical and lower faces of ball join with a radius of 1-16 inch; lower faces curve to web with a radius of  $\frac{1}{2}$  inch; web is formed by arcs of a circle of 14 inches radius, and is 17-32 inches thick in narrowest place; web curves to base with a 5-16 inch radius; upper faces of base slope 1 to 4 and intersect center line of rail  $\frac{7}{8}$  inches above lower base line; thickness of base on outside  $\frac{1}{4}$  inch, both corners rounded by a 1-16 inch radius; the drilling diagram in elevation shows 3 holes 1 inch in diameter, 5.6 inches from center to center, first hole 2.7 inches from end of rail; center line of holes  $2\frac{1}{4}$  inches from lower base line. Cross-sectional area is divided so that the head contains 42.2 per cent., the web 21.1 per cent. and the base 36.7 per cent. of the total area.

The 100-pound rail has a base of  $5\frac{1}{2}$  inches and a height of 6 inches; top of ball is curved to a radius of 14 inches and upper corners to a radius of 5-16 inches; the vertical faces of ball slope 1-16 to 1 and join the lower faces with a curve of 1-16 inch radius; lower faces slope 1 to 4 and intersect in center line of rail  $1\frac{5}{8}$  inches below

crown of ball; the web is formed by arcs of a 14-inch radius circle, curving to ball with  $\frac{1}{2}$ -inch radius and to base with 5-16 inch radius; thickness of web at thinnest point 19-32 inch; upper faces of web incline 1 to 4 and intersect in center line of rail 31-32 inches from lower base line. They taper to 9-32 inches at extreme end and both corners are rounded by a circle of 1-16 inch radius. The 3 bolt holes are shown in drilling diagram to be 1 inch in diameter and 5.6 inches from center to center; first hole 2.7 inches from end of rail, center line of holes  $2\frac{5}{8}$  from lower base line. Of the total cross-sectional area to ball contains 40.8 per cent., the web 23.5 per cent., and the base 35.7 per cent.

FOR SEVENTY-TWO AND NINETY-FIVE POUND RAIL—BOSTON AND ALBANY RY.

Plate III., page 19, shows two sections of rails as used on the B. & A. R. R. The left hand section is a 95-pound rail,  $5\frac{1}{2}$  inches base and 5 1-32 inches high; the upper face of ball is formed by an arc of 14-inch radius circle, curving down with a 5-16 inch radius; the vertical faces of ball incline 1-16 to 1, curving to the lower faces of ball with a radius of  $\frac{1}{4}$  inch; the lower faces slope 1 to 4 and intersect center line of rail 1 9-16 inches below crown of ball; the web is formed by arcs of a circle with a radius of 14 inches, joining the ball by a  $\frac{1}{2}$ -inch radius and upper faces of base by a 5-16 inch radius. The web is  $\frac{5}{8}$  inch thick in narrowest place; upper faces of base slope 1 in 4 and intersect center line of rail 1 inch above lower base line; the base is 5-16 inch thick at edge, both corners rounded with 1-16 inch radii.

The right hand section is a 72-pound rail,  $4\frac{1}{2}$  inches base and  $4\frac{1}{2}$  inches high; upper face of ball is curved to an 11-inch radius and the corners to an 11-32 inch radius; vertical sides of ball join the web with  $\frac{1}{4}$ -inch radius. The web is formed by arcs of circles having 10-inch radii and curve to ball with  $\frac{1}{2}$  inch and to the base with  $\frac{3}{8}$ -inch radii; least thickness of web is  $\frac{1}{2}$  inch; upper faces of base incline so as to intersect center line of rail 13-16 inch from lower base and taper down to  $\frac{1}{4}$  inch, rounded by a  $\frac{1}{8}$ -inch radius.

## STANDARD ROAD AND STREET CROSSINGS.

## STANDARD ROAD AND STREET CROSSINGS—BALTIMORE AND OHIO RY.

A public road crossing for a double track is shown on plate XXXIII., page 88, which is the standard on the B. & O. R. R. It consists of 8 planks 4x10 inches by 16 feet, one laid next each side of rail, the plank lying in flange way having upper corner cut away 2 inches by 2 inches; a piece, 4x10 inches, is framed to the planks, making rectangular fields between the tracks and rails, which are filled level to top of planks with ballast (either broken stone or gravel).

## STANDARD STREET CROSSINGS—NEW YORK CENTRAL AND HUDSON RIVER RY.

Plate LXXXIX., pages 182 and 183, shows a double track crossing in a stone-paved street on the N. Y. C. & H. R. R. R. The upper figures are a longitudinal elevation and plan of track, showing the rail raised above the ties resting on specially constructed chairs (Duggan chairs); the intermediate ties are 25 inches from center to center and 2 Duggan chairs are placed on each tie of the style shown in lower left hand corner. Joint ties are 15 inches from center to center and the chairs used on these ties are like detail shown in upper left hand corner. The general arrangement of street and tracks is shown in the section, leaving a stone-paved drive way between tracks and curb. The stone blocks between the rails rest on a layer of fine sand, while outside the ties the paving rests on concrete. The ties lie in a bed of gravel ballast. The enlarged plan and section show further details. An angle rail is bolted to track rail for full length of crossing on the running side, giving a clear flange of 1 9-32 inches for the cars and preventing the wheel of vehicles from getting wedged in between rail and paving. The chairs raise the rails 4 inches above ties and are 10¼ inches wide at the base.

The crossing shown on plate XCIII., page 198, is the Union street crossing at Schenectady, N. Y., on the line of the N. Y. C. & H. R. R. R. The street crosses

eight tracks, which are paved between the ties by the so-called Belgian block pavement.

Another type of street crossings is shown on plate XCIV., page 199, which represents West street crossing the N. Y. C. & H. R. R. R. tracks at Syracuse, N. Y. The plan in the upper right hand corner shows the arrangement. A 12-inch plank is placed next to each side of rail and the intervening space is filled with brick placed edgewise. The section shows that two 3-inch planks are placed on top of each other, the lower one butting up against rail and upper one spiked to lower one, thus making lateral displacement impossible. The brick rest on fine gravel, reaching about 2 inches above top of ties and bringing the upper face of brick level with top of plank and rail.

STANDARD ROAD CROSSINGS—LOUISVILLE AND NASHVILLE RY.

Plate CXVI., page 325, shows a single track road crossing on the L. & N. R. R. The details of the construction are given in the enlarged plan and sections. A special feature is the double rail, which assures a permanent flange way for car wheels and makes the crossing more substantial. The ends of these auxiliary rails are turned out like guard rails. The planks are 4x8 inches, with  $1\frac{1}{4}$  inches spaces between, which are filled in with ballast, level with top of planks. A transverse plank, 2x8 inches, is morticed into the planks, binding them together. The whole is securely spiked to the ties by 8-inch boat spikes. Box drains, 10x10 inches, are placed in both ditches to carry the water under crossing.

Plate CXVII., page 330, shows a standard street crossing over the L. & N. in Louisville, Ky. The rails are raised above the ties by 12x12 inch stringers and rest directly on wrought-iron plates,  $\frac{3}{8}$ x8 inches. The paving consists of brick, set edgewise. The details are plainly shown in cut.

STANDARD ROAD CROSSING—UNION PACIFIC RY.

Plate CXLIII., page 463, shows four styles of road crossings as used on the U. P. R. R. Pattern 1 is used

on standard gage tracks, with broken stone ballast. No. 2 is used on standard gage, where ballast is either gravel or earth. The space between rails is covered by 2 planks  $3\frac{1}{2}$  by 12 inches by 16 feet, placed next to rails, and the space between these is filled by two planks 14 inches wide. One plank 12 inches wide is placed on outside of either rail.

No. 3 is a narrow gage crossing, having 3 planks 10 inches wide between rails and one 12-inch plank on outside of each rail.

No. 4 is a three-rail crossing, used on tracks arranged both for standard and narrow gage. The crossing over the narrow gage part is the same as in No. 3, and the space between middle rail and outer rail of standard gage is filled by a plank 15 inches wide. The ends of planks are beveled, also edge of planks adjoining gage lines. This is shown in the different cross sections.

#### STANDARD ROAD CROSSING—CENTRAL RY. OF GEORGIA.

Plate CLV., page 475, shows the standard road crossing of the Central Railroad of Georgia. It consists of 2 planks  $4\frac{1}{2} \times 10$  inches, placed  $2\frac{3}{8}$  inches from rail at gage side and two planks  $4 \times 12$  inches, placed outside each rail. The spaces between the inside planks are filled with ballast level with the planks. The planks are adzed down at the ends. This form makes a simple and efficient crossing.

#### STANDARD ROAD BEDS.

There is no one consideration upon which the stability of a track depends more than upon the judicious selection of the form of the roadbed, and in order to provide as much information as possible in regard to this subject a considerable variety of standard sections have been collected and are described below, reference being had to the accompanying illustrations.

#### DOUBLE TRACK ROADBEDS—BALTIMORE AND OHIO R. R.

The upper figure on plate IV., pages 28 and 29, represents the cross-section of rock ballasted double track, being standard on the B. & O. R. R., taken on a straight

line, while the lower figure is a section through the same roadbed, taken on a curve. The slope of embankment is uniformly 1 to  $1\frac{1}{2}$ , but the slope in cuts is  $\frac{1}{4}$  to 1 in rock, 1 to 1 in common soil and  $1\frac{1}{2}$  to 1 in sand and loose material. The subgrade is level and 12 inches below base of ties, but slopes from outside end of ties slightly to the ditch line in cuttings and to berm line in embankments, the ditchline being 7 feet and berm line 6 feet from nearest rail; broken stone is filled in flush with top of ties, giving a total depth of ballast of 19 inches (12 inches below base of  $7\times 8$  inches by 8 feet 6 inches ties); the ballast slopes from end of ties to subgrade 1 in 1, base of rail is 2 feet 4 inches above berm line, and 2 feet 6 inches above ditch line; the total width of roadbed is 31 feet  $1\frac{3}{4}$  inches from ditch line to ditch line and 29 feet  $1\frac{3}{4}$  inches from berm to berm, the two tracks being 12 feet from center to center.

The section of the curved roadbed agrees with the one just described for the straight tracks, except the modification made necessary by the elevation of the outer rail, changing the form of the ballast and slightly increasing amount of rock, since a depth of 12 inches is maintained under the low rail. Such increase varies naturally with the amount of elevation given.

The sections shown on plate VI., pages 40 and 41, are also standards of the B. & O. R. R., being sections through main track and siding. The upper one represents the main track ballasted with rock, the sidings with engine cinders, while the lower one shows main track ballasted with gravel and side track with cinders. The general dimensions and slopes are identical with those described above and the only difference is in the gravel bed, which is filled in level to top of ties between rails, but curves gently from inner edge of base of rail to subgrade, just touching tie end at bottom and reaches subgrade 2 feet 6 inches from end of tie.

Plate V., pages 34 and 35, shows sections through gravel ballasted, double track road, straight line as well as on curve. The arrangement of subgrade, cuts and fills are the same as described on plate IV., and the dif-

ference is in the arrangement of the gravel, which is shown plainly by the shaded portions in the figures. On the straight line section the ballast is curved uniformly from center of track, where it reaches up level to top of ties to the subgrade, which it strikes 2 feet 6 inches beyond end of tie, just touching base of tie end; depth of ballast 12 inches below tie.

The curved section on lower half of plate shows arrangement of ballast as made necessary by the elevation of the outer rail. The gravel is 12 inches deep under lowest rail and consequently the depth of ballast increases under outer rail according to the degree of curve. All other dimensions remain unchanged.

#### DOUBLE TRACK ROADBED—BOSTON AND ALBANY RY.

Plate I., page 11, represents a standard road view of the B. & A. R. R. double track, the left side showing embankment and the right side cutting and arrangement of ditch. Bank and cut slope  $1\frac{1}{2}$  to 1. The ditch is 12 inches wide, level at the base and 24 inches below the level of rail tops. All slopes under the rails are 1 in 12 and tracks are spaced 12 feet from center to center. The depression midway between the two tracks is 9 inches below level of rail tops. The berm is 5 feet from nearest rail.

#### STANDARD ROADBED SECTIONS FOR SINGLE, DOUBLE, THREE AND FOUR TRACKS—PENNSYLVANIA R. R.

The sections on plate LXI., page 132 and 133, are very complete, giving full information for single, double, three and four track beds, and are standard on the P. R. R. It will be observed that the cutting and filling is the same in the four different road beds. The subgrade slopes 1 to 48 from center line of bed to end of ballast, thence 1 to 6 from end of ballast to berm line, thence  $1\frac{1}{2}$  to 1 from berm line to ditch in cutting or continues with the same slope to base of embankment. The ballast, whether of stone or gravel, is 8 inches deep below base of ties in center of roadbed. The gage is 4 feet 9 inches and the tracks are 12 feet 2 inches from center to center. The stone ballast is handled as shown

by diagrams; namely, tracks are filled in level to top of ties, but both ends are curved from extreme ends of ties down to subgrade, 3 feet  $8\frac{1}{2}$  inches from outside rail; spaces between tracks are also filled level to top of ties. In the case of gravel ballast it is different and is shown by the dotted lines in diagrams, leaving the ends of all ties in full view; width of ballast on subgrade for single track 12 feet 2 inches, for double track 24 feet 4 inches, for three tracks 36 feet 6 inches, and for 4 tracks 48 feet 8 inches; width of bed, from berm to berm, for single track, 19 feet 2 inches, for double track 31 feet 4 inches, for three tracks 43 feet 6 inches, and for four tracks 55 feet 8 inches. The ditch is 24 inches wide at base level, and 8 inches below berm line. Ballast required per mile is as follows: The single track requires 1,900, the double track 4,075, the three track 6,950, and the four track bed 10,185 cubic yards of gravel; the single track requires 2,315, the double track 5,300, the three track 8,500 and the four track bed 12,260 cubic yards of broken stone per mile.

On curves the corresponding rails in the different tracks must be on the same level.

A modification of roadbed section is shown in the single track diagram to be used on lines of light traffic, in which case the line of excavation starts directly on berm line under a slope of  $1\frac{1}{2}$  to 1. This decreases the cost of road considerable.

Plate LXII., page 138, details another standard roadbed section of the Pennsylvania Railroad. The roadbed is for double track, gravel ballasted, and conforms chiefly to the specification described above, being principally used on lines of light traffic. The width of bed from berm to berm is 31 feet 4 inches, whence fill or cut slope 1 to  $1\frac{1}{2}$ . Outside end of tie is 5 feet 4 inches from berm (or ditch) line and base of tie is 20 inches higher than ditch; the subgrade is level for 12 feet 2 inches (from center of track to center of track), and slopes 8 inches down to berm line. There is 12 inches of gravel below ties, ends of ties are exposed and gravel slopes to subgrade at the rate of  $2\frac{1}{4}$  to 1; ditch line runs 7 feet



from outside rail. Ties are 8 feet 6 inches long and placed 14 to 30 feet of track.

STANDARD ROADBED SECTIONS FOR SINGLE, DOUBLE AND FOUR TRACKS—NEW YORK CENTRAL AND HUDSON RIVER RAILWAY.

Plate XC., page 187, represents the single track, gravel ballasted roadbed section as used on the N. Y. C. & H. R. R. R. The subgrade is 15 feet wide from berm to berm and has a 3-inch raise in center, equal to a slope of 1 to 30. If the roadbed is on a fill the bank slopes from berm uniformly at the rate of  $1\frac{1}{2}$  to 1. In cuttings the ditch is formed 6 inches below berm line, having a horizontal base 12 inches wide and side faces sloping  $1\frac{1}{2}$  to 1. The different lines shown in diagram represent different angles of cuttings and vary according to the materials. Thus, in solid rock the slope is from  $\frac{1}{4}$  to  $\frac{1}{2}$  in 1; in loose rock from  $\frac{1}{4}$  to  $\frac{1}{2}$  in 1; in gravel and earth from 1 to  $1\frac{1}{2}$  in 1, and in clay and slippery material from  $1\frac{1}{2}$  to 3 in 1; width of ditch level with berm is 30 inches. The ties are 8 feet long and the gravel is filled in to top of ties, the ends of which are embedded in ballast. The gravel slopes with a curve from end of ties to subgrade, which is reached 12 inches from berm. Top of ties is 18 inches higher than berm, leaving 9 inches of gravel between bottom of tie and subgrade at the center.

Plate LXXXVIII., pages 175 and 176, shows two types of roadbeds, constructed for heavy and fast traffic. The top cut shows a section of double track roadbed ballasted with gravel; the two tracks are 12 feet from center to center, giving a clearance of 4 feet between ties; subgrade from berm line to berm line is 27 feet, sloping from center at the rate of 1 in 27; top of ties is 18 inches above berm line and angle of ditch in cuts is formed by faces sloping  $1\frac{1}{2}$  to 1; bottom of ditch is 6 inches below berm line and 12 inches wide; slope in embankments is uniformly  $1\frac{1}{2}$  to 1, but varies in cuts from  $\frac{1}{2}$ :1 to 3:2, according to the quality of material. The slope starts on subgrade 30 inches beyond berm line; the gravel ballast is brought up from subgrade

level to top of ties, making depth of ballast 12 inches in center of roadbed. Ballast is rounded off from end of ties, leaving a clear strip of 12 inches of berm adjoining ditch.

The lower view shows a section of the four track line of the N. Y. C. & H. R. R. R. through the city of New York. The level of the road is depressed and enclosed between two retaining walls 53 feet apart. Width of roadbed proper is 50 feet, the two inside tracks being 12 feet from center to center and outside tracks 13 feet. The subgrade is level, on top of which a 6-inch course of rough quarry spawls, 4 to 6 inches in diameter, is placed. On top of this comes crushed rock 2 inches in diameter, filling up to top of ties, a thickness of 12 inches and rounded off at the edge of ditch. The ditch is formed by two faces, inclining under an angle of 45 degrees. Its bottom is level, 6 inches wide and 6 inches below grade line, giving a clear width of 18 inches to ditch between retaining wall and ballast. The extreme ends of ties in outside tracks reach to within 2 feet of edge of ditch and the broken stone slopes from end of ties in a curve to the edge of layer of coarse rock, giving an easy slope of 1:2. The ballast required for 100 lineal feet of this quadruple track is 158.4 cubic yards of 2-inch crushed rock and 92.6 cubic yards of rough quarry spawls, or a total of 251 cubic yards.

STANDARD ROADBED SECTIONS FOR SINGLE AND DOUBLE TRACK—NEW YORK, LAKE ERIE AND WESTERN RY.

Plate XCV., page 207, shows the standard single track roadbed sections, the upper cut being the rock ballasted and the lower cut the gravel ballasted section; width of roadbed is 18 feet 8½ inches, both for cuts or fills, and is 8 inches higher in center than at ditch line. Ballast has a clear depth of 12 inches below ties in center. The stone ballast is filled in level to top of ties, clear to end of ties, while the gravel ballast leaves the ends of ties just clear. The slope of cuts and embankments is uniformly 1½ to 1; length of ties 8½ feet.

Plate XCVI., page 209, gives standard dimensions for double track, the upper figure for gravel and the

lower for stone ballast. The width of bed in both cases is 31 feet 8½ inches, bringing the tracks 13 feet from center to center. The gravel ballast is handled similar as explained above and forms a curved ditch between the tracks, while the stone ballast is carried across level with top of ties. Slopes of ditches and embankments are uniformly 1½ to 1. Depth of ballast under center of ties is 12 inches and bottom of ties is 20 inches above bottom of ditch.

Plate XCVII., page 211, shows arrangement of roadbeds of main and side tracks. The upper figure represents the main track ballasted with stone and side track with engine cinders and the lower cut the main track ballasted with gravel and side track with cinders. The same general dimensions are followed as explained above. It is seen the engine cinder ballast is handled like the stone ballast.

STANDARD ROADBED SECTIONS FOR SINGLE AND DOUBLE TRACK—PHILADELPHIA AND READING RY.

Plate LVI., page 113, shows two varieties of single track section. The upper cut is an embankment, track ballasted with gravel or cinders and the lower figure shows a cut for the same kind of ballast. The dimensions and arrangement is very plainly shown in illustration, requiring no further comment.

Plate LVII., page 114, shows similar views for single track roadbed sections, ballasted with broken stone or slag. It will be observed that the section of cut differs according to whether the cut is dry or wet. If dry the ditch is formed as shown in left hand corner; if wet, as shown in right hand corner.

Plate LVIII., page 117, shows the standard double track section; three varieties shown, the upper figure shows a double track fill ballasted with gravel or cinders: the berm is 31 feet 6 inches wide and fill slopes 1½ to 1; the ballast is 12 inches deep under ties and is filled up level to top of ties in center, curving down to base of tie at tie ends. The tracks are 13 feet from center to center and ballast forms a curved ditch between the two tracks, being 3½ inches deep in lowest place.

The middle figure illustrates the double track roadbed section, ballasted as above, but located in a cut. Observe again the difference in ditch formation for wet and dry cuts.

The lower cut shows the double track roadbed section on a curve in a cut. The same general dimensions are maintained as in the middle figure, and the only difference is in the elevation of the outer rail.

Plate LIX., page 120, shows the stone or slag ballasted double track roadbed sections, the upper figure illustrating the fill, the second figure straight line through cut and the third figure curved line through cut. The illustrations are so plain as to require no further information.

STANDARD ROADBED SECTIONS FOR DOUBLE AND FOUR TRACK ROAD—NEW YORK, NEW HAVEN AND HARTFORD RAILWAY.

Plate CLXVII., page 493, describes the standard roadbed sections of the N. Y., N. H. & H. R. R. The upper cut shows the double track, gravel ballasted and the lower cut a half section of the four-track bed, stone ballasted. The double track section is 30 feet wide, with 12 feet between track centers, while the four-track bed is 54 feet wide, also 12 feet between track centers. The gravel ballast curves from center of track to middle of tie ends, while the stone ballast is carried clear through level to top of ties.

STANDARD ROADBED SECTION FOR DOUBLE TRACK—MICHIGAN CENTRAL RY.

Plate CI., page 221, shows the standard double track roadbed section of the M. C. R. R. The subgrade is arched 6 inches in center. The left hand corner shows arrangement of bed for fill and the right hand corner for cut, indicating the formation of the ditch. The cut is very plain and gives all necessary information.

STANDARD ROADBED SECTIONS FOR DOUBLE TRACK—LAKE SHORE AND MICHIGAN SOUTHERN RY.

Plate CLXIII., page 483, shows the double track roadbed of the L. S. & M. S. R. R. The upper cut is a

section of an excavation and lower cut is a section for embankment. Tracks are centered 13 feet, with 12 inches of gravel below ties. All slopes are  $1\frac{1}{2}$  to 1. The ballast required per lineal foot of roadbed in cut is 1.31 cubic yards for double track and .71 cubic yards for single track; on embankments ballast required for double track .79 cubic yards and for single track .41 cubic yards per lineal foot.

STANDARD ROADBED SECTIONS FOR SINGLE AND DOUBLE TRACK—LOUISVILLE AND NASHVILLE RY.

Plate CXI., page 306, shows standard roadbed sections on the L. & N. R. R., both cut and embankment and for stone ballast, as well as for gravel. The figures are very plain and require no further explanation.

STANDARD ROADBED SECTIONS FOR SINGLE TRACK—SOUTHERN RAILWAY.

Plate CLVII., page 477, shows cut and embankment for single, stone ballasted track; gage of track 4 feet 9 inches; ballast slopes from tie seat 2 to 1 to the subgrade.

Plate CLIX., page 479, shows the section for round gravel ballast. The dimensions are the same as in plate CLVII.

Plate CLX., page 480, shows the same sections for angular gravel ballast.

Plate CLXI., page 481, shows same sections ballasted with earth. All of the sections are plainly shown in the illustrations.

STANDARD ROADBED SECTIONS FOR SINGLE TRACK—CENTRAL RAILWAY OF GEORGIA.

Plate CXLVIII., page 468. The upper figure shows the fill of a single track section unballasted, the lower figure shows fill for single track ballasted with cinders or gravel.

Plate CXLIX., page 469, shows cuts for unballasted single track and for cinders or gravel ballast.

Plate CL., page 470, upper figure shows earth cut for single track ballasted with broken stone. The lower

figure shows a single track roadbed in a rock cut, ballasted with broken stone.

Plate CLI., page 471, shows a modification of the stone ballasted single track section. The lower figure is a diagram from which the section foremen are to determine the elevation of curves. A string 58 feet long is taken and tightly stretched on gage line of a curve; then the distance between center of line and gage line of rail is the required elevation.

STANDARD ROADBED SECTIONS FOR SINGLE TRACK—CINCINNATI, NEW ORLEANS AND TEXAS RY.

Plate CVII., page 286, shows three different styles of single track roadbed sections in rock cuts, namely for stone, slag and gravel or earth ballast. All the principal dimensions show plainly in cut.

Plate CVIII., page 289, shows three varieties of roadbeds for earth fills or cuts. The upper figure shows stone ballast, the middle figure slag ballast and the lower figure gravel or earth ballast. All slopes are  $1\frac{1}{2}$  to 1.

STANDARD ROADBED SECTIONS FOR SINGLE AND DOUBLE TRACK—CHICAGO, BURLINGTON AND QUINCY RY.

Plate CXXXII., page 446, shows standard roadbed sections for single and double track on embankments. The ballast is either gravel or stone. All slopes are  $1\frac{1}{2}$  to 1.

Plate CXXXIII., page 449, shows standard sections of cuts for single and double track, ballasted with gravel or stone. The slopes are again  $1\frac{1}{2}$  to 1 and a tile 6 inches in diameter is laid 2 feet below lowest point of ditch. The dimensions are plainly indicated in the drawings.

STANDARD ROADBED SECTIONS FOR SINGLE TRACK—ATCHISON, TOPEKA & SANTA FE RY.

Plates CXXII., CXXI. and CXXIII., on pages 403, 402 and 404, show five variations of roadbed sections as used on the Santa Fe road. The upper section on plate CXXII. shows a ballasted fill. The subgrade is level 8 feet (directly under tie), and slopes 1 in 7 feet 6 inches to berm, whence the regular embankment slope

1½ to 1 commences. Ballast is carried in level with top of ties and slopes 2 in 1 to subgrade, commencing 6 inches outside of ties. Total width of embankment from berm to berm is 23 feet. The section of the unballasted earth cut, shown in lower half of plate CXXII., has a width of 26 feet from ditch to ditch. The ties lie directly on subgrade, which is level for 8 feet and slopes from ends of ties to ditch line at the rate of 1 to 9, bringing bottom of ditch 12 inches lower than bottom of tie. Slope of cutting is 1 in 1. The slope of subgrade is continued between ties meeting in center of track at top of tie.

The upper section shown on plate CXXI. represents an unballasted fill, which is in all respects the same as the ballasted fill described above, with the exception of the ballast. The ties rest directly upon the subgrade, which is level for 8 feet and slopes 1 in 7 feet 6 inches to berm.

The lower section describes a ballasted rock cut. The subgrade is level just under tie and slopes to line of ditch, which is 2 feet 4 inches below top of tie. Depth of ballast under tie is 14 inches and tie is 6 inches thick. Ballast is put in level to top of ties and commences to slope to subgrade 6 inches beyond end of ties at the rate of 1 in 2, striking subgrade 2 feet 3 inches from line of ditch. The face lines of the rock cut recede from track under an angle of ¼ inch in 1.

Plate CXXIII., page 404, is the section of a ballasted earth cut and agrees with lower section described on plate CXXII., except that in this case the ties rest on 14 inches of ballast. The subgrade slopes 1 in 9 to ditch and cut slopes 1 in 1, bringing top of rail 2 feet 4 inches higher than lowest point in ditch. The arrangement of ballast is the same as described in the ballasted rock cut. The two ditch lines are 26 feet apart.

STANDARD ROADBED SECTIONS FOR SINGLE AND DOUBLE  
TRACK—THE GREAT NORTHERN RAILWAY LINE.

Plates CXXXV., CXXXVI., CXXXVII. and CXXXVIII., on pages 454, 455, 456 and 457, show dia-

grams of the standard roadbed sections of the G. N. R. R. line.

The upper figure on plate CXXXVII. is a single track section, without ballast, cut type. The subgrade falls 12 inches in 8 feet 6 inches, lowest point of ditch being 12 inches lower than base of ties and faces of cut rise from ditch line at the rate of 1 in  $1\frac{1}{2}$ .

The lower figure shows same type of single track on embankment. Berm lines are 10 inches lower than bottom of ties and are 4 feet 3 inches beyond end of ties. The embankment slopes at the rate of 1 in  $1\frac{1}{2}$ .

Double track sections, without ballast, are shown on plate CXXXVIII.; the upper shows roadbed in cut, sloping 3 to 1 both sides. Ditch is 4 feet 6 inches from end of tie and 12 inches lower than base of tie. Tracks are 15 feet apart from center to center and a ditch is formed between the two tracks, same depth as the outer ditches. The cut faces slope  $1\frac{1}{2}$  to 1.

The lower view, showing embankment, has a similar profile, excepting berm line begins 4 feet 3 inches from end of ties and embankment slopes  $1\frac{1}{2}$  to 1. A ditch 12 inches lower than base of ties is formed between the two tracks.

Upper part of plate CXXXVI. shows a section through an excavation of single track, ballasted with gravel. The subgrade is level for 12 feet and then slopes to ditch 3 to 1. Lowest point of ditch is  $10\frac{1}{2}$  inches lower than berm. The ballast is rounded off, leaving tie ends clear and leaving 6 inches of berm free.

The lower figure shows single gravel ballasted track on embankment. The subgrade is level between berm line, 14 feet apart. The embankment slopes uniformly from berm line at the rate of 1 in  $1\frac{1}{2}$ . The ballast is arranged as above, giving a clearance of 18 inches to berm line. Average depth of ballast about 6 inches below ties.

Plate CXXXV. shows double track cross sections, ballasted with gravel. The arrangement is identical with those shown on plate CXXXVIII., excepting that



there is 6 inches of gravel below tie. The gravel is rounded off to a point 5 feet, 6 inches from center of each track. A ditch 3 feet wide is midway between the tracks, the sides of which slope 3 to 1.

STANDARD ROADBED SECTIONS FOR SINGLE AND DOUBLE  
TRACK—UNION PACIFIC RY.

Plates CXXXIX., CXL., CXLI. and CXLII., on pages 459, 460, 461 and 462, show different types of standard roadbeds as used upon the Union Pacific system. Plate CXXXIX. shows single track fill and cut ballasted with earth. Plate CXL. shows double track fill and cut, ballasted with earth. Plate CXLI. shows double track fill and cut, ballasted with gravel, cinders or rock, and plate CXLII. shows single track roadbeds on fill and in cut, ballasted with gravel, cinders, burnt clay or broken stone. In cuts the maximum depth of ditches is 12 inches; where track is level the depth of ditch in middle of level stretch is reduced to 6 inches to secure drainage of ditch.

### STANDARD SIGNS.

STANDARD SECTION POSTS, CROSSING SIGNS, WHISTLING  
POSTS, ETC.—BALTIMORE AND OHIO RY.

Plates XXXIV., XXXV. and XXXVI., pages 89, 90 and 91, show a number of signs which are standard on the B. & O. system. Commencing on the left on plate XXXIV., the first design is a mile post, the next a whistling post, then a yard limit post, next a state line post, and the last a water station number. The dimensions are all plainly stated and explanations given will be sufficient to reproduce any of them if required.

Plate XXXV. gives full direction for the making and setting of the following signs, viz., section post, bridge number, clearance posts, property post and stop post. The system of numbering bridges as explained on this plate is of especial interest and value.

Plate XXXVI. gives working drawings, bills of ma-

terial and instructions for setting of road crossing sign, trespass sign, railroad crossing sign and station sign.

STANDARD CROSSING SIGNS, SECTION POSTS, CURVE POSTS  
ETC.—ATCHISON, TOPEKA AND SANTA FE RY.

A road crossing sign, as shown on plate CXXVIII., page 434, is the standard on the Santa Fe system. The post is 8 by 8 inches by 17 feet, of oak or cedar, sign boards of pine, lettered both sides alike, as shown, and sign to be placed parallel to track, 14 feet from rail, and on that side of highway where persons approaching track can best observe it. The two cross pieces are  $1\frac{1}{2}$  by 12 inches by 6 feet, mortised half into post and fastened further by two  $\frac{3}{4}$ -inch bolts through two wrought iron plates,  $\frac{3}{8} \times 2 \times 16\frac{3}{4}$  inches. The splitting of boards is prevented by cross pieces, 2x12 inches, fastened to board by oak tree nails, details of which are shown on plate.

Plate CXXVII., page 433, shows an elevation and section of relay box and guard. The posts are of oak or cedar, set 2 feet 8 inches below ground. The box proper sets up against telegraph pole, which is flattened, to give a good bearing for back of box. The door, when opened, will serve as a desk to write upon, as shown in section. Outside dimensions of frame work 3 feet 3 inches by 2 feet 5 inches.

On plate CXXIX., page 435, are shown a number of standard signs as used on the Santa Fe system. The figure lettered "1670" is a mile number plate, made of  $\frac{3}{8}$ -inch boiler plate, 10x18 inches. It is fastened to a telegraph pole with two lag screws,  $\frac{1}{2}$  inch by 3 inches long, plate being placed parallel to main track.

The sign immediately below this is a bridge number plate used on Howe truss bridges. It is made of wrought iron plate  $\frac{3}{8} \times 10 \times 30$  inches. One is placed at each end of bridge on the right hand end post approaching bridge, 6 feet above top of rail, and fastened by four  $\frac{1}{2}$  inch by 3 inches lag screws.

Directly below appears the slow board, which is made of an oak post, 3 by 3 inches by 7 feet, set 3 feet below ground. The sign is made of pine, 3 feet 9 inches by 12

inches, placed perpendicular to track, center line of post 8 feet from nearest rail on right hand side of engine, approaching point of danger, for which slow board is a warning. It must be placed at least 3,000 feet from point of danger, in a conspicuous place, so that it can be readily read by an approaching engineer.

To the left of the slow board is a curve post, which is a post 3 by 3 inches by 3 feet 4 inches, of square section, set 2 feet below ground. It is lettered on opposite faces and is set on right hand side of track, as one faces the direction in which mile numbers run and 2 feet from rail, with lettered faces of sign at right angles to track.

To the left of curve post is the clearance post, an oak post 5x6x36 inches, painted white, without lettering. It should be set so that top of sign will be 4 inches above top of rails, and at a point where the nearest gage lines of two adjacent tracks are 6 feet 10 inches apart.

The whistling post is shown to the right of the slow board. Its dimensions are 3 by 10 inches by 11 feet, oak, set 5 feet 10 inches below the ground and at right angles to the track, 6 feet from nearest rail and 1,320 feet each way from road crossing on the engineer's side of track, i. e., on the right side approaching crossing.

On plate CXXX., page 436, the sign to extreme left, is a station boundary post. It is 5 feet 6 inches high, either of oak or cedar, set at each corner of the boundary of station grounds. The part set in ground is painted with coal tar and upper part brown.

The next figure shows the section post. It is made of oak, 2 by 6 inches by 5 feet, lettered on both sides of posts, as shown in cut. The lower part is painted brown. Sign is placed at right angles to track, 6 feet from nearest rail, on the north side of track, running east and west, and on the west side of track, running north and south.

A telegraph signal station sign is shown in right hand upper corner. It is 7 feet long and 7 inches wide, made of pine. Strips  $\frac{1}{2}$ x2 inches are framed around sign board.

Lower right hand corner on plate CXXX. shows an elevation and section of a way bill box, the construction of which is easily understood from the drawing. It is  $7\frac{1}{2} \times 4$  inches, inside measure, made of  $\frac{3}{4}$ -inch pine, has a  $4\frac{1}{2}$ -inch slit for letters and reports, and a door,  $9 \times 6$  inches, secured by hasp and padlock.

The curve post shown on plate CXXXI., page 437, deserves some special recommendation, since it is made from old boiler flues, leaving lower part round and flattening upper end for the lettering. It is set 2 feet 6 inches below ground line, leaving 16 inches above ground, of which 12 inches have been flattened and lettered as a curve post. The rules for setting are the same as described on plate CXXIX.

## STANDARD SWITCHES.

### STANDARD SPLIT SWITCHES—BALTIMORE AND OHIO RY.

Plate VII., page 45, shows arrangement of 15 feet point switch for 60 to 67-pound rail. The gage at point of switch is 4 feet  $8\frac{3}{4}$  inches and throw of switch is  $4\frac{1}{2}$  inches. The point rails are 15 feet long, spiked on two ties and sliding on plates placed on 6 ties. Plate A under point of switch has  $\frac{1}{4}$ -inch riser, plate B on next tie 3-16 inch riser, plate C on next tie  $\frac{1}{8}$  inch riser, plate D on next tie 1-16 inch riser and next two plates, E and F, are level. There are four tie rods. The first one (which is also called the head rod) is placed 9 inches from end of switch and the other three follow at equal intervals of 24 inches. The method of fastening rod to switch rail is shown in upper right hand corner. In the left hand upper corner a perspective view is shown of a slide plate, showing the riser on one end and a rail brace on the other.

A ten-foot split switch, as used on the same road, is shown on plate VIII., page 46. It is used for the same weight of rail, from 60 to 67-pound section. The point rails are only 10 feet long, sliding on five pairs of plates. The throw of switch is  $4\frac{1}{2}$  inches and gage at point 4 feet  $8\frac{3}{4}$  inches. The head rod is  $2\frac{1}{4} \times \frac{3}{4}$  inches iron, fastened to slide rails by malleable iron sockets,

shown in detail in upper right hand corner. A hole for  $\frac{3}{4}$ -inch bolt is placed in either end, to join it to connection rod. Two more tie rods are provided, spaced 24 inches from center to center and fastened to the rails similar to head rod. Slide plates of the same form, as shown in upper left hand corner, are made of wrought steel, acting at the same time as a brace. Plate A rises  $\frac{1}{4}$  inch, plate B 3-16 inch, plate C  $\frac{1}{8}$  inch, plate D 1-16 inch and plate E is level.

An 18-foot switch for 85-pound rail is shown on plate IX., page 47. The point rails are 18 feet long, resting on ten ties and 8 pairs of slide plates. Throw of switch is  $4\frac{1}{2}$  inches and gage at point is 4 feet  $8\frac{3}{4}$  inches. There are five rods of the same construction as explained above and placed 24 inches from center to center. The first five slide plates, marked A, have 5-16 inch risers; the next, marked B, has 7-32 inch, and the last, marked C, has  $\frac{1}{8}$ -inch riser. The malleable iron socket fastening is again shown in the upper right hand corner, while the slide plate is shown in the body of cut.

On plate X., page 48, a  $7\frac{1}{2}$ -foot split switch for 60 and 67-pound rail is shown. The slide rails are only  $7\frac{1}{2}$  feet long, resting on 4 ties and 4 slide plates. Throw of switch is  $4\frac{1}{2}$  inches and gage at point 4 feet  $8\frac{3}{4}$  inches. There are only 3 rods, the first (head rod) being 9 inches from point, and the other two spaced 24 inches from center to center. They are fastened to the slide rails by malleable iron sockets, bolted through web of rail by two  $\frac{5}{8}$ -inch bolts and to rod by one  $\frac{3}{4}$ -inch bolt. Perspective views of the socket and the wrought steel slide plate, with rail brace, are shown on plate at the right of the switch.

#### STANDARD SPLIT SWITCH—MICHIGAN CENTRAL RY.

Plate CIV., page 239, shows an elevation, plan and numerous details of 15-foot split switch for 80-pound steel, as used on the M. C. R. R. There are 8 slide plates, numbered from No. 1 to No. 8, and two switch rods, one of which (No. 1) is attached to connecting rod of switch stand. The ties are 10 inches wide and spaced 10 inches apart; the head block is 16 inches wide and

gage is 4 feet  $8\frac{3}{4}$  inches at throw. A special feature of this switch is the reinforcing plate,  $\frac{1}{4}$  inch thick, which is riveted to the web of the two switch points on gage side, running from A to D. The switch rods are of an excellent design and are adjustable. Plates Nos. 1, 2, 3, 4 and 5 have  $\frac{3}{8}$ -inch risers; No. 6 rises 5-16 inch, No. 7 rises  $\frac{1}{4}$  inch and No. 8 rises 3-16 inch. The plates below risers are  $\frac{3}{8}$  inch thick. Other details can be readily read from drawing.

STANDARD SPLIT SWITCH—LAKE SHORE AND MICHIGAN SOUTHERN RY.

Plate CLXII., page 482, shows a plan and details of 15 feet standard split switch, as adopted by the L. S. & M. S. R. R. There are four tie bars, bar No. 1 being connected to the connecting rod of switch stand. The length and fastenings of the rods show on a larger scale above plan. There are six slide plates on each side, each provided with a rail brace. The spacing of ties and rods are plainly shown in cut and need no further explanation.

STANDARD SPLIT SWITCH—LOUISVILLE AND NASHVILLE RY.

Plate CXIII., page 314, illustrates a standard split switch turnout for a No.  $9\frac{1}{2}$  spring rail frog. On account of the length of switch drawing is so made that the lower part is a continuation of the upper one. Switch is 79 feet 3 inches from switch point to frog point and the split rails are 15 feet long; 8 slide plates are used on each side, numbered from 1 to 8, beginning at point of switch. The first six are provided with rail braces and risers are as follows: No. 1,  $\frac{3}{8}$  inch; No. 2, 5-16 inch; No. 3, 9-32 inch; No. 4,  $\frac{1}{4}$  inch; No. 5, 3-16 inch; No. 6,  $\frac{1}{8}$  inch; No. 7, 3-16 inch, and No. 8, 1-16 inch. A guard rail for switch point and for spring rail frog is also shown.

STANDARD SPLIT SWITCH—CINCINNATI, NEW ORLEANS AND TEXAS RY.

Plate CIX., page 292, shows a standard 18-foot split switch in use on the C., N. O. & T. R. R. There are five tie bars spaced, as shown in cut, and nine slide

plates, with rail braces on each side. The side, top and bottom of split rail are shown in the lower part of plate; details of fastenings appear on a larger scale in upper right and left hand corner. The gage of track is 4 feet 9 inches and throw of switch is 4 inches. The risers on the first 8 plates beyond head rod are all  $\frac{1}{4}$  inch and on the two last plates  $\frac{1}{8}$  inch; the tie rods are  $\frac{3}{4} \times 2\frac{1}{2}$  inches, with holes for  $\frac{1}{8}$ -inch pin, and are made at the railway shops.

#### STANDARD SPLIT SWITCH—CENTRAL RAILWAY OF GEORGIA.

Plate CLIII., page 473, shows the standard 18-foot split switch of the Central Railway of Georgia. It is somewhat similar to the C., N. O. & T. standard just described. The stock rail is supported by 12 steel die-formed rail braces of the Weir pattern; head of point rails is planed down from A to B, is level from B to C and rises  $\frac{1}{4}$  inch from C to D. The tie rods are  $2\frac{1}{2} \times \frac{5}{8}$  inches and fastenings as shown in enlarged details. There are two guard rails provided for split rails.

#### STANDARD SPLIT SWITCH—CHICAGO AND NORTHWESTERN RY.

Plate CLXIV., pages 485 and 486, shows a 15-foot split switch in use on the C. & N. W. R. R. It has three tie rods and 8 slide plates on each side. The spacing of ties and rods is as shown in plan. The first 5 slide plates next to switch point have  $\frac{3}{8}$ -inch risers, the next one has  $\frac{1}{4}$ -inch and the next  $\frac{1}{8}$ -inch riser, the last plate being level. All plates are  $\frac{3}{8}$  inch thick and 4 inches wide, the first 5 pairs being 1 foot  $1\frac{1}{2}$  inches, and the balance 1 foot  $\frac{1}{2}$  inch long. The various sections show enlarged details at different points of the switch. The tops of heads of slide rails are planed down 1 inch in 4 feet  $6\frac{1}{4}$  inches. The switch rods are  $\frac{3}{4} \times 2$  inches, with improved clip fastenings.

### STANDARD SWITCH STANDS.

#### HIGH SIGNAL GROUND STAND—BALTIMORE AND OHIO RY.

A 16-foot target stand is shown on plate XI., page 49, first view showing the white face of target indicating safety, while next view shows red face of target indicating danger; a ladder, 15 feet 6 inches long, with a bat-

ter of 4 feet  $3\frac{1}{4}$  inches, braced by 2 iron rods 13 feet long, gives stiffness to the structure and provides means to suspend signal lamps at the target.

LOW SIGNAL GROUND STAND—BALTIMORE AND OHIO RY.

This is shown on plate XI., page 49, the first view showing stand displaying safety signal—white, and second view displaying a double red disc as a danger signal. The center of signal is but 12 inches from top of ties, making the stand serviceable in crowded yards. The target is 6x12 inches.

SWITCH STAND—BALTIMORE AND OHIO RY.

Plate XII., page 50, shows a switch stand of different construction. The lever throwing switch moves in a vertical plane, so that in daylight the position of lever is indicating danger when the target stands oblique, and safety when it stands perpendicular. The switch lamp holder is connected by a toggle joint to switch lever, so that when lever turns the switch the lamp is turned one-quarter around, showing true position of switch in night time. The center of signal lamp is 7 feet from nearest rail. The target is 7 feet 8 inches high from ground, 2 feet long and consists of 3 strips 4 inches wide each, the two outer ones painted white and the inner painted red. The second view shows a vertical section through stand and target.

DISTANT SWITCH SIGNAL—BALTIMORE AND OHIO RY.

Plate XIII., page 51, shows a distant switch signal for facing point switches. The plan readily explains that as the switch is thrown the position of lever is changed and the cords connected to the end of the lever and the distant signal will accordingly change the position of the signal. The view at bottom of cut represents the style of distant signal in use.

SWITCH TIES—BALTIMORE AND OHIO RY.

Plate XXX., page 85, gives a complete bill of switch ties for a No. 6 frog turnout. Cross section of ties is 7x8 inches. Plate XXXI., page 86, is a bill of switch ties for a No. 10 frog turnout. The tables are self-explanatory.



## STANDARD SPIKES—BALTIMORE AND OHIO RY.

Plate XLIX., page 104, shows the standard spike of the B. & O. R. R. It is 6 inches long over all and has a square cross section 9-16x9-16 inch; the point is wedge-shape and curved and  $1\frac{3}{4}$  inches long. The head is oblong,  $1\frac{1}{2}$ x1 3-16 inches; the under side of head gripping rail inclines under an angle of 20 degrees, and where it meets the shaft of the spike the latter widens out to 11-16 inch, sloping back to 9-16 inch, 1 inch below the head; head projects 5-16 inch around shaft of spike, to provide means for the use of claw bar. As a rule but few roads have adopted special standards for track spikes.

## STANDARD TIE PLATES.

## SOUTHERN RAILWAY AND NEW YORK CENTRAL AND HUDSON RIVER RAILWAY.

Extensive inquiry among the leading railroads of the country reveals the fact that Tie Plates are in very general service and used in large quantities. Most roads using standard sections of rails receive the Tie Plates in such satisfactory form and dimensions from the manufacturers that they can directly use them on any kind of rail or ties, it being found unnecessary to prepare standard plans for them. In fact, it can be said that longitudinal flanged Tie Plates have become almost a universal standard and the designs herein shown corroborate the statement. Plate CLVIII., page 478, shows the Tie Plates used as standard on the Southern Railway. There are two forms of the same type. Plates A and B are used on joint ties, the plates being punched so that spike holes will coincide with the slots in angle bars, the plate A being for 75-pound rail and B for 80-pound rail. As will be observed, these joint plates are of the same form, the only difference being in the position of the spike holes. The 80-pound rail having a base three-sixteenths inch wider than the 75-pound rail, the two plates are punched with spike holes to correspond. Plates C and D are used on intermediate ties, the one for 75, the other for 80-pound rails. It will be noted that the position of spike holes is reversed so as to provide for rights and lefts. The dotted lines show the

punching for the left hand and the full line holes for the right hand rail. The manifest object of this is to prevent the ties from slewing around.

The mechanical principles of these plates are at once simple and correct and their wide and successful use has resurrected the Tie Plate as a railway standard, notwithstanding that the repeated failures of other forms had resulted in a general condemnation and total abandonment of their use. The longitudinal flanges, marked A, B, and C, in the three flange plates, and used on joint ties upon the Southern Railway, and the flanges marked D and C on the two flange plates, which on this line are used as standard on intermediate ties, perform the necessary function of uniting plate and tie as though they were one solid piece. These flanges are of such form that they enter the tie parallel to its fibres, similar to a knife edge, as the fibres are simply separated, the wood fibres are neither cut, bruised or otherwise injured, as is the case where flanges running transversely to the grain are used. Thus confined, the slightly compressed fibres are held within the faces of the flanges or ribs, which grip them with great force, making such a tight fit that it is impossible for moisture to enter, or for the plate to work loose. Thus it will be seen that a tie equipped with the longitudinal rib plates is stronger in itself than the bare tie, while the distribution of metal is such as to afford a maximum of strength with the least metal, thereby avoiding the lamination of the rail. As a valuable factor in the preservation of ties and in the reduction of maintenance expenses, its value becomes apparent from the following consideration:

The life of a tie is cut short by two main causes, viz., by the chemical process of decay and the physical process of wearing away under the rail seat.

The first cause is now in a fair way of losing its destructive character, as suitable preserving processes are evolved and put in use, thus ties which formerly became worthless, after five or six years, on account of decay, have had their lives trebled and quadrupled by proper chemical treatment. Yet this would by no means solve

the tie question unless provision is made to prevent the rails from wearing away the ties; indeed, the longer the life of the tie as against decay the more the necessity for Tie Plates will be recognized, as many ties which could resist the action of the rail during normal life of six years would be utterly destroyed if preservatives would arrest decay, so as to give an available life of twelve or fifteen years or more. It is a fact that a great percentage of ties are removed from the track, not because of decay, but on account of being weakened on account of the rail base cutting into the wood. This is particularly true of the soft, but long-lived timbers, such as our cedars, the Louisiana cypress and the Pacific Slope redwoods. This physical destruction of the tie is entirely prevented by the Tie Plate, and where used they have more than doubled the usefulness of the soft wood ties above mentioned. It is generally conceded that a wooden tie for the maintenance of good, smooth riding track is better than any of the metal ties thus far experimented with. This is particularly true where the longitudinal plate is used, for no matter what age the tie may be, the plate affords a uniform support on every tie throughout, and by increasing the life of ties, as indicated, the cost of tie renewals has been so reduced as to set aside the question of metal ties to a future day.

The success, under all kinds of severe tests of the longitudinally ribbed plate, has led to their adoption by numerous railway systems, they being preferred to the many forms, having ribs or flanges running transversely of the grain, which is entirely wrong in principle; as such ribs, flanges or prongs running transversely will cut across, break down, and destroy the fibres of the tie, preventing a close union of the plate while the tie itself is weakened by their use. Another important function performed by the longitudinally ribbed plate is that it preserves the gauge and alignment of the rails on tangents as well as curves, thus effectually displacing the rail brace. It is a well-known fact that on ties not protected by Tie Plates the base of the rail will cut into the tie, and generally deeper on the outside than

on the inside flange of the rail, the consequence being that the rail soon begins to lean outward, thus widening the gauge, which can only be rectified by the trackman adzing the rail seat level and restoring the rail to its perpendicular position. This brings but temporary relief, since every passing train forces the outer rail flange into the tie fibres, again causing the rail to lean out, widening the gauge. The Tie Plate is a simple and efficient preventative, which maintains the rails in their normal position and prevents excessive wear on the side head of the rail. On curves they have given the most gratifying results, and have done splendid service for the last eight years in the Allegheny, Rocky and Sierra Nevada mountain ranges.

The Tie Plate shown on page 192, plate XCII., is standard on the New York Central and Hudson River Railroad. It is practically the same form as plates A and B described above. It is  $9\frac{3}{4} \times 6$  inches, a longitudinal stiffening rib running midway between the two outer flanges; the spike holes are eleven-sixteenths inch square, leaving a clear distance of 6 9-16 inches between punchings.

The Tie Plate shown herewith (Fig. 1) is in very general use, being the same form as A and B, but only five inches wide. Those who have made a special study of rail and tie movement are enthusiastic in their praise of the five-inch plate, as distrib-

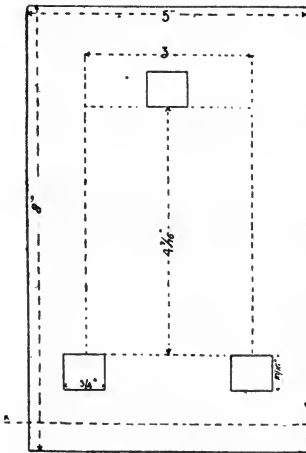

FIG. 1.

uting the weight of the rolling loads to the tie in such a manner as to prevent its rocking in the ballast.

Tie Plate shown herewith (Fig. 2) is a five-inch plate, having four (4) under flanges, with a rail seat cut to fit the rail flanges on the upper surface of the plate.

These plates preserve the exact radial position of the rail and have been successfully used on curves of five hundred feet radius where no elevation of the outer rail was permissible and where other form of fastening had entirely failed. As the hook head spike in common use in this country is used to hold the rail down when it springs up, as the reflex movement due to the deflection of the rail under its load, so should any shoulder Tie Plate where the same are needed provide

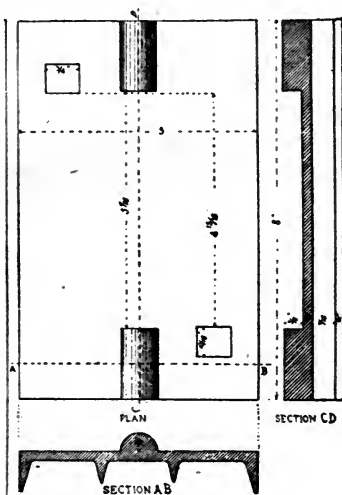

FIG. 2.

not only for the movement out of the rail by direct pressure, but also for the inward movement due to the reaction, and the plate herein shown is without doubt the most perfect Tie Plate which has yet been offered the railways of the world and is attracting the attention of Europeans, who have experimented and used many types of Tie Plates with only partial success.

### STANDARD TOOLS.

STANDARD CLAW BAR, CHISEL, GAGE, ETC.—BALTIMORE AND OHIO RY.

Plate L., page 105, shows a heel claw bar, 5 feet 6 inches long, weighing 30 pounds; a lining bar, 5 feet long, weighing 20 pounds, and a straight track wrench, 24 inches long, for 1 5-16 inch nuts.

Plate LI., page 106, represents a so-called pig foot claw bar, 5 feet 6 inches long, weighing 30 pounds. The

opening is triangular, 2 inches deep,  $1\frac{1}{2}$  inch at the base, and the claws are  $\frac{3}{8}$  inch wide, curving as shown in cut.

Plate LII., page 107, shows a 4-pound track chisel, a rail fork, and a rail tong in perspective.

Plate LIII., page 108, shows a 10-pound spike maul, 11 inches long, eye passing through 6 inches from point, diameter at point  $\frac{3}{4}$  inches and at back  $1\frac{1}{4}$  inches; also an 8-pound tamping pick, tamping end being  $1 \times 2\frac{1}{2}$  inches, and a clay pick, weighing 7 pounds, 20 inches long.

Plate LIV., page 109, shows a track gage made of wood,  $1 \times 3$  inches, and bound with iron. The gage points are formed by  $\frac{1}{4}$  inch band iron, projecting 1 inch; total length, 5 feet  $9\frac{1}{2}$  inches; gage measure, 4 feet  $8\frac{3}{4}$  inches.

Plate LV., page 110, shows the track level. It is 5 feet  $\frac{1}{4}$  inch long, 4 inches wide and  $1\frac{1}{2}$  inches thick. The level is protected by an iron plate,  $\frac{1}{8} \times 1\frac{1}{2} \times 4\frac{1}{2}$  inches, and both ends terminate in iron fastenings, as shown in elevation and plan. The adjustable slide on left end of level permits of readings up to  $6\frac{3}{8}$  inches of elevation on curves.

#### GENERAL STANDARD TOOLS.

The subject of "Properly Constructed Tools" is receiving more specific attention from the heads of the Maintenance of Way Departments of the different railways. There can be but one best design for a track tool which is used for a specific purpose and the form and material which is best adapted for each case should be determined by men qualified to do so. A great deal of trouble is caused in this direction by the railroad shop-m.n, whose duty it is to make and repair tools, such as claw bars, tamping bars and tools of this class, and as they do not handle them practically they are often not judges as to their most suitable form, temper, weight, etc., and in consequence trackmen receive what they do not want or need. The Roadmasters' Association of America and the New England Roadmasters' Association have taken up this subject and will eventually determine upon a complete standard outfit of track tools, best adapted to the needs of American trackmen.

Very few railroad companies engage at present in making their own tools, since they can buy them of manufacturers at a price much less than they could be made at their own shops; and besides that they get articles much superior in material, workmanship and finish. For this reason but few railroads prepare standard designs for such tools as track chisels, tamping bars and picks, claw bars, etc.

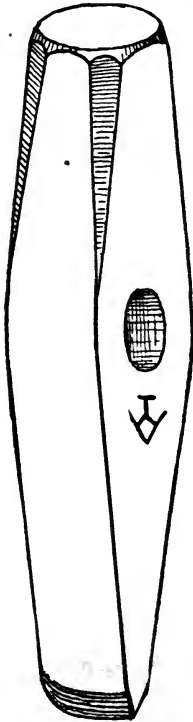

FIG. I.  
TRACK CHISEL.

One of the oldest and most reliable firms who are making a specialty of manufacturing standard track tools is the Verona Tool Works, who in 1873 brought out the justly celebrated Verona Nut Lock, which has been so well appreciated that to-day there are over 226 millions in use on American roads.

Fig. 1 shows the Verona Track Chisel, which has been adopted as standard by the Pennsylvania Railroad. Its cutting edge is wedge shape,  $1\frac{1}{8}$  inches wide at point and weighs  $3\frac{1}{2}$  pounds. It is made of special steel, and gives excellent results in the most severe usage.

Fig. 2 shows a well-designed tamping pick weighing 8 pounds. It is 25 inches long, with an eye  $3 \times 2$  inches and a tamping face of  $2\frac{1}{2} \times \frac{3}{4}$  inches. They are made of solid steel, solid eye and are warranted in temper and quality.

Fig. 3 shows a claw bar 5 feet long, weighing 30



FIG. II—TAMPING PICK.

pounds. This bar has been adopted by the Roadmasters' Association of America as standard.

Fig. 4 shows tamping bar 5 feet  $4\frac{1}{2}$  inches long, made of round steel  $\frac{7}{8}$  inches in diameter. The tamping end is  $\frac{1}{2}$  inch thick and 4 inches wide and is bent to an angle of 24 degrees from direction of bar. The other end is flattened out to a knife edge 2 inches wide. This bar has also been adopted by the Roadmaster's Association as standard.

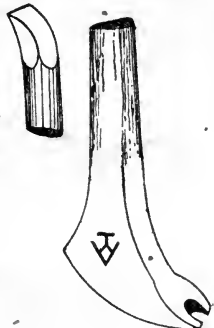

FIG. III—CLAW BAR.

Fig. 5 shows a small, but exceedingly useful tool, a spike puller which is indispensable in yards where spikes have to be pulled from between rails.

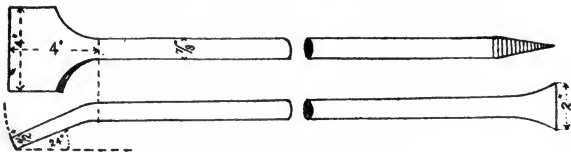

FIG. IV—TAMPING BAR.

Aside from the above described tools, the Verona Tool Works manufacture a full line of clay picks, lining bars, pinch bars, spike mauls, sledges, track punches, rail tongs, rail forks, spike pullers, track wrenches, timber bars, shackle bars and track gages. All tools are tested before leaving their work, hence failures are rarely known, and if they occur the Verona Tool Works replace them free of charge. They also make a specialty of making any desired track tool to

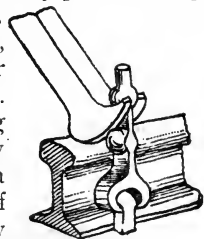

FIG. V—SPIKE PULLER

STANDARD WATCH BOX—BALTIMORE AND OHIO RY.

The elevation and plan shown on plate XXXIX., page 94, shows watch box 7 by 7 feet by 7 feet 11 inches



high, which will serve well enough to protect a flagman or a watchman and will be useful where room is scarce. The door is 2 feet 2 inches by 6 feet 2 inches, and there is sufficient room for a small stove.

STANDARD WATER TANK—BALTIMORE AND OHIO RY.

The design on plate XII., page 97, shows an elevation, foundation plan, plan of roof and tank floor of the standard dimensions on the B. & O. R. R. The height of tank is 16 feet, diameter at base 24 feet and diameter on top 23 feet 6 inches. The roof is a 16-sided pyramid, while the cross section of tank is octagonal. The floor is 12 feet above the ground, carried on 12 posts, spaced as shown on foundation plan.

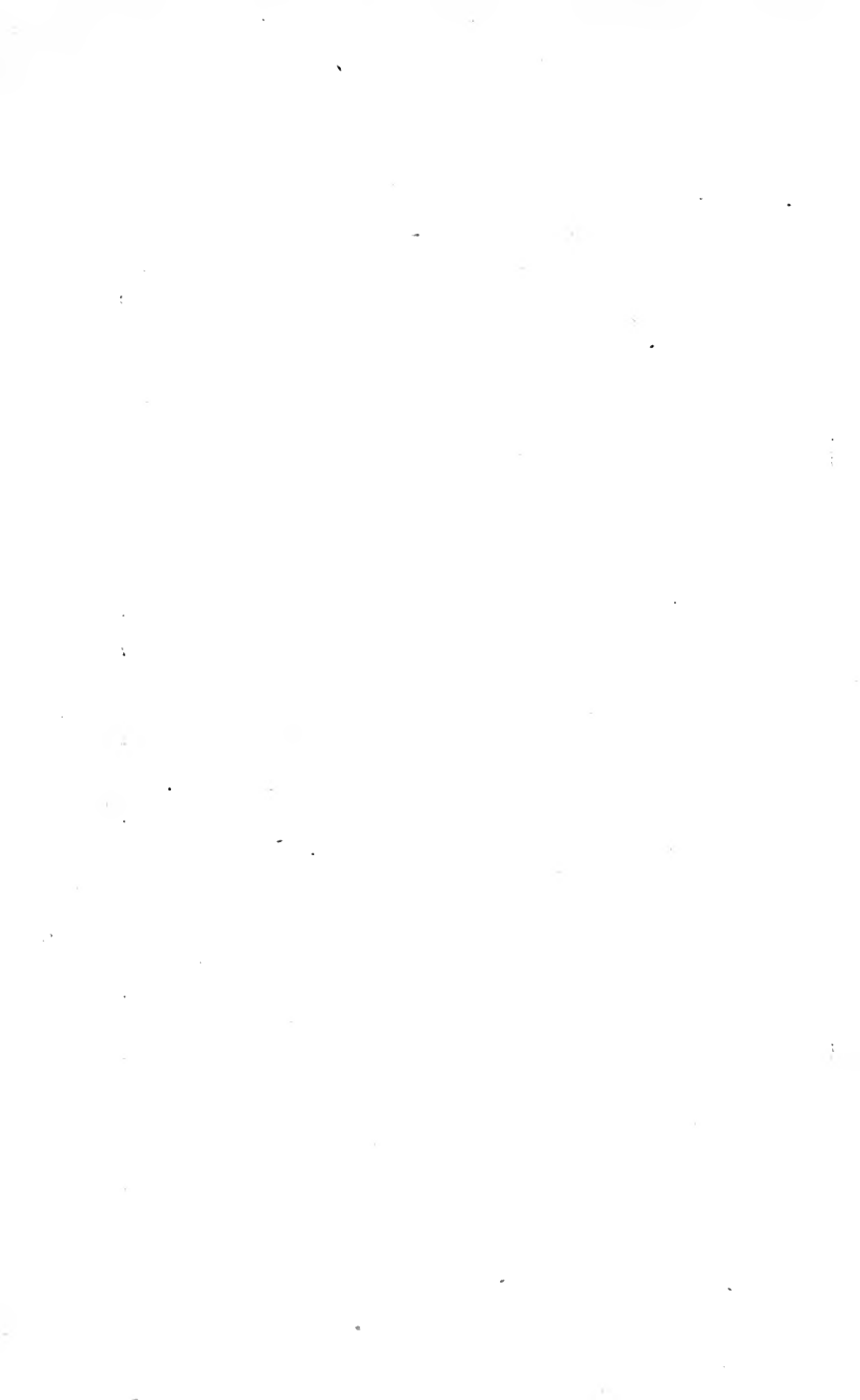

**Multiplying Millions in Service**

..... ATTEST THE .....

**GREAT SUPERIORITY**  **OF THE...**

**SERVIS THE PLATE.**

LONGITUDINAL FLANGED PLATES FOR ALL CONDITIONS OF TRACK  
SERVICE---ABSOLUTE PROTECTION AGAINST THE CUTTING, RAILS  
CANTING OR TRACK SPREADING--BUY ONLY THE BEST. . . .



**The Q. & C. Company,**

700-707 Western Union Building, CHICAGO, ILL.

# Don't Neglect the Picket Line.

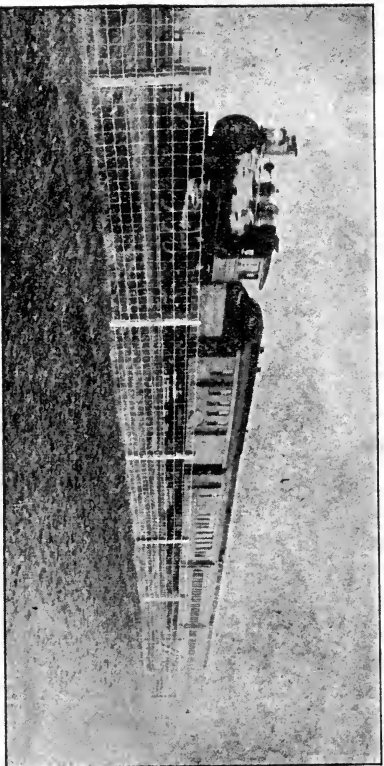

*Great armies of brave, well-trained soldiers have been sacrificed for lack of attention to this most important detail. Just so the heaviest rails, a perfect roadbed, the best equipment and service availleth not if the outposts are unguarded. A poor measley cow may cause a wreck costing the loss of many lives and much treasure, all of which could be saved by using the STANDARD for railroads.*

**PAGE WOVEN WIRE FENCE CO., Adrian, Mich.**

Established 1888.

## Continuous Rail Joint Company

OF AMERICA.

Room 912 Prudential Building,  
NEWARK, N. J.

IN SUCCESSFUL USE ON SIXTY-FIVE  
RAILROADS.

Write for Circular and Full Information.

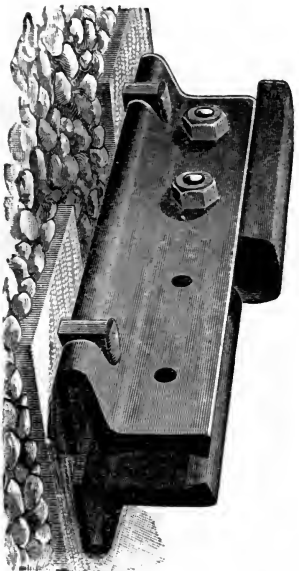

It is used as a supported and suspended joint. It is in the fewest possible parts and gives greater vertical strength than the angle bar, and holds the track in perfect surface.

The base support given with our joint and the increased bearing surface makes it stronger, and counteracts the motion or play so fatal to life of other fastenings.

Our joint provides for the increased tonnage of locomotive and cars, and the high speed at which trains are now run.

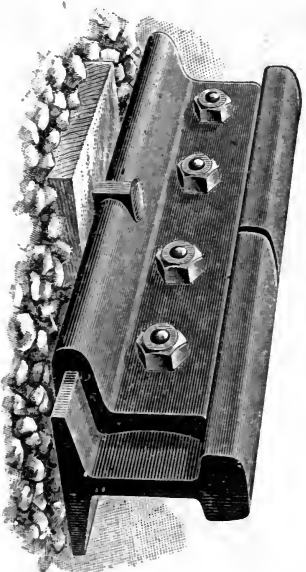

# The Alexander Pressed Steel Engine Car Replacer

MANUFACTURED BY

Alexander Car Replacer Manufacturing Co., Scranton, Pa.

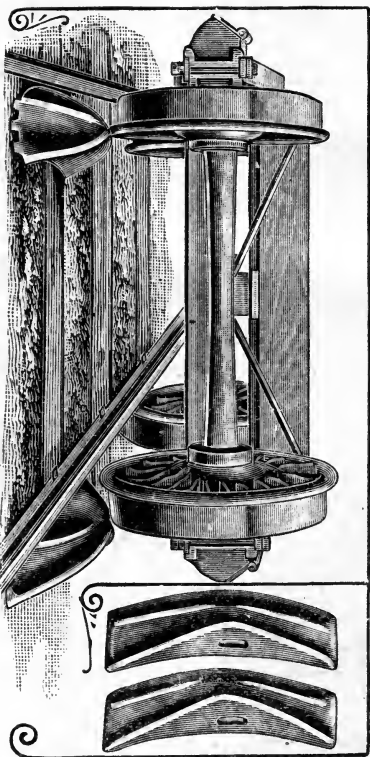

PUT HIGH REPLACER ON  
OUTSIDE OF RAIL.

No. 1 Device, 120 lbs. per pair, high enough for 6-in. rail, per pair ..... \$15.00

No. 2 Device, 100 lbs. per pair, high enough for 5-in. rail, per pair ..... \$14.00

No. 3 Replacer, 50 lbs. per pair, suitable for Traction Companies and mine engines, per pair..... \$10.00

Lightest and Cheapest  
WRECKING FROG  
on the market.

THEY CAN BE PURCHASED FROM Railway Supply Co., St. Louis, Mo.; W. & A. C. Semple, Louisville, Ky.; Flint, Eddy & Co., 68 Broad St., New York; Manning, Maxwell & Moore, 111 Liberty St., New York; Sherburne & Co., 53 Oliver St., Boston, Mass.; Brewer & Rowley, 1030 Monadnock Building, Chicago; Strait-Smith Co., St. Paul, Minn.; The E. S. Greely Co., 5 Dey St., New York. Guaranteed to carry 100 tons. A pair sent subject to approval at our expense.

# THE ELLIS PATENT BUMPING POST

FOR PASSENGER AND FREIGHT CAR SERVICE.

NOTED FOR SIMPLICITY, STRENGTH AND LASTING QUALITIES.  
NEAT IN APPEARANCE, OCCUPY LITTLE SPACE,  
ADAPTED TO ALL POSITIONS.

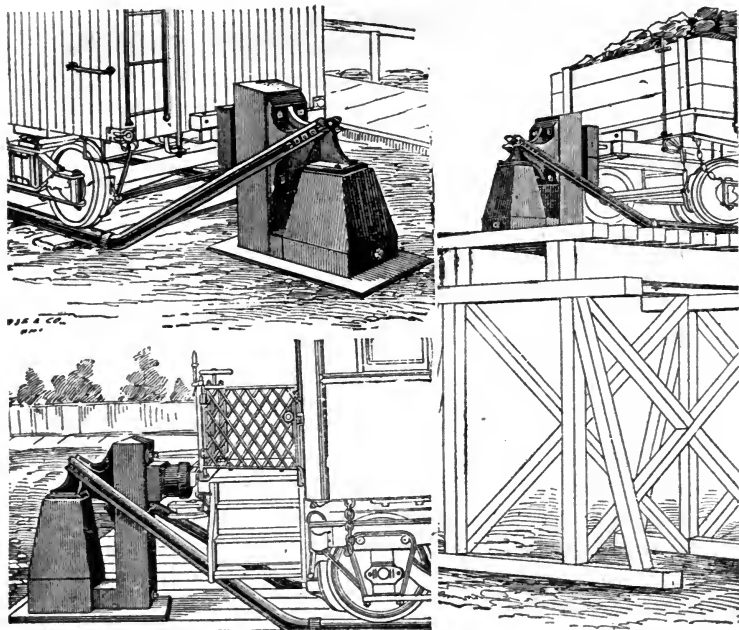

HAS STOOD THE SEVEREST TESTS.

Highest Award at the World's Fair, Chicago, 1893.

Shipped Complete, with directions for erecting. Prompt Delivery.  
Write for Circulars and Prices.

GEO. L. CHATFIELD, AGENT, CHICAGO, ILL.

### LOCATION OF FACTORIES.

The name of the CHICAGO, MILWAUKEE & St. PAUL RAILWAY has long been identified with practical measures for the general upbuilding of its territory and the promotion of its commerce, hence manufacturers have an assurance that they will find themselves at home on the company's lines.

The CHICAGO, MILWAUKEE & St. PAUL RAILWAY COMPANY owns and operates 6,150 miles (9,900 kilometers) of railway, exclusive of second track or sidings. The eight states traversed by the company, Illinois, Wisconsin, Northern Michigan, Iowa, Missouri, Minnesota, South Dakota and North Dakota, possesses in addition to the advantages of raw material and proximity to markets, that which is the prime factor in the industrial success of a territory—a people who form one live and thriving community of business men in whose midst it is safe and profitable to settle. Many towns on the line are prepared to treat very favorably with manufacturers who would locate in their vicinity.

Mines of coal, iron, copper, lead and zinc, forests of soft and hard wood, quarries, clays of all kinds, tan-bark, flax and other raw materials exist in its territory in addition to the vast agricultural resources.

A number of new factories have been induced to locate—largely through the instrumentality of this company—at towns on its lines. The central position of the states traversed by the CHICAGO, MILWAUKEE & St. PAUL RAILWAY, makes it possible to command all the markets of the United States. The trend of manufacturing is Westward. Nothing should delay enterprising manufacturers from investigating. Confidential inquiries are treated as such. The information furnished a particular industry is reliable.

Address,

LOUIS JACKSON,  
Industrial Com'r., C., M. & St. P. R. R.,  
425 Old Colony Bl'd., Chicago, Ill.



## What Trackmen Say of The Roadmaster and Foreman.

### COLORADO MIDLAND RAILWAY.

"Inclosed you will find \$1, for which please renew my subscription for your valuable paper. This makes the fifth year that I have been reading your paper and I must say that I like it better every year and would not do without it for twice its price. It does me good to read the many letters of the different foremen and I have learned a great deal out of the paper in regard to my work. There are some things in the journal I do not fully understand, but a great many things I do, and that repays me many fold."—V. McClellan, Roadway Foreman.

### RICHMOND AND DANVILLE RAILWAY.

"Our highly esteemed Roadmaster, Mr. James Hartigan, first introduced your valuable journal to me, to which I subscribed through him. I have secured two numbers, February and March, and am highly pleased with it and would not be without it. You can count on me as a subscriber as long as I remain in track service. I also think every section foreman should subscribe for it. I think it is both interesting and instructive, therefore every foreman should have it."—W. L. Smoke, Section Foreman.

### MISSOURI PACIFIC RAILWAY.

"Inclosed please find express money order for \$1 for THE ROADMASTER AND FOREMAN another year, as I see my time is out, and I do not want to miss one number. No trackman should be without it."—W. W. McWilliams, Sec. Foreman.

### FT. S., W. & W. RAILWAY.

"I have been a subscriber to THE ROADMASTER AND FOREMAN one year, and am highly pleased with the journal. I think it should be in the hands of every trackman. Am especially pleased with the articles written by the different section foremen, and would like to see more of them written."—Alfred Morris.

"I have been reading your valuable journal for seven years, and as long as I remain in track service I shall take it."—J. H. Lair, Section Foreman.

### FROM A SECTION FOREMAN IN SOUTH AFRICA.

J. Gardner, of Johannesburg, Transvaal, South African Republic, South Africa, writes as follows: "Inclosed you will find postoffice order for which please accept subscription for Mr. G. Robinson and myself—one copy for each of us—for two years, ending December, 1895. \* \* \* The fact of our renewing our subscriptions for two years, also the fact that our engineer, Mr. Kerman, having subscribed for two copies for two years, is ample proof that your very valuable paper is highly appreciated in South Africa."

### FROM A SOUTHERN ROADMASTER.

"I notice in the proceedings of the New England Roadmasters' Association of 1893 that THE ROADMASTER AND FOREMAN was indorsed as a paper devoted entirely to the Maintenance of Way Department and the general advancement and welfare of Trackmen, and as the official organ of that association. The American Roadmasters' Association at its convention in Chicago last year also expressed their high appreciation of the valuable work done by THE ROADMASTER AND FOREMAN to improve the track service, and as I heard one roadmaster say: 'We should lend our aid to the upbuilding of this paper and the subsequent betterment of the track service.' I have been a subscriber to this paper since 1885, and I must say that I have derived more real information about the practical details of track work than from any other source, and I attribute what little success I have attained in the past to the assistance of THE ROADMASTER AND FOREMAN. There is no man, I care not who he may be or how well versed in the track service, but what, if he will take the files of THE ROADMASTER AND FOREMAN for one year and read them over carefully, will be benefited more than its subscription price."

### EAST TENNESSEE VIRGINIA & GEORGIA RAILWAY

"I am glad I am permitted to live in this age of progress. \* \* \* \* \* My desire is to get out of the old rut and make a few improvements we can, as rapidly as possible, get the benefit of all new ideas, and teach our boys so they will not have to teach us as they grow up. I would advise all who wish to keep pace with this electric age to subscribe for THE ROADMASTER AND FOREMAN."—W. K. Marcer.

### DENVER, TEXAS & FORT WORTH RAILWAY.

"THE ROADMASTER AND FOREMAN is a very artistic and neat journal, and contains much valuable and instructive information, which can but prove of great value to all who peruse its columns. Letters from different officials of our great railway systems of this country, expressing their views of doing work, must be of incalculable value to trackmen."—J. B. Shea.

Address ROADMASTER AND FOREMAN, 91-93 Jefferson St., Chicago

# PRACTICAL SWITCH WORK.

PRICE \$1.00, PREPAID.

Among the prominent topics treated may be mentioned: General Turn-outs; the Theory of Leads, with tables for Frogs and Gages; Stub and Split Switches, how they are put in and lined up; analysis of curves for different Frogs and Guard Rails, and methods of adjusting them properly; also Cross-Over Tracks, Split-Switch Crossings, Split Point Frogs; Length of Lead Rails, adjustment of Stock Rails, Switch Stands, Switch Rods, Head Chairs, Length of Switch Timbers, etc., etc.

WHAT TRACKMEN SAY OF "PRACTICAL SWITCH WORK":

I like "Practical Switch Work" very much, and think it is the best book of the kind ever published. It ought to be in the hands of all trackmen.—J. H. CONLAN, Ass't. R. M., G. N. Ry

Lovell's "Practical Switch Work" is a handy, practical work.—L. C. HOWES, R. M., U. P. Ry.

I consider it the best work of the kind for trackmen.—F. S. BOWEN, Asst. R. M., G. R. & I. Ry.

The book is rightly named. It should be in the hands of every trackman.—P. W. KELLOW, R. M., D. & H. C. Co.

I consider it of great value to trackmen.—J. H. CONLAN, Caldwell, Kansas.

I am well pleased with it—J. A. ROLAND, R. M., C. & N. W. Ry.

After carefully looking over "Practical Switch Work," by Superintendent D. H. Lovell, I can say it meets with my approval, and I think every man directly or indirectly interested in switch work would find it to his advantage to peruse its pages.—J. H. WHITED, Superintendent Southern Pacific Ry.

SENT PREPAID TO ANY ADDRESS ON RECEIPT OF PRICE.

ADDRESS, ROADMASTER AND FOREMAN,

91 AND 93 JEFFERSON STREET, CHICAGO, ILL.

# The Trackman's Helper.

Revised Edition. Price \$1.50, Prepaid.

## *What Trackmen Say of The Trackman's Helper.*

Louisville, Evansville and St. Louis Consolidated Railroad.

*Editor Roadmaster and Foreman*—Your Trackman's Helper has been recommended to our roadmasters. I can simply say to you that it is a good thing and should be in every roadmaster's hands, also his trackmen. Of course, there are some things about it that an engineer would criticise, as I do, but that does not make any difference, anyway; but such features as may be cut out. You have simplified the matter for trackmen, and that is what is best to be done. Yours truly, T. A. ALLEN.

The Missouri Pacific Railway Company.

*Editor Roadmaster and Foreman*—I like the Trackman's Helper very much, and I think it is the best book of the kind ever published. The book is rightly named. I consider it of great value to trackmen. I am well pleased with it. JACOB PERRY.

Chicago and Northwestern Railway Company.

*Editor Roadmaster and Foreman*—I received the Trackman's Helper and have perused its pages thoroughly, and can say it fills a long-felt want among our young foremen and also section men. While us older men have learned by long experience and hard work how to keep a railroad in good condition at a nominal cost, without any help in the way of literature, such as your paper and Trackman's Helper give, I have recommended these publications to all my foremen, as I consider them the best papers and book published. F. W. SPENCER.

Wisconsin Central Railway.

*Editor Roadmaster and Foreman*—I have received the Trackman's Helper. It is a practical book. I can say it meets with my approval. Every trackman should have one. Yours truly, F. C. BAKER, R. M.

Address ROADMASTER AND FOREMAN, Pubs.,

61 and 93 S. Jefferson St., Chicago, Ill.

# The Roadmaster and Foreman

THE AMERICAN RAILWAY TRACK JOURNAL.

TENTH YEAR.

## PENNSYLVANIA RAILWAY.

"Inclosed you will find \$1.00 as a subscription to THE ROADMASTER AND FOREMAN. I notice a great many articles of interest from different foremen and other writers. I like your paper very much, and think it should be in the hands of every foreman."—S. S. KUHN, S. F.

## C., R. I. & P. RAILWAY.

"I have been reading your valuable journal one year, and while I am in the track service will continue to do so, for saying it is a valuable paper is not doing it justice. Every trackman in America should take it."—W. J. GIST, S. F.

## NORTHERN PACIFIC AND MANITOBA RY.

"I am in receipt of my first copy of THE ROADMASTER AND FOREMAN, and think it is the best track journal I have ever read. I am only sorry I did not get it long ago, but as long as I remain in the track service I will not be without it. It is both interesting and instructive; just what every foreman should have."—J. MCPHAIL, S. F.

## UNION PACIFIC RAILWAY.

"After carefully reading several copies of your journal, handed me by a friend, will say that it is the strongest lever of light and knowledge that has ever been presented to trackmen. It is the very thing we need to bring about a system of ideas and work. Any man who wishes to follow railroading and wants advancement and improvement should subscribe for THE ROADMASTER AND FOREMAN or be classed as a drone if he does not."—JOHN MARCUS, S. F.

---

**Subscription Price, \$1.00 Per Year.**

---

**Address Roadmaster and Foreman, 91 & 93 Jefferson St., Chicago**



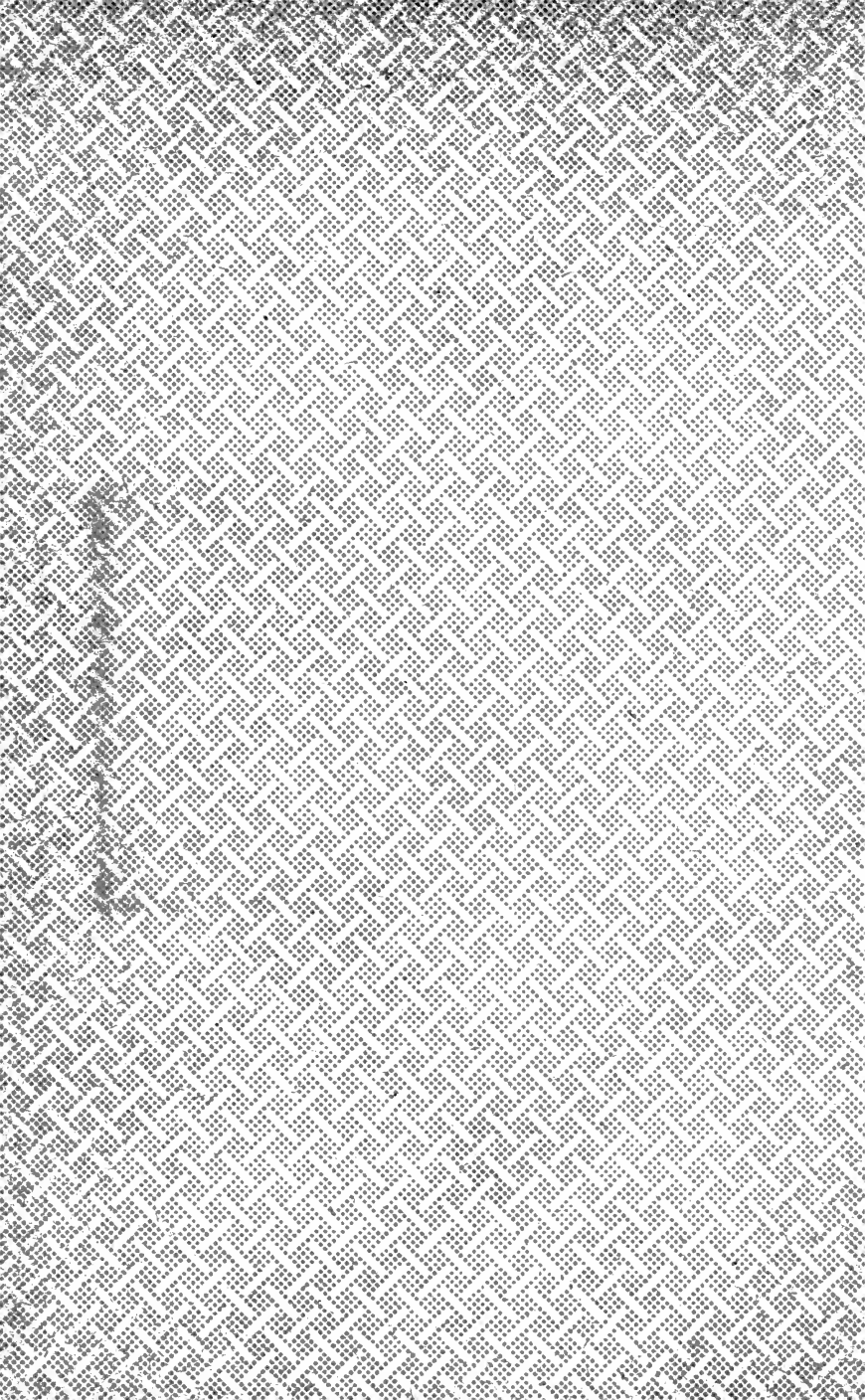

YC 69502

TF530

SG

506907

UNIVERSITY OF CALIFORNIA LIBRARY

