

Historic, archived document

Do not assume content reflects current scientific knowledge, policies, or practices.

02.31

Mann's'

1926

**SUPERIOR
SEEDS**

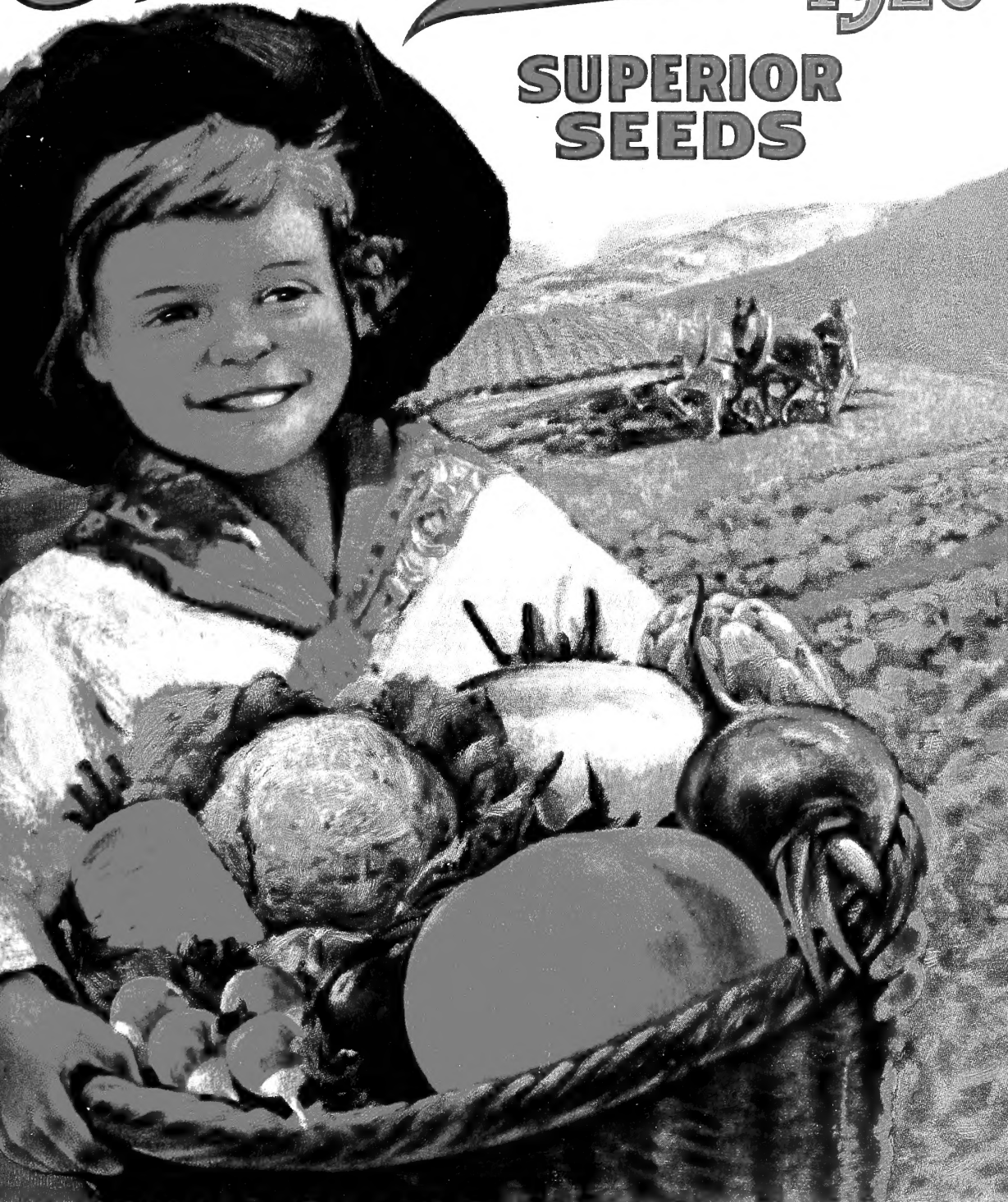

J. MANNS & CO.

FORREST & HILLEN STS.

ESTABLISHED 1887

BALTIMORE, MD.

AT BELAIR MARKET

GALLUP & STEWART CO. C.F.

J. MANNS & CO.

"Where Market Gardeners Buy"

Forrest and Hillen Sts.

At Belair Market

BALTIMORE, MD.

TESTED, PROVEN AND DEPENDABLE

SEEDS

Farm, Garden and Poultry Supplies



The broad smile of the young man pictured on the front cover page, exemplifies the degree of satisfaction which results from sowing MANNS' SUPERIOR SEEDS.

Thousands of successful Market Gardeners in the vicinity of Baltimore and throughout the South are thoroughly familiar with our Service of supplying SEEDS of Superior Quality, grown from pedigreed stocks, produced by experienced growers and carefully tested for vitality and purity of type. The quality of our stock is unexcelled and better seed cannot be purchased at any price.

Our prices, however, are low; for, in them are reflected our policy of fair and honest dealing, a thorough understanding of our customers' needs, and efficient methods growing out of long experience.

On the basis of quality, price, and the high standards which have brought us continued success for nearly forty years, we look forward with a keen sense of responsibility, to the privilege of serving you during 1926.

FOR THAT SMILE OF SATISFACTION SOW MANNS' SUPERIOR SEEDS

ORDERS. Be sure to sign your name plainly and give full shipping instructions.

REMITTANCES should be made by Post Office Money Orders, Registered Letters, Express Money Orders, or Draft, For amounts up to one dollar clean postage stamps will be accepted. Our terms are **Net Cash.**

SHIPMENTS. We deliver free to any Post Office in the United States seeds by the packet, ounce and quarter pound. For larger quantities, postage must be added to the prices quoted. Agricultural Seeds, Implements, Fertilizers and other heavy and bulky goods are sent by Freight or Express at purchaser's expense.

PLEASE READ—NON-WARRANTY. It is very evident to anyone who gives the matter the slightest thought that it is to our best interests to send out only such stock as will grow and prove true to name and description. There are, however, so many contingencies to be encountered, entirely beyond our control, such as the weather, soil and other conditions that: **J. Manns & Company give no warranty, express or implied, as to description, quality, productiveness, or any other matter of any Seeds, Plants or Bulbs sent out, and will not be in any way responsible for the crop.**

Domestic Parcel Post Rates Within the U.S. and Possessions		For First Pound	For Each Addit'l. Pound
First Zone within	50 miles	\$0.07	\$0.01
Second Zone within	50 to 150 miles	.07	.01
Third Zone within	150 to 300 miles	.08	.02
Fourth Zone within	300 to 600 miles	.09	.04
Fifth Zone within	600 to 1000 miles	.10	.06
Sixth Zone within	1000 to 1400 miles	.11	.08
Seventh Zone within	1400 to 1800 miles	.13	.10
Eighth Zone over	1800 miles	.14	.12

1887

MANN'S

1926

SUPERIOR VEGETABLE SEEDS

Selected from improved strains having true commercial merit, offered at lowest possible prices consistent with highest quality. FOR MARKET GARDENERS and other judicious and careful growers who sow the best.

ASPARAGUS

1 ounce to 60 feet of drill; 1 lb. per acre; 3,000 plants per acre.

Asparagus grows easily in almost any good soil, but best results are obtained in well-enriched, deeply dug, sandy loam. It may be grown from seed, but much time is saved by planting roots.

If you wish to grow plants from the seed yourself, sow in spring in drills about eighteen inches apart and two inches deep in light, rich soil, planting fifteen to twenty seeds to each foot of row. When the plants are well up, thin to about one inch apart and give frequent and thorough cultivation during the summer. If this has been well done, the plants will be fit to set the next spring.

The permanent bed should be prepared by deep plowing or spading and thoroughly enriching the ground with stable manure or other fertilizer; a moist, sandy soil is best. Set the plants about four inches deep and one to two feet apart in rows four to six feet apart. After the plants are well started, give frequent and thorough cultivation. Early the next spring spade in a heavy dressing of manure and about one quart of salt and double the quantity of fresh wood ashes to each square rod and cultivate well as long as the size of plants will permit, or until they begin to die down. The next season the bed may be cut over two or three times, but if this is done, all the shoots, no matter how small, should be cut. After the final cutting, give a good dressing of manure, ashes and salt. Cultivate frequently until the plants meet in the rows.

In autumn after the tops are fully ripe and yellow, they should be cut and burned. A bed fifteen by fifty feet, requiring about one hundred plants, if well cultivated and manured, should give the following season an abundant supply for an ordinary family and continue productive for eight or ten years.

Giant Argenteuil Famous French variety noted for its earliness and size. It resists rust better than some domestic sorts and is also very prolific, producing an abundance of light green, tender shoots. Pkt., 5c; ¼ lb., 20c; lb., 60c.

Palmetto This is one of the most popular varieties grown for general garden purposes, being early, prolific and very uniform. Shoots are light green but frequently deep green when allowed to grow above ground. Pkt., 5c; ¼ lb., 20c; lb., 60c.

Washington Pedigree Developed by the U. S. Dept. of Agriculture for resistance against "rust" and other Asparagus disease. Produces an abundant crop of large, tender stalks. The finest strain of Asparagus available. Pkt., 10c; oz., 25; ¼ lb. 75c; per lb., \$2.00.

ASPARAGUS ROOTS

From one to two years may be saved by planting Asparagus roots instead of seed. Choice, 2-yr. old roots, all leading varieties. \$1.75 per 100. Special price on large quantities.

ARTICHOKE (Jerusalem of Tuberous Rooted)

Grown exclusively for their large potato-like roots which are valuable for feeding hogs. Price, 1/4 pk., 45c; pk., \$1.25; bu., \$4.00. Expressage extra.

Artichoke (Large Green Globe). About 500 plants from 1 oz. The scale like leaves of the flower heads are used as a salad or boiled, making a delicious dish which is very popular with the French and Italians. Pkt., 10c; oz., 50c.

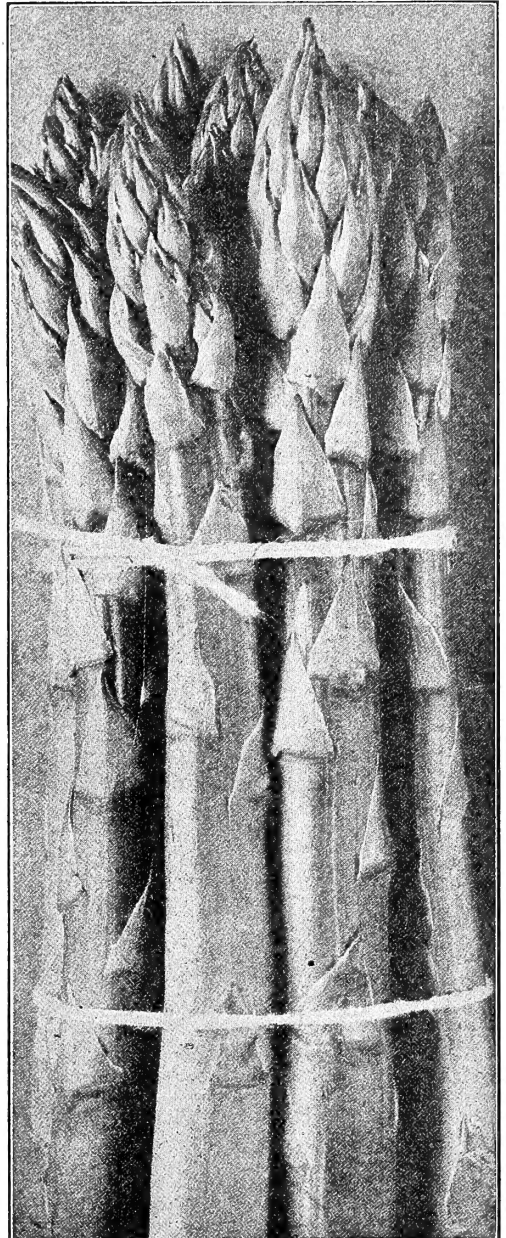

Asparagus, Martha Washington Rustproof.

BUSH BEANS

1 pint to 100 feet of drill; 1 to 1 ½ bushels per acre.

Beans are tender and should not be planted until the soil is well warmed. Sowing too early will often result in a poor stand and uneven ripening. Sow the seed 1 ½ to 2 inches deep in rows not less than 18 inches apart and firm the soil to assist germination. Allow the plants to stand 4 to 10 inches apart in the row according to variety.

Shallow cultivating and hoeing should be done frequently until the vines are in blossom. To prevent blight do not cultivate deeply and avoid working them while the vines are wet. Beans grow best in a warm, well-drained, sandy loam. For succession plant every two weeks until about August 15th.

ROUND GREEN PODDED VARIETIES

Burpee's Stringless Green Pod This variety has justly become the most popular of all stringless sorts, and can be profitably grown by either the trucker or the home gardener. It combines unusual hardiness, extreme earliness and wonderful productiveness. The pods are handsome in appearance, being rich, dark green in color, almost round, stout, meaty, and average 5 inches in length. They are tender, brittle, absolutely stringless in all stages of growth and of fine quality. Mature in 45 days. For succession, plant every two weeks until September. Qt., 40c; pk., \$2.25; bu., \$8.50.

Giant Stringless Green Pod A very productive long, round-podded variety, longer and straighter than Burpee's Stringless. The pods are light in color and show slight depressions between the beans. Vines are large, vigorous and spreading. A splendid succession to Burpee's if planted at the same time. Qt., 40c; pk., \$2.25; bu., \$8.50.

Full Measure Stringless A second early, round-podded, stringless bean of recent introduction. The pods are straight, very fleshy, and are dark green in color. They are entirely stringless and measure 6 to 8 inches in length. Very prolific and possessing the hardy qualities of the old Red Valentine. Qt., 40c; pk., \$2.25; bu., \$8.50.

Fordhook Favorite or White Seeded Stringless Rapidly becoming a favorite among market gardeners. Pods are 5 ½ to 6 ½ inches long, thick, meaty and almost round. Strictly stringless and medium green in color. They are medium early and fairly productive, and afford an additional opportunity by reason of the fact that the seed being white may be profitable saved for winter use. Pt., 25c; qt., 50c; pk., \$2.50; bu., \$9.00.

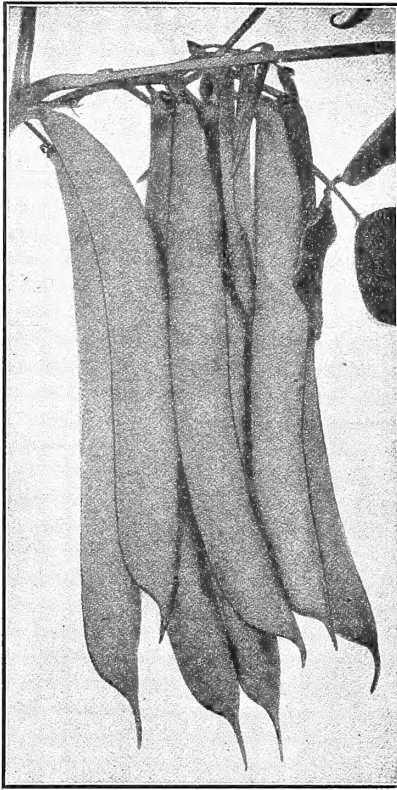

Burpee's Stringless Green Pod.

Dwarf Horticultural or Dwarf Cherry One of the best dwarf sorts for green shell beans for the home garden and market and can be used early as a snap bean. As a green shelled bean it is equal to the lima in quality while any surplus crop can be kept for winter use. The pods are 5 inches long, stout, flat and stringless. They are green at first changing as they mature to yellow splashed with carmine. The dried seeds are large, almost round, light buff spotted with dark red. Our special stock of this variety is superior to the old style Dwarf Cherry, being entirely stringless and free from runners. Qt., 40c; pk., \$2.50; bu., \$9.00.

Longfellow Extra long, slender, round, straight pods, measuring 7 to 8 inches, early, prolific and ripening uniformly, very slightly stringy, tender, attractive and of good quality. Excellent for canning purposes. Qt., 40c; pk., \$2.25; bu., \$8.50.

Keeney's Stringless Refugee Combines all the advantages of the 1000 to 1 Refugee but is entirely stringless. Qt., 40c; pk., \$2.75; bu., \$9.50.

Black Valentine This variety has proven itself to be the most hardy of all string beans. It will resist cold and wet better than any other sort and therefore can be planted extremely early and very late in the season as well as during the summer. It is very productive and the pods which measure 6 inches in length are of a beautiful dark green color. They should be picked as soon as ready as they will become tough if allowed to remain on the vines too long. Qt., 40c; pk., \$2.25; bu., \$8.50.

Hopkins' Improved Extra Early Red Valentine A very early and productive sort. Pods about 5 inches long, round, medium green, delicious flavor. Qt., 40c; pk., \$2.25; bu., \$8.50.

Extra Early Refugee A very hardy type of Refugee, bearing pods 4 inches long, slightly stringy, round, brittle and fine grained; quality good; color light green. Qt., 40c; pk., \$2.25; bu., \$8.50.

Late Refugee or Thousand-To-One Noted for its great productiveness, this variety has gained favor for canning and pickling. The dense foliage protects the pods from early frosts, thereby prolonging the season. The pods measure 5 to 5 ½ inches, are round, somewhat slender, almost stringless and of good quality. Qt., 40c; pk., \$2.25; bu., \$8.50.

FLAT PODDED GREEN STRINGLESS

Bountiful Being more prolific than the round podded varieties; entirely stringless and of excellent quality, Bountiful has become the standard variety in the markets using flat podded beans. Qt., 50c; pk., \$2.75; bu., \$9.75.

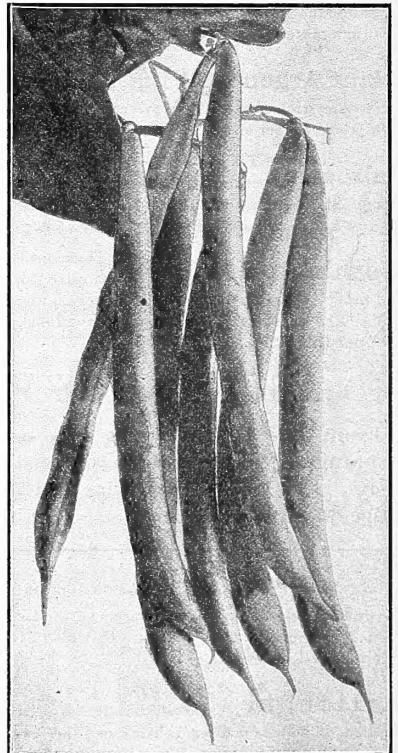

Full Measure.



SURE CROP STRINGLESS WAX BEANS

WAX BEANS--Flat Podded Sorts

Sure Crop Wax Decidedly better quality than Currie's Rust Proof but vine and seed very similar in appearance, and maturing about a week later. The pods are of a rich yellow color, growing an inch longer than Currie's and being stringless at all stages of growth. The disease resistant qualities found in Currie's are duplicated in this variety and it is vigorous, hardy, and very productive. For quality use Sure Crop, while for earliness Currie's is better. Qt., 45c; pk., \$2.75; bu., \$9.50.

Wardwell's Kidney Wax A very popular standard gardeners' variety, bearing a large crop of handsome, light golden yellow, long, broad pods which are nearly stringless and of very good quality. Very attractive and always command a good price in the markets. Qt., 40c; pk., \$2.50; bu., \$9.00.

Burpee's New Kidney Wax Resembles Wardwell's Kidney Wax, excepting that the pod is larger and thicker, though not so broad. Fairly productive and of high quality, stringless, very fleshy and brittle. Pods measure 6 inches and are of attractive, clear yellow color. Mid-season sort; not damaged by wet weather. Qt., 45c; pk., \$2.50; bu., \$9.50.

Davis' White Kidney Wax An early productive and attractive sort of fair quality. Pods 6 to 7½ inches, stringy, the white seed being the best feature as it makes a very satisfactory shell bean for winter use. Qt., 50c; 40c; pk., \$2.50; bu., \$9.00.

ROUND PODDED SORTS

Round Pod Kidney Wax (Brittle Wax). An excellent early round-podded variety of handsome appearance. Like all other round-podded varieties however, it does not yield as heavily as the flat wax beans. It is hardy, always stringless and of highest quality, especially desirable for snaps for the home garden. Qt., 50c; pk., \$2.50; bu., \$9.50.

Hardy Round Podded Rustless Wax The most dependable round-podded wax variety, as it is unusually disease-resisting and is vigorous enough to stand adverse weather conditions. Fairly prolific, entirely stringless pods of rich golden yellow color measuring 6 to 8 inches. Qt., 40c; pk., \$2.75; bu., \$9.50.

Pencil Pod Black Wax The best black seeded wax variety. It is early and very productive, exceptionally strong and vigorous, producing pods 6½ to 7 inches long which are fleshy, brittle, strictly stringless and free from fibre. They are of fine quality and clear yellow in color. Qt., 45c; pk., \$2.50; bu., \$9.00.

Currie's Rust Proof Wax This variety is not stringless, but being the earliest, hardiest and one of the most prolific of all flat wax-podded beans, has become a favorite among market gardeners and truckers. It is ready for picking in 42 days and the large, flat, straight pods which are of a bright golden yellow color make an attractive appearance when offered for sale. The vines are strong and upright, holding the pods well off the ground, their vigorous and hardy nature making them immune from rust, mildew or blight. Qt., 45c; pk., \$2.75; bu., \$9.50.

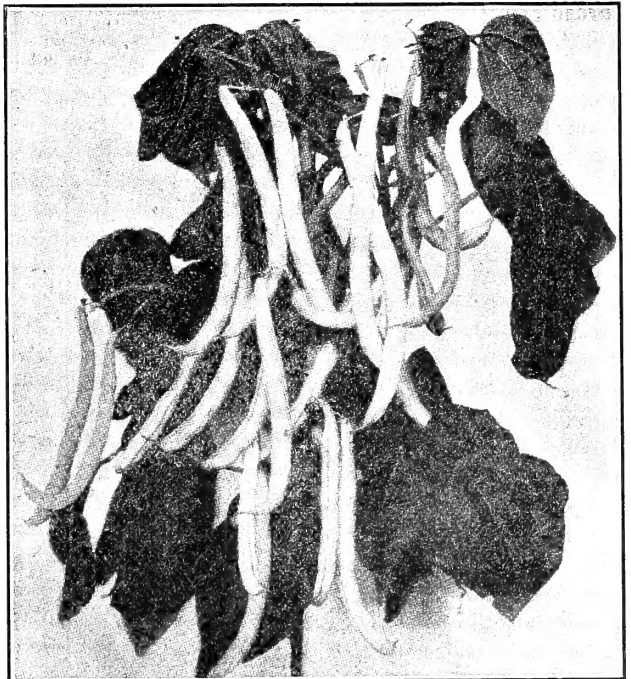

Hardy Round Pod Rustless Wax

EDIBLE-PODDED POLE BEANS

For Cultural Directions See Pole Limas.

Burger's Stringless Green Pod or White

Kentucky Wonder A new pole variety of great merit, bearing large, brittle, stringless pods of excellent flavor, dark green in color. It resembles the Kentucky Wonder in form of pod but is much earlier, more productive and bears longer. Seeds white, fine for baking. Qt., 50c; pk., \$2.75; bu., \$9.50

Kentucky Wonder or Old Homestead

This old standard variety is extremely productive and of finest quality. It is early and produces round, green pods about 9 inches long. Splendid for use as snaps for the home gardener as it continues to bear for a long period. Seed light brown. Qt., 50c; pk., \$2.75; bu., \$9.50.

White Creaseback Excellent as a snap bean as well as dried for winter use. Pods 5 inches long, fleshy, stringless and borne in clusters. Very productive. Qt., 50c; pk., \$2.50; bu., \$9.00.

Horticultural Cranberry or Wren's Egg

An old favorite, excellent both as a snap and shell bean. Medium early, producing large quantities of 5 and 6 inch pods which are broad, thick, and of fine flavor. Qt., 40c; pk., \$2.50; bu., \$9.00.

Cut Short, Red Speckled or Corn Hill

Popular variety for planting among corn instead of using poles. Will give a good crop of fine quality, short, round, tender pods. Qt., 40c; pk., \$2.50; bu., \$8.50.

Lazy Wife One of the best general purpose pole beans; of superior quality as a snap, green shelled or dried bean. Pods which are borne abundantly throughout the summer are very easily gathered and entirely stringless, brittle, light green in color and of a mild, sweet flavor. Seed pure white, 6 to 8 in each pod. Qt., 50c; pk., \$2.75; bu., \$9.50.

Yard Long, Celestial or Asparagus Bean

Somewhat of a curiosity and yet possessing excellent qualities. It is very prolific, absolutely rust proof and a rank grower. It will produce pods 18 to 24 and sometimes 30 inches long. An excellent table vegetable, the pods being tender, stringless and of a rich asparagus flavor. Oz., 10c; lb., \$1.00.

BUSH BEANS

VARIETIES USED AS SHELL BEANS

Dwarf Horticultural, Fordhook Favorite, and Davis' White Kidney Wax. Three very satisfactory shell bean sorts have been listed previously.

White Marrowfat This is a very prolific variety and has become a choice family sort both for green shells and dry beans. Pods are broad, about 5½ inches long, medium green changing to yellow, having large, clear, white seeds which cook very dry and mealy. Qt., 35c; pk., \$2.00; bu., \$7.00.

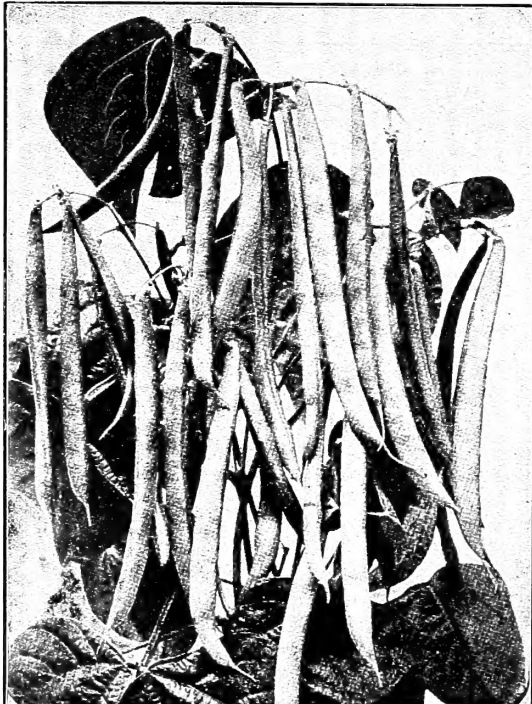

WHITE MARROWFAT

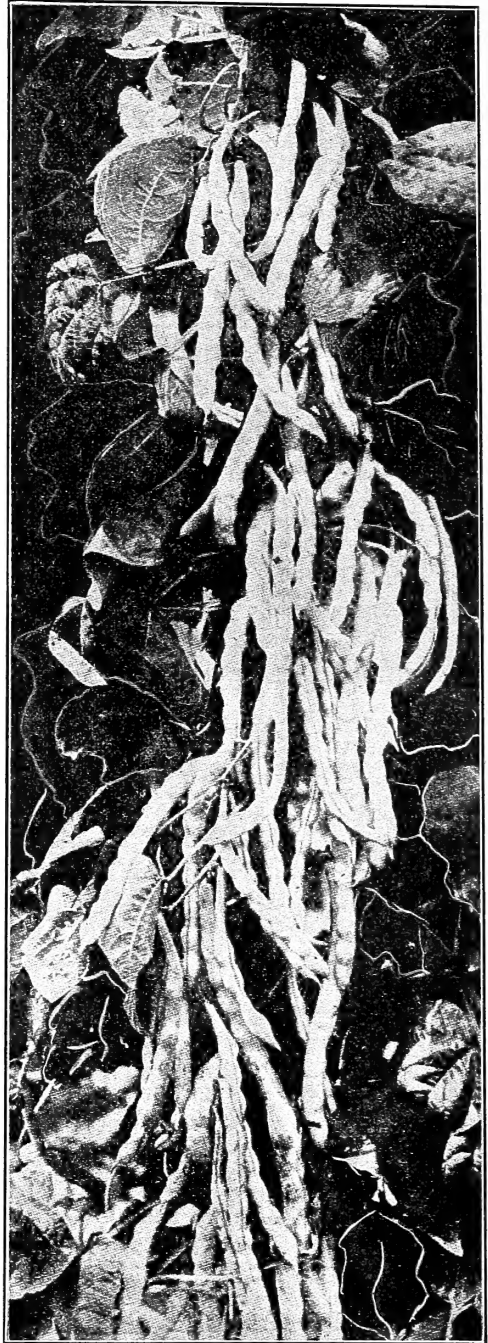

KENTUCKY WONDER

Royal Dwarf or White Kidney Excellent late, variety, green shelled or dry. Seeds are large, white, kidney shaped, and of fine quality. Qt., 40c; pk., \$2.25; bu., \$8.00.

White Navy or Boston Pea Bean

The standard small seeded, pure white variety which has become so popular for its baking qualities. The yield is invariably very heavy. Sow during June and July in rows three feet apart dropping 2 to 3 seeds a foot apart in the rows. Qt., 35c; pk., \$2.00; bu., \$7.00.

Broad Erfurt Of foreign origin and entirely different from any other variety, being larger than the ordinary lima, with much darker pods. This sort will prove profitable for market gardeners who have Italian and Spanish trade. Qt., 40c; pk., \$2.25.

POLE LIMA BEANS

1 quart to 150 hills; 8 to 10 quarts per acre.

Pole beans do not bear as early as the bush varieties but they are more productive, their bearing season is longer and they are more easily gathered. They succeed best in a warm sandy loam which has been enriched with well rotted manure. If poles are used they should be set three to four feet apart each way. After the ground has become warm and dry, plant 4 to 6 beans to a pole and when well started thin out to 2 or 3 plants to a pole. By placing the seed eyes down they will germinate more quickly and for this reason are less liable to rot. Cultivate frequently but shallow.

Sunnybrook This variety was introduced in 1922 and has rapidly gained favor because of its extreme earliness and abundance of medium sized, well filled pods of deep green color, having four and often five large thick, meaty, light green beans of the finest quality. The vines are of most vigorous growth and produce pods which are ready for picking earlier than any other large seeded pole lima. **Qt. 60c; Pk., \$3.25; bu., \$12.00**

Early Leviathan The Early Leviathan stands supreme because of its combined qualities, earliness, size and productiveness. The large, well filled pods are borne in clusters of five to ten and are spaced over the entire vine. They are well filled with large fleshy beans of excellent quality, delicate pale green in color. **Qt., 60c; pk., \$3.00; bu., \$11.00.**

Carpinteria A very desirable pole lima for the home and market garden, producing an abundance of large four-seeded medium green pods. The color is distinctive in having a decided greenish tint, an indication of very finest quality. The beans are thin skinned, delicious flavor and retain the distinctly green tinge even when dried. **Qt., 60c; pk., \$3.00; bu., \$11.00.**

Ideal One of the largest and most valuable of the medium late varieties, producing a tremendous crop of seven-inch pods, which are filled with five to six large beans of excellent quality. Seed large, ovoid, flat white with slight greenish tinge. Splendid for market gardeners. **Qt., 65c; pk., \$3.25; bu., \$12.00.**

King of the Garden This is the best and most popular main crop variety. Vines are strong and vigorous; setting pods early and continuing to bear until frost. Is used extensively by market gardeners because of its very prolific nature and the immense size of the pods, which are very straight and handsome; of medium dark green color, broad, flat and filled with four or five large white beans of finest quality. **Qt., 65c; pk., \$3.25; bu., \$11.50.**

Challenger or Dreer's Pole Vigorous, productive, and quite early, producing pods which are much thicker than any other sort and filled with four thick beans so closely set that the ends are flattened. A favorite among market gardeners. **Qt., 60c; pk., \$3.25; bu., \$11.50.**

Giant Podded The largest podded lima in cultivation; extremely vigorous in growth, mid-season. Pods are borne in clusters of 6 to 8 and measure 7 inches long and 1½ inches broad. The beans are extra large and of excellent quality. **Qt., 70c; pk., \$3.50; bu., \$13.00.**

BUSH LIMA BEANS

Large seeded sorts, 1 quart to 100 hills; 1 bushel to the acre.

Small seeded sorts, 1 quart to 150 hills; 3 pecks to the acre

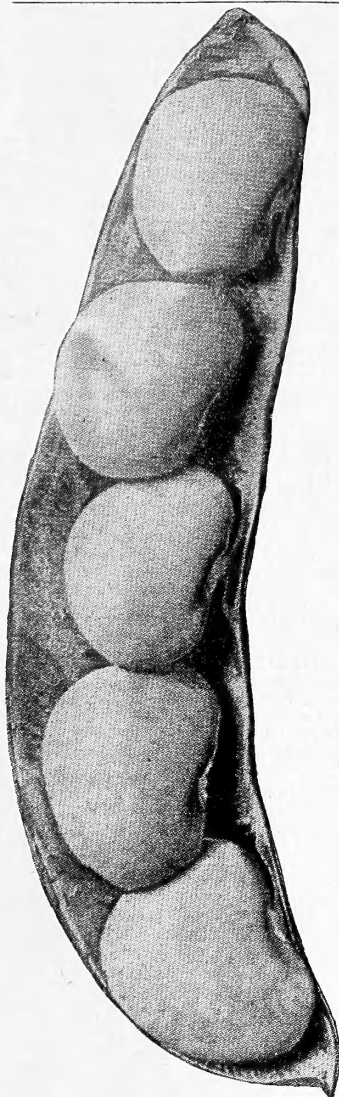

Sunnybrook

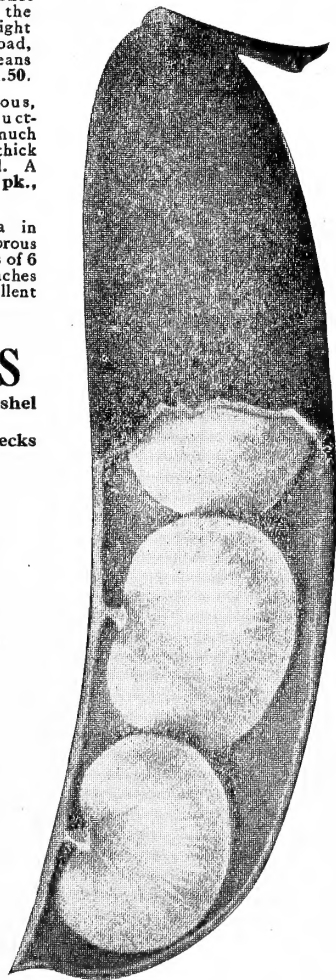

Early Giant

These varieties require no support, are about two weeks earlier than the pole beans, and can be planted closer in the rows. They are therefore used by large growers and by gardeners who do not find it convenient to use poles. After danger of frost is past and the ground has become warm, plant in 3 ft. rows dropping 3 seeds to a hill and the hills 15 inches apart.

Early Giant Bush Lima The largest and earliest bush lima; two weeks earlier than Fordhook, very prolific and of excellent quality. Pods contain 4 to 5 large, close setting beans, and are borne in clusters of 5 to 8. Plant very vigorous and upright, often attaining a height of 30 inches. **Qt., 75c; pk., \$4.50; bu., \$16.00.**

Fordhook Bush Lima A most excellent variety and exceedingly popular with market gardeners. The plants are freely branching and very erect in their growth. Four or five large, very thick beans are contained in each pod and the plants continue to produce large quantities from July until frost. The green beans even when full size are tender, juicy and sweet when cooked, being a distinct improvement over the rather dry and mealy character of other varieties of this Potato Lima type. **Pt., 40c; qt., 65c; pk., \$4.00; bu., \$14.00.**

Burpee's Improved Bush Lima A very prolific mid-season variety of very hardy, vigorous and true bush growth, bearing clusters of 5 to 8 pods measuring 5 to 6 inches long. The pods are borne abundantly, enormous in size and well filled with handsome beans which are both larger and thicker than those of the regular Burpee's Bush Lima. **Qt., 65c; pk., \$3.75; bu., \$14.00.**

Wood's Prolific or Henderson's Improved Bush Lima Greatly resembles Henderson's Bush Lima in form and habit of growth, but produces much larger and thicker beans, equally as good in quality and very prolific. **Pt., 35c; qt., 65c; pk., \$3.25; bu., \$12.00**

Wilson's Improved Bush Lima **pt., 35c; qt., 65c; pk., \$3.25; bu., \$14.00**

TABLE BEETS

1 oz. to 50 feet of drill; 5 lbs. per acre.

The soil for beets should be light, rich fine and deeply cultivated. Smooth beets cannot be grown if fresh manure is used. If wanted very early, sow in hot beds and transplant, cutting off the outer leaves. For early outdoor crop plant the seeds about 1 inch apart and 1 inch deep in rows 1 to 2 feet apart, firming the soil about the seeds by walking on the row. This should be done as soon as the ground can be worked and for table use, plantings should be made every three weeks. Thin out the plants to 3 inches apart. For main crop sow in the early part of May while for winter use they may be planted up to July 1st.

Extra Early Flat Egyptian One of the very earliest, excellent for forcing and early crop. Roots are distinctly flat, very dark red, have very small tap root and are of fine quality when young. They measure 2 inches in diameter when mature and have very small tops. Pkt., 10c; $\frac{1}{4}$ lb., 25c; lb., 75c.

New Model "Early Spring" A very good early variety for growing under sash or in the open ground. Perfect in shape and of a beautiful red color, very uniform in shape and size, the entire crop maturing during the same week. Short tap root and small tops. The fact that many customers bought their 1925 requirements as soon as 1924 crops were harvested proves that this variety fills a definite need among the market gardeners and has met with success. Pkt., 10c; $\frac{1}{4}$ lb., 35c; lb., \$1.00.

Crosby's Egyptian This is most popular early variety for the trucker or home gardener, as the roots are smooth, globe shaped, deep red in color, tender, sweet and richly palatable when served. This should not be confused with Flat Egyptian as it is similar only in point of earliness, and size of tops and tap root. Pkt., 5c; $\frac{1}{4}$ lb., 25c; lb., 75c.

Early Eclipse An early variety with small tops and medium sized, round, bright red roots; flesh dark red with zones of lighter color. Pkt., 10c; $\frac{1}{4}$ lb., 25c; lb., 75c.

Electric Extra early, almost round, with very small leaves set close to the crown, deep red, smooth skin, with flesh crimson slightly zoned. Quality is good, being tender, sweet and free from fibre. Pkt., 10c; $\frac{1}{4}$ lb., 20c; lb., 65c.

Crimson Globe An excellent main crop variety of medium size, globe shaped, with a remarkably smooth surface and high in quality, being tender, crisp and sweet, never stringy. The flesh is very deep purple, slightly zoned in lighter and darker shades. Is without rootlets and the foliage is small and attractive. Extensively used by market gardeners. Pkt., 10c; $\frac{1}{4}$ lb., 25c; lb., 75c.

Eureka Early sort, growing 3 to 4 inches in diameter. Of good quality and color and nearly as early as the extra early varieties. Pkt., 10c; $\frac{1}{4}$ lb., 25c; lb., 75c.

Edmand's Blood Turnip Second early; short tops, nearly round, flesh purplish red, with little zoning; a good keeper. Pkt., 10c; $\frac{1}{4}$ lb., 25c; lb., 75c.

BEETS—MANGEL AND SUGAR

The Mangel Wurzel, also called Mangel, Field Beet and Cow Beet is extremely valuable for stock feed. Very large yields are produced on almost any soil, but a deep, rich loam is most suitable.

Sow 1 ounce to 100 feet of drill, 6 lbs. to the acre in drills and 15 to 20 lbs. to the acre is sown broadcast.

Plant from middle of May to middle of June in drills about 2 $\frac{1}{2}$

Mammoth Long Red Attains enormous size, producing thirty to fifty tons per acre. The roots are straight, well formed and much thicker than other sorts. Grows well above the ground and is therefore easily gathered. The flesh is white tinged with rose. Highest feeding quality. $\frac{1}{4}$ lb., 20c; lb., 50c; 5 lbs., \$2.00.

Lane's Improved Sugar The best general purpose stock feeding beet known. It is an American variety and in comparison with the French sorts is much longer and finer grained. White flesh, high in quality and a good keeper. Pkt., 5c; $\frac{1}{4}$ lb., 20c; lb., 50c.

Danish Improved Very large and heavy, oval shaped roots, which are very sweet and most desirable for stock feeding. $\frac{1}{4}$ lb., 20c; lb., 50c.

feet apart and 1 inch to 1 $\frac{1}{2}$ inches deep. When the plants are about three inches high begin thinning out and continue at intervals until they stand 8 inches apart in the rows. By thoroughly firming the soil over the seeds after planting and frequently cultivating, more uniform germination and a more even maturing crop will result.

Golden Giant Intermediate A fairly long, red, dish-yellow, oval shaped root, growing half above the ground, very heavy and of good quality. $\frac{1}{4}$ lb., 20c; lb., 50c; 5 lbs., \$2.25.

Golden Tankard The best Yellow Mangel in cultivation. It contains a larger percentage of sugar than the red sorts. Very desirable for feeding purposes and easily harvested. $\frac{1}{4}$ lb., 20c; lb., 50c.

USE A FELINS TYING MACHINE
FOR BUNCHING BEETS

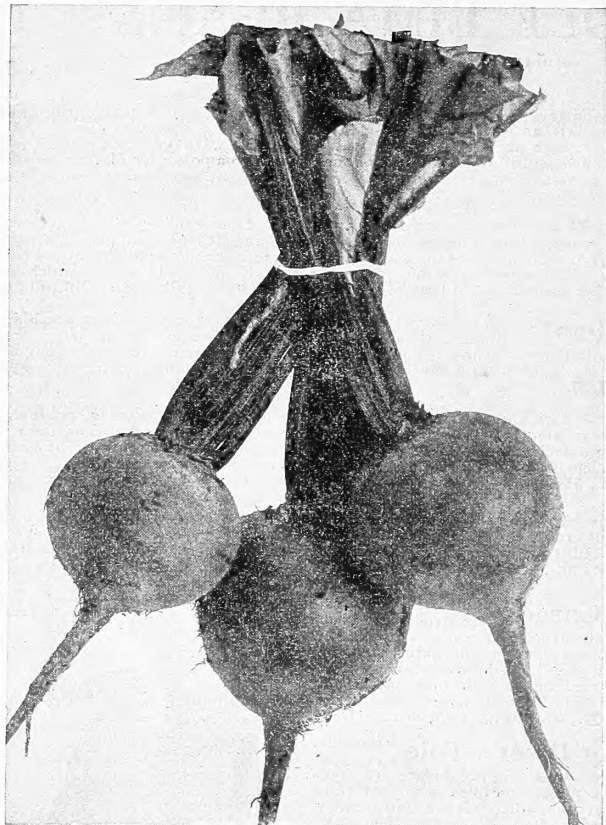

Detroit Dark Red Beets

Detroit Dark Red Careful comparison with all prominent varieties on the market prove Detroit Dark Red to be the most uniform in size and shape, the most attractive in color, and unsurpassed in quality. The tops are small and upright in growth with dark green leaves shaded with red. The roots are globular, of medium size, very smooth and dark blood red in color. Excellent for bunching, making a handsome appearance when offered for sale. Decidedly the best variety for either the home or market gardener, and on account of its uniformly deep rich color is most desirable for canning. May be planted for early or main crop. Pkt., 10c; $\frac{1}{4}$ lb., 25c; lb., 75c.

Half Long Blood Excellent second early sort and a good keeper. Roots half long and smooth, distinctly zoned. Very desirable for storing or pickling as it retains its good quality longer than other varieties. Pkt., 10c; $\frac{1}{4}$ lb., 20c; lb., 65c.

Dewing's Improved Blood Turnip A good quality, medium early sort; turnip shaped and of good size. Deeply colored flesh, tops medium size. Pkt., 10c; $\frac{1}{4}$ lb., 25c; lb., 75c.

BORECOLE

Superior to the ordinary Kale in quality and extensively grown in this section for marketing during the winter months, when other vegetables are scarce. Borecole should be grown like cabbage, the seed being sown from early spring to the middle of August. It is customary to pull off the lower leaves and let the plant grow on to furnish a continuous supply.

Hardy Winter This variety is the most salable and profitable sort for either the home or market gardener. The plant attains a height of 18 inches and produces an abundance of beautiful light green leaves, which are densely curled and crimped. It is extremely hardy and has the additional advantage of putting forth a second crop of leaves after the first have been gathered or have fallen off. This new growth of sprouts is of the finest quality and is ready for market during the winter months and early spring, when it commands a fancy price in the markets. It is better not to cut or handle the plants while frozen but if this is unavoidable, thaw them out in cold water. **Pkt., 10c; oz., 20c; ¼ lb., 60c; lb., \$2.00.**

Mossbach A half dwarf, white ribbed variety of very distinct appearance. Its gracefully curled light green leaves are self-folding which causes the heart to blanch to a beautiful yellow. It matures very early and is superior to all other varieties in quality and flavor for fall use. It is not hardy however, and should be gathered before frost or protected. **Pkt., 10c; oz., 20c; ¼ lb., 60c; lb., \$2.00.**

Dwarf Green Scotch This excellent sort is low spreading and compact in its nature of growth, forming a mass of leaves which are beautifully curled and mosslike in appearance. The color is an attractive bright green and the quality is excellent. Being quite hardy, the plants will remain green throughout the entire winter where the temperature does not fall below zero. This strain is also called Norfolk Kale and is extensively grown in this section and farther South or the Northern markets. **Pkt., 10c; ¼ lb., 30c; lb., \$1.00.**

BROCCOLI

Large White French Grown for the cauliflower-like heads and for greens; easily marketed among the French and Italian trade. **Pkt., 10c; oz., 50c; -lb., \$1.75.**

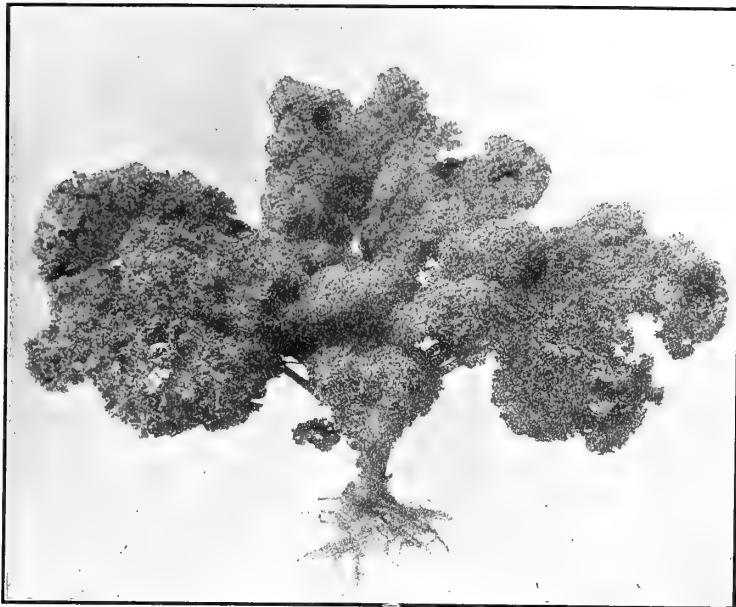

Borecole—Dwarf Green Scotch.

BRUSSELS SPROUTS

1 oz. will sow 500 ft. of drill or 3,000 plants.

Brussels Sprouts are grown for use during the fall and winter months. An abundance of sprouts, resembling miniature cabbages are produced over the entire stem from tip to the ground. When the young sprouts are well formed the lower leaves should be stripped off to aid the formation of the heads. Sow the seed thinly in drills in April for early crop or in early June for a late fall crop. After the plants are 6 inches high transplant to rows which are 3 to 4 feet apart and 18 to 24 inches apart in the rows. The plants are hardy and in this section will live out through the winter without protection. The sprouts are improved in quality and flavor by frost.

Danish Prize Found to be the best variety both in quality and productiveness. The sprouts develop very evenly over the entire stem, the lower sprouts being as tightly folded and as solid as those higher up. Consequently a large crop can be gathered. Unsurpassed in quality. **Pkt., 10c; oz., 30c; ¼ lb., 90c; lb., \$3.00.**

SWISS CHARD or Spinach Beet

This excellent vegetable is grown for its large, broad leaves which make a delicious dish when prepared like spinach or asparagus. The increasing demand proves conclusively that this variety is finally receiving the attention its many valuable characteristics deserve. It produces all tops and no edible root, the leaves stand 2 to 2½ feet high, growing well even in hot weather when spinach fails altogether. It soon sprouts again after cutting and gives several crops each year.

Plant the seeds the same as ordinary beet seeds but thin out at first to 6 inches apart, later to 1 foot apart. Ready for use in about 60 days.

Large Ribbed White The large leaves are pale yellowish-green in color, having very broad, white, tender midribs which are prepared and served like asparagus. The leafy portion is cooked similar to spinach. **Pkt., 5c; oz., 10c; ¼ lb., 25c; lb., 75c.**

Lucullus An improved type of Chard, being of more upright growth. The leaves are dark green with white mid-rib and veins; very much crumpled and curled. The stalks are thick and broad and as large as rhubarb. **Pkt., 5c; ¼ lb., 25c; lb., 75c.**

COLLARDS

This is a tall, loose leaved kale-like plant grown throughout the South for table use and for stock feeding purposes. Collards usually succeed in locations where cabbage cannot be grown to perfection. One ounce of seed will sow 300 feet of drill; two pounds per acre.

Georgia, Southern or Creole The chief Southern variety for greens, growing 2 to 3 feet high and forming a large, loose, open head or cluster of leaves with a rather long stem. Quality is improved by a light frost. **Pkt., 5c; ¼ lb., 25c; lb., 75c.**

CHIVES

Chives are a small hardy perennial plant, resembling the onion in appearance and growing in clusters. They are grown for the young leaves, which are produced freely from early in the spring and give a mild onion flavor to sausages, salads and various dishes. **Pkt., 10c. oz. 60c.**



Swiss Chard—Lucullus.



FIELD OF MANNS' EARLY JERSEY WAKEFIELD CABBAGE

CABBAGE

1 oz. for 2,000 plants; $\frac{1}{4}$ lb. per acre.

CULTURE:—The best results are obtained from a well-drained, deep rich loam. The very early varieties should be sown about September 15th and in 4 or 5 weeks transplanted to coldframes, from which they are transplanted to open ground from March 15 to April 15. If this is not done the seed should be sown in hotbeds in February; making plantings later of course according to variety and time crop is wanted. The earliest sorts should be set out in rows 2 feet apart and 18 inches apart in the rows.

If it is not especially desired to have very early cabbage the seed may be sown in open ground and transplanted after 4 weeks. For second early crops sow in April and transplant in May; these will mature in July and August. The later varieties should be planted in May and transplanted in July to rows 3 ft. apart and 2 feet apart in the rows; these will mature from September to November.

Cabbages should be hoed every week and the ground thoroughly stirred as they advance in growth, drawing a little earth to the plants each time until they begin to head, when they should be thoroughly cultivated and left to mature.

Copenhagen
Market



FIRST EARLY SORTS

Early Jersey Wakefield The earliest and surest heading of first early cabbages. Most gardeners depend upon it for the bulk of their extra early crop. Its exceeding hardness, not only to resist cold, but other unfavorable conditions, insures the greatest likelihood of profitable and satisfactory results. Our stock is grown and selected with the greatest care; there is none better. Plant compact and erect or very slightly spreading, with few outer leaves, which are smooth, thick, nearly oval and light green. Stem short. Heads of medium size, very solid, uniformly pointed and of excellent quality. Pkt., 10c; oz., 25c; $\frac{1}{4}$ lb., 75c; lb., \$2.25.

Charleston or Large Wakefield Produces larger and less pointed heads than Jersey and a week or two later in maturity. The heads are very solid and the leaves are large, smooth, thick. It is exceedingly hardy and has become very popular with growers and shippers because of its earliness and size. An excellent succession to Jersey Wakefield. Pkt., 10c; oz., 25c; $\frac{1}{4}$ lb., 75c; lb., \$2.50.

Copenhagen Market This very fine, large round headed variety is of Danish origin and has proven to be very valuable to the American grower. It is nearly as early as Jersey Wakefield, being the earliest large round head variety in cultivation. The heads average about 10 lbs., and the stems are very short. Close planting is possible because of the fact that there are very few outer leaves, the stems are short and the heads very compact. Pkt., 10c; oz., 25c; $\frac{1}{4}$ lb., 75c; lb., \$2.50.

Early Winnigstadt Medium early, short stem variety. The leaves are dark green in color, smooth, having a peculiar and distinct twist at the point of the head. Pkt., 10c; oz., 20c; $\frac{1}{4}$ lb., 60c; lb., \$2.00.

New Leader Very early flat heading sort forming small solid heads very early but developing larger heads if allowed to stand. Oz., 20c; $\frac{1}{4}$ lb., 60c; lb., \$2.00.

Eureka First Early The earliest short stem, round headed variety, comparing favorably with Copenhagen Market but a little smaller and earlier. The quality is excellent and it is a reliable header and a sure cropper. Popular with market gardeners as it matures at the same time as the early pointed varieties. Pkt., 10c; oz., 20c; $\frac{1}{4}$ lb., 60c; lb., \$2.00.

SECOND EARLY SORTS

New Glory Of vigorous growth, with large and rather spreading outer leaves which are noticeably curved and frilled. The head is globular or very nearly round, very solid and of large size for so early a variety. Pkt., 10c; oz., 25c; $\frac{1}{4}$ lb., 75c; lb., \$2.25.

CABBAGE

SECOND EARLY SORTS—Con.

Volga One of the earliest main crop cabbages of superior quality. Very desirable where a large, uniformly round head with short stem and compact growth is wanted. Exceptionally hardy and a good keeper. Pkt., 10c; oz., 25c; ¼ lb., 75c; lb., \$2.50.

Fottler's Short Stem Rapid Grower Heads are large and solid and of excellent quality, few outer leaves, short stem. Oz., 25c; ¼ lb., 65c; lb., \$2.25.

All Head Early or New Early Remarkably uniform in color as well as in shape and size, its sure heading qualities and tenderness make it a favorite for the home garden. By reason of its compact growth, it is possible to produce 1,000 more heads per acre than many other good sized varieties. For winter use sow in July. Splendid sort for kraut making. Pkt., 10c; oz., 25c; ¼ lb., 75c; lb., \$2.25.

Early Flat Dutch Excellent large early flat sort, producing solid heads that mature with Early Summer. The stem is short and it has comparatively few outer leaves. Compares favorably with Large Late Flat Dutch but much earlier and smaller. Pkt., 10c; oz., 20c; ¼ lb., 65c; lb., \$2.25.

American Drumhead Savoy This is the finest of the Savoy class and very distinct from all other sorts. It forms the hardest heads and is the best for either early or late crops. The leaves are heavily crimped or savoyed and grow closely about the large, solid, dark green heads. The flavor is far superior to that of other cabbages, and for this reason is very much in demand. It is an excellent keeper and very hardy. Entire "pits" of it will keep in perfect condition until May. Oz., 25c; ¼ lb., 75c; lb., \$2.50.

Early Summer Heads medium in size, round, somewhat flattened, compact and solid; outer leaves spreading and light green in color. Ten days later than Jersey Wakefield, and one of the best large second early sorts. Oz., ¼ lb., 75c; lb., \$2.25.

Henderson's Succession The best very large mid-season cabbage, about a week later than Early Summer but much larger and can be planted closer because of its compact growth. It is sure to head, very uniform in habit and the quality is excellent. Oz., 25c; ¼ lb., 75c; lb., \$2.50.

All Seasons A reliable variety to use when only one planting of cabbage is made. It is equally as good for fall and winter as for summer use. Nearly as early as Early Summer and much larger heads of the best quality are produced. Pkt., 10c; oz., 25c; ¼ lb., 65c; lb., \$2.25.

Sure Head Extremely popular with the private gardener because of the sure heading qualities and the remarkably large, uniform, heavy heads. A good keeper and one of the best for late crops. Pkt., 10c; oz., 25c; ¼ lb., 65c; lb., \$2.25.

Lupton A grand Cabbage, combining the qualities of the second early and late sorts. It is vigorous, perfect in type and has the fine qualities of the early maturing varieties. The stem is short and the heads are large, uniform and dark green in color. It is sure to head and is an excellent keeper. Pkt., 10c; oz., 25c; ¼ lb., 75c; lb., \$2.50.

Danish Ball Head or Hollander A very hardy sure heading variety which has proven to be the best keeper and the most desirable for distant markets. The plants are vigorous, compact and

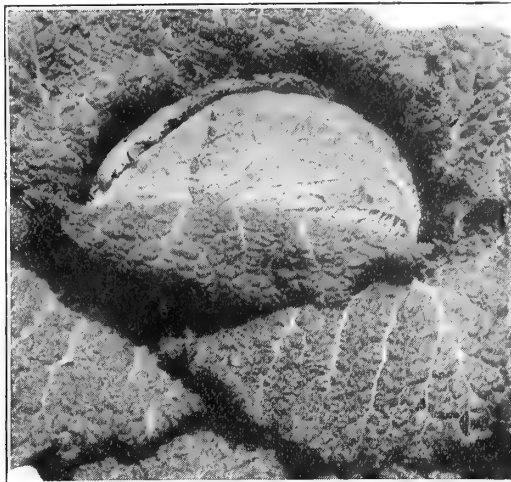

American Drumhead Savoy.

have a stem of medium length. Exceedingly hardy and standing dry weather very well. Extremely solid, large and heavy heads are produced. Pkt., 10c; oz., 25c; ¼ lb., 75c; lb., \$2.50.

Penn State Ball Head This new variety has been developed by the State of Pennsylvania in response to the demand for a large, hard, round headed type, capable of resisting blight, club root, and other common cabbage diseases. Our seed has been grown on Long Island from some of the original stock seed supplied by the Pennsylvania authorities. Pkt., 25c; oz., 75c; ¼ lb., \$2.50; lb., \$8.00.

New Danish Round Head Compared with Danish Ball Head, has less outer foliage. The heads are larger in size and are set on shorter stalks, maturing two weeks earlier. They are extremely hard and solid, of sweet flavor and tender texture. It is very light resisting and vigorous in growth during the hot summer, and a good keeper. Oz., 25c; ¼ lb., 75c; lb., \$2.50.

LATE OR WINTER SORTS

Premium Flat Dutch A very good variety for fall use or for making kraut. The heads are very solid, tender and of superior quality. They mature earlier than other late varieties but do not keep as well over the winter. Pkt., 10c; ¼ lb., 65c; lb., \$2.00.

Extra Large Late Flat Dutch The best and most profitable late variety, possessing all the qualities a winter variety should have. It is hardy, vigorous, and high in quality. The heads are "as solid as a stone" and for that reason keep well for winter use. The leaves are formed about the head in such a way as to resemble a saucer, in which the light rains and dews collect, the moisture then being absorbed through the stem by the roots. This gives an added advantage when a very dry season is experienced. A favorite with the private gardener as well as the trucker. Oz., 20c; ¼ lb., 65c; lb., \$2.00.

Autumn King or World Beater

One of the finest strains of late Cabbage. It produces regular, even heads of enormous size; a great cropper on account of few outside leaves. Pkt., 10c; oz., 25c; ¼ lb., 65c; lb., \$2.25.

Mammoth Rock Red

This is the largest and surest heading red Cabbage yet introduced and much better than the stocks offered as Red Drumhead. The plant is large, with numerous spreading leaves. The head is large, round, very solid, of very attractive deep red color. Nearly every plant will form an extra fine head. Pkt., 10c; oz., 50c; ¼ lb., \$1.75.



Extra Large Late Flat Dutch

CABBAGE PLANTS
Fresh Daily
See Page 33

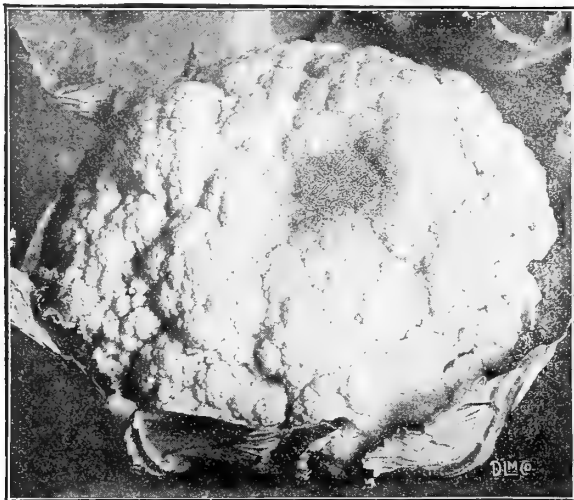

Early Snowball Cauliflower

CHINESE CABBAGE

Chinese or Celery Cabbage belongs to the cabbage family but more closely resembles lettuce. It is a delicious vegetable served either as a salad like lettuce or a cold-slaw. When boiled it is even more palatable than cabbage and resembles Brussels Sprouts in flavor. For best results plant the seed late in July or very early in August as spring plantings in this section are liable to bolt to seed. Plant the seed in the permanent bed and thin out to stand 12 to 15 inches apart. Transplanting is not practical, cultivate same as cabbage. Thrives well in any good soil and matures full sized heads in 75 to 90 days.

New Pe-Tsai "Peking" The finest Chinese cabbage in existence. The heads are large, compact and the crisp, tender interior blanches to a creamy white. It will stand long before bolting to seed and is not injured by light frosts. Pkt., 10c; oz., 35c; ¼ lb., \$1.00.



Pe-Tsai Peking

CAULIFLOWER

1 ounce to 2,000 plants.

This delicious and very profitable vegetable is not as extensively grown as it should be because many gardeners have an erroneous opinion that cauliflower is difficult to grow. Anyone will be reasonably sure of success if the following suggestions are followed:

For an early crop sow the seed either indoors or in a hot-bed in January or February, transplanting them to 2 or 3 inches apart thus allowing the plants to put forth a vigorous growth before being set in the permanent rows.

As soon as danger of freezing is over, set the plants in the open ground in rows 2½ to 3 feet apart and 18 inches apart in the row. The soil for Cauliflower should be like that for cabbage, but it is better if an additional quantity of manure is used so that the ground is very rich. Cultivate often and thoroughly. For fall crop sow the seeds during April or May. It is well to plan so that the early crop heads before very hot weather and the late crop matures after hot weather.

Plenty of moisture is needed at all stages of growth but is especially necessary when the plants are heading. At this time the leaves should be loosely tied over the heads as a protection from the sun. Cauliflower is highly esteemed for its mild, delicate flavor and always commands a favorable price in the markets.

Early Snowball The best early variety in cultivation. If planted March 1st, large heads will be produced early in June, and scarcely a single plant will fail to form a head. Its compact habit renders it a very profitable variety to force under glass, and it does well for late planting also. Our stock cannot be excelled in quality. Pkt., 25c and 50c; oz., \$2.00; lb., \$25.00.

Extra Early Dwarf Erfurt (Extra Selected). This is the choicest selected strain of the popular Erfurt type, and is remarkable for its extreme reliability in heading. Nearly as early as Early Snowball. Pkt., 25c; oz., \$1.75.

Dry Weather Cauliflower Especially adapted for growing in dry locations where nearly all other varieties fail, and for heads of good size. Dry Weather, which is also known as Gilt Edge and Danish Giant, is about one week later than our Early Snowball, is much larger and with much more foliage; hence it is not so suitable for forcing. The heads are very large, white, firm and compact, and being well protected by the dense foliage, are easily blanched and remain fit for use for a long time. Pkt., 25c and 50c; oz., \$2.00; lb., \$25.00.

CELERIAC

Celeriac or Turnip Rooted Celery is grown for its edible roots which keep well for winter use and are excellent for flavoring. Sow seed and cultivate same as celery, with the exception that it is not necessary to blanch the plants. When the roots attain a diameter of two inches they are fit for use. To keep these through the winter, pack in damp earth or sand and store them in a cellar or leave them out of doors, covering with earth and straw for protection.

LARGE SMOOTH PRAGUE

An improved form of turnip rooted celery. One of the largest, very smooth and almost round with very few side roots. Plants are vigorous, with large dark green foliage. Pkt., 5c; oz., 25c; ¼ lb., 75c; lb., \$2.50.

CRESS

Sprinkle seed freely along shallow drills 1 foot apart at intervals through spring and summer, as desired.

CURLED or PEPPER GRASS American Upland

This small salad is much used with lettuce. Pkt., 5c; oz., 15c; ¼ lb., 25c; lb., 75c.

TRUE WATER

Thrives only when its roots and stems are submerged in water. Pkt., 10c; oz., 50c.

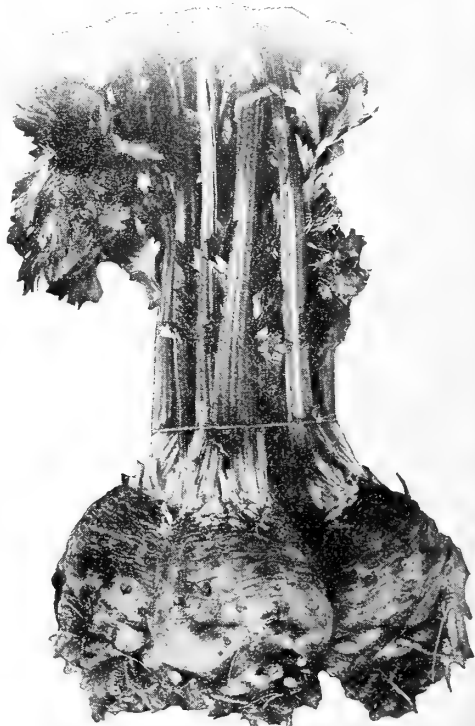

Large Smooth Prague Celeriac

CAULIFLOWER PLANTS: We are especially equipped to supply strong plants, fresh daily. Per doz. 25c; per 100 \$1.60 per 1000 \$12.00

CARROTS

1 ounce to 150 feet of drill; 4 lbs. per acre.

Our stock is grown from choice selected and transplanted roots only, and are of the truest type and richest color money can procure.

CULTURE—Any good soil will grow this vegetable, but the most perfect roots however, are developed in rich, friable soil, preferably sandy loam. The flavor and tenderness of the table varieties is secured by having a quick growth, which usually means good growing weather and proper cultivation. Sow as early as the ground can be worked or for late crop until the latter part of July, in drills 15 to 18 inches apart, finally thinning the plants to 3 to 4 inches in the drills. The seed is slow to germinate and if sown early or on moist soil, half an inch is deep enough. When sown during the hot summer months it is well to protect the seed bed with a thin layer of chips or straw as excessive heat will kill the vitality of the seeds before they germinate. After the seed has sprouted remove the covering, selecting the late afternoon for this work. Carrots are usually quite free from pests and diseases. The usual danger from ground worms and slugs if of course always prevalent, but once up they are easier to grow than most vegetables. They are ready for table use in about two months.

Early Horn The most popular forcing variety, producing top-shaped reddish-orange roots about three inches long. Very early with small tops. Second in size, fine grained and of good quality when pulled young. Popular for early marketing but small. Pkt., 10c; ¼ lb., 30c; lb., 90c.

Oxheart or Guerande. One of the most popular sorts for table and stock. When full grown, 5½ to 6 inches long, but should be pulled young for table use. Very stout and thick, ending in an abrupt small tap root. If the soil is too wet this variety will sometimes split badly, but this can be prevented by properly controlling the drainage. Very easily harvested and can be grown in very shallow soils where other sorts would not thrive. Quality excellent. Pkt., 10c; ¼ lb., 35c; lb., \$1.00.

Chantenay or Model Carrot A most excellent, medium early, half-long variety. Its quality, shape and size make it one of the best and most profitable sorts for either the home garden or for marketing. The roots grow to a length of about 5 inches, very uniform, stump-rooted but tapering slightly. They are smooth, deep orange-red in color and the flesh is very crisp

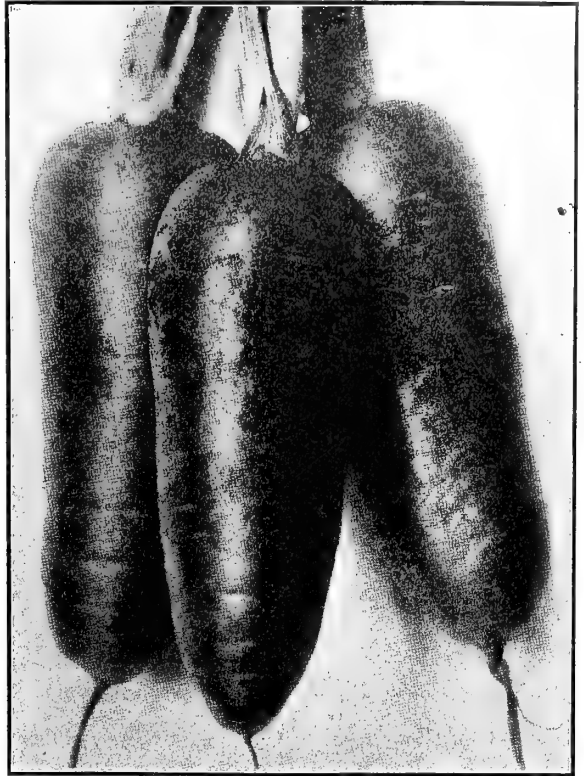

CHANTENAY

and tender. Although a medium early sort the roots are suitable for use nearly as early as any, and will also prove very satisfactory if grown for winter use. Very easily harvested and conveniently bunched. Pkt., 10c; ¼ lb., 35c; lb., \$1.00

New Sunrise This new variety has become a favorite with our Market garden trade because of its fine quality, perfect shape and attractive color. The crown stands above the ground causing the shoulders to turn green. Sunrise has been found to be specially valuable for medium and late use, an excellent keeper and thoroughly dependable. It is of most perfect form, pointed-rooted, with a broad, high shoulder; about 7 inches in length. It is the brightest scarlet and the smoothest grain of all the half-long carrots. Pkt., 10c; oz., 15c; ¼ lb., \$35c; lb., 1.25.

Danvers Half Long This is an exceptionally fine Carrot for private and market garden use. It is slightly longer than Chantenay and our strain produces uniformly smooth and evenly sized roots of handsome appearance. They are orange-red in color and the flesh is sweet, crisp and tender, being fine grained and of highest quality for table use. The tops are a little larger than those of Chantenay and the crown as flat, the roots taper very slightly from the crown but form a blunt point at the tap root. For main planting this sort has no superior, and when sown during June may be depended upon to produce the very best crop of roots to store for winter. Pkt., 10c; ¼ lb., 35c; lb., \$1.00.

St. Vallerie or New Intermediate

A long pointed variety, very smooth and regular in growth, resembling Long Orange, except in size, being thicker at the shoulder and not so long. They grow to a length of 9 to 10 inches and are about 2 to 2½ inches thick at the shoulder, tapering in a straight line to the tip. The roots grow entirely under ground and are bright orange scarlet in color. Pkt., 10c; ¼ lb., 30c; lb., 90c.

Improved Long Orange A standard late variety, beautiful and uniform in shape, deep orange in color. The roots grow to a length of 12 inches and are of good quality for table use as well as for stock. They require a deep soil and if full size roots are wanted they should stand at least 8 inches apart in 18 inch rows. The tops are not large when compared with the size of the root and a very heavy crop can be produced. The keeping qualities of this splendid variety are unexcelled and will be found to be very beneficial when fed to stock. Carrots are highly nutritious and their high feed value combined with the low cost of production make them a very profitable crop for dairymen. Pkt., 10c; ¼ lb., 25c; lb., 75c.

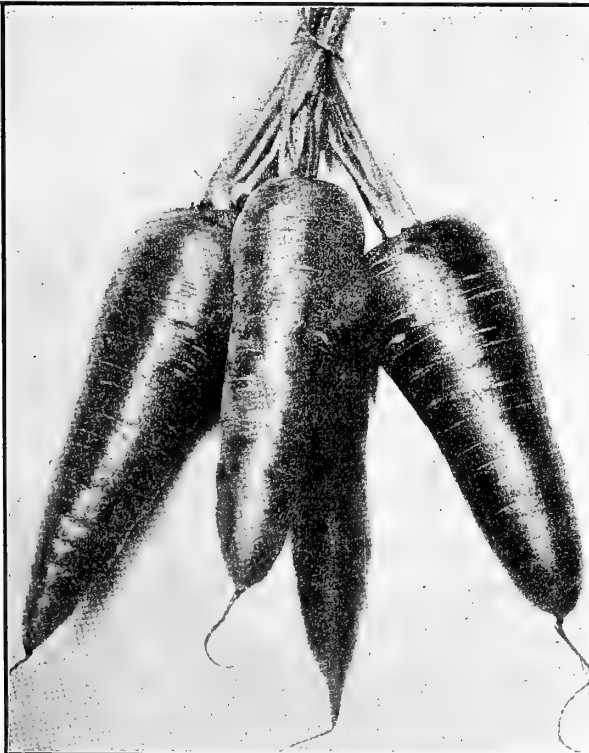

SUNRISE

CELERY

1 ounce to 1,000 plants.

Celery seed is very slow to germinate and therefore should be started indoors in boxes from February to April or sown out of doors in a finely prepared seed bed during April. See that the seed is not covered too deep and that the bed is kept moist, almost wet until the seeds germinate. When the plants are about two inches high thin out and transplant to a distance of two or three inches apart each way. These must be kept entirely free from weeds and when they are four inches high the tops may be cut off so that the plants will grow more stocky. The plants are usually set out in the permanent bed when five inches high and it is usually best to do this during July or the first of August. In some sections best results are obtained by transplanting in June.

The permanent beds should be thoroughly prepared and well enriched with rotted manure, which should be spaded in deeply the rows being spaced 3 to 4 feet apart. Cut off some of the root and set the plants 8 to 12 inches apart in the rows, firming the soil tightly, and cultivate them frequently for a period of six weeks. Celery needs plenty of moisture.

When the plants are nearly full grown they should be blanched. This is done by drawing the soil closely about the plants to about two-thirds of their height, being careful not to allow any of the earth to fall between the leaves. Repeat this process every few days until only the top of the leaves are visible. Do not disturb the plants while they are wet or the soil is damp as this is liable to result in injury from rust.

Golden Plume This new strain of Golden Self-Blanching has been pronounced by authorities to be the best of all the early varieties. It matures two or three weeks earlier than any other sort, blanches more quickly and shows less tendency to blight or crown-rot. Distinctly larger and ranker in growth than Golden Self-Blanching; more plainly ribbed and does not grow hollow. The crisp, tender stalks are very broad and the large full plumed centers are displayed to advantage. Combining the assets of earliness, finest quality and appearance Golden Plume offers a splendid opportunity to Market Gardeners. Celery Growers in New York and New Jersey have met with tremendous success using this variety. Pkt., 25c; ¼ oz., 90c.; 1 oz., \$3.00; ¼ lb., \$10.00.

White Plume A very popular market variety, being very early, easily blanched and of handsome appearance. The leaves are light, bright green and the flesh is a beautiful silvery-white color. Not as good a keeper as French Golden Self-Blanching. Oz., 25c; ¼ lb., 75c; lb., \$2.50.

French Golden Yellow Self-Blanching (Originator's Stock). This is the standard celery for early use, being ready for use very early, and much superior to other varieties in a great many respects. Our strain of this very popular sort cannot be excelled in quality or appearance. The plants are of medium size, compact and stocky, with yellowish green foliage. As they mature the inner leaves and stems turn to a beautiful golden yellow, which adds much to their appearance and makes the work of blanching much easier. The stalks are solid, crisp, tender, free from strings and of a fine nutty flavor. A favorite with both large and small growers. Pkt., 10c; oz., 75c; ¼ lb., \$2.75; lb., \$10.00.

Easy Bleacher Two weeks later than Golden Self-Blanching. Blanches readily and is a great favorite with Southern growers who usually plant a full crop of this one sort. Vigorous in growth and a splendid keeper. Pkt., 10c; oz., 40c; ¼ lb., \$1.25; lb., \$3.50.

Winter Queen Of medium height, an excellent winter keeping sort, producing thick creamy white stalks which are broad, very solid and crisp. The hearts are large and it blanches well. Pkt., 5c; oz., 20c; ¼ lb., 50c; lb. \$1.75.

Evans' New Triumph This variety has a very strong and vigorous plant, with very large but crisp, brittle, tender and fine-flavored stalks. It is late and requires the whole season to develop, but will keep longer than other sorts. We recommend it as worthy of the first place as a late Celery. Pkt., 5c; oz., 20c; ¼ lb., 50c; lb., \$1.75.

Golden Heart A distinct variety of sturdy dwarf habit. It is solid, and an excellent keeper, and of fine nutty flavor. When blanched, the heart, which is large and full, is of a light yellow, making it exceedingly showy and desirable for either market or private use. Pkt., 10c; oz., 25c; ¼ lb., 60c; lb., \$2.00.

Columbia An exceptionally fine, early variety, which for size and shape is unsurpassed. The plant is of medium height, but very stocky, foliage is a light shade of green with yellow tinge, and the stalks are thick, almost round, and resemble Giant Pascal in shape, but are of a rich, yellow color, similar to the well-known Golden Self-Blanching, which it resembles very much when trimmed and bunched. It matures early, and its exceedingly fine flavor and crispness will please even the most critical. Pkt., 10c; oz., 20c; ¼ lb., 50c; lb., \$1.75.

Giant Pascal A superior keeping sort. The stalks are very large, thick, solid, crisp and of rich nutty flavor; it blanches very easily and quickly, and retains its freshness a long time. Pkt., 10c; oz., 25c; ¼ lb., 75c; lb., \$2.50.

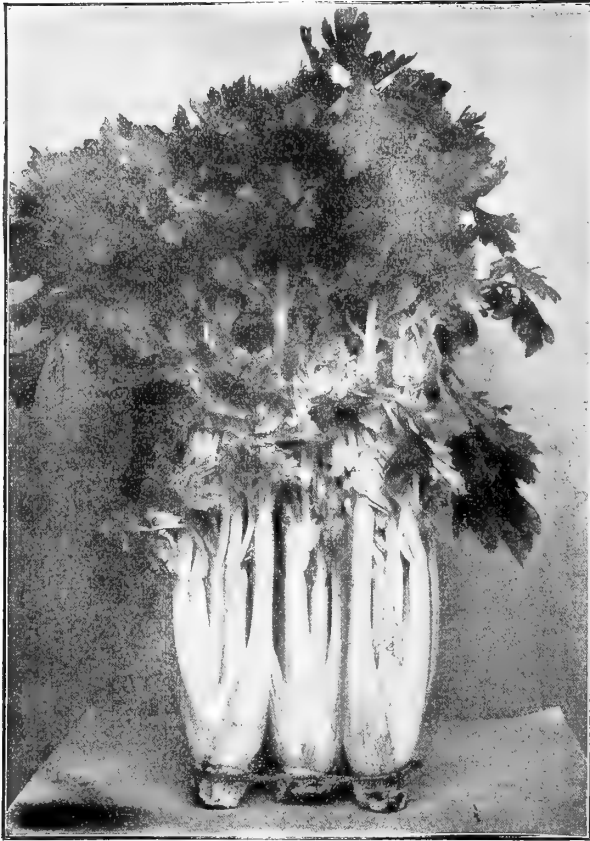

French Golden Self-Blanching Celery.

Golden Self-Blanching (American Grown Seed.) An early sort, of very compact growth, with thick, solid, heavily ribbed stalks which are very easily blanched to a clear waxen yellow. Pkt., 10c; oz., 35c; ¼ lb., 90c; lb., \$3.00.

Silver Self-Blanching Somewhat similar to French Golden Self-Blanching in habit of growth but resembling White Plume in color. High in quality, very brittle and free from strings. Pkt., 10c; oz., 35c; ¼ lb., 90c; lb., \$3.00.

CELERY PLANTS

All Leading Varieties

Ready During July and August

SEE PAGE 33

USE A
FELINS VEGETABLE TYING MACHINE
Described on Page 55

CORN SALAD

1 ounce will sow 20 square feet; 6 lbs. to the acre.

Ackersalad A vegetable used as a salad. It is sown in the opening of spring in rows 1 foot apart, and is fit to use in 6 or 8 weeks from sowing. If wanted in early spring, sow in September; cover with straw as soon as cold weather sets in. Can be grown in cold frames, covered with straw mats or shutters, and used any time during the winter. Large Seeded Dutch ¼ lb., 40c; lb., \$1.25.

POP CORN

White Rice The most popular variety. The pearly white grains are pointed and set closely on a small cob. 10c per lb.

Queen's Golden Yellow It pops perfectly white, and produces very large flakes. 10c per lb.

CORN--Table Varieties

(FIELD CORN—Page 46).

1 quart to 200 hills; 3 quarts per acre.

Sugar Corn should not be planted until May, or when the ground is warm. For succession, plant about every two weeks until the last of July. All varieties may be either sown one inch deep in rows three to four feet apart, the seeds being placed about 8 inches apart in the rows, or they may be planted in hills at distances of three or four feet apart each way, allowing not more than 3 plants stand to a hill. The size of the variety and the richness of the soil should determine the distance of planting. Cultivate frequently and thoroughly but shallow until the tassels appear.

EXTRA EARLY

First Early Neck This variety can be planted earlier than any other sort; ear short, grain white. It is not a Sugar Corn, but, on account of its being largely sold for table use, we class it among the Sugar Corns. Ear, 7c; doz., 65c; qt., 30c; pk., \$1.25; bu., \$4.50

Adams' Early A splendid early variety and safe cropper. Doz., 65c; qt., 30c; pk., \$1.25; bu., \$4.50.

Improved Early Adams A distinct improvement over the Old Early Adams, fully as hardy; ears measure from 10 to 14 inches in length, with 12 or more rows to the ear. Grains are narrow and deep, of excellent table quality. Qt., 30c; pk., \$1.25; bu., \$4.50.

Delicious Cream A little later than Early Adams, makes ears much larger and longer. It is a strong grower. Has from 2 to 3 ears to the stalk, of a most desirable size. The ears contain from 8 to 10 rows of bright, attractive grains well filled out to the tip. Qt., 35c; pk., \$1.75; bu., \$6.50.

Peep o' Day Exceptionally early, comparing favorably with the Premo, of unparalleled sweetness. The stalks bear from 2 to 5 ears each, and are very dwarf, which permits close planting. Qt., 35c; pk., \$1.75; bu., \$6.50.

Premo An Extra-early 65-day Sweet Corn; medium sized ear of good quality. Qt., 35c; pk., \$1.75; bu., \$6.50.

Early Mayflower Ten to twelve rowed sixty day variety, of very good quality. Qt., 35c; pk., \$1.75; bu., \$6.50.

Golden Bantam A very early variety. The ears are but medium size, usually 8 rows, thickly set with delicious yellow kernels. Qt., 35; Pk., \$1.75; bu., \$6.50.

Early Superior This new variety is of remarkable size considering its earliness. The ears are 8 in. long and have 16 to 20 rows of rather narrow deep grains. The quality is excellent and the attractive appearance of the rich, tender, well-filled ears make it a very desirable sort for the Market Gardener. Qt., 40c; pk., \$2.50; bu., \$9.00.

De Lue's Golden Giant From 3 to 5 days earlier and 2 or 3 times as large as its own parent, the Golden Bantam, of better quality, deeper color and more productive. Pt., 25c; qt., 40c; pk., \$2.00; bu., \$8.50.

Red Cob or Ninety-Day Corn A distinct and well-known sort of white Corn; matures in about 90 days; produces large, handsome ears. It adapts itself to any kind of soil, and can be used green as a table corn or when dry for stock feeding. It may be planted for early market at intervals as soon as the frost is out of the ground until middle of July. Used by many truckers for late planting, as it produces a sure crop. Qt., 30c; pk., \$1.25; bu., \$4.50.

MEDIUM EARLY

Howling Mob Stalks are of strong, vigorous growth, 5 feet in height; produces 2 large ears of sweetest quality. Qt., 35c; pk., \$1.75; bu., \$6.50.

Sheffield This cross-bred early variety combines the robust growth and extreme hardness of the Extra Early Adams with the finer sugary quality of the Cory. Ears average 7 inches long, and are well filled with grains of medium size, arranged in 10 or 12 regular rows. It is as hardy as the Adams, and of much sweeter quality. Qt., 30c; pk., \$1.75; bu., \$6.00.

Kendel's Early Giant Remarkably large in ear for a second early sort and very popular. The stalks are about 5½ feet high. The ears are about 8 to 9 inches long, 12-rowed. The grain is rather broad and shallow, and the quality very good. Qt., 35c; pk., \$1.75; bu., \$6.50.

Black Mexican Although the ripe grains are bluish-black, they are remarkably white when in roasting ear stage. In tenderness and fine quality none can surpass it. We recommend it highly to follow the first early varieties. Pkt., 10c; qt., 40c; pk., \$2.25.

Trucker's Favorite Sugar Corn Is a very desirable variety, of sweet and delicious flavor, producing a large ear well filled to the end. Qt., 35c; pk., \$1.75; bu., \$6.50.

Country Gentleman Very deep grains, small cob and exceedingly rich flavor. Often produces 3 to 4 ears to the stalk. The grains are "staggered" on the cob, leaving no signs of rows. Qt., 35c; pk., \$2.00; bu., \$7.00.

Early Evergreen The ears grow 8 inches long; are mostly 14 to 16 rows. It ripens 10 to 12 days in advance of Stowell's Evergreen, and is equally as good in quality. Kernels sweet and tender; cob small, with irregular rows. Qt., 35c; pk., \$1.75; bu., \$6.50.

Early Mammoth Resembles the late Mammoth; ears are fully as long, but more tapering; pens 2 weeks earlier. Qt., 35c; pk., \$1.75; bu., \$6.50.

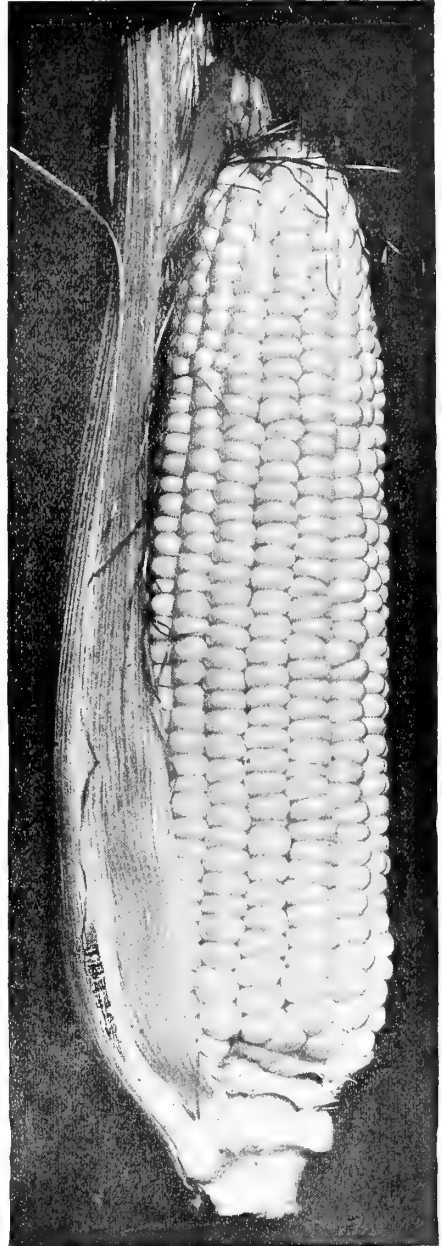

Stowell's Evergreen

Main Crop and Late Varieties

White Evergreen A pure white strain of the popular Stowell's Evergreen. The ears are very large and well filled from butt to tip with long, slender, pure white grains of the most delicious sweetness. Qt., 35c; pk., \$1.75; bu., \$6.50.

Improved Narrow Grain Evergreen In maturity and habit of growth resembles the well-known Stowell's Evergreen. The cob is small in comparison to the size of the ear, and the kernels are very narrow, sweet and remarkably free from starch, producing 24 straight, uniform rows on the cob. Qt., 35c; pk., \$2.00; bu., \$7.00.

Stowell's Evergreen Grown more extensively than any other; a favorite with canners and market gardeners for late use. The ears are of large size, kernels very deep, tender and sugary; very productive and remains for a long time in fit condition for table use. Qt., 35c; pk., \$1.75; bu., \$6.50.

Late Mammoth Produces larger ears than any other Sweet Corn; very weighty, profitable for growers selling by ton. Qt., 35c; pk., \$1.75; bu., \$6.50.

CUCUMBERS

1 ounce to 100 hills.

CULTURE:—Plant as soon as the weather becomes settled in hills 4 feet apart each way, with 8 or 10 seeds in each hill, cover half an inch deep, smoothing the hill off with the hoe. Keep the soil well stirred, and when the plants are out of danger of insects, leave 3 or 4 plants to the hill. For pickles, plant from the first of June to the first of August. The fruit should be gathered when large enough, whether required for use or not, for if left to ripen on the vines, it destroys their productive uses.

Arlington White Spine The cucumbers are very regular in outline, uniform in size, averaging 7 to 8 inches in length, straight and of a rich dark green color. Flesh white, crisp and solid, with comparatively few seeds. Vines of vigorous growth and very productive. **Pkt., 10c; ¼ lb., 30c; lb., 90c.**

Klondike A favorite with market gardeners and shippers all over the country. The handsome dark green cucumbers average 7 inches long and 2 inches in diameter. **Pkt., 10c; ¼ lb., 30c; lb., \$1.00.**

Early Green Cluster A short, prickly variety, bearing clusters; prolific, fine for bottle pickles. **Pkt., 10c; ¼ lb., 30c; lb., 90c.**

Fordhook Famous This extra long White Spine cucumber produces perfectly smooth, very dark green, handsome straight fruit, measuring 12 to 17 inches long. They are always solid, flesh being a greenish white, firm, crisp and of most delicious flavor. It is a great cropper, and fruit is full of flesh, with but few seeds. **Pkt., 10c; ¼ lb., 40c; lb., \$1.25.**

Early Fortune One of the best of the very desirable "White Spine" type. It was selected out of a field of Davis Perfect by reason of its outstanding qualities and the strain has now become so well established that large plantings do not show any variation either in plant or fruit. Early, very productive, and having unusual disease-resisting ability. Fruits are 8 inches long with very dark green skin and thick, firm flesh which is crisp and tender. Excellent shipper. **Pkt., 10c; ¼ lb., 40c; lb., \$1.25.**

Early Cyclone It is not only the earliest cucumber in cultivation, being fully two weeks ahead of White Spine, but it is of the desirable White Spine type, being shorter, thicker and holding better its deep green color than any other early Cucumber in cultivation. Very prolific, and grows its fruits in bunches of threes and fours, of uniform size and shape. A single hill will sometimes produce from 10 to 12 shapely Cucumbers. **Pkt., 10c; ¼ lb., 30c; lb., \$1.00.**

Boston Pickling or Green Prolific Noted for its uniform growth, seldom yielding Cucumbers too large for pickling, immensely productive. **Pkt., 5c; ¼ lb., 25c; lb., 75c.**

Long Green Our carefully-selected strain, under favorable conditions, produces fruit averaging from 12 to 16 inches in length. Skin is a deep rich green, flesh solid, crisp and of excellent quality. **Pkt., 5c; ¼ lb., 40c; lb., \$1.25.**

Japanese Climbing Vines are extra strong, vigorous; being a climbing sort, can be grown on trellises, etc.; valuable in small gardens. Very prolific, from 40 to 50 having been counted on single plants. Fruit long, round, of fine flavor. **Pkt., 10c; ¼ lb., 40c; lb., \$1.25.**

Evergreen Extra Long White

Spine This is a strain of White Spine Cucumber with longer fruit than the old type. The cucumbers grow 10 inches long, and are straight and handsome and of fine quality, retaining their green color for a long time. Matures a little later than the early strain, but the fruit is larger and handsomer. One of the best varieties. **Oz., 10c; ¼ lb., 40c; lb., \$1.25.**

Davis' Perfect

As now selected, this popular new variety is well worthy of praise. The long, even fruits are of fine form, with an intensely dark rich green skin. With very few seeds, the solid white flesh is of superb quality for slicing. The vines are of strong growth and quite prolific. **Pkt., 10c; ¼ lb., 40c; lb., \$1.25.**

Jersey Pickle In size between the Half Long and Long Green and is used extensively by pickle growers, being productive and of deep green color. **Pkt., 10c; ¼ lb., 30c; lb., 90c.**

Gherkins or Burr

Very small, quite distinct from all others. It is grown exclusively for pickling, and should be picked when young and tender. **Pkt., 10c; ¼ lb., 40c; lb., \$1.40.**

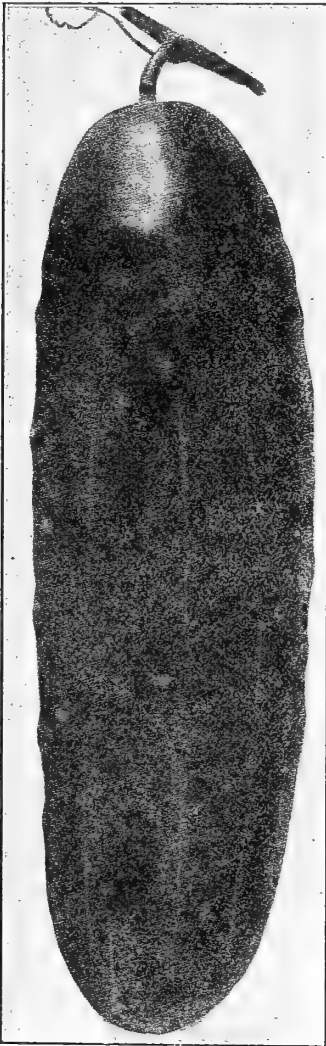

Klondike.



Davis Perfect.

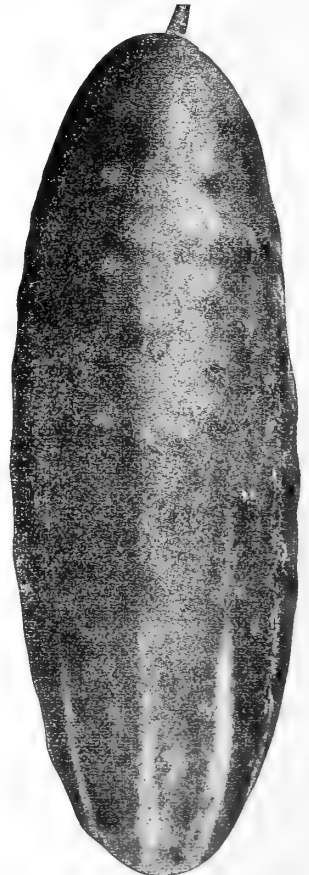

Early Fortune.

EGG PLANT

1 ounce will produce 1,000 plants.

Sow in March in hotbeds, and transplant when 2 inches high into a second hotbed, or let them remain and thin out to 4 inches apart. When the weather becomes settled, transplant into the open ground 3 feet apart each way. Good culture is quite as important as good seed. Work the ground deep, make it rich with well-rotted manure and hoe often.

Mammoth Smooth Stem A decided improvement on the New York Large Purple in quality, size and beauty. The plants are large and vigorous, leaves of a light green, shade, stem smooth, fruit large, oval, early and of a fine deep purple. Pkt., 10c; oz., 40c; ¼ lb., \$1.25; lb., \$4.50.

Black Beauty The most beautiful and earliest of all large Egg Plants. Pkt., 10c; oz., 40c; ¼ lb., \$1.25; lb., \$4.50.

Florida High Bush Very vigorous and productive; of upright growth holding the fruit well off the ground; color light purple; of oblong shape. Pkt., 10c; oz., 30c; ¼ lb., \$1.00.

New York Improved Purple Oval shaped, thornless, dark purple color, and rich flavor. Pkt., 10c; oz., 40c; ¼ lb., \$1.15; lb., \$4.00.



Black Beauty Egg Plant

KOHLRABI

1 oz. will produce 1,500 plants.

This forms a bulb above the ground and its flavor is somewhat similar to Cabbage. Sow in April in rows 18 inches apart, thinning out to 8 inches between the plants.

Early White Vienna

Excellent for forcing and of fine quality. The bulbs grow to the size of an apple when ready for use, and are a pale whitish green. They are of delicate cabbage-like flavor. Pkt., 10c; oz., 15c; ¼ lb., 60c; lb., \$2.00.

ENDIVE

1 ounce to 100 feet of drill, 3 lbs. to the acre.

Ever White Curled

Plants moderately dense; leaves coarser than those of the Green Curled, but the mid-rib is yellow and the leaves almost white. Pkt. 10c; oz., 20c; ¼ lb. 40c; lb., \$1.25.

Broad-leaved Batavian

(Escarolle) Leaves broad and almost plain; color light green. Pkt., 10c; oz., 20c; ¼ lb., 40c; lb., \$1.25.

Green Curled

This is the hardest variety, and very desirable for the home and market garden. The deep green leaves are beautifully cut and curled, easily blanched and become very crisp, tender and fine flavored. Pkt., 10c; oz., 20c; ¼ lb., 40c; lb., \$1.25.

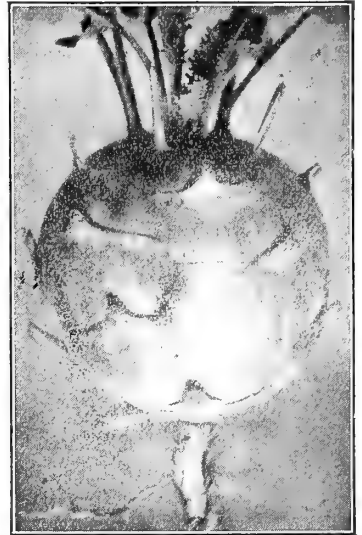

Early White Vienna



Ever White Curled Endive

LEEK

1 oz. to 50 yards of drill.

Sow early in the spring in drills 1 inch deep and 12 inches apart; when about 6 inches high transplant into deep, rich soil, 5 inches apart; use a dibble and plant deeply, close to their leaves.

Large London Flag

A favorite market variety, of enormous size, leaves large and broad; flavor mild and pleasant. Pkt., 5c; oz., 20c; ¼ lb., 50c; lb., \$1.50.

Monstrous Carentan or SCOTCH CHAMPION.

Of extra large size; the leaves are fan-shaped, of a dark green color; the edible stem is 6 to 8 inches long and 3 inches in diameter. Pkt., 10c; ¼ lb., 50c; lb., \$1.75

KALE

Broadcast, 2 to 3 lbs. per acre. 1 oz. to 200 feet of drill.

The Kales are more hardy than Cabbage, and make excellent greens for winter and spring use, and are improved by frost. For early spring use, sow broadcast in September and protect during winter. It may also be sown in April or May for later use.

New Floradale Savoy

Of medium height, with long deep curled green leaves, and is one of the handsomest Kales ever developed. Its graceful leaves are unmarked by frost. It is late seeding, and will be found in good condition after all other varieties have lost their usefulness. Pkt., 5c; ¼ lb., 40c; lb., \$1.00.

Extra Curled Long Standing

An improvement on the well-known German Extra Curled Kale; beautifully curled, of strong, vigorous habit, perfectly hardy and slow shooting to seed. Pkt., 5c; ¼ lb., 20c; lb., 60c.

Siberian Kale

¼ lb., 15c; lb., 40c.

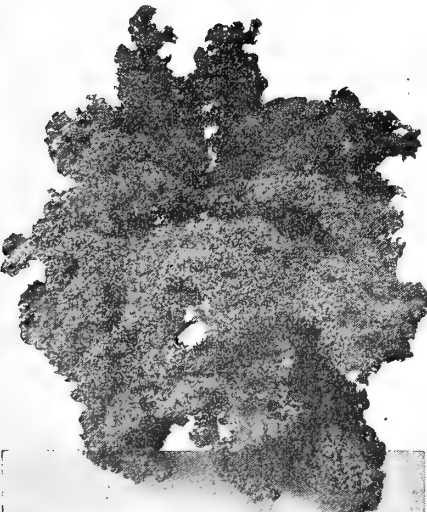

Kale, Extra Curled-Long Standing



Monstrous Carentan Leek

LETTUCE

1 ounce to 2,500 plants; 3 lbs. per acre.

Lettuce to be at its best should be grown rapidly, hence the soil should be made as rich and friable as possible by liberal manuring and thorough preparation. For early crop sow in a seed-bed in September or October and protect through the winter with cold frames, which should be removed as soon as danger of severe freezing is past. Lettuce in the open ground will stand some freezing but is killed by prolonged frost or frequent freezing and thawing. The seed may also be sown in hotbeds in March, and the plants, if well hardened, may usually be set in the open ground in April, maturing a crop much earlier than complete open ground cultivation would produce. If, however, it is not convenient to get the plants started either in the fall or early spring in hotbeds, the seed may be sown in open ground from the middle of April until July, selecting varieties suitable for the season.

The plants should stand 8 to 10 inches apart in the rows, and the rows should be about 18 inches apart.

May King Extremely early, compact cabbage or heading variety, forming very firm heads of medium size and excellent quality. Color light yellowish-green, tinged with reddish-brown when mature. Inner leaves blanch rich golden-yellow, very tender and buttery. **Pkt.** 10c; **oz.**, 15c; $\frac{1}{4}$ **lb.**, 40c; **lb.**, \$1.25.

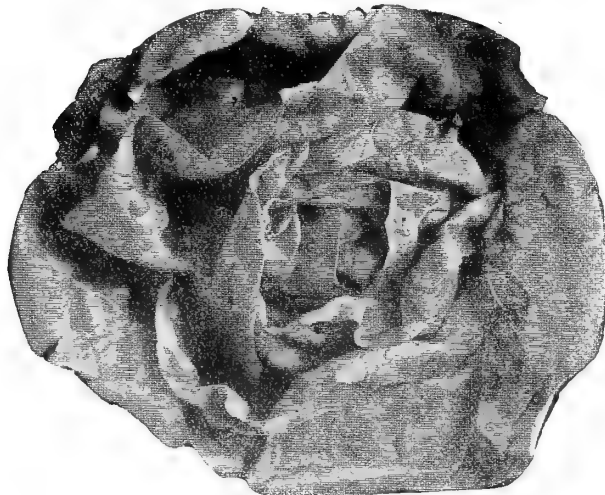

Unrivalled

Unrivalled This lettuce might well be called an Improved Big Boston. Its usefulness and value are identically the same as Big Boston, but it is preferred by market gardeners because of its being a solid green color with no brownish tinge at the border of the leaves; its heads are larger and of better appearance than Big Boston. **Pkt.**, 10c; **oz.**, 20c; $\frac{1}{4}$ **lb.**, 60c; **lb.**, \$2.00.

Baltimore Early Market Originated by a local market gardener, who for several years past has supplied the earliest and finest Butterhead Lettuce to the Baltimore market. In comparison with May King, it is earlier and free from the red tint; the outer leaves are a light green, with the entire head fully blanched to a rich buttery yellow tint, which makes it so attractive. **Oz.**, 20c; $\frac{1}{4}$ **lb.**, 50c; **lb.**, \$1.50.

Large White Loaf This is a standard variety among truckers for planting early in the fall to stand out over winter. It is an exceedingly early heading variety, compact, tender, solid head and of fine quality. **Pkt.**, 5c; **oz.**, 15c; $\frac{1}{4}$ **lb.**, 40c; **lb.**, \$1.25.

New York or "Wonderful" This variety is also known as the famous 'Iceberg' of California, truly a wonderful lettuce. Plants of extra large growth, producing heads of immense size under favorable conditions. Inner portion is beautifully blanched and stands for a considerable time before running to seed. Outer leaves a deep, rich green. **Pkt.**, 10c; **oz.**, 25c; $\frac{1}{4}$ **lb.**, 75c; **lb.**, \$2.50.



Tuccorodo

Tuccorodo Being of very vigorous and hardy nature, this variety is especially desirable for fall or early spring sowing. Large handsome heads, solid, crisp and of superb quality. The strain is well established and we do not hesitate to strongly recommend this dependable sort to the most critical market gardeners and private growers. **Oz.**, 20c; $\frac{1}{4}$ **lb.**, 60c; **lb.**, \$2.00.

Grand Rapids As a lettuce for greenhouse forcing this variety undoubtedly stands at the head of the list, being of quick growth, hardy, little liable to rot and remaining in condition several days after being fit to cut. The plant is upright and forms a loose cluster of large, thin, bright green leaves, savoyed, finely crimped at edges. The leaves do not wilt quickly after cutting, so that the variety will stand shipping long distances better than most sorts. Very attractive and desirable for garnishing. **Pkt.**, 10c; **oz.**, 15c; $\frac{1}{4}$ **lb.**, 40c; **lb.**, \$1.25.

Earliest "Wayhead" Shows a remarkable combination of earliness, firm heading character, handsome appearance and fine quality. In cold frames early in the spring and in the open ground—in spring, summer and early fall months—it has proven to be the very earliest and surest heading of all early lettuces. **Pkt.**, 10c; **oz.**, 15c; $\frac{1}{4}$ **lb.**, 40c; **lb.**, \$1.25.

Black Seeded Big Boston In comparison with Big Boston, the leaves are a trifle smaller and rather lighter shade of green with less color on edges, producing larger solid heads, which are always tender and crisp, more compact and will stand shipping better. Excellent for forcing or growing in the open ground, spring or fall. **Pkt.**, 10c; **oz.**, 15c; $\frac{1}{4}$ **lb.**, 40c; **lb.**, \$1.25.

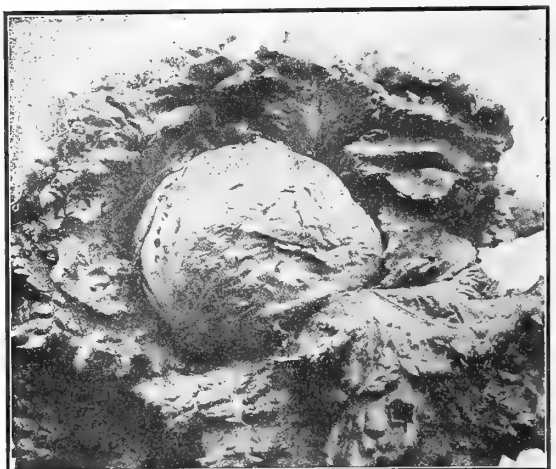

New York or Wonderful

LETTUCE—Continued



BIG BOSTON GROWING FOR SEED—35 ACRE FIELD 100 PER CENT TRUE

Big Boston This is a fine forcing variety for cold frames during the winter months, as it produces heads of very large size, often 12 inches or more across, and succeeds better in cooler temperature than most forcing strains. The large heads are beautifully blanched and of superior quality. It also heads well in the open ground during cool weather of spring and fall, and has lately become popular in the South to grow for shipping North. Our seed is an extra selected strain of the true stock. Pkt., 10c; oz., 15c; $\frac{1}{4}$ lb., 45c; lb., \$1.50.

Hanson The plant is compact and forms a large, flat, cabbage-like head, and is so slow to form a seed stalk that it often fails to seed at all. Outer leaves bright green, with prominent light-colored veins; inner leaves white and usually curved and twisted at the base; very tender and sweet; a favorite variety for home use. Pkt., 10c; oz., 15c; $\frac{1}{4}$ lb., 40c; lb., \$1.25.

Mann's' Defiance Summer This variety, introduced by us several years ago, has made a very eventful impression upon the grower, as well as the consumer. It forms handsome, solid heads of enormous size, which remain in good salable condition long after all others have gone to seed. The flavor is excellent; the leaves are beautiful light green. Very profitable for market gardeners. Oz., 20c; $\frac{1}{4}$ lb., 60c; lb., \$2.00.

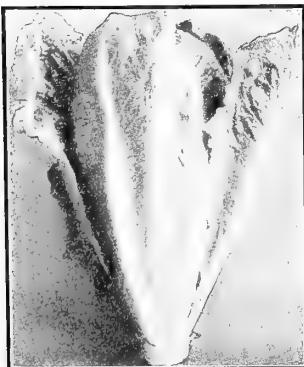

Paris Cos Lettuce

COS, ROMAINE OR CELERY LETTUCE

Paris Self-Folding White Cos

Grows to very large size, producing long-pointed, compact bunches. The outer leaves are closely folded about the center and interior is well blanched. Pkt., 10c; oz., 20c; $\frac{1}{4}$ lb., 50c; lb., \$1.50.

All Seasons One of the best all-head Lettuces, standing the hot sun to a remarkable degree, slow to seed. The outer leaves are a bright soft green; the finely-blanched inner leaves are a rich golden-yellow, tender and mild in flavor. The heads are broad and nearly flat at the top; they continue to increase in size for about two weeks after they are ready for use. Pkt., 10c; oz., 15c; $\frac{1}{4}$ lb., 40c; lb., \$1.25.

Improved Mammoth Salamander

Grand mammoth hard-heading Cabbage Lettuce. Plants 12 inches across with extra large, solid round heads that are particularly rich and buttery in flavor; always well blanched and tender. The inner leaves are beautifully white and curled like a fine Savoy Cabbage. Splendid for summer use, both for the home table and for market. Most highly recommended. Pkt., 10c; oz., 15c; $\frac{1}{4}$ lb., 50c; lb., \$1.50.

All-Heart Lettuce A very bright green and attractive variety. It forms large, solid heads, composed of thick, smooth, very tender leaves, the inner ones finely blanched and all of the finest quality. It remains a long time in head before running to seed. Pkt., 10c; oz., 15c; $\frac{1}{4}$ lb., 50c; lb., \$1.50.

Baltimore Oakleaf This is a great improvement upon the old variety; instead of the loose, green oak-leaved-shaped plants, of inferior quality and taste, we are offering in this new strain a well-compact, large-headed, round-leaved variety of a beautiful light green color, which remains in fine condition long after other varieties have gone to seed. It is very hardy and largely used by market gardeners for late planting to stand out over winter and develop large, solid heads very early in the spring. Oz., 15c; $\frac{1}{4}$ lb., 40c; lb., \$1.25.

Tenderheart The heads are large and round, tightly formed, tender, sweet and crisp, with waxy cream colored leaves. This fine lettuce matures in 40 days and will withstand the early summer heat splendidly. Pkt., 10c; $\frac{1}{4}$ lb., 50c; lb., \$1.50.

The "Deacon" Heads are light green outside, while the inner blanched portion is beautiful cream yellow, of delicious rich buttery flavor. A splendid lettuce for summer use. It stands the hot summer heat to a remarkable degree. Pkt., 10c; oz., 15c; $\frac{1}{4}$ lb., 40c; lb., \$1.25.

LETTUCE PLANTS

FRESH DAILY IN SEASON—See Page 33

MUSKMELON

CANTALOUPE

1 oz. for 50 hills; 3 lbs. per acre.

The most suitable soil for melons is a warm, sandy loam, well worked and enriched with rotted manure. After danger from frost is over, sow ten to twelve seeds to a hill, about 2 inches deep; the hills being six feet apart each way. When the plants have the second pair of leaves and danger from insects is past, thin out to four plants to a hill. Cultivate frequently, deeply away from the plants and shallow close to them. When hoeing, remove the crust from around the plants and replace with fine, loose soil.

GREEN FLESHED VARIETIES

Knight's Early Maryland

An extremely early medium sized melon. Fruit oblong, showing the neck tendency; skin deep green, turning to golden at maturity, well covered with a close gray netting and distinctly ribbed; flesh fairly thick and very sweet; color medium green blending to light pink near the center. The earliest high quality melon and a good shipper. Pkt., 5c; $\frac{1}{4}$ lb., 40c; lb., \$1.25.

Extra Early Jenny Lind or Jersey Button

An extra early, small, green-fleshed melon; fruit round and flattened at the ends, deeply ribbed and heavily netted. Pkt., 5c; oz., 10c; $\frac{1}{4}$ lb., 25c; lb., 75c.

Bottomly Is planted exclusively by the foremost cantaloupe growers of Anne Arundel County, in connection with the now famous Knight, maturing about 10 days later. The most exacting will be satisfied by the delicious quality while its appearance exhibits all the refinement of form, color and netting so necessary to a good melon. Pkt., 10c; oz., 15c; $\frac{1}{4}$ lb., 40c; lb., \$1.25.

Honey Ball The result of crossing the Texas Cannon Ball Cantaloupe and the California Honey Dew Cassaba Melon; possesses characteristics that make it one of the finest melons that has ever been offered to the grower, the shipper and the consumer. Matures in approximately 105 days, resists sun scald better than most other melons and is early enough to escape the mid-summer heat. It is as round as a ball, has very small seed cavity and a very thick wall of delicious green meat clear to the rind. The sugar content is higher than even the Honey Dew but the fruits are excellent keepers and shippers, the hard and tough rind keeping them in perfect condition for three weeks or more. The color is greenish white until fully ripe, then turning to a creamy white; slightly netted. Honey Ball is exceedingly prolific, producing as many as fifteen to twenty large cantaloupes to the plant. Shippers in the South have found it impossible to supply the increasing demand for this delicious

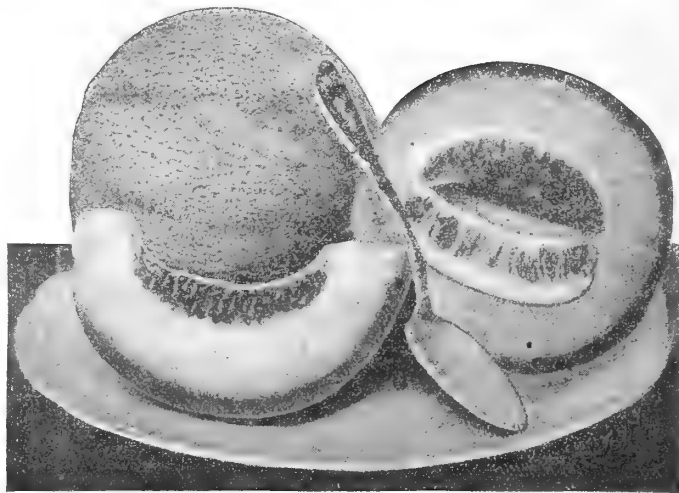

BOTTOMLY CANTALOUPE

new variety in the larger cities. Every commercial grower and home gardener should have at least a trial patch of Honey Ball. Pkt., 10c; 1 oz., 35c; $\frac{1}{4}$ lb., \$1.00; lb., \$3.50.

Honey Dew A melon of the Cassaba type. The fruit is large, oval in form, about 10 inches long and 8 inches in diameter; surface smooth and hard, without ribbing or netting, creamy white in color turning to a lemon tint when fully ripe. The very thick flesh is light green in color, ripening to the rind, very tender, with an extreme sweetness. The vines are vigorous and set 6 to 10 melons to the hill. An excellent shipper, will keep for several weeks even when fully ripe. Pkt., 5c; $\frac{1}{4}$ lb., 35c; lb., \$1.25.

Golden Honey Dew Has a rich golden flesh which is deep and very sweet. It combines the spicy flavor of Emerald Gem with the sweetness and long keeping qualities of the original Honey Dew, of which it is a sport. Pkt., 10c; $\frac{1}{4}$ lb., 50c; lb., \$1.50.

Thoroughbred Rocky Ford This has become one of the most popular of small or basket melons. The fruit is oval, slightly ribbed, densely covered with coarse netting. Flesh light green, very thick and highly flavored. We offer an exceptionally fine stock of this sort, the fruit being wonderfully uniform in shape and quality. Pkt., 5c; $\frac{1}{4}$ lb., 25c; lb., 75c.

Eden Gem This is one of the leading muskmelons of the Rocky Ford type. It is of medium size, nearly round in shape, very heavily netted and slightly ribbed. The flesh is extremely thick, seed cavity small, making it very heavy for a melon of its size. In quality it compares with the best strain of Rocky Ford. It is medium early and very prolific. The vine is vigorous and will resist blight better than most varieties. Pkt., 5c; oz., 10c; $\frac{1}{4}$ lb., 25c; lb., 75c.

SALMON FLESHED VARIETIES

Paul Rose, Petoskey, or Salmon-Fleshed

Gem This is the original salmon-fleshed "basket" Melon. It holds the same place in the salmon-fleshed sorts as the Netted Gem does in the green-fleshed. Pkt., 5c; $\frac{1}{4}$ lb., 35c; lb., \$1.00.

Burrell Gem Of sweet and aromatic flavor, oblong shape, smoothly rounded ends, closely netted and slightly ribbed dark green skin. Fruits average 6 inches long by 4 inches deep. Very fine for marketing. Pkt. 5c; $\frac{1}{4}$ lb., 30c; lb., 90c.

Emerald Gem Ripens early, medium size, nearly round flesh a delicate light salmon color, very thick, fine grained and of superb flavor. The rind is thin, dark green, ribbed, slightly netted. Pkt., 5c; $\frac{1}{4}$ lb., 30c; lb., \$1.00.

Hoodoo The fruits average nearly round. The netting is exceptionally dense. The rind, although thin, is so very firm that the Melons arrive in distant markets in perfect condition. The flesh is very thick, highly colored and of most delicious flavor. Pkt., 5c; $\frac{1}{4}$ lb., 35c; lb., \$1.00.

CITRON

Red Seeded A small globular variety, striped and marbled with light green. Flesh white and solid; seeds red. Used exclusively for pickles and preserves. Pkt., 5c; oz., 10c; $\frac{1}{4}$ lb., 40c; lb., \$1.25.

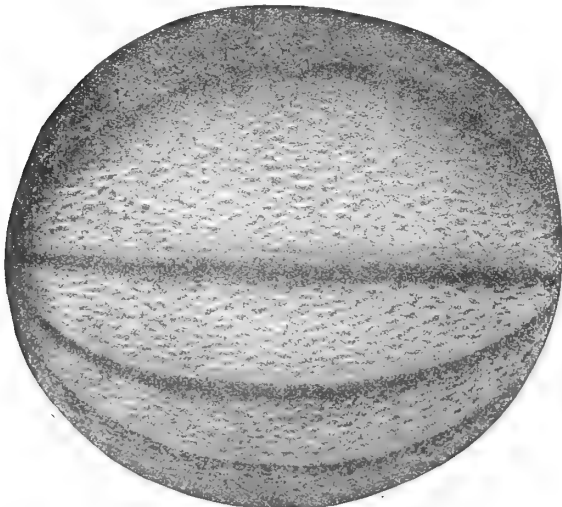

KNIGHTS EARLY MARYLAND

WATERMELON

1 ounce for 30 hills; 3 or 4 pounds per acre.

Cultivate exactly as for Cantaloupe, except that the hills should be 8 to 10 feet apart.

Kleckley's Sweet, or Monte

Cristo This very popular melon is one of the best for nearby markets. Fruits are medium size, oblong, of a dark green color and have very thin rind. Flesh bright scarlet with solid heart, crisp, sugary and melting, and entirely free from stringiness. Pkt., 5c; ¼ lb., 25c; lb., 75c.

Halbert's Honey Fully equal in quality to Kleckley's Sweet, which it resembles. It is more even in outline, is blunter at the ends and the skin is of a richer, darker color. Pkt., 5c; ¼ lb., 25c; lb., 90c.

Tom Watson A large long melon with dark green rind and light crimson flesh of excellent quality. It is a splendid shipper, and is being grown extensively in the South for Northern markets. The seeds are white marked with brown. Pkt., 5c; ¼ lb., 20c; lb., 90c.

Alabama Sweet This excellent shipping melon is the leading sort grown by Texas and other Southern melon growers. The rind is dark green, marked with a still darker green mottled stripe, and while thin, it is very tough, making the melon a first class shipper. The



Tom Watson

flesh is bright red, fine grained, sweet and luscious, entirely stringless and very firm. The seeds are white, slightly tipped with brown, and are firmly set in small cavities near the rind. Pkt., 5c; ¼ lb., 25c; lb., 75c.

Florida Favorite Fruit long, dark green, mottled and striped with a lighter shade. Rind thin but firm. Pkt., 5c; ¼ lb., 25c; lb., 75c.

Triumph A splendid shipping variety of large size and handsome appearance. The melons are rather shortened in form, but thick through. Skin deep bluish green, with dark-red flesh and of good quality. Pkt., 5c; ¼ lb., 20c; lb., 60c.

Dark Icing Skin dark green, indistinctly veined with a lighter shade. Fruit almost round. Pkt., 5c; ¼ lb., 25c; lb., 75c.

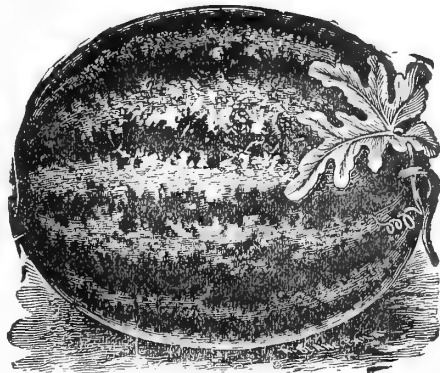

Sweet Heart

Sweetheart Most popular for market. Large heavy fruits of oval or round form; skin very pale green, with distinct netted lines of a slightly darker shade. The large handsome fruits bear shipping well. The solid flesh is a deep rich red, crisp and melting; its luscious quality has made it a leading favorite in the Eastern markets. Pkt., 5c; ¼ lb., 25c; lb., 75c.

Shaker Blue Melons grow as large as that great shipping variety, the Triumph, but are very much better flavored and even handsomer in appearance. The melons are a round oval in form, from 16 to 18 inches long by 12 to 15 inches in diameter. Well-grown melons average 40 to 50 pounds, but frequently there are some that weigh from 60 to 80 pounds each. The rind is dark green, striped with narrow bands of a lighter green, and when ready for shipping the melons are seemingly of a solid dark green color. The flesh is red, the heart large, with no core, and the flavor superb. For shipping to distant markets this melon is most satisfactory. Pkt., 5c; ¼ lb., 25c; lb., 75c.

Irish Gray In sweetness it is like Kleckley's Sweet; in shipping quality, uniformity in shape, size and in productiveness it is even better than Tom Watson. The thin rind is so tough it will not burst from rough treatment in transit; its keeping quality will appeal to shippers who have experienced losses on account of glutted markets. The color is a distinct mottled greenish gray; the flesh is red, sweet, crisp and free from stringiness. An unusual melon, for although a grand shipper it is equally fine for the home garden. Pkt., 5c; ¼ lb., 25c; lb., 90c.

OKRA OR GUMBO

10 lbs. to the acre.

Sow in drills during April and May. Thin until plants are 12 inches distant, and draw earth to the stems for support.

Improved Dwarf Green Prolific or Density

A distinct variety growing about 14 inches high. Grown in competition with the ordinary dwarf, it produces twice the number of pods, which are very smooth and beautiful. Pkt., 5c; ¼ lb., 20c; lb., 60c.

White Velvet Pods are large, perfectly smooth. Pkt., 5c; ¼ lb., 15c; lb., 50c.

Lady Finger Plants producing long, slender pods of pale green color. Pkt., 5c; ¼ lb., 15c; lb., 50c.

Perkins' Mammoth Green Pod A splendid variety. Very prolific, with slender long green pods of best quality and most desirable color for canning. Pkt., 5c; ¼ lb., 20c; lb., 60c.

MUSTARD

Southern Giant Curled The true curled-leaf variety, so popular in the South for planting in the

fall to furnish an early spring salad. Those who do not care for Mustard as a salad will be delighted with the leaves if cooked like spinach, as the flavor is much superior to that of spinach. Pkt., 5c; ¼ lb., 25c; lb., 75c.



MUSTARD

Mushroom Spawn

These delicious fungi can be grown in a warm cellar or enclosed shed, in which an even temperature can be maintained of from 50 to 60 degrees, and where a plentiful supply of fresh horse-stable manure for making the beds can be obtained. Bricks weigh about 1½ pounds, and a brick is sufficient to plant about 9 square feet.

English Mill Track Spawn Bricks 25c; 10 bricks \$2.25; If sent by mail, add postage.



OKRA

ONIONS



White Silver Skin Onion

To grow large bulbs 1 oz. to 100 feet of drill; 4 to 5 lbs. to the acre.
To grow sets 10 ozs. to 100 feet of drill; 50 lbs. to the acre.

The Onion must have a clean and very rich soil. Use well-rotted manure freely, and get the seed in as early as possible in the spring, no matter if it is cold and unpleasant. If onions do not get a good growth before hot, dry weather, the crop is sure to be a failure. Keep the soil mellow and clear of weeds. Sow in shallow drills, not less than a foot apart nor more than half an inch deep. As onions grow on top of the ground, they may be allowed to remain pretty thick, no matter if they crowd each other. In hoeing, destroy weeds and keep the ground mellow; do not cover the young bulbs with earth. It is useless to try to grow onions on poor, unsuitable soil. Three days neglect when the weeds are growing rapidly will sometimes ruin a crop, and a week too late in sowing makes the difference between a good and a bad harvest. With proper manuring, onions can be grown on the same land for a score of years, and it will become cleaner and better every year.

White Silver Skin, or Portugal This is the most popular variety of all white Onions; is almost exclusively used for growing sets. It is a good keeper. The bulbs grow to good size, ripening early and quite evenly. The flesh is mild and sweet, the thin skin a clear silvery white, of handsome appearance if the bulbs are gathered as soon as ripened and carefully dried under shelter away from the strong sunlight. When seed is sown at the rate of 20 to 25 pounds per acre, it makes bulbs of suitable size and most desirable for pickling. Pkt., 10c; oz., 35c; ¼ lb., 90c; lb., \$3.00.

White Pearl Very fine and very early variety. Bulbs when well grown are large, round, flattened, with a delicate pure white skin; flesh very mild in flavor. In the South this variety is largely planted for sets. Pkt., 10c; ¼ lb., 90c; lb., \$3.00.

Mammoth Silver King The large bulbs are of attractive form, flattened, but quite thick through, with silvery white skin, frequently measuring 20 inches in circumference. It matures quite early, coming just after Onions grown from sets are gone. Must be sown thinly to produce large onions. Our stock is true American grown, of finest strain. Oz., 30c; ¼ lb., 90c; lb., \$3.00.

Japanese This new variety promises to be one of the best for the production of large onions for Fall and Winter market, yielding almost twice as many bushels per acre than any other set onion. Somewhat similar to Flat Danvers in color and shape but a trifle thicker and very much larger in circumference. They are very mild, excellent keepers, rapid growers and very few go to seed. The appearance, size, quality and wonderful yields of this variety give it a prominent place among the most valuable sorts. Pkt., 10c; oz., 30c; ¼ lb., \$1.00; lb., \$3.50; (Prices of sets on request).

Prizetaker (American grown). The seed we offer produces large, well-ripened bulbs the first season from seed; flesh white; crisp and mild in flavor. The skin is thin, of a bright straw-yellow; form nearly a perfect globe. Under ordinary cultivation this variety will yield bulbs nearly three times as large as the Globe Danvers, while under special cultivation specimen bulbs have been raised to weigh from 4 to 5 lbs. each. Pkt., 10c; oz., 30c; ¼ lb., 90c; lb., \$3.00.

Yellow Dutch, or Strasburg The most popular and best variety for set purposes. Is similar to the Yellow Danvers. Flat in shape, good color and size, but as a set onion it has the quality of ripening down earlier and more uniformly. Pkt., 10c. ¼ lb., 60c; lb., \$2.00.

Yellow Globe Danvers Our superior stock of this celebrated variety is of fine round shape. It grows to good size, with thin yellow skin, white flesh, fine grained and excellent quality. It ripens early, keeps well and is very productive. Pkt., 5c; oz., 20c; ¼ lb., 60c; lb., \$2.00.

Red Wethersfield Large sized, somewhat flattened; skin deep red and very hardy. Oz., 25c; ¼ lb., 60c; lb., \$2.00.

Australian Brown An early and very hardy variety which does especially well in the South. Should be planted early, on low, wet ground, to get large bulbs. The skin is thick and the color is a rich brown. Is especially noted as a long keeper, as it keeps well into spring and much longer than other varieties. Pkt., 5c; ¼ lb., 60c; lb., \$2.00.

Australian Yellow Globe It is a fit companion to the new well-known Australian brown. The bulbs are globe-shaped, with a light brown-yellow skin. Solid and heavy. Oz., 20c; ¼ lb., 60c; lb., \$2.00.

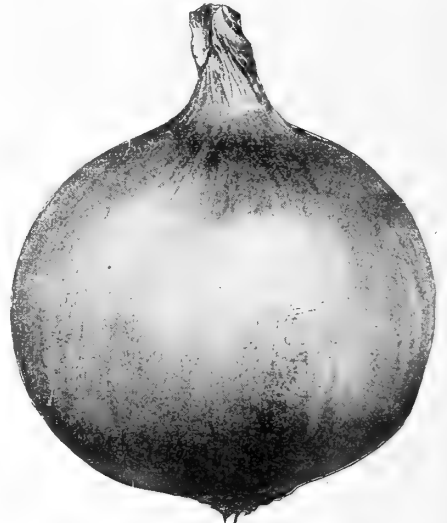

Danvers Yellow Globe

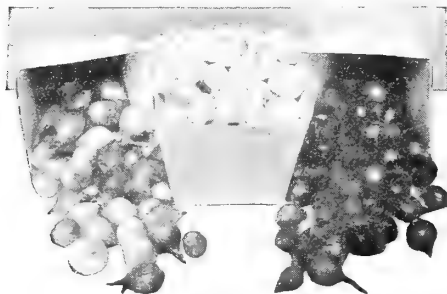

ONION SETS

We handle Onion Sets in Carload lots and have excellent facilities for storing and shipping; therefore our prices are always attractive and quality unsurpassed. As the market fluctuates greatly, we cannot quote at the time our catalogue goes to press but we shall be pleased to name a definite price on request.

Plant in drills 12 inches apart, and 4 inches between the sets.

Yellow Danvers; Yellow Strasburg; Japanese; White Silverskin.

USE A FELINS TYING MACHINE

For Bunching Spring Onions

See Page 55

PUMPKINS

1 ounce to 15 hills; 4 lbs. per acre, in hills 10 by 10 feet apart.

CULTURE.—Sow in good soil in May, when the ground has become warm, in hills 8 to 10 feet apart each way, or in fields of corn about every fourth hill; always avoid planting near other vines, as they will hybridize.

Sugar Pie Pumpkins This is the best of all Pumpkins for pies. The fruit is small to medium in size, flesh solid and fine grained, the seed cavity small, and it is a splendid keeper. Pkt., 5c; ¼ lb., 30c; lb., 90c.

Quaker Pie It is oval in shape, and tapers toward each end; of a creamy color, both inside and out. Being fine grained and rich flavored, it makes a superior quality of pies. Pkt., 5c; ¼ lb., 30c; lb., 90c.

Connecticut Field Used principally for feeding stock, shape almost round, of medium size, skin deep yellow and smooth, flesh yellow. Pkt., 5c; ¼ lb., 20c; lb., 60c; 10 lbs., \$5.50.

Cushaw, or Crookneck One of the most popular varieties to grow for pies as well as for stock feeding. Fruits 2 feet in length, with long, solid neck, most frequently curved in form; seeds are located in the lower bulb-like end. Skin striped with mottled bands of creamy white. Flesh, rich, creamy yellow, tender and of exceptionally fine flavor. Pkt., 5c; ¼ lb., 30c; lb., \$1.00.

Sweet Potato Excellent for pies, pear-shaped, medium sized, flesh and skin creamy white, fine grained, sweet and delicious; first-class keeper. ¼ lb., 30c; lb., \$1.00.

Japanese Pie Crookneck variety, with extremely small seed cavity; nearly all solid meat; quality extra fine; seeds distinct in appearance, being curiously sculptured in the manner of Chinese letters. Productive, ripens early, medium size, good keeper. ¼ lb., 25c; lb., 90c.

King of Mammoths This giant variety grows to enormous size. Deep yellow, glossy color. Splendid to grow for stock and exhibition purposes. ¼ lb., 30c; lb., \$1.00.



Sugar Pie Pumpkin

PARSLEY

1 oz. to 150 feet of drill.

Sow in rows 1 foot apart and 1 inch apart in the row. The seed is slow to germinate, and should be given the most favorable conditions. A deep, rich, loamy soil is required. For winter use a few plants placed in a box in the cellar will give a supply.

Champion Extra Dark Moss Curled The large leaves are very heavily crimped and curled, being quite moss-like in appearance and of a peculiarly rich, extra dark green coloring. Very productive and most attractive as a garnish, both on account of this green coloring and fine mossy appearance. Pkt., 5c; ¼ lb., 25c; lb., 75c.

Fine Double Curled Plants of dwarf, compact growth and the young leaves have the edges heavily crimped, being of quite moss-like appearance. Pkt., 5c; ¼ lb., 20c; lb., 60c.

Turnip-Rooted, or Hamburg The edible portion of this variety is the large swollen or fleshy root, which resembles the root of a Parsnip, and is highly esteemed for flavoring soups, stews, etc. As the root is the portion desired, the young plants should be well thinned out. Pkt., 5c; oz., 15c; ¼ lb., 25c; lb., 75c.

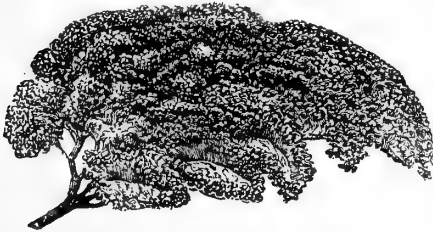

Extra Dark Moss Curled Parsely

Extra Curled Dwarf, or Emerald The plants are of dwarf compact growth, while the leaves are of a handsome bright green coloring, very finely crimped and curled, of a most ornamental appearance. One of the finest for garnishing or flavoring. Pkt., 5c; ¼ lb., 25c; lb., 75c.

PARSNIPS

1 oz. to 150 feet of drill.

Parsnips are well known as a delicious table vegetable, but their value for the purpose of feeding cattle and stock is but little appreciated. The parsnip is rich in saccharine food, which adds greatly to the richness of the milk when fed to cows, while the fresh, succulent roots increase the flow of milk as greatly as does the use of fresh, green food in the spring. It is especially valuable for the purpose from its extreme hardiness, as the roots can be left in the ground all winter and improve in quality by the continued freezing.

Sow as early in the spring as the weather will permit, in drills 15 inches apart and half an inch deep in rich, well-manured ground,

well dug. Cultivate similar to Carrots, and thin out to 6 inches apart in the rows. To keep well in the ground over winter, draw a little earth over the tops.

Hollow Crown, or Large Sugar The best variety in cultivation for general use; roots white, smooth, of intermediate length; sugary, of excellent flavor. Pkt., 5c; ¼ lb., 25c; lb., 75c.

Improved Guernsey An improved strain, which has given general satisfaction. The roots do not grow so long as those of the Hollow Crown, but are of greater diameter and more easily gathered. Of excellent quality. Pkt., 5c; ¼ lb., 25c; lb., 75c.



Hollow Crown Parsnip

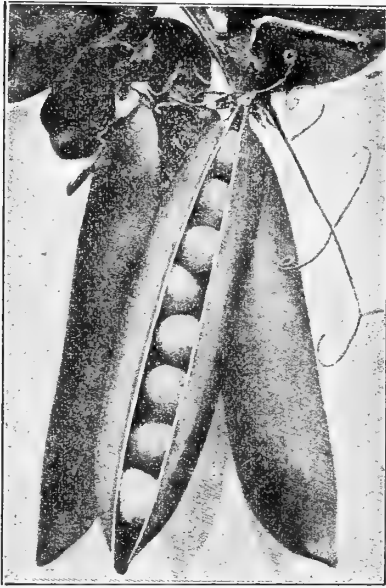

Extra Early Alaska Peas

PEAS

1 quart to 100 feet of drill; 1½ bushels per acre.

Peas grow best on a light, rich, mellow soil under cool and moist weather conditions. Fresh manure and very rich or wet mucky soil should be avoided.

The extra early varieties are very hardy and should be planted as soon as the ground can be made ready, while the larger wrinkled varieties, which are not as hardy but of superior quality, may be planted when the soil has become slightly warmed, as the seed will rot if planted too early.

For private use, sow the seed in double rows, 18 inches apart and 3 inches apart in the row; for market, in single rows 2 to 3 feet apart and 1 inch apart in the rows. The peas will give quicker returns if covered only one inch deep, and where earliness is most important they may be treated this way. Larger pods and greater quantity will be produced if the seed is planted in trenches three to six inches deep and covered with only one to two inches of soil. When the plants are five or six inches high, fill the trench level with the surface. This will result in deep rooting, prevent mildew and prolong the bearing season. If the peas are covered to the full depth at first, or if water is allowed to stand in the trenches the seed will not germinate or grow well. The crop should be gathered as fast as it becomes fit for use, as even a few ripe pods left on the vines tend to retard the development of the young pods and prevent the formation of new ones.

FIRST EARLY SMOOTH VARIETIES

Extra Early Alaska Vine strong and vigorous, 2 to 2½ feet high, of a peculiar light green color, pods 3 to 3½ inches long, straight and blunt at the end. Is ready for picking 49 to 50 days from planting. Seed round, blue, slightly pitted. Matures crop very evenly. Qt., 40c; pk., \$2.25; bu., \$8.50.

Pedigree Extra Early This superb strain is a great favorite with large growers. Equally as early as the choicest stock of Alaska, the peas are much better in flavor. The vines are quite slender, of very quick growth, and average 18 to 24 inches in height. The pods are well filled, and the entire crop can be gathered generally in one picking. Qt., 40c; pk., \$2.25; bu., \$8.50.

New Market Surprise This new and very profitable variety is as early as Extra Early Alaska and as large and prolific as Prolific Early Market. It has for these reasons become established as a favorite among private growers and market gardeners. Our trials have given us every reason to be very enthusiastic over this pea and we recommend it highly to all growers who want an early, prolific, and high quality crop. The vines grow about 2 feet high and bear a wonderful crop of large pods, well filled with luscious peas. Pt., 25c; qt., 45c; pk., \$2.50; bu., \$9.00.

Long-Podded Alaska A favorite with truckers and shippers to Northern markets, producing a very early crop of large, broad, well-filled, dark green pods. Equally as hardy as Extra Early Alaska and much larger. The vines usually grow three feet high and the crop will remain fresh a long time after picking. Qt., 45c; pk., \$2.50; bu., \$9.00.

Bountiful Resembling the Alaska in general habit of growth. Vine 36 inches, foliage gray-green, pods 3½ inches in length, pointed, gray-green in color. Fit for table use 55 to 57 days from planting; a prolific bearer, making it a valuable variety. Seed blue, medium pitted. Qt., 40c; pk., \$2.25; bu., \$9.00.

Early Bird Very large, early, hardy, semi-wrinkled variety, producing a good crop of fine quality. Vines 2 to 2½ feet. Qt., 50c; pk., \$3.00; bu., \$10.50.

Prolific Early Market Longer podded and more prolific than Pedigree Extra Early, for which it is a fit companion and close second, as it comes in only four or five days later. The vines average 24 to 30 inches high and produce pods singly. One picking will take about three-fourths of the crop, and a second picking, which is to be made about three days later, will take the balance. It is remarkably uniform and very free from spots of any kind. The peas are of the finest quality. Qt., 40c; pk., \$2.25; bu., \$8.50.

SECOND EARLY SMOOTH VARIETIES

Improved Sugar Marrowfat This fine Pea has given wonderful satisfaction to all who have planted it. It grows about 2 feet high, bears enormous handsome pods, which are completely filled with large, deliciously flavored, deep green peas. It is undoubtedly the most productive Pea offered. Qt., 40c; pk., \$2.25; bu., \$8.50.

Dwarf Giant Podded Prolific Green Marrow This variety has become a favorite with the consumer as well as grower. Vines of a strong growth, with a large dark green foliage, but only 18 to 20 inches in height, and do not need to be supported. Pods of large size, well filled with large dark green peas of rich marrow flavor. Qt., 50c; pk., \$2.75; bu., \$10.00.

EDIBLE PODDED PEAS

This is a class of Peas not generally known in this country, but much used abroad, in which the sweet, brittle and succulent pods have none of the tough inner lining found in the ordinary varieties of garden peas. They are used in the same way as snap or string beans.

Mammoth Melting Sugar This is by far the largest and finest of the true sugar or edible podded Peas. The vines are of strong, vigorous growth, frequently 4 to 5 feet in length, and the pods come rather late, or about the same time as the Telephone and Stratagem Peas. The vines are very productive of enormous pods, and continue bearing for a long time. Pods average 5 to 6 inches in length and 1½ inches broad, thick and fleshy. Broken and boiled like string beans and served with butter sauce, they have a luscious flavor. Qt., 60c; pk., \$3.75.

Dwarf Sugar, Edible Pods This variety possesses all the fine cooking qualities of the Mammoth Sugar, nearly two weeks earlier in maturing, average growth 30 inches. Qt., 60c; pk., \$3.50.

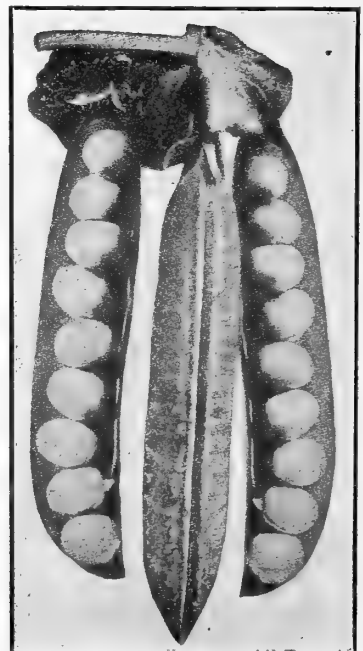

Early Bird Peas



Extra Early Gradus or Prosperity

PEAS

Continued—

WRINKLED VARIETIES

Extra Early Gradus

Also called "Prosperity" Pea. This popular new large-podded wrinkled pea of finest quality matures pods only two or three days later than the small-podded, round-seeded extra earlies. Vines grow from 2½ to 3 feet. We consider it one of the most desirable for the market garden or home use. **Qt., 50c; pk., \$3.00; bu., \$11.00.**

Pioneer Introduced two years ago and found to be a money-maker for the trucker. Vine 24 inches, large, dark green pods, maturing in about 75 days. **Qt., 50c; pk., \$3.00; bu., \$11.00.**

Little Marvel A new variety of recent introduction, similar to Nott's Excelsior. The vines grow 15 inches high and produce an abundance of pods; finest quality. **Qt., 40c; pk., \$2.75; bu., \$10.00.**

American Wonder This is a dwarf variety, and leads all others in point of earliness, growing about 10 inches high, and produces a profusion of good sized, well-filled pods, with finest-flavored peas. **Qt., 50c; pk., \$2.75; bu., \$9.50.**

Premium Gem Nearly as early as the American Wonder, and the very productive vine is decidedly larger, growing to a height of from 15 to 18 inches. The pods are large and crowded with 6 to 8 very large peas of fine quality. **Qt., 50c; pk., \$3.00; bu., \$10.00.**

Nott's Excelsior One of the best Early Dwarf Peas. It combines the good qualities of the American Wonder and Premium Gem Peas. The vines are larger and more productive than American Wonder and earlier than Premium Gem. The peas in sweetness and quality are unsurpassed. **Qt., 50c; pk., \$3.00; bu., \$10.00.**

Sutton's Dwarf Defiance

A new wrinkled marrow of fine quality. Vines stocky, quite dwarf, pods large and well filled. The exceeding productiveness of this variety for a dwarf sort makes it one of the most valuable of all for home gardens. **Qt., 45c; pk., \$2.75; bu., \$10.00.**

Admiral Dewey The largest podded pea yet introduced. Height 3½ feet; pods a rich dark green color, frequently 6 inches long, beautifully shaped. Peas large, tender and of first-class flavor. **Qt., 50c; pk., \$3.00; bu., \$10.50.**

Long Island Mammoth or Telegraph

Very popular with market gardeners who want a large, handsome pod of a deep green color. **Qt., 45c; pk., \$2.75; bu., \$10.00.**

Alderman This splendid new pea comes from a European specialist in hybridizing. It is similar in growth to the Telephone, maturing about the same time. **Qt., 50c; pk., \$3.00; bu., \$10.50.**

Dwarf Champion This new pea possesses all the merits of the Champion of England, with less vine (26 inches), larger pods and more of them, and coming a little earlier. **Qt., 45c; pk., \$2.75; bu., \$10.00.**

Prince Edward Hardy and very prolific. Vine 1½ feet in height, with dark green foliage. Pods dark green, curved and pointed at the ends. Ready for table use 60 days after planting. **Qt., 50c; pk., \$3.00; bu., \$10.50.**

Boston Unrivalled An improved strain of the popular Telephone. Vines grow 4 to 5 feet high, and are covered with fine, large pods. **Qt., 50c; pk., \$3.00; bu., \$10.50.**

Telephone A tall-growing late sort, 3½ to 4 feet in height, having pods of very large size, containing 6 to 7 large peas of delicious flavor. Continues in bearing for quite a long time. **Qt., 50c; pk., \$3.00; bu., \$10.50.**

Potlatch Strong, vigorous vines of even growth, 20 to 24 inches in height, with luxuriant dark foliage, bearing pods medium green in color, 3½ to 4 inches in length. Broad and pointed at the ends. No variety known will produce more pods, and no pods could possibly shell out better. The Potlatch is a variety from which everyone may expect great things. Fit for table use 61 days from planting. Seed green, wrinkled. Large in size. **Qt., 45c; pk., \$2.75; bu., \$10.00.**

Thomas Laxton This variety is of the same growth with that of the Gradus, but is usually three to four days later for market. The pods are square at the ends instead of having a long, sloping point, and considered by some to be of a better flavor than the Gradus. **Qt., 50c; pk., \$3.00; bu., \$10.50.**

Champion of England A universal favorite, delicious flavor, profuse bearer of large pods, filled well with large green wrinkled peas. Height about 4 feet. **Qt., 45c; pk., \$2.50; bu., \$9.00.**

Daisy, or Dwarf Telephone A second early, of fairly even growth. From 16 to 18 inches high. The stout plants are fairly loaded with large, bright green pods. Each pod contains from 7 to 9 large peas of a light bright green color, tender and well flavored. **Qt., 50c; pk., \$3.00; bu., \$10.50.**

Laxtonian This is the finest dwarf early pea offered today. The vines grow 18 to 20 inches high and produce an enormous crop of dark green pods as large as Gradus, maturing a few days ahead of this variety. **Qt., 50c; pk., \$3.00; bu., \$10.50.**

PEPPERS

1 oz. to 1,500 plants.

Peppers should be sown either indoors or in hotbeds early in April and transplanted to the permanent beds when about 3 inches high in two foot drills and two feet apart in the drills. The seed can also be sown in open ground when danger from frost is past but the crop will naturally be much later. A top dressing of fertilizer or poultry manure well mixed with the soil when the plants are about 6 inches high will materially aid in the production of a big crop.

Royal King Plants grow about 2½ feet high, and are vigorous; compact and very productive, commencing to bear very early and continuing until killed by frost. The fruit is very large, bright and glossy and the extremely thick flesh is sweet and mild. They will stand distant shipping and hold up well for market as they do not wilt nor become ripe near so quickly as other large varieties. This strain is extensively grown in the South by large shippers and deserves the attention of every trucker and home gardener, as the quality and marketing possibilities are unexcelled by any other variety. **Pkt., 10c; oz., 35c; ¼ lb., \$1.00; lb., \$3.50.**

Early Giant The earliest medium large pepper in cultivation, being earlier than Neapolitan. The plants are very uniform in growth, dwarf and compact, seldom over 18 inches in height, and very productive. Fruits pendant, mild and sweet, similar to Bull Nose in form. **Pkt., 25c; oz. \$1.00; ¼ lb. \$3.75.**

Ruby Giant A variety of Mango Pepper which is of a desirable size and shape for stuffing. A cross of Ruby King and Chinese Giant; grows to large size and is very mild. **Pkt., 10c; oz., 35c; ¼ lb., \$1.00; lb., \$3.75.**



World Beater

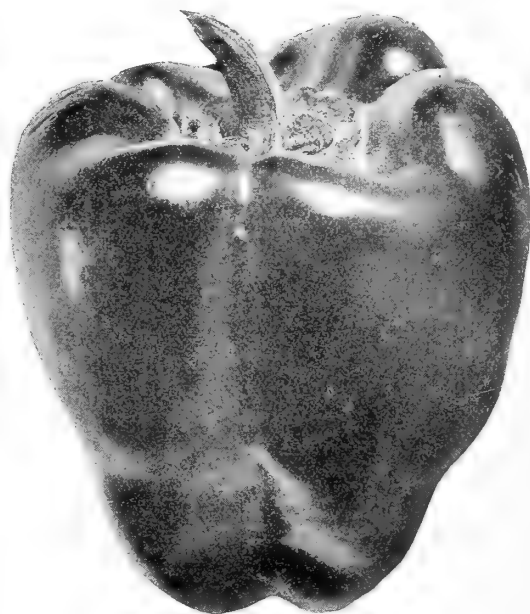

Royal King Pepper

Pimento or Perfection A medium early, prolific, perfectly mild variety with extremely thick flesh. On account of its thick flesh it will hold up for a long time and is an excellent sort for canning whole. **Pkt., 10c; oz., 30c; ¼ lb., 85c.**

Chili, Small Red conical pod about 2 inches long, very hot. Fine for pepper sauce and seasoning. **Pkt., 10c; oz., 40c; ¼ lb., \$1.00; lb., \$3.75.**

Cherry Red Fruit small round, color rich scarlet; very hot. **Pkt., 10c; oz., 40c; ¼ lb., \$1.00; lb., \$3.50.**

Ruby King Good variety for mangoes or pickling; very productive and sweet. **Pkt., 10c; oz., 25c; ¼ lb., 75c; lb., \$2.75.**

Chinese Giant This desirable variety is one of the largest Sweet Peppers ever offered. The flesh is quite thick, very mild and remarkably sweet. **Pkt., 10c; oz., 40c; ¼ lb., \$1.25; lb., \$4.75.**

Large Bell, or Bull Nose This large early and productive sort has the most pungent flavor of all the large peppers. Thick flesh. **Pkt., 10c; oz., 25c; ¼ lb., 75c; lb., \$2.75.**

Neapolitan A variety of Sweet Pepper which matures very early. It grows about 3 inches long, and is remarkably sweet. **Pkt., 10c; oz., 35c; ¼ lb., \$1.00; lb., \$3.50.**

Long Red Cayenne The pods are long and slender; bright red color and is used extensively for bunching with pot-herbs. This is an old-time favorite and very pungent. **Pkt., 10c; oz., 35c; ¼ lb., \$1.00; lb., \$3.00.**

Mammoth Golden Queen A large, sweet, fine flavored, bell shaped pepper with very thick flesh. Fruit light green turning to rich golden yellow when fully ripe. **Pkt., 10c; oz., 35c; ¼ lb., \$1.00; lb. \$3.75.**

World Beater

This splendid pepper of recent introduction is a cross between Chinese Giant and Ruby King and combines the size of one and the earliness of the other. It is exceedingly mild, very large and the color is at first green changing to a beautiful shade of scarlet. The flesh is very thick, making distant shipment possible. **Pkt., 10c; oz., 35c; ¼ lb., \$1.00; lb., \$3.75.**

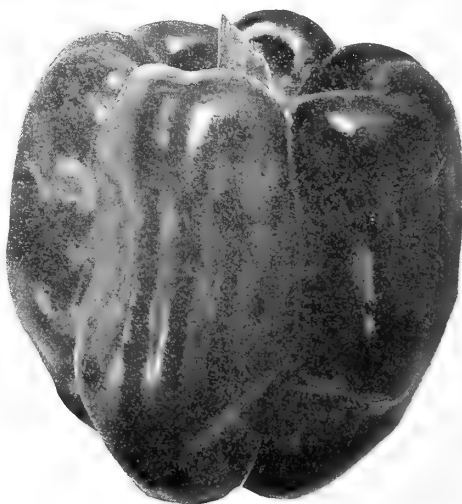

Chinese Giant Pepper

PEPPER PLANTS

In All The Leading Varieties

Fresh Daily

See Page 33

**Selected
Seed Stock**

SEED POTATOES

**Strictly
Maine Grown**

Let us quote close prices on highest quality seed on basis of lowest market value

Potatoes will adapt themselves to various soil conditions as easily as most vegetables. A better crop will be produced, however, on a sandy loam which contains a quantity of well rotted vegetable matter. A clover sod, vetches turned under in the fall, or land which was heavily manured for a previous crop supply ideal conditions.

In preparing the seed the eyes should be cut so that the largest part of the surrounding flesh is situated toward the stem end, because the eyes of a potato always have a root system running toward that end and for that reason the sprouts cannot draw moisture from the opposite direction. If the ground you intend to use has produced a scabby crop previously or the seed shows any trace of disease, the pieces should be soaked in a formaldehyde solution as a preventative.

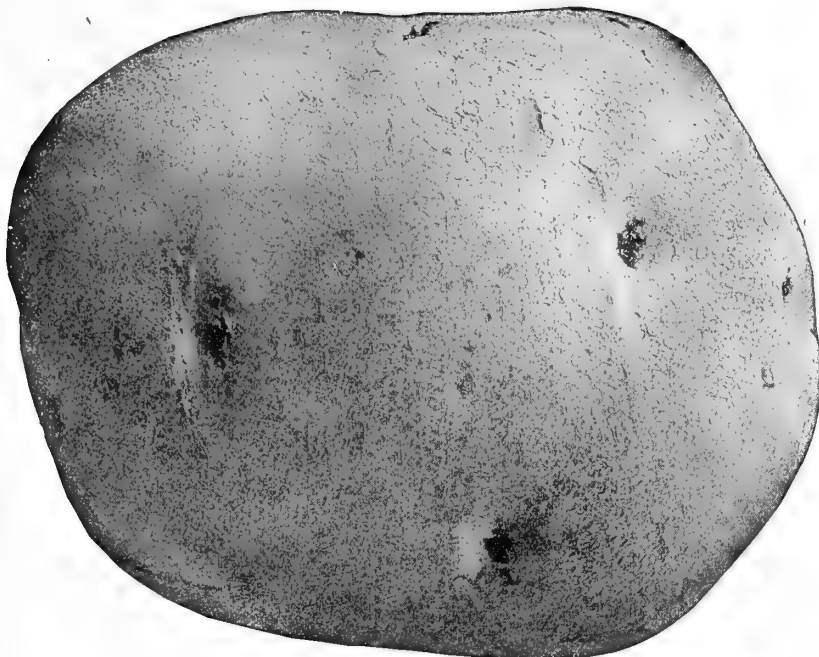

Norcross

For a very early crop, run off furrows about three feet apart and about four inches deep. Drop the pieces about 15 inches apart in the furrows and cover to a depth of about 1½ inches, gradually filling in the furrows to level as the vines grow larger. For main crop it is just as well to cover the eyes with four inches of soil at once. If fertilizer is used, apply it either in the row or broadcast before planting and be sure that it is thoroughly mixed with the soil so that the seed is not burned. Fresh stable manure will cause the potatoes to become scabby.

Just before the sprouts have appeared above the ground run a light harrow over them to kill the weeds and break up the crust. Continue weeding and harrowing until there is danger of breaking off too many sprouts. Cultivate thoroughly and frequently, being careful not to cut any of the roots, continuing until the vines have attained full growth and begin to spread.

Spraying for insects and blight is very necessary, Pyrox, Bug Death, etc., giving very satisfactory results.

The size and quality of the crop and the ability to resist disease is directly dependent upon the seed planted and no amount of cultivation or attention will offset the uncontrollable results of poor seed.

Be sure of your crop and plant only the best Maine grown seed potatoes.

Early Six Weeks Medium sized, very smooth skinned and shallow eyed; in color light pink and of fine texture.

Red Bliss, or Bliss Triumph This variety is rapidly growing in favor. The tubers are round and uniform in shape, eyes slightly depressed and of a beautiful bright red color. very hardy and vigorous, maturing with extra earlies.

Early Ohio Generally accepted throughout the Western States as the standard early Potato. A week earlier than Early Rose. Dull red, round oblong, quality dry and mealy; requires rich, moist soil for perfect development.

Irish Cobbler The biggest Potato and greatest producer known among the first early varieties. It will outyield all other early kinds and equal most of the later varieties. Fine quality, color a pure creamy white, shape round to oblong and smooth. Vines very stocky, with dark foliage.

Early Rose For a generation the standard Potato of the whole country for earlies, yield, thrift, beauty and table qualities, because it always succeeds well in any soil, in any climate and in any latitude. Too well known to need description. Our stock is strictly pure.

Maggie Murphy This is a decidedly valuable acquisition to the Potato family. The shape is flattened oblong with smooth eyes and of rose color. It is very hardy, productive and bears tubers of large size.

Green Mountain White skin, flat, oval form, smooth, of good appearance; fine for the table quality. Ripens slowly, and is a good keeper. Valuable for late crops. Now taking the lead in all markets.

Gold Coin A very desirable main crop variety of recent introduction; has proven to be very hardy, of vigorous growth, most productive, of the very best quality. The tubers are slightly oblong, rather broad and quite thick through. The eyes are small, and there is but little waste in paring. The skin is thin, smooth and glossy, of a light golden tint.

Second Crop Seed Potatoes are of medium size, and require less seed per acre than Maine-grown stock. Planters who have tried them will use no other. Prices on application.

White Star Medium late, of good size and quality, white in color; eyes flush with the skin and a good keeper.

Norcross Its shape is a little oblong and slightly flattened, the skin is finely netted or rusty, which always indicates good cooking and eating qualities. The tubers are large and very uniform, maturing medium early.

American Giant Is one of the heaviest yielders grown, and a favorite with all large growers. It is a long, white, smooth, handsome Potato, of good quality, with shoal eyes; maturing with the second earlies and is a late keeper.

Prosperity This is a very handsome general crop Potato. Its skin is slightly rusty, of a light cream-white color; its shape is an oblong and slightly flattened. The eyes are very shallow, the size is large and desirable, very few under market size. Always smooth and regular in form and of splendid quality.

Burbank This variety is quite largely used as one of the reliable late Potatoes, is of good size, white skinned, of oblong shape and good yielder. It is a late keeper and also of good flavor.

Puritan A splendid early variety, fine quality, color a pure white, shape oblong, yielding large crops.

SEED SWEET POTATOES

Yellow Jersey Select "up-river" strains of smooth, short, "chunky" Yellow Jersey. Yields 25 to 50 per cent more marketable stock and sells higher than any other. Dry and sweet; decidedly the best of all. Prices subject to market fluctuations.

Sweet Potato Plants See Page 33

RADISHES

1 oz. for 100 feet of drill; 9 lbs. per acre.

Light, sandy soil, rich in organic matter is essential to produce crisp and tender radishes. For an early crop sow the seed as soon as the ground can be worked, in drills 6 to 10 inches apart, covering the seed half an inch deep. When the plants are well started, thin out to one inch apart in the drills. Frequent watering in dry weather is very beneficial as high quality is largely dependent upon rapid growth. For a continuous supply, successive plantings should be made at intervals of 10 days to two weeks, selecting varieties best suited for the season.

Extra Early Scarlet Globe (Forcing)

This is the market gardener's favorite as a forcing Radish, very early; mild and crisp, juicy and tender; top small; will stand heat without becoming pithy. One of the best selling and most attractive Radishes on account of its bright scarlet color and handsome shape. Our stock of this is the very best, selected with special care as to size, shape, color and earliness, and market gardeners will find it a money maker, as it is just right in every respect. **Pkt., 10c; ¼ lb., 30c; lb., 85c.**

Extra Early Deep Scarlet Turnip

Deep scarlet, turnip shaped, small top, desirable for frames or outside. **Pkt., 10c; ¼ lb., 25c; lb., 75c.**

Early Deep Scarlet Turnip For outdoor sowing this is the most important in the Baltimore market, thousands of pounds being annually used. Our stock is the very best. It has a rich scarlet color, ball shape, a little larger top and matures a week later than the forcing varieties. **Pkt., 10c; ¼ lb., 25c; lb., 75c.**

Ruby-Pearl The color is a bright scarlet and white. It is extremely quick to mature, being ready for the table in 20 days from the time of sowing the seed. It is invaluable for forcing under glass as well as for growth in the open air. The skin is very smooth, and its clear color gives it an appetizing appearance on the table. Its flavor is excellent, and its qualities high in all respects. **Pkt., 10c; ¼ lb., 25c; lb., 75c.**



Extra Early Scarlet Globe Radishes

Early Scarlet Turnip, White Tipped One of the handsomest of the Turnip Radishes for early planting outdoors. Roots slightly flattened on the under side, color very deep scarlet with a white tip; flesh white and of the best quality. **Pkt., 10c; ¼ lb., 25c; lb., 75c.**

Crimson Giant A variety combining earliness and great size. It grows much larger than other extra early varieties, but does not become pithy, even when fully twice as large in diameter and a week older; beautiful crimson-carminé; turnip-shaped; flesh firm, crisp and tender. We recommend it for outdoor garden planting as well as for greenhouse forcing. **Pkt., 10c; ¼ lb., 30c; lb., 85c.**

(New) Round Scarlet China

This new variety of the China Radish may be sown at intervals from spring until autumn. Matures in from six to seven weeks, and is much harder than most other varieties. Valuable as a winter Radish, as well as for summer. Its handsome round shape, rich scarlet color and pure white flesh commend it to all. **Pkt., 10c; ¼ lb., 35c; lb., \$1.00.**

Golden Globe

Second early, grows to a good size; stands the heat well; very popular with market gardeners, a beautiful golden yellow, flesh crisp and tender. **Pkt., 10c; ¼ lb., 25c; lb., 75c.**

Half Long Deep Scarlet, or "Paris Beauty"

This is a splendid strain of similar season to the Early Long Scarlet. Very popular. The Radishes are of slightly larger diameter and most brilliant scarlet coloring. Flesh purest white, crisp and juicy. **Pkt., 10c; ¼ lb., 30c; lb., 85c.**

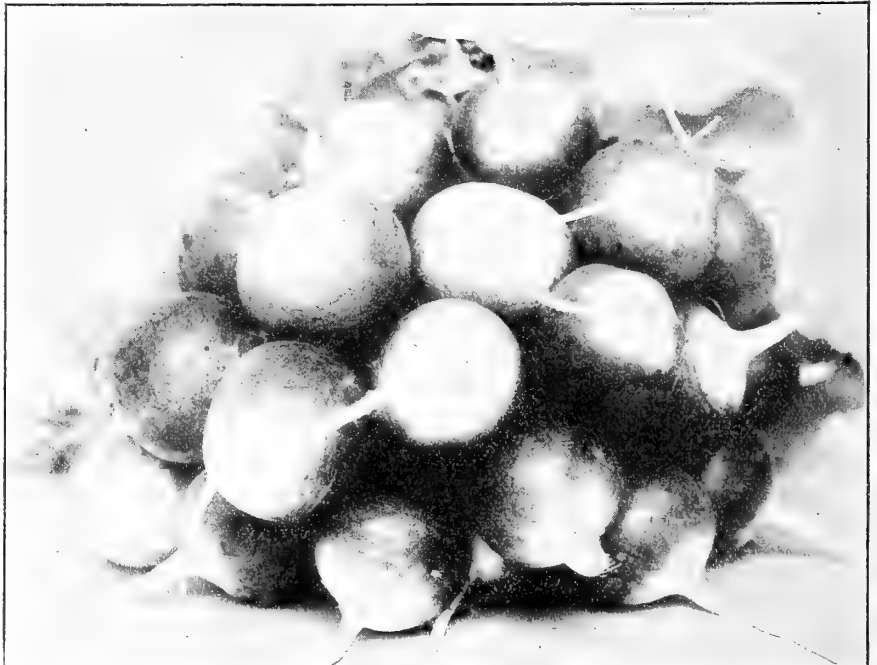

Early Scarlet Turnip, White Tipped

RADISHES--Continued.

French Breakfast Color is a scarlet rose, shading to a waxy white at the tip; quick growth, mild and tender, good for forcing. Pkt., 10c; ¼ lb., 25c; lb., 75c.

Feton's Model White Box (Forcing) It is of most handsome shape very early and has but few leaves, thus making it of special value for growing in hotbeds or "boxes," and one-third more radishes can be grown in the same space than with most other sorts. It is of clear white color, solid, juicy and unsurpassed in flavor. Pkt., 10c.; ¼ lb., 25c.; lb., 75c.

Long Scarlet This is the standard extra early long scarlet market variety, short top, long scarlet roots; crisp, fine flavor. Pkt., 10c.; ¼ lb., 25c.; lb., 75c.

White Icicle Radish It fully equals in crisp, tender flesh and mild flavor the popular White Vienna or Lady Finger, while it is as early as Long Scarlet Short Top. Planted in spring the young Radishes are ready for use in 20 to 25 days from sowing the seed, and their long, slender form and pure paper-white skin are most attractive when bunched for market. Pkt., 10c.; ¼ lb. 25c.; lb., 75c.

Cincinnati Market ("Glass Radish") A selected strain of the Long Scarlet, growing to slightly larger size fully as early and darker in coloring. Pkt., 10c.; ¼ lb., 25c.; lb., 75c.

Long Bright Scarlet, White Tipped This is the brightest and handsomest colored scarlet Radish known. Pkt., 10c.; ¼ lb., 25c.; lb., 75c.

Improved Chartier The color at top is crimson, running into pink at middle, and from thence downward is pure waxy white. It is of a very quick growth, and ready for use nearly as early as Long Scarlet. Exceedingly tender and crisp. Pkt., 10c.; ¼ lb., 25c.; lb., 75c.

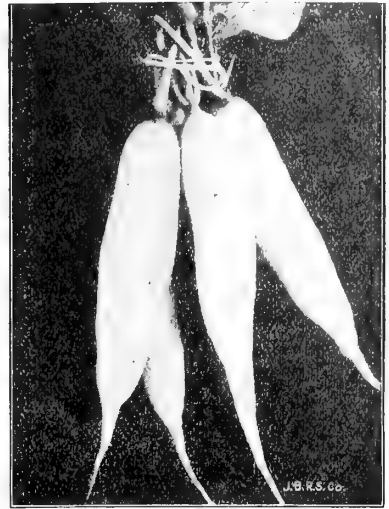

White Icicle

Pearl Forcing This variety is a cross between Wood's Early Frame and White Strasburg. The color is a pearl white with a fine waxy appearance, very firm and solid. They will remain in good condition longer than any other extra early variety. Pkt., 10c; ¼ lb., 25c; lb., 75c.

Long White Vienna, or Lady Finger This is the finest Long White Radish in cultivation; it is most beautiful in shape, white in color, both skin and flesh are pure snow-white, crisp, brittle, and of rapid growth. Highly recommended Pkt., 10c; ¼ lb., 25c; lb., 75c.

New White Strasburg A very new desirable summer variety a favorite with our market gardeners. skin and flesh both white. It is excellent quality and a quick grower. Pkt., 10c. ¼ lb., 25c; lb., 75c.

Perpetual White Summer This variety introduced by us has given splendid satisfaction to all who have tried it. They are pure white, of uniform good quality, crisp and brittle, and they keep longer in a fit condition for the table than any variety we know of, hence their name. Perpetual White Summer can be sown any time of the year, and will always produce good radishes fit for market earlier than the Chartier, and keep in perfect shape for marketing about four weeks, or longer for home use. Pkt., 10c; ¼ lb., 25c., lb.; 75c.

White Stuttgart Quick growing and therefore very early. Of the largest size, and both flesh and skin are pure white; quality fine, firm, and brittle, can be pulled for use at any stage. Pkt., 10c; lb., 30c.; lb., 85c.

Large White Summer Round, smooth, very white, crisp, and tender. The market gardener's favorite for summer use. Pkt., 10c.; ¼ lb., 25c.; lb., 75c.

WINTER VARIETIES

White Chinese New Celestial

Large, stump-rooted Radish with white skin and flesh. Can be sown from July 1 to August 15, and will keep in prime condition, mild, in flavor this a special seller. Pkt.,

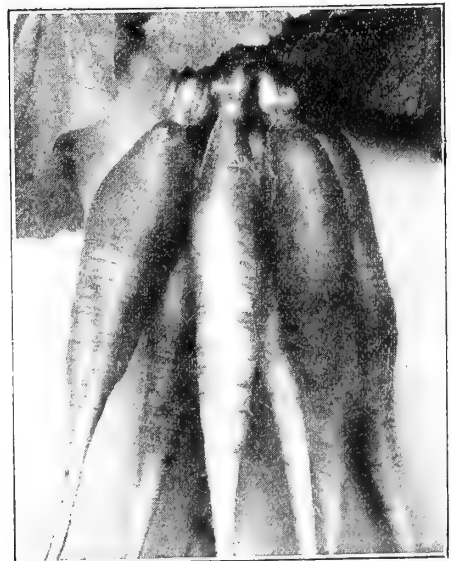

Long Scarlet



White Strasburg

brittle, and never woody. Market gardeners will find 10c.; ¼ lb., 30c.; lb., 85c.

White Round Spanish Root large, often five inches in diameter, turnip-shaped, skin pure white, flesh white crisp and not becoming pithy, very compact and highly flavored; an excellent sort for winter, as the roots keep a long time. Pkt., 10c; ¼ lb., 30c; lb., 85c.

Improved Half-Long, Black Spanish Radish This new sort is intermediate in shape between the Old Round and Long Black Spanish, and much superior to either. Flesh mild, very sweet and crisp, never pithy, and is decidedly the best of all black radishes. If stored in damp sand in the cellar, they will keep all winter. Pkt., 10c; ¼ lb., 30c; lb., 90c.

Round Black Spanish Like the Long White Spanish, except in shape. Pkt., 10c; ¼ lb., 25c; lb., 75c.

Chinese Rose A splendid rose-red variety that keeps during winter; tempting flavor and very crisp. Pkt., 5c; ¼ lb., 25c; lb., 75c.

Long White Spanish This variety is of a snow white color, similar to the White Strasburg in shape, but rather more stump-rooted. Pkt., 10c; ¼ lb., 25c; lb., 75c.

Long Black Spanish Black skin, white flesh, very firm and solid, good keeper, grows long and large. Pkt., 10c; ¼ lb. 25c; lb., 85c.

California Mammoth Was first introduced into this country by the Chinese in California. It is pure white, about one foot long, and two or three inches through, tapering regularly to the tip. The flesh is tender and crisp, keeping well through the winter. Pkt. 10c; ¼ lb., 30c; lb., 90c.



Mammoth Sandwich Island Salsify

SALSIFY or Oyster Plant

1 oz. for 50 feet of drill.

Requires a well enriched, mellow soil, which, previous to sowing the seeds, should be stirred to a depth of 18 inches. Sow early in the spring in drills 15 inches apart; cover the seed with fine soil 1½ inches in depth, and when the plants are strong enough thin out to 6 inches apart. As the leaves resemble grass, be careful they are not mistaken for it when weeding.

Mammoth Sandwich Island A new and improved type, producing roots of nearly double the size and weight of the old varieties; mild and delicately flavored. Pkt., 10c; ¼ lb., 60c; lb., \$1.75

RHUBARB or Pie Plant

Sow in April or May, in drills 1 foot apart; when 3 or 4 inches high, thin out in rows 6 to 10 inches apart. Transplant the ensuing fall or spring in rich soil. Set out the roots 3 to 4 feet apart each way; the following spring it will be fit to use.

Linnaeus Pkt., 5c; oz., 20c; ¼ lb., 40c; lb., \$1.25.

Victoria Very large, the finest cooking variety. Pkt., 5c; oz., 20c; ¼ lb., 40c; lb., \$1.25.

RHUBARB ROOTS—See page 33.

HERBS

	Pkt.	Oz.	¼ lb.
Anise.....	\$0.05	\$0.15	\$0.40
Basil.....	.05	.15	.50
Caraway, lb., 75c.....	.10	.15	.25
Coriander.....	.05	.10	.25
Dill, extra large.....	.05	.10	.25
Fennel, lb., 60c.....	.05	.15	.35
Lavender.....	.10	.25	.85
Marjoram, sweet.....	.10	.20	.60
Sage.....	.10	.25	.75
Summer Savory.....	.10	.20	.40
Thyme.....	.10	.50	1.75

SORREL

A hardy plant grown for its leaves, which are used as boiling "greens" or salad. Seed should be sown thinly in drills early in spring. When well started thin out to stand 4 to 6 inches apart in the row. The leaves can be gathered for use at any time after the plants are well started in growth, and the roots will continue to produce a further supply. The plant is entirely hardy, and, starting into growth early the following spring, will afford a large supply of fine "greens" quite early.

Large-Leaved French

Pkt., 5c; ¼ lb., 35c; lb., \$1.15.

SQUASH

1 oz. of bush sorts to 40 hills; large seeded 15 hills.
2 lbs. of bush sorts to acre; large seeded 3 to 4 to acre.

Squashes, like other vines, are partial to a light, dry, rich soil. Plant the running varieties in hills 10 feet apart each way; thin out to three plants in a hill. Cultivate frequently until the vines commence running, after which do not work the soil deep. Use Paris Green to destroy bugs, as with Cucumbers. Plant Bush Squashes in hills 5 feet apart each way; thin out to four plants in a hill.

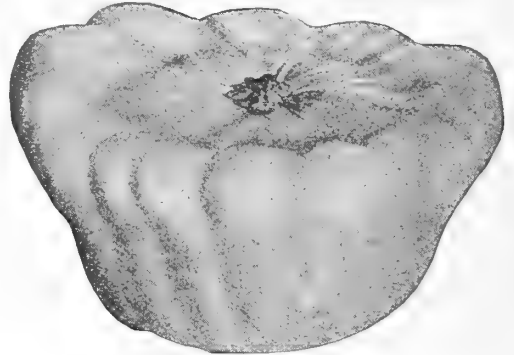

Extra Early White Bush Squash

Extra Early Jersey White Bush Scallop

This is an improved strain of the Old White Bush. It sets fruit 10 days earlier, of a beautiful clear waxy white instead of the greenish white often seen. Very productive, and shows less ridge or scallop; containing a larger amount of solid flesh. Pkt., 5c; ¼ lb., 30c; lb., 90c.

Summer Crookneck A beautiful bright yellow, bears all summer, and commands good prices. Very desirable for market and private use. Pkt., 5c; ¼ lb., 25c; lb., 75c.

Bush Fordhook Squash In this new true bush type the plants can be grown much more closely together. The fruits are rather shorter and thicker than those of the running type, and have a smaller seed cavity. Our Fordhook Squash is about a week later than the Early White Bush, but is much sweeter and better flavored. Stored in a dry place they will keep in good condition until the following June. Pkt., 5c; ¼ lb., 35c; lb., \$1.00.

FALL AND WINTER VARIETIES

Hubbard Well-known winter variety, with very hard, firm shell, fine grain, sweet and rich flavor, and excellent for table use. A splendid keeper. Pkt., 5c; ¼ lb., 35c; lb., 90c.

Winter Crookneck Flesh red, of fine flavor and good keeper. Pkt., 5c; ¼ lb., 25c; lb., 75c.

Boston Marrow A fall and winter variety regarded very highly in the markets. Oval form, pointed, thin rind, fine grain; salmon-colored flesh, remarkably sweet and delicious. Keeps well in winter and will boil dry as a mealy potato. Pkt., 5c; ¼ lb., 25c; lb., 75c.

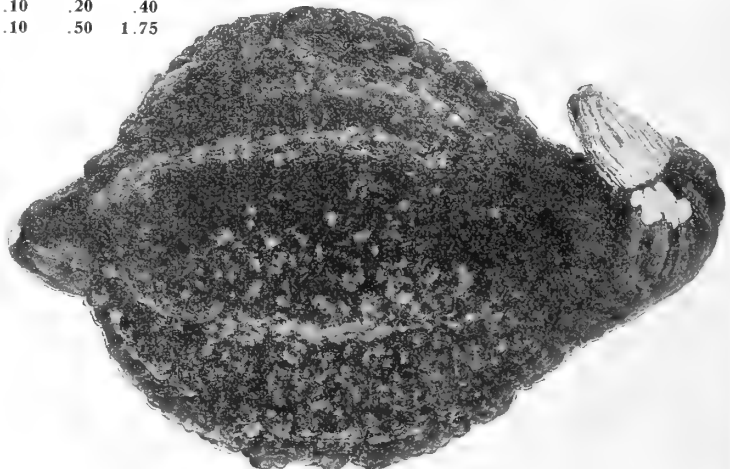

Improved Hubbard

SPINACH

1 oz. to 100 ft. of drill; 12 to 15 lbs. per acre.

One of the most staple vegetables of the American table, possessing highly valuable and health giving qualities; easily grown, requiring but little attention and in sections where the soil is rich, very profitable crops are produced.

Select a rich piece of ground, the richer the better; and for late spring and early summer use, sow the seed during February, March and April in drills one foot to 20 inches apart, one-half to one inch deep. When the plants are well started thin out to 4 to 6 inches apart, or sow the seed thinly and allow all the plants to stand.

For winter and early spring use, sow either in drills or broadcast during August, September and October. A top dressing of Nitrate of Soda will make a vast improvement in the earliness, size and quality of the crop.

Manns' Reselected Bloomsdale Savoy

This new strain has been developed in response to the urgent demand on the part of large spinach growers for an improvement in the quality of the regular commercial Bloomsdale grown in Holland. The plants are large, heavy, uniform and in every way especially re-selected to match the ideal Bloomsdale Savoy type. Lb., 20c; 10 lbs., \$1.60; 25 lbs., \$3.75; 100 lbs., \$14.00.

Bloomsdale Curled Savoy We grow large quantities of this variety in Europe, in sections best suited for its perfect development, and our product is greatly respected and continuously used by the largest and most successful truckers. Pkt., 5c; lb., 20c; 10 lbs., \$1.50; 100 lbs., \$12.50.

Early Long-standing Bloomsdale Possessing all the merits of the best strain of Bloomsdale Savoy and the additional feature of remaining in the field three to seven days after it is ready to cut; without danger of running to seed. This permits the grower to take advantage of market fluctuations. Lb., 35c; 10 lbs., \$3.00; 25 lbs., \$6.25.

Virginia Blight Resistant Bloomsdale A strain of Bloomsdale Savoy especially developed by the Virginia Experimental Station for the purpose of resisting the disease commonly called yellows. Used extensively in the vicinity of Norfolk and in other sections where blight is encountered. Lb., 35c; 10 lbs., \$3.00; 100 lbs., \$22.50.

New Triumph This remarkable summer variety stands supreme in its ability to produce a very profitable crop during warm weather when all early varieties have either gone to seed or wilted in the heat. Pkt., 5c; lb., 20c; 100 lbs., \$15.00.

New Zealand (TETRAGONIA EXPANSA) Not related to regular spinaches but forming large spreading plants producing fleshy brittle tips and leaves which are used as spinach. Of delightful flavor and practically ever-bearing. Pkt., 10c; oz., 15c; ¼ lb., 25c; lb., 75c.

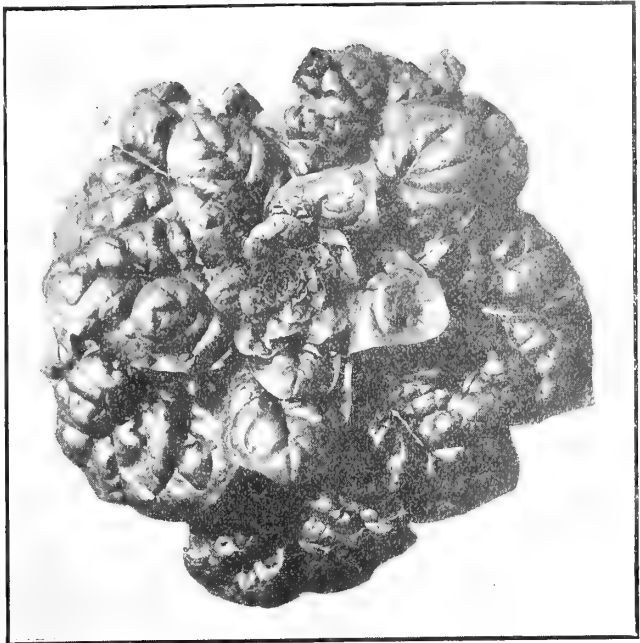

Princess Juliana

Princess Juliana This new introduction when grown in competition with ordinary Bloomsdale Savoy is sure to command a fancy price from shippers and packers because of its excellent quality and beautiful appearance. It is also very successfully grown in warm weather similar to Triumph as it withstands the heat and is very late seeding. The leaves are a rich dark green, very thick, crumpled and of splendid quality. Lb., 35c; 10 lbs., \$2.25; 25 lbs., \$5.00; 100 lbs., \$18.00.

King of Denmark Plants remain in condition from a week to two weeks after all other varieties have gone to seed. One of the leading sorts for home gardeners. Pkt., 10c; lb., 25c; 10 lbs., \$2.25; 100 lbs., \$20.00.

Victoria Midseason sort of low spreading habit, producing an abundance of very dark green leaves, slightly crumpled in the center. Late seeding and of excellent quality. Pkt., 5c; lb., 15c.

New Giant Market, or Mammoth Evergreen Of recent introduction, producing plants of large size and vigorous growth. The leaves are of the Bloomsdale type, of remarkably fine texture and of deepest green color, very hardy and slow to run to seed. Pkt., 5c; lb., 25c; 100 lbs., \$20.00.

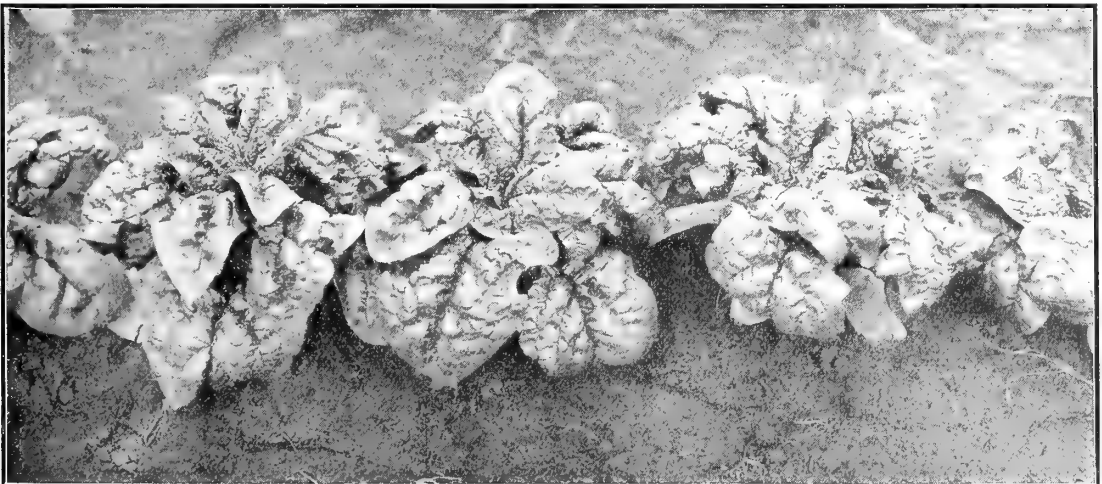

MANNS' RESELECTED BLOOMSDALE SAVOY

TOMATO

1 oz. to 2,000 plants; ¼ lb. per acre.

All our tomato seeds are grown from stocks, exclusively for seed purposes, by the originators, experienced growers and experts. We are fully convinced of the merit of all new varieties before placing them in our catalog, and therefore strongly recommend our strains as being absolutely reliable.

For early, the seed should be sown in hotbeds during February or the first week in March, in drills 5 inches apart and half an inch deep. Later sowing may be made until the last of April. When the plants are 3 or 4 inches high they should be set out 4 or 5 inches apart in another hotbed or cold frame, or removed into small pots allowing a single plant to the pot. Expose to the air as much as possible to harden. Water freely at time of transplanting, and shelter from the sun a few days until the plants are established. Cultivate thoroughly as long as the vines will permit, but the last two or three workings should be very shallow or the crop may be badly injured, especially if the cultivator is run too near the plants.

Extra Early Varieties

Improved Advance An extra early, large tomato of high quality, round or slightly flattened shape, and exceptionally smooth for such an early variety. As early and hardy as Earliana and yielding more fruit both in the first and subsequent pickings. It is more shapely, more free from cracks and shows less green about the stem than other extra early sorts. With Improved Advance the grower can produce a crop which will stand superior in appearance and quality, in competition with the other extra early and command the fancy prices of an early market. **Pkt., 10c; oz., 50c; ¼ lb., \$1.50; lb., \$5.00.**

Sparks' Earliana This is an extremely early variety and produces large clusters of fair-size fruits, which are very uniform in size and shape. It is hardy, and can be set out early. Color of flesh deep red, very solid and fine flavor. **Pkt., 10c; oz., 30c; ¼ lb., 90c; lb., \$3.00.**

IXL Extra Early For description see King of the Earlies. **Pkt., 10c; oz., 30c; ¼ lb., 90c; lb., \$3.00**

King of the Earlies A very productive and quite early variety, very similar to Sparks Earliana; the vines are somewhat heavier and leaves more plentiful, which furnish great protection for the fruit, and for this reason it has become a favorite with many growers. **Pkt., 10c; oz., 30c; ¼ lb., 90c; lb., \$3.50.**

Second Early and Main Crop Varieties

Bonny Best Our special strain of Bonny Best has become a favorite among large growers for the early market. It is truly so superior to the ordinary stocks that it might rightfully be considered a new variety. It is earlier than Chalk's Early Jewel, and within two or three days as early as Earliana. Very prolific, with liberal foliage to protect the fruit from the sun. The beautiful scarlet-red fruit is set in clusters of 5 or more. Its great characteristic is that it ripens each setting of fruit nearly all at once, and ripens evenly all over up to the stem. **Pkt., 10c; oz., 40c; ¼ lb., \$1.25; lb., \$4.00.**

Chalk's Early Jewel Ripens 10 days later than Sparks' Earliana, but more desirable for home use, as fruits are thicker through and more solid, comparing favorably with the later maturing sorts. Color bright scarlet and quality very best. **Pkt., 10c; oz., 30c; ¼ lb., \$1.00; lb., \$3.50.**

John Baer A second early variety, maturing 10 days later than the King of the Earlies. Fruit is borne in clusters of 3, of bright red color, averaging 3 inches across and 2¾ inches from stem to blossom end. **Pkt., 10c; oz., 30c; ¼ lb., \$1.00; lb., \$3.50.**

Wisdom Tomato Medium early, perfectly smooth deep red and uniform. **Pkt., 10c; oz., 35c; ¼ lb., \$1.00; lb., \$3.50.**

Livingston's Globe One of the main varieties grown by the leading Tomato growers in Florida. It is of beautiful globe shape, very deep through from blossom end to stem, which permits of a greater number of slices being taken than with the flat fruited sorts. Among the very first to ripen, although of large size; very smooth, firm fleshed, few seeds, ripens evenly; color a beautiful glossy rose-tinged purple. A good cropper and one of the best for greenhouse or first crop on stake or trellis. **Pkt., 10c; oz., 35c; ¼ lb., \$1.00; lb., \$3.50.**

Coreless A very large, uniformly globe-shaped, bright scarlet, main crop or late tomato. Fruits very solid, almost entirely free from green core and with little or no depression at stem end, making the variety especially desirable for slicing, canning and shipping. Vines very vigorous, blight resistant and productive. **Pkt., 10c; ¼ lb., \$1.00.**

Livingston's Beauty A decided favorite for home market or shipping, being early, hardy, a strong grower, productive, large, always smooth, of perfect shape and excellent quality. Color is very glossy crimson, with a tinge of purple. Grows in clusters of 4 to 6 large fruits, retaining its large size until late in the season. Ripens early, and is entirely free from ribbed or elongated fruits. **Pkt., 10c; ¼ lb., 90c; lb., \$3.00.**

Livingston's Early Perfection An improved Acme with a red skin, produces large fruit until the close of the season. Invariably smooth and of handsome blood-red color. Some canners prefer it to all others, especially those who can the tomatoes whole. It usually ripens 10 days ahead of Stone. **Pkt., 10c; oz., 35c; ¼ lb., 90c; lb., \$3.00.**

Kelley's Red The plants grow vigorously and are very productive. The fruit is very large, slightly flattened, bright scarlet, smooth, ripening evenly to the stem without a crack, twenty tons having been grown to the acre. **Pkt., 10c; oz., 25c; ¼ lb., 75c; lb., \$2.50.**

Matchless The vines are of strong, vigorous growth, well set with fruit, the foliage is very rich, dark green color. They are entirely free from core, of a very rich cardinal red color, and are not liable to crack from wet weather. The fruits are of the largest size, and this is maintained throughout the season, the healthy growth of foliage continuing until killed by frost. **Oz., 30c; ¼ lb., 90c; lb., \$3.00.**



Bonny Best Tomatoes

TOMATO—Continued

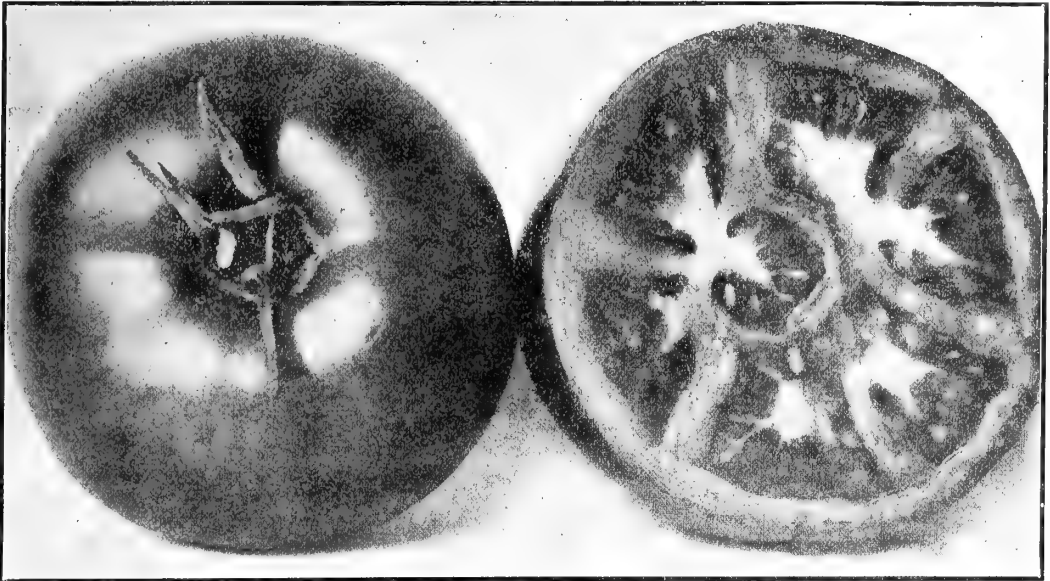

MARYLAND PRIDE TOMATO

Maryland Pride Since our introduction of it in 1905 it has been grown with great success by canners and market gardeners, who pronounce it "the very best second early and main crop Tomato they have every grown." The fruit is a beautiful bright red color, magnificent size and handsome, smooth shape. The vines grow vigorously, and produce abundantly until killed by frost. **Pkt., 10c; oz., 30c; ¼ lb., 90c; lb., \$3.00.**

Enormous So named on account of the large size of Tomatoes, which are very solid and smooth. Quality good. **Pkt., 10c; oz., 40c; ¼ lb., \$1.25; lb., \$4.00.**

Greater Baltimore Large, smooth, solid, bright scarlet; second early Tomato; a prolific bearer and fine shipper. **Pkt., 10c; oz., 40c; ¼ lb., 90c; lb., \$3.00**

Favorite, or Queen Large size, ripens evenly and early, very prolific, red color; flesh solid and good flavor. **Pkt., 10c; ¼ lb., 60c; lb., \$2.25.**

Ponderosa The largest purple fruited Tomato in cultivation; very solid and of finest quality. **Pkt., 10c; oz., 40c; ¼ lb., \$1.25.**

Buckeye State, or Duke of York

One of the largest; fruits in immense clusters; solid and meaty. Color similar to Beauty, but darker and richer. **Pkt., 10c; ¼ lb., \$1.00; lb., \$3.50.**

Red Rock By close comparison of this new Tomato we find several strong points in its favor; extreme hardness, size of fruit and productiveness. Compared with Livingston's New Stone, they yield one-third more Tomatoes of a deeper red; in beauty of coloring and symmetry of form it is indeed without a peer. The vines are of strong, vigorous growth, with very rich, dark green foliage. The rich cardinal red fruit has very tough skin, and is not able to crack from wet weather. **Oz., 30c; ¼ lb., 90c; lb., \$3.00.**

PRESERVING TOMATOES

The following small-fruited varieties are used for making preserves, and are also quite ornamental while growing in the garden:

- Pear-Shaped Red
 - Pear-Shaped Yellow
 - Yellow Plum
- } **Pkt., 10c; oz., 30c; ¼ lb., \$1.00.**

TOMATO PLANTS—*Fresh Daily*

Stocky, well rooted plants, grown from our own Superior Seeds, all leading varieties, ready from April to July.

See Page 33

New Stone This variety has attained great favor with canners and market gardeners everywhere. Its solidity and carrying qualities are remarkable. Its color is a desirable red; in shape perfectly smooth, and thicker from stem to blossom end than most varieties, making it most handsome and salable. **Pkt., 10c; oz., 25c; ¼ lb., 75c; lb., \$2.50.**

B. B. Tomato For description see New Stone. **Pkt., 10c; oz., 25c; ¼ lb., 75c; lb., \$2.50.**

Livingston's Paragon Color of skin deep red. Flesh solid and highly flavored. It is larger than several of the standard varieties, and grows large fruit up till frost. **Oz., 25c; ¼ lb., 75c; lb., \$2.50.**

Success The vines are of strong, vigorous growth, with abundant foliage. The fruits, set in clusters, average three inches in diameter and two to two and a half inches through from stem to blossom end. Color brightest scarlet; perfectly smooth; very meaty; of fine flavor. **Pkt., 10c; ¼ lb., 90c; lb., \$3.00.**

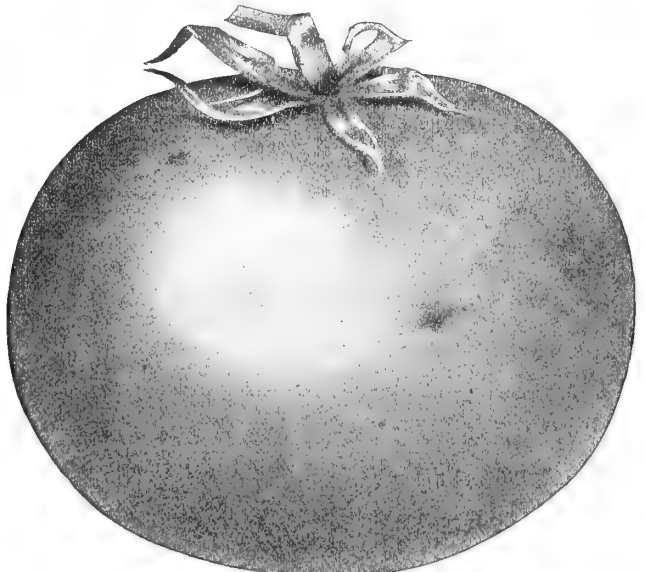

Red Rock Tomato

TURNIP

1 oz. to 150 feet of drill; 1 lb. per acre.

Being primarily a cool weather vegetable, turnips thrive best when planted in early spring or in the fall. For spring crop sow the seed early in April, while for fall and winter use, plantings should be made from July to August. Sow in rows not less than 18 inches apart and one-half to three-quarters of an inch deep. A very popular method, however, is to broadcast the seed between rows of corn or in the cultivated orchard. Proper control of root maggots is effected by rotation of crops, the use of commercial fertilizers instead of manure and the application of Mag-o-tite or other carbolic acid emulsion.

Extra Early Purple Top Milan A white variety, purple-top and strap leaf. This, with the White Milan, is the earliest of all turnips. Remains in good condition a long time. Oz., 10c; ¼ lb., 25c; lb., 75c.

Extra Early White Milan Similar to above, except it is pure ivory white in color, and about one week earlier. Oz., 10c; ¼ lb., 25c; lb., 75c.

White Early Flat Dutch A standard variety, good size, pure white; small top, few leaves and very sweet. ¼ lb., 15c; lb., 40c.

Purple Top Strap Leaf The popular variety, either for family or market use large size, white, purple above ground, flesh fine grained. ¼ lb., 15c; lb., 40c.

Yellow Globe Orange Jelly One of the best for general crop; flesh firm and sweet; grows to a large size; splendid for table or stock, and keeps well until late in spring. ¼ lb., 20c; lb., 50c.

Purple Top White Globe Also known as Red Top White Globe. This excellent turnip is decidedly the most popular variety and more extensively grown than any other. The roots are globular, very handsome and of superior quality; either for table use or stock feeding purposes. It is a heavy producer, early, of rapid growth, and one of the best for winter storage. ¼ lb., 15c; lb., 50c.

Cow Horn Very heavy cropper, a quick grower, most practical for stock feed. ¼ lb., 15c; lb., 40c.

Seven Top This variety is principally planted in the South for the green tops which are produced very abundantly. ¼ lb., 20c; lb., 50c.

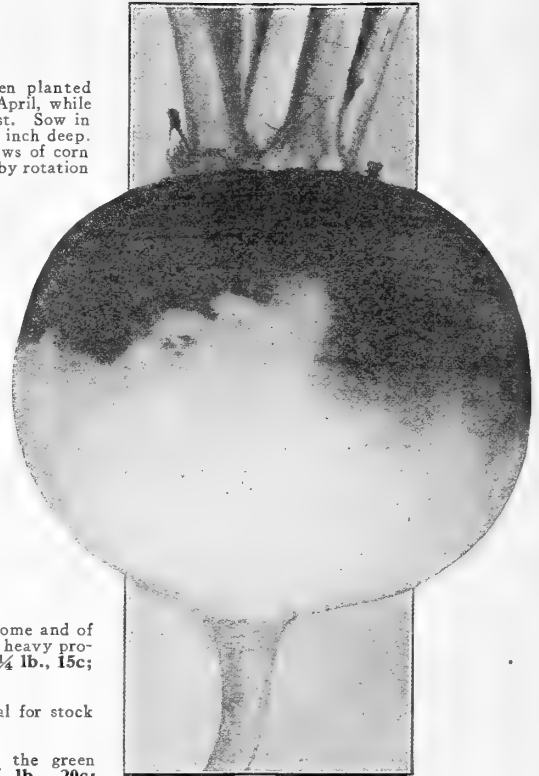

Purple Top White Globe Turnip

RUTABAGAS or SWEDES

Rutabagas require about four weeks longer to mature than ordinary varieties of turnips, but are more solid, of firmer flesh and therefore keep later into the spring. They are for this reason more desirable for storage, while turnips are better adapted for the early market. Sow during July either in drills or broadcast.

Neckless Purple Top Our superb strain of this excellent variety has become a favorite because of its hardy and productive nature. The flesh is sweet and solid, excellent for table use or stock feeding. ¼ lb., 25c; lb., 75c.

MANNS' HIGH GRADE FERTILIZER

When Thinking of Fertilizer, Do Not Overlook the High Value of Clovers, Cow Peas, Soy Beans, Vetches, Etc., For Plowing Under as Green Manure.

Bone Meal (Extra Fine) An excellent fertilizer especially recommended for lawns, rose bushes, grape vines, and deep rooted shrubbery, where it is desired to furnish the plants with a perfectly safe, slow acting but continuous supply of nourishment. Florists and nurserymen use large quantities of our bone meal very successfully. 2 lbs., 15c; 10 lbs., 50c; 50 lbs., \$2.00; 167 lb. bag, \$4.80. (Add transportation charges). Special price on large quantities.

Commercial Fertilizers Animal Base. (Not Chemical). This class of fertilizer can be supplied in a number of combinations, each having a guaranteed analysis which will prove most helpful to the crop for which it is intended. Our volume of business in vegetable fertilizers is rapidly increasing, because our customers have found our stock to be strictly first class, dependable, low priced, and productive of the best crops in competition with other brands.

- 2-10- 2 \$2.70 per 167-lb. bag; \$27.00 per ton
- 5- 8- 0 3.60 per 167-lb. bag; 36.00 per ton
- 4- 8- 4 3.70 per 167-lb. bag; 37.00 per ton
- 4- 8-10 4.50 per 167-lb. bag; 45.00 per ton

Sheep Manure One of the most popular fertilizers for lawns, garden crops and potted plants; of high analysis, thoroughly dried and pulverized, giving lasting results. For top dressing of lawn, use 1 ton per acre, applying in fall or early spring. For garden crops use 1 to 2 tons per acre, turning half the quantity under and top dressing the remainder. Clean to handle and very effective. 5 lbs., 25c; 50 lbs., \$1.50; 100 lb. bag, \$2.50. Special price in quantities.

Land Plaster Useful as a medium for retaining moisture and the fluids and ammoniates of manure. Also used for dipping potatoes after they have been cut for seed, sealing the cuts as a protection and also supplying nourishment. 200 lb. bag, \$2.25. Special price in quantities.

Nitrate of Soda Highly soluble, quick in action and hastens the maturity of crops fully two weeks. Will not take the place of other fertilizer but supplies the growing crop with an abundance of nitrogen which greatly assists the plants to make use of other nourishment already in the soil. Lb., 8c; 10 lbs., 55c; 100 lbs., \$3.75; 167-lb. bag, \$6.00. Special price on quantities. (Add transportation charges).

Blood Meal One of the best plant foods for forcing flowers and vegetables. Excellent for Rose Bushes during blooming season. 10c per lb., 3 lbs., 25c; 100 lbs., \$4.50.

Hydrated Lime Especially useful for correcting acid condition of soils in gardens and lawns. 50 lb. bag, 55c.

Manns' Vegetable Plants And Roots

We are large producers of the following plants and can fill orders daily with fresh, strong, stocky plants grown from the best strains of seed. Varieties not grown by ourselves are contracted for with the most reliable and trustworthy plant growers in this section, who, we know from experience, produce only the best plants. We shall be pleased to quote special prices on lots of 5,000 or more.

CABBAGE PLANTS. Frame-grown and transplanted.

(Ready in March and April).

- Early Jersey Wakefield. Pointed head.
- Charleston Large Wakefield. Pointed head.
- Copenhagen Market. Round head.
- Eureka First Early. Flat head.
- All Head or New Early. Flat head.

Postpaid, per 100, 75c; 1,000, \$4.50.

CABBAGE PLANTS. Field-grown, strong and stocky (Ready May and June).

- All Head Early. Flat head.
- Early Flat Dutch. Flat head.
- Volga. Larger round head.
- Early Summer. Flat head.
- Succession. Flat head.
- Improved Lupton. Flat head.
- Large Late Flat Dutch. Flat head.
- Imperial Drumhead Savoy. Flat head.

Postpaid, per 100, 50c; 1,000, \$3.50.

CABBAGE PLANTS. For late planting. (Ready September and October).

- Extra Early Jersey Wakefield. Pointed head.
- Charleston, or Large Wakefield. Pointed head.
- All Head, or New Early. Flat head.

Postpaid, per 100, 50c; 1,000, \$3.00.

CAULIFLOWER PLANTS. (Ready in March, July and August).

Postpaid, per doz., 25c; 100, \$1.50; 1,000, \$12.00

BORECOLE PLANTS. (Ready in May and June).

- Hardy Winter.
- Dwarf Green Scotch.

Postpaid, per 100, 75c; 1,000, \$4.50.

CELERY PLANTS. (Ready in July).

- American Self-Blanching.
- Columbia.
- Giant Pascal.
- Winter Queen.

Postpaid, per 100, \$1.10; 1,000, \$6.00.

CELERY PLANTS. Grown from French seed.

- Golden Self-Blanching.

Per 100, \$1.25; 1,000, \$8.00.

EGG PLANTS. (Ready in May and June).

- Mammoth Imp. Purple.
- Black Beauty.

Postpaid, per doz., 25c; 100, \$1.50. By express, 1,000, \$10.00.

STRAWBERRY PLANTS

We can supply fresh, strong, healthy plants of all the leading varieties in any quantity. Following is a partial list of the most popular sorts for planting in the vicinity of Baltimore.

- Mitchell's Early. Extra early.
- Bib Joe. Midseason.

Gandy. Late, very productive.

\$1.50 per 100; \$9.00 per 1,000. Postage or expressage extra.

EVERBEARING

PROGRESSIVE. Undoubtedly the best everbearing variety in cultivation, producing a large crop of high quality fruit the same year they are set out. The main crop ripens in the fall.

\$2.75 per 100; 1,000, \$15.00. Postage or expressage extra.

GET OUR PRICE ON BERRY BOXES

LETTUCE PLANTS. (Ready in March, April, September and October).

Postpaid, per 100, 50c. By express, 1,000, \$4.00.

PEPPER PLANTS. (Ready in May and June).

- Ruby Giant.
- Chinese Giant.
- Perfection.

Postpaid, per doz., 25c; 100, \$1.50. By express, 1,000, \$10.00.

PEPPER PLANTS.

- Ruby King.
- Bull Nose and Needle.

Postpaid, per doz., 25c. By express, 1,000, \$8.50

SWEET POTATO PLANTS. (Ready May and June):

- Up Rivers.
- Big Stems.
- Yellow Jerseys.

Postpaid, per 100, \$1.00. By express, 1,000, \$7.00.

TOMATO PLANTS. Hotbed grown. (Ready in April and May).

- King of the Earlies.
- I. X. L.
- Bonny Best.

Maryland Pride.

Postpaid, per doz., 20c; 100, 75c. By express 1,000, \$5.00.

TOMATO PLANTS. Field-grown plants. (Ready June and July).

- Maryland Pride.
- Red Rock.
- New Stone.
- Greater Baltimore.

By express, per 100, 60c; 1,000, \$4.00; 5,000, \$18.00.

ASPARAGUS ROOTS. See page 1.

HORSERADISH ROOTS.

Maliner Kren or Bohemian.

Postpaid, doz., 25c; 100, \$1.25; 1,000, \$9.00.

RHUBARB ROOTS. (Best market varieties).

Postpaid, each, 15c; doz., \$1.50; 100, \$9.00.



Clean, Odorless, Easy-to-Use Tablets that contain every element needed to feed the roots and start vigorous, healthy growth.

Especially recommended for potted plants, flower gardens, shrubbery and home vegetable growing. More effective than the finest fertilizer. Acts quickly, results usually appearing in ten to fourteen days.

25c 50c and \$1.00

Packages containing full directions.

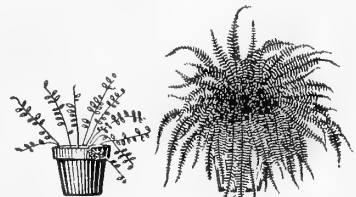

Before

After

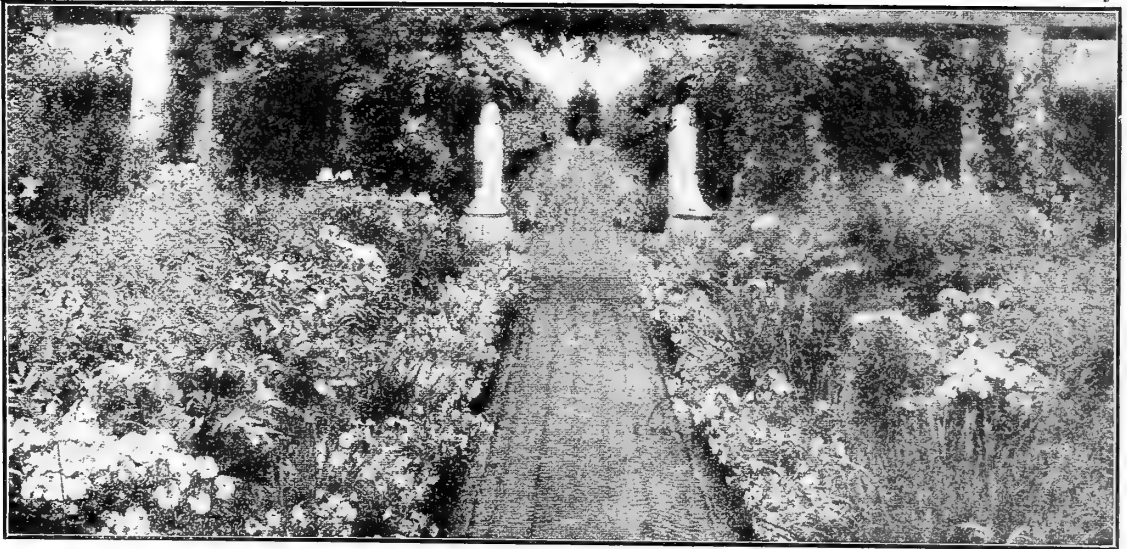

MANNS' SUPERIOR FLOWER SEEDS

Our constant aim is to supply our customers with the very best domestic and imported strains obtainable. We spare no expense in our efforts to maintain the highest standard of quality. Our list contains those varieties which are most popular because of their beauty, usefulness, and ease of cultivation.

Annuals are those which attain full growth, bloom and die the same year, and are raised from seed exclusively.

Biennials attain full growth, bloom and die the second year from the planting of seed.

Perennials produce plants the first year, which with a few exceptions do not flower until the second year from planting of seed after which they bloom every year and last several years.

The class to which each variety belongs is indicated as follows: (A) for Annuals; (B) for Biennials; (P) for Perennials.

AGERATUM (A)

Splendid for bedding or pot culture, covered from June until frost with a mass of very attractive flowers of a tufted appearance. Very effective when contrasted with geraniums. **Large-flowered White, large-flowered Blue or Mixed.** Pkt., 10c; $\frac{1}{4}$ oz., 25c.

ALYSSUM (A)

Sweet Alyssum. Little Gem. Very popular border flower, coming into bloom six weeks after planting seed and requiring the least attention of all flowers. Very erect and dwarf, its white flowers greatly enhancing the beauty of any bed or border. Height 4 inches. Pkt., 10c; $\frac{1}{4}$ oz., 15c; oz., 45c.

AMARANTHUS (A)

Very useful in borders of tall plants, among shrubs, or in centers of large beds. One type has large feathery plumes or sprays of rich crimson coloring while the other is grown exclusively for the brilliant-colored leaves.

CAUDATUS. (Love Lies Bleeding). Plants of erect growth three to four feet high, producing numerous feather sprays of rich crimson color. Pkt., 5c; oz., 15c.

SALICIFOLIUS. (Willow-Leaved or Fountain Plant). Grows two to three feet high, with long hanging flower heads and foliage of a deep purple coloring. Pkt., 10c; $\frac{1}{4}$ oz., 40c.

SPLENDENS. (Rainbow Plant). Beautiful variegated foliage with large crimson flower heads. Pkt., 10c; $\frac{1}{4}$ oz., 25c.

TRICOLOR. (Joseph's Coat). Similar to Splendens, having a single erect stalk of brilliantly colored foliage. Pkt., 5c; $\frac{1}{4}$ oz., 15c.

ANTIRRHINUM or Snapdragon (P)

This border and bedding plant of long blooming season is now one of the best perennials suitable for flowering as an annual. The long showy spikes of curiously-shaped tubular flowers with spreading lobes and finely marked throats are fragrant as well as brilliantly-colored. They are very desirable for cutting as the blooms are borne well above the dark glossy leaves and keep fresh for a long time.

For flowers the first season outdoors, sow seed very early under glass and transplant to open border as soon as the ground is warm and dry, in rich loamy soil in a sunny situation, setting one foot apart each way and giving them plenty of water; or sow the seed in August or September and cover the plants with a mulch on approach of cold weather. These fall-sown plants may be transplanted into pots and flowered, and treatment as geraniums and carnations. Tender perennial, often treated as an annual or biennial, attains a growth of one and one-half to two feet high. Special mixtures of the very best delicate colors. **Giant mixed, pkt., 10c; $\frac{1}{4}$ oz., 35c; oz., \$1.25. Semi-dwarf mixed, pkt., 5c; $\frac{1}{4}$ oz., 15c; oz., 40c. Separate colors, pkt., 10c; oz., \$1.00.**

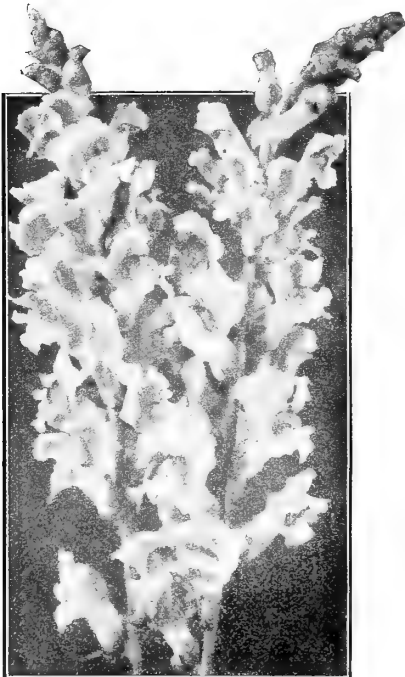

Antirrhinum

in this case give them the same temperature and treatment as geraniums and carnations. Tender perennial, often treated as an annual or biennial, attains a growth of one and one-half to two feet high. Special mixtures of the very best delicate colors. **Giant mixed, pkt., 10c; $\frac{1}{4}$ oz., 35c; oz., \$1.25. Semi-dwarf mixed, pkt., 5c; $\frac{1}{4}$ oz., 15c; oz., 40c. Separate colors, pkt., 10c; oz., \$1.00.**

AQUILEGIA OR COLUMBINE

(P)

As a cut flower the long spurred Aquilegias are the daintiest of our outdoor grown flowers. Very hardy, blooming profusely early in the season and remaining in bloom for a considerable period. Pkt., 10c; $\frac{1}{4}$ oz., 30c.

ASTERS (A)

Very popular because of their beauty and ease of culture. The varieties listed represent the finest Asters of the early, midseason and late types and will give a profusion of bloom from July to late October. Asters require good rich soil and during the growing period should be well supplied with water.

QUEEN OF THE MARKET. Branching habit, 1 ft. high, large flowers borne on long stems, blooming in July. Mixed colors, pkt., 10c; $\frac{1}{4}$ oz., 25c; oz., 75c.

GIANT COMET. Very distinctive, the outer petals being broad, flat and reflexed, while the center of the flower has a feathery appearance. Follows Queen of the Market in season and grows 12 to 24 inches high. Deep scarlet, dark blue, light blue, delicate yellow, snow white and rose. Pkt., 10c; $\frac{1}{4}$ oz., 35c; oz., \$1.25. Mixed, $\frac{1}{4}$ oz., 20c; oz., 65c.

CREGO. Flowers of immense size, 4 to 5 inches in diameter borne on very long stems. Plants are of strong branching growth, 2 to 2 $\frac{1}{2}$ feet high. Separate colors, pkt., 10c; $\frac{1}{4}$ oz., 40c; Mixed pkt., 10c; $\frac{1}{4}$ oz., 35c.

AMERICAN LATE BRANCHING. A handsome and very distinct variety resembling Japanese Chrysanthemums. The plants grow 1 $\frac{1}{2}$ feet in height and width and the large full petaled blossoms are borne on long stems or branches. Comes into flower ten days later than other asters. Separate color, pkt., 10c; $\frac{1}{4}$ oz., 35c; Mixture, pkt., 10c; $\frac{1}{4}$ oz., 30c.

BELLIS PERENNIS-DOUBLE DAISY (P)

Favorite perennials producing their handsome double flowers in the spring. Rich soil and a cool situation suit them best.

MONSTROSA. Extra double giant flowered red, pink or white. Pkt., 10c; $\frac{1}{4}$ oz., \$2.00.

LONGFELLOW. Red, large flowered. Pkt., 10c; $\frac{1}{4}$ oz., \$1.25

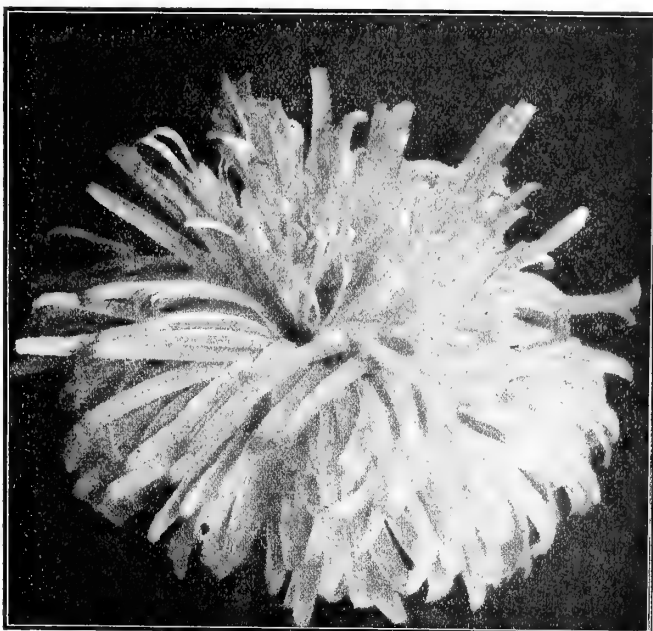

Giant Comet Aster

BALSAM or LADY SLIPPER (A)

An easy growing annual of quick growth, producing numerous flowers resembling tiny roses. Splendid double mixed, pkt., 5c and 10c; oz., 25c.

COREOPSIS - CALLIOPSIS (A)

Very handsome and showy plants with numerous flowers of brilliant colors excellent for bouquets. Thrive well in any soil. Pkt., 10c; oz., 25c.

CALENDULA—POT MARIGOLD (A)

effective in beds or potted; showy, free-flowering, hardy annuals. Extra Double Orange Giant. Pkt., 10c; oz., 40c. Finest mixed, pkt., 10c; oz., 20c.

Campanula-Canterbury Bells (B)

An old-fashioned favorite, stately, showy, and easily grown, hardy biennial. Single pkt., 10c; $\frac{1}{4}$ oz., 15c. Double Pkt., 10c; $\frac{1}{4}$ oz., 30c.

CANDYTUFT (A)

This hardy annual is universally known and its clusters of small flowers are very beautiful and useful for cutting and borders.

EMPRESS. Large spikes of the purest white, erect growth. Pkt., 5c and 10c; oz., 25c.

FINEST MIXTURE OF ALL COLORS. Pkt., 5c and 10c; oz., 20c.

CARNATIONS (P)

With protection these well known half-hardy perennials can be wintered over outdoors. When planted early they will begin to bloom in about four months and continue until late in the fall. For winter blooming they should be cut back by removing the flower shoots early in the fall and transplanted to pots and kept in a cool room.

AMERICAN GIANT HYBRIDS. Finest quality mixed. Pkt. 10c; 100 seeds, 75c.

BORDER or GARDEN Carnations. Extra Double Flowered. Pkt., 10c; $\frac{1}{4}$ oz., 50c.

VIENNA. Early flowering, extra double dwarf mixed. Pkt., 10c, $\frac{1}{4}$ oz., 60c.

PERPETUAL (Famous Chabaud type). Choicest mixture. Pkt., 10c; $\frac{1}{4}$ oz., 70c.

PERPETUAL. (Very popular Marguerite type) Half dwarf mixed. Pkt., 10c; $\frac{1}{4}$ oz., 45c.

Pure White or Pure Pink. Pkt., 10c; $\frac{1}{4}$ oz., 75c.

CELOSIA or COCKSCOMB (A)

PLUMOSA. Feathered varieties mixed. Pkt., 5c; $\frac{1}{4}$ oz., 15c.

EMPRESS. Dark-leaved, bright crimson. Pkt., 10c; $\frac{1}{4}$ oz., \$1.15.

GLASGOW PRIZE. Pkt., 10c; $\frac{1}{4}$ oz., \$1.00.

CHILDSII. (Chinese Woolflower). Pkt., 10c.

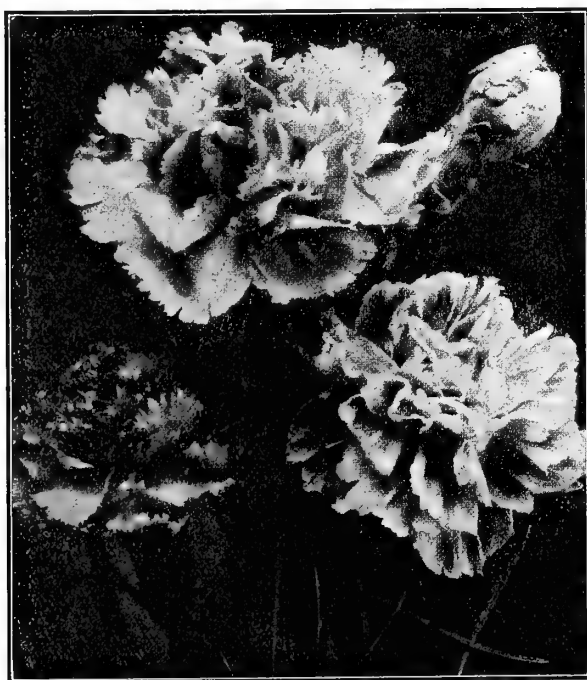

Marguerite Carnations

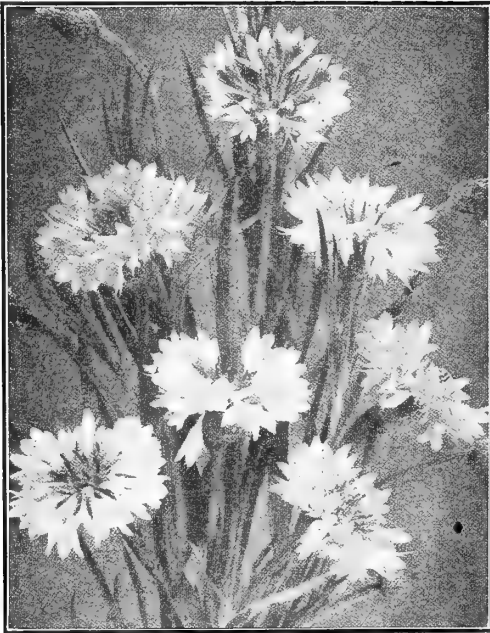

Centaurea Cyanus or Bachelors' Button

CENTAUREA (A)

CENTAUREA CYANUS or **BACHELOR'S BUTTON** or **CORN FLOWER**. Charming old-fashioned flowers, requiring little or no care and flowering within eight weeks from planting of seed. Free and uninterrupted in its flowering habit, reseeding itself year after year. Useful as a cut flower as well as a garden decoration. Double blue or double mixed. Pkt., 5c and 10c; $\frac{1}{4}$ oz., 15c.

CENTAUREA GYMNOCARPA or **DUSTY MILLER**. One foot, foliage finely cut of silvery gray color, used for bedding. Pkt., 10c; $\frac{1}{4}$ oz., 15c.

CENTAUREA MOSCHATA or **SWEET SULTAN**. Beautiful, sweet scented, artistic shaped flowers borne on long stems, when cut will last for several days. Yellow. Pkt., 10c; $\frac{1}{4}$ oz., 25c.

CHRYSANTHEMUM (P and A)

The annual Chrysanthemums are free-blooming, easily grown plants, having large flowers in a variety of brilliant colors, fine for cutting.

CARINATUM, The Sultan. Double, brilliant scarlet.

Aureum. Large double yellow.

Dunnetti. Free flowering double white.

Mixed. Finest double hybrids.

Pkt., 5c and 10c; $\frac{1}{4}$ oz., 20c; oz., 45c.

Perennial Chrysanthemums are grown chiefly from divisions of roots of the Japanese varieties and cultivated by florists for late fall and winter cut flowers. The following perennials however, can be very satisfactorily grown from seed, producing beautiful, double flowers.

INODORUM PLENISSIMUM. Pkt., 10c; $\frac{1}{4}$ oz., 25c.

BRIDAL ROBE. Pkt., 10c; $\frac{1}{4}$ oz., 50c.

MAXIMUM PERFECTION. Pkt., 10c; $\frac{1}{4}$ oz., 25c.

MAXIMUM KING EDWARD. Pkt., 10c; $\frac{1}{4}$ oz., 30c.

MAXIMUM LACINIATUM. Pkt., 10c; $\frac{1}{4}$ oz., 30c.

CINERARIA (P—Greenhouse)

Among the most ornamental plants that can be grown for hot-house or conservatory decoration, producing large heads of brilliant flowers in all shades of blue, purple and red. One of the most beautiful potted plants.

HYBRIDA. Extra large flowered, first quality mixture. Pkt., 50c; $\frac{1}{8}$ oz., \$6.75.

MARITIMA. Entirely different from the popular Cineraria, being most useful for bedding. Silver-leaved; also called Dusty Miller. Pkt., 5c; $\frac{1}{4}$ oz., 15c.

CLARKIA (A)

Very pretty, profuse flowering annuals, much used for edging. They grow from nine to eighteen inches high, producing mostly red or white flowers. Useful for hanging baskets. Pkt., 5c; $\frac{1}{4}$ oz., 15c.

CLEMATIS. See page 43.

COLEUS (P—Tender)

An attractive foliage plant for ornamental bedding. Finest hybrid mixture. Pkt., 25c; $\frac{1}{4}$ oz., \$2.00.

COSMOS (A)

One of the most satisfactory hardy annuals, flowering in late summer. Fine for cutting and easily grown. Can be sown anywhere and transplanted. Grows 4 to 6 feet high. Mammoth large flowered. Mixed and early flowering mixed, pkt., 5c; $\frac{1}{4}$ oz., 10c; Double-crested mixed, pkt., 10c; $\frac{1}{4}$ oz., \$1.25.

CYCLAMEN (P—Tender)

Universally admired, tuberous rooted house plants with beautiful foliage and richly colored flowers. Sow the seed in light rich soil, barely covering, and keep at a temperature of 50 to 60 degrees F. Water freely until well started. Seeds sown in spring, by autumn will produce little bulbs, which placed in pots will bloom the following spring.

AMSTERDAM GIANTS, Florists Prize Mixture. Pkt., 25c; 100 seeds \$2.00; $\frac{1}{16}$ oz., \$3.00.

DAHLIA (P—Half Hardy)

For Roots, see page 43.

Seed should be planted very early indoors and the plants transplanted in May or June. Most of the plants will bloom the same year. The roots should be dug before freezing weather and stored in sand in a cool place.

GIANT FLOWERED. Choice mixed. Pkt., 25c; $\frac{1}{4}$ oz., \$3.00.

EXTRA DOUBLE. Large flowered choice mixed. Pkt., 10c; $\frac{1}{4}$ oz., 75c.

CACTUS HYBRIDS. Extra double mixed. Pkt., 25c; $\frac{1}{4}$ oz., \$1.50.

DATURA (A)

Large branching plants producing very large handsome, double double or single, trumpet-shaped blossoms of exquisite fragrance. Excellent for late summer and autumn flowering. Mixed colors Pkt., 10c; $\frac{1}{4}$ oz., 20c.

DELPHINIUM or HARDY LARKSPUR (P)

Splendid border perennial of vigorous growth, strikingly effective as a background for borders and for planting among shrubbery. The blooming season is very long and the beautiful irregular flowers are clustered on long spikes 3 to 5 feet high. Double and semi-double varieties mixed. Pkt., 10c; $\frac{1}{4}$ oz., \$1.00.

BELLADONNA. Pkt., 10c; $\frac{1}{4}$ oz., \$1.50.

DIANTHUS OR PINKS (B)

These very beautiful and popular biennials flower freely the first year from seed, and in most locations they are quite hardy and produce larger flowers the second year.

CHINENSIS. Extra double flowered in choicest mixture. Pkt., 5c; $\frac{1}{4}$ oz., 15c.

HEDDEWIGII. Fringed single, very large flowers. Pkt., 5c; $\frac{1}{4}$ oz., 15c.

HEDDEWIGII PLUMARIUS. Double and semi-double mixed. Pkt., 10c; $\frac{1}{4}$ oz., 75c.

FLORISTS PERPETUAL. Large clusters, fragrant, very useful for cut flowers. Double mixed. Pkt., 10c; $\frac{1}{4}$ oz., 30c.

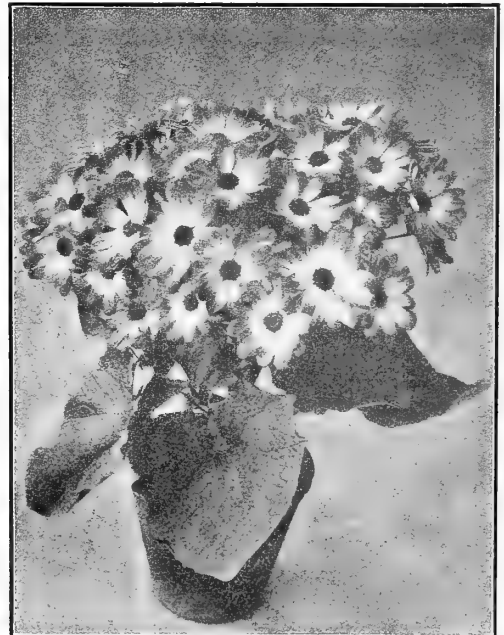

Cineraria—Hybrida

DIGITALIS or FOXGLOVE (P)

Handsone and highly ornamental hardy perennial plant of stately growth, very effective among shrubbery, thriving best in half-shady places. Three feet high. Finest mixed. **Pkt., 10c; ¼ oz., 20c.**

GAILLARDIA GRANDIFLORA (P)

A very showy flower easily raised from seed. Should be sown early to produce large plants which will bloom profusely the first year. Very beautiful in beds or borders and very useful for cutting. Extra fine mixed. **Pkt., 10c; ¼ oz., 20c.**

GLOBE AMARANTH - GOMPHRENA (A)

Similar in type to Bachelor's Button but having flowers of perfect globe shape. Mixed colors. **Pkt., 5c; oz., 25c.**

HILICHRYSUM-EVERLASTING FLOWER

Also called Immortelles and Strawflowers. The Helichrysum is the most beautiful of all the everlastings. The plants grow from two to three feet high and are literally covered with fine, large, double flowers in a variety of brilliant colors. The blooms should be cut as soon as they are open, tied in small bunches and dried slowly in a dark cool place, hanging the flowers downward to keep the stems straight.

Monstrosum. Double, first quality, mixed. **Pkt., 5c and 10c; ¼ oz., 20c; oz., 60c.**

HELIOTROPE (P—Half Hardy)

The delightful fragrance and duration of bloom of this flower make it a garden favorite. Can be grown from seed as easily as Verbenas, and should be started early so that large plants may be had for bedding out. The colors of the blossoms range from white through all shades of violet to the deepest purple.

GIANT LEMOINI, mixed. **Pkt., 10c; ¼ oz., 75c.**

HESPERIS MATRONALIS-SWEET ROCKET (P)

Old fashioned garden plants growing 2 to 3 feet high, bearing spikes of white or purple flowers. Excellent for planting in a border or among shrubbery. **Pkt., 5c; ¼ oz., 15c.**

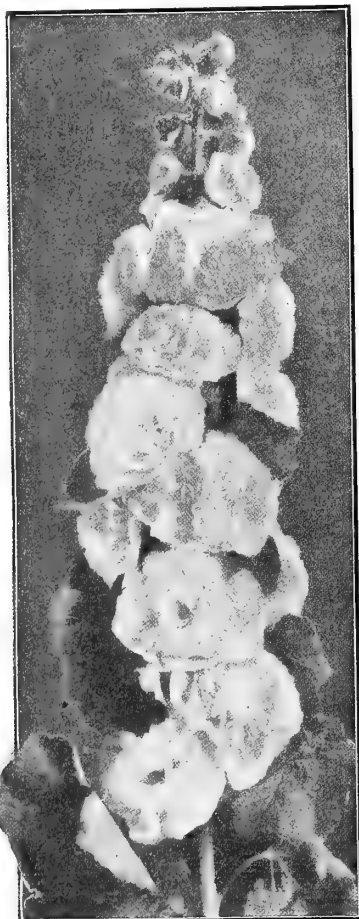

Double Hollyhock

HOLLYHOCK (P)

All old-fashioned garden perennial of great beauty, very useful as a background to a flower garden. The large, richly colored blossoms are crowded around the strong flowering stalks. Seed planted in open ground in June or July will furnish blooms the following summer.

DOUBLE MIXED. Extra fine quality. **Pkt., 10c; ¼ oz., 40c.**

SINGLE MIXED. Large very artistic blooms. **Pkt., 10c; ¼ oz., 30c**

KOCHIA - SUMMER CYPRESS (A)

Quick growing hedge plant about two and one-half feet high. Very symmetrical and attractive, the bushes taking on a distinctive red tinge late in the summer; for this reason often called Mexican Fire Bush. **Pkt., 5c; oz., 15c.**

LARKSPUR (A)

One of the best known of garden flowers and if planted in April will produce flowering plants by the first of July and continue to bloom until frost.

IMPERIAL DOUBLE MIXED. **Pkt., 5c; ¼ oz., 15c.**

For Perennial Larkspur see Delphinium.

LANTANA (P—Half Hardy)

One of the most desirable greenhouse or bedding plants, constantly in bloom, somewhat resembling Verbenas; 2 to 3 feet. Mixed colors. **Pkt., 5c; ¼ oz., 15c.**

LOBELIA (P)

ERINUS COMPACTA. This charming variety forms compact bushes about 6 inches high and are covered with bloom throughout the season. Highly desirable for edging and garden decoration as well as for pot culture. They flower the first season from seed. **Pkt., 10c; ¼ oz., 75c.**

LUPINUS (A)

Free-flowering, easily grown annuals with long graceful spikes of richly colored pea-shaped flowers. Prefers a little shade. 2 feet high.

DWARF ANNUAL MIXED. All colors. **Pkt., 5c; ¼ oz., 15c.**

TALL MIXED. Blooms in May and June. 3 feet high. **Pkt., 10c; oz., 25c.**

LYCHNIS (P)

Handsome hardy perennial plants of easy culture, for massing in beds and borders; blooming the first year if sown early. Very popular by reason of their beauty and ease of culture. Also called Maltese Cross, Jerusalem Cross, Lamp Flower and Burning Star. 1 foot high.

CHALCEDONICA. Scarlet or white. **Pkt., 10c; ¼ oz., 15c.**

HAAGEANA HYBRIDA. Brilliant colors mixed. **Pkt., 10c; ¼ oz., 75c.**

VISCARIA SPLENDENS (Ragged Robin). Bright rose-red, very showy. **Pkt., 5c; ¼ oz., 15c.**

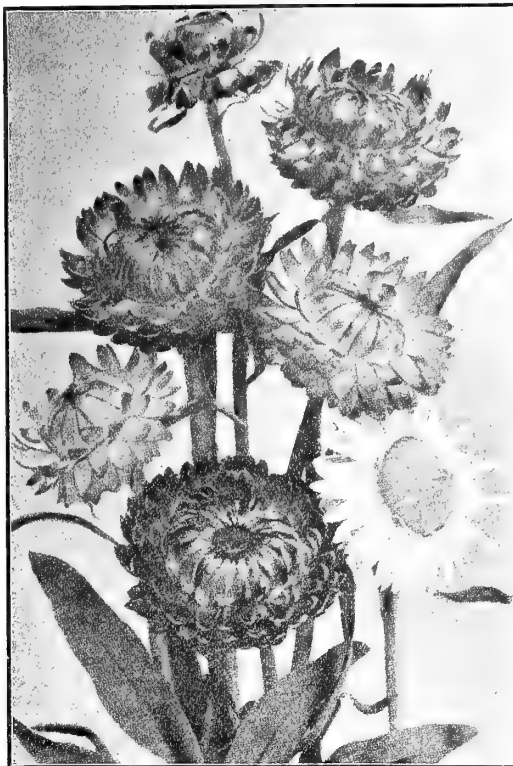

Helichrysums

MARIGOLD (A)

The African and French Marigolds are old favorite free-flowering annuals of easy culture, extremely effective and well adapted for large beds. Thrive best in a light soil fully exposed to the sun. The flowers of the French type are smaller than the African but are marked and spotted with varied shades of red and orange. The African are very large, double and in solid colors.

AFRICAN. Double, extra mixed, first quality. Pkt., 5c; ¼ oz., 20c.

FRENCH. Dwarf double mixed. Pkt., 5c; ¼ oz., 40c.

MARVEL OF PERU - FOUR O'CLOCK (A)

Large showy fragrant flowers, blooming the entire season. Succeed well in any ordinary garden soil in a sunny location. Mixed. Pkt., 5c; oz., 20c.

MESEMBRYANTHEMUM (A)

CRYSTALLINUM or **ICE PLANT.** Dwarf trailing annual plants. Flowers white, prized for its distinctive icy foliage. Pkt., 5c; ¼ oz., 10c.

MIGNONETTE (A)

Well known fragrant bedding or potting plant. Sowings made in April and again in July will result in a succession of bloom from early summer until frost.

GOLIATH. Large flowering. Pkt., 5c; ¼ oz., 25c.

MACHET GIANT. Large spikes, very fragrant. Pkt., 10c; ¼ oz., 15c.

MIMULUS (P—Half Hardy)

Showy, profuse flowering plants, fine for greenhouse or moist shady situations, blooming the first year from seed if sown early; 1 foot high. Often used for hanging baskets or window boxes.

MOSCHATUS, or **MUSK PLANT.** Fragrant foliage. Seed extremely small. Pkt., 10c; 1/8 oz., \$3.00.

MYOSOTIS OR FORGET-ME-NOT (P)

These dainty and greatly admired spring flowers are especially effective when grown in masses. They are hardy if given slight protection through the winter.

ALPESTRIS. Blue, 9 inches; flowering in April. Pkt., 10c; ¼ oz., 20c.

ALPESTRIS. Dwarf white. Pkt., 10c; ¼ oz., 50c.

PALUSTRIS. Blue, everblooming; flowers from May until frost. Pkt., 10c; ¼ oz., \$1.00.

NICOTIANA (A)

AFFINIS. Gives a continuous display of flowers through the summer and autumn; plant 2 to 3 feet high. The blooms are white, sweet scented and measure 3 inches in diameter. Pkt., 5c; ¼ oz., 20c.

NIGELLA OR LOVE-IN-A-MIST (A)

Free-flowering plant, 1 foot high, producing curious flowers surrounded by the finely cut foliage. Easily grown; useful for cutting.

DOUBLE BLUE. Pkt., 5c; ¼ oz., 10c.

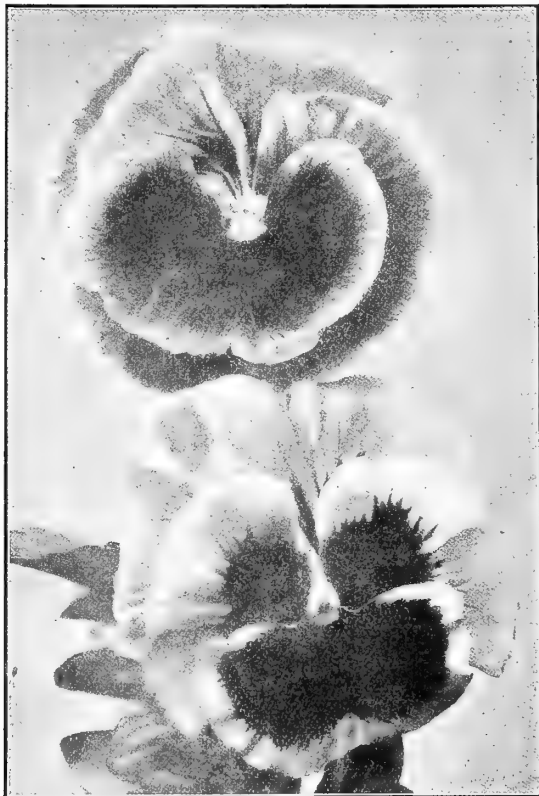

Pansies



Nasturtiums

NASTURTIUM (A)

TOM THUMB. The very popular dwarf or bedding variety, producing very showy large flowers. Our mixture contains all the newest hybrids as well as the distinct old varieties, all in proportion to assure a marvelous display of colors, ranging from cream-white to the very darkest red. Pkt., 5c; oz., 15c; ¼ lb., 40c; lb., \$1.25.

SPENCER. Choice mixed, very brilliant, in all shades of yellow, red and purple. Pkt., 5c; oz., 15c; ¼ lb., 45c; lb., \$1.50.

LACINIATUM. Dark leaved, very showy, mixed. Pkt., 5c. oz., 20c; ¼ lb., 50c; lb., \$1.50.

PENTSTEMON (P)

HARTWEGII. Beautiful bell-shaped flowers on 18 inch spikes. Pkt., 10c; ¼ oz., \$1.00.

PANSIES

These very popular and beautiful flowers may be sown in April or May for summer flowering or in August for early spring blooming. They thrive best in an open exposure, with protection during the winter.

BUGNOT'S GIANT. Flowers of enormous size, nearly circular in form and in a great variety of the most rare and handsome colors. Pkt., 10c; ¼ oz., \$1.40.

TRIMARDEAU GIANT. Plants of strong robust growth producing very large beautifully colored blooms.

ADONIS. Bright Blue, white center. Pkt., 10c; ¼ oz., 75c.

FAIRY QUEEN. Bright Blue, white edge. Pkt., 10c; ¼ oz., 75c.

FIRE KING. Yellow, Upper Petals crimson. Pkt., 10c; oz., \$1.50.

GOLDEN QUEEN. Pure Yellow. Pkt., 10c; oz., \$1.75.

LORD BEACONSFIELD. Deep purple violet shading to white. Pkt., 10c; ¼ oz., 60c.

BRILLIANT MIXTURE, **TRIMARDEAU Giants;** Pkt., 10c; ¼ oz., 50c.

MADAM PERRET. Giant Flowered, red marbled shades; Pkt., 10c; oz., \$1.50.

SIEGFRIED. Giant Flowered, Ruffled, five spotted, Wall-flower colored. Pkt., 10c; ¼ oz., \$2.00.

MASTERPIECE or **GERMANIA.** Giant frilled or ruffled flowers, wonderfully blotched; in choicest mixture. Pkt., 10c; oz., \$3.75.

CASSIER'S SUPERB STRAIN. Large, well formed, beautifully blotched flowers in great variety of color. Pkt., 10c; oz., \$3.25.

CASSIER'S Golden Yellow. Pkt., 10c; oz., \$3.00.

MAMMOTH EXHIBITION MIXTURE. True round and solid pansy form of giant size, each color an attraction. Pkt., 10c; ¼ oz., \$1.50; oz., \$5.00.

MANNS' TRIUMPH OF THE GIANTS. Finest mixture for commercial or private use. Blooms enormous, most striking in brilliancy and beauty of color. Pkt., 25c; oz., \$7.50.

PETUNIAS (A)

Very popular because of their free-flowering habit and ease of culture; succeeding in almost any soil and giving a mass of blooms from June until frost. Beautiful in beds and borders, growing 1 to 1½ feet high. Our mixtures contain the best colors obtainable and are of the highest quality.

HYBRID. Choice mixture, first quality. Pkt., 10c; ¼ oz., 25c.

HOWARD'S STAR. Finest striped colors mixed. Pkt., 10c; ¼ oz., 60c.

NANA COMPACTA. Of dwarf habit, excellent for bedding. Pkt., 10c; ¼ oz., 60c.

HYBRID FIMBRIATA. Giant flowering fringed varieties, extra selected. Pkt., 25c; 1/8 oz., \$9.00.

PHLOX (A and P)

Phlox makes a magnificent show in beds and masses where their brilliant and varied colors produce a gorgeous effect. Very easily raised and afford a bright display of flowers all through the summer.

DRUMMONDII. Choice mixture, first quality. Pkt., 10c; ¼ oz., 35c.

STAR PHLOX (Cuspidata). With star-shaped flowers dwarf growth. Pkt., 10c; ¼ oz., 50c.

FIMBRIATA. Fringed flowers of beautiful form and color. Pkt., 10c; ¼ oz., 50c.

LARGE FLOWERING DWARF VARIETIES

DEFIANCE. Deep scarlet, very compact, free-flowering. Pkt., 10c; ¼ oz., \$1.50.

DWARF MIXED. Selected colors, compact habit of growth, very effective in beds or borders. Pkt., 10c; ¼ oz., 70c.

HARDY PERENNIAL PHLOX

DECUSSATA. Quite distinct from the above mentioned annual varieties, being very hardy and producing large heads of beautifully colored flowers, blooming in August and September. Pkt., 10c; ¼ oz., \$2.00.

POPPIES (A and P)

Annual poppies should be planted as early in the spring as possible in their permanent places as they will not stand transplanting. The Perennial or Oriental varieties should be sown thinly in the spring and the plants transplanted in September. They are extremely hardy and when once established will remain for years, producing immense single flowers 4 inches in diameter.

TULIP POPPY. One of the most brilliant annuals, the flowers are 3 inches in diameter and of a brilliant scarlet color, greatly resembling tulips. Pkt., 10c; ¼ oz., 15c.

THE SHIRLEY. Special strain mixed; fine for bedding or cutting; single annual. Pkt., 5c; ¼ oz., 10c.

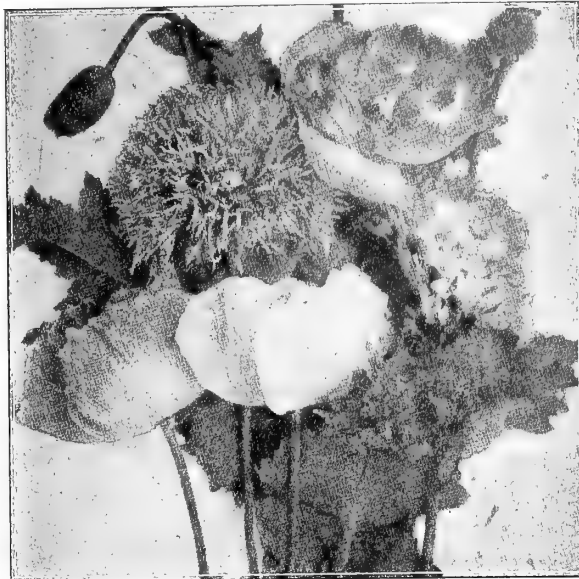

Annual Poppies—Various Types

CARNATION FLOWERED. Splendid double fringed flower; annual; mixed. Pkt., 5c; oz., 10c.

PEONY FLOWERED. Tall growing annual, very double; mixed colors. Pkt., 5c; oz., 15c.

DWARF PEONY FLOWERED. Dwarf annual very useful for bedding. Pkt., 5c; oz., 15c.

HARDY PERENNIAL ORIENTAL POPPIES; ORIENTALE. Very charming, producing numerous leafy stems, 2½ ft. high, with large deep crimson flowers, having a conspicuous black blotch on each petal; exceedingly showy. Pkt., 10c; ¼ oz., 50c.

MIXTURE of all the very best Oriental Varieties. Pkt., 10c ¼ oz., 70c.

PORTULACA (A)

Very showy annual, easily grown, and very effective when massed in beds or edgings. A profusion of brilliantly colored flowers are produced throughout the summer. They thrive best in rather rich soil in a sunny situation.

LARGE-FLOWERING EXTRA DOUBLE MIXED. Pkt., 10c; ¼ oz., \$1.50

LARGE-FLOWERING SINGLE MIXED. All colors. Pkt., 5c; ¼ oz., 20c.

PRIMROSE (Primula)

VULGARIS. Old English garden favorite, beautiful shade of yellow. Pkt., 10c; 1/8 oz., \$1.50.

AURICULA. Finest mixed, all colors. Pkt., 10c; 1/8 oz., \$2.00.

COWSLIP or OENOTHERA. Evening Primrose; free-flowering plants of easy cultivation, producing an abundance of brightly colored single flowers, which open on approach of twilight. Pkt., 10c; ¼ oz., 20c.

PYRETHRUM (P)

Hardy extra double and semi-double mixed. Ranging in color from white to deep red, with yellow centers, blooming in May and June and again in the fall. The flowers are very large and somewhat similar to the Daisy or Cosmos. Pkt., 10c; 1/8 oz., \$2.00.

SENSITIVE PLANT - MIMOSA (A)

Curious and interesting annuals, with pinkish-white flowers; the leaves close and droop when touched or shaken. Pkt., 5c; ¼ oz., 15c.

RICINUS - CASTOR OIL BEAN (A)

Ornamental plants of strong, stately growth, the foliage having the appearance of a tropical plant, very effective when planted in masses or as centers of Canna or Dahlia beds.

ZANZIBAR. Extra mixed. Oz., 25c.

SALVIA SPLENDENS or SCARLET SAGE (A)

Very popular bedding plant, extensively used for lawn and conservatory decoration, bearing long spikes of brilliant flowers from July to frost. It is preferable to start the plants indoors very early in the spring and transplant to the beds when the weather has become warm and settled; also planted in the open ground in May with very favorable results. Pkt., 10c; ¼ oz., 80c.

SNAPDRAGON. See Antirrhinum, page 34.

SWEET ROCKET. See Hesperis.

STOCKS - 10 WEEKS (A)

One of the most popular annuals, either for potting or bedding. For brilliancy and diversity of color, fragrance, profusion and duration of bloom it is unsurpassed.

DWARF GERMAN DOUBLE MIXED. Pkt., 10c; ¼ oz., 80c.

SCABIOSA or MOURNING BRIDE (A)

Fine free-flowering plants for mixed borders and highly esteemed for cut flowers. The blooms are borne on long, erect stems in globular heads in colors ranging from white to dark maroon. Height 2 to 2½ feet. Pkt., 10c; ¼ oz., 20c.

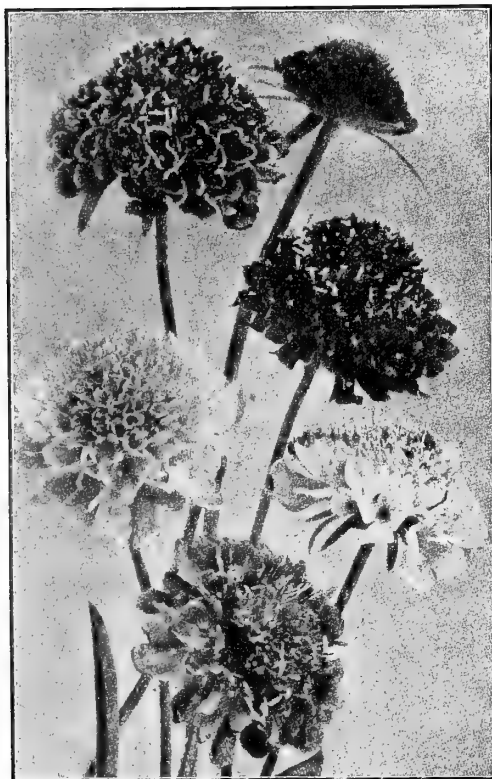

Scabiosa

SWEET PEAS

CALIFORNIA GROWN SUCCESSFUL EVERYWHERE

One ounce for 50 feet of row.

THE GRANDIFLORA type, owing to its vigor of growth, its freedom of bloom and extremely wide range of colors is well suited for most conditions and locations.

THE SPENCERS are of exceptionally large size, the petals waved and frilled and the general effect remarkably graceful and effective. The plants are of vigorous growth and remain in bloom for a longer time than the Grandiflora sorts.

CULTURE.—Early in the spring make a trench three to four inches deep in rich, mellow soil, so arranged that no water can stand in it and plant the seed in the bottom, covering at first only one inch deep. When the plants are two inches high, cultivate; and as they grow, gradually fill in the trench. When the plants are about five inches high they should be supported by poultry netting, strings or brush. Water should be applied thoroughly once or twice a week early in the morning or in the evening. The blooms should be picked before they form pods or the plants will soon stop flowering. The following have been selected from hundreds of varieties, as being those of the highest quality in their respective classes.

GRANDIFLORA VARIETIES

- AMERICA.** Bright red and white striped.
BLACK KNIGHT. Deep maroon.
DOROTHY ECKFORD. Large white.
FLORA NORTON. Bright blue.
HON. MRS. E. KENYON. Large primrose.
JANET SCOTT. Bright pink and buff.
KING EDWARD VII. Bright red.
LADY GRISEL HAMILTON. Lavender.
LORD NELSON. Brilliant navy-blue.
MISS WILMOTT. Orange-pink.
MRS WALTER WRIGHT. Rose purple.
OTHELLO. Deep maroon.
PRIMA DONNA. Pink.

Prices: Pkt., 5c; oz., 10c; ¼ lb., 30c; lb., \$1.00.

EARLY FLOWERING SPENCERS

- EARLY ALL WHITE.** Pure White.
EARLY FAIR MAID. Large bluish pink.
EARLY FLORA. Clear blue.
EARLY GLITTERS. Bright cerise-scarlet.
EARLY HARMONY. Clear lavender.
EARLY SNOWFLAKE. Pure white.
EARLY SUNPROOF SCARLET. Brightest scarlet.
ZVOLANEK'S ROSE. Bright rose-pink.

Prices: Pkt., 10c; oz., 50c; ¼ lb., \$1.75; lb., \$6.00

SPENCER VARIETIES

- ASTA OHN.** Pinkish-lavender.
BLANCHE FERRY. Bright rose standard, wings white flushed pink.
COUNTESS SPENCER. Pure pink.
DOBBIE'S CREAM. Extra deep, selected stock.
ELFRIDA PEARSON. Giant bluish pink.
HELEN LEWIS. Orange-pink; re-selected.
JACK CORNWALL. V. C., deep blue.
KING EDWARD SPENCER. Pure red.
MAJESTIC CREAM. Large deep cream.
MARGARET ATLEE. Rosy salmon-buff.
MARGARET MADISON. Azure-blue and lavender.

- MASTERPIECE.** Lavender.
MRS. TOM JONES. Deep amethyst-blue; fine form
OTHELLO SPENCER. Deep maroon.
ROYAL PURPLE. Rich purple.
ROYAL SCOT. Brilliant scarlet.
SUNSET. Bright rose.
THOS. STEVENSON. Bright orange-scarlet.
VALENTINE. Large bluish pink.
WARRIOR. Giant maroon.
WEDGWOOD. Deep azure blue.
WHITE SPENCER. Pure white.

Prices: Pkt., 5c and 10c; oz., 25c; ¼ lb., 75c; lb., \$2.50.

SWEET PEA MIXTURES

Our Sweet Pea Mixtures are combined of carefully considered proportions of all the named varieties in our list, which have proven themselves to be the very choicest of their respective types and colors. These mixtures cannot be equaled in their beauty and flowering qualities.

MANNS' GRANDIFLORA SUPERIOR MIXTURE. Pkt., 5c; oz., 10c; ¼ lb., 25c; lb., 75c.

INOCULATE THIS
SEED WITH
MULFORD CULTURE

MANNS' SUPERB SPENCER MIXTURE. Pkt., 10c; oz., 15c; ¼ lb., 50c; lb., \$1.75.

SWEET WILLIAM DIANTHUS BARBATUS (P)

A universally admired perennial flower, which, when once started, will last for years. Free-flowering and attractive, producing a splendid effect in beds and borders. It is preferable to sow the seed very early in the spring every year and have vigorous young plants coming into bloom the same season. They may be sown, however, in August to bloom the following spring. Very satisfactory results are also obtained by dividing the roots of old plants.

SINGLE MIXED. All shades of white, pink and red. Pkt., 10c; oz., 60c.

DOUBLE MIXED. Very fine; all colors. Pkt., 10c; oz., 80c.

VERBENA (A)

One of the finest bedding plants and also suitable for borders, with its heads of brilliantly colored flowers, producing one mass of bloom throughout the summer. Seeds may be planted as soon as the ground can be worked or earlier indoors and transplanted to the beds in April or May. They succeed in almost any good garden soil.

DEFIANCE. Deep scarlet, large attractive blooms. Pkt., 10c; ¼ oz., 40c.

HYBRID MIXED. Extra large flowered, brilliant colors and vigorous. Pkt., 5c and 10c; ¼ oz., 25c.

HYBRID COMPACTA MIXED. Very compact and erect in its habit of growth; excellent border variety. Pkt., 10c; ¼ oz., 50c.

VIOLAS or TUFTED PANSIES (P)

Well known, free-flowering hardy perennials, easily grown from seed. While the flowers are not so large as the regular type of Pansy, the blooms are produced in such an abundance and the flowering season so much longer that they are superior to pansies for some purposes. Seed sown in April produces flowering plants by June and from then on until frost they are a sheet of bloom.

PURPLE QUEEN. Clear distinct blue. Pkt., 10c; ¼ oz., 35c.

VIOLET-ODORATA (P)

This beautiful, sweet-scented hardy perennial can be easily grown from seed, thriving best in a partially shaded, moist situation. Pkt., 10c; ¼ oz., \$1.50.

WALLFLOWER (P)

These deliciously fragrant half-hardy perennials should be better known. Their beautiful spikes of double flowers in their rich Oriental shades of red, yellow and purple are very effective in beds or potted. 1½ feet high.

GIANT GOLIATH. The earliest and best single variety; large flowered, extra dark blood red. Pkt., 10c; ¼ oz., 20c.

SINGLE MIXED. Pkt., 10c; oz., 25c.

BRANCHING-TALL. Double mixed. Pkt., 10c; ¼ oz., \$2.00.

ZINNIAS-DOUBLE (A)

We have given particular attention to these annuals, developing them into perfection unsurpassed.

GIANT WHITE. Pkt., 10c; oz., 50c.

GIANT BUTTERCUP. Pkt., 10c; oz., 50c.

GIANT PINK. Pkt., 10c; oz., 50c.

DOUBLE GENERAL MIXED. Pkt., 10c; oz., 50c.

DAHLIA FLOWERED MIXED. Pkt., 10c; oz., 75c.

CURLED AND CRESTED. Pkt., 10c; oz., 50c.



Sweet William

VINES

BALLOON VINE. (*Cardiospermum*). Very graceful, rapid grower, producing inconspicuous flowers, foliage light green. Pkt., 5c; oz., 20c.

BALSAM. Beautiful foliage with apple or pear-shaped fruits of a rich golden yellow color. Pkt., 5c; ¼ oz., 25c.

CANARY BIRD FLOWER (*Nasturtium peregrinum*). A most beautiful climber of rapid growth with handsome fringed, rich yellow flowers and fine delicate foliage. Pkt., 5c; ¼ oz., 15c.

COBAEA SCANDENS. Of rapid growth, with fine foliage and large bell-shaped flowers of a beautiful violet blue color. Pkt., 5c; ¼ oz., 25c.

WILD CUCUMBER VINE. (*Echinocystis lobata*). A quick-growing and attractive climber, will grow 20 feet in six weeks, the large foliage affording plenty of shade. Covered during the summer and fall with sprays of small white flowers. Pkt., 5c; oz., 20c.

CYRPESS VINE. (*Ipomoea quamoclit*). Beautiful and very popular, slender vine, with fern-like foliage and a mass of small star-shaped flowers. Mixed colors. Pkt., 5c; ¼ oz., 15c.

GOURDS. A large and interesting class producing a great variety of curious fruits, many of which are peculiarly marked. Pkt., 5c; oz., 25c.

HYACINTH BEAN. (*Dolichos*). Of extra rapid growth, introduced from Japan and very much superior to the old-fashioned flowering bean. Darkness, purple flowers; Daylight, white flowers; or mixed. Pkt., 5c; oz., 10c.

JAPANESE HOP VINE. (*Humulus Japonicus*). Where an attractive climber is desired that will stand rough usage there is nothing better. Pkt., 5c; ¼ oz., 20c.

MOON FLOWER. (*Ipomoea mexicana*). Very pretty, rapid growing vine, with handsome white trumpet-shaped flowers. Pkt., 5c; ¼ oz., 20c.

MORNING GLORY. (*Ipomoea purpurea*). This splendid and very popular climber needs no introduction. Our **Giant Japanese Imperial Mixture** is unsurpassed. Pkt., 5c; oz., 15c.

PASSION FLOWER. (*Passiflora*). A most interesting and well known climber, bearing singularly beautiful flowers. Pkt., 10c; ¼ oz., \$1.00.

SMILAX. (*Medeola*). This popular Boston Smilax is a most desirable window vine, on account of its charming, glossy green, graceful foliage. Perennial, splendid for greenhouse or conservatory. Pkt., 5c; ¼ oz., 25c.

THUNBERGIA (*Black-eyed Susan*). Free-flowering and of rapid growth. May be trained on a slender trellis or allowed to run freely over the ground to cover bare spaces. Pkt., 10c; ¼ oz., 35c.

CLIMBING NASTURTIUM. Flower and foliage similar to dwarf *Nasturtium*s; the growth, however, being much more vigorous. 5 to 7 ft. They may be used for porches or urns or left to run freely over the ground. **Choicest Mixture**, Pkt., 5c; oz., 10c; ¼ lb., 30c; lb., 75c.

SCARLET RUNNER. Of very rapid growth, producing clusters of showy bright scarlet pea-shaped blossoms, followed by edible beans of very fine quality. Pkt., 5c; lb., 50c.



Dahlia Flowered Zinia

BULBS AND ROOTS for Spring Planting

GIANT ORCHID FLOWERED CANNAS

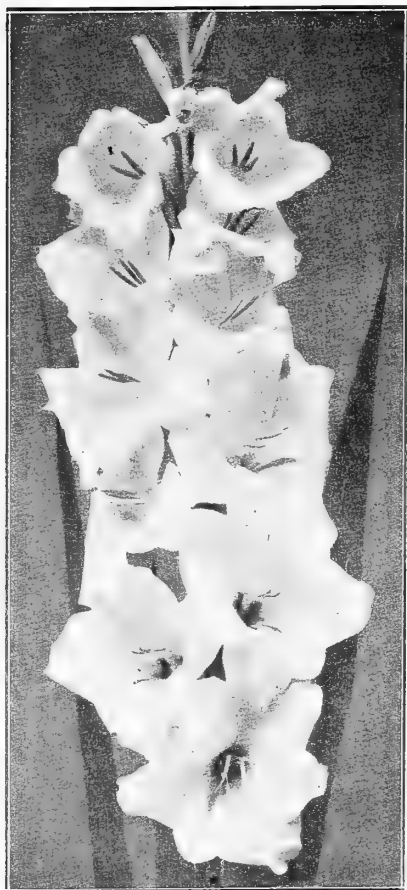

Gladiolus, Chicago White

FINEST MIXED GLADIOLUS

Large size bulbs of all the leading varieties, selected to give the most harmonious color scheme of all the most desirable sorts. 35c per doz.; \$2.50 per 100.

CALADIUM \bar{Z} ESCULENTUM or ELEPHANT'S EAR.

These are very effective either as single plants on the lawn, in beds, or along the edges of a pond or stream. The leaves often attain a length of 36 inches. Bulbs can be kept over winter and used year after year by storing them in dry sand. Large bulbs, 3 to 4 inches in diameter, 15c each; \$1.50 per doz. Medium size bulbs, 10c each; \$1.00 per doz. Add postage. Special price on quantities.

EXCELSIOR PEARL TUBEROSE.

One of the most fragrant and most popular of the summer flowering bulbs. May be started early in hotbeds or pots, or planted in open ground after the first of May. Extra large size bulbs, 5c each; 50c per doz.; \$3.00 per 100.

TUBEROUS ROOTED BEGONIA.

Excellent for bedding and well adapted to window or conservatory culture, thriving best in partial shade. Single or double mixed, 2 inches and up in diameter. 30c each; \$3.00 per doz.

HARDY PHLOX.

These perennials are very useful and beautiful in borders and for cutting. They succeed in almost any soil enriched with manure and should be watered freely in dry weather. Strong roots, separate colors, 15c each; \$1.75 per doz.

PEONY.

This old-fashioned flower is still considered the Queen of spring flowers. They are perfectly hardy, requiring no protection and once planted increase in beauty each year. All leading varieties, 2 to 5 eyes, 30c to 50c each.

CITY OF PORTLAND. 3½ ft. pink. Flowers of largest size borne on heavy trusses. A glowing shade of pink. The foliage is substantial and strong, of rich green color and free from defects. 10c each; \$1.00 per dozen.

MRS. ALFRED F. CONARD. 4 feet. The grandest salmon pink in existence. Magnificent heads of perfectly formed flowers of great size and wonderful substance. 10c each; \$1.00 per doz.

FLORENCE VAUGHAN. 4 feet. Flowers of golden yellow, thickly dotted crimson. 5c each; 50c per doz.

GOLDEN GATE. 4 feet. The flowers open almost pure gold but soon become richly rayed with orange crimson and apricot centering to the throat. 5c each; 50c per doz.

YELLOW KING HUMBERT. 4 feet. Like King Humbert in habit of growth and flowering, green leaves and golden yellow flowers, blotched red. 7c each; 75c per doz.

MADAM CROZY. 3½ feet. Flowers brilliant vermilion scarlet, with narrow edge of bright golden yellow. 5c each; 50c per doz.

EUREKA. 4 feet. The best white Canna for all purposes. The large substantial flowers are very freely produced on strong, vigorous plants. 7c each; 75c per doz.

APRICOT. 4 feet. Buff yellow base overspread with salmon-pink, making a mass effect of rich apricot. 10c each; \$1.00 per dozen.

KING HUMBERT. 4 feet. This is the grandest canna ever offered. The large heart-shaped leaves are purple brown over bronze. The plants are crowned with immense heads of orchid-like, velvety orange scarlet, rose-tinted, and margined at the base. A combination of leaf and blossom incomparably beautiful. 7c each; 75c per doz.

METEOR. 4½ feet. Deep dazzling crimson flowers, produced in mammoth clusters. Foliage green. One of the best crimson cannas. 7c each; 75c per doz.

STARTED CANNAS.

Fresh daily in all leading varieties. 2 for 25c; \$1.25 per doz.

GLADIOLUS

Large, Sound Bulbs, Sure to Bloom. 1½ inches and up in diameter

SCHWABEN. The best yellow. Very popular. 5c each; 45c per doz; \$3.00 per 100.

MRS. FRANK PENDLETON. Most exquisite salmon pink with blood-red blotch. Vigorous grower. 6c each; 60c per doz.; \$4.00 per 100.

AMERICA. Beautiful soft flesh pink; one of the best for cutting or bedding. 35c per doz.; \$2.50 per 100.

BARON J. HULOT. Rich royal violet blue; full round flower. 8c each; 90c per doz.; \$7.00 per 100.

CHICAGO WHITE. White, with lavender marking in throat. 5c each; 45c per doz.; \$3.00 per 100.

HALLEY. Delicate salmon pink, very effective. 4c each; 40c per doz.; \$2.75 per 100.

MRS. FRANCIS KING. Brilliant vermilion scarlet, very popular. 50c per doz., \$3.50 per 100.

NIAGARA. Delightful cream yellow, splashed with carmine. 6c each; 65c per doz., \$4.25 per 100.

PANAMA. Rich salmon pink, one of the best. 5c each; 45c per doz.; \$3.00 per 100.

PEACE. Grand large white flower, with pale violet feathering on lower petals. 5c each; 45c per doz.; \$3.00 per 100.



Caladium or Elephants Ear.

DAHLIAS

The following varieties of dahlias are selected for beauty, utility and free flowering qualities. We offer a wide range of colors and shades in each of the important types and can confidently recommend them for the ornamental garden and for cut flowers. The tubers are taken from healthy, vigorous, field grown clumps; are in first class condition and with proper attention are sure to bloom and give entire satisfaction.

Dahlias do well in almost any kind of soil, but thrive best in a medium loam. The tubers should be planted in a horizontal position, with the sprout up and about four inches below the surface; they should be set three or four feet apart each way in deeply spaded soil. A good plant food applied just as the buds start to form will increase the size and improve the color of the blooms. If large exhibition blossoms are desired, it is absolutely necessary to disbud. After the frost has killed the flowers, the roots should be removed from the ground, allowed to dry for two or three days, and then stored away in a cool, dry, dark place where frost will not reach them.

HYBRID CACTUS DAHLIAS

This splendid type is considered by many to be the most beautiful of all. The colors are very distinctive and some are variegated in unsurpassed tints. The petals are long and pointed, some curled and reflexed.

ATTRACTION. Beautiful and greatly admired, 6 inches in diameter, soft silvery mauve-rose with white suffusion. **50c each; \$5.00 per doz.**

CONOWINGO. Salmon yellow shading to lemon yellow at center. Large free bloomer on good stems. **40c each.**

COUNTESS OF LANSDALE. Rich Salmon, **15c each.**

LAWINE. White showing blush as the flower matures. **20c.**

MARGUERITE. Brilliant rose with large white center and distinctly fine white tips. **15c each.**

PINK PROFUSION. Pink shading slightly to flesh at center early bloomer of fine habit, dwarf and profuse. **85c.**

DECORATIVE DAHLIAS

The decorative dahlias are an intermediate form between the cactus and show types, having petals which are broad and flat, and sometimes twisted and curved almost resembling chrysanthemums. Preferred by florists for use as cut flowers.

DELICE. Beautiful glowing rose pink; good stems, fine for cutting **15c each.**

JACK ROSE. Rich velvety crimson. An ideal cut flower sort **15c each; \$1.50 doz.**

JACK'S DISCOVERY. White mottled violet rose. **15c each; \$1.50 per doz.**

OREGON BEAUTY. Oriental Red, with golden sheen and garnet suffusion; large flowers, long stems. **15c each; \$1.50 per doz.**

PATRICK O'MARA. Pleasing shade of deep orange, slightly tinged with rose. Very large flowers on long stiff stems. **50c each; \$5.00 per doz.**

SEBASTAPOL. Rich bright orange. Best of its class and color. Good cut flower. **15c each; \$1.50 per doz.**

YELLOW LE COLOSSE. Large double flowers of brightest yellow. **15c each; \$1.50 per doz.**

PEONY FLOWERED DAHLIAS

The flowers of this type are semi-double, the petals being twisted and curled, somewhat resembling the semi-double peony.

MRS. CHARLES L. SEYBOLD. Distinct bright crimson pink, each petal tipped with white. Strikingly beautiful variety. **15c each; \$1.50 per doz.**

HONORABLE R. L. BORDEN. Large; distinct, rich golden bronze. One of the finest of recent introduction. **25c each; \$2.50 doz.**

SHOW DAHLIAS

This type produces large fine shaped flowers with plain petals showing solid colors or sometimes two or more shades of the same color; petals often tinted with beautiful harmonious shades. Usually very free-flowering.

A. D. LIVONI. Blush shell pink. **15c each. \$1.50 per doz.**

BLACK DIAMOND. Purple garnet, shading black. **15c each; \$1.50 per doz.**

JEAN KERR. Pure white. Foremost garden and cut flower variety, compact, stocky growth; free flowering. **25c each \$2.50 per doz.**

VIVIAN. A constant bloomer; white, heavily overlaid strawberry red. **35c each. \$3.50 per doz.**

ZEBRA. Pearl white, edged with deep pink. **15c each; \$1.50 per doz.**

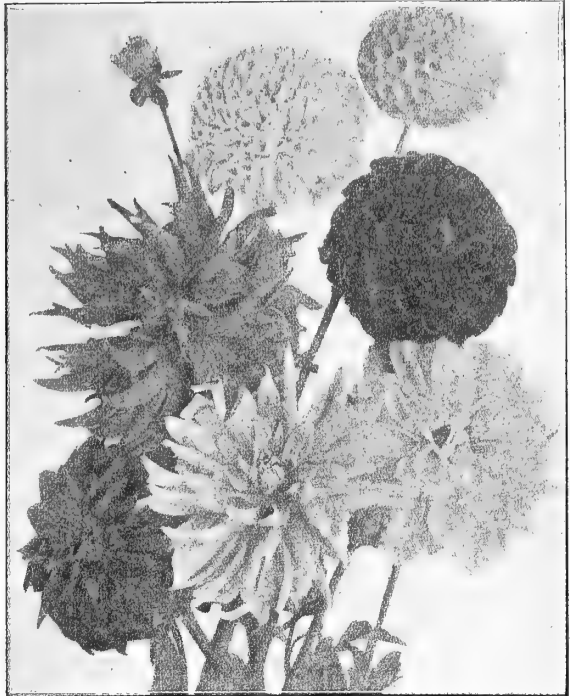

Dahlias

SUPERB DAHLIA MIXTURE

This mixture is made up of un-labeled roots from a regular planting of named varieties of the various types, produced in sufficient quantity to enable us to offer our customers an unusual opportunity to secure high quality stock at a very low price. **25c each. \$2.50 per dozen.**

SPECIAL DAHLIA MIXTURE

Made up of very good but low priced varieties, sound tubers, sure to bloom. **10c each. \$1.00 per dozen.**

DAHLIA PLANTS

Many successful dahlia growers use plants in preference to roots. The following varieties can be supplied in strong, vigorous growing plants from May 20 to June 20. (In the vicinity of Baltimore this is the best time for transplanting).

- | | |
|--|---|
| A. D. Livoni (show) 15c. | Lawine (cactus) 20c. |
| Delice (decorative) 20c. | Mrs. C.L.Seybold (peony) 15c |
| Golden Gate (cactus) 35c. | Queen of the Yellows (show) 15c. |
| Hon. R.L.Borden (peony) 25c. | Standard Bearer-Red (cactus) 20c. |
| Jack Rose (decorative) 25c. | Wm. F. Gude (decorative) 25c. |

PLANT COLLECTION

Ten plants; one each of the above named varieties, postpaid, \$1.85.

Plant Stakes for Dahlias—See page 50.

DAHLIA SEED

Very satisfactory results are obtained from seed planted early indoors and transplanted permanently in May or June. With proper care the plants will bloom the same year. (See page 36).

CINNAMON VINE

Hardy climber, small white flowers. **Strong tubers, 15c each.**

MADEIRA VINE

Rapid growing climber. **15c each. \$1.50 per doz.**

HARDY CLEMATIS

One of the most beautiful hardy climbers; of strong rapid growth producing a profusion of deliciously fragrant flowers. **25c, and 35c each.**

MISCELLANEOUS FARM SEEDS



Red Clover

Our fair dealing and conservative methods have resulted in an enormous increase in the volume of our field seed business and we are thoroughly convinced that high quality seed at a reasonable price will make many more pleased customers during this year.

Our experience in this line and our equipment protect you from the many losses which must result from the planting of inferior seed, which is expensive at any price. All seeds offered must strictly conform to our high standards, and purchasers may depend upon our best efforts to supply only seed which is fresh, pure and free from weeds.

Continual market fluctuations make it impossible to quote firm prices here; changes are made almost

daily. We shall therefore appreciate the opportunity to mail samples and quote the very latest price on any quantity. When comparing quotations, consider both purity and germination.

CLOVERS

MEDIUM or COMMON RED. (*Trifolium pratense*). The Clover Seed of Commerce, and the most important and valuable of the Clover family for agricultural purposes. Sow 15 lbs. per acre. (Bushel 60 lbs.)

ALSIKE or HYBRID. (Swedish). (*Trifolium hybridum*). Hardest of all Clovers; perennial. On rich, moist soils it yields large quantities of hay or pasturage, as it forms a thick bottom; has fibrous roots like White Clover. Esteemed highly by bee keepers.

MAMMOTH CLOVER. (*Trifolium pratense perenne*). Valuable with other grasses for mixed hay; ripens about with Timothy. Being a rank grower, it is largely used for plowing under as a fertilizer.

WHITE DUTCH. (*Trifolium repens*). Grows naturally in pastures in a great variety of soils and situations; indispensable in parks and lawns.

CRIMSON CLOVER. (*Trifolium incarnatum*). Being an annual, it must be sown in July, August, and September of each year, and, the spring following, can be cut for soiling by April 20th; for ensilage, May 1st to 15th; for seed, about first week of June. Can be grown in corn, or any cultivated crop. Ten to fifteen pounds necessary to seed an acre. Cover with a light harrow. (Bushel 60 lbs.)

ALFALFA or LUCERNE. (*Medicago sativa*). This Clover claims to bear the palm as a forage plant, coming earliest in spring and remaining latest in fall. It delights in plenty of sun, being a veritable child of the sun; must be sown at the rate of from 10 to 25 pounds of seed per acre on well drained, well pulverized deep soil after danger of freezing is over, and prefers sand or gravel sub-soil. Wet sub-soil is fatal to the plant. Roots 3 to 4 feet deep, and when well established lasts for years. 2 to 3 crops a year can be cut. Not recommended for pasture. (Bushel 60 lbs.)

BOAKHARA or WHITE BLOSSOM SWEET CLOVER. (*Melilotus alba*). This slightly resembles Alfalfa in growth, but is much taller, with leafier and stiffer stems. It frequently grows 5 to 6 feet in height and branches freely, with slender spikes of small, fragrant, white flowers, which afford an excellent food for bees. (Bushel 60 lbs.)

JAPAN CLOVER. This makes most nutritious and desirable summer pasture. Grows well and spreads rapidly on poor lands, hillside and under the shade of trees. (Bushel 25 lbs.)

DROUGHT RESISTING GRASSES

PERENNIAL RYE GRASS. (*Lolium perenne*). Very nutritious; valuable for meadows or permanent pastures; rapid grower; most prominent grass in England. Sow 1 to 1½ bushels per acre. (Bushel 24 lbs.)

MEADOW FESCUE. (*Festuca pratensis*). Thrives in all soil; excellent for permanent pastures; starts early; very productive. Sow 1 to 1½ bushels per acre.

SHEEP'S FESCUE. (*Festuca ovina*). Grows naturally on light dry, sandy soils and mountain pastures; considered quite valuable mixed with other grasses for permanent early spring pasture. (About 12 lbs.)

HARD FESCUE. (*Festuca duriuscula*). Not very productive, but it is of a very fine quality, and thrives well in dry situations where many other grasses would fail, thus making a desirable pasture variety.

MILLET

GERMAN or GOLDEN MILLET. True Southern grown German Millet Seed is far superior to Western grown seed.

HUNGARIAN GRASS. A very valuable forage plant of the Millet family, but not so coarse. Two or three weeks earlier than German Millet.

GRASS SEEDS

KENTUCKY BLUE GRASS. June Grass. (*Poa pratensis*). Universally known; desirable for pastures and lawns. Sow in fall or spring at rate of 2 or 3 bushels per acre. Fancy clean seed.

RED TOP GRASS. (*Agrostis vulgaris*). Thrives well in any soil, but best on low land; produces a firm sod. Sow 1 to 2 bushels per acre.

TIMOTHY. (*Phleum pratense*). Well known variety. When ready to buy write for latest prices, whether a bag or a carload. (Bushel 45 lbs.)

ORCHARD GRASS. (*Dactylis glomerata*). Extremely hardy and widely known. One of the earliest to start in spring; grows rapidly; furnishes an abundance of pasture the entire season, 1½ to 2 bushels per acre. (Bushel 14 lbs.)

RHODE ISLAND BENT GRASS. (*Agrostis canina*). Valuable for lawns. Sow 3 to 4 bushels per acre for lawn. 1½ to 3 bushels for pasture. (Bushel 12 lbs.)

TALL MEADOW OAT GRASS. (*Avena elatior*). Used for soiling. Succeeds well in sandy lands, and owing to its long, fibrous roots, stands cold and drought well. Sow 3 bushels per acre. (Bushel 10 lbs.)

SWEET VERNAL. (*Anthoxanthum odoratum*). Very fragrant, especially when bruised or cut. Mixed with other grasses for pasture it is quite valuable, as it starts early in the spring and grows until late in the fall. (Bushel 10 lbs.)

CREeping BENT GRASS. (*Agrostis stolonifera*). Excellent for pasture when mixed with other grasses; succeeds well in most situations and thrives in moist land. Sow 40 pounds per acre. (Bushel 14 lbs.)

WOOD MEADOW GRASS. (*Poa nemoralis*). Recommended especially for low, wet pasture, or for lawns in damp, wet situations. It starts early in the spring and produces a beautiful green turf, which lasts a long time. (Bushel 14 lbs.)

MANNS' PERMANENT PASTURE MIXTURES

are giving wonderful results. They contain pure seed of high vitality, with varieties proportioned to meet the specific requirements of our individual customers. Let us know your particular needs and we shall be pleased to quote attractive prices.



Orchard Grass.

BIRD SEED

Fresh, Recleaned Stock
Postage extra.

Canary.....	lb.	15c
Rape.....	lb.	15c
Millet.....	lb.	10c
Hemp.....	lb.	10c
Maw, ¼ lb., 10c.....	lb.	30c
Sunflower.....	lb.	15c
Lettuce Seed.....	lb.	25c
Mixed Canary Seed.....	lb.	15c
Cuttle Fish Bone.....	doz.	40c

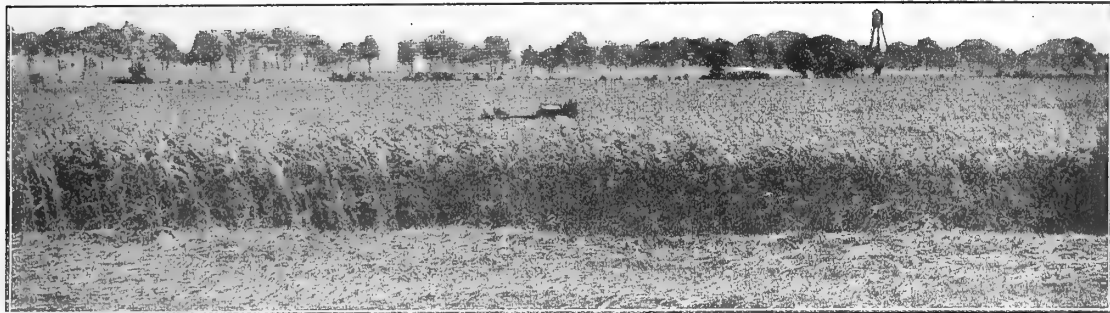

SUDAN GRASS

SUDAN GRASS

Sudan, the greatest forage crop, should be grown on every farm, where either hay or pasture is desired. It is highly resistant to drought and stands very heavy grazing. Yields from 2 to 10 tons per acre, is superior to either Millet or Sorghum in feeding quality, and may be fed in unlimited quantities.

Sow 10 to 20 lbs. per acre, 1 to 1½ inches deep, the highest quality hay resulting from heavy seeding. Should be harvested just before the heads appear, in the same manner as other grasses. Cures quickly and matures as early as Millet, the first cutting being ready in about 6 to 8 weeks.

Successive cuttings may be made every 30 to 45 days until frost. Highly recommended by the Government as being very nutritious and easily digestible. Being an annual, this must be seeded every year and therefore never becomes a pest. **\$12.00 per 100 lbs. Subject to change.**

KAFFIR CORN

The heads are greedily eaten by horses and cattle and make splendid food for poultry, fed either in the grain or ground and cooked. Excellent forage. Cultivate same as common corn, requiring four or five pounds per acre.

DWARF ESSEX RAPE

This plant is extensively grown for forage, especially for sheep, and for green manure. Prepare the ground as for turnips and sow in June or July in rows two and a half feet apart at the rate of two and a half pounds of seed per acre.

SORGHUM or CANE

EARLY AMBER SORGHUM. Furnishes a large yield of most nutritious forage, which can be fed either green or cured, and will yield two or three cuttings a year, stooling out thicker each time it is cut. It grows ten or twelve feet high. Sow at the rate of one peck per acre in drills three and a half to four feet apart.

EARLY ORANGE SORGHUM. This variety is similar in growth to Early Amber, but under fair conditions produces a heavier crop. It is better for stock feeding than the Amber.

BUCKWHEAT

JAPANESE. This variety yields very largely. The kernels are larger than other sorts, but owing to its branching qualities it need not be sown so thickly. **Peck, 60c.**

SILVER HULL. A superior variety in every way to the ordinary Buckwheat which it has almost entirely superseded.

OATS

WHITE SPRING OATS. Our best re-cleaned stock of these are Choice Northern grown, all heavy oats, which have been re-cleaned by us

RUST-PROOF OATS. A favorite spring variety in the South, particularly where the land is rich; produces enormous yield, and excellent for cutting for hay.

CANADA FIELD PEAS

Sown in open weather during December, January, February and March, making large yields of most nutritious food, which can be used either green or cured for hay. It also makes a good green manuring crop to turn under, but not equal to Cow Peas. A light seeding of oats, rye or barley will increase the yield and help to support the vines when the crop comes to maturity. Ready for cutting in May and June, cures easily and makes splendid hay.

COW PEAS

There is no surer or cheaper means of improving and increasing the productiveness of our soils than by sowing the Cow Pea. It has the power to extract costly nitrogen from the atmosphere and to store the same in the vines and roots, so that the land is enriched and its condition improved. From five to nine tons of green fodder per acre have been produced. For ensilage they are unsurpassed. When it is desired to turn the whole crop under, as a soil improver, it is better to do so after the vines are partly dead. Cow Peas can be sown in May or June, at the rate of one and a half bushels per acre.

BLACK. Quick to mature, adapted for late planting in Northern sections; vigorous grower and great yielder.

BLACK EYE. A prolific vine-growing variety of merit, seed often sold for table use.

WHIPPOORWILL. A favorite early bunch-growing variety. A prime favorite in the North and West on account of its early maturity and habit of growth.

SOY or SOJA BEANS

A Great Drought-Resisting Forage Crop, Producing Immense Quantities of Nutritious Food, Beside Being an Excellent Soil Improver.

The Soy Bean is coming right to the front as a great soil enricher, as a food for hogs or cattle, both in the green and dry state. To plow under in the green state it is certainly one of the very best plants, next to Cow Peas.

SAND or WINTER VETCH

Sometimes called Hairy Vetch. The most valuable of all Vetches. It succeeds on nearly all soils and is especially recommended for poor lands, where it thrives and improve the soil wonderfully, as it is very rich in nitrogen. It belongs to the pea family, but the vines are more leafy and longer. It may be sown in the spring or in the fall, preferably with rye. It remains green all winter and is valuable for early pasturing, as well as a fertilizer. 60 pounds per acre.

Mulford Cultures
FOR LEGUMES



Mammoth Yellow Soy Beans



MANNS' SUPERIOR LAWN GRASS

Sow 1 pound to 200 square feet, 40 to 60 pounds per acre. Our Superior Lawn Grass is a correctly proportioned mixture of the very best varieties of grasses blended according to a formula which has resulted from many years of study and experience.

Every variety included has its special duty to perform in the quick production and steady maintenance of a beautiful and permanent lawn. Soil and climatic conditions are provided for by including each of the grasses which flourish during the various seasons. There are those which develop to perfection very early in the spring, some especially suited for resisting the heat of the summer while others grow best during the fall and early winter. We have also included the types which produce strong, fibrous root systems holding the turf in place, preventing the soil from washing and holding the moisture, greatly assisting the other varieties. Others because of their creeping nature quickly fill up the bare spots which may be caused by the taller sorts dying down; some particularly useful for their beautiful, velvety appearance, some for drought resisting qualities and others for ability to withstand very wet seasons.

Both imported and domestic grasses are procured from growers best equipped to produce the respective sorts in their highest quality most economically. We do not purchase an ounce of ready mixed lawn seed and therefore we positively know our customers are getting Superior Lawn Grass mixed according to our own formula. By this method of purchasing, we also find it possible to supply the highest quality seed at the lowest possible prices.

In offering this mixture, we realize that the customer does not merely purchase a bag of seeds, but also makes an investment of time and money for the establishment of a permanent lawn with which to beautify his property. We therefore do not grade our mixture down to a price, but carefully follow our formula and our knowledge of the markets and experienced purchasing methods take care of the prices.

MANNS' SUPERIOR LAWN GRASS

As described above, 45c per lb.; 10 lbs., \$4.25; 100 lbs., \$40.00.

MANNS' EVERGREEN LAWN GRASS

A special mixture containing larger proportions of the lower priced grasses and smaller quantities of the expensive sorts. 35c per lb.; 10 lbs., \$3.25; 100 lbs., \$30.00.

MANNS' SHADY PLACE LAWN GRASS

This mixture contains only those grasses which are best adapted for growing under trees and in shaded spots. It quickly produces an abundant and even growth of beautiful grass, harmonizing in color and general appearance with our regular "Superior." Lb., 50c; 10 lbs., \$4.50; 100 lbs., \$40.00, f. o. b. Baltimore.

FIELD CORN

The stock we offer has been especially grown and selected for seed purposes.

Clark's Early Smoky Dent This new introduction has been developed by one of the largest and most reliable growers of corn in this country. Early Smoky Dent is today the earliest Dent Corn in cultivation, maturing in 75 to 80 days; is a good yielder and entirely free from disease; grows strong, quick and has splendid 7 to 8 ft. fodder. Pkt., \$1.00; bu., \$3.50.

Ninety-Day Red Cob See page 13.

Golden West This variety will yield a larger crop than any other yellow corn in existence. It is vigorous in growth very deeply rooted and produces broad-leaved stalks of medium height. It is most attractive in appearance, and the ears usually have 18 to 20 rows of large kernels which are tightly wedged to make a solid ear. It requires about 100 days to mature and deserves the attention of any grower who wants a big crop of fine quality yellow corn. Pkt., \$1.00; bu., \$3.50.

Pride of the North Maturing perfectly in 90 days and being very hardy and prolific. Pride of the North has become a favorite among Northern growers and planters needing a 90-day yellow variety. The ears are of medium size with very small red cob. The kernels are closely set, long and compact. Pkt., \$1.00; bu., \$3.50.

Golden Beauty It is a large and broad-grained yellow corn. The ears of perfect shape with from ten to fourteen straight rows of grains. The cob is very small. Pkt., \$1.00; bu., \$3.50.

Leaming Improved Dent A very popular and extremely productive variety. On good lands the stalks grow tall, producing two good ears to each stalk. The ears are long, with small red cob well filled with grains of medium size, but deep, of a rich golden color. It ripens with us in from 100 to 110 days and makes a good crop. Pkt., \$1.00; bu., \$3.50.

Iowa Silver Mine The National White Corn. A remarkable drought resister and under adverse conditions seems to pull through and make a crop where other varieties fail. Silver Mine is deep grained, pure white, rough-topped, with a small, white cob. Ears run from 9 to 12 inches long, with 16 to 20 rows of pure white kernels. Stalks medium height, very leafy, with broad blades, frequently bearing two ears weighing 1 to 1½ pounds each. Iowa Silver Mine has probably taken as many sweepstakes and first premiums as any corn in existence. Pkt., \$1.00; bu., \$3.50.

Iowa Gold Mine With the expert farmer Gold Mine is known as medium early, between the 110 day and the extra early sorts that mature in 85 days. It is a great producer and sure cropper. Ears are medium, symmetrical. Color bright golden yellow. The grain is deep and the cob is small. Pkt., \$1.00; bu., \$3.50.

Improved Maryland Yellow Dent

A cross with the Golden West and Maryland Yellow Dent, both well known varieties. Ears measure 12 to 15 inches in length with 14 to 18 rows of very deep grains closely placed on the cob. The strain has been fully established and will mean larger and more profitable crops to the grower. Pkt., \$1.00; bu., \$3.50.

Boone County White Boone County is a very large white corn, something like Silver Mine, but larger and later in maturing. Ears well filled out at both ends, cylindrical, 9 to 11 inches long, averaging 20 rows, some 18 to 22. Grain very deep, a little rough. Cobs white, of medium size. Matures in 110 to 120 days. Pkt., \$1.00; bu., \$3.50.

Maryland White Dent An old standard variety and great favorite of every farmer who has grown it. The stalks are of a strong growth, bearing from one to two large ears, which have 10 to 12 rows to the cob. Grain is pure white and of fine quality. Pkt., \$1.00; bu., \$3.50.

Improved Hickory King Largest grains of any white variety. Matures early and very productive. Ears set low, are of large size, well filled, very deep grained. It produces well, even on light land. Pkt., \$1.00; bu., \$3.50.

Cuban Giant Ensilage Well known as the leading variety for the production of fodder. Pkt., 90c; bu., \$3.00.

INOCULATE YOUR ALFALFA, CLOVERS, COW PEAS, AND ALL OTHER LEGUME CROPS WITH MULFORD CULTURES

The U. S. Department of Agriculture strongly recommends the use of nitrogen-fixing bacteria to induce a prompt "catch" and increase the yield of legume crop. Mulford's Cultures are scientifically prepared and tested by experts. The first cost is very small but the returns large because crops are increased, and the soil is improved. ¼-acre size, 60c; 1-acre size, \$1.30; 5-acre size, \$4.00.

Always state variety of seed to be inoculated.

DUSTING AND SPRAYING MATERIALS

ARSENATE OF LEAD.

For destroying leaf eating insects, not harmful to the foliage, greatly adhesive. Powdered arsenate of lead is more economical than other forms. Prices: Powder, 1 lb., 30c; 4 lbs., 90c; 24 lbs., \$5.00.

ARSENATE OF ZINC.

Kills quicker than Arsenate of Lead, adhesive and less liable to burn foliage than Paris Green. Excellent for potatoes. Lb., 30c; 4 lbs., 90c; 24 lbs., \$5.00.

ATOMIC SULPHUR.

(One lb. to 10 gal. water).

Pure sulphur manufactured into a paste which may be readily diluted with water and sprayed upon the fruit and foliage to prevent fungous growth. Particularly useful for spraying stone fruits for the control of brown rot and scab. Lb., 25c; 5 lb. keg, \$1.00; 25 lb. keg, \$3.00; 100 lbs., \$8.00.

BLACK LEAF 40.

A highly concentrated solution of Nicotine Sulphate, easily soluble in cold water. It is highly recommended by Experiment Stations and Spraying experts, for use against aphids and other sucking insects. Full directions on each package. 1 oz. bottle, 35c; ½ lb. tin, \$1.25; 2 lb. tin, \$3.50; 10 lbs., \$13.50.

BORDEAUX (Orchard Brand)

(12½ Per Cent. Metallic Copper).

Use 8 lbs. to 50 gallons of water. For preventing many fungus growths, blights, etc. May be either sprayed or dusted. Powder, 1 lb., 25c; 4 lbs., 75c; 50 lbs., \$7.00; 100 lbs., \$13.00.

BORDEAUX-PARISGREEN MIXTURE

Has the same insect killing qualities as Paris Green and in addition protects against blight. Very useful for treating potatoes, tomatoes, and other crops. 50c per lb.; 5 lbs., \$2.25; 10 lbs., \$4.00.

BORDEAUX - ARSENATE OF LEAD

3 to 7 lbs. to 50 gallons of water. To kill leaf-eating insects and control fungus diseases: a double purpose spray in one application. Lb., 40c; 4 lbs., \$1.00; 24 lbs., \$5.25.



BUG DEATH

The popular non-poisonous insecticide and can therefore be used safely and very effectively on Cabbage, Tomatoes, Celery, Lettuce, Berries, Egg Plants, Squashes, Melons, Cucumbers, etc. Highly recommended

for Potatoes. Can be used dry or with water. 1 lb. pkt., 20c; 3 lbs., 50c; 5 lbs., 70c; 100 lbs., \$10.00.

B. T. S.

Barium-Sulphur.

Barium is very similar to Lime (or Calcium) in its chemical properties but when combined with Sulphur it greatly improves the value of both elements as a spray for controlling scale. May be used in both dormant and growing period applications. 1 lb., 20c; 5 lbs., 85c; 100 lbs., \$9.25.

CARBON DI-SULPHIDE.

For control of insects in grain. Lb., 50c.

CUTWORM KILLER.

Lb., 30c; 5 lbs., \$1.25.

FORMALDEHYDE.

Extensively used in the preparation of potatoes for seed, as a preventative against potato scab and to destroy other germs on the seed. Will also control some forms of grain smut. For potatoes a solution of 1 pt. to 15 or 20 gallons of water is made and cut pieces are soaked for 2 hours. One to two gallons of this will be sufficient for 1 bushel of seed. Pt., 65c.

GOOD'S No. 1 FISH OIL SOAP

Keeps trees, plants and vines clean and healthy, effectively controlling sucking insects and many forms of scale. Price, 1 lb. 20c; 5 lbs., 75c.

GRAPE DUST.

A readily diffusible, light weight powder fungicide, very efficient in destroying mildews and preventing blights. 5 lbs., 70c.

HELLEBORE.

Finely powdered remedy against rose slugs, cabbage worms and other leaf eating insects. Can be applied dry or sprayed. Per lb., 45c; ½ lb., 25c.

KAYLOX.

Excellent for fruit and vegetables, a remedy against many forms of fungus and all leaf eating insects. ½ lb., 30c; 1 lb., 55c; 5 lbs., \$2.50; 10 lbs., \$4.50; 25 lbs., \$10.00; 100 lbs., \$35.00.

LEMON OIL.

Soluble in water; will destroy Aphids, Rust, Scale, and Bugs on Palms, Ferns, Rose Bushes, etc. Highly recommended as a wash for dogs and other animals, destroying lice and relieving mange. ½ pt., 35c; 1 pt., 60c; 1 qt., \$1.00.

LIME AND SULPHUR SOLUTION.

The popular spray material for dormant spraying against scale and as a Summer spray against certain fungus diseases. 50 gal., 17½ cper gal. Drum \$3.00 extra, (returnable before August 1st).

DRY LIME AND SULPHUR.

Dormant Season: 12 lbs. to 50 gallons. Growing Season: 3 lbs. to 50 gallons. Just as effective as liquid but more economical because of the absence of water. Dissolves readily in cold water and complies with Government specifications. 1 lb., 30c; 5 lbs., \$1.25.

MAGOTITE.

Protects your crops against root maggot. 2 lb. pkg., 35c; 4 lbs., 60c; 8 lbs., \$1.00; 25 lb. sack, \$2.50; 100 lbs., \$8.50.

NICO-FUME.

This is the strongest tobacco paper on the market. Does not injure blooms and furnishes the easiest method of fumigation ever devised. Tin box of 24 sheets, \$1.25; 144 sheets, \$5.50; 288 sheets, \$10.00.

NICO-FUME LIQUID.

Very powerful tobacco extract. Soluble in water. Guaranteed 40% nicotine. ¼ lb. tin, 75c; 1 lb. tin, \$2.25; 4 lbs., \$8.00; 8 lbs., \$15.00.

NIKOTEEN.

An economical and powerful nicotine extract. Effective remedy against aphids and fly insects. Half lb., \$1.15; 1 lb., \$2.00; 4 lbs., \$6.75.

PARIS GREEN.

A poisonous, insoluble powder similar to arsenic in its effects; used extensively against potato bugs, worms and caterpillars, etc. Half lb., 30c; 1 lb., 50c; 5 lbs., \$2.25.

PURE PARA-DICHLOROBENZENE For Peach Borer Control.

Very powerful and effective remedy just coming into general use as a result of the experiments of the Department of Entomology. Should be applied September 1st to October 10th, according to latitude. Some growers prefer to make two applications, the first being in the month of June. One pound is sufficient for 10 to 30 trees, according to size. It is not advisable to treat trees under 4 years of age with Para-Dichlorobenzene, and apple trees should never be treated. Lb., 50c; 10 lbs., \$4.00.



PYROX.

Kills Insects— Prevents Fungus and Diseases.

1 lb. Jars....	\$ 1.50
5 lb. Drums..	1.75
10 lb. Drums..	3.00
25 lb. Drums..	6.25
50 lb. Drums..	10.75
100 lb. Drums..	17.00
300 lb. Drums..	48.00

LET US TELL YOU ABOUT SEMESAN

SLUG SHOT.

(Hammond's). Guaranteed to destroy potato bugs, cabbage worms, lice, fleas, beetles, striped bugs, etc., on currants, egg plants, melons, turnips, beets, etc.; canker worms and caterpillars on fruit and ornamental trees. 1 lb. sifter, 15c; 5 lb. pkg., 45c.

SCALECIDE.

(One gal. to 15 gal. water).

Known for many years as one of the most effective of the dormant spray materials destroying both scale and blight. Easily applied, not injurious to the skin, penetrating the bark and destroying forms of blight which other materials do not reach. Considered by many to be superior to lime sulphur. Qt., 60c; gal., \$1.40; 5 gal. \$5.50; 15 gal., (Drum \$2.00 extra) \$11.50; 50 gal., \$35.00.

SULPHUR

Commercial Flour of Sulphur. 1 lb., 6c; 10 lbs., 50c; 25 lbs., \$1.00; 100 lbs., \$2.75.

Superfine Dusting Sulphur. 1 lb., 10c; 10 lbs., 70c; 25 lbs., \$1.25; 100 lbs., \$4.25.

STRAWBERRY DUST

85-15 Mixture successfully used for many years. 1 lb., 15c; 10 lbs., \$1.00; 25 lbs., \$2.25; 100 lbs., \$7.50.

TOBACCO DUST.

Excellent insecticide and fertilizer combined, extensively used against black and green aphids, fleas, beetles, etc. Finely powdered and high in nicotine content. Grade 1: 1 lb., 10c; 5 lbs., 35c; 10 lbs., 60c; 50 lbs., \$2.50; 100 lbs., \$4.25; ton, \$74.00.

Grade 2: Per 100, \$2.25; ton, \$39.00.

TREE TANGLEFOOT.

Applied directly to the bark of trees, protecting them from climbing insect pests. Easily applied and will remain sticky for three months fully exposed to the weather. 1 lb. can, 60c; 5 lb. can, \$2.75; 10 lb. can, \$5.25.

WEED KILLER.

For killing weeds in walks, drives, and tennis courts where no vegetation is wanted. Successful against all kinds of weeds and grass, applied dissolved in water with an ordinary watering pot. 1 lb., 50c; 5 lbs., \$2.00.

SPRAYERS

THE "MISTY" SINGLE ACTION



A low-cost sprayer made of heavy tin for general purposes; holds one quart.
 Misty..... \$.40
 Rapid..... .55
 Midget, 1-pint size.30
 Powder Duster..... .40

GLASS JAR SPRAYER

Holds one quart; has long, powerful pump; two discharge tubes, which send the spray over a wide area. Price, 60c.

EASY AIR COMPRESSOR

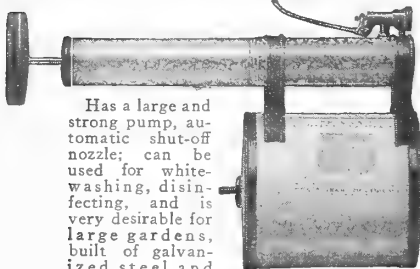

Has a large and strong pump, automatic shut-off nozzle; can be used for white-washing, disinfecting, and is very desirable for large gardens, built of galvanized steel and holds one gallon.
 Price, \$3.25.

CONTINUOUS (Detachable Tank)

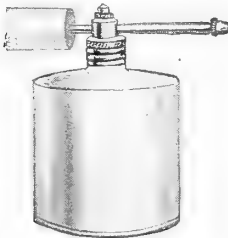

Heavy tin, fitted with cupped plunger leathers; all working parts brass. Tank, heavy tin; capacity 1 quart. Price, 75c.

CONTINUOUS (Rigid Tank)

Built on the same principle as the sprayer described above, except that the tank is fastened rigidly to the pump and placed in a horizontal position. Heavy tin, 65c; galvanized, 75c; brass, \$1.00.

COG-GEAR BARRELL SPRAY PUMP



The construction is such that the entire pump sets inside the barrel containing the liquid, being bolted fast at its upper end to the head of the barrel.

Has bronze ball valves and brass seats. The air chamber is 32 inches in length, enabling the pump to throw a uniform, constant and elastic spray.

It has a good leverage, is very powerful and easily operated. Complete with 15 feet of 1/2-inch 5-ply hose, Vermorel or Bordeaux nozzle and agitators. Price, No. R305B, \$15.00. No. 318B (illustrated) \$16.00.

PERFECTION



This is the most powerful machine in its class. The barrel is 7 1/2 in. in diameter and 20 in. high. The pump is 1 3/4 seamless brass tubing. The valves are metal and work automatically from 8 to 15 minutes, and may be recharged in 12 seconds. A boy with the Perfection can easily do as much work as three men using a hand atomizer, and do it more thoroughly. For whitewash use a No. 2 cap in the nozzle, which is furnished with each sprayer. Galvanized Steel, \$6.00; Brass, \$9.00.

HUDSON FAVORITE SPRAYER

The Favorite sprayer meets the demand for large capacity at a minimum cost. (No. 130-G). With galvanized tank, \$5.40.

HUDSON JUNIOR SPRAYER



The Hudson Junior is a high pressure compressed air sprayer.

Tank is heavy gauge galvanized sheets or all brass as ordered. Side seams are riveted and soldered. Pump is seamless brass tubing which seals into the tank by a half turn of the D-handle and is easily removed for filling, cleaning, etc. It is equipped with special spray hose built to withstand high pressures, and our "Perfection" automatic shut-off nozzle. An extension may be used with it if desired. Capacity about 2 1/2 gallons. Shipping weight 8 pounds.

No. 140C. Junior with galvanized tank, \$4.50. No. 140B, Junior with brass tank, \$6.75.

MYERS COMPRESSED AIR SPRAYER No. 296.

Made of heavy galvanized iron, with 1 1/4 in. brass tube cylinder, attached to the can by means of a heavy brass screw nut. The nozzle is a special feature of this sprayer, making long distance spraying possible. The solution can be thrown a distance of 25 feet. Has always given entire satisfaction. Capacity 3 gallons. Price, Galvanized, \$6.50. Brass, \$9.75.

LITTLE GIANT AND PEERLESS BUCKET SPRAY PUMPS.

Made entirely of brass, malleable footrest, provided with large air chamber and throws a continuous spray. Price, with 4 ft. 1/2-inch hose and two nozzles, \$4.50.

PERFECT LEVER BUCKET SPRAY PUMP

The air chamber is 50 per cent. larger than the Little Giant Sprayer. Price, complete with agitator, hose and nozzle, \$6.00. 8-foot extension pipe, 50c.

MODOCK BUCKET SPRAYER

Price..... \$3.50

No. 28 LIGHTNING WHITEWASH BUCKET SPRAYER

Price..... \$2.25

JUNIOR NO. 5 BUCKET SPRAYER.

Does away entirely with the objectionable foot-rest, clamps, leather suction, packing, etc.

This Pump requires no fastening of any kind, holds itself down and works anywhere and everywhere.

Will pump from a pail, barrel, tank, spring or creek. Weighs only 4 lbs. and is ready for instant use everywhere. Price, \$3.75.

No. 22 BANNER

One of the highest quality compressed air sprayers made. Has many advantages for convenience of the user and efficiency in operation. Tank, 21 in. by 7 1/2 in., double seamed; Pump seamless brass 2 in. in diameter. Shipping weight 10 lbs. Galvanized, \$6.00; Brass, \$8.75; Nickel Plated Brass, \$10.00.

"KANT KLOG" COMPRESSED AIR SPRAYER.



The most practical compressed Air Sprayer, and useful in every variety of spraying and white-washing. The tank is made of either heavy brass or galvanized iron as ordered, and has a capacity of around 3 gallons of solution. The pump is of heavy brass, 2 inches in diameter, and four or five strokes from the plunger will discharge the contents under a high pressure. Has the famous "Kant Klog"

patented nozzle, which can be instantly cleaned by pressing it with the thumb. Stops liquid instantly when the thumb pressure is released. Galvanized Tank, \$6.00. Brass Tank, \$9.00.

MYERS POWER SPRAYERS

The use of an efficient power sprayer assures a better crop because the straying can be done more thoroughly and more rapidly, making it possible to spray just at the proper stages in the development of the fruit blossoms. A power sprayer will very soon pay for itself on any orchard two acres or over.

The No. 17 Junior, illustrated, is equipped with a 100-gallon tank, all steel truck and double-acting pump, belt driven (engine not included), one Myers Spray Gun, 25 ft. High-pressure Spray Hose, pressure gauge, agitator, belt tightener, relief valve, etc. Price, \$165.00.

No. 15 Junior. Same as No. 17, but without truck. Price, \$105.00.

No. 25 Power Outfit. With Duplex (double cylinder) pump, without steel truck. Price, \$185.00.

Engine prices on application. 1½ to 2 h. p. required.

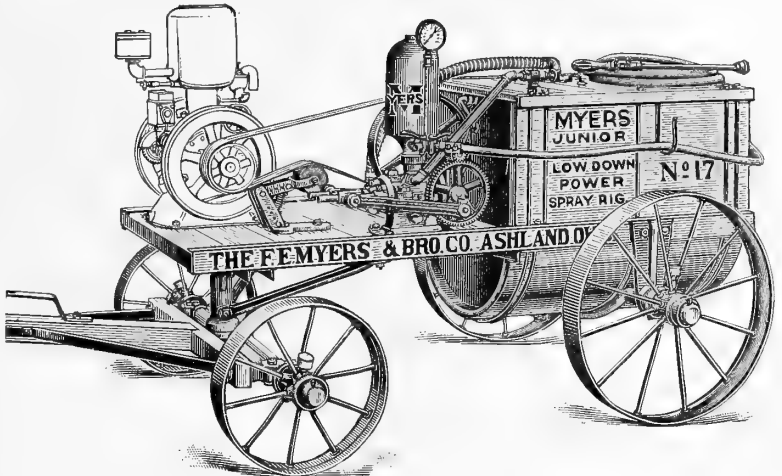

SUNSHINE WHEELBARROW SPRAYER

Especially useful for spraying operations where large capacity but compact construction are required. Has two 16 in. wheels, 5 ft. spray hose, 2 ft. extension and angle nozzle. Capacity 12½ gal., \$14.00.

IDEAL PORTABLE SPRAYER

An ideal wheelbarrow type sprayer, with 15 gal. galvanized tank and operated with a large removable barrel pump. The frame is made of heavy steel tubing reinforced with channel iron cross braces. Discharge equipment consists of 6 ft. spray hose, 4 ft. extension pipe, an ideal angle nozzle and leakless shut-off. No. 32, \$24.00; No. 33—above outfit with air pressure tank and 200 lb. pressure gauge, \$32.00.

LOW DOWN SPRAY PUMP.

R309B. This is an entirely new type of pump, with double the power of any other. Fitted with removable 2½-inch brass cylinders and poppet valves, and adapted for the use of hot or cold mixtures. They are built for use in extensive spraying operations of any kind, as their capacity is sufficient to carry from 1 to 3-leads of hose. Complete with 6 feet wire bound suction hose, 15 feet of 7-ply discharge hose, 8-foot extension pipe and one Fembro nozzle. Price, \$40.00.

No. 316B. Complete outfit, cog gear, double action Spray Pump mounted on platform with very substantial 50 gal. barrel. Mechanical agitator, pressure gauge, 15 ft. of 3/8 inch, 7-ply discharge hose, nozzle, 8 ft. pipe extension and lever shut off. Equipped with No. R309B low down pump described above. Price \$50.00

MEYERS "HANDY"

The Myers Handy Portable Sprayer is made for general use about the home, greenhouse or orchard, for spraying or whitewashing. Fitted with cog gear handle. Has the No. R318B pump, rigidly placed in an extra heavy galvanized iron tank of 12½ gal. capacity. Complete with dasher agitator, 15 feet ½ inch 5-ply discharge hose, extension rod and nozzle. Price \$25.00.

EXTENSIONS.



Extension Pipe, 5-foot length, ¼-inch steel, with couplings. Price, 50c. Assortment of spray Pump Fittings are carried in stock.

BAMBOO EXTENSION



The Bamboo Extension as illustrated is made of selected bamboo 8 and 10 feet in length, through which is placed a 5/16 brass tube, equipped with brass shut-off lever, and has a wide shield on top to prevent solution running down the pole. Price, 8 ft., complete, \$5.00; 10ft., complete, \$5.25.

DUSTERS

The Improved "Champion" Duster will apply any dry material desired.

Light in weight, convenient to carry; used for one or two rows; an even flow of powder, regulated as desired. Gives an ample dust cloud. Has strong air force. Gear driven, easy to operate. Price, \$12.50.



LITTLE GIANT DUSTER

Covers two rows perfectly and can be adjusted to any desired width. Each machine is furnished with two tubes, five nozzles and strap, and weighs 6 pounds. Price, \$9.50.

DICKY DUSTER.

A tube-shaped shaker for dusting vines and plants of all kinds. Price, 45c.

FEENY MODEL B.

The Feeny Model B is one of the most popular dusters made. It sends forth a dust cloud which thoroughly envelopes the plants, reaching both top and bottom surfaces and thoroughly penetrating every crack and crevice. This high efficiency is made possible by the patented features of the cylinder packing found only in the Feeny. It is easily filled, operated with greatest ease, is very effective, saves material and requires no cleaning. \$1.00 each.

ACRE-AN-HOUR SIFTER

For applying Bug Death, Slug-Shot, etc., to any kind of plants and bushes as fast as a man can walk. Will cover perfectly a plant 3 feet in diameter. Price, \$1.00.

ACME DRY POWDER GUN.

Applies all kinds of insect powder in any desired quantity. Price, complete with spreader, \$1.25.

LET US SEND YOU LITERATURE AND PRICES ON POWER DUSTERS AND DUSTS

HOT BED SASH

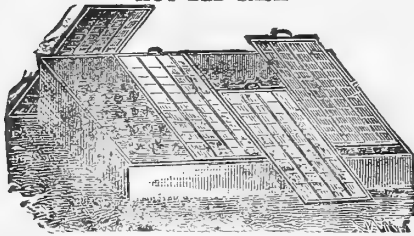

Finest quality; white pine lumber, free from knots, substantially made, grooved for glass to lap or for putty, (unglazed). **\$1.85 each.**

HOT BED GLASS

1 box of glass will glaze 3 sash, 8x10 and 10x12. **\$2.50 per box.**

CEL-O-GLASS

The new substitute for glass; resembles galvanized fly-screen wire, coated with a glasslike substance, admitting plenty of light, but practically unbreakable. May be used on very light frame work, thereby greatly reducing the cost of construction of cold frames, poultry houses, etc. Standard width 3 feet. **13c per sq. ft.; \$35.00 per roll of 300 sq. ft.**

PEERLESS GLAZING POINTS

These will positively keep the glass from sliding and are interchangeable, right or left. The use of a special pincers is recommended. **Price, per box of 1000, 65c.**

PINCERS

Price per pair, 70c; by mail, 75c.

PUTTY BULBS

A very useful tool for applying liquid Putty and Mastica for glazing Sash or Greenhouses. Large size, **\$1.15.**

MASTICA

For glazing greenhouses, sashes, etc., new and old. It is elastic, adhesive and easily applied. It is not affected by dampness, heat or cold. **Price, 1/2 gal., \$1.50; 1 gal., \$2.50.**

MASTICA GLAZING MACHINE

Price, **\$2.25.**

TWEMLOW'S OLD ENGLISH GLAZING PUTTY. Semi-Liquid.

For bedding glass in sash and filling tracks or seams in roof joints or frames of greenhouses or hotbeds. **16-pound can (1 gallon capacity), \$2.75.**

HOT BED MATS

Burlap. Made of strong burlap interlined with wool.
Size, 40x76 inches, each, **\$2.40**
Size, 76x76 inches, each, **3.25**

GALVANIZED WATERING POTS "WIDE SPOUTS"

Made of heavy galvanized iron, with removable sprinkler.
4 quarts, **\$.60**
6 quarts, **.70**
8 quarts, **.80**
10 quarts, **1.00**
12 quarts, **1.10**
16 quarts, **1.25**

WOODEN LABELS

	Plain	Painted
4 inch pot, per 1000.....	\$1.60	\$2.00
4 1/2 inch pot, per 1000.....	1.75	2.30
5 inch pot, per 1000.....	1.90	2.50
6 inch pot, per 1000.....	2.40	3.00
12 inch pot, per 100.....	.75	
3 1/2 inch Tree, iron wired.....		\$2.00
8 inch Garden, per 1000.....		6.50
10 inch Garden, per 1000.....		8.00
12 inch Garden, per 1000.....		11.50

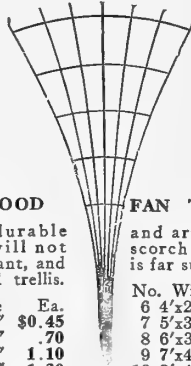

HARDWOOD

Very durable made; will not tender plant, and any metal trellis.

No.	Wide	Ea.
2	24"x10"	\$0.45
3	30"x13"	.70
4	36"x16"	1.10
5	42"x21"	1.30

FAN TRELLIS

and artistically scorch the most is far superior to

No.	Wide	Ea.
6	4'x27"	\$1.75
7	5'x32"	2.25
8	6'x38"	3.00
9	7'x42"	3.50
10	8'x46"	4.00

EARTHEN FLOWER POTS.

We carry a complete line in stock and quote as follows:

	Doz.	100	Stands
2 inch.....	\$0.15	\$1.10	100
3 inch.....	.25	1.85	
4 inch.....	.40	2.80	\$ 2.25
6 inch.....	1.00	7.50	4.50
8 inch.....	2.50	18.25	8.25
10 inch.....	5.00	38.00	13.50

WOOD PLANT STAKES "SQUARE"

Particular Gardeners prefer the wood stakes for their heat-resisting qualities.

Light Plant Stakes.

Height	Each	Doz.	100
1 1/2 ft.....	\$0.03	\$0.25	\$1.60
2 ft.....	.04	.35	2.65
2 1/2 ft.....	.05	.45	3.75
3 ft.....	.07	.70	5.00
4 ft.....	.09	1.00	8.00

Heavy Dahlia Stakes.

Height	Each	Doz.	100
4 ft.....	\$0.19	\$2.00	\$15.00
5 ft.....	.24	2.75	20.00
6 ft.....	.30	3.40	25.00

DIBBLES



Decidedly the best tool for transferring plants.
All steel, D-handle..... **\$0.80**
All steel, bent handle..... **.60**
Wood bent handle, steel point..... **.65**
Steel points for same..... **.35**

GALVANIZED HARD STEEL WIRE PLANT STAKES

Very durable, neat and strong, and extensively used for carnation and rose beds.
No. 9 gauge.
Height Doz. 100 1000
3 ft..... **\$0.20** **\$1.20** **\$10.85**
3 1/2 ft..... **.25** **1.40** **12.65**
4 ft..... **.30** **1.60** **14.45**
5 ft..... **.35** **2.00** **18.00**

GARDEN TROWELS



6-in. Steel Blade, Malleable Shank, each **15c**
6-in. Extra Strong, Hollow Back, each, **35c**
6-in. Solid Steel, Bronzed and Polished, each, **50c**
6-in. American Solid Steel, Hollow Back finely finished, each, **50c**
5-in. Solid Steel, Forged Shank, each, **60c**
6-in. Florists' favorite, solid steel forged, Shank and Blade one piece, each, **75c**.

TRANSPLANTING TROWELS



No. 2, 5-inch blade..... **\$0.20**
No. 1, 8-inch blade..... **.25**

MARLINE

Made from Indian Hemp and the best product in making Straw Mats. Furnished in 1 and 5-lb. balls. **Per pound, 25c.**

RAFFIA. (West Coast).

The best material for tying plants, vines, etc. **Per pound, 25c; 10 pounds, \$2.25.**

RAPID PLANT SETTERS.

These setters are giving entire satisfaction to many large growers of Tomatoes, Cabbage, Tobacco, etc. They take the place of the dibble in making the hole; the plant slides through a slot into the ground and is watered all in one operation. The plants are fed into the setter from a basket which the planter carries and the work can be done standing almost erect. A great time saver and more satisfactory than hand work. **Price, \$6.00.**

The SAVO Steel All - Year - Round FLOWER BOX



For windows, porches, sun parlors, etc. Scientifically constructed; perfect air circulation, sub-irrigated, the most perfect plan ever devised for the growth of any kind of plant life. Savo Flower and Plant Boxes are made of the best grade of galvanized steel with neat round corners and a full roll rim, finished with green enamel inside and out.

	High	Wide	Long	
Model A.....	8"	9 1/2"	23"	\$2.70
Model B.....	8"	9 1/2"	29"	3.60
Model C.....	8"	9 1/2"	35"	4.05
Model D.....	8"	9 1/2"	41"	4.50

GUARANTEED RUBBER HOSE

Moulded Hose made of the very best materials—first class cotton fibre and brand new live rubber, giving entirely satisfactory service to many of our florist customers who need high quality material to withstand the hard usage of the greenhouse. **Furnished in any length. Price, 15c per foot, \$13.00 per hundred. Best quality Wrapped Hose, 11c per foot; \$5.00 per 50 feet.**

HOSE NOZZLES

Mystic Spray Nozzle..... **\$.60**
Justrite Spray Nozzle..... **.75**

OAT AND BARLEY FORKS.

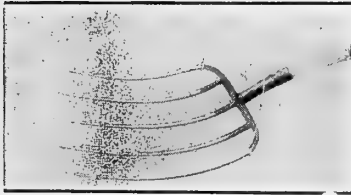

All steel. Each, \$2.00.

**GENERAL UTILITY FORK
D Wood Handles.**



Stone Fork, 10 square 1 3/4 in. tines. Steel D Handle. Price, \$2.50.
10-tine, 15-inch Diamond tine, scoop shape, heavy strap ferrule and cap, wood D-handle. Price, \$3.00
Coal Forks, 12-tine, 14 inches long, D-handle, strap ferrule. Price, \$3.25.
Coal Forks 14-tine, 15 inches long, D-handle, strap ferrule. Price, \$3.70.
Ensilage Forks, D-handle with strap ferrule and cap, 8-16 inch tines. Price, \$2.40.

HEAVY MILL AND STREET FORKS

4 extra heavy, 16-inch Diamond tines, steel D-handle. Price, \$2.15.
5 extra heavy 15 in. oval tines, steel D-handle. Price, \$2.55.
5 extra heavy, 16-inch Diamond tines, steel D-handle. Price, \$2.75.
6 heavy, 14-inch Diamond tines, steel D-handle. Price, \$2.80.
6 light, 14-inch oval tines, steel D-handle. Price, \$2.75.

**MANURE FORKS.
4 and 4 1/2-ft. Handle.**

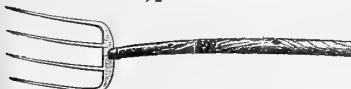

Banner, oval 4-tine, strap ferrule. Price, \$1.50.
Continental, oval, 4-tine, strap ferrule. Price, \$1.45.
Continental, oval, 5-tine, strap ferrule. Price, \$1.65.
Continental, oval 6-tine, strap ferrule. Price, \$1.80.
Herkimer, oval, 4-tine, strap ferrule. Price, \$1.30.
Herkimer, oval, 5-tine, strap ferrule. Price, \$1.45.
Herkimer, 4 1/2 ft. handle, 6-tine, strap ferrule. Price, \$1.65.

**MANURE FORKS,
D-Handle.**

Continental, oval, 4-tine, light strap, mall. D-handle. Price, \$1.45.
Oval, 5 13-inch heavy tines, cap ferrule, mall. D-handle. Price, \$1.65.
Herkimer, iron D-handle, 5-tine, strap ferrule. Price, \$1.45.

POST-HOLE DIGGERS.

Baldwin Brand. Price, \$1.75.

EARTH AUGER.

No. 1. Bores holes 8 to 14 inches in diameter, 3 1/2 ft. deep. Price, \$6.00.
No. 2. Bores holes 8 to 16 inches in diameter, 3 1/2 ft. deep. Price, \$6.75.

ENGLISH DIGGING FORKS.
4 square tines, 12 inches long, 7 1/2-inch spread. Price, \$2.30.

HAY FORKS.



Continental, 2-tine, plain ferrule, 6-foot straight handle. Price, \$1.15.
Herkimer, 3 tines, 6-foot straight handle. Price, \$1.30.

SPADING FORKS, D-HANDLE



Continental, heavy, polished angular tines. Wood D-Handle, \$1.85; Iron D-Handle, \$1.50.
Jumbo, extra heavy, wood D-handle. Price, \$2.00.
Boys' Spading Fork, iron D-handle. Price, 85c.

HOES.



Solid Socket, all steel. Size, 6, 6 1/2, 7, 7 1/2 inch. Price, Continental, \$1.00; Herkimer, 90c. Faultless, \$1.10.
Malleable Iron Socket, Riveted steel blade. Price, 55c.

Planter Hoe, heavy handled, large eye, suitable for stiff ground. Price, 65c.
Mattock Hoe, double pointed, very useful. Price, 85c.
Ladies' Hoe, 5-inch blade, 4-ft. handle. Price, 70c.
Weeding Hoes. 2-prong, 45c; 4-prong, 95c.

WARREN HOES.

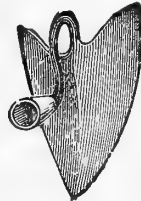

Heart-Shaped Square eye, handled, 5 1/2 in. blade, 75c.
Large size, 7 1/2 inch. Price, \$1.15.

**PRONG HOES OR
POTATO HOOKS.**



4 broad tine, solid steel. Price, \$1.10.
5 round tine, solid steel. Price, \$1.15.
6 flat tine, solid steel. Price, \$1.70.
Nurseryman's Hook, 2-prong extra heavy. Price, \$1.80.

RAKES.

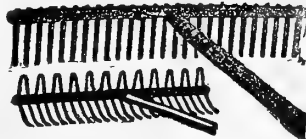

Lawn Queen—24 steel wire teeth, reversible head. Price, 55c.

STEEL GARDEN RAKES.

Bow Shank Curved Teeth, gold bronze finish. Price, 12 teeth, \$1.00; 14 teeth, \$1.10; 16 teeth, \$1.20; Flat Bow, 14 teeth, 85c.
Road Rakes, extra heavy, 14 tine, Price, \$1.25.
Single Shank, bronze finish. Price, 12 teeth, 90c; 14 teeth, 95c; 16 teeth, \$1.00; 18 teeth, \$1.10.

Malleable Iron Shank. Price 10 teeth, 50c; 12 teeth, 55c.

Wood Lawn Rake. 3 Wire Brace, 22 teeth, 65c; 1 Wire Brace, 20 teeth, 50c.
Wood Hay Rake. 2 Wire, 10 teeth, 40c.

SCYTHES.



Best American Grass. Price, \$1.50.
Bush or Brier Scythes. Price, \$1.50.
English T. Waldron, 34, 36 and 33-inch. Price, \$2.25.

SNATH, OR SCYTHE HANDLES.

Two Ring, plain. Price, \$1.40.
Patented Fasteners. Price, \$1.40.
Bush Snath, heavy. Price, \$1.50.

GRASS AND BRUSH HOOKS.



American Grass Hook. Price, 60c.
Draw Cut Grass Hook. Price, 75c.
German Grass Hook. Price, 60c.
Best English Grass Hook. Price, 90c.

BRUSH HOOKS.

For shrubbery and underbrush. Tempered steel. Price, \$1.75.
Imported solid socket. Price, \$1.25.
Imported solid socket, with Cutter, Price, \$1.40.

LIGHTNING HAY KNIFE.

Crucible steel. Price, \$1.75.

HAND-MADE GRAIN CRADLES

Hand-made, 4-finger Cradle, with best American scythe. Price, \$5.00.
With English Waldron scythe. Price, \$5.75

SHOVELS.



Prices are alike for both, round point and square point; also for long handle and D Handle.

	Knox All	Semper	Idem	\$ Brand
No. 2	\$1.30	\$1.50		\$1.75
No. 4	\$1.40	\$1.55		\$1.85

	Nnox All	Semper	Idem	\$ Brand
No. 2	\$1.40	\$1.55		\$1.85
No. 4	\$1.45	\$1.60		\$1.90
No. 6	\$1.50	\$1.70		\$2.00

HOES—Acme.



For weeding and cultivating, double prong, 4 1/2 inch blade. Price, 80c.
Acme W. & C., single prong polished steel. Price, 65c.

Onion or weeding, two-prong, polished steel. Price, 45c.

SPADES.



Semper D-handle, carbon steel. Price, \$1.50.
Nursery, extra heavy D-handle, full strap. Price, \$2.00.
Knox All, long handle; Price, \$1.40.
U. S. Army spades. Price, 75c.

DOCK CUTTERS.

4 1/2 foot handles, with foot rest. \$1.15.

HAND WEEDERS



40c. 25c. 20c. 10c. each.

HAND GARDEN FORKS

No. 2. 11 inches long, hardwood handle, 3 tines, Japanned. Price, 40c.
 No. 3. 10 inches long, hardwood handle, 4 tines, Japanned. Price, 30c.

ASPARAGUS KNIFE.



Made of solid steel; see the cutting point. Price, 45c.

ASPARAGUS BUNCHER.....\$4.00

THE RODERICK MOLE TRAP.



Self-setting by pressing down on lever. Very convenient feature, found on no other trap. Made from best spring steel, thoroughly galvanized. Simple and durable in its construction. Price, 85c.

OUT-O'-SIGHT MOLE TRAP.

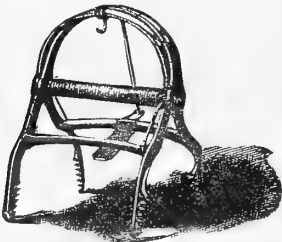

This, while possessing all the good qualities of other traps, is especially adapted for setting under glass in hot beds. Price, \$1.25.

THERMOMETERS.

8-inch, Tin, Japanned. Price, 50c.
 10-inch, Hardwood Cabinet. Price, 60c.
 12-inch, Tin, Japanned, Hot-Water Reg. Price, \$1.00.
 Mushroom Bed and Hot Bed, Brass Point. Price, \$2.00.



AMERICAN EDGING KNIVES.
 All Steel. Price, 95c.

SCUFFLE or PUSH HOES.
 Price, \$1.00.

NORCROSS CULTIVATOR.

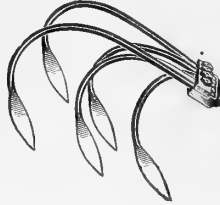

The Norcross is an adjustable garden cultivator of 5 blades. A very handy garden tool. By removing the center tooth you can straddle the rows. The teeth can be made to set close or wide apart. Can be detached from handle and attached to any wheel hoe. Price, \$1.00.

MIDGET NORCROSS.

3-prong, short handle. Price, 40c.
 3-prong, long handle. Price, 75c.

MAGIC WEEDER.



A perfect and efficient tool, made of best tempered steel and furnished with 6 and 18-inch handle. Price, 15c and 20c.

FRUIT PICKER.

Made of galvanized hard-steel wire, shaped so as to imitate the human hand. Without pole. Price, 50c.

GRAFTING WAX.

Trowbridge Brand.
 Price, 1/2 lb., 15c; 1 lb., 50c.

PRUNING SAW.



16-inch.....\$1.20
 18-inch.....1.50
 20-inch.....1.75

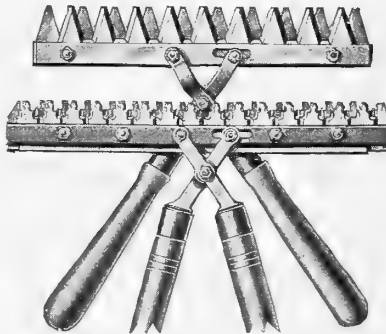

SIMPLICITY HEDGE TRIMMER—SIMPLICITY PRUNER AND TRIMMER.

"Cutting more surface with more cutting surface," the Simplicity tools will make it possible to trim and prune hedges quickly, easily and accurately.

The Trimmer is designed to cut new growth only, but the Pruner and Trimmer does both the trimming of the fresh growth and pruning back the old growth. Both patterns are so easily operated that no experience is necessary to do a first class job. They will trim every variety of hedge growth in any shape or cut desired.

"Simplicity" tools are made of the finest high-grade carbon steel, and will give you long service and satisfaction. Price, Trimmer, \$4.00. Pruner and Trimmer \$6.00.

(Write for descriptive circular)

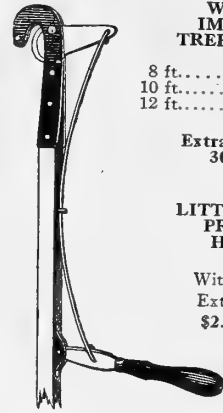

WATERS' IMPROVED TREE PRUNER.

8 ft.....\$2.00
 10 ft.....2.20
 12 ft.....2.40

Extra Knives, 30c each.

LITTLE GIANT PRUNING HOOKS.

Without pole.
 Extra heavy.
 \$2.50 each.

HEDGE SHEARS.

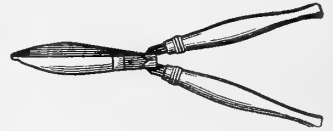

8-inch American.....\$1.75
 10-inch English.....2.00
 8-inch English.....2.70
 9-inch.....3.10
 10-inch.....3.40
 12-inch.....3.75
 With Notch, 25c extra.

SUDDING KNIVES, PRUNING.

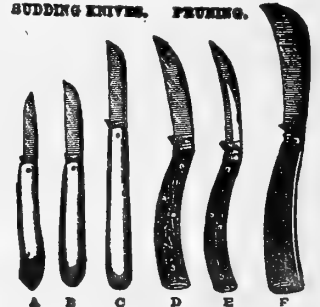

75 75 75 85 85 \$1.15

PRUNING SHEARS.

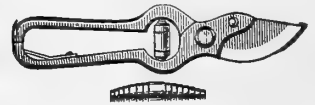

Malleable Handle Steel Plate. Price, 50c and 60c.
 Solid Steel, 8-inch. Price, 75c.
 Solid Steel, see illustration. Price, \$1.00.
 Imported French Steel. Price, \$1.75.
 Imported IXL. Price, \$2.00.

BUCKEYE PRUNERS.



No. 1. 18-inch. Price, \$1.50.
 No. 10. 18-inch adjustable. Price, \$1.75
 No. 3. 36-inch, extra heavy. Price, \$2.25.
 No. 26. Oakland. Price, \$2.75.

OLIVER CHILLED PLOWS.
Wood or Steel Beam.



- A1 Light, one horse, wood beam, \$10.00. Steel Beam,.... \$10.50
 - B Medium, one-horse, wood beam, \$12.00. Steel Beam.... 12.75
 - 10 Full, one-horse, wood or steel beam..... 16.00
 - 13 Heavy, one-horse, wood or steel beam..... 18.00
 - 19 Light, two-horse, wood or steel beam..... 19.50
 - 20 Medium, two-horse, wood or steel beam..... 21.00
 - 40 Two- or three-horse, wood or steel beam..... 24.00
 - E Full, two-horse, wood..... 24.00
- Wheel and jointer extra.

OLIVER TRACTOR PLOWS.

The No. 135 Oliver (two 12-inch bottoms) has been found to be the most practical for use with Fordson Tractors. Comparative tests in which this plow has been placed in competition with other makes have always resulted in favor of the Oliver. There are more Oliver tractor plows in use among our customers than any other and all are giving entire satisfaction. Let us send illustrated literature giving full description. Price, \$110.30.

SYRACUSE CHILLED PLOWS.

John Deere Syracuse Plows are the result of forty years study and experience in plow manufacture and "Quality" always has been the motto of the Syracuse Plow Co.

The Company has made a special study for years of shapes and the assembly of different materials in the same plow, with the purpose of fitting properly a particular plow for a particular section.

Syracuse plows have proved their worth through years of use. They are scientifically designed, built of the best material obtainable and are equipped with attachments which will permit of a fine, accurate and reliable adjustment for governing the plow.

Prices quoted are subject to 5% cash discount. Wheel and jointer extra.

One-horse Plows.

- No. 50. Right, wood beam, light, one-horse, making furrow 2 to 5 inches deep and 8 to 10 inches wide: \$10.00.
- No. 52. Right, wood beam, medium, one-horse, making furrow 3 to 5½ inches deep and 9 to 11 inches wide. \$15.50.
- No. 53. Right, wood beam, heavy, one-horse or light two-horse making furrow 3 to 6 inches deep and 9 to 12 inches wide. \$17.50.
- No. 1464. Right, steel beam, \$17.50.
- No. 1465. Right, steel beam, \$15.50.

Two-horse Plows—Wood Beam.

- No. 603. Right, wood beam, light two-horse, making furrow 4½ to 6½ inches deep and 10 to 12 inches wide. \$20.00.
- No. 602 Right, and No. 502 Left. Wood beam, medium, two-horse, making furrow 5 to 7 inches deep and 11 to 14 inches wide, \$22.00.
- No. 601 Right, and No. 501 Left. Wood beam, heavy, two-horse or light, three-horse, making furrow 5½ to 8 inches deep and 12 to 16 inches wide. \$23.00.

Two-horse Plows—Steel Beam.

- No. 401 Right, and No. 301 Left. Steel beam, making furrow 5 to 8 inches deep and 12 to 15 inches wide. \$24.00.

PLOW REPAIRS AT POPULAR PRICES.



SHOVEL PLOWS

- Steel beam, single shovel. Price, \$4.50.
- Steel beam, double shovel. Price, \$5.00.
- Steel beam, triple shovel. Price \$6.75.

BOSS DRAG SCOOPS.

- No. 1. With runners.....\$10.00
- No. 2. With runners..... 9.00
- No. 3. With runners..... 8.00

STEEL FRAME SPRING TOOTH HARROW.

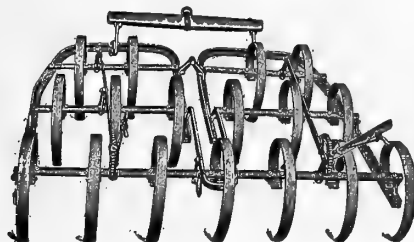

This Steel Frame Spring Tooth Lever Harrow is now a favorite with every farmer. The frame is made of angle steel and the bottoms are equipped with detachable runner shoes, which can be renewed when they become worn. Adjustable to any depth.

- 15-Tooth 2 Section Cuts, 53-inch..... \$28.00
- 17-Tooth 2 Section Cuts, 64-inch..... 30.00
- 23-Tooth 3 Section Cuts, 87-inch..... 42.25

Wheel and Lever, 15-Tooth (Farquhar)..... 29.50

SYRACUSE CULTIVATOR.

7-Tooth Diverse Cultivator, with regular spring teeth, adjusted by two levers. Very efficient one-horse tool. Weight 60 lbs. \$9.75

WOOD FRAME SPRING TOOTH HARROW.

This is the well-known, favorite Perry Harrow, Steel lined, guarded, protected bolt heads, perfect tooth seat.

- 14-Tooth Harrow..... \$15.00
- 16-Tooth Harrow..... 18.00
- 18-Tooth Harrow..... 19.50
- 20-Tooth Harrow..... 22.00

ALL-STEEL SPIKE TOOTH HARROW.

A spike-tooth Harrow will ever up. A smoothing Harrow with lever down. Made entirely of steel. The teeth can be instantly set at any angle from forward pitch to straight up or slanting backward.



- One-horse, One Section, 4 ft. Cut, with Bale..... \$11.00
- Two-horse, Two Sections, 8 ft. Cut..... 23.75
- Two-horse, Two Sections, 10 ft. Cut..... 25.25

DISK HARROWS.

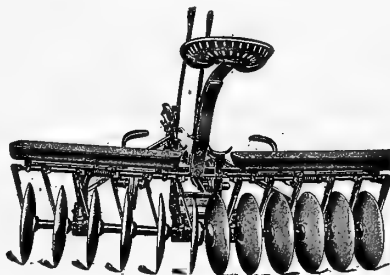

John Deere Model 'B', 3-Lever Flexible, with Spring Pressure Lever, Hand Oilers and Scrapers without Weight Boxes.

- 8 Disk, 16 inches, 4 ft., 2 horse evener and pole..... \$48.00
- 10 Disk, 16 inches..... 52.00
- 12 Disk, 16 inches..... 58.00

If Scrapers not taken, deduct \$2.40.

TONGUE TRUCK FOR DEEP DISK HARROW

The Harrow Truck is a new device and enables the user to make a short turn and relieves the neck weight entirely. \$10.00.

EMERSON-BRANTINGHAM DISK HARROWS.

For Horse and Tractor Power.

If you are farming to make money, you cannot ignore the advantages and the economy of labor-saving machinery, and the farmer who labors along without the good implements that modern conditions demand, pays a higher price in the end.

The E-B Tandem Disk Harrow enables you to do more work in shorter time and with less man labor. With one of these double action machines one man can do the work of two men with single disks in the same length of time and the work will be done better. Besides it may be equipped with either a horse or tractor hitch, which is an advantage when both kinds of power are available. If desired, the rear section may be detached and the front section used alone as a horse or tractor-drawn single disk harrow. Many of our customers operating Fordson Tractors now have these harrows in use and are highly pleased with them. Quality and usefulness are built in. Let us send you illustrated literature and prices.

72 Page
Catalog

Planet Jr. Farm and Garden Tools

Get Your
Copy

No. 4. Price, complete, \$19.00. Weight, 50 lbs.

No. 4-D. As a Seeder only, Price \$15.00.

Holds $2\frac{1}{2}$ qts. of seed. The most popular of all seeders. Always gives entirely satisfactory results.



No. 4.—Combined Hill AND DRILL SEEDER AND CULTIVATOR

NO. 16.—SINGLE WHEEL HOE, CULTIVATOR, RAKE AND PLOW.

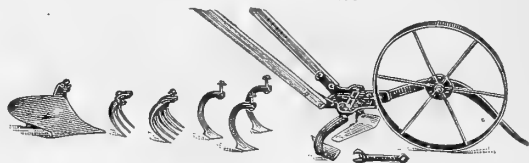

Equipment: One pair of 6-inch hoes, three cultivator teeth, one large garden plow, one 7-inch rake, one 4-inch rake, one leaf guard. All oil tempered. Price, \$9.50.

NO. 25.—COMBINED HILL AND DRILL SEEDER, DOUBLE AND SINGLE WHEEL HOE.

Holds $2\frac{1}{2}$ quarts. It combines in a most practical way the No. 4 Drill and No. 12 Double Wheel Hoe. Price, \$22.50.

The most complete and useful combination of Hill and Drill Seeder and Double and Single Wheel Hoe that you can buy. Sows seed in hills, and drops in hills, at the proper thickness, depth, and economically. Cultivating attachments permit one to do all the garden cultivating work plowing, hilling, etc. Can work both sides of the row by straddling until plants are 20 inches high.

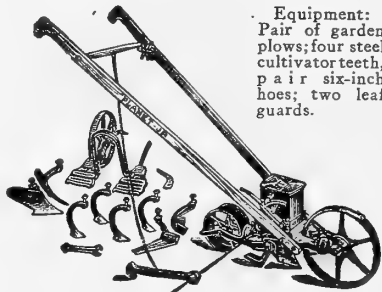

Equipment: Pair of garden plows; four steel cultivator teeth, pair six-inch hoes; two leaf guards.

NO. 12.—DOUBLE AND SINGLE WHEEL HOE.



Equipment: One pair of 6-inch hoes, four steel cultivator teeth one pair of plows, two leaf lifters. All oil tempered. Price, with attachments as in cut, \$11.50.

NO. 13.—WHEEL HOE.

Most useful. Has same frame, wheels and handles as No. 12, but has for equipment one pair of 6-inch hoes only. Price, \$8.25.

NO. 17.—SINGLE WHEEL HOE.

Is of the same construction as No. 16, omitting the two rakes. Price, \$8.00.

NO. 17½.—SINGLE WHEEL HOE.

Equipment. One pair of 6-inch hoes, three steel cultivator teeth, one leaf lifter. Price, \$7.25.

NO. 18.—SINGLE WHEEL HOE.

Frame and wheel as No. 16, but has for equipment one pair hoes only. Price, \$6.00.

NO. 3 AND NO. 5.—HILL AND DRILL SEEDERS.

Recommended for the general market gardener. 15-inch and 16½-inch driving wheels. Seed hopper capacity 3 and 5 quarts. Price, No. 3, \$18.50; No. 5, \$21.00.

NO. 35.—PLANET, JR. SEEDER ATTACHMENT FOR WHEEL HOES AND GARDEN PLOWS.

Price, \$6.50.



Can be attached to any Planet, Jr. Wheel Hoe or Garden Plow, with the exception of the Fire Fly Plow. Sows a five cent packet of seed as economically as a full hopper, at the proper depth and thickness, and produces a uniform stand. Attached with one bolt in an instant. Seed index accurate

and arranged for all garden seeds.

NO. 20-D.—PLANET JR. FERTILIZER DRILL.

Distributes

Right
or
Left.

Both
Right
and
Left.

All
Down
Center.



Save fertilizer. Instead of distributing all the fertilizer before sowing the seed, distribute only a portion and when the crop is up, side-dress with a quick-acting fertilizer—using the Planet Jr. No. 20-D Fertilizer Drill. It enables you to rush young plants, to get more tender crops and to get better prices for those crops.

Planet Jr. Covering Rollers, \$6.50.

NO. 19.—SINGLE WHEEL HOE CULTIVATOR AND PLOW.

Is strong, well made, with 15-inch high wheel, which makes it easy running; equipped with one 2-inch cultivating tooth, one 4-inch cultivating tooth, one 5-inch sweep, one 10-inch sweep and one plow. Price, \$6.25.

NO. 119.—GARDEN PLOW AND CULTIVATOR—HIGH WHEEL.

The favorite high wheel tool. 24-inch steel wheel. Wonderful assortment of cultivating attachments. Does all plowing, cultivating, and furrowing required in the home garden. Price, \$5.25.

NO. 8.—HORSE HOE AND CULTIVATOR.

Equipment: Four 3x8 inch cultivator steels; one 4x8 inch cultivator steel; two 6 inch hillers; one 7 inch shovel; lever wheel; lever expander; depth regulator. The farmer's favorite. Price, \$19.00.

NO. 9-D.—HORSE HOE AND CULTIVATOR.

Same as the No. 8, less the depth regulator and steel lever wheel. Strong and light. Does perfect work. Price, \$14.50.

NO. 9-D.—PLAIN 5-TOOTH CULTIVATOR.

Equipment: Four 3x8 inch cultivator steels; one 4x8 inch cultivator steel; lever expander. Hollow steel standards and steel draft hook. Simple, practical—always ready for work. Price, \$12.75.

NO. 4-D.—PLAIN CULTIVATOR.

Same as the No. 9-D, but does not include lever expander. Patent beveled steel teeth. An every-day, all-day tool. Price, \$10.25.

NO. 101-D.—PLAIN CULTIVATOR.

Equipment: Five 3x8 inch cultivator steels; lever expander. Lever is all steel; simplified and improved; works very easily. Just the tool for sandy soils or light cultivating. Price, \$10.25.

NO. 100-D.—PLAIN CULTIVATOR.

Same as the No. 101-D, less the lever expander. The right tool for sandy soils in this section. Price, \$8.25.

NO. 90-D.—12-TOOTH HARROW.

The fruit, berry and vegetable grower's favorite. Does fine, thorough cultivation. Expands to 32 inches; contracts to 12 inches. Price, \$12.75.

NO. 92-D.—PLAIN 12-TOOTH HARROW—NO WHEEL.

A light, but effective cultivator for fine work—at a moderate price. Price, \$11.00.

EMERSON AUTOPIVOT CULTIVATOR NO. 48.

Has the celebrated Emerson foot-lift device. Can be raised or lowered, and guided with the feet, leaving the hands free to manage the team. Has Roller and Ball Bearings. Can be used as a surface cultivator or a corn plow. Wheels can be widened or narrowed. Furnished in 6 or 8 shovels and has no complicated balancing devices. The gauges are nearer the team than are other makes and the draft is direct to the beams instead of the wheels. This machine has proven satisfactory wherever it has been placed.

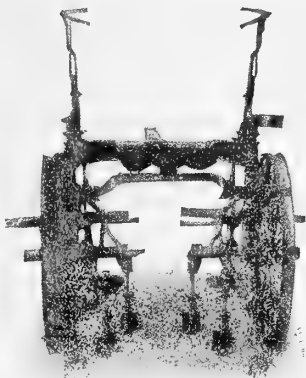

Circular is yours for the asking.

6-Shovel Pin Break.....	\$62.00
6-Shovel Spring Trip.....	67.00
8-Shovel Pin Break.....	64.00
8-Shovel Spring Trip.....	72.00

IRON AGE CULTIVATORS

Plain 5-tooth cultivator; expands 9 to 24 inches. Price, \$6.75. Lever Expander, \$1.50 extra.

I. A. extra heavy Cultivator, plain Bent Frame. Price, \$8.00. Plain Wheel, \$1.00 extra.

I. A. Cultivator and horse hoe combined, as illustrated. Price, \$12.00.

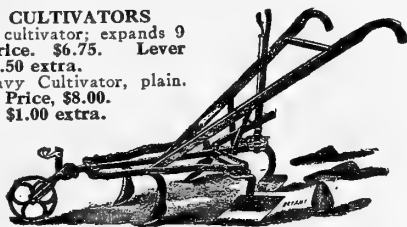

IRON AGE COMBINED HARROW AND CULTIVATOR.

A splendid tool for cultivating crops in rows; thoroughly pulverizes and loosens the soil without throwing dirt on the small plants. The teeth are reversible and can be changed in 4 different positions. Expands 11 inches to 36 inches. Price as shown in illustration, \$8.00.

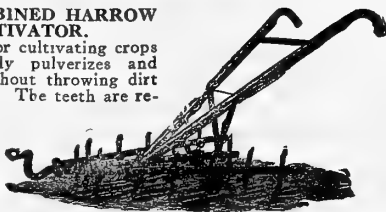

Price, with lever expander, \$9.50.

FELINS VEGETABLE TYING MACHINE.

The Felins vegetable tying machine is an absolute labor-saving device for market gardeners and florists; larger loads can be made ready for market in less time.

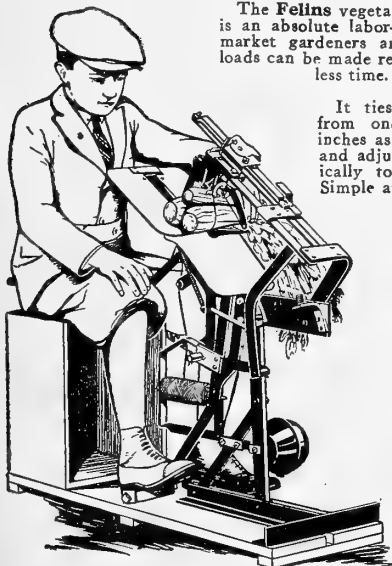

It ties any size bunch from one-quarter to five inches as tightly as desired and adjusts itself automatically to any size bunch. Simple and durable in construction, speedy, and can be operated by a child.

With this machine the market gardener has more time to devote to actual gardening and is therefore permitted to give better attention to those more important matters which make for success. Let us demonstrate.

Price, \$75.00.

HAYING TOOLS AND IMPLEMENTS.

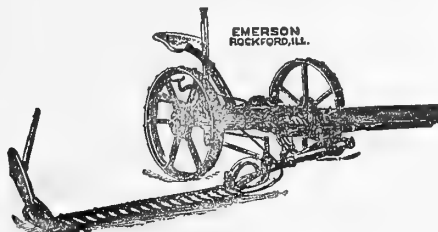

EMERSON ROCKFORD, ILL.

EMERSON-BRANTINGHAM STANDARD MOWER

E-B Standard Mowers are more easily handled, run lighter and are more durable than any other mowing machine. The manner in which the cutter bar is carried on the wheels, together with a proper distribution of the weight, greatly increases the traction power of the machine, overcomes side draft and weight on the horses' necks, giving it a powerful cutting capacity which enables it to cut through the heaviest grass without materially increasing the draft. The gear and driving mechanism is the three motion gear and is especially valuable in obtaining the high speed required without undue strain on any portion of the machine. This mower has many other points of superiority and we would be pleased to give you full information. Prices on request.

EMERSON-BRANTINGHAM SELF-DUMP RAKE.

The only absolute automatic lock-down self-dump rake. Built for light draft, efficient work and durability.

8-foot, 20 teeth.....	\$44.00
8-foot, 25 teeth.....	45.50
9-foot, 23 teeth.....	47.00
9-foot, 28 teeth.....	48.25

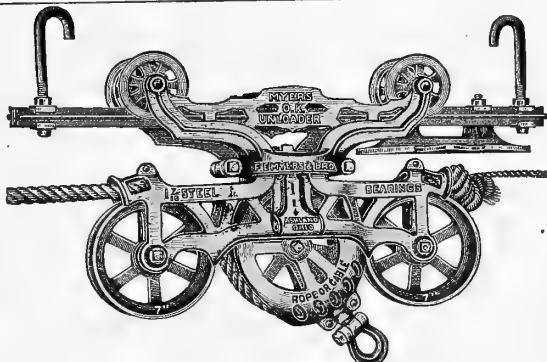

Myers' Double Lock Unloaders.

No. 209. Has extra long truck, wheel base 16 inches, large steel bearings, 7 inch sheaves, reversible and swivel, for double steel track, designed for heavy work. Price, \$12.50.

MYERS' CLOVER LEAF UNLOADER.

No. 114. This is the well-known reversible car for double steel track. The locking device grasps the fork pulley on either side and permits it to swing free. Price, \$10.25.

- Double Steel Track. Price per foot, 25c.
- Hanging Hooks. For double steel track. Price, each, 18c.
- Rafter Brackets. Steel. Price, each, 6c.
- Pulleys, 6-inch; wood sheave; malleable iron frame. Price, each, 75c.
- Pulleys. Knot-passing swivel; 6 inch malleable iron sheave. Price, each, 80c.
- Double Harpoon Forks. All steel. Price, each, \$2.50 to \$6.00.
- Floor Hooks, 3/4-inch wrought iron. Price, each, 18c.

WAGNER BARNDOOR HANGER.

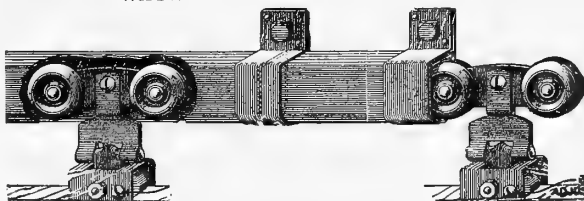

Extra Heavy All Steel and Self-cleaning.

Tandem Ball-bearing Rollers, per set.....	\$2.00
No. 15 Tubular Steel Track, per foot.....	.25
No. 100 Evertight Steel Track, per foot.....	.32
Steel Brackets, each.....	.20

STERLING MOWER

Simple in construction, light running, made of the very best material throughout, and warranted in every particular.

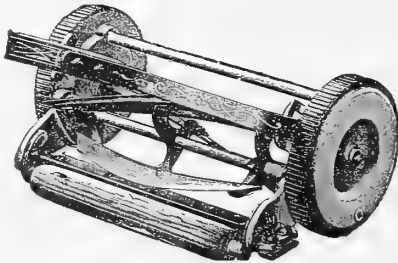

10 and 12-inch cut.
Price, \$5.50.
14-in. cut, four knives. Price, \$5.75.

TERRACE SPECIAL (Style P. P.). Price same as Sterling.

LEADER MOWER

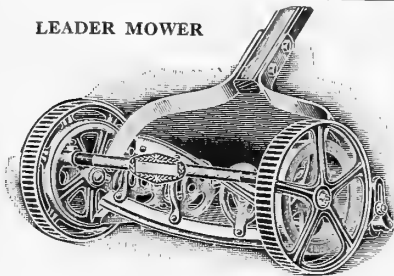

High wheel Ball Bearing. Very light running. Wheels 9 in. high; reel 6 in. in diameter; all latest improvements; noiseless action; keen cutting; self-sharpening; high speed.
14-inch cut.
Price, \$9.00.
16-inch cut.
Price, \$9.35.

ARDMORE LAWN MOWER (Style J). BALL BEARING.

High Wheel. Case-hardened Bearings, double geared. Every detail of this Mower is in keeping with any highgrade machine on the market. High cylinders and very easy running.
14-in. cut, 4 knives, net. \$ 9.50
16-in. cut, 4 knives, net. 10.00
18-in. cut, 4 knives, net. 10.50

SUPREME LAWN MOWER

Ball bearing; 4 Crucible Steel Blades; no screws or bolts to adjust; all necessary adjustment made by one thumb screw; floating knife bar; quiet in operation; 10 inch drive wheels; revolving cutter 6 inch in diameter; 14-in., \$11.50; 16-in., \$12.00; 18-in., \$12.75.

KING HIGH GRASS MOWERS

Driving wheels 9 1/2 inches high; 6-inch ball-bearing revolving cutter; blades crucible steel, hardened and tempered in oil.

14-inch cut, \$13.50
16-inch cut, 14.25
18-inch cut, 15.00

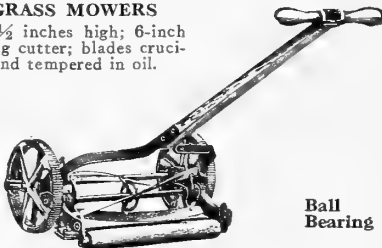

Ball Bearing

Plain Bonehardened Bearings, 5 Blades, 10-inch Drive Wheels.

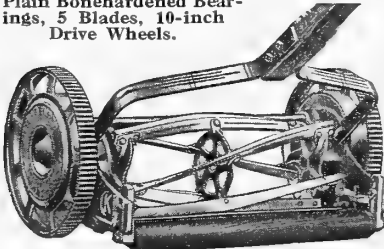

PHILADELPHIA STYLE "K"

PLAIN BEARING
14-inch. . . . \$16.00
16-inch. . . . 17.50
18-inch. . . . 18.75
Roller Bearing
14-inch. . . . \$19.25
16-inch. . . . 20.75
18-inch. . . . 22.50

INDEPENDENCE MOWER Roller Bearing

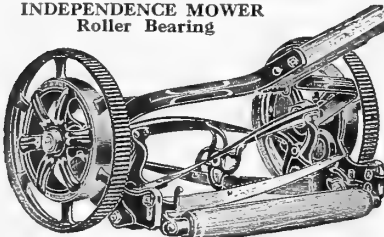

Philadelphia Independent
14-inch. . . . \$13.50
16-inch. . . . 14.00
18-inch. . . . 14.50
Philadelphia All Day Mower. Plain Bearings.
12-inch. . . . \$12.00
16-inch. . . . 12.50
18-inch. . . . 13.00

PHILADELPHIA HIGH-WHEEL "GRAHAM" MOWER

Represents the highest achievement in lawn mower manufacture.
All steel cylinder 6 1/2-in. diameter; four blades; driving wheels 10 in. No front rod. Removable box caps to take out cylinder for sharpening

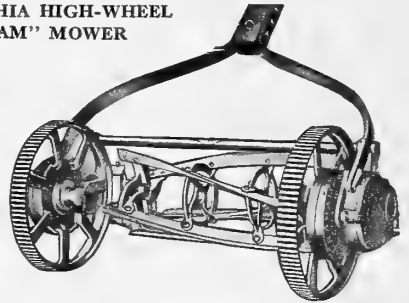

Price, 15-in., \$22.75; 17-in., \$25.00; 19-in., \$28.00.

PHILADELPHIA EAGLE HORSE LAWN MOWER AND ROLLER.

This is the latest production of this well-known factory, and is now acknowledged by every user to be the best Mower in operation. 30-in., with seat, shafts and draft pole, \$130.00; 35-in., \$160.00; 40-in., \$180.00. Special price on motor mowers.

CALIFORNIA SCIENTIFIC SPRINKLERS.

These sprinklers, which are especially adapted for use on lawns and golf links, supply a long-felt need for an efficient simply constructed sprinkler, which has no movable parts to get out of order. The spray produced is just like rain and a remarkable distance is covered. Four, five, six and seven foot lengths. 50c per foot.



FOUNTAIN SPRINKLER Made of Heavy Brass.

Easily moved over the lawn without turning off the water. The mist-like spray is a veritable "thing of beauty." Price, 75c.

REVOLVING SPRINKLER

These sprinklers are compactly and strongly made with phosphor-bronze bearing.
Eureka Sprinkler, 12 in. high, Price, \$1.85.
Newport Sprinkler, 24 in. high. Price, \$3.25



REVOLVING SPRINKLER

GRASS COLLECTOR

Made of best quality duck with galvanized iron bottom, easily attached or detached. 12 in., \$2.75; 14-in. \$3.25; 16-in. \$4.00; 18-in., \$5.00. D & M Collectors, No. 1 \$1.50; No. 2 \$1.60.



Water Ballast Lawn Roller

LAWN ROLLERS

These rollers represent all the latest and up-to-date improvements; they are fitted with hardened steel roller bearings, which reduces the draft by 40 percent.; the counter-balance attached on the outside of the drum induces the handle to stand in an upright position. The outer edges of the drum are well rounded to prevent cutting.
No. 605 has plain bearings and no scraper.

WATER BALLAST LAWN ROLLER

No. 601—14x24 Empty 70 lbs.; filled 175 lbs. Price, \$17.00
No. 602—18x24 Empty 85 lbs.; filled 265 lbs. Price, 20.00
No. 603—24x24 Empty 110 lbs.; filled 420 lbs. Price, 23.00
No. 605—14x24 Empty 68 lbs.; filled 175 lbs. Price, 13.50

	Diameter	Total	Weight	Price
	Face	Length	Pounds	
Cast Drum Rollers				
No. 504—2 section	20	20	250	\$23.00
No. 507—2 section	20	24	300	27.50
No. 509—2 section	24	40	400	36.50

Wire Fencing

UNITED STATES POULTRY NETTING.

U. S. Poultry Fence is strictly a "NO SAG" fence, as the combination of line and mesh wires, closely woven, prevents any lengthening or narrowing between posts. In erecting U. S. Poultry Fence the line wires permit of being stretched to a high tension, which compels the fence to remain rigid and upright without anchoring it to a baseboard or top rail. These features place it a long stride beyond the Hex mesh netting, which never fails to narrow and lengthen if you attempt to stretch it to a tension required to prevent sagging. There is no netting on the market that compares with U. S. Poultry Fence for strength, beauty and durability, and we invite comparison with other makes, feeling confident that all our claims of superiority will be substantiated.

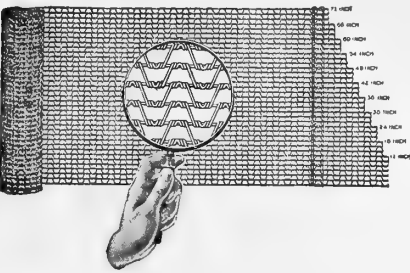

Made of No. 19 hard steel wire, double twisted and galvanized after weaving.

2-inch Mesh Put up in Rolls of 150 feet.

12-inch.	12 lbs.	\$1.35
24-inch.	23 lbs.	2.50
36-inch.	32½ lbs.	3.45
48-inch.	44 lbs.	4.60
60-inch.	54½ lbs.	5.75
72-inch.	63½ lbs.	6.90

In less than Roll lots, 1½¢ a square foot.

Also made in 1 inch Mesh. Price on application.

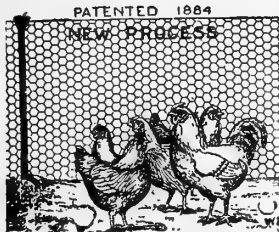

1-inch Mesh. (Hexagon)

12-inch, 150 sq. ft.	\$3.00
18-inch, 225 sq. ft.	4.25
24-inch, 300 sq. ft.	5.50
30-inch, 375 sq. ft.	6.60
36-inch, 450 sq. ft.	7.50
48-inch, 600 sq. ft.	10.00

Less than roll lots, 3¢ sq. ft.
Poultry Netting Staples, lb. .10

American Steel Fence Posts



No tamping—no back-breaking post hole digging. You can drive steel posts in ordinary soil. Steel posts protect your live stock from lightning. Allows you to burn your fence rows, destroying bugs and weeds that damage crops. Eliminates repairs. Requires no staples. Makes land more valuable.

TAMP TAMP! TAMP!
The Boys Are Tamping While We Have Our Work ALL DONE!

Steel Posts Need No Tamping They Pierce Firm Ground

Made by American Steel & Wire Company

End post, 7 ft. high, weight 52 lbs.	\$3.50
Corner post, 7 ft. high, weight 76 lbs.	5.15
Ball Posts for Line Posts.25
Ball Tops for End and Corner Posts.40
Upper Collar for hanging Gate and End Post.75
Lower Collar for hanging Gate and End Post.75
Pig-Ear Latch.75
Driving Caps for Line Post.40

Special Prices on Large Quantities.

5 ft. Line posts.	\$0.55	7 ft. Line posts.	\$0.70
6 ft. Line posts.60	7½ ft. Line posts.75
6½ ft. Line posts.65	8 ft. Line posts.80

CHAMPION WIRE STRETCHER

No. 1 has hickory handle and malleable clamp; can be quickly adjusted, and is a favorite with fence builders. Price..... **\$1.50**

RATCHET WIRE STRETCHER

Is operated by one man and holds the wire in any desired position. Price..... **\$1.50**

BARBED WIRE—GALVANIZED.

Two and four points, price per 100 lbs. **\$4.75**

REBBIION WIRE

Galvanized, per 100 lbs. **\$9.00**

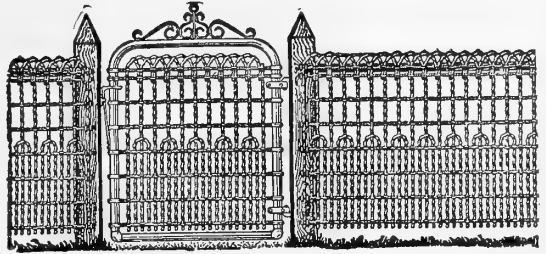

ORNAMENTAL LAWN FENCE.

Very attractive and we believe the most durable wire lawn fence made. Can be furnished heavy galvanized, or, in addition, coated with a specially prepared Gray Enamel Paint. Spaces, 1¼ inches: wire, No. 9 Crimped Pickets in No. 12½ Tw. Cables.

Price, 36-inch, per ft., 14c; per 100 ft.	\$12.75
Price, 42-inch, per ft., 15c; per 100 ft.	13.75
Price, 48-inch, per ft., 17c; per 100 ft.	16.00

In Rolls of 250 feet, deduct 1c a foot.

FLOWER GUARD.

Designed for protecting Flower Beds.
16-inch, per ft. **.08** 22-inch, per foot **.10**
100 feet or more, 1c per foot less.

ORNAMENTAL GATES.

Heavy steel frames, filled to match the fence; fittings for wood or metal posts.

Height	Distance Between Posts.					
	3 ft.	3½ ft.	4 ft.	5 ft.	8 ft.	10 ft.
36-inch	\$4.10	\$4.20	\$4.40	\$4.85	\$8.00	\$11.00
42-inch	4.20	4.50	4.80	5.10	8.25	11.50
48-inch	4.40	4.75	5.20	5.40	8.50	12.00

DISTANCE BETWEEN BARS—INCHES	11 BARS 55 INCH	
	9"	10 BARS
8"	9 BARS	39 INCH
7"	8 BARS	32 INCH
6"	7 BARS	26 INCH
5½"	6 BARS	20 INCH
5"		
4½"		
4"		
3½"		
3"		

AMERICAN STOCK AND POULTRY FENCE.

American fence is one continuous wire from top to bottom, and is locked to the strand wires with a simple lock or knot.

No. 635.6 strands, 35 in. high, 12-in. stays, per rod.	\$0.28
No. 845. 8 strands, 45 in. high, 12-in. stays, per rod.36
Regular No. 1047, 10 strands, 47-inch height.41
Hog Style, No. 726, 7 strands, 16 stays, 12-in. apart.30
Hog Style, No. 726, 7 strands, 32 stays, 6 in. apart.40
Hog Style, No. 832, 8 strands, 16 stays, 12 in. apart.33
Hog style, No. 832, 8 strands, 32 stays, 6 in. apart.44

Put up regular in 20-rod Rolls. Prices subject to change.
10 Rod/Rolls, 25¢ per Roll, Extra.

AMERICAN POULTRY FENCE

An ideal fence against poultry and small animals. The spacing is graduated from 1½ inches at the bottom to 5 inches at the top, and the distance between the stays is 6 inches.

No. 1948. 48 inches high, per roll of 165 ft.	\$5.85
No. 2158. 58 inches high, per roll of 165 ft.	6.40

BANNER POULTRY FENCE

4 ft. high—10 rod Roll.	\$5.15
5 ft. high—10 rod Roll.	6.00
6 ft. high—10 rod Roll.	6.75
7 ft. high—10 rod Roll.	7.65

DISTANCE BETWEEN STAYS—INCHES	21 BARS 58 INCH	
	5"	
5"		
4½"		
4½"		
4"		
4"		
3½"		
3½"		
3"		
3"		
2½"		
2½"		

POULTRY SUPPLIES, FEEDS AND REMEDIES



DON'T BREAK THE CHAIN OF

Conkey's

THE ORIGINAL

BUTTERMILK FEEDS

Conkey's Buttermilk Starting Feed

This superior chick mash was the first commercial poultry feed containing buttermilk; that is why we call it the only original buttermilk starting feed.

Conkey's carries buttermilk in just the right proportion as an aid in prevention of bowel troubles, white Diarrhoea, "leg weakness," etc. The buttermilk is semi-solid buttermilk, blended with the other ingredients by the original process in such a way as to preserve the appetizing, tonic, and other properties of the newly-churned product. Buttermilk is also rich in one of the vitamins necessary to growing birds. It is a wonderful appetizer, aid to digestion, and flesh builder.

FEED IT FIRST 8 WEEKS.

Conkey's is all the chicks need the first eight weeks, except greens, charcoal, grit, clean water and some fine scratch grains in the litter for exercise. Give grit and water from the start. During the second week add green stuff and in the fourth week finely cracked grains, like Conkey's Chick Grains. Prices 2½ lbs. 20c.; 5 lbs. 35c.; 10 lbs. 65c.; 25 lbs. \$1.35; 100 lbs. \$5.00.

Conkey's Buttermilk Growing Mash

This mash is fed after the chicks are eight weeks old. It is balanced for rapid and even development of muscles, bone, vital organs and feathers. Like all Conkey mashes it is low in fibre, clean and always uniform.

The Growing Mash differs materially from the Starting Feed—meat scraps are added, bone is increased, and corn decreased—growing birds demand a heavier diet than delicate baby chicks. Prices. 10 lbs. 55c.; 25 lbs. \$1.25; 50 lbs. \$2.25; 100 lbs. \$4.25.



Conkey's Buttermilk Laying Mash

To produce eggs abundantly, the flock must have a good scratch grain mixture, a regular supply of green feed, plenty of water, and a good Dry Mash. One or two of these items will not be sufficient to permit the hens to do their best; all four feeds are absolutely necessary and experienced poultrymen have learned this from experience. Our laying mash is very low in fibre and just right in protein for layers; it is uniform in quality and always dependable. Prices, 10 lbs. 50c.; 25 lbs. \$1.10; 50 lbs. \$2.10; 100 lbs. \$4.00.



Conkey's Chick Grains

Well balanced, clean, fresh, nutritious feed. Price, per 100 lbs. \$4.00

Conkey's Growing Grains

The very necessary small scratch feed for the proper development of young fowls. Price, per 100 lbs. \$3.75.

Conkey's Scratch Grains

Wholesome, clean grains, correctly mixed to give a well-balanced ration. Contains no grit and no cob. In mixing this feed we have made quality the first consideration but believe that our price is attractive as well. We shall be pleased to mail sample. Price, per 100 lbs. \$3.00 (Conkey's Red Seal Scratch \$2.75).

AVICOL

For White Diarrhoe

Stops Chicks Dying

Avicol is positively guaranteed for both prevention and treatment. Easy to give. Simply drop it in the drinking water. It will pay you to give Avicol to all your chicks this year, and keep them healthy and free from disease. Prices, 50c and \$1.00.

"T. S. F."

Kills Chicken Lice Both Young and Old

This is the method endorsed by the U. S. Department of Agriculture for killing all poultry lice. It never fails to do the work. Three sizes, 35c; 60c and \$2.50. (If by mail, add 10c for postage and packing).

DONSUNG

MAKES HENS LAY GUARANTEED

A wonderful tonic that acts directly on the egg-laying organs and is beneficial in every way. Makes chickens healthy, keeps them developing, and gets the eggs. Prices, 50c, \$1.00 and \$5.00

Roup-Over

The sure way to treat Colds, Roup and Canker. Used and endorsed by leading poultrymen everywhere. Prices, 50c and \$1.00.

LICE POWDERS. For dusting hens, nests, growing chicks, wherever body lice must be overcome. Pratt's 15c and 25c packages. Sodium Fluoride, endorsed by the U. S. Dept. of Agriculture, 35c and 60c.

CARBOLA. Combination whitewash and disinfectant. Very readily mixed with water for spraying. 10 lbs., \$1.25.

BOURBON POULTRY REMEDY. A useful medicine for the treatment of Cholera, Limberneck, Roup, Gapes, Diarrhoea, Black Head and certain other poultry diseases. A general remedy which will be of great assistance in the cure and prevention of many diseases. Price, 60c; pint, \$1.50.

PRATT'S SPECIAL REMEDY. For simple bowel complaints sometimes mistakenly confused with Cholera. Also for the relief of indigestion, sour crop and dysentery. Price, 30c and 60c.

PRATT'S POULTRY REGULATOR. A scientifically prepared tonic, acting on the digestion, bowels and blood, thus helping to keep the fowls in good condition and to increase egg production. It assists poultry to make rapid growth, fatten more quickly and develops pullets into earlier layers. Price, small size, 25c; 4-lb. package, 50c; 12-lb. package, \$1.40; 12-lb. pail, \$1.65; 25-lb. bag, \$2.50.

HESS' PANACEA. Price, 25c and 50c.

WATER GLASS. Put down eggs in the spring and summer when they are cheap and keep them fresh for ten months. One gallon makes sufficient solution for 50 dozen. Price, quart, 40c; gallon, \$1.25.

STAR JAR FOUNTAIN AND FEEDER.

Will fit any pint, quart or half-gallon jar. Manufactured of one piece of non-rustable metal. No parts to come unsoldered. Leaking impossible. Convenient, cheap, sanitary. Little chicks cannot get drowned. Can be used for feed as well as water. Price, without jar, 10c.

SELL EGGS By Mail

To Your City Friends Shipped in Aluminized

METAL EGG CRATES

Indestructible; pays for itself in a few shipments; lasts years; makes interchangeable shipping easy. Buy yours now and realize more money for your eggs. Your friends want them.

The Metal Edge Filler is a wonder. A new invention and cannot be beat for safely carrying Eggs by mail. Light in weight but strong.

Write us about Butter-Egg Crates

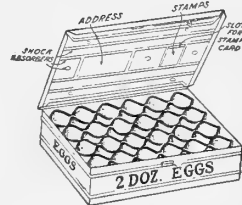

1½-do. size.....	\$1.25	6-do. size.....	\$2.50
2-do. size.....	1.50	9-do. size.....	3.25
3 do. size.....	1.75	12-do. size.....	4.00
4-do. size.....	2.00	15-do. size.....	4.75

Postage Extra.

CHICK FEEDERS.



They are constructed so as to keep feed near the outer edge where it can be easily reached. The small openings around the top keep the chicks out of the feed, keep the food clean and prevent crowding thereby insuring that the weakest chicks will get food. Top removable for cleaning. Thoroughly galvanized.

6 in. diameter, 8 feeding holes.....\$0.15
 8 1/4 in. diameter, 12 feeding holes..... .25

DRY-MASH HOPPERS.

These hoppers are made from heavy galvanized iron, and are so constructed that they can be closed up at night to keep out mice and rats. They are also provided with a screen to prevent the chickens from scratching the mash out and wasting it.

It not only saves the feed, but keeps it before the fowl where they can get as much as they should have. Made in two sizes.
 12 inch.....\$2.00
 24 inch..... 2.80

MOE'S WALL FOUNTAINS.

DROP BOTTOM WALL FOUNTAINS. A square fountain filled at the bottom, easily kept clean, very durable. Price, 2-qt. size, 95c; 1-gal., size \$1.20; 2-gal. size, \$1.50.

ROUND WALL FOUNTAINS. A practical and convenient style, made of heavy galvanized iron. The one-gallon size has removable bottom so that all parts may be easily cleaned. Price, 75c. Five-gallon size appeals to many breeders desiring a large capacity fountain at small cost. Easily filled at the side; nothing to get out of order. Price, \$1.95.

SHELL AND GRIT BOXES.

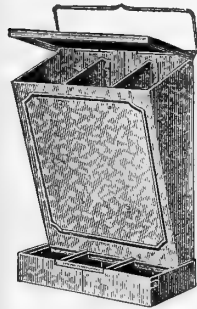

This box is made of heavy galvanized iron with 3 compartments for grit, shells and charcoal. It is provided with lid and cover, which protects the contents and may be suspended to the wall of poultry house by the handle.

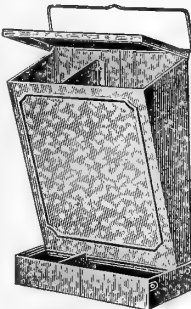

3 Compartments, Height 13 in., Width 8 1/2 in.....\$0.90
 2 Compartments, Height 8 in., Width 5 in..... .40

NESCO SANITARY DRINKING FOUNTAINS.

Quarts..... 1 2 3
 Prices..... 20c 25c 35c 50c

IDEAL POULTRY MARKER.

Easy to operate, and one of the latest made. Price, 50c each.

WIRE HEN'S NEST.

Very substantially made of heavy copper wire and 1/4-inch metal strips; will last indefinitely, and always sanitary. 14 inches. Each, 25c; doz., \$2.80.

MEDICATED NEST EGGS.

A white, sanitary, lice-repelling nest egg of superior quality and appearance, aiding greatly in keeping the nest and the hen free from vermin. They closely imitate a real egg in appearance and contain a powerful disinfectant. Price, per doz., 60c.

PORCELAIN NEST EGGS.

Price, per doz.....\$0.30

KEY RING, COLORED LEG BANDS.

These leg bands are spiral or key ring shaped, are quickly put on or removed, and make it easy to keep an accurate register of your birds. They are of a proper temper, keep their shape, light in weight and very durable. Will not fade and are weather proof. Made in six sizes and ten colors. Poultry sizes, doz., 15c; 50 for 45c; 100 for 75c; 500 for \$3.60. Baby Chick and Pigeon sizes, doz., 10c; 25 for 20c; 50 for 35c; 100 for 50c.

CHAMPION LEG BAND



This is one of the best and most popular bands. A favorite among all poultry raisers. It is adjustable to suit all fowl. Doz., 15c; 25 for 25c; 50 for 45c; 100 for 75c.

RED CHIEF HAND CORN SHELLER.

Clamps on barrel or box; has patented oval-shaped teeth, shelling the corn without cracking the grains. It shells very easily and throws out the cob every time. Price, \$2.25.

RED CHIEF RAPID GRINDING MILL.

It is built on scientific lines and combines all the elements which make up the most satisfactory Hand-Power Mill for grinding small grain. The burrs are extra hardened and self-sharpening; they cut; do not mash.

The only Mill that can be cleaned and adjusted in a moment's time without the use of a wrench.

No. 2. Is operated by a crank; chains or bolts to a box as desired. Has hooks on which to hang a bucket.

Capacity 1-2 bushels per hour.

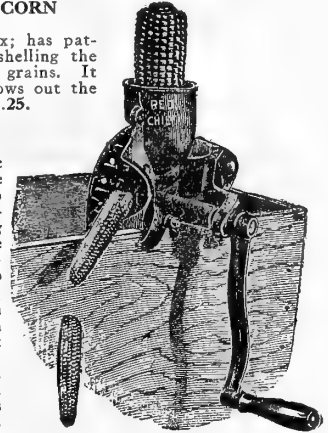

Price, \$5.00.

No. 5. Has a fly wheel which makes the Mill run steady, and requires the least possible power to turn it. It fastens by chains or bolts. Capacity 2-4 bushels per hour. Price, \$7.25.

No. 10. This Mill has beautiful outlines, as shown in illustration; will grind any kind of small grain; also oyster shells and dry bone. Capacity 2-4 bushels per hour.

Price, \$9.00.

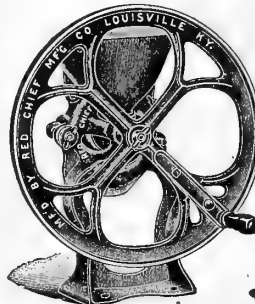

No. 20. Combined Hand-Power Mill. It is substantially constructed; all bearings bronze metal, and when run a speed of from 300-450 revolutions per minute will grind from 10-20 bushels per hour. Power required, from 1 1/2 to 2 horse-power engine. Price, \$21.00.

Extra Attachments for No. 20 Mill.

These devices, including Corn Sheller and Table Meal Separator, can be attached to any No. 20 Mill now in use, and can be operated combined or independently, as may be desired, and enable the user to shell, grind or crack corn, also save fine table meal in one operation.

Table Meal Separator. Price, \$6.50.

Corn Sheller Attachment. Including hand crank. Price, \$9.00

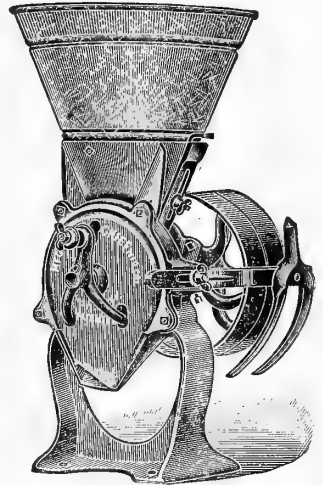

MANN'S NEW MODEL GREEN BONE CUTTERS.

The easiest running and the most rapid, green bone cutting machine made. Has a perfect automatic and self-governing feed. Adjustable to cut coarse or fine, fast or slow. The hinged opening cylinder is easy to clean and adjust without taking the machine apart. The bones are dropped into the open cylinder, no careful feeding or packing necessary. The machine regulates itself to the resistance of various sizes bones.

No. 231, Style 5B. With balance wheel, cylinder 6 inches in diameter. Price, \$15.00

No. 232, Style 5BM. With balance wheel and mounted on heavy iron stand; cylinder 6 inches in diameter. Price \$18.00.

No. 234, Style 7 1/2. Hand or power. Tight and loose pulleys 1 1/2 x 2 1/2; cylinder 7 1/2 inches in diameter. Capacity 50 to 100 lbs. of bone per hour. 1/2 to 1 h. p. required. Price, \$28.00.

(Send for Complete Catalogue on Power Machines)

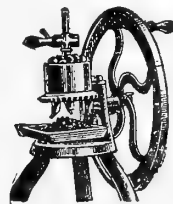

Ideal ^{HOT WATER} Incubators

Reliable Safe Guaranteed

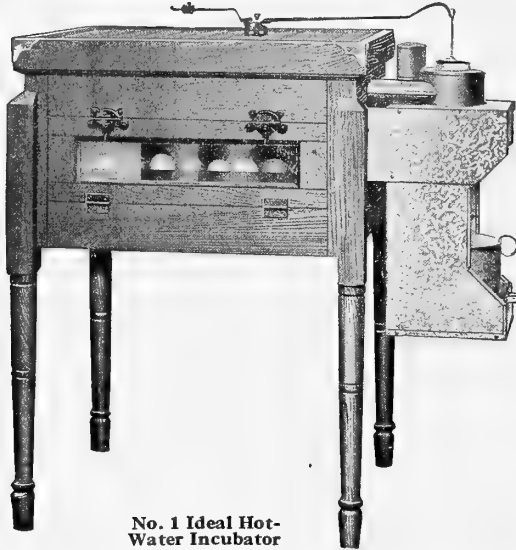

No. 1 Ideal Hot-Water Incubator

Ideal Incubators are real hatchers in spite of the fact that they are low priced. They have commanded respect for their efficiency for many years, are absolutely first class in every respect and are guaranteed to give satisfactory service.

When purchasing an Ideal you can be sure of good material, good workmanship, efficient, practical and convenient arrangement of parts, and that the hatcher has been tested before leaving the factory.

The Ideal incorporates every advantage and improvement known in a first-class incubator, and is the simplest method of artificial hatching. The outside and inside walls of the incubator are made of one-inch thick California Red wood, interlined with corrugated fiber board, which produces a dead-air space between the inner and outer walls of the incubator, so that the outside temperature has no effect upon the Egg Chamber. Every size except No. 7 has a nursery under the egg tray.

The lamp support is a fireproof box, which encloses the boiler in such a way that the heat is concentrated direct to the boiler and eliminates all possible waste of fuel.

The tubular tank and boiler is made of pure copper, and guaranteed against leaks. By filling the tank with hot water in starting the incubator, a temperature up to 103 degrees can be obtained in less than two hours. The Ideal is furnished complete with all necessary fixtures, attachments and instruction book to operate same successfully.

- No. 1, capacity 75 Hen Eggs, or 60 Duck Eggs..... 14.50
- No. 2, capacity 150 Hen Eggs, or 120 Duck Eggs..... 18.00
- No. 3, capacity 235 Hen Eggs, or 200 Duck Eggs..... 25.00
- No. 8, capacity 375 Hen Eggs, or 280 Duck Eggs..... 34.25
- No. 9, capacity 550 Hen Eggs, or 400 Duck Eggs..... 57.75

IDEAL METAL-COVERED INCUBATORS.

The incubator case is constructed of first-class timber. Over the outside of the wooden case a heavy layer of wool felt, then the entire outside of incubator case is covered with 28-gauge galvanized iron. The top and bottom is made of four thicknesses of material, which makes the incubator well insulated.

The incubator is trimmed with black enamel iron, and is held up by substantial, strong and well-finished steel angle legs.

- No. 4, 110 Egg size..... \$13.50
- No. 5, 165 Egg size..... 19.00
- No. 6, 225 Egg size..... 21.50

OAKES HOT WATER INCUBATOR

This round shaped, all-metal incubator has been approved by poultry raisers because of its simplicity of construction and economy of operation. There is nothing to get out of order, nothing complicated that needs watching—no failures. Thoroughly dependable and reliable.

- No. D-98, 60 egg capacity, weight 25 lbs.....\$9.75
- No. D-99, 100 egg capacity, weight 40 lbs.....13.75

LET US SEND INFORMATION AND PRICES ON LARGE SIZE, COMMERCIAL OUTFITS.

OAKES ELECTRIC HEN

The most modern incubator; thoroughly efficient, highly convenient and very economical. Heat and ventilation regulated automatically. Also serves as a perfect brooder when the lid is removed and the legs and curtain attached. Furnished for either 32 volt or 110 volt currents. The Electric Hen, if properly handled, will last a life time and is guaranteed to give satisfactory results. Each machine is thoroughly tested before it leaves the factory and is adjusted to maintain the proper temperature. Prices include thermometer, egg tester, hover-curtain and legs.

- No. D-87, 60 egg capacity, weight 25 lbs.....\$13.00
- No. D-88, 100 egg capacity, weight 40 lbs..... 18.00

MOE'S FOUNTAIN HEATER. Can be used with all styles of fountains and solves the problem of uniform supply of fresh, clear water at all times, no matter how cold the weather. The lamp bowl holds sufficient kerosene to burn continuously for seven days. Simple and safe. Nothing to get out of order. Height 7 inches; diameter 11 inches. **Price, \$1.90 each.** Shipping weight 5 pounds.

LITTLE PUTNAM STOVE. Made of galvanized iron and equipped with a burner which embodies an entirely new principle in oil combustion. The combustion is complete and perfect, doubling the heat value of the oil. The oil tank holds three pints of oil and burns three to four weeks without refilling or other attention. This stove is absolutely fire-safe and non-explosive. If it is tipped over it will go out. Size, 4 inches high and 9 inches in diameter. **Price, \$2.50 each, postpaid.**

PUTNAM BROODER STOVES.....\$4.75

"STANDARD" INCUBATOR OIL.

"Standard" Incubator Oil is a superfined kerosene. It is far superior to the best grades of water-white kerosene hitherto obtainable, both in point of heat and light resulting from its use. **Price, per 5-gallon can, \$2.50.**

OAKES SANITARY METAL BROOD COOP..... \$2.00

IDEAL BROODER FOR INDOOR AND OUTDOOR USE. HOT-AIR HEATED.

The brooder is divided into two compartments: The hover, which is directly under the heater pipes, and the exercise-room in front next to the glass windows. The two compartments are separated by a heavy felt curtain. The chicks go into the hover to get warm the same as they do when they go under the old hen in the natural way. The brooder is well finished, well manufactured, and will last indefinitely. Only first-class lumber is used in its construction.

Made in two sizes, priced as follows:

	Floor Space	Weight	Price
No. 1, 100-chick size.....	24x30 inches	85 lbs.	\$10.25
No. 2, 200-chick size.....	32x44 inches	110 lbs.	13.00

COLONY BROODER STOVES.

Burn any kind of fuel, are safe, dependable and easily operated. Galvanized steel, fastened with bolts to a strong cast-iron ring that fits perfectly to the top of the stove. Hover is 42 inches in diameter, and is removable; it requires a floor space of 6 to 8 feet. 500-chick size.....\$21.50
1000-chick size..... 26.50

Subject to Special Discount.

ECONOMY PORTABLE BROODER.

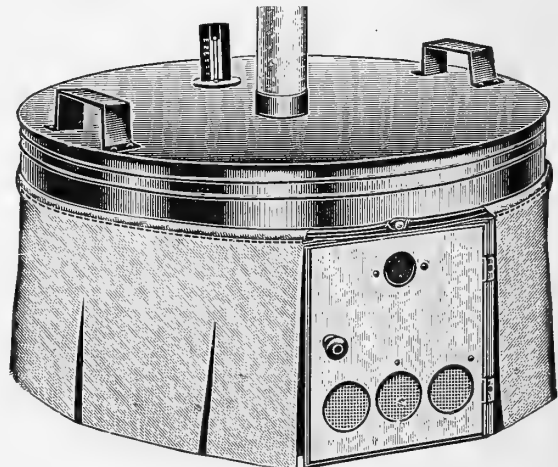

The Economy Hover is simple in construction, made of steel throughout, and all parts are seamed or welded together, making it light, strong and durable.

- No. D-102 (18 in. drum), weight 14 lbs.....\$4.75
- No. D-103 (22 in. drum), weight 32 lbs.....7.25

Dairy Supplies

FARM AND CONTRACTORS CARTS

These carts are made of the best well-seasoned hickory and white oak wood and are heavily ironed. They are well made throughout and especially designed to withstand the heavy loads and rough treatment of a farm; nicely painted, striped and varnished.

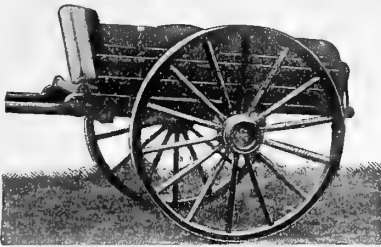

The body is 4 ft. 8 in. long, the axle 1 1/2 in. and the tires have a 3 in tread. **Price \$75.00.**

AMERICAN CREAM SEPARATOR.

The advantages of the Centrifugal Cream Separator are now acknowledged everywhere, and the American possesses the following points of merit:

Simplicity, durability, clean skimming, ease of operation and price.
No. 10, 125 lbs. milk per hr., \$30.00; No. 2, 550 lbs. milk per hr. \$71.00; No. 1, 425 lbs. milk per hr., \$62.00; Fully guaranteed.

BOSS CREAM SEPARATOR.

Every small dairy should certainly have the Boss. It means one-quarter more cream of better quality and saves one-quarter the time. No machinery to run or look after. Separation is effected by circulation of cold water in outer can. All the cream rises to the surface in an hour or two and is drawn off sweet. Suitable for table use or other purposes.

- 2 1/2 gallons, capacity 1 to 2 cows... \$6.00
- 4 gallons, capacity 3 to 4 cows... 6.50
- 6 gallons, capacity 4 to 5 cows... 7.25
- 8 gallons, capacity 5 to 7 cows... 8.00

TWIN SEPARATOR.

Has many advantages over the separator with a single milk vessel; one can be used in the morning and the other in the evening. Made in 5 to 20 gallon sizes.
2 cans, 12 gallons, capacity 6 to 7 cows... \$14.25

WATER MIXERS.

In the Diluters or Water Mixers the water is poured right into the milk so as to chill it instantly and cause the cream to rise in about one hour.

- 8 gallons, to hold 4 gallons of milk... \$4.00
- 12 gallons, to hold 6 gallons of milk... 4.65
- 16 gallons, to hold 8 gallons of milk... 5.25

DAIRY THERMOMETERS.

Each... \$0.75

CREAM-TESTING TUBES.

Each... .60

PARCHMENT BUTTER PAPER.

Is furnished in sizes: 24x36, 9x12, 6x9, 6x6. Price, per pound, 30c. By mail, add regular Parcel Post rate.

HAND BUTTER PRINTS.

- 1/2 lb. Seeley Pattern, as shown in cut... \$0.75
- Baltimore Pattern... 1.25
- Round Print and Mould... .40



BUTTER WORKER.

- Inside Measurement. Cap. Price
- No. 1. 23x36x2 1/2 in., 50 lbs. \$15.25
- No. 2. 20x36x2 1/2 in., 30 lbs. 13.25
- No. 3. 17x27x2 1/2 in., 20 lbs. 8.50

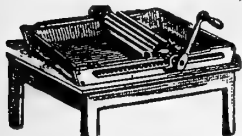

DANDELION BUTTER COLORING.

Dandelion Brand Butter Coloring is guaranteed to be purely vegetable, and that the use of same for coloring butter is permitted under all Food Laws—State and National.

Will not color the buttermilk; will never turn rancid; gives the brightest and best color; butter never becomes reddish; perfect economy in use. It is cheaper than any other coloring. Put up in four sizes.

- Small size to color 500 lbs. \$0.35
- Medium size to color 1250 lbs. .65
- Large size to color 2800 lbs. 1.25

HUDSON COW STANCHIONS.

Tubular Stanchions (No. 66W). These stanchions are wood lined, and so constructed as to be comfortable, strong and durable. They are made of high quality metal with but very few working parts to get out of order. The wood lining is a very important feature, as it is a protection against the cold iron. **Price, \$35.50 each. Bull Stanchions, \$6.00.**

MILK CANS.

Made of special heavy cold rolled milk can material. One of these cans will outlast two or three of the common light weight cans. Sold at very attractive prices. 5 gal. size only.
No. 105. Old Style Concave Cover, 12 lbs. empty, each... \$3.65
No. 205. Umbrella Cover, 13 lbs. empty, each... 3.55
No. 520. N. Y. Pattern, extra heavy, 14 lbs. empty, each... 4.35
No. 820. Balt. pattern, extra heavy, 13 1/2 lbs. empty, each... 4.35

RYDE'S CREAM CALF MEAL.

Quality is of more importance in Calf Meal than in any other feed; it pays to buy the best. The advantages in feeding it are many. 1. It saves milk. 2. It costs less to feed. 3. It makes better veals. 4. You can raise your own dairy cows on it cheaper than they can be bought. 5. It leaves more milk to sell, and more profit to you. **Satisfaction guaranteed. Price on request.**

LETZ GRINDERS.

No. 6 Letz Junior. Has 6 inch diameter plates, 1 1/4 inch diameter drive shaft, Pulley either 6, 8, 10 or 12 inch diameter and 4 inch face. Fly wheel 14 inches in diameter, weighing 25 lbs. Complete weight of mill, 175 lbs. It will operate on 1 h. p. to 3 h. p., at 200 r. p. m. to 800 r. p. m., grinding 3 to 15 bu. (of 70 lbs.) of ear corn, according to power and speed. **Price, \$30.00.**

KELLY DUPLEX GRINDING MILLS.

The only mill manufactured which has double or duplex grinders. It has a grinding surface of just double that of any other mill of equal size, and therefore can do twice as much work; or as much work as any other mill twice its size. Grinds any kind of grain cotton seed, corn and cob, and corn, cob and shucks equally well, and produces a grit of any desired quality—coarse, medium or fine. Its shifting device for regulating the grinding is the most perfect known. A positive force feed, no choking; no end thrust on the main shaft under any conditions. Simple in construction, easily operated, strong, durable and efficient.

- No. 1. 3 1/2 to 6 h. p.** Three feet, 4 inches high, shaft 3 feet, 6 inches long; capacity, 8 to 18 bu. ear corn, according to power and speed. **Price, \$57.00.**
- No. 11, Junior, 3 to 6 h. p.** Height, 3 feet, 2 inches, length of shaft, 3 feet, 2 inches; capacity, 6 to 12 bu. ear corn, according to power and speed. **Price, \$38.00.**

TORNADO ENSILAGE CUTTER AND SILO FILLER.

Made strong and durable in every respect; repairs are seldom necessary. Cuts 100 per cent. finer and puts 25 to 30 per cent. more feed into your silo than any other machine on the market. This firm packing of the feed keeps it in better condition and saves space, giving much greater storage capacity. The feed is cut so fine that the cattle will eat it all.

No. 13 Cutter, with blower, 30 feet of pipe, flat feed table, mounted on steel truck, \$163.20.
Same, with traveling feed table, \$181.00. Requires 6 to 8 h. p.

CONKEY'S FLY KNOCKER.

The best preparation on the market for keeping flies off cattle and horses. Easily sprayed on and retains its strength all day, allowing the cows to pasture without annoyance, and therefore assists in the production of milk. **Qt., 60c; gallon, \$1.50.**

CYLINDER CHURN—Illustrated.

CYLINDER CHURN.

Made of selected white cedar and well put up.

- Full churning capacity.
- No. 1 2 3 4
- Gals. 1 1/2 2 3 1/2 6
- Price, \$4.25; 5.00; 6.00; 7.25.

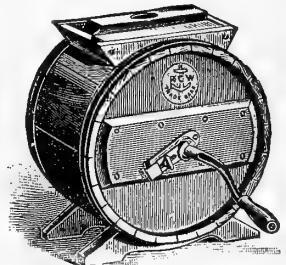

BARREL CHURN.

Oak stave; steel top; it works by concussion and will not break the grain of the butter nor make it of a salvy consistency.

- No. 0 1 2 3 4 5 6
- Gallons churned. 3 5 7 10 13 18 30
- Price... \$6.00 6.75 7.50 8.25 10.50 12.00 16.50

BUTTER SHIPPING BOXES.

- 36 1/2-lb. prints... \$15.50 20 lb. prints... \$13.75
- 64 1/2-lb. prints... 17.60 30 lb. prints... 16.00
- 80 1/2-lb. prints... 18.75 40 lb. prints... 19.75
- 100 1/2-lb. prints... 23.25 56 lb. prints... 23.75

Meyers Electric Fresh Water System

Direct From the Well
NO STORAGE TANK

Capacity, 450 Gallons per Hr.

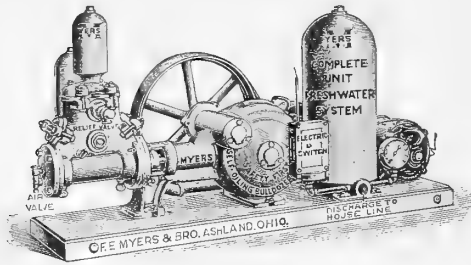

Just think of it; fresh water direct from the well, day or night, summer or winter, anywhere in the house or outbuildings, supplied automatically by merely turning the faucet.

The No. 622 A. M. system illustrated is used for shallow wells or cisterns up to 22 feet in depth, while outfit No. 655 A. M., somewhat similar is used for deep wells. Both systems are equipped with one-half horsepower motors, either 32 or 110 volts, and the pumps are the self-oiling or splash system type.

The Myers Direct Water System is of sufficient capacity to pump directly against the faucets supplying an ordinary residence. The opening of any faucet starts the pump by releasing the air pressure against the electric switch. The expense of the current in operating an outfit of this class is no greater than is required for operating a pump of one-half the capacity when connected with a large storage tank as they are obliged to work under a pressure of from 40 to 50 pounds, whereas the Myers Direct Water System works under a pressure of 10 to 30 pounds only.

MYERS' PUMP JACKS.

Well built of best materials for perfect service. No. 422 for gasoline engine power and No. 422M for electric motor. Both are self-lubricating, and have machine cut gears. This construction, not only insures perfect and continuous lubrication, but protects the moving parts from dust and dirt, greatly increasing the life of the jack. Can be used in connection with any make pump stand. Price, \$18.00.

No. 425. Steel shafts, \$15.00. No. 366. Angle iron shafts, \$12.00.

MYERS SELF-OILING BULLDOZER POWER PUMP—FOR PNEUMATIC PRESSURE SERVICE.

No. 610A. This pump has a capacity of 450 gallons per hour and is capable of producing 100 lbs. pressure. It has a cog gear handle attachment which makes hand operation very easy. Also equipped with tight and loose pulleys for power operator. The self oiling feature is very favorable.

Price, \$50.00. For use with electric motor, \$54.00.

No. 612A. Self-oiling, for power only. Capacity 500 gallons at 70 r. p. m. Quite similar to No. 610A but has vacuum chamber additional. Price, \$47.00.

HYDRAULIC RAMS.

For elevating water by its own pressure; a very economical means of supplying water to a storage tank, in cases where a natural water fall can be made available. These rams are constructed of iron and bronze and have always given entire satisfaction. No. 2, \$18.00; No. 3, \$21.00.

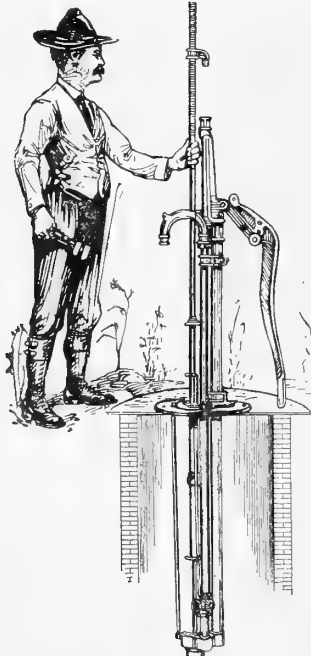

RED JACKET IRON EASY-TO-FIX PUMPS.

Prices quoted below are Pumps ready to set in the well. Subject to Cash Discount.

Fig. 28. Fig. 51.

Depth of Well.	No. 1, 3-inch Cylinder, Double Act.	Depth of Well.	2 1/2-inch Cylinder, With 3-way.
10 ft.	\$28.50	28 ft.	\$53.50
12 ft.	29.50	30 ft.	55.75
14 ft.	30.50	32 ft.	58.25
16 ft.	31.25	34 ft.	60.50
18 ft.	32.25	36 ft.	63.00
20 ft.	33.00	38 ft.	65.25
22 ft.	34.00	40 ft.	67.75
24 ft.	35.00	42 ft.	70.00
26 ft.	36.00	44 ft.	72.00

If over 44 feet, add \$1.25 per foot to the above prices.

If 3-way is not wanted for Fig. 51, deduct \$5.00.

If 3-way is wanted for Fig. 28, add \$5.00.

MYERS COG - GEAR SINGLE - ACTING FORCE PUMPS

No. R. 1072. This has adjustable base and reversible spout. Has patent glass valve seat, poppet valve and brass lined cylinder. Capacity, 440 gallons per hour. The extra leverage adapts the Pump for deep wells. Price, \$13.00

Add 20c per foot for wells up to 26 feet deep.
28 ft. depth of well. Price, \$22.50.
Add 30c per foot for wells up to 60 feet.

MYERS COG-GEAR BRANCH-PIPE DOUBLE-ACTING FORCE PUMP FOR WELLS FROM 10 TO 150 FEET.

No. R5. Will go in a 5 1/8-inch cased well. Capacity, 440 gallons per hour; has a 3-in. brass-lined lower cylinder with glass valve seat; tapped for 1 1/4-inch pipe. Price, for 10 foot deep well, \$18.50. \$6.00 extra for 3-way and windmill head.

Add 20c per foot up to 26 feet.

Price for deep-well Pumps, 28 feet, \$30.00.

Add 30c per foot for wells up to 100 feet.

KANAWHA WOOD PUMPS.

Porcelain Lined—Ready to Set in the Well.

Subject to Cash Discount.



Depth of Well	No. 2 6x6	No. 5 7x7	Depth of Well	No. 6 6x6	No. 4 7x7
8 ft.	\$13.20	\$15.80	31 ft.	\$28.50	\$32.50
9 ft.	13.60	16.20	32 ft.	28.90	32.90
10 ft.	14.00	16.60	33 ft.	29.30	33.30
11 ft.	14.40	17.00	34 ft.	32.10	36.10
12 ft.	14.80	17.40	35 ft.	32.50	36.50
13 ft.	15.20	17.80	36 ft.	32.90	36.90
14 ft.	15.60	18.20	37 ft.	35.70	39.70
15 ft.	16.00	18.60	38 ft.	36.10	40.10
16 ft.	16.40	19.00	39 ft.	36.50	40.50
17 ft.	16.80	19.40	40 ft.	36.90	40.90
18 ft.	17.20	19.80	41 ft.	40.90	44.90
19 ft.	17.60	20.20	42 ft.	41.30	45.30
20 ft.	18.00	20.60	43 ft.	41.70	45.70
21 ft.	19.20	22.00	44 ft.	42.10	46.10
22 ft.	19.60	22.40	45 ft.	44.90	48.90
23 ft.	20.00	22.80	46 ft.	45.30	49.30
24 ft.	20.40	23.20	47 ft.	45.70	49.70
25 ft.	20.80	23.60	48 ft.	47.30	51.30
26 ft.	22.00	25.00			
27 ft.	22.40	25.40			
28 ft.	22.80	25.80			
29 ft.	24.80	28.20			
30 ft.	25.20	28.60			

We shall be pleased to quote attractive prices on Galvanized Pipe.



Miscellaneous Farm Supplies

Barrett Roofing Material



The Barrett Company makes roofing materials of the very highest quality, in a variety of styles and weights. These products carry the Barrett Guarantee and are moderately priced.

MINERAL SURFACED. A good grade of rubber and felt covered with a coating of granulated slate, furnished in Red, Green or Blue-Black. Everlastic \$2.70 per roll; Vitex \$2.35 per roll. (100 sq. ft.).

SMOOTH SURFACED. Combination of a little felt and plenty of rubber. One of the most popular roofing materials.

Everlastic—Heavy or '3-ply' \$3.00 per roll of 100 sq. ft.

Vitex—Medium or '2-ply' \$2.25 per roll of 100 sq. ft.

Tomahawk—Light or '1-ply' \$1.25 per roll of 100 sq. ft.

MULTI-SHINGLES. (4-in-1). Mineral-Surfaced \$6.50 per square.

BLACK DIAMOND TARRED FELT. 432 sq. ft. 55 lbs. \$2.55 per roll.

5-X SHEATHING PAPER. 500 sq. ft., roll, \$1.10.

ONE-PLY TARRED FELT. 216 sq. ft., 28 lbs., \$1.30.

Asbestos Liquid Roofing

Guaranteed for 10 years. This roofing is a heavy liquid which thoroughly seals every hole and makes a leak impossible for at least ten years. It is made of asbestos fibre and contains no coal tar products and therefore is not injurious to metal. Not affected by summer heat, is absolutely fire proof and may be used on any roof.

1 gal., \$1.25; 5 or 10 gal. at \$1.15; 15 gal. at \$1.00; f.o.b. Baltimore.



KURE-A-LEAK

A semi-liquid mastic or cement-like composition, not affected by extreme heat or cold; absolutely water tight and fireproof. It 'kures' the leaks in worn-out tin, galvanized iron or composition roofings. 1 gal., \$1.15; 5 gals. \$5.00.

Wheel Barrows

Garden Barrows

Substantially made of seasoned wood, firmly bolted and braced. **Buch's No. 1.** Size of body 30 inches long, 24 inches wide in front and 25 inches in back. Side-boards 12 inches high. \$8.75.

Buch's No. 2. Size of body 28 inches long and 20 to 24 inches wide. Side-boards 12 inches high. \$7.00.

Buch's No. 3. 26 inches long, 19 to 22 inches wide. Side-boards 12 inches high. \$6.65.

No. 20. Steel wheel, wooden body. \$5.75.

No. 10. Steel wheel, wooden body. \$5.50.

No. 8 Canal Barrow. With steel spoke wheel, full-sized bent tray, planed, cleated and strapped together, well finished. \$4.75.

Steel Tray Barrows.

No. 17B. Size of tray 32x27 inches; capacity 4 cu. ft. \$7.30.

No. 21. Light steel tray cement and dirt barrow. \$5.00.

No. 25. All steel, tubular handles, riveted tray, high front to prevent spilling. Specially built for heavy work and rough usage. \$8.00.

MOUNTED GRINDSTONES

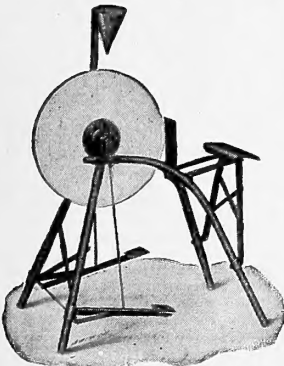

Climax. Frame is a combination of wood and steel, well finished.

No. 1. \$7.00

No. 2. 7.50

No. 3. 8.00

Eli Wood, No. 1. 7.50

Invader. 9.00

Victor. 8.50

King. The frame is constructed of tubular steel, very rigid, ball bearing, adjustable seat, and equipped with treadles. Stone 20-22 inches diameter by 2-inch face \$9.00

Cycle. Of angular steel, well braced, with sliding seat, ball bearing bicycle treadles. Stone is 20-22 inches in diameter by 2-inch face of the best Berea grit. \$7.50

Loose Grindstones, 11c per pound. (40 to 200lb. stones).

Corrugated Iron Roofing

Heavy galvanized iron corrugated roofing is always carried in stock in all the standard sizes. Prices subject to change. \$5.00 per square (100 sq. ft.).

LADDERS

Made of the very highest quality lumber and assembled to give the safest, most durable and most rigid construction. Side rails made of the best selected Norway, Southern Pine or Spruce and the rungs are Hickory. Equipped with sturdy gravity catches rope and pulley.

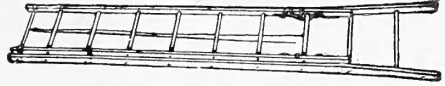

Automatic Extension Ladders.

24, 26, 28, 30, ft.....	per ft.	40c
32 and 34 ft.....	per ft.	44c
36 ft.....	per ft.	46c
STRAIGHT Ladders, 14 and 16 ft.....	per ft.	27c
18 ft.....	per ft.	32c

Washing Machines

Electric Power Engine Power. Hand Power. Water Power.

No human being should be employed at a task which can be done as cheaply and as well by a machine. This applies to washing clothes as well as pumping water, grinding feed, or sawing wood. Our line of washing machines is complete, and in every case we have selected machines which are well made from first class materials and designed to do the work most efficiently. **R. C. W. MAJESTIC.** Hand Power, operated by turning handle attached to wheel. Cedar tub, very satisfactory for small family. \$12.75

R. C. W. HIGH SPEED. Hand Power, operated by lever handle geared to quickly revolving fly-wheel, the lightest running hand power washer. Price \$17.50

R. C. W. WATER POWER. For use in the city where water power is available. Long motor, best materials and workmanship. Price \$19.00

QUEEN. Power washer with power wringer, built on substantial steel frame with pulleys for operation by gasoline engine or motor. We shall be pleased to send illustrated literature giving full information. (Engine or motor extra). Price \$65.00

SAW FRAMES.

Built of hard wood, mortised and tenoned, and full bolted; with Cold Rolled Steel mandrel; heavy balance wheel, and the table firmly hinged to frame—thoroughly braced and reinforced. The blades are made of genuine saw steel and have given universal satisfaction.

No. 3, with 24 in. blade..... \$34.25

No. 5, with 24 in. blade..... 33.75

No. 4 'Pony Saw' 18 in. blade..... 21.00

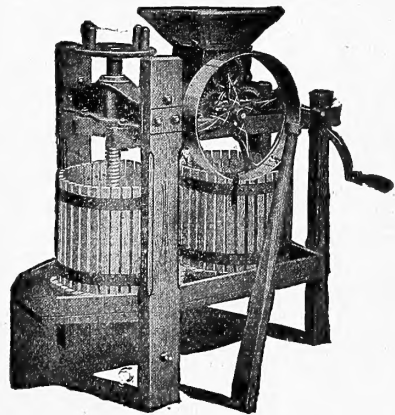

Red Cross Cider Mills and Wine Presses

	Plain	Hinged Cages
SINGLE CAGE CIDER MILL.....	\$18.25	\$19.25
JUNIOR 2-CAGE CIDER MILL.....	24.00	26.00
MEDIUM 2-CAGE CIDER MILL.....	29.50	31.50
SENIOR 2-CAGE CIDER MILL.....	45.00	47.00
No. 1 FRUIT PRESS.....	\$11.75	\$12.75
No. 2 FRUIT PRESS.....	15.15	16.25
No. 3 FRUIT PRESS.....	20.30	21.40
No. 5 FRUIT PRESS.....	31.50	32.50

THE GRAVELY MOTOR CULTIVATOR

A practical implement that is light, compact and powerful; designed for the market gardener who appreciates the importance of clean crops, frequent cultivation, and highest quality and quantity of production at the lowest possible cost. The Gravelly is capable of doing the work of one horse, and doing it more accurately, with greater speed, greater ease, and at less expense. Purely as a matter of economy every market gardener and home gardener should have a Gravelly Motor Cultivator, because the old methods of cultivating are slow, wasteful, inconvenient, inefficient and expensive. Can you afford to be without a Gravelly?

\$195

F.O.B. Baltimore

Uses Planet Jr.
and other
Standard Make
Tools

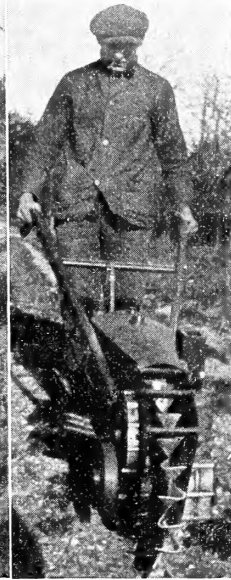

2 H. P.

Engine having
all moving
parts housed
and running
in oil

Mr. J. J. Schuler
Mr. J. Schuessler
Mr. P. Cook
Mr. J. A. Schafer

Read the Opinions of Gravelly Users

As a user of the Gravelly Motor Cultivator would say that I am more than well pleased with it. For its many uses among vegetable cultivation it cannot be beat, works like a charm, saves time as well as labor and would highly recommend to anyone growing flowers or vegetables.—HENRY MINTZ.

It affords me great pleasure to inform you that I have gotten the utmost satisfaction from the Gravelly Cultivator I purchased from you last spring. Most practical tool and labor saving device on the place.—CHARLES H. LEISTNER

I am more than pleased with my Gravelly Motor Cultivator and would not take five hundred dollars for it if I could not get another one. There is nothing better to work in beets, carrots, lettuce and other small seed. The rows can be much narrower if you use this cultivator and you can get into a crop sooner than with a horse. It really does good work.—JOSEPH COOK.

I have had one of your Motor Cultivators for the past five months and must say that I am more than satisfied with it. The clean condition of our ground and the healthy appearance of the crops has been the admiration and wonder of visitors. They wondered how we could keep it so clean until we showed them the tractor. In fact, it has all the other garden tractors we have ever seen skinned a mile. We had absolutely no trouble in getting the tractor started, and the exceedingly small expense of running it is one of its good features.—JOHN SCHUESSLER.

With the Gravelly Motor Cultivator, rows can be run off straight, without a marker or a line. Crops can be worked in rows 6 inches or more apart, and the ground can be cultivated very close to small plants with the greatest ease. It is adaptable for every practical purpose, and the owner soon finds many special uses for the machine as he becomes more and more familiar with its possibilities.—DOMINIC DI LEGGE & SONS.

I found it possible to grow flowers on a larger scale with the aid of the Gravelly, and not interfere with my regular employment. In previous years I worked about one quarter of an acre and never had any time for myself, but this year with the aid of the Gravelly I worked nearly one acre with greatest ease and pleasure and more time for myself. With this increased acreage I more than tripled my production. In fact, my profits for the year were much larger than previously earned, even after deducting the initial cost of the machine and cost of operation.—JOSEPH A. SCHAFFER

I have found the Gravelly Motor Cultivator to be a great labor saver, a wonderfully accurate and efficient implement. Can strongly recommend it to any home gardener who wishes to work his ground intensively, and who operates his garden for pleasure as well as profit.—JOHN M. STRICKER.

Relative to your inquiry regarding the Gravelly Cultivator, wish to advise that we are more than pleased with the results obtained, in that it has cut down our work to a minimum. I can highly recommend this cultivator for general use.—WM. A. BOCHAU.

I wouldn't sell the Gravelly Cultivator for twice the price if I couldn't get another one. It can't be beat for small crops, and in fact I have used it for cultivating every crop on my place.—JOSEPH J. SCHULER.

You will remember that I purchased the Gravelly Motor Cultivator very late in the season, and that the weeds were 12 to 15 inches high when I began cultivating the Gravelly Way.

After the flowers and vegetables were once cleared of the accumulation resulting from neglected hand cultivating, it was a pleasure to work in the garden, and far more work was accomplished in much less time.

If I would have started with the Gravelly early in the season I could have saved time and had better crops.—H. G. SIELING.

—Let us send Illustrated Literature giving further information—

INDEX

Vegetable Seeds

Artichoke	1
Asparagus	1
Asparagus Roots	1
Beets	6
Borecole	7
Broccoli	7
Brussels Sprouts	7
Bush Beans	2-3
Bush Limas	5
Cabbage	8-9
Carrots	11
Cantaloupe	18
Cauliflower	10
Celeriac	10
Celery	12
Chinese Cabbage	10
Chives	7
Collards	7
Corn	13, 46
Corn Salad	12
Cress	10
Cos Lettuce	17
Cucumber	14
Egg Plant	15
Endive	15
Gumbo	19
Herbs	28
Kale	15
Kohl Rabi	15
Leek	15
Lettuce	16-17
Lima Beans	5
Mangel Beets	6
Melons	18-19
Mushroom Spawn	19
Muskmelon	18
Mustard	19
Okra	19
Onion	20
Onion Sets	20
Parsley	21
Parsnips	21
Peas	22-23
Pepper	24
Plants	33
Pole Beans	4-5
Popcorn	12
Potatoes	25
Pumpkins	21
Radishes	26-27
Rhubarb	28
Rhubarb Roots	33
Roots	33
Rutabagas	32
Salsify	28
Shell Beans	4
Scorrel	28
Spinach	29
Spinach Beet	28
Squash	28
Strawberry Plants	33
Sugar Corn	13
Sweet Potatoes	25
Swiss Chard	7
Tomatoes	30-31
Turnips	32
Vegetable Plants	33
Watermelon	19
Wax Beans	3

Field Seeds

Alfalfa	44
Alsike Clover	44
Bokhara	44
Buckwheat	45
Canada Field Peas	45
Clover	44
Creeping Bent Grass	44
Crimson Clover	44
Cow Peas	45
Dwarf Essex Rape	45
Field Corn	46
Hard Fescue	44
Hungarian Millet	44
Japan Clover	44

Kaffir Corn	45
Kentucky Blue Grass	44
Mammoth Clover	44
Meadow Fescue	44
Millet	44
Oats	45
Orchard Grass	44
Perennial Rye Grass	44
Rape	45
Red Clover	44
Red Top	44
Rhode Island Bent	44
Grass	44
Sheep's Fescue	44
Sorghum	45
Soy Beans	45
Sudan Grass	45
Sweet Vernal	44
Tall Meadow Oat	44
Grass	44
Timothy	44
Vetch	45
White Dutch Clover	44
Wood Meadow	44

Flower Seeds

Ageratum	34
Alyssum	34
Amaranthus	34
Antirrhinum	34
Aquilegia	35
Asters	35
Bachelor's Button	36
Balloon Vine	41
Balsam	35
Balsam Apple	41
Balsam Pear	41
Begonia	42
Bellis	35
Black Eyed Susan	41
Caladium	42
Calendula	35
Calliopsis	35
Campanula	35
Canary Bird Flower	41
Candytuft	35
Cannas	42
Canterbury Bells	35
Carnations	35
Castor Oil Bean	39
Centaurea	35
Chrysanthemum	36
Cineraria	36
Cinnamon Vine	43
Clarkia	36
Clematis	43
Climbers	41
Climbing Nasturtium	41
Cobaea Scandens	41
Cockscomb	35
Coleus	36
Columbine	35
Coreopsis	35
Corn Flower	36
Cosmos	36
Cowslip	39
Cypress Vine	41
Dahlias	36, 43
Dahlia Roots	43
Daisy	35
Datura	36
Delphinium	36
Digitalis	36
Dianthus	36, 41
Dusty Miller	36
Evening Primrose	39
Everlasting Flower	37
Forget-me-Nots	38
Four O'Clocks	38
Foxglove	36
Gaillardia	37
Gladiolus	42
Globe Amaranth	37
Gomphrena	37
Gourds	41
Hardy Clematis	43
Hardy Phlox	42
Helichrysum	37
Heliotrope	37

Hesperis	37
Hollyhock	37
Hyacinth Bean	41
Ice Plant	38
Ipomoea	41
Japanese Hop Vine	41
Kochia	37
Lady Slipper	35
Larkspur, Annual	37
Larkspur, Hardy	36
Lantana	37
Lobelia	37
Love-in-a-Mist	38
Lupinus	37
Lychnis	37
Madeira Vine	43
Marigold	38
Marvel of Peru	38
Mesembryanthemum	38
Mignonette	38
Mimosa	39
Mimulus	38
Moon Flower	41
Morning Glory	41
Mourning Bride	39
Myosotis	38
Nasturtium	38
Nicotiana	38
Nigella	38
Oenothera	39
Pansies	38
Passion Flower	41
Pentstemon	38
Peonies	42
Petunias	39
Phlox	39, 42
Pinks	36
Poppies	39
Portulaca	39
Primrose	39
Pyrethrum	39
Ricinus	39
Salvia Splendens	39
Scabiosa	39
Scarlet Runner	41
Scarlet Sage	39
Sensitive Plant	39
Smilax	41
Snappdragon	34
Stocks	39
Summer Cypress	37
Sweet Peas	40
Sweet Rocket	37
Sweet William	41
Ten Week Stocks	39
Thunbergia	41
Tuberose	42
Tufted Pansies	41
Verbena	41
Vines	41
Violas	41
Violets	41
Wallflower	41
Wild Cucumber Vine	41
Zinnias	41

Supplies, Im- plements, Etc.

Arsenate of Lead	47
Asbestos Liquid	63
Roofing	63
Asparagus Bunchers	52
Asparagus Knives	52
Auburn Wagons	61
Barbed Wire	57
Barley Forks	51
Barn Door Hangers	55
Black Leaf Forty	47
Bordeaux mixture	47
Brooders	60
Brush Hooks	51
Budding Knives	52
Bug Death	47
Butter Coloring	61
Butter Paper	61
Butter Prints	61

Butter Shippers	61
Butter Workers	61
California Sprinklers	56
Cel-o-glass	50
Churns	60
Cider Mills	63
Corn Grinders	59
Corn Shellers	59
Corrugated Iron	63
Roofing	63
Cultivators	51, 55
Cut Worm Killer	47
Dairy Supplies	61
Dibbles	50
Disc Harrows	53
Don Sung	58
Drag Scoop	53
Dry Lime and Sulphur	47
Dusters	49
Earth Augurs	51
Egg Carriers	58
Electric Water Systems	62
Emerson Standard Mowers	55
Ensilage Cutters	61
Feeds	58
Fence Posts	57
Fencing	57
Fertilizer	32
Flower of Sulphur	47
Flower Boxes	50
Flower Pots	50
Forks	51
Formaldehyde	47
Fruit Pickers	52
Fruit Presses	63
Garden Trowels	50
Garden Barrows	50
Grass Hooks	51
Glass	50
Gravel Mctor Cultivator	64
Glazing Points	50
Glazing Putty	50
Grafting Wax	52
Grape Dust	47
Grass Collectors	56
Grain Cradles	51
Grinding Mills	61
Grindstones	63
Hand Cultivators	54
Hand Plans	54
Hand Weeders	52
Harrows	53-54
Harrow Teeth	55
Hay Forks	51
Hay Knives	51
Hay Rakes	51
Haying Tools	55
Hedge Shears	52
Hellebore	47
Hose	50
Horse Hoes	55
Hot Bed Glass	50
Hot Bed Mats	50
Hot Bed Sash	50
Incubators	60
Insecticides	47
Kaylox	47
Knives	52
Kura Leak	63
Ladders	63
Lawn Mowers	56
Lawn Rakes	51
Lawn Rollers	56
Lawn Sprinklers	56
Lawn Swings	56
Leaf Rakes	51
Leg Bands	59
Lemon Oil	47
Lime and Sulphur	47
Mag-o-tite	47
Manure Forks	51
Marline	50
Mastica	50

Metal Egg Crates	58
Milk Cans	61
Mole Traps	52
Motor Cultivator	56
Mowers	56
Mulford's Culture	46
Nest Eggs	59
Nico Fume	47
Norcross Cultivators	52
Nozzles	50
Paris Green	47
Peerless Glazing Points	50
Pincers	50
Plant Junior Imple-ments	54-55
Plant Setters	50
Plant Stakes	50
Plows	53, 54, 55
Pot Labels	50
Post Hole Diggers	51
Potato Hooks	51
Poultry Feeds	58
Poultry Fencing	57
Poultry Supplies	58, 60
Pruners	52
Pruning Knives	52
Pumps	62
Putty Bulbs	50
Pyrox	47
Raffia	50
Rakes	51
Rams	62
Red Chief Mills	59
Roofing Materials	63
Rubber Hose	50
Sash	50
Saw Frames	63
Scuffle Hoes	52
Seeders	51
Separators	61
Scythes	51
Shears	52
Shovels	51
Slug Shot	47
Snaths	51
Spades	51
Spading Forks	51
Sprayers	48-49
Spraying Materials	47
Spring Tooth Harrows	53
Sprinklers	56
Sulphur Flour	47
Thermometers	52
Tobacco Dust	47
Traps	52
Tree Labels	50
Tree Pruners	52
Tree Tanglefoot	47
Trellis	50
Trowels	50
Turf Edgers	52
Vegetable Tying Machines	52
Wagons	61
Warren Hoes	51
Washing Machines	63
Water Glass	60
Watering Pots	50
Water Systems	62
Weeders	52
Weed Killer	47
Wheel Barrows	63
Wheel Hoes	51
Window Boxes	50
Wire Fencing	57
Wire Splicers	57
Wire Stretchers	57
Wire Hen's Nests	60
Whale Oil Soap	47
Wine Presses	63



Mann's

POPULAR
FLOWER COLLECTION

OF

CALENDULA MORNING GLORY
LARKSPUR SWEET PEAS
COSMOS SCABIOSA
ZINNIAS

7 PACKETS
FOR 60¢
POST PAID

Mann's
1926

SUPERB ASTER COLLECTION

MANNS LATE BRANCHING ASTER
CRIMSON-LAVENDER
VIOLET

MANNS CREGO ASTERS
PURE WHITE - ROSE PINK
SHELL PINK

THIS COLLECTION OF SIX 10¢ PACKETS
50¢ POST PAID

J. MANNS & CO.

FORREST & HILLEN STS.

ESTABLISHED 1887

BALTIMORE, MD.

AT BELAIR MARKET