



LIBRARY  
UNIVERSITY *of*  
PENNSYLVANIA



*Rittenhouse Cherry*

GIFT OF

*Leonard Pearson*

*University of Pennsylvania  
Libraries*

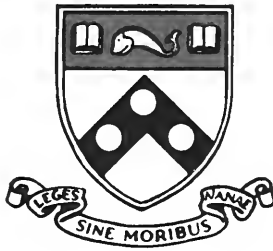

*Annenberg Rare Book  
and Manuscript  
Library*

Digitized by the Internet Archive  
in 2009 with funding from  
Lyrasis Members and Sloan Foundation





**A MANUAL  
OF  
COACHING**

THIS EDITION IS LIMITED  
TO FIFTEEN HUNDRED  
COPIES PRINTED FROM  
TYPE, ONE THOUSAND  
FOR AMERICA AND FIVE  
HUNDRED FOR ENGLAND







TO  
MY FRIEND  
WILLIAM G. TIFFANY  
RECALLING  
MANY PLEASANT HOURS  
PASSED WITH HIM  
BOTH ON AND OFF A COACH



# TABLE OF CONTENTS

## THE COACH

---

### CHAPTER I

	PAGES
DEVELOPMENT OF THE COACH.—SIMPLE FARM WAGON CARRIAGE-PART. ADDITION OF THE SEATS AND BODY. EARLY AMERICAN 'STAGE WAGGON.' USE OF SPRINGS. ENGLISH COACH AT THE END OF THE EIGHTEENTH CENTURY. WORD 'TALLY-HO' ERRO-NEOUSLY APPLIED . . . . .	1-15

### CHAPTER II

GENERAL CHARACTER OF A COACH.—DISTINCTION BETWEEN COACH AND DRAG . . . . .	16-18
--	-------

### CHAPTER III

CARRIAGE-PART. — AXLES, WHEELS, SPRINGS, POLE, LEAD-BARS . . . . .	19-60
--	-------

### CHAPTER IV

BODY.—BOOTS, DRIVING-SEAT, ROOF-SEATS, PAINTING	61-79
---	-------

### CHAPTER V

ACCESSORIES.—BRAKE, SKID, LAMPS, BASKET, AWNING, TABLES, LUNCH-BOXES, TOOL-BOX, APRONS . . . . .	80-101
--	--------

### CHAPTER VI

DRAG, MAIL-COACH, <i>MALLE POSTE</i> , DILIGENCE, BREAK, BAROUCHE LANDAU, PHAETON, JAUNTING CAR, PRIVATE OMNIBUS, CAPE CART . . . . .	102-115
---	---------

ix

## CHAPTER VII

	PAGES
AMERICAN COACH.—CONSTRUCTIVE PECULIARITIES, DIMENSIONS . . . . .	116-122

## CHAPTER VIII

COMPARISON OF COACHES.—CARE OF A COACH, COST OF COACHES . . . . .	123-128
---	---------

## CHAPTER IX

WEIGHT OF A COACH.—DISTRIBUTION OF WEIGHT, CENTRE OF GRAVITY, EFFECT OF CENTRIFUGAL FORCE	129-146
---	---------

## CHAPTER X

DRAUGHT.—ROLLING FRICTION, AXLE FRICTION, TOTAL RESISTANCE TO MOTION, TRACTION, ROADS, SYSTEMS OF ROAD MAKING, ACTION OF HORSE IN DRAUGHT	147-193
---	---------

## CHAPTER XI

HARNESS.—DETAILS OF HARNESS. BRIDLE, BIT, BEARING-REIN, COLLAR, HAMES, TRACES, PAD, REINS, COCK HORSE HARNESS, LEATHER, MOUNTINGS, SPARE PARTS TO CARRY, CARE OF HARNESS . . . . .	194-246
--	---------

## CHAPTER XII

HARNESSING.—PUTTING-TO, BEARING-REINS, COUPLING-REINS, BUCKLING REINS . . . . .	247-273
---	---------

## CHAPTER XIII

DIFFERENT ARRANGEMENTS OF HARNESS.—TANDEM, THREE ABREAST, PICKAXE, UNICORN, SIX HORSES, POSTING, <i>DAUMONT</i> . . . . .	274-284
---	---------

## CHAPTER XIV

	PAGES
DRIVING.—GETTING UP, STARTING, PLACES OF REINS IN HAND, SEAT, FINGERING, TURNING, STOPPING, GETTING DOWN, VARIOUS METHODS OF FINGER- ING, AMERICAN METHOD, TURNING AND BACKING, DRIVING APPARATUS . . . . .	285-348

## CHAPTER XV

GENERAL OBSERVATIONS ON DRIVING.—BITTING, AND HANDLING HORSES . . . . .	349-379
--	---------

## CHAPTER XVI

HORSES FOR COACH OR DRAG. COST OF PRIVATE COACHING . . . . .	380-389
---	---------

## CHAPTER XVII

THE WHIP AND ITS USE. SALUTE . . . . .	390-414
--	---------

## CHAPTER XVIII

THE MEN. DUTIES AND DRESS. COACHING DRESS . . . . .	415-426
---	---------

## CHAPTER XIX

PUBLIC COACHING.—PUTTING A COACH ON THE ROAD, LENGTH OF STAGES, TIME-TABLES, TIME-CHARTS, COACHMAN'S AND GUARD'S DUTIES AND DRESS, CHANGES . . . . .	427-464
---	---------

## CHAPTER XX

ROAD COACHING GENERALLY.—SPEED, DISTANCES DRIVEN, AMERICAN COACHING, ENGLISH COACHING . . . . .	465-483
--	---------

## CHAPTER XXI

COACHING TRIPS, COACHING CLUB TRIPS . . . . .	484-489
---	---------

	PAGES
CHAPTER XXII	
THE RULE OF THE ROAD . . . . .	490-501
CHAPTER XXIII	
ACCIDENTS . . . . .	502-509
CHAPTER XXIV	
COACHING CLUBS.—RULES AND CUSTOMS OF MEETS, JUDGING AT SHOWS, DRIVING COMPETITIONS . . . . .	510-530
CHAPTER XXV	
MUSIC FOR THE HORN . . . . .	531-532
CHAPTER XXVI	
COACHING MEDALS OR TOKENS . . . . .	533-535
CHAPTER XXVII	
LIST OF BOOKS. FRENCH NAMES FOR PARTS OF HARNESS	536-566
INDEX . . . . .	567-579



## LIST OF PLATES

---

PLATE	PAGE
Coach and Horses. ( <i>From a photograph. Re-drawn by HARRY FINNEY</i> ) . . . . . <i>Frontispiece</i>	
A May Morning in the Park. ( <i>From a painting by THOMAS EAKINS</i> ) . . . . .	I
I. The London and Oxford Coach. Phototype of a Painting by CORDERY, 1792, showing the Basket, the Front Boot attached to the Carriage-Part, and the Suspension of the Body. ( <i>Reproduced by the kind permission of Messrs DICKINSON &amp; FOSTER, New Bond Street, London</i> ) . . . . .	10
II. Drawing of same Coach. ( <i>Half-inch scale, with transparent sheet</i> ) . . . . .	10
III. The Carriage-Part of a Coach in Isometrical Perspective. ( <i>Scale one-half inch to the foot</i> ) . . . . .	20
IV. Phototype of Two Etchings from a Political Pamphlet of 1766, showing Coaches of the period . . . . .	71
V. Phototype of a Print of HOGARTH'S, 'The Inn Yard,' 1747, showing a Coach with Passengers on Top, and an Old Woman in the Basket. ( <i>One-half the size of the original print</i> ) . . . . .	72
VI. Phototype of an Etching by ROWLANDSON, 1793. A Coach with Two Extra Horses, ridden by a Postilion; the Traces of the Leaders attached to the Traces of the Wheelers and not to Lead-Bars . . . . .	72
VII. Mail-Coach by GUIET, 1892. Built for Mr W. G. TIFFANY, on the lines of the Old English Mail-Coach. Used on the Trouville trip in July 1892. ( <i>Drawn to a half-inch scale, with transparent sheet</i> ) . . . . .	102

PLATE	PAGE
VIII. French Malle Poste of the period of 1830. ( <i>From a drawing by VICTOR ADAM</i> ) . . . . .	104
IX. Swiss Diligence on the Julier Pass, 1891 . . . . .	105
X. French Posting with a Private Travelling-Carriage, early part of the present century. ( <i>Reproduction of a drawing by ALFRED DE DREUX</i> ) . . . . .	107
XI. <i>Char à bancs</i> , for five persons and two servants. ( <i>Drawn to a half-inch scale, with transparent sheet</i> ) . . . . .	111
XII. American Stage-Coach, as made by The ABBOT DOWNING COMPANY, Concord, N. H., and generally known as a Concord Coach. ( <i>Drawn to a half-inch scale, with transparent sheet</i> ) . . . . .	116
XIII. Concord Coach, rear view. ( <i>Half-inch scale</i> ) . . . . .	116
XIV. Concord Coach, Plan of Carriage-Part. ( <i>Half-inch scale</i> ) . . . . .	116
XV. Heavy Concord Coach, as sent to the West, to Africa, and to Australia. ( <i>Phototype from an original photograph</i> ) . . . . .	116
XVI. Light Concord Coach, as used in the White Mountains. ( <i>Phototype from an original photograph</i> ) . . . . .	116
XVII. Road-Coach, by BREWSTER & CO., of Broome Street, New York, The 'Vivid,' used on the road between Philadelphia and New York. ( <i>Drawn to a half-inch scale, with transparent sheet</i> ) . . . . .	124
XVIII. Standard Park-Dray, by BREWSTER & CO., of Broome Street, New York. ( <i>Drawn to a half-inch scale, with transparent sheet</i> ) . . . . .	124
XIX. Road-Coach, by GUIET & CO., Paris. ( <i>Drawn to a half-inch scale, with transparent sheet</i> ). . . . .	124
XX. Dray, by BARKER & CO., London. Built for the Author in 1873. ( <i>Drawn to a half-inch scale, with transparent sheet</i> ) . . . . .	124

## LIST OF PLATES

xv

PLATE	PAGE
XXI. Front and Rear Views of same Drag. ( <i>Half-inch scale</i> ) . . . . .	124
XXII. Road-Coach, by F. & R. SHANKS, London. ( <i>Drawn to a half-inch scale, with transparent sheet</i> )	124
XXIII. Tipping Angles of a Coach . . . . .	135
XXIV. Cock Horse Harness . . . . .	236
XXV. Lead-Rein passed through Terrets . . . . .	249
XXVI. Bitting and Coupling Diagram . . . . .	270
XXVII. Position on the Box . . . . .	302
XXVIII. Turning Diagrams . . . . .	340
XXIX. Team for Drag . . . . .	380
XXX. Half-bred Mare 'Josephine' . . . . .	380
XXXI. The Salute . . . . .	414
XXXII. Time-Chart . . . . .	444
XXXIII. Lead-Rein passed through Terrets . . . . .	460
XXXIV. Pole and Bars on front of Coach . . . . .	517

The Title-Page Vignette is from a painting by HARRY FINNEY.

The Wood Engravings of Harness and of Hands are by JAMES D. COOPER, of London.

The Five-Horse *Vetturino* (Fig. 131) is from an original drawing by G. LA ROCQUE, of Paris.





A MAY MORNING IN THE PARK.



# A MANUAL OF COACHING

---

## THE COACH

### CHAPTER I

#### DEVELOPMENT OF THE COACH

THE History and Evolution of the Coach\* will be here treated of only so far as it is necessary to assist the reader to understand the general construction of a coach before we proceed to details.

Those who wish to study the subject at length are referred to THRUPP'S *History of Coaches*, to STRATTON'S *The World on Wheels*, and to ADAMS'S *English Pleasure Carriages*, which give much that is interesting on the subject, including copious extracts from earlier writers; and also to the other authorities named in the 'List of books' given in Chapter XXVII., where will be found the full titles of the books referred to in the text.

The earliest vehicle which bears any resemblance to a coach (its predecessors being merely cars on

---

\* The word 'coach,' always with nearly the same sound, is found in almost all European languages during the last four centuries. It is variously spelled *coche*, *caroche*, *kutsche*, *koets*, *katsi*. In France the name was also applied to a passenger boat.

two wheels) is the farm wagon of the ancient Romans which still exists, with but little change, in almost all agricultural countries. It consists of a hind axle with its two wheels, to which the perch is attached, and a front axle, with usually somewhat smaller wheels, so connected by a bolt to the front end of the perch as to turn about it (Fig. 1). In order to make a rigid connection between the

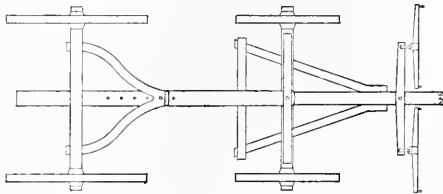

FIG. 1.

hind axle and the perch, two pieces, called hounds, or wings, are fastened to the perch and to the axle, or, in ruder constructions,

a forked branch of a tree, all in one piece, which rests upon the top of the perch, supplies their place. If it is desirable to be able to change the length of the wagon, the perch is made to slide through the hind axle, and has in it a number of holes, through any one of which a bolt will fasten it and the hounds together. The front end of the perch is firmly attached at right angles to a bed or transom, somewhat shorter than the front axle, upon which it rests, being connected with the axle by a bolt (perch-bolt or king-bolt), which permits the axle to turn underneath the bed. The pole or tongue, fastened to the axle, completes the simplest form of wagon. If it is intended for one horse, a pair of shafts takes the place of the pole.



A simple attachment of the pole to the axle being deficient in strength, two hounds or futchells are added, fastened to the axle near its ends and running out on the pole a short distance, and, in order to support the pole more efficiently, their hinder ends, prolonged, are connected by a cross bar, the sway-bar, which bears against the under side of the perch, and balances the weight of the pole. Sometimes the futchells are fastened directly to each other in front, and the end of the pole, being forked, is attached to them by a bolt. In this case, the point of the pole must be supported by the harness, as it is in a trotting wagon. For the purpose of attaching the horses to the wagon, a double-tree rests on the pole in front of the futchells, and is secured to it by a pin which permits it to turn; to this double-tree are attached two swingle-trees.\* Near the ends of the hind axle, two vertical standards are firmly fixed, and at the ends of the bed in front are similar ones. Boards laid between

---

\* There is some uncertainty as to the proper spelling of this word. BARTLETT, in his *Dictionary of Americanisms*, says that swingle-tree is vulgar for single-tree, but SKEAT in his *Etymological Dictionary* says, under Swingle-tree, 'Corruptly called *single-tree*, whence the term *double-tree* has arisen to keep it company. "A *single-tree* is fixed upon the end of another cross-piece called the *double-tree*, when two horses draw abreast," HALDEMAN (in WEBSTER). Middle English, *swingle-tre*, spelt *swyngletre* in FITZHERBERT *On Husbandry*. The word *tree* here means a piece of timber as in *axle-tree*. The word *swingle* means a "swing-er," a thing that swings; 'so named from the swinging motion, etc.'

these, on the axle and on the bed, form the floor, and other boards fastened vertically against them, form the sides of a body. A wagon of this kind, sometimes covered by a canopy, was undoubtedly the first four-wheeled vehicle in which people were carried.

The next advance was to suspend seats by means of straps attached to the sides, whereby more comfort could be had than by sitting on the rigid carriage-part; wagons thus arranged can be seen at the present time in Switzerland.

Finally, a 'body,' distinct from the carriage-part, was suspended from the points of the four standards, the fixed body having been removed, and this form of carriage remained in use for a long time, as is shown in prints as late as the end of the 17th century.

About 1660 (THRUPP, p. 43), the 'Berlin' was invented in Germany. In this, the floor of the body was rounded and rested on long leather straps, called thorough-braces, which ran from one standard to the other, and the under-carriage was frequently made with two parallel perches for strength and stiffness. The coachman's seat was on the carriage-part, and not attached to the body.

We have now reached the form of carriage which lasted until late in the 18th century, and which still exists in the modern American 'Concord coach,' with the modification of having the coachman's seat placed on the body instead of on the carriage-part.

It is sometimes supposed that the American coach was invented especially for use on the early, rough American roads; but it is evidently the European vehicle of the latter part of the 18th century, arrested in its development, because the condition of the roads in those parts of the United States where coaches were used, resembled the conditions existing at that time in Europe.

In America, the vehicle called the 'stage-waggon,' which preceded the coach, was evidently evolved from the carrier's wagon, keeping its essential form but being much lighter.

There is shown in Fig. 2, copied from an Amer-

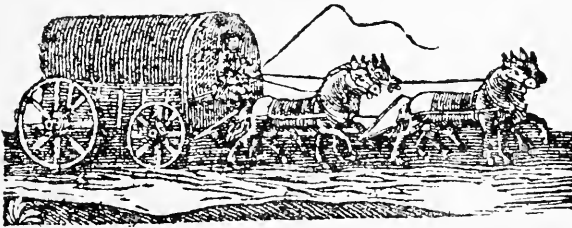

FIG. 2.

ican newspaper of 1759, a 'stage-waggon' running between Philadelphia and New York. Fig. 3 is from a paper of 1812 representing a 'stage' on the same road, and shows the same general form, improved after an interval of fifty-three years.

The 'Concord coach,' which succeeded this, was an adaptation of the private coach, or chariot, to the purposes of the road. In England, road-coaches

were, from the first, direct copies of the private carriage, as will be seen by comparing Fig. 4 with Plates I. and II.

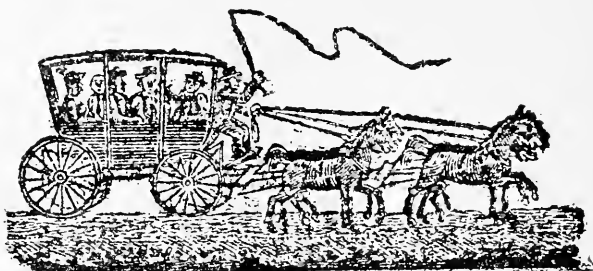

FIG. 3.

Engravings and pictures, and also the descriptions, show that the driving-seat remained on the carriage-part, and with-

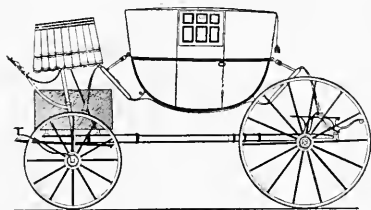

FIG. 4.

out any springs, until very near the end of the 18th century. No drawing, such as often headed the advertisement of a regular stage-coach in the

early American days, has come under my observation, in which the driving-seat is *not* on the body of the coach; and it is probable that this change was made in America, since there are no drawings of English carriages with thorough-braces, and with the box on the body; so long as thorough-braces were used, the box was on the carriage-part.

MR WARDE, of Squerries, is credited by 'NIMROD,' in his *Essays*, reprinted in MALET (p. 249\*), with having induced the proprietors of the Manchester 'Telegraph' to put the box on springs, which, 'NIMROD' says, 'was not the case when I first mounted them.' As 'NIMROD' was born in 1778, it was probably about 1798 that he 'first mounted them,' and that would fix the date of the use of springs under the driving-seat as being early in this century. It can hardly be supposed that the driving-seat was separately placed on springs; it was probably attached, therefore, to the body, which was already on springs, and thus led to the substitution of steel for leather suspension.

The reproduction in MALET'S *Annals of the Road* (p. 15), of an advertisement of the Edinburgh Stage-Coach of 1754, is headed by a cut which shows the driving-seat as being on the body; but this cut is not an accurate copy of the original and does not show the construction of the coach of that period. The photographic reproduction of an advertisement in *The Edinburgh Courant* of May 13, 1754 (given on p. 8), shows a vehicle resembling a private carriage much more than a coach, but not unlike the coach shown in Plate IV. The driving-seat is evidently on the under-carriage.

---

\* These *Essays* were originally published in *The Sporting Magazine* in 1822-1827. 'NIMROD' (J. C. APPERLEY) left *The Sporting Magazine* in 1829.



**T**HE EDINBURGH STAGE-COACH, for the better Accommodation of Passengers, will be altered to a new genteel Two-end Glass Machine, hung on Steel Springs, exceeding light and easy, to go in ten Days in Summer and twelve in Winter, to set out the first Tuesday in March, and continue it from Hofea Eastgate's, the Coach and Horses in Dean-street, Soho, LONDON, and from John Somervell's in the Canon gate, Edinburgh, every other Tuesday, and meet at Burrow-bridge on Saturday Night, and set out from thence on Monday Morning, and get to London and Edinburgh on Friday. In the Winter set out from London and Edinburgh every other Monday Morning, and to get to Burrow-bridge on Saturday Night; and to set out from thence on Monday Morning, and get to London and Edinburgh on Saturday Night. Passengers to pay as usual. Perform'd, if God permits, by your dutiful Servant,  
HOSEA EASTGATE.

Care is taken of small Parcels, paying according to their Value.

Cross (vol. ii., p. 70) speaks of the change from the old, heavy, six-inside coaches, 'with the boot fixed on the fore-axle, and a large basket on the

'hind,' to the 'new and elegant Telegraph coaches,' as occurring just before 1816, as well as the date can be made out from the context.

The suspension of the bodies of carriages, other than stage-coaches, by four leather braces, is continued to the present day, but always in connection with springs. As early as 1669 springs were tried, but they do not seem to have come into general use for many years later, probably not until after 1700, when the standards, which held the straps on which the body was hung, were made of steel and were called whip-springs (Fig. 5, A). Small springs were also used to attach the ends of the straps to the body, as at B. About 1790, the whip-spring was replaced by the C-spring (Fig. 5, C), which is still used in expensive carriages.

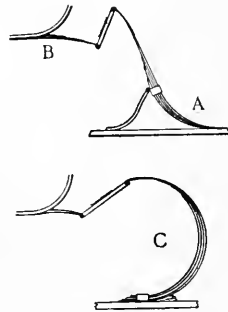

FIG. 5.

Down to 1805, all carriages had perches, but in that year the elliptic spring was invented in England by ELLIOT, and since that time the majority of carriages are made without perches, although coaches still have them.

Plate I., which is a reproduction of a picture by CORDERY, 1792, shows the coach as hung on whip-springs by short straps attached to pump-handles projecting from the bottom of the body, as in the present C-spring carriage. The front boot is built

up solidly from the front end of the perch, and the top of it forms the driving-seat. The whip springs are fastened to what might be called the platform of the carriage-part. To prevent too much play, and consequent breakage of the springs, their tops are attached in front, to the boot, by straps, and behind, to the upper ends of standards which are built up on the platform. Straps from the body to the same points also prevent too much motion of the body. The space on the platform between the springs and between the standards is occupied by a basket, in which was carried either merchandise or passengers. From the ends of the splinter-bar, iron stays ran, outside of the wheels to the ends of the axles,—an arrangement not uncommon even now, in heavy vehicles in Europe. This particular coach has a narrow body, accommodating only four inside, and the roof-seats do not overhang the body.

Plate II. is a drawing of this same coach to a half-inch scale ; it may be compared with the other half-inch scale drawings on Plates XVII. to XXII. The transparent sheet, printed in red, can be torn out so as to be superposed on the black plates.

Shortly after 1800, the bodies of coaches, and of some travelling carriages, were lengthened by the addition, as a part of the construction of the body, of a front and hind boot, the whole being hung on the springs ; the coachman's seat and the rumble for servants were on the boots, as is shown in the drawing of a 'Britszka' of 1825 (Fig. 6). This



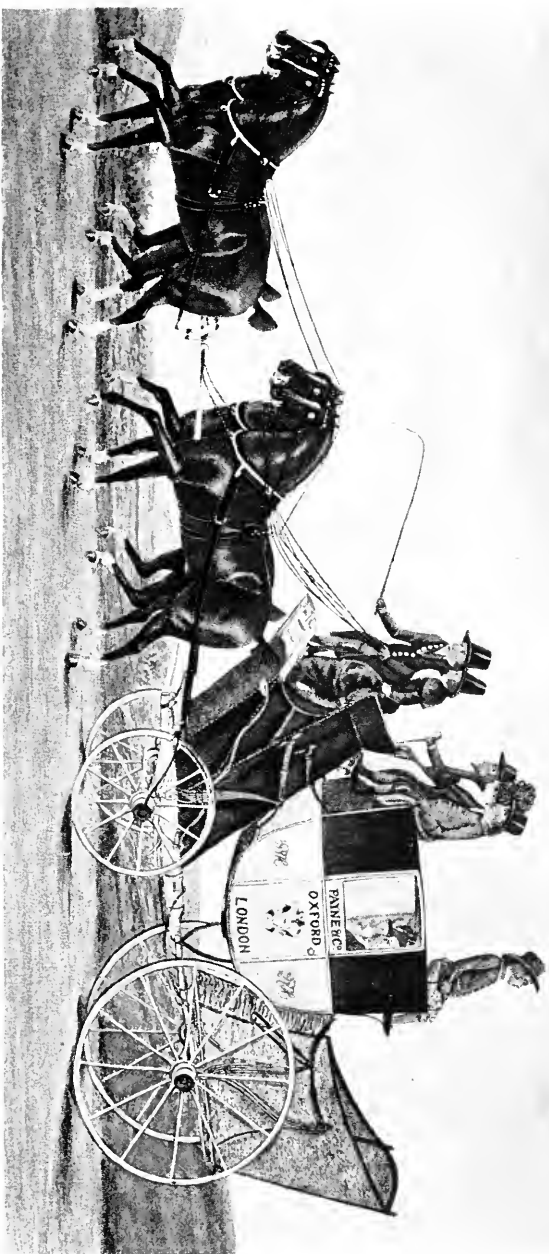
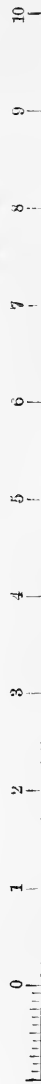
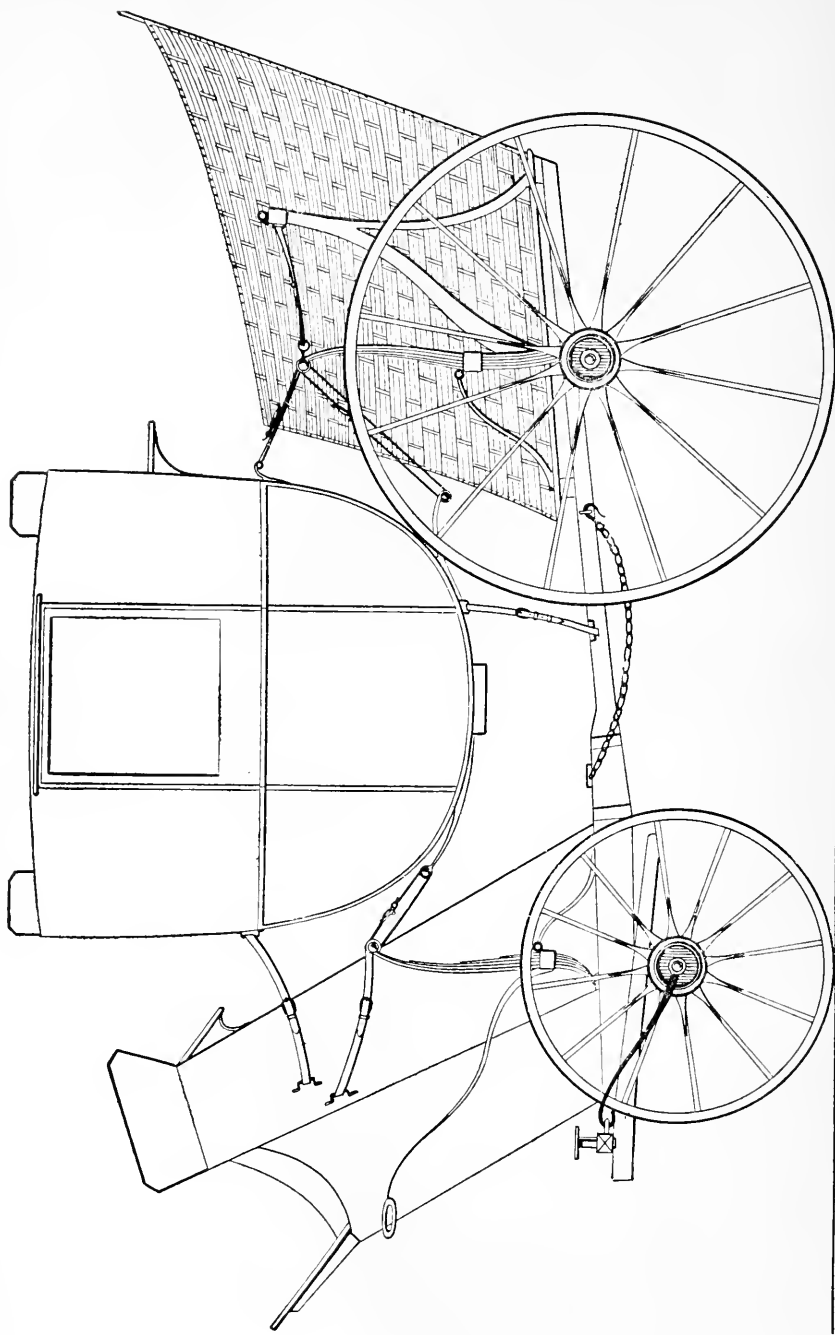

PLATE I.

THE LONDON AND OXFORD COACH. FROM A PAINTING BY CORDERY. 1792.

Reproduced by the kind permission of Messrs Dickinson & Foster New Bond St. London.



LONDON AND OXFORD COACH, CORDERY, 1792.

DEVELOPMENT

Scale of Feet

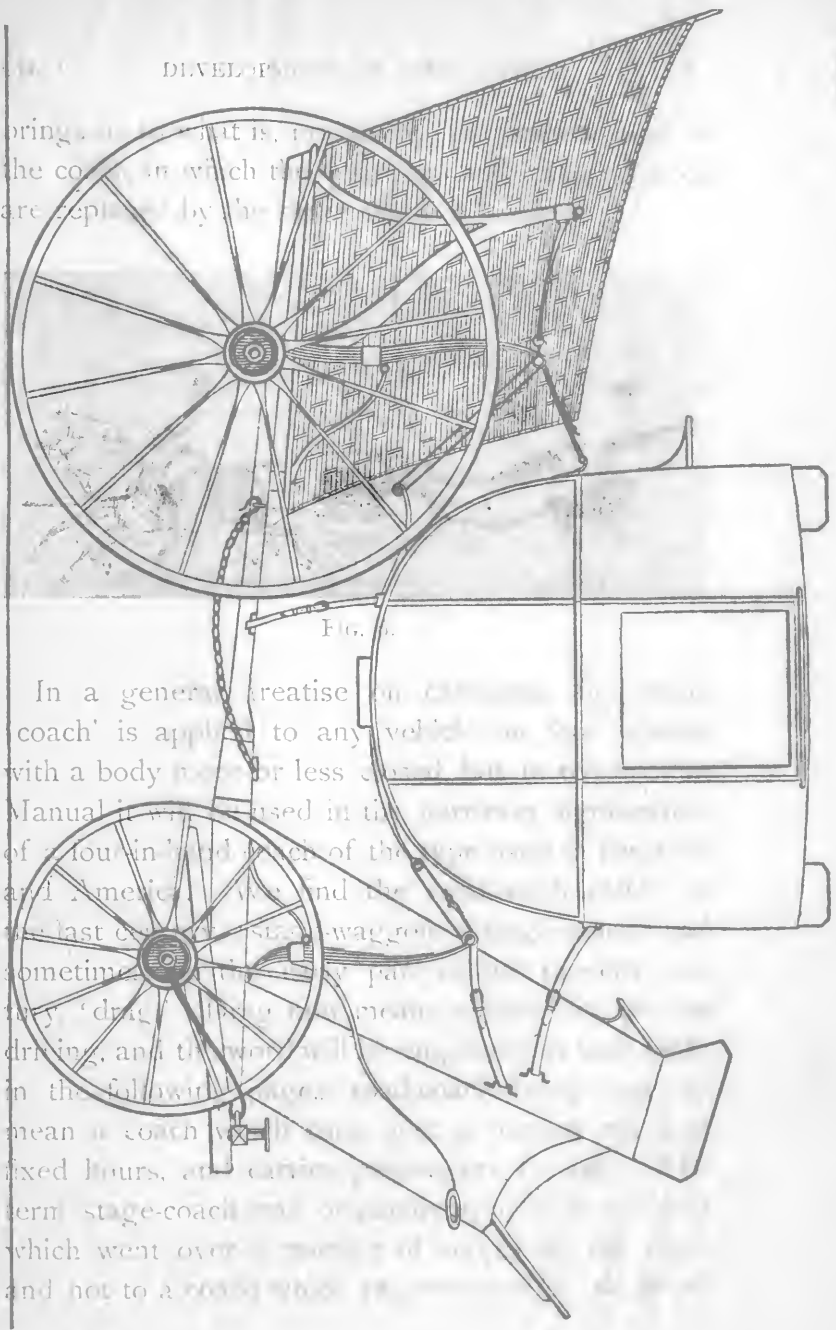
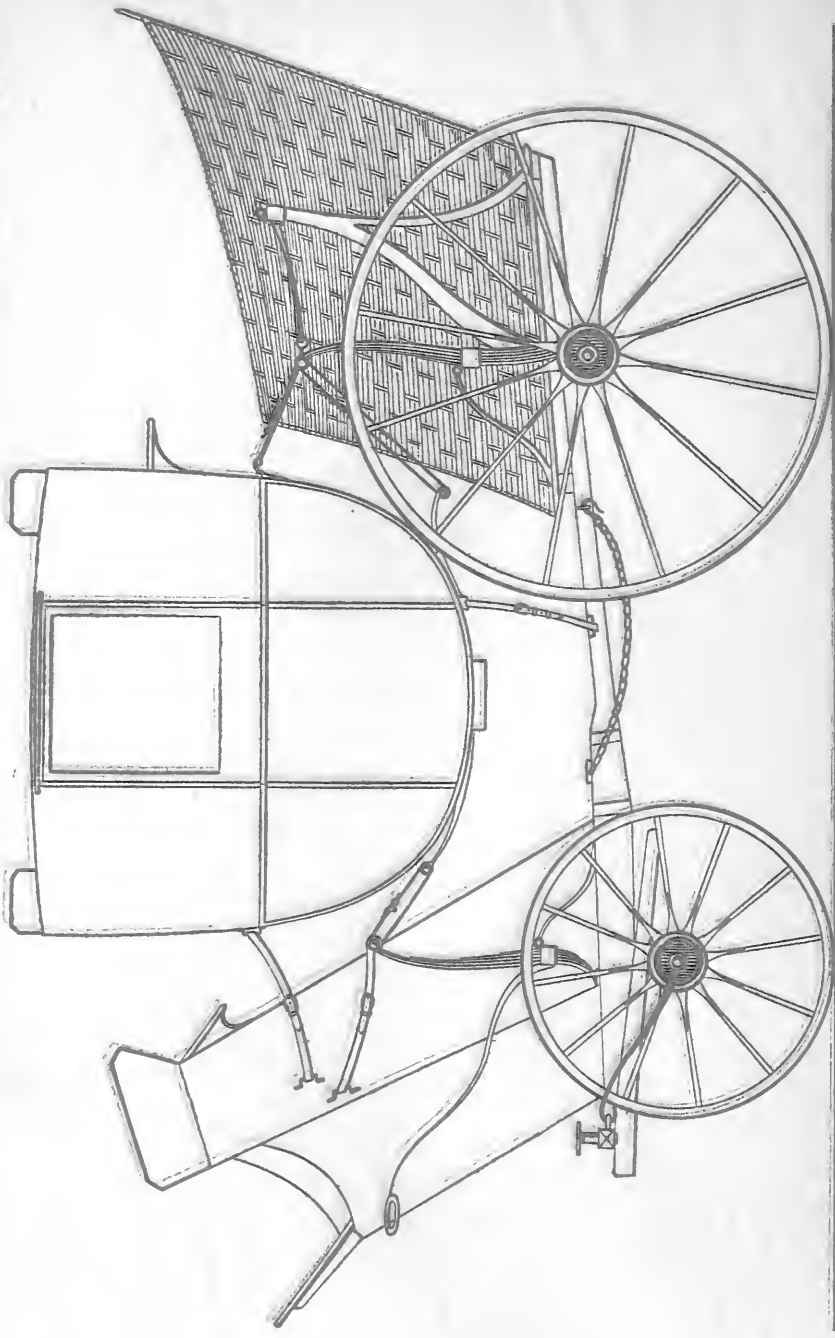

FIG. 1.

bring... that is, the...  
the coach in which the...  
are replaced by the...

In a general treatise on 'stage-coach' is applied to any vehicle with a body more or less closed but Manual... used in the... of a four-wheeled... and America... and the... last... stage-waggon... sometime... pay... try 'drag'... from... driving, and the... in the following... mean a coach... fixed hours, and carries... term stage-coach... which went over... and not to a...



Scale of Feet.

LONDON AND OXFORD COACH. CORDERY. 1792.

brings us to what is, practically, the present form of the coach, in which the C-springs and leather braces are replaced by the stiffer platform springs.



FIG. 6.

In a general treatise on carriages, the name 'coach' is applied to any vehicle on four wheels with a body more or less closed, but in the present Manual it will be used in the narrower signification of a four-in-hand coach of the type used in England and America. We find the road-coach called in the last century, 'stage-waggon,' 'stage-coach,' and sometimes, in the early part of the present century, 'drag.' Drag now means a coach for private driving, and the word will be employed in that sense in the following pages, road-coach being used to mean a coach which runs over a regular route at fixed hours, and carries passengers for pay. The term stage-coach was originally applied to a coach which went over a number of stages on the road, and not to a coach which ran only a short distance.

As an example of the curious changes of language, it may be worth noting that, in New York, it became the custom to call an omnibus, which ran only over a short route, a 'stage;' first applying an improper name 'stage-coach,' and then dropping the characteristic term and retaining the other designation only.

The popular word in America for a four-in-hand coach: 'Tally-ho,' is entirely incorrect, and should not be used. It originated thus: When, in 1876, Colonel DELANCEY KANE first put on his road-coach from the Brunswick Hotel, New York, to Pelham, he named it the 'Tally-ho.' This was in accordance with the old English custom of giving names to coaches, just as, for many years, engines were named on railroads. 'Tally-ho,' 'Tantivy,' 'Lightning,' 'Meteor,' 'Defiance,' 'Quicksilver,' 'Independent,' were favourite names, and were used in advertising the coaches, and in speaking of them on the road. Some newspapers, in writing about the Pelham coach, called it *the* 'Tally-ho,' and others, less well informed, called all four-horse coaches 'Tally-ho's.' Many mild protests were made, without avail, by coaching men, against such an incorrect expression, and finally an American Dictionary, the *Century*, published in 1891, embalmed and perpetuated the error as follows:

'Tally-ho (tal'i-hō) [*<* tally-ho, interj.]. 1. A cry 'of "Tally-ho." See the interjection. 2. A four-in-hand pleasure-coach; probably so called from the 'horn blown on it.

‘ “The mail still announced itself by the merry notes of the horn ; the hedge-cutter or the rick-thatcher might still know the exact hour by the unfailing yet otherwise meteoric apparition of the pea-green *Tally-ho* or the yellow *Independent*.—*George Eliot*, *Felix Holt*.” ’

WEBSTER'S *Dictionary* (1892) gives the same erroneous definition. WORCESTER'S last edition is correct, and gives only the proper meaning of the word.

After having been for so long a time thus popularly used, the expression will probably survive, but coaching men, at least, should avoid it.

In somewhat the same way, the coach has in France come to have the name : ‘ *Le Mail*.’ A mail-coach, as will be described later, is different from a road-coach, and it is the road-coach which has been copied for pleasure purposes ; not the mail-coach.

MORTIMER D'OCAGNE (*Le Mail Coach en France*, p. 3) says : ‘ At the outset we must make a comment upon the title of this little sketch. One should not say, a *mail coach*. In reality, the mail is the carriage which carries the mails, but the use of this name has become general in France, and every one says, a mail ; the sporting journals themselves often speak of the meet of the mails. We will not assume an authority to change this way of speaking, but we must note its inaccuracy.’ \*

---

\* ‘ Dès la première ligne il nous faut faire une réserve contre le titre même de cette notice. On ne devrait pas dire un *mail coach*. En effet, le mail, c'est la malle, la malle poste ; mais l'usage est pris en France et tout le monde dit un mail ; les journaux de sport eux-

Since 'Tally-ho' and 'Tantivy' are names frequently given to coaches, their origin is interesting to the coaching man.

HUNTER'S *Encyclopædic Dictionary* gives, 'Tally-ho [Norman French—*Taillis-au* = to the cop-pice], The huntsman's cry to urge on his hounds.'

*Le haut taillis* is a wood of twenty-five to thirty years' growth and presumably 'cut high,' or with no underwood, so that the hunted animal, on running into it, can be plainly seen. In fox-hunting, it is when the fox is viewed, that the cry is used.

The Dictionary of the French Academy gives 'Taïaut' as being the cry of the hunter when he views the deer.

'Taïaut' is given in old French books on Hunting in the same sense, and is also used as a verb; just as in English, one is said to 'tally-ho' the fox. 'Taillis-au' or 'taillis-haut' are not given as hunting cries.

Since tally-ho is a true fox-hunting expression, it is considered proper, when a coach bears that name, to have a fox or a fox's head on the harness, unless there is a monogram or crest. If the coach is named 'Tantivy,' something belonging to a deer is used, since that term is associated with stag-hunting; but the connection is not so clear as is that of tally-ho with the fox.

---

'mêmes parlent souvent de la réunion des mails. Nous n'avons pas la prétention de modifier cette façon de dire; nous en signalons toutefois l'inexactitude.'



No word resembling *tantivy*, either in sound or in spelling, occurs in the nine hundred pages of the great work on Hunting by the Comte DE BEY, written in 1635.\*

There are two possible derivations of this word ; it is not in the French dictionaries except in that of Chambaud, 1805, and seems to be of English origin ; its usual meaning is 'at full speed.' Chambaud gives it as, 'Tantivy, au grand galop.'

The following quotations give both derivations :

HUNTER'S *Encyclopædic Dictionary* gives 'Tantivy [from the note of a hunting horn], swiftly, a rapid, violent gallop. As a verb, to hurry off.'

TODD'S JOHNSON'S *Dictionary* gives 'Tantivy, from the note of a hunting horn, so expressed in articulate sounds. From tantâ vi, says Skinner, Dr. Johnson. The old French language has *tentiveux* to denote an eager person "homme qui est tenté par tout ce qu'il voit : avide etc." To ride tantivy 'is to ride at great speed.'

GODEFROY, *Dictionnaire de l'ancienne langue française*, gives 'Tentir : faire entendre un son "Les cors as bouces commencent à tentir."' *Retentir* is from *tentir*, and this again from the Latin, *tinnire*, to sound.

---

\* *Les Meutes et Veneries de* JEAN DE LIGNIVILLE, Chevalier, Comte DE BEY. Introduction et notes par ERNEST JULLIEN et HENRI GALLICE. Paris, 1892. 2 vols. quarto.

## CHAPTER II

## GENERAL CHARACTER OF A COACH

As at present built, either for public or for private use, the coach is essentially the same as that which existed at the time when coaches in England were superseded by railroads.

A distinction is made, however, between a drag, built for private use, and a road-coach intended to carry always a full load, and to be driven at a high speed over long routes. The drag is made lighter than the coach, but between the two extremes of weight and of finish there are many grades, depending upon the taste of the owner.

Some men, living in the country and liking to drive long distances, use their coaches like road-coaches, at high speeds and with changes of horses ; certainly the most 'sporting' way of doing the thing. A coach for this purpose should be built almost exactly like a road-coach. Other men use their coaches only about home or, if they live in a city, principally in park driving, with small loads, at a moderate pace, on good roads, and such a coach should be two or three hundred pounds lighter than a road-coach, and may be slightly ornamented with plain mouldings worked on the edges of the under-carriage timbers, and with a little carving on the

ends of the splinter-bar and the futchells, which in a road-coach are always perfectly plain.

There are, however, between the two kinds of coaches, some essential differences which should be observed. In a road-coach, the rumble is supported on the hind boot by a solid wooden bench, and seats three or four persons, including the guard; in a drag, the rumble holds only two persons, usually the grooms, and is supported by open irons. It is quite easy to have both kinds of rumble fitted to a coach, so that it can be used either as a drag or as a road-coach. On a road-coach there is an iron rod running between the side-irons of the roof-seats along both sides of the coach, and this usually has a net of leather straps (see Plates XVIII. and XIX.), connecting it with the roof, so that wraps thrown on the roof cannot fall off. This net should be omitted in a drag, although for long trips one may be made with buckles in such a way that it can be taken off. The door of the hind boot of a road-coach is hinged on the off side; that of a drag is hinged at the bottom (see Fig. 36). The road-coach is not trimmed inside, but is usually finished in hard wood. This hard-wood finish is, however, a modern fashion, as in old coaching days the inside passengers paid higher fares than those outside and were made as comfortable as possible. The interior of a drag is trimmed plainly in morocco, cloth, or cord. The general finish of a drag may be higher than that of a road-coach without being elaborate;

it should be about the finish of a plain, first-class brougham.

The reader should be reminded that a drag is a *sporting* vehicle; it is not at all a *voiture de luxe*, and in all its appointments it should retain the sporting character. Elaborate harness or unnecessary ornament of any kind, about a drag is in bad taste; a drag is nothing more than a well 'turned out,' neat, road-coach, and the showy features of a lady's carriage should be avoided.

Down to about 1870, drags were made to take only three persons on each roof-seat, and these seats, like those of a mail-coach, did not extend beyond the edge of the roof; now they are always made long enough to accommodate four persons.

After these general indications of the difference between the two classes of coach, we will consider the parts of a coach.

## CHAPTER III

## CARRIAGE-PART

THE carriage-part of a coach (see Plate III.) consists of the axles, the perch (sometimes called the reach), the futchells, the bed or transom, and certain minor parts, constituting, with the wheels, a complete vehicle, upon which the body is supported by springs.

The perch is of wood, mortised at its rear end into the hind axle; its connection with the axle is strengthened by the hounds, also of wood, which are mortised into the axle, and bound to the perch by bands.

To insure steadiness in the running of a coach, the length of the perch (that is, the distance between the axles) should be not less than six feet, which was the minimum formerly allowed by the English Post-Office authorities for the mail-coaches. Six feet four inches is not any too long; a short-coupled coach will rock unpleasantly and little is gained by diminishing the length.

To the front end of the perch is attached, at right angles, a bed or transom. This transom rests upon the top of the front axle and is connected with it by the king-bolt or perch-bolt, about which the front axle turns. The under side of the transom and the

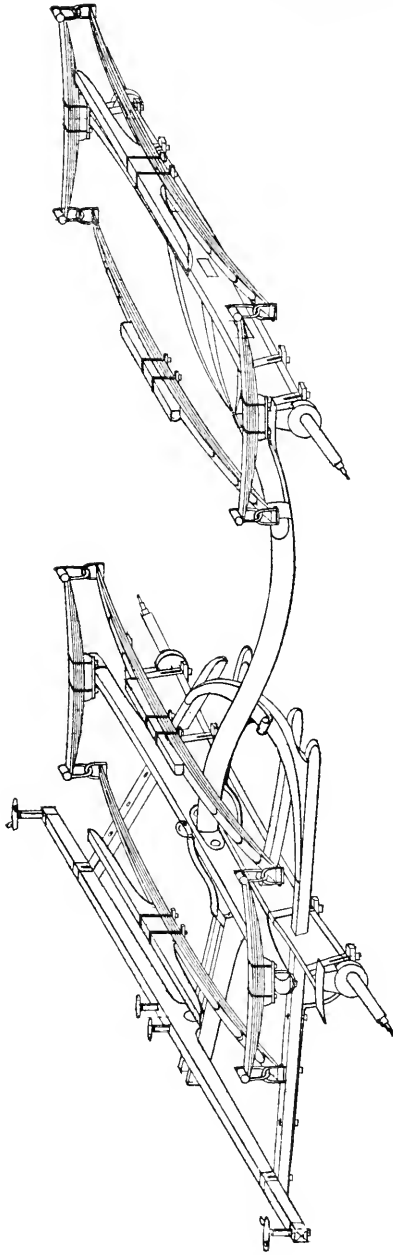

CARRIAGE-PART OF A COACH.

Drawn in isometrical perspective on a scale of one-half inch to the foot.

upper side of the axle are covered with steel plates (transom plates) which slide on each other. When the axle and the transom are parallel, these plates touch each other throughout their whole length; but when the axle is turned round the perch-bolt, the plates touch only near their centres and their bearing is consequently much diminished. To obviate this defect certain American builders add 'horns' to the transom plates, which practically widen these plates and permit them to bear upon each other through the whole angle of turning.

In ordinary carriages the transom does not bear directly upon the axle, but carries upon its under side (Fig. 7) a circular plate, which turns upon a similar plate attached to the top of the axle. This is called the fifth-wheel, and it is generally a



FIG. 7.

full circle, although sometimes, as in light wagons, it is a half circle only. A fifth-wheel is not used in a coach, but is sometimes used in a break.

Inasmuch as the bearing just described, of the bed on the axle, would be insufficient to give the requisite strength and stiffness, two additional pieces of wood, the inside futchells, are mortised through the axle and run backward, spreading to a width of about sixteen inches at their hinder ends, where they are connected by the sway-bar. In the rough farm wagon, before described, this bar is straight, but in a coach it is curved to a radius equal to its distance from the perch-bolt, so that it is really a

short section of a large fifth-wheel. This sway-bar is plated with steel on its upper surface, and bears against the under surface of the perch, which is also plated at that point. The plate on the under surface of the perch has an arm or lug projecting downward and embracing the sway-bar plate so as to prevent the sway-bar from springing away from the perch under any jumping motion of the pole. The sway-bar plate has projections near its ends, which bring up against this lug when the axle has turned through a certain angle, usually about twenty degrees, to prevent the wheel from touching the body when the coach is on the lock. A coach is said to be 'on the lock,' when the front wheels are turned as far as they can go without touching the body.

The inside futchells project forward of the axle, approaching each other near enough to form a channel into which the pole is fitted. Near their ends they carry the draw-bar, or splinter-bar, which is bolted on top of them. For the purpose of supporting the ends of this bar, two straight pieces, the outside futchells, run through the axle, and are attached to the sway-bar (the plate of which runs over on top of them), and projecting in front, take the ends of the splinter-bar, to the under side of which they are firmly clipped. The splinter-bar is straight, six feet long, and carries the four roller-bolts to which the traces are attached. The roller-bolts have flanges on top to prevent the traces from slipping off, and the flanges of those on the outside



are wide enough to serve as steps in mounting to the box.

On a drag, these flanges should be lined underneath with thick leather, to prevent the metal slides of the traces from rattling against them. The inside roller-bolts should be larger in diameter than those on the outside, in order to take up a portion of the length of the inside trace, for the reason given in the article on 'Putting to,' in Chapter XII.

With the traces attached directly to the stiff splinter-bar, the horse, in the movement of his shoulders, pulls alternately on one trace and the other, and if he has on a breast-collar, or as it is sometimes called a 'Dutch collar,' this movement inside of the leather will frequently rub the shoulder, and make it sore. For this reason, when English travelling carriages were taken to the Continent in old posting times they had loose swingle-trees attached to the splinter-bar because the Continental posting harness had breast collars. (BEAUFORT, p. 353.) See Plate X.

Even with ordinary collars, horses work more easily with moveable swingle-trees, and it will be noticed that those who work horses as a matter of business, such as livery-stable keepers, invariably use them. My own experience long ago led me to modify the arrangement of the splinter-bar of my coach in such a way that, while the roller-bolts are retained and the general outward appearance of the

bar but little altered, the advantage of a moveable swingle tree is obtained.

The general arrangement is seen in Fig. 8. The

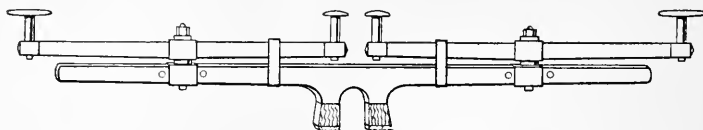

FIG. 8.

details, with dimensions which should be somewhat closely adhered to, are shown in Fig. 9, drawn to one-quarter of the full size. The bolt which passes through the splinter-bar should be not less than three-quarters of an inch in diameter, the swelled portion being welded upon it. It should be carefully

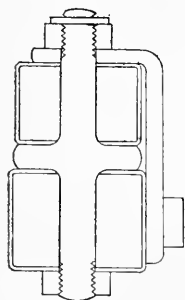

FIG. 9.

turned in the lathe to the proper fit, and the corners between the swelled portion and the pin must be left full, and not cut in sharply, since it is here that the pin is most liable to break. After the nut on the bottom of the pin is screwed up, the end of the pin should be hammered over so that the nut cannot come off; the top end of the bolt should

have a split pin passing through it over the nut. The shackle, which is bolted to the back of the splinter-bar, must be strong and of tough iron, because, should the pin break, all the strain will come upon the shackle. Of course the objection may be made to this arrangement that every additional

moveable part about a coach increases the chances of breakage, but the increase of comfort to the horses is undoubted. This arrangement is similar to that usually seen on light wagons, with the difference, however, that the swingle-tree is deep enough, and the pin stiff enough, to permit the use of the outside roller-bolt as a step. The motion of the swingle-tree is restricted by a strap, which should be put on quite tight, since a movement of the roller-bolt of an inch and a half in front of, and behind, the bar is sufficient.

Some coachmen think that a coach can be guided more accurately with an entirely stiff bar than with moveable swingle-trees, because either horse, if urged forward, will turn the fore-carriage very quickly by the application of his force to the outer end of the bar. Since, however, the motion of the swingle-tree is limited by the strap and by the neatness of fit of the pin, it will be found, in practice, that the difference is not noticeable.

The amount of the motion of the ends of the swingle-trees corresponding to the action of the horses' shoulders can be well observed in a trotting wagon, which always has swingle-trees, and it is very noticeable to the occupant of any one-horse vehicle, a coupé for instance, in which the traces are attached directly to the root of the shafts and not to a swing-bar, the alternate sideways motion given to the carriage being extremely disagreeable.

·NIMROD' says (MALET, p. 386): 'The swing bar

'we use in coaches is an excellent invention, as a  
'horse works in it from either shoulder, and of  
'course quite at his ease.' This, of course, refers  
to the lead-bars, and shows that 'NIMROD' recog-  
nises the importance of the principle.

LE NOBLE DU TEIL (p. 349) thinks that with a collar, the freedom of movement of the swingle-tree is not important, although it is important with the breast-collar, or *bricole*, because the collar is *pressed* forward alternately by the shoulders, and there is pressure but not friction. This alternating pressure must, however, tire the shoulders, even if it does not rub the skin.

After the preceding pages were written, I found the following passage in PHILIPSON *On Harness*, p. 57, ed. 1882, written by 'GLENCAIRN' (Colonel J. P. PEDLER) to *The Field*, in June 1878:

'A word about sore shoulders. I never drive  
'with anything but a swingle bar, and that not  
'fixed by a band of leather eight inches broad,  
'which defeats the object of a swingle bar, but by  
'a bolt running through it vertically, or by an eye  
'playing on a hook. I think a *proper* swingle bar  
'is a help to preventing sore shoulders, besides  
'having other and most important advantages.  
'Even in a four-wheeled carriage and with a pair  
'I always put swingle bars, and the following is  
'the best way to fix them, viz.: Put them on top  
'of the splinter bar, bring an iron support from  
'the futchells to the top of the swingle bar, and

'make an eye in the end of it; drive a bolt through this eye, the swingle bar, and the splinter bar, with a nut underneath. On this bolt the swingle bar revolves beautifully. You can have the ordinary roller bolts on the swingle bars. I have written to "Nimshivich," who is evidently one of those who knows what he is talking about. I consider that with swingle bars a horse is always pulling with both shoulders instead of with one at a time alternately; also that the evil of uneven traces is nullified.'

A full-sized model of the bars, as shown in Fig. 8, was exhibited by me in the Coaching Exhibitions in London of 1894 and 1896, and had Colonel PEDLER'S letter been seen earlier, the model would have been accompanied by a note of explanation. The arrangement was applied to my coach in 1877, and the invention seems therefore to have been made by us both at about the same time.

In many vehicles, the bar itself is made to move about a central pin, and is then called an evener, because it ensures, within certain limits, each horse doing an *even* share of the work, but it is not used on a coach, nor is it necessary, as the coachman should be able to make his horses work evenly without the aid of any mechanical appliance.

An evener is sometimes made with two holes on either side of the middle one, so that by shifting it on the pin, a weak horse can be favoured. This is not likely to be used on a coach, but a good

coachman ought to know all the *dodges* that at some time might be of use to him.

The front axle of a vehicle with a perch, or with a body which is wide and low, can turn through a small angle only, before the front wheel touches the perch or the body, and many attempts have been

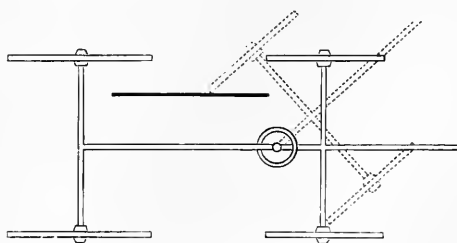

FIG. 10.

made to remedy this defect. One method is to put the perch-bolt *back* of the line of the axle-arms, in which case (as is shown in Fig.

10, where the wheel is represented as touching the body), a larger angle of the pole with the centre line can be obtained. This is dangerous, however, if carried to excess, because when on the lock, the front wheels are to one side of the centre line and the stability of the coach is much diminished.

In broughams the perch-bolt is frequently put somewhat *forward* of the line of the axle-arms, which brings the inside wheel forward in making a turn and permits it to go under the boot without touching the body, still keeping the carriage-part short.

A variety of plans for jointed axle-arms have been proposed: by ACKERMAN in 1818; by ROCK in 1850; by HERDIC in 1880; and later by JEANTAUD, of Paris. Nearly all modern horseless carriages

have this arrangement, which permits part of the machinery to be sunk between the front wheels. These plans all depend upon an arrangement of parallel bars, with arms that turn the axle-arms and wheels, about the end of a fixed axle. If the boots are not too deep, a coach fitted in this way will turn, on an almost square lock, round a point inside of the spot where one hind wheel touches the ground, and the lowest points of the front wheels will not deviate greatly from the lines running through the hind wheels, as is shown by the dotted lines in Fig. 11, which is only a diagram, and is not intended to show details of construction.

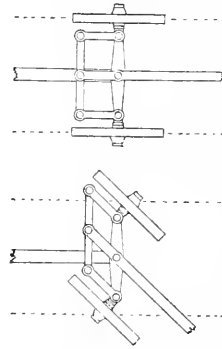

FIG. 11.

To obtain the greatest freedom in turning, the parallel bar A B (Fig. 12), which is behind the axle and connects the arms, must be as much shorter than the distance on the axle between the joints of the axle-arms as will make the lines of the arms, produced, join at the centre of the hind axle (Fig. 12, C).

The front wheels, when turning, will then assume positions which are not parallel to each other, as they are in Fig. 11, but at right angles to two radii meeting on a line which is the prolongation of the hind axle, and all four wheels will turn round that point, as a common centre, without any grinding upon the road.

A practical objection to this arrangement, is the largely increased number of parts and joints, with

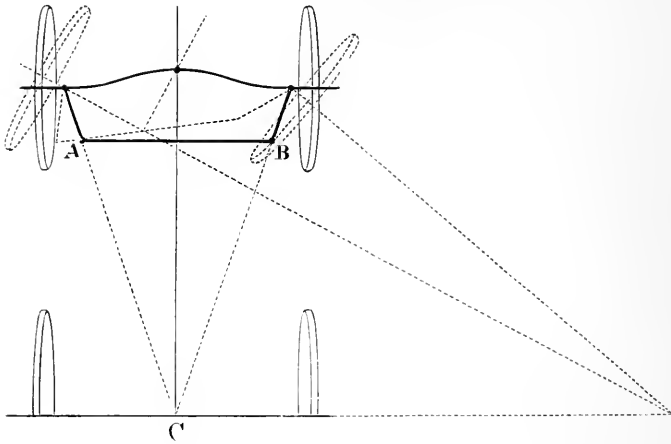

FIG. 12.

the consequent risk of breakage, and difficulty of preventing rattling.

AXLE.—The axle of the simplest cart or wagon is entirely of wood, the ends being tapered and rounded, and covered by a thin conical iron tube called a skein, on which the wheel, which has an iron boxing or lining of some more or less complete form, runs. The axle of a coach is made in several parts. The axle-bed is of wood, sometimes in two pieces, between which the futchells are held, and under it is fastened the axle proper, which is of strong, tough iron or mild steel, about two inches square, in one continuous length, terminating in arms upon which the wheels run. Originally these



arms were tapered, and projected beyond the face of the hub of the wheel, and through a hole near the end a linchpin of iron or hard wood passed, to keep the wheel on. Until the end of the last century, the linchpin was universally used, but it was then superseded by a nut screwed on the end of the axle. On private carriages the linchpin was used to a much later date than on coaches; until 1830 or 1840. (BEAUFORT, p. 307.)

A simple axle-arm is used in light carriages and in business wagons; it is tapered, and the nut, which screws against a shoulder so that it cannot be set up too tight, is cut with a right hand thread on the off side axle and a left hand thread on the near side axle, so that the turning of the wheel tends to keep the nut on and not to screw it off.

All coaches have either mail axles or Collinge axles. The mail axle (Fig. 13), so called because it was originally used on the mail-coaches, is not tapered, but the arm is cylindrical. It is not long

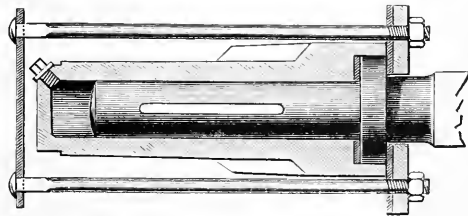

FIG. 13.

enough to extend *through* the hub of the wheel, and it has at the back end a wide collar against which the back of the hub bears. The box in the hub is turned to fit the cylindrical axle-arm, and the two are ground together, or ground by gauges,

so as to fit with accuracy.\* This box is closed at its outer end, and there are neither nuts nor linch-pin. Behind the collar of the axle there is a loose circular plate, called the moon plate, which has been put on *before* the axle is welded together in the middle. Around the edge of this plate there are three holes; three bolts run entirely through the hub from the front and pass through the holes in the moon plate, terminating in threaded ends, on which there are nuts. As will be seen in Fig. 13, these bolts hold the wheel, by drawing the moon plate towards the back of the hub, the collar of the axle being between them, so that the wheel cannot come off unless all three bolts break, and even if the axle breaks, the wheel will not be released unless the fracture takes place behind the collar. For this reason the mail axle is the safest axle in use.

The Collinge axle (Fig. 14), so named from its inventor,

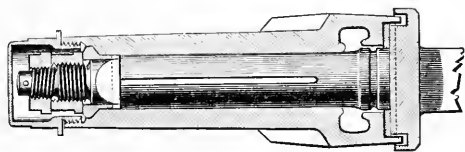

FIG. 14.

was introduced in 1792.† Its arm is also cylindrical and fits accurately to its box. The arm

extends *through* the box and has on its end two nuts having threads running different ways, so that

\* A journal which is an *absolute* fit will not run so easily as one that has a little play both in its diameter and endwise.—THURSTON, *Friction and Lost Work in Machinery*, p. 44.

† It is interesting to note that this axle, first made at a date when

any movement tending to unscrew one will screw up the other. Outside of the nuts there is a small pin passing through the reduced end of the axle, which pin is prevented from coming out by the cap covering it. This cap screws into the *box*, and consequently into the hub, and not on the axle; it turns, therefore, with the wheel. The cap holds about half a pint of oil which slowly finds its way along the arm through shallow grooves made for the purpose. The outward pressure of the wheel is not taken directly by the back of the nut, but by a loose collar, called the collet, which is behind the nut, and prevented from turning by being fitted to a flat place worked on that part of the axle.

The thrust in the other direction is against an enlargement of the arm, a leather washer being put there to regulate the play of the wheel. This washer also prevents the oil from oozing out at the back of the wheel, and the dirty oil accumulates in a recess in the box, made for the purpose.

It will be noticed that both these arms are cylindrical and not tapered; the fit is therefore made by the maker and is not adjustable.

The point at which an axle-arm is most liable to break, is at its back end, owing to the leverage of the wheel being the greatest there, and the diameter at that point must be made proportionate to the

---

mechanical processes were not so far advanced as at present, should have been so perfect that little improvement has been made upon it in a hundred years.

strain. A taper arm can be considerably reduced at its outer end without weakening it and a smaller box and hub can be used ;

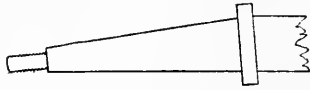

FIG. 15.

for this reason, in light carriages the taper arm (Fig. 15) is generally adopted. One disadvantage of it is,

that the tightness of the wheel depends upon the thickness of the leather washer behind it ; if this is too thin, the wheel may be so shoved up on the taper as to run too tight ; if it is too thick, the wheel will be too loose and will not run true.

With a cylindrical arm, a certain amount of end-play can be given by using a thin washer while the wheel will still run perfectly true. Some coachmen think it well to have this end-play (to have the wheel *talk*, as it is called), thereby avoiding some sidewise shocks from small stones and ruts. A slight end-motion undoubtedly helps to distribute the oil, prevents the arm from wearing in grooves, and is in accordance with the best modern practice in railway and mill work.

There is a parallel or cylindrical arm made, which, to a certain extent, fulfils both conditions, by being tapered in a curve at its back end and parallel throughout

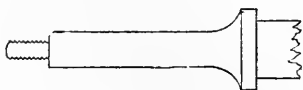

FIG. 16.

most of its length (Fig. 16). The effects of taper and of parallel arms will be further considered when treating of Wheels.

There is some difference of opinion among coaching men and builders as to the relative merits of the mail and Collinge axles for coaches. The usual practice is to put Collinge axles on private coaches and mail axles on public coaches. Owing to the absence of the bolt-heads and the presence of the plated cap, the Collinge axle looks the neater and more finished, and with the use that it gets in private driving, it will run for two or three months without re-oiling. The mail axle is no doubt somewhat safer, but the breaking of the axle close to the back of the wheel, even though the wheel could not come off entirely, would, at any speed, probably cause an accident due to the wheel's being twisted to pieces.

The mail axle requires oiling every one or two weeks, which is not only troublesome, but necessitates the constant unscrewing and screwing up of the bolts, which wears the threads, and ruins them if it is not done with much care. An oil chamber *can* be made in the end of the axle, as shown in the cut of an improved mail axle in STRATTON (p. 454), and in Fig. 13; but it is difficult to fill this chamber, the only way being to pour the oil into the wheel before putting it on, while the cap of a Collinge axle is readily filled and quickly put on, before the oil can run out. Collinge axle-boxes are usually merely forced into the hub and not otherwise fastened; consequently they sometimes work out; this is impossible with a mail axle and is one of its chief

advantages. The fancy of some builders or owners for having a Collinge axle with a sham plate and three bolt-heads, put on over the cap, cannot be commended, since one of the objections to the mail axle is the ugliness of the plate, especially on a private coach.

The present fashion certainly is to have Collinge axles on private coaches and mail axles on road-coaches, and there seems to be no objection to it as a proper distinction ; but the more the coach is used for long drives and fast work, the more reason is there for adopting the mail axle. The fact that a public coach, running at a high speed, a number of miles every day, with heavy loads, requires a much more frequent inspection in all its parts than does a private drag, makes the trouble of frequent oiling of relatively less importance.

It is a mistake to have the axle-arm too small ; a somewhat large hub is not out of place on a heavy vehicle, and the best practice in modern machinery tends toward large rubbing surfaces on all journals, although the resistance to the turning of the wheel due to friction is directly as the diameter of the axle. The value of the oil as a lubricant depends upon its particles remaining in good condition between the rubbing surfaces, and on small surfaces, with heavy pressures, this condition is rapidly destroyed. In any question as to the dimensions of an axle-arm, therefore, the designer should lean toward a large size, both on account of its superior strength and

its lighter running. Two inches is the minimum diameter for a coach axle-arm ; two and a quarter inches is better.

India-rubber bands, or rings, are sometimes inserted between the inside of the hub and the outside of the axle-box, and they undoubtedly lessen the vibrations, but they require a large hub since they weaken a small one, and if a brake is used, they are twisted out of condition, so that they are not adapted to coaches,—at least not to the hind wheels. Since rubber tires have come into use, the rubber-cushioned hubs have been abandoned.

The length of the axle obviously depends upon the distance apart of the wheels ; this distance is called the gauge or track, and is usually measured from centre to centre of the tires, on the ground. It varies from 5 ft. 4 in., in an American Concord coach, to 4 ft. 8½ in., which is given by HARRIS (*Coaching Age*, p. 102), as having been that of the old mail-coaches.

That was probably the distance from *out* to *out*, since it was adopted as the railway gauge, and an Act, of George III., fixes 4 ft. 6 in. as the minimum gauge for a coach from *centre* to *centre*. In the coaches and drags of the present day, the gauge is usually about 5 ft. 1 in. On good roads a uniformity of gauge of the different vehicles used is unimportant, but on the earth roads of America, a carriage which does not fit in the ruts already made, runs very hard. In any one locality, therefore, all

carriages are made to *track* the same, but in different localities this track varies ; for instance, in New York it is 4 ft. 8 in., while in Pennsylvania it is 5 ft. 2 in.

WHEEL.—The wheel is a simple mechanical contrivance for transferring the friction between the moving body and the ground, to a surface which reduces that friction, and also for diminishing the resistance opposed by an obstacle on the ground.

If a weight is drawn along on the ground on a sled, the friction between the runner of the sled and the ground is great, and is due to the roughness of both surfaces, as is shown by the fact that when both are very smooth, as in a steel runner on ice, the friction becomes very small. When a wheel is introduced, as it does not *slide* on the ground, the friction is changed to a rolling friction, and the rubbing friction is transferred to the axle, which can have its surface so polished and supplied with a

lubricant that this rubbing friction is greatly diminished.

As to the obstacle : it is obvious that the wheel has to be *lifted* over it, and the draught, acting in the line

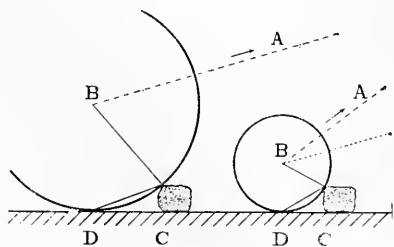

FIG. 17.

A B (Fig. 17), pulls on a bent lever, B C D, raising the weight, which may be considered as concentrated



at D. The longer the arm B C, and the shorter the arm C D, the more easily will the draught raise the weight of the wheel, and for the same sized obstacle the larger wheel will evidently have the advantage.

In the figure, the lines of draught make the same angle with the radius-arm of the lever ; if the lines of draught are parallel, the advantage of the larger wheel is still greater.

There is a limit in practice to the size of wheels, because, if very large, their weight may more than balance their other advantages ; but this will be true only of extravagant designs ; within the usual limits, the larger the wheel the better. The very small wheels sometimes used on pony phaetons are cruel to the horses.

On a road which is level crosswise, the wheel which will run the easiest must be straight, vertical, with a tire at right angles to the face of the wheel, and the axle must be cylindrical,—that is, not tapered,—and horizontal. In other words, the wheel must be a short section of a true cylinder, revolving on a horizontal cylindrical axis. All rolling frames or carriages in ordinary machinery are thus mounted.

In wagon and carriage building, departures from this system have been made for various reasons.

In the first place, it is much more easy to make a wheel fit on a taper axle-arm than on one with parallel sides, since the application of washers behind the wheel will determine how far it may be pushed on the arm and how tight it may be ; while with a

parallel arm the box must be fitted to it with accuracy, requiring very good workmanship and perfect tools, and no adjustment of the fit is afterward possible. The greatest strain on the arm being at the back end, a tapered arm can be made lighter for a given strength.

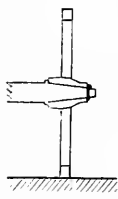

FIG. 18.

With a straight, vertical wheel on a taper arm, the centre line of which is horizontal, the tendency of the wheel will be to run *off*, or against the nut, or linch-pin, while to be safe it should tend to run *on*, or against the collar (Fig. 18).

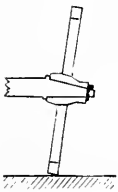

FIG. 19.

To obviate this defect, the taper axle-arms are so set that their undersides are horizontal (Fig. 19).

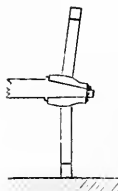

FIG. 20.

This arrangement places the wheels farther apart at the top than at the bottom, and evidently brings a strain upon the lower part of the wheel, tending to push it inward. To provide against this, the wheel is *dished*, so that the lower spoke is always vertical or *plumb* (Fig. 20).

This turning down of the point of the axle is called variously : hang, dip, swing, and pitch.

The amount of dish, is the distance of the front side of the root of the spoke from the face of the rim, measured in the direction of the axle.

This construction of the wheel also strengthens

it, since, owing to the clasp of the tire, the wheel cannot be flattened out by a force acting on the inside end of the hub; but it is correspondingly weak in the opposite direction. Equal strength in both directions can be secured by placing the spokes alternately on both sides of a line around the hub, as is done to an exaggerated extent in a bicycle wheel and to a smaller extent in carriage wheels (Fig. 21). This 'staggering,' or 'dodging,' of the spokes also less weakens the hub.

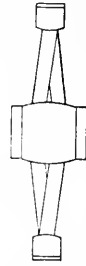

FIG. 21.

The best results would seem to be obtained in heavy work, by using a parallel axle, fitted by the best processes, set very nearly level, with an almost vertical wheel having but little dish.

If a wheel is dished and the axle so set as to give a plumb bottom spoke, the tire, in order to fit a flat road, must be horizontal cross-wise at its bottom point, and must therefore be a section of a cone, the position of the apex of which will be determined by the dip of the axle (Fig. 22). If the tire is not so made in the beginning it will finally wear into that form.

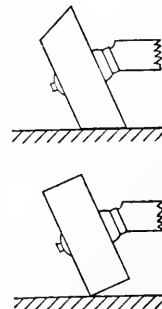

FIG. 22.

Now a cone, or a section of a cone, will tend to roll in a circle, the centre of which is the point at which the apex of the cone would touch the ground, so that if the wheels of a

carriage are sections of cones, they will not tend to roll straight on in the direction in which the carriage is going, but to turn off to the outside, as

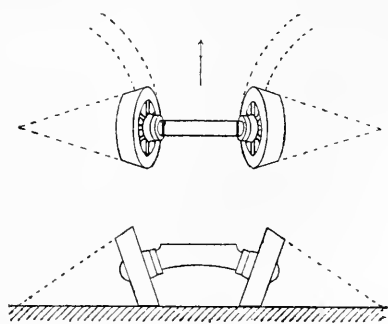

FIG. 23.

shown by the dotted curves of Fig. 23; consequently, they will run against the nuts, or linchpins, and thereby set up a resistance which will increase the draught. In addition to this, the face of the wheel

having different diameters, its parts will revolve with different velocities; and as all parts must move over the surface of the road at the same forward velocity, there will be but one line of the tire that will *roll*, all other lines of the tire being *dragged* on the surface, with a grinding action that destroys the road and the tire, and increases the draught. Some old English wagons are said to have had tires 10 inches wide, and with coned wheels these would grind on the road excessively. It was because, in the last century, all wheels in heavy vehicles were considerably coned, that the road authorities objected to wide tires as injuring the road; wide tires on *cylindrical* wheels are an advantage to a road.

In the figures an exaggerated amount of coning is shown, for clearness, but exactly the same kind

of action takes place in a less degree with a less amount.

We have so far assumed that the road is flat crosswise; the conditions will be changed if the cross section is different.

To take an exaggerated case, such as might occur in a special piece of machinery: the treads of the wheels, and the axles, must be parallel to the surfaces on which they run in order to determine a straight direction, as in Fig. 24; and in the case of a road, the cross section of which is curved, a straight, not a coned, wheel, with the axle bent down so as to bring the tire to bear flat on the road, would be correct. This probably gave rise to the early practice of building vehicles in this manner, but it is obvious that to be correct, the cross section of the road must be the same in all places, which is not likely to be the case.

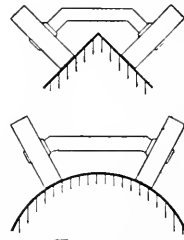

FIG. 24.

All roads are somewhat lower at the sides than at the middle, and when a carriage leaves the centre, it inclines toward the gutter, so as to throw the weight more on the down side wheel and to take it off the higher wheel. The danger always is, therefore, of bending the wheel from its inside outward, but not in the other direction; this is resisted by the shape of a dished wheel, as the hub cannot possibly be pushed through from the back without compressing and shortening the spokes; an

important reason for at least a small amount of dish.

In turning a corner, the centrifugal force acts in the same way upon the outside wheel.

In some heavy vehicles we find wheels made with a slight dish, but fitted on horizontal axle-arms, so that the face of the wheel is vertical, but the bottom spoke not plumb; this dish gives strength to the wheel and is not a disadvantage, since the bottom spoke approaches the vertical when the vehicle inclines sidewise on the down side of the road. On the continent of Europe, this construction is very common in carts, which frequently have wheels 6 feet high.

It must be noted that in a small, heavy wheel the width of the spokes compared with the diameter of the wheel is so great that any line representing a moderate dish falls entirely within the substance of the spokes, as shown by the dotted lines in Fig. 25; such a wheel is therefore strong, although not really dished.

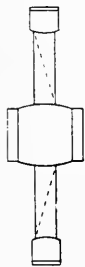

FIG. 25.

'NIMROD,' in *The Road* (1832), prefers straight, vertical wheels, and speaks of the mail-coach wheels as being the best; made with a large nave, every other spoke framed perpendicular to the nave; the others behind the line.

Since these old wheels were made with 'strokes,' and not with hooped tires, a part of the advantage of dishing the wheel was lost. Strokes were tires

put on in pieces and secured by bolts ; they overlapped the joints of the fellies and added to the strength of the wheel, but not nearly so much as does the modern hoop-tire, which is continuous and binds the wheel tightly together. The hoop-tire is made somewhat too small to go on the wheel ; it is expanded by heating, and being then put on the wheel, is rapidly cooled and shrunk by the application of water. A great deal of judgement must be exercised by the smith in this operation with light wheels, as they may have their dish increased beyond the intention of the designer, by drawing the tire too tight. Machines are now made which compress the tire after it is on the wheel without its having been previously heated.

According to CORBETT (p. 28), continuous tires were adopted for the coaches before they were used on the mails. On some of the wide wheels of the old 'stage-waggon,' two widths of strokes were put on with their joints overlapping.

There are many details of the construction of wheels too technical to be entered upon here, but it may be said that there is no good reason for making the tire very narrow on upright wheels, especially as a somewhat wide tire protects the rim of the wheel, which is otherwise liable to be rubbed and scratched. If it projects too much beyond the rim it will cast up the mud. There is no advantage in a narrow or round faced tire on a vertical wheel, but on a coned wheel there is an advantage,

especially on a hard road, inasmuch as the grinding action is less (see page 42). On a soft road, the narrow tire will cut in and cause friction, or adhesion between the faces of the rim and the mud.

The coach wheel shown in Fig. 26, may be taken as a good example, not being exaggerated in any way, having a dish of  $\frac{3}{4}$  of an inch.

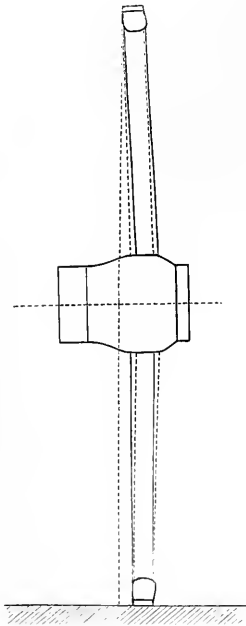

FIG. 26.

There are reasons outside of the purely mechanical questions of draught and strength, which induce builders to dish their wheels and to give them the resulting outward flare. In a brougham, made to a narrow track, the flare of the wheels gives more room for the body, and in all carriages the flare of the wheels throws the mud away from the body. A carriage with nearly vertical wheels will have its panels covered with mud in wet weather. These are good

reasons for the practice in certain cases, but as a question of draught, the horizontal, parallel axles, with straight and vertical wheels, are the best; and on four-horse coaches, the track of which is always wide, a close approach to these conditions is desirable.

In light vehicles the points of the axles are not only turned *down*, but they are also turned a little



to the front ; this is called the 'gather' of the axles. A light axle will spring backward when the draught upon it is opposed by the resistance of the wheel on the ground ; the axle-arms will be no longer in a straight line, and the wheels will not be parallel to each other or to the centre line of the carriage, hence they will run against the nuts instead of against the collars ; and if the axle-arm be tapered, the motion of the carriage causes a pressure against the front side of the taper, and increases this tendency, so that, to counteract it, the gather must be still more increased.

Wheels, when not parallel, will rub sideways upon the road and increase the resistance. When an old carriage has axles badly bent, the wheels may be observed to plough up the mud on the inside of their rims as they move along. Cabs in a crowded city, which frequently have collisions, sometimes have their axles bent back in this way, and it will be seen that their tires are polished from being partially dragged on the surface of the road instead of running with a true rolling motion. In coaches which have very strong axles and parallel arms, the necessity for gather does not exist, and it is not given ; but in overhauling a coach, or in buying one second-hand, it is important to notice whether or not the axles are in the least degree bent backward.

The height of coach wheels varies, in the best examples, from 4 ft. 2 in. to 4 ft. 4 in. for the hind wheels, and from 3 ft. 2 in. to 3 ft. 4 in. for the front

ones. 'NIMROD' gives 4 ft. 8 in. as a usual height of the hind wheels in old coaches. The wheels of an American Concord coach are 5 ft. 1 in. and 3 ft. 10 in. There are usually twelve spokes in the hind wheels and ten in the front wheels, but in the old English coaches there were frequently fourteen and twelve, respectively, and these are the numbers in the Concord wheels.\*

What is now usually called the 'patent wheel,' the characteristic of which is a hub formed by two iron plates applied to the back and front of the spokes, is not particularly new; it is described in ADAMS'S book, published in 1837. It is used extensively on business wagons but not on fine work.

SPRINGS.—Coaches are hung upon what coaching men usually call *telegraph* springs (because they were first used in England on the Manchester 'Telegraph'), but known by coach-makers as platform

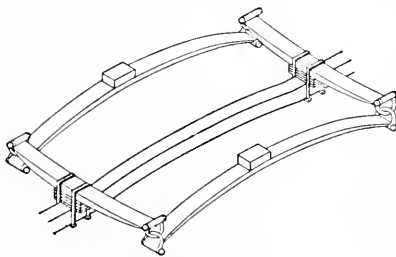

FIG. 27.

springs, which permit the body of the coach to be hung low (Fig. 27).

---

\* The following dimensions of the wheel of a very light, one-man trotting buggy, are given for the purpose of comparison with coach wheels: height, 48 in.; diameter of hub,  $2\frac{7}{8}$  in.; diameter of axle,  $\frac{5}{8}$  in., taper; dish,  $\frac{5}{16}$  in. from outer spoke; swing or overhang of

They are fastened by clips to the transom bed in front and directly to the axle behind, and the body rests upon the centres of the cross springs and is attached to them in the same way.

It will be noticed that the body is attached to the springs at four points only, and that these points are all in the centre line of the coach. This arrangement permits an amount of rolling motion, which would be serious were the springs not stiff, and is an obvious disadvantage, which is, however, more than compensated by the lowness of the body, a greater height of which would increase the liability to roll.

The four springs forming this combination are connected at the corners by shackles, or 'D's,' and in a coach for the road, carrying heavy loads, these shackles should be as short as possible, otherwise the body will sway sidewise too much, and in going down-hill will swing forward, taking the brake away from the face of the wheel, and in going up-hill may move back enough to put the brake-block against the wheel. If they are long, the coach will ride somewhat easier and the body will be lower. These are points to be considered, but, on the whole, it

---

wheel,  $3\frac{1}{2}$  in. ; gather,  $\frac{1}{4}$  in. ; tire,  $\frac{5}{8}$  in. face and  $\frac{1}{8}$  in. thick ; spoke,  $\frac{7}{8}$  by  $\frac{1}{2}$  in. ; rim,  $\frac{7}{8}$  in. The swing given to the wheel is much greater than that called for by the dish, because the axle being light the weight of a man on the centre of it, where the spring is attached, will spread the wheels enough to ensure a plumb spoke with this amount of swing. There are fourteen spokes.

is better to make the shackles short and close, giving them as little play as possible. They should be covered with leather, to prevent rattling.

According to CORBETT (p. 28), the telegraph springs were used on coaches before they were used on the mails, and after the expiration of Vidler's contract in 1836, they were put on the mails, which appear to have been hung originally with a cross spring behind.

Springs are always made of several plates, or leaves, which give more elasticity than would be obtained with one plate of steel of the same strength, and are also less liable to break from a sudden shock or rebound, which is communicated successively to the plates.

The springs are fastened to the bed, and to the body, by clips, which embrace them, so as not to have holes through their centres.

In many business wagons, three-quarter springs, shown in Fig. 28, called in England 'denet springs,'

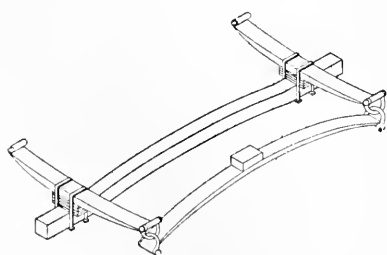

FIG. 28.

are used. The front ends of the side springs are fastened directly to the body, or to the carriage-part, as the case may be, and there are therefore six points

of attachment, four of them so far apart sideways as to resist a rolling motion much better

than when all the supports of the body are in one centre line. Since a backward and forward motion of the body is prevented by the attachment of the front ends of the springs, the brake-blocks will not be carried away from the hind wheels in the way that the movement of the shackles of the ordinary springs permits. This arrangement would be probably an improvement in a road-coach and it is necessary for the hind axle of a break which has no perch, since, when there is no perch, the action of the brake brings a great strain on the elliptic springs.

POLE.—The pole, which fits into the space between the inside futchells, completes the carriage-part.

There is some difference of opinion among coaching men as to the proportions of the pole. It should obviously be heavier for a road-coach than for a drag, and in all cases should be strong enough to bear safely any strain that can come upon it in going down a hill; the best coachman can hardly avoid an accident if, on a steep hill, a pole breaks.

In turning round and getting the coach on the lock, the leaders may pull nearly at right angles to the end of the pole, and if anything breaks at such a time, it is better that it should be the pole than some more complicated part of the carriage, as it is the most easily repaired, or than that the coach should be overturned, as might happen upon side-

long ground. In turning, the bend of a flexible pole will indicate the danger before a break occurs.

Some drag poles are not plated at all on the underside, and some road-coach poles are plated throughout their whole length, which makes them stiff and inelastic. The best way is to plate them for two-thirds of the length, since a fracture will naturally occur near the hinder end, and to use a tough, soft iron, not too heavy, which will bend and keep the pole together, even if the wood is broken.

The places at which a pole is most likely to break, are where it leaves the futchells, or through the hole for the pin, which is just behind that point; and a light plate on each side, extending from the hinder end of the pole to a point ten or twelve inches in front of the ends of the futchells, is of service and prevents the wear of the pole in the jaws of the futchells.

The proper size of a pole at a point two feet from the splinter-bar, is  $3\frac{1}{2}$  inches wide and  $4\frac{1}{2}$  inches deep for a road-coach, and somewhat less for a drag.

The pole goes between the plates which connect the futchells on their under and upper surfaces, and is thus stiffly attached to the fore-carriage. A pin passes horizontally through the futchells and the pole and makes it fast, and, since by it the leaders do their part of drawing the coach, it must be strong. Sometimes a second pin is put in near the hinder end of the pole; a proper precaution against accident.

In the majority of European four-horse vehicles, except in England, the leaders do not draw from the point of the pole, but by means of a chain, or a rope, passing along the underside of the pole, from a hook which is under the futchells. This hook is sometimes put in this place in a coach, to be used in case six horses are driven; but it is not well to have it there, since, should a wheel horse fall and get under the coach, he may be badly torn by the hook.

The length of the pole should be 9 feet from the front of the splinter-bar to the cross-head of the pole-head or crab. If it is longer than this it takes the leaders too far away and impairs the 'smart' look of the turn-out. French carriage poles are usually much too long.

The length given above, for the pole, is proper for sixteen hand, or fifteen-three hand, horses; if smaller horses, or short, cobby horses are to be driven to a drag, an extra pole, two or three inches shorter, should be provided.

When the coach is standing on a level pavement, the end of the pole should be three feet from the ground.

It must be remembered that a short pole requires a longer cross-head, or else the pole-chains will pull too much sideways from the horses' necks. The most exaggerated form of a long cross-head is the yoke of a trotting wagon, which is so long as to make the pole-straps parallel to the pole. There is

a regular pattern of crab, or metal mounting of the pole, which is well adapted to its purpose and should be adhered to. It is shown in Fig. 29, and

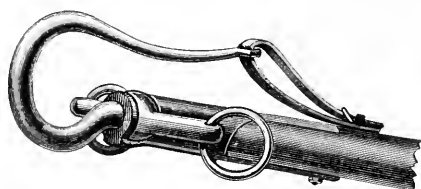

FIG. 29.

consists of a kind of sheath which fits on the end of the pole and is fastened to it by two bolts, which must be strong, since

by them the leaders pull. This sheath terminates in a hook to take the lead-bars. At the root of the hook is the cross-head, which is free to turn upon the stem, and has a ring at each end into which the pole-chains are fastened. The arms of the cross-head should be about six inches long from the centre of the pole to the rings. A strap, attached to the pole, passes through the eye on the point of the hook; it should be strong and always kept in good order, as it may serve to prevent the lead-bars from being jerked off the hook in case of an accident with the leaders.

In many French four-horse vehicles, the hook is *under* the pole; but this is not a good arrangement; the bars are liable to come off unless the point of the hook is fastened by a screw to the pole, which is troublesome.

The whole pole-head should be of the best steel, highly polished. On a road-coach it is usually painted black, but lately, on some road-coaches,



especially in France, it is bright, as on a drag. This looks much better, and it is really but little more trouble to polish it than to keep revarnishing it. On a long route, however, and in bad weather, the bright steel becomes tarnished toward the end of the day. Of course, the chains must correspond to the pole-head, and it is more trouble to varnish them than to brighten them by shaking in a bag. In old road-coaches the chains were usually made fast to the pole-head, as they now are on farm-wagons, and they had to be blackened.

Pole-heads, chains, or lead-bar fittings, should always be of bright steel, never plated with silver or with brass. The plating soon wears off at the rubbing surfaces.

Road-coaches, or private coaches on long trips, sometimes carry a spare pole made in three pieces to screw together, the joints being strengthened by collars which slide over them. This pole is strapped to the perch. Its head is of a simple form and painted black.

LEAD-BARS.—The lead-bars are made after one regular pattern. Fig. 30 gives a better idea of them than any description can give. They should be rather heavy than light. The main bar is 3 ft. 4 in. long; the single bars are 2 ft. 11 in.

The D fixture on the main bar is better than the eye fixture shown alongside of it. It is somewhat the fashion to use the eye for drags and the D for

road-coaches, but the objection to the eye is that, on account of its small size, it may get caught

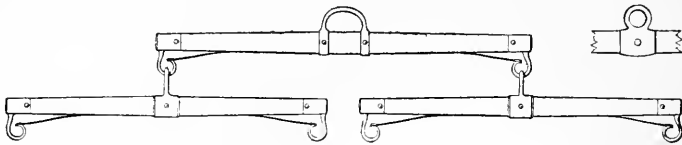

FIG. 30.

sideways on the hook and twist or break it. This cannot happen with the D.

On the other hand, the D, having much more play, is more noisy. This is a slight objection, and at night it is an advantage, since the coachman can tell by the 'chatter of the bars' whether or not his leaders are working, since there will be no rattle if they are pulling. The D is, therefore, recommended for both drags and coaches.

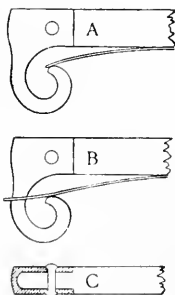

FIG. 31.

The fixtures of the single-bars have eyes set at right angles to the bars; these eyes hook on the ends of the main-bar, and there are springs which prevent them from becoming unhooked. These springs are usually made as shown at A in Fig. 31, but a better method, devised by BREWSTER & Co., is to have the end lengthened into a loop, which surrounds the stem of the hook as at B, so as to keep the fitting from coming off should it be-

come loose. These springs were comparatively new in 'NIMROD's' time. (MALET, p. 348.)

The fittings of the bars are usually secured by screws, and the bars should be always put on with the screw-heads *up*, so that the loss of a screw will be noticed. It is, however, much better to have the fittings secured by bolts which go entirely through them, as at C, and are riveted, so that they cannot possibly come off.

A dangerous accident, which not infrequently happens, is to have the fitting on the end of the main-bar come off, which lets the single-bar drop on the leader's hocks and may cause even the quietest horse to kick; therefore the method of fastening the fittings with bolts should be insisted on. It is not so important for the centre fittings, since their coming loose cannot do much harm.

A single link, or three or four short links, of steel are sometimes used to connect the inside hooks of the bars.\* This should never be done, as in the event of a horse kicking and getting his leg between the main-bar and the single-bars, it is almost impossible to release him, and great damage may result.

Such an arrangement is useless, at any rate, but if, for any temporary reason, it should be desired, merely a strap, which can be quickly cut, should be used.

---

\* This is as old as 'NIMROD's' time. See *Essays*, MALET, p. 191.

An extra main-bar and one extra single-bar are carried on the back of the rumble. They are usually strapped on as shown in Fig. 32, but they

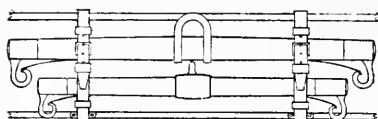

FIG. 32.

are sometimes held in steel spring-racks. Straps are better; the steel springs are difficult to clean and the bars sometimes shift

sideways in them. The extra bars should be always taken off when the coach comes in; else they will harbour dust and soon get rusty.

The lead-bar has sometimes been made in one piece (Fig. 33), which is objectionable, not only because



FIG. 33.

it does not permit the free action of the horse's shoulder, but because, if one horse is

more free than the other and works in front, the bar is oblique, and each horse has his collar pulled sideways on his neck, which is certain to cause sore shoulders.

The mails in old times carried this single-bar with four hooks on it, as a spare bar in case of breaking the lead-bars. ('NIMROD'S' *Essays*, MALET, p. 190.)

A method of rigging the lead-bars, frequently used by Italian and Swiss *vetturini*, is well adapted to the temporary conversion of a two-horse carriage into one for four horses. A rope is attached to the centre of the front axle and carried along

the under side of the pole, from which it is suspended at intervals by straps (hame-straps, for

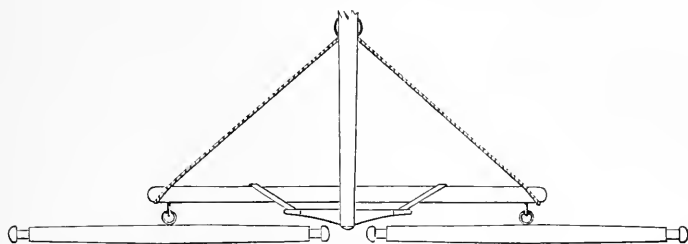

FIG. 34.

instance). About two feet behind the point of the pole, this rope is attached to the centre of a somewhat lighter line, the two ends of which are made fast to a bar, 3 ft. 9 in. long, corresponding to the main-bar. To the end of this bar are attached the single-bars. The main-bar is held up by straps, like light pole-pieces, from the pole-head. They may go to the end of the bar or can be made fast nearer its centre. The short bridle of the main-bar can be replaced to advantage by a chain.

For three horses the lead-bars are made as shown in Fig. 35. The long arm of the main-

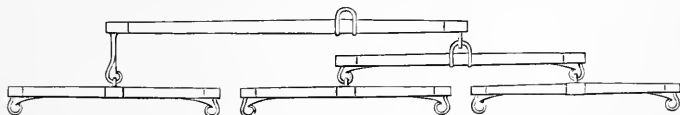

FIG. 35.

bar is twice the length of the short arm, so that all three horses do an equal share of the work.

The steel hook of the bar of the single horse is long enough to bring his bar out to the line of the other bars. This is a common arrangement in three-horse ploughs.

## CHAPTER IV

## BODY

THE bodies of coaches are essentially the same, but builders vary them sufficiently to make noticeable differences in their proportions, as can be seen by comparing the plates of coaches in the present volume by detaching and superposing, the sheets of transparent paper upon each other, or upon the plates, which are all drawn to the same scale.

The average length of the body is 4 ft. 10 in., the width 4 ft. 0 in., and the height 4 ft. 2 in. The extreme lengths, as shown in the drawings, are 4 ft. 11 in. for the longest, and 4 ft. 8 in. for the shortest; these are outside dimensions. The dimensions within these limits are, to a certain extent, a matter of taste, but extreme shortness should be avoided, since it leads to a short coupling in the under-carriage, which is objectionable. The body should be made as light as is consistent with strength, so as to keep the centre of gravity of the whole coach low. Its weight is usually rather more than half that of the whole coach, the irons and cushions of the roof-seats being included. The roof is very nearly flat, so that the seats can be adapted to it, and for convenience in carrying bag-

gage. The sides are moderately curved in both directions, or have, what coach-makers call the 'cant' in the horizontal direction, and the 'turn-under' in the vertical direction.

The 'Wonder,' a coach much admired on the Shrewsbury road in 1825, built by WAUDE, is said to have had perfectly flat sides.\* A body looks 'smarter' if it has not too much curve. The bottom line of the coach should be between the extreme boat curve and the nearly straight, side and bottom lines, connected by short curves.

The doors of the body are hinged on the *front* edge, unlike the doors of broughams or landaus, so that if they are left open by accident they will swing shut on starting. They have solid, or stable, shutters in addition to the usual glasses, and there should be some way, on the inside, of fastening them up by buttons, or by pulling up the inside glasses tight against them, so that they cannot be pushed down from the outside in case it is desirable to lock up the coach. For the same reason, the doors have locks, which work with a key; in addition to the usual latches.

The inside of a modern road-coach body is usually not lined, but finished in hard wood, and it has cushions only. Old road-coaches were comfortably stuffed and lined inside and had arm-straps, as the inside places were the highest priced.

---

\* *Old Coaching Days*, p. 37.



A drag is plainly lined, and there is nothing more stylish for the purpose than a very light drab cloth. There should be straps of some kind on the under side of the roof to hold hats or any similar light things. It is a serious mistake to make the inside of a coach so low that a man cannot sit in it with his hat on. When a full load is on a drag, the servants have to go inside, and, apart from the question of their comfort, it does not look well to have the men sitting bare-headed; and if they are required to get out, they should be ready to do so quickly, and not have to wait to put on their hats. For this reason the height from the top of the wooden seat should be not less than 3 ft. 8 in. This will admit of a cushion 3 inches thick, and will give a height of 3 ft. 5 in. from the top of the cushion to the under-side of the roof, which is enough for a tall man with his hat on. If the top of the wooden seat is 12 inches above the centre of the floor, the whole inside height will be 4 ft. 8 in. This is apparently greater than the outside height of the body given in the beginning of this chapter, but that is because the floor drops *inside* as low as the bottom of the rocker.

Many of the road-coaches in England in the early part of this century were uncomfortably low, and there has been a disposition to copy them in modern drags.\*

---

\* 'The inside of the coach was very small. E. had to sit without his hat, and he is not particularly tall.'—Extract from a private *Journal of Travel*, in England in 1835.

BOOTS.—The boots are constructively a part of the body; they vary considerably, being made more or less deep according to the taste of the designer; shallow boots give a poor air to a coach, and it is better to err on the side of depth. Their distance below the top of the body should be such as to give comfortable leg-room to persons sitting on the roof-seats, and for that 16 inches is right. This is from wood to wood, and does not count the cushion. The hind boot is about 2 feet long, the front one 3 feet, and both are about 2 feet deep. The front boot should be from 1 to 2 inches higher on the body than the hind boot, as that always gives a 'smarter' appearance, and prevents the appearance of the coach's hanging down in front, when the back seats are not occupied. The front boot slopes backward from the root of the foot-board, usually about 7 inches. This may be varied, but it must not be so straight that, in the motion of the coach, the boot will touch the inside roller-bolts, which may happen if the spring-shackles are long. The boots are 4 inches narrower than the body. There is an opening into the front boot from *above*, and the front part is usually hinged at the top so as to turn up. This door must *never* be hinged at the *bottom*, else it may fall open and, striking the horses, occasion an accident.

In a road-coach the front of the boot is generally entirely closed, and it is sometimes covered with iron to prevent a kicking wheeler from knocking it

in ; in this case the boot is accessible only from the top by lifting a flap which is under the feet of the persons sitting on the box-seat. While, on the score of safety, it may be well to make a road-coach boot in this way, it is so exceedingly inconvenient for a drag, that it is better to have a door, but *always* hinged at the top and with a lock, or still better two locks, that can be trusted to hold. On a race-course, for instance, the hind boot is full of the lunch-boxes, or should, at any rate, never have anything dirty put into it, the horse clothing and halters must be in the front boot. It is difficult for the grooms to get out these articles through the small opening in the top, under the feet of the person, sitting on the box-seat ; but after the horses are taken out, the front of the boot is quite accessible if it has a door.

The boot may be made accessible from the inside of the body, the opening being closed by the back of the front seat, which is hinged or made to come out altogether. In old travelling-carriages this arrangement was frequently used, to permit a bed to be made inside of the carriage, the feet of the person lying on it, extending into the boot.

A coach was designed by Mr W. G. TIFFANY, and built for him by PETERS of London, in 1868, in which the *sides* of the front boot turned down, being hinged near the bottom edge, one of the steps serving as a handle to the lock, and so arranged that the door could not be opened unless the step were

turned edgewise, which would prevent any one from stepping upon it unless the door were fastened. A second coach, with the same kind of boot, was built by LAURIE & MARNER in 1873, and both were used on the London and Brighton road by Mr TIFFANY in 1873.\* This arrangement is perhaps somewhat complicated, but it is one way out of the difficulty and gives convenient access to the boot.

It may be said that while in a road-coach (where horse cloths, or anything else, may be put in the hind boot) the front boot should be solid, the front boot of a drag may have a door well secured.

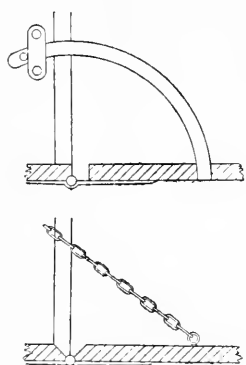

FIG. 36.

The hind boot of a drag has its door hinged at the bottom in such a way that, when it is open and horizontal, its inner surface is level with the bottom of the inside of the boot. If it is higher, the boxes which belong in the boot will not slide out over it unless it is put down altogether. This door should have iron quadrants, or chains, which hold it when open, in a horizontal position, so that it serves as a table for serving lunch (see Fig. 36).

---

\* The 'PETERS' coach was built for Mr TIFFANY to take to Tunis, and the seats were covered with pigskin, the first time that this material was used for that purpose.

If the door is not hinged so as to be fair with the bottom of the boot when horizontal, it may have a chain and hook, as in a dog-cart, so that it can be let down entirely in order to get out the boxes, and afterward hooked up.

The door of the hind boot of a road-coach is hung, not at the bottom, but at the off side, so as to be easily opened by the guard to take out parcels; unless, however, a coach is built *especially* for a road-coach, it is better to hang the door drag-fashion, and the coach can then serve both purposes.

In some of the old road-coaches, a rack on which additional packages could be carried, was fitted behind the rumble, and it was placed even as low as the bottom of the boot, in which case the boot was opened at the top, as was also the case for security in the mail-coach.

BOX AND DRIVING SEAT.—On the front part of the front boot is placed the driving-seat. In all coaches it is supported by solid ends, or risers, and has a board running crosswise under it, so as to close the space entirely. The top of the bench is flat, and the proper shape of seat for the coachman is made by the cushion. The best form for this cushion is shown in Fig. 37. It may

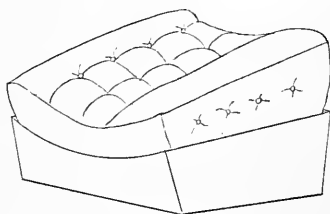

FIG. 37.

be entirely stuffed, in which case it is fastened on by two straps which cross on top of it, or it may be made with box sides and back, like the driving cushions of a landau or of a brougham, and fastened to the seat by a strap underneath. The former is the old-fashioned coaching style. The seat should not be too flat, nor should it be as steep as it is sometimes made, so that the coachman rather leans against it than sits on it, a point that will be referred to when treating of the Position on the Box. On a road-coach there is usually a pocket on the near side of the cushion. The iron rail on the off side should rise above the cushion, to prevent the coachman from being thrown off by a violent jolt. The box-seat has a back which does not extend behind the coachman's cushion. It is sometimes curved, as shown in Plates VII. and XIX., but this is no improvement. It is frequently so made that it can be taken off, in which case, it should be, when in place, strapped tightly, otherwise it may yield to the pull of a passenger who takes hold of it in getting up or down with the risk of giving him a fall. It is better to have it a fixture.

Attached to the upper front edge of the boot (Fig. 38) is the footboard, the angle of which is of great importance. An angle of 33 degrees with the horizontal is the best.

Too large a footboard is uncouth; in the old mails it was both short and narrow, so that the

traces could be readily seen by the coachman. It should be large enough 'fore and aft' to keep the toe from projecting beyond it, but no larger; 24 inches from a vertical line touching the front edge of the cushion is correct.

A foot-board which is narrow, from right to left, permits the coachman to see his

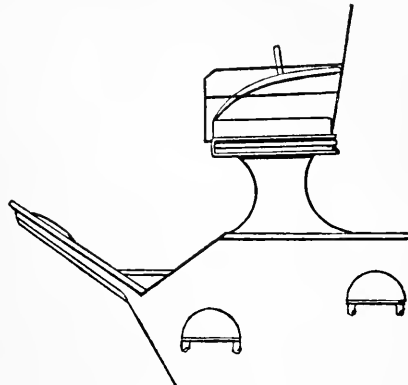

FIG. 38.

horses better than if it is too wide; and as the passengers do not want to walk about on the foot-board, there is no reason for making it more than 46 inches wide, on any coach.

On the hind boot is placed the rumble (Fig. 39), which, in a drag, is a seat for two servants. It is supported by irons at its ends, and is entirely open underneath. It should be 44 inches long, which length does not make it look out of proportion and will give room enough for three slender persons, which is sometimes very convenient with a full load on top, as for a picnic or

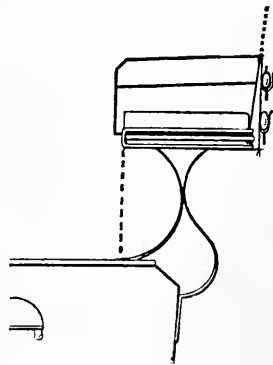

FIG. 39.

paces. It should have a lazy-back, which can be put on when it is used in this way, and there should be also a valance of patent leather, which can be buttoned on the front edge of the seat. These are shown by the dotted lines of Fig. 39. When the grooms occupy the rumble, neither the back nor the valance should be used.

On a road-coach the rumble is supported by a solid bench like that of the driving-seat; the board

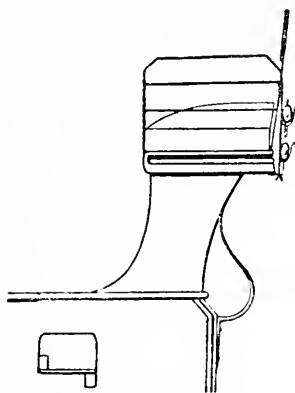

FIG. 40.

at the back joins the boot at its upper angle, and the seat is 60 inches long, so as to hold three persons comfortably. On the near side is a cushion (a couple of inches higher than the cushion of the other two seats) for the guard, which ensures him his proper place and enables him to see over the heads of the passengers.

Sometimes a road-coach has a rumble long enough for four persons, but it gives a clumsy air to the coach. This seat has a permanent back.

A strap with a loop should be fastened to the underside of the back roof-seat, on the near side, half-way between the centre and the end, so as to come between the end passenger and his neighbour, by which strap the guard can steady himself when standing up to sound the horn.





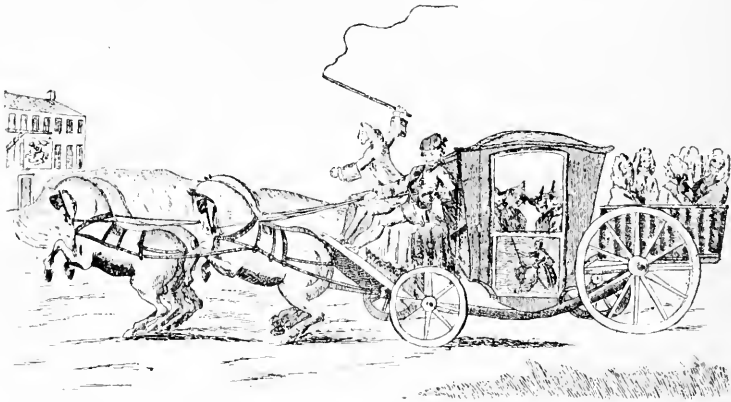
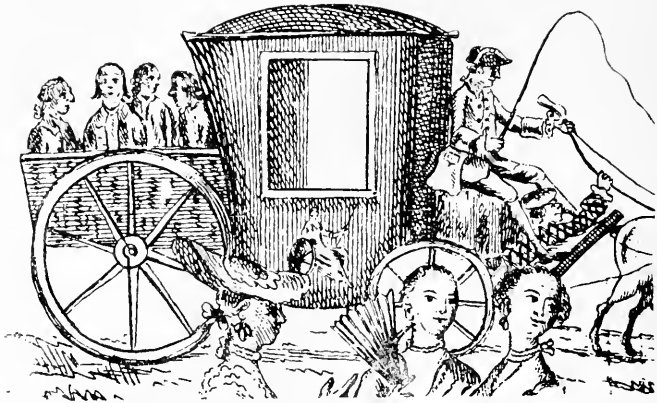

Print-types from etchings in a pamphlet called *The Coach Drivers, a Political Comic-Opera &c.* London. Printed for M. Fleury, opposite Gray's-Inn Gate, Holborn, 1766.

They show persons in the basket and also a man in the front seat.  
 • And look at Hawney in the foot conceal'd  
 • Who by his outstretched arm is quite reveal'd.

p. 25, l. 68, 69.

In carriages of the seventeenth century, in addition to the four people who sat inside, two more persons, usually pages, or persons of lower rank, sat sideways in the door-ways, facing the side of the road, with their legs in a kind of box built out from the side of the carriage and not unnaturally called a 'boot,' and when what we now call the 'boots' were added to a carriage, the name went with them. The front boot, which was the support of the driving-seat, must have had a closed top, but in a road-coach, the addition behind was originally a *basket*, open at the top, fastened upon the hind axle, in which packages and passengers were carried. If the passengers could do so, they sat down, but if there were too many of them for this, they stood up, and in cold weather the basket was half full of straw to keep their legs warm.

This basket is shown in Plates I., IV., V., and VI. ;\* it was later replaced by a wooden box, open at the top; this was afterward closed at the top, the passengers sat on it, and it assumed its present form. In the early coaching books we read of persons *in* the hind boot.

In CROSS, vol. ii. p. 6, we read: 'Now the guard

---

\* In a plate published by EDW. ORME, Bond Street, London, in 1816, of 'The Ghent and Brussels Diligence,' there is shown a basket behind, another on the top, and another for the box-seat. The coachman is on the roof, his reins passing over the heads of the persons on, or *in*, the box. The flat, shallow basket is still seen on the roof of broughams fitted up for station work.

‘had taken up two soldiers on the road, and from ‘good feeling, as I thought, had, not long before we ‘stopped, put them into the hind boot and covered ‘them up—the boots in those days being very capa- ‘cious and opening at the top.’ This happened in January 1814. The guard’s object was, of course, to prevent the proprietor from knowing that he had carried the soldiers free, or else had pocketed their fares.

Again in CROSS (vol. ii. p. 81), we find as follows, where an old coachman is speaking of sailors just paid off, travelling by the Portsmouth coach: ‘We ‘used to set ‘em a-fighting in the rumble-tumble, ‘when they’d be sure to drop something worth ‘picking up.’

The whole hind boot seems to have been called the rumble. The name is now applied only to the seat.

Some of the older coachmen called it the ‘dickey’ (CROSS, vol. iii. p. 128), but that name is now applied to the driving-seat of a carriage.

ROOF-SEATS.—In the very old coaches (Plates V. and VI., HOGARTH and ROWLANDSON) there were no seats on the roof, but passengers frequently sat there, clinging on as they best could. Seats were afterward added in the form that we have them now, and finally, so many accidents were there from top-heavy coaches, that a certain Mr GAMMON procured the passage of an Act of Parliament, in 1788, prohibiting coaches from carrying

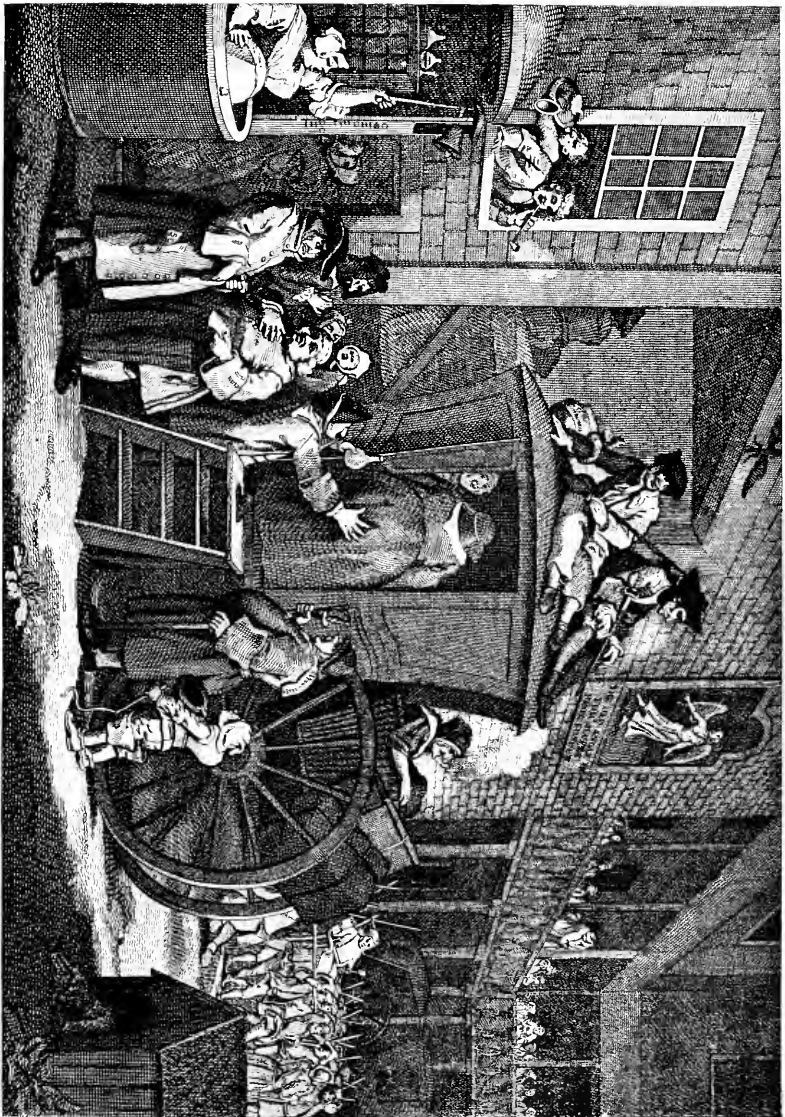

STAGE-COACH IN INN YARD AT ELECTION TIME. FROM A PRINT OF HOGARTH'S. 1747.

PLATE V.



more than six persons on the roof and two on the box beside the driver.\*

The roof-seats, therefore, did not extend much beyond the edge of the roof, but later they were lengthened so as to hold four. These roof-seats are sometimes called the 'gammon-boards,'† obviously from the name of the author of the Act.

In the present coach, the roof-seats are fastened to the roof, with their edges fair with the front and back parts of the body. To carry four persons with comfort they should be 6 feet long, and their length may be practically increased without adding to their apparent size, by bending the side irons outward, six inches being thus easily added.

The mail-coaches had no hind roof-seat and carried only three on the front roof-seat, and down to 1870 drags usually had seats long enough for only three, and extending slightly beyond the edge of the roof. These seats are now uniformly made to hold four; and while the width of the load on top does undoubtedly detract somewhat from the 'smart' appearance of the coach, the additional accommodation more than makes up for it, and when only three people are up, they have a comfortable abundance of room and do not make the load look really much wider than if they were crowded together.

---

\* *Brighton and its Coaches*, p. 25.

† 'NIMROD,' *Road*, p. 17, calls the hind roof-seat 'the gammon-board.'

The roof-seats have backs, which, on a drag, are covered on both sides with patent leather; on a road-coach, with the same covering as that on the seats. On a drag, the standards should be hinged just above the cushion, so that they can be turned down when the seats are not occupied,—which should always be done. On a road-coach, the standards are usually fixed.

On a roof-seat for four, the outside persons have their feet partially unsupported, and on road-coaches it is usual to extend a board on both sides so as to provide a footing. It is rather clumsy and very much in the way in getting up, and is commonly omitted in drags or made very small.

As the roof-seat is usually somewhat high for a lady, it is well to have two boxes to fit on the top of the boot, as shown in Fig. 41, so made that



FIG. 41.

they cannot readily slip off, and yet can be pushed sideways to accommodate the persons sitting there. If two ladies are in the middle, the boxes can be put close together, so as not to occupy the whole foot room. A similar arrangement is convenient for the box-seat. Carpet foot-stools serve the same purpose, but they are always slipping about, falling off, and getting lost.

The tops of the boots and the foot-board should be covered with perfectly plain, single-coloured oil-cloth, kamptulicon, or india-rubber. The foot-board sometimes has, in addition, a perforated india-rubber



mat, which must be firmly fastened on, since accidents have happened from its being pushed off by the feet and frightening the wheelers by falling on their backs.

On some road-coaches running out of London, there is a seat for three persons on the middle of the roof,—‘the knife-board,’—but it makes the coach top-heavy, and is a dangerous arrangement not to be commended.

#### PAINTING AND LETTERING

Coaches are usually painted in two colours; the colour chosen for the body is on the quarter panels, the whole of the door, and the panel of the hind boot.

The colour of the carriage-part is on the risers of the box-seat (also on the risers and panel of the rumble, in a road-coach), the underside and edge of the foot-board, and on any portion of its upper surface not covered with kamptulicon, on all the carriage-part including the springs, and on the long rocker-bed which runs under the body and really forms a part of it.

The upper panels, the sides of the boots, the front of the front boot, and the roof, are always black.

All iron-work not *on* the wood, such as the standards of the rumble, steps, seat-rails, roller-bolts, hub-bands and plates, shoe, chain, and ladder, is black. To this rule, the springs are an exception,

but their shackles are usually black, or are covered with black leather.

The rule of painting the panel of the hind boot the same colour as the body is not invariable; it is frequently the same as the colour of the carriage-part, as in the mail-coaches. The choice of the colour is somewhat a matter of taste, depending on which colour will look the best when the coach is seen from behind. If the body-colour is *light*, it is put upon the panel; not if it is *dark*.

A road-coach usually has no striping. A drag may have striping, preferably black, at the root of the spokes, on the rims of the wheels, round the doors, and on the box-seat risers, and a lined panel on the under side of the foot-board. The corners of the wood-work of the carriage-part are sometimes moulded and striped; in this case some of the bolt-heads and clips are black.

The only other ornamentation on a drag is the monogram, or the crest, of the owner, painted on the crest-panel (which is the narrow panel under the window), and the devices of any coaching clubs to which the owner may belong, which are painted on the door under the crest-panel, and in the centre of the panel of the hind boot; or the crest, or monogram alone, may be there.

A road-coach has painted on it the names of the places between, and through which, it runs.

The names of the two ends of the route are on the panel of the hind boot, the more important

one *first*;\* for instance, 'London and Brighton' in three lines, the 'and' being in letters; not the sign &. On the boots, near the lower edges, are the names of places on the road. On the crest-panel of the door are the same names as on the hind panel, but without the 'and.' Sometimes the name and address of the proprietor are on the crest-panel; during a certain period in the old coaching days this was required. On the risers of the driving-seat and of the rumble, are the names of the offices or inns at the ends of the route. For instance, the Paris and Poissy coach has 'HERALD OFFICE' on one riser and 'HÔTEL DE L'ESTURGEON' on the other.

The name of the coach is in large letters on the back of the rumble.

Colonel KANE'S New York and Pelham coach had on the crest panels HARLEM  
UNION—PORT on the near side, and MOTT—HAVEN  
PELHAM—BRIDGE on the off side; and on the riser of the box-seat, the name of the coach 'TALLY-HO' with a Maltese cross above it. There was 'NEW YORK AND PELHAM' on the hind boot panel and no names on the boots. The lettering was in gold and black,—the coach being yellow,—and was very quiet and in good taste.

Some coaches, both in England and in France, have names of places on the lower panels also of the body, near to and following, the curved lines

---

\* This rule was not universal in the old coaches; in many of the old prints the name of the less important place comes first.

of the panels ; but this is, perhaps, putting too much on the coach. Sometimes a device, such as a comet or a meteor, suggestive of the name of the coach, is painted on the upper panels, but there is never any lettering there.

In the old coaching days, the name of the principal place to which the coach ran, was often painted on the under side of the foot-board, so that the coaches, when standing under a shed at a large coaching inn, could be readily distinguished ; or else the name of the coach was there painted, a fashion which has been copied in the mail-coaches recently built in Paris.

The mail-coaches in England were all painted alike ; the under-carriage red, the body a maroon or claret colour. On the side of the front boot was the cipher G.R. or V.R., of the sovereign, in large interlaced gold, script letters ; on the side of the hind boot the number of the coach (*N<sup>o</sup> 2*), in similar letters. On the crest-panel, which was deep, were the names of the towns between which the mail ran, and the words 'Royal Mail,' in gold. On the four black panels were the stars, of the Thistle on the near side, and of the Bath on the off side, of the front boot ; of the Garter on the near side, and of St. Patrick on the off side, of the hind boot ; on the doors the royal arms ; on the hind boot panel the names of the places between which the mail ran. On the iron legs supporting the guard's seat on a mail-coach, there was

no place on which the name could be painted, and while some of the mails had names, many of them had none.

In MALET'S *Annals of the Road* there is an admirable drawing, in colour, of a mail-coach, which distinctly shows all these details, and in the same book there is a drawing of a stage-coach with body and carriage-part painted the same colour.

The colours of the mail-coaches have been adopted by the Reunion Road Club of Paris, and all its coaches are painted maroon and red, with the *red* on the panel of the hind boot.

## CHAPTER V

## ACCESSORIES

**BRAKE.**—Coaches are now always fitted with a brake, consisting of blocks which can be pressed against the tires of both hind wheels. The blocks are fixed to arms projecting from a horizontal shaft which runs across under the body of the coach, turning in suitable supports or brackets fastened to the underside of the body. An arm projecting upward from this shaft, passes into the body and is pulled forward by a rod leading from the front boot and connected with the handle of the brake, the upper end of which is on the off side of the boot.

Every maker has his own way of carrying out these details, but that arrangement in which only the upper part of the brake-handle is visible from the outside is the neatest.

The block which rubs against the wheel may be made of iron, or of wood covered with some material, or of wood alone. Iron is the least satisfactory, because it does not take a good hold of the wheel, and because it frequently makes a noise; it lasts, however, a long time. Wood covered with leather holds well, but the leather requires frequent renewal and is almost always ragged and torn.

The best leather for this purpose is old belting, which is flat and somewhat oily. Pieces of old india-rubber tires, fastened on a wooden block, are much used by French builders and make a good brake ; this is shown in Fig. 42. The best material, however, is a tough wood, like chestnut, used alone ; oak is too hard and squeaks almost as loudly as iron. The soft wood wears, but it can be easily replaced. The arm should terminate in an iron socket, of the form shown in Fig. 42, the hollow being somewhat smaller at the bottom than at the top, and the block being made to fit it. A dozen blocks can be made at a time by any carpenter, and kept ready for use. When a block is

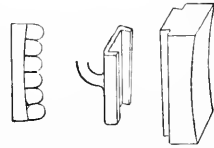

FIG. 42.

worn, it can be knocked out by a blow from below, and the new block dropped into its place ; no other fastening being necessary. Of course, both blocks should be renewed at the same time, so that they shall bear equally on both wheels.

Blocks of this shape in solid rubber can be bought ready made, from the manufacturers.

The handle of the brake moves past a toothed rack, and when the block is pressed against the wheel, a sharp projection on the side of the handle engages with one of the teeth and holds the brake against the wheel. To release the brake, the handle is pushed outward, its length giving it enough spring for that purpose, and the projection

is disengaged from the tooth. The shape of the teeth of the rack is important. If they are too square, as in A, Fig. 43, the handle will jump out with the shaking of the coach; if they are cut back too much, as in B, it will be difficult to disengage the handle. This should be carefully looked to in a new coach, since either fault is serious.



FIG. 43.

There is a difference of opinion among coaching men as to whether the brake-handle should move forward or backward to put on the brake. Fig. 44 shows the two arrangements. In A, the handle, when the brake is off, is far forward and

down; to reach it, the coachman must lean forward somewhat, but he can exert a great deal of

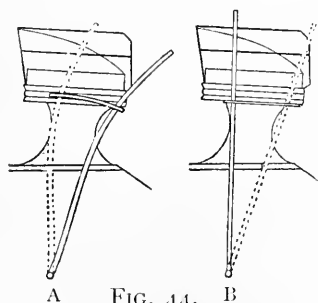

FIG. 44.

force upon it as he pulls it back. In its off position it is much in the way in getting up and down. If it is placed further back to avoid this difficulty, the arm of the coachman, when he has the handle nearly back, and needs to

exert the most power, is in the worst position for so doing. If the handle works by pushing instead of pulling, as shown in B, it is always out of the way, and in putting on the brake, the coachman has to exert the least force when the handle is first



moved ; as he requires to exert more force, his arm is constantly getting into a better position to do so, and during the whole operation, the body is much less disturbed,—an advantage when it is remembered that all movements in driving should be as little noticeable as possible. I prefer decidedly the brake which works forward, and many brakes are now made in that way, but the advantages seem to be somewhat evenly divided.

The handle should be flexible sideways, enough to enable it to be pushed off by pressing the outside of the right arm against it.

The brake-blocks should be applied to the front of the wheel, because the rod running to them is thereby shorter and consequently lighter, and because if applied to the back they will work up out of the sockets by the action of the wheel, unless the sockets have their large ends down, in which case the blocks will drop out if not fastened. The brake should be applied at a point of the tire level with the axle. If it is not exactly at that point, it is better to have it a little below it, so that when the brake is put on, the springs of the coach will help to keep up the pressure ; whereas, if it is above the line of the axle, every time that the body of the coach jumps up, on a rough hill, the pressure of the brake will be for the moment diminished.

It was a long time before the brake, which was first used on the Continent, was adopted in England, the older coaches having the shoe only, but in

America it was used early in this century on heavy wagons, and was worked by a handle at the back by the wagoner, who was on foot.

The majority of Continental carriages and coaches have a wheel by which the brake is applied, but it is too slow in its operation, requiring several turns, and therefore is not nearly so good as the direct acting handle, and, moreover, it is frequently so placed that the coachman has to stoop, or to lean sideways to take hold of it, which is objectionable, since he should not change his position on the box.

The brake is also sometimes so arranged that it can be worked from the back of the coach by a groom, as well as from the front ; but this is entirely unnecessary, since the coachman should be competent to work the brake himself.

Paris omnibuses use the 'LEMOINE brake,' which is worked by the hind wheel itself. On the inner end of the hub of this wheel there is a flanged pulley, round which a hemp cord is passed three or four times. That part of the cord which is on the lower side of the hub is attached directly to the ordinary brake ; the other end passes to a foot lever at the coachman's seat. As long as the cord is slack, the pulley runs round inside of it freely, but as soon as the forward end of it is tightened by the coachman, the pulley winds up the cord and puts on the brake with great force. The cord, on the side against the pulley, is lined with blocks of wood or leather. It is useful in crowded streets, and it has been applied

to some coaches, but is so rarely needed, that it is an unnecessary addition.

In the American (Concord) coach, the brake is worked by the foot, and there being no rack to hold it, the continued pressure of the foot is necessary to keep the brake on. With this arrangement the driver is able to increase or diminish the pressure in crossing the many catch-water banks which are met with on American hilly roads. In some late English coaches there is an arrangement by which the brake can be put on by the foot, the handle at the same time moving back and engaging in the rack. It is disengaged by the hand in the ordinary way. This does very well for an omnibus, which has to stop frequently in crowded streets, but it is certainly not necessary on a coach; as has been pertinently said by an eminent coaching authority, 'let the coachman drive with his hands and not with all fours.'

A left-handed coachman may have his brake-handle at his left side, between his cushion and the box-seat.

Even with a brake, the coach should have a skid or shoe, to carry one wheel, on a hill that is too steep for the brake alone to be depended on. The skid should have continuous sides, as in Fig. 45, and not merely four lugs standing up, as in Fig. 46, since a skid of the latter form is much more apt to come off of the



FIG. 45.

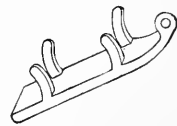

FIG. 46.

wheel. The bottom of the skid is usually made not much wider than the tire, but it is better to have a light plate, at least 6 inches wide, welded \* to it, as this tears up the road much less ; the underside of the plate should be rounded up along all its edges.

A strong chain attaches the skid to the centre of the front axle, and is of the proper length to keep the skid vertically under the centre of the wheel when in use. It is better to have the chain an inch too long than an inch too short, in order to prevent the skid from coming off of the wheel. A hook, large enough to hook round the rim of the wheel (Fig. 47, A), and covered with leather, is sometimes

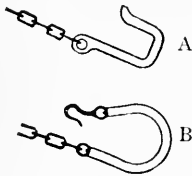

FIG. 47.

attached by another chain to the same part of the axle. This is hooked on the rim of the wheel below where the brake touches it, and holds the wheel in case the skid comes off. Instead of having a large hook, the chain itself is sometimes made sufficiently long to go round the rim, that part of it which touches the rim being covered with leather, as shown in Fig. 47, B. At the end of the leather-covered portion, there is a small hook which goes into one of the links of the chain.

The hook is perhaps an almost unnecessary addition, yet on a road-coach running over steep hills, it is safer to have it.

---

\* The objection to *bolting* it on is, that the bolt-heads wear off.

The skid, when not in use, should hook on the body of the coach, just behind the bracket of the brake-arm. Sometimes the hook for the skid is worked on this bracket. It must be far enough back to keep the bight of the chain entirely off the ground. A leather loop is fastened to the body to take the hook shown in Fig. 47.

In English coaches the hook and loop are on the near side of the coach, because the skid is put under the near wheel. In America, where we drive on the right-hand side of the road, the skid should be put under the off wheel, for the reason that the skid, holding very tightly to the ground, acts almost as if it were a fixed point, and the tendency of the force exerted by the horses will be to pull on the chain in a straight line from that point; the coach will therefore slide over to the side away from the skid, which should be, therefore, always on the lower side of the road;

if it is on the upper side, the coach will be constantly sliding toward the gutter (see Fig. 48).

The reader can satisfy himself that this is so, by putting a skid on any four-wheeled carriage and then pulling the carriage over a smooth, level pavement, such as asphalt.

Attention is especially called to this, because

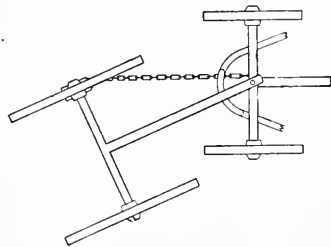

FIG. 48.

builders in this country have blindly followed the English fashion of putting the skid on the near side, ignoring the fact that we drive on the off side of the road.

It being the duty of the guard on a road-coach, and of the second man on a drag, to put on the skid, it is more convenient to have it on the near side, but it is used so rarely that this is of little importance.

A skid attached to a rod has been devised, that can be worked by a cord or light chain and dropped under the wheel, which would then run up on it and thus save a man's getting down to put it on, but the arrangement has not found favour in practice.

It has been also proposed to have the chain which holds the skid, so long that the skid can drag *behind* the wheel. By a hook and ring it may be shortened to the proper length to go under the wheel, and, at the bottom of the hill, the ring being knocked off the hook, the wheel will run off the skid without its being necessary to back the coach.

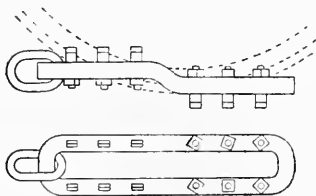

FIG. 49.

The ordinary skid does not hold on ice, and in Switzerland an ice-skid, shown in Fig. 49, is used. It is a link about 28 inches long, with chisel-shaped teeth.

The wheel rests in the opening, and the ring can be shifted to either end, so as to use one or the other set of teeth.

A chain wrapped round the rim of the wheel and round the ordinary skid when on the wheel, may be used in an emergency. Icy roads are always dangerous to a coach and alarming to the coachman.

Some Swiss travelling-carriages are fitted with an additional brake on the front wheels, which is worked from the near side of the coachman's seat. Obviously the rod working this brake must pass through the centre bolt of the fore-carriage, which bolt is made hollow for the purpose. This second brake obviates, in many cases, the employment of the skid, but it should not be used unless the hind brake is also on, as the retardation of the front wheels while the hind wheels are running free, may cause an accident.

A drag-staff was formerly attached to travelling-carriages. It is a short pole, hinged to the hind axle and trailing on the ground, so that, should the carriage be stopped in going up a hill, the staff prevents it from running back. It was rarely used on coaches.

LAMPS.—The lamps of a coach are large, with good reflectors, and should be made to burn the ordinary, large, carriage-candles; oil lamps are dirty and troublesome. They are made to fit easily into the lamp-irons, which are fixed on the front edge of the body of the coach, and should have stops on them to prevent turning in their sockets. There

should be brackets, or straps of some kind, in the front corners of the interior of the coach, to hold them when they are not in the lamp-irons.

Road-coaches usually have another pair of lamps (see Fig. 50), which are put on the lower step-irons of the front boot. These additional lamps should throw their light to the side as well as to the front.

There is also a foot-board lamp, which is hung on the front edge of the foot-board; no part of it should project *above* the foot-board, lest it catch the reins, and if it extends much *below*, a horse may touch it with his croup, in making a short turn; it should therefore be small, and it is not necessary to have

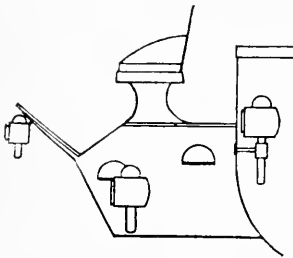

FIG. 50.

more than one candle in it; its only use is to light the pole-head, which is always in the shadow cast by the horses' shoulders. Foot-board lamps with *three* candles are too large. It is not easy to find the proper place for this foot-board lamp; it

is more out of the way at the root of the foot-board, but the heat from it is likely to blister the paint above it, and it can be put there only when the front of the boot is fixed.

A completely equipped road-coach which runs after dark should have a lamp on the near side of the hind boot, shining backward, to enable the guard to see the address on packages and to read



his way-bill. This lamp is so made that it can be readily taken off to be used to look along the road in the case of a doubtful bridge, or the like. The main coach-lamps are often used for the same purpose.

Lamps are sometimes made with slides which cover the glass when they are not lighted, but they are ugly, and when lamps are not in use they should be inside the coach.

It is not considered the 'proper thing' to carry the lamps in the daytime. This is, to a certain extent, an arbitrary dictate of coaching fashion, based, however, on a real custom of road-coaching. When coaching was a business, the lamps were kept at the station where the coach changed just before dark, and were put on the coach at the change, having been trimmed and filled,—for they were oil lamps,—during the day. When morning came, they were left at the first change-place, so that a coach was never seen carrying them in the daytime, and this has been adopted as a fashion. Moreover, the lamps, being large, are a good deal in the way of persons, especially ladies, getting up and down,—a practical reason for leaving them off. At coaching meets, where uniformity is desirable, they must be either *on* all the coaches or *off* all of them, and they are always off.

It has become, therefore, one of the conditions of a perfectly turned-out coach that it should not have its lamps on, though it is hard to give any good

reasons, apart from those just mentioned, why the lamps should not be on a coach as they are on a brougham or a landau, which would look naked without them. A break is always driven with its lamps on.

The modern coach-lamp is so large,—almost like a locomotive head-light,—that it is very conspicuous when it is in place. Smaller and plainer lamps are coming into fashion of late, more like the old mail-coach lamps. It is a good plan to have two plugs, of mahogany, or other polished, dark wood, with smoothly rounded tops, to keep in the lamp-sockets of a drag when the lamps are not in use. They give a finished look and are more agreeable to the touch than the sharp edge of the socket if the lamp-iron is taken hold of in getting on the coach.

A light ladder is necessary to enable ladies to mount to the top of the coach. It folds in the middle, so as to be convenient to hang up, and is usually made of iron. Two designs are shown in Fig. 51; the one with a platform is the more complete, and better for a public coach. The other is lighter and convenient for a drag. The steps should be covered with woollen plush

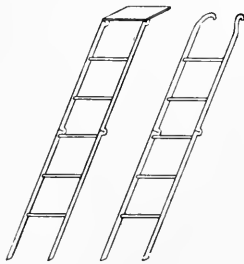

FIG. 51.

or india-rubber, to prevent the foot from slipping. The ladder must have hooks or pins which catch in the step, made open for that purpose, or on

top of the wheel when it is used for the hind roof-seats. The length of the ladder should be carefully considered. If it is too long it will be difficult to use it from a kerb, and for this reason it is better to have it as short as will do on a flat road. On a drag it is best carried on two hooks under the rumble-seat; on a road-coach it is hung under the hind boot, since it would hide the lettering on the back panel were it under the seat.

A basket, for umbrellas and sticks (Fig. 52), is fastened on the near side, to the iron of the back roof-seat. It is 27 inches long, 10 inches in diameter, and has a flat side which lies against the panel. For a road-coach, it has usually a division, making a small place in which the horn, with its bell up, is carried.

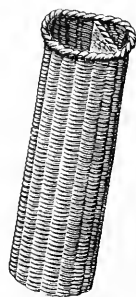

FIG. 52.

The lower end of the basket is strapped to the handle which is on the edge of the body.

While a basket is essential to a road-coach, it is doubtful whether it is worth while to carry one on a drag, when not on a journey. It does not improve the appearance of the coach as seen from behind; it widens it out and detracts from its 'smart' look; and since a stop can be made at any time, the umbrellas can readily be taken from the inside; in the basket they get chafed and dusty.

When a basket is carried, it is not necessary to have a horn-case; but if the horn is wanted when there is no basket, it should be carried in a russet

leather case (Fig. 53) strapped to the off side roof-seat iron. It is on the off side, because the head groom sits on that side, and it is he who usually sounds the horn. The case should be slightly



FIG. 53.

longer than the horn and open at the bottom, so that dirt will not lodge in it. A wire pin across the end will prevent a loose mouth-piece from dropping through.

On a road-coach, the rails of the roof-seats are connected by a rod, which serves for the guard to take hold of in climbing round from his seat to the front of the coach, and also serves to hold a net, made of straps, which prevents coats and wraps, laid on the top of the coach, from falling off (see Plates XVII., XIX., and XXII.). Similar rails may be temporarily attached to a drag for a journey, but they should not be on when the drag is used for park driving.

Lunch-boxes are fitted to go in the hind boot. The best arrangement is shown in Fig. 54. These boxes should be made of mahogany or oak, panelled. The large ones should be lined with tinned (planished) copper, which is much cleaner and nicer than zinc, and each one should be divided into three watertight compartments. In these compartments bottles, ice, salad, &c., can be carried, separated from each other.

The shallow case, which rests on a slide, over the large boxes, should be 7 inches deep outside, and divided as shown. Plates, with napkins between them, are in one side, dishes in the other, tumblers in the places made for them in the centre. A large division holds glass pitchers and one or two table-cloths, and a tray, fitting on top of the tumbler compartment, takes knives, forks, and spoons. A number of small pantry towels should be added, in which the soiled plates can be wrapped to bring them home in the lower boxes. It is needless to say that no soiled articles should be put in the divided box, which should be lined with buckskin, not with the baize frequently used.

In addition to the boxes for the hind boot, an 'imperial' is frequently added to the roof of the coach. It fits in between the seats, as shown in Plate XVIII., and the front, back, and sides, turn down, so that it flattens out into a table. It holds a quantity of provisions, and generally has a tray hanging near the top which is convenient as an additional table top. The imperial is an ugly

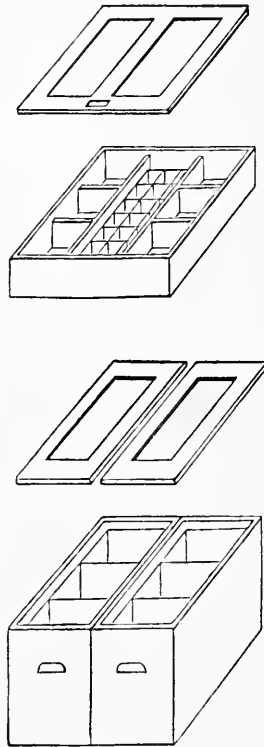

FIG. 54.

adjunct to the coach, and with reasonable ingenuity in stowing what is needed, the boxes should carry enough for any ordinary lunch.

For lunching on the coach, tables fitting on the hind boot and on the foot-board are convenient. A

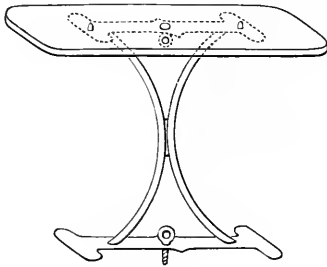

FIG. 55.

simple arrangement for this purpose is shown in Fig. 55.

The tops of the tables are of a size to be carried under the cushions of the inside seats of the coach ; the iron legs go in the front boot. The method of screwing the parts together is shown in Fig. 55.

For attendance at race-courses, &c., where the people on a drag sit in the sun for a long time, an

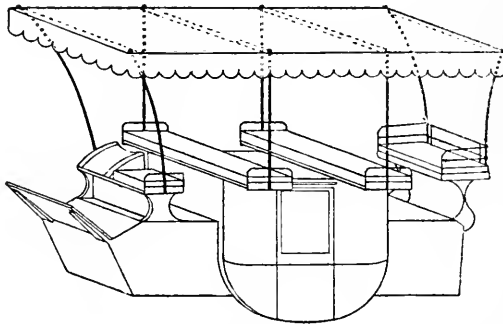

FIG. 56.

awning is useful. A satisfactory way of arranging it is shown in Fig. 56.

The standards are of iron  $\frac{5}{8}$  of an inch diameter,

jointed in the middle like a fishing-rod, so that they can be put in the boot, or inside the coach. They slip into sockets under the seats. There are four on each side; those in the middle rise straight up from the ends of the roof-seats. Those in the front and back are of somewhat different shape, so that, while rising from narrower seats, they have their upper ends in a line with those in the middle; those for the box-seat also turn somewhat forward. The standards have collars and knobs, at the top, and four strips of hard wood,  $1\frac{1}{2}$  inch by  $\frac{1}{2}$  inch, with brass plates on the ends, drop over these knobs, making a complete frame, over which the awning is laid. The awning is best made of striped material, not too heavy, and should have a valance 8 inches deep all round it. Braid or ribbons should be provided by which the valance can be brailed up if desired; these braids can be passed through the holes which have to be made in the awning where it goes over the knobs.

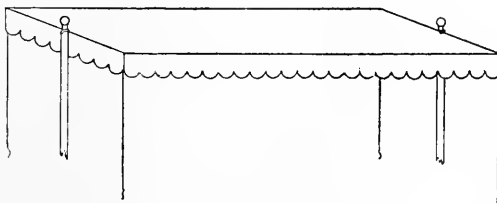

FIG. 57.

A simple awning is shown in Fig. 57, but it can be used only when the long and rather heavy poles which it requires, can be sent by another convey-

ance than by the coach. These poles are long enough to reach from the ground to about 4 feet above the roof of the coach ; they are driven slightly into the ground and strapped to the rumble and to the middle of the foot-board. For a week's race-meeting or cricket-match, this awning may be kept on the spot. One great advantage of it is, that it can be canted to suit the direction of the sun.

TOOLS.—The following articles should be carried in a coach :—

The wrenches belonging to the wheels.

Monkey-wrench. Foot-pick.

Blacksmith's hammer. Horseshoe nails.

One fore shoe. One hind shoe.

Large cutting pliers. Copper wire. Oil-can.

Cord and piece of manila rope  $\frac{3}{8}$  inch diameter.

Punch for making holes in straps. Strong knife.

Piece of canvas. Extra candles and matches.

Screw-driver. Brush. Cloth. Bucket.

If possible, a small hydraulic jack for raising the wheel.

The uses of these articles will be referred to in the Chapter on Accidents.

A list of spare parts of harness is given in the Chapter on Harness.

APRONS.—Sometimes a small apron, usually of some light stuff, such as is used for linen horse-covers, or of thin cloth, is worn by the coachman,



over the lap, reaching from a little below the waist to the ankles, and long enough the other way to tuck under the legs on both sides, so as to be sat upon. This is for the purpose of keeping dust, and any dirt from the reins, off the trousers. When it is worn for warmth it must be of thicker material, and fastened around the waist by a strap, so that when the wearer stands up it is much like a skirt. An apron of this kind does not, however, protect the feet from cold; it is better to have one long enough to go under the feet.

In cold weather it is well for the box passenger to have a small, soft rug, to be wrapped round his legs in the same way, under the box-apron, since, from the position of the coachman's legs, an opening letting in cold air, is left necessarily at the side, under any apron covering both persons.

The fashions of coaching having originated in a country where fur robes are but little used, there seems to be a certain lack of appropriateness in using a fur robe on the box, although there is, of course, no good reason against it; but a thick drab cloth looks rather more 'coaching,' and if necessary, it can be lined with fur.

For ordinary weather there is no better material for aprons than plain, drab, Bedford cord, either hemmed on the edge, or bound with cloth of the same colour. The corners should be rounded, with a radius of 4 or 5 inches. The apron for the box-seat should be 4 ft. 6 in. wide and 6 ft. 6 in. long,

and should have a strap 30 inches long, fastened to the underside, 7 inches below the upper edge, which can be passed round the rail of the box-seat to keep the apron from slipping down. This strap is passed through a ring fastened to a metal boss, which shows on the outside of the apron.

Box-aprons sometimes have sewed in the middle of the upper part, a gusset which is supposed to go down between the two persons who are on the box, but it is of doubtful utility, since, if the apron is wide enough, its centre part will be well kept down by the strap without displacing the ends.

The box-apron sometimes has two pockets near its upper edge, and then there is a long flap over them ; unless there are pockets, the flap is hardly necessary.

The aprons for the roof-seats should be 4 feet wide and 9 feet long, so as to cover all four passengers, and there should be one for the rumble, 4 feet wide and 6 feet long. These sizes may seem excessive, but it is a mistake to have aprons too small ; they cannot be tucked under at the ends and are always slipping about.

There should be an apron, of a cloth the colour of the liveries, for the *men* to use in the rumble.

For cold weather, aprons made of heavy, drab cloth, waterproofed, and lined with some check material, are the proper thing. They should not be bound, but stitched on the edge with several rows of stitches. The box-seat apron is sometimes lined

along its lower edge, inside, with a band, about 8 inches wide, of pig skin, so that the feet may be placed upon it without wearing it out. This band should be only as long as the foot-board, say 40 inches, and should not extend to the ends of the apron, else it will be difficult, on account of their stiffness, to tuck them in.

The most comfortable apron for cold weather is a *bag*, 4 feet long, up and down, and 27 inches wide double, that is, made of stuff 54 inches wide. The seam is not at the side, but at the back, in the middle, and extends for a distance of about a foot from the bottom, the rest being open. The bag is pulled over the feet after sitting down and the sides tucked in, so as to sit upon them. The bottom of the bag is, of course, closed.

Against rain, india-rubber aprons should be provided, and, since it is not necessary that they should be thick, the best, and by far the cheapest, material is ordinary rubber-cloth, which can be bought by the yard and merely cut to the proper length, without any binding. It comes about 48 inches wide. Whether it is white or black is a matter of taste; the white looks better, but has a whitish powder on it, which marks dark clothes. The advantage of these thin aprons is that they *are* thin and can be folded and kept under the inside cushions, while the regularly made rubber aprons are usually thick and stiff.

## CHAPTER VI

## DIFFERENT FORMS OF FOUR-IN-HAND CARRIAGES

## DRAG

As regards the different vehicles for four-horse driving, the road-coach and the private drag have been already sufficiently described. The name drag is now restricted to the private coach, but in the early part of this century a public coach was frequently called a 'drag' and the coachman a 'dragsman.' \*

ADAMS writes, in 1837: 'A Driving Coach is a 'vehicle formerly much used by gentlemen fond of 'driving and attending races.'

## MAIL-COACH

When, in 1784, at the suggestion of Mr PALMER, of Bath, mail-coaches were established in England, to replace the boys on horseback and the mail-carts, the road-coach, so modified as to make it more suited to higher speeds and lighter loads, became essentially the mail-coach shown in Plate VII. It had a heavy carriage-part, but the body was comparatively light and somewhat narrower

---

\* CROSS, vol. ii. p. 136. 'NIMROD'S' *Northern Tour*, p. 32.

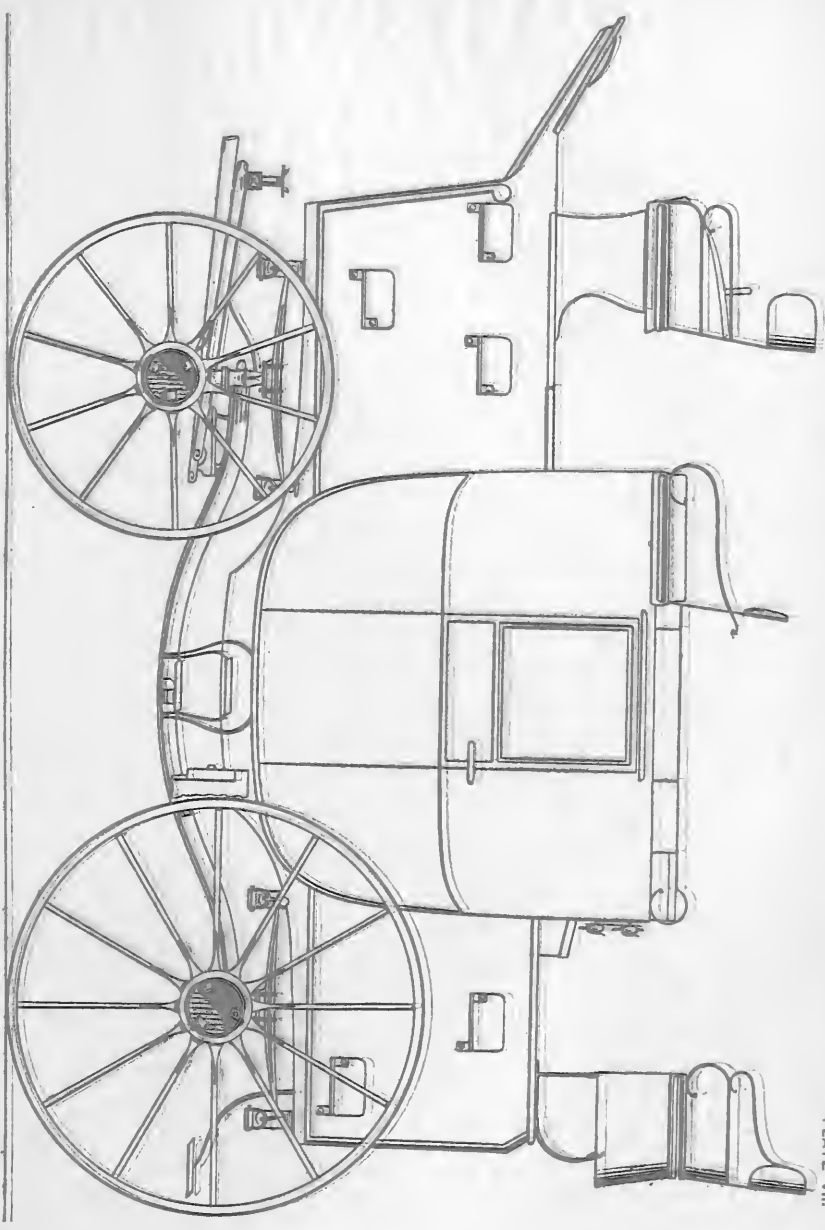

Scale of Feet

MAIL-COACH BY GUIET & CO., PARIS.

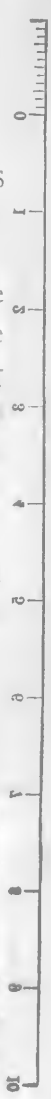
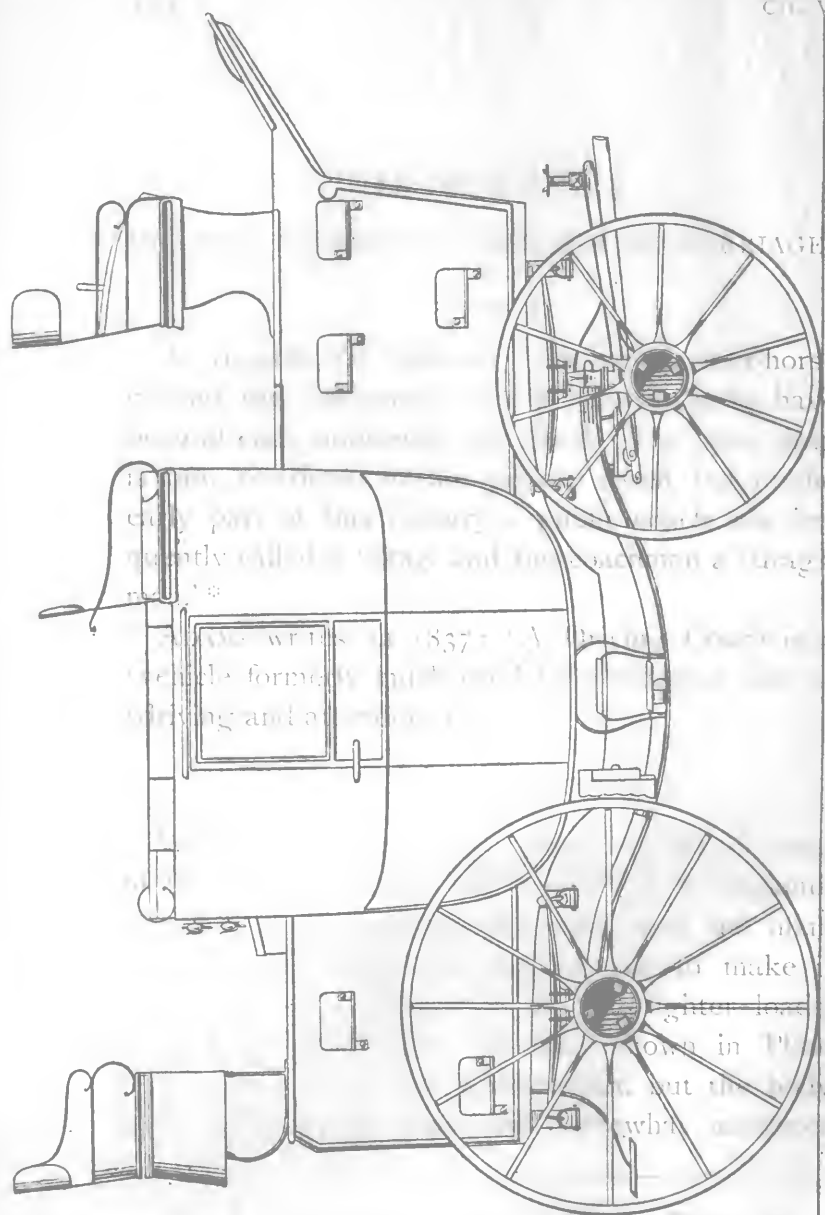

MAIL-COACH BY GUIET & CO., PARIS.  
Scale of Feet.

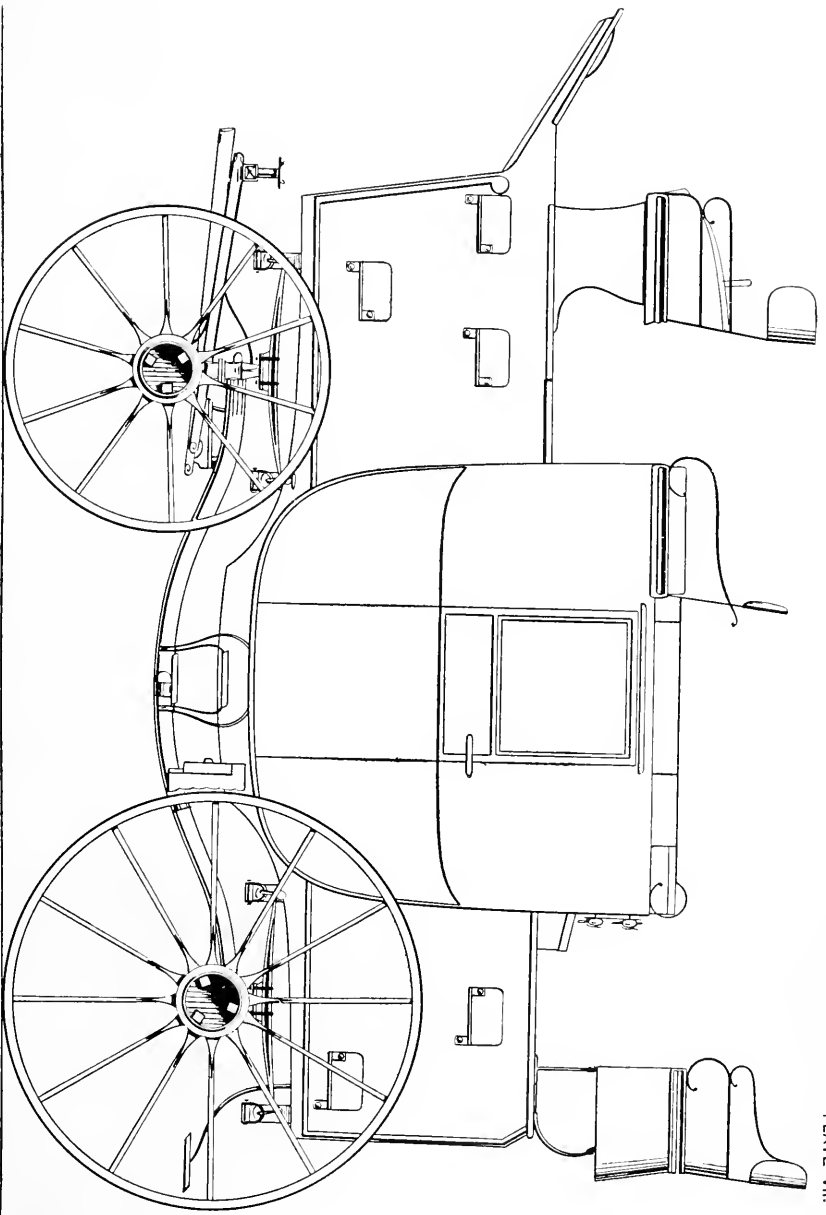

Scale of Feet.

MAIL-COACH BY GUIET & Co., PARIS.





than that of the road-coach. It carried four passengers inside, one on the box, and three on the front roof-seat. There was no hind roof-seat, and the rumble, supported by irons, carried only the guard.

The hind boot had no door behind, the mail-bags being put in through an opening in the top closed by a lid, on which the feet of the guard rested. In the place of the hind roof-seat there was a box containing a blunderbuss and tools. The earlier mails had telegraph springs in front and a cross spring behind, which was later replaced by telegraph springs. The axles were heavy, with *mail* axle-arms, the wheels had but little dish and were set nearly vertical; the hind wheels were larger than those of the coaches, and measured 4 ft. 8 in. The foot-board was small, the boots were large and deep, and sometimes the full width of the body.

These coaches were made on contract by VIDLER, whose firm built them from 1784 to 1836. There were other builders, however; WARD and WRIGHT are mentioned.

There is a model of a mail-coach, on a scale of one inch to the foot, in the General Post-Office in London, and an exact copy of it is in the possession of The Coaching Club, New York. It has a hammer-cloth. On occasions of ceremony (such as the Procession of the Mails, which took place from the General Post-Office, on the King's birthday), a

hammer-cloth, like that used on a dress carriage, was put on the box-seat. It was red, like the royal livery of the guard.

During VIDLER'S contract, probably few changes or improvements were made in the mail-coaches, but at the outset, the subject seems to have been studied with much care by the Post-Office authorities, with the result of turning out a very complete vehicle.

An exact reproduction of the mail-coach was built by Messrs GUIET & Co., of Paris, in 1892, for Mr W. G. TIFFANY, and was used in the drive against time, from Paris to Trouville in July of that year. It has been copied since then for other private persons, and is shown in Plate VII.

#### MALLE POSTE

The French Mail, or 'Malle poste,' was entirely different from the English; it was a britzka with a dickey for the guard. It carried only two passengers, had four horses, and travelled very fast. (BEAUFORT, p. 327.)

General MORIN, in his *Report on the London Exhibition of 1862*, says that the malle poste ran on certain stone-paved roads at a speed of from 15 to 16 kilometres (9.32 to 9.94 miles) an hour. The stages were short, only five miles. BEAUFORT states that the changes of horses were made in forty-five seconds. Plate VIII., from an old drawing by VICTOR ADAM, shows this vehicle.



PLATE IX.



SWISS DILIGENCE. 1891.

MORIN's description of the English coach and his comments upon it, in the Report just mentioned, are too good to be lost :—

‘At the same period the English mails and coaches had an entirely different form from ours, and are reproduced in the vehicle now used in England to take a party of people to the races ; the body of a berline, with places inside for four persons only, and with twelve or fourteen seats outside, entirely uncovered and surrounded by a simple iron rail which barely afforded a point of support to the passengers ; a space on the roof for the baggage against which the passengers leaned : such is the vehicle to which the English gave, and still give, their preference in a climate which is wet and rainy the greater part of the year. We cannot dispute their taste in such things, or in colours.’\*

#### DILIGENCE

On the Continent of Europe, in old coaching days, the vehicle which corresponded to the stage-coach of England was the Diligence. Plate IX., from a photograph of a Swiss diligence of 1891, shows it well, since few changes have been made in it during the past seventy years. The main body is like that of a coach, carries four or six persons, and is called the ‘intérieur.’ In front, and constructively forming part of the body, is the ‘coupé,’

---

\* MORIN, *Rapport sur Classe VI.*, p. 411.

holding three persons. Behind the body is a boot, on top of which is a seat for two, or for three passengers; this seat is furnished with a hood. The driver sits on the top of the coupé, with his feet on a foot-board, which is in front of the windows of the coupé. This seat is usually long enough to take the 'conducteur' (guard) alongside of the driver, but he sometimes sits in the rumble.

The brake is applied both to the front and to the back of the hind wheels, and is so arranged that it can be worked from both sides of the driving-seat, by either man. There is no perch, and therefore, necessarily, three-quarter springs. The front wheels turn under the body. The lead-bars are not attached to the end of the pole, but to a rod which runs under the pole from the futchells. When three horses are in the lead, as is quite common, the main-bar is long enough to spread the outside horses sufficiently to admit the centre horse between them, and his bar is hooked to the centre of the main-bar, no attempt being made to equalise the draft.

The baggage is piled on the roof and covered with a tarpaulin; the mail-bags and small packages are put in the hind boot. Various modifications of this vehicle are in use, but that just described may be considered the standard diligence.

The harness is simple, and breechings are invariably used on the wheel horses. The lead reins are passed sometimes *over* the wheelers' heads, some-





TRAVELLING-CARRIAGE POSTING IN FRANCE.



times on the *inner* side of the bridle, never through terrets on the pad. The leather portion of the trace is short and terminates in a  $\frac{5}{8}$  inch rope, which is looped round the score cut in the end of the swingle-tree. There is no attempt at any finish in harness, or appointments, or in methods of driving, but these diligences go with safety, night and day, over good, though sometimes dangerous roads, at a fair rate of speed.

#### TRAVELLING-CARRIAGE

A European Travelling-carriage of the early part of this century, is shown in Plate X. It had a large body made in the form of a coupé, but with length enough to admit of a comfortable, additional seat inside, and had large imperials and boxes, which could be taken off and used as trunks. The horses were always ridden by postilions, therefore there was no driving-seat, but there was a rumble, usually provided with a hood.

#### BREAK

A Break, according to English usage, is strictly the four-wheeled vehicle shown in Fig. 58, used for *breaking* horses; but, either from the obvious utility of putting a body behind the driving-seat, or else as a development of the well-known wagonette, it has assumed the form shown in Fig. 59.

This in turn has been simplified by omitting the perch and mounting the body on four elliptic springs.

By this simplification, while the form of the vehicle is but little changed, the mechanical principle is much modified.

In a carriage made with a perch, the horses are attached directly to the *whole* of the carriage-part, which follows them as one piece, while the body alone is above the springs; in a carriage without a perch, the horses pull upon the body, and second-

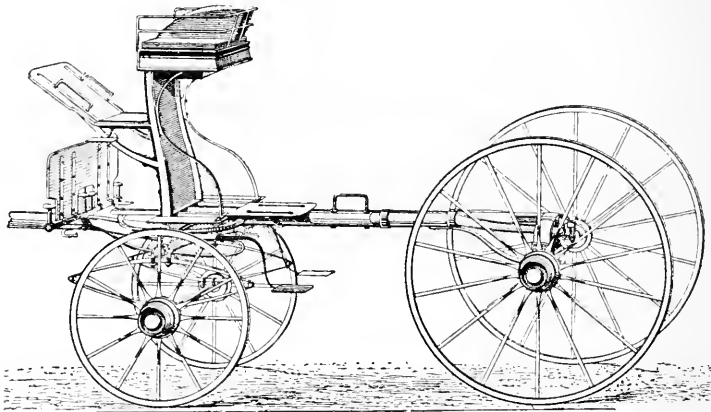

FIG. 58.

arily upon the axles and wheels through the springs, the body, in a measure, taking the place of a perch.

It will be noticed that when any wheel of a perched carriage strikes an obstacle, the shock is felt directly by the horses; while in one without a perch, the shocks, both vertical and horizontal, are taken largely by the springs, and reach the horses with their violence much diminished.

For this reason carriages without a perch are undoubtedly easier on the horses, and nearly all vehicles, nowadays, are so made.

They are also much lighter, and as the front wheels can be made to go far, or, in fact, all the way, under the body, such vehicles turn in a small space. It is, however, supposed that, from the greater flexibility of the vehicle, the hind wheels do

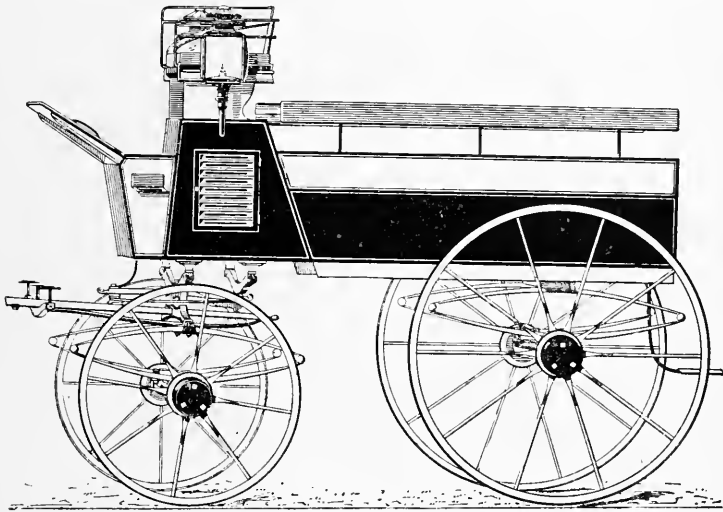

FIG. 59.

not follow the front wheels with accuracy, and that thereby the draught may be increased.

It must be also noted that the pole of a carriage without a perch is liable to fly up in crossing a depression, such as a gutter, and strike a horse in the mouth.

Experience, up to this time, and, perhaps, a cer-

tain amount of prejudice, have led to the retaining of the perch construction in heavy vehicles, like coaches.

A light buggy has only two elliptic springs, and therefore, of necessity, a perch, because the springs, set crosswise, would not be in the proper position to resist the strain of the draught; carriages intermediate in weight between coaches and buggies usually have no perch, and have four elliptic springs, or some modification of them.\*

Mail-phaetons are almost the only carriages to which the two systems are applied, some having perches and regular telegraph springs, and others four elliptic springs only. In this particular style of carriage, the body is not heavy enough to make the telegraph springs work easily, and a phaeton with a perch, although stylish, is apt to be stiff and uncomfortable.

Since a break is principally to 'knock about' with and to use in rough places, it is better to have it without a perch; its greater lightness and the ease with which it can be turned in narrow places much more than counterbalances any advantages that the perch construction may possess.

The wagonette break is the kind most frequently used, but while it is convenient to carry baggage or the like, it is not as good a four-in-hand vehicle as

---

\* BEAUFORT (p. 238) speaks of CLARK'S coach, on the Brighton Road, in 1862, as having no perch and being good to carry a load.

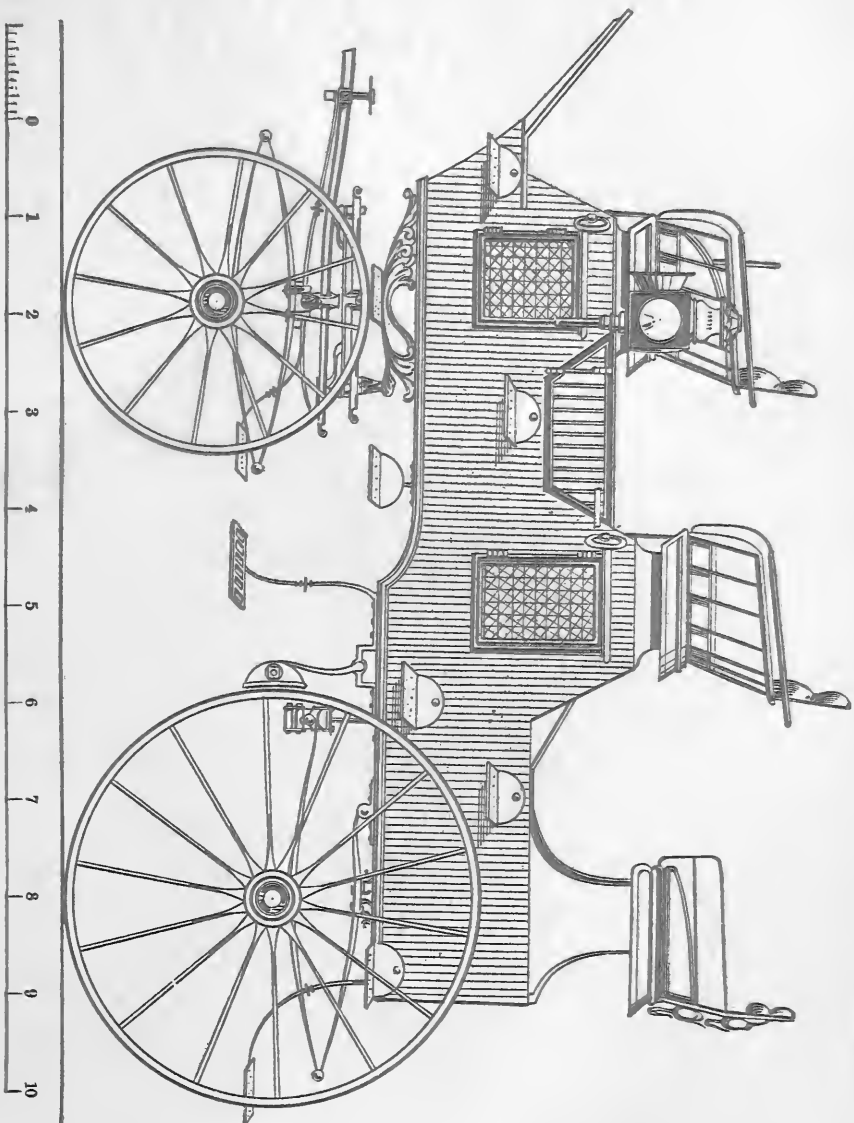

Scale of Feet.

CHAR & BANCS BREAK.

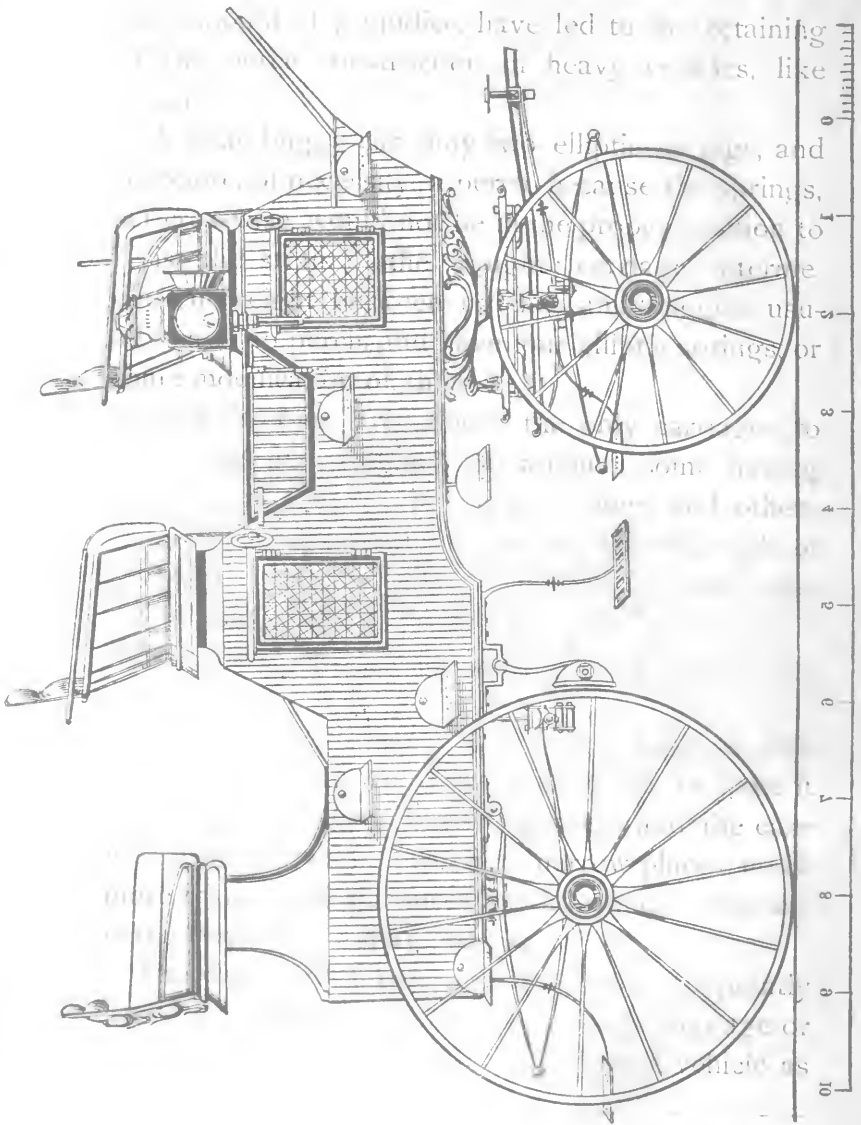

CHAIR A BANKS BREAK.  
Scale of feet.

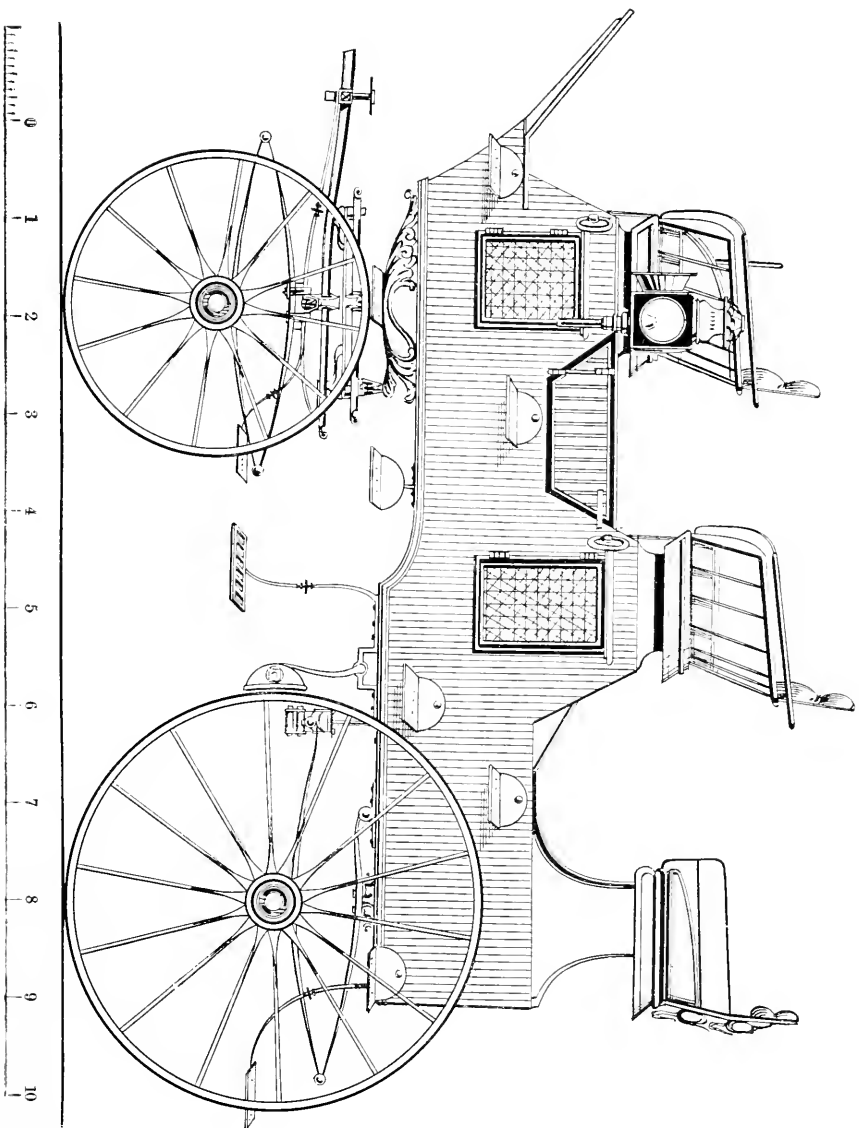

Scale of Feet.

CHAR À BANCS BREAK.





some form of the French *char à bancs* (so called from its being a *car* with *benches* placed across it), shown in Plate XI. The driving-seat is exactly like that of a coach, and can be made the same height from the ground; the splinter-bar, and consequently the horses, will be then in the same relative place as in a coach. The second seat, which can be made for three, or for four persons, is a little higher than the box-seat, and the leg-room is much better than on a coach; the rumble, as usual, seats the grooms. The body has doors in the sides and a door behind, and takes the place of the boots; with open gratings in the sides, or in the doors, dogs can be carried comfortably. For country and sporting purposes nothing can be better. A *char à bancs* like that shown in the plate will weigh about 1600 pounds; twice as much as a light mail-phaeton without a perch. The connection of the hind springs with the axles and with the body should be carefully considered in designing this vehicle, since the brake tends to push the hind axle backward in a manner in which it will not be pushed in a carriage without a brake. There is a way of connecting the front end of the spring to the body which will counteract this strain, but somewhat to the detriment of the easy action of the springs (see Fig. 28).

The pole, pole-hook, lead-bars, &c., of a break should be exactly like those of a coach, but somewhat lighter, not, however, in proportion to the difference of weight of the vehicles.

BAROUCHE LANDAU.—In the early part of this century, the favourite carriage for the four-in-hand amateur seems to have been a 'Barouche Landau,'\* which was a barouche with a high driving-seat, and a rumble for two servants. A carriage of this kind was used by the Prince Regent at Brighton.

A very high phaeton (Fig. 60) was also used at the same period; it was sometimes called a 'high flyer.'

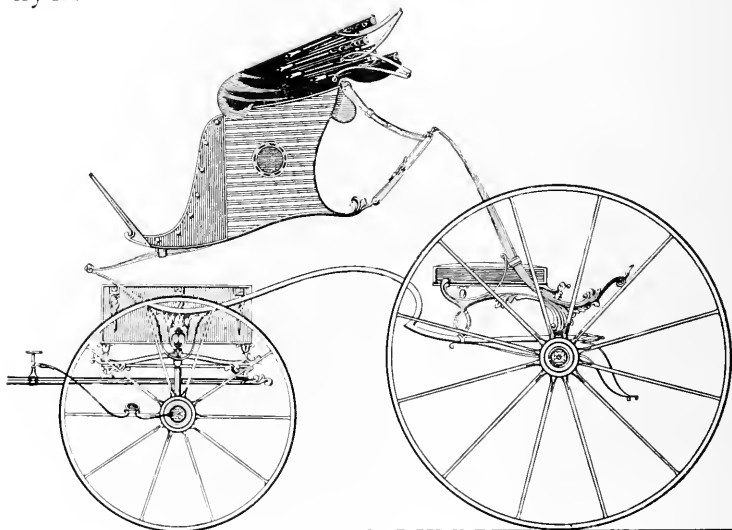

FIG. 60.

The Jaunting Car, introduced into Ireland in 1815 by BIANCONI, is another four-horse vehicle; although it is generally used with two horses only (Fig. 61).

---

\* *Sporting Magazine*, 1826. Mentioned by MALET, p. 127; also by LENNOX, p. 201.

PRIVATE OMNIBUS.—A vehicle much used in the country for station purposes, and the like, is the Private Omnibus (Fig. 62). It is admirably adapted for four-in-hand driving, since the driving-seat is high and a seat for three, or for four people can be readily arranged on the roof. The interior is entered from the back, and, therefore, the hind wheels can be large, and the axle well under the body, hence the vehicle runs easily.



FIG. 61.

Small seats are added at the rear, on each side of the door, for the grooms.

The omnibus may be also used with three horses abreast.

CURRICLE OR CAPE CART.—Any two-wheeled cart made with a pole instead of shafts, to be drawn by two horses, can of course be used with four.

Such a cart is the Curricie, the pole of which is suspended from the centre of a bar which rests upon the pads of the harness. A simpler arrangement, much used in the English Settlements at the Cape of Good Hope, and therefore called a Cape Cart, has the pole supported by a yoke attached to the lower part of the collars just as the pole of a

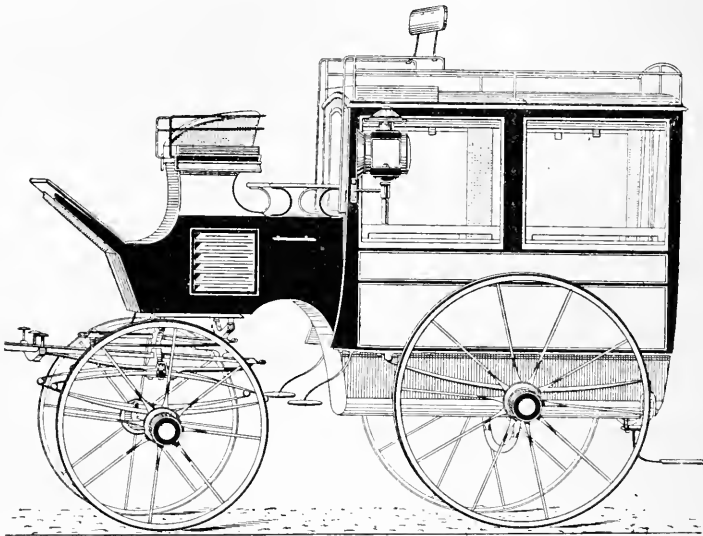

FIG. 62.

trotting wagon is supported, except that the pole-straps are much longer. With a hook on the point of the pole, or a rope running back to the axle (as described on page 58), four horses can be driven to such a cart, and it is admirably adapted to wild regions where the roads are little more than tracks.

A curricule-bar may be made to go under the horses' bellies instead of over their backs, and such a 'rig' is described by 'NIMROD,' *Northern Tour*, p. 68, as being part of the 'curricule mail.' It has been revived in America as part of a plough harness, and has been used for the leaders of a coach, with a single trace, or rope, going from the middle of it to the point of the pole.

In PHILIPSON *On Harness*, pp. 49-63, will be found an excellent article on the Cape Cart, with full details of its construction and mode of harnessing.

SLEIGH.—A sleigh is not well adapted to four-in-hand driving, since it is usually too low, and if the height of the driving-seat is increased the sleigh is likely to tip over.

Probably the best arrangement for driving four-in-hand on snow or ice, would be to fit four 'bob-runners' to the axles of a break. A bob-runner is a quarter of a wheel, with the lower part of the rim lengthened horizontally, and having a hub and box fitting on the axle-arm.

## CHAPTER VII

## AMERICAN COACH

As has been said in a previous Chapter, the American coach seems to be nearly the English coach of the middle of the eighteenth century, arrested in its development, because the conditions under which, in this country, it has been, and is still, used, are nearly similar to those of that period in England.

The long distances in America, and the newness and comparative poverty of the country, prevented the construction, at an early period, of roads as good as those of Europe, and later, the rapid development of railroads checked the building of main driving roads, so that coaches had to be adapted to rough roads and bad usage.

The typical American coach, usually called the 'Concord coach,' from Concord, New Hampshire, where the majority of them are built, is shown in Plate XII., which is an accurate drawing to a half-inch scale, kindly furnished by 'The ABBOT-DOWNING Company of Concord.'

The photogravure, Plate XV., of a heavy coach made for our Western States and Territories and still sent to Africa ; and Plate XVI., of a light coach such as is still used in some places in the White

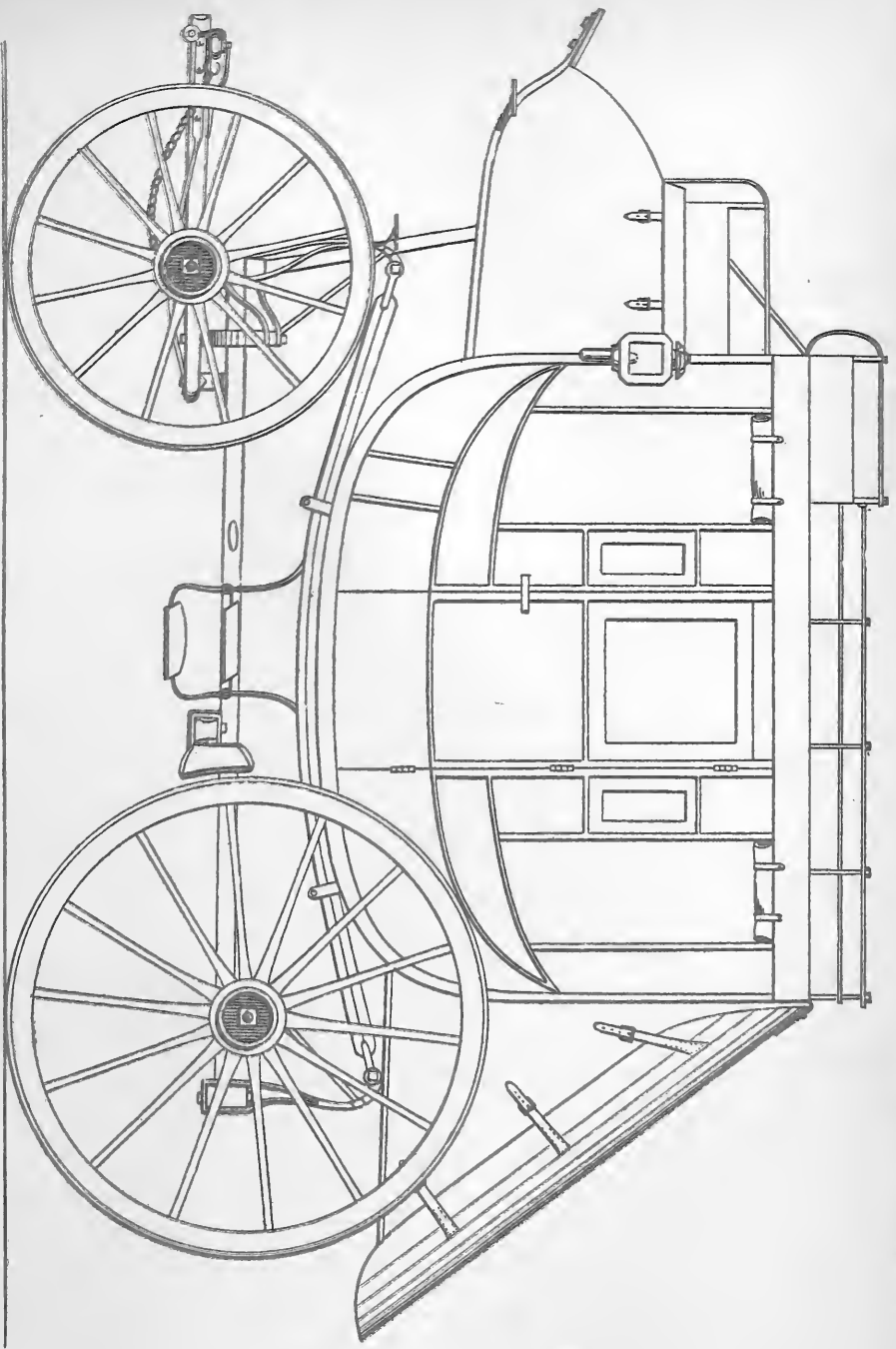

Scale of Feet.

HEAVY COACH BY ABBOT DOWNING CO., CONCORD, N. H.

Scale of Feet.



CH. VII

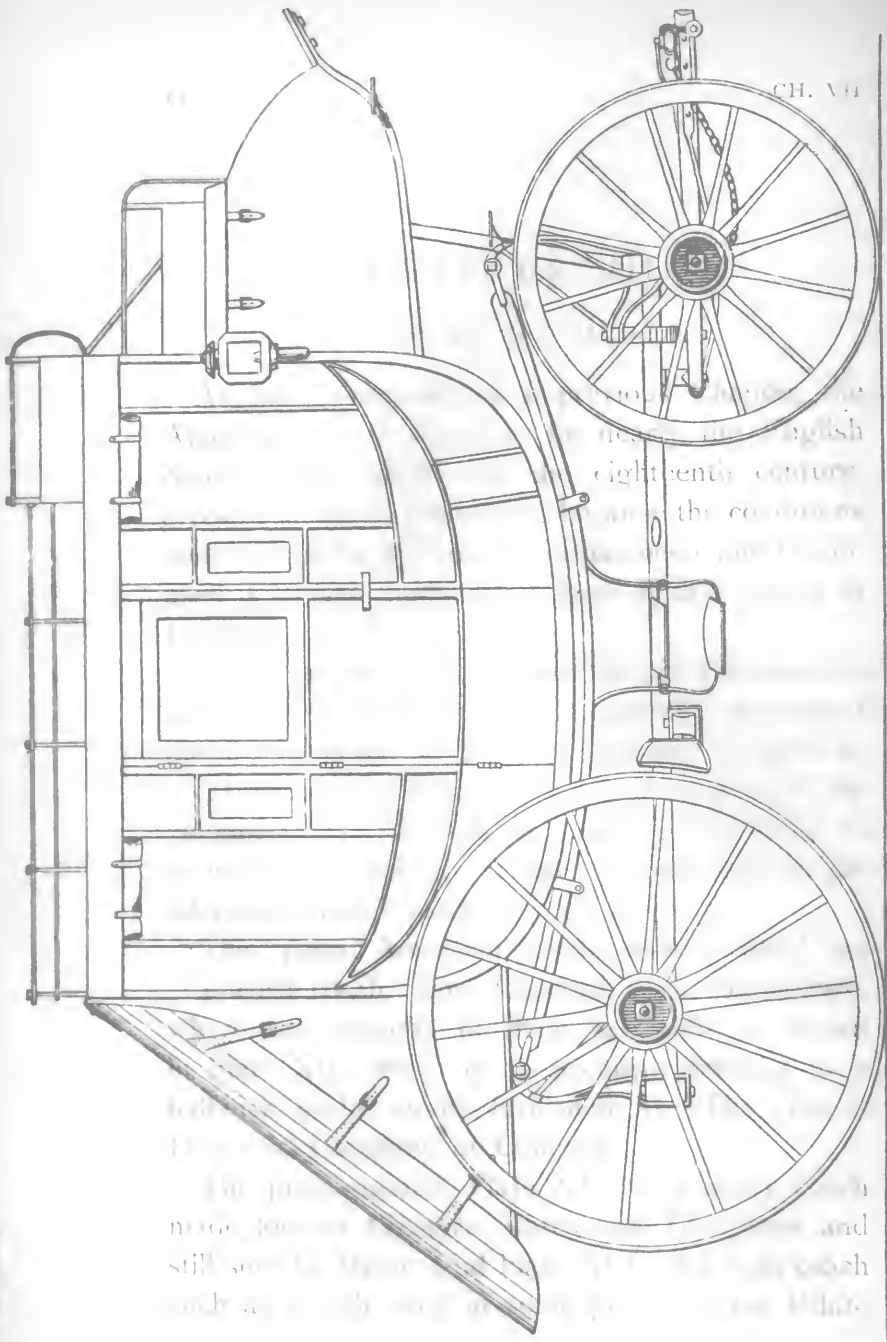



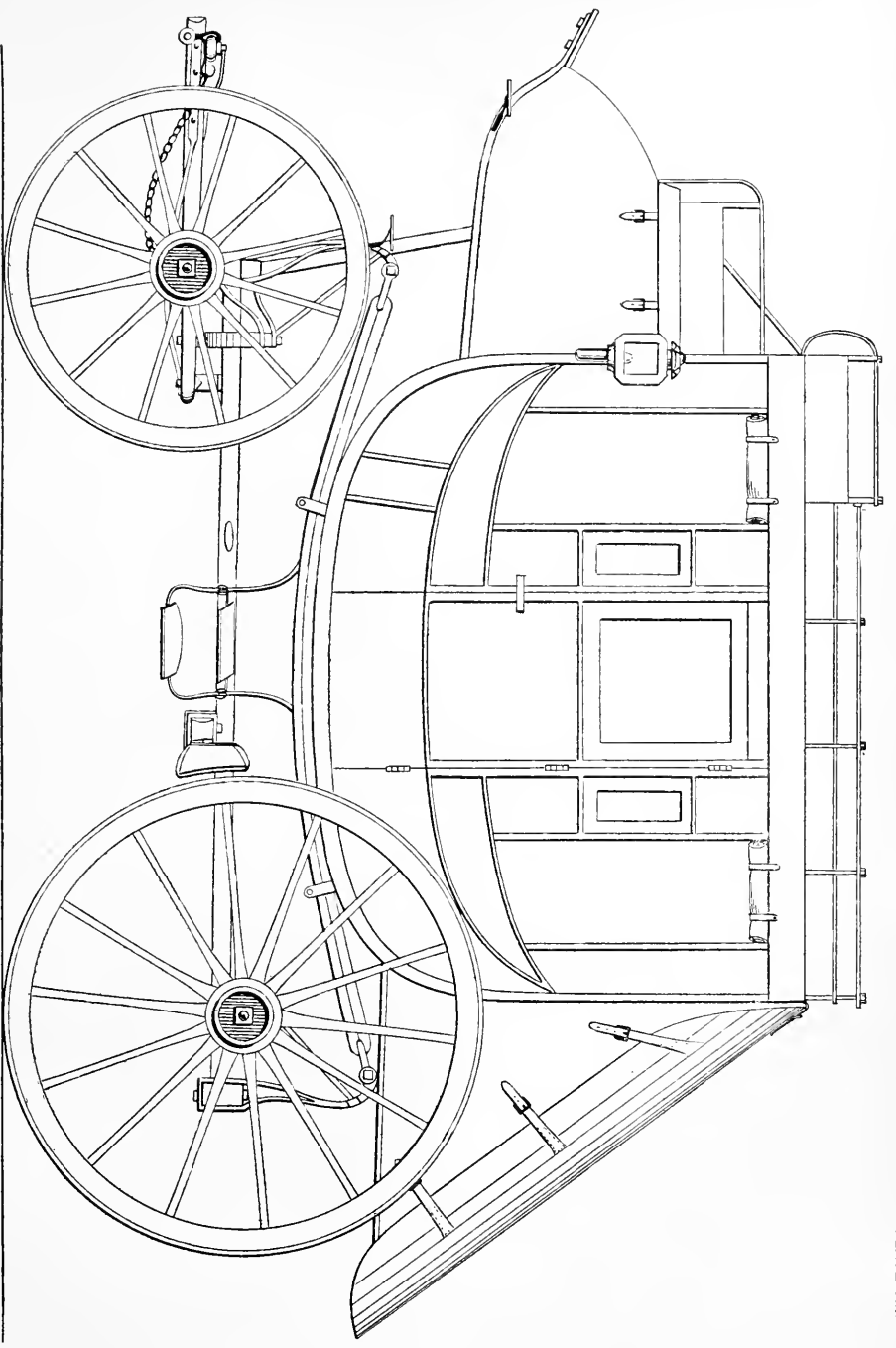

Scale of Feet.

HEAVY COACH BY ABBOT DOWNING CO., CONCORD, N. H.



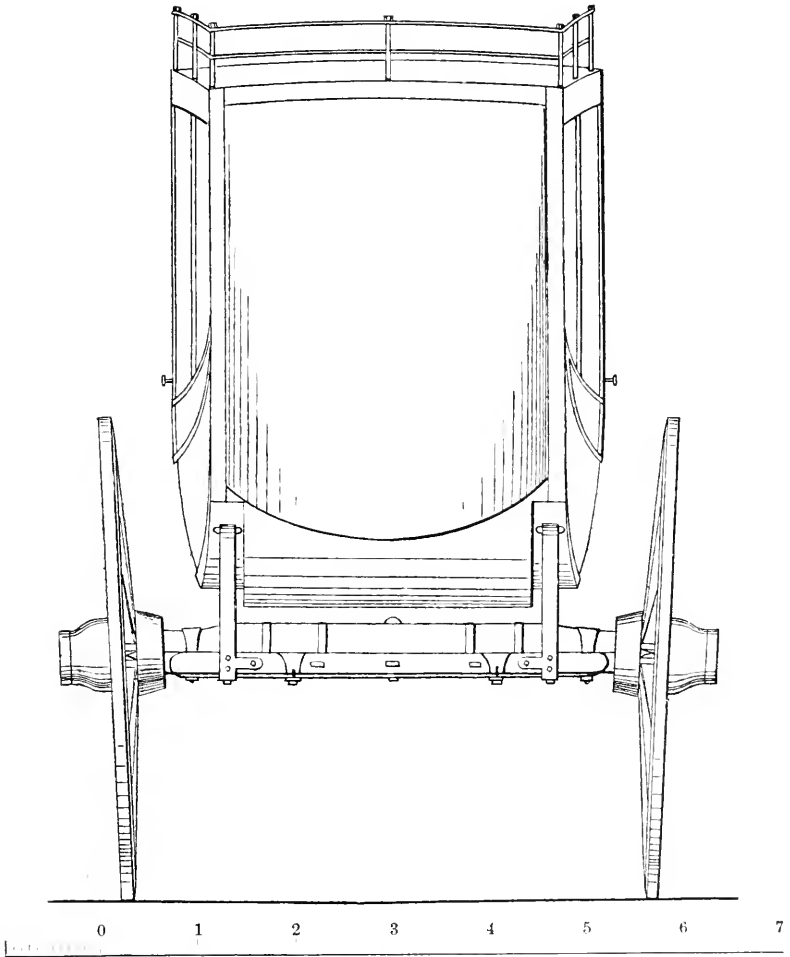

Scale of Feet.

REAR VIEW OF CONCORD COACH

PLATE XIV.

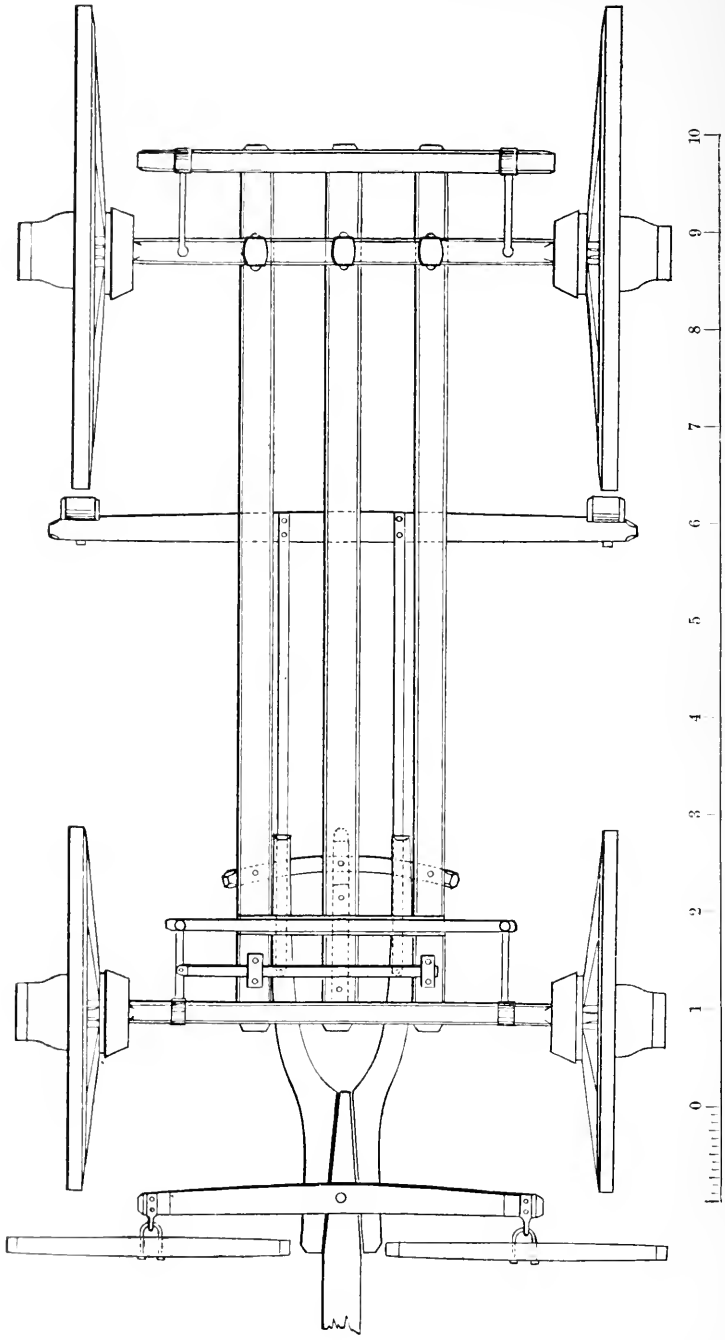

Scale of Feet.

CARRIAGE-PART OF CONCORD COACH.

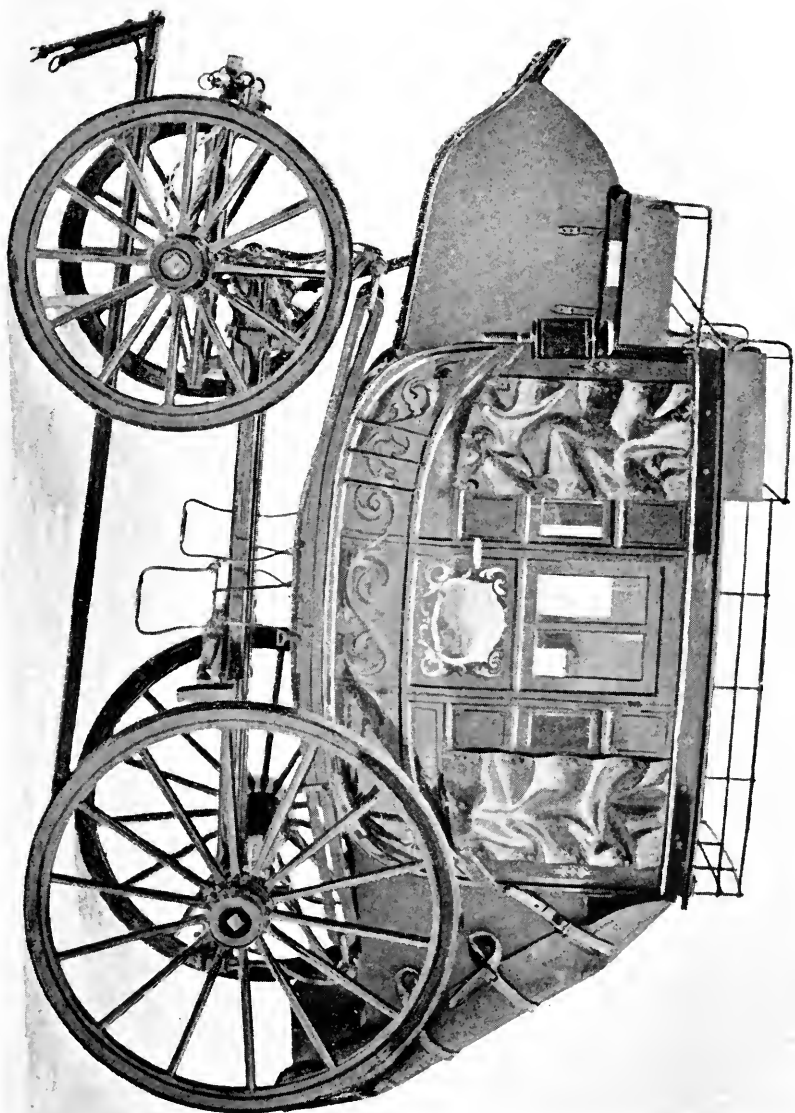

HEAVY CONCORD COACH. ABBOT DOWNING COMPANY.

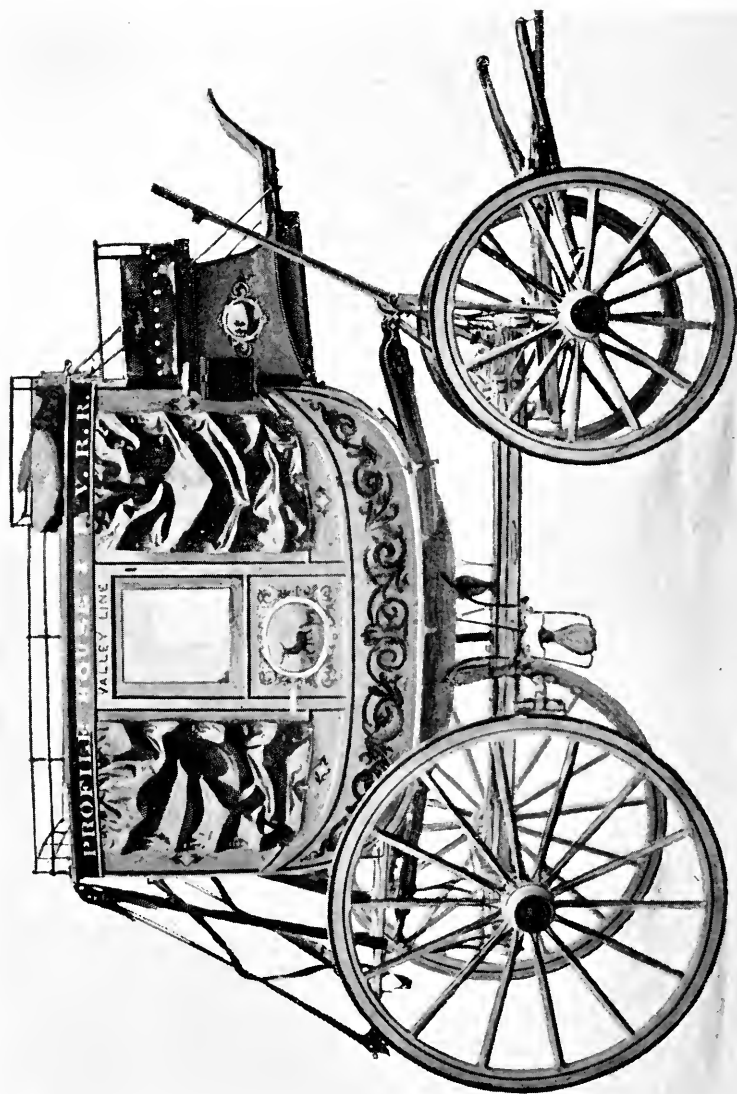

Mountains not as yet reached by the railroad, show the two extremes of design.

The peculiarities in construction of this coach are, that it has three parallel, straight perches connecting the hind axle and the front transom-bed and forming a very stiff rectangular frame. See Plate XIV. The three perches extend 9 or 10 inches back of the hind axle and are connected by a cross piece. At the four corners of this frame rise four stiff, iron standards, firmly braced so that they cannot bend, which carry, at their upper ends, square iron shackles; connecting these shackles on each side are thick leather straps, and upon these straps, or thorough-braces, rests the body of the coach.

This is exactly the mode of suspension of European carriages before the introduction of springs, which, it will be noticed, are wholly absent in the Concord coach.

The fore-carriage differs from that of the English coach principally in not having any outer futchells. The inner futchells are spread out behind to take the sway-bar, and brought together in front to take the pole; corresponding to the splinter-bar is an evener, attached to the top of the futchells by a bolt, about which it turns, its motion being limited by chains which go from its ends to the axle. To this evener are hooked the swingle-trees.

The pole measures 9 ft. 7 in. from the front of the evener, but inasmuch as the swingle-trees are  $4\frac{1}{2}$

inches in front of the evener, the pole is only  $2\frac{1}{2}$  inches longer than the English pole, measured between the same points.

The brake is attached to the under-carriage and not to the body, of which it is entirely independent, and the brake-blocks are *shoved* against the wheels, being on the ends of a bar which slides under the perches ; it is worked by a lever, shown distinctly in Plate XVI., rising alongside of the off side of the coachman's seat. This lever has, near its upper end, an iron cross-bar on which the coachman's foot can be placed for the purpose of forcing the lever forward ; there being no rack to hold the lever when it is pressed forward, the brake can be kept against the wheel only by constant pressure of the foot.

The form of the body is shown in the drawings. It has a great deal of 'cant' and 'turn-under,' and its extreme width is 4 ft. 6 in. It is made to carry nine persons, three on each of the three seats.\* The middle seat is a bench in three parts, the centre part fixed to the floor, the ends turning up on hinges, to facilitate access from either door to the seats. The passengers sitting on the middle seat lean against a broad leather strap, which is hung from the roof by two straps, and has, at each end strong hooks going into sockets on the pillars of the door (Fig. '63).

---

\* Many English coaches in the early part of the century carried six persons inside, three on each seat.



That which corresponds to the front boot of an English coach is a large foot-board with leather sides, and the hind boot is a baggage-rack with leather sides and cover.

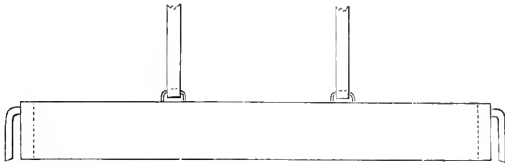

FIG. 63.

In the light coach, the front boot is small and of wood; in both light and heavy coaches, the front seat and the boot are held to the roof by diagonal iron rods.

The passengers occupying the roof-seat rest their feet upon the back part of the cushion of the box-seat.

The upper panels of the sides are not solid, but closed by curtains; a narrow panel with a small glass in it, on each side of the door, admits light when the curtains are down. The door has the usual sash, with glass in one or more panes.

When the coach is running, the body sways about freely upon the thorough-braces, the motion being principally fore and aft, sometimes quite enough to make a sensitive person sea-sick. An excessive movement is checked by straps from the sides of the body to the perches. This rocking to and fro adds to the difficulty of driving, because the arm

has to go backward and forward to counteract the movement of the body, interfering seriously with fine work. When the foot is on the brake, the leg is kept constantly in motion from the same cause.

The hind wheels are high, being 5 ft. 1 in., while those of the old mails were 4 ft. 8 in., and of a modern coach 4 ft. 4 in.

The front wheels are 3 ft. 10 in., the same in height as those of the mails, those of a coach being 3 ft. 4 in.

The body is high, being mounted upon the thorough-braces, and it is somewhat singular that the height of the roof from the ground is almost exactly that of the old English coaches.

An Act of Parliament passed in 1806 provided that no passengers should be carried on top of a coach the top of which was more than 8 ft. 9 in. from the ground, and that 2 feet of luggage could be carried on top, if the whole load were not higher than 10 ft. 9 in. from the ground, thus giving again 8 ft. 9 in. as the height, or at least the maximum height, of the roof. The height of the roof of a Concord coach is 8 ft. 6 in., that of a modern English coach 6 ft. 10 in.

It will be observed that the body is as far back as the opening of the door past the wheels will permit, and as the heaviest baggage is put on the hind rack, the load is thrown well back on the large wheels.

A comparison of the Concord coach with an English coach can be best made by placing the transparent print of either on top of the other.

There are obvious reasons why the Concord coach is not well adapted to amateur pleasure coaching. In the first place, it is too large, and while it could be much reduced in size, it would of necessity be high on account of its suspension, unless the wheels should be reduced below a proper size. It is certainly neither a compact nor a 'smart' looking vehicle: it lacks the boots, which are convenient for many purposes; the arrangement of its front roof-seat is not good; there is no place at the back for the servants; a brake, with a rack, cannot be readily adapted to it; and last, but not least, the rocking of the body interferes seriously with fine driving, since the coachman's hand is always in motion back and forth, to the discomfort of his horses' mouths, unless he is continually giving his hand, which is an ungraceful movement.

The changes from the old type of English coach to the present type are precisely those which were suggested by better roads and by the demand for increased comfort; the improved form of coach is therefore that best adapted to pleasure coaching.

For rough business purposes on bad roads, the Concord coaches are well adapted, and there can be no better proof thereof than the fact that they are largely used in Africa and Australia (notwithstanding English influence naturally predominates

in those countries), to say nothing of Mexico and South America.

These coaches are made almost wholly of wood ; there is little about them that ordinary country mechanics cannot repair ; they have no expensive steel springs, but leather thorough-braces which can be replaced by the roughest workman ; they are loose and flexible in their movements ; bear an immense amount of hard usage without being disabled, and run safely over roads which would dislocate an English coach in the first half-mile. Other points in connection with these coaches will be noted in the remarks on the American system of driving in Chapter XIV.

## CHAPTER VIII

## COMPARISON OF COACHES

PLATES II., VII., XI., XII., XVII., XVIII., XIX., XX., and XXII., give drawings of coaches of various types, all drawn to the same scale, one-half inch to the foot, and printed *dry*,\* so that the dimensions are accurately shown. The duplicate plates, on transparent paper, can be torn out and superposed on the different plates for the purpose of comparison.

The coaches in Plates VII., XVII., XVIII., XIX., XX., and XXII., being of the same period (1873 to 1896), differ mainly in details. It will be noticed that XX. is longer than the others between the axles,—a good point; XXII. is much lower than the others. The relative sizes of the boots, places of driving-seats, and foot-board angles, are of interest.

Since the bodies in all the coaches are nearly of the same size, the differences of form and detail may be most clearly observed by so placing the transparent sheet that the ground lines and the front or the back lines of the bodies coincide in the

---

\* That is, printed on paper which has not been wetted for printing. The scale of the drawing has not been affected, therefore, by shrinkage.

drawings. The outlines of the bottoms of the bodies will be seen to vary, some being rounder than others. The heights of the foot-boards from the ground also vary, that of XX. being somewhat too low; otherwise the proportions of the driving-seat and foot-board of XX. are exceptionally good. In XVIII. and XIX. the foot-board and driving-seat are somewhat too high, the persons on the box-seat cutting off the view from those on the roof-seat. It is desirable to have the box-seat at least three inches lower than the roof-seat; in XX. it is five. The foot-board angles in VII., XVII., XVIII., XIX., XX., and XXII. are practically identical, ranging from 30 to  $33\frac{1}{2}$  degrees, and are very good; a greater angle tires the ankles of the coachman, and a lesser one places his feet too flat. The foot-board of XI., with an angle of 40 degrees, is somewhat too steep.

The coach shown in Plate XXII. differs from the other coaches in having its top much lower. This is brought about by making the body itself slightly smaller, and by hanging it closer to the perch, a somewhat smaller hind wheel being adopted, thus lowering the axle. Lowering the centre of gravity is of course an advantage; here it is obtained at the cost of smaller hind wheels, of a low foot-board, and of a low roof-seat.

The foot-boards of XX. and XXII. are somewhat too low; a large horse might touch them with his rump, unless the traces are longer than is desirable.

A high foot-board and a steep front to the boot

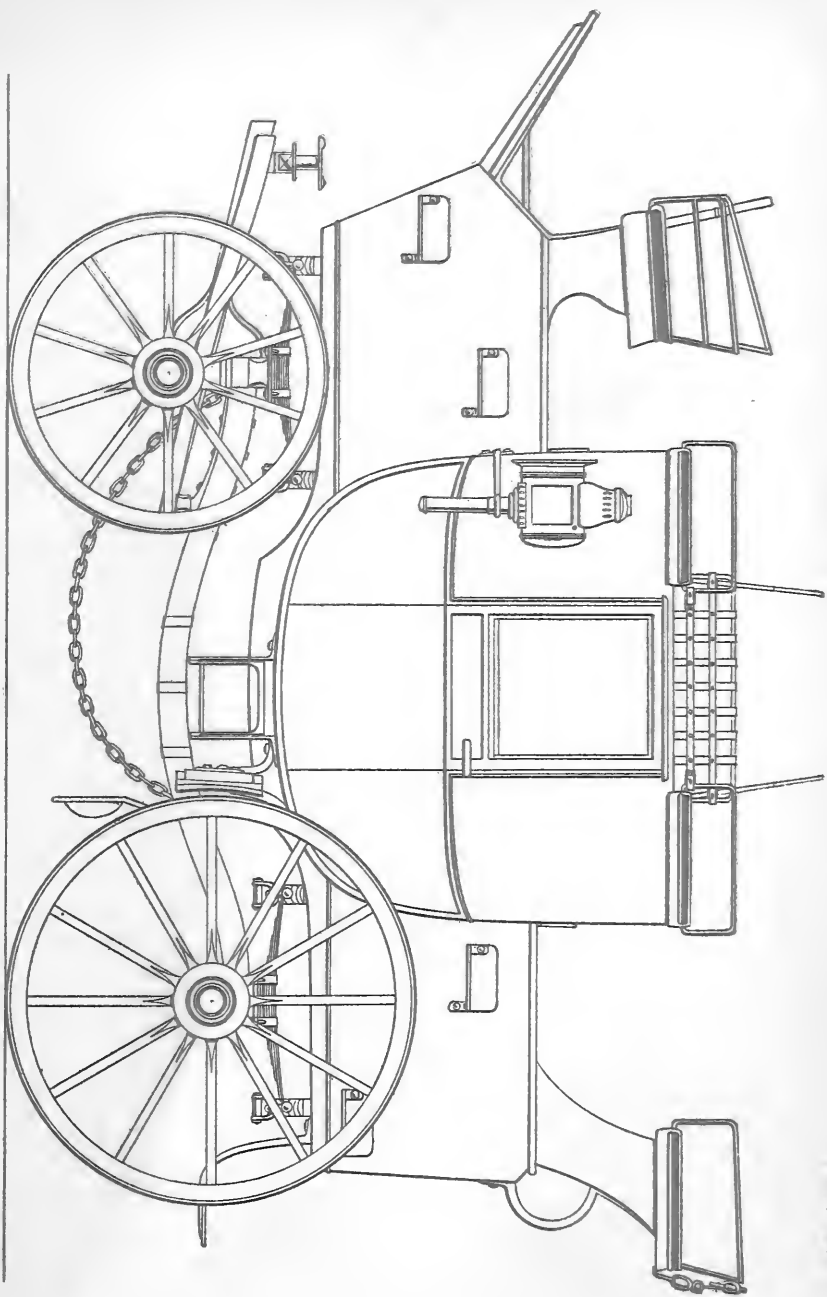

Scale of Feet.

ROAD-COACH BY BREWSTER & CO., NEW YORK.

ROAD-COACH BY BREWSTER & CO., NEW YORK.  
Scale of Feet.

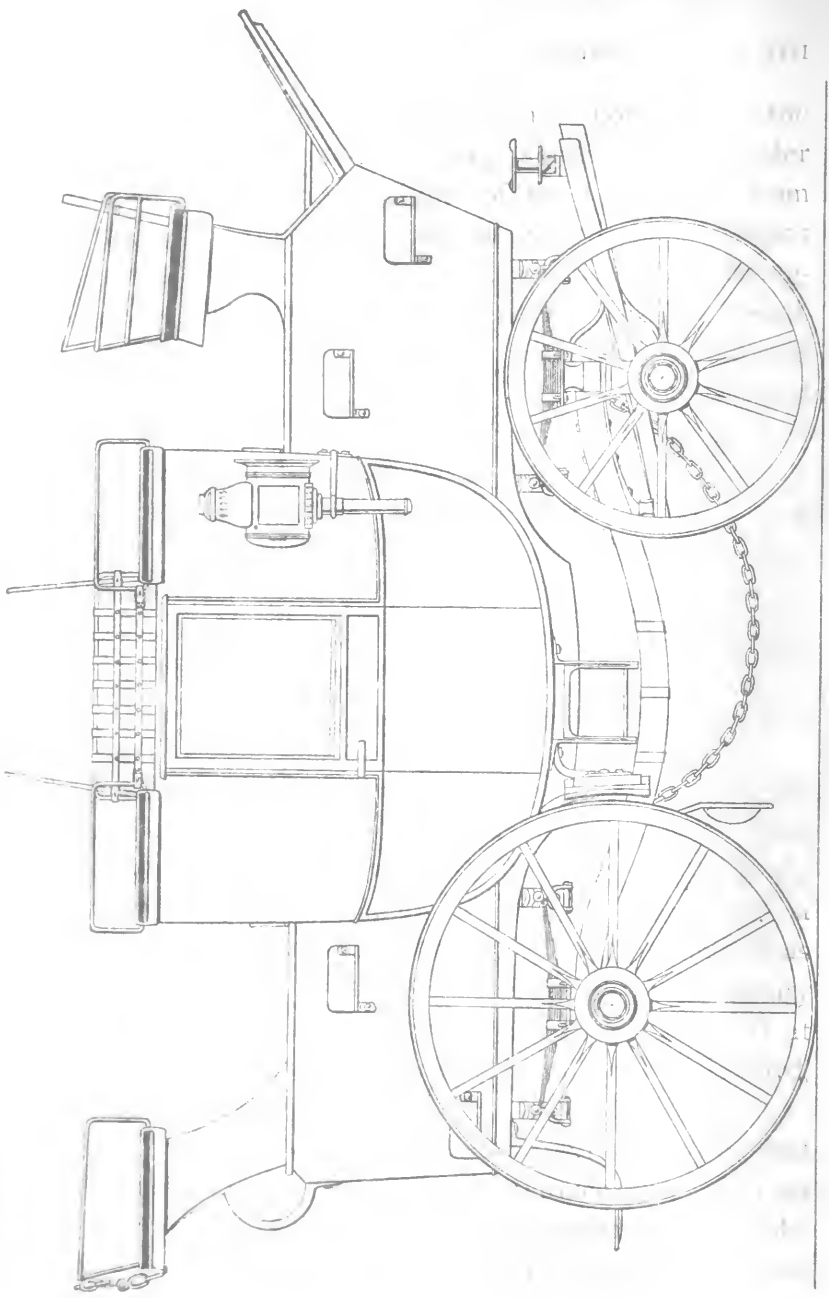



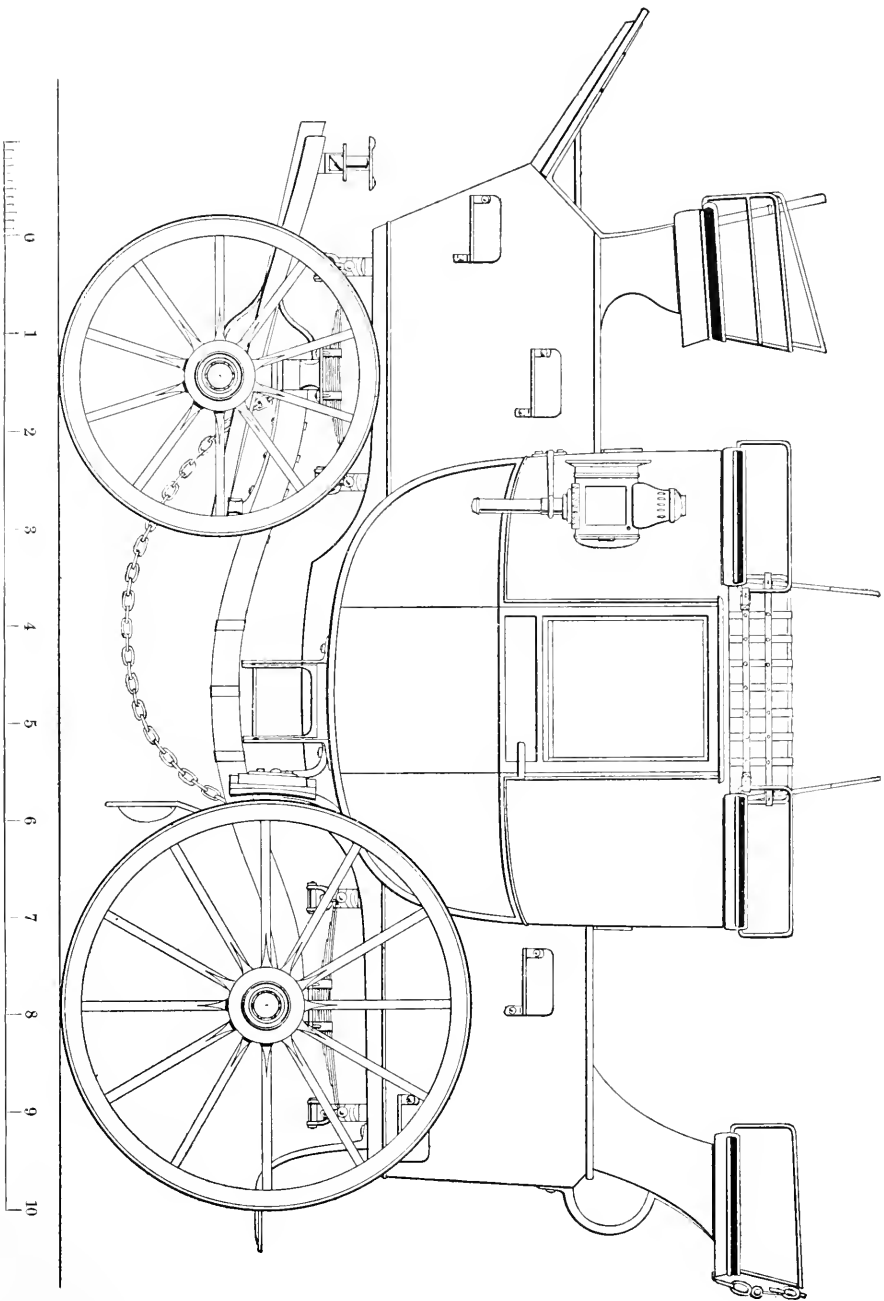

Scale of Feet.

ROAD-COACH BY BREWSTER & CO., NEW YORK.

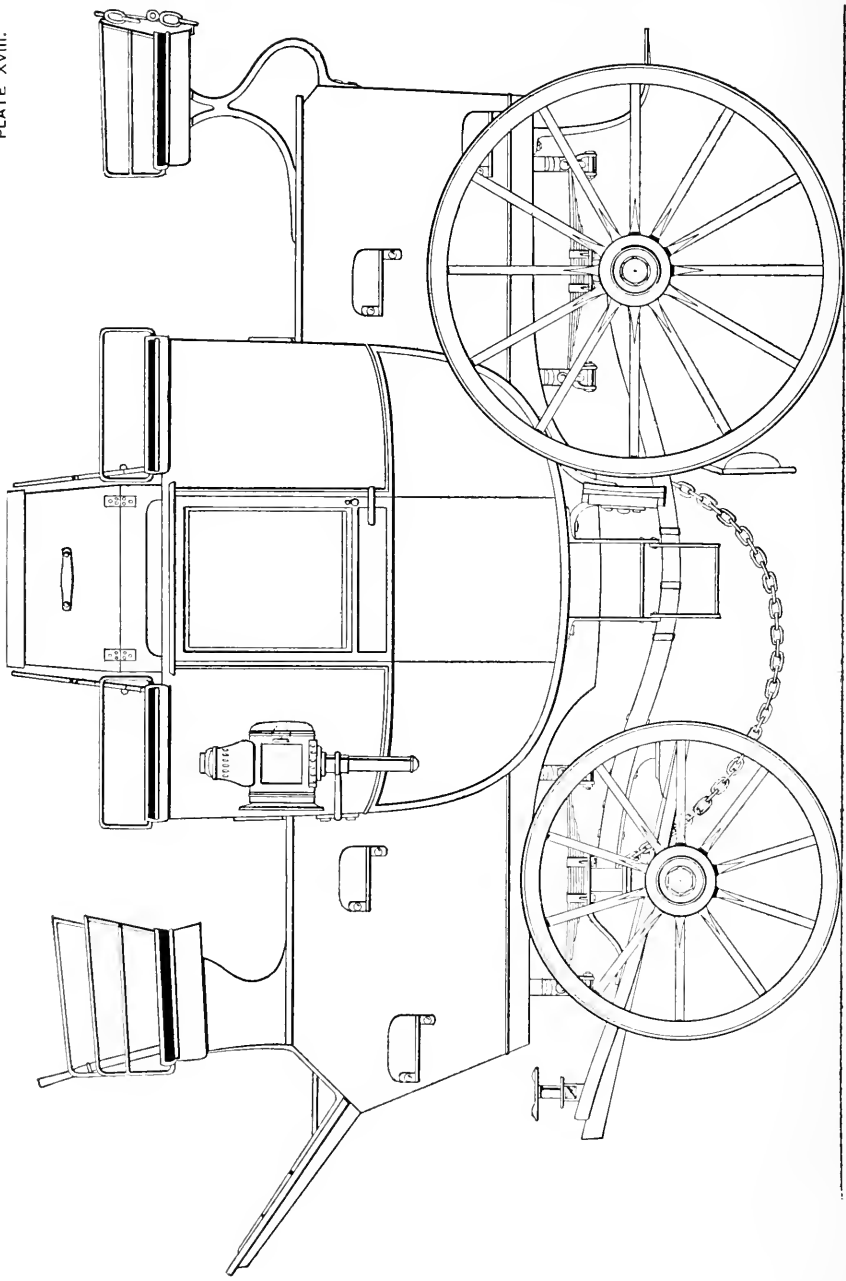

Scale of Feet.

DRAG BY BREWSTER & Co., NEW YORK.

DARG BREWSTER & CO., NEW YORK.  
RIVAD-COACH - QUIET & Co., PARIS

Scale of Feet.

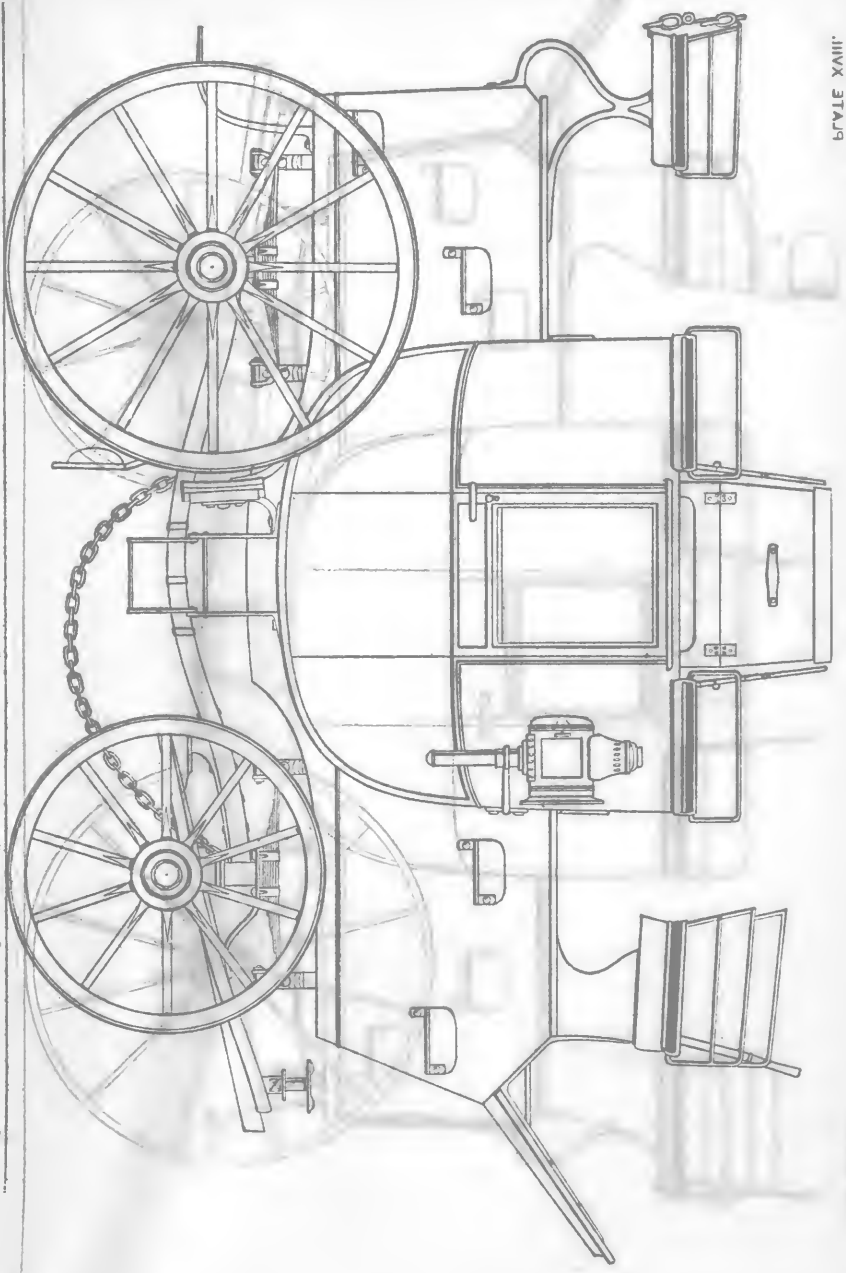

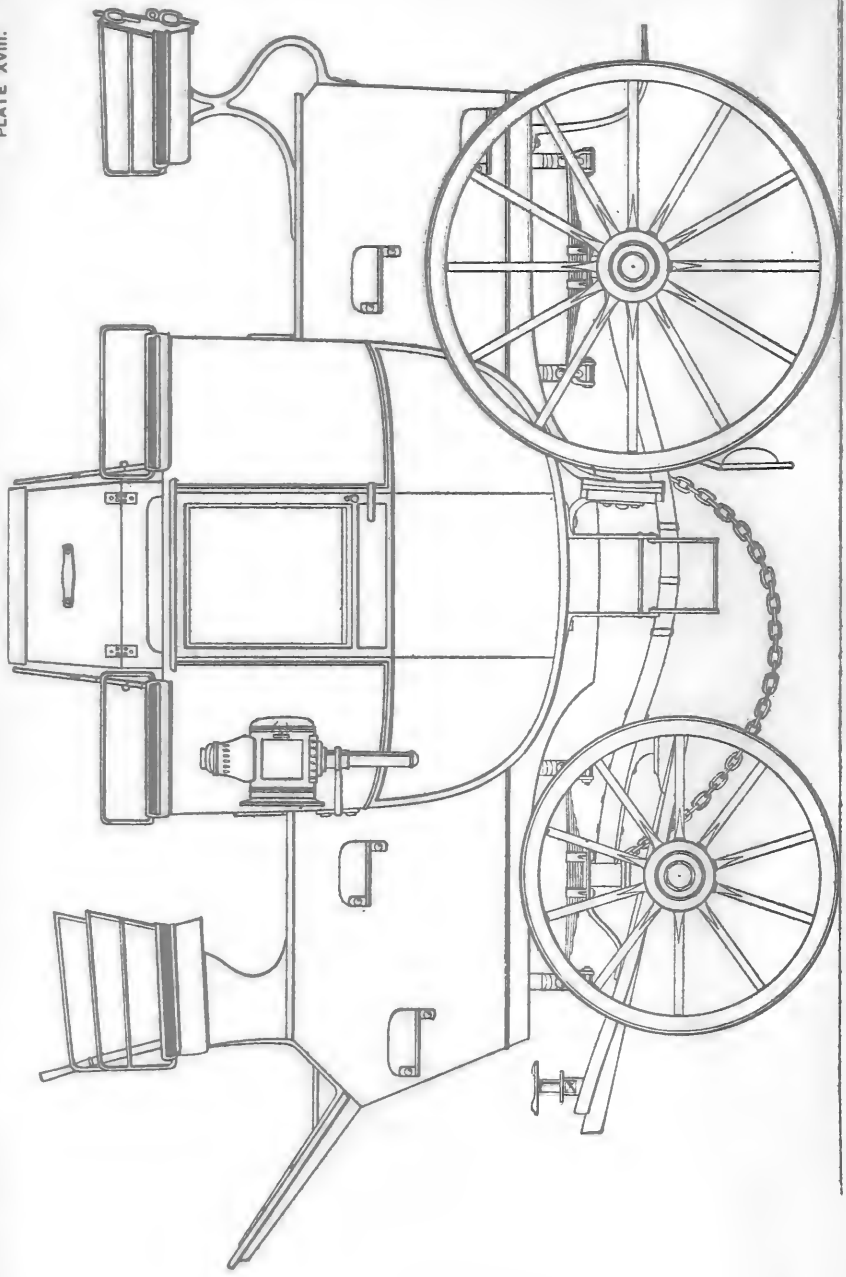

Scale of Feet.

DRAG BY BREWSTER & Co., NEW YORK.

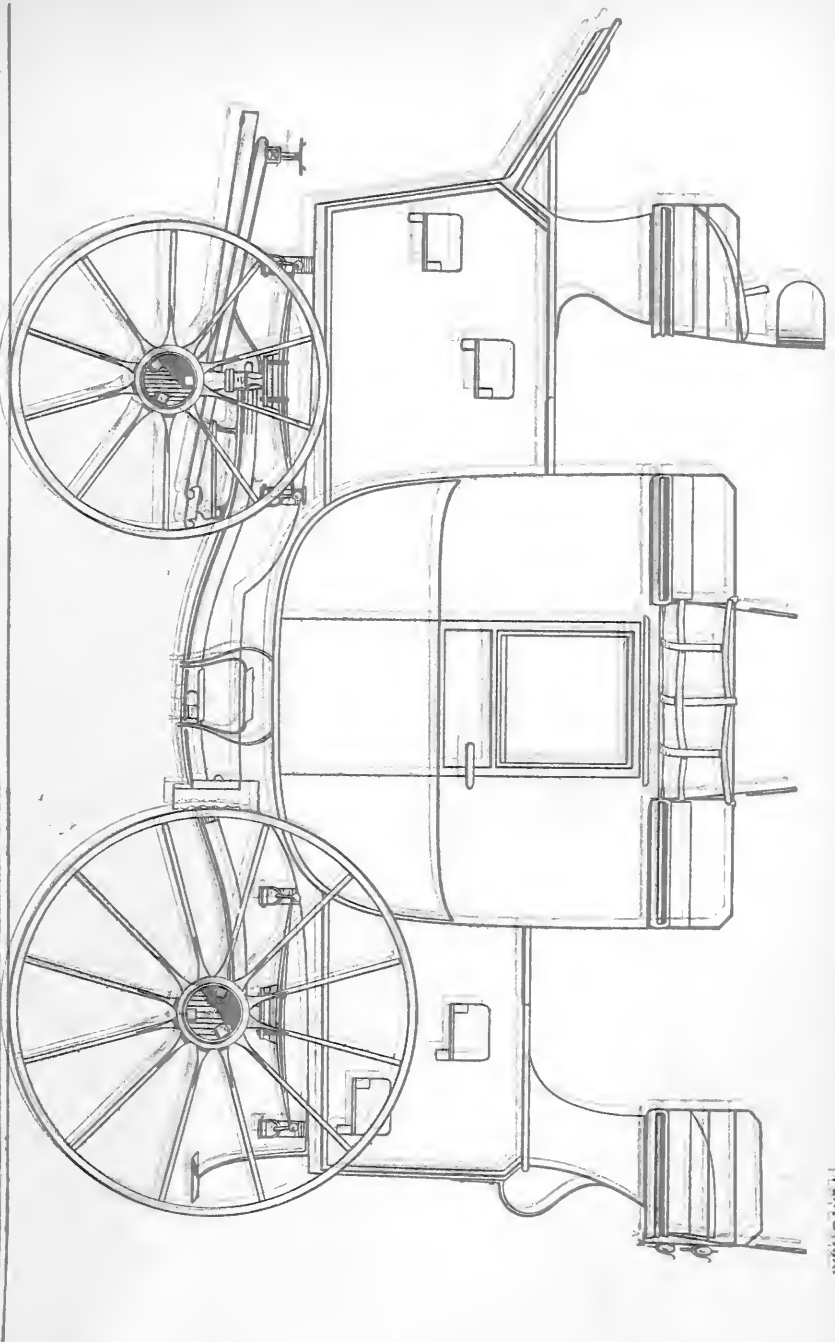

Scale of Feet.

ROAD-COACH BY GUIET & CO., PARIS.  
ROAD-COACH BY GUIET & CO., PARIS.



ROAD-COACH BY GUIET & Co<sup>s</sup> PARIS.

ROYAL WAGON FOR THE IMPERIAL GARDE

Scale of Feet.

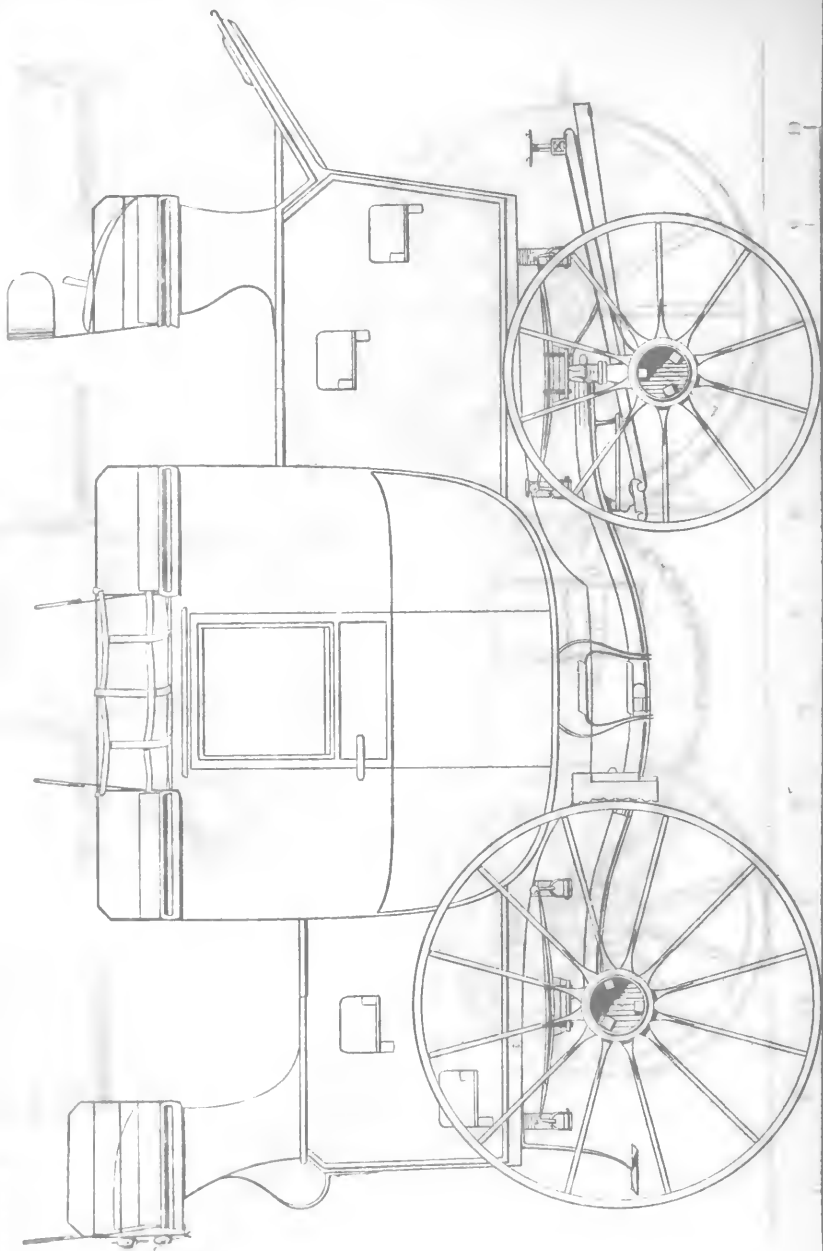
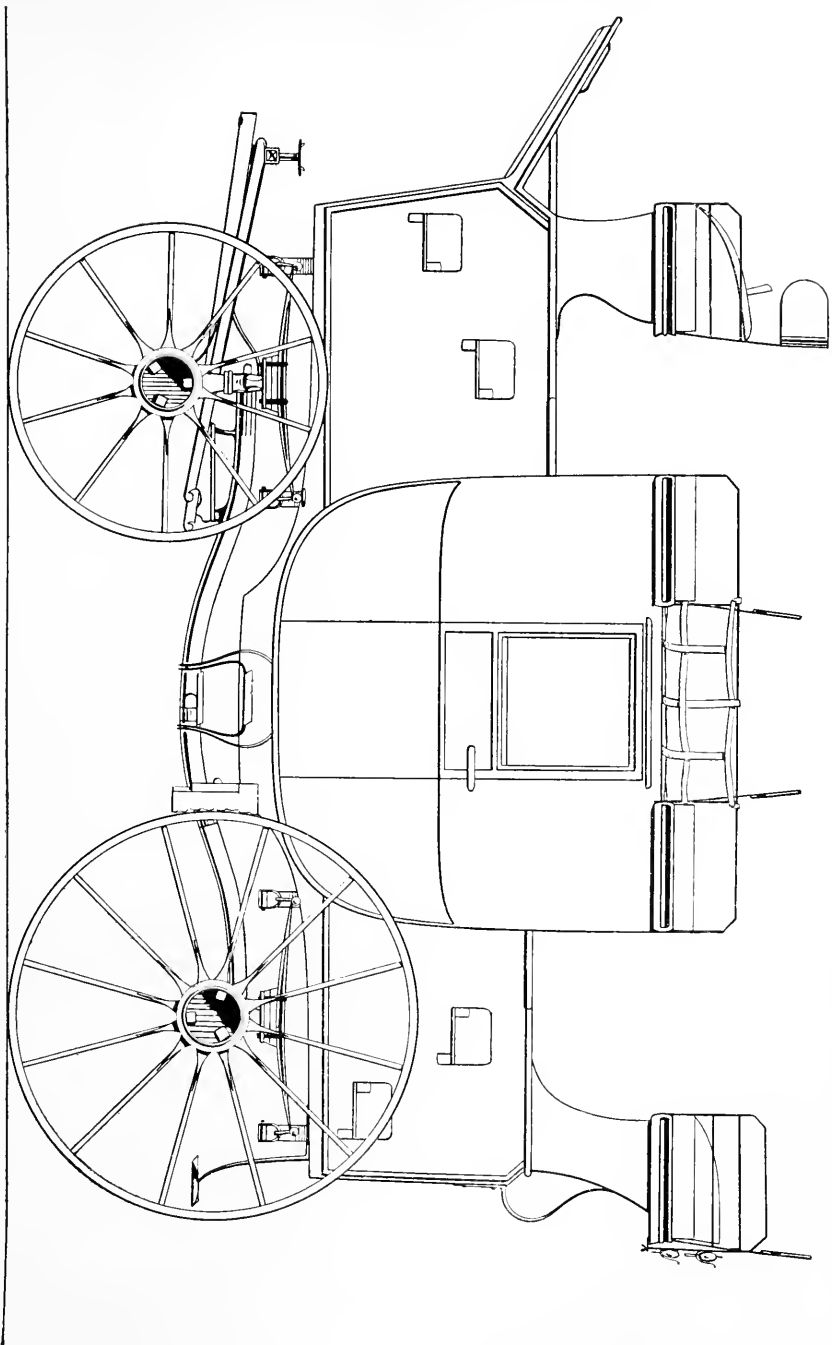
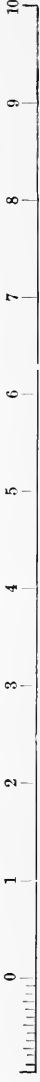
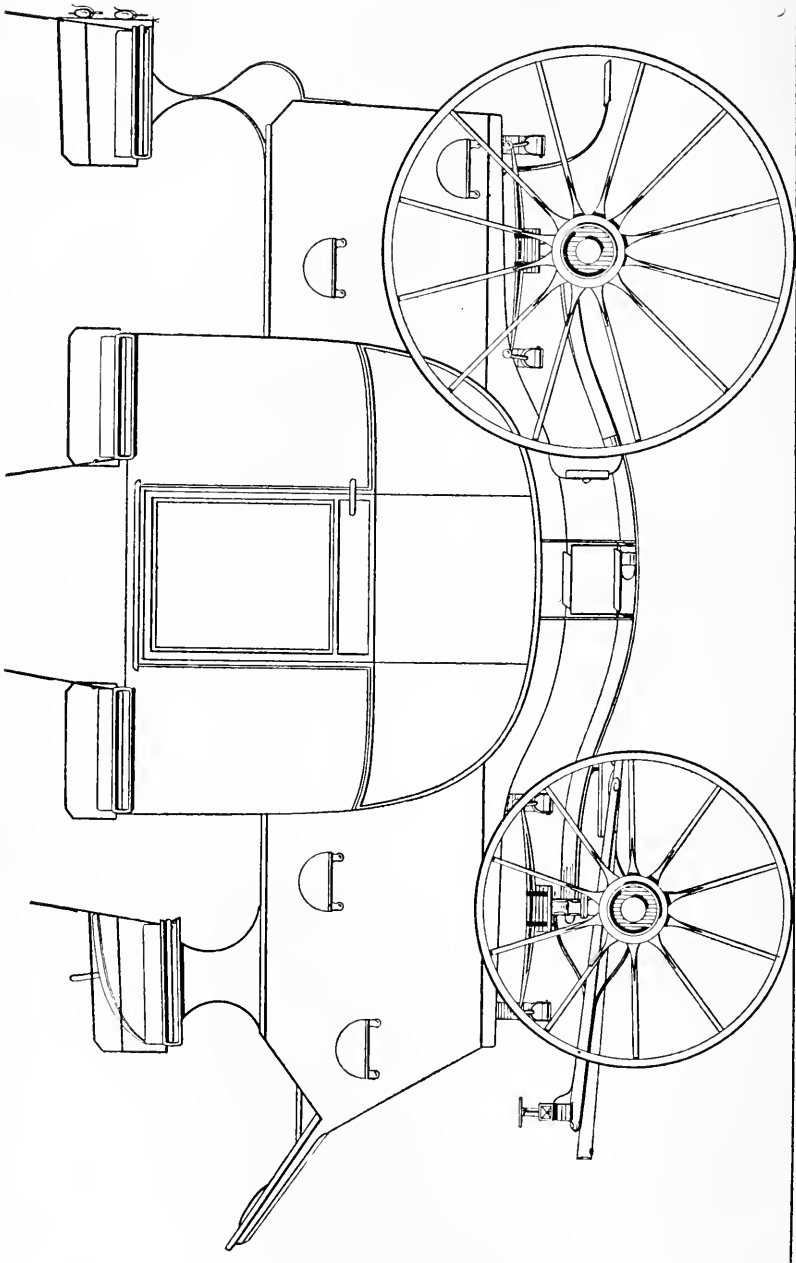

PLATE XIX.



Scale of Feet.

ROAD-COACH BY GUIET & Co., PARIS.



Scale of Feet.

DRAG BY BARKER & Co., LONDON.



Scale of Feet

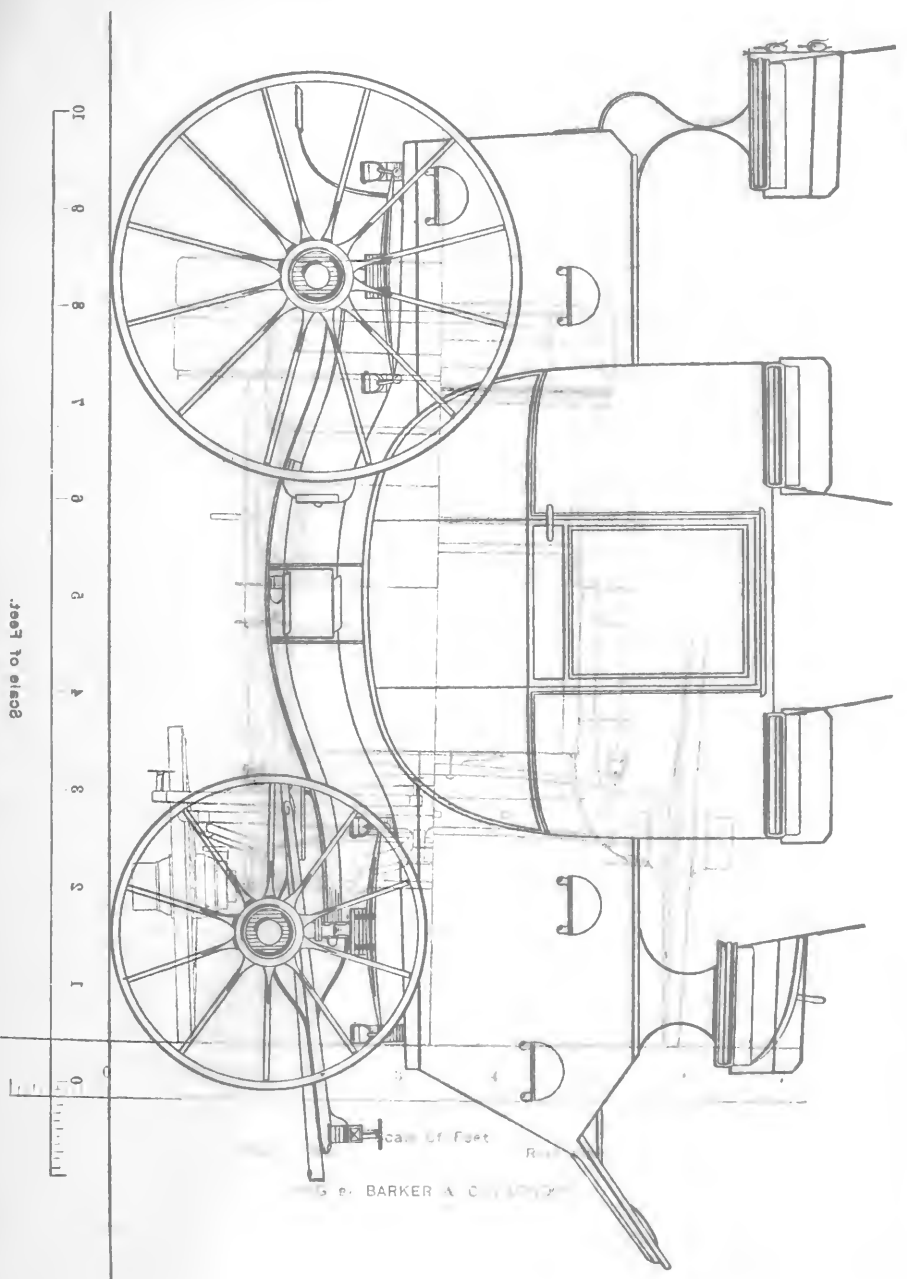

B. BARKER & CO. LONDON

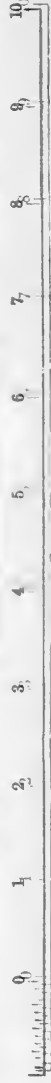
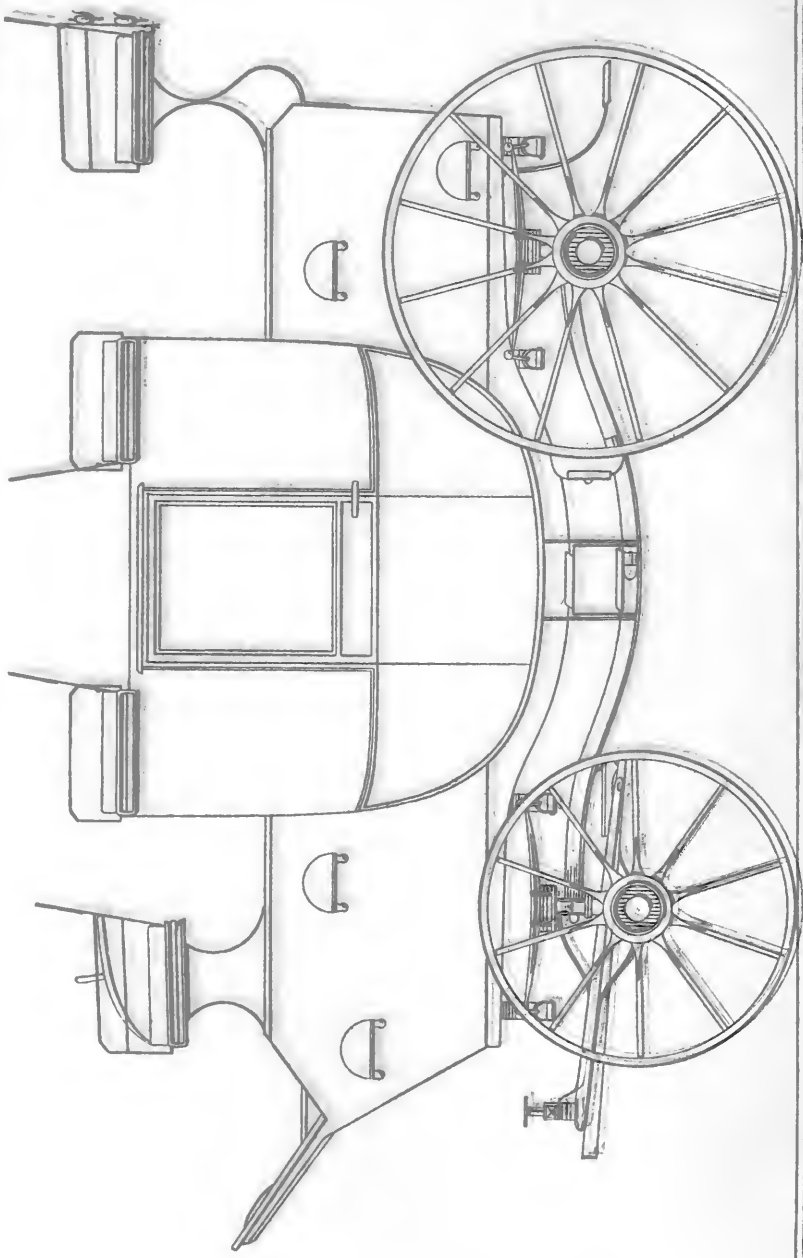

Scale of Feet.  
DRAG BY BARKER & Co., LONDON.

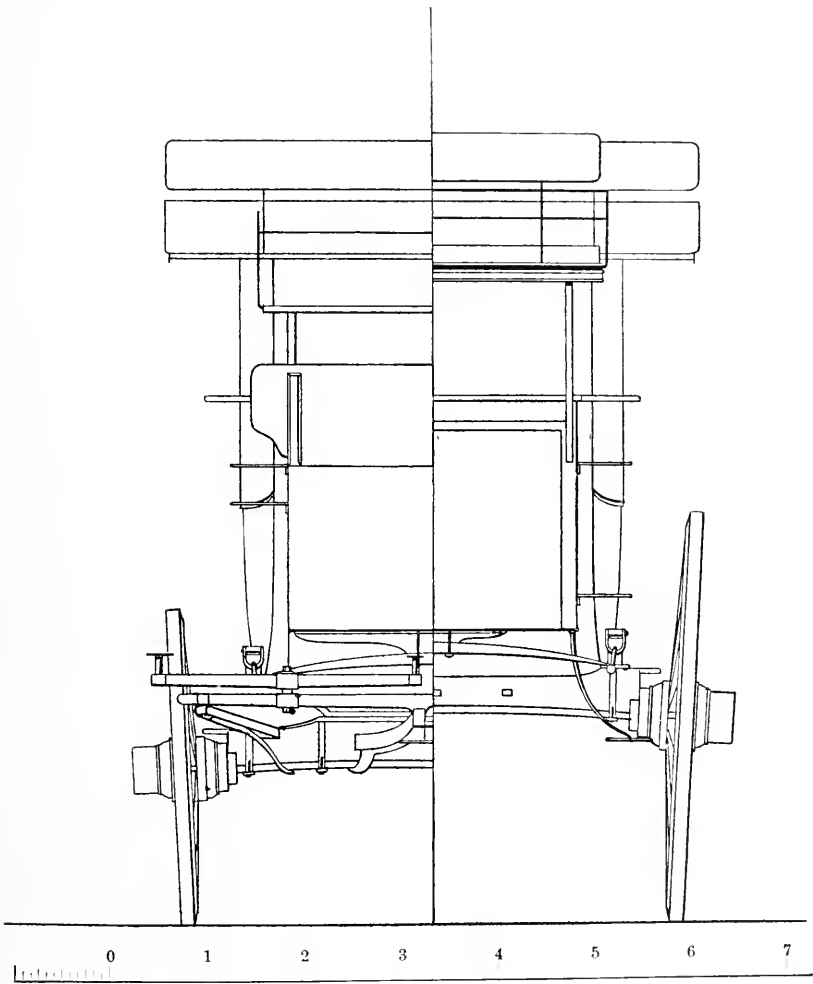

Scale of Feet.  
FRONT VIEW. REAR VIEW.

DRAG BY BARKER & Co., LONDON.

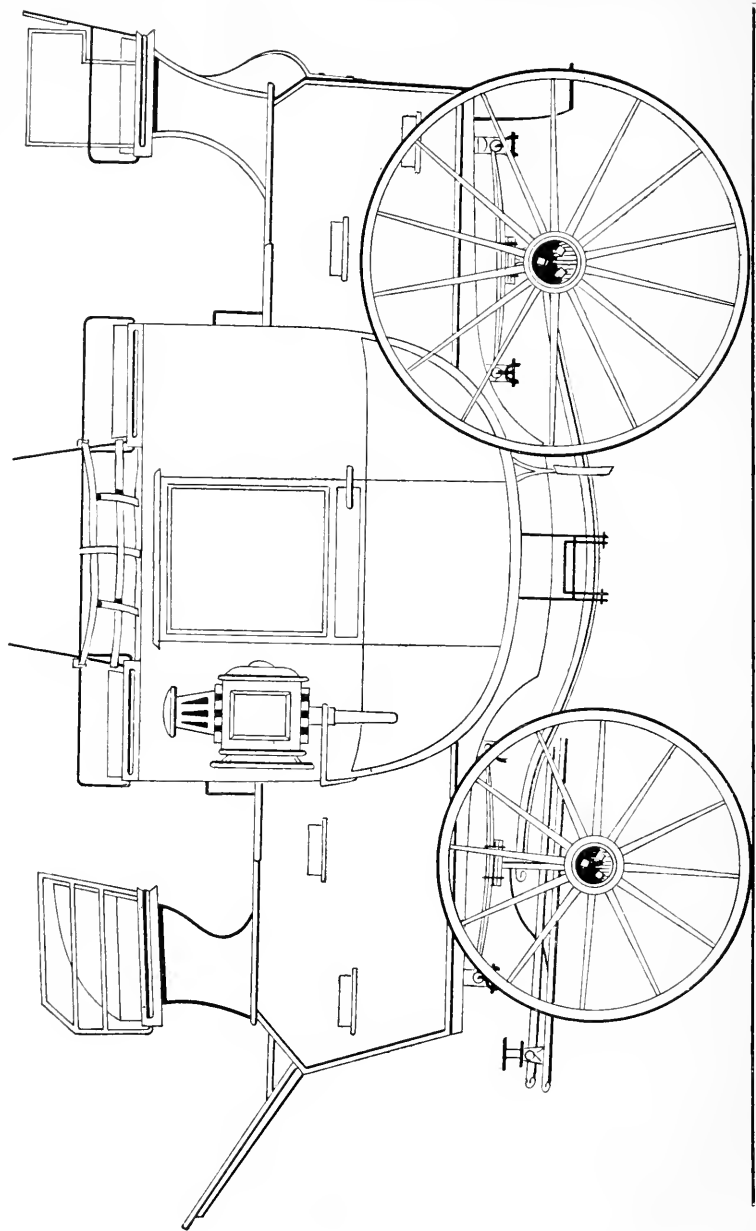

Scale of Feet.

ROAD-COACH BY F. & R. SHANKS, LONDON.

Scale of Feet.

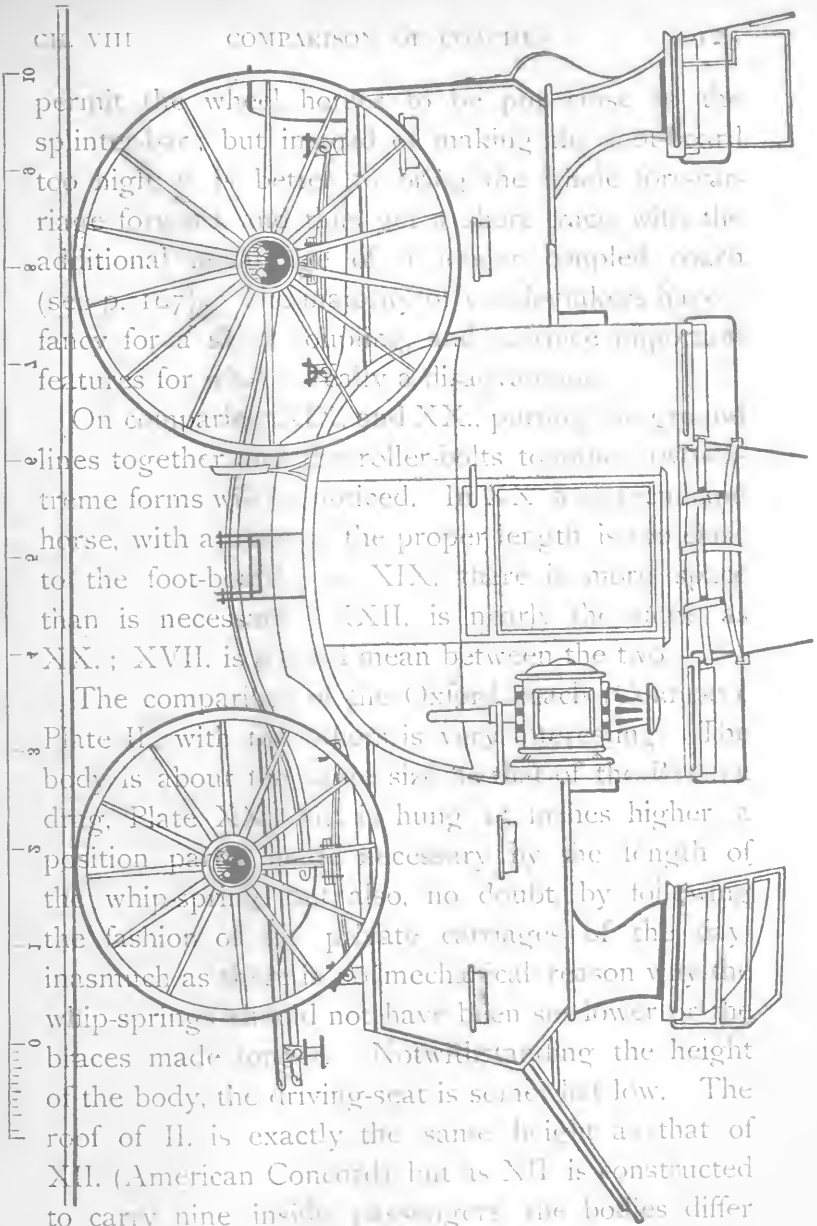

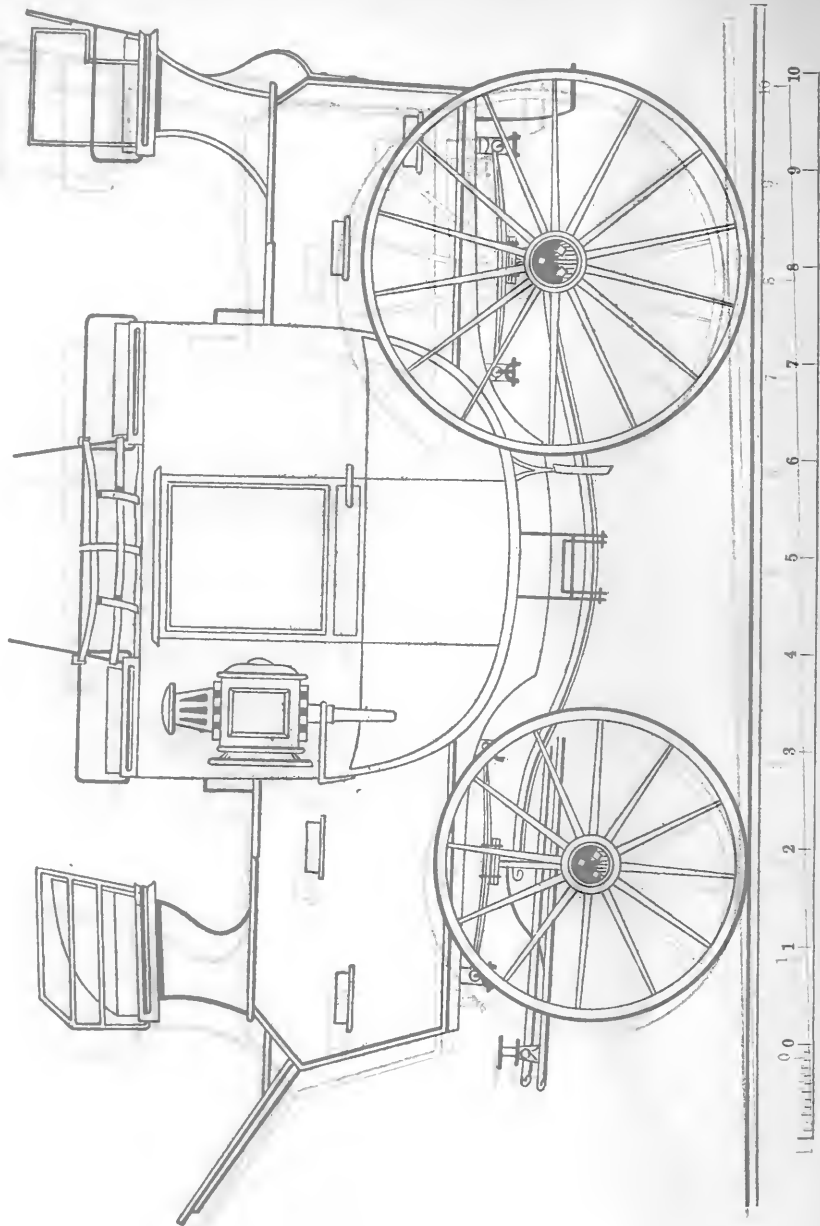

Scale of Feet.  
ROAD-COACH BY F. & R. SHANKS, LONDON.

permit the wheel horses to be put close to the splinter-bar ; but instead of making the foot-board too high, it is better to bring the whole fore-carriage forward, and thus get a short trace, with the additional advantage of a longer coupled coach (see p. 167). The majority of coach-makers have a fancy for a short coupling, and sacrifice important features for what is really a disadvantage.

On comparing XIX. and XX., putting the ground lines together and the roller-bolts together, two extreme forms will be noticed. In XX. a sixteen-hand horse, with a trace of the proper length, is too close to the foot-board ; in XIX. there is more space than is necessary ; XXII. is nearly the same as XX. ; XVII. is a good mean between the two.

The comparison of the Oxford coach (CORDERY), Plate II., with the others is very interesting. The body is about the same size as that of the BARKER drag, Plate XX., but is hung 13 inches higher, a position partly made necessary by the length of the whip-spring, but also, no doubt, by following the fashion of the private carriages of the day, inasmuch as there is no mechanical reason why the whip-springs should not have been set lower or the braces made longer. Notwithstanding the height of the body, the driving-seat is somewhat low. The roof of II. is exactly the same height as that of XII. (American Concord), but as XII. is constructed to carry nine inside passengers, the bodies differ extremely.

The distance between the axles of XII. is made necessary by the length of the body and of the thorough-braces.

The hind wheels of II. and of XII. are of the same size, and much larger than in any of the other plates.

Plate XI. shows a break designed by me many years ago for my own use, and a comparison of it with the coaches, shows that it preserves their main proportions, while being much lighter; weighing only 1600 pounds. As in almost all breaks, the horses are from six to ten inches further away from the coachman than they are in a coach. This distance can be diminished by putting the front wheel further under the body, but somewhat to the detriment of the steady running of the vehicle and of its appearance.

#### CARE OF THE COACH

As soon as the coach returns to the stable after use, it should be washed, and under no circumstances should mud be allowed to dry on it, since that will inevitably spot the varnish. There is no way of washing so good as with a stream from a hose, where water under pressure is available; failing this, water must be dashed on the carriage from a bucket. As the under part of a coach is much more complex than that of an elliptic-spring carriage, it is more difficult to wash, and the man must get under the coach to do it thoroughly. Where plenty of water can be had there is little



necessity for using a sponge, and the water should be dried off with a damp chamois leather. Sponges should be carefully selected and examined; they almost always contain gritty lumps, which are sure to scratch the varnish.

There is no great art in washing a carriage, except to exercise care and not to be in a hurry. India-rubber boots should be provided for the washer; in French stables he wears sabots.

Water must not be allowed to go through the joints of the doors so as to wet the linings and carpet.

The blueness of the varnish on the dark parts of a coach, resulting from a long wetting by rain, will disappear after complete drying.

Little need be done to the steel-work at first, except to dry it thoroughly. At the first convenient time, generally the morning after the coach has been used, it must be polished. If it is much rusted by exposure to the damp, *very* fine emery cloth may be used to brighten it, and it should be afterward burnished by rubbing with the chain rubber (see Fig. 121) until a high polish is obtained.

A piece of hard, steel chain, made exactly like a curb-chain, but about two feet long, is the best thing for burnishing a pole-head; it can be pulled back and forth over it with a great pressure.

A long piece of chamois leather dusted with flour of emery may be used to advantage on the pole-

head, but coarse grit will scratch the surface and make it impossible to get a proper polish. Care must be taken not to rub off the paint where it joins the steel. Nothing shows good stable-care more emphatically than really well-kept steel, and only hard work will bring about the desired result.

In taking off the wheels for oiling, a small table or chair, or at least a paper spread upon the floor, should be used to receive the nuts, washers, and pins; if laid upon the floor they are sure to get grit upon them, which will damage the finely finished axle. The old oil must be carefully removed and all the parts scrupulously cleaned before re-oiling and putting together. On a private coach, Collinge axles run from one to two months without attention, but mail axles require oiling once a week, and on road-coaches it is usual to clean and oil the axles every day, and at the same time to make a thorough examination of all nuts and bolts. When washing a coach, public or private, the washer should always bear in mind the necessity of examining every part of it, to see whether all is in good order.

#### COST OF A COACH

The cost of a coach depends upon its finish and the locality where it is built. For what may be called a standard drag, built in the very best way, the price is usually in America 2400 dollars, in England 300 guineas, and in France 8000 francs.

## CHAPTER IX

## WEIGHT OF A COACH

THE weight of a drag varies from 2100 to 2400 pounds, and of a road-coach from 2200 to 2600 pounds. It is not worth while to go beyond these limits in either direction. A drag lighter than 2100 will not stand the hard usage that an enterprising coachman will give it, and will go to pieces before its time, besides giving constant trouble, and nothing is gained in strength or stability by exceeding 2400. A road-coach is loaded more heavily than a drag, and driven faster; consequently it should be both stronger and heavier, but need not exceed 2400 pounds.

'NIMROD,' in *The Road* (1832), and MACNEILL (1830),\* give the weight of the stage-coach of that day as 18 cwt. (2016 pounds), and there is no doubt that stage-coaches were then generally lighter than they were made afterward. 'NIMROD' (*Northern Tour*, 1834, p. 13) speaks of coaches as being, always under one ton (2240 pounds).

The more of the whole weight there is in the carriage-part and the less in the body the better, since the great object is to keep the centre of

---

\* PARNELL, *Roads*, p. 333.

gravity low, and the carriage-part has to bear the major part of the strains.

The following Table shows the distribution in several examples :—

	CARRIAGE.	BODY.	TOTAL.
Road-Coach . . . .	1367	1499	2866
	477	523	1000
Mail . . . . .	1323	1389	2712
	488	512	1000
Drag . . . . .	992	1257	2249
	441	559	1000
Road-Coach . . . .	1582	890	2472
	640	360	1000

The larger figures give the weight in pounds, the smaller ones the parts in 1000. The Table shows somewhat wide differences of design, the last example being one in which pains were taken to get a very light body for a heavy carriage-part.

Figures of this kind are only approximately correct, unless all the coaches compared are weighed by the same person, since the weights given by different makers may not always include the same parts. For the purpose of this comparison the coaches should be in the condition in which they are to go on the road, with cushions, seat-backs, &c., the separation between the body and the carriage-part being made at the blocks which are on top of the springs. Neither the pole nor the chain and shoe should be included.

The distribution of the weight between the front and hind wheels is important ; usually there is more

than half on the front wheels, and this seems unavoidable, but as the hind wheels are the larger they should have more to carry.

In omnibuses this is usually well arranged, since, there being no door in the side of the body, the axle can be placed well forward. They consequently run light.

In coaches the distribution of weight between the front and hind axles is as follows :—

	FRONT.	HIND.	TOTAL.
Road-Coach . . . . .	1532	1334	2866
	535	465	1000
Mail . . . . .	1455	1257	2712
	537	463	1000
Drag . . . . .	1219	1030	2249
	542	458	1000

As in the preceding Table, the smaller figures show the parts in 1000.

If it is borne in mind that there are frequently five or six persons on the front of a drag and only two servants on the back, the overloading of the front wheels becomes more apparent, and suggests an additional reason for not putting the front wheels too far under the body.

The weights here given are taken without the pole. It must be noticed that the pole, projecting so far in front, will add by its leverage more than its own weight to the front wheels, the difference being taken off the weight on the hind wheels. This can be more readily appreciated by reflecting that a pole might be made so long that, with a comparatively

small weight on its end, it could balance the weight on the hind wheels so as to lift them off the ground, and thus concentrate the whole weight on the front wheels without adding very much to the total weight. The influence of a pole weighing, with its bars, 60 pounds, is shown in the following Table. The weights, as shown on the scale, were as follows :—

On front wheels, without the pole	. pds.	1213	1213	
„ „ with „ „	. „	1345	....	1345
Increased weight on front wheels	. „	132,		
On hind wheels, without the pole	. „	1253	1253	
„ „ with „ „	. „	1186	....	1186
Decreased weight on hind wheels	. „	67,	2466	2531

The increased weight on the front wheels is due, one-half to the weight of the pole and one-half to the 67 pounds taken off the hind wheels, but the total weight, 2531, is only 65 pounds more than the weight of the coach without the pole.

The weights are given as they came out in the experiment; theoretically, they should balance exactly, but inaccuracies in the scales cause the small discrepancy.

The distribution of the weight on the front wheels and hind wheels depends also upon the inclination of the road.

The following Table gives the results of an experiment with a coach weighing 2200 pounds :—

	WEIGHT ON		
	FRONT WHEELS.	HIND WHEELS.	TOTAL WEIGHT.
On a level . . . . pds. .	1194	1006	2200
Hind wheels raised 3 inches „ .	1204	994	2198
Front „ „ „ „ .	1190	1014	2204

Therefore in going up-hill, a portion of the weight is transferred to the hind wheels, which is an advantage, since they are larger than the front wheels.

For comparison, the following average weights of different vehicles are given : A *Char à bancs* Break, 1600 pounds ; Mail-Phaëton without perch, 800 ; City Brougham, 1000 to 1100 ; Landau, 1500.

#### CENTRE OF GRAVITY

We now come to one of the divisions of our subject, important from a practical point of view :—the position of the centre of gravity of a coach.

The centre of gravity of a body is that point in which its whole weight may be considered as concentrated ; in a symmetrical body of equal thickness and equal density in all its parts, it is at the centre of figure of the body. For example, a square piece of board of even thickness will have its centre of gravity at the point at which its two diagonals cross (Fig. 64).

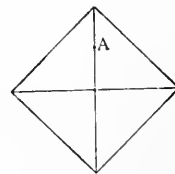

FIG. 64.

If at that point we bore a hole, and hang the board on a smooth pin, the board will remain in any position into which we turn it, be-

cause the centre of suspension and the centre of gravity coincide.

If we suspend it from some other point, A, we find that the board will hang steadily in one position only, namely: when the centre of gravity is vertically under the point of suspension.

If we flatten one corner slightly, as shown in Fig. 65, we can make the board stand upon it, when G is vertically above A, but it will be in unstable equilibrium and will fall to the right or left at the slightest touch. We therefore say that the board is in equilibrium when the centre of gravity is vertically above the point of support. Conversely, the centre of gravity is vertically above the point of support when the body is in equilibrium.

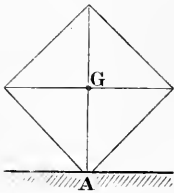

FIG. 65.

Now, a coach, looked at from behind, is symmetrical as to the distribution of its parts about its vertical centre line, and its centre of gravity must be, therefore, somewhere in that centre line.

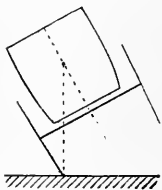

FIG. 66.

If we tip the coach on the two wheels of one side until it exactly balances and would fall to either side, the centre of gravity must be in the vertical line passing through the point of support. Since it is *also* in the centre line of the coach, it must be at the intersection of these two lines, as shown in Fig. 66.

We can determine by this experiment the angle



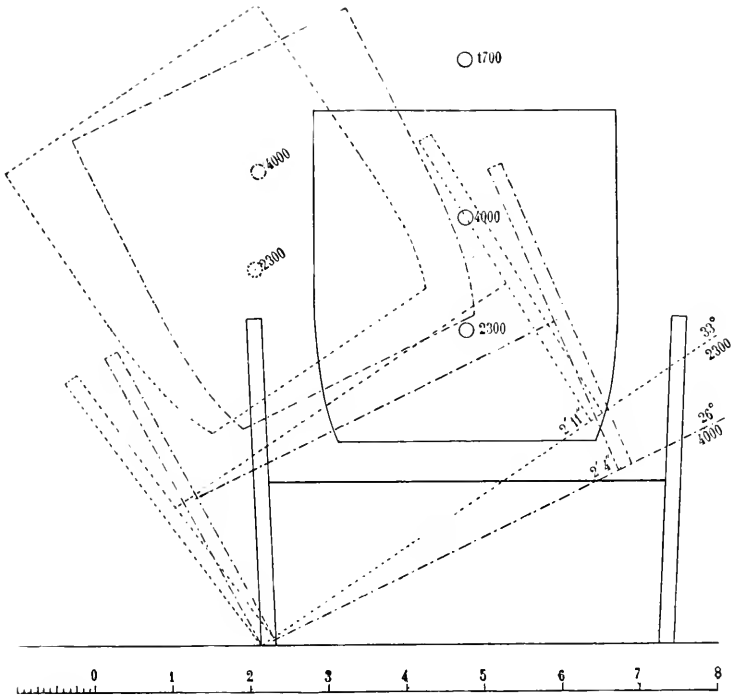

DIAGRAM SHOWING POSITION OF CENTRE OF GRAVITY.

Since a coach is symmetrical, the centre of gravity is at some point in a plane passing vertically through the centre of the body. When the coach is tipped on the wheels of one side until it balances and would fall either way, the centre of gravity is over the point of support, and must therefore be in a plane which passes vertically through the points where the wheels rest on the ground.

In the case of an empty coach experimented with, the balance was found when the wheels on the higher side were raised to the position shown by the dotted lines . . . . .

With a load of 1700 pounds added on the top, the position of balance is shown by the lines . . . . .



at which the coach will tip over, or, what is the same thing, the elevation of the wheel on the higher side which will cause it to balance.

It will be evident by comparing diagrams A and B in Fig. 67, that the lower the centre of gravity for the same wheel-base, the higher the wheel must be raised to cause a tip-over; whence the importance of keeping the centre of gravity low.

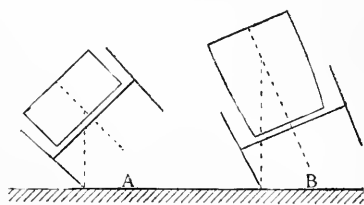

FIG. 67.

To be strictly accurate, we must say that we have thus far only found a horizontal line passing through the body of the coach, in which line the centre of gravity is somewhere situated. If we wish to know the position of the *point*, we must go through the same operation for the *side* of the coach, but since a coach never turns over forward or backward, where the centre of gravity is situated lengthwise is of small moment, and the relative weights on the front and hind wheels will show it with sufficient accuracy.

Plate XXIII. shows the method of tipping a coach for the purpose of finding the position of its centre of gravity. A drag weighing, without any load, 2300 pounds, was tipped until it exactly balanced on the wheels of one side. The vertical line passing through the point of support, intersected the centre line of the coach at the point marked 2300 (which

is therefore the position of the centre of gravity), at a point 4 feet above the line joining the bottoms of the wheels (that is, 4 feet from the ground when the coach is standing level). The elevation of the higher wheel is 2 ft. 10 in., and the inclination is 34 degrees.

If the coach is loaded on top with twelve persons, weighing together 1700 pounds, the centre of gravity of this additional load will be at the point marked 1700; and the resultant centre of gravity of that additional weight and of the empty coach, will be at the point marked 4000, which is 5 ft. 6 in. from the bottom of the wheels, the whole weight being 4000 pounds.

If the coach is now tipped, the centre of gravity having been made higher, will come sooner into the vertical line over the point of support, and the coach will balance when the higher wheel is 2 ft. 4 in. from the horizontal line or the inclination 27 degrees.

It is evident that a very considerable elevation of the road sideways is required to upset a coach at rest, but it must be noticed that for some time before reaching the actual balancing point the coach becomes very *tender*, to use a yachting expression. For instance, in the case of the unloaded coach, when the upper wheel was 2 ft. 6 in. from the floor, the coach seemed on the point of balancing, although 4 inches more elevation was actually required to make it do so. When, therefore, even a slight horizontal force is acting on the coach, an

elevation of the wheel very much less than that required to make the coach balance, will result in an overturn.\*

Since the whole weight of the coach may be considered as concentrated at the centre of gravity, any sideways force, resulting from the momentum of the coach, will act through that centre.

If, from going fast over a bad road or from the horses galloping unevenly, a coach gets to swinging laterally, the higher the centre of gravity, the more readily will the coach turn over, since it is obvious that a horizontal force applied to the coach near the top (as at A, Fig. 68) will pull it over more readily than the same force applied nearer to the ground (as at B).

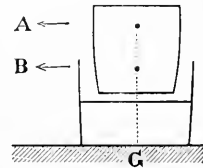

FIG. 68.

**CENTRIFUGAL FORCE.**—The danger in turning a corner is increased by a high centre of gravity. A body in motion has, by reason of its inertia, a tendency to continue its motion in the original direction until it is acted upon by some exterior force. A coach going along a straight road is deflected, when it comes to a corner, by the horses pulling

---

\* CORBETT, p. 26, quotes some experiments made by VIDLER in 1820, in which it is stated that in the case of a mail, the wheel was raised 26 inches without an upset, and in the case of a 'double bodied coach,' 31 inches, but he does not say whether this was exactly the point of balance, or not.

it round the turn ; it has, however, a tendency to keep on in the straight line, and this tendency is shown as a force acting at right angles to the direction of the coach, pulling it outward from the circle in which it is moving. This is called the centrifugal force, and acting as it does upon each particle of the vehicle, the sum of these numberless forces acts as if it were concentrated at the centre of gravity ; and it evidently acts in a direction to overturn the coach ; moreover, the higher it is applied, the more effect it will have (see Fig. 68). This force is opposed by the weight of the coach which, acting downward through G, keeps the coach to the ground.

The centrifugal force varies exactly with the weight ; increasing the actual weight does not increase the stability, but diminishing the height of the point, at which the centrifugal force is applied, does increase it.

In the diagram, Fig. 69, the black spot indicates

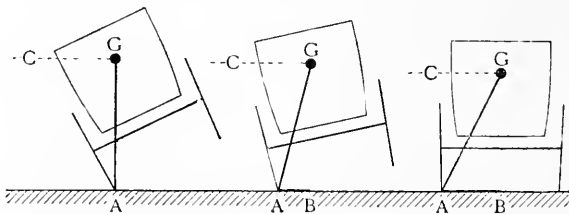

FIG. 69.

the weight of the coach concentrated at the centre of gravity, C is the centrifugal force acting horizontally outward, at G ; the weight is acting vertically down-

ward; A is the point at which the outside wheel rests on the ground. The centrifugal force tends to turn the weight about the point A, and in so doing it is resisted by the weight at G, which acts with a leverage AB.

As the coach tips more, and AG becomes more nearly vertical, the leverage AB decreases, and the action of the weight to resist the centrifugal force becomes less, until when G is over A, the weight has no leverage and the coach is acted upon by C only.

It is evident that, the centrifugal force and the weight being constant, the effect of the centrifugal force will depend entirely upon the height of G above the ground. It is also evident that, from the moment the wheel which is on the *inside* of the curve, leaves the ground from the action of the centrifugal force, the resistance of the weight to overturning, diminishes.

With a known weight of coach, the centrifugal force, corresponding to any speed round a turn of any radius, may be computed. The formula for this computation is as follows:—

$$\text{centrifugal force} = \frac{w v^2}{32.2 r}; \text{ where}$$

$w$  = weight in pounds.

$v$  = velocity in feet per second.

$r$  = radius of curve, in feet.

The quantity 32.2, usually expressed by  $g$ , is the velocity in feet per second that a falling body has at the end of the first second of its fall.

It is evident that the centrifugal force increases *directly* with the weight and with the square of the speed, and also as the radius of the curve *diminishes*, or as the turn becomes sharper.

Since the weight keeps the coach down at the same time that it increases the centrifugal force, the weight does not affect the safety, but the sharpness of the turn has a great deal to do with the safety, and the velocity, or speed, very much more. If the radius of the curve is halved, the centrifugal force is doubled, but if the speed is doubled, the centrifugal force is quadrupled. Therefore, a corner should be always turned slowly.

Inasmuch as, in going around a turn, the centrifugal force tends to turn the coach over toward the outside, an elevation of the outside of the road will counteract this action, and roads being usually more or less crowned, a corner to the right can be turned more safely than one to the left, because being on the right hand side of the road the off wheels are down and the inclination of the coach counteracts the centrifugal force which is acting in the direction of the arrow (Fig. 70).

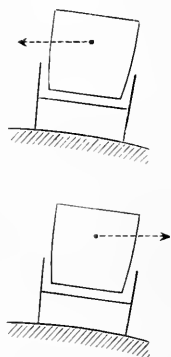

FIG. 70.

In turning to the left, the coach is still on the right hand side of the road, and the centrifugal force acting to the right, the effect of the inclination of the coach is added, and not opposed, to it.



The formula for the centrifugal force being  $\frac{wv^2}{32.2r} = CF$ ; with a weight of 2300 pounds and a radius of 50 feet, we find, corresponding to different velocities, the following centrifugal forces :—

At 7 miles an hour,	$v = 10.30$	ft. per sec.,	CF = 151.5	pbs.
10 ,, ,,	$v = 14.66$	,, ,,	CF = 307.0	,,
15 ,, ,,	$v = 22.00$	,, ,,	CF = 691.4	,,

With a weight of 4000 pounds,

At 7 miles an hour,	$v = 10.30$	ft. per sec.,	CF = 263.6	pbs.
10 ,, ,,	$v = 14.66$	,, ,,	CF = 534.0	,,
15 ,, ,,	$v = 22.00$	,, ,,	CF = 1202.0	,,

In an empty coach weighing 2300 pounds, the centre of gravity is 4 feet from the ground.

The weight, 2300, will act at the end of an arm AB, Fig. 71, 2.5 feet long, with an effect of 5750 pounds ( $2300 \times 2.5 = 5750$ ) holding the coach down; the centrifugal force corresponding to a speed of seven miles an hour, 151.5 pounds, will act at the end of the arm BG, 4 feet long, with an effect of 606 pounds ( $151.5 \times 4 = 606$ ) tending to overturn the coach.

At different speeds, the forces will be as follows :—

FOR THE UNLOADED COACH.

At 7 miles an hour,	$151.5 \times 4 = 606$	pounds.	$\frac{1}{9}$
10 ,, ,,	$307.0 \times 4 = 1228$	,,	$\frac{1}{3}$
15 ,, ,,	$691.4 \times 4 = 2765$	,,	$\frac{1}{2}$

The fractions  $\frac{1}{9}$ ,  $\frac{1}{5}$ ,  $\frac{1}{2}$ , show the proportions of the overturning force to the holding down force.

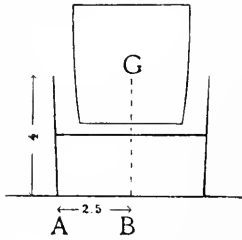

FIG. 71.

In a coach weighing 2300 pounds, loaded with 1700 pounds on top, the total weight will be 4000 pounds, which acting at the end of the arm AB will give a holding down force of 10,000 pounds. The centrifugal force will act at the

centre of gravity, 5.5 feet above the ground, and at different speeds the forces will be as follows :—

## FOR THE LOADED COACH.

At 7 miles an hour,	$263.6 \times 5.5 = 1450$	pounds.	$\frac{7}{8}$
10    "    "	$534.0 \times 5.5 = 2937$	"	$\frac{1}{3}$
15    "    "	$1202.0 \times 5.5 = 6611$	"	$\frac{2}{3}$

In the case of an empty coach, the centrifugal force acting at a height of four feet, required to balance the weight of the coach, 2300 pounds, with a leverage of 2.5 feet, will be 1437 ( $2300 \times 2.5 = 5750$ , and  $1437 \times 4 = 5750$ ). This is the force due to a speed of 21.6 miles an hour, on a curve of 50 feet radius, at which speed the wheels on the inside of the curve would be lifted from the ground and the coach overturned.

$$\frac{w v^2}{32.2 \times 50} = 1437 \text{ or } v^2 = 1006.6$$

$$v = 31.73 \text{ feet per second or } 21.6 \text{ miles an hour.}$$

In the case of the loaded coach, the centrifugal force, acting at a height of 5.5 feet, required to balance the weight of the coach, 4000 pounds, with a leverage of 2.5 feet, will be 1818 ( $4000 \times 2.5 = 10,000$ , and  $1818 \times 5.5 = 10,000$ ). This is the force due to a speed of 16.5 miles an hour on a curve of 50 feet radius, at which speed the coach would be turned over.

$$\frac{w' r'^2}{32.2 \times 50} = 1818 \text{ or } r'^2 = 732$$

$v = 27$  feet per second or 16.5 miles per hour.

It must be borne in mind that these are the figures for a perfectly smooth road, level cross-wise; trifling depressions in the road causing lateral swinging will overturn the coach at lower speeds.

In the familiar example of a horse galloping round a circus ring, it will be noticed that the horse's body is inclined toward the centre of the circle at an angle which depends upon the velocity with which he is moving; the faster he goes the more he leans.

Another example is that of a bicycle moving round the curve at the end of a cycling track.

Since a man and his bicycle may be said to form a single straight line from his head to the point where the wheel touches the ground, the angle of this line with the horizontal must be such that the action of the centrifugal force

will be exactly balanced by that of the weight, or else the bicycle will fall to one side or the other.

In Fig. 72, where the man is turning to the left, the centrifugal force will be developed in the direction indicated by the arrowhead, and may be represented by the line  $CF$ ; the weight acting vertically downward is represented by  $CW$ . The resultant of these two forces will be represented in amount

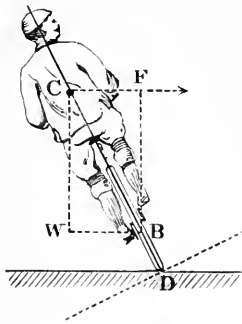

FIG. 72.

by  $CB$  in the direction of the line  $CD$ , and the point of support must be in this line, as at  $D$ , to prevent the man from falling. If the speed, and consequently the inclination, is not great, the bicycle may go safely round a level curve, but if the speed be greatly increased the wheel may slip on the ground.

To avoid this, the surface must be sloped, as shown by the dotted line, until it is at right angles to the inclination of the rider.

This is done in a circus ring by heaping the earth at the outer edge, and in a cycling track by sloping the asphalt path on the curve, at angles proportional to the squares of the speeds, one part of the curve, usually the lower, having steeper slopes than the upper, to suit all speeds.

The inclinations of the line  $CD$ , and consequently that of the lines at right angles to it, will be propor-

tional to the squares of the velocities, the radius of the curve being constant.

For a curve of 50 feet radius these inclinations will be as follows :—\*

At 7 miles an hour, 3 degrees, 45 minutes.				
10	„	„	7	„ 35
15	„	„	16	„ 42
20	„	„	28	„ 06
25	„	„	41	„ 21

It is obvious, that if the angle of the road cross-wise is, for any given curve and speed, that which is indicated by the above computation, the coach will have exactly the same stability as if it were going straight on a level, and for a curve of 50 feet radius the elevations of the outer wheel are given in the following table :—

At 7 miles an hour, 3.8 inches.				
10	„	„	7.9	„
15	„	„	17.2	„
20	„	„	28.4	„
25	„	„	39.6	„

These quantities are the natural sines of the angles given above, the length of the axle, 5 feet, being unity.

Since the base of the coach is wide, unlike that of a bicycle, the resultant line of the centrifugal force and of the weight will fall within the base with very

---

\* In these computations, the centrifugal force is to the weight, as the tangent of the angle is to unity.

much smaller inclinations ; and the lower the centre of gravity compared with the width of the base the greater will be the stability at any speed, or on any curve.

It must be also noticed that the load of the coach has been supposed to be in the centre ; if it should be moved over to the *inside* of the turn, its resistance to the action of the centrifugal force (by increasing the length of AB, Fig. 69) will be increased ; if it is moved to the *outside*, its resistance will be correspondingly diminished.

If the surface of the road is slippery, a coach, under the influence of a centrifugal force much less than is required to turn it over, will slide bodily sideways, and if it brings up suddenly against an obstacle or in the gutter, it may be upset.

## CHAPTER X

## DRAUGHT

THE amount of power, usually called the *draught*, which is required to overcome the resistance to motion of a vehicle, may be examined from two points of view: first, as to the actual mechanical force expended; and, secondly, as to the way in which that force should be applied by an animal.

The resistance to movement of a sled, is simply that due to the friction between the surface of the ground and the underside of the runner, but when wheels are used, this resistance is composed of the rolling friction between the tire and the ground, and the friction of the axle in its box.

The rolling friction results from the necessity of surmounting obstacles in the way of the wheel, as shown in Fig. 73, where the power to move the load is acting in the direction  $CP$  parallel to the road, and the weight of the vehicle is acting vertically downward through the centre of the wheel and the point  $A$ , at which the wheel touches the ground. In order to surmount the obstacle  $B$ , the power acting on the bent lever  $CBA$  must lift

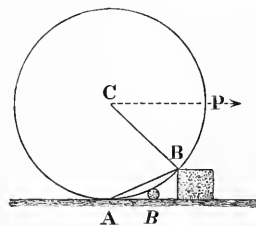

FIG. 73.

the weight, and its ability to do so depends obviously upon the relative lengths of the two arms CB and AB. CB is the radius of the wheel, and AB will depend upon the size of the obstacle as indicated at *B*. For the same size of wheel, therefore, the smaller the obstacles, or, in other words, the smoother the road, the less will be the resistance to rolling, and for the same roughness of road the larger the wheel, the less will be the resistance.

The length of the arm AB, in the case of the small obstacles, which make up the roughness, will be practically the same as the arc AB, and will be measured by the angle BCA. For any given surface of road, this arc may be represented by a *constant*, which, multiplied by the radii of various wheels, will measure the rolling resistance. Theoretically, therefore, this resistance should be inversely proportional to the diameter of the wheel. In 1838–1840, a series of elaborate experiments made by MORIN \* for the French Government, on the Traction of Vehicles, confirmed this as a practical fact; it may be therefore laid down as a law, that on any given road, the rolling friction will diminish directly in proportion as the size of the wheel is increased.† If

---

\* Notwithstanding the comparatively early date of these experiments they are still the most satisfactory that we have, and the most complete, having been made on a very large scale, with heavy vehicles, on all kinds of roads; later experiments have only confirmed them.

† DUPUIT and other writers maintained that resistance diminished



the surface of the road is at all loose or soft, as in newly stoned roads, or in roads wet, and partly disintegrated by hauling over them, the resistance to rolling will be measured not only by the effort required to surmount the obstacle, but also by the force expended in pushing, in front of the wheel, the loose stones or particles which oppose its motion.

If a wheel rolling on ice meets a stone, it is more likely to push the stone before it, sliding it on the ice, than to mount over it; and in a loose road some of this sliding, with the consequent friction between the particles of the road, takes place. Into such a road a narrow wheel will sink deeper than a wide one, or will, in other words, form a rut, and will have to push a portion of the material forward before surmounting it. On soft ground, therefore, increased width of tire is an advantage, and MORIN'S experiments indicate, that up to six inches of width the draught diminished, but that no advantage was gained by a further increase. On good roads

---

in proportion to the *square root* of the diameter, while MORIN'S experiments seem to show that it changes directly as the diameter.

Accurately, the relation between the resistance and the diameter, depends on the relation of the sine and the cosine of the angle at the centre of the wheel, included between the vertical radius CA, and the radius CB which ends at the point of contact of the rim with the obstacle (Fig. 73). On ordinary roads the relation is measured closely enough by the diameter, but on rough, stony roads, it is measured more nearly by the square root of the diameter and the advantage of the larger diameter compared with that of the smaller one, diminishes.

nothing was gained by having a greater width than four inches, and on pavement less was sufficient. These figures refer to heavy loads, 2000 to 2500 pounds on *each wheel*, and are applicable only to wheels that are very nearly cylindrical, vertical, and with horizontal axles (see notes on Wheels in Chapter III.), in which case there is no grinding action on the road. On a very hard, smooth road, such as good macadam or the best pavement, the draught appears to be independent of the width of the tire. There always has been a belief that a narrow tire affords an easier draught, and it is probable that this opinion was formed when wheels had more dish and axles more drop than is now given in the best practice, in which case, the wheel being a section of a cone, the tire ground on the road.

Even on a hard, unyielding road like a stone pavement, *if it is rough*, a wide tire is advantageous, inasmuch as it prevents the wheel from dropping into the inequalities between the stones.

If the wheel is nearly or quite cylindrical, an increased width of tire is an advantage to the road itself, but with coned wheels the increased width is a disadvantage; it increases the grinding action.

It is obvious, that in stiff mud, sand, or ordinary earth, such as is crossed in hauling over a field, the wheel, sinking in under the pressure of the load, is constantly surmounting a little hill in front of it, and leaving an open rut behind it, which, owing to the nonelasticity of the material, is not filled up. If,

however, the wheel is drawn over an elastic material, india-rubber, for instance, as in some of MORIN'S experiments, the material recovers its form behind the wheel, and in so doing restores most of the force expended in compressing it. Notwithstanding, therefore, that the wheel sinks into such an elastic track, hauling over it requires but little more effort than over a hard surface. With carriages this condition occurs very nearly, when india-rubber tires are used, which, notwithstanding their constant compression *in front* of the wheel, again give out the force *behind* the point of contact with the ground.\* Such tires seem to increase the draught somewhat, but less than might be expected, which is due to the fact that they diminish the shocks. Experiment shows that, while at a walk, the resistance on hard roads is the same for vehicles with or without springs, it increases with the speed more rapidly for rigid vehicles than for those on springs. This is no doubt due to the fact that the shocks which occur at higher speeds are largely taken up by the springs, and the force thus absorbed is again given out by them, and not all wasted in raising the load and hammering the road, and the same effect is produced by the interposition of the elastic rubber.

The pneumatic tire, by which the whole load is literally floated on air, has given results at first some-

---

\* This springing back of the road, or of the tire, has been termed *resilience* by some of the later experimenters on Draught.

what unexpected to the mechanic. Instead of increasing the draught even slightly, it has diminished it, owing to the perfect elasticity of the air contained in the tubular tire preventing any appreciable rising of the weight of the carriage in passing over an obstacle, the resistance merely forcing the air from one part of the tube to another, and experiment has shown (MICHELIN, p. 21) that the saving in draught is greater as the speed is higher: for instance, with the same spring vehicle:—

With iron tires:

At a walk,	3	ms. pr hour,	the traction was	48	pds pr ton.
„ trot,	6.5	„ „ „ „	„	59	„ „
„ fast trot,	9.4	„ „ „ „	„	77	„ „

With pneumatic tires:

At a walk,	the traction was	48	pds pr ton.
„ the other speeds,	„ „ „	50	„ „

The pneumatic tire, almost in exactly its present form, was invented and patented in 1845, by R. W. THOMSON, of London. (English Patent Specification, A.D. 1845, No. 10990.) Experiments made with it, reported in *The Mechanics Magazine*, of March 27th 1847, gave the following results:—

A carriage weighing 1050 pounds, running at 9 miles an hour, on a good macadam road, required 28 pounds of tractive force (53.3 pds per ton) with pneumatic tires, and 45 pounds (85.6 pds per ton) with iron tires. On broken stone, rough, the force required was 38 pounds (72.3 pds per ton) with

pneumatic tires and 120 pounds (228 pds per ton) with iron tires,—about the same results which are obtained now.

Notwithstanding these successes, the device seems to have been entirely lost sight of until it was re-invented a few years ago.

The ton here used, as in all the computations which follow, is that of 2000 pounds.

MORIN'S experiments, which are especially valuable, because they were made with large vehicles on the road and not with small models, further showed that the rolling friction increased directly with the weight of the carriage and load, and that for a given kind of road it could be computed by the simple formula,  $R = A \frac{P}{r}$ , where P is the weight (pressure), r the radius of the wheel, and A a constant or coefficient,\* determined by experiment.

---

\* A coefficient is a proportion and can be thus exemplified: If A and B are associated in a business of which A owns  $\frac{1}{4}$  and B  $\frac{3}{4}$ , the coefficient of A will be  $\frac{1}{4}$  or 0.25, so that any profits or losses must be multiplied by 0.25 to determine A's share. In the friction of a body sliding on a surface, if the coefficient of friction is 0.05, the weight of the body multiplied by 0.05 expresses the friction, which in this case will be 5 per cent. of the weight or pressure.

In using the French coefficients from MORIN'S book, it must be borne in mind that in the formula for the *rolling* friction, the wheel radius in metres enters as a divisor, and the French coefficient must be multiplied by 3.281, the value of a metre in feet, to obtain a coefficient for use with English measures. For instance, A (French) 0.015 is the same as A (English) 0.05.

In the formula for resistance from *axle* friction, the multiplier  $\frac{r}{R}$  is

For example: if  $P = 10,000$  pounds,  $r = 2.5$  feet, and  $A = 0.05$ , which is the constant derived from a number of experiments made on a road of the same character as that for which this resistance is now to be computed,  $R$  will equal  $0.05 \frac{10000}{2.5}$ , or 200 pounds,  $\frac{1}{50}$  of the load. If  $P = 10,000$ , and the radius of the wheel is increased to three feet, the rolling friction will be reduced to 166.6 pounds,  $\frac{1}{60}$  of the load. If the quality of the road changes for the worse, the value of  $A$  will increase. On a road covered with loose gravel two inches deep, MORIN (p. 144), found the value of  $A$  to be 0.165, and with this coefficient the resistance will become  $0.165 \times \frac{10000}{2.5} = 660$  pounds, or  $\frac{1}{15}$  of the load.

As to the influence of the width of the tire in diminishing the draught, MORIN'S experiments give the following results (p. 132):—

		In English units.
In thick mud, on a road,	a 7 in. tire gave	$A = 0.097$
„ „ „	a $4\frac{1}{2}$ in. „	$A = 0.084$
On a dry earth road	a 7 in. „	$A = 0.073$
„ „	a $4\frac{1}{2}$ in. „	$A = 0.068$
„ „	a $2\frac{3}{8}$ in. „	$A = 0.084$
On a hard road	a 7 in. „	$A = 0.052$
„ „	a $4\frac{1}{2}$ in. „	$A = 0.045$
On a pavement	a 7 in. „	$A = 0.035$
„ „	a $4\frac{1}{2}$ in. „	$A = 0.030$
„ „	a $2\frac{3}{8}$ in. „	$A = 0.030$

On *roads*, therefore, while there does not seem to be much difference in the resistance of wide and

---

a ratio which is the same whether feet or metres are used, and therefore the French *f* and the English *f* have the same value.

narrow tires, a narrow tire gave somewhat the best results. It may be observed, however, that the wide tire is very wide, seven inches, and unfortunately MORIN does not give the dish of the wheel or the drop of the axle, but he does say (p. 133) that, 'the inclination of the axle-arm, obliging the wheel to move about the axis of a cone, the rubbing of the surface of the tire on the ground, which is the consequence, tends to increase the resistance of the wider wheel.' This is no doubt the whole reason for the increase of friction, and since all axle-arms are somewhat inclined, for the reasons already given when treating of Wheels, it would seem that the disadvantage of the grinding, counterbalances an advantage from increased width.\* In farm wagons used on soft ground and grass, there is no doubt that a width of tire up to at least four inches, is an advantage, and experience has indicated the same thing at many sandy sea-shore places; but to get the best result, the wheel must be nearly straight and vertical. As far as damage to the road itself goes, it would seem from experiments, that on hard, good surfaces, well united, and with a hard bottom,

---

\* In the experiments made at the Bedford Agricultural Show, England, July 1874, with two loaded wagons practically alike, except that in one case the inclination of the face of the wheel was 4 degrees, corresponding to an overhang of 3 inches or  $1\frac{1}{2}$  inch dish, and in the other case  $1\frac{3}{4}$  degrees,  $1\frac{1}{2}$  inch overhang or  $\frac{3}{4}$  inch dish, the proportions of draught were  $\frac{1}{45}$  of the load for the more inclined wheel and  $\frac{1}{31}$  for the straighter wheel.

the width is not important, but when only a thin layer on top is hard, and the under part soft, the wide tire injures the road much less than the narrow one. The somewhat obsolete cobble-stone pavement of eastern American cities is generally laid upon an insufficient layer of gravel, on undrained soil, which, in wet weather or when the frost is coming out of the ground, is soft, and the stones, being round, and touching each other only at points, become unstable, the narrow tires of heavily loaded carts soon displace them and ruin the pavement.

Under these circumstances, city ordinances which encourage the use of wide tires are eminently proper, and since it seems to be clearly shown that if the width does not diminish the traction, it does not increase it (provided the wheel is nearly vertical and therefore cylindrical), wide tires cause no injury to the interests of the carter. The shocks and jerks felt by the horse in pulling a cart through ruts and over little holes must be vastly more fatiguing to the animal than the simple traction, and these shocks are much reduced by a wide tire which spans many inequalities into which a narrow one will drop.

Among late experiments on 'Draught' are those made by Mr H. J. WATERS, of The College of Agriculture and the Mechanic Arts, of Missouri, reported in *The Engineering Record* of March 12, 1898. Tires of  $1\frac{1}{2}$  and 6 inches in width were



compared, with the results here noted: On almost all roads, the wide tire diminished the traction by an amount varying from 16 to 30 per cent., but where the surface was sticky and there was a smooth hard road below, the narrow tire cut down to the hard road, whereas the wide tire adhered to the mud, showing an advantage for the narrow tire of 20 or 30 per cent. In 14 experiments out of a total of 21, with greatly varying conditions, there was shown a decided advantage in the use of a wide tire, and in all cases the road was improved by the passage over it of the wide tire.

We have so far considered only the rolling friction of the wheel, but to obtain the whole resistance to the forward motion of the vehicle we must add the friction between the axle and its box. This is a sliding friction, the laws of which, as determined by large number of experiments of different investigators, are, within the limits met with in well designed machinery, as follows:—

This friction is directly proportional to the pressure per unit of surface; that is, between any two given surfaces, if the pressure is one hundred pounds per square inch, the friction will be twice as great as if it were fifty pounds per square inch. It is therefore independent of the absolute amount of surface, because with the same weight, if the rubbing surface is increased, the pressure per square inch is diminished. A brick, for example, will move with just the same amount of friction over the surface of a

table, whether it is on its flat face, its edge, or its end. The friction, therefore, between an axle and its box is directly proportional to the weight of the carriage without its wheels, and is not dependent upon the length of the axle-arm. The absolute friction of the axle depends very slightly upon the diameter, but the resistance to the turning of the wheel due to friction, acts at the surface of the axle with a leverage which is represented by the radius (or semi-diameter) of the axle-arm. If the axle is raised off of the ground so that the wheel can revolve freely, the force applied to the outside of the wheel

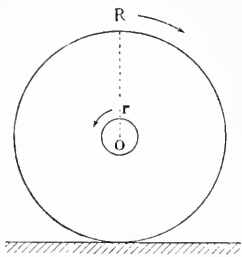

FIG. 74.

to make it turn will be resisted by the friction at  $r$ , Fig. 74, and the force will act with a leverage  $RO$ . The longer  $RO$  is, the less force will be required, applied at  $R$ , to turn the wheel, and the longer  $rO$  is, the greater will be the resistance of the friction. The

ease, therefore, with which the wheel can be turned will depend upon the relation, or ratio between  $RO$  and  $rO$ ; the larger the axle the greater the effect of the friction, and its *amount* will be measured by the ratio  $\frac{r}{R}$  multiplied by a constant to be determined by experiment.

This constant, or coefficient, usually designated  $f$  by writers upon this subject, is found, for polished, well-oiled metal surfaces, to have a value, according

to MORIN, of from 0.05 to 0.065. Later experiments with machine shafting bring this to a lower figure, but for coach axles 0.065 is a fair value. This friction is much diminished by thorough oiling, and with a constant supply, or *bath*, of oil it is sometimes not over 0.005, or one-tenth of the value given above. When the bearing is thus flooded with oil, the surfaces do not touch each other at all, and the friction is that of a *fluid*.

This condition cannot be fully maintained in a wheel, but the distribution of the oil by means of shallow grooves in the axle-arm, or in the box, and a large supply of oil in the wheel-cap, approach it, and form an important feature of the Collinge axle. Heating the oil, even to a moderate degree, increases the friction, and great heating, as we all know, by the expansion of the arm, soon brings the wheel to a stop.

As is now well exemplified in the bicycle, the ball-bearing, by converting the sliding axle friction into rolling friction between very hard and smooth surfaces, diminishes greatly the resistance to the turning of the wheel. The rolling friction between perfectly spherical, highly polished, hard, steel balls and a hard, steel surface is so small that it may be said to be nothing. In the bicycle, this has been successfully turned to account, and there is no reason why the ball-bearing should not be adopted in a coach wheel, except for the comparative complication of such arrangements, and from the fact

that the horse, to whom the draught is of prime consequence, is not able to express his opinion as readily as the human cyclist. Some forms of carriage axles with ball-bearings have been already brought out but are not yet in general use.

The results of some late experiments, made at the Engineering Department of Yorkshire College, Leeds (*Engineering*, Sept. 11, 1896), are interesting as showing the resistance to crushing of hard steel balls. Balls of a quarter-inch diameter stood a pressure of five tons each, before crushing; those of a half-inch, more than ten tons. These were statical pressures; the balls would not probably stand so much if they were in rolling motion.

Taking 0.065 as the coefficient of friction,  $r$  the radius of the axle, and  $R$  that of the wheel, or of the average of the front and hind wheels, the expression  $0.065 \frac{r}{R}$  will represent the proportion of the weight of the coach *without its wheels*, which measures the axle friction. It is of course the weight of the coach resting on the axles, that causes the friction on the axles. If, therefore, a coach with its load, and *without its wheels*, weighs 3100 pounds, has axles two inches in diameter, and wheels averaging 46 inches in diameter, the expression will be  $f \frac{r}{R} (w - w)$ ,\* or  $0.065 \frac{1}{23} 3100 = 8.77$  pounds, as the amount of the axle-friction, and since experiment gives an average of 70 pounds

---

\*  $W$  being the weight of the whole coach and  $w$  that of the wheels.

per ton (of 2000 pounds), as the total resistance to motion in a coach on a good hard road (see p. 163), that resistance for a weight of 3400 pounds, will amount to 119 pounds, of which 9 pounds, or 7.5 per cent., will be axle friction, and 110 pounds, or 92.5 per cent., rolling friction.

The total resistance to forward motion on a level surface is therefore represented by the rolling friction and the axle friction added together, or by the formula  $P = A \frac{W}{R} + f \frac{(W - w)r}{R}$  in which:—

$P$  is the power required to draw the vehicle.

$A$  is the constant for rolling friction for a given road surface (see p. 153); for a hard road 0.0615.

$W$ , the total weight of the coach and load.

$w$ , the weight of the wheels.

$R$ , the radius of the wheel (or the mean of the radii of the front wheels and hind wheels).

$r$ , the radius of the axle-arm.

$f$ , the coefficient of friction, 0.065.

Example of computation for a coach:—

$$W = 3400 \text{ pounds.}$$

$$w = 300 \text{ pounds.}$$

$$R = 23 \text{ inches, or } 1.9 \text{ foot.}$$

$$r = 1 \text{ inch, or } .083 \text{ foot.}$$

$$A = 0.0615.$$

$$f = 0.065.$$

$$A \frac{W}{R} = 0.0615 \frac{3400}{1.9} = 110 \text{ Rolling friction}$$

$$f \frac{(W - w)r}{R} = 0.065 \frac{(3400 - 300)0.083}{1.9} = \frac{9}{119} = P \text{ Axle friction}$$

The proportion of the total resistance due to friction of the axle being small, it is evident that the improvement of the road surface is more important than the improvement of the axle, and this is shown in the gain arising from the use of pneumatic tires, which is equivalent to having a smoother road.

The following tables give an abstract of some experiments on the force required to draw vehicles under different conditions :

KIND OF VEHICLE.	DESCRIPTION OF ROAD	PROPORTION OF DRAUGHT TO WEIGHT.	DRAUGHT IN POUNDS PER TON OF 2000 POUNDS.
EXPERIMENTS OF MORIN (pp. 182, 184).			
Diligence. Diameter of wheels, 1.15 metre. 3 ft. 9 in.	Pavement . . . . .	$\frac{1}{50}$	33.3
	Dry macadam . . . . .	$\frac{1}{50}$	40.0
	Muddy macadam . . . . .	$\frac{1}{27}$	74.0
	Dry earth . . . . .	$\frac{1}{27}$	74.0
	Dry earth with gravel 4 in. deep . . . . .	$\frac{1}{8}$	250.0
Cart. Diameter of wheels, 1.60 metre. 5 ft. 3 in.	Pavement . . . . .	$\frac{1}{86}$	23.3
	Dry macadam . . . . .	$\frac{1}{66}$	30.3
	Muddy macadam . . . . .	$\frac{1}{36}$	55.5
	Dry earth . . . . .	$\frac{1}{36}$	55.5
	Dry earth with gravel 4 in. deep . . . . .	$\frac{1}{11}$	181.0
Cart. Diameter of wheels, 2.0 metres. 6 ft. 6 in.	Pavement . . . . .	$\frac{1}{107}$	18.7
	Dry macadam . . . . .	$\frac{1}{82}$	24.4
	Muddy macadam . . . . .	$\frac{1}{45}$	44.4
	Dry earth . . . . .	$\frac{1}{45}$	44.4
	Dry earth with gravel 4 in. deep . . . . .	$\frac{1}{14}$	142.8

KIND OF VEHICLE.	DESCRIPTION OF ROAD.	PROPORTION OF DRAUGHT TO WEIGHT.	DRAUGHT IN POUNDS PER TON OF 2000 POUNDS.
EXPERIMENTS OF MACNIELL. <i>Report of Committee.</i>			
Stage Coach. Weight, with load, 3400 pounds.	Good Telford road, 6 miles per hour . . . . .	$\frac{1}{29}$	68.0
	8 miles per hour . . . . .	$\frac{1}{28}$	72.4
	10 miles per hour . . . . .	$\frac{1}{24}$	83.3
Wagon, at 2½ miles per hour, 2300 pounds. Diameter of wheels not given.	Good pavement . . . . .	$\frac{1}{55}$	31.0
	Telford } . . . . .	$\frac{1}{35}$	56.0
	Macadam }		
Gravel on earth . . . . .	$\frac{1}{15}$	122.0	
BEDFORD EXPERIMENTS. <i>Engineering, July 10, 1874.</i>			
Wagons. Mean diameter of wheels, 4 ft., without springs.	Hard gravel . . . . .	$\frac{1}{46}$	43.6
	Field of oats . . . . .	$\frac{1}{11}$	182.2
The same with springs.	Hard gravel . . . . .	$\frac{1}{57}$	35.4
	Field of oats . . . . .	$\frac{1}{11}$	189.7
Carts. Diameter of wheels, 4 ft. 6 in.	Hard gravel . . . . .	$\frac{1}{69}$	29.4
	Field of oats . . . . .	$\frac{1}{15}$	126.3
EXPERIMENTS OF MICHELIN, 1896.			
Brake, 1270 pounds. Mean diameter of wheels, 3 ft. 4 in., iron tires.	Good road, 3 miles per hour . . . . .	$\frac{1}{43}$	46.0
	6½ miles per hour . . . . .	$\frac{1}{34}$	59.0
	9½ miles per hour . . . . .	$\frac{1}{25}$	77.0
The same with pneumatic tires.	3 miles per hour . . . . .	$\frac{1}{12}$	48.0
	6½ miles per hour . . . . .	$\frac{1}{10}$	50.0
	9½ miles per hour . . . . .	$\frac{1}{10}$	50.0

## FROM THE BEDFORD EXPERIMENTS ON TRACTION.

	MEAN DIAMETER OF WHEELS.		INCLINATION OF WHEELS TO THE VERTICAL.	WIDTH OF TIRE.	ROAD.	FIELD.	PROPORTION OF DRAUGHT ON FIELD TO THAT ON ROAD.
	Ft.	In.			DRAUGHT PER 2000 POUND TON.	DRAUGHT PER 2000 POUND TON.	
			Degrees.	Inches.	Pounds.	Pounds.	Times.
Four-wheeled wagons.	4	0	4	2 $\frac{3}{16}$	44.1	205.0	4.6
	4	0	4	4	45.1	168.8	3.7
	4	0	1 $\frac{3}{8}$	2 $\frac{1}{16}$	39.1	183.0	4.7
	.	.	5 $\frac{1}{4}$	3	44.8	200.0	4.5
	4	0	2	4	47.3	183.9	3.8
	4	0	3 $\frac{1}{4}$	4	39.4	167.8	4.2
	.	.	3 $\frac{1}{4}$	4 $\frac{1}{16}$	.	167.8	.
	.	.	5	4	45.7	181.2	4.0
	.	.	2 $\frac{3}{16}$	2 $\frac{3}{16}$	29.6	188.4	6.3
	4	0	5	2 $\frac{3}{16}$	41.2	191.0	4.7
Two-wheeled Carts.	4	6	1 $\frac{3}{16}$	3 $\frac{1}{16}$	26.7	125.0	4.6
	4	7	2 $\frac{1}{4}$	4	32.1	127.6	4.0

Without springs.

With springs.

Without springs.

An examination of the Bedford Experiments shows: 1st, That the draught on the soft field is about  $4\frac{1}{2}$  times that on the hard road; 2nd, that with a wide tire this difference is less; 3rd, that an increased angle of the wheel to the vertical increases the draught; 4th, that carts have a lighter draught than wagons, and that the difference is greater than is merely in proportion to the greater size of their wheels; and 5th, that springs diminish the draught on the road, but not on the field.

These results agree, substantially, with those obtained from other experiments, but it must be



noted that it is difficult to compare such experiments with accuracy, on account of varying conditions. In this abstract of the Bedford Experiments, for instance, the *mean* size of the front and hind wheels is given ; in the full Report, their respective sizes are given with the proportions of the full load on each. The figures would be somewhat different if the load of the four-wheeled wagon were placed principally on the front wheels or on the hind wheels.

The inclination of the wheels, the character of the axles, the equality or otherwise, in length of the two axles, all affect the result.

The subject may be summed up as follows :

To obtain the least draught we must have the largest wheel and the smallest axle ; the axle must be highly polished, well-fitted, but not too tight, and profusely oiled ; the axle must be cylindrical and horizontal ; and the wheel straight and vertical. On a hard road with a vertical wheel, the width of the tire, within reasonable limits, is unimportant ; on soft ground, a wide tire diminishes the draught. If the wheel is dished and inclined, the increased width increases the draught on a hard road. On a hard road, it is not important that the two axles should have the same length, but on a bad, or soft, road the draught is increased, if the front wheels are closer together than the hind wheels, because there are four new tracks to break instead of two.

On good, hard roads, the draught increases with the speed, as is shown in the preceding tables,

and at much higher speeds than coaches attain, as on railroads, it varies as follows :—\*

At 5, 10, 15, 20, 30, 40, 50, 60 miles per hour.  
9.15 ; 9.6 ; 10.5 ; 11.4 ; 14.6 ; 19.0 ; 24.0 ; 31.5 pds per long ton.

On hard roads that are *rough*, the draught increases rapidly with the speed, owing to the shocks which absorb part of the power, and on such roads suspension on springs diminishes the draught, at high speeds, by diminishing the shocks.

Well-laid, firm, stone pavements give from one-half to two-thirds the resistance to rolling that is given by good, broken-stone roads. This difference seems, at first sight, to be too great ; but all the experiments give substantially the same result, and show that a solid, unyielding road is better than an elastic one with ever so smooth a surface ; this is confirmed by the experience of old coaching men, who consider what they call the *soundness* of a road its most important quality.

On a smooth surface, with a well-made vehicle, there is no indication that the distance between the axles in any way affects the draught.

It is a general opinion, however, that placing the axles close together, or making a coach 'short-coupled,' as it is called, makes it run easier.

No doubt a *very* long-coupled carriage, like a

---

\* When it is said that the draught increases with the speed in a certain degree, only the statical draught as indicated by a dynamometer, is meant. The amount of *actual work* expended is represented by this quantity combined with the distance passed over.

landau, runs hard, especially on a soft road, because the hind wheels do not follow promptly, and sometimes run partly sideways in lines different from the front wheels; but within the limits of variation of distance, possible in a coach, this can occur in only such a small degree that the disadvantage is more than balanced by the other advantages of a longer coupling.

A very short-coupled coach can never be entirely safe at high speeds, especially if the horses are galloping: a short wheel base, overhung in front by the body, will cause the coach to rock to and fro, and especially to swing sideways. A short base is generally obtained by putting the front wheels far

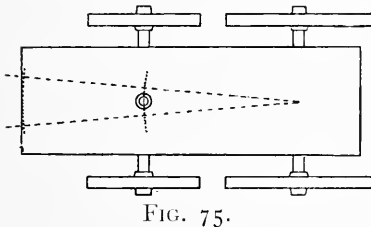

FIG. 75.

under the front boot, and the effect of this projection of the front of the coach beyond the perch-bolt can be appreciated by imagining the front axle pushed

back nearly as far as the centre of the body, and the coach pulled from that point. It will be seen that a slight side motion of the front wheels will be greatly magnified at the front end of the coach, and will cause a dangerous swing (Fig. 75).

The distance between the axles of a coach should not be less than 6 ft. 6 in.

A third element of resistance to the motion of a vehicle, is the action of gravity when ascending a

slope, where a portion of the weight has to be raised vertically. The proportion of the weight thus lifted is directly as the height of the inclined plane is to its horizontal length, and is, therefore, easily computed.

If a road rises one foot in every ten of its length, or, in other words, has a grade of one in ten, the power of the horses must be exerted to raise one-tenth of the weight of the coach all the time that the coach is ascending the slope, and this resistance must be added to that of the rolling friction and the axle friction.

On all except very slight grades, this resistance becomes important, as the accompanying table shows.

GRADE.	PERCENTAGES OF RESISTANCE FROM			
	ROLLING FRICTION.	AXLE FRICTION.	EFFECT OF GRADE.	TOTAL.
Level	88	12	. .	100
1 in 200	69	10	21	100
1 in 100	57	9	34	100
1 in 90	55	8	37	100
1 in 80	53	8	39	100
1 in 70	49	8	43	100
1 in 60	46	7	47	100
1 in 50	42	7	52	100
1 in 40	38	6	56	100
1 in 35	35	5	60	100
1 in 30	32	5	63	100
1 in 25	28	4	68	100
1 in 20	24	3	73	100
1 in 15	20	3	77	100
1 in 10	14	2	84	100
1 in 8	11	2	87	100
1 in 6	9	1	90	100

These figures are for a heavy four-wheeled vehicle, on hard macadam (MORIN, pp. 45 and 127). As the grade increases, its importance in using up the power is manifest, until at a grade of 1 in 55 the percentages of rolling resistance and grade resistance are equal, and at 1 in 45 the grade resistance is one-half of the whole. At 1 in 20, which may be considered a permissible grade on a mountain road, the grade resistance is nearly three-quarters of the whole, and at 1 in 10, which should be the utmost limit of mountain roads, it is 84 per cent.

Grades of 1 in 8, to 1 in 6, now and then met with, can be ascended with an ordinary load only by the use of extra horses.

MACNEILL, in 1838, recommended 1 in 40 as the maximum grade on a main road of the best class, but on a large proportion of the great European roads, in mountainous countries, 1 in 25 is constantly used, and there are grades of that steepness on the great Holyhead coach road in England and Wales. In all these cases, the surface is nearly perfect.

A grade of 1 in 20 is the steepest up which a fresh team, with a moderately loaded coach, should trot, and then only when the distance is short, not more than 300 yards.

All experiments agree in putting the resistance to rolling, on a well-paved stone street, at about two-thirds of that on a good, macadam-surfaced, road, and every attentive coachman will feel the difference in the action of the horses and the movement of the

coach when he runs off of any other kind of a road on to the stones.

Of course, a paved road to be good must be made of flat topped stones, and the joints must be so small, that the wheels cannot drop into them in crossing them. In many old pavements the stones are so rounded and worn, that they are excessively disagreeable to drive over, even while their resistance to traction may be less than that of smooth macadam.

The goodness of a road depends not only upon its smooth upper surface, but also upon its solidity, or what coachmen often call its *soundness*. In England, about 1830, which was the height of the coaching era, just before railroads came into use, there was a great controversy between the advocates of the two systems known as TELFORD'S and MACADAM'S.\*

MACADAM held that a sufficient layer, that is from 8 to 12 inches, of stone broken to a size to pass through a two-inch ring, laid on even a yielding foundation, made the best road; TELFORD insisted that it was necessary to have a strong stone foundation under the broken stone.

TELFORD'S view is now generally adopted in Europe, especially for wet climates, but in America it is an open question which system is the better.

---

\* As the name MACADAM lends itself readily to being made into a verb, *macadamised* has become a well-known expression and has taken its place in English as the designation of a road surface formed of broken stone without reference to what is underneath it. The French use *en empierrement* and also *macadamisée*.

European road makers, particularly in England, insist that everything must be done to keep roads dry, and object even to trees which may shade them ; but in America the summer dryness is an enemy to the stability of a road, since it permits movement of the pieces of stone, and thereby facilitates the disintegration of the road under the traffic, and the working up of the large stones from below. In winter, on the other hand, the freezing and thawing of the water in a road disturb the connection between the stones and break up the road, allowing ruts to be formed ; and the Telford system undoubtedly provides the best drainage.

If cost is disregarded, a *good*, deep Telford road is the best, although, perhaps, the top covering of stone wears out more rapidly than that of a macadam road, from its being hammered between the wheels and the unyielding pavement beneath. As soon as the top is so worn down as to be not more than four inches thick, the stones of the foundation are likely to work loose and to come to the surface, with the result of making the worst kind of a road. If the lower pavement is made of stones merely gathered from the fields and *thrown* in without being packed, these stones will inevitably work up through the small stone and make a road worse than poor macadam.

One of the most experienced road makers of eastern Pennsylvania is decidedly in favour of macadam, as giving the better practical results in all

regards, and especially as being the more easily repaired, acknowledging, however, that it is more likely than the Telford road to become rutted when the frost is coming out of the ground.

For a Telford road of the best quality, the bed, formed 12 to 16 inches below the intended surface of the finished road, should be carefully graded with a slope from the centre toward the sides, and thoroughly drained by tile, shallow broken stone, or gravel drains. No road of any system can be good or lasting unless it is thoroughly drained; this is absolutely essential. Upon the bed thus prepared, a paving of one layer of stones, from 7 to 10 inches deep, is laid by hand. Each stone must be laid with its widest face on the bed, the object being to prevent the stones from being pressed into the ground, and to distribute the pressure from passing wheels over as large a surface as possible.



FIG. 76.

Since the stones should touch each other where they rest on the ground, the upper surface will be broken by irregular openings which must be packed tightly with stone chips. Upon this rough pavement, which may be made of any inferior stone, not too soft, is spread the hardest stone procurable, broken to sizes of from  $1\frac{1}{2}$  to 2 inches, to a depth of from 4 to 8 inches and well rolled with a steam



or horse roller. The depth of both the under pavement and the upper layer of stones will vary between the limits noted, accordingly as the road may be intended for light or heavy traffic, and according to the amount of money at the disposal of the engineer. The more substantial the road, the easier will be the draught upon it, and the less will be the expense for repairs. No earth should be put upon the surface of the road; it is by the interlocking of the clean angular stones under the rolling and the traffic that the road is made, and earth prevents such interlocking. If a surface finish is required, very sharp stone screenings should be used, put on after the road has been partially rolled.

Much rolling with a light roller, or prolonged ramming with a light rammer, is preferable to heavy rolling or ramming, because the object is not to break the angles of the stones, but to shake them into interlocking with each other, an operation not altogether unlike the felting of hair. Continuous light shaking will turn the small stones about among each other until they fit closely together and form a solid mass.

If a road is equally good all over, it ought to wear down evenly under the traffic, and when worn should be repaired by putting on a new layer of stone, not less than 3 inches thick, after the old surface has been picked up, so that the new stone will bind into it. On a road that is not well made, and sometimes even on a good road, uneven wear will

take place, and depressions be formed, which must be patched with new stone. These repairs require great judgment on the part of the road foreman, and the old surface of the portion repaired should always be picked up before adding new stone. When new stone is put on in patches, it should be well wetted and rammed.

The dust or mud which is formed on the surface by the wearing action of the wheels should be frequently removed; it does no good to the road and is obviously objectionable. The effect of mud in increasing the draught is shown in the Table on p. 162, the resistance of thick mud being to that of a hard clean road as 84 to 45. It seems almost needless to add that a soft, 'woolly' road, even if it is dry, gives a heavy draught.

It is difficult to give an estimate of the cost of a Telford road, on account of the varying price of stone and of labour, and the difference of natural ground, but the following figures are from late American sources. Paving 8 inches deep, \$4 per square rod; broken stone 4 inches deep, \$2 per square rod. An 18-foot road has 340 square rods to the mile, which at \$6 per rod is \$2040, and with \$200 per mile for grading and shaping the road bed, is \$2240 per mile. This must be considered a low cost; culverts and ditches may add largely to it. For the same thickness of road bed, there does not seem to be much difference between the cost of Telford and of macadam, since the cost of hand laying the

pavement is balanced by that of breaking *all* the stone small.

Although country roads, paved with stone, or, as in Holland, with brick, are common on the Continent of Europe, they are not used in America ; but for cities where the traffic is heavy, stone pavements, apart from their noisiness, have many good qualities. The following extract, from a paper prepared by the present writer, as a member of a committee of The Coaching Club, to be submitted to the authorities of the city of New York, in 1884, describes a good method of their construction :—

‘ The proper conditions of a paved city street, as indicated by the experience of the engineer and of the driving expert, may be stated as follows :

‘ The subsoil on which the paving is to be laid, if not naturally porous, must be thoroughly drained to a depth of at least four feet. A sewer, the crown of which is pervious to moisture, will usually effect this purpose, but there are grave objections to any leaks from or into a sewer, owing to the danger of the escape of noxious gases ; and some simple system of special drainage similar to that used in farming land is preferable.

‘ The surface of the subsoil should be carefully graded and consolidated, so as to insure that no water reaching it can stand in puddles upon it, or that any portion can settle below the grade originally given to it. The best method of consolidation is by the use of a rather narrow steam roller.

‘Upon the subsoil, thus carefully prepared, there  
‘should be laid a base of concrete from eight to  
‘fifteen inches thick, depending upon the amount  
‘and character of the traffic, and somewhat upon  
‘the quality of the subsoil—a dry gravel or sand  
‘requiring less depth of concrete than a clay  
‘soil.

‘The upper surface of this concrete must cor-  
‘respond in form to the finished grade of the  
‘pavement to be placed upon it.

‘The pavement itself should be of stone blocks  
‘about three inches wide, nine inches deep, and  
‘from thirteen to fifteen inches long. The width  
‘and depth must be as uniform as possible; the  
‘lengths may vary.

‘The blocks should be laid upon the concrete,  
‘over which a light coat of sand, not gravel, should  
‘be spread merely sufficient to enable the workmen  
‘to bed the stones evenly. Less than an inch of  
‘sand should suffice if the stones are reasonably  
‘even and smooth. The blocks are set with their  
‘longest dimension across the street, their smallest  
‘parallel to the axis of the street.

‘After they are set, a small quantity of fine sand  
‘must be swept over their surface with brooms, so  
‘as to fill the joints about half full.

‘The joints should then be filled to the top with  
‘melted asphalt. This must be done, if possible,  
‘in dry, warm weather, and cannot be done when  
‘the stones are wet.

‘The stone selected must be one which wears  
‘rough and gritty, and does not polish and become  
‘slippery. The softer stone will not wear so long  
‘as the hard one, but that must be submitted to.

‘The asphalt serves three purposes : it closes the  
‘joints, and prevents any water passing through  
‘the pavement to the concrete or the subsoil, which  
‘is necessary to the maintenance of a good pave-  
‘ment ; it prevents dust rising from the joints ; and  
‘it fills the top of the joint so as to prevent, to  
‘some extent, the rounding of the upper surfaces  
‘of the stones by the continued impact of the  
‘wheels, which is the way that the best laid pave-  
‘ment finally becomes rough and noisy. There is  
‘no remedy for this other than turning the stones  
‘upside down, or re-cutting their upper surfaces,  
‘and using them on streets admitting of a thinner  
‘pavement.

‘The asphalt diminishes the noise by preventing  
‘the wheels from striking the edges of the stones  
‘with as much force as if the joints were open, and  
‘it can be renewed during any hot, dry weather at  
‘a small cost. It must be poured into the joints  
‘neatly from a ladle, or equivalent device.

‘At street intersections, it is best to carry each  
‘line of paving to a point in the intersection, to  
‘avoid, as far as possible, the longitudinal joints  
‘being in the direction of the traffic.

‘Continuous lines of joints in the direction of the  
‘traffic are fatal to the maintenance of a good

‘pavement; and for that reason flat gutter stones  
‘should be positively interdicted, and the paving  
‘should be carried directly to the curb.

‘There is no occasion, in a well laid pavement,  
‘for any crown to the street beyond what is neces-  
‘sary to insure the centre not being lower than the  
‘sides; for that reason no crown of more than two  
‘inches should be permitted in any street of sixty  
‘feet in width, and less in a narrower street.

‘The excessive crown that most American city  
‘streets have makes them uncomfortable to drive  
‘upon, owing to the sliding of the hind wheels of  
‘vehicles toward the gutter.

‘In streets newly laid out and paved, the curb-  
‘stones should have more slope than is usually  
‘given them. In a five to seven-inch curb, the  
‘slope of the face backward should be at least  
‘two inches, so that wheels rubbing against them  
‘may strike the tire only, and not wear the wood  
‘of the rims of the wheels.

‘The method of construction advocated is prac-  
‘tically that of the streets of Liverpool, England,  
‘which are now the best in the world. The con-  
‘crete base possesses the advantage, among others,  
‘that in laying gas or water pipes it can be cut  
‘up in blocks, and relaid so as to insure a more  
‘perfect patching than can be made on a soft  
‘substratum.

‘Any pavement, however, is very much injured  
‘by taking up a portion over a long trench, as the

‘most skilful and careful workman cannot possibly replace the stones, even if they are marked, so as to form the original continuous surface.’

The asphalt and wooden pavements now rapidly being introduced in cities, while not better for draught than stone, have the great advantage of diminishing the noise. Both are worthless unless they are underlaid by a thoroughly well-made concrete foundation. Indeed, it cannot be too positively asserted that the surface, whether it is stone, wood, asphalt, or macadam, is *only* a surface, and that the true road is below, which if once well-made and not injured by excavations, should last indefinitely. The surface can be renewed as it wears out. The wooden pavement, known in America as the Nicholson, and others of its kind, were laid on a lining of thin elastic boards upon poorly prepared foundations of earth or gravel. These pavements soon went to pieces, and gave a bad name to wooden pavement of all kinds; but creosoted wood, laid as it should be, on a perfectly firm concrete foundation, makes the best covering that has yet been found, being nearly as smooth as asphalt, and less slippery. The application to the wood, from time to time, of very sharp, finely broken stone, almost like coarse sand, which is forced into the end grain of the wood by the traffic, gives the horses' feet a better hold. A pavement must always be a compromise: if it is very smooth it is slippery. Certain stone pavements in the streets of Rome,

made with a very hard lava, closely jointed, are perfect for wheels, but extremely slippery for horses.\*

Elaborate experiments were made in London in 1873, by WILLIAM HAYWOOD, Engineer and Surveyor to the Commissioners of Sewers, on the slipperiness of pavements; they are described in a Report entitled: *Accidents to Horses on Carriageway Pavements*. Many thousand passing vehicles were observed and the falls of horses recorded, in certain streets paved with different materials. The observations showed that on stone a horse falls once in travelling 132 miles, on asphalt, once in 191 miles, and on wood, once in 330 miles, proving the great advantage of wood as affording a good foothold to the horse.

The following results are quoted from pp. 72, 73:—

‘On the average of the whole fifty days’ observations, the Granite was found to be the most slippery, the Asphalt the next so, and the Wood the least.

‘Separating the accidents under three conditions of surface as regards moisture, it appears:

‘That Asphalt was most slippery when merely damp, and safest when dry;

---

\* Within the last few years, the introduction of india-rubber pads in the horses’ shoes have overcome this difficulty and it is now (1899) a rare thing to see a horse fall in the streets of Rome. The pad is, in effect, a shoe inside of the iron shoe, so much thicker that it touches the ground below the iron. It is sometimes open at the back, sometimes closed and covering the frog. The outer portion is expanded into a thin web which lies between the hoof and the shoe; the nails passing through this web, keep the pad in place.



‘ That Granite was most slippery when dry, and  
‘ safest when wet ;

‘ That Wood was most slippery when damp, and  
‘ safest when dry ;

‘ That when the surface of the pavements was  
‘ generally dry, Granite was the most slippery, and  
‘ Wood the least slippery ;

‘ That when the surface of the pavements was  
‘ damp in different degrees, Asphalt was the most  
‘ slippery, and Wood the least slippery ;

‘ That when the surface of the pavements was  
‘ wet, Asphalt was the most slippery, and Granite  
‘ the least slippery ;

‘ That on the whole, Wood was less slippery than  
‘ either Asphalt or Granite.’

There is nothing so nearly perfect, from a driving point of view, as a macadam surface, giving sufficient smoothness without being in the least slippery ; but its drawbacks of dust, mud, and rapid wear have nearly banished it from large cities.

ACTION OF A HORSE IN DRAUGHT.—If a man, attached to a vehicle, throws his body into the position shown in Fig. 77, he would fall forward were he not supported by the strain on the line by which he pulls. If his inclination is slight, he will merely put a portion of his weight upon the line, and the remainder will be supported by the ground through his legs, but if he increases his inclination suffi-

ciently, the vehicle will move forward as soon as the horizontal force acting on the line is equal to



FIG. 77.

the resistance to motion of the vehicle. When the vehicle moves in obedience to this strain, the man is forced, in order to avoid falling, to put one foot in front of the other and so successively to walk forward. As this strain upon the line is produced entirely by the weight of the man, it is evident that the heavier he is the more

he can pull. The action of the horse is exactly the same (Fig. 78), though at first sight it seems

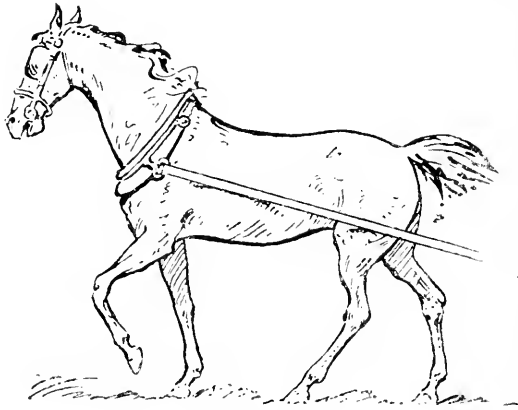

FIG. 78.

complicated by the fact of his having four legs instead of two. As the vehicle moves in obedience

to the impulse of his weight, he is forced to support himself by advancing a leg, and he continues to move, throwing his weight forward.

As in the case of the man, the heavier the horse, the more he can pull, a fact well recognised by those who use horses for slow, heavy draught. A horse with a man on his back will pull a heavier load than without the man, and the weight which is sometimes hung on the yoke of a pair of oxen produces the same result; the advantage in both cases, however, is obtained at the cost of additional strain upon the legs and on the general powers of the animal. A heavy animal has more weight of his own to move than a light one, and he must therefore be proportionately stronger; and this becomes more important as the pace is increased, since a speed may be reached when all the power of the animal is employed in moving himself and nothing is left for purposes of draught. In selection of horses for service this should be duly taken into consideration: for slow stages on soft roads, or for starting a coach on grass and earth, heavy wheelers are desirable, but for fast work on good, hard roads, light, quick, active horses are the best. These are important points in distributing horses along a road for service on different stages, and show the judgement, good or bad, of the person undertaking this duty.

If a horse weighing 1000 pounds throws himself forward into such a position (Fig. 79) that his weight overhangs the points of support 4 inches,

the horizontal force will be equal to about 111 pounds, since the joints about which the body moves may be considered as being about 36 inches from

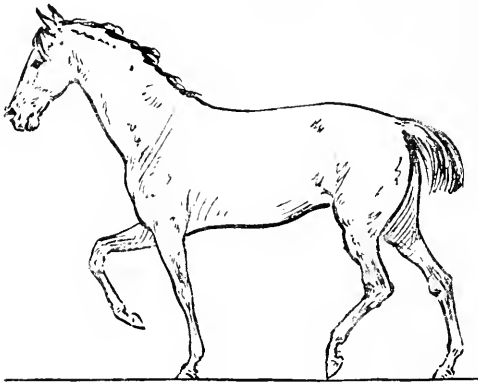

FIG. 79.

the ground, and 36 is to 4 as 1000 is to 111, so that a moderate inclination is sufficient to produce a considerable effect of draught.\*

\* This proportion is determined by what is known in mechanics as

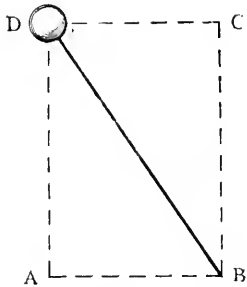

FIG. 80.

the parallelogram of forces. The weight at D, supported by a rigid strut, DB, will tend to move in a circle of which B is the centre, unless prevented by a resistance acting in the line DC, and its effect will be represented in direction and amount by the lines DB and DC, DA representing the weight.

The pressure on the ground acting in the direction DB is greater than the weight itself, and it would appear, therefore, that

some force is in this way made out of nothing, but it must be remembered that mechanical *work* is the result of pressure multiplied by the

The relation of the power of a horse to the draught of a vehicle is modified by the condition of the road, since the exertion of moving his own body is much the same to the horse, whether the surface of the road is good or bad, provided it is not slippery or so loose and deep as to yield excessively to his feet; but as the surface of the road deteriorates, more power is required to pull the same vehicle.

There is some difference of opinion as to the relative merits of a rigid, and an elastic connection between the horse and the vehicle; since the animal's motion forward is not uniform, but, as shown by the experiments of MAREY and others, consists of a series of motions of varying velocity, a number of shocks must occur with a rigid connection which are avoided by a certain amount of elasticity.

As has been remarked, when speaking of carriages with and without perches, the springs to some extent take up such shocks, and a number of devices are in use, such as the spring swingle-tree of a brougham, or a dog-cart and the spiral springs connected with the traces sometimes used with heavy business-vehicles. With a spring interposed, a forward

---

distance through which it acts and not by the amount of the pressure alone.

As the load becomes greater and the inclination of the legs of the horse must be increased to move it, the strain on them will be increased to their injury.

movement of the horse, more or less sudden, instead of being resisted by the entire weight of the carriage, is partially taken up by the spring and then gradually communicated to the vehicle; none of the force is lost.

The difference between an elastic and a long connection must be carefully noted. If the traces are so long that the horse, when commencing to pull gets into motion before acting upon the vehicle, he is brought up with a jerk when the trace tightens, and much of his power is wasted to no purpose. A slack connection by an unyielding trace is therefore objectionable. This does not apply to the case of a horse pulling a canal boat by a long rope, as the sinking and rising of the rope takes the place of elasticity, and the force expended in raising the rope before the boat begins to move, is restored by its sinking again.

From a purely physiological point of view, a long continued action by a horse, the same in character and in amount, is undoubtedly more fatiguing than when it is varied, and the majority of horsemen have observed that in a given distance, on a road with some undulations, a horse is less tired than on an even grade, no matter if that grade is the minimum one mathematically.

The European roads, laid out by engineers with the view of having the easiest grades attainable, nearly all have the grave defect of long steady slopes for surmounting elevations with scarcely any

resting-places. American roads, otherwise much inferior, usually have on the hills, places which are level or of slight grade, and there can be no doubt that it is much better for the horses, to have steeper grades alternating with flatter ones than to have a minimum average grade for the whole of a long distance. An objection sometimes made to such a plan, is that if horses are stopped on a hill they are sometimes disinclined to start again, but often they have to be rested on the regular grade, and are then much more likely to refuse than if they have a short level on which to start.

As a matter of fact, the increase of grade, which is the result of a location with short flats, is not great. With a steady grade of 1 in 25, the rise is 211 feet in a mile; if at every half-mile, a level of 200 feet long is made, the grade of the remaining portion will be 1 in 23 instead of 1 in 25. With a regular grade of 1 in 40, the rise in a mile is 132 feet; a level place of 400 feet, in each mile will increase the remaining grade to 1 in 37.

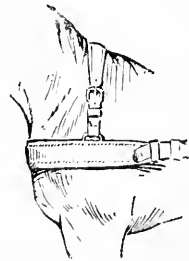

FIG. 81.

ATTACHMENT OF THE HORSE.—  
There are two ways in general use of attaching a horse to the traces by which he draws the vehicle. One is by the breast collar (Fig. 81), or Dutch collar, as it is frequently called, which was in almost universal use

on the Continent until of late years ; it is still frequently seen there, and in America is used in some light trotting harness. It has the advantages of being simple, light, and cool in hot weather, and, with slight adjustment, of fitting any horse.

Its disadvantages are that with a stiff splinter-bar it rubs the shoulders as they move backward and forward within it, and, bearing upon the point at which the shoulder-blade joins the upper bone of the leg (Fig. 82), cripples the action of the joint. It

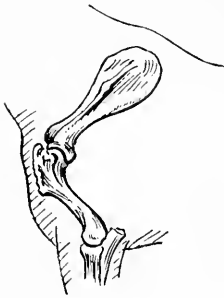

FIG. 82.

does not enable the horse to hold back effectively without the addition of a somewhat complicated strapping, or a metal yoke. It may be necessary in travelling to use one for a time to relieve a horse with a sore neck, but moveable swingle-trees of some kind must be used with it, or else a galled shoulder is sure to result.

The other way, is to use the ordinary collar (Fig. 83), a part of the harness which requires the greatest care and consideration, sometimes taxing the ingenuity of the most experienced horsemen and harness-makers. It must fit ; if it is too long or too wide it will slip about and rub the skin ; if it is too short it will choke the horse ; if it is too narrow it will pinch and gall him. These questions will be treated more in detail in the Chapter on Harness. But in this place it is proper to call attention to what



Major DWYER\* has so pertinently pointed out, that the attachment of the trace must be at that part of the collar which has the least motion when the horse, in action, works his shoulder.

If the tug to which the trace is attached, is too low down, the collar will act somewhat like a breast-strap, the bearing will be against the moving joint, and the collar will stand forward at the top, away from contact with the horse's neck.

If the tug is too high, the bearing will be on the thin part of the neck, where it will act obliquely against the skin instead of resting on the part which is of such a form as to give a sort of seat for the collar. Being too high is a less serious fault than being too low, but it should be as nearly as possible at the point (Fig. 83), where the *seat* for the collar exists, and where the rocking motion of the shoulder-blade is the least.

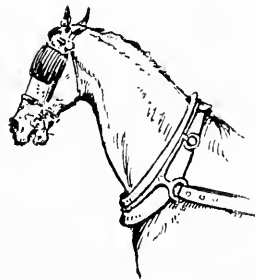

FIG. 83.

A great deal has been written about the angle of the trace, and the experiments of MORIN, and others, indicate 12 degrees to the horizontal as being the most effective. As a matter of fact, with the usual point of attachment to the collar, with an average

---

\* Major FRANCIS DWYER, *Seats and Saddles*. Chapter on *Draught*, Am. Ed. n.d., part iii.

horse, and with the usual height of splinter-bar, 2 ft. 7 in., the angle of the trace of a coach is about 16 degrees, and therefore somewhat exceeds the theoretical angle. The direction of the trace continued falls above the front axle and below the hind axle in the way which is shown by PHILIPSON (*Draught*, p. 18) to give the best results. It is obvious from an inspection of Fig. 73 (showing the manner in which a wheel is drawn over an obstacle), that a downward direction of the trace from the vehicle to the collar would be wasteful of power, and that a moderate upward inclination, tending to lift the load somewhat, is better.

DWYER has pointed out that the direction of the trace should be, as nearly as possible, perpendicular to the collar, but no shoulder is straight enough to bring a trace, with an angle of 12 degrees, at right angles with the collar. On a well-made horse, the collar will have an inclination of about 36 degrees to the vertical, and a trace with an inclination of 12 degrees to the horizontal will not come within 24 degrees of being at right angles to the collar, or with an angle of 16 within 20 degrees. On a horse with a very sloping shoulder, the collar will be even less upright, and the strain on the trace will pull the collar up, on the neck, choking the animal and chafing the skin. The correction for this is, obviously to have the splinter-bar low, and to put the draught-eye of the harness high.

Close observation of passing horses will fre-

quently disclose exaggerated cases of this mistake ; a small horse with a sloping shoulder, attached to a carriage with a high bar or swingle-tree, and with the tug low, will have his collar pulled into an absurd position.

In Fig. 83, the angle of the collar is 36 degrees to the vertical, and that of the trace 12 degrees to the horizontal ; in Plate XXXI. these angles are 36 and 16 respectively.

In a trotting-wagon, the swingle-trees are usually very high, in order to give the horses ample room for the action of their hind legs ; this brings the traces nearly horizontal, but the draught is so light that the inaccuracy is not important.

It is a common opinion among coaching men that there is a great advantage in having the horse *close to his work*, that is, in having a very short trace. But this must be taken with some allowance. There is no absolute mechanical advantage in a short trace. A vehicle drawn along a surface by a horizontal cord and a weight, passing over a pulley, will require exactly the same weight to move it, be the cord long or short ; variations in the effect can come only from the action of the animal.

It is, of course, important that the motion of the vehicle should be as uniform as possible, and that, once set going, it should continue to move at the same speed, so that small obstacles can be surmounted or crushed by the instant action of the horse, before the carriage has time to stop and to

require to be set in motion again. With *very* long traces this objectionable stoppage may take place, which is no doubt the foundation for the wide-spread belief in the advantage of putting a horse close to his work. Undoubtedly, on smooth roads the horses may be harnessed as close to the coach as will permit them to trot fast without the danger of being touched by the splinter-bar or of striking the wheels with their feet; this means tight pole-chains to prevent the horses from getting back too far. But on uneven roads, with holes and ruts, such close harnessing will strain the horses by subjecting them to violent shocks from the irregular motion of the coach. The custom, therefore, in rough countries, such as Western America, Africa, and Australia, is to have a long pole and to harness the horses *loosely* by long traces and long pole-chains, so that while the coach cannot touch them, they are less affected by the movements of the coach and of each other. In park driving on smooth roads, with light loads, low speeds, and well-trained horses, both traces and pole-chains may be short; but it is a common fault with coachmen to have them too short even under these circumstances and to distress their horses unnecessarily. For higher speeds, especially galloping, and on less good roads, more flexibility is required and more length should be given. A short-harnessed team looks 'smarter,' takes up less room, and is more easily handled than a long one, and, where circumstances permit, it is proper; but judge-

ment must be used as to the conditions. The leaders should have their traces long enough only to keep them well out of the way of the bars, and a *short* pole with a crab the branches of which are of sufficient length to bring the pole-chains into the proper direction, will, by bringing the leaders well back, add much to the appearance of a team.

The proper length for a wheel-trace is 84 inches from the tug-buckle to the centre of the roller-bolt ; for a lead-trace, 76 inches from the tug-buckle to the end of the cock-eye (pp. 216, 217). From the tug-buckle to the front end of the trace, the length is 15 inches, making the whole length of the wheel-trace 99 inches, and of the lead-trace 91 inches.

## CHAPTER XI

## HARNESS

HARNESS.—The essential parts of the harness are the bridle, bit, reins, collar, hames, and traces. All other parts are accessory, and may be somewhat varied, and, in some cases, omitted.

BRIDLE.—The bridle shown in Fig. 84 is the usual pattern of a coaching bridle.

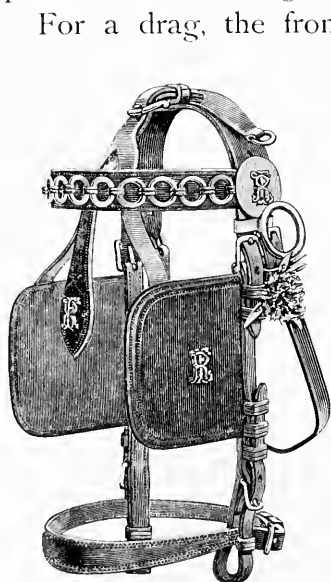

FIG. 84.

For a drag, the front should be a simple pattern of chain; for a road coach, patent leather, or worsted, of the colours of the coach, plaited round the leather front. Where the front joins the bridle there should be a plain metal boss, preferably flat, with initial or crest. On a drag harness, these bosses should be on the inner side as well as on the outer side; on a road-coach they are on the outer side only,

and serve to indicate the off side or near side bridle. Ribbons or rosettes are out of place; they belong to

a lady's harness; but flowers are correct at all times, and should customarily be worn. On a road-coach, only flowers in season should be used; they are supposed to be given by the fair friends of the coachman, along the road. In winter, holly berries and leaves are suitable. On a drag, any kind of flowers may be worn, and frequently the owner adopts an especial flower from which he never varies. It is well to have it correspond to one of the colours of the coach. Of course, *artificial* flowers must be used; natural ones are too fragile. The wire stems should be pulled through the loop below the buckle which is at the top of the winker. They are worn only on the outer side of the bridle. In Fig. 84, the flower is shown as being put in the throat-latch buckle because the rein-ring is high and close to the boss; if the ring is on the throat-latch, the flower should be in the cheek-piece buckle so as not to be rubbed by the rein.

On occasions of ceremony, such as Meets, it is usual for the owner and the grooms to wear *boutonnieres* of the same flowers as those on the horses' heads, and on the road, the person driving may do the same. There is one occasion when ribbons may be used: on the last day of the season of a road-coach, on the last stage into town, it is customary to put on the horses' heads knots of ribbon of the coach colours, and on the pads, similar knots, with long ends.

Winkers should be square, with rounded corners;

round winkers, with or without metal edges, belong to dress harness. They should be much hollowed or cupped, so as to stand away from the eye. Winkers are unquestionably necessary in driving-harness; a saddle-horse is ridden without winkers, but the rider is on the back of the animal, where he has good control over him; driving-horses have the coachman and the whip behind them, and without winkers they will be nervously watchful of whatever happens *there*.

Were all horses driven from the first, without winkers, they would probably work well enough; but, in using horses which have been broken to harness with winkers, it is dangerous to omit them. They should not be close enough to the eyes to heat them, but they should be high enough to prevent the horse from seeing backward over them. The split strap connecting the winkers with the crown-piece, should be exactly of the right length to make the winkers set properly, neither too close to the eyes, nor spread apart. Care must be taken that, in the harness-room, the bridle is not hung on a *single* hook, since this hook must come on one side or the other of the buckle of the crown-piece, and the bridle will get a crooked set, and not fit squarely on the head. Attention to details like these makes the difference between a well turned-out team and a slovenly one. The centre of the winker is a proper place for any crest, monogram, or device that may be used. In drag-harness, there is



a face-drop which goes under the front, and usually has the monogram on it. This is entirely ornamental and is omitted in road harness. On one side, the nose-band has a loop which goes on the billet of the side of the bridle to keep the nose-band from slipping round, and on the other side, it passes between the side of the bridle and the billet, so that it can be tightened by the buckle which is under the chin. Ordinarily, the nose-band is more an ornament than anything else, but, with a high-port bit on a pulling horse, it may be buckled somewhat tight to prevent the horse from opening his mouth too wide, and thereby escaping the action of the bit; then, it is useful. When a side-rein is used to hold back a pulling horse, it may be buckled to the nose-band, which then acts as a cavesson.

In the wheel-horse's bridle, the ring through which the leader's rein runs, is fastened on in several ways. In Fig. 84 it is shown as brazed to a flat loop or band, which slips on to the crown-piece, and is kept in its place by the buckles below it. This brings the ring close under the boss and above the flower. It can be readily taken off when the bridle is used in a pair-harness.

Another way is to have the ring sewed on the throat-latch under its buckle, as is done in road-coach harness, as in Fig. 85; it is then further below the boss, and the flower may be put through the buckle over it. Thus arranged, the rein comes straighter to the pad-terret, but it rubs the sur-

face of the winker. The throat-latch in this case should not be a part of the crown-piece, as is usual in pair-horse harness, but should be separate, with a buckle at each end, so that it can be removed and a plain throat-latch without a ring, substituted

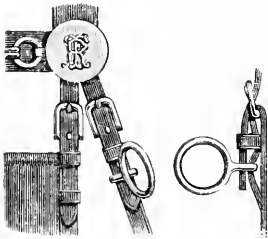

FIG. 85.

when desired. When using four-in-hand harness for pair-horse work, it is in better taste to remove the parts which are only necessary for four horses. It is a good plan to have the harness so made that it can be used for either purpose, and it keeps in

much better order when in constant use, and is frequently cleaned and oiled, than when hung up and allowed to become dry. Two sets of four-in-hand harness, thus arranged, will serve the requirements of a large private stable for pair-horse work, and will make it possible to turn out two teams for a change of horses.

Carrying the lead-reins *over* the heads of the wheelers has now gone out of fashion; twenty-five years ago it was almost universal for drags, but before that time it was being gradually abandoned on road coaches.\*

---

\* In a print, after W. J. SHAYER, published in 1841, of the DUKE OF BEAUFORT'S road-coach, the lead-reins are through the throat-latch rings. This is the earliest print in which that arrangement is shown, that has come under my notice.

‘NIMROD,’ in 1834, comments upon the fashion as follows (*Northern Tour*, p. 31):—

‘It was now I found that I had taken leave of  
 ‘coaching in anything like its proper form, at least  
 ‘for some time to come; for the horses were slow,  
 ‘the coachman slower, and the stupid, unworkman-  
 ‘like, unsafe practice of running the leader’s reins  
 ‘through the throat latches instead of the head ter-  
 ‘rets of the wheel horses was the order of the day;’  
 and again (p. 340), ‘Such a thing as a leader’s rein  
 ‘running through a wheeler’s throat latch, instead  
 ‘of through his head terret, is not to be seen on the  
 ‘Defiance.’ The objections to using the head-terret  
 are, that when a wheeler tosses his head, he disturbs  
 the lead-rein more than when it passes through the  
 side ring, which is more flexible, and which moves  
 without jerking the rein; that the rein, when over-  
 head, sometimes gets behind the horse’s ear, and  
 often in wet weather gets the foretop hair tangled  
 round it; and that it is difficult to reach up so high  
 to pass the rein when changing horses. When  
 a head-terret is used, it is

screwed into a plate sewed  
 into the crown piece, or,  
 more frequently, there is  
 a double ring (shown at  
 A, Fig. 86), which to some  
 extent prevents the rein

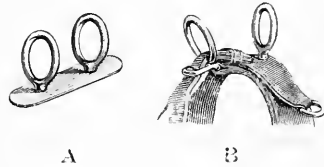

FIG. 86.

from getting behind the ear. With a single head-  
 terret the same result may be obtained by putting

a loose ring between the buckle and the loop, or keeper, in front of the terret, as shown at B.

The terrets may be kept on the top of the head in a road-harness, as well as the rings on the throat-latch, since leaders that throw their tails over the reins, or that are inclined to kick, will be less likely to do either, if the rein is kept that much higher; but when the terret is near the boss, as in Fig. 84, pretty much the same end is attained.

In road-harness the ring is often sewed on lower down than is shown in Fig. 85. In American\* road-harness these rings are invariably on the *inner side* of the bridle, since the lead-reins are *not* passed through a terret on the wheelers' pad, and from the inner side go more directly to the driver's hand; but it is much more difficult to pass the rein through, at a change. Sometimes the lead-rein is simply passed *through* the throat-latch.



FIG. 87.

The strap with a ring at the end (shown in Fig. 84), which is sewed on the crown-piece, is to take the short strap holding the ring (Fig. 87) through which the bearing-rein passes, and, when the bearing-rein is not used, the strap and ring show very little.

The buckle which is sewed on the cheek strap at the top of the winker should be a little above the

---

\* When reference is made to the 'American' way, the original fashion, as practised in the West, is meant.

edge of the winker, so as to permit some flexibility to the side of the bridle.

BIT.—A great many different bits are fancied by horsemen, but, for coaching, the patterns shown in Fig. 88 are those most in use. The Liverpool bit,

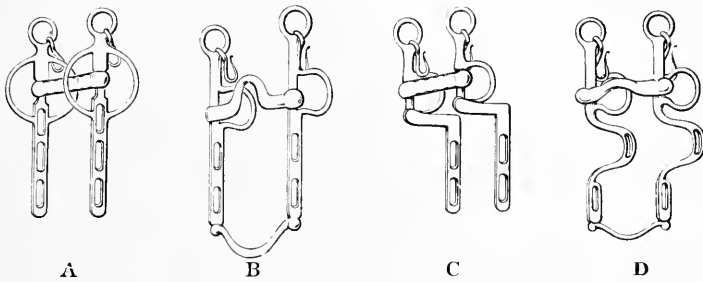

FIG. 88.

A, has a straight mouth-piece, smooth on one side and slightly fluted on the other, which plays up and down on the branches of the bit for the distance of about an inch. The portion of the branch on which it moves should be *square*, as well as the hole in the end of the mouth-piece, so that the branch cannot turn, or else the coupling-rein will pull the ring of the bit into a position to press against the side of the horse's mouth and hurt him. An objection to having the branches moveable in the mouth-piece is that they wear rapidly; consequently many coaching men prefer to have them fixed. When the rein is buckled to the ring, or, as it is called, 'in the cheek,' the bit acts like a plain snaffle. When

it is in one of the holes in the branch, it is said to be 'in the upper, middle, or lower bar,' and the lower it is, the more effect it has.

The rein is sometimes buckled round the branch *inside* of the ring, and below the mouth-piece (Fig. 89), when it acts, perhaps, like a mild curb bit; but this arrangement prevents the play of the mouth-piece up and down, and does not have any compensating advantage. The billet being constantly wetted by the horse's mouth is soon rotted. The

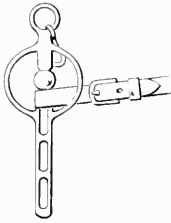

FIG. 89.

branches of the bit may be joined at the lower ends by a bar, as shown in B. This bar prevents a horse from catching the end of the branch in the bridle of his partner when he tosses his head, and such bits may be used on the lead horses. On the wheel horses, this bar might be caught in the hook of the pole-chain, and it is therefore better not to use bar bits on the wheel horses.

Either style of bit may be used on all four horses, but bits with bars on the wheelers, and bits without bars on the leaders, in the same team, are decidedly wrong.

To prevent a horse from taking the branch of his bit in his lips, the elbow bit, C, is used; the bend in the branch serves the same purpose as a lip strap on a riding bridle. In this bit, the shank, if it passes loosely through the mouth-piece, must be square, or else the coupling-rein will pull it out of position.

The Liverpool bit, having straight branches, can be used either with the fluted side or with the smooth side of the mouth-piece against the horse's jaw, but the elbow bit obviously cannot be so used unless the shank is round, so that the branches can be turned. For this reason, the Liverpool bit with the straight branch is the most useful 'all-round' bit.

The Buxton bit, D, is considered a 'dressy' bit and is used on pair-horse harness: it is proper enough on a drag team, but not quite so simple and workmanlike as the Liverpool. The branch is curved to prevent the horse from catching it with his lip.

A straight mouth-piece is not always suited to a pulling horse, since it rests upon the comparatively insensitive tongue, and does not press much upon the bars of the mouth. Such a horse requires a mouth-piece with a *port*, or, as the French call it, *liberty of the tongue*, which is an arch, as at P, Fig. 90, of greater or less height, permitting the tongue to go up into it, and the *canons*, C C, of the mouth-piece to rest upon the bars. When considerably exaggerated, the port serves another purpose: it presses upon the roof of the mouth when the rein is drawn, and, if the nose-band is buckled tight, it presses very hard. This arrangement is one of great severity, and should be used only by a person of judgement, and with a very light hand. The action

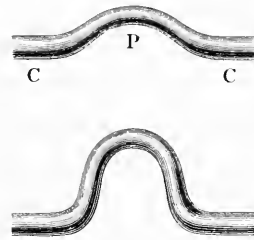

FIG. 90.

of all these bits, when the rein is buckled in one of the holes in the branch, depends upon the curb-chain which is attached to the upper eye of the bit and passes under the chin. The tightness of the chain can be regulated by engaging one or other of its links in the hooks. Usually, before hooking, the chain should be turned until all the links lie flat; if it is turned so that the links are open, or 'roughed,' as it is called, it is more severe. There should be a hook on *each* side of the bit, so that the chain can be entirely removed for cleaning, and these hooks should have spring points, or the chain will be constantly coming unhooked. The chain should be so hooked that when the bit is hanging loose, with the horse's head nearly vertical, three fingers can be passed between the horse's jaw and the chain, which will then lie in what is sometimes called the 'chain-groove,' above the cushion-like thickening of the lower lip. When the rein is pulled tight, the head of the horse being vertical, the branch of the bit should come to an angle of about 40 degrees with the vertical; if it approaches nearer to the horizontal, the chain is too loose to have any effect. A curb-strap, with a billet at each end to buckle in the eye of the bit, is in many respects more convenient than a chain, and no hooks are needed on the bit, but it is not as severe as is a chain.

Since the function of the curb-chain is to provide a fulcrum on which the branch of the bit acts in pressing the mouth-piece against the bars, a



wide strap fulfils this purpose without hurting the chin ; for which reason I have always preferred the strap.

The action of the chain, on a pulling horse, may be much increased by tying the centre of it by a piece of cord to the throat-latch, so as to make it bear higher up on the jaw, or the chain may be passed once round the part of the nose-band which lies above it, with the same effect.

Plain snaffle-bits (Fig. 91) are rarely used on coach horses.

If one horse in a team will not go pleasantly with any other bit, he must have one ; but it is dangerous to bit a team all round with snaffles, for if they start suddenly, it may be difficult to hold them, and an unnecessary risk is being run ; a curb bit with a light hand is the proper thing.



FIG. 91.

The double-ring, jointed snaffle (Fig. 92) is the favourite hansom-harness bit, and in severity comes between the plain snaffle and the curb.

The loose rings are fastened to the head-stall of the bridle, and the reins buckled to the ordinary rings ; the pull

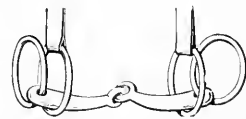

FIG. 92.

bends the bit at its joint, and squeezes the loose rings together, making the bit quite severe. The action of the various Bits will be discussed in Chapter XV.

THE BEARING-REIN is made in the two forms shown in Fig. 93. The pulley bearing-rein, A,

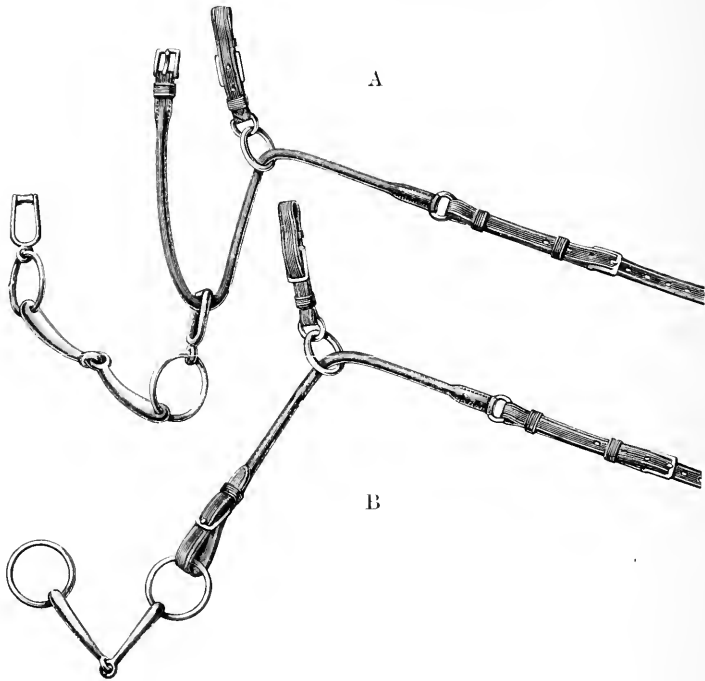

FIG. 93.

requires a special snaffle, having a roller or pulley attached to it. The bearing-rein is buckled to a point or chape on the crown-piece, passes through the pulley (being made round for the purpose), and then through the ring of the gag runner, terminating in a ring to receive the flat portion of the rein. This flat portion is looped over the centre-hook of the pad (p. 220); its length is adjusted by the buckle shown at the right-hand side of Fig. 93.

The plain bearing-rein, B, is buckled to a light snaffle-bit, which is not attached to the bridle, and, passing through the ring which is attached to the crown-piece by the strap already described, it loops the centre-hook of the pad. For the purpose of adjusting its length, it has the arrangement of rings and buckles shown in the figure. Form A, is much more heavy and clumsy than form B, and it is difficult to see any advantage in it. The double purchase of the pulley enables a stableman to pull the rein up very tight, and to make it cruel. (See Article on Bearing-Reins, Chapter XII.)

The bearing-rein is sometimes, in America, called the 'check-rein.'

COLLAR.—Inasmuch as the collar is that part of the harness by which the horse does his work, it is of the utmost importance that it should be of the proper shape and should fit well, and to get a collar which will not rub the horse, usually exercises all the care and ingenuity of the harness-maker and the coachman. If possible, every horse should have his own collar; with the horses of a road-coach it is indispensable, for which reason every horse should have a number, which is usually branded on the hoof, and his collar should have a corresponding number, in brass figures, on the little cape which is usually on the top of a road collar, where they can be seen by the coachman from the box.

Collars are either *straight*, that is, so made that when laid upon a table, face down, they will touch the table at all points (Fig. 94), or *bent back* (Fig. 95). The latter shows off the horse's neck much

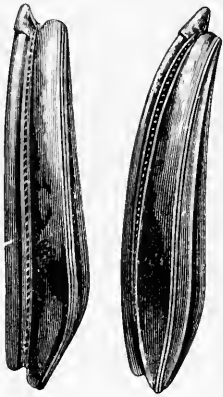

FIG. 94. FIG. 95.

better, giving it more apparent length, and collars for drag-harness are usually thus made. Since the metal hames must fit the collar closely, they must be also bent back, and if there is any difference in the degree of bending, they will not fit. For this reason road-coach collars are usually made straight, since any straight hames will fit any straight collar, provided there is not too much difference in size. Some coachmen think that straight collars are less apt to rub the neck.

The hames rest in the groove formed by the roll which makes the front of the collar, and when this groove shows also on the inside, or neck side, of the collar, the collar is called a 'rim collar.' Sometimes the groove does not show on the neck side, the lining being carried round smoothly from back to front. Such collars are called 'Kay collars,' from the name of the inventor, and, being neater looking than rim collars, are well adapted to drag-harness. In drag-harness, the outside of the collar is always made of patent leather; in road-coach harness, it is frequently of plain, black leather, and sometimes of

russet leather, which last is rather 'smart' looking when it is dark brown. What are called 'straw collars' are really made either of split rattan, or of a kind of rush; they have no particular advantages.

The lining against the horse's neck is of soft leather, black or russet, or sometimes of thin and very smoothly worked patent leather. The latter has the advantage of being easily kept perfectly clean by sponging, and, in warm weather especially, is, perhaps, preferable to any other lining.

Cloth, or woollen of any kind, is not good, although many heavy collars for carts, and the like, are so lined; it absorbs the sweat, and is difficult to dry. A collar must be so stuffed as to be soft and elastic.

The shape of the collar is, of course, of the first importance; if it is too wide, it will slip about sideways, and rub the shoulders; as a rule, the width that permits it to go easily over the horse's head will be right for the shoulders. A horse with a very wide head and thin neck requires a collar which can be opened at the top, in order to put it on, or the collar must have a lining which can be fitted into it to reduce its width. This lining should have a roll at each edge, to prevent it from slipping out of place.

A collar should be of such a length that the four fingers of the hand, held vertically, can be readily inserted between it and the neck when the horse holds his head in a natural position, or else

when he lowers his head, the collar will choke him. If it is much longer than this, it will slip up and backward. It is impossible to give precise directions as to the length; careful observation must determine it for each horse. The proper form of collar, looking at it in front, is shown in Fig. 96. The

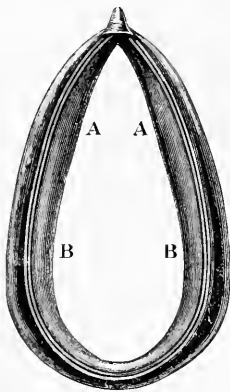

FIG. 96.

top should be sharp, and not rounded, or it will press on the withers, and make a sore spot; a serious and common fault. To guard against this same fault, the sides, at the points marked AA, should be somewhat filled out, but not enough to prevent a solid bearing on the neck at BB, where the draught comes. It is usually very difficult to make a harness-maker appreciate the necessity

of attending to the filling at AA, or to the pointed top.

A pipe collar is made with a hollow about three inches long and half an inch deep, at the bottom of the inside curve, so that there shall be no pressure at that point on the windpipe.

The upper ends of the rim are covered by a leather point, or cap, and there is sometimes a little cape which extends backward and covers the place where the collar is sewed together. On this cape, is the proper place for the number of the horse. In dress-harness the crest is put there, but

not in drag-harness. Sometimes a buckle is sewed on the collar on each side, back of the hames, and eight or ten inches below the top of the collar, into which a strap an inch wide, with holes in each end, called a housing-strap, can be buckled; this passes over the top of the collar, from side to side, and over the bearing-rein to keep it from shaking about; it is now rarely used.

The collar is really only a pad which goes next to the horse's neck, and is surrounded by the hames, which are two pieces of iron, flat on the inside and round on the outside, to which the traces are attached. The hames are sometimes covered with black patent leather, but are usually plated with silver or with brass, to match the rest of the harness mountings; black hames are rarely used in coach-harness. In drag-harness they have eyes at the lower ends, through which passes the kidney-link (Fig. 97), to hold them together. The kidney-link, so called from its shape, is made open at the top, so that it can be taken off the hames; it is better to have this opening closed by a hinged piece, also shown in Fig. 97, to prevent the points of the links from chafing the collar, and from catching on the edges of the martingale. On the kidney-link is slipped the ring through which the pole-chain is passed. This ring should not be left on the link of the lead-horse harness, where there is *no* pole-chain,



FIG. 97.

although it is frequently left there by thoughtless coachmen.

In road-coach harness the lower ends of the hames have hooks (Fig. 98) and a chain which joins them. If the chain is entirely loose it is easily lost, and it is better, therefore, to have it fast to one side of the hames, as is also shown in Fig. 98. It is usually made as shown in the Figure, but it is better to have two links between the kidney-link and the eye of the hames ;



FIG. 98.

the kidney-link then comes more nearly in the centre. Both chain and link should be very strong.

The purpose of a hook and chain is that the distance between the ends of the hames, and consequently their spread, can be varied to suit the collar ; with the drag pattern this can be done only by changing the link, and, for that reason, links of two or three different lengths should be kept on hand in the harness-room.

It is obvious that, with the long link and chain, the hames must be made in pairs, near side and off side, since the link and ring are on the inner side.

In heavy diligence-harness, the hames are of wood, and to the rings to which the traces are attached, or to others below them, a leather strap is buckled, hanging quite slack, on the middle of



which the pole-chain runs instead of being fastened into a kidney-link.

The hames are fastened together at the top by the hame-strap, and this must be strong and frequently renewed, since the strain from the pole-chain comes upon it. The hame-strap must be put on with its point turned toward the *inner side*—that is, to the *off* side on the near horse, and the *near* side on the off horse ; because, should a horse fall, the quickest way to loosen his traces and pole-chain, and to free him, is to unbuckle his hame-strap, which is much more readily done when the strap can be pulled *toward* the operator. This is such a simple way of getting the harness off, that it is strange that many experienced horsemen forget it and try to pull the traces out of the tug-buckles without success. The hame-strap can be cut in an emergency, with the loss of only an insignificant part of the harness, whereas cutting a trace means serious damage.

DRAUGHT-EYE.—At a point about two-fifths of the whole length of the hame from the bottom, the draught-eye is welded on, and to it is attached the trace.

There are several patterns of draught-eye, but those most in use are shown in Fig. 99 ; A is the most common ; B is practically the same as A, and is really a better design, since it is fastened at two points, and hence is stronger ; C has the same form

as A, but has in addition a ring, to which the tug is sewed, and is generally used on road-coaches, while A and B are used in drag-harness; D, called

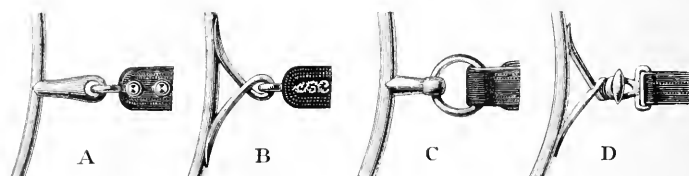

FIG. 99.

from its shape the *olive*, is almost universal in French cab-harness, but is rarely used in other harness, although it has the advantage that the tug can be readily detached by turning it a quarter round. It is not so strong as any of the other forms, C being the strongest of all, and, therefore, very properly adopted for road-harness.

It is usual in road-harness to leave the steel end of the draught-eye unplated; the brass plating is apt to wear at that place and look ragged; the ring is also steel.

The draught-eyes should be long and should stand out well, to prevent the trace from chafing the collar.

MARTINGALE.—The bottom of the collar is kept from rising by the martingale, which passes from it, between the fore legs of the horse, to the belly-band. When a horse is holding back, on a hill, the pole-chain pulls on the kidney-link and hames, and the martingale must, therefore, pass *round* the

collar and inside of one side of the kidney-link, binding it and the collar together, as in Fig. 100. It is a common mistake to buckle the billet of the martingale to the kidney-link *only*; in this case, should the hame-strap break, or be too loose, the link and hames may be pulled off together, entirely leaving the collar.



FIG. 100.

Harness-makers sometimes make the martingale billet too short to go round the collar, in which case, a new billet must be put

on; as a temporary expedient a short strap should be buckled round link and collar.

Another reason for buckling the billet round the collar is, that if it is on the link only, it is swung from side to side by the action of the horse, with an ungraceful motion, as may be often noticed on a pair of horses approaching the observer. For the same reason the patent-leather ornament, which is usually on the martingale, must be firmly sewed to it, as shown in Fig. 100, and not attached by a ring. Martingales should not be used on the collars of the

lead-harness, since the leaders have no part in holding back the coach.

Near the upper end of the hame is a terret, through which the rein passes. This terret is usually made with the ring *loose* in the foot which attaches it to the hame.

TUG.—The *tug* is a strapping of leather (Fig. 101). The clip, made of iron, is slipped into the

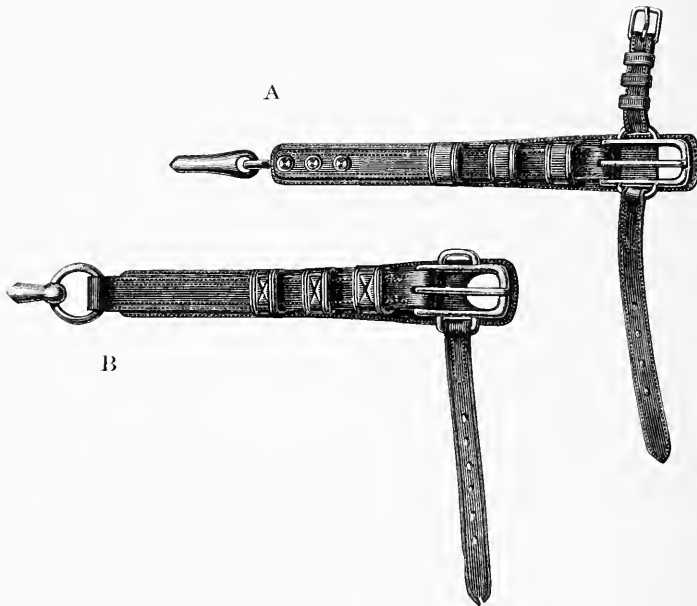

FIG. 101.

front end of the tug as shown at A, and secured by rivets, the heads of which show ; or for road-harness, the tug is sewed to the ring, as shown at B. The other end of the tug takes the buckle for the trace.

The length of the tug is important: if it is too long,—and harness-makers are very apt to make it so,—the buckle reaches back of the pad and the belly-band and looks very awkward, as is shown in Plate XXV. For a fifteen-three horse of good, average shape, the length from the head of the clip to the middle of the buckle, should be  $20\frac{1}{2}$  inches; to the end of the buckle, 22 inches.

TRACE.—The wheel-trace is made of two thicknesses of leather, and should have a narrow strip, shaved on both edges, inserted between the two thicknesses to swell it out in the middle, which improves its appearance, and diminishes its liability to rub off the hair. Road-traces do not usually have this inside piece.

The stitching of the traces should be coarse,—that is, the stitches should be far apart, about ten to the inch, and made with strong thread; in fine stitching, the holes are too close together and cut the leather unnecessarily. Road-harness may be stitched throughout more coarsely than drag-harness.

The front end of the trace is pierced by five holes, an inch and a quarter apart, for the tug-buckle. The rear end is fitted in several different fashions: for a drag it has a running loop (Fig. 102, A), which is put on the roller-bolt with the loose end on the outer side; for a road-coach, what is called the French loop (B) is generally used; it has the advantage of simplicity, and, if the loop of the *inside*

trace is made somewhat small, it will be impossible to get it on over the step iron, which is on top of the *outside* roller-bolt, and there will be no danger, therefore, of getting the traces on the wrong side



FIG. 102.

of the harness. (See Harnessing, Chapter XII.) It will not rattle against the under side of the roller-bolt step as does the metal slide of the loop (A). Road-coach traces frequently have chain ends about 20 inches long, which terminate in a ring, by which the chain is looped over the roller-bolt. These

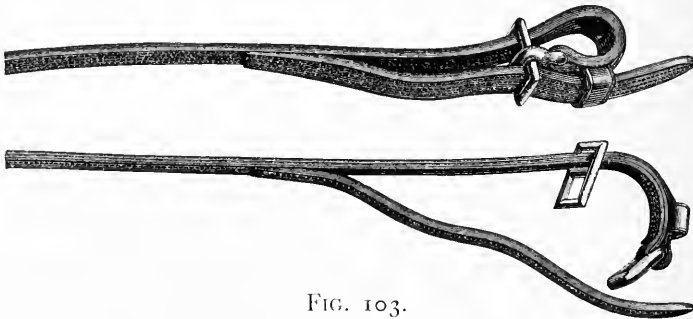

FIG. 103.

chains are not as good as the French loops, since, notwithstanding the swivels in them, they frequently take a partial turn and bring the edge of the trace against the horse.

A good arrangement for trace-ends, lately introduced in England,\* is shown in Fig. 103. On pulling the end of the short strap out of the metal loop, the trace is released from the roller-bolt. This is important in the case of a fallen horse, since to unbuckle the trace at the tug-buckle, or to get any of the ordinary trace-ends off the roller-bolt, is almost impossible.

The near horse's traces should have the short straps both toward the near side, and the off horse's toward the off side, so as to be easily reached. This short strap can always be pulled out, no matter how much strain there is on the trace.

The lead-traces terminate in cock-eyes (Fig. 104), which hook on the hooks of the lead-bars. Traces



FIG. 104.

should be of such length that even when they are buckled in the shortest hole, the point of the trace will not project more than two inches beyond the last loop on the tug; few things look more slovenly than six or eight inches of trace flapping about in front.

PAD.—The bridle, reins, collar, hames, and traces constitute the absolutely essential parts of the harness, and street-car and omnibus-harness, and some-

---

\* WILLIAMSON & DE NEGRI, London.

times road-coach lead-harness, have no other parts. The pad is used on all wheel-harness, and on the lead-harness of a drag. It is usually made quite straight as seen from the side (Fig. 123), and has a centre-hook to take the bearing-rein, and a terret on each side for the reins to pass through. In wheel-harness the centre-hook is surmounted by the centre-terret, through which runs the lead-rein.

In drag-harness, it is a good plan to have this centre-terret made to *screw* into its place, so that it can be taken out and replaced by a small ball when the harness is used for a pair. Sometimes, the centre-terret alone, on its stem, is put on the wheel-pad, and no centre-hook on either wheel-pad or lead-pad,—on the supposition that no bearing-rein is to be used; but it is better to have the centre-hook; a bearing-rein may be at some time required. The pad has a broad strap or belly-band, by which it is kept in its place. This belly-band is usually one flat piece going round the horse, and buckling on the near side of the near horse, and the off side of the off horse.

The shape of the pad is important. It is frequently made too flat, or too open, on the under side, and rests upon the spine, in which case it will inevitably rub the skin, especially if drawn forward by the bearing-rein; it should stand up, as in Fig. 105. To the end of the pad proper is attached the point-strap, which buckles into a strap running up from the tug-buckle. In drag-harness this is made



as shown at A in Fig. 105, and also in Fig. 123; in road-harness it is usually made as at B, where *one* long strap goes through both the ring of the pad

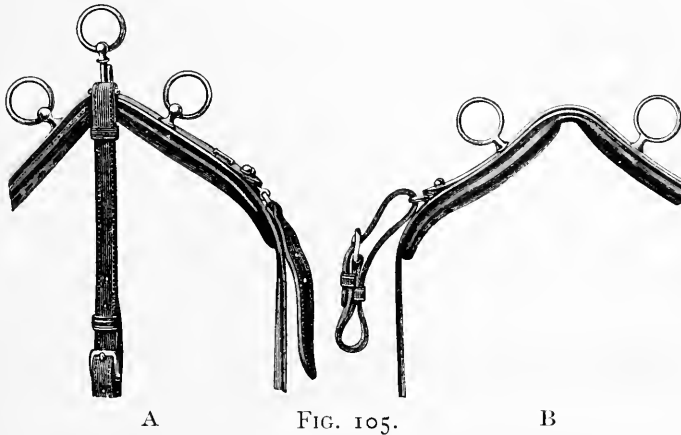

and the loop on the buckle; this is usually called the Newmarket tug-bearer, or Newmarket strap. A false belly-band is sewed into the under loop of the buckle, and buckles on the outside; its purpose is to keep the buckle from jumping up when the horse is moving, but it is of doubtful utility, and its point is apt to catch the whip thong.

Pad cloths are never used with coaching-harness; they are proper only with dress-harness.

Since the lead-rein passes from the ring on the bridle through the pad-terret and then, at a considerable angle, up to the coachman's hand, it tends to pull the saddle forward, and to prevent this, the back-strap and the crupper are added. This does not apply to the lead-harness, from which the back-

strap and crupper are sometimes omitted ; but they are necessary if bearing-reins are used, and on drag-harness, at least, it is best to have them on all the horses. Road-coach lead-harness is often made without them.

BACK-STRAP.—The back-strap of the wheel-harness is usually double (Fig. 106), but in the lead-harness it should be made as in Fig. 107, because the loose point of the double strap is likely to catch



FIG. 106.



FIG. 107.

the fork of the lead-reins, which is annoying and might cause an accident. There is no objection to using this single strap on wheel-harness also. The crupper-dock itself should be large ; it is then less apt to wound the tail and is a good preventive against kicking ; a horse when he kicks always puts his tail tight down, and if he cannot do so, he is very apt to give up the attempt to kick. Coaching-harness is usually made with the split end of the back-strap sewed to the crupper, which is simpler than if it is buckled to it, but sometimes a horse makes a difficulty about having his tail pushed through the crupper, and to obviate this, it is well to have a spare back-strap with buckles, or one which is split

very far up, which will serve the same purpose. The back-strap should be short enough to keep the pad well back ; when the pad is close to the withers and to the collar the apparent length of the horse is diminished.

Hip-straps or trace-bearers are not used on coach-harness, but sometimes, when driving a young horse on the lead, they are useful, because if he kicks, he takes his trace up with him and is less apt to get over it. It is not considered 'good form' to use them, but this is, perhaps, one of the cases where simplicity is purchased at the cost of suppressing what is really useful.

For a kicking wheeler, a kicking-strap may be made fast to the splinter-bar close to the outer roller-bolt, and, passing over the horse's back, be buckled to the pole two or three feet in front of the futchells ; it should pass under the back-strap and be attached to it by a small strap.

The thorough coachman must be always prepared with the knowledge and, as far as is possible, with the appliances, to overcome all difficulties.

BREECHING.—In early days, when coaches had no brakes, the wheel horses always had breechings to enable them to hold back in descending hills not steep enough to require the skid, and they are now sometimes seen on road-coaches in hilly parts of England.

The breeching consists of a strap somewhat nar-

rower than the trace (under which it is buckled in the tug-buckle), passing behind the horse to the tug-buckle on the other side, as nearly horizontally as possible ; it is held up by a split strap which passes through or under the back-strap, over the horse's hip. It may be doubled by a wider strap where it passes behind the horse.

Since the breeching is not now in fashion, it is hardly necessary to describe it more in detail, but it may be said that if for any reason a breeching is used, it must be carefully put on, neither too high nor too low. It is apt to chafe a horse not used to wear it, and the modern brake and the shoe should be together quite sufficient.

In the *Sporting Magazine* of 1830, 'NIMROD' speaks as if the breeching should be attached to the pole-pieces, and criticises the custom in Germany of attaching it to the breast-collar. His remarks suggest the arrangement that can still be seen on heavy wagons in New England cities, where a long yoke crosses the point of the pole, and to this yoke, and not to the trace-tugs, the ends of the breeching, lengthened by straps, are fastened.

REINS.—The reins are made of russet leather and should all be of the same width throughout. One inch is a good width, suiting the average coachman. Some men with long, thin fingers prefer to have them a little wider, while other persons, women especially, like them an eighth of an inch narrower.

They should be somewhat thick, the four together measuring  $\frac{3}{4}$  of an inch, and should be made of firm leather. The outer, or draught-rein, runs straight through from the hand to the bit; the inner, or coupling-rein, terminates in a buckle which runs on the draught-rein, the latter having a number of holes to take the tongue of this buckle. The reins buckle to the bit by billets and buckles. Usually these billets have three holes in them so that their places in the bit can be changed; but it is better to have only one hole, and to make all changes in the length of the coupling-reins by the buckle which runs on the draught-rein. This is important for road-harness, because a horse keeper by buckling in the wrong hole of the billet will change the length of the couplings. An objection to a billet long enough to have three holes is, that the branch of the bit may get caught in the loop when the rein is in the middle bar. The billets ought to be frequently examined, and when *one* is found to be worn, all should be replaced, since the breaking of a rein-billet is sure to cause an accident.

The lengths of the reins are as follows: The lead draught-rein should be 282 inches (23 ft. 6 in.) in length from the double of the bit-billet to the end: that is, from the bit to the end. At a distance of 81 inches (6 ft. 9 in.) from the bit is the middle hole of fifteen which are punched, one inch apart, to take the coupling-rein buckle. The hand of the coachman will be 242 inches (20 ft. 2 in).

from the bit, leaving 40 inches (3 ft. 4 in.) of rein to hang down behind the hand.

If this rein is made of *three* lengths of leather, the first splice should be 96 inches (8 feet) from the bit, which will bring it behind the holes in the rein, and the second splice 192 inches (16 feet) from the bit, or 14 inches behind the pad-terret of the wheel horse, which is as near as it should be to the terret.

If the rein is made of *four* pieces, the first splice will be in the same place, 96 inches, the second one 152 inches (12 ft. 8 in.), which will bring it between the head-terret and the pad-terret of the wheeler, and the third splice 220 inches (18 ft. 4 in.) from the bit, which will bring it opposite to the coupling buckle of the wheel-rein.

The lead coupling-rein should be 85 inches (7 ft. 1 in.) long from bit to buckle, and, when buckled into the middle hole of the draught-rein, it will extend 4 inches beyond the bit end of the draught-rein.

This length brings the fork of the lead-reins at the proper place ; if it is further back, it may catch on the tail of the leader and cause an accident.

The wheel draught-rein is 162 inches (13 ft. 6 in.) in length from bit to end ; at 98 inches (8 ft. 2 in.) from the bit is the middle hole of the fifteen. The hand will be 121 inches (10 ft. 1 in.) from the bit, and 23 inches from the coupling buckle ; and 40 inches of rein will hang down behind the hand.

The splice is 86 inches (7 ft. 2 in.) from the bit.

The wheel coupling-rein is 104 inches (8 ft. 8

in.) long, and will then project 6 inches beyond the draught-rein. If the leather used does not permit of so long a rein in one piece, the splice should be about 86 inches (7 ft. 2 in.) from the bit.

The diagram (Fig. 108), drawn to a scale of  $\frac{1}{4}$  inch to the foot, shows the position of the terrets and of the coupling-buckles.

Care must be taken that there shall be no splice in that part of the rein which passes through a terret, because, besides interfering with the rein's free running, the splice is likely to rip by its sewing becoming worn. Saddlers are often careless about this, and furnish reins the splices of which correspond to the terrets or come into the hand.

In the diagram the proper places of the splices are marked: for two splices by a single line; for three splices by a double line.

Really good reins are expensive, since the pieces of which they are made must be cut out of the choicest part of the skin. They must be firm throughout; any

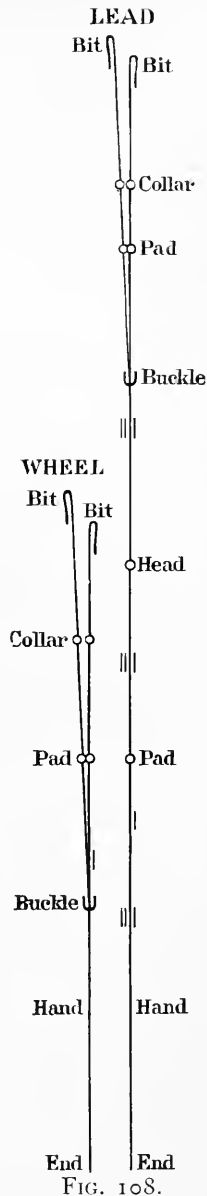

soft places will stretch. The greatest wear on the lead-rein is where it passes through the pad-terret of the wheeler.

According to the dimensions given, about 40 inches of the ends of the reins will hang down behind the hand, which is as it should be ; if there is more than 40 inches, the ends will drop over the edge of the foot-board on the off side, and be likely to catch on the roller-bolt when the coachman is getting up. The buckles of the coupling-reins will be about 23 inches in front of the hand, near enough to be reached for the purpose of changing the couplings, and not near enough to bring the buckles into the hand when taking the horses up short,— a serious fault with coupling-reins which are too long, and one which results in getting a handful of buckles at a critical moment, when pulling up suddenly. This is a very common fault of reins by even good makers. It is better to have the buckles too far away from the hand than too near to it ; there is always a groom or a guard on a coach who can change the couplings if necessary.

It must be said, however, in favour of long coupling-reins, that should the horses run away they may sometimes be stopped by seizing the wheel coupling-reins in front of the buckles and pulling the wheelers' heads together.

A loop is frequently sewed upon the coupling-rein about 10 inches in front of the buckle, through which the draught-rein passes. On the wheel-reins



it does no harm, but it should not be on the lead-reins, because, if the coupling buckle is in the position given by the directions above, this loop will bring the fork of the reins too near the pad-terrets, and if the *loop* is at the proper place for the fork, the buckle must be put back 10 inches, with the result of having that much more weight of rein to no purpose.

This loop is a somewhat modern arrangement, and on pair-horse harness keeps the reins together at the proper point, while permitting the buckle to be near enough to the coachman's hand to enable him to alter it, and its use for a pair has probably led harness-makers to put it on four-horse harness.

The keeper or loop, in front of the coupling buckle, should not be nearer to the buckle than  $2\frac{1}{2}$  inches or else it will be difficult to change the place of the buckle quickly: for the same reason, the holes should be long and not round.

The reins, at the end behind the hand, usually have buckles, by which they can be fastened together; a substitute for this arrangement will be described in Chapter XII.

Four-horse reins are never made of black leather, nor round, nor have they hand parts *separate* from the rest of the rein, as is sometimes the case in pair-horse harness.

In the early days of English coaching, a *short* wheel-rein was used. It was made just long enough to come into the hand, and hung on the second and

third fingers. Its buckle was not in the middle, where it would have been in the way, but a few inches to one side, on the off rein. It went out of use about 1825, being considered dangerous, because, should a wheeler fall, the coachman might be pulled off his box; and it was, no doubt, frequently too short or too long, and in either case inconvenient.

According to 'NIMROD' (*Essays*, p. 208), the majority of coachmen in the early part of this century, drove with a short wheel-rein, and he discusses the question *pro* and *con* through four pages, but it is now only a matter of history, since it has gone entirely out of fashion. According to him (*Essays*, p. 285), SIR PHILIP AGAR used a short wheel-rein when he drove his coach at a trot round the fox which stood in the centre of TATTERSALL'S old yard; a feat referred to in several of the coaching books.

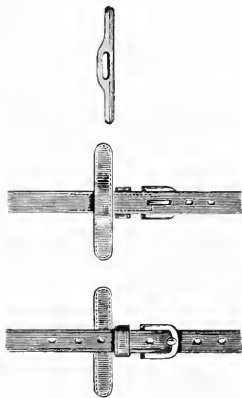

FIG. 109.

The wheel horses are kept together by the pole-chains, but since the lead horses are quite free, one of them, by shying suddenly, can pull his coupling-rein with the buckle and a part of the draught-rein, through his partner's pad-terret, where it becomes jammed, with every chance of causing an accident. To prevent this, a piece of steel, about

3½ inches long, covered with leather (Fig. 109), is slipped on the coupling-rein in front of the loop (as is frequently done on the snaffle-rein of a riding bridle to keep the martingale ring from catching on the buckle), and this bar is too long to go through the terret. It must be strong, because a horse in shying, will bring it with great force against the terret. It may be put upon the coupling-rein in front of the loop, when there is a loop in front of the buckle (it is obvious that with the loop a bar at the buckle would be of no use); but it will not be so strongly fastened at the loop as when it is supported by the buckle; this is a good reason for omitting the loop.

Another device for the same purpose is shown in Fig. 110: a piece of steel, somewhat narrower than the rein, curved in section so as to increase its stiffness, and covered with leather, is fastened at one

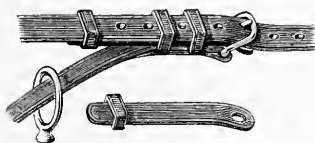

FIG. 110.

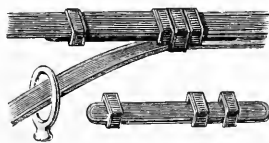

FIG. 111.

end, by letting the tongue of the buckle pass through the projecting leather, and at the other end by a loop which holds it on the draught-rein. It will be seen from the Figure that if the coupling-rein should be pulled through the terret, it will be stopped, by the steel bar getting across the terret. The strain

evidently comes upon the loop, and this must be fastened on strongly. This bar can be also put on the rein when there is a loop at some distance in front of the buckle, as in Fig. 111. In this case the main loop must be very strong.

What is known as WARD'S terret, from the well-known English coachman who introduced it, is shown in Fig. 112. It is used on the lead horses



FIG. 112.

only, and has a bar across its centre with an opening in it through which the rein can be passed edgewise into its place. The space in which the rein is shown, is too small to permit the coupling buckle to be pulled through it, but the billet and buckle for the bit will pass through the larger space.

It may be noted that *bar* buckles, often used on dress-harness, but rarely on coach-harness, are dangerous on the coupling-reins, since, should a leader behave badly and run back, or turn round, the front edge of the bar buckle may catch in the throat-latch ring of the wheeler behind him, especially if the coupling-rein is too long and the buckle, consequently, far back. This happened once in my experience, fortunately without any serious result, since, as we were leaving a house through an awkward gateway, the men were still near the horses' heads, and one of them instantly cleared the rein.

A method of buckling together the wheel-reins and lead-reins is used in Hungary :—

The lead-reins are made in the usual way, but the wheel-reins terminate in buckles, and are buckled to the lead-reins precisely as a coupling-rein is attached to a draught-rein (Fig. 113), with a distance

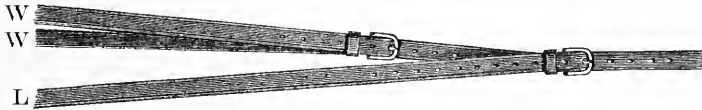

FIG. 113.

of about ten inches between the buckles. In driving, the portion of the wheel-rein which is between the buckles, and that part of the lead-rein which is opposite to it, come into the hand. For the method of using this rein see page 253.

**POLE-CHAINS.**—Pole-chains, and not leather pole-straps, are always used on a coach. Originally they were fastened to the pole-head, as they still are on farm wagons; but now they are separate from the pole, and may be therefore considered as part of the harness. On a road-coach, if the pole-head and the fittings of the bars are black, the chains are black also, and are kept in condition by being painted or varnished. On drags, they are always of polished steel, and on some road-coaches they are also of polished steel. The approved forms are shown in Figs. 114, 115; they should have straight open links, and not links like a curb-chain. For a road-coach, one end has a ring, and the chain being passed through the ring of the pole-head, passes

afterward through its own ring, making a loop. The hook end is then run through the ring of the



FIG. 114.



FIG. 115.

kidney-link, and hooked into that link of the chain which will make it of the proper length (Fig. 116).

A stout india-rubber ring, which has been already put on the chain, is pushed over the bow of the hook to keep it from unhooking.

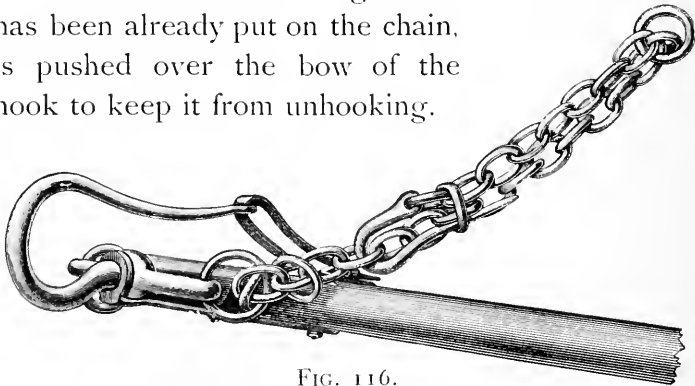

FIG. 116.

The hook must be always put on, back up, to prevent the bar of the bit, if a bit with a bar is used,

from catching in the point. The chain should be somewhat short, otherwise the hook may come down to the pole-head before the horse is poled up tightly enough.

This chain may be used on a drag, but a chain with two spring hooks (Fig. 115) looks better. It may be somewhat short, so that the hook can be hooked into any link ; but for a private coach, it is better to find the exact length required, by experiment with the chain (which, when bought, is always too long), to cut off enough links to make it the proper length when both hooks are in the pole-head, and to have the hook properly fastened into the end link. No links must be left beyond that one in which the hook is fastened ; few things are more slovenly on any kind of a carriage than loose links dangling and jingling.\*

The spring hooks must be put on the pole-head with their backs up, to prevent the bar of the bit from catching in them ; but since the rings on the pole-head are usually vertical, the hooks will be horizontal, which serves the same purpose. Spring hooks are frequently so made that the small eye

---

\* Pole *chains* should be used only on a carriage driven by the master or mistress, such as a coach, mail-phaeton, or lady's phaeton ; never on a carriage driven by a coachman, such as a landau, coupé, or victoria, when *straps* should be used. This is a custom based upon the fact that the working originals of coaches and mail-phaetons had chains ; an adherence to it marks the difference between well and badly turned-out vehicles.

opens when the tongue is pushed open (Fig. 117), and are thus hooked into the chain; they are very likely to pinch the fingers when putting them on, and are not so strong as the hooks shown in Fig. 115.

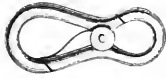

FIG. 117.

COCK HORSE HARNESS.—Sometimes, on a road where a stiff hill has to be surmounted, an extra horse, usually called a ‘cock horse,’\* ridden by a man, is required. A good pattern of cock horse harness is shown in Plate XXIV. The riding saddle has one wide girth of leather or web. The upper eye of the tug-buckle has a short strap and buckle sewed into it, which buckles on one of the usual saddle girth straps under the flap.

There being no necessity for changing the length of a cock horse trace, it is better to make it in one piece from the draught-eye to the bar. There is then no buckle under the saddle-flap, where it is always a discomfort to the rider. A simple loop is sewed under the flap to support the trace, and the false belly-band, which is of no use, is omitted. The trace should be 6 ft. 6 in. long, from collar to bar.

---

\* JOHN BELLENDEN KER says, ‘*Ghuck-horse*, now cock-horse, ‘literally fool-horse, in the sense of one who lets another ride him. ‘The cock-horse among school-boys, is the one who is fool enough ‘to carry another astride on his back.’ *Archæology of Nursery Rhymes*, vol. i. p. 274. *Ghuck*, according to KER, is old Dutch. *Gek* is fool in modern Dutch. KER’s derivations are often fanciful; this is given merely as a matter of curiosity.





COCK HORSE HARNESS.



The rope, which passes between the leaders, and is hooked to the pole-hook on *top* of the main bar, should be 10 feet long, including its two hooks. It is a good plan to wrap the rope for a distance of two feet with sheepskin, with the wool-side out, where it comes against the shoulders of the leaders, to prevent chafing them. The hip-strap, shown in the plate immediately behind the saddle, is perhaps hardly necessary. A strap, 3 feet long, with a spring hook at each end, should be provided, to fasten into the kidney-links of the leaders' collars, across from one horse to the other, on which the rope may rest when the cock-horse is not pulling. It is well to have a ring, about three inches in diameter, in the middle of this strap, through which the rope is passed.

The cock horse bridle is like the bridles of the other horses.

If two extra horses are required, they have the regular lead-harness, with the addition of a saddle on the near horse, and with a set of bars attached to the rope ; or they may have traces long enough to reach back to the tug-buckles of the leaders, as in an equipage *à la Daumont*, in which case the tug-buckles of the lead-harness must be made with eyes to take the hooks of the traces (Fig. 118), exactly like a tandem harness. These traces must be 10 ft. 8 in. long from tug-buckle to hook.

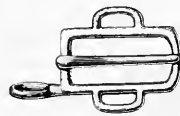

FIG. 118.

Compare Plate VI., ROWLANDSON, in which the regular leaders are thus harnessed.

## GENERAL REMARKS ON HARNESS

As has been before remarked (p. 14), a coach is a *sporting* vehicle, and the harness should be plain and look serviceable. The illustrations which have been given, are taken from a set of harness carefully made as a standard pattern, and can be safely copied for a drag-harness.

The loops through which the loose points of the various straps pass behind the buckles, are sometimes replaced by 'pipes' or continuous loops, but there is more coaching style about the separate loops.

The winkers, the front (whether it has a chain on it or not), the face drop, the outside of the collar, the ornament on the martingale, and the top of the pad are all made of patent leather ;\* the rest of the harness is made of plain, black leather, firm in quality, but with a smooth, velvety surface, not showing minute cracks when bent over the finger. The reins are of russet leather (usually called rein leather), even in thickness and quality throughout the whole length, and since such leather is difficult to obtain, four-in-hand reins are necessarily expensive.

English russet leather, especially such as is used for riding bridles (usually called tallow-tanned), is

---

\* Patent leather is modern : in the first quarter of this century it was unknown.

better than American russet leather ; but American black leather, such as is used in the rest of the harness, is more even in surface and wears better than the English.

The mountings and buckles of the harness shown in the illustrations, are those known to harness-makers as the English wire mountings, and are the simplest and best ; no fanciful mountings are admissible on coach-harness.

Whether the mountings of a drag-harness are of silver or of brass is a matter of taste, but for a road-coach they are always of brass ; carrying out the old road traditions.\*

All the mountings of harness, carriages, whips, &c., should be of the same metal in any one stable, and those of the coach must conform thereto. White mountings may be nickel-plated as well as silver-plated, and nickel has the advantage of being hard and of keeping its polish with but little cleaning ; since all cleaning of the mountings with powder is apt to injure the leather, this is an advantage.

Among yellow metals, aluminium-bronze, one part by weight of aluminium to nine of copper, is strong and does not tarnish readily, but it is difficult to procure, while the common patterns of mountings in *brass* can be had everywhere.

---

\* 'NIMROD,' *Northern Tour*, p. 333, 1835, speaks of plated furniture being old-fashioned for a road-coach.

Bits, chains, kidney-links, and the cock-eyes of lead-traces are always of bright steel. The loops of the wheel-traces are of the same metal as the mountings.

All the steel about coach and harness should be white, hard, and close grained; some steel is soft and blue, and will always have a leaden look, no matter how well it is polished and burnished.

SPARE PARTS OF HARNESS.—The following spare parts of harness should be carried in the coach:—

A hame-strap, useful for many purposes besides its legitimate one; a kidney-link, a curb-chain, or, better, a curb-strap, which is more useful, in the case of a curb-hook's breaking; a simple bearing-rein, with its bit and the short straps by which the rings are attached to the crown-piece (Fig. 87); a chain-trace,—that is, a chain 6 feet long, with straight flat links like a pole-chain, and a ring at one end, so that it can be put, as required, round the roller-bolt, or hooked to the lead-bar, the straight links going into the tug-buckle; a strap 6 inches long and of the same width as the reins, with a buckle at each end, to be used in repairing a broken rein; and two or three pieces of cord of different sizes.

Strong, round, black linen shoe-laces, with the usual metal tags on the ends, are very useful for temporary repairs; the tags can be quickly passed through holes made in the leather. The coachman

will not find it amiss to have one always in his pocket.

When there is any chance of having a pulling horse, a side-rein should be carried. The simplest is a strap to buckle to the bit, and long enough to pass through the hame-terret of the other horse, and then to go into the tug-buckle. Since this pulls on one side of the horse's mouth, it should be used only when nothing else is at hand. The proper rein is shown in Fig. 119. The short strap, which is neater when round, is buckled to both sides of the bit, and the ring on the end of the side-rein plays upon it, so that the rein draws evenly.

In an emergency, a side-rein may be made with a piece of cord an eighth of an inch in diameter, as shown in Fig.



FIG. 119.



FIG. 120.

120. One end of the cord is tied to a ring, then passed through one side of the bit, back through the ring, then through the other side of the bit, double knotted into the ring, and the long end made fast to the other horse's tug-buckle. In lack of a ring, a loop may be made on the cord itself.

CARE OF HARNESS.—On being taken off the horses, after even the shortest drive, all parts of the harness

should be thoroughly wiped with a cloth, no dust being left under the buckles, or in the loops, every strap being unbuckled and cleaned throughout its whole length. The inside of the collars and parts on which sweat has lodged must be well cleaned with water, and dirt on other parts which the cloth will not remove must be *washed* off, without wetting the leather more than is necessary. The mountings should then be polished, using as little powder as possible, care being taken not to smear the leather round the mountings, or to scratch it with the powder.

The harness-maker usually furnishes thin plates of metal which fit round the monogram, or crest, and protect the leather from the cleaning powder.

The leather should then be blackened and polished. Much the best thing for this purpose is the black preparation of wax and turpentine sold by harness-makers, or by shoemakers for polishing kid shoes. It is expensive, but protects the leather from the effects of wet, gives a good surface, and does not rub off upon the hand or glove; ordinary shoe-blackening is dirty. The same preparation, without the black ingredient, is the proper application for reins and for whatever is of russet leather, such as saddles and boot-tops, and is usually called saddle-paste. It must be applied sparingly, and well polished by rubbing, or it will be sticky.

Every now and then, and especially after a wetting in the rain, harness should be oiled thoroughly with neat's-foot oil, well rubbed in and well rubbed off.



No varnish should be used ; it hardens the leather, and soon cracks, and looks shabby.

Patent leather should be wiped and polished with a soft rag and a little oil, or vaseline, but the wax preparation should not be used on it.

In damp weather a fire is essential in or near the harness-room. Cleaning should not be done in the harness-room, but a light, airy place of sufficient size for the purpose is necessary to secure the best results. Iron rods terminating in hooked ends of good size, covered with leather, and of such a length as will bring the pieces of harness to a proper height for a man to work at them when the rods are hung to hooks in the ceiling, will be found more convenient for holding harness while it is being cleaned, than the trestles or horses which are generally used. There should be rods of two lengths, a short one to hold the collar, &c., and a longer one to hold the bridle. When not in use they may be unhooked and hung against the wall out of the way.

The steel pole-chains, bits, and curb-chains should be washed and dropped into a covered vessel containing lime-water, which is made by dissolving in water as much common lime as the water will take up, and pouring off, for use, the clear liquid. In this they can remain for any length of time without rusting, and the chains in every-day use may be kept in the vessel, and taken out only when wanted. They are then roughly dried and put into a long bag with a little sawdust and fine sand, and shaken

until they become bright. For this purpose, a canvas bag about thirty inches long, with a strong handle at each end, is convenient. The curb-chains are usually polished by rolling between the hands.

The bits should be taken out of the lime-water after the harness is cleaned; wiped, polished, and put in the bit-case. If they have rusty spots, it may be necessary to rub them with very fine emery paper, but if this is done they must be afterward burnished.

Steel articles when received from the maker, have a high polish, which makes them more capable of resisting the action of dampness in producing rust.

The ordinary, stable method of cleaning, with sand or emery cloth, will not produce this polish, but leaves a surface full of minute scratches, and very liable to rust. The only way of regaining a surface at all resembling the original one, is by burnishing, which consists in rubbing with a smooth and very hard, steel instrument. This consolidates the surface somewhat, or, at least, rubs down the edges of the scratches, obliterating the lines made by the emery.

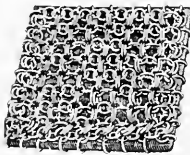

FIG. 121.

Usually a sufficiently satisfactory result can be obtained by rubbing with a hard, steel chain, fastened to a pad, so as to be held in the hand (Fig. 121). For large, fixed pieces of steel, like the pole-head, a long steel chain can be pulled backward and forward across it. In any case, considerable force and

pressure must be applied, but steel cannot be made to look well without the burnisher.

When harness is put away, it should be hung against the wall on racks made for the purpose. Iron racks, made open so that the air circulates through them, are sold by makers of stable fittings. A good arrangement is shown in Fig. 122.

The crupper dock hangs upon a small semi-circle which can be raised or lowered, so that the back-strap will hang taut to the pad.

The pad rests upon a bracket of the proper shape. The collar with its tugs hangs on a curved bracket at the top. Under the pad bracket, the bridle hangs on a bracket, also made to the proper curve. If the bracket has a rim to keep the bridle from slipping off, this rim should be cut through at the top, so that the face-drop will lie in the notch, and the bridle be kept straight, a precaution to which reference has been already made when describing the bridle. When a bridle is hung on a hook, this face-drop is, of necessity, on one side or the other of the hook, and the bridle will be bent out of shape.

The traces and the reins are hung on small hooks alongside of the harness.

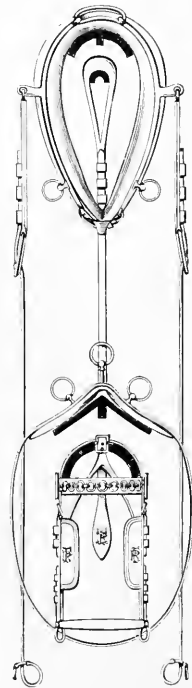

FIG. 122.

Harness is frequently protected by glass doors, but if the room is clean, dry, and well-closed, this is hardly necessary.

The bits, chains, and all steel articles, should be arranged in a bit-case with glass doors, which is lined with a bright-coloured baize or cloth. In this bit-case, the flowers may be kept, and it can be made a handsome feature in the harness-room. If there is an open fire, the bit-case may be placed on the wall above it.

In a well-regulated stable, the harness-room may be made an attractive place; the floor should be covered with matting, and some coaching prints on the walls will add to its cheerfulness.

Small spare parts of harness, clippers, bandages, and new cloths should be kept in a cabinet, divided into a number of shallow drawers; in deep drawers the articles most wanted are invariably at the bottom.

## CHAPTER XII

## HARNESSING

WITH a road-team, it is usually considered advisable to put on each horse's collar about half an hour before he is to go out, that it may get warm against his neck, and so be less liable to chafe him in his work. Unless, however, it is fastened back in some way, such as by drawing in front of it, the neck part of his rug, it will slip forward the first time that the horse puts his head down, and will not stay in its place to get warm.

The collar having been put on, the hames are buckled on it afterward. The practice of putting the harness on *all together*, with the hames buckled on the collar,—almost universal in private stables on account of its convenience,—is not a good one; the collar with the hames in place, is frequently too narrow to go easily over the horse's head, and by forcing it on, the horse is hurt. After the harness is laid on the horse's back, the crupper put under the tail, and the belly-band temporarily buckled to keep the pad from slipping off, the hames are fastened upon the collar. The martingale is then buckled to the collar (see Fig. 100), and the belly-band passed through it.

The traces are laid over the back, crossed, the

outside trace on top, so that in putting-to it will come off first ; the habit that some coachmen have, of tying a knot in the trace to keep it from dragging on the ground is not a good one, because the knot twists the trace.

The bridle is then put on, the reins passed through the terrets, the draught-rein buckled to the bit, and the coupling-rein to the throat-latch or to the nose-band, under the chin. Passing the rein-billet through its loop, but not through its buckle, is sufficient to hold it.

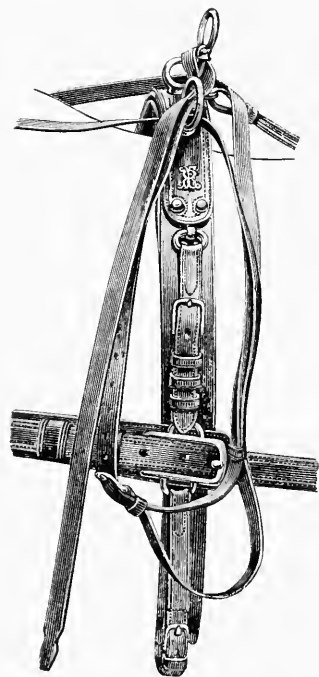

FIG. 123.

The rein must then be looped over the centre-terret in the manner shown in Fig. 123. Care must be taken that the rein which has *no* buckle at the end is put on the *near* horse. The reason for this is, that, when at a change, the reins are thrown over from the near to the off side so as to be

taken up by the coachman, the heavy buckle end might hurt a person standing on the off side. It is therefore a rule, that, even when there is to be no change of horses, the reins should be thus put on,



PLATE XXV.



LEAD-REIN IN THE TERRETS.



and it is in this way that they are distinguished from each other. In some stables, it is the custom for the reins of a pair to be put on the other way, that is, with the buckle-ended rein on the near horse, but, in a four-in-hand stable at least, it should be the rule to put the buckle-ended rein on the off horse, so as to avoid mistakes in harnessing.

On the lead horses, the long rein is pulled through the terrets in the way shown in Plate XXV.; if the bight of the rein, in front of the collar-terret, is too long, it may be loosely looped on itself behind the collar-terret.

After being harnessed, the horse is turned about in his stall, and fastened by snapping the pillar-reins into the bit. His mane is then brushed and his foretop pulled down smoothly *under* the bridle front.

PUTTING-TO.—The coach having been run into the proper position for driving out, and thoroughly dusted and looked over, the pole is put in, the pole-pin put in its place, and the lead-bars hung on the pole-hook, with the heads of the screws up; they are *up* so that, should one come out, its loss would be noticed from the box-seat.



FIG. 124.

The chains are put on the pole-head in the manner shown in Fig. 124, and laid across each other over the pole.

The wheel horses are then brought to their

places. If possible, they should be led up alongside of the pole from behind, instead of being brought with their heads to the pole and then pushed round, during which movement they are apt to strike against the splinter-bar, or to slip on the floor. The hooks of the pole-chains are hooked to the kidney-link rings; the whole length of the chain allows the horse to go back far enough to permit the traces to be put over the roller-bolts.

The *outside* trace is first put on its roller-bolt, to prevent the horse from turning his croup away from the pole, and afterward the inner trace. In unharnessing, the *inside* trace is taken off first.

Since the pole-chains keep the horses somewhat close to the pole, the distance from the collar to the inner roller-bolt is less than that to the outer one, and with traces of the *same* length the collar will be pulled toward the outer side, and will bear harder on the outer side of the neck, sometimes rubbing the neck at that spot. To obviate this, the inner trace should be shorter by one hole than the outer one. The usual distance apart of the holes in traces (about  $1\frac{1}{4}$  inch) is rather an over-correction, but it brings the collar more nearly right than when the traces are of the same length. A better way of making the correction is to cover the inside roller-bolts with several thicknesses of leather to increase their diameter and thus take up more of the length of the trace. The inner roller-bolts might be set back from the line of the outer ones

about an inch, which is as nearly as possible the difference required. It is still better to have moveable swingle-trees (see page 23). The leaders' traces are all of the same length; the lead-bars, being moveable, adapt themselves to the position of the collars.

If chain-end traces are used, they must be put on so that the chain passes from the outside in, as shown in Fig. 125.

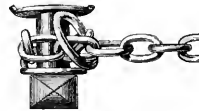

FIG. 125.

After the traces are on the roller-bolts, the hook of the pole-chain is passed through the kidney-link ring, so as to bring out the chain through the ring from the side next to the pole, and hooked into such a link of the chain, down near the pole-head, as will make the chain the proper length (see Fig. 116). For very good roads there should be two links to play,—that is, the chain should be as tight as though it had been pulled up as far as possible, and then two links let out. It is better to have the chain too loose than too tight. In hooking the chain, the point of the pole *should not be lifted*, because this will bring its weight on the horses' necks. For inferior roads, the chains should be looser, as few things distress horses more than being jerked about by the coach, in consequence of poling up too tightly, and it is a very common error. One objection to an evener in place of a stiff splinter-bar is, that with an evener the guiding of the vehicle

must be done by the pole-chains, which must be, therefore, tight, or else the carriage will run from one side of the road to the other.

Since the chain of a road-coach is first attached to the pole-head, it cannot be readily put on with the wrong end up, but this may be done with the chains of a drag which have snap hooks at both ends. The mistake should never be made of putting the hooks into the *kidney-link ring*, as is frequently done with a pair of horses by ignorant coachmen. When the chain is attached first to the pole and then passed through the ring, a man, standing in front of the horses, can pull with force upon the end of the chain and get it tight. If it is already in the ring and must then be passed through the pole-head, he has to stand under the horse's head, where he has no pull upon the chain, and where he is beslobbered by the horse.

The wheelers' coupling-reins then should be buckled to the bits.

The leaders should be brought to their places; their traces hooked on, the outer ones first; and their coupling-reins buckled to the bits. Care must be taken that the horse which carries his head the higher has his rein *on top* of the other coupling-rein, or else the horse which carries his head low will be continually pressing with his rein upon the mouth of the other horse and worrying him. For the same reason, a ring should never be put upon the coupling-reins where they cross.

The lead-rein must then be seized by the end and passed through the throat-latch ring and pad-terret of the wheeler (the loop of the wheel-rein having been first taken off the pad-terret), and the near side reins thrown across the wheelers' backs to the off side (see page 248). If the lead-rein has been properly laid in the lead horse's terrets (see Plate XXV.), it will pull out freely when drawn by its end.

The leaders' inside traces may be hooked straight to their respective bars, as shown at A, Fig. 126, or

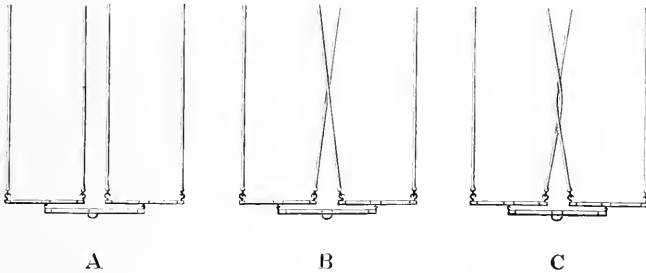

FIG. 126.

they may be crossed, or lapped. When they are crossed, both of the near horse's traces go to the near ends of the lead-bars and the off horse's traces to the off ends, as at B, which equalises the draught of the horses, if one is more free than the other. It cannot be recommended, because it is better to make the horses work evenly by proper biting and coupling. For the same reason, it is unnecessary to have either a link or a chain between the bars.

In lapping, one horse is hooked up straight,—that

is, with both his traces to his own bar,—and the inside trace of the other horse is passed inside of the first horse's trace and hooked to its proper bar (Fig. 126, C). Lapping serves two purposes: it prevents the leaders from pulling apart, and it keeps the inside traces away from the sides of the horses, so that in muddy weather they will not chafe; on the other hand, if a leader kicks over his inside trace he gets his leg over both traces, or if one horse falls it is more difficult to disentangle the pair.

For park driving it looks better to have the traces straight; neither crossed nor lapped.

After all the reins are on the off side, they should be pulled through the terrets to about the right length, straightened, so that there are no twists in them, the ends buckled, and the loop, or bight, drawn through above the trace and tug-buckle from the front toward the back, leaving the points in front (Fig. 127).

The whip should then be caught up with a double-thong, and laid across the backs of the wheelers, behind the pads and quite well over toward the near side, so that the weight of the handpiece of the whip will not cause it to fall off. It is a good plan to pull the butt of the whip backward between the two parts of the back-strap, which will keep it in place.

If the thong of the whip, by touching his side, worries the near wheeler, the whip may be laid from front to back across the roof-seats on the off side,

where the coachman can easily reach it after he is in his seat. It should not be put in the whip-socket; the ceiling of a coach-house is rarely high enough to permit it, without bending or breaking the whip.

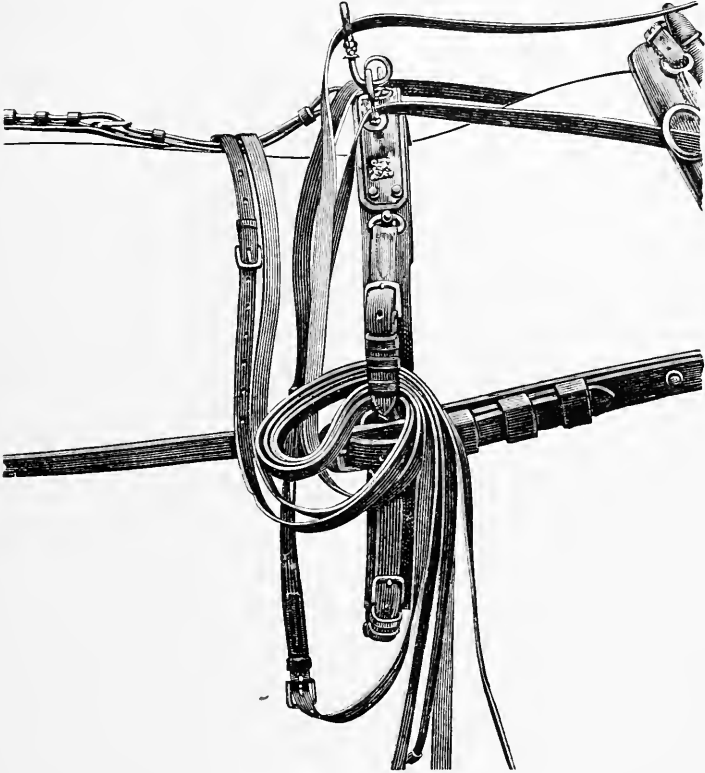

FIG. 127.

In driving from the stable to the place of starting, the stable-shutters should be up, that is, closed.

In a road-coach they should be let down upon arriving at the place of starting. There is a difference of opinion as to whether they should be opened

or should be kept closed in the case of a drag, but it is more in conformity with road practice to let them down and to pull up the glass, which keeps the dust from the inside of the coach. It is not, perhaps, a matter of much importance, except so far as uniformity is desirable at Meets, and 'stable-shutters down' is the rule at the Meets of The Coaching Club at New York.

At the New York Meets, since the rule is to have a front load only, the grooms are in the rumble, and there is no one inside; at the London Meets there is no rule as to loads, and the coach is sometimes full on top and the grooms are inside; in which case the windows must be open, although it is stated by an Officer of one of the London Clubs that it is understood that the stable-shutters should be closed.

In driving to races, picnics, and the like, the grooms are frequently inside, or there is an extra servant there for serving lunch, in which case the windows must be open.

For the sake of uniformity, therefore, it seems better to have the windows open; with the glass up or down as may be desired. When exercising, or trying horses, or giving lessons, there seems to be a certain propriety in having the stable-shutters closed.

#### BEARING-REIN

There is a great difference of opinion among coachmen as to the use of bearing-reins, and while for road work, either public or private, they have



been generally abandoned, they are by many still thought to be necessary for park driving, and especially at Meets. Where uniformity in the appearance of a team is important, as at formal Coaching Meets, the use of bearing-reins certainly ensures uniformity of position of the horses' heads, since some horses when standing, drop their heads, and may even catch their bridles on the pole-head, and on such occasions the use of bearing-reins, if they are adjusted with intelligence, may be excused. In this connection a consideration of their action is not unimportant.

In the first place, the bearing-rein should always have its own snaffle-bit, independent of the driving-bit, to which it should never be attached, since it would seriously interfere with the proper action of the driving-bit.

In what is usually called the 'bit and bridoon,' or 'double bridle,' for a saddle-horse, the functions of the two bits are essentially different. The bit, which has branches of some length and a curb-chain, has its own head-piece and its own rein,—the curb-rein. The bridoon, which is a plain snaffle, is attached to its own head-stall, and placed high in the horse's mouth; it has its own rein,—the snaffle-rein.

The snaffle-reins are held, by most horsemen, on top of the forefinger of the left hand, or, in handling a green horse, separately in the right hand, and are used to *raise* the horse's head; in some cases they are held so high as to make their action almost

exactly like that of a harness bearing-rein. The curb-reins are on the lower fingers of the left hand, and are used to restrain the horse, and to bring his head in, the bit being put as low in the mouth as possible without touching the tusks. By a judicious use of the two bits the horse's head can be 'placed' in the position which gives the greatest control over the animal, and ensures what is usually called 'lightness of mouth,' which is, in most cases, a matter of the muscles of the neck and jaw, and not of the bars of the mouth.

A bearing-rein and a driving curb-bit, both properly adjusted, will, to some extent, imitate the action of the two bits of the saddle-horse, except that there is no elasticity in the bearing-rein such as there is in the rider's hand. The position of the horse's head should be carefully studied, and the bearing-rein buckled at such a length as will prevent the horse from dropping his head too low, and at the same time will not hold the head in a constrained position. This will require judgement, as a bearing-rein which seems tight when the horse is standing still, will frequently be entirely too slack when he is moving. It may be said, however, that it should be always somewhat slack when the horse is in motion. With this rein properly adjusted, with the driving-bit as low as possible in the mouth, and with the curb-chain of such a length that the branch of the bit, when pulled upon by the rein, will come back to a position about half-way between the

vertical and the horizontal directions, the conditions will be as nearly as possible similar to those of a saddle-horse, and, with a good hand, something of the same effects ought to be obtained.

As is described in Chapter XV., Article on 'Bitting,' the best results with a harness-horse are obtained when the horse has been already carefully handled on foot, and the flexions, at least partially executed, so that the action of the two bits in driving will resemble that of the riding bridle. If adjusted and used in this way, the bearing-rein may be considered unobjectionable, and even useful, for parade purposes and in the show ring ; under other circumstances, and in any but the very best hands, it is better dispensed with.

On the road, and especially in going up-hill, horses work much better with their heads free ; at any moderate pace and with a heavy load a horse throws his weight forward into the collar and puts down his head, a fact recognised in some countries in the practice of tying *down* a horse's head, from the notion that it adds to his power for draught. On a level, hard road with a light load, a horse does not require to have his body thrown forward, and can assume the gathered position, with head up and in, and with hind legs under him, a position with which the bearing-rein does not interfere.

It is hardly necessary to add, that a very tight bearing-rein which keeps the head constrained, and elevated above a natural position, is to be strongly

condemned, but some horses have a habit of putting their heads down and boring on the bit so as to be very fatiguing to the coachman.

On such a horse, it is well to put a bearing-rein, and let him pull on his own tail, instead of on the arms of the coachman ; but, if he is to be kept in the team, he should, if possible, be broken of the habit by changing his bit, or by such mouthing and handling as the skill of his owner permits.

One of the reasons for using bearing-reins on parade occasions, is, that many teams which go pleasantly enough on the road, pull uncomfortably when being driven close behind another coach, or when excited by the continual stopping and starting, unavoidable in crowds or at such places as the entrance to a race-course. In such cases, bearing-reins will save the coachman much annoyance and fatigue ; but it must be said that a team which will do all this kind of work, and look stylish, with heads in the proper position, without bearing-reins, is a better team and pays a higher compliment to the coachman's hand, than one which requires them.

The bearing-rein will in many cases prevent a horse from kicking, which he will not usually do unless he can get his head down. As to the bearing-rein keeping a horse from falling, it is entirely impossible that it should do so in any sense of supporting him ; although as far as it assists in gathering him and keeping his hind legs under him, it

may have a useful effect with a horse that is inclined to go in a slovenly way.

On a journey, or in driving a strange team without bearing-reins, it is a good plan to have in the coach at least one bearing-rein with its proper bit, to be slipped on a troublesome horse if necessary, and for this reason it is wise to have centre-hooks on the pads of all harness, even if they are not habitually used. In the absence of the centre-hook, the rein can be attached to the pad by a short strap, such as should be always carried among the spare articles. If bearing-reins are used, the lead-harness must, of course, have cruppers.

As to appearance, the less leather there is about a horse's neck the better; and this is especially true of short-necked horses.

In nearly all cases, a properly adjusted bearing-rein will be somewhat slack when the horse is moving, and it will shake about in an unseemly way, noticeable from the top of the coach, if not from the ground; which is the reason for having the housing-straps formerly used.

Bearing-reins are made in two ways, as already described and as shown in Fig. 93. It is sometimes considered that the double, or pulley-rein, is easier for the horse, because the bit plays backward and forward upon the round part of the rein when the horse tosses his head, but it is much heavier and more complicated than the single rein, which, in my opinion, is to be preferred for its simplicity.

An objection to the pulley-rein is, that a careless man can exert twice the power in reining up the horse with it, that he can with the single rein.

Bridles sometimes have a light strap, with a small snap-hook on the lower end, sewed under the rosette, to hold the bit of the single bearing-rein, which will drop out of the horse's mouth when the rein is not hooked to the centre-hook.

That instrument of torture, the overdraw-check (the 'Kemble Jackson'), while it may be useful, when judiciously applied, in getting the highest speed out of a trotting horse by keeping his head high and his breathing organs unobstructed, has never been proposed for any four-in-hand team, and, except on a trotter, is seen only on the horses of careless or ignorant owners. The star-gazing position of the head which it enforces, should alone be sufficient to prevent its use.

According to BRACEY CLARKE and other authorities, the bearing-rein was little used until after 1800, and by 1835 it began to go out of fashion on the road-coaches.

CRACKNELL, who drove a fast coach on the London and Birmingham road about the latter date, is said to have been one of the first to give it up, and, in so doing, to have brought upon himself the displeasure of his proprietor, Mr CHAPLIN, who considered the practice of driving without it to be dangerous.\*

---

\* CORBETT, p. 239.

In the coaching prints of the first part of this century the bearing-rein is always shown, but it is not found in those previous to 1800.

In conclusion, it may be said, that all coachmen should have their attention called to the *abuses* of the bearing-rein and to the serious pain and discomfort resulting to a horse from having it too tight, although it must be noted, that these abuses are confined almost entirely to pairs and single horses, a subject with which we are not at present dealing.

If bearing-reins are not used, the coachman must always keep his eye on his wheelers when they are standing still, or one of them may drop his head and, getting his bit caught on the pole-head, pull off his bridle. For this reason the bearing-rein is not out of place on a pair used for shopping or visiting, but it should be loose.

In this connection, Mr FLOWER's admirable pamphlets on *Bits and Bearing Reins* may be recommended to the attention of all horsemen.

#### COUPLING

In all harness, the outside rein, usually called the draught-rein, runs from the hand to the outer side of each horse's bit. In some rude farm harness the inner sides of the bits are attached to each other by a short rein, which couples the horses together, so that when one horse is pulled to one side he leads the other with him. This is obviously a crude

arrangement, serving only to guide the horses, but not to restrain them.

In better harness, therefore, each draught-rein has attached to it, a rein which passes to the bit of the other horse, so that a pull on the off side rein, for instance, will be communicated to the off side of each horse's mouth. It is obvious that to do this evenly, the inside, or coupling-rein must have a certain definite length from the bit to the point at which it is buckled to the draught-rein. Owing to its crossing over between the horses, the coupling-rein must be longer than that part of the draught-rein which is in front of the coupling-buckle, or else the horses' heads will be brought too near together. Usually, with horses of the same size, and at the proper distance apart, the coupling-rein will be four inches longer than the draught-rein for the leaders, and five or six inches longer for the wheelers; and, if the saddler has made the reins properly, the coupling-buckle will then be in the middle hole of the fifteen holes which are punched in the draught-rein. If the horses, when driven in this way, are found to be too far apart, the taking up of each coupling-rein one or two holes shorter on each draught-rein will bring them nearer together, supposing always that the horses are of the same size and that they hold their heads alike.

On driving them, however, it will be very likely found that one of the horses holds his head in, with his neck bent, and the other holds his head out and



forward. The coupling-rein of the former will be, therefore, slack, and the horse being less restrained, will go away from the pole until his inside rein becomes tight. To counteract this, it will be necessary to shorten, or *take up his coupling*, remembering always that *his* coupling is that which goes from his bit to the draught-rein of the other horse.

It may also happen that one horse is more eager or free, than the other, and will be too far ahead ; in which case the taking up of his coupling will bring him back,—that is, it will draw more tightly on his bit and restrain him.

In both cases, however, the shortening of the coupling-rein will bring the horses' heads nearer together ; and, if their distance apart was originally correct and is to be maintained, *whatever is taken up in one coupling must be let out in the other*.

This is shown in the diagram (Fig. 128), where the relative distances are exaggerated to show the action more clearly.

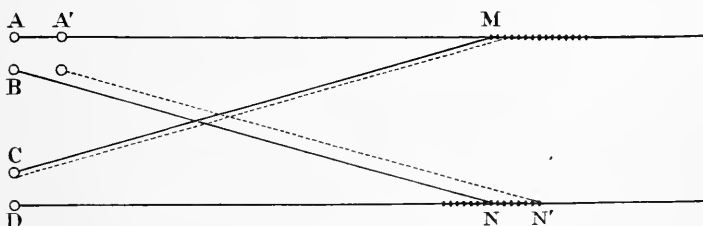

FIG. 128.

When the horses are working exactly alike, the reins are arranged as shown by the black lines ; A

and B are the two sides of the off horse's bit, C and D those of the near horse. The draught-reins AM and DN run straight to the coachman's hand. The coupling-reins are BN and CM, buckled to the draught-reins at N and M.

Now, if the off horse bends his neck so as to bring his head nearer to his body, both the reins which run to his bit will be too slack, and he will run forward and do more than his share of the work, while the near horse is held back. To prevent this, the off horse's coupling-rein BN is shortened by running it up the draught-rein to N', the last hole, until it comes just tight to the bit; but this obviously leaves the off draught-rein AM, as slack as it was before, so that the coachman has to draw his hand back to bring it to bear upon the bit at A'. In so doing, however, he draws back the coupling-rein CM, and pulls the head of the near horse to the inside. To prevent this, the coupling-rein CM must be let out on its draught-rein exactly as much as the other coupling-rein has been taken up, which is equivalent to pulling back the draught-rein, whereupon the coupling-reins will have the positions shown by the dotted lines, with the buckle of C rein in the first hole, and all the reins will act evenly on both horses, notwithstanding that the mouth and bit of the off horse is nearer to the coachman's hand than that of the near horse.

If the horses are too far apart, but otherwise are working evenly, the coupling-reins must be short-

ened equally ; or lengthened equally if they are too near together.

The fact that a horse, when he holds his head in, and curves his neck, is thereby practically lengthening his rein and consequently doing more than his share of the work, must be carefully remembered ; simple as it appears, it is not always noticed by the coachman.

Reins are frequently made with three holes in the inside billet, or in both billets, the object being to prevent wear by changing the places where the bit touches them (see Article on Reins, in the Chapter on Harness). These holes *can* be used to alter the length of the coupling-rein, and some coachmen seem to think that there is a difference between shortening it in this way and in moving the buckle up the draught-rein. A little reflection will show, however, that it is only a question of the distance between the part of the draught-rein where the coupling-rein is attached, and the bit, and that it is perfectly immaterial whether this distance is lengthened or shortened at one end or the other, of the coupling-rein. It is better to have only *one* hole in the billet ; as a matter of fact it is rarely changed for the purpose of preventing wear, and if there is more than one hole and the billet is buckled in the wrong one, the coupling is thereby changed without the knowledge of the coachman. A renewal of the billets when they show the slightest sign of wear is the best precaution, and a most important one ;

nothing can be more dangerous than a damaged rein.

In a coach team, the wheelers should be coupled far enough apart to enable them to travel parallel to the pole and not to be pulled in with their heads too near together, but since they are kept in a somewhat fixed position by the pole-chains, care must be taken that their coupling-reins are short enough to make the bits bear evenly on both sides of their mouths ; it is quite possible for the coupling-reins to be so long that the strain will be almost entirely on the draught-reins. This will not happen with the leaders, because not being held together except by the reins, they will spread as wide apart as the reins permit.

Leaders should have their couplings short and be brought somewhat close together, in which position they look much better and work just as well ; at the same time, they should not be driven with their heads almost touching, as is sometimes seen. If their coupling-reins are long and the horses move close up against each other, the inside reins, becoming thereby slack, will not command them quickly in case of necessity. On bad roads, in hot weather, or for slow, heavy work up-hill, they should be further apart.

Although what may be called the *geometrical principles* of the coupling-reins, as shown in the diagram, are simple enough, a great deal of experience and judgement is required to adjust them

to the best advantage, and the lack of such judgment is the weakest point of many coachmen.

Ordinarily, the horse that is the more eager and free will require to be brought back by his rein, but horses have minds and tempers of their own, and purely mechanical considerations are sometimes insufficient. A high-spirited horse, for instance, will be fretted by being restrained and by seeing his partner a few inches ahead of him ; if his coupling-rein is let *out* he may stop pulling on the bit and go pleasantly. This is much more frequently the remedy than the inexperienced coachman imagines, and is always worth trying, care being taken, however, that the horse does not do more than his share of work. Of course, in addition to changing the couplings, the different place of the rein in the bit, and the tightening or loosening of the curb-chain, discussed in the Article on 'Biting,' in Chapter XV., are necessary to be considered.

It seems almost needless to reiterate remarks about the importance of the couplings, but so many teams are badly put together, that it is well worth while for the beginner to master the mechanism of the matter thoroughly, and then to exercise his common sense in applying his knowledge. A team well put together is a delight, and one badly put together cannot be well driven by the very best of coachmen.

As mentioned in the Chapter on Harnessing and on Putting-to, the horse which carries his head the

lower must have his rein *underneath*, or he will be continually bearing on the rein of his partner. The same horses behave differently about the carriage of their heads on different days.

Inasmuch as the coachman sits on the right side, the near horse's coupling-rein may have to be a hole longer than that of the off horse.

To ensure the coupling and the biting of a team being correctly done, the diagram devised by Mr TIFFANY (Plate XXVI.) is useful. A number of blanks can be printed and filled up as occasion requires. The diagram in force at the time is posted on the order-board of the stable.

#### BUCKLING THE REINS

The question as to whether the reins should or should not be buckled together at their ends is frequently discussed among coaching men, and each practice has its advocates.

The arguments against buckling are: First, that in case the lead-bars should become loose, either through the breaking of the pole-hook, or of the eye of the main-bar, or of the bar itself, the lead-reins may be pulled out of the hand, and if buckled together will tear off the pads and the bridles of the wheel horses. Secondly, that an appreciable amount of time is lost at a change, in buckling the reins before getting up, and that they must be unbuckled before arriving at a change.

The argument in favour of buckling is, that a rein

The holes for the buckles are counted from the bit end of rein.

**NOTES**

<p><b>NEAR LEADER</b>          N<sup>o</sup> 25 <i>Dixie</i>  <i>Middle Bar</i>  <i>7<sup>th</sup> Hole</i></p>	<p><b>OFF LEADER</b>          N<sup>o</sup> 13 <i>Dude</i>  <i>Middle Bar</i>  <i>10<sup>th</sup> Hole</i></p>
<p><b>NEAR WHEELER</b>          N<sup>o</sup> 8 <i>Deacon</i>  <i>Lower Bar</i>  <i>9<sup>th</sup> Hole</i></p>	<p><b>OFF WHEELER</b>          N<sup>o</sup> 10 <i>Doctor</i>  <i>Check</i>  <i>8<sup>th</sup> Hole</i></p>

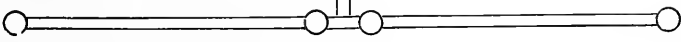

Diagram proposed by Mr W. G. Tiffany  
 for noting the Bitting and Couplings of a Team.





may slip out of the fingers and drop off of the foot-board beyond recovery, in which case a serious accident is almost inevitable. It is also suggested that the catching of the lead-reins in the pad-terrets might check the leaders sufficiently to permit the guard or the servants to get to their heads and stop them, and that, moreover, a coachman has no right, if he can prevent it, to let two frightened horses, with the bars at their heels, run down the road to the danger of the public.

To this it may be answered, that should the reins pull the harness off of the wheelers, there would be four frightened and unmanageable horses instead of two. It seems hardly possible, however, that the reins could tear off the pads and still remain buckled, so as to tear off the bridles, and the loss of the pads would not render the wheelers unmanageable.

As to authorities in print: all appear to prefer buckling, except CORBETT, who in *An Old Coachman's Chatter*, p. 245, after discussing the matter, says: 'And now, gentle readers, I leave you to take your choice, premising that, for myself, I lean to unpinned ribbons.'

REYNARDSON (*Down the Road*, p. 186) says: 'Formerly [that is up to about 1825] all reins were buckled. Gradually it became the fashion not to buckle, and then to have no buckles, on fast coaches.' He ends by saying, 'it is a safe plan to buckle.'

'NIMROD,' in his Essay, *The Road*, printed in 1832, objects strongly to the practice of not buckling,

and says: 'This is *new*, and it is a mere piece of affectation, and should be put a stop to.' Also: 'It is evident, that with the reins unbuckled at the ends, should either of them drop out of his hands, all command of his team is gone.' And again in his *Essays*, in discussing the merits of short and long wheel-reins: \* 'In quick opposition work also, long reins are the best, as there is no occasion to buckle them until the coachman is up, and it is immaterial whether they are buckled at all—a consideration *in minute and half time*. Indeed, I know one or two swells who have banished the buckles altogether from the leaders', as well as the wheelers' reins, on the ground of their being in the way of expeditious changing; but this must be awkward for their horse-keepers, as without the buckles, they cannot tell the near from the off rein when harnessing their horses, and then the coupling-reins would be as often wrong as right.'

Leaving the reins unbuckled was apparently for the purpose of shortening the time required to make the changes.

The question seems to be, whether it is more important to guard against the consequences of the rein's being dropped or of the leaders' breaking away. There is certainly much more chance of the former's happening than of the latter. The off wheel-rein may easily slip out of the hand,

---

\* In early coaching days short wheel-reins were used (see p. 229).

especially in cold weather, and if it once leaves the finger it is sure to go overboard.

The weight of argument and experience seems to be in favour of buckling the wheel-reins, at least. From its position in the hand, it is hardly likely that a lead-rein could be dropped. If the reins are to be buckled, it should be done before getting up, since it is at the moment of starting that the rein is the most liable to slip away.

I long ago devised a way of satisfying all the conditions, and have used it for many years. It is to have (see Fig. 129) the usual loop, or keeper,

on the near rein, but without any buckle, and on the off rein a somewhat long point, with a hollow cut in each edge of the rein behind the

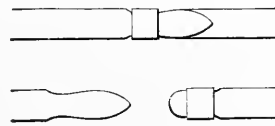

FIG. 129.

point, so that when the end of the rein (which fits as tightly into the loop as will permit it to be forced through) is once in, a considerable force is required to pull it out, and it is, for all practical purposes, the same as if buckled.

If a rein is dropped, it cannot get away, but it will be released by a strong pull, and at a change the reins can be separated by a single jerk.

This device has the still greater advantage, equally important in driving one or two horses as in driving four, that should the driver be thrown off, he cannot be dragged by the reins, which will immediately come apart.

## CHAPTER XIII

## DIFFERENT ARRANGEMENTS OF HARNESS

TANDEM.—Since tandem driving is not included in the plan of this book, and is, moreover, fully described in *Hints to Young Tandem Drivers*, and in the *Badminton* volume on *Driving*, only the mode of harnessing for tandem will be described. The shaft horse has the usual gig-harness, with the addition of rings on the throat-latch for the lead-reins to pass through, and pad-terrets with horizontal bars across their centres to divide the lead-reins and shaft-reins. The lead-harness is light, and the traces are long enough to reach to the tug-buckles of the shaft horse, these buckles having eyes on them, as shown in Fig. 118. If the lead-traces are hooked to the points of the shafts there is more danger of the leader's pulling the shaft horse down in turning, than when they are hooked to the buckles.

Lead-traces should not be extravagantly long, 10 ft. 4 in. is sufficient; any team looks better and is more handy, if compact, and, should the leader behave badly, the longer the trace the more likely he is to get his leg over it. LADY GEORGIANA CURZON, in the *Badminton* volume on *Driving*, describes an arrangement of light lead-bars, which seems to

lessen the danger of his so doing. The leader should have a hip strap.

The question which is the more difficult to drive, four horses or a tandem, is frequently discussed; almost any kind of a horse can be driven in a team, but a tandem leader must have reasonably decent manners, or he will be impossible; on the other hand, more strength is needed to drive four horses than to drive two, and a coach *can* be upset, whereas a cart can twist about in almost any space.

The position so frequently described, of a tandem leader's turning round and looking the driver in the face, can be usually corrected by backing the shaft horse until the traces become straight again.

Since the handling of the reins is much the same as that for four horses, Tandem-driving is not a bad introduction to Coaching.

THREE ABREAST.—Three horses driven abreast in the lead require the arrangement of bars shown in Fig.

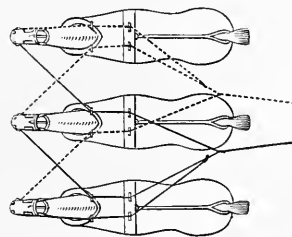

FIG. 130.

35; when they are at the wheel, their traces are attached to a long splinter-bar which has six roller-bolts. The best way of running the reins is shown in Fig. 130.

In the South of Italy, a third horse is often used as an out-rigger to a pair; he is put on the near side,

with his traces attached to a bar which is lashed to the splinter-bar (or sometimes to the foot-board) of the carriage. He has one forked rein which serves to restrain, but not to guide him. He is guided by a short rein running from his bit to the end of the pole.

Three horses at the wheel make a good team for a station omnibus ; for travelling with a coach, three on the lead not only give additional power, but ensure still having a team of four in case anything happens to one of the horses. It is a favourite team with Swiss and Italian *vetturini* (Fig. 131), but is a little less handy in sharp turns and narrow places, than four horses. An objection to this arrangement of three horses is, that in warm weather the middle horse suffers from the heat.



FIG. 131.

SPIKE OR UNICORN.—It may be sometimes convenient to drive two horses at the wheel and a single leader, in which case it is necessary to have for this leader a pair of long reins and a single lead-bar

with the eye large and set horizontally, or with a regular  $\square$ , so that it will go on the pole-hook ; all his harness is the same as that of one of the leaders. The long reins may with advantage be passed on the *inner* side of the wheelers' bridles.

Should one of the horses of a team of four give out, thereby forcing the team to become a spike, the single lead-bars should be taken off and the leader's traces hooked to the main-bar.

If the hooks of the main-bar are too thick to permit the cock-eyes of the lead-traces to go on them, one of the single-bars must be used, attached to the pole-hook by a strap, since its eye is turned the wrong way to go on the hook.

SIX HORSES.—When six horses are put to a coach in three pairs, the middle pair is called the swing pair. This designation is also used in the Artillery.

The harness is exactly the same as for four horses. The lead-reins pass through the throat-latch rings and the pad-terrets of the swing horses, and then through those of the wheel horses to the hand.

The swing-reins run exactly as do the lead-reins of an ordinary team, but the throat-latch rings on the wheelers must be doubled to take the additional reins, those from the leaders going on top, and the wheel pad-terrets should have a bar across them to keep the lead-reins and swing-reins apart.

Either a pole or a chain may be used to connect the lead horses to the coach.

The pole has, at its hind end, an eye which goes on the main pole-head hook under the lead-bars, and at its front end, a head, or crab, of the usual form, with bars to which the leaders' traces are attached. This pole should be *much* lighter than the main pole, since there is no strain upon it, except the direct pull, and the bars also should be somewhat lighter, half the weight of the pole and all the weight of the bars being supported by the necks of the swing horses.

An alternative similar arrangement consists of a light chain covered with leather, or a rope, like that on a cock horse harness (see Plate XXIV.), instead of a pole, with lead-bars. It should be suspended by a chain, or straps, from the collars of the swing-pair, and the leaders when at rest must be kept well forward to prevent the bars from hanging down. It is also well to have a strap from one tug-buckle of the swing horses to the other, on which this chain may rest.

The swing pole or chain and the bars may be dispensed with altogether, by using for the leaders long traces going to the tug-buckles of the swing-pair, as shown in Plate VI.

POSTING.—In posting, the near horse of a pair is ridden by a postilion, who leads the off horse.\* The

---

\* In a plate published by EDW. ORME, Bond St., London, 1816, entitled *Paris Diligence*, a postilion, on the near wheeler, is *driving* three leaders.



off side harness is the same as that of a pair, with the exception of the reins, but the near side harness has a saddle like that shown in the plate of the cock horse harness.

The bridle, collar, and traces are as usual, except that a long trace without a buckle is preferable to the ordinary one, on account of its not making a lump under the saddle-flap. The saddle is plain, and has an iron loop on the tree behind, to take the back-strap, which must be shorter than in an ordinary harness.

The off, or 'hand horse,' as he is called, from the fact that he is led, has a single leading-rein, which goes to the near side of his bit, and a short rein from the off side of the bit to a point on the leading-rein, about fifteen inches from the bit; in other words, the leading-rein is forked, so as to be attached to both sides of the bit; the buckle of the short piece runs on the main rein, in order that the proportionate lengths of the forked ends can be so adjusted as to give an equal bearing on each side of the mouth. The near horse has a simple rein for the postilion, like that of a riding bridle.

If four horses are required in posting, the leading horses are harnessed as already described for the wheelers, except that the traces are sufficiently long to reach to the tug-buckles of the wheelers as described on page 237.

Before the days of railways, posting was the best

method of travelling in England and on the Continent; there is an interesting description of it by the DUKE OF BEAUFORT in the *Badminton* volume on *Driving*. On a journey, either a private travelling carriage belonging to the traveller was used, or a vehicle was hired from a postmaster. In England the postmasters were usually hotel-keepers, and not employed by the Government, except in some cases, to handle the mails, the horses being their private property; they were required, however, to have a license and to put up a sign: 'Licensed to Let Post Horses.' They paid a duty of three half-pence per mile for each horse used, and there was an elaborate system by which the toll-gate keepers checked off this duty.

The stages varied greatly in length, but the distances were all noted in the posting and road-books, published in those days. The charges were not uniform, but were from sixpence to ninepence a mile, for each horse, and sixpence for the post-boy, which was paid him at the end of the stage, where he was succeeded by a new boy.

According to the *Penny Cyclopædia*, 1840 (Article *Posting*), the stages at that date were from 8 to 12 miles in populous districts, and from 15 to 20 in others; the rate of speed from 8 to 9 miles an hour; and the cost of a pair, with fees and turnpikes amounted to about 22 pence (44 cents) per mile, so that posting with four horses, double the cost of a pair, was an expensive way of travelling. The

charge was the same whether a carriage was furnished or not.

On frequented roads, some one was usually on the watch for carriages approaching the post house, and since one or two pairs always stood ready harnessed, a change was rapidly effected. The speed was frequently ten miles an hour, but depended, naturally, upon the hurry of the passenger and his liberality to the post boys.

On the Continent, in France for instance, the whole system was under the control of the Government, and a book, *Livre de Poste*, giving a map of all the routes, distances, charges, and general regulations, was published annually by the Government Printing Office. The right to furnish horses to travellers by *relays* was restricted to those persons (*maîtres de poste*) commissioned by the Government.

The charge for each horse was 2 francs per 10 kilometres, equal to about  $3\frac{1}{4}$  pence per mile ( $6\frac{1}{2}$  cents). One franc per 10 kilometres was established by law as the fee for each postilion, but the custom obtained, and was recognised by the authorities, of giving twice that amount, or the same as for each horse,  $3\frac{1}{4}$  pence per mile.

Somewhat elaborate regulations were contained in the book as to the number of horses required for certain sizes of carriages, and the number of passengers was also taken into account.

Tables of charges based upon these items were given to obviate the necessity of computation, for instance :—

NUMBER OF		21 KILOM.	22 KILOM.	23 KILOM.
HORSES.	POSTILIONS.			
4 at 2 francs.	2 at 2 francs.	25.20 francs.	26.40 francs.	27.60 francs.
One person additional . . . .		28.35 francs.	29.70 francs.	31.05 francs.
Two persons additional . . . .		31.50 francs.	33.00 francs.	34.50 francs.

On certain steep portions of the road a traveller was required to take, and to pay for, one or two extra horses.

Ordinarily a carriage was taken by the post-horses, only on the main road, from one station to another ; but arrangements could be made to go off of the main road to a country-house or to have horses sent there to take the carriage.

In a town, the carriage was loaded at the door, having been brought round by men, or by a single horse, a short time before the hour fixed for starting, at which hour the postilions and horses appeared.

The regulations required that postilions should go at a speed of not less than from  $6\frac{1}{2}$  to 8 miles an hour, depending upon the road, but there was no upper limit of speed prescribed. No postilion was allowed to pass another on the road, except when the carriage in front was stopped intentionally.

Five minutes were allowed for changes in the daytime, and a quarter of an hour at night.

Plate X. gives a good idea of French posting, and shows the dress of the postilions, with the heavy leather boots into which the feet were slipped, thin shoes and all, at the moment of mounting.

The English postilion was dressed in a dark jacket and a bright waistcoat, a high, white, beaver hat, breeches, and top boots. He had an iron guard strapped on the outside of his right boot to save his leg from being bruised by the pole.

While regular posting has given way, in England, to travelling by rail, there are still a few job-masters in London who, for special service, provide horses and postilions, harnessed and dressed, in the regular old-fashioned style.

*Daumont.*—When four horses, ridden by two postilions in posting fashion, are attached to a private landau, or barouche with handsome harness, the equipage is called a *Daumont*, or *à la Daumont*. Thirty years ago, it was not an uncommon gala turnout, but it is now confined to royalties on occasions of ceremony. The harnessing is precisely the same as for posting, but the pole of the carriage is usually of iron and bent down in the middle so as to be below the leg of the wheel horse postilion to avoid bruising it.

The postilions wear round caps instead of hats. When the same carriage is used with two horses

instead of four, the equipage is called a *Demi-Daumont*.

A *Demi-Daumont* is a handsome 'turn-out,' and the occupants of the carriage have a clear view, unobstructed by servants in front of them.

The carriage is made, of course, without any driving seat, but, for full dress, there is a rumble occupied by two footmen.

This equipage takes its name from the Duc d'AUMONT, a French leader of fashion, both before and after the Revolution. He was born in 1762 and had estates near Rouen, where he had superb stables, fitted up with mahogany, marble, and Bohemian glass. During the Restoration he introduced this style of carriage. LA ROUSSE (*Dictionnaire Universel du XIX<sup>ème</sup> Siècle*, article 'Aumont'), says that the usual spelling is *à la Daumont*, but also, *en d'Aumont* and *en Daumont*. EUGÈNE SUE in one of his novels, writes: 'Je demande si l'on attellera en grand'guides ou à la d'Aumont.'

## CHAPTER XIV

## DRIVING

GETTING UP.—The horses having been put-to (as described in Chapter XII.) and the coach driven to the door, or ready in the stable yard, the coachman is prepared to start.

Before getting up to his seat, he should walk round his coach and horses, beginning on the off side, going behind the coach and coming forward on the near side, then in front of the horses, and to a position abreast of the off wheeler. While doing this, he should make a rapid but thorough inspection of coach, horses, and harness, to see that everything is right, especially noting whether the reins are buckled to the bits in the places where he intends to have them, and whether the draught-reins are outside, since sometimes the reins are turned over, and the coupling-reins are put outside. If the horses are in, for the first time, or have had their places changed, or if the harness is new, this inspection is all the more necessary.

Then, standing opposite to the pad of the off wheeler, he draws the reins from above the tug-buckle (see Fig. 127), where they have been looped by the man who has brought the coach round, or, if the coach is still in the stable yard, by the groom

after putting-to, and then taking the near lead-rein in his left hand, draws it until it comes tight from the leader's bit. He then drops his hand, slipping it along the rein until his arm hangs straight down by his side. He draws the off lead-rein with his right hand until it comes tight, and, passing it into the left hand, pulls it forward with the right until the buckle ends of the rein are even; this makes exactly the proper amount of slack in the off rein and ensures both reins being of the same length when the coachman gets on the box. He then passes both reins into his right hand, holding them at the same point at which his left hand grasped them. He does precisely the same thing with the wheel-reins, and holds them all in his right hand in the proper fingers, that is, with the near lead-rein on top of his first finger, the off lead-rein and the near wheel-rein between the first and second fingers, lead on top, and the off wheel-rein between the second and third fingers.

This may be also done more simply by taking all the reins in the left hand and drawing them as tight as the shortest will permit, then tightening the others in succession, and finally pulling out the off reins ten or twelve inches, after which they are passed properly divided, into the right hand.

If the reins are of the proper length, as noted on page 226, the ends will not hang down too far behind the hand. If they are longer than there specified, the ends should be thrown over the right arm, from



left to right, to prevent them from catching on the roller-bolt in getting up.

These instructions may seem somewhat minute, but none too minute for a beginner, who will find the first method a good one; the second method may be used later; but the coachman should adopt a uniform way of taking up his reins, so that he can always do it quickly and neatly, and not stand fumbling with them in an uncertain way; and he should always so take them that he will have little to do when he gets on the box.

An expert can judge, at first sight, pretty fairly of a coachman by the way he gets up.

If the reins have been carefully put in their place above the tug-buckle (Fig. 127) and have not slipped, they can be taken out ready to go into the fingers without in any way changing them; when the coachman notices that they have been so placed, he can take them up instantly, and neatly. This is a reason for tucking the reins into their place from the front *backward*, as shown in Fig. 127, since they remain there more securely than when merely pushed through from the back.

When the coachman has the reins in his right hand, with the same hand he takes the whip (which has been lying on the wheelers' backs, see p. 254), steps back, puts his left foot on the hub of the wheel, his right foot on the roller-bolt, his left on the step, and his right on the foot-board, using his left hand to help himself and keeping his right arm straight down.

The moment that he reaches the foot-board he should sit down, but, if he is driving a road-coach, before doing so, and while he is partly facing his passengers, he should raise his hat slightly to them. It is awkward to remain standing while shifting the reins to the left hand, and there is a risk of being thrown off of the box. On a road-coach, the coachman should not get up until within a minute of the time of starting.

As soon as he takes his seat on the cushion, he passes the reins to his left hand in the same order in which he had them in his right. He catches up his whip, if it has become unwound, and arranges the driving-apron. He then adjusts the reins to the proper length. The man at the leaders' heads should keep the horses far enough forward to have their traces nearly as tight as if they were pulling, otherwise the coachman cannot readily judge how long his lead-reins should be. The reins should be taken in the hand at such a point that *all* the horses when they are started shall have their traces equally tight.

Many authorities think that the wheelers alone should start the coach, the traces of the leaders being slack, but there does not seem to be any good reason for this.

Certainly, the leaders alone should not start the coach while the wheelers' traces are slack, but when the team starts, the leaders should feel their traces before they tighten their reins, or from the sudden

check to their mouths, they will be apt to stop, or to back, with the result of having the pole run on them, whereupon they will jump forward to be brought up again by the short rein. With leaders inclined to rear at starting, it is best to give a good deal of rein, so that they shall feel their traces and have some work to do from the very beginning; they can be easily brought back later.

Once in his seat, with his reins adjusted, the coachman must glance over his team to see that no rein has a twist, that the coupling-reins are crossed, and that neither of the inside lead-traces is twisted; from the box, he is better able to notice these points than from the ground.

All is now ready for the start. The groom should be in front of the leaders, and facing the coach. The head man should be at the wheeler's head on the off side. Just before starting, the brake should be taken off,\* very quietly, the whip having been passed into the left hand; the brake-handle should never be touched while the whip is in the right hand, because to do so causes a wide movement of the whip, which may be noticed by the horses.

The coachman then intimates, by a nod, to the groom at the leaders' heads, that, if he is holding the leaders, he is to let go; the man steps to the near side and moves back a few paces so as to be

---

\* For a discussion of this question of the brake, see further on, under *Stopping*.

opposite to the man who is at the wheeler's head ; and as the back of the coach reaches them, both men get up at the same time into the rumble.

The start should be made as quietly as possible ; the movement of the man from the leaders' heads, combined with a slight yielding of the coachman's hand, is generally a sufficient intimation to the horses. If anything must be said to make them start, a short exclamation should be used, such as 'Right!' uttered sharply and only once. Sometimes 'Pull up!' is used, but this seems to be hardly appropriate, since to *pull up*, means to stop.

In giving a rule for starting a team, it would be difficult to satisfy all coaching critics. Some authorities prescribe dropping, or yielding, the hand, to give the horses the signal, others tighten the reins slightly. 'NIMROD' (*Northern Tour*, p. 340), speaking of a doubtful-looking team at a change, says : 'But dropping my hand to them at starting, they all went away.' BEAUFORT (p. 10) says : 'An unworkmanlike trick, which the coachman cannot be too careful to avoid, is that of slackening his reins and pushing out his hands before him when he wants to start ; a trick, however, which is much affected by many men who find themselves on a driving-seat which they do not adorn.' HOWLETT teaches that the hand should be dropped or yielded at starting.

Possibly, these differences are more imaginary than real ; since the proper action depends a good

deal upon what has gone before it. I incline to the opinion, that the proper way is, just before starting, to feel all the horses' mouths by tightening the reins very gradually, so as to not excite any one of them, and thus to gather the horses, and indicate that something is to be required of them ; then, at the instant of starting, the hand should be yielded, decidedly, but not too far, three or four inches, for instance, to let the horses get off. It must be said, however, that with another team, which has been differently handled, a tightening of the reins will have the same result ; and, in fact, no coachman can exactly predict what a team entirely strange to him, will do at the start ; and he may have to employ both methods in rapid succession.

Gathering the horses and then yielding the hand, is more in accordance with the general rules of horsemanship, and the coachman's own team should be accustomed to that way of starting. The exclamation : ' Right ! ' or whatever word may be adopted, will, usually, if heard by all the horses, make them start ; the clucking noise frequently made for this purpose is not always heard by the leaders, and it excites other horses which may be near the coach. The reins are, after all, the proper means of communication between the coachman and his horses.

The touch of the whip is too exciting to be used in starting, unless a sluggish horse decidedly holds back, and it is successful only in practised hands.

It need hardly be said, that the favourite news

paper expression, 'the coachman *cracked* his whip and started off,' is entirely due to the imagination of the reporter; no one ever cracks a four-in-hand whip.

On a road-coach, it is the business of the guard to see that the passengers are seated, and when all is ready for the start, he comes forward, on the off side as far as the wheelers' shoulders, and says 'Right, sir!' to the coachman.

Since on a drag there is no guard, the coachman must be sure that no one on the coach is *standing up* when he is about to start, and if there are persons on the back of the coach where he cannot readily see them, it is well, as a warning, to say 'Sit fast!' before starting.

If a coach has only one servant with it, or if one of the two is driving, the man on the ground should hold both the wheelers and the leaders, by grasping the coupling-reins of the wheelers and the lead-reins together, with his hand passed under the off wheeler's neck. He can thus restrain the whole four; but if he holds the leaders only, by their heads, and the wheelers start, they may push the leaders over the man and set the whole team off.

If a team standing still, starts suddenly, when no one is on the box, a bystander should seize the heads of the *wheelers* and not run to those of the leaders, as people generally do. If the wheelers are held, the leaders cannot well run away with them.

MOVING OFF.—There are larger opportunities for awkwardness in the start than at any other time ; even the most practised coachman will sometimes not know, until the team straightens out whether he has his reins exactly right, and for this reason a few moments spent in making sure that the reins are exactly where they should be, are not wasted.

A beginner may sometimes have the following experience : when he gets into his seat he has great difficulty in catching his double thong, the loop *will* run down too far on the stick, and he finds his right hand full of loose thong ; after he has arranged this and has pulled his reins about a good deal before getting them to his liking, he nods to the men to let go, probably forgetting to take off the brake.

The leaders, which always should be quick at starting, jump forward, and one of them, brought up suddenly by his draught-rein's being held too short, rears, or else stops while his partner rushes forward to the extent of his longer rein. The wheel horses, moving forward, run the point of the pole into the stern of the stopping leader, with the result of making him move forward again, if he does not kick. If he goes on, one lead-rein being shorter than the other, brings both leaders off to the side of the road, so that one of them goes up on the kerbstone or on the grass ; and in his frantic endeavours to get those two reins straight, the coachman lets the off wheel-rein slip through his fingers and run out a couple of inches, not improving the situation.

By this time the second groom may have reached the horses' heads, and straightened the animals out until the reins can be pushed through the fingers to their proper places, and a second start made in somewhat improved fashion, although some one rein will keep slipping in the most provoking manner.

When the coach *does* get fairly under way, one of the grooms whispers in as confidential a manner as is possible from his distant seat: 'Brake's on, Sir!'

These difficulties overcome, the tyro next finds that in the scrimmage he has got his near wheel-rein on top of the off lead-rein, and the two reins seem to be all edges while he is endeavouring to get them right.

If the team pulls at all, as is quite likely after this little flurry, the two middle reins keep slipping out from between his first and second fingers, with the result of having the leaders off to the right-hand side of the road; at last all calms down and things go more smoothly.

At such a moment, the beginner is apt to think that driving is not so amusing as he believed it to be when he came out of the house, drawing on his gloves, and admiring the 'smart' looking 'turn-out' before him.

All this is intended to emphasise the importance of having everything as nearly right as possible before giving the signal for starting, with the reins



the right length and so drawn up that each horse's mouth is just felt, thus ensuring their being evenly held, or evenly released, as the hand is moved.

Since, in taking up a load, the coach is usually close to a step or kerb, it follows that immediately after starting an inclination must be made to the right or left, and this is most neatly made by taking a point with both the lead-rein and the wheel-rein on the proper side (see Figs. 136, 137), which may be done before giving the signal to move. This leaves the whip hand free for a prompt use of the whip on a wheeler, sometimes necessary at the moment of starting, and as soon as the desired inclination has been obtained, the points are dropped and the reins are again even. In driving away from the door of a house in confined grounds, nice handling is required,—for instance, to go round a curved road, to the left out of a narrow gate, and then to the right into the road or street, and to keep the wheel tracks in the middle of the drive and not have them almost on the grass, first on one side and then on the other.

If of two ways of going up to a door one is more difficult than the other, it is best to go *in* by the difficult way, when the horses are already moving and well in hand, and to go *out* by the easier way.

In going through a gateway, the leaders should be taken back and the coach guided by the wheelers; then if the lead-bar touches the post, the bar will yield and slip by, whereas if the traces are tight, the

bar will tear the post, or else the bar or the trace will be broken.

Having got fairly on the road, a few minutes are spent in noticing how the team is going, and, if it is a strange team, what are its peculiarities ; the places of the reins in the hand can then be determined, and that having been done, the reins should be kept in the left hand as far as possible unchanged, with the right hand always free.

*The right hand should not remain on the reins an instant longer than the time required to make a change of some kind.*

For example, in making a point with a lead-rein, it should be done promptly, taking enough rein and not too much, and, after putting the point in its proper place, the right hand should be taken off immediately ; or, if an inclination is to be made to the off side of the road, the two points must be made, or the reins shortened, for that side, but the right hand should not be put on the reins and kept there, since this action is likely to pull the reins a little out of the left hand, and the moment the right hand is taken off, the horses will run over to the left, and all the beauty of the movement will be spoiled.

It seems hardly possible that there should be a difference of opinion as to whether or not the reins should be kept in the left hand in an unchanged position ; an unchanged position must not be understood to mean that a dead pull should be kept upon the horses' mouths ; the whole hand can give readily

to the mouth just as it does on the rein of a saddle horse.

Some coachmen are constantly changing the position of the reins in the left hand, in the mistaken belief that they are keeping the horses' mouths light ; in reality, they are only worrying the horses.

As to the wheel-reins, for example ; when they are once evenly adjusted, the horses are going straight ; if one or the other is lengthened the pair will go to one side or the other, which is not desired, and exactly the same is true of the leaders, as a pair. That the lead-reins may require to be let out or taken back is more likely, but even this need not often happen on a level road.

The more successful the coachman is in keeping his reins unchanged in his left hand the better, always remembering that this does not mean or necessitate a dead pull upon his horses' mouths ; on the contrary, he should constantly give and take his *whole hand*, so as to prevent his horses from pulling.

As a matter of fact, a man must be a very good coachman and his team an even one, to keep the reins unchanged in his left hand ; the reins will slip more or less and require re-arrangement by the right hand. Slight changes of direction can be readily made by the left hand alone (see page 311).

The perfection of driving is to have the least visible motion of hands or reins, and a cultivation of this quiet way is strongly recommended to the beginner ; it will worry his horses less, save him

from fatigue, and be considered much more elegant by good judges, and even by those who admire it, without knowing exactly why. A fussy coachman is not necessarily a good one, although many people seem to think so.

It was once said in my hearing, of a certain four-in-hand man, that his horses must be very well trained, because they always went along of themselves; as a matter of fact, he drove all sorts of horses, but knew how to put them together and how to drive them.

As to authorities on this matter, the following quotations are interesting. 'NIMROD' (*Northern Tour*, p. 274), speaking of DAVID ROUP, a coachman for the famous Captain BARCLAY, says:—

'His seat on his box is perfect; his reins well laid over his fingers, and as firm as if they were stitched there; his hands as quiet as if he were asleep, the right hand never stirring at all till it was wanted, when it was used as it should be; and taken altogether, there was a combination of strength, with ease and smoothness, about his performance that pleased me as much as it surprised me.' This was written in 1834, the best period of coaching, by an excellent critic.

CORBETT (*An Old Coachman's Chatter*, p. 256) says: 'I was once talking on this subject to CHARLES TUSTIN, with whose name I have already taken liberties, when he remarked that a coachman should take up his reins at the beginning of a stage

‘and never have to alter them in his left hand till he throws them down at the end of it. Some drivers I have seen, appear to think it a sign of a light hand to be constantly fiddling with their reins. I believe it is more a sign of a fidgeting hand, and I am quite sure, from experience, that hot-tempered horses settle down much better without it. The less their mouths are meddled with the better.’

This subject has been treated here at some length because there are excellent coachmen who hold views opposite to those here expressed, and who advocate a constant playing with the reins and shifting of them.

POSITION OF HAND AND ARM.—According to the instructions given for getting up, the reins are

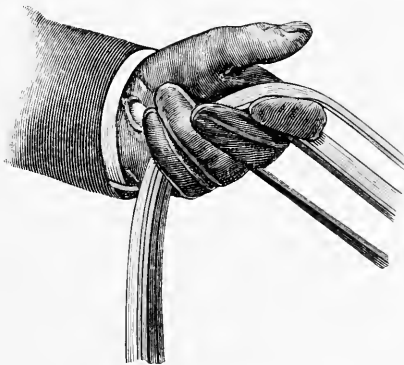

FIG. 132. PLACES OF REINS IN HAND.

shifted from the right to the left in the same positions in which they were held in the right hand ; that is, the near lead-rein on top of the fore-finger, the

off lead and the near wheel-reins between the first and second fingers, the lead on top, and the off wheel between the second and third fingers (Fig. 132).

There is undoubtedly a disadvantage in having one rein on top of the other between the first and second fingers, but in what is called *a full hand*, see Fig. 147, where one rein is in each space, the off wheel-rein cannot be held strongly enough by the little finger, and the method of holding the reins, shown in Fig. 132, is that universally adopted in England and sanctioned by the best practice. (See the end of this Chapter for other Continental methods.) The thumb should not be closed down upon the lead-rein, because that tires the hand, and because it should be always ready to receive the loop of the lead-rein when making a point; for the same reason the fore-finger is kept a little distance away from the second-finger.

The reins are held, not by *squeezing* them on their flat surfaces, but by the pressure of the third and fourth fingers on their edges. If they are too wide and too thick for the size of the hand, the two middle reins will not touch the fingers, which will, as it were, arch round them; if they are of a proper width the fingers will touch all the edges and hold them fast. This is an obvious reason for having them all of the *same* width. With a light team, the pressure of the reins upon each other, and their friction against the glove are quite sufficient to keep them in place with the hand easy and open.

While reins should not be glassy or slippery, it is a mistake to have them sticky with wax ; it will be difficult to shift them slightly, as may be required. The more experienced the coachman, the less he will care for sticky reins ; just as a beginner on horseback likes a sticky saddle, while nothing is more disagreeable to an old horseman.

The normal position of the arm is nearly horizontal, the hand slightly lower than the elbow, opposite to the centre of the body, and about four inches away from it. The hand must be slightly bent at the wrist toward the body, so that the knuckles point straight to the front. This gives a lightness to the hand, from the play of the wrist, which cannot possibly be had if the hand is held out straight. The lead-rein will, in this position, run nearly over the knuckle. The back of the hand must be vertical, neither turned up nor down ; it is then ready to be rotated on the wrist, as may be required.

If the hand is held much higher than about the height of the waistcoat pocket, there will be no room to raise it further in making a sudden stop ; if it is too low it will be difficult to keep it in the middle line of the body, and the right hand will have too far to go to take hold of a rein in front of the left ; if it is tight up against the body, there will be no room to draw it back in stopping or in shortening all the reins together ; if it is much further forward than four inches, it will be too far from the

right hand, will not be opposite to the centre of the body, and will induce the coachman to lean forward.

In fact, it may be said that the normal positions of hand, arm, or body should be intermediate ones ; that is, they should be such as will permit prompt motion in any direction.

During a long drive, for the purpose of resting the arm, the hand may be permitted to go down and forward as far as it will, for a time.

Naturally, men of different mould and stature, will adopt somewhat different positions of the arm, but for the average man, the position just described is the correct one, since it permits latitude of motion in all directions and ensures the coachman's sitting straight to the front, which is very important.

The proper position for the hand and arm is shown in the photograph facing this page, but it is only the *average* position ; a variety of causes may lead to a change of position. With a very light team and on a short drive, especially where appearance is important, the hand can be held somewhat high with the wrist rounded in. This gives lightness and sufficient strength for the purpose. With a pulling team, on a long drive, the hand and arm *must* come down somewhat. One extreme may be when showing a highly dressed team in the exhibition ring ; all the horses will be very light, going well up to their bits and not pulling a pound apiece ; then a high hand, sensitive to the slightest touch, is proper ; the coachman is



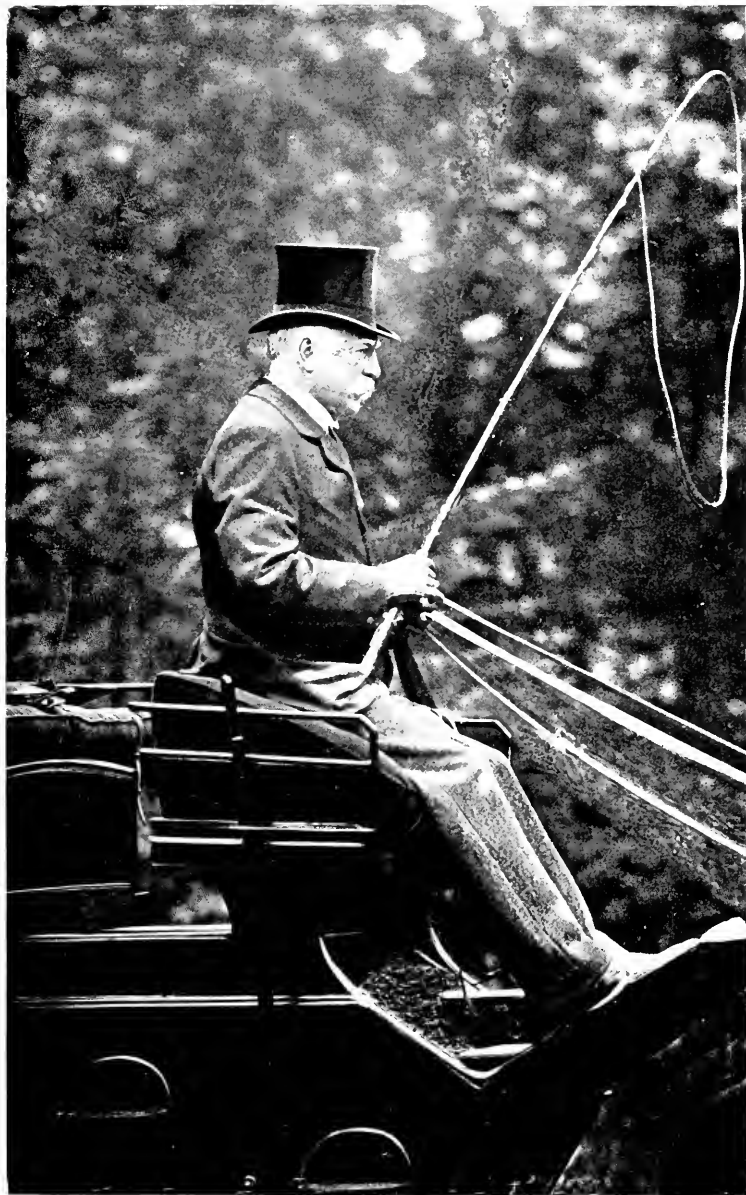

POSITION ON THE BOX.



perfectly familiar with his team, and knows exactly what he can do with them.

The other extreme may be with a heavy, lugging team which the coachman has never before seen, with bad mouths and perhaps no one horse bitted as he should be. The coachman must then keep his hand down and his arm rather straight, or he will be tired out in a short time.

It is just the difference between riding a highly trained horse with a very light hand and steering a pulling brute across country with a snaffle-bit. No doubt a fine horseman with good hands can take the puller with one-half the exertion that a bad horseman can, and at the end of the day will have him pulling less than when he began ; in the same way an accomplished coachman will drive a bad team with less exertion than a poor one will, but he cannot keep his hand and arm as high as with a light team.

The hand need never be higher than the elbow, that is, with the forearm horizontal ; even this is rather too high for ordinary work ; any greater elevation is an affectation. Every now and then the fashion comes up, especially in pair-driving, of holding one or both hands up under the chin, but for this there is no reason. In road work, and with any but the most finely dressed park team, the hand should come down to about the lower button of the waistcoat, which will give the forearm a decided inclination downward ; and the hand must be

at least three to five inches away from the body ; if it is not, there will be no room to draw it back for a sudden stop, and the body will have to be thrown back ; a most ungraceful motion.

The evidence seems to show that the coachmen of 1820 to 1840, whom we suppose to have been the best, held their hands somewhat low and out, with a straight arm, as it is sometimes called.

The left hand should be kept opposite to the centre line of the body, so as to be ready to move in either direction, and not to be too far away from the right hand ; but it is sometimes a relief in a long drive to drop the arm almost straight down by the left side for a short time. In doing so, however, it must be remembered that the off side reins are shortened, and it will be necessary to pull them out a little, to prevent the team from going over to the right.

The driving-seat must not be so steep that the coachman hardly sits upon it, but only leans against it, which is fatiguing, because the weight of the body does not sufficiently assist the pull of the arms with a troublesome team, and the coachman may be even pulled off the box should a wheeler fall ; neither must it be too flat, as that brings the knees in the way of the reins and diminishes the effect of the legs in resisting a pull. The cushion shown in Fig. 37 and in Plate XXVII. is of a proper shape, and is such that the knees are somewhat bent and the feet rest comfortably on the foot-board, without the ankle's being strained, which will happen if the lower

part of the leg is at too much of an angle with the foot-board.

The coachman should sit straight, and square to the front, his shoulders back, and his knees and feet close together, his toes not projecting beyond the edge of the foot-board. It is hardly necessary to add that he should never cross his legs or have one foot in advance of the other. If he sits with his feet drawn back, off of their proper place on the foot-board, he is merely preparing himself to be thrown on his wheelers' backs, in case of striking a stone or a post.

The whip is held by the right hand, at the ferule (which is ten inches from the butt), and at an angle of about forty-five degrees from the horizontal, and forty-five degrees to the front. In this position the thong is above the near wheeler, and the whole whip is out of the way of a person on the box. If it is nearer to this passenger, a sudden touch on a branch, in passing, will drive the whip back into his face before the coachman can stop it. If it is too low the loop of the thong may touch, or catch on, passing vehicles.

ON THE ROAD.—On a road which is not crowded, the coach should be kept near the centre, where the surface is usually hardest and smoothest, and where the coach will not incline to one side. On a crowded road, the proper side should be kept, or constant deviations in meeting vehicles will be necessary. The best place, in very crowded traffic, is just to the right of the centre line of the road; advantage can

then be taken to slip along past the vehicles which are in front, whereas if the coach is far over to the right it will be hopelessly hemmed in by the vehicles about it, some of which may be going at a walk. In driving through very crowded streets, this is of the utmost importance if time is to be made.

Of course the side of the road just mentioned refers to America. In England it must be reversed. In France it is the same as in America.

In turning out, when meeting another vehicle, the right hand should take hold of the off reins, with the third finger between them, about six inches in front of the left hand, and then be drawn *toward* the left, while at the same time the left should be allowed to go forward somewhat, so that the hands nearly meet (Fig. 133).

If the right hand is moved outward or *away* from the left, it will inevitably pull the reins out of the left, so that when the movement is completed the reins, in the left hand, will not be even, and will require re-adjustment.

This is a mistake that the majority of beginners make, and it is a serious one. If the right hand is not fully six inches in front of the left on the reins, it is more liable to pull them out.

The reason for letting the left hand *go forward* is that the pace shall not be diminished, as will be the case if no rein is given to compensate for the pull. In fact, it must be remembered that the horses should be *permitted to go to the right*, instead of

being pulled to the right, and with some horses it is better to make the whole movement by letting the left hand go forward, not taking the right hand back.

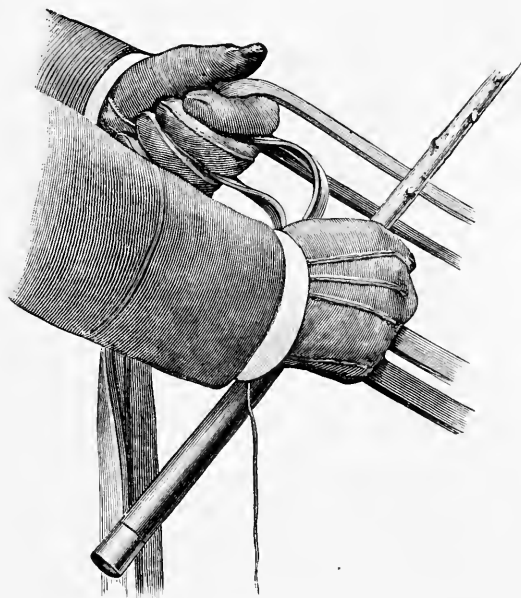

FIG. 133. INCLINE TO THE RIGHT (OFF REINS SEPARATED).

Some good coachmen put the whole hand on the off reins, with the nails downward, taking both reins in one grasp, between the under side of the hand and the thumb (Fig. 134), but it is better to take the reins with the *third* finger between them, because the hands and reins are then exactly in the position to make a point with both off reins into the spaces on both sides of the third finger of the left hand, if it is desirable to do so in order to continue

for more than a few seconds, the movement toward the right, or to put the right hand on *all* the reins *in case* the horses pull.

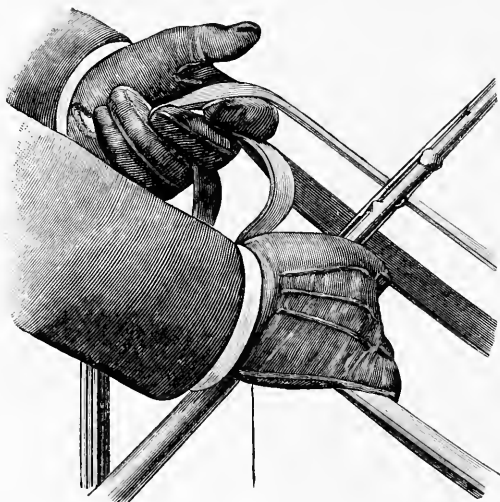

FIG. 134. INCLINE TO THE RIGHT (OFF REINS TOGETHER).

It may be added, that the hands should be always kept with the backs vertical, and with the fingers pointing toward each other, in order to make the fingering as simple and as rapid as possible.

Having the reins separated by a finger, permits either rein to be allowed to slip, if this is necessary to make the movement more accurate.

The right hand must be taken off of the reins as soon as the movement to the side of the road is accomplished, and it may be necessary to use it immediately in the same way on the near reins to return to the centre of the road.



In turning out to the left, the converse of this must be followed, and the right hand passed in front of the left, taking the near reins, separated by a finger, and pulling them toward the right hand. It

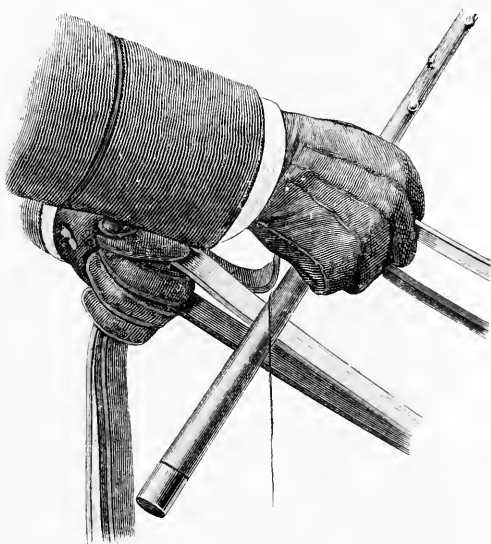

FIG. 135. INCLINE TO THE LEFT.

is sometimes said, that the right hand never should be crossed over the left to seize the reins ; but it is not really crossed over ; only put in front ; it is impossible to take hold of the near reins with the right hand without putting the right hand in this position.

Since the right hand, when on the near reins and in front of the left, naturally pulls toward the left hand, there is not much likelihood of disturbing the reins, but too much stress cannot be laid upon the

fault of drawing the right hand away from the left and the reins with it,—the source of much bad driving.

The method just described occupies the right hand and prevents, for the time, the use of the whip, for *the whip never must be used while the whip hand is on the reins*. There is another method which is neater and which leaves the whip hand free ; this is, to take

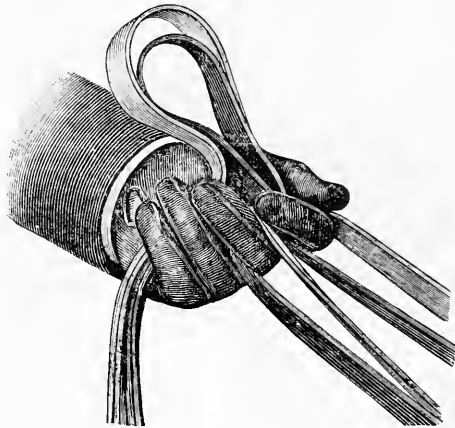

FIG. 136. POINT OF TWO NEAR REINS.

a point or loop with both lead-rein and wheel-rein of the proper side in the left hand and to hold it, forwarding the hand slightly to make up for the point, until it is necessary to return to the original direction, when the points are simply allowed to run through the fingers. All this time, the right hand is free to use the whip on a wheeler, if necessary, or to increase for a moment, the effect of the point. This is much the better way of making the movement, but it requires strength in the fingers, par-

ticularly for the off side reins. In turning out to the left to pass a succession of objects on the road, it is especially useful, as it also is in obliquing across a street, after having stopped at that kerb which is on the side against the traffic.

There is another way of making a slight inclination to the right or left, with the left hand only. If the left hand is turned so that the back of it is



FIG. 137. POINT OF TWO OFF REINS.

uppermost and at the same time the hand is drawn off toward the left side of the body, the off side reins will be shortened, the near side reins slackened, and the team will go over to the right. If the left hand is turned at the wrist so that the thumb comes toward the body, and the hand moves at the same time toward the right, the near side reins will be tightened and the team will go to the left. This is a very neat way of getting over from one side of the road to the other.

TURNING A CORNER.—The next movement to be considered is that of turning a corner.

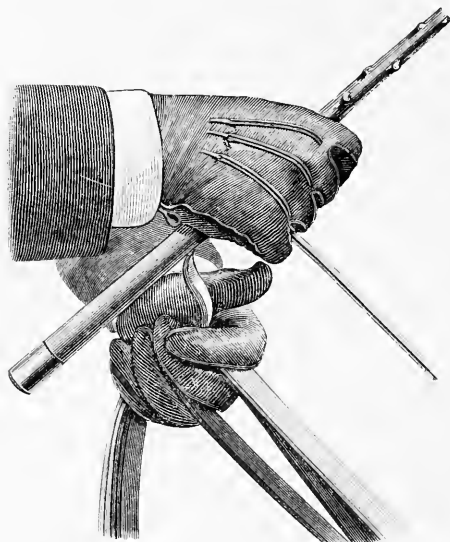

FIG. 138. POINT TO THE LEFT.



FIG. 139. POINT TO THE LEFT.

Turning to the *left* is done by taking the near lead-rein between the third and fourth fingers of the

right hand about seven inches in front of the left hand (Fig. 138), and looping it at that point *under the thumb*, holding it there (Fig. 139) until the leaders have got straight in the new direction, and then letting the loop slip gradually until the rein is straightened out into its original position.

In turning to the *right*, the off lead-rein is taken in the same way (Figs. 140, 141), and looped between the *first and second* finger and afterward allowed to slip through. If this rein is put under the thumb, the last part of the loop will snap out with a jerk, but from under the first finger it slides out smoothly, since it is all the time in the space in which it belongs.

The length of rein taken up to make the point depends upon the sharpness of the turn and the promptness with which the team responds to the rein. In turning an accustomed corner, horses require a very slight hint; but for a very sharp turn, especially if it is less than a right angle, or, as it is sometimes called, a *back corner*, it is well to take, first a small point to intimate to the leaders what is expected of them, and then to make another point a few seconds later.

In *making* a point, the left hand must not go forward to meet the right, but the right must come all the way back to the left, for the reason that the forwarding of the left hand lets the wheelers rush forward just at the moment when they should go steadily round the turn.

No harm is done by bringing the right hand all the way back, since in a turn, the leaders should be

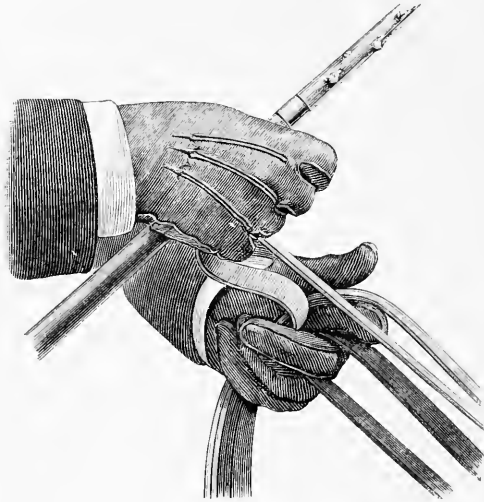

FIG. 140. POINT TO THE RIGHT.

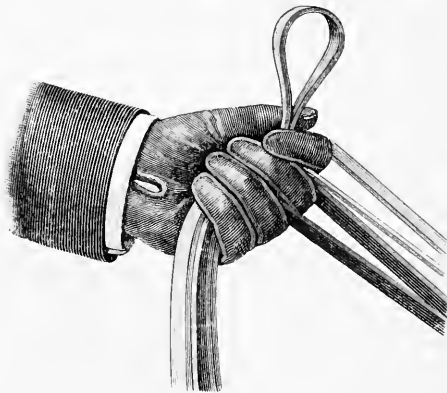

FIG. 141. POINT TO THE RIGHT.

a little back, so as not to pull on the point of the pole ; and what is taken in the point is equivalent to

half that amount taken back on both reins together, and is usually quite sufficient. If the approach to the turn is up-hill and the leaders are working strongly, while the road beyond the turn, is down-hill, it may be necessary to take the leaders back *before* making the point; to do this, the lead-reins should be taken entirely out of the left hand, by seizing them with the right (with a finger between them) an inch or two in front of the left hand, pulling them out sideways and replacing them in the left by carrying the right hand behind the left.

OPPOSITION.—In many cases, *pointing* the leaders is not all that is necessary to be done in making a turn; the wheel horses usually incline to follow the leaders too quickly, and, by making too short a turn, to force the coach against a corner, or a post. To prevent this, the wheel-rein on the side away from the turn must be shortened.

If the turn is to the left, after making the point with the near lead-rein, the off wheel-rein must be, for the purpose of making the opposition, *pushed back* from in front, through the fingers, or, still better, *looped* in its proper place between the second and third fingers (Fig. 142).

If the turn is to the right, the two centre reins, which are the off lead and the near wheel, are shortened by looping them together between the first and second fingers, and then allowing as much of the wheel-rein to slip,—which it will readily do with-

out disturbing the lead-rein,—as will give the proper amount of opposition. Fig. 143 shows this *after* the wheel-rein has been allowed to slip so as to diminish

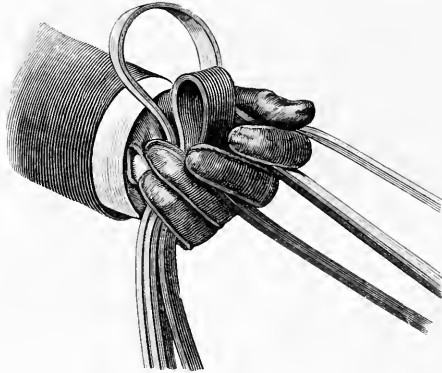

FIG. 142. OPPOSITION OF OFF WHEEL REIN.

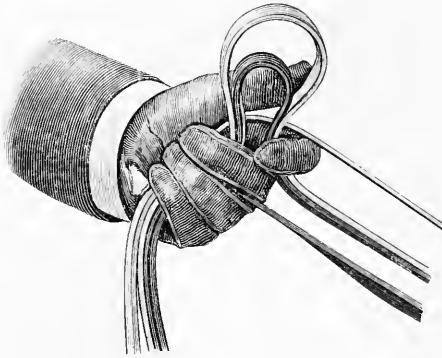

FIG. 143. OPPOSITION OF OFF WHEEL REIN.

its action. All this is done without *keeping* the right hand engaged.

HOWLETT teaches, that a turn to the right, for a sharp corner, should be made by bringing up the near wheel-rein between the two lead-reins, and



hanging it over the root of the thumb *before* making the lead point (Figs. 144, 145), letting it slip off when no longer needed.



FIG. 144. HOWLETT'S OPPOSITION.



FIG. 145. DITTO, WITH LEFT POINT.

The corresponding fingering for the turn to the left, is to push back the off wheel-rein as described above.

For very sharp turns, going into gateways and the like, this opposition of HOWLETT'S is useful, and he himself employs it with great effect.

Another way is, to point whichever lead-rein is required, and then, putting the right hand on both the reins of the other side, in this way to control the turn; the third finger of the right hand being between the reins, the wheel-rein can be drawn more tightly than the other. If this turn is to the left, the hands will be in the position shown in Fig. 135; if to the right, as in Fig. 133, the proper point being made at the same time in the left hand.

This method occupies the right hand during the whole of the turn, but it is very simple.

It must be stated generally, that it is desirable to use such methods of fingering as will leave the right hand as free as possible, since the coachman may be called upon, during a movement, to use his whip, which he cannot do if his hand is on the reins. The awkward spectacle is not uncommon of a coachman trying to hit a wheeler while his hand is on his reins; under these circumstances, to hit a leader is obviously impossible.

In turning to the right, when the opposition is made by using the two centre reins, they can be shortened by pushing them back instead of looping them, and afterward they can be allowed to slip out to their proper lengths; in turning to the left, it is obvious that a corresponding result will be attained by pulling the same reins out to a sufficient distance, but this necessitates bringing back the hand almost too far against the body in order to make up for this lengthening.

With handy horses this is a neat way of working, but any method which keeps these two reins absolutely together has the disadvantage of giving too much opposition in proportion to the amount of point.

After this description of these various methods, it may be repeated, that, in turning to the right the two reins which are between the first and second fingers,—namely, the off lead and the near wheel,—should be looped in that space together, by one motion of the right hand. In turning to the left, the near lead must be pointed first and the off wheel afterward, each in its proper place, and in both cases the opposition is quickly and simply effected. This is only when an opposition is required; in easy turns, as out of one wide road into another, with no vehicles in the way, a point of the lead-rein is all that is required, and if sufficient point is taken, steadying\* the team with the left hand will keep the wheelers in their places. If, however, the turn is into a narrow gateway, especially to the right, the coach will be close to the corner or to the gate-post, and the wheelers, unless properly controlled, will be almost certain to turn too short, especially if it is a turn with which they are familiar.

Generally the most difficult place to enter gracefully is one's own gateway.

---

\* Steadying a team is an accepted coaching expression for holding the horses back somewhat.

This use of an opposition was called by the older coachmen *pointing* the leaders and *shooting* the wheelers, and must have been very necessary in entering the cramped archways of old coaching inns out of narrow streets.

It is almost unnecessary to add that for such turns all possible room on the opposite side of the street must be taken ; but sometimes it is not to be had.

In turning a corner up-hill, particularly if the road beyond the turn is still steeper than that on which the coach is, it is sometimes an advantage to *let out* the outside lead-rein instead of making a point with the inside one, so as to encourage the leaders to make some extra exertion.

DOWN-HILL.—It is obvious that the leaders should never have their traces tight when going down-hill, and judgement is required to know how much to take them back. They must not come back far enough to let the bars, or the pole, touch them. They should have their traces just hanging, and the bars entirely clear of their hocks, and this position should be attained immediately before the coach begins to descend, since few things look worse than to see the leaders pulling for several yards after the coach has begun its descent.

It will not be necessary, however, to shorten the lead-reins always, or much. Usually a general pull upon all four reins will bring back the leaders suffi-

ciently ; it will depend largely upon how the leaders and wheelers are working in relation to each other.

In a well assorted team, the leaders should be somewhat more free than the wheelers, and their reins will be therefore a little tighter than those of the wheelers, so that a general tightening of all the reins will be sufficient to shorten the lead-reins. Should the wheelers be pulling and the leaders, in consequence, have slack reins, it may be necessary to take up the lead-reins a little.

Even with very light-mouthed horses, however, all the reins should be tight enough to enable the coachman to 'feel' the horses' mouths all the time.

The horses should always be 'in their bridles,' or, in other words, up to their bits ; else they will not instantly feel, as they should, the slightest indication from the hand. This is not at all incompatible with slight pressure, and constitutes that lightness of hand which is so desirable.

As a general principle, after the reins are once adjusted to the proper place in the left hand, they should remain there unmoved *and held tightly in the bend of the third and fourth fingers, as if they were fastened together at that point*, in front of which all the fingering must be done.

The reason for pushing in any or all of the reins from the *front* is, that when the right hand is in that position it is just where it is needed to make any movement, or to do any fingering ; while *be-*

*hind* the left hand, it is out of the way and has to be brought forward to be of use.

The fingering to be good, must be very quick; a single second lost may mar it.

In driving at night, it is more difficult to select a rein behind the hand than to find it in front.

When, however, all the reins are to be shortened together, they may be taken between the first and second fingers of the right hand *behind* the left, and the left slipped forward on the reins to its new place. It would be difficult to do this from the front, especially if a good deal of shortening is necessary, because the reins are too flexible to be pushed readily, and they separate when they get a short distance from the left hand, so that the right hand cannot take hold of them all together.

As examples that authorities do not always agree as to what is proper, the following extracts are given:—

CORBETT (p. 249) says: ‘But I have seen what is even worse. I once beheld a gentleman performing in Hyde Park, who, finding himself seriously incommoded with the slack of his reins, stretched out his right hand over the left, seizing the reins in front of it, and then, like sailors hauling a rope hand over hand, proceeded to pass his left hand to the front and take hold of them in front of the right hand. I have frequently seen this manœuvre practised by coachmen driving one or a pair, but only this once did I see the trick played on a

‘four-horse box, and I should think, when it was completed, that the reins must have very much resembled a pack of cards well shuffled and admirably calculated to land the coach in the ditch after dark.’

‘NIMROD’ (*Essays*, MALET, p. 345) says: ‘There is an excellent way of handling reins not generally adopted. That is, when you want to take a pull at your horses, to open the fingers of the right hand and to put the reins into them. Then pass the left hand, with the fingers open, in front of the right hand, and receive the reins into it again. Thus you get extra power over your team without disturbing their mouths.’\*

Who shall decide? At all events, it is well to have charity toward those who think differently from ourselves.

One of the first troubles that the beginner will encounter is that of having his centre reins, the off lead and the near wheel, slip through his fingers. He will discover that this has happened by finding his leaders going to the near side of the road, while his wheelers are going to the off side, and it need hardly be said that at all times, except in turning, the horses must be exactly in front of each other and the team perfectly straight. This inequality of the reins must be corrected by pushing the two centre reins in from the front, and it

---

\* This is what French writers call *la reprise des guides*.

must be prevented by holding the edges of the reins more tightly in the bend of the third and fourth fingers (see p. 300).

When a team pulls so hard as to be nearly unmanageable, it usually happens that these two centre reins slip, and the leaders get far over to the left. For this, the remedy, for the moment, is to take *these two* reins in front with the right hand, and pull the team up by them, which will, at least, have the result of getting the horses straight and of keeping them in the road.

With new reins, this slipping is a frequent trouble.

STOPPING ; PULLING-UP.—In stopping straight,—that is, not inclining to the right nor to the left,—it is only necessary to put the right hand on all the reins, with the third finger between the near and off pairs of reins, and to pull slowly with both hands, raising the left higher than the right (Fig. 146).

The right hand must be put far enough forward to enable it to be brought back the distance necessary to stop the team without disturbing the position of the body, but it should not be advanced so far, as to require the body to lean forward to make the motion. Above all, in pulling-up, the coachman should never lean backward, but he may straighten his legs; all the pull should be taken without moving the body, and by raising the left hand and lowering the right. If this cannot be



done, it shows that the reins have been too loose before commencing to pull-up.

With very free leaders it is sometimes well to bring them back a little before making a halt, since the wheelers can then more readily stop the coach at the last moment; but this must be done with caution; if the leaders stop too soon, the pole will



FIG. 146. STOPPING.

run into them, the coachman not always remembering that the coach keeps running on. This should be especially borne in mind at a place where the horses expect to stop, as at a change, or at the end of a drive, when the leaders will often want to stop before the exact spot is reached, and the slightest check to them then, will precipitate their action. Pulling-up with the leaders huddled back

upon the bars and the point of the pole, is extremely awkward.

In stopping, and at the same time, inclining to one side, as in coming from the middle of the street to the sidewalk, a point should be taken with the two reins on the proper side (Figs. 136, 137), and the right hand kept free to use the whip. This is especially necessary in coming up to an accustomed stopping place, since some one of the horses is likely to stop too soon and may require to be touched with the whip. At the moment of stopping, the right hand can be placed on the reins in front of the points to finish the movement, and the points then allowed to slip out.

The stop should not be made abruptly, but the coach should glide to its place and come to rest, with a gradual diminution of speed, exactly at the proper spot. Coming up at full speed and pulling the horses on their haunches, is bad coaching, and happily has pretty much gone out of fashion even with pair-horse coachmen. A coach is a heavy vehicle for *two* horses to stop by the back of their necks,—for the leaders can do nothing to assist,—and if it runs on beyond its place the consequences may be disastrous, especially on wood or asphalt pavement, which is apt to be slippery. Too much speed in coming up may necessitate the use of the brake, which is very ‘bad form,’ because it shows that the coachman cannot stop the coach with his horses. The rattle, sometimes heard at a

halt, of the brake-handle over the teeth of the rack, is enough to set those of a coaching man on edge.

GETTING DOWN.—*After* the coach has come to rest, the brake should be put on very quietly and as hard as possible (see discussion of this, further on), and the coachman, shifting his reins to the right hand, in which he retains his whip, should get down immediately, in exactly the reverse way from that in which he got up. He tucks his reins, all kept closely together, into the tug-buckle bearer, in the manner shown in Fig. 127, and lays his whip across the backs of the wheelers behind the pads.

He should get down *immediately*, because there is nothing more for him to do on the box, and because the head groom, or the guard, has to wait for him to do so, before putting up the ladder for the passengers to descend. On a road-coach, the professional coachman who is to drive away from the office, should be standing at the wheelers' off side as the coach comes up and receive the reins and whip from the person who has been driving, but the horse-keeper should not do so; he ought to be at the wheelers' heads. With a private coach, if the head coachman has come from the stable to drive the coach away, it is he who receives the reins and whip, and, keeping them in his hand, mounts the box as soon as the people are all off the coach. If the head coachman has been on the coach, or is

occupied with the ladder, or if one of the grooms is to drive away, the reins remain tucked into the harness until they are taken out by the person who is to drive away, and, if they have been kept together when tucked in, they can be seized exactly in their proper places when taken up (p. 287.)

There is a difference of opinion among authorities as to whether the brake should be put on after the coach stops, on a level; all agree that it should be on if the coach is standing on an up or down grade. I must express myself strongly in favour of putting it on after stopping, since there are good reasons in favour of so doing and none that seems to me of any real force, against it.

In getting down from a coach, the passengers cause a little shaking of the vehicle, which is apt to produce a slight forward movement, and this, communicated to the horses, causes them to step forward, with the result of displacing the ladder while some one may be descending; this, the brake prevents. At a change, the coachman is on the ground and frequently women only are left on the top of the coach. The consequences, should the horses get away under these circumstances, might be frightful, and they are very much less likely to do so with the brake on. At a change, the wheelers just put-to, may push over the horse-keeper at their heads, or there may be some carelessness in holding them. Several instances are on record of accidents of this kind, and I once witnessed one, fortunately attended

with no serious results, which made a deep impression upon me. For a road-coach, there should always be a block with a long handle, ready to be put under the wheel, at the changes, but this is sometimes forgotten, and a habit of putting on the brake diminishes danger. The only reason for not putting it on appears to be that it is thought to look rather *slow*.

CORBETT (p. 55) says, apropos of an accident which happened from the horses' running away from a change place at Colchester, July 1839: 'Probably this accident would not have occurred if the coach had been fitted with a brake, which the coachman ought to put on tight before leaving his box.'

What should be done with the whip, on getting down, is also a good deal discussed. On some road-coaches the coachman throws it across the horses' backs before getting down; this requires practice, and the whip is very likely to fall on the ground, and get muddy, or broken; on others, the coachman throws it to a man waiting to receive it. It ought not to be put into the whip socket, or bucket, which indeed many coaches very properly are without. In the socket, it is in the way of getting up and down, and is likely to be broken by some one's taking hold of it. It should be taken down by the coachman; and there seems, on the whole, no better way of disposing of it than to lay it across the wheelers' backs, unless, as has been

before mentioned, a near wheeler dislikes having the thong hanging against him, in which case it must be disposed of by standing it, with its butt on the ground, behind, and leaning against, the lamp iron on the off side of the coach.

At a change, it is usually kept in the hand, unless the coachman assists with the horses.

OTHER METHODS OF HOLDING THE REINS.—The method of holding the reins and of fingering, thus far described, may be properly called the *English* method, since, with slight variations, it is that which has been in use in England for at least a century, the only essential change having been the substitution of the long wheel-rein for the short one, described on p. 229. Although this method is accepted as the best, there are others which should be noticed.

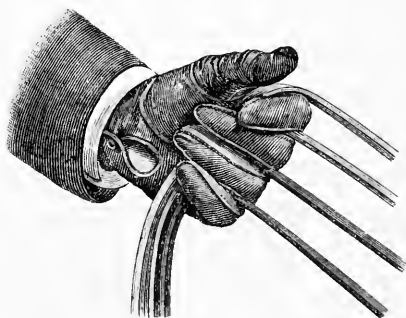

FIG. 147. FULL HAND.

In what is called the 'full hand,' Fig. 147, the order of the reins is the same as in the English method, but instead of there being two reins be-

tween the first and second fingers there is a rein in each space. The reins are entirely separated, but the off wheel-rein, on top of the little finger, is not firmly held owing to the want of strength in that finger, which is a serious objection to the method. This used to be the manner of holding the reins in France not long ago, and is given as being the proper way, in MONTIGNY'S *Manuel*, published in 1865.

Among the professional coachmen of Switzerland and Italy, where there is a great deal of four-horse driving to diligences and private travelling-carriages, many varieties of fingering can be seen, and the diagrams (Fig. 148) show several methods which are certainly widely different; it will be noticed, however, that in none of them is there a rein over the little finger. The reins are never used in both hands except for some momentary purpose.

The two Italians (whose methods are illustrated by diagrams A and B) are experienced drivers and masters of

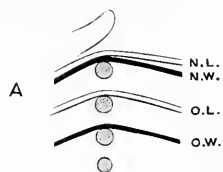

ITALIAN VETTURINO.

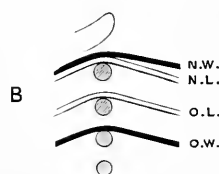

ITALIAN VETTURINO.

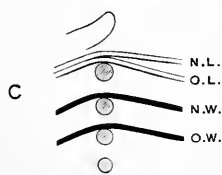

DILIGENCE. S. MORITZ.

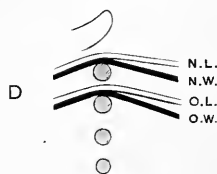

DILIGENCE. S. MORITZ.

FIG. 148.

their art. The arrangement of the reins shown at B is the most illogical of the four ; yet it is that of an extremely good coachman.

The method of the St. Moritz diligence, C (also shown in Fig. 149), approaches nearest to the English in having the lead-reins adjoining and the wheel-reins adjoining ; in all the others, the near reins are next to each other and the off reins next

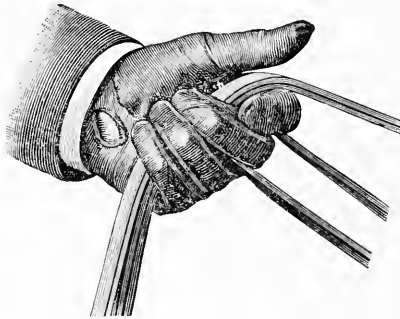

FIG. 149. ST. MORITZ DILIGENCE.

to each other ; in the American method (see succeeding pages) this latter arrangement is adopted, as is inevitable in all two-handed driving. In the English method more importance is attached to being able to regulate the work of the two pairs of horses, and of all the methods, it is the best adapted to fine work, inasmuch as the reins are in the positions most convenient for making the points both for the leaders alone, and for leaders and wheelers combined, and for taking off the lead-reins in order to equalise the work of the horses.



As an instance of how many different ways of doing the same thing may be suggested, the following method given in JOUFFRET'S *Conduite en Guides* deserves mention: The near lead-rein is over the first finger, the end coming out in front between that finger and the next; the near wheel is on the second finger, coming out in front, below that finger; the off lead-rein is over the third, and the off wheel over the little finger, both reins hanging down. A worse arrangement of the reins for any useful purpose it would be difficult to imagine.

In WALKER'S *Manly Exercises*, ed. 1835, a plate by ALKEN shows the near lead and the near wheel-reins *together* on *top* of the fore-finger, but another plate in the same edition shows them in the accepted position, although the back of the hand is horizontal instead of vertical. The first drawing is possibly a mistake of the artist or the engraver; there is no mention of that method in the text.

AMERICAN METHOD.—An American stage-driver holds his reins in the manner shown in Figs. 150 and 151. The near lead-rein is on top of, and the near wheel-rein underneath, the fourth finger of the left hand, the ends coming up in the hand and falling backward over the thumb. The off lead-rein is on top of, and the off wheel-rein underneath, the second finger of the right hand, the ends hanging downward in the interior of the hand.

When the coachman wishes to take all the reins in one hand, or to 'club' them, he passes those in

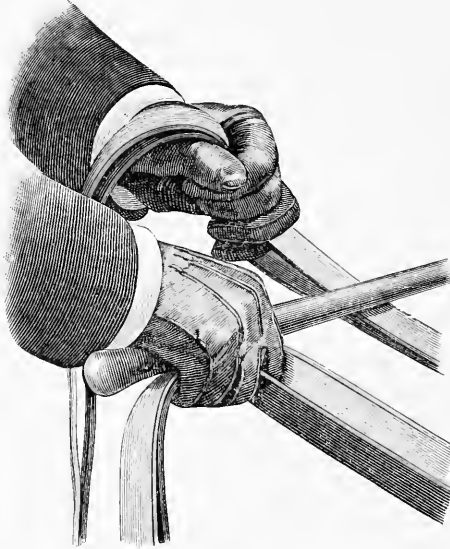

FIG. 150. AMERICAN METHOD

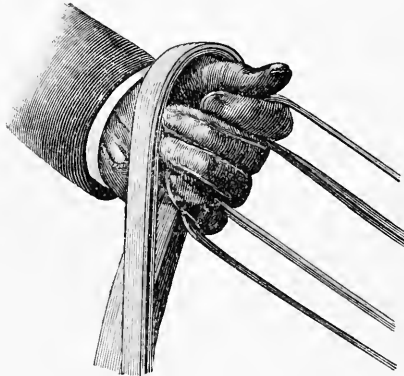

FIG. 151. AMERICAN METHOD.

his right hand into his left, so that the off lead-rein

is on top of, and the off wheel-rein underneath, the first finger, the ends hanging down through the hand. The reins in this way cross in the hand, and can be pressed upon each other very tightly so as to prevent their slipping. The racing jockey often crosses the reins in his hand in the same way. With thick fur gloves, such as are worn by stage-drivers in the mountains in winter, this hold of the reins is strong without being fatiguing.

For six horses, in the American fashion, the order is as follows: in the left hand, the near wheel under the fourth finger, the near swing under the third, and the near lead under the second, the ends going up; in the right hand, the off lead over the first finger, the off swing over the second, and the off wheel over the third, the ends hanging down.

The American stage-driver drives habitually with both hands, the whip being held in the right, close to the butt, and resting on the reins.

In turning a long corner the near or off reins are frequently pulled to the proper side without changing their relative lengths, an operation called 'chopping'; but in turning sharper corners, the hands are brought near together, and with the thumb and finger of one hand, the lead-rein on the proper side is shortened by pushing or pulling it back; it being allowed to slip out after the turn is completed. This serves the same purpose as making a point.

If the road is bad or up-hill and the turn not very sharp, chopping is generally used, as it does not

take the leaders back, but permits them to pull through the whole turn.

For the same reason, a coachman turning on a steep place will let *out* the rein of the leader on the outer-side of the turn, instead of taking up the inner-side rein, so as to permit the leaders to do still more work (see p. 320).

For further comments upon the American method, see Chapter XX.

FINGERING FOR SIX HORSES.—With six horses, according to the English method, the reins are held as shown in Fig. 152; the lead-reins and those of the swing, or middle horses, in the same places as those

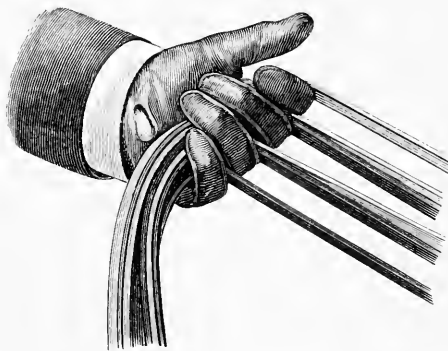

FIG. 152. SIX HORSES.

of the leaders and wheelers of four horses, and those of the wheelers, which may be considered as a pair added, are placed below all the others, on the two sides of the third finger. The lead points are made exactly as with four horses, and if the

swing-reins require pointing, it is done in their proper spaces. In fact, usually only the lead and wheel horses are driven; the swing horses follow in their proper places, of necessity, although in making sharp turns they sometimes require guiding.

For six-horse driving the leaders must work evenly and be quite free, since they cannot be reached by the whip. In making a turn they must be held back somewhat, but, if a chain is used between the swing horses instead of a pole (see p. 278), they must not be so held back as to permit the bars to drop too low.

When more than four horses are required, three harnessed abreast on the lead, with two at the wheel, will do nearly as much work as three pairs, because more easily handled.

TURNING AND BACKING.—The space in which a coach and four horses can be turned, depends on the angle at which the fore carriage will lock, and on the length of the perch. The angle of lock is that made by the pole with the centre line of the coach, when the front wheel is turned as far as it will go against the body, or against the stop which prevents it from touching the body. In a coach, it is usually about twenty degrees, rarely as much as twenty-two. The larger it is, the smaller the circle in which the coach will turn.

As breaks are built of many different patterns, their angles of lock vary, but they usually lock much

further round than a coach, and consequently can be turned in a smaller space.

By the following method the angle of lock of a coach is found by a simple measurement, without any computation :—

Place the coach on a level floor and block the hind wheels, put the pole in its place, and mark upon it a point 11 ft. 8 in. (140 inches) from the perch-bolt. With a pole of the usual length this point will be near its end. Put the fore-carriage hard on the lock (Fig. 153), and with a plumb-bob,

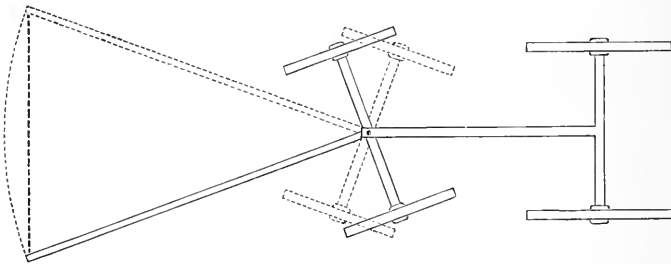

FIG. 153.

or any convenient substitute therefor, drop a line to the floor from the point marked on the pole and mark that spot on the floor ; then, taking care not to disturb the position of the hind wheels, put the fore-carriage on the other lock and mark on the floor, the spot vertically under the point on the pole ; measure the direct distance between the two marks ; the angle given in the following Table, opposite to that distance, is the angle of lock.

Example: The first position of the pole being indicated by the black lines, and the second by the dotted lines, the coarse dotted line will be the distance, = 8 feet, and the angle of lock will be 20 degrees on each side of the central position of the pole.

TABLE FOR ANGLE OF LOCK. POINT ON POLE 11 FT. 8 IN.

FT.	IN.	DEGREES.	FT.	IN.	DEGREES.	FT.	IN.	DEGREES.
6	0	15	7	5	18½	8	9	22
6	3	15½	7	7	19	8	11	22½
6	5	16	7	9	19½	9	1	23
6	7	16½	8	0	20	9	3	23½
6	10	17	8	2	20½	9	6	24
7	0	17½	8	4	21	9	8	24½
7	2	18	8	6	21½	9	10	25

The length of the perch also affects the space in which the coach will turn: the shorter the perch the less will be the width required.

The following Table shows how much the diameter of the circle made by the outer front wheel is affected by different angles, and lengths of perch:—

PERCH 6 FT. 6 IN.

Angle of lock . . . . .	20°	22°	24°	30°
Diameter of circle, ft. in. . . . .	43 0	39 9	37 1	31 0

PERCH 6 FEET.

Angle of lock . . . . .	20°	22°	24°	30°
Diameter of circle, ft. in. . . . .	40 1	36 11	34 9	29 0

With a coach locking at an angle of 20 degrees and having a perch 6 ft. 6 in. long, a turn can be made in a street which measures 44 feet in width without the outside leader touching the kerb; if the leaders are pulled well to the inside of the turn before reaching the kerb, it may be done in a few inches less.

Fig. A, Plate XXVIII,\* shows the tracks of the wheels and the position of the horses' feet in such a turn. The dotted lines are the tracks of the front wheels and the full lines those of the hind wheels; the round foot-prints those of the fore-feet and the longer ones those of the hind-feet.

If there were no leaders, the space required would be only a few inches less.

To turn in a road of less width than 44 feet, backing must be resorted to, and the narrowest street in which a turn can be made with a coach that locks at the usual angle, 20 degrees, is 24 feet between the kerbs.

The manœuvre must be executed as follows:—

The coach should be brought into a position about 16 feet from the off side kerb and *parallel*

---

\* The diameter of the circle in which a coach will turn, may be thus found. In Fig. A, the lines of the front and hind axles, when on the lock, meet in the centre of the circle, the perch is the sine of the angle of lock, and the distance from the perch-bolt to the centre is the radius, to which half the length of the axle must be added to get the radius of the circle of the outside front wheel. The angle of lock is the same as the angle at the centre.



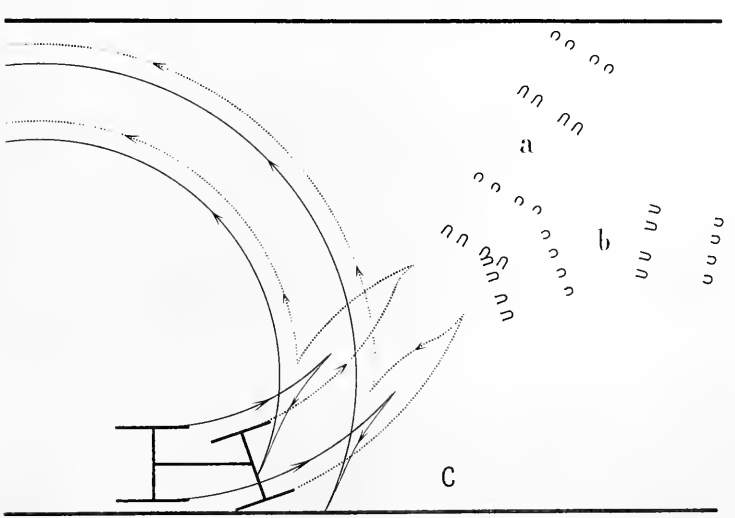
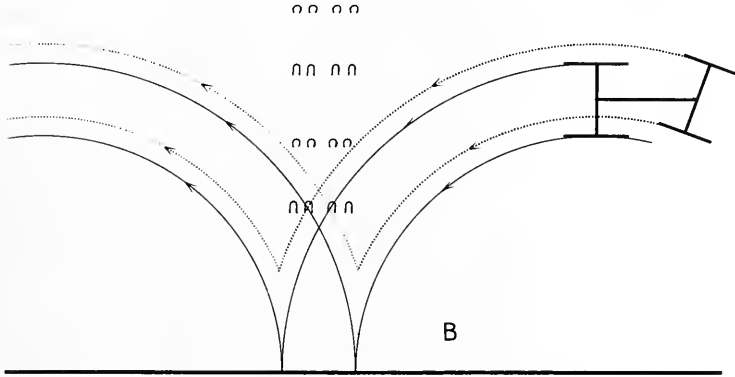
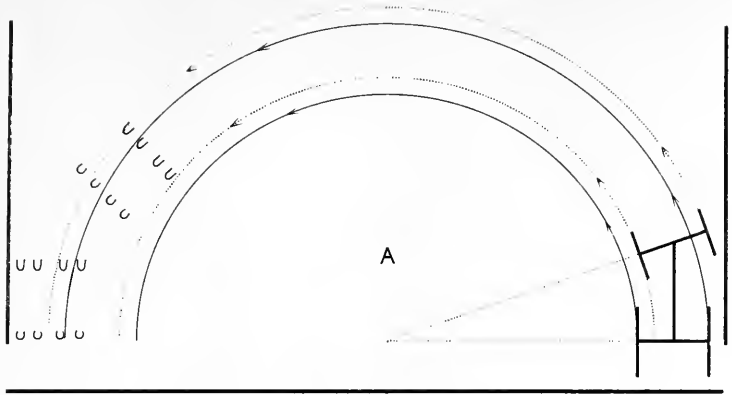

TURNING DIAGRAMS.



to it (Fig. B, Plate XXVIII.), the horses turned to the right until the coach is on the lock, and then backed until the hind wheels touch the kerb, which they will both do if the coach has been kept hard on the lock. The leaders must then be drawn to the left, and, in a street 24 feet wide, they can pass the kerb without touching it. As the leaders can be brought back more than a foot behind the position which they occupy when straightened out, it is possible to squeeze round in 23 feet. About the time that the leaders reach the kerb, the wheelers must be pulled to the left, not letting them go forward until the coach is hard on the other lock, and the leaders having been kept turning, the coach can then be drawn off in the new direction, which will be parallel to the kerb and 16 feet from it.

In making a turn in this way, the coach is *backed* through an entire quarter circle. If the street is wider, say 30 feet, it is better to draw close to the right-hand kerb, and then to drive obliquely across the street (Fig. C, Plate XXVIII.) nearly on the left lock, until the leaders' feet reach the kerb; the coach will stand partly across the street. Then putting the horses over to the right until the coach is on the right lock, they are backed until the hind wheels touch the kerb, which they will soon do, since before beginning to back, the coach was already partly in the proper position. In a 30-foot street it will be necessary to back through less than an eighth of a circle instead of a whole quarter,

which is important, since the majority of horses dislike backing; they have also to back only on a part of the street which inclines toward the gutter, so that the coach runs down-hill.

In Fig. C, the leaders could be brought back somewhat more on approaching the kerb, so that the coach could go further on, and then on being backed, it would come more nearly square to the kerb behind it. The letter 'a' shows the first position of the horses; 'b,' the second position just before backing.

When, therefore, the street is only 24 feet wide, the movement must be commenced parallel to the kerb and about 16 feet from it, in order to get round, but for a width of 30 feet or more, it is better to bring the coach somewhat across the road before going on the lock, so as to diminish the distance through which it must be backed; in a width of less than 30 feet there is no advantage in obliquing across the road, since the coach will not go far enough away from the kerb (on account of the leaders' reaching the other side) to back square against it, and the movement would have to be repeated.

If the coachman, starting to make a simple turn in a 44-foot street, finds that he is not going to get round without backing, he should commence his backing movement as early as possible, so as to get the advantage of the slope of the side of the road. It is difficult for the horses to back a coach up even a slight grade.

In the movements thus described, the coach is supposed to be put on the lock by one movement of the front axle from a straight line, but in turning into a curve from a straight line, until the constant angle of the axles is reached, the hind wheels will follow the front ones, not in a circle, but in a curve called the 'tractrix,' because it results from their being *drawn* by the front wheels by means of the perch, and, on returning from a circle to a straight line, it will be some time after the front wheels have taken the straight line before the hind wheels will take it. The further apart the axles are, the more marked this will be, and this is a reason why a long geared carriage, like a landau, runs harder than a short one, after making a turn, the hind wheels coming into the straight line very slowly.

In backing movements, the mistake is usually made of not turning the front wheels enough to one side, and the coach does not, therefore, in its movement, respond to the expectations of the coachman.

In driving up to a door, it may be desirable to back into a position closer to the kerb than could be taken at first, owing to some obstacle's being in the way, and it will be found, that unless a very decided angle is made with the front wheels, the result will be unsatisfactory and very little ground will have been gained in the proper direction.

Should there be an obstruction on the street at a

point which must be passed just before reaching a door, the best way is to drive beyond the obstruction, going close to it, and to draw in to the kerb as soon as possible, gradually bringing the horses parallel to the kerb. When all four wheels are parallel to the kerb the coach can be backed straight into its place.

If, for example, the obstacle projects 6 feet into the street and is 10 feet from the centre of the door, the hind wheels will have to go 20 feet beyond the obstacle before they will come straight, and the coach must then be backed 14 feet to bring it opposite the centre of the door.

In backing the horses, they should not be forcibly pulled back, but they should be *gathered*, by slight, varying pressures, not exactly jerks, and not by a dead pull, and in turning the leaders through the long sweep that they make in going from one lock to the other the handling should be the same; a dead pull would bring them back; they should be coaxed round as it were.

In ordinary coaching, backing round in a narrow place will not be often required, but if the coachman finds himself in a road the far end of which is closed, he will be, or should be, mortified if he is not able to turn around promptly and gracefully without help from his grooms, or uncertainty as to the result; there are sometimes long stretches of road without places sufficiently wide to turn, in the ordinary way, in which the coachman may have to

drive helplessly on when he knows that he should have turned round long before, to get his load home in time for dinner.

At race-courses, country-clubs, and similar places it is frequently necessary to back the coach into position under a shed, or in an enclosure of small size, and although that operation usually falls to the lot of the professional coachman or groom, it is to be assumed that the owner will not expect his servant to do anything of that kind which he himself cannot do as well, or better, and he may be assured that no small amount of practice and judgement is required to accomplish the feat even moderately well,—which may also be said of moving a carriage without horses, in a coach house; some coachmen do it with quickness and certainty, and others only after many failures.

DRIVING APPARATUS.—A little device designed by me in 1892, will be found convenient for practising and for illustrating methods of fingering.

Two pulleys, each with two rollers, have hooks by which they can be attached to eyes screwed into any convenient wood-work, or to clamps fastened on the edge of a heavy table, or on the balustrade of a piazza.

Over these pulleys, straps an inch in width, representing the reins, are passed. Each strap terminates in a ring, to which is hooked a wire stem, long enough to carry eight weights of one pound

each. In Fig. 154, two pounds are represented as on each rein.

One pound barely keeps the rein tight.

Two pounds on each rein represent the pull of a very light team.

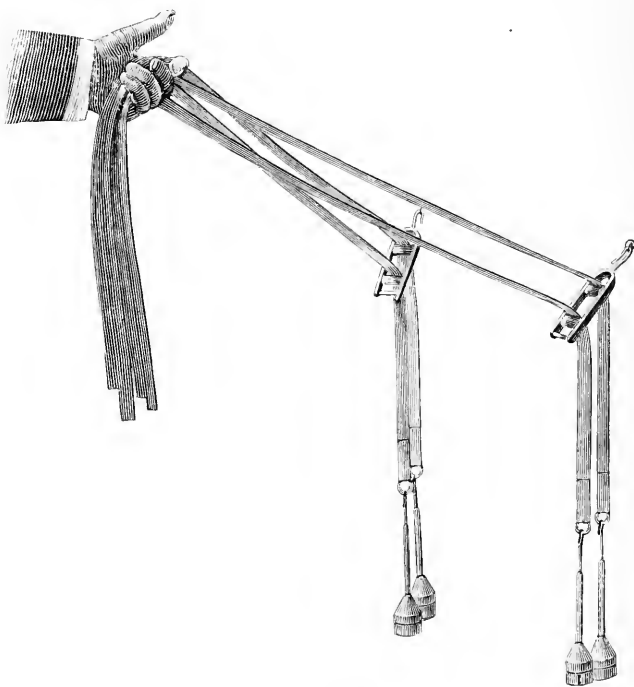

FIG. 154.

Three pounds, a light but strong-going team that will not tire a man in good condition.

Four pounds, as much as is at all pleasant for a long drive.

Five pounds, too much to be pleasant, even when in good condition.



Above five pounds represents a lugging team, and with eight pounds, or, in all, thirty-two pounds, a man's arm would soon give out.

Since seventy pounds is a fair tractive force for a coach, on a good road, it often happens with a pulling team, that a large part of the traction is through the reins and the coachman's arms; in speaking of the strength required to hold a team, it must be remembered that no man on the box can exert more strength than the amount required to draw the coach, for as soon as that is reached, the horses draw wholly by their mouths instead of by their shoulders, and the coachman's arms merely take the place of traces.

In using the apparatus, the conical weight should be put on top, to prevent the weights from catching on each other as they move up and down.

In discussing methods of fingering, this apparatus is convenient, since all the movements of the hand and fingers can be made, exactly as they are made on the coach-box. Any new fingering can be, by practice, easily acquired, and when one has not been driving for a time, the fingers and arm can be brought into condition by a little daily work with heavy weights.

The space between the lower roller and the smooth round pin which connects the sides of the frame, permits the addition of a third rein in case practice in six-horse driving is desired.

Several interesting little matters, such as the

tendency of certain reins to slip more than others, will be discovered by the expert in practising with the weights.

This apparatus can be simplified by substituting for the pulleys and weights, india-rubber bands, such as are sold by stationers for packages of papers. Such a band, five-eighths of an inch wide, and of a thickness of fourteen to the inch, will, when somewhat stretched, give a resistance of about a pound, and any number may be attached to the end of the rein. This makes the apparatus portable, and a hundred or more pulls upon it every morning, when one has no opportunity of driving, will keep the fingers and the arm in good condition.

## CHAPTER XV

## GENERAL OBSERVATIONS ON DRIVING

ALTHOUGH a boy may acquire confidence and learn a great deal about horses and driving, by 'knocking about' and finding out things for himself, the beginner should not fail to take lessons from the most competent teacher that he can find. That man who thinks he can deduce from his 'inner consciousness' all the knowledge which is the result of the long experience, and the accumulated ingenuity, of generations of performers, is assuming a great deal. Every art is perfected by the successive inventions of its masters, which, observed by or communicated to one another, are slowly formed into a system much more perfect than it is possible for any one man to create for himself. A self-taught man inevitably contracts bad habits which he will find very difficult to abandon, even when he knows the better way, and the longer he drives without competent criticism the more fixed these bad habits become.

There is no teacher so good as a professional teacher; he is paid to do what even a very skilful friend is not willing to do:—find fault, in addition to giving instruction. A pupil should make up his mind to do precisely what his instructor tells him, as long as he is driving with him; to drive with a

teacher and to be constantly objecting to or criticising his methods is a mistake, although not an uncommon one.

In addition to taking all the regular lessons that he can get, the beginner will find it greatly to his advantage to observe carefully any skilful performer alongside of whom it may be his good fortune to be placed ; even when a man is well advanced, he will often learn much by watching another who does not drive as well as himself, if only by noticing mistakes.

The time required to become a fairly good four-in-hand coachman will depend upon a variety of circumstances. If the beginner is young and strong, and has already had a good deal of experience with horses, two or three months of conscientious work under a good teacher will put him well on the way, but only years of practice will make him a master of the art.

It must be remembered that there are two parts in all driving ; one is general, relating to everything connected with the management of horses ; it is the same, whether one, two, or four are in hand, and may be likened to *general strategy* ; the second resembles *tactics*, and must be separately learned in every branch of the service. A movement well planned and well executed is likely to be successful ; one well planned but badly executed is doubtful ; one badly planned but well executed may come out right, but one badly planned and badly executed is sure to be a failure.

No experience in general practice is thrown away ; a mere knowledge of how to finger four reins in the most accurate manner does not make a coachman ; and a man who has not been brought up among horses, and acquired his general knowledge through rough-and-tumble methods at the time in youth when discretion does not outweigh rashness, will find it difficult, even under the most favourable circumstances, to attain the highest proficiency, since he will be likely to lack that confidence and coolness which are of the first importance to a good coachman.

It is for this reason that the old professional coachmen of England were so admirable : put to their work when boys, sometimes under pretty rough masters, they early became familiar with all the details of a complicated art, and acquired an instinctive method of meeting every difficulty. Instinctive is the proper expression, because there is frequently no time to think,—the action must be quicker almost than the thought, like the closing of an eye against a missile, independent of any conscious intention.

One reason for beginning in the right way is that having adopted a method, it is most important to adhere to it, and obviously no one should wish to adhere for ever to a bad method. Unless a coachman has a way which has almost become a second nature of doing each thing, he is likely to be confused in an emergency, by trying to do two different things at once, and failing in both.

It will be found that competent professional

teachers usually have an absolutely fixed way of doing each thing, and are intolerant of any deviation from it, which is only natural, since they cannot teach with authority anything in which they have not an implicit belief.

One often hears coachmen, those especially who are devoted to road work, speak sneeringly of what they consider 'fancy' four-in-hand driving, such as backing round in narrow places and turning difficult corners, and insist that to go ahead on a reasonably plain road is the only duty of a coach; and when asked what they would do in a difficult situation they will answer that a coach has no business to be in that kind of a place. The accomplished coachman, however, will hardly be willing thus to restrict himself, and will prefer to be able to execute all movements which are mechanically possible.

As the temperaments of men differ, so will their methods of driving: one man, with great skill and a somewhat rash disposition, will not hesitate to take great chances, confident that he can get out of a 'scrape,' which he will probably do in a brilliant manner; another, with good judgement and foresight, will attain his end without getting into the difficulty at all. In the long run, the latter method is preferable, as it is usually better to *keep* out of a 'fix' than to *get* out.

The coachman should train himself to be a good judge of pace: some men never know how fast

they are going, and either lose time, or overwork their cattle. Four horses to a coach, on a good road, get over the ground faster than they seem to do, to an unpractised observer. In driving a road-coach over an unknown road, as is sometimes the good fortune of a coachman, all that he can know of a stage is, that it is so many miles, to be done in so many minutes, with a hint that there is such a part up-hill and such a part down-hill ; and, unless he is able to judge accurately of the rate at which he is going, he must do the stage badly, arriving at the end of it either too early or too late. Various suggestions are made as to the means of estimating the speed, such as looking at the wheels, &c. ; but the only true way is to acquire, by careful observation, a knowledge of the manner in which horses of different qualities and sizes go at a certain pace, whereupon the ability to judge will come insensibly. Perfect judgement in this respect is not given to all men, and in race-riding it is justly considered one of the most important and one of the rarest qualities that jockeys possess.

Of importance, also, in a minor way, is the ability to decide upon how much time will be required to cover a certain amount of road in attempting to overtake and pass a vehicle, so as not to be forced, after commencing such a movement, to pull up, when half through it, in order to permit something coming in the opposite direction to go by.

Galloping the horses to a coach may be resorted

to, either for the pleasure of the motion, or because with a team, some of the horses of which cannot trot fast enough, it is better to gallop them all than to permit only one or two to do so ; horses which will not trot evenly can often be made to share the work equally by galloping them all together.

A horse cannot trot at the top of his speed without soon becoming distressed, whereas he can gallop the same number of miles an hour, still going within his speed, since the majority of horses can gallop faster than they can trot. A gallop rests him, and a tired horse will break into a gallop much slower than his ordinary trot.

In galloping, except down-hill, the leaders' traces should be kept tight, because their pulling on the point of the pole will keep the coach straighter than if the wheel horses alone pull by the splinter-bar, when the coach is apt to swerve about and get to swinging from one side of the road to the other. What is called *rolling*, in a coach, commences in this way, the lateral motion soon inducing a rocking motion of the body, which may cause an overturn if it becomes too great. Care must be taken, therefore, that all the horses, and especially the wheelers, gallop evenly ; as a rule, while the horses must be sufficiently steadied by the reins, they should not be held too tightly, especially if, as in the case of galloping to make time, they are doing nearly their best. In galloping, great caution must be exercised that the team does not get ahead of



the coachman; for no man can stop four good horses on a level road, if once they get beyond his control. At the slightest indication that this is about to happen, they must be pulled down to a slower pace, without a moment's hesitation. What these indications are it is difficult to describe, but the experienced coachman recognises them by a kind of instinct; to the inexperienced man they frequently come too late.

Should the horses get away, on a road which has no traffic on it, and which can be seen for some distance ahead, there is one remedy which sounds somewhat desperate, but which, in good hands, is the proper one: this is, not only to let them go, but to urge them on, all the energy of the driver being concentrated on guiding them; pulling on them will only exhaust him, and with no result. Horses, unless they are frightened, and therefore crazy, will not run far at the *top* of their speed, pulling a coach with the brake on, but they must be made to go at the very top of their speed, or they will not tire soon enough. If the coachman, when he finds that they are beginning to slacken their speed, has the good fortune still to have a piece of unobstructed road ahead of him, he may give them a little of the whip all round, when the pace will soon take out of them all desire to run further, and they can be stopped with the impression on their minds, that they have been made to do something disagreeable and fatiguing, which was not by any means fun.

If nothing is broken, nor has hurt or frightened the horses, a runaway thus managed will not injure them for future driving ; but it will be prudent to take them carefully over that particular bit of road on any future occasion ; they may think that they are expected to repeat the performance, and a horse has a good memory.

It must be borne in mind that the chance of success in the application of this method depends entirely upon the horses being *driven* all the time that they are running ; if they are allowed to get out of hand and to gallop along, each one on his own account, a leader or a wheeler may come back on his bar, and get to kicking, with every probability of a general smash up.

In all this, a clear road has been assumed ; on a crowded road with sharp turns, a regular runaway will usually result seriously, and it is, therefore, far better to avoid it than to make the best of it. This is one reason for the excellent old rule of going slowly off the top of a hill ; since pulling horses are frequently inclined to start off suddenly when they are relieved of the weight of the coach, and then to get beyond control.

Horses will sometimes run away at a trot ; that is, without breaking into a gallop, they will get beyond the control of the coachman long before it may appear to any but an expert observer that they are so.

It may be remarked that galloping is not always

faster than trotting, although it usually looks so ; it is quite easy to gallop a team at a slower pace than their best trot.

Coachmen differ much in the use that they make of the brake, and it would be difficult to lay down positive rules about it. The brake should not be used for stopping, except to avoid an accident under some unexpected circumstances ; on a steep descent it should be put on hard enough to take most of the strain off of the pole-chains, and on a long hill which is not steep (say about three per cent., that is, one foot rise in thirty-three) it should be put on lightly, so that the horses can go along at a good speed without having to pull or to hold back ; toward the foot of an incline the end of which turns, or cannot be distinctly seen, it is well to have the brake a little on, both to moderate the pace and to be prepared for an emergency.

It is a bad plan to use the brake so much that the horses get out of the habit of holding back, since upon occasion it is of great importance that they should be able and willing to do so. Many professional four-horse coachmen on the Continent, use the brake to keep the traces tight in going down a moderate hill, so that the horses shall be always at the same distance from the hand ; but it is a bad plan, both because it keeps them at work all the time, and because it does not permit the collars to lift from the necks,—a great relief to the wheelers in warm weather.

The brake may be used, however, to advantage in descending a slippery slope, even if the grade is but slight; a horse, when holding back, is apt to pull away from the pole, and in that position is likely to slip sideways on a smooth pavement.

The person sitting on the off side roof-seat of a coach should never touch the brake unless he is asked to do so by the coachman.

In driving in a crowd, the horses should always be kept 'in their bridles,' or, in more exact language, 'up to their bits.' If this is not done, they will not respond promptly to an indication of the reins. In fact, horses well driven should always go up to their bits, quite a different thing from pulling or taking hold too much. In crowded streets, it is quite necessary to take care that the near leader be not struck by the wheel of a carriage which, overtaking the coach and passing on the left-hand side, turns in too soon in front of the leaders; unless the horses are well in hand they cannot be pulled off to the right quickly enough to avoid the blow.

The grooms should not get down and go to the horses' heads whenever there is a block or a slight stop. It indicates an habitual nervousness on the part of the coachman or a want of confidence in his skill, on the part of his men. There are occasions when it is necessary, and then active men who can get to the spot quickly, are invaluable, but the finished coachman rarely requires such aid. In driving away from a difficult place, the men may linger a

little near the horses' heads until the horses are fairly started, but out of the way and without interfering, merely so as to be at hand should their assistance be absolutely required; for instance, in leaving a race-course, where there is a crowd, and perhaps a narrow passage or gate, and when the horses are excited, by waiting, and by the people around them; but as a rule, when three persons are required to manage four horses, something is wrong.

A helpless-looking man seated on the driving cushion, with his whip in the socket, his reins all of different degrees of tightness, with a man at each leader's head, endeavouring to make way through an admiring crowd, is not an edifying spectacle.

A little quick thought will sometimes get a coachman out of a difficulty.

On a certain occasion, as I was driving a coach to a private race-meeting, I noticed, in approaching the course, that the entrance to it had been made by pulling down two panels of fence at a corner, making a sharp

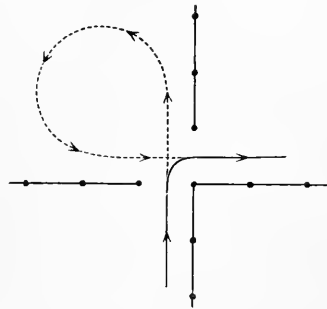

FIG. 155.

turn in, as shown in Fig. 155, the full black line being the track which the vehicles were expected to follow. A friend asserting that it would be impossible to drive in there with a coach, I offered to

bet that I could do it at a sharp trot, and, following the line indicated by the dots, did so easily. Since the turn was made in a ten-acre field, there was no particular difficulty in the feat.

Another time, when driving a pair of strange horses to a phaeton and approaching, on an upward slope, a narrow gate into a park, a carriage came suddenly out of the gate and made it necessary to stop. Upon attempting to start up the slope, the horses baulked, and refused to go on; the groom, jumping down, ran to their heads with the intention of leading them, an operation which, besides being awkward even if successful, would very likely have led to an altercation between the horses and the groom. The latter being ordered to stand aside, the horses were merely turned round down the hill and again turned at a distance sufficient to give them some headway, and then went through the gate at a trot, without the slightest hesitation.

BITTING AND HANDLING HORSES FOR DRIVING.—  
The bits described and figured in the chapter on *Harness*, are those most in use for driving, although there are many other patterns which for special reasons, are favourites.

For saddle purposes, the bits are: first, the plain snaffle, which is a jointed bit (like that shown in Fig. 91), but with cheek-pieces, or horns, added to the rings, so that they cannot be pulled through the horse's mouth. This is the mildest form of bit, and

is used on race horses and sometimes on hunters. With horns, and with loose rings to be attached to the cheek-pieces of the bridle (Fig. 92), it is an admirable hunting bit. Without horns and as shown in Fig. 91, it is used, in a riding-bridle, as the bridoon, or accompanying bit to the curb, but it then has a thinner mouth-piece. Secondly, the curb-bit, which for saddle purposes has lighter branches than the driving-bit, with one ring at the top, to fasten it to the bridle, and one ring at the bottom, for the rein. The mouth-piece usually has the form shown in Fig. 88, B, with a port or *liberty of the tongue*. The best form of this bit is shown in Fig. 156, in which the canons of the

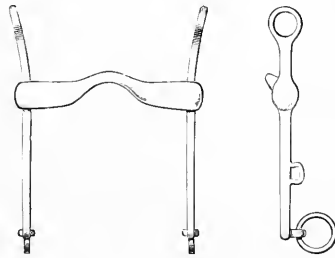

FIG. 156.

mouth-piece are thick and the port somewhat thinner, so as to give room for the tongue while not bringing the port too near the roof of the mouth.

In Fig. 156, the port is inclined forward, from the line of the branches, so that when they take their proper position under the pull of the reins, the tongue will have really the most liberty, which will not be the case if the port is in the same plane with the branches.\*

---

\* I am tempted to add an extract from a letter written to me in June 1872 by BENJAMIN LATCHFORD, the well-known bit and spur

Major DWYER, in his valuable book, *Scats and Saddles, Bits and Bitting*, gives what he considers the proper dimensions of the different parts of the bit, namely:  $1\frac{3}{4}$  inches from the under side of the mouth-piece to the centre of the upper ring, showing clearly, that for the average horse this brings the curb-chain in its proper place on the under side of the jaw; and  $3\frac{1}{2}$  inches for the length of the lower part of the branch from the under side of

---

maker of London. 'DEAR SIR,—Yours of 24th May last is now before me; I have noted its contents. Mine is a lifelong experience in, and of, the Bitting of Horses: take that for what it is worth, and, believe me, you are the first and only one (as far as I can recollect) that can see as I do the true position of the horse's head with the bits, and the bits with the horses' heads. If you simply question any breeder, trainer, breaker, hunting or driving gentleman, park or road rider, or jockey (as I have done hundreds of them), you will find the idea is that the horse's head is naturally horizontal, and the cheeks and the bits perpendicular, and that the part in a line with the cheeks is the position to give ease and freedom to the tongue; however absurd, I have always found it the prevailing idea among them. Your drawings exactly accord with my proper construction of a bit with a port mouth of any sort,—*i.e.*, the port to be one-eighth of a circle (or 45 degrees) forward from the perpendicular cheek of the bit: as you know, the horse's head is nearly perpendicular; the bit fastened to the leather hangs perpendicular; consequently the mouth-piece with a port of any kind, lies a crooked bar on the tongue, unless set forward one-eighth of a circle as your drawing is, in which case the tongue has the benefit of it when not in use, and the greater benefit when in use.' The letter to which this was an answer, accompanied an order for a bit, and I was much pleased to find my ideas on the subject endorsed by so good an authority.



the mouth-piece to the ring to which the rein is attached. The measures are not from the centre of the mouth-piece, but from its underside, because that is the point about which the bit rotates on the *bars* of the horse's mouth.

Major DWYER'S opinions are supported by such good arguments and illustrations, unfortunately too long to be quoted here, that they may be safely adopted.

It is not so easy to give dimensions in inches for the *width* of the bit as for the length, since the widths of horses' noses differ greatly, but a good fit in width is even more important than the proper length of the branches; no horse will work really well with a bit which is not of the proper width; a fact so rarely recognised that out of any twenty harness-horses taken at random, ten will be found to have bits too narrow or too wide, usually too wide. The bit must be of such a width that when the curb-chain is hooked properly and the rein pulled back, the outside of the lower lip will fill the space between the branches without being pinched by them. If it is much wider than this, it may be pulled sideways in the mouth, and instead of the canons of the mouth-piece (C C,

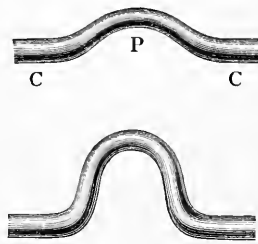

FIG. 157.

Fig. 157) resting fairly on the bars of the mouth, which are narrow, the point of junction of the canon

and port, or, still worse, even the middle of the port, P, will bear upon one of the bars. As a rule, the width of the port should be about one-third the whole width of the bit; bits will vary from four to five inches, the latter width being rare.

The width of a bit may be reduced by using a leather washer on each side of the lips, but this still leaves the port too wide for the changed width of the bit.

The washer prevents the horse from taking hold of the branch with his lip, but if he has this trick, it is better to put on an elbow bit (C, Fig. 88), or a lip strap. Of course, with a straight mouth-piece without a port, the use of the washer is quite satisfactory. A straight mouth-piece is rarely used on a riding bit, and leather washers never.

The high port, referred to on page 203, when combined with a tight nose-band, which prevents the horse from opening his mouth, is very effective by pressing against the roof of the mouth; but it must be used with a light hand, or with the rein in the cheek.

The Pelham bit has a mouth-piece without any port, but with a joint in the middle (Fig. 158).

In addition to the rings for the reins, which are at the ends of the branches, there are rings at the ends of the mouth-piece, and when the reins are buckled to these rings, the bit is practically a snaffle.

This is a favourite riding-bit and is used with two pairs of reins, so that it acts as a curb or a snaffle, at

the pleasure of the rider. BATTERSBY (p. 69) recommends it, with much justice, as a bit for cavalry, supplying, as it does, a snaffle-bit more convenient than the separate watering-bridle now in use. There is an advantage to a cavalry man in having two reins, in case one should be cut.

The ordinary driving-bit is, in one sense, a Pelham, since, although it has no joint, there is a ring at the mouth-piece for the rein, but, instead of having a ring only at the end of the branch, there are two or three eyes in the branch, to either one of which the rein can be buckled (Fig. 89).

A, in Fig. 88, is usually called the Liverpool bit, and sometimes, by French writers, the German bit; B and C are only modifications of it. D, the Buxton bit, is on the same principle, but has its branch curved, to prevent the horse from taking hold of it with his lip.

The Mexican, or South American, bit, which is the same as the Turkish bit, has no curb-chain, but in its place a ring, which is attached to the top of a high port and goes under the chin of the horse; it is very severe.

These classes comprise the bits that are in common use, but the number of forms and names is very great; more than ninety are figured in LATCHFORD'S *Loriner*.

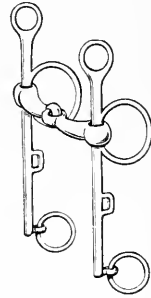

FIG. 158.

HANDLING.—While driving-horses in England are usually thoroughly handled by the dealer before being offered for sale, in America they are 'broken to harness,' as it is called, and only so far prepared that they can be driven with safety, but with little or no finish, and, for a man who likes to have his horses light and handy, are rarely very agreeable to drive.

On a private coach the pleasure of driving depends greatly upon the *manners* of the horses, and, unless the owner employs some professional trainer who can handle and prepare them for him, he ought to be able to put some work upon them himself to make them anything like perfect.

A London dealer has at least one man in his employ, to show and to handle horses, who is a master of his business, and who, without any system that he could describe, will in a comparatively few lessons make a pleasant horse out of a green one. The man himself has had good training and large experience, and has patience, courage, and *hands*. Usually he puts a new horse, assuming it to be 'broken to harness' in the ordinary sense of the phrase, to a dealer's break (Fig. 58), alongside of an old horse, 'the schoolmaster,' and soon decides upon the bit and the details of harnessing which suit the horse best. After a few lessons he puts him alongside of the horse with which it is desired to mate him, and, driving them together with great judgement and skill, makes them fit to show and to sell.

An amateur, if he has equal knowledge and skill, can do the same, and on our side of the water he usually must do it for himself.

The breeder of a horse should begin to accustom the colt at an early age to be haltered, to bear a surcingle strapped on, to be led about, and to have his feet held up and struck as if he were being shod. All these things can be easily done with a little weak foal, which will not resent them, if reasonable care and gentleness are used, and thus the way is well prepared for the after operations of *breaking*,—a word expressive of the difficulty of doing anything with a horse which has been allowed to run wild until he is so strong that only brute force can subdue him to obedience,—but which should be replaced by the word *training*, where the horse has been properly handled as a colt.

Assuming that a coaching owner receives a horse as a fairly well broken animal, he will find it advantageous to handle him in the manner about to be described.

It is frequently supposed that the work done to prepare a saddle-horse, is wasted if applied to a driving-horse, and no doubt much of it would be ; but a certain portion of it is most useful. The elaborate systems of training saddle-horses, mainly for military purposes, since the time of GRISON and FIESCHI, in the middle of the sixteenth century, have been gradually superseded by simpler methods, or, at least, by methods requiring fewer appliances and

assistants, and the Frenchman BAUCHER brought out, in 1842, a method, not, of course, entirely new, which is, more or less, the basis of all the best practice of the present time.

BAUCHER'S method consists in *placing* the horse, by the use of the bit and the whip, or the spur, in such attitudes as to give the rider control of the horse's movements and to make him *light*, the trainer working first on foot and afterward mounted.

The attitude assumed by a horse when he resists, or puts himself in a position of defence, is with his legs extended somewhat backward and his neck and head advanced. In order to prevent him from exercising this resistance, his hind legs should be brought under his body, his neck raised and bent, and his nose brought in. In this position he is said to be *gathered*, and is ready to respond to the indications of his rider, or driver, and cannot exert that resistance which makes a horse heavy on the hand.

This correct position is of more importance in a saddle-horse than in a driving-horse, but as the stiffness of the body affects that of the neck, a driving-horse well gathered, will respond more readily to the hand and to the bit, when being driven, than an untrained horse, is more agreeable to drive, and in every way more handy.

This handling is the basis of what is known as 'High-School' riding, which has always been popular on the Continent, but never so much so in

England or America, and it may be briefly described, as modified by successors of BAUCHER, notably by FILLIS, as follows :—

The horse, in an ordinary riding-bridle, curb, and snaffle, is brought to the place of the lessons, preferably a riding house where there is nothing to distract his attention. The system, when exactly followed, requires that preceding this he should have been exercised with a cavesson and the lunge, and we will assume that this, or something equivalent, has already been done by the breeder of the horse.

The trainer, standing on the near side of the horse, takes the reins of the snaffle together in his right hand, close to the bit and under the chin, the ends, with the whip, being held in the left hand, and leads the horse forward a few steps at a time. Should the horse refuse to move forward, the whip must touch him just behind the girth, where the spur would touch him if he were mounted. This lesson is repeated, by the trainer walking on the other side, reversing the position of his hands. The next thing is to make the horse yield, or bend his neck. This is done by taking the snaffle-reins in the left hand *in front* of the horse's nose, holding the hand high; and the curb-reins together in the right hand, eight inches from the bit, drawing the snaffle up and forward and the curb backward until the horse drops his head slightly and opens his mouth. This action on his part must be rewarded

*instantly* by yielding the right hand, and should then be repeated, the left hand being used to keep the head up. (It is a fault of BAUCHER'S method, soon recognised by some of his followers, and especially by FILLIS, that he made his horses carry their heads too low; this must be carefully avoided.) This operation is called the 'flexion of the neck and of the jaw,' and, although by some writers these flexions are treated of separately, they are usually obtained simultaneously.

There are two purposes in this part of the training. While a well-made horse may be supposed to assume proper positions when free and following the instincts which prompt his action, all horses are not well-made, and even those which are, have their equilibrium altered by being put to draught or by having a man on their back. The horse's head and neck, overhanging the shoulders as they do, throw weight on the fore-hand, which tends to make the fore legs slow in their movements, and also causes the horse to lug, or to bore on the bit. Raising and drawing back the head and neck, as are done by these flexions, improve the position in these respects, but, above all, accustom the horse to yield to the pressure of the bit, when he finds that by so doing he avoids the discomfort produced by it.

Not by any means the least advantage of the process is that it educates the hand of the operator, and gives it that lightness without which no good riding or driving is possible.



As the neck comes in and up, the hind legs of the horse tend to come in more under his body, in order to preserve his general balance.

These preliminary flexions were made by BAUCHER with the horse at rest, but it is important, as FILLIS has pointed out, to combine them with a forward motion, so as to prevent the horse from contracting the habit of *retaining* himself, a result which is an objection justly urged against BAUCHER'S method. The horse should be, therefore, kept moving forward while the flexions are being made, even when the trainer is on foot, and later on, when the trainer is mounted, the horse should be urged forward all the time, by the pressure of the legs.

The flexions thus described may be considered the only flexions of the neck necessary for driving purposes; for saddle-horses, lateral flexions, turning the head to the right and to the left, are added; but they can be easily overdone, and sometimes result in teaching the horse a means of defence, which he uses to the disadvantage of the rider.

After the neck is suppld, the next thing is to bring the horse's hind legs well under him. If a horse is observed when free in a field, it will be seen that in his quick movements, especially in turning, he brings his hind legs forward, so as to throw a considerable portion of his weight upon them, and this position will be quickly recognised by a mounted man, as making the horse more pleasant to sit and more responsive to the action of the rider than if he

has his legs stretched out behind him. This placing of the hind legs is best accomplished by the use of the spur.

The horse being mounted, his head and neck having been brought as completely as possible into position, the tightening of the rider's legs and pressure back of the girths should induce him to move forward. Since, in so doing, his hind legs propel him, this pressure is usually first answered by the advance of one of his hind legs under his body, followed by that of the other. His forward movement being somewhat restrained by the bit, but not enough to stop him, he will step forward in a position slightly different from that which he would have assumed if he had been merely led forward by the head. Thus, the combined action of the legs and the hand, opposed to each other, will *gather* the horse, throwing more of his weight on his hind legs and lightening his fore-hand. It has been assumed that merely pressing with the legs will produce the desired result, and with some horses it will do so, at the first attempt; but in many cases more vigorous means are needed, and for that reason the heel is armed with the spur, which, however, must be used at first with great caution, for fear of exciting the horse and producing a defence.

Whatever may be the reason, a slight touch with the spur will induce the horse to lift and to move forward the hind leg on the side on which he is touched, and this fact is the basis of the whole use

of the spur, except when it is employed vigorously as a punishment, a proceeding not at all to be recommended, a blow of the whip being much better.

Since the effect of the spur is to cause the horse to move his hind-quarters away from it, a pressure of the left spur will turn the croup to the right, and one from the right spur will stop or reverse that movement.

Inasmuch as the turning of the horse's head to the right or left by the rein, will determine his motion in these directions, the rider, when the horse is accustomed to obey all these indications, has the means of entirely controlling him. By the bit, he restrains him, places his head in a position to respond to the action of the hand, and turns his fore-hand to either side; by the leg and spur, he moves him forward, brings his hind legs under him, and turns his croup to the right or left; and by skilfully combining these effects he can produce what movements he desires, and all the accurate and exaggerated movements which characterise *Haute École* riding.

If, in backing a horse, he is forced backward by mere pressure on the bit, his motion will be awkward, his hind legs being stretched out to resist the force which is urging him. The proper way to make him back is to begin by restraining him slightly, and then touching him with *one* spur to make him lift one hind foot; a slightly increased pull on the reins will generally make him move to the rear, bringing that

hind foot to the ground somewhat back of the position which it previously occupied. A touch with the other spur will raise the other hind foot, which, responding to the pressure of the reins, will be also replaced further back ; the front feet will follow, and by alternate attacks of the spur the horse will be made to walk backward, all the time in a balanced position.

This is one of the regular lessons, but it must be used with discretion, because when a horse learns to walk backward, he will sometimes do so as a means of defence. All harness-horses should back freely when called upon.

Just as regular gymnastics improve the action of the most perfectly formed man, this training improves that of the most perfectly formed horse ; it is not an argument against the system to say that the horse, having been made for his own purposes of life, cannot be improved for man's uses.

While, therefore, the driving-horse may not require much training beyond the flexions of the jaw and neck, the further training of his hind-quarters will give him lightness and grace of carriage, which are very desirable.

It is also true that if a horse is excited by the spur, the whip, or the voice, and at the same time somewhat restrained by the bit, his energy of movement will be partly put into the *height* of his action, instead of its being all put into the forward movement, with the result of increasing his brilliancy.

The English system of riding being based on hunting and racing, its principal object is to get the horse forward as fast as possible, without much attention to his manner of going. The Continental system is based upon the requirements of military service, and, in the training of horses, the methods used are adapted to making the horse quick, handy, and obedient.

In the eastern part of the United States, the English fashion prevails, but in the West, in Texas, and in Mexico, the Spanish style of riding, with its accompanying horse equipments, is adopted, because it is suited to the purposes for which the horse is there largely used: herding and catching cattle.

English professional horse-breakers being, by nature and selection, good horsemen, succeed in giving their horses good manners, without working upon any system which they distinctly recognise as such; but the amateur who wishes to accomplish the same results, should have a good system to work upon.

Before BAUCHER'S time, the suppling of a horse was produced mainly by riding him, and gradually obtaining all the required results more or less simultaneously. The horse was carefully urged forward by the rider's legs, and restrained by the rein, until he partly assumed the gathered position. He was then ridden in a circle, which was gradually made smaller as the horse became more handy, the head being drawn in toward the centre by the inner rein,

and the croup turned out by the pressure of the inside leg, until the horse moved nearly sideways, his fore legs being at or near the centre of the circle. In this way his hind legs were suppld, and he became much more responsive to the demands of his rider. This movement is called *shoulder in*. The next movement was that of *croup to the wall* (the work was assumed to be done in a riding house); in this movement, the horse, with his hind-quarters turned to the wall and his body nearly at right angles to it, was moved sideways by the spur, while his head was turned by the rein to look slightly in the direction toward which he was going. These two movements constituted the whole education of the horse for ordinary purposes; the use of the pillars, for teaching the 'airs' of the 'high school,' such as the *croupade*, the *ballotade*, &c., are outside the limits of our present subject.

To a certain extent, the same results are obtained by all the methods, and the advocates of the older ones contend that the horse is not restrained in his forward action by them as he is by training under the BAUCHER system. But the old method required, from the first, that the trainer should be an accomplished and determined horseman, because he encountered difficulties which one less experienced could not overcome, and much was left to his tact in using means the exact effect of which he imperfectly understood; whereas, BAUCHER has laid down every step with accuracy. As a fact, the horses

trained by his method, for exhibition purposes in *haute école* riding, are far superior in accuracy of action to anything that was dreamed of by the trainers before his time, and the fact that many of the early lessons of the method can be applied on foot, to a horse that is too young to ride, commends it to the breeder.

It is not at all my intention to attempt to teach here, in the limits of these few pages, any system of handling, or *dréssing*, a horse, but only to suggest that if the driving man will undertake to improve his horses by either of the methods: BAUCHER'S or his successors', he will reap great benefit from so doing in the improvement, not only of the animals, but especially of his own hands.

The secret of good driving is to have good hands, and while good hands may be to some extent a gift, they are to be acquired mainly by practice and thought. In the saddle, no man can have good hands who has not a perfectly firm seat, so that the action on the reins may be absolutely independent of the movements of the body. The action of the hand in driving is coarser than in riding, where the hand, holding light reins, is closer to the horse's mouth, and the action of the animal under the rider indicates to him instantly the horse's intentions; but the principles are the same, and a good hand in the saddle means a good hand on the driving-cushion. Regularity and accuracy of pace can be much better cultivated under the

saddle, and every riding lesson, judiciously given, will improve the horse for driving.

The training of a horse which is to be finally put into a team, may be advantageously continued by driving him single, to a dog-cart, where, the whip replacing the spur, some of the same effects obtained under the saddle may be repeated; and the method of training by driving on foot with the long reins, described by Captain HAYES in his *Illustrated Horse Breaking*, may be also used with great advantage, at all stages of the work.

In our American climate, with so many winter days on which riding out of doors with any pleasure is impossible, the amateur will find that the hours passed on the tan of the riding house, in training a favourite horse, according to some good system, will be among the pleasantest of his 'horsey' pastimes.

All professional riding-masters have intentionally, or unconsciously, made use of one or other of the old methods, or of a combination of them, generally imparted by tradition.

When BAUCHER'S book (translated into English by JOHN SERGEANT and GEORGE H. BOKER, of Philadelphia, in 1851) first appeared in America,\* some amateurs who had been working somewhat blindly on the old systems, recognised its value, especially when illustrated by the beautiful perform-

---

\* The first edition of BAUCHER'S book was published in Paris in 1842.



ances of two horses trained by BAUCHER, and ridden by one of his pupils, CAROLINE LOYO, in the old Walnut Street Circus. A riding school in Sansom Street above Eighth Street, long since torn down, was the scene of the first applications of BAUCHER'S method, by several enthusiastic horsemen, JUDGE CADWALADER, JOHN D. BLEIGHT, and others, and out of those pleasant meetings for companionship and discussion grew the *The Philadelphia Riding Club*, the first, and for many years the only home of that kind of equestrian practice in the United States.

## CHAPTER XVI

## HORSES FOR COACH OR DRAG

HORSES for coach or drag will vary according to the taste of the owner and the depth of his pocket. For a drag, horses of fifteen-three hands, all four of the same size, will be generally found the most useful. Of these the lightest and quickest should be selected for the lead, and the strongest put at the wheel. It is not difficult to find four horses of the same height, of which two will weigh forty or fifty pounds apiece more than the other two. The team shown in Plate XXIX. corresponds to this description.

The extreme type of racing thoroughbred does not look in place to a coach, but the half-bred horse of the English hunter style is in every way suitable, although he is not always easy to drive when multiplied by four. The nearer that this latter type is approached, the better, as far as appearance goes.

The half-bred mare shown in Plate XXX., fifteen-three hands, by a thoroughbred sire out of a trotting dam, hunted many seasons and driven as a leader, is as nearly as possible perfection in all her points.

The hackney, as now produced in America and in England, makes an admirable coach-horse when large enough, and if his recent introduction into

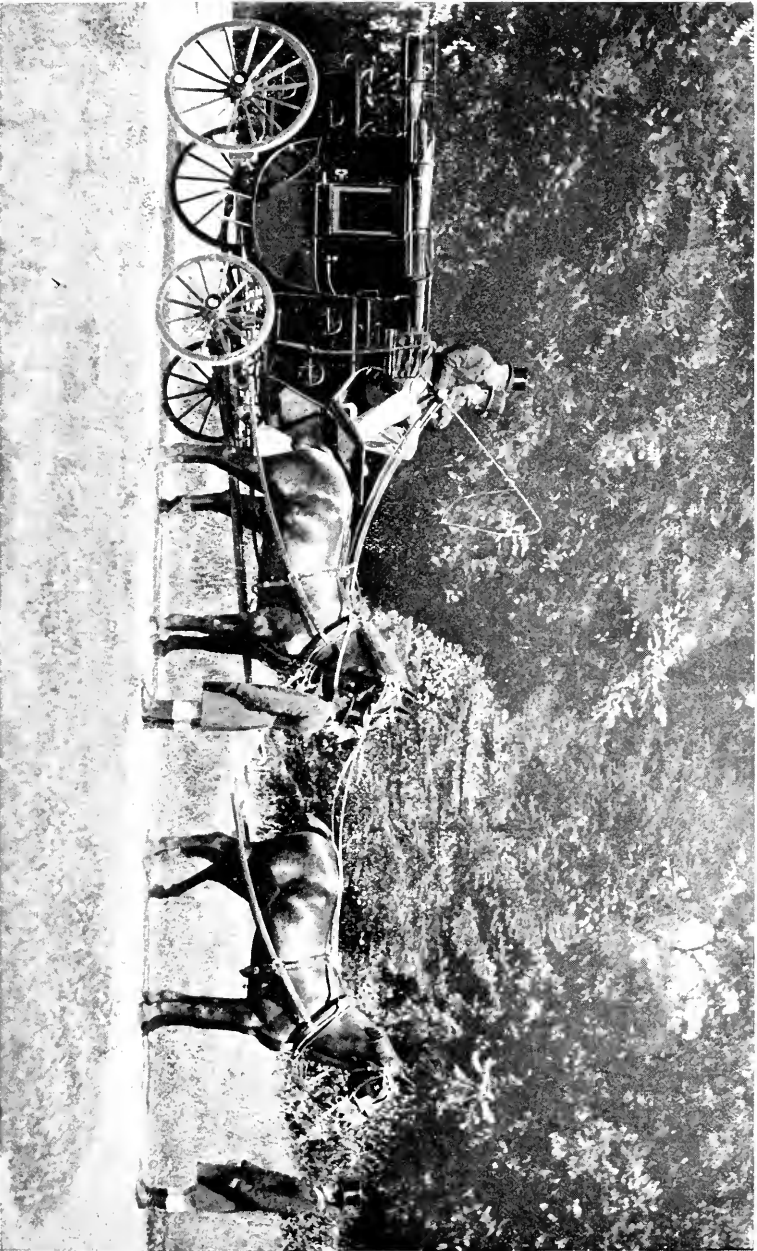

TEAM FOR DRAG. HORSES, 15 HANDS 3 INCHES. WHEELERS, 1090 POUNDS. LEADERS, 980 POUNDS.

PLATE XXX.

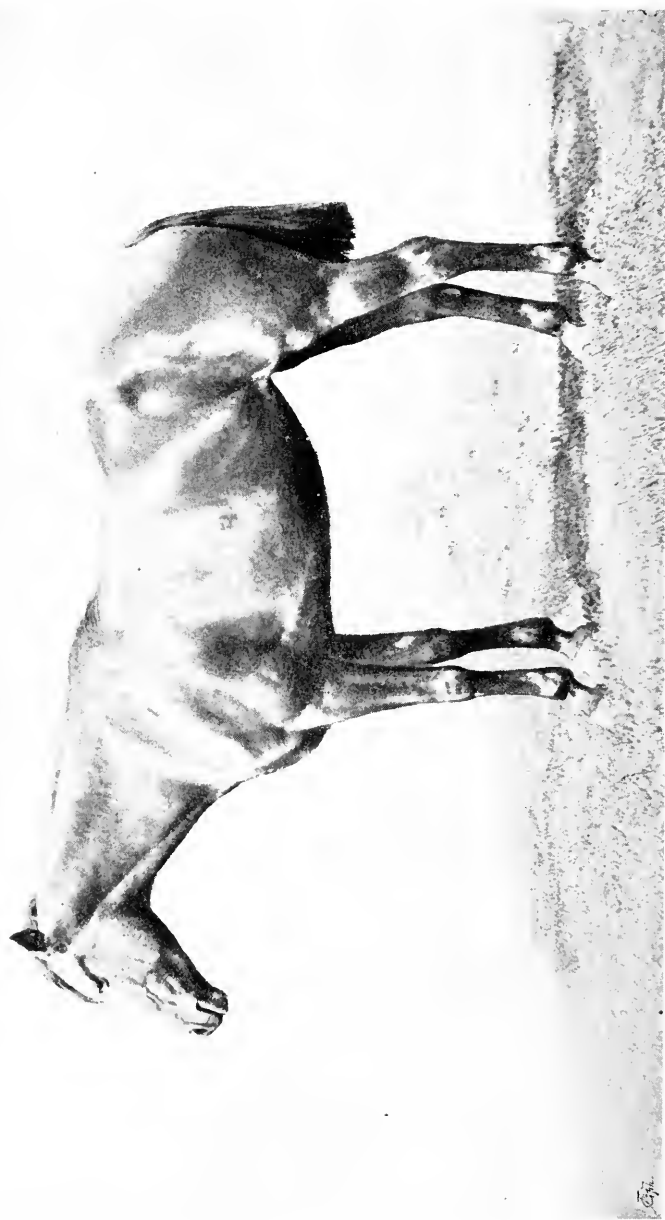

HALF-BRED MARE 'JOSEPHINE,' 15 HANDS 3 INCHES.

America has had no other advantage, it has raised the standard of form in the driving-horse. The best horse will be one resulting from judicious crosses of the hackney and the trotter, improving the form of the latter by giving him a finer head, a better carriage of it, and a less sloping rump, and by heightening his action without too much diminishing his speed.

The free forward action, with sufficient height, which some exceptional trotters possess, is the perfection of gait for either the road or the park, and in any horse, a trot approaching it, can be often improved by judicious handling under the saddle.

The Morgan horse, formerly a great favourite in New England, is in many respects not unlike the hackney, both in good qualities and defects. He is 'near the ground,' that is, rather short-legged, as is shown by his heavy weight compared with his height, and this form, although in some eyes it detracts from showiness, is the best adapted to hard work in harness or under the saddle, as many hard riding hunting-men know; legginess is a great fault in a horse.

This breed, less talked about now than formerly, has had a strong influence upon the horses of New England; it combines the good qualities of fair speed, great endurance, fine up-headed carriage, and, above all, good temper; the defects being want of size, and a certain coarseness and shortness of neck. Having rather upright pasterns, the Morgans lack

the springiness and grace required in a saddle-horse, or the highest class of drag leader, but to road-coach purposes they are admirably adapted, and several of the coaches running out of New York have been horsed by animals selected in Maine.

In the New England States it is usual to describe a horse by weight as well as by height, and the two together give a better idea of him than the height alone.

A large sixteen-hand horse, rather clumsy for a wheeler, will weigh 1120 pounds, but from 1070 to 1090 is heavy enough for an ordinary wheeler. A fifteen-three horse, suitable for lead or wheel, will weigh from 1000 to 1040 pounds; and one fifteen-two, from 950 to 990 pounds. The Morgan horses of 1855 (described in LINSLEY'S *Morgan Horse*) when of fourteen-two hands, weighed from 1000 to 1050 pounds; of fifteen hands, 1025 to 1076 pounds; and the average weight of twenty-two horses is given at 1040 pounds, their heights ranging from fourteen to fifteen hands; these weights show that the horses were very short-legged, since their bodies were not clumsy.

For the same breed of horses, from that date down to the present time, the weights are about the same.\*

There is a type of carriage-horse now happily disappearing from the show-ring and the best dealers' stables,—awkward and long legged, with a head of

---

\* *Rider and Driver*, January 12, 1895.

one kind, legs of another, and body of a third, which is to be avoided for all purposes.

The horses of a drag-team should have 'quality,'—that is, a certain fineness and distinction which are not at all incompatible with strength. Weedy, long-legged, tucked-up, thin-necked horses are out of place to a coach, especially at the wheel, however well they may suit a hansom.

Horses over sixteen hands are unnecessarily large; their rumps are too close to the foot-board; those under fifteen-two are somewhat small for an ordinary coach, although if they are up-headed they may do for leaders.

For park driving, the leaders may have a good deal of action, but it does not do for long drives, and is not, to my taste at least, as good as the long and only moderately high action which some trotters have. A coach-team, to be perfect, must have a *sporting* appearance, and look as if they were good for long, continuous work, and not for trotting all day in a space of a hundred yards. The horse-shows of the past few years have opened the eyes of judges and of the public to the fact, that good action is not incompatible with ability to get over the ground, and, in a coach-team, the combination is exactly what should be aimed at.

LORD ALGERNON ST. MAUR (*Driving. Badminton Library*, 1889, p. 192) says: 'I dislike carriage-horses in a coach; they are quite different animals 'from coach-horses;'; this is true, but applies more

to England and to some years ago, than to America in the present day. The old-fashioned, large, eight-spring landaus and barouches required tall, heavy horses, which were reined up tightly ; but the modern landau is not a heavy nor very high carriage, and the wheelers of a coach look well to it if they have sufficient action ; and in all but exceedingly large establishments, it is necessary to use the horses for several purposes. The opinion is, however, worth bearing in mind, inasmuch as a coaching man would make a mistake were he to put to his drag a pair of carriage-horses of the type just mentioned.

The most nearly perfect team is that which is the best matched in temper, size, action, pace, and colour. A cross team of two colours, that is, off leader and near wheeler alike, is always good, but four of different colours, require exceptional 'quality' to bring the team into the front rank. A team with two horses of one colour on one side and two of another colour on the other, always has a one-sided look, and leaders matched and wheelers matched in pairs as to colour, look too much like two pairs. These remarks apply, however, to strongly marked colours, greys, &c. ; bays and browns may be put together in any way. A cross team of two greys and two dark horses has usually a gay and brilliant look.

Some qualities are sufficient to exclude any horse ; a kicker is no better in one place than another ; and



an incorrigible puller should be sold, given away, or shot, rather than be put in a team. A horse may pull, from some cause which may be removed; if he can be cured, very well; but a regular puller spoils all the pleasure of driving, worries the other horses, and makes impossible any fine handling of the team.

Some coachmen advocate having the leaders taller than the wheelers, but it is not generally a symmetrical arrangement, especially as the leaders, when seen from the front, will, from the perspective, always look the larger.

It is the general practice to put the smaller horses on the lead, where they certainly look the best. In any case, the *heavier* horses should be at the wheel; they have to control the coach in going down-hill, and in turns, where the leaders are held back; and they may be considerably coarser than the leaders without hurting the appearance of the team. At races, when a coach is on the grass, a pair of wheelers that can do more than their share in starting the coach on the soft ground, will add to the coachman's comfort and perhaps save a balking match.

Undoubtedly, the leaders should be the freest; it is disagreeable to have the wheelers free and the leaders slack, 'floating leaders,' as a well-known coaching man calls them.

Of the two leaders, the lazier should be on the off side, because it is more easy to get at him with

the whip on that side than on the other. If they are equally free and there is any difference in size, the taller horse should be on the off side, since he is likely to be on the side of the road, which is lower than the centre.

Of the wheelers, the lazy horse should be on the near side, under the whip, and it is well to put the stronger wheeler on the gutter side (the off side in America and the near side in England) so as to pull the coach out of the low ground to the centre of the road, after having gone to the side in meeting a vehicle, and that is also a reason for putting the taller horse on the gutter side, since he may be generally assumed to be the stronger.

It is a good plan to accustom the horses to go in any place in the team; but if a horse does better in one place than another, it is well to keep him there, and this will often be the case, especially in a road-team, where the horses cannot be so carefully selected in the beginning, as for a drag, and where one horse sometimes fancies a place, and will, therefore, work cheerfully in it, and unsatisfactorily in any other.

As to the pace: horses, to be pleasant to drive, should be able to go eleven miles an hour. On a good level road, a team should take a coach along at nine miles an hour for two hours, but they will not do this unless they *can* go a good deal faster; a horse continuously pushed to the top of his speed never travels pleasantly, and soon tires, but if he

can do eleven, he will easily do nine, which is quite within his powers.

A team to a private coach not too heavily loaded ought to do from eighteen to twenty miles in an afternoon drive, on fairly level roads, and can do, day after day, from twenty-four to twenty-six miles, divided into two parts, with a couple of hours for rest and feed in the middle of the day.

Horses are usually clipped in the winter ; indeed at any season, when they require it for appearance, and it undoubtedly adds much to their comfort when doing fast work. In our climate, however, it must not be forgotten that they sometimes require the protection of a blanket when they are not moving ; it is thoughtless and cruel to keep them standing uncovered on a cold day.

The length of the tails of coach-horses is a matter of fashion. In the early part of this century the tails of all horses were cut short (or docked), and *pricked* (by cutting the under sinews), so that they stood up very high (see CORDERY'S Picture, Plate I.). Later, the tails were banged ; that is, cut square just at the end of the bone, as the tails of race horses are now ; and the fashion has again come round to the very short tail, but without pricking. Undoubtedly, the tail being short makes the horse look 'smarter' and prevents his getting it over the rein. The very long tails of the trotters of some years ago would certainly look out of place in front of a coach.

Horses are sometimes trained, formerly more than at present, to stand, when in harness, with their hind legs stretched out. It is done to prevent the horse from jumping forward when he hears or feels some one stepping into the carriage,—an unpleasant trick, very damaging to hats and bonnets. A horse cannot do this if his hind legs are much stretched out, since he must gather himself before making the movement. The position is, however, an ugly one for a coach-horse, and shows at once that he is a carriage-horse.

#### COST OF COACHING

As to the actual cost of private coaching it is difficult to give exact figures, prices vary so much in different localities, but it may be said, that a well turned-out coach need not necessarily add much to the expenses of a good sized stable. Where four horses are kept for any purpose, it is easy so to select them according to the hints given in the remarks on *Horses*, that they can be put together as a team. Four horses in a stable mean, under any circumstances, two men, and all that is necessary in addition is the coach, which with its various appointments can be had for less than three thousand dollars. As has been remarked in the Chapter on *Harness*, two sets of pair-horse harness, properly made, are right for four horses, and thus equipped, the lover of coaching can have as much of it as he desires, without interfering materially

with other uses of his stable. Two saddle-horses do not make bad leaders, in fact, they often make the best ; and a man and his wife may have their driving, their riding, and their coaching, all within the limits of a modest establishment, while it is quite certain that any man who cares enough for his coaching to obtain it in this way, will enjoy it much more than he who merely buys a team because he thinks it fashionable or wishes to have something better than his neighbours.

There is so much already in print about Stable Management, the Care of Horses, and Stable Expenses, that these subjects need not be touched upon here.

## CHAPTER XVII

## THE WHIP AND ITS USE

WHILE coachmen differ somewhat in their ideas as to the weight, stiffness, etc., of a whip, there are certain dimensions and characteristics which may be considered as standard, and from which the deviations are, after all, very slight.

The whip best adapted to four-in-hand driving has come down to us from the palmy days of English coaching, when thousands were made for, and used by the most accomplished coachmen.

It has a straight stick, crop, or cross, with the thong attached by what is called the quill (from its being made of goose quills), which, being in form a prolongation of the stick, is stiff at its root, gradually merging into the thong proper; the quill and the first part of the thong forming a bow or portion of a circle (see Fig. 159). ~

This quill is characteristic of the English whip, the whip of other countries having a stiff stick to which the thong is attached by a loop. The stick, or crop, is made of an elastic wood: holly, yew, blackthorn, lancewood, or white hickory.

Holly is by far the most generally used, and is obtained from second growth shoots, six or seven years old. The sticks are carefully selected, the

straightest of course being preferred, but those which are somewhat crooked can be steamed and straightened by the maker. They are cut to nearly the length required, and stored, seasoned, and dried with great care, being examined at intervals, and kept straight, the whole operation requiring, with the best makers, a period of about five years. They are then trimmed to their final shape, stained, varnished, and mounted. The varnishing is of great importance in protecting the stick from the effects of dampness, and every maker has his special way of doing it, the work of some makers being far superior to that of others.

The stick should be springy but not soft, and must be proportioned to the weight of the thong ; a four-horse whip requires to be stiffer than a pair-horse whip, which has a short thong.

The whole length of the stick should be five feet, measured from the metal butt of the handle to the end, which end is marked by the knot always worked on the quill. Five feet, one inch and a half, is the extreme length that the stick should have.

The stick usually has a handle, but some sticks show the wood throughout from butt to knot ; they do not, as a rule, balance as well in the hand as those that have handles. Rabbit-bitten hollies are much fancied ; they are found in holly plantations frequented by rabbits ; these animals eat the bark near the ground, and leave it in irregular patterns on the portion which is used as the butt of the

stick. The natural knots of the holly are usually the proper distance apart to look well on the stick; they are filed to the proper shape, and if there are not enough of them, artificial ones are made by leaving elevations when reducing the size of the stick. In some whips, the knots are left quite prominent, in others they show slightly; this is a matter of taste. The majority of coachmen like to have a few knots close to the upper end of the stick, to keep the thong from sliding down when it is caught up.

White hickory, worked perfectly plain, without any knots, makes a beautiful stick and looks like ivory. It is particularly pleasant to handle if properly proportioned, but unless the thong is very soft, it is liable to slip down the stick. Owing to the stick having no knots, the thong can be quickly freed from it for use.

A good holly stick should have a diameter of six-tenths of an inch where it leaves the collar or ferule, and of three-tenths of an inch at its upper end. A hickory stick, being heavier and stiffer, should be very little over a quarter of an inch at the upper end.

Some coachmen fancy a 'dog-legged stick;' that is, one with a crook more or less square, a short distance above the ferule, but it is certainly not handsome, and usually it is not pleasant to handle.

The handle, or hand-piece, of the whip, is ten and a half inches long, including its ferule, or collar,



and its cap. To make the handle, the stick is cut down to a cylindrical form about four-tenths of an inch in diameter from the butt to the point where the collar is to be, and an iron tube eight and a half inches long, fitting this cylindrical part tightly, is pushed on, and cemented to it. This tube is of such thickness as to weigh about one ounce. Tow is evenly wound round the tube until it has assumed the shape, and nearly the size, that the finished handle is to have, larger at the butt than at the collar; over the tow, paper is pasted, and over this the final covering of the handle is put on. The ferule, or collar, which has been slipped on the stick before wrapping, is pulled backward to its place on the covering and cemented, and the cap at the butt is cemented on.

The large end of a well-proportioned handle is nine-tenths of an inch in diameter, the small end six and a half tenths. The cap will be as much larger as the thickness of the metal makes it, and the same is true of the collar, which tapers enough to fit over the leather of six and a half tenths and the stick of six-tenths of an inch diameter.

For a four-in-hand whip the handle should be covered with pig-skin. It may be put on plain with a neat seam down its length, the usual way for a drag whip, or it may be wound helically round, which is right for a road-coach whip, and is somewhat less slippery when wet.

The butt-cap and the collar should be perfectly

plain, and made of silver or of brass, *always* of the same metal with which the harness is mounted. Their proportions affect the appearance of the whip, and they should be neither too light nor too heavy. The collar is the proper place on which to engrave a name or a monogram.

A stick which has no handle,—a rabbit-bitten stick, for instance,—has a butt-cap, but no collar.

The thong is of white leather made from horse-hide, other leather, such as sheep-skin, being too soft and absorbent; it must be plaited tightly without being very hard, and is usually tapered regularly from the quill to the small end. A thong is sometimes made with a slight belly or swell, commencing about two feet from the quill; it is easier to catch than a tapered thong, but not so good to hit with.

The butt-end of the thong is stiffened by several pieces of quill worked into it, and the stick is pushed into the tube thus made, until its point comes opposite to the knot worked on the thong (Fig. 162\*); the pieces of quill, and the ends of hide of which the thong is made, come down on the sides of the stick, and are bound to it by waxed silk.

The quill has a bend or turn up, which is put on the stick *opposite* to the seam on the handle, and the whip must be always so held that the seam is down and the bend of the quill up. There is something

---

\* In Fig. 162 the knot shows at the point where the broad pieces of leather commence to separate. The two pieces of quill also show below the knot.

forlorn about a whip without a quill, or a whip held upside down, in which position it can neither be properly caught, nor properly used on a horse.

The stamp of the maker, which is on the stick above the collar, opposite to the seam and on the same side as the turn up of the quill, indicates the side of the whip which is to be uppermost in the hand. The pleasant feeling of a whip in the hand depends largely upon the make of the quill, and a whip is ruined if the quill is allowed to get out of shape.

Good thongs can be had only from the best makers. The thong terminates in a *point*, called by whip-makers the *lash*. It is sometimes made of whip-cord, but is much better of the same material as the thong, since the cord, when wet, is apt to wrap round parts of the harness.

Silk points, of any colour, are entirely out of place on a coach whip, or, in fact, on any whip thong.

A finished whip should have the following qualities: It should feel light in the hand, springy, not as if it were too heavy at the point, and not 'dead.' With the thong caught up (as described further on) it should balance at a point twenty-one and a half inches from the butt, or about one-third of the total length of the stick; accurately, 36 per cent. If the balancing point is further from the butt, the whip will feel heavy in the hand.

The spring, or stiffness, must be measured by the feeling, but for the purpose of establishing a numerical standard, several whips of the best quality

were experimented with, and were found to have a deflection of about eight inches at a point four feet two inches from the collar, or near the knot, when a weight of ten ounces, avoirdupois, was hung at that point, the whip being supported at the collar.

The following Table gives the details of these experiments :—

DESCRIPTION OF WHIP.	No. I.	No. II.	No. III.	No. IV.	No. V.	No. VI.	No. VII.
Diameter of handle in 100ths of an inch :							
At the butt . . . . .	70	90	85	88	57	80	80
At the collar . . . . .	65	64	60	62	55	70	70
Diameter of stick in 100ths of an inch :							
At the collar . . . . .	60	58	55	60	52	57	60
At the upper end . . . . .	29	30	29	27	23	26	30
Length of handle, inches . . . . .	9 $\frac{3}{4}$	10 $\frac{1}{2}$	10 $\frac{3}{8}$	10 $\frac{5}{8}$	. .	10 $\frac{1}{2}$	10 $\frac{1}{2}$
Length of stick, including handle, to knot, feet and inches	5 0 $\frac{1}{2}$	5 0 $\frac{1}{2}$	5 0 $\frac{1}{2}$	5 1 $\frac{1}{2}$	5 1 $\frac{1}{4}$	4 10 $\frac{1}{2}$	4 8 $\frac{1}{2}$
Length of thong, from knot, feet and inches	12 8	12 8	12 6	12 10	13 9	12 2	11 9
Deflection with weight of 10 ounces at a point 4 ft. 2 in. from collar, inches . . . . .	6 $\frac{1}{2}$	8 $\frac{1}{2}$	8	6 $\frac{1}{2}$	9 $\frac{1}{2}$	9	9
Total weight of whip, ounces, avoirdupois . . . . .	7 $\frac{3}{4}$	8 $\frac{3}{4}$	8 $\frac{1}{4}$	8 $\frac{1}{4}$	6 $\frac{1}{4}$	8 $\frac{3}{4}$	8 $\frac{3}{4}$
Distance of point of balance from butt, inches . . . . .	23	21 $\frac{1}{2}$	23 $\frac{1}{4}$	21	23	21	22
Percentage of this distance in total length of stick . . . . .	38	36	37	34	41	36	39

No. V. has no handle. Nos. VI. and VII. are jointed whips.

Nos. II. and III. may be considered standard whips.

No. V., a light rabbit-bitten whip with no handle,  $\frac{52}{100}$ ths of an inch in diameter ten and a half inches from the butt (the place of the collar), had a deflection of nine and a half inches. This is an extremely pleasant whip to handle with a properly proportioned light thong. It is really a tandem whip.

Nos. VI. and VII. are jointed whips made to carry on a board, as spare whips (Fig. 160), and such whips, owing to the screwed joint, are apt to be less springy than an ordinary whip; these two examples, however, are very good. On them, the point of attachment of the ten-ounce weight came somewhat above the knot on the quill, owing to the shortness of the stick.

The pressure upon the thumb, of even a well-balanced whip, is considerable, at least as much as twenty ounces when the stick is held at the collar, owing to the centre of gravity of the whip being twice as far from the butt as is the collar. The twisting strain on the hand is caused by this leverage, of ten inches against the breadth of the hand, which is only four. This strain is usually severely felt by the beginner, for which reason a light whip is desirable. If the butt-cap is weighted to improve the balance it makes the whole whip too heavy.

In buying a whip, the beginner should avail him-

self of the aid of an expert who can select for him one that is really good, as a standard by which future purchases can be made; a man who has been using whips not of the best quality will be astonished, upon getting hold of something exactly right, to find how far superior it is to those which he has been handling.

Inasmuch as a good whip can be soon ruined by being improperly taken care of, it is important to keep the quill and upper part of the thong in shape, by hanging it on a spool (Fig. 159) fastened against the wall. The spool should have a V-shaped groove, and pulling the thong tightly into the groove will prevent the whip from slipping; it is better also to tie the point round the thong and stick together, as shown in the Figure.

If the proper part of the thong, as shown in Fig. 159, is jammed in the groove the weight of the stick will give, and will keep, the proper backward curve to the quill.



FIG. 159.

In default of a spool, a short loop of twine should be tied round the stick below the knot, and the whip hung by that (Fig. 159); but a whip should never be kept leaning against a wall or in a corner.

A jointed whip, the pieces of the stick of which screw together, should be carried in the coach. It is fastened upon a board, as shown in Fig. 160. Two whips may be put upon the same board.



FIG. 160.

For carrying whips on a journey, the leather case divided by me for my own use, shown in Fig. 161, is very convenient. It is 6 ft. 5 in. long,  $4\frac{1}{2}$  inches wide, and  $1\frac{1}{2}$  inches deep, outside dimensions; made of sole leather, with a bottom of hard wood,  $\frac{1}{4}$  inch thick, on the *inside* of the case, to make it stiff. Tapes, fastened to the bottom, serve to tie in the whips, six of which can be carried. The tapes round the handles must be tied so tight that the whips cannot slip on to their heads when the case is on end, or else the bows of the thongs will be bent out of shape.

A whip should always be wiped, or, if necessary, washed thoroughly after use, to keep the varnish in good order, and the thong must be washed with soft soap (crown soap) and water, and sometimes rubbed with soap alone to keep it soft. Glycerine, vaseline, or a mixture of lard and wax, may be used,

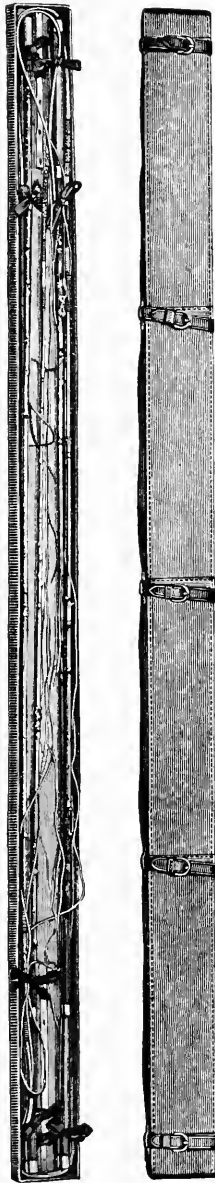

FIG. 161.

but to keep a thong in condition, there is nothing so good as soap and *constant* use. If it is hard and stiff it will be impossible to catch it up readily or to keep it on the stick. Pipeclay should never be used on a thong; it makes it stiff and rots it. There is a condition into which a thong gets during the first part of a drive in rain or fog which is just right, but afterward it often becomes too soft, and finally, when dried, it is stiff and requires soaping or greasing.

When a thong is worn, it is best to put on an entirely new one, with its quill complete. Thongs are sold by whip-makers put up as shown in Fig. 162, and a coachman can learn, without much difficulty, by examining a finished whip, to braid one on to the stick for himself. The two wide strips of leather, which hang below the



FIG. 162.



knot, must be slit so as to give four strips, round and between which to braid the black thread.

A thong, otherwise good, which has been cut or broken, should be spliced as shown in Fig. 163:—

The unbraided strands 'a' and 'b' of the ends of the broken thong, being tied round the parts of the

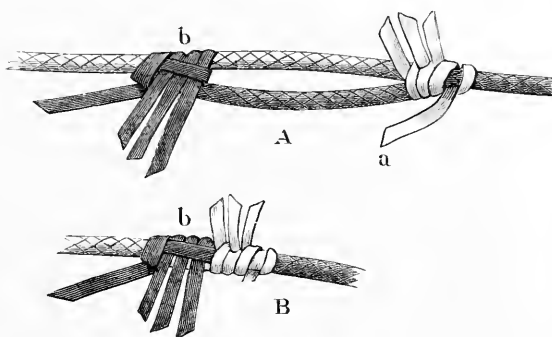

FIG. 163.

thong, as at A, the two knots are pulled tight together as shown at B. The ends are then cut off and the knot rolled between two hard surfaces.

In Fig. 163, A, the end 'a' is left in a position to show the knots under it, but before pulling the knots together, it must be pulled \* tightly into the space between the two parts of the thong, as at 'b,' and it then covers the knots and is jammed when they are drawn together, as shown at B.

---

\* After tucking the last ends, 'a' and 'b,' into the space between the two parts of the thong, it is convenient to seize them with a pair of nippers in order to pull them as tight as possible.

A point may be put on in the same way, but it is more usually done as in Fig. 164:—

The end of the thong being unbraided, one of the four strands is tied round the others, and pulled

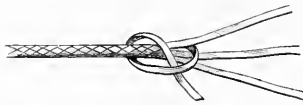

FIG. 164.

tight to keep the thong from unplaiting, and the end of the point having been unplaited is pushed close against the end of

the thong. Each strand in succession is laid on top of a strand of the thong, and that thong-strand having been turned back, the point-strand is tied round it and the body of the thong, in a single knot and pulled tight. After all four are thus tied, the ends are cut off and the knot rolled.

Another way of splicing a thong is to make with the two ends, what sailors call a 'shroud knot,' which can be learned from any book on sailors' knots. In this knot the pieces of thong are unplaited and butted against each other, and each strand is tied with a single knot around the main part of the thong to which it does *not* belong, one half of all these knots coming above the joint and one half below it. The knots are all pulled tight and the ends cut off.

The whip used in the West, and elsewhere than in England, has a straight stick of an elastic wood, from 3 ft. 6 in. to 4 feet long. The thong is from 8 to 10 feet long, rather heavy, and has usually a

belly near the stick end ; it has nothing resembling a quill, but in its place there is a loop.

The stick, or 'stock,' frequently has metal bands at intervals for its whole length, but it has no handle proper, the lower part being swelled out to fit the hand. A leather loop is fastened on the upper end of the stick by wrapping, and to it the thong is attached by its loop, exactly like a hunting-whip or like the thong of the long whip, or *chambrière*, of the circus ring-master.

The short stick is convenient in narrow forest-roads, where trees are close to the track, but the whole whip is stiff, and entirely inferior to the English whip. It is difficult to strike a wheel horse with it without using the whole length of the thong, since a 'double-thong' cannot be made with it.

The whips used in Africa with teams of eight or ten animals are described as being exceedingly long, with a very heavy thong, and are used with both hands, one man driving and another flogging.

CATCHING A DOUBLE-THONG.—Owing to the length of the thong of a four-horse whip, it is convenient to carry it looped on the stick, and for that purpose it is caught up in what is called a double-thong (Fig. 165), with a loop of the upper part hanging on the end of the stick and the rest of the thong coming down to the hand.

A learner who desires to master the trick of

the double-thong should, if possible, get some one to teach him ; it is extremely difficult to do it from a description ; but the mechanism of it is as follows :—

If the whip is held in the right hand, pointing slightly upward and to the front, and moved sharply to the right and a little upward, with the thong *loose*,

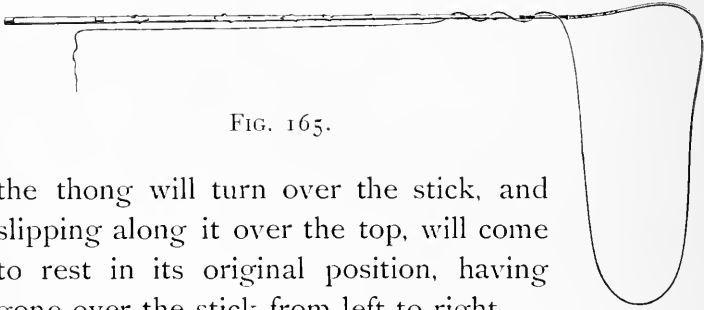

FIG. 165.

the thong will turn over the stick, and slipping along it over the top, will come to rest in its original position, having gone over the stick from left to right.

If, however, the point of the thong is held against the collar of the stick by the thumb, and the operation repeated, the point not being free to run out, but being suddenly arrested, the bight of the thong will swing back to the left and will wind itself round the stick from right to left, the upper turns being in the direction of a right-handed screw and the lower turns in that of a left-handed screw (Fig. 166, A). Since the upper part of the thong has made a turn over the stick, there will be one more turn in the right-handed part than in that near the hand. If these lower turns are pulled out, leaving only the upper turns, the thong will lie as shown at B, Fig. 166.

In practice, to catch the double-thong, the hand, after being moved to the right, somewhat sharply but steadily, that is, without a jerk, so as to give

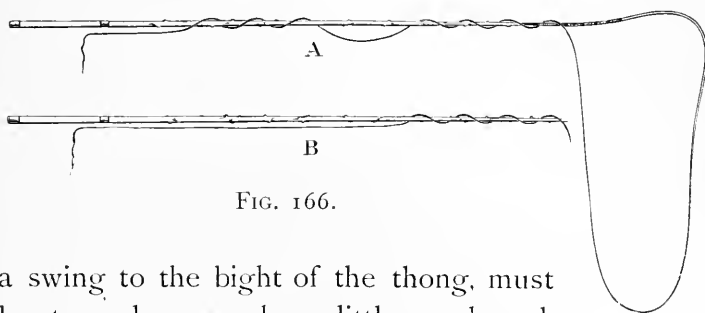



FIG. 166.

a swing to the right of the thong, must be turned upward a little, and suddenly stopped, so that the thong will come on the proper point of the stick, the upper turn being just below the knot; if it is above the knot it may strain the quill.

In all this movement, the point of the whip should follow a line like this , supposed to be marked on a wall in front of the operator, but it is the turn of the wrist at the end of the movement which catches the thong, and that is really almost the only motion made by one who is very expert.

The motion of the stick must be uniform, until the stop at the end, and the thong must be left to curl round the stick of *itself*. The thong should not be *struck at* by the stick, as is frequently done.

In all movements of the whip, whether catching the thong or in hitting a horse, it must be held easily in the hand, and the wrist must be free and

loose. It should be grasped by the whole hand with all the fingers underneath; to extend the fore-finger up the stick, results in an objectionable stiffness.

The knack of catching the thong dextrously, or even at all, can be acquired only by practice, and while sometimes a lucky man will hit upon it very soon, another will try without success for months, when it will suddenly come to him.

After the double-thong is caught, the right hand must be moved to such a position that the bight of the thong will come under the thumb of the left hand; the *lower* turns can then be pulled out by raising the right hand (for the left hand, with the reins, must not be moved), and the thong having been pulled down tight from the lowest of the upper turns, must be held against the stick by the thumb (Fig. 166, B). Some men take two or three turns of the end of the thong round the whip handle before placing the thumb upon it, but it is better to acquire the habit of keeping it straight, since the operation just described takes some time, and it is not advisable to prolong it.

If the lower turns are *not* pulled out, the thong will come unwound too readily.

If there are knots close to the end of the wrapping of the quill, the thong, if it is soft and clinging, ought to remain in its place, but it is likely to slip down, and this can be prevented by putting two or three more turns on the stick by a motion of the

wrist. If more than two turns are put on, they will show in the loop, and when it is desired to hit a wheeler hard, they will hold the thong more securely together (see Fig. 167).

As long as the consecutive motions of catching the double-thong are properly performed, it does

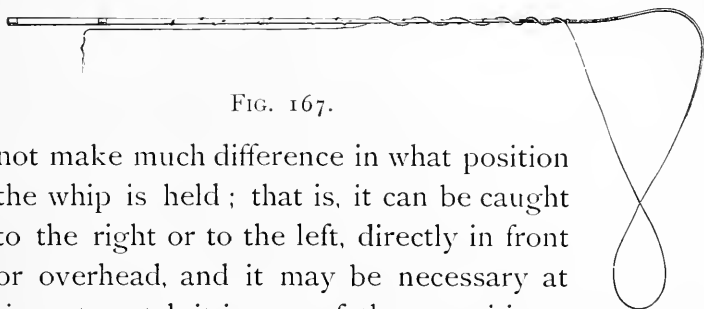

FIG. 167.

not make much difference in what position the whip is held; that is, it can be caught to the right or to the left, directly in front or overhead, and it may be necessary at times to catch it in any of these positions, depending upon whether or not there is anything in the way, but in general, unless there is some reason to the contrary, it should be caught, with the point high and in front, or directly over the horses, for the reason that this is the direction in which the coachman's eyes should be always kept, and if he is tempted to look at his whip he will still be looking in the right direction.

What is sometimes called the 'whitewash act,' resorted to by coachmen who have not mastered the double-thong, consists in holding the whip vertically downward on the right side of the coach, and stirring it round and round until the proper number of turns are obtained; it is effective but not elegant.

When the wind is strong from the near side of the coach, or the thong not in the best condition, the turns may slip down the stick ; they may be pushed back to their places by drawing the stick under the thumb of the left hand, which must not be moved ; but it is better to catch the thong up afresh in the regular way.

USE OF THE WHIP.—To hit a near wheeler, the hand must be somewhat advanced, and the stroke delivered by turning the thumb down and the outside of the hand up, striking the horse on the shoulder, or as far forward as possible. For an off wheeler the hand is carried forward to the right and down, underhanded, the back of the hand going down and the fingers up. The horse should be hit on the shoulder, and with the loop of the thong parallel to the line of the pole-chains, that is, as extended as possible, when the thong will be less likely to catch on the point of the trace, or on the point of the belly-band chape. Both of these strokes are made with the loop of the thong.

An off leader is easy to reach : the thong is untwisted by swinging the whip on the right-hand side and letting go the point just as the last turn comes off. The unwound thong is then directed, with the hand in the same position as for the off wheeler, toward the hind legs of the horse *below* his trace. It takes an extremely long thong to hit a leader in front of his pad, and he should not



be hit above his trace, which may make him kick ; moreover, if the thong is muddy, it leaves a mark.

There are three ways of hitting a near leader : The usual one is to swing the thong over the top of the coach (being sure that it is swung high enough to avoid striking any one on the back seat), and then throwing it out alongside of the near wheeler so as to touch the leader from the outside. Another way, is to pass the whip, unwound, of course, to the left side of the coach, and to describe a vertical circle with the thong, throwing it forward as before, but not permitting any part of the thong to go back behind the driving-seat. This resembles what Scotch fishermen call a 'Spey-cast' with the rod ; used where trees are behind the angler ; it is difficult, and requires long practice. The neatest way is to hit the horse from the off side, under the bars, the point of the thong passing in front of the wheelers and behind the off leader, catching the near leader on his off hind leg. If the stroke is delivered as if aimed at the kidney-link of the off wheeler it will be successful. This is also a difficult stroke, but so neat that it is worth acquiring, and it will be hardly noticed by persons on the coach, whereas, owing to their necessary amplitude, the other two motions are conspicuous.

Some good coachmen recommend, and practise, throwing the thong on the leaders' backs between the heads of the wheelers ; possibly in certain confined places it may be necessary, but it is a bad

stroke ; one is almost certain to touch a wheeler in bringing the thong back, or to get the point caught in the harness or on the pole-head.

In touching any horse, and especially a leader, the maxim 'hold and hit' must be remembered, which means that the coachman must have a hold on the horse's mouth, because if the horse is hit while his rein is loose, he will rush forward before he can be properly restrained. No crack or whistle must be made with the whip ; only that horse alone which is hit, should know anything about it.

After a stroke the thong must be brought back by lifting the point of the stick, so that the thong will fall on the inside of the right arm, whence it can be allowed to slip down to the hand. There will be several feet of thong hanging down behind the hand, and this must be pulled through the right hand by the left thumb, until only a few inches remain under the right thumb, when a double-thong can be caught.

In bringing the thong back, it must not touch any horse, or trail on the ground so as to get muddy.

In striking an off wheeler, the loop of the double-thong may catch either in the point of the trace or in the point-strap which is buckled into the false belly-band, and it will be difficult to get it out ; it may sometimes be released by letting the point of the thong go entirely off of the stick, and then pulling it through single.

After striking a leader, the point may catch between the hook and the spring of the lead-bar, and it will be generally necessary for one of the servants to get down and release it; but a series of gentle jerks, or pulling back the leaders, so as to slacken the lead-trace, will sometimes bring it out. To order a servant to get down for the purpose of clearing the thong, the coachman says, sharply, 'near side' or 'off side,' as the case may be. If the point is wet, especially if it is of whipcord, it will often lap round the hook of the lead-bar or some part of the bar; which is called: 'getting a bite;' a little jerking and coaxing will usually free it. Another expression used for having the thong caught is: 'getting hung up.'

Should the loop of the thong catch on a tree, the whip must be quickly let go entirely, and picked up afterward; an attempt to pull it away may not only break it, but possibly inflict a blow upon the occupant of the box-seat. The balls or ornaments on gateposts may catch the whip unless it is held high.

In approaching a spot where the horses may be troublesome, such as under a railroad bridge, the whip should be unwound, and only the point of the thong held in the hand, ready for instant application to a leader. In meeting a steam-roller, for instance, the leaders are very apt to shy, and a quick touch to the off side of the off leader will keep the leaders in the road.

There is an unwritten rule of the *Reunion Road*

*Club*, of Paris, that any member neglecting this precaution, of unwinding his whip, shall pay a fine of one franc to every other member who may happen to be on the coach.

The whip should never remain in the socket (many coaches have no whip-socket, which is a good plan); it should always be in the hand ready for use, since the wheelers may need to be turned by it more quickly than they can be turned by the reins; for a sharp forward movement of a wheeler, owing to his pulling on the end of the splinter-bar, will promptly take his side of the coach round.

In galloping, it is usually better to guide with the whip than by the reins, because *pulling* a horse to one side will take him out of his even stride or cause him to change his leading leg.

It is in the management of the whip that an amateur coachman is of necessity weakest, private teams generally requiring more to be restrained than to be urged, so that if he does not keep his right hand quiet, his horses may 'get too much for him;,' consequently, it is a good plan to spend some spare time on foot, or on a coach-box, practising upon imaginary animals.

In addition to the regular whip, old coaching chronicles tell of the 'short tommy,' or 'docker,' and the 'apprentice;' the former appears to have been a whip with a short stick and a short thong, with which, on a bad hill, the coachman of a night-coach, after putting his whip under his right leg,

would 'lay into' his wheelers, while the guard, running alongside, persuaded the leaders with a similar weapon. A plate by STURGESS in HARRIS'S *Old Coaching Days* (p. 78) illustrates the operation. The 'apprentice' was more like a cat-o'-nine-tails.

On a coach which has no whip-socket, when it is necessary for any temporary purpose to get the whip out of the hand, the handle is put under the right leg, the stick projecting horizontally to the off side, an eye being kept on it, that it does not catch in a tree.

REYNARDSON tells a story, also illustrated by ALKEN, in *Down the Road* (p. 134), of 'stamping the foot-board,' in which an old coachman, being in the habit of rattling his feet on the foot-board whenever he used the 'short tommy,' got his horses so used to the signal that as soon as they heard the noise they jumped into their collars, without it being necessary to apply the instrument.

The catching up of the whip in a double-thong seems to date from the early part of this century, but not to have become general until much later. The pictures of the last century do not show it (see Plate VI.). In ALKEN'S well known plate *Three blind'uns and a bolter*, published in 1833, and in a plate by J. L. A., published by WATSON in 1824, the whip is *not* caught up. In a picture of a coach-and-six, by CORDERY, in 1803 (Coachmakers' Company, London), the double-thong *is* shown. The books are silent on the subject.

THE SALUTE. — When road-coaches meet, the coachmen salute each other with the whip. In early days, it was customary to move the whip-hand to the right, keeping it low, as shown at A, Plate XXXI. ; later, it became the fashion to raise the hand to the level of the face, as at B ; and finally, about fifteen years ago, the manner shown at C, which resembles a soldier's 'present sabre,' was adopted. CORBETT (p. 248) calls the oldest fashion : 'a neat meeting,' and the second one : 'a muffish meeting.'

A person driving a private coach should always make a salute with the whip to a road-coach, when meeting one. If there are ladies with whom he is acquainted, on a coach, he should raise his hat, passing his whip into his left hand.

It is hardly necessary to say that a man when driving should always take off his hat to a lady of his acquaintance ; it is in bad taste merely to raise his whip in place of so doing. If he has not hands enough to spare one for his hat, he should continue to practice driving, until he can find one.

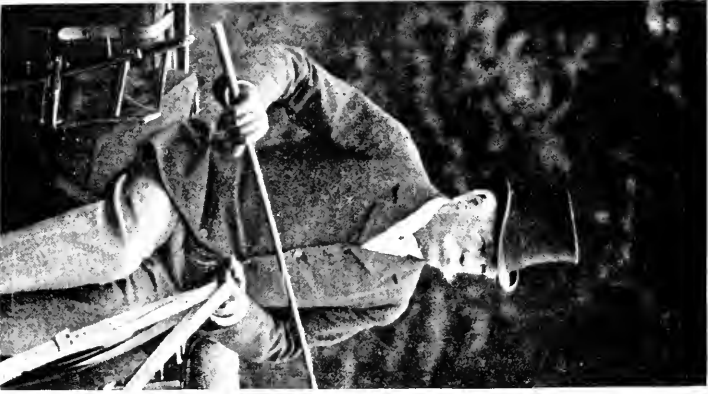

A



B

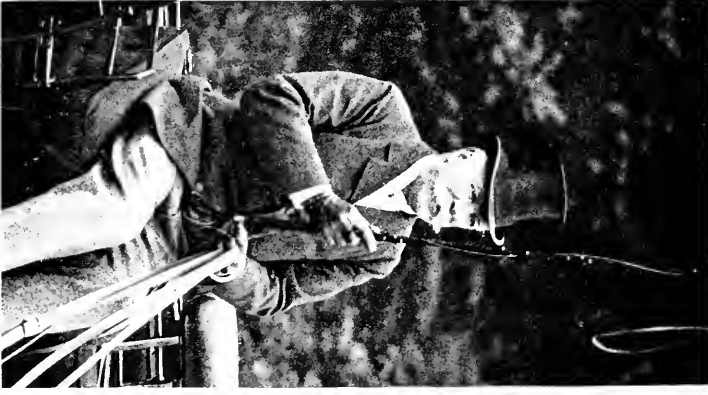

C

THE SALUTE.

PLATE XXXI.





## CHAPTER XVIII

## THE MEN: THEIR DUTIES AND DRESS

ON a private coach there should be two servants: a first and second groom, or coachman and groom. The head man sits on the off side in the rumble, the other man on the near side. When the owner is not driving, as, for instance, when the coachman brings the coach from the stable to the door, the second man keeps his place in the rumble on the near side. After coming to the door, the second man goes immediately to the heads of the leaders and stands in front of them facing the coach, taking hold of their heads if necessary, and straightening them forward; the leaders, on stopping, are very apt to hang back and to be too near the end of the pole. Their traces should be nearly tight, and while they stand, the man at their heads should see that they are always in their proper places. The coachman quietly puts on the brake, gets down immediately, with the reins and whip in his right hand, draws the reins through the point-strap above the tug-buckle (in the manner shown in Fig. 168), lays the whip across the backs of the wheelers, and then stands at the wheelers' heads on the off side.

Should there be only men going on the coach, and the ladder is not required, the man who is at

the wheelers' heads remains at his place ; if the ladder is to be used, it is his duty to take it down and put it in position, and also to get out any rugs,

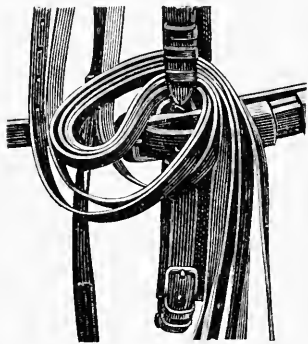

FIG. 168.

aprons, etc., that may be required. As soon as he has finished these duties he returns to his station on the off side.

Meanwhile, the second man, at the heads of the leaders, must be looking toward the coach, and at a nod from the person driving he moves to his right, that is, to the near side, and takes three or four steps toward the coach ; at the same time the head man takes a step forward, which brings him opposite to the second man.

As the coach passes them, they take hold of the irons supporting the rumble, and putting up the inside foot first, mount to the back seat as nearly as possible simultaneously.

On stopping, they immediately descend, and take their places, as before, at the horses' heads ; but if a lady is to get down, the head man brings the ladder.

Both men should be on the alert to get down in case of an accident or if their services are really required, but they should not jump down and run to the horses at every temporary block in the street,

as if the coachman were not competent to manage his horses.

All the men about a four-in-hand establishment should be carefully instructed, that should a team suddenly start, the proper way to stop it is by seizing the heads of the *wheel horses*; there is always an impulse on the part of bystanders to rush to the heads of the leaders; if they succeed in stopping them, the point of the pole runs into the leaders' rumps, resulting in confusion worse confounded. It is the wheelers alone that can hold the coach; if they are stopped, the leaders can do but little. Therefore, the proper thing is to reach the wheelers first, and bring them under control.

When wheelers are troublesome, the man at their heads can hold them by taking all four of their reins in his hand, about two feet from the bits, and every man should be shown how he can hold all four horses at once, by taking in his hand, or in both hands, the leaders' reins in addition,—a much safer way than merely standing at the leaders' heads when there is no one to look after the wheelers.

In large establishments, the head coachman frequently brings the coach to the door, but goes no further, in which case, the two grooms come round in the rumble, and take their stations as above described. Under these circumstances, the head coachman is not in livery. He places the ladder and discharges the duties, described above as be-

longing to the head man, and the principal groom remains at the wheelers' heads.

When, as at races and picnics, a stable-man out of livery is taken inside the coach to help with the horses, he does not do any of the duties just described, but assists immediately in taking out the horses, holding them, running the coach into position, etc.

DRESS.—The men should be dressed in breeches and boots, with single-breasted coats not too long in the skirt, waistcoats of the striped material especially made for the purpose, known as 'valencia,' or of any coloured material that is desired. The waistcoats should have sleeves, so that the men will look neat if their coats are taken off to do any work; the waistcoats should be high enough to show an edge in the opening of the coat when this is buttoned.

The scarf should be white; there is a regular form of coachman's scarf, sometimes combined with a collar, which is sold by dealers (Fig. 169). The scarf and collar must be always scrupulously clean, and it looks well for the two men to wear small horse-shoe scarf-pins exactly alike.



FIG. 169.

The high silk hat should be in the mean of the fashion, and not exaggerated, but always of the best quality and never shabby. The oil-cloth covers, sometimes provided for rainy weather, are not satisfactory: they rub the hat when

they are being put on, and are heavy. A *good* silk hat is not much hurt by rain, if, after coming home, it is wet all over and wiped with a wet cloth. After it is quite dry, it should be brushed with a hard brush, and then with a soft one or a velvet pad; some coachmen keep a hatter's iron in the harness-room to improve it still further.

Cockades are worn in the men's hats only when the owner of the coach is, or has been, an Officer of the Army or Navy, or in the Diplomatic Service. It is usually considered that the cockade with a fan belongs to military officers, and the cockade with only the oval body, to Civil Servants of the Government.\*

Tan-coloured dog-skin gloves complete the costume; the gloves should not be white.

A coachman's coat has flaps on the hips where pockets would be; a groom's coat has not. The buttons are silver or gilt, corresponding to the mountings of the harness, and should have, raised on them, a monogram or crest; a perfectly plain metal button suggests a livery stable. The tails of

---

\* The cockade probably originated with the button used to fasten up the brim of the hat, and seems to have been confined at first to the military servants of Army officers; it has, for a long time, been a badge of party, as the white, the red, and the tricolour cockades of French history and the black or white cockades of the Houses of Hanover or Stuart. The cockades of Embassy, and Legation servants have different colours: for Austria they are black and yellow, for Belgium, black, yellow, and red, etc.

a livery coat, where they lap over, should be sewed together for a distance of about five inches below the buttons, to prevent them from spreading apart when the man is seated. The overcoat is double-breasted, with two rows of buttons, and should be long,—half-way between the knee and the ankle. It is usually of the same colour as the other coat, but it is perfectly proper to have it of drab cloth, whatever the other coat may be.

The men should always have india-rubber coats, preferably black and with a cloth finish, not with a rubber surface, which looks common.

For ordinary carriage purposes, the men have trousers of the same colour as the coats, but trousers should not be worn on a *coach*, with livery coats; always breeches and boots.

In a well mounted establishment the men should have, in addition to their liveries, morning suits, consisting of a sack coat, waistcoat, and trousers of grey or light brown material, that known to tailors as 'Chipping Norton tweed,' being the most suitable.

These clothes are worn when the coach is taken out in the morning, or on a journey, or for trying a team. Instead of ordinary trousers, breeches and gaiters, all of the same stuff, may be worn, but trousers are the best on a journey, not being so conspicuous when the men are walking about a town.

The hats worn with these suits are Derby or pot-hats, either of the colour of the cloth, or black, but both of exactly the same shape. The white tie

and collar are of course necessary. The coat belonging to this suit may be put on *after arriving* at a race-course or a horse-show, in place of the livery coat, and it looks very 'smart' on such occasions over the breeches and boots. The pot-hat must be worn with it, having been taken out in the coach.

The colour of the boot-tops is a matter of taste, and varies with fashion from time to time, but the regular old dark brown is much the best, the pink and the white having a less sporting look.

The breeches, to look well, must be made by the best maker and carefully put on, the buttons not too much to one side, but half-way round between the front and the side. They should not be too tight, but must not be at all baggy above the knee, as hunting-breeches are now made. In fact, livery-breeches and hunting-breeches are altogether different articles. Breeches made of leather, are handsome and last for a long time, but they are expensive, require a great deal of care, and should be in duplicate, because when they get wet it is difficult to dry them in time for next day's use. The pipeclay with which they are cleaned, rubs off on the cushions and is a little untidy.

Breeches are perhaps better made of moleskin, an elastic cassimere, which comes for the purpose. This may be pure white, but it usually has a slight grey tinge, which is quite as pleasing as a dazzling white. They are kept clean by washing, and must

be dried on a breeches-stretcher, or they will soon get out of shape. A careful man will have an apron to keep his breeches clean, when doing any work in the stable after he is dressed.

It is usual in Europe, for coachmen and grooms to have their own boots and breeches, which they take with them in changing a place. It is a custom that might be introduced to advantage in America, inasmuch as these articles are expensive items if they have to be furnished frequently for new men. Of course, wages have to be adjusted to compensate the man for providing this part of his dress.

The owner's dress for coaching hardly demands remark ; it is the same that he would wear for any driving. For the coat, a dark grey is suitable, and shows dust less than black. The tails should be sewed together as described for the men's coats. A high hat should be worn in the afternoon, but a pot-hat is proper in the morning (unless the occasion is a formal one), and is also proper in the country at any time of day, or on any kind of coaching trip.

In the early days of The Coaching Club, in New York, the members wore white hats at the Meets ; but later this was changed, and now black hats are worn. Ten or fifteen years ago it was considered the proper thing for a lady, on a coach, to wear a bonnet, but now the rule is relaxed and hats are in the majority.

Tan-coloured gloves are the proper thing for



driving ; light or white gloves never. If a coachman wishes to be happy, he will have large gloves, easy about the wrist, and with very long fingers. If they are short, the bending of the hand will pull the glove against the ends of the fingers, which they will tire and make perfectly numb in cold weather. A glove is sometimes left unbuttoned at the wrist, but this permits the glove to slip about and to catch on the cuff of the coat ; it is much better to have it large at the wrist, or the buttons so moved as to make it easy. Some men like a thin glove, but the majority of coachmen find a thick, *soft* glove the most comfortable, and for hard work, I like a soft lined glove. It is somewhat a question of thin or fat hands.

A pair of cotton, or thin woollen, gloves should always be carried either in the coach or in the pocket of the waterproof cape, to put on over the other gloves when it rains ; when wet, leather gloves are slippery and most uncomfortable.

After gloves have been wet, a thorough rubbing with crown soap well worked in will make them all right again.

For cold weather there is nothing better than the ordinary drab cloth box coat, easy, but not too large, double-breasted, buttoning up close in the neck. It may have covered buttons to match the cloth, or pearl buttons, plain and not too large.

A cape, either of drab cloth or of some waterproof material, large enough to lie outside of the

top of the apron and over the back of the driving cushion, so as to shed the rain off *outside*, is convenient for showery weather. Any shape of waterproof thing which leads the rain down *inside* of the apron and into the lap is maddening.

A cape with sleeves (Fig. 170) I have found useful. It can be thrown over the shoulders like a cape, while driving, and the arms, one at a time, thrust into the sleeves afterward; the sleeve is short and very large at its upper end, so that the hand readily slips into it, but it fits tight around the wrist. To put on, while driving, an ordinary coat with long sleeves, is a dangerous experiment; for some moments the coachman is perfectly helpless.

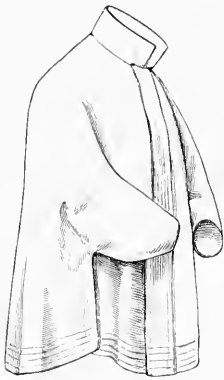

FIG. 170.

For public coaching a somewhat more 'down-the-road' style of dress may be adopted. It is proper for the coachman to wear a white hat, which may be rather low in the crown and wide in the brim, but not extravagantly so.

Russet-leather shoes with white linen spats are not out of place in summer; blackened leather shoes, which soil the apron, are objectionable.

A white hunting scarf and collar, with some kind of a coaching pin, is the best neckgear.

A dark-grey coat is good; as is also, for cold

weather, a drab box-coat with large pearl, or ivory buttons, on which a coaching device is engraved.

In wet weather, an apron which can be buckled round the waist, reaching to the ankles and meeting behind, is a good protection, and if the coat or cape is put on over it, it is hardly possible for the rain to penetrate; it must be confessed that in this garb, the coachman, when on the ground, looks somewhat like an old woman.

In the early part of this century in England, when 'the road' was the fashion, not only the professional coachmen but the amateurs who imitated them, affected many eccentricities of dress. Coats of many capes, very low broad-brimmed hats, and voluminous wrappings about the neck were the rage, and LORD WILLIAM LENNOX (*Coaching*, p. 202) gives the following description of the dress of a member of 'The Whip Club': 'A light drab-coloured cloth coat, made full, single-breasted, with three tiers of pockets, the skirts reaching to the ankles, a mother-o'-pearl button of the size of a crown-piece; waistcoat blue and yellow stripe, each stripe an inch in depth; smallclothes, corded silk plush, made to button over the calf of the leg, with sixteen strings, and rosettes to each knee; the boots very short, and finished with very broad straps, which hung over the tops and down to the ankle; a hat three inches and a half deep in the crown only, and the same depth in the brim. Each wore a large bouquet of flowers at the breast,

‘resembling the coachmen of the nobility on a ‘Drawing-room or Levée day.’

In the present day the ‘Driving’ and ‘Coaching Clubs’ of London, New York, Philadelphia, and elsewhere, have a distinctive uniform for Meets, but it is simple, consisting of a plain dark coat of green, brown, or blue, with gilt buttons with the club device, a uniform waistcoat, and plain trousers of any colour. Usually a dress-coat of the same cloth, for evening wear, is prescribed.

## CHAPTER XIX

## PUBLIC COACHING

DRIVING a coach on the road between fixed points, according to a regular time-table, with changes of horses, in imitation of old-fashioned business coaching, has a great fascination for the coaching man, and with good reason. It bears much the same relation to taking an afternoon drive at one's leisure, that playing an instrument in an orchestra bears to practising solos at home. In the latter case mistakes are easily corrected, movements may be repeated; if one passage is not interesting another can be selected; but in an orchestra, when once started, the performer must go on, time must be kept, everything must be according to rule, with no chance to correct omissions or mistakes.

In fact, a coachman never detects how little he knows until he undertakes to drive a fast road-coach, or a musician until he tries his hand in concerted pieces. In an afternoon drive in the park, if the reins are not quite right, if one horse pulls, if any one of many inaccuracies troubles the coachman, he can stop, try experiments, and re-arrange matters, and as he has no time to keep, he is not afraid of losing any; but on a fast road-coach it is very different: it is usually all that the teams can

do, to get over their ground in the time allotted ; there is no opportunity to slow down in order to cool a fretful leader ; if he will gallop, he has to gallop, or else to be handled with such skill as to bring him down to a trot without materially diminishing the pace ; for minutes are precious. In a coach timed at ten miles an hour including changes, very close to eleven miles an hour must be made while moving, and a minute or two lost, by stopping or going slow, is hard to make up ; so that whether the team is going pleasantly or most disagreeably, there is nothing to do but to make the best of it, and to notice carefully how things may be improved on the run back, or on the next day. Horses have to be shifted from one stage to another to make the best use of them or to counteract their peculiarities. Some horses go best in town, others in the country, a bad wheeler may make a good leader, changing sides may turn a troublesome horse into a good one, and all these matters are interesting and require judgement on the part of the coachman.

Quickness at the changes, smartness of the service generally, attention to small details by all persons employed, are points which interest the proprietor and please the connoisseur ; and the coachman never knows but that in his load of strangers there may be a master of the craft, who will express his opinion, on the spot or at a future time.

The mere driving is of itself much more interesting than that of a simple afternoon outing : every

mile of the road must be carefully studied ; a little piece down-hill must be used to make time and to compensate for a loss on another part, where for some reason the pace has to be reduced ; a sharp turn at the bottom of a hill must be remembered, and the horses kept well in hand as they approach it ; the exact minute of passing each point must be learned by experience, in order that there shall be no uncertainty as to whether or not the coach is on time ; the pace on certain parts must be sometimes modified, depending upon the weather, so that a long hill may be taken slowly on a hot day with the wind behind, even at the cost of increased speed over some less trying stretch. A careful study of these conditions makes a road more and more interesting the oftener it is driven over.

Added to all this, the variety of passengers that the coachman finds on a public coach is very entertaining, and there is something so exhilarating in the motion behind four horses, through the fresh air, that even stupid people wake up and for once make themselves agreeable.

If a coachman is lucky enough to get a day's turn on a strange coach, on a road new to him, it is most interesting. His only guide as to time will be the pace as determined by a study of the time-table, and he must, therefore, depend upon his own judgement of the rate at which his horses are going, and upon an occasional hint from the guard, as to whether or not he is keeping his time.

Under such circumstances the loss of even a few minutes makes it necessary for a coachman to use all his skill to enable him to pull up at his change on time.

In England the construction of good roads toward the latter part of the last century, the love of country life and its amusements, and the thickly populated state of the country, made travelling by coach a pleasure as well as a business.

The same kind of talent now bestowed upon railway management, was then devoted to coaching, and in connection with the Post-Office system, the Government exercised, with an almost military uniformity, a rigid supervision over the service. Able and highly-placed people were interested in it, as a business. Country gentlemen furnished horses for this important service, and went frequently over their roads, often themselves driving, for the purpose of seeing that everything was done properly. A fierce competition as to speed and punctuality sprang up on the important roads, and every detail was duly considered by the most competent persons, often under Government penalties as to performance of contracts. It was this series of conditions, lasting through a period of nearly fifty years, that made English coaching the thorough and complete system that it was: the standard for what has now changed from a serious business to an amusement.

That many men fond of fresh air and horses



should have availed themselves of the opportunities which the public coaches afforded of gratifying this fondness was natural, and many an amateur, as skilful as the best professional, passed pleasant hours on the driving cushion.

After 1835, however, the locomotive came rapidly upon the scene, and one by one the coaches disappeared, the coachmen dropped into other employments, and four-in-hand driving bade fair to become one of the lost arts. Its traditions were kept up, however, by the Driving Clubs, the earliest of which, The Bensington Driving Club, was formed in 1807. Other clubs, the histories of which are pleasantly told in the volume on *Driving*, of the *Badminton Library*, were formed and dissolved, but the 'B. D. C.' lasted until 1854. There seems to have been a short gap until 1856, when The Four-in-Hand Driving Club was formed, but according to the annals, this gap was filled by a solitary coachman, SIR HENRY PEYTON, who, with his yellow coach and grey horses, was a well-known figure on the London streets.

From 1856 until 1870 The Four-in-Hand Club kept Coaching in memory, and in 1870 The Coaching Club was formed in London with a larger number of members, and both clubs now maintain a vigorous existence.

The Brighton Road, always famous in the annals of coaching, had on it, in different years, some road-coaches, notably 'The Age,' driven first by CLARK,

and in 1862 by the DUKE OF BEAUFORT ; and others run in 1866, and afterward, by a band of amateurs, among them Messrs ANGELL, HAWORTH, CHANDOS-POLE, and HOARE, whose names appear frequently in coaching annals.

About 1869 and 1870, at the time of what is usually called the 'Coaching Revival,' amateur coaching increased in England, and has since then spread to America, and to the Continent.

Although four horses were used a great deal in America in Colonial days and later, both for public coaches and for private travelling, there does not seem to be any mention in the memoirs of the period of driving as an amusement. The roads were too bad to make driving much of a pleasure, and lovers of the horse preferred to enjoy themselves in the saddle.

In 1860, a coach, built by MAY & JACOBS, of Guilford, England, was sent to Mr BIGELOW LAWRENCE, of Boston ; this was probably the first regular English coach in America, unless some had been sent out in Colonial times. This coach afterward went to New York.

It was not until after 1865 that a few four-in-hands driven to brakes or barouches were seen at races in the neighbourhood of New York and Philadelphia ; but from that date they rapidly increased in number, and the establishment of 'The Coaching Club,' at New York, in 1875, aided materially in increasing the taste for the sport.

In 1876 Colonel A. DELANCEY KANE, who in the previous year had driven in England, working the road from London to Virginia Water, put on the first amateur road-coach in America, running from The Brunswick Hotel, New York, to Pelham Bridge. This was succeeded by others in different parts of the United States, some of which are mentioned below.

PUTTING A COACH ON THE ROAD.—It is well understood among coaching men that the person who has been working a certain road has a right to that road, and it is not in accordance with coaching etiquette for any one else to put a coach upon it, or upon any important part of it, without having first obtained permission of the original proprietor, or the assurance from him that he does not intend to occupy the road that season. This matter having been arranged, or a vacant road selected, the next thing is to go over the road and to study it carefully.

In modern public coaching the distance to be run, is usually such that a coach starting at a convenient hour in the morning can have time for lunch at the end of the route and get back to its starting-place late in the afternoon; or a longer route is chosen which requires all day, the coach going down one day and back the next.

In the first case, starting at ten, a thirty-mile drive at ten miles an hour will allow two hours for lunch, with a return to the starting place by six o'clock.

The hours of some well known coaches are given as examples ; the distances are one way :—

- Brunswick Hotel, New York, to Pelham Bridge,  
 Down 10 A.M. to 11.30 A.M. 15.5 miles.  
 Up 4 P.M. to 5.30 P.M.
- Brunswick Hotel, New York, to Yonkers,  
 Down 11.30 A.M. to 1.15 P.M. 18 miles.  
 Up 3.25 P.M. to 5.10 P.M.
- Holland House, New York, to Ardsley Casino,  
 Down 10 A.M. to 12.30 P.M. 25.8 miles.  
 Up 3.30 P.M. to 6 P.M.
- Berkeley Hotel, London, to Guildford,  
 Down 11 A.M. to 2 P.M. 28.5 miles.  
 Up 4 P.M. to 7 P.M.
- Northumberland Avenue, London, to Box Hill,  
 Down 11 A.M. to 2 P.M. 25 miles.  
 Up 4 P.M. to 7 P.M.
- Northumberland Avenue, London, to Virginia Water,  
 Down 10.45 A.M. to 2 P.M. 26.5 miles.  
 Up 3.30 P.M. to 6.50 P.M.
- Northumberland Avenue, London, to Windsor,  
 Down 10.30 A.M. to 1.30 P.M. 30 miles.  
 Up 3.40 P.M. to 6.40 P.M.
- Northumberland Avenue, London, to Dorking,  
 Down 10.45 A.M. to 1.45 P.M. 29 miles.  
 Up 3.15 P.M. to 6.15 P.M.
- New York Herald Office, Paris, to Cernay-la-Ville,  
 Down 10 A.M. to 1 P.M. 29 miles.  
 Up 3.05 P.M. to 6.05 P.M.

New York Herald Office, Paris, to Pontoise,

Down 10 A.M. to 12.45 P.M. 26.3 miles.

Up 3.30 P.M. to 6.15 P.M.

New York Herald Office, Paris, to Maisons-Laffitte,

Down 10.30 A.M. to 12.30 P.M. 19.4 miles.

Up 3 P.M. to 5 P.M.

New York Herald Office, Paris, to Versailles,

Down 10.45 A.M. to 12.30 P.M. 14.5 miles.

Up 4.30 P.M. to 6 P.M. (Different Road) 12.5 miles.

The following routes are arranged for one day down and another day up :—

Plaza Hotel, New York, to Tuxedo Park,

Down 9.45 A.M. to 5.15 P.M. 47.5 miles.

Up 10.30 A.M. to 5.30 P.M.

White Horse Cellar, Piccadilly, London, to Brighton,

Down 11 A.M. to 5 P.M. 54 miles.

Up 12 A.M. to 6 P.M.

New York Herald Office, Paris, to Fontainebleau,

Down 11 A.M. to 6 P.M. 60 miles.

Up 11 A.M. to 6 P.M.

On these long routes there is always a stop of from 35 to 40 minutes for luncheon.

The lengths of the stages, of course, depend largely upon the places where stabling can be obtained for the change-horses. If they are of less than five miles, the time lost at the changes will not be made up by the increased speed which the shorter stages permit, to say nothing of the larger

number of horses and men to be kept, and if they much exceed eight miles, they cannot be travelled so fast. An ideal road is one with good stabling every seven miles. On a twenty-eight mile road this would require four teams, or sixteen horses, but as each stage should have at least one extra horse to fill vacancies caused by lameness or accident, twenty horses in all would be required as a minimum, and, if the pace is at all fast, four more horses, to rest the others, would be necessary.

It is usually considered that a fast coach, running out and in, should have a horse to each mile of road; that is, for a coach going once a day each way, between two places thirty miles apart, thirty horses will be required.

This will work out as follows, each team doing two stages a day, one each way:—

Stages five miles; one rest-horse to each team.

30 ms., 6 stages; 24 horses + 6 rest = 30.

Stages six miles.

30 ms., 5 stages; 20 horses + 5 rest = 25.

A horse to the mile would give two rest-horses to each team.

Stages seven and a half miles.

30 ms., 4 stages; 16 horses + 4 rest = 20.

A horse to the mile would give  $3\frac{1}{2}$  rest-horses to each team.

Beginning with five-mile stages, a horse to the mile will give one rest-horse to each team, and when the lengths of the stages are increased to six, and to seven and a half miles, the number of rest-horses to each team is increased to two, and to three and a half, respectively.

It may, therefore, be a matter for consideration whether to have shorter stages or more rest-horses, a question obviously controlled by the location of the change-stables.

The Maisons-Laffitte coach of 1894, doing  $19\frac{1}{2}$  miles, with four teams, in two hours each way, or 39 miles in the day, ran for six weeks with twenty horses, several of them being replaced for a day or two by hired horses owing to slight causes of unfitness. This was a fast coach, always well loaded, running six days in the week, and in warm weather ; five miles of the road not very good.

It is sometimes a question whether or not the last team down the road should do the last two stages as one, a fresh team bringing the coach back over those two stages. This arrangement will require the same number of horses, but the location of the stable for the last change must be such as to reduce those two stages together, to a distance of not over twelve miles.

A twenty-eight mile road, for example, would be usually divided as follows : first stage 7 miles, second stage 8 miles, third stage 7 miles, and fourth stage 6 miles, each team doing one stage each way.

The last stage should always be the shortest, if possible, since the team which does it has the least time to rest between its two turns of work.

This might be modified as follows: first stage 8 miles, second stage 8 miles, leaving 12 miles to be done by the last team, which will, however, have a long rest; that is, until it is required to take the coach back the *next* day; this last stage being done *back* by the fresh team which came out the day before.

This is not an uncommon arrangement, and has the advantage of suppressing one stable with its attendant helpers; but, as a rule, the horses of the long stage are not quite so pleasant to drive, especially in warm weather; they are somewhat tired toward the end of it, but they will be entirely rested by their long stop in the stable and come out fresh the next day.

To give an example from actual practice. The coach from Paris to Maisons-Laffitte in 1894, was, in the beginning of the season, arranged as follows, the proprietors of the previous season having so run it: First stage: Paris to Suresnes, 5.6 miles, 35 minutes, town team; second stage: Suresnes to Bougival, 5.3 miles, 33 minutes; third stage: Bougival to Maisons-Laffitte, 8.5 miles, 52 minutes, a five-minutes' stop being made on the terrace at St. Germain. The last team remained at Maisons-Laffitte, a fresh team bringing the coach back after lunch to Bougival.

It was found, however, that the last team, after



the stop at St. Germain, was not so pleasant to drive as on the first part of the stage, especially as it had surmounted a long, steep hill to reach that point. The arrangement was therefore altered; and a stable was equipped at St. Germain, so that the last change was made there, and the horses which did the last stage to Maisons-Laffitte took the coach back to St. Germain, no horses or men remaining at Maisons-Laffitte overnight. A man from the St. Germain stable was taken in the coach to Maisons-Laffitte to attend to the horses while they spent their two and a half hours there at noon; he was assisted by a local stable-man, and replaced by a local man at St. Germain.

This arrangement was a decided improvement; the last team was fresh and pleasant to drive both ways. It took no more horses, and only required accommodation in an additional stable for the noon rest, and the services of one additional man, or of two local men for half a day each.

As this coach ran in warm weather and was fast (19.4 miles in 109 minutes driving time, or 10.7 miles an hour), the fresh horses at St. Germain were very welcome, and since the original time-table provided for a stop of five minutes there, no time was lost by the change.

The examples of twelve miles for a last stage, and of this Maisons-Laffitte time-table, are the extremes, since the former gives a somewhat long stage and those of the latter are very short.

A long stage, with two teams to work it, may be convenient in the middle of a route, if the stables are so situated that a uniform division is not possible.

Inasmuch as street work in a large city is more trying to the horses than work in the country, and since the horses of the end stage have only a short rest between their work, these two stages (in a city, and at the end), should be shorter than the stages of the middle ground.

The divisions have been, thus far, considered as if the road were of the same character throughout, but four miles of bad or hilly road may be as tiring as eight of the best, and the distribution of stages must be made accordingly. On a hilly road, where the pace *must* be slow, a long stage may be made, for 'it is the pace that kills.'

Four Swiss *vetturino* horses will take a large carriage thirty-five miles a day, over heavy mountain grades, at a slow walk when going up, and they will travel twenty-five miles a day regularly, but they go very slowly; while an average coach team, timed at ten miles an hour, will find two seven-mile stages a day quite enough.

An active team to a drag should be able to do nine miles an hour steadily for two hours on good level roads without fatigue, but that is too much work to be continued, at that pace, day after day. Three hours at seven miles an hour, would not be so much work, although the distance would be greater.

On a hilly road, the time of any one stage need

not be each way the same ; if it is all up-hill one way, it will be all down-hill the other, and the time lost in going up and that gained in coming down must be properly apportioned to the other parts of the road.

Owing to the wide-spread fondness in the United States, for trotting, an average team of American horses will undoubtedly get over the ground at a faster pace without galloping than the horses usually to be found in England or France, nevertheless it may be desirable to arrange for one galloping stage on a road. Such a stage is usually very attractive to the passengers, and on it horses may be used which cannot, or will not, trot pleasantly. This stage should be rather level ; it is hard work for horses to gallop up-hill, and it may be timed pretty fast,—thirteen or fourteen miles an hour, if it is not more than six or seven miles long.

When Mr TIFFANY was working the Brighton road in 1873, he had a galloping stage, from The White Hart, at Reigate, to The George, at Crawley, a distance of nine miles, which he did in thirty minutes, stopping once at a toll-gate.

When a coach runs out and in, the same day, the arrangement of the teams is simple, since the morning team out is the afternoon team back, the last team having the time for rest at mid-day that the coach has for lunch ; but if two coaches run in opposite directions on the same hours, each the whole length of the road, with a stop in the middle

of the day of only half an hour for lunch,—not time enough for a team to rest,—the arrangement is more complicated.

If long stages are adopted, each coach can take its teams one after the other straight through, each team working only once on one day and returning the next. This is simple, but not adapted to a fast coach, because the stages will be either too long to be done at a high speed, or each team will be doing less than a good day's work, it being assumed that a team can travel a greater distance in two hours than in one.

If short stages are adopted, and each team works once each way, over its own ground, while the early morning and afternoon teams will have sufficient rests between their turns, those working in the middle of the day will not.

If, for instance, the two coaches start from the different ends of the road at 10 A.M., and arrive at 6 P.M., meeting at two o'clock at a point where only a half-hour's stop is made, the team which brought one coach down from 1 to 1.45 would have to take the other up, starting at 2.15, without sufficient rest. It will be, therefore, necessary to have at this centre point another team for each coach, that team which comes in, resting until the next day. The two stages joining at this place would have to be longer than the others to equalise the work. If the whole road, for instance, is fifty-six miles long, or each half twenty-eight miles, divided into four seven-mile

stages, and supposing for simplicity that each stage requires one hour, the arrangement will be as follows :—

Hours—	10	11	12	1	2	3	4	5	6
Teams—	A	B	C	D	G	H	I	J	

Hours—	6	5	4	3	2	1	12	11	10
Teams—	A	B	C	E	F	H	I	J	

Team A	10 to 11	}	rests 6 hrs.	Team F	1 to 2	rests all day		
	5 to 6				,,	G	2 to 3	rests all day
,, B	11 to 12	}	rests 4 hrs.	,,	H	12 to 1	}	rests 2 hrs.
	4 to 5				,,	I		
,, C	12 to 1	}	rests 2 hrs.	,,	J	10 to 11	}	rests 6 hrs.
	2 to 4				,,	E		
,, D	1 to 2	rests all day						
,, E	2 to 3	rests all day						

This requires ten teams, four of which, D, E, F, and G, do only one turn a day.

It is evident that to equalise the work the middle stages should be longer than the others, and they might be divided as follows : 6, 6, 6, and 10, making 28 miles, with the times modified to suit the changed distances.

The fact is, that the additional teams are necessary because there is no long stop in the middle, or because the road is done in two hours less *total time* than it would have been if there were a long stop, although the actual *driving time* is the same.

Of the two coachmen required to work such a road, one coachman, going over the whole road each day, will go out Monday, Wednesday, and

Friday, and come in on the other days, the other coachman going in the opposite direction, and each one will drive the end teams every day, but each one will always drive the *same* middle teams.

In arranging the time-table of a road it is convenient to make a time-chart, such as is used on railroads.

One is shown in Plate XXXII. ; the names of the places and the distances, are at the top, the hours and minutes at the sides. If a coach were to start from A at 10 o'clock, and run straight through without stopping, to F, thirty miles, arriving there at 1 o'clock, its course would be indicated by the dotted line representing a speed of ten miles an hour.

If it makes four stops of 3, 3, 5, and 3 minutes each at B, C, D, and E, its course will be indicated by the full line, the *flatter* angle of which indicates its superior speed while running. If we suppose the road to be varied in its character, so that, between C and D, the pace must be slow, the time required for that stage must be taken from the adjacent stages making them faster, or from the whole of the rest of the route.

This is shown, in a somewhat exaggerated manner, by the line ————. If the road is up-hill from C to D, the speed coming down from D to C can be greater than on the other portions of the road, as shown by the return line.

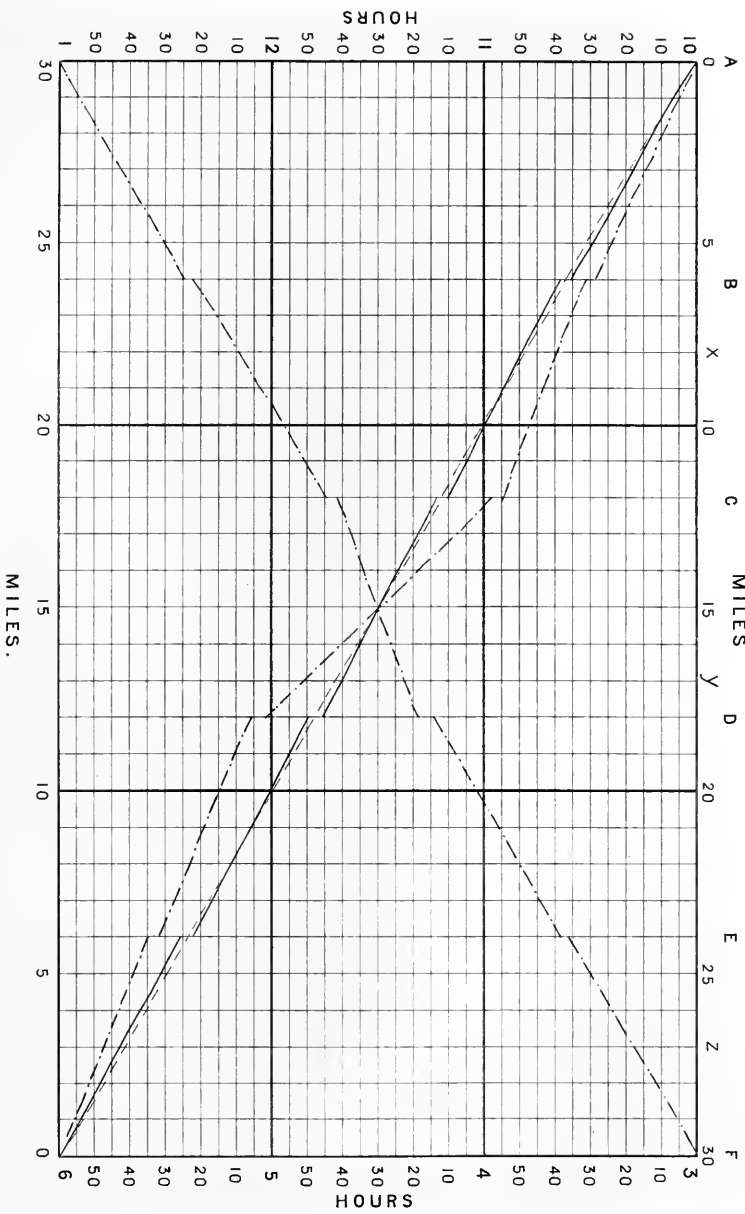

TIME-CHART.





By constructing a diagram of this kind, it will be easy to see exactly how the time should be arranged, and at what moments the coach should pass any other points : x, y, z.

The diagram should be made upon the engraved, divided paper which can be bought of any dealer in engineering supplies.

After the road has been laid out in this way, a Time-table is prepared, as follows :—

NO. OF TEAM.		LENGTH OF STAGE.	TIME IN MINUTES.	HOUR OF COACH.
	Start from A at 10 A.M.			
1	A to B . . . . .			
2	B to C . . . . .			
3	C to D . . . . .			
	Stop 5 minutes.			
4	D to E . . . . .			
5	E to F . . . . .			
	Total . . . . .			

The 'Hour of Coach' is the time of *arriving* at each station. The time in minutes of each stage is from arrival to arrival, except in the first line, where it is from the time of *starting* from the initial point.

In the old English mail-coach days the guard was provided with a Time-bill something in this form, except that it had a column in which the actual times of arrival had to be entered by the guard so as to show how the time had been kept. For this pur-

pose he was furnished with an official time-piece or large watch. A number of these Time-bills are printed in HARRIS'S *Coaching Age*, pp. 277-292.

The following Table shows how much the driving speed has to be increased to make up the time lost at changes, with seven-mile stages :—

At 9 miles an hour. 1 mile in 6 min. 40 sec.			
7 miles in	46.6 min.,	no stop	= 9.0 ms. per hour
7 "	45.6 "	1 min. stop	= 9.2 " "
7 "	44.6 "	2 " "	= 9.4 " "
7 "	43.6 "	3 " "	= 9.6 " "
7 "	42.6 "	4 " "	= 9.9 " "

At 10 miles an hour. A mile in 6 minutes.			
7 miles in	42.0 min.,	no stop	= 10.0 ms. per hour
7 "	41.0 "	1 min. stop	= 10.2 " "
7 "	40.0 "	2 " "	= 10.5 " "
7 "	39.0 "	3 " "	= 10.8 " "
7 "	38.0 "	4 " "	= 11.0 " "

At 11 miles an hour. 1 mile in 5 min. 27 sec.			
7 miles in	38.15 min.,	no stop	= 11.0 ms. per hour
7 "	37.15 "	1 min. stop	= 11.3 " "
7 "	36.15 "	2 " "	= 11.6 " "
7 "	35.15 "	3 " "	= 12.0 " "
7 "	34.15 "	4 " "	= 12.3 " "

The importance of making quick changes is evident, and also of not losing time by stopping for the purpose of altering couplings or of changing the biting.

The horses intended for the road are usually brought together at one point, as they are bought, and tried so as to arrange them in teams ; it is an

advantage to have them all of the same type, so that however they may be shifted about, they will look well together. The town-team should be the best looking, and made up of handy, quick, fearless horses ; a sluggish team, requiring the whip, is neither pleasant nor safe in the streets. As soon as possible the horses should be put out on the road and exercised over the ground on which they are to work.

The men required will be : a professional coachman and a guard, whose duties are described further on, and if perfection is desired, two horse-keepers for each change ; but one horse-keeper and a local hostler at the change-place can do the work, provided it can be so arranged that the latter will not be called off by his other duties at the change-time. If there are two horse-keepers, one of them must decidedly out-rank the other and have authority over him, or there will be endless friction between the two ; and the chief man must have the entire responsibility of the feeding. Their duties are obviously those of ordinary stable-men, but they have to be drilled in all the points of making a quick and neat change, so that the changes will be made in the same way at all the stations.

The material furnished to each stable, such as buckets, sponges, forks (and, by the way, a steel fork should never be allowed in a stable, only wooden four-pronged forks being used), brushes, halters, rugs, etc., should be entered in a book, in

which should be noted all purchases and losses, or the articles will rapidly disappear. Every man should have a strong canvas bag for his kit and be required to keep all his tools in it. Each horse should have a number branded on his fore hoof, and his collar, with a corresponding number permanently fastened on it, must always go with him when he changes his stable, otherwise changes of collars will give endless annoyance due to sore necks. The best way to mark a collar is by a brass number on the small cape, which, for that purpose, should be put upon the top of a coaching collar (p. 210).

Whether or not the horses should have loin rugs to be thrown over them while they are standing, depends upon the climate, the time of year, and somewhat upon the fancy of the owner. They are more important at the ends of the road, where the horses stand for some time while the passengers are getting on the coach. At the changes, if the time is kept punctually, they are not so necessary, since the horses should be brought out only a few minutes before the coach arrives, and they can have thrown over them, their stable rugs, which, when the coach appears, can be pulled off and laid aside, ready to be put on the horses which are taken from the coach; rough canvas rugs are good for this purpose.

If loin rugs are used, they should be uniform throughout the road; they certainly look 'smart,' but they are apt to fall off if the horses caper while

being led to their places, and sometimes cause a difficulty. They must be laid on *under* the reins.

It is a good plan to have in each stable a diagram showing the coupling and biting of the team, such as is described in Chapter XII. (Plate XXVI.).

Ten days or two weeks will be required to try the horses and the road thoroughly, and just before the opening day the whole road should be driven over at least twice, keeping the time and making the changes *exactly* as they are to be made in future.

It is usual on the opening day to have a party of invited guests, generally persons interested in coaching, and on this occasion everything should be done in the most careful manner and with scrupulous attention to punctuality.

COACHMAN'S AND GUARD'S DUTIES.—The professional coachman of a road-coach drives the coach from its stable to the office from which it starts and takes it back from the office to the stable, at the end of the day. He has charge of the horses, and should frequently go over the road to be sure that they are properly cared for and to arrange any transfers of horses from one stage to another, which may be necessary. He examines and pays the accounts for wages, feed, and shoeing. If he rarely drives the coach he has plenty of time for all these duties ; but if he is called on to occupy the cushion

several days in the week, he must have exceptionally good horse-keepers. It is convenient for him to have a light wagon in which to go over the road, for which the extra horses will serve, and he may sometimes go down on the coach and, stopping at one of the change-places, attend to the business of that and an adjoining station.

Of some of the London coaches, in late years, the professional coachman is the proprietor, and takes subscribers who pay for the privilege of driving on certain days, in which case the proprietor also goes on the coach, sitting on the back seat, and sometimes drives a stage or two if it is agreeable to the subscriber. At times the subscriber takes only one or two stages, out or in, at his convenience.

The duty of the guard is : to receive the way-bill from the booking-office, to show the passengers their places, to see that they have their tickets or to collect the proper fares from those who have not, to take charge of baggage or parcels, to assist at the changes, and to transact all the business connected with the passengers ; ordinarily he has nothing to do with the horses.

Usually at noon, the coach stops at an inn, where the horses are put up immediately upon being taken out, and the coach is drawn into the yard or left standing in the road near the door ; but if the stable is at some little distance from the stopping-place, or if, for any reason, the coach cannot remain

where it stops, it is convenient to have the guard drive well enough to take the coach to its stable and bring it back again, and guards who know anything about horses are glad to get that much practice.

The guard must be able to blow the horn *well*, not producing those melancholy sounds sometimes heard. To do this requires good instruction and much practice. The calls are given in the Chapter on 'The Horn,' and the *proper* ones should be blown at the changes and stopping; as to this, guards are frequently careless. As a rule, the guard can sound a call better when standing in his place on the hind boot, holding to the strap fastened for that purpose, to the roof-seat.

In the country, the horn should be used to ask for the road, of vehicles going in either direction, and also, according to the taste of the proprietor, to enliven the journey. Guards are apt to give too much horn; it interferes unpleasantly with conversation on the coach. In a city it should be used with judgement, and the calls needed to warn other vehicles should be short, of a few notes only. The horn is a great help to driving in a crowded street; but its use should not be abused; it is particularly annoying to other persons driving, when suddenly blown, in passing, so close to a horse as to alarm him. It is the duty of the proprietor to see that the guard does not thoughtlessly commit this fault. In driving through small towns, there is no objec-

tion to a free use of the horn ; there are apt to be obstructions in the streets, and the inhabitants usually welcome the passage of the coach, with its accompanying music, as a cheerful break in the day's monotony.

COACHMAN'S AND GUARD'S DRESS.—The dress of a gentleman coachman has been already described ; the professional of a road-coach need not dress very differently. He should always wear a white hat when driving, but when on the coach going to inspect the stations, this is not necessary. His dress should be plain and neat, and should have that unmistakable coaching or 'horsey' look which is difficult to describe. If the weather is cool, a drab overcoat, single-breasted, with pearl buttons, with flaps to the pockets, buttoning up rather high, and reaching to within eight inches of the ground, is very 'smart.'

The guard's dress should be a single-breasted, drab frock-coat, the skirt several inches above the knees ; with buttons on the back, and side pockets with flaps ; or it may be double-breasted and easy, having somewhat the style of an overcoat. It should button tolerably high in the throat, and show a white collar and scarf, or a regular hunting-scarf. The collar of the coat may be of a bright colour. Trousers of the same colour as the coat are correct, or else somewhat tight breeches, with gaiters, all of the same cloth ; the latter are neater than trousers.



With gaiters, laced boots look best. The hat should be light grey, with low crown and wide brim, but not exaggerated; it may have a dull felt surface or a nap. Tan-coloured driving gloves should be worn. A russet-leather case like a cartridge-box, about seven inches by four and a half, is carried on the left side by a strap over the right shoulder. It holds the way-bill or other papers, and has a pocket for the key of the coach. A small case for an open-faced watch is usually fastened on the front of it, but it is better to have the watch on the side next the body, where it can be easily seen by tipping the case outward away from the side of the body, and where it is not likely to be broken. If the watch is on the outside, it should be upside down, so that the guard can easily read the time when the case is turned up.

The mail-coach guards in England formerly wore red coats, the Government livery, and the fashion is still retained on some of the road-coaches of the present day, but in America it means nothing, and seems to be hardly appropriate.

BOOKING-OFFICE, ETC.—The booking-office should be at a place where some one will always be in attendance to take orders and money for seats. For this reason, an hotel, or a public office which is always open, is selected. For many years the starting-place of the road-coaches, in London was The White Horse Cellar (Hatchett's), in Piccadilly,

an hotel and booking-office in 'the old business coaching days, and later a public parcels-office. About 1889 the coaches abandoned the Cellar and started from the Hotel Metropole, or the Hotel Victoria, in Northumberland Avenue; the 'Guildford' Coach starts from the Berkeley Hotel, Piccadilly. In New York, the 'Pelham' Coach, and afterward the 'Yonkers' and others, started from the Hotel Brunswick in Fifth Avenue; the 'Tuxedo' Coach from the Plaza Hotel. In Philadelphia, coaches start from the Bellevue Hotel. In Paris, all the coaches start from the office of The New York Herald, Avenue de l'Opéra.

A book, properly bound, with the name of the coach on the outside, should be provided, one page being devoted to each day. These pages should be headed with the day of the week and of the month, and it is better to do this for the whole season, when the book is first opened.

The following is a good form of page:—

MONDAY, JUNE 7, 1897.		Dols.
Coachman : <i>Mr Thompson</i>		
Box :	<i>Mr Jones</i> . . . . .	4 <i>Pl.</i>
1 :	<i>Mr Smith</i> . . . . .	3 <i>Pl.</i>
2 :	<i>Mr Brown</i> . . . . .	3 <i>Pl.</i>
3 :	<i>Mr</i> . . . . .	
4 :	<i>Mr Robinson</i> . . . . .	out 2 <i>Pl.</i>

and so on for the other six seats, the sum at the foot being the amount for which the agent selling the tickets is responsible. When the settlement is

made, the amount may be receipted for on the page of that day.

A ticket should be given to each passenger bearing the name of the coach, the date, and the number of the seat.

The seats are usually numbered as follows :—

Box Seat		Coachman	
4	3	2	1
5	6	7	8
Guard		10	9

In Paris, it is the custom to have the numbers of the front seats run from left to right.

This diagram should be printed on the ticket, the seat sold being marked thereon. It is usually on the time-card also.

It should be an inflexible rule that a seat is to be paid for when it is booked ; places merely engaged, without payment, are frequently given up at the last moment, to the loss of the coach and to the disappointment of other applicants.

It is also a good plan to permit places to be booked for any date, no matter how far ahead ; it avoids any possibility of complaint of favouritism. In other words, the coach book should be open for the entire season to any one who chooses to select a date and to pay. It is proper, however, to re-

serve the opening and the closing days of the season, or any day like that of a coaching Meet; across the page should be written, 'no seats can be booked for this day.'

For the information of passengers a time-card is prepared and given with the ticket. Two specimens are printed below:—

From Monday, April 10th, until Saturday, June 3d, 1899.						
THE NEW YORK AND ARDSLEY COACH,						
"PIONEER,"						
WILL LEAVE						
HOLLAND HOUSE,						
DAILY, (Sundays excepted) at 10.00 A. M.						
TIME TABLE AND FARES						
MILES	FARES	LEAVING	TIME A. M.	FARES	RETURNING will leave	TIME P. M.
		Holland House	10.00		Ardsley Club	
6.2	\$ .75	*Harlem .....	10.30		Ardsley .....	3.30
2.7	1.00	Washington Bridge	10.53	\$ .25	Dobbs Ferry .....	3.40
3.6	1.50	*Kingsbridge...	11.15	.50	*Hastings .....	3.50
1.	1.75	Van Cortlandt..	11.20	.75	Glenwood .....	4.10
4.2	2.00	{ *Yonkers .. }	11.40	1.00	{ *Yonkers .. }	4.15
		{ Getty House.. }	11.45		{ Getty House.. }	4.20
1.	2.25	Glenwood .....	11.50	1.25	Van Cortlandt..	4.40
				P. M.	*Kingsbridge...	4.45
3.8	2.50	*Hastings .....	12.10	2.00	Washington Bridge	5.07
1.6	2.75	Dobbs Ferry .....	12.20	2.25	*Harlem .....	5.25
1.7	3.00	Ardsley .....	12.30	3.00	Holland House..	6.00
25.8		Ardsley Club...				

The Privileges of the Ardsley Club are Extended to Passengers on the Coach.  
 Single Fare, \$3.00. Round Trip, \$5.00. Box Seat, \$1.00 extra each way. This coach stops to take up and set down passengers wherever hailed, except between Holland House and 59th Street.

**BOOKING OFFICE, HOLLAND HOUSE.**

N. B.—PASSENGERS ARE CAUTIONED TO BE ON TIME.

\* CHANGE HORSES.

This Coach is worked with seven teams daily (including Sunday),  
 GIVING FINE VIEWS OF THE  
 River Thames, Windsor Castle, and Cliveden Woods, &c.

On and after 6th APRIL, 1896,

**THE MAIDENHEAD COACH**  
 "EXPRESS"

LEAVES  
**HOTEL VICTORIA, NORTHUMBERLAND AVENUE,**  
 at 10.45 a.m.

AND RETURNS FROM  
**THE THAMES HOTEL, MAIDENHEAD,**  
 at 3.45 p.m., every day (Sundays included).

Inter- mediate Fares.	DOWN JOURNEY Daily (Sundays included).	Mile- age.	Time Table.
s. d.	<b>NORTHUM'LAND AVENUE, "Hotel Victoria"</b> ... ..	—	10. 45
1 0	<b>KEW, STAR AND GARTER</b> ... ..	9	11. 30
5 0	<b>*ISLEWORTH, "Coach &amp; Horses"</b> ... ..	—	11. 45
5 0	<b>HOUNSLOW, RED LION</b> ... ..	13	12. 5
	<b>*GRANFORD BRIDGE, "Berkely Hotel"</b> ... ..	—	12. 20
	<b>HARLINGTON CORNER</b> ... ..	—	12. 32
6 0	<b>LONGFORD, PEGGY BEDFORD</b> ... ..	18	12. 40
7 0	<b>*COLNBROOK, "The George"</b> ... ..	—	12. 55
8 0	<b>SLOUGH, "Crown Hotel"</b> ... ..	23	1. 25
	<b>TAPLOW, RAILWAY STATION</b> ... ..	—	1. 50
10 0	<b>*MAIDENHEAD, "Thames Hotel"</b> ... ..	30	2. 0
	<b>UP JOURNEY.</b>		
	<b>MAIDENHEAD, "Thames Hotel"</b> ... ..	—	3. 45
	<b>TAPLOW, RAILWAY STATION</b> ... ..	—	3. 55
2 0	<b>*SLOUGH, "Crown Hotel"</b> ... ..	7	4. 20
3 0	<b>COLNBROOK, "The George"</b> ... ..	—	4. 45
4 0	<b>*LONGFORD, PEGGY BEDFORD</b> ... ..	12	5. 5
	<b>HARLINGTON CORNER</b> ... ..	—	5. 13
	<b>*GRANFORD BRIDGE, "Bedford Hotel"</b> ... ..	—	5. 25
5 0	<b>*HOUNSLOW, "Red Lion"</b> ... ..	17	5. 40
5 0	<b>ISLEWORTH, "Coach &amp; Horses"</b> ... ..	—	5. 55
10 0	<b>NORTHUM'LAND AVENUE, "Hotel Victoria"</b> ... ..	30	7. 0

\* Change Horses.

Single Journey, 10/-. Return 15/-.

Box Seat, 2/6 extra each way.

The whole of the Coach to Maidenhead and back, £8 8s.

Places can be secured at Coach Booking Office,  
 "HOTEL VICTORIA," Northumberland Avenue.

Some cards are much more elaborate, that of the 'Guildford,' for example, being in three folds, and having on the sides, descriptions of the road.

Blank way-bills should be also provided; a good form, one half the proper size, is given on the next page. The way-bill is filled up in the office as far as the seats are booked, and any additional fares are put on it by the guard. A way-bill is not very

necessary on a short coach where a majority of the passengers go through, at least the whole of one way.

THE CRESCENT  
SERVICE FROM PARIS TO PONTOISE  
WAY-BILL

DESTINATION.	NO. OF SEAT.	BOX SEAT	FRANCS.	CENTS.	REMARKS.
		OUTSIDE SEATS			
	1	.....			
	2	.....			
	3	.....			
	4	.....			
	5	.....			
	6	.....			
	7	.....			
	8	.....			
	9	.....			
	10	.....			
	11	.....			
	12	GUARD			
		COACHMAN			
		INSIDE SEATS			
	1	.....			
	2	.....			
	3	.....			
	4	.....			
		PARCELS			
		.....			
		.....			
		.....			
		.....			

PLAN OF COACH

11	10	9	gd
8	7	6	5
4	3	2	1

Coach-  
man
Box  
Seat

*Paris* ..... *189*

CHANGES.—Just before arriving at the change, the ends of the reins must be unbuckled; if the device described on p. 273 is adopted, it is necessary only to pull them apart.

If the passenger on the box-seat is accustomed to coaching, he will quietly pull up the ends of the reins and unbuckle them, when the change is in sight, or when the guard sounds the call for the change, and if this passenger happens to be a lady, there is a manifest reason for having the reins scrupulously clean, so that they will not soil her gloves. It may be also said that the tongue of the buckle should play loosely, the hole of the rein should be large, and the keeper, or loop, should be large and far back from the buckle, or too much time will be consumed in unbuckling and buckling.

The coach should pull up at the change-place easily but promptly, and care must be taken that the leaders do not stop too soon, as they almost always want to do.

The coachman throws the reins on the horses' backs, the off reins to the off side, and the near to the near side. With a little care they may be so thrown that they will lie in a fold across the back, and the ends will not fall in the mud. The reins must not be thrown down, however, until the coachman sees that some one is at the horses' heads.

The coachman then puts on the brake, without noise, but as hard as possible (see p. 328), and gets down, taking his whip in his hand; if he wants to

get rid of it, he should stand it behind the lamp-iron and leaning against it, with the butt on the ground. The horse-keepers, one on each side, pull the lead-reins through the terrets of the wheelers, and run them through the leaders' terrets, as is shown in Plate XXXIII. They then unhook the traces, the inside one first, and lay them over the leaders' backs, being sure that they are laid well

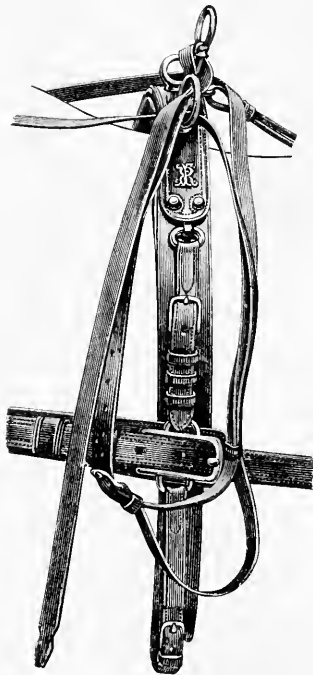

FIG. 171.

over, so as not to fall off when the horses move. The leaders should be led a short distance away and their coupling-reins unbuckled; they may be trained to stand still where they are left, or to walk to the stable if it is close at hand.

The wheelers' reins are hung on the centre-terrets (Fig. 171), the pole-chains slacked; the traces unhooked, the *inside* one first; the coupling-reins unbuckled (since the wheelers cannot get clear of the bars unless this is done), and the

horses led out of the way. If a spare man, or boy, is at hand, he can collect the four horses and hold them all at once, clear of the coach.



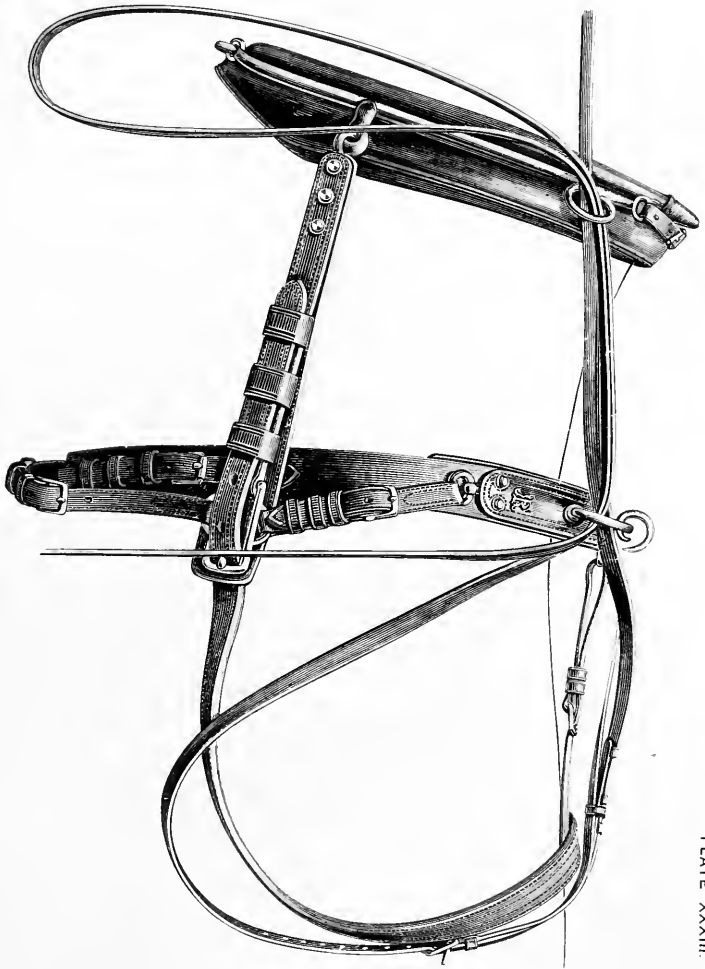

LEAD REIN PASSED THROUGH TERRETS



The wheel horses are then led to their places from the *side* or from *behind*. It is a bad plan to bring them to the pole, head on, and then turn them into their places. The pole-chains are hooked at their *full length* into the kidney-link ring; the traces put on the roller-bolts, the outside one first; and the pole-chain passed through the ring from the inside, outward, pulled down, hooked into the proper link, and its india-rubber ring pushed over the hook. The coupling-reins are then buckled.

The leaders are then led to their places, with the coupling-reins already crossed and buckled; the *lead-reins are run through* the wheelers' terrets, care being taken that the wheel-rein is first taken off the pad-terret, or it will be bound down by the lead-rein. Then the leaders' traces are hooked to the bars. The reason for running the reins before hooking the traces, is, that if the leaders start they can do no harm, not being attached to the coach, and they can be stopped by the reins, whereas if they are hooked to the bars *before* the reins are run, they might bolt and cause a serious accident. If the lead-reins have been properly put into the lead-harness terrets, they can be pulled through the throat-latch ring and the centre-terret by taking hold of the end, the whole rein running through freely. When the near side reins are ready, they are thrown over the wheeler's back to the off side, where the coachman is ready to receive them. This

is the reason for having the point, and not the buckle, on the near side reins.

The horse-keeper remains at the heads of the leaders ; the coachman gathers up his reins, buckling them and adjusting them to the proper length (see p. 286), and, taking his whip, gets up. He should glance rapidly over his horses to see that all is right, and especially that the coupling-reins are *crossed*, and that the draught-reins are outside and not inside, adjust his apron, take off the brake, and, nodding to the man at the horses' heads, start off as quietly as possible.

Horses are more apt to give trouble in starting from a change-place than when they are leaving the office at the beginning. In a quick change they know that they are to go the moment that they are put-to, and it is usually necessary to let them go promptly, or they will fret and balk. For this reason, the men should be instructed to move aside quickly, well out of the way, and since there usually is, or should be, plenty of room, the horses cannot do any harm.

The change should never take more than three minutes ; it can be easily done in two minutes if every man knows his business.

For a *very* quick change, if there is room enough and there are men enough, the wheelers of the change should be waiting, one on each side of the road, in such places that they will be abreast of the coach when it stops. The leaders coupled together

should be abreast of the place which they are to take in the coach, and standing on the side of the road away from the stable, so that they will not be in the way when the old leaders come from their places.

For a three-minute change, the horses may stand in a row, with their heads out, on whichever side of the road is the more convenient, usually on the off side, and in such a position that the coach will stop alongside of them. In a narrow road, with vehicles going passing by, they must stand in front. In some confined places they may have to wait in the stable yard, but this will obviously add to the time of making the change.

Accounts are given in coaching books, of changes made in old times in less than a minute on very fast coaches like the 'Wonder.' 'NIMROD' (*Northern Tour*, p. 338) says that on Captain BARCLAY'S famous coach, the 'Defiance,' one of the changes was made in a minute, and that the average did not exceed a minute and a half. In a road-coach competition at the New York Horse-Show in 1897, two contestants made a change of horses in the ring in 58 seconds; there were two grooms with the change team, and a guard and a groom on the coach. With a fast coach, no time must be lost at the changes; as will be seen by the Table on p. 446, the pace has to be very much increased to make up such loss, especially on short stages.

If there is only one horse-keeper, as was frequently the case with the old coaches, the coachman

and guard must assist if the change is to be other than a slow one, and the guard of the English mail-coach was required, by his instructions from the Post-Office, whose servant he was, to assist, in so far as it did not interfere with his mail duties.

On the modern road-coach, since the guard has no letter bags, and rarely any packages, to deliver, he assists regularly, and with two horse-keepers it is not necessary for the coachman to do anything. The coachman usually gets down, however, and receives the reins as they are thrown over to him. In rainy weather, if there are plenty of people to assist, he frequently remains upon the box to keep dry. In this case he keeps the whip in his hand, and holding it to the front, the reins are thrown over it one by one as they are drawn through the terrets, when by raising the whip, they slip down to his hand. This was done on the very fast coaches in old times, and saved, at the change, all the time that was required for the coachman to gather his reins and get up.

The question as to whether or not the coachman should get down at the change, has been mooted lately in some criticisms on road coaching; either way is perfectly correct.

Howsoever the change is made, the duties of each person must be carefully laid down and strictly adhered to, and the drill for it should be uniform at all the stations on the road.

## CHAPTER XX

## ROAD COACHING GENERALLY

SPEED.—On good roads the proper pace for a road-coach is ten miles an hour including changes: if it is made much faster, it may be difficult to keep time, but if the quality of the horses, and their consequent cost, is no object, ten and a half miles may be attempted. Less than nine miles is too slow to be entertaining either to coachman or to passengers.

The time of some of the road-coaches running in the past few years, is as follows: London and Brighton, 54 miles in 6 hours,—9 miles an hour; New York and Tuxedo,  $47\frac{1}{2}$  miles in  $5\frac{1}{2}$  hours (leaving out the time for lunch),—9 miles an hour; London and Guildford,  $28\frac{1}{2}$  miles in 3 hours,— $9\frac{1}{2}$  miles an hour; New York and Pelham,  $15\frac{1}{2}$  miles in  $1\frac{1}{2}$  hours,— $10\frac{1}{3}$  miles an hour; Paris and Maisons-Laffitte,  $19\frac{1}{2}$  miles in 2 hours,— $9\frac{3}{4}$  miles an hour; Paris and Pontoise,  $26\frac{1}{3}$  miles in  $2\frac{3}{4}$  hours,—a little over  $9\frac{1}{2}$  miles an hour. In all these cases the time of making the changes is included, so that the actual driving time is faster.

In old coaching days in England, the mail-coach rates of speed were from 9.4 miles an hour to 10.3; the majority running about 9.5. The 'Telegraph,'

London and Manchester, ran 186 miles in 18½ hours, —10 miles an hour; the Edinburgh and Aberdeen, Captain BARCLAY'S 'Defiance,' 129½ miles in 12 hours and 10 minutes (with a 2-mile ferry at which 30 minutes were lost and 30 minutes out for breakfast and lunch, making the driving distance 127½ miles in 11 hours and 10 minutes),—11.4 miles an hour.\* A part of this road was travelled at the rate of 13 miles an hour. The London and Bristol, 121 miles, and the London and Shrewsbury, 153 miles, were timed at 10 miles an hour, and the same speed was kept up all the way to Holyhead by the Irish mail. The London and Devonport was also a fast mail.

An interesting table of the mails and the coaches of those days is given in CORBETT'S *Old Coachman's Chatter*, p. 300.

These speeds over long routes meant going very fast in some places; 'NIMROD,' *Road*, speaks of the 'Regulator' as doing 5 miles in 23 minutes, that is, 13 miles an hour, and of the Devonport mail doing 4 miles in 12 minutes, equal to 20 miles an hour! This was in 1832. REYNARDSON (p. 84) speaks of having driven 14 or 15 miles in the hour.

The French malle poste (see Plate VIII.) was timed at 10 to 10½ miles an hour; † it had short stages of only 5 miles.

In more modern times, Mr TIFFANY'S Brighton

---

\* HARRIS, *Coaching Age*, p. 382.

† BEAUFORT, p. 327, and MORIN, *Report*, p. 410.



coach did the 9 miles between Reigate and Crawley in 30 minutes, stopping at a toll-gate on the way.

The Paris and Pontoise coach, 1891, did the 7.4 miles from Pontoise to Achères in 32 minutes, at the rate of nearly 14 miles an hour.

Of drives against time one of the best known is that of SELBY, on July 13, 1888, from London to Brighton and back, 108 miles, in 7 hours and 50 minutes, a bet having been made that he could not do it in 8 hours. This is at the rate of 13.79 miles an hour, including changes. SELBY had 8 teams; the 14 changes took altogether 6 minutes and 12 seconds; which being taken out, makes the driving rate 13.97 miles per hour.

On July 12, 1892, Mr EUGENE HIGGINS, having as his invited guests Messrs JAMES GORDON BENNETT, WILLIAM G. TIFFANY and T. SUFFERN TAILER, drove from Paris to The Hotel Bellevue, Trouville, 124 miles, in 10 hours and 50 minutes. There were 13 teams, and, owing to the fact that better speed was made than had been anticipated and that consequently the horses at the later stations were not ready, the 12 changes occupied 49 minutes, leaving 10 hours and 1 minute (601 minutes) actual driving time, which was at the rate of 12.4 miles an hour.

This was a remarkable performance, inasmuch as the horses were strange, many of them had never before been in four-horse harness, and the horse-keepers along the road were entirely unaccustomed to their duties.

The horses were none of them at all injured by the drive, and were all returned in good condition to the persons from whom they had been procured. The coach used, was built by GUIET & Co., of Paris, for Mr TIFFANY, and is an exact reproduction of the old English mail. It is shown in Plate VII. ; its weight is 2712 pounds. M. GUIET, M. HIECKEL, an amateur photographer, and M. LUQUE, the well-known artist, were inside passengers, MORRIS E. HOWLETT guard. The time was from 6 A.M. to 4.50 P.M., no stops having been made except for changes.

In a drive against time, there is some difficulty in determining the exact distance unless the roadway is gone over with a very accurate odometer, since measurements made on even a large-scale map fail to include some detours absolutely passed over by the coach. In the account of SELBY'S drive, *The Field* of July 21, 1888, remarks that while the distance is set down as 54 miles, the road-books call it 51 by the road actually followed. Unless, therefore, two coaches pass over exactly the same road, it is not easy to compare the times made by them to fractions of a mile in the hour.

In this same article, *The Field* mentions a run, from London to Brighton, of a coach taking the report of a speech of WILLIAM IV., in three hours and forty minutes, which is faster than SELBY'S time, but the run was only one way. It also states that on May-day, in 1830, the regular coach ran from London to Birmingham, 109 miles, in 7 hours and

39 minutes, which again is better than SELBY'S time of 108 miles in 7 hours and 50 minutes.

WHITLEY, *Coventry Coaching* (p. 13), says that JACK EVERITT drove 'The Wonder' on May-day, from Coventry to London, 150 miles, in 8 hours and 35 minutes; this is at the rate of  $17\frac{1}{2}$  miles an hour.

CORBETT (p. 129) says that the Coventry coaches on other May-days, travelled the same distance in less than 7 hours, or at the rate of 15.4 miles an hour. This was about the year 1823.

In all these cases the coaches were running on their regular routes, with horses and men in thorough training; their superior speed does not in the least diminish the credit due to the performance from Paris to Trouville.

Before the railroads to the Pacific were built, the United States mails were sent through by 'pony express,' and upon a number of occasions races were run by the rival Express Companies.

In 1854 BILL LOWDEN, a messenger in the employment of ADAMS & Co., carried the mail saddle-bags, weighing fifty-four pounds, from Tahama, on the Sacramento River in Northern California, to Weaverville, one hundred miles, in 5 hours and 13 minutes; that is, at the rate of 19.12 miles an hour. He had twenty-eight horses, stationed along the road, about four miles apart. Each horse was held by a mounted horse-keeper, who, when he heard the approaching messenger's whistle, started

ahead at a gallop, leading the fresh horse on his near side. When the messenger came up alongside, both horses being then at full speed, he jumped from his horse to the fresh one without touching the ground, and pulled the bags after him. It was cold weather, December, and the last forty miles were ridden after dark, over mountain trails and through heavy timber, with a light snow falling. The first sixty miles were covered in 2 hours and 37 minutes, at the rate of 22.9 miles an hour, or of one mile in 2 minutes and 37 seconds; the last forty miles in 2 hours and 36 minutes, at the rate of 16.44 miles in an hour, or of one mile in 3 minutes and 36 seconds. This hundred miles was of course only a small part of the whole distance traversed by the express at about the same speed. The nineteen horses which covered the first sixty miles, averaged 3.16 miles each; the nine which did the last forty miles, 4.4 miles each, the pace being slower.

This account is taken from a Western journal and was furnished by LOWDEN himself; while not exactly 'coaching,' it is interesting as a record of speed with relay-horses.

Whatever may be the rate at which the coach is timed, punctuality is most important, and the coachman should make it a point to start and to arrive exactly upon time, and to be at his changes at the moment marked for them. This accuracy is the life of public coaching, and no delays should be permitted nor any passenger waited for. It is a good

plan to print a notice to this effect on the ticket and on the time-card and to adhere to it rigidly.

The coach should not be taken off its regular road or its regular time, unless (in accordance with a notice given in the commencement of the season) for some special reason, such as the holding of a race-meeting, at the place to which the coach runs. A coach which goes here one day and there another, is not a public-coach at all, but merely a vehicle hired for excursions. Public coaching is public business, and as such it must be conducted.

On a public coach, persons known to be competent whips are sometimes invited by the proprietor to drive, either a stage or two, or for several days at a time, and it need hardly be said that the most scrupulous care in giving such invitations must be taken, to avoid any possibility of accident. The coaches run by coaching jobmasters sometimes have subscribers, who pay toward the support of the coach, with the privilege of driving on certain days ; in the selection of subscribers, the same care ought to be exercised.

In Paris, the police regulations in regard to public coaching are somewhat onerous. The proprietor, who may be the coachman himself, must be a resident of Paris, and is responsible for damages in any legal action. The coachman must be examined and licensed by the police authorities, and if he is not himself the proprietor, must be regularly registered as employed by the proprietor. This

does not apply to a subscriber, when driving, but in this case the regular, licensed coachman must be on the coach, and is supposed to have charge of it.

In London, the regulations are more simple, but there, and in American cities, licenses must be obtained, and the coaches numbered, like all other vehicles plying for public hire. In London, public coaches are not admitted to Hyde Park, and there are, in nearly all cities, regulations, more or less restrictive, in regard to Public Parks.

On a route which occupies all day, or on a road where the coach runs to a place and returns, it is usual to make an arrangement with the hotel at which the stop is made, to furnish a lunch at a fixed price, and to send word by telegraph at the time of starting, or from any convenient place, for what number of persons lunch is to be provided. It is customary for the proprietor, or the amateur coachman, to sit at the head of the lunch table. The professional coachman and the guard make their own arrangements for meals. At some change-place which is passed in the afternoon, a stop of six or seven minutes is made for a cup of tea.

The fees given to the professional coachman and to the guard belong, of course, to them ; those which are sometimes given to the amateur coachman are either handed over to the professionals or to some charity.

There are many notes in the books, as to the distances driven by coachmen. CORBETT (p. 134)

says, that on one occasion, a friend of his drove 174 miles without a rest. He also says, that Mr KENYON drove the whole journey from London to Shrewsbury, 153 miles, without resting. Captain BARCLAY of Urie, who was famous in the early part of this century in all athletic sports, as well as in coaching, drove from London to Edinburgh, a distance of 395 miles, straight through, with only the rests allowed for the passengers' refreshment. This was for a large wager with LORD KENNEDY, and far exceeds any long distance drive on record. HARRIS, *Coaching Age* (p. 383), calls it 397 miles, and says that the time was 45½ hours. 'NIMROD,' *Northern Tour* (p. 335), says that the drive was from London to *Aberdeen*, which is 495 miles, but this is, probably, an error; all other authorities give Edinburgh. I have spent a good deal of time in searching for some original or detailed account of this drive, but without success.

Driving regularly one hundred miles a day is hard work, but with a short rest in the middle of the day, a man in good condition ought to be able to drive daily seventy miles. Much will depend upon the horses; a hard-pulling team taking more out of a coachman in one stage than easy-going teams in three stages, and horses lazy, or not up to their work are very fatiguing.

Beside the mere physical fatigue of driving, the mental strain is sometimes great, and at all times the feeling of responsibility and the close attention

required, take a good deal out of a conscientious and careful coachman. A cool temperament is an immense advantage to a driving man.

#### AMERICAN COACHING

The great extension of railroads in the United States has restricted public stage-coaching to a few mountain districts in the East, and to California and the far Western States, where it still flourishes.

The following notes on coaching in the White Mountains, as conducted at the present time, are applicable, in the main, to all American coaching. The coach itself has been described in Chapter VII. ; there is nothing peculiar about the harness, which is usually plain and made of single leather, the wheel-horse harness having breechings. The wheel-reins run through the pad-terrets, but the *lead*-reins go straight to the hand from the wheelers' heads, and consequently reach the hand at a different angle from the wheel-reins. Since they do not pass through the pad-terrets they swing about in a disagreeable manner. The lead-reins go through rings on the throat-latch on the *inner* sides of the wheelers' heads. If there are six horses, the lead-reins go through the throat-latch terrets of the swing-team and of the wheelers, but not through their pad-terrets ; sometimes the swing-horses have head-terrets.

With six horses, a chain is frequently used instead of a middle pole, and the swing-team is sometimes



called the chain-team or the chain-horses. As a rule, the ends of the reins have no buckles.

The lead-traces are never lapped nor crossed. The harnessing is somewhat loose; that is, the traces and the pole-pieces are long and the horses travel far apart. The pole-pieces are straps of unchangeable length (27 inches), and are fastened to the pole-head, a strap attached to the hames being passed through them (see Plate XV.).

In the White Mountains no great speed is attempted; the roads in many places being soft and sandy, with long ascents. Six horses are frequently driven, the load being usually three tons:—one ton for the coach, one for the passengers, and one for the baggage. The time is about seven miles an hour down-hill, and five, up-hill.

In the West, on some routes, the pace is often fast; the horses, small active mustangs, being driven at a gallop.

It is doubtful whether or not it would be worth while to attempt any comparison between the English and the American methods of handling the reins. The professional coachman on each side of the water is firm in his opinion that the man who drives as he does, knows how to drive, and that he who drives differently, knows nothing about the matter.

One can hardly assert that a man who, ever since he was a boy, has successfully driven a coach fifty miles a day, winter and summer, over all kinds of

roads, is not a good coachman and does not know his business; so we are forced to the conclusion that both methods must be more or less right. It is undoubtedly true, however, that many persons who have learned to drive four-in-hand with two hands, have afterward taken to driving with one, whereas no one who began with one hand, has ever abandoned that method to take to two hands.

It is interesting to note that the Austrian method of driving resembles the American. The reins are buckled together (as shown in Fig. 113), the hindmost buckle coming just behind the hand. The near reins are held in the left hand, the off reins in the right, and, in turning long corners, *chopping* is usual; that is, the near or the off reins are pulled while held together, with the result of shaving the corner closely with the hind wheel, the inside wheel horse being sometimes touched with the whip to keep him away from the corner. For sharp turns, a point is made by drawing the lead-rein through the fingers, behind which it makes a short loop, owing to the buckle which holds it, and after the movement is completed this loop is allowed to slip out. For a very sharp turn, the outside wheel-rein is looped in the same way, to make an opposition.

The fingering is, in fact, almost identical with that of the American method, but from the reins being fastened together it has the disadvantage of much less flexibility. In the Austrian style, the wheel horses are poled up tightly, with their traces always

stretched ; the lead-bars are attached rigidly to the pole-head, although the draught is by a rope passing under the pole ; and, in Continental fashion, when going down-hill the brake is always on and all the horses have their traces tight. The length of the team is, therefore, invariable, whether going up-hill or down-hill, and the reins, when once buckled together at the proper place, do not require to be changed, consequently the want of flexibility, above referred to, is not so objectionable as it would be for a team harnessed and driven in the English fashion. In English, and especially in American, driving, the horses are much more loosely harnessed, and the leaders are held back on a descent and usually on a turn, so that an invariable relative length of the wheel-reins and lead-reins would not work satisfactorily.

Coaching in America in the past is not surrounded by that halo of romance which attaches to English coaching. It was always too severely business-like and too roughly done. The 'stage-waggon' (shown in Fig. 172, which is a photographic reproduction of an advertisement in *The Pennsylvania Gazette* of April 19, 1764), and the stage-coach (Fig. 173, from *Poulson's American Daily Advertiser* of July 11, 1812), were gradually superseded by coaches of more modern fashion. These old coaches seem to have been described much in the same way as the English coaches, as the following advertise-

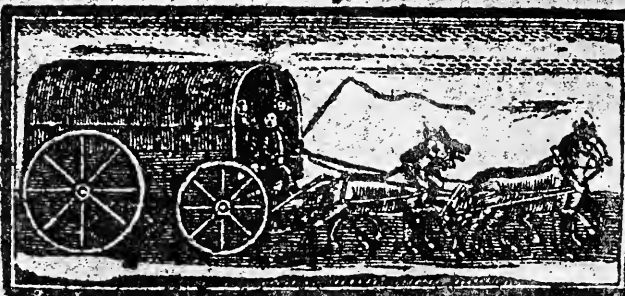

**NOTICE IS HEREBY GIVEN,**

**T**HAT the Subscriber, living in Third-street, next Door to the Sign of the Three Reapers, has provided convenient Stage-Waggons, which go from Philadelphia to Trenton Ferry every Monday, Tuesday, Thursday and Friday, and there deliver Goods and Passengers to Francis Holman, and Daniel Cassner, who carry them to New-Brunswick, to William Richards, and Simon Huffy, who deliver them at Amboy or Elizabeth-Town, where they will be received by Andrew Hampton, who has one of the most convenient Boats to carry them to and from New-York; the said Boats set out from New-York on Moodsays and Thursdays; those who please to favour them with their Custom, may depend on being well served.

JONATHAN BILLS;

FIG. 172.

ment in *The Pennsylvania Gazette* of June 18, 1783, shows :—

‘The NEW YORK flying MACHINE. The SUB-  
 ‘SCRIBERS beg leave to inform the public, that they  
 ‘have established A flying STAGE COACH & WAG-  
 ‘GON to perform the whole distance from this city  
 ‘to Elizabeth Town in one day.

‘THE COACH will leave the Bunch of Grapes  
 ‘Tavern, in Third Street between Market and Arch  
 ‘streets, precisely at 4 o’clock every Tuesday and  
 ‘Thursday morning, breakfast at Bristol, dine at



FIG. 173.

Princeton,\* exchange passengers with the Stage Coach from Elizabeth Town, and return again the same day to the Bunch of Grapes.

The Waggon will leave the tavern, at the same hour, every Monday, Wednesday and Friday morning, proceed and return as the coach mentioned above. The price for each Passenger in the Coach to Elizabeth Town is *Six Dollars* and *Four Dollars* for outside passengers: and *One Guinea* each for a seat in the Waggon.

Each passenger to be allowed 14 lb. weight of baggage under their seat—But *One Guinea* must be paid for every 150 lb. weight, either in the coach or waggon, and in proportion for any less

---

\* Princeton is 44 miles from Philadelphia, making the day's drive 88 miles.

‘or greater quantity. The baggage must be deposited at the Bunch of Grapes the preceding evening, otherwise it cannot be received in the stages.’

‘GERSHOM JOHNSTON

‘Philad. June 16, 1783.

CHARLES BESONETT

‘N.B. The Baltimore Stage Waggon leaves the Bunch of Grapes tavern on Monday, Wednesday and Friday morning precisely at 5 o’clock, and proceeds for Alexandria (in Virginia) a passenger taking a seat in the stage at Elizabeth Town, may arrive at Alexandria in four days, a distance of 240 miles.’

From another advertisement it appears that the ‘flying Stage waggon’ had four horses and changed every 20 miles. Another advertisement, of 1782, says, ‘NEW ERECTED STAGES. These Machines, which are on springs, and very easy carriages, etc.

In the *Pennsylvania Journal* for February 4, 1784, is the following: ‘The stage from this city to Baltimore on Monday the 19th ult. crossing the Susquehannah on the ice, broke in, and with difficulty the passengers were saved, two of the horses were drowned.’

Evidently there was sometimes a competition in speed, for one advertisement of 1788 says that ‘The drivers are prohibited on severe penalties from running their horses.’

These coaches carried the mail under contract with the Government, and a guard in charge of it ; in fact, the system seems to have been the same as that of the mail-coaches in England, but less elaborate.

ENGLISH COACHING.—The story of English coaching is thoroughly told by CORBETT, MALET, HARRIS, BEAUFORT, LENNOX, and REYNARDSON, whose works are mentioned in the List of Books in this volume.

The characteristic feature of English coaching was : that there were two kinds of coaches, namely Mails, which were under special contract with the Post-Office Department and carried mail guards, who were the servants of the Government and not of the coach proprietors ; on these Mails only a limited number of passengers were carried ; and secondly Coaches, which were loaded more heavily and which had a guard of their own, and sometimes, on the less busy routes, no guard at all.

Of course the original purpose of the guard was to protect the mails, and he was therefore armed with a blunderbuss ; for this reason, he was often called 'the shooter.' The mails usually ran at night.

On unimportant roads there were no mail-coaches, and the ordinary coaches carried Government mail-bags. These coaches had places for fifteen passengers ; four inside, and eleven outside ; hence the

expression in coaching songs, of 'eleven and four,' meaning a full load :—

'As he rattles along with eleven and four  
'And a petticoat on the box.'

Both the mails and the coaches were the property of coach-builders, who hired them out to the proprietors of the road or to the mail-contractors, at so much a mile run per month.

On a long route there were usually several proprietors, who together furnished the horses, employed the coachmen, and managed the business generally, dividing the profits according to a monthly settlement.

Some of the large proprietors had as many as twelve hundred horses, and horsed a number of lines of coaches and mails. HARRIS, in *The Coaching Age* and in *Old Coaching Days*, gives a detailed account of all this business.

The *Encyclopædia Londonensis*, 1826, p. 308, says that (at that date) 'there are about 170 coaches and 4500 horses, employed in England for the mails; all private property.'

The average fares were: outside, 2½ to 3 pence a mile, inside, double that; the mails were somewhat dearer.

The 'road game' is frequently referred to in old books, and it is not a bad aid to merriment in any coaching trip. Each person, or party of persons, chooses one side or the other of the road, and cer-



tain objects as they were passed on the right or left, counted in a scale of values well understood among coaching travellers. According to REYNARDSON, a donkey counted as 7, a pig as 1, a black sheep as 1, a cat as 5, a cat in a window as 10, a dog as 1, a magpie as 1, a grey horse as 5, and some other objects, now known to us only by tradition, had higher values. The party of travellers making the largest count in a certain time or distance, won the game.

## CHAPTER XXI

## COACHING TRIPS

FEW more delightful ways of travelling can be imagined than that of driving a coach through an interesting country.

When a man starts with his coach and horses, from his own home, few preparations are necessary beyond laying out the route and making arrangements ahead at the stopping-places.

It is necessary, if the party is at all large, to have the heavier baggage sent on by a messenger, day by day, but where that is not possible, it must be despatched to some point ahead, and the travellers must content themselves with modest valises.

With a good team, carefully driven, from 20 to 25 miles a day can be easily made over good roads, for an indefinite time.

In England and in France, where the roads are admirable, the inns good, and the stopping-places near together, coaching trips can be readily arranged.

A coach with the men, and with either one team or two, can be had from a jobmaster of London or Paris; with two teams, twice the distance that can be made with one team, can be driven each day; four horses being sent on by train every half-day while the others are working.

A good plan for a trip with one team is as follows: the coach starting about ten in the morning, the baggage is sent by rail to the stopping-place for the night, in charge of a man who engages the rooms and stabling and orders the dinner; a stop of at least two hours is made at mid-day for lunch, and to rest and feed the horses; the hours of the afternoon drive may be so arranged as to have the most time at the lunch place or at the night place, as their respective interest demands.

Barring accidents, the same horses will do this work for any number of days, and an unfit horse can be replaced by rail. One of the men hired with the coach, should drive well enough to take it to and from the stable, but if a man is provided who is to drive on the road, a higher charge is always made for him.

The cost of a trip varies with the locality, but the following list of expenses of a drive in the West of England, with a party of five, will give an idea of the expense:—

Coach, horses (a single team), and two men, £42 a week (this includes the night-stabling and feed); hotel bills, £38; fees at hotels, £2; railway fares for valet with baggage, £3; fees to coach men, £3; lunches, and noon-feeds for horses, not included in the coach hire, £10; altogether, £98, about \$484 per week. For a larger party, only the hotel bills will be increased, the other expenses will remain the same.

COACHING CLUB TRIPS.—It has been for many years the custom of The Coaching Club at New York to make one or two trips every year, driving from the city to the residence of a member of The Club, to spend a day there, and to return on the third day. A coach belonging to The Club is used, and teams, sufficient to cover the ground, are furnished by members.

The distance varies from 30 or 40 miles to 80 or 90, and one trip has been made of 317 miles, consuming four days, but driving only one way.

The first of these Coaching Club trips was made, on the invitation of a Philadelphia member, on May 4th and 6th, 1878, from New York to Philadelphia, through Newark, Elizabeth, Rahway, Metuchin, New Brunswick, Kingston, Princeton, Trenton, Bridgewater, and Holmesburg, a distance of 90 miles. The time was from 6.30 A.M. to 6.30 P.M., with a stop of 40 minutes at Princeton for lunch, leaving 11 hours 20 minutes driving time, at a rate of 8 miles an hour. The hours on the return trip, Monday, May 6th, were from 6 A.M. to 6 P.M., and on both days the arrival at the end of the journey was precisely on time. There were nine teams, the stages being 10, 11,  $7\frac{1}{2}$ ,  $7\frac{1}{2}$ , 10, 10, 10, 11, and 13 miles. The coachmen were Messrs A. DELANCEY KANE, FRANCIS R. RIVES, PERRY BELMONT, THEODORE A. HAVEMEYER, HUGO FRITSCH, GEORGE P. WETMORE, FREDERIC BRONSON, GEORGE R. FEARING, and the Philadelphia member, the present writer.

This trip was repeated in 1887, the route and the time being the same, with the exception that the time taken out for lunch was one hour, thereby reducing the driving time to eleven hours, and that there were twelve teams instead of nine. Many other trips have been made since then in all directions from New York, but the Philadelphia trip has been described because it was the first. The longest trip was made in June 1894, from New York to 'Shelburne Farms,' Vermont, the residence of Dr WEBB. This required four days; on the first day, June 6th, the coach went from New York to Poughkeepsie,  $82\frac{1}{4}$  miles; on June 7th to Troy,  $83\frac{1}{2}$  miles; on June 8th to Rutland, 89 miles; and on June 9th to 'Shelburne Farms,' 63 miles; a total distance of  $317\frac{3}{4}$  miles. There were twenty teams, the horses used on the first day being sent forward by train the second day to be driven on the third. Those used on the second were again driven on the fourth day. All the horses were sent back to New York by rail on the fifth day, the drive having been made in one direction only. The time was kept throughout accurately, no accident happened to any horse and not a man was out of his place,—proofs that the arrangements had been carefully made and that the discipline was good.

The arrangements for these trips are briefly as follows: a route having been decided upon in response to an invitation of a member to visit him, every member is asked whether or not he will

furnish a team; the requisite number of teams having been obtained, each member is assigned a stage, usually by lot, and he is notified at what time and place, his horses are to be in readiness, on the road, for his change. It is customary to assign the last stage to the entertaining member.

All the members going on the trip, start on the coach, and each one takes up his own team at its appointed place and drives it over his stage; his men go inside the coach with their blankets and stable tools.

A card for the seats is so made out that the box-seat is occupied in turn by each driving member, thus giving each one an opportunity of seeing one other man drive.

STAGES.	1	2	3	4	5	6	7	8
Mr A,	C	5	4	10	1	6	10	B
Mr B,	10	C	5	B	5	3	8	1
Mr C,	4	10	C	8	B	7	2	9
Mr D,	9	1	8	C	10	4	B	2
Mr E,	3	6	3	7	C	8	1	5
Mr F,	5	B	9	4	6	C	5	10
Mr G,	1	7	2	6	4	10	C	4
Mr H,	B	8	10	1	7	2	7	C
Mr I,	6	2	B	5	3	9	3	7
Mr J,	2	9	1	2	8	5	9	8
Mr K,	7	3	6	9	2	B	4	6
Mr L,	8	4	7	3	9	1	6	3

An example of a card is here given where there are twelve passengers, of whom eight drive, there being only that number of stages. C stands for coachman, B for box-seat.

For the servants, these trips are a useful test ; it is no slight matter to have four horses in good condition, all the harness complete, nothing forgotten, at a certain spot some distance from home, ready exactly on the minute and everything looking neat ; the head coachman who can accomplish it must be a competent man.

These trips are usually timed at nine miles an hour, which experience has shown is quite fast enough, and a point is made of keeping time closely, not an easy thing over a road unknown or only partially known, to the members driving.

## CHAPTER XXII

## THE RULE OF THE ROAD.

THE rule of the road is to a great extent a matter of tradition and unwritten, although in some cases it is recognised and enforced by laws and ordinances.

In the United States, and generally on the Continent of Europe, vehicles which meet, keep to the right ; that is, they have their left sides toward each other ; in the case of ships this rule is rigidly prescribed by the laws of navigation. In Great Britain and in some parts of Europe, the opposite rule is observed, and vehicles keep to the left, while pedestrians, as far as any custom regulating their movements is observed, keep to the right. The reasons for this variety of customs are not easy to trace. In all countries when times were less peaceful than at present, and when nearly every man carried a sword or a cudgel, a pedestrian naturally presented his left side to an approaching stranger as giving the best opportunity of warding off an attack with his left arm while enabling him to attack with his right. Inasmuch as those of high rank, however, usually insisted upon taking the wall side, this custom could not have been universal, although the desire to keep to the wall and at the same time to present the left



side would lead to passing to the right in a narrow street, by all the persons moving in it.

With persons on horseback it would be different ; each one would then prefer to have his sword arm on the side of the person approaching, and not to be obliged to strike across his horse in case of an encounter, so that it is probable that mounted men observed a different rule, as knights in tilting would of course do.

In early days, when the majority of vehicles were guided by a man who rode, or walked beside, the left-hand horse, it was natural that he should keep his vehicle on the right-hand side of the road so as to see how much room to give an approaching vehicle. In all countries it is certain that horses were led and handled from their left side, and the English terms, and American terms as well, of *near* side and *off* side indicate that this custom was identical in both countries.

When carriages with a seat for the driver came into use, the reins were held in the left hand because on horseback they were so held, in order to leave the right hand free for the sword, and the driver sat on the right-hand side of the vehicle to avoid having his whip project over the road, and then it would be more convenient for him to permit approaching carriages to go on his right, so that he could see how near he went to them, and thus the present English fashion might have been, and probably was, established.

Whether or not the English rule of the road was in force in early days in America, and if so, when it was changed to our present rule, I do not know, although I have made careful researches into the question. On many old bridges may be seen the sign,—‘Keep to the right as the law directs,’—but so far, although aided by the opinion of friends learned in the law, I have been unable to find the date or the text of any such statute. It appears that there is no general enactment in England upon the subject, but in both countries the custom in force has so far become law, that decisions in cases of collision and damage are usually decided by the Courts as if a statute did actually exist. There are in both countries numerous local ordinances regulating traffic on the road.

Apart, therefore, from any historical interest that may attach to the origin of these customs, they have to all intents and purposes the force of law and must be observed by coachmen. The English rule is embalmed in the familiar lines :—

‘The rule of the road is a paradox quite,  
‘Both in riding and driving along ;  
‘If you go to the left you are sure to go right,  
‘If you go to the right you are wrong.

‘But in walking the streets ’tis a different case,  
‘To the right it is right you should bear ;  
‘To the left should be left quite enough of free space  
‘For the persons you chance to meet there.’

As there is no 'paradox' in the American rule, no poet seems to have been inspired to embody it in verse.

While the rule of driving is perfectly understood in England and adhered to, that of walking is barely recognised, and the lack of a rule must have struck all Americans when walking in London. In Liverpool and in London there have been somewhat recently put on the lamp-posts, notices to pedestrians of 'Keep to the right,' a sufficient indication that the public did not of their own motion sufficiently observe such a rule. In American cities the rule for pedestrians is usually observed with some strictness.

The rule in driving, of keeping to the right being universal in the United States, it follows that a vehicle when overtaken should be passed to the left, a rule which should be always observed by both parties; that is to say, the vehicle which is moving slowly, upon seeing that another wishes to pass it, should incline to the right sufficiently to give the passing one a fair share of the road. It is ill-natured to neglect to give way for a person who wishes to go on at a faster pace; unfortunately it is a not uncommon form of incivility.

On the other hand, the vehicle, after it has passed, should be driven on at the faster gait, and should not on any account be pulled down to the same pace as that of the overtaken one, when immediately in front of it. If the driver is

not certain that he can go on faster than the carriage he is about to pass, he should not attempt to pass at all.

In a wide road or street the slow traffic should keep to the sides, leaving the centre for those who wish to go faster; only a thoughtless or an ill-natured driver will go at a walk in the middle of the road, thereby preventing those who wish to go faster from passing him, yet it is a spectacle constantly to be noticed in the public parks. In fact, a courteous attention to the rights of others using the road is the duty of all drivers. In passing two horses, one of which is ridden and the other led, it is particularly important to go on their left-hand side; the led horse is on the off side of the two, and when a vehicle passes him on his off side he is likely to turn his croup outward and to kick, in play, or for defence, and in either case an accident may ensue. Obviously, a man leading a horse, should keep well over to the right-hand side of the road so as to have his led horse out of the way.

The introduction of street railways has somewhat unsettled the rule of the road, for the reason that inasmuch as a car cannot go to the right, the overtaking vehicle, if it passes to the left, may meet another one going in the opposite direction on its proper side, where there is rarely room between the car and the kerb for two carriages. It is therefore usually necessary when overtaking a car to

pass upon its *right* side where no meeting vehicle is likely to be encountered. This change of rule is even more necessary when there are two tracks on a street, because cars going in the opposite direction and carriages following them on the track are still more in the way. These movements should therefore be made with much caution. A car usually goes quite as fast as any one ought to drive in the streets, and it is a mistake to attempt to pass it even if it is stopped for a moment, since if it starts while the carriage is alongside of it, a considerable distance must be gone before reaching a place in front of it, with the chance, in the meantime, of being obliged to stop for some vehicle coming in the opposite direction with the right of way.

In going round a corner, the proper side of the road should be kept throughout the whole of the turn. In turning to the right, the carriage should be driven somewhat close to the kerb all the way round, it will then come into the new street on the proper side of the way, but in turning to the left out of one street into another, the left-hand kerb must be avoided, and a wide turn made, so as to come into the new street on the right-hand side, going from the right side of one street to the right side of the other. Even fairly good coachmen frequently make the mistake of cutting close to a left-hand corner, thereby obstructing the traffic which is coming on the right side of the street, inviting

a collision, and making it necessary to continue crossing obliquely to the right, to get on the proper side of the road,—a slovenly way of turning a corner.

The traffic of crowded streets is much facilitated by a custom, common in London and Paris, but not, as yet, generally adopted in American cities, of the coachman signalling his intentions to those about him. If he intends to diminish his pace, or to stop, he raises his whip, usually twirling the thong in a circle, to attract attention; if he is to turn to the right or to go over to the right side of the road, he raises his right hand, having passed his whip into his left, as an intimation to those behind him not to come up on his right side; if he wishes to turn to the left, he does the same with his left hand. If there is a footman on the box, he may make the motion to the left, as soon as he knows the intention of the coachman. On a coach, it should be made by the groom who is on the inside of the turn, if he knows that the turn is to be made; as, for instance, in going round a corner toward home. When about to turn or to incline to the left, the coachman intimates his intention to those who are *meeting* him by pushing his hand and the butt of his whip, horizontally to the right; he can make the same movement to the left, but it is not so distinctly visible.

In turning completely round, these notices should be given with more care than in turning a corner,

since the movement will be unexpected by those behind.

Before turning a corner, out of a road which has several lines of traffic in it, the coachman should edge over toward the side to which he intends to turn, so as not to have any vehicle coming up behind him on the inside of his turn. If, for instance, there are three lines of traffic going each way on a wide road, and he intends to turn to the left, he should get into the left-hand line, and when he turns the corner, the carriages behind him will move straight on without his being in their way, but if he remains in the extreme right-hand line until he begins to make his turn, he must cross two lines of vehicles and stop them, before he can make his turn.

If he wishes to turn out to the right he should get into the right-hand line, and when he reaches his corner he can turn round it, without in the least interfering with those coming behind. These rules seem simple and trite, but it is only necessary to watch for a short time, the driving in a crowded road to see all of them violated.

A good horseman keeps his eyes always in front of him, observing all that is going on, even if he may be at the same time talking to a person alongside of him. This habit should become a second nature to any man wishing to be a good coachman; he will then see what those approaching him are doing or are about to do. He must always be decided as to what he himself intends to do, and not

change his mind after having commenced a movement, or else those meeting him will not know what he intends. This makes an immense difference in the ease and security with which crowded traffic is conducted. In the London streets, where nearly everyone seems to be a born coachman, and where anyone who does not drive well, is unmercifully gayed by those around him, it is easy to know exactly what each person intends to do, and the traffic moves smoothly even at the most crowded hours. In Paris, where cabmen and private coachmen usually drive badly, and without the least attention to each other's rights, it is often extremely difficult to foresee from his actions, what the man in front is going to do, and uncertain movements and collisions are the result.

This is aggravated by the fashion, almost universal in Paris, of driving with both hands, which makes it difficult for a coachman to diminish his pace or to pull up suddenly, owing to his right hand's being so far from his left that he cannot use it promptly to shorten both reins together. The reins should be always held in the left hand, and the right should be used *in front* of the left, and only when required to make some movement.

In American cities, although the police insist upon a much slower pace than is permitted in Paris, the state of affairs is but little better, owing to the prevalent idea that anyone can drive, that no particular skill or practice is required, and to the fact



that there is no recognised standard by which drivers expect to be judged.

Besides the rules of the road, the courtesies of the road should be strictly observed. Every vehicle is entitled to one-half of the road, but it is usual for a light carriage to yield to a heavily loaded business wagon, since that cannot so readily leave the best part of the road, and some English legal decisions recognise this courtesy as obligatory. A vehicle going up a hill should to some extent yield to one coming down, especially at a crossing, inasmuch as it is more difficult to pull up quickly on a descent than on an ascent.

Many coaching men seem to have an idea that for some mysterious reason every vehicle should give way to a coach, and are not sparing in unfavourable comments on those who do not accord them an excessive right of way; but there are no just grounds for such pretensions on the part of a person driving a private coach. The feeling is, probably, traditional, arising from the fact that the mail-coaches and those road-coaches which carried a mail, had by law what might be called an almost *violent* right of way over all traffic. How strongly this was felt is shown by many anecdotes, among them one told by STANLEY HARRIS on p. 72 of *The Coaching Age*, and accompanied by a spirited illustration by STURGESS, in which, in the words of a passenger on the mail, 'The soldiers were marching down the military road which

'crossed the main road. Traffic always stopped  
'for the soldiers: the mail could not get through,  
'and Elwin, the guard, insisted on the Queen's  
'right. "Damn the soldiers! drive through them,  
'Watson!" he cried to the coachman. So the  
'coachman went for them, and the soldiers had to  
'give way, amidst a fair amount of bad language  
'from the officers, which was freely and smartly  
'returned by the guard and one or two of the  
'passengers, especially as the officer had a glass  
'in his eye.'

This sentiment undoubtedly extended itself to all road-coaches, which were more or less identified in the minds of the public with the mail service, and, coupled with the fact that a public-coach is running on time, it appeals to the sympathy of the 'horsey' public of England, so that a road-coach and even a private coach receives an amount of courtesy, perhaps unconscious, not accorded to other vehicles. The demand for the road, suggested by the horn of a public-coach, is usually responded to with alacrity and good nature in England, where it is thoroughly understood, but with a private coach it is not in good taste to demand too much.

In a city, it is certainly not well to use the horn for such a purpose, but on a country road it may properly take the place of the voice, in intimating to a driver hidden under the cover of his wagon that there are other people besides himself using the road.

In connection with this, one is tempted to enquire if a wise legislation ought not to prohibit any driver from shutting himself within a cover which prevents him from seeing out in any direction but forward.

## CHAPTER XXIII

## ACCIDENTS

WHILE it is often said that a man who has had many accidents knows how to avoid them and how to 'get out of a scrape' with the least damage, it is not agreeable to obtain experience in this way, and to avoid accidents altogether is desirable.

It is important, first of all, to have coach and harness in the best order; it is almost criminal to use rotten harness or any weak tackle; next, constant watchfulness is absolutely necessary, and no man is a good or a safe coachman who does not, all the time, see what is going on around him, in front, at his side, and among the horses, no matter what else is engaging his attention. His ear must catch the slightest unusual sound about the coach; a break is generally preceded by some warning. He must not court danger by driving too close to any object or to a doubtful-looking edge of the road.

But apart from the accidents arising from bad judgement or carelessness, there are many which even attention will not altogether avoid.

On slippery pavements the best horse may fall; against this, india-rubber pads in the front feet or all round, are the best preventive.

With soft snow on the ground, balls are formed

in the foot, which slip and render the horse quite helpless ; to prevent this, india-rubber balling-pads are used, but in their absence, filling the hollow of the foot with tallow or with common soap is a satisfactory substitute.

Sometimes an unruly leader, held too tightly at starting, will rear, and throw himself and the other leader down ; but they generally manage to scramble to their feet without any damage since they are so loosely attached to the coach.

The fall of a wheeler is a much more serious matter ; the proper thing is to hold him down until the other wheeler is got out of the way to avoid his being kicked by the fallen horse, and then to release the latter by unbuckling his hame-strap, which will loosen all his harness and permit his traces to be unfastened. In cases of this kind, the trace-end shown in Fig. 103 is useful.

If a leader kicks over the trace, it is, usually, easier to unhook the trace from the bar than to unbuckle it at the tug ; and an objection to the arrangement, otherwise good, of lapping the traces, is that if the horse kicks over an inside trace he has his leg over both traces.

A wheel horse's kicking over his inside trace and getting his leg between it and the pole, is a serious matter. The traces will be drawn so tight that it will be impossible to unbuckle them, and the proper way is to unbuckle the hame-strap on the top of the collar ; the trace will then be slackened and can

be taken off the roller-bolt, or unbuckled ; there is no excuse for cutting a trace. On no account must the pole-chain be unhooked first ; that permits the horse to get back on the splinter-bar and will make him kick.

A leader may kick and catch his leg between the main-bar and the single-bars if they are connected by a link or chain,—a dangerous arrangement which cannot be too strongly condemned.

The breaking of any part of the harness, such as that of the hame-strap of a wheeler, when going down-hill, or of a rein under any circumstances, is a serious matter.

The breaking of a trace has usually no bad result beyond that of delay, which need not be long if a chain or extra trace is carried in the coach.

The breaking of a pole may occasion a serious accident if the coach is going down-hill ; should it happen, if the brake is not sufficient to hold the coach, it is sometimes possible to keep the horses going, out of the way of the coach ; but if the pole is broken absolutely in two, so that the front part trails on the ground, an accident is almost unavoidable. The soft side of the road may be sought, to aid in stopping the wheels, care being taken not to get into a gutter, which may turn the coach over. A turn across the road, or up a slope, is also a remedy ; but while this is possible with a pair and with a vehicle which turns under, it is usually, for want of space, impossible with a coach.

In making a short turn, the pole may easily be broken by the lead horses jumping sideways when the coach is on the lock. When this happens, the break is usually through the pin-hole, in the futchells, and if there is only a short distance to go and not down-hill, by taking out the broken piece, the remaining part of the pole can be jammed back between the futchells; then the pole-chains being taken up very tight and the leaders prevented from pulling on the point of the pole, home may be reached. If a piece of rope is run from the D of the main-bar to the futchells, the leaders can pull by the rope without disturbing the pole.

A broken pole can be temporarily mended by pushing the fractured ends tightly together and then binding on, by a strong cord, two or four thin pieces of board, like splints. A rope should then be carried from the bars to the futchells (as mentioned above) to prevent the leaders from pulling the pole out of its splints.

For mending breaks there is nothing so good as an article not often found in civilized places, namely: a strip of raw-hide. If this is wetted and bound round a joint, or a splice, it will contract in drying, and be much tighter than any cord can be drawn. Skill in tying some of the knots used by sailors is of great advantage in case of accident.

The breaking of a lead-bar, or the coming loose of one of its ends, does little damage, unless the bar falls on the horse's heels and makes him kick.

The reason for putting on the bars with the screw-heads of the furniture *up* is, that if a screw breaks or falls out, its loss will be noticed by the coachman. This is not an uncommon accident, and is best guarded against by using the rivets shown in Fig. 31.

The breaking of a front axle-arm, or the coming off of a front wheel, is serious, and if the coach be going at all fast, an overturn is probable.

The box of a Collinge axle will sometimes work loose in the wheel and the wheel will gradually slip off, but an observant coachman should detect the mishap before any damage is done, especially in the case of the off side wheel.

I once saw a friend bring his coach home from a considerable distance, after the box of a front wheel had become loose, by ingeniously putting the skid under the wheel and fastening it by its chain to the splinter-bar, which was protected from being scratched by having a horse-cloth wrapped round it, the coach being dragged on the skid; of course the wheel had not come off, but had only started.

As may be gathered from the remarks in Chapter IX., it is not difficult to capsize a coach, but it is an unpardonably careless thing to do unless something is broken, or the horses are running away. The coming off of the skid or the breaking of the skid-chain in descending a steep hill, may cause a capsize, whence the importance of having this tackle in good order.



On icy roads, the skid will slip and, with the brake hard on, the tire of the wheel slips also. The ice-skid (Fig. 49) is good for steady work; a temporary substitute for it may be made by putting on the ordinary skid and wrapping a chain-trace or the chain of the hook, round the skid and the rim of the wheel so as to present a rougher surface to the road, as described on p. 89.

It is possible for a wheel horse to catch his bit in the pole-chain hook so as to pull off his bridle, an accident likely to be attended with danger; also, a leader, in throwing his head up and down, may catch the branch of his bit in the bridle of his partner.

Some leaders will kick violently if a rein gets under the tail, an accident likely to happen in the fly season. If the horse is dangerous in that way, one of the men should get down and free the rein, being careful to seize the tail and lift *it* off the rein instead of trying to pull out the rein. If the horse is not a kicker, the rein can sometimes be set free by pulling the leaders to one side and the wheelers to the other in such a way that the diagonal pull will draw the rein out; the rein should be slack at the moment, and a slight flick with the whip on the horse's rump will cause the tail to be lifted, and so facilitate the operation.

A way of preventing the horse from getting his tail over the rein, is to pass both lead-reins through a ring slipped on them between the leaders and the

wheelers, which keeps the reins together, and away from the tails. This ring must be lashed tightly to one of the reins or else it will slip out of place.

Another way is to run the rein of the horse that whisks his tail, through the throat-latch of the wheeler diagonally behind him ; but this is obviously desirable for a short distance only, in an emergency, since it is apt to interfere with the wheeler's work.

A not uncommon accident, which cannot happen if the reins are properly made, is that of catching the fork of the lead-reins on a leader's tail.

Should a leader shy violently, he may pull his coupling-buckle through the pad-terret of his partner. For the means of preventing both of these accidents, see the article on 'Reins' in the Chapter on 'Harness.'

Driving too fast round a turn, and striking the wheel against a stone, is perhaps the most common cause of serious accidents, since by the shock the coachman may be thrown off the coach.

A horse standing unattended, by the side of the road, should, in passing, be watched ; he may turn suddenly into the road and throw down a leader.

To have a horse balk, or jib, and refuse to go, can be, perhaps, hardly called an accident, but it is desperately annoying and very difficult to manage. Every horseman has his own method of inducing the horse to move, which he considers infallible until he tries to put it in practice, when it usually fails.

Anything which distracts the horse's attention from the idea which he has in his head, may be successful,—for instance, lifting his foot and hammering on the hoof as if shoeing him. Violence of any kind usually makes matters worse.

A pulling horse may be made more manageable by passing his coupling-rein under the throat-latch of his partner before buckling it to the bit. This is called throat-latching, frequently pronounced 'throat-lashing.'

In old coaching days, wild or troublesome horses were sometimes 'moped,' that is, a leather screen or shade was fastened to the bridle and covered the eyes, so that the horse could see only downward; 'moping a leader' was an expression frequently used.

Horses must never be left unattended; no matter how quiet they may be, something may frighten them and disastrous results ensue.

During fog, or falling snow, it is frequently difficult to see the road or what is ahead, and at night the light of the lamps shining on the fog is bewildering. This may be somewhat obviated by partially covering the lamps so that the light may shine down on the road, but not too much ahead.

In driving tired horses, the work must be so distributed as to favour a weak horse; under some circumstances the leaders should be kept as fresh as possible, since, as a coaching writer tersely puts it, 'a tired wheeler may be dragged home, but if a leader cuts it, you're planted.'

## CHAPTER XXIV

## COACHING CLUBS

MENTION has been made of the Coaching Clubs in England. Similar ones have been formed in the United States 'for the encouragement of four-in-hand driving.' The oldest is that in New York, established in 1875, which has for its title 'The Coaching Club;' the following is a list of its members from the beginning; those who have died or resigned being marked D or R:—

CHARLES A. BALDWIN.	GEORGE R. FEARING. R.
J. D. ROMAN BALDWIN.	HUGO O. FRITSCH. D.
F. O. BEACH. R.	FREDERICK GEBHARD.
GEORGE A. BECH. D.	ROBERT LIVINGSTON GERRY.
ISAAC BELL, JR. D.	WILLIAM C. GULLIVER.
AUGUST BELMONT. D.	CHARLES F. HAVEMEYER. D.
AUGUST BELMONT, JR.	THEODORE A. HAVEMEYER. D.
OLIVER H. P. BELMONT.	THEODORE A. HAVEMEYER, JR.
PERRY BELMONT.	GEORGE GRISWOLD HAVEN.
JAMES GORDON BENNETT.	EUGENE HIGGINS.
A. S. BIGELOW.	THOMAS HITCHCOCK, JR.
FREDERIC BRONSON.	C. OLIVER ISELIN.
HAROLD BROWN.	WILLIAM JAY.
NEILSON BROWN.	LEONARD W. JEROME. D.
H. R. A. CAREY. D.	C. H. JOY. D.
CHARLES CARROLL.	DE LANCEY A. KANE.
ALEXANDER J. CASSATT.	S. NICHOLSON KANE.
WILLIAM P. DOUGLAS.	GUSTAV E. KISSEL.
TRACY DOWS.	PRESCOTT LAWRENCE.
GEORGE P. EUSTIS.	N. GRISWOLD LORILLARD. D.

PIERRE LORILLARD. R.	CHRISTOPHER R. ROBERT. D.
RICHARD MCCREERY.	FAIRMAN ROGERS.
GEORGE VON L. MEYER.	J. ROOSEVELT ROOSEVELT.
OGDEN MILLS.	F. AUGUSTUS SCHERMERHORN.
EDWIN D. MORGAN.	W. WATTS SHERMAN.
WILLIAM FORBES MORGAN.	F. K. STURGIS.
EDWARD MORRELL.	E. V. R. THAYER.
RICHARD MORTIMER.	NATHANIEL THAYER.
STANLEY MORTIMER.	PERRY TIFFANY.
FREDERICK NEILSON. D.	WILLIAM R. TRAVERS. R.
THOMAS NEWBOLD. R.	FRANCIS T. UNDERHILL. R.
HARRY OELRICHS. R.	JAMES J. VAN ALEN.
E. M. PADEFORD. R.	ALFRED G. VANDERBILT.
JAMES V. PARKER. R.	WILLIAM K. VANDERBILT.
GEORGE R. READ.	W. SEWARD WEBB.
ISAAC H. REED. D.	GEORGE PEABODY WETMORE.
A. THORNDIKE RICE. D.	AUGUSTUS WHITING. D.
FRANCIS R. RIVES. D.	HARRY PAYNE WHITNEY.
REGINALD WM. RIVES.	WILLIAM C. WHITNEY.

## HONORARY MEMBER.

THE DUKE OF BEAUFORT. D.

'The Four-in-Hand Club' of Philadelphia dates from February 28, 1890.

Its members are as follows:—

J. C. MERCER BIDDLE.	JOHN R. FELL. D.
EDWARD BROOKE.	S. F. HOUSTON.
NEILSON BROWN.	H. P. MCKEAN, JR.
EDWARD BROWNING.	E. RITTENHOUSE MILLER.
HARRISON K. CANER.	EDWARD MORRELL.
ALEXANDER J. CASSATT.	P. S. P. RANDOLPH.
B. DAWSON COLEMAN.	EDWARD B. SMITH.
A. J. DREXEL.	WILLIAM STRUTHERS.
G. W. C. DREXEL.	BARCLAY H. WARBURTON.
C. DAVIS ENGLISH.	J. G. WATERMAN.
HENRY FAIRFAX.	J. E. WIDENER.

There are Clubs in other cities of the United States.

In Paris, there is, besides '*La Cercle des Guides*,' which is a French Club, 'The Reunion Road Club,' formed in 1893 with the object of encouraging road-coaching.

Its members are :—

CHESTER ARTHUR.	WILLIAM JAY.
FREDERICK O. BEACH.	DELANCEY A. KANE.
O. H. P. BELMONT.	DE LA HAYE JOUSSELIN.
PERRY BELMONT.	VICOMTE DE LA ROCHEFOU- CAULD.
J. G. BENNETT.	PRESCOTT LAWRENCE.
MARQUIS DU BOURG.	BARON LEJEUNE.
FREDERIC BRONSON.	DONATIEN LEVESQUE.
COMTE DE CARCARADEC.	FORBES MORGAN.
HENRY R. A. CAREY. D.	HENRY RIDGWAY.
A. J. CASSATT.	REGINALD W. RIVES.
WILLIAM P. DOUGLAS.	FAIRMAN ROGERS.
GEORGE P. EUSTIS.	J. R. ROOSEVELT.
WILLIAM C. EUSTIS.	F. K. STURGIS.
CAPTAIN PRYCE HAMILTON.	WILLIAM G. TIFFANY.
T. A. HAVEMEYER. D.	WILLIAM K. VANDERBILT.
EUGENE HIGGINS.	GEORGE PEABODY WETMORE.
C. OLIVER ISELIN.	

The rules and customs of the Meets of Coaching Clubs are simple, and adopted principally with the view of ensuring a certain uniformity.

At the Meets of the Coaching Club in New York, the coaches take a front load only; the wife of the owner, if he has one, takes the box-seat; there are two ladies and two men on the front roof-seat, the back of the hind roof-seat is turned down, and the two grooms are in the rumble. These rules are not

observed by the London Clubs, where either a front load or a full load is carried. In the case of mourning, when the wife of a member does not, for that reason, wish to appear at the Meet, a lady takes her place, or the load is made up of men only.

The only occasion on which the wife of the owner, if she is on the coach at all, is not on the box-seat, is when a very distinguished personage, such as the President of the United States, takes that seat on the leading coach.

If the owner is unmarried, the lady on the box is usually one of his own family.

The owner and his servants usually wear boutonnières of the same variety as the flowers in the horses' heads. There are no lamps on the coaches, and the grooms' overcoats are not on the rumble but, if carried at all, are inside the coach. The stable shutters are down (that is, open), and the glass windows either up or down.

The owner wears the uniform of the Club and a black silk hat, as do all the men on the coach. Some years ago, it was considered *de rigueur* for ladies to wear bonnets, but hats have become so general as to be considered correct even on a coach.

It is hardly necessary to add that every attention should be paid to the proper turning out of the coach and to the dress and attitude of the servants.

At a Meet of private drags, two servants in livery should be on the coach; never a servant in the dress of a guard, as is sometimes seen in Paris.

The time of assembling, by which time all the coaches should be on the ground, is usually fifteen minutes before the hour of starting. The coaches take their places in the order of arrival, either in one or two lines or in a single column, depending upon the locality. One place at the right, or at the head, is left for the President of the Club, and the Vice-President takes the rear. Inasmuch as punctuality is a coaching virtue, the start should be made on the minute by the President, and the coaches should follow at intervals of a coach length ; that is, about forty feet. These intervals should be kept with great precision, since, if they are alternately lost and regained, the changes of pace will be much increased toward the rear of the column, where the coaches will be frequently compelled to go very fast, to make up the gaps. It is a good plan for the leading coach, ten minutes or so after the start, to stop for a few minutes at the first convenient place ; the horses are very apt to get fretted by the waiting and by the start, and an opportunity is hereby afforded of calming them and of changing the couplings or the bitting, if desirable.

The pace should not be slow ; eight miles an hour is not too fast, and an even pace should be kept up all the time, up-hill and down ; this ensures the intervals between the coaches being properly kept, even if the line is long.

If the route chosen permits, it is well to have a countermarch at some place, around a circle in a



park, for instance ; so that the members may see each other's coaches ; if this cannot be arranged, a manœuvre adopted some years ago by The New York Coaching Club serves nearly the same purpose. At an appointed spot, the leading coach, and of course the whole column, halts on the right-hand side of the road ; the rear coach then drives out, passing to the left of the column and takes up its place at the head ; the coach which has now become the rear one does the same, and they all make the movement in succession, until the President, in so doing, resumes his original leading position and then continues the drive. At times, the drive occupies an hour or so, and the coaches return to the point of departure and there separate ; at other times the coaches go to some out-of-town place for lunch or for dinner, and return independently.

The latter is the custom usually followed at the Meets of both the London Clubs ; in Paris, the coaches, after meeting on the Place de la Concorde, drive out together to La Marche or to the Auteuil races, and come home independently.

In the early days of the Coaching Club in New York the Meet took place late in the afternoon, and after a drive over the whole length of the Park, the members and their guests returned to the Brunswick Hotel for a formal dinner. In the last few years, the Meets have been earlier in the day, with a drive to Clermont for lunch.

Where there are Coaching Clubs, it is usual,

on certain race-courses, to have places specially set apart for coaches, those for the Clubs separated from those for other coaches. At Jerome Park, in the old race days, the grassy slope at the foot of the Club House was reserved for coaches, and was a gay point of rendezvous on that most beautiful of courses.

On several English courses each Club has its special enclosure, opposite the Grand Stand, and the penalty attached to a non-appearance at the established Meets of the Club is exclusion from this enclosure. Eighty or ninety coaches, including those of the Clubs, are often drawn up in a line, opposite the Grand Stand, at Ascot.

A few words as to the disposition of a coach on a race-course or at any other gathering, such as a horse-show, a cricket-match or polo-match, will not be out of place here.

The coach should be driven as nearly as possible to its place, the leaders occupying the spot on which the coach is finally to stand; the leaders' traces are unhooked, the *lead*-reins thrown down, and the leaders moved out of the way. The bars are taken off of the pole-head and laid on the ground at one side, and the coach is drawn forward as far as possible by the wheelers; the pole-chains are slackened, the wheel-traces taken off of the roller-bolts and the *wheel*-reins thrown down. The chains are unhooked from the kidney-link rings, one end being left hooked to the pole-head, the pole is withdrawn and the wheel



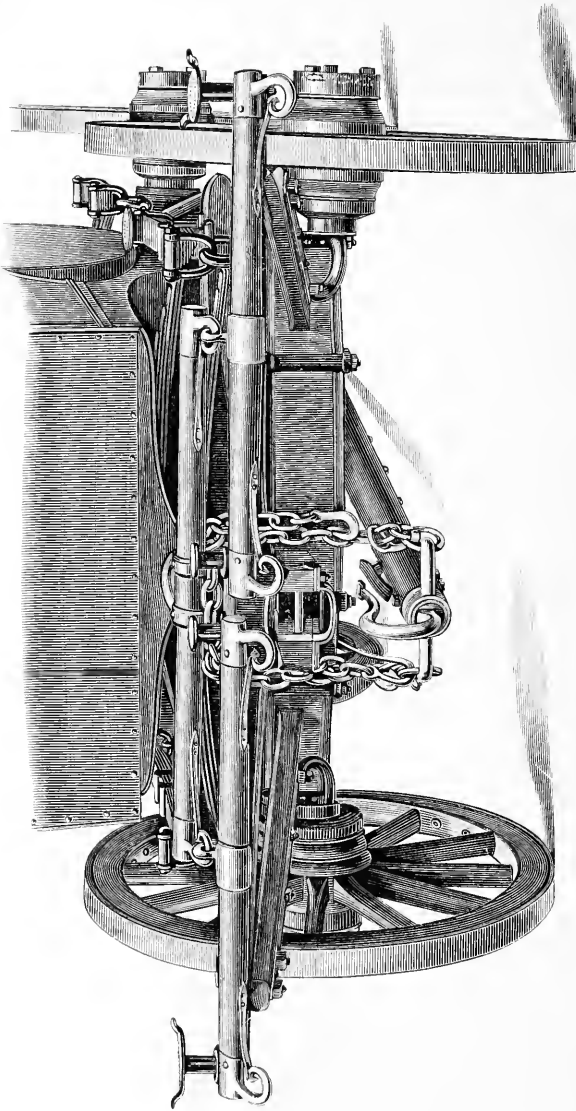

POLE AND BARS ON FRONT OF COACH.

horses led out of the way. The coach is then run forward to its place by hand, the grooms of other coaches usually assisting, until it is as close to the rails or rope of the enclosure as is desired. On sod, or on ground which is known to be soft, it is well to have, in the coach, four small pieces of board, which can be quickly laid down in front of each wheel before the coach is brought to its final position; the wheels run on these boards and are thereby prevented from sinking in the ground, which, from the movement caused by those who get up and down on the coach, they will be likely to do, with the result that it will be difficult to move the wheels out of these deep ruts when the time comes to start for home.

While one man holds the horses, the other one pushes the pole under the centre of the coach, so that its point comes under the splinter-bar; then, hooking the chains together, he hangs up the head of the pole by passing the chains over the roller-bolts, and lays the lead-bars on top of the splinter-bar, as shown in Plate XXXIV. He then takes the halters and horse clothing out of the front boot and assists the other man in leading the horses to where they are to be put up.

Even for a short stop at a race or at a game, it is dangerous to keep the horses attached to the coach; people become interested in the spectacle; the grooms often forget themselves, and if the horses start suddenly, any one standing erect on the coach is liable to be thrown off with serious injury.

The same is true, of course, of any vehicle, under similar circumstances, and I once saw a woman, who was standing on the seat of a buggy, thrown off by the sudden start of the horse as the racing horses passed, receiving injuries which caused her death in a few hours.

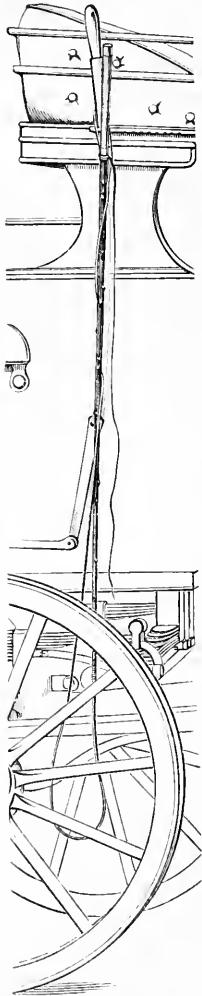

FIG. 174.

After the coach has been pushed to its place, the coachman puts on the brake as hard as possible, and, taking three or four loops of the bight of his whip thong, round the stick at the ferrule, he hangs the whip on the handle of the brake, as shown in Fig. 174.

The whip may be strapped along the pole, instead of hanging it as just described, but this is a more troublesome way of disposing of it. It must not, under any circumstances, be put into the whip socket, where it will be not only in the way but almost certainly broken.

If at the termination of a meeting, the rope or rail in front of the coaches is taken down, it is necessary only to put the horses to, and to drive straight out. If this cannot be done, the coach must be backed by hand

and turned into a position which will allow the horses to be put-to ; it is well to drill the men in doing this, so that the coach can be brought into position without any awkward failures.

Starting off from a race-course requires much judgement, and few things show more clearly the good or bad coachman. The horses after standing, are often somewhat fractious and impatient ; other coaches about them are just getting off, and unless the coachman does the proper thing he is likely to get into trouble. He must be certain before he starts that he has his reins exactly right and that all his horses tighten their traces together, for, on the soft ground, it usually takes all four to pull the coach. If they make a false start without moving the coach, they will be likely to balk or run back, and then a good start is almost impossible.

Everything should be done in the most quiet manner ; the brake must be taken off without any noise, the man at the leaders' heads must draw the horses gently forward without exciting or jerking them, in order to tighten their traces, keeping his eye steadily on the coachman so as to obey any signal promptly. If all this is properly done, the team will get into motion smoothly and quickly, and they should be permitted to go straight on, to give them no chance to rebel. If it is not properly done, one leader will be on his hind legs and the other turning his croup out sideways, while a wheeler will be hanging back with his collar half-way up to his ears.

It seems hardly necessary to add that a start should not be made unless there is room to go somewhere, but one often sees an inexperienced coachman try it, with awkward results.

JUDGING AT HORSE-SHOWS.—It has become the custom at Horse-Shows to make classes for Harness Horses, which classes include the vehicles to which the horses are shown, together with the harness and liveries; these *appointments*, as they are usually termed, count for fifty per cent. and the horses for fifty per cent., in making up the number of points for the award. The Coaching Club in New York has formulated, as suggestions to Judges and Exhibitors, certain Rules for Judging, which are here reproduced by permission of the Club. These Rules will be found to agree with the descriptions of coaches and harness given in the earlier pages of this book, and, being a codification of the best practice among coaching men, may be taken as a guide for turning out a coach properly.

The Rules are printed in double column, for convenience in comparing drags and road-coaches:—

#### THE DRÀG.

The Drag should have a perch and be less heavy than a Road-Coach and more highly finished, with crest or monogram on the door panels or hind boot.

#### THE COACH.

The Road-Coach should be built stronger than a Park Drag, especially as to the under-carriage and axles, which latter should not measure less than two inches in diameter.



THE DRAG—(*continued*).

The axles may be either Mail or Collinges (not imitation).

The hind seat should be supported by curved iron braces, and be of a proper width for two grooms, without lazy-back.

The lazy-backs on the roof-seats should be turned down when not in use.

The under side of the foot-board, together with the risers, should be of the same colour as the under-carriage.

The body of the Drag and the panel of the hind boot should correspond in colour.

The door of the hind boot should be hinged at the bottom, that it may be used as a table when open.

THE COACH—(*continued*).

The axles may be either Mail or Collinges (not imitation).

The hind seat is usually supported by solid wooden risers with wooden curtain, but the supports may be of curved iron, as in a Park Drag, in which case a stationary leather curtain is used. Its seat should be wide enough for at least two besides the guard, who should occupy the near side, with an extra cushion. He should have a strap to take hold of when standing to sound the horn.

The lazy-backs of the box-seat, hind seat, and roof-seats should be stationary.

The under side of the foot-board, together with the risers of the box and hind seat, should be of the same colour as the under-carriage.

The body of the Coach and the panel of the hind boot should also correspond in colour.

The door of the hind boot should be hinged on the off side to enable the guard to open it from the near hind step when the Coach is in motion.

THE DRAG—(*continued*).

The skid and safety hook (if carried) should be hung on the off side.

It is customary to trim the outside seats in either pigskin or cloth, and the inside of the Drag in morocco or cloth.

The coachman's driving-apron when not in use should be folded on the driving-cushion, outside out. Passengers' aprons if carried to be neatly folded and placed on the front inside seat.

A watch and case are not essential, nor is the pocket in the driving-cushion.

There should be no luggage rails or straps on the roof between the seats.

Inside, the Drag should have : Hat straps fastened to the roof ; pockets on the doors ; places over the front or back seat where the lamps may be hung when not in use ; an extra, jointed whip.

THE COACH—(*continued*).

The skid and safety hook must be hung on the off side in countries in which it is customary to drive on the off side of the roadway, for the skid should be on the outside wheel, or the Coach will slide toward the ditch.

The trimming of the outside seats should be of carpet or any suitable material, not leather. The inside of the Coach is usually finished in hard wood or leather.

The coachman's driving-apron when not in use should be folded on the driving-cushion, outside out.

A foot-board watch with case should be provided. The driving-cushion should have a pocket on the near side.

The iron rails on the roof between the front and back seats should have a lattice or net-work of leather straps to prevent small luggage, coats, rugs, etc., placed on the roof from falling off.

Inside, the Coach should have : Hat straps fastened to the roof ; leather pockets at the sides or on the doors ; an extra, jointed whip.

THE DRAG—(*continued*).

The umbrella basket, when carried, should be hung on the near side.

Two extra lead-bars, consisting of a main-bar and a side-bar, fastened to the back of the hind seat with straps; main-bar above.

Lead-bars put on with screw heads of furniture up.

The following articles to be neatly stowed inside the front boot: A small kit of tools, an extra lead-trace and wheel-trace, a rein splicer or two double buckles of different sizes, extra hame-straps.

Loin cloths for team, and the necessary waterproof aprons, should be carried in a convenient and accessible part of the Drag.

It is usual for a Park Drag to be fitted with luncheon boxes, wine racks, &c., also with a box on the roof called an "Imperial." This latter is never carried except when going to the races or a luncheon.

THE COACH—(*continued*).

The basket shall be hung on the near side and in front of the guard's seat. The horn should be placed in the basket with the mouth-piece up.

Two extra lead-bars, consisting of a main-bar and a side-bar, fastened to the back of the hind seat with straps; main-bar above.

Lead-bars put on with screw heads of furniture up.

The following articles to be neatly stowed in a convenient part of the Coach: A wheel jack, extra hame-straps, a chain-trace, extra lead-trace, an extra bit, a bearing-rein, a rein splicer (a short strap of the same width as the reins, with a buckle at either end) or two double buckles of different sizes, a kit of tools, comprising a wrench, hammer, cold chisel, coil of wire, punch, hoof-pick and knife. Two extra, large rings for kidney-links, or a pair of pole-pieces.

The guard should be appropriately dressed, and should have a way-bill pouch with a watch fitted on one side and a place provided for the key of the hind boot.

THE DRAG—(*continued*).

Lamps off. Lamps inside coach.

THE COACH—(*continued*).

Side lamps in place and ready for use.

## PARK HARNESS.

Pole-chains should be bur-nished and have spring hooks. The chains should be of a length which will admit of snapping both hooks into the pole-head ring. If too short, one end should be hooked in the pole-head ring and the other in a link. If too long, one end should be snapped in the pole-head ring, and the other brought through said ring (from the outside in) and snapped in a link.

Cruppers, with buckles, on all horses preferred.

Loin-straps and trace-bearers are permissible.

Face-pieces (drops).

Martingales around the collars of wheelers and not through kidney-links alone.

## ROAD HARNESS.

Pole-chains should be bur-nished or black, but pole-head and chains must be alike. Hooks should have india-rubber rings, not spring hooks. Chains with single hooks should be put on pole-head from inside, out; then passed through the kidney-link and hooked into one of the links of the chain.

Cruppers, with or without buckles, on wheelers, but not necessarily on leaders, unless bearing-reins are used. Martingale back-strap. Trace-bearers on the leaders from the hames to the tug-buckles are permissible.

No loin-straps.

Face-pieces (optional).

Martingales around the collars and not through kidney-links alone.

PARK HARNESS—(*continued*).

Martingales on all horses.

No rings on coupling-reins.

Mountings of coach and harness and the buttons on servants' liveries should be of the same metal.

Wheel-traces with metal loop ends, not chains.

Wheelers' inside traces shorter than outside traces, unless the inside roller-bolt is enlarged to give the same result.

Lead-traces straight or lapped, not crossed.

Eyes on ends of hames through which the kidney-links pass.

Plain kidney-links. No kidney-link rings on leaders.

Solid draught-eyes on hames. Clip inside of trace leather, and showing rivet heads only.

Full bearing-reins, with bit and bridoon. Buxton bits preferred.

Single point strap to tug-buckle.

Metal or ribbon fronts to bridles; if ribbon, the colour should match the livery waist-coats.

ROAD HARNESS—(*continued*).

No martingales on leaders; kidney-link rings on leaders.

Mountings, preferably of brass, but at least all of the same metal throughout.

Wheel-traces with French loop or chain ends. Chain put on roller-bolt with chain out and ring in.

Wheelers' inside traces shorter than outside traces, unless the inside roller-bolt is enlarged to give the same result.

Lead-traces lapped, crossed, or straight.

Hook ends to hames.

Chain and short kidney-links or all chain.

Ring draught-eyes on hames.

One or more bearing-reins are optional.

Metal or leather fronts to bridles; if leather, the colour to match the colour of the coach.

PARK HARNESS—(*continued*).

The crest or monogram should be on the rosettes, face-pieces, winkers, pads, and martingale flaps. Ribbon or coloured rosettes are inappropriate.

Hames-straps put on with the points inside,—*i.e.*, to the off side on the near horse and the near side on the off horse.

Reins of single brown leather.

Draught-reins sewed in one piece, with end buckles only.

Lead-traces with screw heads of the cock-eyes up.

All parts of the harness should be double and neatly stitched.

Collars to be of black patent leather, shaped to the neck.

The hames bent to fit the collar accurately.

Harness black. All straps should be of proper length, but not too short.

When the owner or his representative drives, the stable-shutters should be down; otherwise up.

ROAD HARNESS—(*continued*).

A crest or monogram is not generally used in road work, but instead, lead-bars, or a special device in brass, are put on the winkers and rosettes.

Hames-straps put on with the points inside,—*i.e.*, to the off side on the near horse and the near side on the off horse.

Reins of single brown leather.

Draught-reins sewed in one piece, with end buckles only.

Traces with screw heads of cock-eyes and chain ends, up.

All straps preferably of single leather.

Collars may be of patent, plain black, or brown leather; straight, thick, and full padded.

The hames straight to fit the collar.

Harness black or brown.

DRIVING COMPETITIONS.—Driving competitions are frequently arranged with the view of deciding which of the contestants has the best seat on the box, the best method of handling the reins and whip, and the best general style of driving, while merely going over a simple course; or an intricate course, with obstacles, may be laid out for the purpose of testing the skill of the coachman. In the first case, a figure-of-eight may be added to the simple course; a moderately high rate of speed should be required.

At the Philadelphia Horse-Show of 1893, the course was laid out as in Fig. 175.

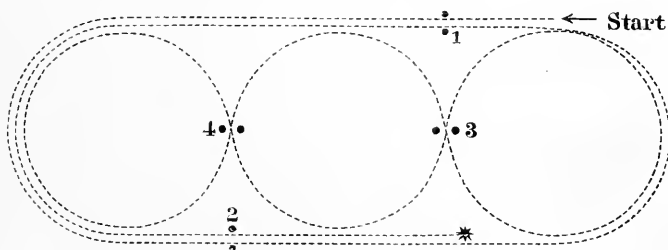

FIG. 175.

Blocks, 10 inches square and 36 inches high, were placed in pairs, with a space of  $8\frac{1}{2}$  feet between the blocks, at the points 1, 2, 3, and 4. The coaches, stationed on the short sides of the ground, were twice driven, one by one, at a sharp trot, through each pair of blocks, following the course shown by the dotted line, thus twice making a figure-of-eight; finishing at the point marked by the star. Striking a block was counted against a contestant, but the

style of driving and the accuracy of the turns were mainly considered. The ground was 300 feet in length and 125 feet in width, so that the turns were portions of circles of about 100 feet in diameter.

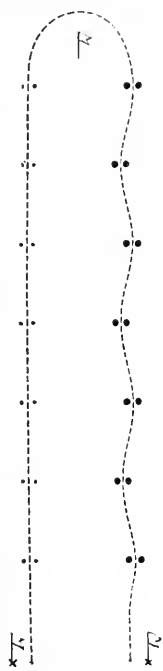

FIG. 176.

For an obstacle course, the following is a good arrangement: Barrels, painted a light colour, are placed (as shown in Fig. 176) 8 feet apart in one direction and 50 feet apart in the other, the coach being driven between them as shown by the dotted line. After passing through the last pair of barrels, a turn is made to the left and the coach is driven in a straight line between two rows of stakes 7 feet apart, the pairs of stakes corresponding to the pairs of barrels.

With seven pairs of barrels, the whole space required for the course will be about 600 feet in length by 120 feet in width. On a course of this length, two minutes is the time allowed for driving up one side and down the other, the time being taken from the moment of starting at the word 'go,' from a line 75 feet in advance of the first pair of barrels, to crossing the same line after having passed through the stakes.

In counting the points to the credit of each competitor, a number is adopted, for example 30; from



this number are deducted two points for each barrel or stake touched, and one point for each 15 seconds, or part thereof, above the two minutes; for each 15 seconds, or part thereof, less than the two minutes, one point is added. Four points are deducted for going outside of a barrel or stake, and four points are deducted should a groom touch the horses.

The following is the form in which the judges' card may be made:—

Competitors . . . . .	A	B	C	D	E	F
Time . . . . .	2.10	2.30	1.48	1.55	1.36	2.00
Barrels touched . . . . .	1	3	0	2	4	1
Stakes touched . . . . .	2	3	3	0	6	3
Outside . . . . .	0	1	0	0	0	0
Groom touching horses . . .	1	0	0	0	0	0
	-1	-2	+1	+1	+2	0
	-6	-12	-6	-4	-20	-8
	-4	-4				
Points to be deducted from 30	-11	-18	-5	-3	-18	-8
Result . . . . .	19	12	25	27	12	22

In this example, competitor D having the greatest number of points to his credit, is the winner.

The foregoing are the Rules for the Driving Competitions at *The Ranelagh Club*, London. There, after passing through the barrels, the turn is made to the right in accordance with the English custom of driving on the left-hand side of the road.

At one of the Open-Air Horse-Shows in New York, a pen of hurdles was arranged as in Fig. 177.

The coach is to be driven in from A in the direction shown by the arrow, passing the barrel C ;

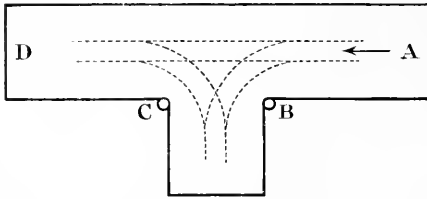

FIG. 177.

then *backed* into the space between B and C until the horses could be turned to the right and finally driven out toward A in

the direction opposite to that in which it entered.

The fences, between A and D, are 22 feet apart, and the barrels B and C are 22 feet apart. The hurdle at D should be moveable, to permit a coachman who is unsuccessful in backing round, to drive out at that end.

In all Driving Competitions, especially when the turns to be made are sharp, the vehicles used should have nearly the same angle of lock ; a coachman driving a break, the front wheels of which turn far under, has a great advantage in being able to make a sharp turn without risk of an accident ; breaks should not therefore be admitted to a competition with coaches.



# COACH CALLS ON THE HORN.

Get Ready.

The Start.

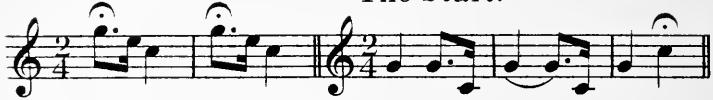

Clear the Road.



Off Side.



Near Side.



Change Horses.



Slacken Pace.

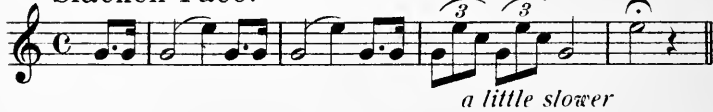

Pull Up.



Higher Up.

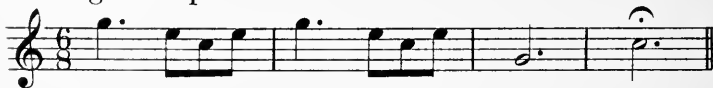

Steady.

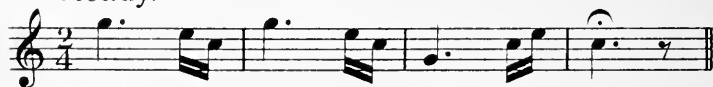

To the Right.



To the Left.

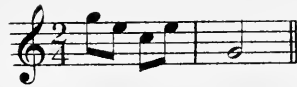

Home.

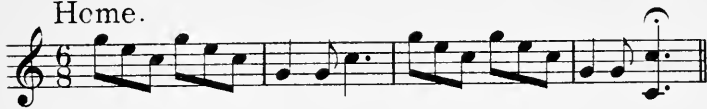

The Post-Horn Call.

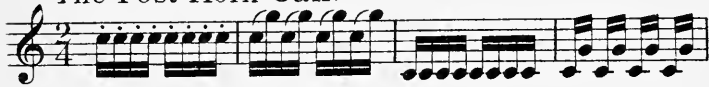

(Continued.)



Off to Charlestown.

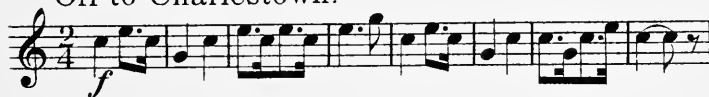

(Continued.)

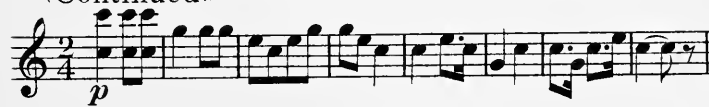

The Huntsman's Chorus.



Buy a Broom.

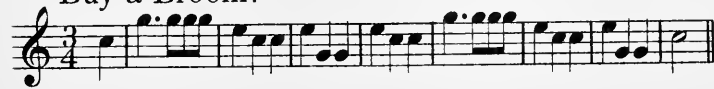

(Continued.)

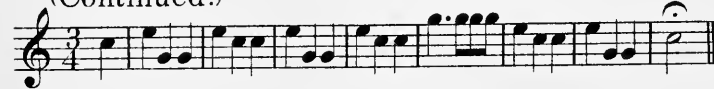

Short Call.

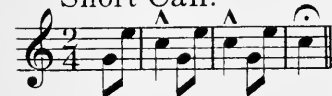

Short Call.

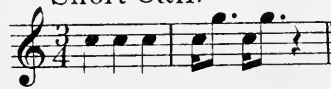



## CHAPTER XXV

## MUSIC FOR THE HORN

IN this Chapter are given the most useful calls for the Coach-Horn, together with three airs adapted to that instrument.

Since the ordinary, straight coach-horn (Fig. 178) has no keys, only the six open notes C, G, C, E, G, C, can be sounded on it; these notes are written in



FIG. 178.

the key of C, the first note in the list being the C below the stave. The high C, with which the 'post-horn call' ends, is difficult to produce.

The actual pitch of the notes sounded when any call is played, depends upon the length of the horn; a horn with a length of about 39 inches, including the mouth-piece, will give the sound of E flat when what is written as C is sounded; one of about 52 inches in length will give B flat, the pitch of a cornet.

The shorter the horn, the more difficult it is to play, but the more brilliant are the calls; the longer horn has a softer tone. A horn 42 inches in length has an agreeable pitch. A horn 54 or 56 inches in

length may be reduced to the more convenient length of 24 or 25 inches by being doubled on itself; its tone is not materially changed.

A horn made of hard brass has a better tone than one made of copper, and the 'cornet' bell is thought to give a sweeter tone than the conical or 'bugle' bell. Ribs of brass or of german-silver are sometimes soldered lengthwise on the horn to strengthen it.

Old coaching books speak of 'the yard of tin,' meaning the horn; a horn made of tin and only 36 inches long could not have been a very musical instrument.

On some coaches, in the early part of this century, the guard used a key bugle instead of a horn. 'PADDY BLAKE' (*New Sporting Magazine*, 1834, p. 102) speaks of a coachman's having a horn in his pocket.

Owing to the limited number of its notes, few of the well known tunes can be played on the coach-horn, but the calls can be varied indefinitely.

Much practice is necessary to enable a person to play the horn well; useful hints and useful exercises are contained in the three little books by GODDEN, by KÖHLER, and by VINOY, the full titles of which will be found in the 'List of Books' in the present volume.



## CHAPTER XXVI

## COACHING MEDALS OR TOKENS

Two medals or tokens are mentioned in the Coaching books; photographic reproductions of them are here given.

The first (Fig. 179), known as the 'mail-coach halfpenny,' was struck soon after the introduction of the mail-coaches.

It has upon the face a mail-coach, with coachman and guard, and four horses galloping; above, 'MAIL



FIG. 179.

COACH HALFPENNY,' below, 'TO TRADE EXPEDITION & TO PROPERTY PROTECTION. PAYABLE IN LONDON.' On the reverse, 'TO J. PALMER ESQ. THIS IS INSCRIBED AS A TOKEN OF GRATITUDE FOR BENEFITS REC'D FROM THE ESTABLISHMENT OF MAIL COACHES,' with a wreath of palm leaves and the letters *J. P.*

The second (Fig. 180) is a copper halfpenny struck by WILLIAM WATERHOUSE, a coaching pro-

prietor, whose headquarters were, about 1722–1800, at the Swan with Two Necks,\* Lad Lane, London.

It has, upon the face, a swan with two necks turned in opposite directions; above, 'PAYABLE AT THE MAIL COACH OFFICE,' below, 'LAD LANE LONDON'



FIG. 180.

w. w.,' on the reverse, a coach with four horses, and the legend 'SPEED REGULARITY & SECURITY.'

After a thorough search I have failed to find any other coaching medals.

Of those just described, one seems to have been a compliment and the other an advertisement. In the United States, at a later period, numbers of stage and omnibus tickets in the form of coins, were issued, two of which are here shown (Fig. 181), together with an English railway ticket.

The copper 'road ticket' (Fig. 182), for the King's Private Road, is a badge, granting admission to certain roads which were closed to the general public.

---

\* It is the custom for the owners of swans to mark them by one or more 'nicks' on their beaks; the name of the tavern is no doubt a corruption of 'The Swan with two *nicks*.'

Finally, the coin (Fig. 183) marked 'Warrington,' called in the Coin Catalogues 'a racing token,' seems



FIG. 181.



FIG. 182.



FIG. 183.

to be a badge, or an admission ticket to some enclosure, since it has a number, 'N° 260,' stamped upon the back.

## CHAPTER XXVII

## LIST OF BOOKS

THIS does not pretend to be an exhaustive Bibliography; it is merely a list of books which are of interest to the coaching man:—

## ADAMS.

*English Pleasure Carriages; their Origin, History, Varieties, Materials, Construction, &c. &c., together with Descriptions of New Inventions.* By WILLIAM BRIDGES ADAMS. London: Charles Knight & Co. 1837. 8vo, 315 pages. (Numerous plates of carriages. The author, brought up as a carriage builder, afterward became a civil engineer, and his book is one of the first on carriage building in which a higher grade of mechanical perfection in carriages is recognised and insisted upon.)

APPERLEY, *see* 'NIMROD.'

## ARTILLERY.

*Light Artillery Drill Regulations. United States Army.* Washington: Government Printing Office. 1896.

## ASHFORD.

*Whips and Whip-Making.* By W. G. ASHFORD, Birmingham. Walsall: T. Kirby & Son. 1893. 8vo, 38 pages.

## BAILEY.

*Bailey's Magazine of Sports and Pastimes.* London. (Commenced in 1825, continued to the present day.)

## BAINES.

*On the Track of the Mail-Coach.* By F. E. BAINES, C.B. London: Richard Bentley & Son. 1895. 12mo, 351 pages. (Reminiscences of Post-Office matters in England.)

## BAUCHER.

*Méthode d'Équitation basée sur des nouveaux principes, &c.* Par F. BAUCHER. Paris: 1842. 8vo. (And many later editions.)

*A Method of Horsemanship, &c.* By F. BAUCHER. Philadelphia: A. Hart. 1851. 12mo. (An English translation by GEORGE H. BOKER and JOHN SERGEANT.)

(There are other books by Baucher, but the important matters are contained in the *Méthode*.)

## BEAUFORT.

*Driving.* By His Grace the DUKE OF BEAUFORT, K.G., with contributions by other authorities. Illustrated by G. D. GILES and JOHN STURGESS. London: Longmans, Green & Co. 1889. Second edition, 12mo, 426 pages. (One of the volumes of *The Badminton Library*, and the most comprehensive book yet published on Coaching in general.)

## BERDMORE.

*Carriages, Roads and Coaches.* By S. BERDMORE.  
London: 1883. 8vo.

## BLEW.

*Brighton and its Coaches.* A History of the London and Brighton Road. By WILLIAM C. A. BLEW. London: John C. Nimmo. 1894. 8vo, 354 pages. (There is an excellent chapter on 'The Growth of Coachmanship' at the end of this volume.)

*Brighton Road,* see HARPER.

## CLARK.

*A Treatise on the Bits of Horses.* By BRACY CLARK. London: 1835. Second edition, 4to, 63 pages. (The first edition was about 1830.)

## COACHING.

*A Coaching Souvenir of 1890.* Paris to Rambouillet, Paris to Poissy. By C. D. 16mo, 18 pages. (A prettily printed Guide-book to two coaching roads.)

## COACHING.

*The Delights of Coaching.* By AN OLD WHIP. Imprinted for Murphy & Company, New York, Cleveland, and St. Louis. 1883. With etchings by STEPHENS JAMES FERRIS. Oblong 12mo, 56 pages.

## CORBETT.

*An Old Coachman's Chatter, with some Practical Remarks on Driving.* By a Semi-Professional, EDWARD CORBETT, Colonel, late Shropshire Militia. With 8 full-page illustrations by JOHN STURGESS. London: Richard Bentley & Son. Second edition. 1891. 8vo, 304 pages. (This book contains some history of Coaching and a great deal that is very interesting and valuable about driving four horses.)

'CRAVEN,' *see* WALKER.

## CROSS.

*The Autobiography of a Stage-Coachman.* By THOMAS CROSS. London: Hurst & Blackett. 1861. 3 vols., 12mo, 311, 312, 292 pages. (A somewhat rare book; the second and third volumes contain interesting reminiscences of Coaching in the early part of the century.)

## DICKINSON.

*The Dickinson Gallery.* Revised Catalogue of an Exhibition of Pictures illustrative of the Old Coaching Days, with an Introduction and additional Descriptive Notes by Captain MALET. London: Dickinson Bros. & Foster. 1877. 12mo, 48 pages. (A catalogue of two hundred and sixty-three pictures and prints of Coaching subjects.)

DWYER.

*Seats and Saddles, Bits and Bitting, and the Prevention and Cure of Restiveness in Horses.* By FRANCIS DWYER. Edinburgh and London. 1868. 12mo, 265 pages. (There are many later editions. The Fourth, reprinted in America, by the United States Book Company, n. d., contains chapters on Draught which are of the greatest interest to the driving man. The whole book may be studied with profit. Major DWYER, an Englishman, was for a long time in the Austrian military service.)

EDGEWORTH.

*Essay on the Construction of Roads and Carriages.* 1817.

FELTON.

*A Treatise on Carriages, etc.* WILLIAM FELTON. London: 1794. 2 vols.

*THE FIELD.*

London. Articles and Correspondence on Coaching in Numbers for Nov. 8, 1890; April 16, 1892; April 30, 1892; May 14, 1892; June 11, 1892; June 18, 1892; July 9, 1892; July 16, 1892; July 23, 1892; July 30, 1892; Aug. 13, 1892; Sept. 3, 1892. (The pages of all Sporting Journals contain articles on Coaching, but the references above given are useful, because the details of Driving are there discussed at some length.)



## FILLIS.

*Principes de Dressage et de l'Équitation.* Par JAMES FILLIS. Troisième édition. Paris: E. Flammarion. 1892. 8vo, 422 pages. (Illustrated. The most satisfactory treatise on Equitation yet written, and by a master of the art.)

## FITZGERALD.

*The Harness Maker's Illustrated Manual.* W. N. FITZGERALD. New York: 1875.

## FLOWER.

*Bits and Bearing Reins.* By EDWARD FORDHAM FLOWER. London: William Ridgway. 1875. Second edition, 8vo, 31 pages.

*Horses and Harness; a Sequel to Bits and Bearing Reins.* By EDWARD FORDHAM FLOWER. London: William Ridgway. 1876. Second thousand. 8vo, 20 pages. (These two pamphlets contain admirable illustrations, which should find a place on every harness-room wall. The author for many years preached a crusade against the abuse of the bearing-rein, and with marked effect upon the fashion.)

## FRITH.

*The Romance of Engineering: The Stories of the Highway, the Waterway, the Railway, and the Subway.* By HENRY FRITH. London: Ward, Lock, Bowden & Co. 1892. 12mo, 356 pages.

## DE GATINES.

*Conférence Hippique, I. Les Cinq Mouvements Clés de l'Équitation.* Par RENÉ DE GATINES. Paris: Le Goupy. 1894. (A good analysis of the Baucher method.)

*Conférence Hippique, II. La Guérinière, d'Aure et Baucher.* Paris: Le Goupy. 1896.

## GODDEN.

*Ye Coach Horn Tootlers.* By WALTER GODDEN. London and New York: Boosey & Co. 1894. Long 12mo, 20 pages. (A collection of twenty-five coach-horn tunes.)

## GUIET.

*From Paris to Trouville in Thirteen Stages.* Some Notes on Coaching, with Reproductions of Photographs taken during the journey, and a Descriptive Account of the Art of Carriage Building. By A. GUIET. Illustrated by L. VALLET. Paris: Guiet & Co., Coach Makers. 1893. Oblong 8vo, 54 pages.

## HARPER.

*The Brighton Road: Old Times and New on a Classic Highway.* By CHARLES G. HARPER. London: Chatto & Windus. 1892. 8vo, 272 pages, illustrated.

## HARRIS.

*Old Coaching Days.* By STANLEY HARRIS ('AN OLD STAGER'). Illustrated by JOHN STURGESS.

London: Richard Bentley & Son. 1882. 8vo, 279 pages, 12 full-page illustrations. Sub-title: *Road Sketches in Bygone Days*. (As its sub-title indicates, a history of Coaching, with anecdotes of the road.)

*The Coaching Age*. By STANLEY HARRIS ('AN OLD STAGER'). Illustrated by JOHN STURGES. London: Richard Bentley & Son. 1885. Large 8vo, 16 full-page illustrations, 468 pages. (A continuation of *Old Coaching Days*, containing much interesting matter.)

#### HAWORTH.

*Road Scrapings: Coaches and Coaching*. By Captain M. E. HAWORTH. London: Tinsley Brothers. 1882. Small 8vo, 202 pages. (Anecdotes of Coaching.)

#### HAYES.

*Illustrated Horse Breaking*. By Captain M. HORACE HAYES. London: Thacker & Co. 1889. (A very valuable work.)

*Riding on the Flat and Across Country*. By Captain M. HORACE HAYES. London: 1891.

#### HAYWOOD.

*Accidents to Horses on Carriage-way Pavements*. By WILLIAM HAYWOOD. Report to London Commissioners. 1873.

## ‘HIEOVER.’

*Stable Talk and Table Talk; or, Spectacles for Young Sportsmen.* By ‘HARRY HIEOVER.’ Second edition. London: Longmans, Brown, Green & Longmans. 1846. 8vo, 2 vols., 452 and 408 pages. (There is a great deal in these volumes of importance to the coaching man. ‘HARRY HIEOVER’ is the pseudonym of CHARLES BRINDLEY.)

*The Sportsman's Friend in a Frost.* By ‘HARRY HIEOVER.’ London: 1857. 8vo, 416 pages.

## HOOPER.

*Notes on the Construction of Private Carriages in England, and Reports on the Carriages of the International Exhibitions of Paris, 1855; London, 1862; Dublin, 1865; Paris, 1867; London, 1873.* By GEORGE N. HOOPER. London: printed by G. Phipps. 1876. 16mo.

## HOUGHTON.

*The Coaches of Colonial New York.* By GEORGE W. W. HOUGHTON. New York Historical Society. 1890. 8vo, 31 pages.

## HOWLETT.

*Leçons de Guides.* Par EDWIN HOWLETT. Paris: Pairault et Cie. 1893. Large 8vo, 154 pages. (Edwin Howlett is well known to American and French coaching men, as an admirable teacher of four-in-hand driving. To a natural ability for instructing, he has joined large practice in driving,

and in his book he has endeavoured, most successfully, to impart what he says to his pupils on the box. Every word should be carefully studied by an aspirant for coaching honours, and the author himself should be sought by any beginner who may have the good fortune to be within reach of his stables in Paris.)

*Driving Lessons.* By EDWIN HOWLETT. New York: R. H. Russell & Son. 1894. Large 8vo, 159 pages.

*THE HUB.*

*A Magazine for Carriage Builders.* New York. Monthly, from 1871.

HUTH.

*A Bibliographical Record of Hippology.* By F. H. HUTH. London: Bernard Quaritch. 1887. Small 4to, 439 pages. (A very complete catalogue of works on Horses, Driving, etc.)

INMAN.

*The Old Santa Fé Trail, The Story of a Great Highway.* By Colonel HENRY INMAN, U. S. A. New York and London: The Macmillan Company. 1898. 8vo, 490 pages. (Contains interesting passages on Coaching in the West.)

JOUFFRET.

*Traité de la Conduite en Guides et de l'Entretien des Voitures.* Par le Commandant JOUFFRET.

Paris : Librairie Militaire de L. Baudoin et Cie. 1889. Large 8vo, 149 pages, 62 wood-cuts. (Does not contain a great deal about Four-in-hand Driving, but gives many explanations of terms, and of parts of harness, which are useful to a person driving in France.)

#### KNIGHT.

*Hints on Driving.* By Captain C. MORLEY KNIGHT, R.A. Illustrated by G. H. A. WHITE, Royal Artillery. London and New York : George Bell & Sons. 1894. 12mo, 180 pages, with illustrations. (Contains detailed instructions both for four-horse, and for tandem, driving.)

#### KÖHLER.

*The Coach Horn : What to Blow, and How to Blow it.* By AN OLD GUARD. London : Köhler & Son. 1893. Third edition. 16mo, 23 pages.

#### LAGARD.

*La Carrosserie Française.* Six Livraisons par An. Paris : L. Lagard. (Magazine.)

#### LATCHFORD.

*The Loriner : Opinions and Observations on Bridle-Bits and the Suitable Biting of Horses.* With illustrations. By BENJAMIN LATCHFORD. London : Nichols, Son & Co. 1871. Small 4to. (A useful, short treatise, with a large number of drawings of bits, and a translation of a treatise on biting by Don JUAN SEGUNDO, 1832. The

Loriners' (Bit Makers') Company is one of the old Guilds of London, dating back to the thirteenth century.)

## LENNOX.

*Pictures of Sporting Life and Character.* By LORD WILLIAM LENNOX. London: 1860. 2 vols., 12mo.

*Coaching, with Anecdotes of the Road.* By LORD WILLIAM PITT LENNOX. London: Hurst & Blackett. 1876. (Contains interesting coaching gossip and hints about driving.)

## LENOBLE DU TEIL.

*Cours Théorique d'Équitation, de Dressage et d'Attelage.* Par J. LENOBLE DU TEIL, Ecuyer; Professeur à l'École des Haras Nationaux. Paris et Nancy: Berget-Levrault et Cie. 1889. Large 8vo, 455 pages. (This book treats of a department of driving too much neglected in America; the *handling* and *bitting* of horses before they are put to harness, and while they are being prepared for driving; the remarks upon this subject are useful.)

## LEVESQUE.

*Les Grandes Guides.* Par DONATIEN LEVESQUE. Paris: Librairie Cynégétique Pairault. 1886. 12mo, 180 pages. (Only three hundred numbered copies printed. An admirable little book by a good coachman.)

*Les Guides.* Par DONATIEN LEVESQUE. Paris : Adolphe Le Goupy. 1897. 12mo, 217 pages.

## LINSLEY.

*Morgan Horses : A Premium Essay on the Origin, History, and Characteristics of this Remarkable American Breed of Horses.* By D. C. LINSLEY, Middlebury, Vermont. New York : C. M. Saxton. 1864. 12mo, 340 pages. (First edition 1856.)

## MACNIELL.

*Seventh Report of the Commissioners, on Road from London to Holyhead.* House of Commons, 13 July, 1830. Folio, 54 pages. (The Appendix contains reports by PARNELL, by TELFORD, and by MACNIELL, and a description of MACNIELL'S Dynamometer.)

## 'MAGENTA.'

*The Handy Horse Book ; or, Practical Instructions in Driving, Riding, and the General Care and Management of Horses.* By a Cavalry Officer ('MAGENTA'). Edinburgh and London : William Blackwood & Sons. 1878. Ninth edition, 12mo, 167 pages. (First edition 1865.)

## MALET.

*Annals of the Road ; or, Notes on Mail and Stage Coaching in Great Britain.* By Captain [HAROLD ESDAILLE] MALET, 18th Hussars. To which are added *Essays on the Road.* By 'NIMROD.' Lon-



don : Longmans, Green & Co. 1876. Large 8vo, 403 pages. (An interesting book on Four-horse Driving, and especially valuable as containing (pp. 177-387) a reprint of *Essays on the Road*, by 'NIMROD' [CHARLES J. APPERLEY], first published in *The Sporting Magazine*, London ; Vols. ix. to xx. New Series ; the first in 1822, the last in 1827. These *Essays* are particularly interesting because they were written by a practical coaching man at the time when public coaching was at its best in England. A coaching man should study them with care, and cannot fail to learn much from them. A large portion of the Chapter on 'Driving' in WALKER'S *Manly Exercises* is taken from these *Essays*. An admirable *Glossary* of Terms of the Road is appended to MALET'S volume.)

## MAUDSLAY.

*Highways and Horses.* By ATHOL MAUDSLAY. London : Chapman & Hall. 1888. 8vo, 471 pages.

## MICHELIN.

*Le Pneumatique, son Application aux Voitures à Chevaux et sans Chevaux.* Par M. A. MICHELIN. Paris : 1896. Pamphlet of 40 pages. (Reprinted from *The Memoirs of The Society of Civil Engineers of France*, June 1896. Contains an account of valuable experiments on the draught of vehicles with pneumatic tires.)

## MONTIGNY.

*Manuel des Piqueurs, Cochers, Grooms et Pale-freniers, à l'Usage des Écoles de Dressage, et d'Équitation de France.* Par M. le COMTE DE MONTIGNY. Paris: L. Baudoin. 1891. Seventh edition, 12mo, 559 pages. (The first edition was published in 1865, under the Second Empire. This book treats very thoroughly of all stable matters, and there are instructions for driving pairs and fours.)

## MORIN.

*Nouvelles Expériences sur le Frottement des Axes de Rotation, faites à Metz en 1834.* Par ARTHUR MORIN. Paris: Carilian-Gœury. 1838. 4to, 100 pages.

*Expériences sur le Tirage des Voitures, faites en 1837 et 1838.* Par ARTHUR MORIN. Paris: Carilian-Gœury. 1839. 4to, 102 pages.

*Expériences sur le Tirage des Voitures et sur les Effets Destructeurs quelles exercent sur les Routes, exécutées en 1837 et 1838, et en 1839 et 1841.* Par ARTHUR MORIN. Paris: L. Mathias. 1842. 4to; 3 parts, separately paged: I. 188 pages; II. 124 pages; III. 67 pages. (The edition of 1842 includes that of 1839.)

*Voitures employées aux Services public et privé autres que celles des Chemins de fer.* Report by General MORIN on Class VI. of the London

Exhibition of 1862. Published in the second volume of Official Reports. Paris: Napoleon Chaix & Cie. 1862.

MURRAY.

*The Perfect Horse.* By WILLIAM HENRY MURRAY. 8vo. Boston: 1873; New York: 1881.

‘NIMROD.’

*The Road.* By ‘NIMROD’ [C. J. APPERLEY]. First published in *The Quarterly Review* in 1832. (Numerous reprints of this have been made, among them a 16mo, by John Murray. London: 1853. 63 pages. This covers some of the same ground as the *Essays*. The description of the astonishment of an old fellow who fell asleep in 1742, and woke up to drive on a coach in 1832, is spirited and has been always deservedly popular. ‘NIMROD’ had a happy faculty for treating sporting subjects, and his famous account of a run with the Quorn Hounds has served as a model for many succeeding writers in that line.)

‘NIMROD’S’ *Hunting Tour in Scotland and the North of England, with the Table-talk of Distinguished Sporting Characters, and Anecdotes of Masters of Hounds, Crack Riders, and Celebrated Amateur Dragsmen.* London: C. Templeman. 1857. Second edition, 8vo, 427 pages. (This is also called ‘NIMROD’S’ *Northern Tour*, and was

written in 1834-35 and first published in 1835. The Coaching part is interesting and valuable.)

NOBBS.

*Old Coaching Days; Some Incidents in the Life of Moses James Nobbs, the Last of the Mail Coach Guards.* Told by Himself. With a Preface by the Controller of the London Postal Service. London: No date or publisher. The Preface is dated December 1861. 18mo, 55 pages. (Some unimportant anecdotes of Coaching.)

D'OCAGNE.

*Le Mail-Coach en France.* Par MORTIMER D'OCAGNE. Paris: Adolphe Le Goupy. 1891. 12mo, 32 pages. (A short sketch of Coaching in France, England, and America.)

PARNELL.

*A Treatise on Roads.* By SIR HENRY PARNELL, Bart. London: Longmans. 1838. 8vo, 465 pages.

PATERSON.

*Paterson's Roads; being an entirely original and accurate Description of all the Direct and Principal Cross Roads in England and Wales, etc., etc.* Eighteenth edition. London: Edward Mogg. 1829.

PHILIPSON, JOHN.

*Harness: As It Has Been, As It Is, and As It Should Be.* By JOHN PHILIPSON. *With remarks*

*on Traction, and the Use of the Cape Cart by 'NIMSHIVICH.'* Newcastle-upon-Tyne: Andrew Reid; and London: Edward Stanford. 1882. 8vo, 80 pages, numerous illustrations. (This treatise is full of valuable information, which the coaching man should have by heart.)

*The Technicalities of the Art of Coach-Body-Making.* By JOHN PHILIPSON. London: John Kemp & Co. 1885. 12mo, 46 pages.

*The Art and Craft of Coach Building.* By JOHN PHILIPSON. London: George Bell & Sons. 1897.

PHILIPSON, WILLIAM.

*Draught.* By WILLIAM PHILIPSON. London: John Kemp & Co. 1885. 12mo, 23 pages. (A short scientific treatise on Draught from the point of view of the resistance of the vehicle.)

*Prize Essay on the Suspension of Carriages.* By WILLIAM PHILIPSON. New York: The Hub Publishing Co. 1889. 12mo, 61 pages. (With many plates. Although this is essentially a coach-maker's book, it is interesting to the driving man who cares to understand the construction of his vehicle.)

*Paper on Brakes for Retarding the Motion of Carriages in Descending Inclines.* By WILLIAM PHILIPSON. Read before the Institute of British Carriage Manufacturers, August 5, 1888. London: 1888. 8vo, 20 pages.

*QUARTERLY.*

*The London Quarterly Review*, October 1877.  
Article on *Coaching*. Anonymous. 17 pages.

## REYNARDSON.

*Down the Road; or, Reminiscences of a Gentleman Coachman.* By C. T. S. BIRCH REYNARDSON. London: Longmans, Green & Co. 1875. 8vo, 224 pages. (Eleven good coloured plates by H. ALKEN. Agreeable reminiscences, with some useful hints.)

## RICHARDSON.

*Practical Carriage Building.* By M. T. RICHARDSON. New York: M. T. Richardson & Co. 1892. 2 vols., 12mo, 222 and 280 pages.

*RIDER AND DRIVER.*

*The Rider and Driver.* Weekly, First number, March 7, 1891. New York. Large 4to.

*ROAD.*

*The Road. The Riding, Driving, and Coaching Journal.* London. Folio. Monthly. Commenced April 1, 1891. Edited by 'FORTINBRAS.'

## SIDNEY.

*The Book of the Horse.* By S. SIDNEY. London: n. d. 1874(?). 4to, 604 pages. (Contains good Chapters on Driving and Coaching.)

*Four-in-Hand Driving as a Fine Art.* By S. SIDNEY, in *The New Quarterly Review*. London: October, 1876. 13 pages.

'STONEHENGE,' *see* WALSH.

STRATTON.

*The World on Wheels; or, Carriages, with their Historical Associations from the Earliest to the Present Time, &c. &c.* By EZRA M. STRATTON. Illustrated. New York: Published by the Author, 325 East Eighteenth Street. 1878. Large 8vo, 490 pages, 364 illustrations. (A very complete history of carriages, which, with THRUPP'S book, really exhausts the subject as far as it is of interest to the driving man.)

SWALES.

*Driving as I Found it, What to Drive, How to Drive.* By FRANK SWALES. Illustrated by WALTER PETTIE. London, Paris, Washington, Chicago, New York: Brentano's. 1891. 12mo, 180 pages. (Contains some useful hints, and good plates of *Hands*. Some of the chapters are taken from *Stable Talk and Table Talk*, now a somewhat rare book.)

TAILER.

*Coaching in France.* By T. SUFFERN TAILER, in *Illustrated American*, August 29, 1891.

*Coaching and Coachmen.* By T. SUFFERN TAILER, in *Illustrated American*, September 5, 1891. (Both of these articles are beautifully illustrated.)

TALLY HO.

*The Tally Ho! Notes on Coaching.* New York: Valentine & Co. 1877. Pamphlet of 28 pages, with illustrations by GREY PARKER.

TANDEM.

*Hints to Young Tandem Drivers by an Old Hand.* Oxford: T. Shrimpton & Son. 1875. 16mo, 24 pages.

THRUPP.

*The History of Coaches.* By G. A. THRUPP. With numerous illustrations. London: Kirby & Edean; New York: The Hub Publishing Company. 1877. 8vo, 152 pages. (The title 'Coaches' includes all carriages. This is a very complete and important book, and of interest to every coaching man.)

TRISTRAM.

*Coaching Days and Coaching Ways.* By W. OUTRAM TRISTRAM. Illustrated by HUGH THOMSON and HERBERT RAILTON. London: Macmillan & Co. 1888. Large 4to, 367 pages. There is also a small edition, 12mo, 376 pages, 1893; the same publishers. (Mainly anecdotes and descriptions of English coach roads.)



## TWINING.

*Travels in America One Hundred Years Ago; being Notes and Reminiscences.* By THOMAS TWINING. New York: Harper & Brothers. 1894. 16mo, 181 pages. (Contains some notes on travelling by coach.)

## UNDERHILL.

*Driving for Pleasure; or, the Harness, Stable and its Appointments.* By FRANCIS T. UNDERHILL. New York. 1896. Large 4to. (Profusely illustrated and thoroughly up to date.)

## VINEY.

*Méthode de Trompe de Mail-Coach.* (Preface par M. le COMTE HENRY D'YANVILLE.) Par VICTOR VINEY et ALEXANDRE PASSEVANT. Paris: Adolphe Le Goupy. 1893. Oblong 12mo, 88 pages. (Contains a collection of the regular coach calls and a large number of tunes and fanfares.)

## WALKER.

*British Manly Exercises; in which Rowing and Sailing are now first described, and Riding and Driving are for the first time given in a work of this kind, &c. &c.* By DONALD WALKER. Third edition. London: J. Hurst. 1835. The first and second editions are dated March 1, 1834, and March 14, 1834. 16mo, 291 pages. (There are 2 plates by H. ALKEN, and 53 line drawings on

copper. Seventy pages of the book are devoted to driving, a large part of it drawn from 'NIMROD'S' *Essays*, and from his article in *The Quarterly Review*. There are other editions of this popular book; the tenth (London: H. G. Bohn, 1860) is edited by 'CRAVEN' [JOHN WILLIAM CARLETON], and has some slight additions and modifications.)

WALSH ['STONEHENGE'].

*Riding and Driving*. By J. H. WALSH. London: 1863.

WARD.

*Hints on Driving*. By C. S. WARD, the well-known 'Whip of the West.' London: published by the Author. 1870. 4to, 24 pages. (With a photograph of the author, one of the most famous Whips of his time.)

WHITLEY.

*Coventry Coaching and Coach Roads*. By T. W. WHITLEY, Coventry. Printed at *The Herald Office*. 1887. 12mo, 27 pages. (A Sketch of Coaching in the Neighbourhood of Coventry in the early part of this century.)

YOUATT.

*Draught*. By WILLIAM YOUATT. 46 pages, 8vo. Forms the latter part of '*The Horse*.' (By the same author.) London: Longmans. 1866, and many other editions. (This is the classical treatise on Draught.)

YOUNG.

*The Four-in-hand, and Glances at the Literature of Coaching.* By JENNIE J. YOUNG. *Lippincott's Magazine*, June 1878.

LIST OF FRENCH NAMES FOR PARTS OF  
HARNESS

THE following French equivalents for the English names of parts of harness or of a coach are given for the convenience of persons driving in France. The list has been revised by Mr MORRIS E. HOWLETT, of Paris, and may be trusted as giving the names actually used in a French stable. The gender is denoted by (*m*) or (*f*). The figures refer to the cuts in the text.

Axle-arm, 13, 14 . . . .	Essieu ( <i>m</i> )
Back-strap, 106, 107 . . .	Croupière ( <i>f</i> )
Bar-bit, B, 88 . . . . .	Mors ( <i>m</i> ) à barette ( <i>f</i> )
In the lower bar . . . . .	en bas
In the middle bar . . . . .	au milieu
In the upper bar . . . . .	au banquet
Upper ring (of a bit) . . .	Œil ( <i>m</i> )
Bar-buckle . . . . .	Boucle ( <i>f</i> ) à traverse
Bearing-rein, 93 . . . . .	Enrênement ( <i>m</i> )
Belly-band . . . . .	Sous-ventrière ( <i>f</i> )
Billet (of a rein), 89 . . .	Porte-mors ( <i>m</i> )
Bit (used for a <i>bit</i> generally, but especially for a curb-bit) . . . . .	Mors ( <i>m</i> )
Black leather . . . . .	Cuir ( <i>m</i> ) noir
Boss, 84 . . . . .	Cocarde ( <i>f</i> ), [Bossette ( <i>f</i> ) when on a bit]

Breast collar, 81 . . . . .	Bricole ( <i>f</i> )
Breeching . . . . .	Reculement ( <i>m</i> )
Bridle, 84 . . . . .	Bride ( <i>f</i> )
Buckle . . . . .	Boucle ( <i>f</i> )
To burnish . . . . .	Polir à la gourmette
Buxton bit, D, 88 . . . . .	Wellington
Canon (of a bit), C, 90 . . . . .	Canon ( <i>m</i> )
Centre-hook, A, 105 . . . . .	Crochet ( <i>m</i> ) d'enrê- nement ( <i>m</i> )
Centre-terret . . . . .	Crochet d'enrênement portant clef ( <i>f</i> )
Chape, A, 105 . . . . .	Courroie ( <i>f</i> ) de man- celle ( <i>f</i> )
Cheek-piece, 84 . . . . .	Montant ( <i>m</i> )
In the cheek . . . . .	Au banquet (or en haut), equally correct
Choke-strap, 100 . . . . .	Fausse martingale ( <i>f</i> )

(It is customary, in America and in England, to call, in double harness, a 'martingale,' the strap which goes from the belly-band to the bottom of the collar, as shown in Fig. 100 of the text; this is 'fausse martingale' in French, and in America, but not in England, is frequently called 'choke-strap.')

Clip (of a tug), A, 101 . . . . .	Chape ( <i>f</i> )
Clipper . . . . .	Tondeuse ( <i>f</i> )
Cock-eye, 104 . . . . .	Mousqueton ( <i>m</i> ) fermé
Cock horse . . . . .	Cheval ( <i>m</i> ) de renfort
Collar, 94, 95, 96 . . . . .	Collier ( <i>m</i> )
Coupling-rein . . . . .	Italienne ( <i>f</i> ), Guide ( <i>f</i> ) intérieure, Accouple- ment ( <i>m</i> )

To cross the traces, B, 126	Croiser les traits ( <i>m</i> )
Crown-piece (of bridle), 86 . . . . .	Tetière ( <i>f</i> )
Crupper, 106, 107 . . . . .	Croupière ( <i>f</i> )
Crupper-dock . . . . .	Culeron ( <i>m</i> )
Curb-bit . . . . .	Mors ( <i>m</i> ) à gourmette ( <i>f</i> )
Curb-chain . . . . .	Gourmette ( <i>f</i> )
To cut the tires . . . . .	Chartrer les roues ( <i>f</i> )
D . . . . .	Dé ( <i>m</i> )
Draught-eye (for drag harness), A, 99 . . . . .	Tirage ( <i>m</i> ) à chape ( <i>f</i> )
Draught-eye (for coach harness), C, 99 . . . . .	Tirage à anneau ( <i>m</i> )
Draught-rein . . . . .	Guide ( <i>f</i> ) extérieure
Driving cushion, 37 . . . . .	Coussin ( <i>m</i> ) de guide
Dutch collar, 81 . . . . .	Bricole ( <i>f</i> )
Elbow bit, C, 88 . . . . .	Mors ( <i>m</i> ) à baïonnette ( <i>f</i> )
Face-drop (face-piece), 84	Plaque ( <i>f</i> ) de front ( <i>m</i> )
False belly-band, Plate XXV . . . . .	Fausse sous-ventrière ( <i>f</i> )
Foot-board . . . . .	Coquille ( <i>f</i> )
French loop trace, B, 102	Trait ( <i>m</i> ) à crosse
Front, 84 . . . . .	Frontail ( <i>m</i> )
Gag-runner, A, 93 . . . . .	Panurge ( <i>f</i> )
Girth . . . . .	Sangle ( <i>f</i> )
Halter . . . . .	Licol ( <i>m</i> )
Web halter . . . . .	Licol de sangle
Hames, 100 . . . . .	Atelles ( <i>f</i> )
Hame-strap, 100 . . . . .	Curroie ( <i>f</i> ) d'attelle
Hame-terret, 100 . . . . .	Clef ( <i>f</i> ) d'attelle

Harness . . . . .	Harnais ( <i>m</i> )
Head-stall, 84 . . . . .	Têteière ( <i>f</i> )
Hip-strap . . . . .	Surdos ( <i>m</i> )
Hole (in a strap) . . . . .	Point ( <i>m</i> )
Horse clothing . . . . .	Couverture ( <i>f</i> ) de cheval ( <i>m</i> )
Kidney-link, 97 . . . . .	Coulant ( <i>m</i> ) d'attelle ( <i>f</i> )
Kidney-link ring, 100 . . . . .	Anneau ( <i>m</i> ) de chaînette ( <i>f</i> )
Lamp . . . . .	Lanterne ( <i>f</i> )
To lap the traces, C, 126	Entrelasser les traits ( <i>m</i> )
Lead-bars, 30 . . . . .	Palonniers ( <i>m</i> ) de volée ( <i>f</i> )
Lead-horse . . . . .	Cheval ( <i>m</i> ) de volée
Lead-rein . . . . .	Guide ( <i>f</i> ) de volée
Lead-trace, 104 . . . . .	Trait ( <i>m</i> ) de volée
To let out near coupling- rein	Allonger l'italienne de gauche
To take up near coupling- rein	Raccourcir l'italienne de gauche
Off coupling-rein . . . . .	Italienne de droite
Link (of the pole-chain, of the curb-chain) . . . . .	Maille ( <i>f</i> )
Liverpool bit, A, 88 . . . . .	Mors ( <i>m</i> ) à ballon sans barette ( <i>f</i> )
Loin-cloth . . . . .	Caparaçon ( <i>m</i> ) de drap
Loop . . . . .	Passant ( <i>m</i> )
Loop, fixed or sliding . . . . .	Passant fixe, ou coulant
Loop-trace, A, 102 . . . . .	Trait ( <i>m</i> ) à de ( <i>m</i> )
Main-bar, 30 . . . . .	Sommier ( <i>m</i> )

Martingale, 100 . . . .	Martingale ( <i>f</i> )
Mountings (of harness) .	Garniture ( <i>f</i> )
Wire mountings, 105 . . .	Jonc ( <i>m</i> ) anglais
Mouth-piece, 90 . . . .	Embouchure ( <i>f</i> )
Monogram . . . . .	Chiffre ( <i>m</i> )
Near horse . . . . .	Cheval ( <i>m</i> ) de gauche
Newmarket tug-bearer, B, 105	Courroie ( <i>f</i> ) de man- celle ( <i>f</i> ) mobile
Nose-band, 84 . . . . .	Muserolle ( <i>f</i> )
Off horse . . . . .	Cheval ( <i>m</i> ) de droite
Pad, 105 . . . . .	Mantelet ( <i>m</i> )
Pad-terret, 105, 112 . . .	Clef ( <i>f</i> ) de mantelet ( <i>m</i> )
Patent leather . . . . .	Cuir ( <i>m</i> ) vernis
Pipe . . . . .	Fourreau ( <i>m</i> )
Point-strap, A, 105 . . .	Contre-sanglon ( <i>m</i> ) de fausse sangle ( <i>f</i> )
Pole . . . . .	Timon ( <i>m</i> )
Pole-chain, 114, 115 . . .	Chaînette ( <i>f</i> ) [d'acier ( <i>m</i> )]
Pole-head, 29 . . . . .	Trompe ( <i>f</i> ) de timon ( <i>m</i> )
Pole-hook, 116 . . . . .	Crochet ( <i>m</i> ) de timon
Pole-strap (pole-piece) .	Chaînette de cuir
Polishing pad, 121 . . . .	Gourmette ( <i>f</i> ) sur buf- fle, Cotte de maille
Port (of a bit), 90 . . . .	Liberté ( <i>f</i> ) de langue
To put-to . . . . .	Atteler
Reins, 108 . . . . .	Guides ( <i>f</i> )
Set of reins . . . . .	Jeu ( <i>m</i> ) des guides ( <i>f</i> )
Rein-billet, 89 . . . . .	Porte-mors ( <i>m</i> )



Ring snaffle, 92 . . . .	Filet ( <i>m</i> ) à quatre anneaux ( <i>m</i> )
Roller-bolt, 125 . . . .	Paumelle ( <i>f</i> )
Rosette . . . . .	Cocarde ( <i>f</i> )
Russet leather . . . .	Cuir ( <i>m</i> ) jaune
Splinter-bar, 8 . . . .	Volée ( <i>f</i> )
Single bar, 30 . . . .	Palonnier ( <i>m</i> )
Snaffle-bit, 91 . . . .	Filet ( <i>m</i> )
Spring, 27 . . . . .	Ressort ( <i>m</i> )
Spring-hook (for pole-chain), 117	Mousqueton ( <i>m</i> ) à ressort ( <i>m</i> )
Splice (in a rein, or in a whip-thong), 163 . . .	Anture ( <i>f</i> )
Swivel . . . . .	Pivot ( <i>m</i> )
Stable-shutter . . . .	Volet ( <i>m</i> ), Store ( <i>m</i> ), Jalousie ( <i>f</i> ), Persienne ( <i>f</i> )
To take out the horses .	Dételer
Terret, 112 . . . . .	Clef ( <i>f</i> )
Throat-latch, 84 . . . .	Sous-gorge ( <i>f</i> )
Tongue (of a buckle) . .	Ardillon ( <i>m</i> )
Trace, 102, 103, 104 . .	Trait ( <i>m</i> )
Trace-bearer . . . . .	Porte-trait ( <i>m</i> )
Tug, 101 . . . . .	Grand boucleteau ( <i>m</i> ) de trait ( <i>m</i> )
Tug-buckle, 101, 118 . .	Boucle à crampons ( <i>m</i> ), or, à mancelles ( <i>f</i> )
Eye of tug-buckle, 118 .	Crampon ( <i>m</i> ), Mancelle ( <i>f</i> )
Wheel . . . . .	Roue ( <i>f</i> )

Wheel horse . . . . .	Cheval ( <i>m</i> ) de timon ( <i>m</i> )
Wheel-trace, 102, 103 . . .	Trait ( <i>m</i> ) de timon ( <i>m</i> )
Whip, 159 . . . . .	Fouet ( <i>m</i> )
Handle of whip, 159 . . .	Poignet ( <i>m</i> )
Ferrule, or collar, of whip, 159 . . . . .	Virole ( <i>f</i> )
Butt-cap of whip, 159 . . .	Cuvette ( <i>f</i> )
Thong of whip, 162 . . .	Monture ( <i>f</i> )
Point (of thong) . . . . .	Mèche
Winker, 84 . . . . .	Œillère

## INDEX

<p>Abbott Downing Co. . . . . 116</p> <p>Aberdeen coach. . . . . 466</p> <p>Accessories. . . . . 80</p> <p>Accidents. . . . . 502</p> <p>ACKERMAN. . . . . 28</p> <p>ADAM. . . . . 104</p> <p>ADAMS. . . . . 1</p> <p>Adams &amp; Co. Express. . . . . 469</p> <p>AGAR. . . . . 230</p> <p>ALKEN. . . . . 333, 413</p> <p>Aluminium bronze. . . . . 239</p> <p>America. Coaching in 432, 474</p> <p>American coach. . . . . 37, 116</p> <p style="padding-left: 2em;">“ method of driving. . . . . 333</p> <p>ANGELL. . . . . 432</p> <p>Angle of lock. . . . . 28, 337</p> <p style="padding-left: 2em;">“ trace. . . . . 189</p> <p>Apparatus. Driving . . . . . 345</p> <p>Apprentice. . . . . 412</p> <p>Aprons. . . . . 98</p> <p>Ardley coach. . . . . 434, 456</p> <p>Arm. Position of . . . . . 301</p> <p>Ascot. . . . . 516</p> <p>Attachment of horse. . . . . 187</p> <p>Austrian method of driving. . . . . 476</p>	<p>Awnings. . . . . 96</p> <p>Axle. . . . . 30</p> <p style="padding-left: 2em;">“ Breaking an . . . . . 506</p> <p style="padding-left: 2em;">“ Collinge . . . . . 32</p> <p style="padding-left: 2em;">“ Dip of arm of . . . . . 40</p> <p style="padding-left: 2em;">“ friction. . . . . 157</p> <p style="padding-left: 2em;">“ Gather of . . . . . 47</p> <p style="padding-left: 2em;">“ Length of . . . . . 37</p> <p style="padding-left: 2em;">“ Mail . . . . . 31</p> <p style="padding-left: 2em;">“ Parallel . . . . . 34</p> <p style="padding-left: 2em;">“ Taper . . . . . 34</p> <p>Back-strap. . . . . 222</p> <p>Backing. . . . . 337</p> <p>Baggage net. . . . . 17</p> <p>Ball-bearings. . . . . 159</p> <p>Balling. . . . . 502</p> <p style="padding-left: 2em;">“ pads. . . . . 503</p> <p>Balls. The crushing of steel . . . . . 160</p> <p>Bar. Splinter- . . . . . 22</p> <p>BARCLAY. 298, 463, 466, 473</p> <p>BARKER. 125, Plates XX., XXI.</p> <p>Barouche landau. . . . . 112</p> <p>Bars. Lead- . . . . . 55</p> <p>BARTLETT. . . . . 3</p> <p>Basket. . . . . 93</p>
--	--

- BATTERSBY. . . . . 365
- BAUCHER. . . . . 368, 375, 378
- Bearing-rein. . . . . 206, 256
- BEAUFORT. 31, 110, 198, 280,  
290, 432
- Bedford experiments. . . . . 163
- Beginner. The . . . . . 293
- BELMONT. . . . . 486
- Bending lessons. . . . . 369
- BENNETT. . . . . 467
- Bensington Driving Club. 431
- Berlin. . . . . 4
- BIANCONI. . . . . 112
- Billets. Rein- . . . . . 225
- Birthday parade. . . . . 103
- Bits. . . . . 201, 360
- Bitting. . . . . 360
- BLAKE. . . . . 532
- BLEIGHT. . . . . 379
- Blunderbuss. . . . . 481
- Body. . . . . 61
- BOKER. . . . . 378
- Booking. . . . . 454
- “ office. . . . . 453
- Books. List of . . . . . 536
- Boots of coach. . . . . 10, 64, 71
- “ men. . . . . 421
- Box coat. . . . . 423
- “ Hill coach. . . . . 434
- “ seat. . . . . 67
- “ Position on the . . . . . 305
- Boxes. Lunch- . . . . . 94
- Braces. Thorough- 4, 6, 117
- Brake. . . . . 80
- “ Foot . . . . . 85
- Brake. LEMOINE. . . . . 84
- Break. Dealer's . . . . . 107
- “ Wagonette . . . . . 110
- Breast-collar. . . . . 23, 187
- Breeches. . . . . 421
- Breeching. . . . . 223
- BREWSTER & CO. Plates  
XVII., XVIII.
- Bridle. . . . . 194
- Brighton coach. 435, 465,  
466
- “ road. . . . . 431
- Britzka. . . . . 10
- BRONSON. . . . . 486
- Brougham. . . . . 133
- Buckling reins. . . . . 229, 270
- Buggy. . . . . 110
- “ wheels. . . . . 48
- Bugle. . . . . 532
- Buttons. Club . . . . . 426
- “ Livery . . . . . 419
- Buxton bit. . . . . 203, 365
- CADWALADER. . . . . 379
- Calls on the horn. . . . . 531
- Cantering leader. . . . . 428
- Cape cart. . . . . 113
- “ Driving- . . . . . 424
- Card. Time- . . . . . 456
- Care of coach. . . . . 126
- “ “ harness. . . . . 241
- Carriage-part. . . . . 19
- Catching up whip. . . . . 403
- C-spring. . . . . 9
- Centre of gravity. . . . . 133

- Centrifugal force. . . . 137  
 Cernay-la-Ville coach. . . 434  
 Chain-end trace. . . 218, 251  
 " trace. . . . 240  
 Chains. Pole- 54, 55, 233  
 CHANDOS-POLE. . . . 432  
 Change. . . . 459  
 CHAPLIN. . . . 262  
*Char à bancs*. . . . 110  
 Chart. Time- . . . 444  
 Check-rein. . . . 207  
 Chopping. . . . 335  
 Circus horse. . . . 143  
 CLARK. . . . 431  
 CLARKE. . . . 262  
 Clipping. . . . 387  
 Club buttons. . . . 426  
 Clubbing reins. . . . 334  
 Clubs. Coaching. 431, 510  
 Coach. . . . 1  
 " and Drag. Dis-  
 tinction between 16  
 " Care of . . . 126  
 " Cost of . . . 128  
 " Development of . 1  
 " General charac-  
 ter of . . . 16  
 " Height of 49, 61, 120  
 " Name of . . 11, 12  
 " on a race-course. 516  
 " Weight of . . 129  
 Coaching Club. New York 422,  
 510  
 " " Meets. . 512  
 " " trips. . . 486  
 Coaching Clubs. . . 431, 510  
 " Cost of . . . 388  
 " in America. 432, 474  
 " in England. 425, 481  
 " medals. . . . 533  
 " Public . . . 427  
 " Revival of . . 432  
 " trips. . . . 484  
 Coachman's dress. . . 452  
 " duties. . . . 449  
 Coat. Box . . . . 423  
 Cockade. . . . 419  
 Cock-eye. . . . 219  
 " horse. . . . 236  
 " " harness. . . 236  
 Coefficient of axle - fric -  
 tion. . . . 158  
 " of rolling-fric-  
 tion. . . . 153  
 Collar. . . . 207  
 " Attachment of  
 trace to . . 213  
 " Breast or Dutch 23,  
 187  
 " Form of . 208, 210  
 " Kay . . . . 208  
 " lining. . . . 209  
 " Rim . . . . 208  
 Collinge axle. . . . 32  
 Colonial coaching. . . 5, 477  
 Colours of coaches. . . 75  
 Comparison of coaches. . 123  
 Competitions. Driving. . 527  
 Computation of resist-  
 ance. . . . 161

- Concord Coach. . . 4, 37, 116  
 Coned wheels. . . . . 41  
 Continental methods of  
     driving. . . . . 331  
 Contractors. Mail- . . . 482  
 CORBETT. 137, 262, 271, 298,  
     322, 329, 414, 466, 469,  
     472, 481  
 CORDERY. . . 9, 125, 387, 413  
 Cost of coach. . . . . 128  
     “ coaching. . . . . 388  
 Coupling. . . . . 263  
     “ diagram. 270, 449  
     “ reins. . . . . 225, 263  
 Coventry. . . . . 469  
 Crab. . . . . 53  
 CRACKNELL. . . . . 262  
 Crest. . . . . 76, 196  
     “ panel. . . . . 76  
 CROSS. . . . . 8, 71, 72  
 Cross team. . . . . 384  
 Crossing traces. . . . . 253  
 Croup to the wall. . . . 376  
 Crown of street. . . . . 178  
 Crown-piece. . . . . 196, 199  
 Crupper. . . . . 222  
 Crushing steel balls. . . . 160  
 Curb-bit. . . . . 201, 361  
     “ chain. . . . . 204  
     “ strap. . . . . 205  
 Curricie. . . . . 113  
 CURZON. . . . . 274  
 Cushion. Driving- 67, 69,  
     304  
 Cycling track. . . . . 144  
*Daumont.* . . . . 237, 283  
 Dealer. London . . . . 366  
 Dealer's break. . . . . 107  
 ‘Defiance.’ . . . . 463, 466  
*Demi-Daumont.* . . . . 284  
 Dennet spring. . . . . 50  
 Development of the coach. . . 1  
 Devices on panels. . . . . 76  
 Devonport mail. . . . . 466  
 Diagram. Backing- . . . 340  
     “ Bitting- . . . . 270  
     “ Coupling- . . . . 270  
     “ Seat- . . . . 455, 488  
     “ Speed- . . . . 444  
     “ Turning- . . . . 340  
 Dickey. . . . . 72  
 Diligence. Ghent . . . . 71  
     “ Swiss. . . . . 105  
 Dip of axle. . . . . 40  
 Dish of wheel. . . . . 40, 44  
 Docker. . . . . 412  
 Docking. . . . . 387  
 Dog-legged whip. . . . . 392  
 Doors of boots. . . . . 64  
 Dorking coach. . . . . 434  
 Double-thong. . . . . 403  
 Down-hill. . . . . 320  
 Drag. . . . . 16, 102  
 Dragsman. . . . . 102  
 Drag-staff. . . . . 89  
 Draught. . . . . 147  
     “ Action of horse  
         in . . . . . 181  
     “ Angle of . . . . . 189  
     “ Experiments on 162

- Draught-eyes. . . . . 213  
 Dress of coachman. 419, 452  
   " " guard. . . . . 452  
   " " servants. . . . . 418  
 Drives. length of . . . . . 472  
 Driving. . . . . 285  
   " American . . . . . 333  
   " apparatus. . . . . 345  
   " competitions. . . . . 527  
   " cushion. 67, 69, 304  
   " General obser-  
     vations on . . . . . 349  
   " Methods of . . . . . 330  
   " seat. . . . . 67, 304  
 DUPUIT. . . . . 148  
 Dutch collar. . . . . 23, 187  
 Duties of servants. . . . . 415  
 DWYER. . . . . 189, 362  
  
 Edinburgh coach. 8, 463, 466  
 Elastic trace. . . . . 185  
 Elbow bit. . . . . 202  
 Eleven-and-four. . . . . 482  
 ELLIOT. . . . . 9  
 Elliptic spring. . . . . 9, 51, 107  
 Evener. . . . . 27  
 Experiments on draught. 148,  
   162  
 Express messenger. . . . . 469  
  
 Falling. Horse . . . . . 502  
 Fares. . . . . 482  
 Farm wagon. . . . . 2  
 FEARING. . . . . 486  
 Fees. . . . . 472  
 FIESCHI. . . . . 367  
 Fifth wheel. . . . . 21  
 FILLIS. . . . . 369, 370  
 Fingering. . . . . 306  
 Flexions. . . . . 369, 370  
 FLOWER. . . . . 263  
 Flowers. . . . . 195  
 Fog. . . . . 509  
 Fontainebleau coach. . . . . 435  
 Foot-board. . . . . 68  
   " boxes. . . . . 74  
   " brake. . . . . 85  
 Force. Centrifugal . . . . . 137  
 Four-and-eleven. . . . . 482  
 Four-in-hand Club. . . . . 431  
 Four-in-hand Club of  
   Philadelphia. . . . . 511  
 French harness terms. . . . . 560  
   " loop trace-ends. . . . . 217  
 Friction. Axle- . . . . . 157  
   " Rolling- . . . . . 147  
 FRITSCH. . . . . 486  
 Fronts. . . . . 194  
 Full hand. . . . . 330  
 Futchell. . . . . 3  
   " Hook under . . . . . 53  
  
 Gag-runner. . . . . 206  
 Gaiters. . . . . 420  
 Galloping. . . . . 353, 441  
 Game. Road . . . . . 482  
 Gammon-board. . . . . 73  
 Gather of axle. . . . . 47  
 Gauge. . . . . 37  
 German bit. . . . . 365

- Getting down. . . . . 327  
 “ up. . . . . 285  
 ‘GLENCAIRN.’ . . . . 26  
 Gloves. . . . . 419, 422  
 GODDEN. . . . . 532  
 Grades. . . . . 167, 186  
 GRISON. . . . . 367  
 Grooms. . . . . 415  
 “ getting down. 358,  
 416  
 Guard’s dress. . . . . 452  
 “ duties. . . . . 449  
 GUIET. 104, 468, Plates VII.,  
 XIX.  
 Guildford coach. 434, 454,  
 457, 465  
 Hackney. . . . . 380  
 HALDEMAN. . . . . 3  
 Half-penny. Coaching . 533  
 Hame-strap. . . . . 213  
 Hames. . . . . 211  
 Hammer-cloth. . . . . 104  
 Hand on the reins. . . . . 296  
 “ Position of . . . . . 299  
 Handling horses. . . . . 360, 366  
 Hang of axle. . . . . 40  
 Harness. . . . . 194  
 “ Care of . . . . . 241  
 “ racks. . . . . 245  
 “ Spare parts of 240  
 Harnessing. . . . . 247  
 HARRIS. 413, 446, 466, 473,  
 481, 482, 499  
 Hats. . . . . 418, 420, 422  
*Haute école.* . . . . 373, 377  
 HAVEMEYER. . . . . 486  
 HAWORTH. . . . . 432  
 HAYES. . . . . 378  
 HAYWOOD. . . . . 180  
 Head. Placing the . . . . . 369  
 “ terrets. . . . . 199  
 Height of coaches. 61, 120,  
 125  
 HERDIC. . . . . 28  
 HIECKEL. . . . . 468  
 HIGGINS. . . . . 467  
 High-flyer. . . . . 112  
 “ school riding. 368, 373  
 Hip-straps. . . . . 223  
 Hitting a leader. . . . . 408  
 “ a wheeler. . . . . 408  
 HOARE. . . . . 432  
 HOGARTH. . . . . 72  
 Hold and hit. . . . . 410  
 Holding four horses. . . . . 292  
 Holly for whips. . . . . 390  
 Holyhead road. . . . . 169  
 Hook under futchells. . . . . 53  
 Horn. . . . . 93, 451, 531  
 Horse. Action in draught  
 of . . . . . 181  
 “ Attachment of . . . . . 187  
 “ keepers. . . . . 447  
 “ shoe pads. 180, 502  
 “ shows. Judging  
 at . . . . . 520  
 Horses for coach. . . . . 380  
 “ to the mile. . . . . 436  
 Hounds. . . . . 2



- HOWLETT. . . . . 468, 560  
 HOWLETT'S opposition. . . . . 316  
 Hungarian reins. . . . . 232  
  
 Ice-skid. . . . . 88, 507  
 Imperial. . . . . 95  
 Inclination of road. . . . . 168  
 Inclining to right or left. . . . . 306  
 India-rubber tires. . . . . 37, 151  
  
 Jack. . . . . 98  
 Jaunting car. . . . . 112  
 JEANTAUD. . . . . 28  
 Jerome Park. . . . . 516  
 Jibber. . . . . 508  
 JOUFFRET. . . . . 333  
 Judging at Horse Shows. . . . . 520  
  
 KANE. . . . . 12, 433, 486  
 Kay collar. . . . . 208  
 KENNEDY. . . . . 473  
 KENVON. . . . . 473  
 KER. . . . . 236  
 Key Bugle. . . . . 532  
 Kicking over trace. . . . . 503  
     " strap. . . . . 223  
 Kidney-link. . . . . 211  
 King-bolt. . . . . 2  
 Knife-board. . . . . 75  
 KÖHLER. . . . . 532  
  
 Ladder. . . . . 92  
 Lamps. . . . . 89  
     " not carried in  
         daytime. . . . . 91  
 Landau. . . . . 133, 343  
 Lapping traces. . . . . 253  
 LA ROUSSE. . . . . 284  
 LATCHFORD. . . . . 361, 365  
 Lazy-back. . . . . 70  
 Lead-bars. . . . . 55  
     " " Swiss. . . . . 58  
     " " Three horse. . . . . 59  
     " reins. . . . . 226, 230  
     " " Ring on . . . . . 507  
 Leaders. . . . . 383, 385  
 Leather. . . . . 238  
 LAURIE & MARNER. . . . . 66  
 LAWRENCE. . . . . 432  
 LEMOINE brake. . . . . 84  
 Length of drives. . . . . 472  
     " " trace. . . . . 186, 191  
 LENNOX. . . . . 112, 425, 481  
 Lessons. . . . . 349  
 Lettering of coach. . . . . 76  
 License. . . . . 471  
 Light hand. . . . . 370, 377  
     " mouth. . . . . 371  
 Linchpin. . . . . 31  
 LINSLEY. . . . . 382  
 Liveries. . . . . 418  
 Liverpool bit. . . . . 201, 365  
 Livery buttons. . . . . 419  
 Lock. . . . . 28  
     " Angle of . . . . . 337  
     " On the . . . . . 22  
 London. Coaching in . . . . . 431  
     " dealer . . . . . 366  
 LOWDEN. . . . . 469  
 LOVO. . . . . 379

- LUQUE. . . . . 468  
 Lunch-boxes. . . . . 94  
  
 MACADAM. . . . . 170  
 Macadam road. . . . . 170  
 MACNEILL. . . 129, 163, 169  
 Maidenhead coach. . . 457  
 Mail axle. . . . . 31  
   " coach. . . . . 102  
   " French . . . . . 104  
   " Le . . . . . 13  
   " Model of . . . . . 103  
   " phaeton. . . 110, 133  
   " The old . . . . . 102  
 Mails. Parade of the . 103  
   " Right of way of  
     the . . . . . 499  
 Maisons - Laffitte coach. 435,  
   437, 465  
 MALET. 7, 25, 58, 79, 112,  
   323, 481  
*Malle poste.* . . . . 104  
 MAREY. . . . . 185  
 Martingale. . . . . 214  
 MAY & JACOBS. . . . . 432  
 Medals. Coaching . . 533  
 Meets. . . . . 512  
 Men. Duties and Dress of 415  
 Mexican bit. . . . . 365  
 MICHELIN. . . . . 152, 163  
 Mileage. . . . . 482  
 Monogram. . . . . 76, 196  
 MONTIGNY. . . . . 331  
 Moping. . . . . 509  
 Morgan horse. . . . . 381  
 MORIN. 104, 105, 148, 153,  
   159, 162, 169, 189, 466  
 Morning suits. . . . . 420  
 Mountings. . . . . 239  
 Mouthing. . . . . 369  
 Moving off. . . . . 293  
 Music. . . . . 531  
  
 Name of coach. . . 11, 12  
 Net. Baggage . . . . 17  
 Newmarket tug-bearer. . 221  
 New York Coaching  
   Club. . . 422, 486, 510  
 Nickel plating. . . . 239  
 'NIMROD.' 7, 25, 58, 102,  
   129, 199, 224, 230, 239,  
   271, 290, 298, 323, 463,  
   466, 473  
 LE NOBLE DU TEIL. . . . 26  
 Nose-band. . . . . 197  
  
 D'OCAGNE. . . . . 13  
 Oil. . . . . 35, 159  
 Omnibus. . . . . 113  
 Opening day. . . . . 449  
 Opposition. . . . . 315  
 Overturn. . . . . 135, 506  
 Oxford coach. . . . . 9, 125  
  
 Pace. . . . . 386  
   " Judgement of . . 352  
 Pad. . . . . 219  
   " cloths. . . . . 221  
 Pads for horses' feet. 180, 502  
 Painting of coach. . . . 75

- PALMER mails. . . . . 102  
 " medal. . . . . 533  
 Panels. . . . . 75  
 Paris. Coaching in . . . 438  
 PARNELL. . . . . 129  
 Patent leather. . . . . 238  
 Pavement. Asphalt . . . 179  
 " Stone 169, 175  
 " Wood . . . 179  
 PEDLER. . . . . 26  
 Pelham bit. . . . . 364  
 " coach. 12, 77, 433,  
 434, 465  
 Perch. . . . . 2, 19  
 " bolt. . . . . 2  
 PETERS. . . . . 65  
 PEYTON. . . . . 431  
 Phaeton. High . . . 112  
 " Mail . 110, 133  
 Philadelphia. Coaching  
 Club trip  
 to . . . 486  
 " Four-in-  
 Hand Club. 511  
 " Riding Club. 379  
 PHILIPSON. . . . . 115, 190  
 Pipe. . . . . 238  
 " clay. . . . . 400  
 " collar. . . . . 210  
 Places of reins in hand. . 299  
 Placing the head. . . . 369  
 Platform springs. . . . 48  
 Plumb spoke. . . . . 40  
 Pneumatic tires. . . . . 151  
 Point. . . . . 310, 313  
 Point. HOWLETT'S . . . 316  
 " on whip. . . 395, 402  
 Pole. . . . . 51  
 " Breaking a . . . 504  
 " chains. . . 55, 233, 249  
 " head. . . . . 54  
 " Length of . . . 53  
 " straps. . . . . 233  
 Poling up. . . . . 251  
 Police regulations. . . . 471  
 Polishing steel. . . . . 244  
 Pontoise coach. 435, 458, 465,  
 467  
 Pony express. . . . . 469  
 Position on the box. 302, 304  
 Postilions. . . . . 278  
 Posting. . . . . 278  
 " French . 107, 281  
 " harness. . . . . 279  
 Postmasters. . . . . 280  
 Procession of mails. . . . 103  
 Proportions of horses. . . 382  
 Public coaching. . . 427, 470  
 Pulling horses. 241, 324, 509  
 " up. . . . . 324  
 Punctuality in coaching. . 470  
 Putting a coach on the  
 road. . . . . 433  
 " to. . . . . 249  
 Quiet driving. . . . . 297  
 Quill of whip. . . . . 390  
 Rabbit-bitten whip. . . . 391  
 Race-course. . . . . 359, 516

- Rate of driving. . . . 386
- Raw-hide. . . . 505
- Red coats. . . . 453
- Rein. Bearing-. . . 206, 256
- “ billets. . . . 225, 267
- “ Side-. . . . 241
- Reins. . . . 224
- “ Buckling . . . 229, 270
- “ Coupling-. . . 228, 230
- “ Hungarian. . . 232, 476
- “ Lead-. . . . 226, 230
- “ Length of . . . 225
- “ on tug-buckle. 255,  
416
- “ Places of, in hand 299
- “ Short wheel-. . . 229
- “ Wheel-. . . . 226
- Resilience. . . . 151
- Resistance to traction. . 147
- Reunion Road Club. 79, 411,  
512
- Review at Meets. . . . 514
- Revival. Coaching . . . 432
- REYNARDSON. 271, 413, 466,  
481
- Ribbons. . . . 194, 195
- Riding bits. . . . 360
- “ Club. Philadel-  
phia . . . . 379
- Rim collar. . . . 208
- Ring on lead-reins. . . 507
- RIVES. . . . 486
- Road-coach. . . . 16
- “ coaching. . . . 427, 465
- “ game. . . . 482
- Road making. . . . 170
- “ On the . . . . 305
- “ Rule of the . . . 490
- “ surface. . . . 173
- “ ticket. . . . 534
- ROCK. . . . 28
- Roller-bolt. . . . 22
- Rolling-friction. . . . 147
- Roof-seats. . . . 72
- Rosettes. . . . 194
- ROUP. . . . 298
- ROWLANDSON. . . . 72, 237
- Rubber tires. . . . 151
- Rugs. . . . 448
- Rule of the Road. . . 490
- Rumble. . . . 69
- Running away. . . . 355
- Russet leather. . . . 238
- ST. MAUR. . . . 383
- St. Moritz diligence. . . 331
- Sailor-fashion. . . . 322
- Salute with the whip. . . 414
- Scarf. . . . 418
- ‘Schoolmaster.’ The . . 366
- Seat-diagram. . . . 455, 488
- “ on the box. . . . 302, 304
- SELBY’S drive. . . . 467, 468
- SERGEANT. . . . 378
- Servants. Dress of . . . 418
- “ Duties of . . . 415
- SHANKS. . . . Plate XXII.
- SHAVER. . . . 198
- Shelburne Farms. . . . 487
- Shoe. (See Skid.) . . . 85

- Shooter. . . . . 481
- Shooting wheelers. . . . 320
- Short tommy. . . . . 412
- “ wheel-rein. . . . . 229
- Shortening reins. . . . 320, 322
- Shoulder-in. . . . . 376
- “ of horse. . . . . 188
- Shrewsbury. . . . . 466
- “ ‘Wonder.’ 62,  
469
- Shutters. Stable-. . . . 255
- Side-rein. . . . . 241
- Signals in the street. . . 496
- Six inside. . . . . 8
- “ horses. . . . . 277, 336, 474
- SKEAT. . . . . 3
- Skid. . . . . 85
- “ Ice-. . . . . 88
- Sleigh. . . . . 115
- Snaffle. . . . . 205, 360
- “ Ring-. . . . . 205
- Soap in horse’s foot. . . 503
- South American bit. . . 365
- Spare parts of harness. . 240
- Speed. . . . . 444, 446, 465
- “ diagrams. . . . . 444
- Spike team. . . . . 277
- Splicing thong. . . . . 401
- Splinter-bar. . . . . 22
- Springs. . . . . 48
- “ Effect of, on  
draught 164, 166
- Spur. Use of . . . . . 372
- Stable-shutters. . . . . 255
- “ tools. . . . . 447
- Stage. . . . . 5
- “ waggon. . . . . 5
- Stages. Length of . . . 435
- Stamping the foot-board. 413
- Starting. . . . . 289
- “ off from a race-  
course. 359, 519
- Steadying a team. . . . 319
- Steel. Polishing . . . . 127, 244
- Stop on lead-rein. . . . 230
- Stopping. . . . . 324
- STRATTON. . . . . 1, 35
- Straw in boot. . . . . 71
- Stretched. Horse stand-  
ing . . . . . 388
- Strokes. . . . . 44
- STURGESS. . . . . 413, 499
- Subscribers. . . . . 471
- SUE. . . . . 284
- Swan with two necks. . . 534
- Sway-bar. . . . . 3, 21
- Swing chain. . . . . 278
- “ of axle. . . . . 40
- “ pair. . . . . 277
- “ pole. . . . . 278
- Swinging of coach. . . . 167
- Swingle-tree. . . . . 3, 23
- Swiss coaching. . . . . 105, 331
- Tables, of coach. . . . . 96
- “ Time-. . . . . 445
- TAILER. . . . . 467
- Tails. . . . . 387
- Taking up reins. . . . . 286
- Tallow for balling. . . . 503

- Tally-ho. . . . . 12  
 Tandem. . . . . 274  
 Tantivy. . . . . 14  
 Taper axle-arm. . . 31, 34  
 TATTERSALL'S. . . . 230  
 Telegraph coaches. . . 7, 9  
     " springs. . . . 48  
 Telford roads. . . . . 170  
 Terret. . 199, 220, 226, 230  
     " WARD'S . . . . 232  
 THOMSON. . . . . 152  
 Thong. Double-. . . . 403  
 Thorough-braces. . . 4, 6, 117  
 Thorough-bred. . . . 380  
 Three abreast. . . . . 275  
     " leaders. . . . . 276  
 Throat-latch. . . . . 197  
     " latching. . . . . 509  
 THRUPP. . . . . 1, 4  
 THURSTON. . . . . 32  
 TIFFANY. 65, 270, 441, 466  
 Time-bill. . . . . 445  
     " card. . . . . 456  
     " chart. . . . . 444  
     " lost in changes. . . 446  
     " table. . . . . 445  
 Tipping angle. . . . . 135  
 Tire. . . . . 44  
     " Pneumatic . . . . 151  
     " Rubber . . . . . 151  
     " Width of 45, 149, 154  
 Tired horses. . . . . 509  
 Tokens. . . . . 533  
 Tommy. Short . . . . 412  
 Tools for stable. . . . 447  
 Tools in coach. . . . . 98  
 Tops. Boot . . . . . 421  
 Trace. . . . . 217  
     " Angle of . . . . 189  
     " Chain- . . . . 240  
     " Chain-end . . . . 218  
     " Elastic . . . . . 185  
     " Kicking over . . . 503  
     " Lead-. . . . . 219  
     " Length of 186, 191  
     " Wheel-. . . . . 217  
 Traces. Crossing . . . . 253  
     " Lapping . . . . . 253  
 Tractrix curve. . . . . 343  
 Transom. . . . . 2, 19  
 Travelling-carriage. . . 107  
 Trips. Coaching Club . 486  
     " Private . . . . . 484  
 Trouville drive. . . . . 467  
 Tug. . . . . 189, 216  
 Turning. 312, 319, 335, 337  
 TUSTIN. . . . . 298  
 Tuxedo coach. 435, 454, 465  
  
 Unicorn team. . . . . 277  
 Uniform. Club . . . . . 426  
 Up-hill. . . . . 320  
 Upsetting. . . . . 506  
 Use of the whip. . . . . 408  
  
 Versailles coach. . . . . 435  
*Vetturino.* 58, 276, 331, 440  
 VIDLER. . . . . 103  
 Virginia Water coach. . 434

Wagon. . . . .	2	Whip. Catching . . .	403
Wagonette break. . . .	110	“ Club. . . . .	425
WALKER. . . . .	333	“ Crop of . . . .	390
WARD. . . . .	103	“ Dog-legged . . .	392
WARDE. . . . .	7	“ Handle of . . .	392
WARD'S terret. . . . .	232	“ holder. . . . .	398
Washing a coach. . . .	126	“ Jointed . . . .	397, 399
Watch. . . . .	453	“ quill. . . . .	390
WATERHOUSE. . . . .	533	“ point. . . . .	395
Water-proofs. . . . .	101	“ Salute with . . .	414
WAUDE. . . . .	62	“ Selecting a . . .	398
Way-bill. . . . .	458	“ Splicing thong of	401
WEBB. . . . .	487	“ spring. . . . .	9
Weight. Distribution of.	130	“ Stick of . . . .	390
“ of coach. . . . .	129	“ Stiffness of . . .	395
“ of horses. . . . .	382	“ thong. . . . .	394, 400
“ of vehicles. . . . .	133	“ Use of . . . . .	408
West. Coaching in the .	474	White Mountain Coach-	
WETMORE. . . . .	486	ing. . . . .	474
Wheel. . . . .	38	WHITLEY. . . . .	469
“ Buggy . . . . .	48	Width of tire. . . .	45, 149, 154
“ Coned . . . . .	41	WILLIAMSON & DE NEGRI.	219
“ Cylindrical . . . .	39	Windsor coach. . . .	434
“ Dish of . . . . .	40, 44	Wings. . . . .	2
“ Patent . . . . .	48	Winkers. . . . .	195
“ rein. . . . .	226	‘Wonder.’ Shrewsbury	62,
“ “ Short. . . . .	229	469	
“ Size of . . . . .	39, 47, 120	Work per day for a horse.	440
Wheeler. . . . .	383, 385, 386	WRIGHT. . . . .	103
Whip. . . . .	390	Wrist. . . . .	301
“ American . . . . .	402	Yonkers coach. . . .	434
“ Balance of . . . .	397		
“ case. . . . .	399		











RBC

FAIRHAN ROGERS

798.64

R63.2

1900



