

MANUAL
OF
HEAVY ARTILLERY
SERVICE,
UNITED STATES ARMY

TIDBALL.

1880.

BY AUTHORITY.

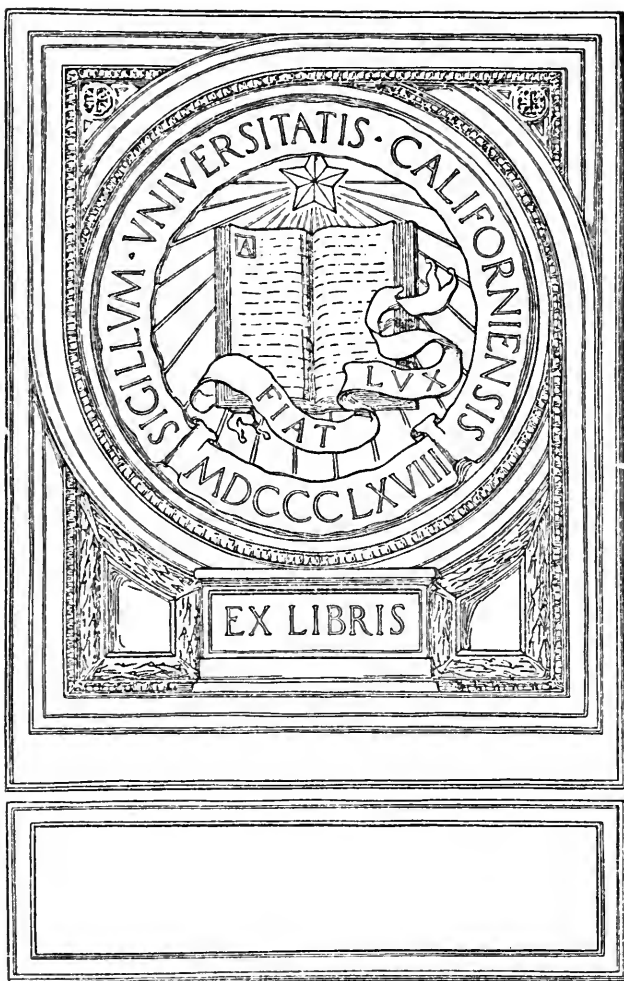

EX LIBRIS

W. A. C. C.

Sept 21

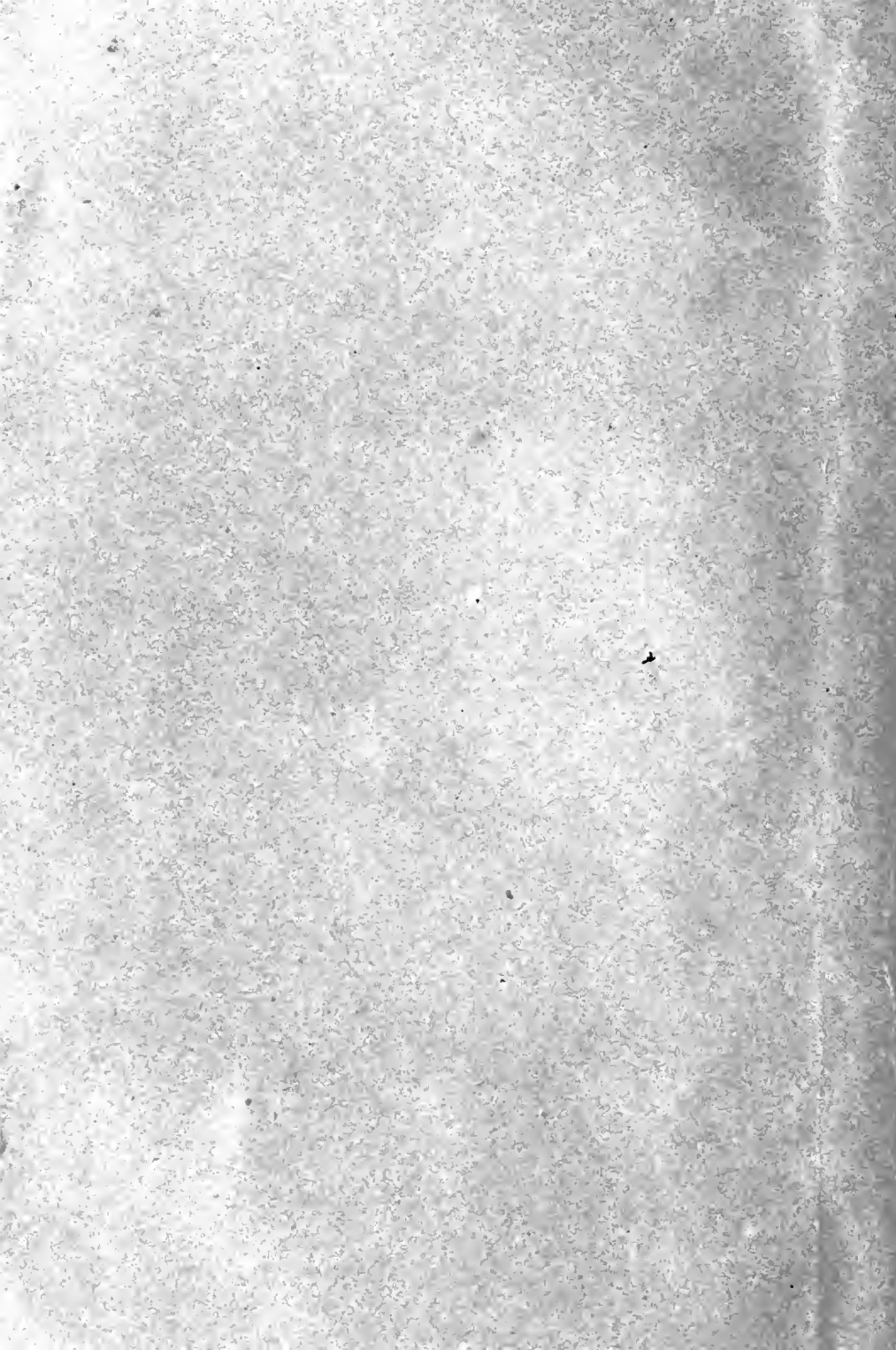

[BY AUTHORITY.]

MANUAL

OF

HEAVY ARTILLERY SERVICE.

PREPARED FOR THE USE OF THE

ARMY AND MILITIA OF THE UNITED STATES.

BY

J. C. TIDBALL,

LIEUT.-COL. FIRST ARTILLERY, BVT. BRIG.-GENL., U. S. A.,

COMMANDANT OF THE ARTILLERY SCHOOL,

FORTRESS MONROE.

THIRD EDITION.

WASHINGTON, D. C.:

JAMES J. CHAPMAN,

—AGENT.—

1884.

UF153

T5

1884-

Entered according to Act of Congress, in the year 1880, by

JAMES J. CHAPMAN,

In the Office of the Librarian of Congress, at Washington, D. C.

Gift of
W. C. Davis

PRESS OF THOMAS MCGILL & Co.,
WASHINGTON, D. C.

→ PREFACE. ←

The basis of this work, so far as the SERVICE OF THE PIECE and the MECHANICAL MANŒUVRES are concerned, has been the "Circulars of the U. S. Artillery School," supplemented by the unwritten customs and practices of that institution.

In FIELD INTRENCHMENTS, "Mahan's Field Fortifications" was used as a reference, supplemented by the methods introduced during the American civil war of 1861-65, and adopted and practiced during the Franco-German and Russo-Turkish wars.

In SUBMARINE MINES, the works of Stotherd and of Sleeman have been taken as authority.

In other parts of the work, Benton's "Ordnance and Gunnery," Roberts' "Hand-Book of Artillery," "Ordnance Notes and Memoranda," "Ordnance Instruction U. S. Navy," "Ordnance Manual U. S. Army," together with many other authorities, have been consulted.

In the labor of arranging and preparing the plates, and in various other matters, I am indebted to Lieut. C. Chase, 3d artillery; and to Lieut. L. V. Caziarc, 2d artillery, for the admirably-arranged Index.

J. C. T.

FORT MONROE, VA., *June*, 1880.

(iii)

Report of the Staff of the U. S. Artillery School on a system of instruction for heavy-artillery troops, submitted by Major J. C. Tidball, 2d artillery, Brevet Brigadier-General, U. S. A.

HEADQUARTERS U. S. ARTILLERY SCHOOL,
FORT MONROE, VA., November 17, 1879.

THE ADJUTANT-GENERAL OF THE ARMY,
Washington, D. C.

SIR: The MSS. for a system of instruction for heavy-artillery troops, prepared by Major John C. Tidball, 2d artillery, Brevet Brigadier-General, U. S. A., having, in accordance with the instructions of the General of the Army contained in indorsement dated Headquarters of the Army, May 16, 1879, on Major Tidball's letter of March 29, 1879, been referred to the Staff of the U. S. Artillery School for examination, the Staff respectfully submits the following as its report thereon.

The work has evidently been designed to supply a want long felt in the artillery service, and which has been pointed out in General Orders No. 3 of 1876, Headquarters of the Army, as being a regular and more comprehensive system of instruction or manual for heavy-artillery troops.

Its general divisions are:

1. Preliminary Instruction.
2. Service of the Piece.
3. Mechanical Manceuvres.
4. Care and Preservation of Artillery Material.
5. Transportation of Artillery.
6. Organization and Command of Artillery.
7. Employment of Artillery in Campaign.
8. Employment of Artillery against Armored Vessels and in Harbor Defense.
9. Field Intrenchments.
10. Attack upon Intrenchments.
11. Submarine Mines.

To which it is intended to add a short chapter on Artillery Salutes and Ceremonies and Courtesies between land and naval forces, which has already been submitted to the General, of date October 18, 1879.

The Staff has the honor to report upon the various divisions of the work as follows:

1. **PRELIMINARY INSTRUCTION.** This embraces: 1st. Definitions of the various kinds of artillery, and a tabular statement of the U. S. system for land service; 2d. The formation and marching drill of heavy-artillery troops,—being "battery," "platoon," and "detachment movements," and "subdivision movements," or those common to all three of such tactical sub-units.

This section of the MSS. has met with critical trial, (with troops on the drill-ground,) close scrutiny, and lengthy discussion, with a view to determining what may be best calculated to insure to the service the best means for the performance of duty devolving upon artillery troops.

It is found that the proposed marching drill is based upon that laid down in the already-accepted foot drill for field artillery, and that the latter has been modified only so far as the peculiarities of the heavy-artillery service render necessary or desirable; such, for example, as emancipation from the "lock step"; the omission of "section" movements as only essential for field artillery; the assimilation of the movements of the guides to those of

the infantry, and a discontinuance of the requirement from detachment chiefs to repeat all commands, as tending toward confusion and being entirely unnecessary.

The few additional movements are essentially adapted from the infantry tactics, and render the proposed marching drill complete.

It is the judgment of the Staff, that while the proposed drill is essential for the service of heavy artillery, and also fully suited for all the duties of artillery troops in garrison or elsewhere in the presence of guns, it is at the same time so closely assimilated to the tactics of infantry in its principles as to render the transition of heavy-artillery troops into infantry formations a thing of quick and easy accomplishment. The same, moreover, may be said in reference to its adaptation for the service of field guns, although its departures from the authorized foot drill for field artillery are but slight, and always in the direction of assimilation with the infantry tactics, which is understood to be the published policy of the General of the Army in such questions.

The Staff is therefore of the opinion that the adoption of this section of the MSS. under consideration will in no way impair the efficiency of the artillery regiments in the infantry duties which they may be called upon to perform, while it will, on the other hand, facilitate the duties pertaining to their special arm, because its tendency as a means of discipline and *esprit du corps* is to strengthen and confirm habits of thought in that direction by continually reminding the men of their weapon as artillerymen.

2. SERVICE OF THE PIECE; 3. MECHANICAL MANCEUVRES. These sections embrace the drill for all classes of pieces known as heavy artillery, and the MSS. are the result of several years' experience at the Artillery School, of daily study, experiment, and observation.

The Staff has carefully examined, revised, and tested this section at the guns, and is of the opinion that it meets the requirements for handling the ordnance now in use.

4. CARE AND PRESERVATION OF ARTILLERY MATERIAL; 5. TRANSPORTATION OF ARTILLERY. These sections embrace the care and preservation of all classes of guns and their belongings, together with the care of stores and of magazines; also the transportation of artillery under all circumstances of service, including railroad and water transportation for artillery material and animals. The MSS. are the result of a life-time's extended experience in the U. S. artillery service in peace and war. Much of the matter is derived from actual experience in the war of 1861-65, and has never been published in any book or report. The Staff is confident that it supplies a vacancy in American military literature.

6. ORGANIZATION AND COMMAND OF ARTILLERY; 7. EMPLOYMENT OF ARTILLERY IN CAMPAIGN. These sections embrace all of a subject of great magnitude, which is indicated by their titles, that there seems room for in a book of the kind under consideration. It cannot be doubted that there is to be found in the artillery of modern war the points of support with which to counteract the effect of the open nature of infantry fighting consequent upon the breech-loader, and that it is the stable element of battle of to-day in the hands of a General, because the dispersed order of the infantry for action renders command of that arm at all times difficult, and quite impossible as the fighting progresses. There can be no doubt, furthermore, that the object which artillery has to attain must be comprehended from the beginning of its action, and must not be left to chance. It is therefore advantageous, to say the least, that there should be one command; for the reason that everything becomes simpler and the carrying out of the fight more certain, because more unity of will pervades it.

To support this view, it is not deemed necessary here to expatiate upon the advantages of the employment of artillery in large masses, because the object is self-evident and is accepted by most officers of experience and culture as an established fact. These sections of the MSS. are the result of

the war experiences of the American artillery, and have followed closely the system pursued at the close of the war of 1861-65 in points of organization and command, although the modified conditions of the battle of to-day have presented a few corresponding modifications in the employment of artillery which have been fully treated in addition. Although we have passed through one of the most sanguinary conflicts of modern times, in which the genius of the American soldier was severely tested, and the nature of the "terrain" entirely different from any which is treated of in the text-books heretofore used by our officers in study, and although we have been at profound peace with the world for fourteen years, with ample leisure for such undertakings, it is a singular fact that no American work is extant which is based upon our experiences, giving authoritative instruction in the application of our arms, beyond what is laid down in the drill-books.

Now, the necessity for such works is self-evident; for although we are not a warlike people, we possess an inherent military spirit which requires direction to be available in the public defense, and such text-books tend to imbue our armies with character and military intelligence when action is required of them. This is especially so in the case of auxiliary troops, such as volunteers and militia.

The Staff is of opinion that these sections of the MSS. constitute a step in the right direction; and while the subject-matter pertains largely to field artillery, it is not considered as tenable as against its publication in this work, because it is germane to the artillery service in general and important to be preserved. Moreover, there is no just reason in favor of such a divorce between the light and heavy artillery service, any more than there has been found one in favor of such a separation of the light and heavy infantry of the past.

The proposed composition of an artillery force in regard to pieces of long range, or for the development of curved fire in the field, is remembered by the Staff as identical with our practice in the war of 1861-65, and the principle involved is confirmed and strengthened by the more recent experiences of European nations, notably in the Franco-German and Russo-Turkish wars.

The increased zone of effective infantry fire calls imperatively for long-range artillery of great accuracy and quick manipulation, so far as guns are concerned; while the universal use of field intrenchments, already rendered necessary by a murderous infantry, demands with equal obstinacy the full use and development of curved fire from mortars on the part of artillery, both in the attack and defense.

The provision in the MSS. for the use of such pieces as we now have in service is therefore regarded by the Staff as an advance toward meeting these new questions as far as possible with economy, while it reserves for future settlement the question of improved artillery material in view of these demands. With these views, the Staff cannot too strongly recommend these sections of the MSS. for favorable consideration and publication.

8. EMPLOYMENT OF ARTILLERY AGAINST ARMORED VESSELS AND IN HARBOR DEFENSE. This section embraces as much of this important subject as will admit of a proper limit in size of the book under consideration. It is a subject upon which little or nothing has been written, and the expressed desire of the General of the Army that it should be included, is regarded as sufficient reason for presenting it.

9. FIELD INTRENCHMENTS; 10. ATTACK ON FIELD INTRENCHMENTS. The MSS. embrace in these sections as much of the subject-matter indicated by their titles as is deemed essential.

It is necessarily a compilation upon a subject which is older than the service itself, and the Staff is informed that it is inserted upon the suggestion of the General of the Army. Further comment, therefore, seems uncalled for.

11. SUBMARINE MINES. This subject is not only important, but highly essential to be understood by artillery troops, upon whom such service will most likely devolve in war; and while secrecy in the matter of particular inventions may be desirable, such secrecy is easily within the control of the government.

The Staff finds no reason against a publication of so much of the subject of submarine mines as these MSS. embrace.

In conclusion, the Staff is of the opinion that, as a whole, Major Tidball's work is full and complete for the present use of the artillery service; that it is in harmony with the experience of the Army in war as well as with the spirit of its organization and instruction in peace; and that it is calculated and is probably invaluable, for the instruction of volunteer and militia artillery, upon whom much of the service of heavy artillery will devolve in any war, and whose attention should undoubtedly be directed to such instruction in peace, rather than toward field-artillery drill merely, as is now the custom.

In this latter connection the Staff respectfully invites attention to the fact that the maintenance of militia field batteries in peace is expensive, and never attended with warrantable success from the very nature of things, and that this branch of artillery can only be kept up in efficiency by the government.

With these views, the Staff of the U. S. Artillery School feels warranted in submitting Major Tidball's work for the favorable consideration of proper authority, recommending its immediate publication.

It is also respectfully recommended that the work be adopted for the Army and for the Militia.

We have the honor to be, very respectfully, your obedient servants.

* * * * *

HEADQUARTERS OF THE ARMY,
WASHINGTON, D. C., *December 10, 1879.*

Hon. GEO. W. McCRARY,
Secretary of War.

SIR: I have carefully examined the manuscript copy of the proposed Heavy Artillery Tactics prepared by General Tidball, and the reports and papers relating thereto, and find—

1st. That the manuscript of the Tactics (a better designation would be "Manual") consists of twelve parts.

* * * * *

As already indicated, it would seem that a modification of the title of the work is desirable, and I would suggest the following, viz.:

"A Manual for the Heavy Artillery Service, prepared for the use of the Army and Militia of the United States, by Major J. C. Tidball, 2d artillery, Brevet Brigadier-General. U. S. A., 1879."

With the title thus modified, the work will consist of parts numbered I, II, III, IV, V, VIII, IX, X, XI, XII, or ten out of the twelve parts prepared, and I therefore recommend that it be published accordingly, as modified.

The degree of authority to be given it might be based upon that given January 24, 1876, to Roberts' "Hand-Book," or thus:

"The Manual for Heavy Artillery Service prepared by Major J. C. Tidball is hereby approved, and will be adopted as a text-book at the Artillery School at Fort Monroe, and used by the artillery companies (batteries) garrisoning the sea-coast forts of the United States. (Signed) G. W. McCRARY, Secretary of War."

I have the honor to be, your obedient servant,

(Signed)

W. T. SHERMAN, *General.*

Approved: (Signed)

GEORGE W. McCRARY,
Secretary of War.

CONTENTS.

| | PAGE. |
|---|---------------|
| Marching Manœuvres | 5 |
| Definitions | 34 |
| Ammunition | 41 |
| Implements | 53 |
| Aiming and Motion of Projectiles | 56 |
| Carriages and Platforms | 65 |
| Service of the Piece. (General Rules.) | 79 |
| Service of Siege Gun; Siege Howitzer; 10-inch Gun; 100- pounder Parrott; 15-inch Gun; Flank-casemate How- itzer; 8-inch Rifle (converted); 10-inch Siege Mortar; 8-inch Siege Mortar; Coehorn Mortar; 13-inch Mortar; 10-inch Sea-Coast Mortar; Gatling Guns..... | 83 |
| Target Practice | 183 |
| Telemeters and Pressure Plug | 192 |
| Mechanical Manœuvres. (General Directions.) | 199 |
| Mechanical Manœuvres with Siege Gun; Siege Howitzer; Siege Mortars; 13-inch Mortar | 204 |
| Cordage; Blocks and Tackles | 231 |
| Machines and Appliances for Moving Heavy Artillery | 242 |
| Mount and Dismount the Flank-casemate Howitzer; 15-inch Gun; 10-inch Gun | 271 |
| Gun-lift; Shears; Derricks | 279 |
| Preservation of Artillery Material | 293 |
| Inspection of Cannon | 301 |
| Magazines and Store-houses | 312 |
| Transportation of Artillery | 321 |
| Harbor Defenses; Strength and Composition of Batteries; Artil- lery against Armor | 343 |
| Field Intrenchments | 357 |
| Attack and Defense of Positions | 403 |
| Sieges; Defiles; Rivers; Demolition | 407 |
| Submarine Mines | 425 |
| Permanent Fortifications. (Outlines of) | 458A |
| Salutes, Ceremonies, and Official Courtesies | 459 |
| Appendix 2 | 478A |
| Index | 479 |
| Illustrations | Plate 1 to 77 |

HEAVY ARTILLERY,

U. S. ARMY, 1879.

1. By the term *Artillery*, is understood all fire-arms discharged from carriages, in contradistinction to *small arms*, which are discharged from the hand. It also denotes the particular troops employed in the service of such fire-arms.

2. ARTILLERY is known as *Light Artillery* and *Heavy Artillery*. *Light Artillery* is formed into batteries and equipped for field evolutions; *Heavy Artillery* embraces all artillery not so formed and equipped.

3. In the land service of the United States there are three kinds of pieces of *Heavy Artillery*, viz.: the GUN, the HOWITZER, and the MORTAR.

4. They are distinguished, according to their principal use, as *Siege* and as *Sea-Coast Artillery*.

5. *Siege Artillery* is used in the attack of places, and, as it accompanies armies in their field operations, is mounted upon carriages, which serve for its transportation.

It is also employed in the defense of field works. It is then sometimes called *Garrison Artillery*.

6. *Sea-Coast Artillery* consists of the heaviest calibres, and is used for the armament of permanent works, chiefly on the sea-coast. Their carriages do not subserve the purpose of transportation.

7. For the service of Heavy Artillery there are four distinct kinds of carriages required, viz.: the SIEGE, the CASEMATE, the BARBETTE, and the MORTAR.

8. The following are the kinds and calibres of *Heavy Artillery* belonging to the present *system* of artillery for the land service of the United States.

Note.—The term “system,” as here used, refers to the character and arrangements of the material of artillery, as adopted by a nation at any particular epoch.

PIECES.

| KIND. | CALIBRE. | BORE. | | WEIGHT. | DESIGNATION. |
|-------------|---------------------------------|----------|----------|---------|--------------|
| | | | | | |
| Gun..... | 20-in..... | Smooth.. | | 116,000 | Sea-coast. |
| "..... | 15-in..... | " | | 49,000 | " " |
| "..... | 13-in..... | " | | 37,000 | " " |
| "..... | 12-in..... | | Rifled.. | 52,000 | " " |
| "..... | 10-in..... | | " | 40,681 | " " |
| "..... | 4.5-in..... | | " | 3,570 | Siege. |
| Howitzer... | 8-in..... | Smooth.. | | 2,600 | " |
| "..... | 5.8-in.—(flank casemate).... | " | | 1,476 | Sea-coast. |
| Mortar..... | 15-in..... | " | | | " " |
| "..... | 13-in..... | " | | 17,120 | " " |
| "..... | 10-in..... | " | | 3,700 | " " |
| "..... | 10-in..... | " | | 1,900 | Siege. |
| "..... | 8-in..... | " | | 1,010 | " |
| "..... | 5.8-in. (Coehorn) | " | | 164 | " |

In service, but not of the system.

| | | | | | |
|----------|--------------------|-----------|----------|--------|------------|
| Gun..... | 10-in..... | Smooth.. | | 15,000 | Sea-coast. |
| "..... | 8-in..... | " | | | " " |
| "..... | 8-in. (converted) | | Rifled.. | 16,160 | " " |
| "..... | 10-in. 300-pdr. } | | " | 26,000 | " " |
| "..... | 8-in. 200-pdr. } | Parrott.. | " | 16,300 | " " |
| | 6.4-in. 100-pdr. } | | " | 9,700 | " " |
| | 4.2-in. 30-pdr. } | | " | 4,200 | Siege. |

Note.—The 20-inch and 13-inch smooth-bore, and the 10 and 12 inch rifle guns, as likewise the 15-inch mortar, may be regarded as experimental pieces, not more than two or three of each kind having been cast. Carriages for them have not yet been determined; consequently instructions for their service must be omitted.

The 4.5-inch siege gun, 8-inch siege howitzer, 5.8-inch (flank-casemate) howitzer, the 5.8-inch (Coehorn) mortar, and the 4.2-inch (Parrott) siege gun are mounted on wooden carriages; all other pieces on iron carriages.

It is intended that the 15-inch smooth-bore and 12-inch rifle guns shall have the same carriage; the 10-inch smooth-bore and 8-inch rifle the same carriage.

The 10-inch smooth-bore and the 200-pounder (Parrott) have the same carriage, and the 8-inch smooth-bore and 100-pounder

(Parrott) have the same carriage. The 20-inch smooth-bore has a separate carriage.

9. Instruction in Heavy Artillery is divided into ten parts, viz. :

- I. PRELIMINARY INSTRUCTION.
- II. SERVICE OF THE PIECE.
- III. MECHANICAL MANŒUVRES.
- IV. CARE AND PRESERVATION OF ARTILLERY MATERIAL.
- V. TRANSPORTATION OF ARTILLERY.
- VI. EMPLOYMENT OF ARTILLERY AGAINST ARMORED VESSELS AND IN HARBOR DEFENSES.
- VII. FIELD INTRENCHMENTS.
- VIII. ATTACK AND DEFENSE OF INTRENCHED POSITIONS.
- IX. SUBMARINE MINES.
- X. OUTLINES OF THE GENERAL PROPERTIES OF PERMANENT WORKS.
- XI. SALUTES AND CEREMONIES.

Part first.

PRELIMINARY INSTRUCTION.

10. The officers and men for *Heavy Artillery* duties should be thoroughly instructed in the "School of the Soldier," *Light Artillery and Infantry Tactics*. The preliminary instructions herein given are only such as are, in addition, necessary for the more general duties of artillerymen.

11. The term *piece*, as herein used, applies to cannon, whether gun, howitzer, or mortar. As a matter of convenience, it is also used to designate both cannon and carriage when the cannon is mounted.

Detachment.

12. The men employed in the service of artillery are called artillerymen.

The artillerymen for a single piece constitute a *gun detachment*, and vary in number with the size and kind of piece.

13. The *detachment* (*Fig. 1, Plate I*) is composed of two non-commissioned officers, and from two to ten privates. The senior non-commissioned officer is called *chief-of-detachment*; the other, *gunner*. The privates are called *cannoneers*.

14. The detachment is formed in double rank, and told off from the right as follows: No. 1 is on the right of the rear rank; No. 2 in front of No. 1; No. 3 on the left of No. 1; No. 4 on the left of No. 2; the other numbers follow in the same order, even numbers in the front, odd in the rear rank. When, by facing about, the front becomes the rear rank, the numbers of the *cannoneers* do not change.

15. The *chief-of-detachment*, when in line, is on the right of the front rank of his detachment. When, by facing about, the front becomes the rear rank, he does not change to the other flank, but steps forward into the rear (now become the front) rank. When in column of files, he is as if he had faced with his detachment from line.

16. The *gunner*, in line, and in column of platoons, is two yards in rear of the centre of his detachment, except when belonging to the left detachment of the battery *in line*, or of platoon when in *column of platoons*,—in either of which cases he places himself on the left of the front rank of his detachment, and is

the guide of that flank of the battery or platoon; in column of detachments, he is on a line with the front rank of his detachment, on the flank towards which the wheel was made, and one yard from it; in column of files, he is as if he had faced with his detachment from line. When he is the left guide of the battery or platoon, and by facing about the front becomes the rear rank, he does not quit his position on the flank of his detachment, but steps forward into the rear (now become the front) rank.

17. When, by wheeling about, the right subdivision becomes the left, the gunner who was the left guide resumes his place in rear of his detachment, and the gunner of the detachment which has now become the left places himself on its left flank as guide of the battery or platoon.

Platoon.

18. Two or more detachments form a platoon, commanded by a lieutenant; and, if circumstances will permit, the battery will be divided into as many platoons as there are lieutenants to command them.

Battery.

19. The term battery is now applied to what was formerly called a company. It is also used to designate a number of pieces of artillery in position for service; likewise the place in a work where they may be located; and it further denotes certain positions in the manœuvres with individual pieces. Whenever this term is used, its meaning must be determined from the context.

20. The battery is assigned to specified pieces in the work, the number depending on the strength of the battery; the latter is divided into a like number of detachments, and these are assigned to the individual pieces. Although thus assigned to the service of specified pieces, the several detachments should be instructed for the service of any piece in the command. The men of each detachment should be selected for their individual fitness for the particular piece.

21. The detachments receive permanent numbers, from right to left, the first detachment being on the right.

Platoons are in like manner permanently designated.

22. During the manœuvres, platoons temporarily change their numbers, when, by wheeling, or by facing, the original right becomes the left. In column, they are numbered from the head, the leading one being always the *first*.

23. The men of each detachment fall in according to height, the tallest men on the right; thus bringing, as a general rule, the strongest men to the duties requiring greatest strength.

Posts of officers, non-commissioned officers, &c.

24. (*Figs. 2 and 3, Plate I.*) The *captain*, in line, is four yards in front of the centre of the battery; in column, on the side of the guide, or on the side towards which the subdivisions are dressed, four yards from the flank and opposite the centre of the column; as instructor, he goes wherever his presence is necessary.

25. The senior *lieutenant* takes post with the right platoon; the next in rank with the left platoon; the third with the second from the right, and the fourth with the second from the left.

Each lieutenant is *chief* of the platoon with which he is posted; and in line, and in column of platoons, is two yards in front of the centre of his platoon; in column of detachments, each is on the side of the guide, or on the side towards which the subdivisions are dressed, two yards from the flank of the column, and opposite the centre of the platoon; (they are always on the side opposite that of the gunners: *par. 23*;) in column of files, each as if he had faced with the battery from line, except the chief of the leading platoon, who takes post by the side of the leading guide.

26. The *first-sergeant*, in line, is on the right of the battery, aligned on the front rank and one yard from it; in column of platoons and of detachments, he is on the same side as the chief-of-platoon, aligned on the front rank of the nearest subdivision and one yard from it; in column of files, he is as if he had faced with the battery from line. When two or more batteries are united in line, he is as explained in (*see Battalion*).

27. Each *chief-of-detachment* is on the right of the front rank of his detachment, as in *par. 15*.

28. Each *gunner* is two yards in rear of the centre of his detachment, except as provided in *par. 16*.

29. The *trumpeters*, in line, are in one rank on the right of the first-sergeant, and two yards from him; in column of platoons and of detachments, they wheel to the side indicated, and are either four yards in front of the centre of the leading subdivision, or four yards in rear of the last subdivision, according as the column has been formed towards their flank of the battery, or the opposite; in column of files, they are as if they had faced with the battery from line, and the one in rear stepped to the right, or left, of the other, according as they faced to the right or left.

30. The *guides* of a battery or platoon are the non-commissioned officers posted on its right and left; the guides of a de-

tachment are the chief-of-detachment and the front-rank man on the opposite flank.

31. The chiefs-of-detachments and platoons give or repeat commands only when it is prescribed. *This rule is general.**

32. For the purpose of instruction in *marching drill*, the detachments are equalized, and should not consist of more than eight cannoneers.

33. When the battery faces about in line, the first-sergeant and the trumpeters face about, but do not change to the other flank.

34. When the number of platoons and detachments are so reduced as to make surplus officers or non-commissioned officers, these take their places two yards behind the rear rank, and, with the gunners, act as file-closers; the officers, and likewise the non-commissioned officers, distribute themselves at equal distances from right to left, according to rank.

35. It is the duty of file-closers to rectify mistakes, and insure steadiness and promptness in the ranks.

36. In all changes of formation, as soon as the movement permits, the officers and non-commissioned officers, whose posts are changed, hasten by the shortest routes to their posts in the new formation; except, when in column of detachments, the detachments are wheeled about, they do not change, unless directed to do so by the instructor.

To form the battery.

37. At the sounding of the *assembly*, the first-sergeant, facing the battery and six yards in front of its centre, commands:

1. FALL IN, 2. *Left*, 3. FACE, 4. CALL ROLLS, 5. REPORT.

The battery being divided into permanent detachments, as prescribed in *par.* 28, at the command *fall in* the chiefs-of-detachment place themselves on the line facing to the right, and at sufficient distance from each other for the formation of the detachments; the men of each detachment fall in, facing to the right, the front-rank men covering their chief; the signal having ceased, the first-sergeant causes, if necessary, the detachment to close up.

At the command *face*, all face to the left.

At the command *call rolls*, the chiefs-of-detachment step out two yards in front of the centres of their detachments, face towards them, call their rolls, and resume their places in the ranks.

At the command *report*, the chiefs-of-detachment, standing fast, report to the first-sergeant, in succession from right to left,

* See (E), Appendix 2.

the results of their roll-calls; the first-sergeant then commands: **CALL OFF**, when each chief-of-detachment steps promptly in front of his detachment and faces toward it to see that the men call off properly; each man in turn calls out distinctly his number—*one, two, three*, and so on; the gunner calls last—*gunner*.

38. If the front and rear rank contain an unequal number of cannoneers, the odd file is the left front-rank man, and the vacant space is in rear of him until after calling off; the left man of the rear rank then steps to his left and covers the left front-rank man; he, however, retains his number, and at the piece takes the position belonging to it.

The first-sergeant then faces about, salutes the captain, or other officer acting in his place, reports the result of the roll-calls, and takes his position in line.

39. If, for *marching drill*, or any other special purpose, the detachments are required of equal size, this is effected by transferring men from the stronger to the weaker detachments; but for ordinary service, such as marching to and from the place of exercise with the pieces, the detachments need not be of equal size.*

40. When a battery is to form for ordinary garrison purposes, such as fatigue duties, or for roll-calls when the battery is small in numbers, the first-sergeant places himself six yards in front of the centre, facing towards the battery, and commands: **FALL IN**.

At the command *fall in*, the senior duty-sergeant places himself, facing towards the right, at the point where the right of the battery is to rest; the privates fall in, in two ranks, facing to the right, the front-rank men covering the senior duty-sergeant.

The second duty-sergeant takes his place in rear of the last front-rank man, and the other non-commissioned officers place themselves, facing in the same direction as the rest, in such positions as, when they face to the left, will bring them equally distributed along the line; the first-sergeant commands: 1. *Left*, 2. **FACE**, when the men face to the left; he then calls the roll, reports, as in *par.* 38, and takes his post in line; at the same time the officers take posts.

41. If the battery is to exercise at *marching drill*, after being thus formed, the first-sergeant, before reporting, divides it into the desired number of detachments of equal size, and assigns the chiefs-of-detachment and gunners to their respective detachments, who take their posts accordingly. The detachments call off as before.

If the exercise is to be at the pieces, the detachments are told off in sizes to suit the particular pieces, and the chiefs and gunners are assigned as before.

42. The manœuvres of a separate platoon are identical with those of a battery, the command *platoon* being substituted for *battery*.

43. The manœuvres of a separate detachment are analogous to those of a battery, the command *detachment* replacing that of *battery*. The chief-of-detachment acts as instructor, and is replaced on the right flank of the detachment by the gunner.

44. The captain, or in his absence the next officer in rank, acts as instructor.

45. All movements not specially excepted may be executed in *double time*. If the movement be from a halt, or when marching in quick time, the command *double time* precedes the command *march*; if marching, this command is omitted.

46. Officers, when on duty with men, will habitually wear their swords; when in ranks, or when giving commands, the sword must be drawn. Instruction in the use of the sword is given in Light Artillery Tactics.

47. The trumpet signals and rules for using them are those prescribed in Light Artillery Tactics.

48. When artillery is armed, equipped, and serving as either cavalry or infantry, and organized into commands of these arms, it will conform to the formation and tactics prescribed, respectively, for these branches of service.

MARCHING MANŒUVRES.

The following manœuvres are those most essential, and generally used by Heavy Artillery troops. The principles embraced in them will serve for more extended exercises.

To open ranks.

49. Being in line, at a halt, the instructor commands :

1. *Rear open order*, 2. MARCH, 3. FRONT.

At the first command, the chiefs-of-detachment, and gunner acting as left guide, step briskly three yards to the rear to mark the new alignment of the rear rank; the instructor goes to the right flank and sees that these non-commissioned officers are on a line parallel to the front rank.

50. When the battery is not divided into detachments, the non-commissioned officer on the right and left flanks, respectively, steps back to mark the line.

At the command *march*, the chiefs-of-platoon step forward one yard, thus bringing themselves three yards in front of the battery. Should there be officers in the line of file-closers, they

pass around the nearest flank and place themselves in the line of officers opposite their former positions. The front-rank men dress to the right; the rear-rank men cast their eyes to the right, step backwards, halt a little in rear of alignment, and then dress to the line established by the non-commissioned officers who have stepped back; the file-closers step back at the same time, taking a distance of three yards from the rear rank.

The instructor superintends the alignment of the chiefs-of-platoon and of the front rank, and the first-sergeant, or in his absence the chief of the right detachment, that of the rear rank; the instructor verifies the alignment of the rear rank and of the file-closers; the chiefs-of-platoon and file-closers cast their eyes to the front as soon as their alignment is verified.

At the command *front*, the non-commissioned officers who have stepped back to mark the line for the rear rank resume their places in the front rank, and the men cast their eyes to the front; the first-sergeant returns to his post, and the instructor places himself six yards in front of the centre of the battery, facing to the front.*

To close ranks.

52. Being at a halt, the instructor commands :

1. *Close order*, 2. MARCH.

At the command *march*, the chiefs-of-platoon face about and resume their posts in line; the rear rank closes to facing distance, each man covering his front-rank man; the file-closers move forward with the rear rank and take their posts in line; the instructor resumes his post in line.

Alignments.

53. Being in line, at a halt, with the ranks open, the instructor establishes two or four men as a basis for each rank, at first in parallel and afterward in oblique directions to the front of the battery. He then commands :

1. *By file*, 2. *Right* (or *left*), 3. DRESS, 4. FRONT; or, 1. *By file*, 2. *Right* (or *left*) backward, 3. DRESS, 4. FRONT; or, 1. *Right* (or *left*), 2. DRESS, 3. FRONT; or, 1. *Right* (or *left*) backward, 2. DRESS, 3. FRONT.

Each rank is aligned as explained in the School of the Soldier, the rear rank remaining parallel to the front rank. The ranks being closed, the alignments are repeated in the same manner.

In all alignments, the file-closers preserve their distances from the rear rank.

* See (B), (C), (D), Appendix 2.

To rest.

54. Being at a halt, the instructor commands :

1. *Battery*, 2. REST; or, 1. *In place*, 2. REST.

To resume attention, the instructor commands :

1. *Battery*, 2. ATTENTION.

To dismiss the battery.

55. Being in line, at a halt, the instructor commands : DISMISS THE BATTERY.

The officers return their swords and fall out ; the first-sergeant then commands :

1. *Break ranks*, 2. MARCH.

To march in line.

56. The battery being at a halt, and correctly aligned, the instructor commands :

1. *Forward*, 2. *Guide (right or left)*, 3. MARCH.

At the command *forward*, the guide selects two points on a line passing through him and perpendicular to the front of the battery ; at the command *march*, the men step off with life ; the guide observes with the greatest care the length and cadence of the step, marches on the two points he has chosen, and selects others in advance on the same line before reaching the first ; the file-closers keep at their proper distances from the rear rank.

To halt the battery and to align it.

57. The instructor commands :

1. *Battery*, 2. HALT, 3. *Right (or left)*, 4. DRESS, 5. FRONT.

To march in the short step ; to mark time ; to change step ; to side step ; to march backward ; to oblique in line ; to pass from quick time to double time, and the reverse.

Executed as explained in the School of the Soldier, substituting, in the commands, *battery* for *squad*, wherever the latter occurs.

58. In the oblique march, the ranks remain parallel to their former position.

59. In marching in double time the left hand, instead of being raised, steadies the scabbard ; the sword, if drawn, is held in a vertical position in the right hand.

To wheel the battery.

60. Being in line, at a halt, the instructor commands :

1. *Right* (or *left*) *wheel*, 2. MARCH, 3. *Battery*, 4. HALT, 5. *Left* (or *right*), 6. DRESS, 7. FRONT.

At the command *march*, the battery wheels to the right on a fixed pivot; the left guide conducts the marching flank; the right guide stands fast, so that the breast of the pivot-man may rest against his left arm at the completion of the wheel; the chiefs-of-platoon face about at the first command, step backward at the second, and superintend the movements of their platoons, resuming their positions at the command *front*; the instructor hastens by the shortest line to place himself directly in front of the pivot-guide, and at a distance from him equal to the length of the battery front, and faces to the late rear.

At the command *halt*, given when the left guide is three yards from the perpendicular, the battery halts; the left guide of the battery advances quickly, places his left elbow lightly against the breast of the instructor, who establishes him on the line.

At the command *dress*, the men dress up to the line of the guides; at the command *front*, the right guide places himself on the right of the pivot-man.

61. To continue the march upon the completion of the wheel, the instructor, without placing himself in front of the pivot-guide, commands : 3. *Forward*, 4. MARCH, 5. *Guide right* (or *left*). The third command is given when the guide on the marching flank is three yards from the perpendicular to the original front; the fourth, the instant the wheel is completed; and the fifth immediately after. The guide on the pivot places himself by the side of the pivot-man at the command *forward*.

62. Marching in line, the instructor commands :

1. *Right* (or *left*) *wheel*, 2. MARCH, 3. *Forward*, 4. MARCH.

At the second command, the battery wheels to the right on a movable pivot; the command *forward* is given when the guide is three yards from the perpendicular, and the fourth command at the instant the change of direction is completed.

In wheeling on a movable pivot, the command *forward* is given in sufficient time to add *march* the instant the wheel is completed. *This rule is general.*

63. Marching in line, to effect a slight change of direction, the instructor commands :

Incline to the right (or *left*).

The guide advances gradually the left shoulder, and marches

in the new direction ; all the files advance the left shoulder and conform to the movements of the guide, lengthening or shortening the step according as the change is towards the side of the guide, or the opposite.

To march by the flank.

64. Being in line, at a halt, the instructor commands :

1. *Right* (or *left*), 2. **FACE**, 3. *Forward*, 4. **MARCH**.

If marching, the instructor commands :

1. *By the right* (or *left*) *flank*, 2. **MARCH**.

The march in column of files is usually in quick time ; if necessary to march in double-time, the distance between files is increased to thirty-two inches, and, upon halting, the files close to facing distance.

65. To halt the battery, and form it in line, the instructor commands : 1. *Battery*, 2. **HALT**, 3. *Left* (or *right*), 4. **FACE** ; or, to form line and continue the march : 1. *By the left* (or *right*) *flank*, 2. **MARCH**, 3. *Guide* (*right* or *left*).

To oblique and to change direction in column of files. Executed by the commands and means prescribed in the School of the Soldier.

To form column of platoons to the right or left.

66. Being in line, at a halt, the instructor commands :

Platoons right (or *left*) *wheel*, 2. **MARCH**.

At the first command, each chief-of-platoon, facing it, cautions it : *Right wheel*.

At the command *march*, each platoon wheels to the right on a fixed pivot, as explained for the wheel of a battery. Each chief, superintending the wheel of his platoon, hastens to the point where the left of his platoon is to rest on the completion of the wheel ; faces to the late rear, and when the marching flank approaches him, commands : 1. *Platoon*, 2. **HALT**, 3. *Left*, 4. **DRESS**, 5. **FRONT**.

At the command *halt*, the guide on the marching flank places his left arm against the breast of his chief, who then aligns the platoon and takes his post in front of its centre, after commanding *front*. If marching, the movement is executed as just explained, the pivot-guides halting at the command *march*, mark time in their places, and conform to the movements of the front of the platoon.

67. In every case where a line is broken in platoons, the

gunner of the left detachment of each platoon, if not already there, hastens to place himself on the left flank of his detachment as soon as the movement will permit; he then becomes the left guide of his platoon. When the line is reformed, he hastens to resume his former position.

68. To form column of platoons to the right or left and continue the march instead of halting, the instructor commands :

1. *Continue the march*, 2. *Platoons right (or left) wheel*, 3. **MARCH**, 4. *Forward*, 5. **MARCH**, 6. *Guide (right or left)*.

The movement is executed as before, except that each chief remains in front of the centre of his platoon, and the platoons move straight forward at the fifth command. The leading guide prolongs accurately his line of march by choosing successively points in advance; the other guides preserve with care the trace, the step, and wheeling distance.

To put the column of platoons in march, and to halt the column.

69. The instructor commands :

1. *Forward*, 2. *Guide (right or left)*, 3. **MARCH**, and 1. *Battery*, 2. **HALT**.

To form line to the right or left from column of platoons.

70. Being at a halt, the instructor commands :

1. *Right (or left) into line wheel*, 2. **MARCH**, 3. *Battery*, 4. **HALT**, 5. *Left (or right)*, 6. **DRESS**, 7. **FRONT**, 8. *Guides*, 9. **POSTS**.

At the first command, each chief-of-platoon, facing it, cautions it : *Right wheel*.

At the command *march*, the pivot-guides stand fast in their places and the platoons wheel to the right on a fixed pivot. At the command *halt*, given when the marching flanks arrive near the line, the subdivisions halt; the instructor places himself, facing to the right, on the prolongation of the line of the pivot-guides, at the point where the marching flank of the leading subdivision is to rest. At the command *dress*, the battery dresses up to the line established by the pivot-guides and instructor, the left guide of the leading subdivision touching the breast of the instructor with the left arm; the instructor superintends the alignment, and gives the command *front* upon its completion. At the command *guides posts*, the guides return to their places in line.

If marching, the movement is executed as just explained, except that, at the command *march*, the guides and pivot-men

halt; the pivot-men mark time and turn in their places, so as to conform to the movement of the marching flank.

71. To form line and continue the march, the instructor commands: 3. *Forward*, 4. MARCH, 5. *Guide (right or left)*. At the command *forward*, the pivot-guides take their places in line.

To form line to the front column of platoons.

72. Being at a halt, the instructor commands: 1. *Right (or left) front into line*, 2. MARCH, 3. FRONT.

At the first command, the chief of the leading platoon commands: 1. *Forward*, 2. *Guide left*; the other chiefs command: *Right oblique*. At the command *march*, repeated by all the chiefs, the leading platoon advances eighteen yards, when its chief commands: 1. *Platoon*, 2. HALT, 3. *Left*, 4. DRESS; the other platoons oblique to the right until opposite their places in line, when their chiefs command: 1. *Forward*, 2. MARCH, 3. *Guide left*, adding, as they arrive near the line: 3. *Platoon*, 4. HALT, 5. *Left*, 6. DRESS; the instructor superintends the alignment from the left flank, and gives the command *front* upon its completion.

If marching in *quick time*, the movement is executed as just explained, the chief of the leading platoon commanding *guide left*, if the guide be not already there.

If marching in *quick time* and the command be *double time*, the instructor commands: *Guide left* immediately after the command *march*; the chief of the leading platoon does not halt it, but cautions it to advance in quick time, and repeats the command for the guide; each of the other chiefs repeats the command *double time*, and, when his platoon is about to arrive in line, commands: 1. *Quick time*, in time to add: 2. MARCH, the instant it arrives abreast of the leading platoon.

If marching in *double time*, the chief of the leading platoon commands: *Quick time* at the first command, and repeats the other commands; the other subdivisions complete the movement as before.

To form column of platoons from column of files.

73. The instructor commands:

1. *Platoons*, 2. *Right (or left) front into line*, 3. MARCH, 4. *Battery*, 5. HALT.

At the command *march*, the leading guide of each platoon moves straight to the front; all the files oblique to the right until opposite their places in line, when each marches to the front.

The leading guide of each platoon moves forward until the command *halt*, which is given when he has advanced five yards; the other men halt on arriving in line; each guide in rear places himself on the right of the front rank upon the arrival of the last file; the leading guide having halted, each chief dresses his platoon to the left, and commands: **FRONT** when the last file is aligned.

If the command be *double time*, the instructor commands: *Guide left* (or *right*) immediately after the command *march*; the leading guide of each platoon moves forward in quick time; the other men oblique in double time, each taking the quick step and dressing to the left upon arriving in line; the rear-rank men then close to facing distance.

This movement is *not* executed when marching in double time.

The instructor's command is *right* (or *left*) *front into line*, according as the column of files is left, or right, in front.

74. The column of files is *right in front* when the front-rank men are on the left of their rear-rank men; it is left in front when the front-rank men are on the right of the rear-rank men.

To change direction in column of platoons.

75. Being in march, the instructor commands:

1. *Column right* (or *left*), 2. **MARCH.**

At the first command, the chief of the leading platoon commands: *Right wheel*; at the command *march*, which he repeats, his platoon wheels to the right on a movable pivot, the chief adding: 1. *Forward*, 2. **MARCH**, upon the completion of the wheel; the other platoons march squarely up to the wheeling point, and change direction by command of their chiefs as explained for the first.

76. In wheeling on a movable pivot, as the dress is always toward the marching flank without command, whenever a wheel is executed toward the side of the guide, each chief, upon its completion, cautions his platoon, *guide right*, or *guide left*, according as the guide was right or left before the wheel.

77. In changing direction, each chief-of-platoon faces his platoon while wheeling, and sees that the guide takes steps of twenty-eight or thirty-three inches, and the pivot, steps of nine or eleven inches, according to the gait.

Column half right (or *half left*) is similarly executed, each chief giving the preparatory command *right* (or *left*) *half wheel*.

To make a small change of direction, the instructor cautions: *Incline to the right* (or *left*).

The leading guide advances his left shoulder and takes two points a little to the right of those upon which he was marching, the men conforming to the new direction of the guide.

78. To put the column of platoons in march and change direction at the same time, the instructor commands :

1. *Forward*, 2. *Guide (right or left)*, 3. *Column right (or left)*,
4. **MARCH.**

To face the column of platoons to the rear, and to march to the rear.

79. The instructor commands :

1. *Platoons right (or left) about*, 2. **MARCH**, 3. *Battery*, 4. **HALT.**

At the command *march*, the platoons execute an about on a fixed pivot; at the command *halt*, each chief-of-platoon dresses his platoon to the left, commands: **FRONT**, and then takes his post.

To march to the rear after wheeling about, the instructor commands :

3. *Forward*, 4. **MARCH**, 5. *Guide (left or right)*.

To form column of detachments to the right or left.

80. Being in line, the instructor commands :

1. *Detachments right (or left)*, 2. **MARCH.**

At the first command, the gunner, acting as left guide of the battery, falls out and takes his place in rear of his detachment; at the command *march*, each detachment wheels to the right on a fixed pivot; upon the completion of the wheel, the front rank of each take the full step (28 inches); the rear rank shortens the step till it gains the distance of thirty-two inches from the front rank; the guide and dress of each detachment is, without further command, towards the side opposite the gunners, *i. e.*, toward the wheeling flank; the leading guide prolongs accurately his line of march by choosing successively points in advance; the other guides preserve with care the trace, the step, and wheeling distance.

The gunners march one yard from the flank of their respective detachments, and see that the ranks maintain accurately their alignments and distances.

The positions of the officers, first-sergeant, gunners, and trumpeters are as prescribed in *pars.* 26 to 33.

To form column of detachments and halt.

81. The instructor commands :

1. *Detachments right (or left)*, 2. MARCH, 3. *Battery*, 4. HALT.

The fourth command is given the instant the front rank complete the wheel; the rear ranks fall back to thirty-two inches, and all the ranks dress, without further command, toward the marching flank.

82. In all wheelings by detachments, the forward march is taken upon the completion of the movement, unless the command *halt* be given. *This rule is general.*

83. In column of detachments, the ranks dress toward the flank opposite the gunners. *This rule is general.*

To march in column of detachments to the front from either flank.

84. Being in line, the instructor commands :

1. *Right (or left) forward*, 2. *Detachments right (or left)*, 3. MARCH.

At the command *march*, the right detachment moves straight to the front, with the guide to the left; its rear rank, shortening the step, falls back to thirty-two inches; the other detachments wheel to the right on a fixed pivot; the second detachment, when its wheel is nearly completed, wheels to the left on a *movable* pivot, and follows the first detachment; the other detachments having wheeled to the right, move forward and wheel to the left on a *movable* pivot on the same ground as the second.

Being in column of detachments, at a halt or marching, to change the chiefs-of-platoons and gunners from one flank of the column to the other.

85. The instructor commands :

1. *Officers and gunners change flank*, 2. MARCH.

At the first command, the officers and gunners close into the flanks of the column; and, at the command *march*, pass quickly through the column between the detachments.

To put the column of detachment in march, and to halt the column.

86. The instructor commands :

1. *Forward*, 2. MARCH, and 1. *Battery*, 2. HALT.

To change direction in column of detachments.

Being in march, the instructor commands :

1. *Column right (or left)*, 2. MARCH.

At the command *march*, the leading rank wheels on a movable pivot ; the wheel being completed, this rank retakes the step of twenty-eight inches ; the other ranks move forward and wheel on the same ground.

Column half right (or left) is similarly executed.

S7. To put the column of detachments in march, and change direction at the same time, the instructor commands :

1. *Forward*, 2. *Column right (or left)*, 3. MARCH.

To march the column of detachments to the rear.

SS. The instructor commands :

1. *Detachments right (or left) about*, 2. MARCH.

The detachments wheel about on a fixed pivot ; the man on the marching flank of the rear rank of each detachment preserves the distance of thirty-two inches from his front-rank man ; the man on the pivot flank closes up to his front-rank man, covering him during the wheel, and on its completion falls back to thirty-two inches ; the chiefs-of-platoon and the gunners oblique to the right or left in turning about, so as to preserve their proper positions with reference to the column.

To form line from column of detachments.

S9. *To the right or left.* The battery being at a halt, or marching, the instructor commands :

1. *Detachment right (or left)*, 2. MARCH, 3. *Guide (right or left)*; or, 3. *Battery*, 4. HALT, 5. *Left (or right)*, 6. DRESS, 7. FRONT.

At the command *march*, the detachments wheel to the right on a fixed pivot. The rear rank of each detachment closes to facing distance during the wheel, except when executed in double time, and the line advances on the completion of the wheel.

If the line be formed towards the side from the chiefs-of-platoon, they close to the flank of the column at the first command, and, at the command *march*, pass quickly through the column between their detachments ; the gunners, at the same time, in like manner, pass to the other side of the column.

When the command *halt* is given, the instructor ; before dressing the battery, places the leading guide on the line of the pivot-

men, and at a distance from the leading pivot-man sufficient to admit the leading detachment; the battery is then dressed on this guide and the pivot-men of the detachments.

90. *On the right or left.* The instructor commands :

1. *On the right (or left) into line*, 2. MARCH, 3. FRONT.

At the command *march*, the leading detachment wheels to the right on a movable pivot, and moves forward, dressing to the right; the other detachments march a distance equal to their front, beyond the wheeling point of the detachment next preceding, wheel to the right, and advance as explained for the first. The leading detachment, having wheeled, advances five yards and is halted by the command: 1. *First detachment*, 2. HALT, 3. *Right (or left)*, 4. DRESS, from the chief of its platoon; at the fourth command it dresses to the right; the other detachments halt and dress successively upon arriving in line; the rear rank of each detachment, upon halting, closes to facing distance. The instructor places himself on the right to superintend the movement, and after the last detachment dresses gives the command *front*.

At the command *front*, given when the last detachment completes dressing, all cast their eyes to the front.

The chiefs-of-platoon and gunners follow up the movements and take their positions in line as the detachments successively come up to it. If the movement be executed on the side opposite the gunners, each takes his place behind the detachment by passing in front of the one next succeeding it.

91. *To the front.* The battery being at a halt, the instructor commands :

1. *Right (or left) front into line*, 2. MARCH, 3. FRONT.

At the command *march*, the first detachment moves straight to the front, dressing to the left; the other detachments oblique to the right until opposite their places in line, when each marches to the front. As soon as the leading detachment has advanced five yards, the chief of its platoon commands: 1. *First detachment*, 2. HALT, 3. *Left (or right)*, 4. DRESS; at the fourth command it dresses to the left; the other detachments halt, and dress to the left upon arriving in line; the rear ranks close to facing distance upon halting. The gunner who is the left guide of the battery in line places himself on the flank of his detachment as soon as it halts upon reaching the line. The instructor places himself on the left to superintend the movement, and after the last detachment dresses gives the command *front*.

92. As a rule, this movement is made towards the side of

the chiefs-of-platoon; should it be made towards the opposite side, the chiefs of the leading and last platoon take their posts in line by passing around the flanks of the battery; the chiefs of the other platoons pass through the column as the oblique commences; at the same time all the gunners pass through to the opposite flank.

If marching in quick time, the leading detachment continues to advance until halted, as before, and the other detachments oblique, at the command *march*.

If marching in double time, or in quick time, and the command be *double time*, the instructor commands: *Guide left* immediately after the command *march*; the leading detachment moves to the front and continues the march in quick time, its rear rank closing to facing distance; the other detachments oblique in double time, each taking the quick time and dressing to the left upon arriving in line; the rear rank, on arriving in line, closes to facing distance.

To march the column of subdivisions by the flank.

93. If at a halt, the instructor commands:

1. *Right* (or *left*), 2. FACE, 3. *Forward*, 4. MARCH, 5. *Guide* (*right* or *left*).

94. If marching:

1. *By the* (*right* or *left*) *flank*, 2. MARCH, 3. *Guide* (*left* or *right*).

The guides of the subdivisions preserve proper intervals, and dress on the guide who conducts the guiding subdivision.

95. To resume the original direction, the instructor commands:

1. *By the left* (or *right*) *flank*, 2. MARCH; and for platoons, 3. *Guide* (*right* or *left*).

To halt and resume the original front, the instructor commands:

1. *Battery*, 2. HALT, 3. *Left* (or *right*), 4. FACE.

To oblique in column of subdivisions.

96. The instructor commands:

1. *Right* (or *left*) *oblique*, 2. MARCH.

During the oblique, the subdivisions preserve their parallelism; the guide of each subdivision on the side towards which

the oblique is made is the guide of the subdivision; the guide of the leading subdivision is the guide of the column. The guides keep on a line parallel to the original direction.

97. To resume the direct march, the instructor commands :

1. *Forward*, 2. MARCH.

The guide is, without indication, on the side it was previous to the oblique.

If the oblique be executed from a halt, the guide is announced upon taking the direct march.

98. The battery being at a halt, in line, or in column of subdivisions, to march it a short distance to the rear, the instructor commands: 1. *Battery*, 2. *About*, 3. FACE; the chiefs-of-detachment and the gunner acting as guide step into the rear, now become the front, rank; the chiefs-of-platoon, now in rear, remain there.

The original direction is resumed by again passing to the flank march, or at once by the commands: 1. *To the rear*; 2. MARCH; or, if at a halt, 1. *Battery*, 2. ABOUT, 3. FACE; the guides and chiefs-of-detachment in either case return to the front rank.

To form column of files from column of subdivisions.

99. Being at a halt, the instructor commands :

1. *Right (or left)*, 2. FACE, 3. *Platoons (or detachments)*, 4. *Column left (or Column right)*, 5. MARCH.

At the command *face*, all face to the right; at the command *march*, each subdivision column changes direction, and joins upon the one which precedes it.

If marching, the instructor commands :

1. *By the right (or left) flank*, 2. *Platoons (or detachments)*. 3. *Column left (or Column right)*, 4. MARCH.

At the command *march*, each subdivision faces to the right in marching, changes direction, and joins upon the one which precedes it.

In both cases, if the movement is executed from column of detachments the rear rank close in elbow to elbow, with the front rank.

The route step.

100. When it is desired to give freedom and ease to the men in marching, the instructor commands :

1. *Route step*, 2. MARCH.

If in line or column of platoons, the rear rank falls back to

thirty-two inches from the front rank; the men are not required to keep silence, nor keep the step, but each man covers the file in his front, and, if armed, carries his piece at will.

To resume the attention, the instructor commands: 1. *Battery*, 2. **ATTENTION**. At the second command, the rear rank, if in line or column of platoons, closes to facing distance, and all the men take the step.

The battery may also be marched at rout step in column of files, the distance between files being increased to thirty-two inches. On resuming the attention, the leading file takes the short step until the other files close to facing distance.

The battery in rout step changes direction by the same commands as when in cadence step.

To form single rank from double rank.

101. For special purposes it may be desired to make this formation.

Being in line, at a halt, the instructor commands:

1. *Form single rank*, 2. *Detachments (right or left)*, 3. **MARCH**.

At the command *march*, all the detachments wheel to the right; the front rank of the right detachment, upon completing the wheel, continues the march with its guide on the wheeling flank; the other ranks halt, and successively resume the march when at wheeling distance from the rank preceding it; the rear-most rank having its distance, the instructor commands:

1. *Detachment left (or right)*, 2. **MARCH**, 3. *Battery*, 4. **HALT**, 5. *Left (or right)*, 6. **DRESS**, 7. **FRONT**; or, 3. *Guide (right or left)*.

102. Marching in column of detachments, to form single rank, the instructor commands:

1. *Form single rank*, 2. **MARCH**.

At the second command, the front rank of the leading detachment continues the march; the other ranks halt, and successively resume the march when at wheeling distance; the rearmost rank having its distance, line is formed as before.

103. In single rank, the relative positions of the officers and non-commissioned officers are the same as when in double rank, and the battery performs, by the same commands and means, all the movements of a double rank. The cannoneers retain their original numbers.

In executing the *rear open order*, the gunners step back to the line marked by the guides for a supposed rear rank.

To form double rank from single rank.

104. Being in line, at a halt, the instructor commands :

1. *Form double rank*, 2. *Detachments right (or left)*, 3. **MARCH.**

At the command *march*, the front and rear rank of each detachment wheels separately to the right; the leading rank halts the instant the wheel is completed; the other ranks continue the march and halt successively, each rear rank upon closing to facing distance from its front rank, and each front rank when at wheeling distance from the rear rank of the preceding detachment. When the column is put in march, the rear rank of each detachment falls back to thirty-two inches from the front rank.

In forming from single to double rank, the instructor wheels the detachments to the *right or left*, according as the front-rank men are on the right or left of their rear-rank men.

105. Marching in column of detachments at single-rank distance, the front-rank men of each detachment in front of their rear-rank men, to form double rank, the instructor commands :

1. *Form double rank*, 2. **MARCH.**

At the command *march*, the leading rank of the first detachment halts; the other ranks continue the march, each halting in the manner just explained.

To march to the pieces, or other place of exercise.

106. The *front*, in connection with a piece of artillery, is the direction in which the muzzle points, except when the piece is mounted on a traveling carriage and the carriage is limbered up; in which case the front is in the direction in which the pole points. The *right or left* is the right or left when looking towards the front.

The battery being formed for drill, as prescribed in *par.* 37, the instructor wheels it into column of detachment, or faces it into column of files; to the *right* if he is to approach the battery on the *left*, and to the *left* if he is to approach it on the *right*. The column is directed so as to bring the detachments as nearly as practicable four yards in the rear of the platforms of the pieces. When the head of column arrives at a distance of four yards from the left or right of the battery, the instructor commands : *Detachments opposite your pieces.*

1st. *Column of files.* As each detachment arrives opposite its piece, it is halted by the chief-of-detachment, who then commands :

1. *Left (or right)*, 2. **FACE**, 3. *Right*, 4. **DRESS**, 5. **FRONT.**

The detachment faces to the piece, and immediately the gunner places himself by the side of the left front-rank cannoneer; this is his place at all times when the detachment is in this position at the piece.

2d. *Column of detachments.* As each detachment arrives opposite its piece, the chief-of-detachment halts it, and commands, according as the battery has been approached on its left or right: 1. *Left (or right) wheel*, 2. MARCH, 3. *Detachment*, 4. HALT, 5. RIGHT, 6. DRESS, 7. FRONT; he then takes his post on the right of the front rank.

As the detachment wheels, the gunner takes his post by the side of the left front-rank cannoneer.

107. The centre of the detachment is four yards in rear of the piece or centre of the platform.

Each chief-of-platoon places himself one yard in rear of the centre of his platoon, or at such other place as he can best observe his detachments.

To take posts.

(*Figure 4, Plate II.*)

108. The instructor commands:

1. *Cannoneers to your posts*, 2. MARCH.

At the first command, the chief of each detachment, stepping two yards to the front and facing his detachment, commands: 1. *Right*, 2. FACE, 3. TO YOUR POSTS; the detachment having faced at the command of its chief, the gunner steps to one side, and at the command *march* by the instructor, repeated by the chiefs-of-detachment, it files to the left, the two ranks separating, the rear rank marching to the right of the piece, and the front rank to the left of it. As each man arrives at his post, he halts and faces the piece, Nos. 1 and 2 one yard from the epaulment, parapet, or scarp; their breasts *eighteen* inches outside of the carriage; the remaining numbers and the gunner dressing respectively on Nos. 1 and 2, at intervals of one yard, except that between Nos. 4 and 6 and 3 and 5 there is an interval of two yards; the gunner places himself in the interval between Nos. 4 and 6.

With mortars, Nos. 1 and 2 are on a line with the muzzle, the remaining number and the gunner being as before.

The chief-of-detachment is facing the piece, and two yards in rear of the platform or rearmost part of the carriage; while superintending the exercises, he goes wherever his presence is most required.

109. As soon as the cannoneers are at their posts, the instructor commands :

TAKE EQUIPMENTS.

This is executed as hereinafter prescribed for each kind of piece.

At the conclusion of the exercises he causes the implements and equipments to be replaced as hereinafter prescribed for each case.

To rest.

110. The instructor commands :

1. *In place*, 2. REST; or, 1. REST.

The cannoneers lay down their handspikes, as explained in *par.* 236.

In the first case, the men remain at their posts; in the second, they may leave their posts, but must remain near the piece.

To resume the exercise.

111. The instructor commands :

1. *Battery*, 2. ATTENTION.

All resume their posts and handspikes.

To change posts.

112. The instructor commands :

1. *Change posts*, 2. MARCH, 3. CALL OFF.

At the first command, the cannoneers lay down their handspikes, place their equipments on the parts of the carriage nearest them, or on the platform, and face to their left. At the command *march*, each cannoneer advances one post; No. 2, passing in rear of the piece, takes the place of No. 1; No. 1 of No. 3; No. 3 of No. 5, and so on. On arriving at their new posts they face the piece and, without further command, take the handspikes and equipments belonging to them; at the third command, they call off according to their new numbers.

To leave the battery.

113. The instructor first causes the equipments to be replaced, as hereafter prescribed for each case, and then commands :

1. *Detachments rear*, 2. MARCH.

At the first command, repeated by the chiefs-of-detachment,

the cannoneers upon the right of the piece face to their left, and those upon the left to the right; at the command march, repeated by the chiefs-of-detachment, they march to the rear, the rank with even numbers closing on that with odd numbers, change direction to the right at the command: 1. *Column right*, 2. MARCH, from the chief-of-detachment, are halted, faced to the front, and dressed to the right by him, so as to bring the centre of the detachment on a line with the axis of the piece, or opposite the middle of the platform, and four yards in rear of it. The gunner takes his place on the left of the front rank.

To reform the battery and leave the pieces.

1st. Into column of files.

114. The instructor commands:

1. *Detachments right (or left)*, 2. FACE, 3. *Close*, 4. MARCH.

At the command *face*, the detachments face to the right, the gunners taking their places in the rank of file-closers, and at the command march, repeated by all the chiefs-of-detachment, (except the leading one,) all the detachments close on the leading one, which stands fast. As each detachment closes up to the one in front of it, it is halted, by its chief, who then takes his post in front of the leading file of the front rank.

2d. Into column of detachments.

115. To form column of detachments, the instructor commands: 1. *Detachments right (or left) wheel*. 2. MARCH, 3. *Close to wheeling distance*, 4. *Guide (right or left)*, 5. MARCH.

At the second command, each detachment wheels to the right and is halted and dressed to the left by its chief; at the third command, the chief of the leading detachment cautions it to stand fast; at the fifth command, all the detachments in rear of the first step off, and each is halted by its chief when at wheeling distance from the preceding detachment.

The column is then marched from the battery by the commands and means heretofore explained.

FORMATION OF A BATTALION.

(Figure 5, Plate II.)

116. When two or more batteries form together in line, the first-sergeants take post beside and on the right of the front-rank cannoneer of their batteries; the chiefs of the right detachments, stepping back for that purpose, take post in line of gunners in rear of the right file of their detachments; the first-sergeants

retain habitually this position during all battalion manœuvres, and are the guides of that flank of their batteries.

117. Gunners acting as left guides of batteries, except the battery on the left flank, fall back and occupy their posts in rear of their detachments.

118. Batteries form without intervals; the first-sergeant of each, except the right, touching the left front-rank cannoneer of the battery on his right.

119. The trumpeters of *all the batteries* are united and take post on the right of the battalion in two ranks, the left of the front rank twelve yards to the right of the first-sergeant of the right battery; when there is a band, they are as provided in *par.* 125.

In all other respects the several batteries have the formation given in *pars.* 24 to 36.

120. A battalion is composed of two or more batteries, not exceeding twelve. When there are more than twelve batteries, they are formed into two or more battalions, the batteries of each regiment being kept, as far as practicable, together.

121. In forming the line, the batteries are posted from right to left according to the following table; the numbers indicate the relative rank of the battery commanders, the senior, or No. 1, being on the right of the line:

| | | | | | | | | | | | | |
|---|---|---|----|----|---|----|----|---|---|---|---|--|
| 1 | 3 | 2 | | | | | | | | | | |
| 1 | 3 | 4 | 2 | | | | | | | | | |
| 1 | 5 | 3 | 4 | 2 | | | | | | | | |
| 1 | 4 | 3 | 6 | 5 | 2 | | | | | | | |
| 1 | 5 | 7 | 3 | 4 | 6 | 2 | | | | | | |
| 1 | 5 | 8 | 3 | 7 | 4 | 6 | 2 | | | | | |
| 1 | 6 | 5 | 8 | 3 | 9 | 4 | 7 | 2 | | | | |
| 1 | 6 | 4 | 9 | 3 | 8 | 5 | 10 | 7 | 2 | | | |
| 1 | 7 | 9 | 5 | 10 | 3 | 11 | 6 | 8 | 4 | 2 | | |
| 1 | 7 | 4 | 10 | 11 | 3 | 12 | 6 | 5 | 9 | 8 | 2 | |

122. Batteries whose captains are absent are posted in line according to the relative rank of the officers present in command of them. At the discretion of the commanding officer, a battery whose captain is absent for a few days only may retain its place according to his rank.

123. Batteries are designated numerically from right to left when in line, and from front to rear when in column, *first battery, second battery*, and so on.

The designations of batteries change when, by facing in the opposite direction, the left becomes the right of the line, and the rear the head of the column.

124. When a battalion is provided with colors there will be a color-guard, composed of a color-sergeant and seven corporals, which is posted as the left detachment of the right centre battery. (Number 3 of the table.)

The front rank is composed of the color-sergeant and the three senior corporals, one posted on his right and two on his left; the rear rank is composed of the four remaining corporals, placed in order of rank from right to left.

The color-sergeant carries the national color. A regimental color (when present) is carried by a sergeant, who takes the place of the corporal on the left of the color-sergeant.

The color is to be carried only when the battalion is under arms with muskets.

At the sounding of the assembly the color-guard forms at the appointed place, and is marched, by commands of the color-sergeant, to the place where the color is kept. The color-sergeant receives the color and faces towards the guard; the senior corporal commands: 1. *Present*, 2. **ARMS**, at which the guard salutes the color; the corporal then commands: 1. *Carry*, 2. **ARMS**, after which the sergeant takes his position in the guard; the guard is then, by commands from the sergeant, marched to the color-battery on its parade-ground.

On returning the color the same ceremonies are observed.

The color-bearer carries the heel of the color-lance in its socket, supported at the right hip; the right hand grasps the staff at the height of the shoulder, to hold it steady. The color-bearer salutes with the color as follows:

(*One.*) Slip the right hand along the staff to the height of the eye; lower the staff by straightening the arm to its full extent, the heel of the lance remaining at the hip.

(*Two.*) Bring back the lance to the habitual position.

At all occasions of ceremony the color is without its case.

When marching in double time, the color-bearer grasps the color to the lance, raises the heel from the socket, and allows the color, the lance sloping to the rear, to rest on the right shoulder.*

Posts of field and staff officers.

125. The following is for a full regiment of twelve batteries; for a less number the same principles are observed:

(*Figure 5, Plate II.*)

The *colonel* is thirty yards in front of the line of captains,

opposite the centre of the battalion. This distance, as also that for the other field officers, is reduced as the front of the battalion is diminished.

The *lieutenant-colonel* is twelve yards in front of the line of captains, and opposite the centre of the three batteries on the right; the *first major* occupies a like position with reference to the three left batteries of the battalion; the *second major* a like position with reference to the three right centre batteries; the *third major* a like position with reference to the three left centre batteries.

The *adjutant* is in line with the chiefs-of-platoon, and three yards outside the right flank of the battalion.

Other staff officers, in the order of rank from right to left, are on the right of the adjutant, with one yard interval between each.

The *sergeant-major* is three yards to the left of the front rank of the battalion.

Other non-commissioned staff officers, when present, are on the left of the serjeant-major, with one yard interval between each.

The *band* is formed in two or more ranks, with intervals between files, and distances between the ranks sufficient to permit a free use of their instruments.

The *trumpeters* form the rear ranks of the band.

The band is posted on the right of the battalion, the left of its front rank twelve yards from the right of the front rank of the battalion.

The field and staff officers are mounted or on foot, as the commanding officer may direct.

126. When the battalion is in column on the march, in campaign; the colonel, lieutenant-colonel, second major, and staff officers march at the head of the column; the other two majors and the non-commissioned staff at the rear; the band at the head or rear, as the commanding officer may direct. In all other cases, when the line is broken into column, whether of batteries, platoons, or detachments, the field officers, adjutant, and serjeant-major take post on the flank of the column on the side next to the wheeling flank of the subdivision; the colonel about thirty yards from the centre of the column; the lieutenant-colonel and majors six yards from the flank, each in line with the subdivision in front of which he was posted in line; the adjutant and serjeant-major in their own wings abreast of and three yards from the flank of the leading and rear subdivisions of the column.

The staff officers (excepting the adjutant) wheel to the right

(or left) and place themselves, with intervals of one yard, opposite the centre of the leading subdivision, and six yards in front of the leading captain, or six yards in rear of the gunners of the last subdivision, according as the line has been broken to the right or left.

The non-commissioned staff (excepting the sergeant-major) occupy a similar position with reference to the other extremity of the column.

The band wheels to the right (or left), and takes post in front or rear of the column, as the colonel may direct.

In column of files, the field, staff, and non-commissioned staff officers, and the band, are as if each had faced with the battalion.

To form the battalion.

127. The batteries being formed on their parade-grounds, *adjutant's call* is sounded, at which the adjutant and sergeant-major, the latter on the left, each followed by a marker, march to the battalion parade-ground, where they post the markers, facing each other at a distance apart a little less than the front of a battery; the adjutant posts the marker nearest the right of the line, the sergeant-major the one nearest the left; each marker holds his staff in front of him; the adjutant and sergeant-major draw swords, face about, and each proceeds battery distance towards his flank of the line; they then face about and cover the markers.

The color-battery is the first established, and is conducted by its captain so as to arrive from the rear, parallel to the line of markers. When it arrives at three yards from the line, the captain halts it; dresses it to the left, against the markers; commands *front*, and takes his post in front.

The batteries of the right wing form successively from left to right, each being brought upon the line and dressed to the left, as explained for the color-battery; the gunner of each battery, acting as left guide, at the command *halt*, returns to his post in rear of his detachment; at the same time the right guide places himself, facing the markers, and aligns himself on them, at battery distance from the right marker, or guide in front of him. The first-sergeant takes the place of the chief-of-detachment who has stepped out to mark the line. The adjutant assures the position of the right guides, placing himself in their rear as they successively arrive. The guides retain their positions on the line until the command *guides posts* is given.

The batteries of the left wing form successively from right to left, in a similar manner, and are dressed to the right; the left

instead of the right guides place themselves on the line, and are assured in position by the sergeant-major. At the command *halt*, the first-sergeant and the chief of the right detachment take their places, as per *par.* 116.

Both wings are formed simultaneously.

To enable the captains to dress their batteries, the first-sergeants step into the rear rank, each resuming his place in the front rank as soon as the captain, after dressing his battery, takes his post in front.

The field and staff and non-commissioned staff officers take their posts as the battalion is formed. The colonel faces towards the line.

128. Before sounding *adjutant's call*, the band takes a position designated by the adjutant, and marches at the same time as the batteries to its position in line.

Each captain commands: 1. *Support*, 2. ARMS, as soon as the captain next succeeding him in his own wing commands *front*; the flank batteries *support arms* as soon as dressed.

The sergeant-major having assured the position of the left guide of the left battery, takes his post on the left of the line.

129. The adjutant having assured the position of the right guide of the right battery, places himself, facing towards the left of the line, three yards in front of his post, and when the last battery arriving on the line is brought to *support arms*, commands: 1. *Guides*, 2. POSTS. At this command, the guides and markers take their posts in line, the latter stationing themselves in the line of gunners on the right and left flanks of the battalion; the first-sergeants step a pace to the rear to permit the guides and markers to pass through their intervals, after which they return to the front rank. The adjutant then passes along the front in rear of the chiefs-of-platoon, to the centre of the line, turns to the right, halts midway between the captains and the colonel, faces about, brings the battalion to a *carry*, and a *present arms*, resumes his front, salutes the colonel, and reports: *Sir! The battalion is formed.*

The colonel returns the salute with the right hand, directs the adjutant: *Take your post, Sir!* draws his sword, and commands: 1. *Carry*, 2. ARMS.

The adjutant faces about, and returns to his post on the right, passing in rear of the chiefs-of-platoon of the right wing.

130. The foregoing is the habitual formation of an artillery battalion when serving as artillery, and will be used for occasions of drill and ceremonies. Where battalion movements become necessary or desirable, those embraced in the "SCHOOL OF THE BATTALION" [Infantry Tactics,] are prescribed, and

will be executed on the principles therein given, substituting the commands *detachments* and *battery* for "*fours*" and "*company*" wherever they occur.

Other differences of detail will suggest themselves from the marching drill heretofore given in this work, which, it is understood, is the basis of movements for heavy artillery troops.

The skirmishing manœuvres are those prescribed in Infantry Tactics, substituting commands as above.

Chiefs-of-detachment and gunners remain with their detachments in all deployments, exercising over the men such control as will insure the maximum of efficiency.

DEFINITIONS.

(*Figure 1, Plate III.*)

131. Cannon. The term *cannon* is applied to all heavy fire-arms discharged from carriages, in contradistinction to *small arms*, which are discharged from the hand. The general form of cannon is that of a truncated cone, the largest part being at the breech, around the seat of the charge; in those of recent model, the exterior elements are curves, and there are neither mouldings nor ornaments on the piece.

All heavy cannon in the U. S. land service are made of cast-iron; those pieces having greater calibres than that of the siege gun are cast hollow, being cooled from the inside upon the principle introduced by Rodman.

The want of ductility in cast-iron is unfavorable to its endurance under high vibratory strains; and as the ballistic power demanded of ordnance has greatly increased of late years, cast-iron is no longer much used for forming the parts immediately about the bore of heavy rifled guns, some other metal being substituted, the molecules of which accommodate themselves more readily to new positions when under strain.

It has been found that cast-iron guns are greatly improved by tubing them with some ductile and strong metal, as low steel or wrought-iron. A large part of the energy that the powder gas exerts on the surface of the bore is absorbed in expanding the tube, and that which finally reaches the cast-iron being much reduced in amount, and also spread over a surface relatively much greater than that of the bore, is largely within the limits of safety for the comparatively brittle envelope. The ductile metal of the tube also cushions the cast-iron against the effects of severe vibration and shock.

Guns thus constructed have great power of endurance, and

when put to extreme test it has been found that the cast-iron casing does not burst explosively, but cracks and gives way without violence.

The 10-inch smooth-bore is converted into an 8-inch rifle, and the 15-inch smooth-bore into a 12-inch rifle, by this method. (See 8-inch rifle, *par.* 319.)

132. The *bore* is the interior portion of the cannon, intended to receive the charge and projectile. It is bored out with the greatest accuracy as to straightness, diameter, and smoothness.

133. The *muzzle* is the mouth of the bore. The *face* is the terminating plane at the muzzle, perpendicular to the axis of the bore.

134. The *axis* of a cannon, or of the bore, is the central line of the bore.

135. The *trunnions* are two solid cylindrical arms projecting from the sides of the cannon for the purpose of supporting it on its carriage. They are placed at or near the centre of gravity, on opposite sides of the piece, with their axes in the same line, at right angles to the axis of the piece, and in the same plane with that axis.

136. The *rimbases* are the shoulders forming the junction between the trunnions and the piece. They serve to strengthen the trunnions, and, being terminated by planes at right angles to the axes of the trunnions, prevent the piece from moving sideways on the carriage.

137. The *breech* is the solid mass of metal behind the bottom of the bore.

138. The *base of the breech* is the rear surface of the breech.

139. The *casable* is the projection in rear of the breech. It is composed of the knob and the neck; the latter unites the knob to the base of the breech.

In heavy guns of recent model the casable is quite rudimentary, while in mortars it is entirely wanting.

The object of the casable is to facilitate handling the piece when mounting, dismounting, and transporting it.

140. The *body of the piece* is that part in rear of the trunnions.

141. The *chase* is that part of the piece in front of the trunnions.

142. The *vent* is the channel through which fire is communicated to the charge in the bore. Its diameter is two-tenths of an inch, and it is generally situated in the plane passing through the axis of the bore, perpendicular to the axis of the trunnions.

It is at right angles to the axis of the bore, and enters the latter at a distance from the bottom of one-fourth of the diameter

of the bore. In mortars and sea-coast guns there are two vents, each situated in a plane perpendicular to the axis of the trunnions, at equal distances on each side of the axis of the piece, and distant therefrom one-fourth of the diameter of the bore. The one on the left is bored entirely through; the other stops short an inch from the bore. When the open vent becomes too much enlarged by wear for further use, it is closed with melted zinc and the other bored out. Each one should endure at least five hundred service rounds.

In some pieces, a *vent-piece*, usually of pure soft copper, through which the vent has been bored, is screwed into the breech. This is called *bushing* the vent.

143. The *bottom of the bore* is the interior termination of the bore, and is a semi-ellipsoid.

144. The *chamber*, or *powder-chamber*, of a piece is that part of the bottom of the bore in which the powder is lodged at the time of firing. Formerly all mortars, howitzers, and shell guns throwing projectiles of comparatively large size with small charges, were provided with chambers *smaller* than the bore, for the purpose of confining the powder into a small space. In the present system the chamber is omitted from all pieces except the flank casemate howitzer and the Coehorn mortar, which are pieces of old pattern still retained in service.

It has been found experimentally that it is advantageous, especially with rifles, to have the bore enlarged, instead of diminished, at the seat of the charge. This gives an *air space* which diminishes the pressure upon the walls of the piece without diminishing the velocity of the projectile.

The object sought for in the construction of modern artillery is to secure great ballistic energy for the purpose of destroying heavy armor. This is secured by using heavy projectiles propelled with great velocity. But to obtain this result without undue pressure on the piece, the character, as to density, shape, and size of the grain, of the powder introduced is such as to cause it to burn progressively, with an increasing volume of gas, thus keeping up the pressure against the projectile as it moves along the bore, without causing an undue pressure upon the bore at any point. This gives a total effect against the projectile greater than was obtained from any of the older and more violent powders.

The charge of powder is much greater than formerly; this requires an increased length of bore, but it has been found that an enlarged chamber, with suitable charge, is equivalent to increase of length of bore, and that by these means the desired velocity is obtained without unduly increasing the length of the

piece, or of producing a strain which it is not capable of standing.

145. The *dispart* is the difference between the semi-diameter of the piece at the muzzle and at the thickest part, usually near the vent.

146. A *gun* is a cannon intended to throw projectiles, either solid or hollow, with large charges of powder, for the purpose of attaining great range, accuracy, and penetration. It is distinguished from other cannon by greater length and weight.

147. A *howitzer* is a cannon employed to throw hollow projectiles with comparatively small charges of powder. It is shorter and lighter than guns of the same calibre. The smallness of the charge and the great size of the projectile adapt it advantageously to ricochet firing.

148. A *mortar* is a short and comparatively light cannon, employed to throw hollow projectiles at great angles of elevation. It is intended to produce effect by the force with which the projectiles descend upon the object, and by the force with which these explode. The great curvature of their fire gives them power of reaching objects behind works which would be secure from direct fire.

149. Cannon are classified as *smooth-bore* and *rifles*. In the former, spherical projectiles are used; in the latter, elongated.

150. A *rifle* is a gun having a number of spiral grooves, called "rifles," cut into the surface of the bore. These grooves are for the purpose of giving to the projectile a rotary motion around its longitudinal axis. The portions of the bore between the grooves are called "lands"; these, in the United States service, are generally of about the same width as the grooves or "rifles."

The object of the rotary or "rifle" motion is to increase the range of the projectile by causing it to move through the air in the direction of its length, or least resistance, and to give increased accuracy by distributing the principal causes of deviation around its axis of rotation.

The projectiles for rifle-cannon are generally made of cast-iron, with a ring or cup around the base, made of bronze, or some other metal capable of expansion. The projectile enters the bore freely when loading, but the pressure of the discharge expands the ring or cup and forces the latter into the grooves, causing the projectile in its outward motion to follow the grooves, thus imparting to it the desired rotary motion.

151. *Twist* is a term denoting the inclination of the grooves to the axis of the bore. If the angle of inclination be equal at all points, the *twist* is said to be *uniform*.

If the angle increases from the breech to the muzzle, the *twist* is called *increasing*; if the reverse, *decreasing*.

The twist is measured by the length of bore corresponding to a single revolution of the spiral. In practice, it means the distance passed over by the projectile while making one revolution about its axis, and is expressed in feet.

152. *Windage* is the space left between the bore of the piece and its projectile. It is measured by the difference of their diameters, and is expressed in hundredths of an inch. Windage is necessary in order to make allowance for the bore becoming foul from firing; for the mechanical impossibility of having all projectiles of the exact size; and when sabots are used, to give room for the tin straps securing them. It facilitates loading, and diminishes the danger of the piece bursting. Windage increases slightly with the calibre; it is much less for rifle than for smooth-bore guns.

153. *Calibre* is the diameter of the bore. It is expressed in inches, except for pieces of old pattern, when it is expressed in terms of the weight of a solid cast-iron ball of the diameter of the bore.

154. *Preponderance* is the excess of weight of the part of the piece in rear of the trunnions over that in front. It is expressed by the lifting force, in pounds, which must be applied at the cascable to balance the piece upon the trunnions.

It is useful only for pieces mounted on travelling carriages, to keep them steady in transportation. For all other pieces of recent model the axis of the trunnions intersects the axis of the piece at the centre of gravity, thus enabling the piece to be elevated and depressed with greater ease. The discharge does not sensibly change the position of the piece before the projectile leaves the bore.

The *life* of a piece is the number of rounds that it will stand before becoming unserviceable. Cast-iron guns become unsafe after 1,000 rounds.

155. *Direct or horizontal fire* is where the piece is discharged, having but a small angle of elevation, and the projectile strikes the object without touching the intermediate ground.

156. *Curved or vertical fire* is where the piece is discharged, having a great angle of elevation, as are mortars, and the projectile effects its work chiefly by the force of its fall.

157. *Ricochet fire* is where the projectile strikes the ground or water and rebounds. Projectiles will ricochet upon ground of ordinary firmness when the angle of fall does not exceed 10° ; or upon water, at 4° or 5° .

158. *Rolling fire* is where the axis of the piece is parallel, or

nearly so, with the ground or water, and the projectile rebounds over the surface in a succession of ricochets.

159. *Plunging fire* is where the object fired at is situated below the piece.

160. The *point of fall* is the point first struck by the projectile.

161. The *angle of fall* is the angle made, at the point of fall, by the tangent to the trajectory with a horizontal line in the plane of fire. It is always greater than the angle of elevation of the piece.

162. The *elevation of a piece* is the inclination of its axis above the horizon. It is measured by the angle included between the axis of the bore and the horizontal line in the plane of fire at the muzzle. It is expressed in degrees.

163. The *depression of a piece* is the reverse of its elevation.

164. *Range* is the horizontal distance from the muzzle of a piece to the point where the projectile first strikes.

165. *Extreme range* is the distance from the piece to the point at which the projectile is brought to a state of rest.

Greatest range of a piece is the farthest distance to which it will throw a projectile, the piece being mounted on its appropriate carriage. All ranges are expressed in yards. In air, the maximum range, under ordinary circumstances, is obtained from an angle not far from 34° .

166. *Velocity* is the rate of motion of a projectile. It is expressed in feet for the space which the projectile would pass over in one second of time, supposing it to have a uniform rate of motion during this second.

Initial velocity, or, more properly, *muzzle velocity*, is the velocity at the muzzle of the piece.

Remaining velocity is the velocity at any other point of its flight.

Terminal velocity is the velocity with which it strikes the object.

167. *Energy.* This term, when used in connection with a projectile, means the resistance it is capable of overcoming at the time of striking an object. The resistance overcome is the work performed, and is made manifest by the crushing effect of the blow, or by the penetration of the projectile. It implies both pressure and motion, and is expressed in foot pounds, which, for convenience, are reduced to tons of 2,240 pounds each. It is the *living force* of mechanics, expressed mathematically by $\frac{w v^2}{2 g}$; in which w =weight of projectile in pounds;

v =velocity of projectile in feet;

g =gravity, which, in the latitude of

To apply this formula, suppose a projectile weighing 500 pounds strikes the side of an ironclad with a velocity of 1,000 feet, we have $\frac{500 \times 1000^2}{2 \times 32.16} = 7773631.8$ foot pounds; by dividing 2240, gives 3470.35 foot tons as the force or energy of the blow.

It has been ascertained by experiment that the resistance offered by armor plates to penetration by a given weight of projectile, the energy of which is constant, varies directly as the diameter or circumference of the projectile; hence, in order to find the penetrative power of a shot, it is customary to divide its energy by the number of inches in its circumference, and when projectiles are compared in this way they can be classed as regards their power of penetration. It will be seen that because a shot has great energy it does not necessarily have great penetrative power, the latter depending so largely on its diameter.

For obtaining the penetration in wrought-iron, Captain Noble's formula is used; which is—

$$Z = a x^2$$

$$Z = \frac{w v^2}{452617 \times d} \text{ in which}$$

Z = number of foot tons per inch of the projectile's circumference,

d = diameter of projectile in inches,

$a = 1.384$,

x = depth of penetration.

168. The *line of metal* is the profile cut from the upper surface of the piece by a vertical plane passing through the axis of the bore.

(Fig. 1, Plate IV.)

169. The *natural line of sight* is the right line passing through the highest point of the line of metal at the muzzle, and the highest point of the same line in rear of the trunnions.

170. An *artificial line of sight* is the right line containing the guiding points of the sights.

171. The *line of fire* is the axis of the bore prolonged in the direction of the muzzle.

172. The *plane of fire* is the vertical plane containing the line of fires.

173. The *angle of fire* is the angle included between the line of fire and horizon.

174. The *plane of sight* is the vertical plane containing the line of sight. It may be, but is not necessarily, either coincident or parallel with the plane of fires.

175. The *trajectory* is the curved line traced by the projectile in its passage through the air; it lies wholly below the line

of fire. In nearly all pieces, the natural line of sight cuts the trajectory at two points; the first point is near the muzzle, and the second farther to the front.

176. *Point-blank* and *point-blank range* are terms formerly supposed to possess great importance in gunnery.

The *point-blank* is the point at which the line of sight intersects the trajectory the second time; or, more practically speaking, it is that point which, being aimed at, is struck by the projectile.

The *natural point-blank* corresponds to the natural line of sight when this line is horizontal, and the distance of this point from the muzzle is called the *point-blank range*.

An *artificial point-blank* is one corresponding to an artificial line of sight.

177. *Deviation* is when the projectile does not move strictly in the plane of fire, but inclines to the right or left of it. Wind blowing across the line of fire is one great cause of deviation.

178. *Drift*, or *dérivation*, is the deviation peculiar to rifle projectiles, the divergence being on the side towards which the grooves *twist*. It is a constantly increasing divergence from the plane of fire, and is allowed for, in aiming, by means of a lateral motion given to the rear sight. (See *par.* 319.)

179. *Recoil* is the running back of the carriage after discharge. The space passed over after the gun is fired is also termed the recoil; it is expressed in feet.

The *directrix* is the centre line in the plane of fire of an embrasure or platform.

AMMUNITION.

GUNPOWDER.

180. Gunpowder is the agent employed in modern warfare to propel projectiles from cannon and small arms, and generally as the bursting-charge of projectiles; for the explosion of mines; blasting purposes, &c. It is a mechanical mixture giving light, heat, and gas in the combustion or chemical union of its ingredients.

Explosion is a phenomenon arising from the sudden enlargement of the volume of a body; as, in the case of gunpowder, a solid body is rapidly converted into a gas many times its volume. If the body is confined in a limited space and exploded, great heat is developed and a vast expansion or propelling force produced, the volume of gas being many times greater than that of the powder.

In the United States service, gunpowder is obtained from private manufacturers. It is distinguished by granulation; irregular, as *musket*, *mortar*, *cannon*, and *mammoth*; regular, as *cubical*, and the *molded powders*, *i. e.*, *pellet*, *hexagonal*, and *prismatic* (perforated hexagonal prisms). In all of these, the proportion of the ingredients are the same; they differ only in the size and shape of grain, density, and details of manufacture.

Musket powder is used for small arms; mortar for field guns; cannon for light siege guns, and the larger-grained and special powders for heavy sea-coast guns.

Note.—Special powders are now being experimented with for both field and siege guns.

Materials.

The materials required are *potassium nitrate* (*nitre*), *charcoal*, and *sulphur*. They should be of the greatest possible purity to insure excellence of quality and guard against accidents in manufacture. The proportions by weight of the ingredients used in the United States service powder are: $\left\{\frac{75}{8}\right.$ nitre; $\left\{\frac{15}{4}\right.$ charcoal; 10 sulphur.

It is essential to the successful and uniform manufacture of powder that the ingredients should be procured in their rough state, and be refined and prepared for use at the factory. This is also necessary as a security against accidents at the mills. All foreign matter must be carefully excluded, and every precaution taken against their introduction in handling and moving the refined materials.

General qualities.

Gunpowder should be of an even-sized grain, angular and irregular in form, without sharp corners, and very hard. When new, it should leave no trace of dust when poured on the back of the hand, and when flashed in quantities of ten grains on a clean plate it should leave no bead or foulness. It should give the required initial velocity to the ball, and not more than the maximum pressure on the gun, and should absorb but little moisture from the air.

A compact shape of grain, approaching the cube or sphere, is desirable. Elongated flat scales are objectionable. The number of grains in several weighed samples should be counted.

Size of grain.

The size of the grain is tested by standard sieves made of sheet brass pierced with round holes. Two sieves are used for each kind of powder: Nos. 1 and 2 for musket, 3 and 4 for mortar, 5 and 6 for cannon, and 7 and 8 for mammoth powder. (*Figs. 2 and 3, Plate IV.*)

Diameter of holes for musket powder, No. 1, 0.03 in.; No. 2, 0.06 in.

Diameter of holes for mortar powder, No. 3, 0.10 in.; No. 4, 0.25 in.

Diameter of holes for cannon powder, No. 5, 0.25 in.; No. 6, 0.5 in.

Diameter of holes for mammoth powder, No. 7, 0.75 in.; No. 8, 0.9 in.

Hexagonal, } Dimensions of these powders vary with the calibre
Cubical, } of the gun in which they are used, and have not as
Prismatic. } yet been definitely determined upon in our service.

Specific gravity.

The specific gravity of gunpowder varies from 1.65 to 1.8. It is important that it should be determined with accuracy. Alcohol, and water saturated with saltpetre, have been used for this purpose; but they do not furnish accurate results. Mercury only is to be relied upon.

Hardness is tested by breaking the grains between the fingers, and is judged of only by experience.

Muzzle, or initial velocity.

This is determined by any of the electro-ballistic machines available; the Boulongé chronograph is one of the simplest and most generally used for proof of powder. For a full description and use of the instrument, see Ordnance Memoranda, No. 25.

Strain upon the gun.

This is determined by the Rodman pressure-gauge. For description and use of the instrument, see Ordnance Memoranda, No. 25.

Determination of moisture and resistance to moisture.

The amount of moisture in powder is determined by drying samples in an oven with a water bottom.

The powder is subjected to heat as long as it loses weight, the loss indicating the percentage of moisture driven off. On being removed from the oven it should be transferred at once to perfectly clean, dry, air-tight weighing bottles.

The ability to resist moisture is determined by subjecting samples which have been dried to exposure, first in open air, then in a hygroscope containing a solution of nitre at 100° cooled to 80° Fahr.

The hygroscope is an air-tight box in which the powder is

subjected to a damp atmosphere at a uniform temperature for 24 hours.

The powder to be tested is placed in circular cups of copper with fine wire-gauze bottoms, affording free access of moisture to all parts of the sample under test. The percentage of gain is determined by weighing the powder in carefully-prepared bottles on opening the hygroscope. A careful record is kept of the barometer, hygrometer, external, and maximum and minimum internal thermometers.

Incorporation.

On breaking the grains, a fine uniform ashen-gray color throughout should appear; the grain texture should be close, without white specks even when magnified. For "flashing" on glass or porcelain plates, the powder should be in small conical heaps. Small copper measures for fine-grain powders, inverted on the plates, keeps the heap nearly the same at each trial. If the incorporation is good, only smoke marks remain on the plate after flashing; if bad, specks of undecomposed nitre and sulphur will form a dirty residue. The test requires experience to insure success.

Inspection report.

The report of inspection should show the place and date of fabrication and of proof, the kind of powder and its general qualities, as the number of grains in 100 grs.; its specific gravity; whether hard or soft, round or angular, of uniform or irregular size; whether free from dust or not; the initial velocities and pressures per square inch obtained in each fire; the amount of moisture absorbed; and, finally, the height of the barometer and hygrometer at the time of proof.

Marks on the barrels.

Each barrel is marked on both heads (in white oil-colors, the head painted black) with the number of the barrel, the name of the manufacturer, year of fabrication, and the kind of powder, *cannon, mortar, or musket, &c.*, the mean initial velocity, the pressure per square inch on the pressure-piston, and density. Each time the powder is proved, the initial velocity is marked below the former proofs, and the date of the trial opposite it. Each barrel contains 100 pounds.

SPECIAL POWDERS.

181. For some years it has been a recognized fact that the ignition, combustion, and explosive effect of gunpowder depend,

in a great degree, on the size, shape, and density of the grain, and that guns of different calibres require for their most efficient service powders differing in these features, in order to secure the best results. The rapid increase in weight of projectiles with the increase in calibre of guns, and the comparatively smaller power of resistance of the guns, renders it necessary that the rate of combustion of the charge be regulated so as to reduce the strains on the guns as much as possible, while at the same time preserving high initial velocity to the projectile, thus rendering practicable the use of the heaviest guns, projectiles, and charges.

The amount of gas evolved at the first instant of inflammation and combustion is measurably controlled by the size and form of grains, offering a lesser surface of ignition, and the increased density, offering greater resistance to the penetration of the hot gases through the grains, graduates its rapidity of burning. The form of grain affecting the amount of surface exposed to combustion—that shape which offers a comparatively small surface at the first instant of ignition, increasing progressively—is theoretically the best.

Experiments have settled the important part played by powders suited in the above qualities to the guns in which they are to be used, and have led to the adoption of large-grain powders in heavy guns, resulting in the production, among the best, of mammoth, pebble, cubical, hexagonal, and perforated prismatic powders. (*Figs. 4, 5, 6, 7, Plate IV.*)

Hexagonal powder.

This powder has been found to give the best results when used in pieces of heavy calibre. The uniform size of grain, and their polyhedral shape, insure great uniformity in position and size of the interstices in the make-up of the cartridge; this insures, with a uniform density of grain, a high degree of uniformity in pressures and velocities from given charges of powder and weights of projectiles. The powder used is composed of United States standard proportions of the ingredients, with a specific gravity of 1.7511. Its shape and dimensions are given on *Plate IV, Figs. 8, 9.*

The proportions of the ingredients of hexagonal powder conform to the United States standard, and up to the completion of the incorporation in the wheel mill, its manufacture is like that of ordinary powder.

Mealing. The wheel mill cake is revolved in a cylinder of wire-wove cloth, with wooden balls, until it is mealed.

Pressing. The mealed powder is then carefully pressed be-

tween horizontal metallic plates or dies. The powder comes out in a sheet or cake of polyhedral granules united along their vertical edges, the dies being nearly perfect dodecahedrons.

Graining. The press-cake is passed between rollers armed with brass cutting teeth at an angle of from 60° and 120° to the axis, which cut the cake into granules, their cross-section being almost *hexagonal*, whence the powder derives its name.

The powder is then sent to the glazing-mill and glazed; after which it is brushed and dried. The powder is now minutely examined, its specific gravity taken, and a count made of the granulation; a variation of two granules to the pound is enough to condemn the powder, the granulation being 72 to the pound. It is packed in barrels in the usual manner, and is fired in cartridge-bags as other powder.

Mammoth powder.

This powder is formed by breaking up mill cake. Exact uniformity of size and shape of grains does not therefore exist. The average granulation is 85 to the pound. (*Fig. 3, Plate IV.*)

Prismatic powder.

This variety is formed by pressing mealed powder into prisms. The hexagon is usually adopted, as it offers a good shape for piling, and the angles are sufficiently obtuse to prevent spawling at the edges. In order to insure uniform and progressive combustion, each prism is perforated with a small hole through its axis; formerly several holes were pierced.

Cubical powder.

This powder is of a regular cubical grain, being formed by cutting press-cake in two directions at right angles to each other. Each grain is 0.75 inch in size. The granulation is about 72 to the pound. (*Fig. 4, Plate IV.*)

It is important to observe that the proper kind of powder is used in the guns for which intended.

182. The system of classification in use in the Navy differs somewhat from that employed in the Army. The hexagonal, cubical, and mammoth are about the same; but Navy *rifle* corresponds nearly to Army *cannon*, and the Navy *cannon* is the nearest equivalent to Army *mortar*.

In exchanging powder with the Navy, it is necessary to observe these distinctions.

Powder barrels should never be opened, except when required for use, as grains of powder falling between the staves would

prevent their being tightened. Samples must be taken from the bung.

183. For ordinary examination, the *flashing test*, heretofore mentioned, is a ready way of ascertaining whether the powder is of good quality and in good condition.

If powder has been much damaged by damp it will be caked, and a close inspection will generally detect a white appearance on the grains, due to nitre having been dissolved and deposited in crystals on the surface.

Powder sometimes becomes caked by being tightly packed in cartridges, or for want of being rolled when in barrels. It will then readily crumble into its original grains by being pressed in the hand; but if the grains break or appear friable, the powder is unfit for service.

This latter characteristic indicates that the caking has resulted from dampness, and is to be carefully distinguished from the former.

Pressure.

184. The pressure of gunpowder, when fired in its own space, is placed at about 95,000 pounds to the square inch. When, however, the powder gas expands in the bore of the gun, though the proportion of the products of combustion are the same, the tension is greatly less.

185. *Cartridge-bags* are sacks for containing charges of powder when put into the piece. They should be made entirely from either woolen or silken stuff; the fabric should be soft, and closely woven, to prevent the powder from sifting through. The seams should be sewed with woolen yarn or silk.

PROJECTILES.

186. *Projectiles* for the U. S. artillery service are made of cast-iron, a material combining in a greater degree than any other the essential qualities of hardness, strength, density, and cheapness.

Projectiles are classified as *spherical* and *elongated*. The first are used exclusively in smooth-bore guns; the second in rifles.

They are further classified, according to their structure and mode of operation, as *solid*, *hollow*, and *case-shot*.

187. *Solid projectiles* produce their effect from impact alone, and as they can be fired with the greatest charge that the piece will bear, are used when great range, accuracy, and penetration are required. They are the only projectiles that can be used with effect against very strong walls, or armor-plated vessels.

Under the head of hollow projectiles are included shells for guns, howitzers, and mortars.

188. *Shells* have less strength to resist shock from the discharge of the piece and from impact; they are therefore generally fired with smaller charges of powder than solid shot. The weight of a shell is generally about two-thirds that of a solid shot of the same calibre. They are charged with mortar powder, which, exploding with violence, produces great destruction to both animate and inanimate objects.

The principal parts of a shell are :

First. The *cavity*, used to hold the bursting charge; or bursting charge and incendiary composition, when the intention is to destroy by setting fire to objects.

Second. The *fuse-hole*, which is used for inserting the charge, and to hold the fuse which communicates fire to it.

Spherical shells have two small shallow holes, one on each side of the fuse-hole, into which are inserted the shell-hooks when loading. These holes are called *ears*.

Shells for mortars, being fired with lighter charges than those for guns, have less thickness of metal.

Spherical shells for *guns* are reinforced on the inside, around the fuse-hole, to prevent the fuse-plug from being driven in by the force of the discharge. This reinforce serves, in some measure, to compensate for the loss of weight on that side of the shell caused by the fuse-hole, thus rendering the shell more accurate in flight.

189. *Case-shot* is a projectile similar to a shell, but with much less thickness of metal. It is filled with leaden bullets, which are secured against moving loosely about by having their interstices filled with melted sulphur. Through the fuse-hole, a hole is bored into this mass of bullets and sulphur sufficient to contain a bursting charge. This projectile is intended only for use against troops. The fuse is so regulated as to burst the shell a short distance in front of the object, when the bullets and fragments, separating, move forward in a *sheaf* form, and produce effect as from musketry.

The charge for case-shot should be only sufficient to rupture the case.

190. *Elongated projectiles* are used exclusively for rifle guns, and, like the spherical, may be either solid or hollow. There are in service various patterns, each known, generally, by the name of the inventor. They all, however, have a general resemblance to each other, and consist of a cylindrical body surmounted by a conoidal head. To the base is attached a ring or cup of some softer metal, which, expanding from the force of

the discharge, enters the grooves of the piece and causes the projectile to take a rotary motion about its axis.

The fuse-hole, which is in the pointed end, is coincident with the axis. The fuse-plug is screwed into the fuse-hole.

The most approved pattern is known as the Butler projectile, (*Fig. 1, Plate V.*) the sabot of which consists of a bronze ring screwed upon the base. In this ring an annular groove is cut; the gas from the charge acting on this channeleur forces the exterior lip into the grooves of the bore, while the interior is forced still tighter upon the body of the projectile, thus preventing it from stripping.

191. A *cored shot* is an elongated projectile having a cavity in the body of it. This cavity is for the purpose of throwing the centre of gravity towards the front end of the projectile, thus insuring greater steadiness of flight.

The hollow projectiles are either shells or case-shot, both of which, in their construction and use, are similar to those heretofore described for smooth-bore guns.

Rifle projectiles have a length of two to three times their diameter, depending upon the pattern, and whether solid or hollow, the latter being generally the longest.

192. A *canister* is a projectile consisting of a hollow tin cylinder filled with cast-iron or leaden balls, which vary in size and number with the kind and calibre of piece. The cylinder is closed at the bottom with a thick cast-iron plate, and at the top by one of sheet iron. The balls are packed in with dry sawdust. Canister is not effective at a greater distance than 400 yards, and, with the exception of flank howitzers, is but little used for heavy artillery.

193. *Grape-shot.* A stand of grape is composed of nine cast-iron balls, disposed in three layers of three balls each. They are held together by two circular iron plates, united by a bolt passing through their centres. Around this bolt the balls are held by two iron rings. The plates have a diameter corresponding to the calibres of the gun in which the grape is to be used. The size of the balls depends, likewise, upon the calibre of the gun.

Grape is not fired from rifle guns, and has but limited use for those of smooth-bore; the modern musket and Gatling being much more effective than either canister or grape.

194. A *carcass* is a spherical shell, having three additional holes, of the same dimensions as the fuse-hole, pierced at equal distances apart in the upper hemisphere of the shell. The shell is filled with a composition which burns, with intense power, from eight to ten minutes, and the flame, issuing from the holes,

fires whatever is combustible within reach. It is used in bombardments for setting fire to shipping, magazines, camps, &c.

When the prepared carcass is not to be had, a common shell, either spherical or elongated, may be substituted by placing in the bottom of it a bursting charge contained in a bag; over this, carcass composition is driven until the shell is nearly filled; four or five strands of quick-match are then inserted, and secured by driving more composition upon them. These shells, after burning as a carcass, explode.

Port-fire composition is suitable for filling them.

195. A *fire-ball* is a projectile of an oval shape, formed of a sack of canvas filled with combustible composition, which, in burning, emits a bright flame. It contains a loaded shell, and is used for lighting up the enemy's works. It is fired from a mortar.

FUSES.

196. A *fuse* is the contrivance for igniting the charge of a hollow projectile, after it has left the piece, upon being fired.

They are divided into four classes, viz.: the time-fuse, the percussion-fuse, the concussion-fuse, and the combination-fuse.

197. *The time-fuse*, now used for heavy artillery, is composed of a paper case inclosing a column of compact composition, which is ignited by the flame from the charge in the piece. It burns for a certain time, at the end of which it communicates the flame to the charge in the projectile. The paper case is made slightly conical to insure a close fit and to prevent it from being driven through and into the projectile. It is inserted, at the time of loading the piece, into a metal or wooden fuse-plug previously driven or screwed into the fuse-hole of the projectile. The composition has the same ingredients as gunpowder, the proportions being varied to suit the required rate of combustion. To insure ignition, it is primed at the larger end with rifle powder. They are furnished from arsenals in water-proof packages, each package being marked with the number of seconds required for the burning of the fuse; this time varies from two to twenty seconds per inch. The paper case is graduated into seconds, which enables the fuse to be cut to a length corresponding to any intermediate time. All fuses of this kind are of the same diameter and are two inches in length.

When it is to be used for ricochet firing, especially over water, a plug, known as the water-cap fuse-plug, is used. This is constructed to prevent the burning composition from being extinguished when the projectile strikes, and consists of a *brass* plug

firmly driven or screwed into the fuse-hole of the projectile; the paper fuse is inserted at the time of loading the piece, after which a *water-cap* is screwed into the plug.

The water-cap is of brass, and is perforated with a crooked channel, filled with mealed powder; the mealed powder communicates fire to the paper fuse, and the angles of the channel break the force of the water or dirt. The top of the cap has a recess filled with a priming of mealed powder, covered by a protecting disk of lead or paper, which is pulled off immediately before inserting the projectile into the piece. For security against accidental ignition, a small leaden plug is placed in the inner end of the fuse-plug, where it remains until it is driven out by the shock from the discharge of the piece.

Fuse-plugs for mortar shells are generally turned from some hard wood; these are made to fit closely by rasping them off to the exact size.

The paper time-fuse is used for either smooth-bore or rifle pieces.

198. The *percussion-fuse* is used only for rifle projectiles, and is ignited by the striking of the point of the shell against an object. There are many varieties of this fuse, all consisting, essentially, of a brass or pewter fuse-plug containing a plunger. This plunger does not move in its place until the sudden arresting of the shell, by striking, causes it to break its fastening, and, by its inertia, is driven against a priming of fulminate, which, exploding, communicates flame to the charge of the shell.

199. The *concussion-fuse* is made to operate by the shock of the discharge of the piece. There are also many varieties of this kind of fuse, all of which are composed essentially of a plunger, which, by its inertia, when the shell starts to move in the bore, breaks its fastenings, and, striking against a priming of fulminate, explodes it and communicates fire to a time-fuse inclosed in the same fuse-plug. The time-fuse is cut or set to burn the required time; it then communicates flame to the charge in the shell.

Concussion-fuses are seldom used except for rifle projectiles.

The *combination-fuse* is one combining the principle of action of the three former. There are, also, a great variety of this kind of fuse, all of which are more or less complicated.

PRIMERS.

200. The *friction-primer* is a device for communicating fire through the vent to the charge in the piece. It is composed of two brass tubes soldered together at right angles. The shorter

tube contains a small quantity of friction composition, in contact with which, and contained also in the short tube, is a serrated wire, which wire is doubled at its other extremity into a loop forming an eye for the hook of the lanyard; the long tube is filled with rifle powder, and has its lower extremity closed with wax. (*Fig. 2, Plate V.*)

The long tube is inserted in the vent; a pull upon the lanyard disengages the serrated wire, which, by its friction upon the composition, causes the latter to ignite, and thus communicating fire to the rifle powder in the long tube, explodes the cartridge in the *piece*.

The charge of rifle powder has sufficient force to pass the flame through the longest vent and penetrate several thicknesses of cartridge-cloth.

(*Fig. 3, Plate V.*)

201. The *electric-primer* is an invention for firing cannon by means of electricity. It consists of the long tube of the friction-primer split at one end to receive a short but larger piece of brass tube, to which it is soldered. The larger piece incloses a cylindrical piece of hard wood, slotted midway of its length and perforated at each end to receive short pieces of copper wire, which are connected across the slot by a coiled piece of fine platinum wire. The outer ends of the copper wires project a few inches to connect the wires of the primer with the terminal wires of the battery. When thus connected, the battery current heats the platinum sufficiently to ignite a small piece of loose gun-cotton, which, together with the platinum wire, occupies the slotted portion of the wooden cylinder. The ignited gun-cotton communicates flame to the powder in the long tube.

202. *Sabots* are circular blocks of wood, fastened with tin straps to hollow projectiles for smooth-bore guns. Their object is to prevent the projectile from turning in the bore and bringing the fuse in contact with the charge of the piece. The diameter of the sabot corresponds to that of the projectile; it has a shallow dish-shaped cavity for the projectile to rest in, and is always attached to the side opposite the fuse-hole.

When the piece is fired, the fragments of the sabot fly a short distance from the muzzle; consequently it is dangerous to use this kind of ammunition when firing over the heads of our own troops. Owing to the liability of premature explosions, the same objection applies to hollow projectiles of every variety.

The metallic ring, or cup, attached to the base of rifled projectiles for the purpose of expanding into the grooves of the piece and giving rotary motion to the projectile, is also called a sabot.

IMPLEMENTS.

203. *Implements* for artillery are those instruments employed in loading, pointing, and firing cannon, and in mechanical manœuvres therewith.

Equipments are those things used for the same object, but which are *carried* by the individual men.

204. *Gunner's quadrant* (*Fig. 10, Plate IV*) is an instrument for giving elevation or depression to a piece. It consists of a graduated quarter of a circle of sheet brass, of six inches radius, attached to a straight brass bar twenty-two inches long. It has an arm carrying a spirit-level at its middle, and a vernier and clamp screw at its movable end. The arc is graduated to half degrees, and the vernier reads to five minutes. To get a required elevation, the vernier is set at the indicated degree; the brass bar is next inserted in the bore parallel to the axis; the piece is then elevated or depressed until the level is horizontal. The elevation may likewise be obtained by applying the bar to the face of the piece, care being taken to have it in a plane parallel to the plane of fire. The latter is the mode of using it with mortars.

The difficulty of applying the quadrant to the muzzle of guns, especially to those in embrasure, has suggested that a metallic ledge be attached to the end of a trunnion; upon this ledge the bar of the quadrant is applied when the elevation is to be given. The top of the ledge is parallel with the axis of the bore.

205. *Gunner's level* is an instrument for marking the line of metal on a piece. Until within a very recent period it was required with all pieces, but since the application of sights to guns its use is confined solely to mortars; and owing to the fact that these pieces are left rough and unturned on the exterior, the line of metal marked, in the usual manner, with the gunner's level and a chalk-line, is, at best, but a crude and imperfect method of obtaining a line of sight. (*Fig. 11, Plate IV*.)

The method of using this instrument is readily understood by an inspection of it.

Sponge. This is a *woolen* brush, attached to a staff, used in cleaning the bore of cannon, and for extinguishing any burning fragments of cartridge that may remain after firing. For field pieces the sponge and rammer-heads are on the opposite ends of the same staff; for siege and sea-coast pieces they are attached to separate staves.

With pieces of less than eight inches calibre the sponge-head consists of a cylindrical block of wood about three calibres in length; upon this is tacked the woolen stuff forming the sponge. For pieces of larger calibre a *spring-head* (*Fig. 4, Plate V*) is used. This consists of three pieces of sheet iron, so fashioned as

to form, when put together, a semi-ellipsoid corresponding to the bottom of the bore of the piece for which intended. To these plates is attached the sponge material, which is secured by pack-thread stitching through holes in the iron. Each plate is attached to the staff by a steel strap; these by their spring allow the plates to close together and enter the bore with a tight fit. The necessary size is thus secured without the greater weight of solid wooden heads.

Sponges are protected from the weather by canvas covers, which are painted. They are preserved from moths by the same means used for cartridge-bags. (*Par.* 568.)

The *rammer*. This is used for shoving the cartridge and projectile to their place in the bore of the piece. For small calibres the head of the rammer is a short cylindrical piece of tough wood, fixed to the end of a staff; for the larger calibres it consists of a wooden ring bound with iron or copper and attached to the staff by three iron prongs or straps. (*Fig. 5, Plate V.*) This secures lightness with the necessary size.

The *ladle* is a copper scoop (*Fig. 6, Plate V*) attached to a staff. It is used for scooping out the powder of a cartridge which may have become broken when withdrawing it from the bore.

The *worm* (*Fig. 7, Plate V*) is a species of double cork-screw attached to a staff, and is used for withdrawing cartridges from pieces.

The *pass-box* is a wooden or metallic box with a lid and handles, used for carrying cartridges from the service magazine to the piece. The boxes are of various sizes to suit the calibre of the piece, one cartridge being carried at a time.

The *budge-barrel* is a barrel, to the top of which is attached a leather cover, which is gathered with a draw-string like the mouth of a satchel. It is used with pieces requiring small-sized cartridges, to carry them from the magazine to near the pieces to be served.

The *priming-wire* is used to clear the vent and prick a hole in the cartridge. This latter is not, however, an absolute essential, as the explosion of the primer, as now made, will, with ordinary cartridges, carry flame to the powder.

The *vent-gimlet* is a long gimlet for removing obstructions from the vent.

The *vent-punch* is an instrument for the same purpose. As these instruments are made of hardened steel, great care must be observed in using them, that they do not break in the vent and spike the piece.

The *fuse-setter* is a brass drift for driving wooden fuse-plugs into shells.

Fuse-wrench is a three-pronged wrench used for setting fuse-plugs that are to be screwed into the shell. One prong contains forks for the fuse-plug, and another one smaller forks for the water-cap.

Fuse-block, sometimes called *fuse-gauge*, (*Fig. 8, Plate V*), is a simple contrivance for holding paper time-fuses when being cut. It consists of two blocks of wood hinged together so as to open and shut after the manner of a book. In each end is a recess into which the fuse is placed, and where it is securely held by pressing the blocks tightly together. The fuse is put in with the small end extending out of the end of the block, the point at which it is to be cut being even with the end of the block.

Along one side of the recess is attached a brass scale. This was intended for fuses of obsolete pattern. As now made, each fuse is divided into as many equal parts as the number of seconds for which its entire length (two inches) is intended to burn. These parts are marked, and are the guides in cutting the fuse; the latter operation being performed with the *fuse-knife*, which is a sharp thin-bladed knife, (preferably a shoe-knife,) or a fine saw. (See Fuses, *par.* 196.)

Fuse-plug extractor. This is an instrument for extracting fuse-plugs after they have been driven. It is a stout screw, which may be screwed into the fuse-hole of the plug, which is then pulled out by means of a screw operating after the manner of certain kinds of cork-screws.

Fuse-reamer is used to enlarge the hole in a fuse-plug so as to make it of proper size for the paper fuse.

Powder-measures are made of copper, of cylindrical form and of various sizes, for the purpose of determining the charges for shells and cannon by measurement. Each measure is marked with the weight of *mortar* powder which it holds. They come in sets, holding from one ounce up to several pounds, and fit together in a *nest*.

Lanyard is a strong cord, one end of which has a small iron hook and the other a wooden handle. It is used for exploding the friction-primer when a piece is to be fired.

Shell-hooks is an implement constructed to fasten into the ears of a shell for the purpose of lifting it to the muzzle of the piece.

Gunner's pouch and *primer-pouch* are made of leather, and are attached to the person by a strap buckling around the waist.

Cartridge-pouch is made of leather, and is carried suspended from the shoulder to the opposite side. It is used when small cartridges are required, for carrying them from the magazine or budge-barrel to the piece.

Sight-pouch is a long, slender case, used sometimes for carrying the breech sight. It is suspended from the shoulder.

Handspikes. With siege guns and mortars, wooden handspikes are used for manœuvring them. Those for mortars are *shod* with iron, which is turned up in a way to prevent slipping on the platform.

Guns with iron carriages have iron handspikes, made to fit into the mortises of the truck-wheels.

Elevating-bar is a stout bar of iron with one end squared and made to fit into the ratchets on the breech of the piece for the purpose of giving elevation. It is operated as a lever, the fulcrum being the ratchet-posts of the carriage.

The implements and machines used for *mechanical manœuvres*, for the *inspection*, and for the *aiming* of cannon, are described under those heads respectively.

MOTION OF PROJECTILES AND DEVIATING CAUSES.

206. A projectile fired from a cannon is acted on by four distinct forces, viz.: First, the projectile force; second, the force of gravity; third, the resistance of the air; fourth, the friction against the surface of the bore.

With the exception of gravity, none of these forces are constant, varying not only for different pieces, but for different shots from the same piece.

The projectile force is that produced by the combustion of the powder in the piece, causing sudden development of gas, the expanding force of which, acting on the projectile, impels it forward and out of the piece. It is physically impossible to obtain exact uniformity in the charges. In practice there will always be a difference in weight and shape in the cartridges, and in pushing them home, greater pressure will be applied at one time than at another, thus causing want of uniformity in combustion. The temperature of the piece, arising from previous discharges and from the temperature of the air or rays of the sun; the nature of the projectile and its movement in the bore; the condition of the bore with respect to humidity and foulness,—all have more or less influence on the combustion of the powder, and consequently on the velocity and range. Above all, however, is the want of uniformity in the *quality* of powder. In this respect considerable latitude must be allowed in the size and density of grain or pellet, in the manipulation of the ingredients, and in its condition resulting from age, moisture, and handling. With small charges, especially with fine-grained

powder, it is possible to so mix the contents of different barrels for any series of shots as to secure a fair degree of uniformity for that particular occasion; but with charges requiring large quantities of powder, this, except to a limited degree, is impracticable.

The force of gravity. As soon as the projectile leaves the muzzle of the piece this force has free power to act, and draws the projectile downwards, causing it to describe a curve.

The resistance of the air. The projectile, in passing through the air, meets from it a resistance depending in intensity upon the velocity, the shape of the projectile, and density of the air. This resistance consumes a portion of the projectile force, which, being gradually diminished, causes the projectile to pass over unequal spaces in equal intervals of time. These spaces gradually diminishing, give to the trajectory unequal curvatures in its two branches, that of the last part being much more curved than the first.

Atmospheric resistance increases as the square of the velocity, and with the cross-section of the projectile exposed to the action of the resistance.

It is manifest that the resistance due to the atmosphere varies with the density of the latter, and this depends upon and varies with the temperature, the humidity, and the barometric pressure. The retarding effect of rain is evident.

The foregoing influences operate principally in a vertical direction, and therefore affect only the range. Other influences affect lateral accuracy, among which may be mentioned *wind*, the velocity and force of which are classified as follows:

| VELOCITY. | | Pressure on 1 square foot. | Common designations of the force of the wind. |
|------------|-------------|----------------------------------|--|
| In 1 hour. | In 1 sec'd. | | |
| Miles. | Feet. | Lbs. | |
| 1 | 1.47 | 0.005 | Hardly perceptible. |
| 2 | 2.93 | .020 | Just perceptible. |
| 3 | 4.40 | .044 | |
| 4 | 5.87 | .079 | Gentle, pleasant wind. |
| 5 | 7.33 | .123 | |
| 10 | 14.67 | .492 | Pleasant, brisk breeze. |
| 15 | 22.00 | 1.107 | |
| 20 | 29.34 | 1.968 | Very brisk. |
| 25 | 36.67 | 3.075 | |
| 30 | 44.01 | 4.429 | High wind. |
| 35 | 51.34 | 6.027 | |
| 40 | 58.68 | 7.873 | Very high. |
| 45 | 66.01 | 9.963 | |
| 50 | 73.35 | 12.300 | A storm or tempest. |
| 60 | 88.02 | 17.715 | A great storm. |
| 80 | 117.36 | 31.490 | A hurricane. |
| 100 | 146.70 | 49.200 | A hurricane that tears up trees, carries buildings before it, &c. |

It is evident from the foregoing that the effect of wind, on so large a body as a cannon projectile, is considerable. This effect is in direct proportion to the strength of the wind and the time of flight of the projectile.

When the wind crosses the plane of fire, the deviation of spherical projectiles is on the side towards which the wind is moving; with elongated projectiles, especially shells and cored shot, the wind has a slight tendency to cause them to go in the opposite direction. Wind coming from the *left* tends, therefore, to correct the drift of rifle projectiles, the latter being always to the right; when coming from the *right* it augments the drift. A front wind diminishes the range; when coming from the rear it increases, but to a very slight degree, the range.

When the range is great the projectile may have to traverse several currents of air of different directions and velocities. This would have the effect of giving a waving motion to the projectile.

The condition of the atmosphere with reference to mirage has a marked influence upon accuracy of aiming; for it is evident that a projectile will not strike the object if the piece is directed only at the reflected image of it.

Aberrations arising from atmospheric influences are so numerous and subtle as to make it impracticable to formulate them into tables useful for practical gunnery. Practice at small-arm firing, as now conducted at rifle-ranges, leads to habits of observation and exercise of sound judgment highly advantageous to the artilleryman.

Friction against the bore. The projectile, in passing along the bore, experiences more or less friction; this has a retarding effect, varying the velocity and consequently the range. The unequal degree of friction at different parts of the bore may cause the projectile to leave the muzzle with a greater pressure on one side than on the other, forcing it to deviate from the true line of fire. This is more particularly the case with spherical projectiles, in which there is considerable windage and ballooning, than with rifle projectiles.

Resistance from rifling. The cup or sabot of an elongated projectile, expanding from the pressure of the gas, fills the grooves, which, being inclined to the axis of the bore, offer resistance to the forward motion of the projectile. That side of each groove towards the muzzle is the one against which the expanded sabot constantly impinges, and is called the driving side.

Owing to the mechanical impossibility of constructing guns and projectiles of exact uniformity, a certain departure from

the true dimensions is allowed in receiving them from the manufacturer. This, to a certain degree, prevents uniformity in firing. Roughness of the bore and projectile, especially with rifles, influences velocity, accuracy, and range. The bore becomes foul from firing, and this foulness is hard and rough or soft and unctious, depending on the humidity of the atmosphere, or whether the sponge is moist or dry. With rifle projectiles, lubrication, or the want of it, has a marked effect upon their range and accuracy.

Want of uniformity in the density, weight, figure, and centre of gravity of projectiles, are other sources of error in firing.

In many instances these various sources of aberration may combine in such manner as to partly neutralize each other. On the other hand, they may so fall together as to produce the maximum degree of inaccuracy.

In addition to the foregoing, there are other sources of error in firing, which, although exceedingly minute, nevertheless exist. Among these may be mentioned the influence of the axial rotation of the earth; the spring of the carriage; the dip of the muzzle; the effect of the rays of the sun in heating one side of the piece more than the opposite side, and a like effect on the projectile.

From the foregoing, it must be evident that exact uniformity of firing with any piece is an impossibility. It is by practice alone that the artilleryist can be brought to distinguish between inherent defects and faults of gunnery which he may correct.

AIMING.

207. To aim a piece of artillery is to give it such a direction and elevation as will cause the projectile to strike the object, and the rule is: first give the direction, and then the elevation.

With the exception of mortars, all modern pieces are furnished with two sights: a front one and a rear one. These are situated either on the *line of metal*, or slightly to the right of it in a plane parallel to the plane of fire.

The front sight is securely attached to the piece by means of a screw, and for the heavier class of guns is over the axis of the trunnions.

The rear sight is on the breech, fitting into a socket attached to the piece with screws, and when the gun is to be discharged is removed from the socket.

For the 10 and 15 inch guns the breech sight is without graduation, and serves merely to give direction to the piece, the ele-

vation being given by means of the *elevating-arc*, or, when practicable, with the quadrant applied in the muzzle.

208. For siege and Parrott guns the breech sights are graduated to correspond to degrees and parts of degrees of elevation of the axis of the bore, and have a slide to move up or down. This slide has a screw thread cut on one end of it, upon which works a nut with four short arms; through each of these arms is a small hole for sighting. The screw upon the slide is for the purpose of giving lateral motion, when allowing for drift.

Each kind of gun has its particular breech sight, but, as there are in service many of old or experimental pattern, they should be verified for the particular pieces upon which they are to be used. This is done by directing the piece at some well-defined point at a distance of 1000 yards or more, and on the same horizontal plane with the axis of the trunnions. A straight-edge and spirit-level applied to the face of a trunnion suffices for this operation. Place the slide of the breech sight at any degree of the graduation, and, sighting through it at the object, give the piece the corresponding elevation. Insert the gunner's quadrant into the bore, and ascertain from it the inclination of the axis of the piece. If the reading on the breech sight corresponds to that of the quadrant, the former is correct. The line of sight passing through the zero of the breech sight is parallel to the line of fire.

209. For 10 and 15 inch guns an *elevating-arc* is used. This consists of a strip of brass attached to the base of the breech parallel to the ratchets. It is graduated into degrees and parts of degrees, and a pointer, attached to the ratchet-post, indicates the elevation or depression of the piece. When the pointer is at zero, the axis of the piece is horizontal. Besides the graduation on the arc, the ranges in yards for the ordinary charges for shot and shell are given.

In batteries for garrison and sea-coast defense, where the platforms are fixed, the line of metal may be considered as permanent; but with siege guns, mounted on traveling carriages, the wheels are liable to vary in position from unevenness of ground, or unequal settling in newly-constructed platforms. This line is constantly changing, and approximates the higher wheel in proportion to the difference of level between the wheels; hence, to secure accuracy of fire, allowance must be made by observing where the shots strike and correcting the aim accordingly. Deviation from this cause is always towards the side of the lowest wheel.

210. All range tables are made out with reference to the horizontal plane passing through the axis of the trunnions;

when the object to be fired at is situated on a plane lower than this, an allowance must be made for this difference of level by deducting from the elevation laid down in the table of ranges.

The following table is calculated for cases in which the piece is *above* the object; it will also serve with sufficient degree of approximation for cases in which the piece is *below* the object, by simply reversing the method of application; *i. e.*, by adding, instead of subtracting, the quantity due to the height and distance.

| DISTANCE. | HEIGHT. | | | | | | | | | | | | | | | |
|-----------|---------|---|-------|---|-------|---|-------|---|--------|---|--------|---|--------|---|--------|------|
| | 1 Ft. | | 2 Ft. | | 4 Ft. | | 8 Ft. | | 16 Ft. | | 32 Ft. | | 64 Ft. | | 96 Ft. | |
| Yards. | ° | ' | ° | ' | ° | ' | ° | ' | ° | ' | ° | ' | ° | ' | ° | ' |
| 1000 | 1.1 | | 2.3 | | 4.6 | | 9.2 | | 18.3 | | 36.7 | 1 | 13.3 | | 1 | 50. |
| 1100 | 1. | | 2.1 | | 4.2 | | 8.3 | | 16.7 | | 33.3 | 1 | 6.7 | | 1 | 40. |
| 1200 | .9 | | 1.9 | | 3.8 | | 7.6 | | 15.3 | | 30.6 | 1 | 1.1 | | 1 | 31.7 |
| 1300 | .9 | | 1.8 | | 3.5 | | 7. | | 14.1 | | 28.2 | | 56.4 | | 1 | 24.6 |
| 1400 | .8 | | 1.6 | | 3.3 | | 6.5 | | 13.1 | | 26.2 | | 52.4 | | 1 | 18.6 |
| 1500 | .8 | | 1.5 | | 3. | | 6.1 | | 12.2 | | 24.4 | | 48.9 | | 1 | 13.3 |
| 1600 | .7 | | 1.4 | | 2.9 | | 5.7 | | 11.4 | | 22.9 | | 45.8 | | 1 | 8.7 |
| 1700 | .7 | | 1.3 | | 2.7 | | 5.4 | | 10.8 | | 21.6 | | 43.1 | | 1 | 4.7 |
| 1800 | .6 | | 1.3 | | 2.5 | | 5.1 | | 10.2 | | 20.4 | | 40.7 | | 1 | 1.1 |
| 1900 | .6 | | 1.2 | | 2.4 | | 4.8 | | 9.6 | | 19.3 | | 38.6 | | | 57.9 |
| 2000 | .6 | | 1.2 | | 2.3 | | 4.6 | | 9.2 | | 18.3 | | 36.7 | | | 55. |
| 2100 | .5 | | 1.1 | | 2.2 | | 4.3 | | 8.7 | | 17.5 | | 34.9 | | | 52.4 |
| 2200 | .5 | | 1. | | 2.1 | | 4.2 | | 8.4 | | 16.7 | | 33.3 | | | 50. |
| 2300 | .5 | | 1. | | 2. | | 4. | | 7.9 | | 15.9 | | 31.9 | | | 47.8 |
| 2400 | .5 | | 1. | | 1.9 | | 3.8 | | 7.6 | | 15.3 | | 30.6 | | | 45.8 |
| 2500 | .4 | | .9 | | 1.8 | | 3.6 | | 7.3 | | 14.7 | | 29.3 | | | 44. |
| 3000 | .4 | | .8 | | 1.5 | | 3. | | 6.1 | | 12.2 | | 24.4 | | | 36.7 |
| 3500 | .3 | | .7 | | 1.3 | | 2.6 | | 5.2 | | 10.4 | | 21. | | | 31.4 |
| 4000 | .3 | | .6 | | 1.1 | | 2.3 | | 4.6 | | 9.2 | | 18.3 | | | 27.5 |
| 4500 | .3 | | .5 | | 1. | | 2. | | 4.1 | | 8.1 | | 16.3 | | | 24.4 |
| 5000 | .2 | | .5 | | .9 | | 1.8 | | 3.7 | | 7.3 | | 14.7 | | | 22. |

When the height of the piece above the water or horizontal plane is known, the angle of depression for different distances can be found thus: Find the angle for any height not given in the table, as follows: divide the given height into parts, which are found in the table, using the largest numbers possible; and add the angles corresponding to those parts, for the required distance. Example: Required the angle for distance 1000 yards and height 130 feet. 130 feet gives the parts 96', 32', and 2'; the sum of the angles for these heights is $1^{\circ} 50' + 36.7' + 2.3' = 2^{\circ} 29'$; the amount to be deducted from the *elevation* as given in the table of ranges for the particular piece used.

211. Owing to the great range at which rifled guns are used, and of the accuracy of fire demanded of them, it is important that they should be provided with aiming apparatus more perfect than the coarse and clumsy sights heretofore supposed to be sufficient for artillery purposes.

The Lorain sight, (*Plate VI.*) of which the following is a brief description, combines the properties most desirable in a sight for heavy rifled guns.

This instrument is essentially a transit with a vertical and horizontal limb, the former to give the required elevation or depression, and the latter to give proper allowance for drift.

The telescope (A) has a top, a front and rear open sight (*a a'*), used to bring the object aimed at within the field of view.

The vertical limb (B) is graduated to degrees. The least count of the vernier (*b*) is six minutes.

The tangent screw (C) elevates or depresses the telescope.

The horizontal limb (D) has a scale of 20° on each side of the zero, which is graduated to degrees.

The standards (E E') are supported by the horizontal limb.

The tangent screw (F) moves the horizontal limb to right or left.

The base of the instrument (G) has on it the vernier (*g*) of horizontal limb, the least count of which is six minutes.

When in use, this instrument sits in a seat (H) which is screwed on to the right trunnion of the gun.

This seat is so placed that the plane of its top is parallel to the horizontal plane through the axis of the bore. When the vertical limb is at zero, the axis of the telescope will be parallel to the axis of the bore, if the zero of the horizontal limb coincides with the mark (I) on the seat.

This mark (I) is on a movable piece (K) attached to seat, and its position is easily determined.

The elevations given with this sight and with a quadrant do not agree, the latter being measured from the horizontal and the former from the line from sight to object. In firing from above an object, the telescopic sight requires more elevation than the quadrant. If from below an object, it requires less elevation than the quadrant.

When the piece is to be fired, the instrument is lifted out of its seat. One instrument suffices for three or four guns, it being carried from piece to piece as they are prepared for firing. For short range and rapid firing, the pieces should, in addition, have the ordinary sighting arrangements.

Note.—The proper place for the sight is on the left trunnion; but as, with carriages now constructed, it would be interfered with by the crane, it is placed on the right trunnion.

Aiming mortars.

212. Mortars, like other cannon, are aimed by first giving the direction and then the elevation.

The elevation, which is usually that of the greatest range of projectiles in *vacuo*, viz., 45° , is determined by applying the quadrant to the face of the piece, and raising or lowering the breech until that number of degrees is indicated.

The charge of powder is varied to suit the required range.

To give the shell, for the same range, a greater velocity in the descending branch of its trajectory, the mortar is sometimes fired at an angle of 60° , in which case the charge of powder must be increased accordingly.

As mortars are usually masked from the object to be bombarded by an epaulment or parapet, different means from those used with guns become necessary for giving them their direction.

There are several processes employed, all of which, however, are reduced to determining practically two fixed points which shall be in line with the piece and the object, and sufficiently near to be readily distinguished by the person pointing the mortar. These points determine a vertical plane which, when including the line of metal, becomes the plane of fire.

The various methods are explained in *pars.* 342 and 343.

213. The following is a description of Dyer's pointing apparatus, and instructions for its use.

This method is easy of application, and is especially adapted for use with mortars mounted on centre-pintle carriages; it is also readily adapted for use with mortars mounted on ordinary and temporary platforms. Practically it is independent of the distance from the crest of the parapet to the platform. The method is as follows :

Find the point where the vertical plane containing the directrix of the platform cuts the interior crest of the parapet. At this point establish a level plate containing an arc graduated both ways from the point where the vertical plane cuts it, the centre being the point first established on the interior crest. An arm with two vertical sights revolves about this point as a centre, and determines, by means of an indicator attached to the front of the arm, the angle made by any object with the vertical plane through the centre, called the plane of the zeros. The mortar being given the same angle with the plane of the zeros, the plane of fire will practically intersect the object.

To apply this method to a mortar mounted on a centre-pintle carriage: On the rear of the platform, with the centre of the pintle as a centre, describe an arc. Find the point where the

plane of the zeros cuts this arc, and mark the point *zero*. Divide the arc both ways from the point into degrees and parts of degrees. An indicator attached to the centre of the rear transom (in the vertical plane containing the axis of the piece) will always mark the degrees to the right or left of the plane of the zeros.

(Plate VII.)

Description of the pointing instrument.

A horizontal iron plate is permanently established on the parapet, the rear edge being on the crest and the centre in the plane of the zeros.

In order that the same instrument may be used at different places in a work, or be removed when not in use, a detachable plate containing the graduation and sights is adjusted to the permanent plate, as shown in *Fig. 1*. P is a pintle on the detached plate which fits into a socket in the permanent one. LL are levels on the detached plate $\frac{1}{8}$ inch below the upper surface of the plate. SS are leveling screws. By the use of this plate the index arm will always be made to move in a horizontal plane.

Application of the method.

1st. Place the plate containing the graduated arc on its bed, and level it by means of the tangent screws; then place the arm, to which the sights are attached, on the plate. Traverse the chassis until the index on the rear transom indicates the required number of degrees as indicated by the instrument.

If the arm of the instrument be to the right of the zero, traverse the chassis to the left; and *vice versa*.

For the successful operation of this method with the centre-pintle mortar carriage, it is essential that the guides of the top-carriage should fit true and snug to the chassis rails.

RICOCHET FIRING.

214. The angle of fall of projectiles in *vacuo* is equal to the angle of elevation; but in air the angle of fall is somewhat greater.

It is known from experience that a projectile falling upon ground of ordinary firmness, at an angle not greater than ten degrees, or upon water at four or five degrees, will generally make one or more bounds. In this case the projectile is said to *ricochet*.

The purpose to be sought in ricochet firing is to cause the projectile to bound along near the surface of the ground or water,

and thus increase the chances of hitting the object to be destroyed. It is chiefly advantageous against troops in the field, and against boats and unarmored vessels. With the exception, however, of occasional use against the latter objects, it is generally but incidental to direct firing. Owing to the inequalities of ground, it is uncertain of effect when employed against objects on land.

Spherical projectiles are more certain of ricochet than those of elongated form; with the latter the first graze usually causes them to *tumble*, after which their motion is both feeble and erratic.

The pieces principally employed for ricochet firing are the 8-inch howitzer and the 8 and 10 inch siege mortars. The first two may be used when the angle of fall is less than ten degrees, and the latter when the angle of fall is less than fifteen degrees. With the howitzer, a range of 2000 yards may be obtained; with the mortars, the limit of ricochet is about 1000 yards.

With the 15-inch gun, the most effective ricochet upon smooth water is obtained from two degrees elevation; this, with the piece fifteen feet above the water, will cause the first graze to take place at a distance of about 1500 yards, giving a rebound of about 800 yards in length and 100 feet in height. The next rebound will be about 500 yards in length, after which they rapidly diminish until towards the last, when the projectile appears to almost roll upon the surface of the water. The extreme range at this elevation is about 4000 yards, and the number of distinct ricochets about thirty-five.

The slightest roughness of the water has a decided effect upon ricochet, diminishing both accuracy and range.

With elongated projectiles, after the first strike, the course is quite erratic, and they are, therefore, entirely unsuited for accurate ricochet firing.

CARRIAGES.

215. Carriages for artillery are classified as traveling and stationary. The former are for artillery that is to be moved from place to place; the latter, for that occupying fixed positions.

Strength, durability, and facility in serving the pieces are the chief requisites for all carriages.

Stationary carriages consist of two parts: the carriage—or, as it is usually called, the top-carriage—and the chassis, and, with the exception of that for the flank-casemate howitzer, are all constructed of wrought-iron.

216. The top-carriage (*Fig. 1, Plate VIII*) is composed of two

cheeks, held together by two plates of boiler iron, called the front and rear transoms. Each cheek is formed of two plates of boiler iron cut to a triangular shape, separated by interposing at the edges the vertical portion of a T-shaped bar. The horizontal branches project over each side to form a double flange, giving stiffness to the cheeks. Flat bars of iron are placed between the plates at suitable intervals to stiffen the cheeks in the direction in which the weight and recoil of the piece bear upon them. All these parts are held together by screw bolts.

The piece rests between the cheeks, and is supported on them by the trunnions, which work in circular cavities called *trunnion-beds*. This permits the piece to have free play for purposes of elevation and depression.

For most pieces, the motion of the top-carriage to and from battery is regulated by a pair of truck-wheels, one on each side, which work on an eccentric axle placed underneath and a little in front of the axis of the trunnions.

The wheels are thrown *into gear* by means of handspikes inserted into sockets upon the ends of the eccentric axle; the wheels then rest upon the top of the chassis rails, and only the rear part of the soles of the top-carriage rest on the chassis rails and have sliding friction. The wheels are thrown *out of gear* in the same manner; the entire soles then have sliding friction upon the chassis rails, thus checking recoil.

In the 15-inch gun carriage there are two pairs of truck-wheels, one pair being placed in front, as just described, and the other pair near the rear end of the carriage; the rear wheels only are on eccentric axles, and when these are *out of gear* the soles of the top-carriage rest fairly on the chassis rails, and the motion is on sliding friction. When the rear wheels are *in gear* the front wheels also touch the chassis rails, and the top-carriage moves on rolling friction. To prevent the rear wheels from working *out of gear* while the gun is being run from battery, or jumping *in gear* when the piece is fired, pawls are provided for locking the rear axle.

When the rear wheels are *in gear*, motion is communicated to the carriage by means of a handspike on each end of the front axle. This handspike carries a double pawl, which works in ratchets or cogs on the truck-wheels. The handspike is arranged with a counterpoise, consisting of a heavy piece of iron on the short arm of the lever.

In the 10 and 15 inch guns, as also in mortars, the elevation and depression are given by means of a lever, called the *elevation-bar*. The point of this bar works in ratchets cut in the breech of the piece. The fulcrum—usually called the *ratchet-*

post—rests on the rear transom of the gun carriage. It is of cast-iron, and has several notches for adjusting the position of the elevating-bar.

Carriages for the 8-inch rifle (converted) have an improved elevating apparatus. This is described in *par.* 320.

Guns of the Parrott pattern have an elevating screw. This is attached to the rear transom of the carriage at its lower end, while the nut is connected to the cascable of the gun. The screw is worked by a handle passing through it above the nut. Both screw and nut admit of movements by which the screw can take any position required in the various degrees of elevation.

217. Chassis. The chassis is the movable railway on which the top-carriage moves to and from battery. It is composed of two wrought-iron rails inclined three degrees to the horizon, and united by transoms, as in the top-carriage. In addition to the transoms, there are several diagonal braces, to give stiffness to the chassis. (*Fig. 1, Plate VIII.*)

For the 10-inch gun and all smaller carriages, the chassis rails are single beams of rolled iron, 15 inches deep; for all calibres above, the rails are *built up* of long rectangular pieces of boiler plate and T-iron, in a manner similar to that of the cheeks of the top-carriage.

Traverse-wheels. The chassis is supported by wheels, which allow of its having a horizontal motion, for the purpose of giving the piece a proper direction when aiming.

Traverse circles. The traverse-wheels roll on circular bars of iron resting on a bed of masonry or wood.

Pintle. This is an upright journal, around which the chassis traverses. It is a stout cylinder of wrought-iron, inserted in and firmly fastened to a block of stone called the *pintle block*. When wooden platforms are used it is fastened as described in *par.* 635.

The *centre-pintle carriage* is one in which the chassis is attached to the pintle at its middle, and revolves around it through the entire circumference of the circle. The traverse circles are consequently continuous. By this arrangement a much greater horizontal field of fire is secured.

The *front-pintle carriage* is one in which the chassis is attached to the pintle by its front transom; the traverse circles are segments of circles.

The *pintle key* is a stout key of iron passing through the pintle, to prevent the chassis from jumping off when the piece is discharged. The pintle is surrounded by a plate firmly bolted to the block; this plate is called the *pintle plate*, or *friction plate*.

Hurters and counter-hurters. These are flat pieces of iron bolted,—the first to the front and the latter to the rear part of the chassis rails, to check the motion of the top-carriage when the piece is run *in battery*, and when it recoils upon being fired.

In carriages of improved model the hurters and counter-hurters are stout buffers of gutta-percha, which, absorbing the shock, prevent racking of the carriage.

Guides are stout claws of iron bolted to the cheeks of the top-carriage, and, catching under the flanges of the chassis rails, prevent the carriage from slipping or jumping off.

Through the chassis, immediately over the pintle, runs an eccentric axle, carrying upon each end a truck-wheel. This axle and wheels are for the purpose of throwing the chassis *in gear*, thus raising the pintle transom from the friction plate and allowing the carriage to be traversed with freedom.

It is prescribed that the chassis shall be *out of gear* when the piece is fired. This, however, is not necessary, and the omission of it when firing saves much time and labor. The lighter class of carriages are without the arrangement just described.

In the improved pattern of carriages the axle and truck-wheels above mentioned are replaced by two stout rollers attached to bolsters on the front end of the chassis. These rollers move upon the friction plate, and give firm support and easy motion to the chassis.

Casemate carriages differ from barbette carriages in being much lower, but their mode of construction is essentially the same. The pintle is placed immediately under the throat of the embrasure, and the chassis is connected to it by a bar of iron called the *tongue*.

Recoil checks. For the 10-inch smooth-bore and all below that calibre, recoil is checked simply by the inclination of the chassis rails and the sliding friction thereon of the top-carriage. To increase this friction, the rails should be sanded with sand free from pebbles.

218. *Pneumatic buffers or air-cylinders* are devices for checking recoil through the agency of atmospheric air. At present, only the 15-inch gun is thus provided.

Between the front ends of the chassis rails are attached two cast-iron cylinders each 110 inches long, with an interior diameter of 14.25 inches. The ends of the cylinders are closed with tight-fitting heads secured with screw bolts. A piston works in each cylinder. The rods of the pistons pass out through the rear cylinder heads and are attached, by nuts, to a heavy transom on the rear end of the top-carriage. The cylinders have the same

inclination as the chassis rails, and are secured to the latter by three cylinder transoms.

When the piece recoils the piston-rod is withdrawn, and the air contained in the cylinder compressed between the piston and the rear head of the cylinder. A small hole in the front head admits air to supply the vacuum in front of the piston.

The air in rear of the piston thus forms an elastic cushion, offering but slight resistance to the first movement of recoil, but gradually increasing in resisting force as the carriage moves back, until finally the force of recoil is overcome and the top-carriage is brought to a state of rest. The shock of recoil is to a great extent absorbed without sudden strain to the carriage.

The top-carriage must be *out of gear* when the piece is discharged; it then moves on the chassis with sliding friction. This, together with the inclination of the chassis rails, assists in checking the recoil. When the carriage is in good running order, it generally runs forward a short distance by the reaction of the compressed air after recoil.

To run the piece *in battery*, the top-carriage is thrown *into gear*; it then moves forward, the air is compressed in front of the pistons, and, escaping gradually through the small holes in the heads of the cylinders, allows the carriage to move forward with a gentle motion.

The weight of the air-cylinders with attachments is about 5000 pounds.

219. *Hydraulic buffer.* This is a recoil check, in construction very similar to the air-cylinder. A liquid is used instead of air, but the principles of operation are similar.

At present these buffers are furnished only with the (converted) 8-inch rifle, and are described in connection therewith. (See *par.* 320.) Water or any other free-flowing liquid answers for filling the cylinder. In cold weather a non-freezing liquid, as a mixture of glycerine and water, methyl and water, or some of the non-freezing oils, must be used. The greatest care must be observed to have in the cylinder the exact amount required. The difficulty of properly regulating all of these matters makes the hydraulic buffer greatly inferior to the air-cylinders.

220. *Friction bars.* This device for absorbing recoil is supplied only with the experimental 8-inch rifle (converted). It is described in *par.* 320.

221. *Depressing carriages.* These are carriages that permit the gun to fire over a parapet in the usual manner, and, upon recoil, allow the piece to descend behind the parapet, where it can be reloaded in safety.

Various plans for effecting this have been proposed, but none actually adopted, in the U. S. service. The King carriage, mounting a 15-inch gun, has, however, been tested and found to work efficiently. This consists in lowering the rear end of the chassis until it nearly touches the ground, thus forming an inclined plane at an angle of about 30° to the horizon. The top-carriage is attached to a counterpoise by a band composed of wire ropes. This counterpoise is a heavy mass of metal descending into a well in front of the pintle.

The carriage that has been adopted, and hereafter to be furnished for barbette service, has an increase of 15 inches in height over those of old pattern. This modification is effected by inserting sections, similar in construction to the chassis rail, between the rails and feet, props, and fork of the low chassis. The increase of height thus gained admits of a corresponding depression of the terre-plein, and consequently greater protection behind the parapet for the cannoneers. The gun, nevertheless, is exposed as before. Depressing carriages are intended to protect the piece and carriage as well as the cannoneers.

The accuracy of modern artillery fire increases the danger to the guns with which a work is armed; and the disabling of a piece by the enemy's fire is of greater moment now than formerly, when works were garnished with a greater number, and of such small size as to be readily replaced when injured.

222. *Mortar carriages.* These are constructed and put together in a manner similar to the top-carriages for guns. At the ends of each cheek are projections, called front and rear notches, underneath which the cannoneers embar with their handspikes to move the carriage. On those for siege mortars there are also two front and two rear manœuvring bolts for the same purpose. The bottom part of each cheek, resting on the platform, is called the shoe; the front and rear ends being designated the toe and heel, respectively.

Carriages for siege mortars are without truck-wheels, and rest directly on the platform. Sea-coast mortars have two truck-wheels on an eccentric axle, for manœuvring the carriage on the platform, and manœuvring bolts are omitted. (*Figs. 1, 2, 3, 4, Plate IX.*)

The *centre-pintle mortar carriage* is described in *par.* 370.

223. The *flank-casemate carriage* (*Fig. 2, Plate VIII*) consists of two cheeks of wood united by two iron transoms. The chassis consist of two wooden rails three inches apart, and joined by four transoms and assembling bolts.

To the rear end of the top-carriage is attached an eccentric

roller, and to each cheek, in front, a roller which, when the eccentric roller is *in gear*, rests on the chassis rails, giving to the carriage rolling friction. The piece is then easily run in and out of battery, the cannoneers applying themselves to rings and handles on the sides of the cheeks.

The front end of the chassis rests on the sole of the embrasure, and is provided with a lunette, through which a pintle drops into the masonry beneath. The rear of the chassis is supported by an iron fork, to the lower extremity of each prong of which is attached a small traverse-wheel.

For description of traveling gun carriages, see Siege Gun, *par.* 231, *et seq.*

PLATFORMS.

224. To insure accuracy of fire with heavy guns and mortars, it is absolutely necessary to have solid and substantial platforms.

For casemate and barbette batteries in fortifications, fixed platforms are constructed with the works.

The barbette platform consists essentially of the pintle block, which is of granite firmly imbedded in concrete; in the block is inserted the pintle, of iron, and around this is the friction plate for the pintle transom of the chassis to rest upon. Traverse circles, of iron, form level and smooth tracks, upon which the traverse-wheels run.

The pintle of a casemate carriage is inserted in a hole in the sole of the embrasure, and is lifted out when the chassis is to be removed. The chassis is attached to it by a tongue, and is provided with a front set of traverse-wheels.

Platforms for siege pieces are supplied by the Ordnance Department, and, as they accompany troops in the field, it is desirable to have them as light as is compatible with sufficient strength to endure the shock of firing. Those hereafter described combine, in a high degree, the essential qualities of strength and portability. All the pieces composing them are of the same dimensions, and, as the weight of each piece is only fifty pounds, a soldier can carry one from the depot to the batteries, or any moderate distance, in addition to his arms and equipments.

Another platform for mortars is described, which is very simple, strong, and well suited to positions where trees or timber can be easily procured. This is designated the *rail platform*.

PLATFORM FOR A SIEGE GUN OR HOWITZER.

(Fig. 1, Plate X.)

225. Dimensions, &c., of siege platforms.*Guns and howitzers.*

| NAMES OF PIECES. | No. of pieces. | Length. | Width. | Thickness. | Weight. | KIND OF TIMBER USED. |
|------------------------|----------------|---------|--------|------------|---------|----------------------|
| | | Inch. | Inch. | Inch. | Lbs. | |
| Hurter..... | 1 | 108 | 5 | 3.5 | 51 | } Yellow pine. |
| Sleepers..... | 12 | 108 | 5 | 3.5 | 612 | |
| Deck-planks..... | 36 | 108 | 5 | 3.5 | 1836 | |
| Stakes (securing).... | 6 | 48 | 3.5 | 2 | 70 | |
| Stakes (implement).. | 4 | 32 | 2 | 1 | 10 | |
| Stakes (pointing)..... | 4 | 14 | 0.75 | r'nd | | |
| Eye-bolts (iron)..... | 4 | 14 | 0.75 | r'nd | | |
| Total weight..... | | | | | 2579 | |

When the piece is to be fired constantly in one direction, it is best to give the platform an inclination to the rear. This prevents excessive recoil, and also serves to carry off water from rain. The degree of inclination is not absolute. In the following it is given as one and a half inches to the yard.

When the piece is to be traversed over a wide field of fire, the platform should be perfectly level; the recoil is then checked by placing a bag of earth or a pile of sods at a proper distance (about five feet) behind each wheel.

The following is the method of laying the platform when it has an inclination. To lay it horizontally, simply omit what is said with reference to the slope:

The direction in which the piece is to fire is established by stretching a cord over the centre of the place where the platform is to be laid. This line is the directrix of the platform.

Prepare a bed for the platform by excavating the earth so that it will have the proper inclination to the rear and be perfectly level across. The earth, if not already firm, should be well rammed.

Lay the outside sleepers parallel to the directrix, their outside edges being fifty-four inches distant from it. The four other sleepers are laid parallel to these, the edge of each fifteen and a

half inches from the edge of the next. The upper surface of the front ends of these sleepers is fifty inches below the sole of the embrasure, and they are laid with an elevation to the rear of one and a half inches to the yard, or four and a half inches in their whole length. This elevation is determined by placing a block four and a half inches high on the front end of the sleeper, and laying a straight-edge, with a level on it, from this block to the rear end; the earth is then arranged so as to bring the level true in this position.

The next set of sleepers are laid against and inside of the first, overlapping them three feet, having the rear ends inclined outwards, so that the outer edges of the exterior ones shall each be fifty-four inches from the directrix, and the space between the rear edges of the others the same as in the first set, viz., fifteen and a half inches from the edge of one to the edge of the next: all having an elevation to the rear of one and a half inches to the yard, and perfectly level across. The earth is then rammed firmly around the sleepers and made even with their upper surface. The first deck-plank, with a hole through each end for the eye-bolts, is laid in place, perpendicular to the directrix, its holes corresponding with those in the sleepers. The hurter is placed on it, and the bolts driven through the corresponding holes in these pieces. The hurter should be so placed as to prevent the wheels from striking against the epaulment when the piece is in battery.

If the interior slope has a base of two-sevenths of its height, the inner edge of the hurter should be two and a half inches from the foot of the slope. The other planks are laid, each being forced against the preceding, with the dowels fitting into their respective holes; the last plank has holes for the eye-bolts. By drawing out or driving in the outside sleepers, the holes through their rear ends are made to correspond with those in the last deck-plank. The bolts are then driven.

Drive stakes in rear of each sleeper, leaving their tops level with the upper surface of the platform. Raise, ram, and level the earth in rear of the platform, so as to have a plain hard surface to support the trail when the recoil is great.

The earth should be raised nearly as high as the platform at the sides, and well rammed, giving it a slight inclination outward to allow water to run off. The platform is fifteen feet long and nine feet wide.

Instead of twelve sleepers, each nine feet long, it is preferable to use six, each fifteen feet long.

FIELD PLATFORM.

226.

Dimensions, &c.

| NAMES OF PIECES. | No. of pieces. | Length. | Width. | Thickness. | Weight. | KIND OF TIMBER USED. |
|---------------------|-------------------|---------|--------|------------|---------|--------------------------|
| | | Inch. | Inch. | Inch. | Lbs. | |
| Hurter..... | 1 | 96 | 5 | 3.5 | 44 | Yellow pine. |
| Sleepers..... | 4 | 103 | 5 | 3.5 | 204 | Yellow pine. |
| Wheel-planks.... | 2 | 120 | 13 | 2.25 | 160 | Beech, yel. pine or oak. |
| Trail-plank..... | 1 | 84 | 13 | 2.25 | 60 | Beech, yel. pine or oak. |
| Eye-bolts..... | 9 | 14 | 0.75 | r'nd | | Iron. |
| Securing stakes. | 8 | 48 | 1.25 | 1.25 | 32 | Hickory or oak. |
| Total weight... | | | | | 500 | |

(Fig. 2, Plate X.)

This platform is for siege guns and howitzers when serving with an army in the field, and the method of constructing it indicates the way in which platforms may be extemporized from such material as may be at hand.

To lay this platform, level off the ground and mark the directrix; dig trenches for the sleepers; place the latter in the trenches so that the holes for the eye-bolts will correspond in place to those in the wheel-planks; place the wheel-planks in position, and drive in the eye-bolts. The front eye-bolts pass through and secure the hurter; apply the level and make the structure perfectly level; secure the front sleeper with stakes; it is well to secure also the rear ends of the wheel-planks with stakes; lay on the trail-plank and secure it with an eye-bolt to the third sleeper; ram the dirt well in around the sleepers.

To check recoil, place sacks of earth or piles of sods over the eye-bolts of the third sleeper, or a stick of timber, similar to a sleeper, laid across will effect the same object.

This platform admits a change of direction of about ten degrees on each side of the directrix, thus covering as much of a field of fire as is ordinarily required. To make this change of direction, slightly loosen or remove the earth about the three rear sleepers, and heave the rear ends of the wheel-planks over with handspikes. The platform then has the position indicated by the dotted lines in the figure.

227.

SIEGE MORTAR PLATFORM.

| NAMES OF PIECES. | No. of pieces. | Length. | Width. | Thickness. | Weight. | KIND OF TIMBER USED. |
|-----------------------|----------------|---------|--------|------------|---------|----------------------|
| | | Inch. | Inch. | Inch. | Lbs. | |
| Sleepers..... | 6 | 105 | 5 | 3.5 | 252 | } Yellow pine. |
| Deck-planks..... | 21 | 108 | 5 | 3.5 | 1070 | |
| Stakes (securing).... | 6 | 48 | 3.5 | 2 | 70 | |
| Stakes (pointing).... | 4 | 48 | 1 | 1 | | |
| Eye-bolts (iron)..... | 12 | 11 | .75 | r'nd | | |

(Fig. 3, Plate X.)

This platform is composed of six sleepers and twenty-one deck-planks. It is laid level, and the front and rear deck-planks are connected by eye-bolts to each sleeper. A bed for the platform is first prepared by leveling off the ground, and, if not already solid, the earth should be well rammed. This bed should be sunk only so deep as to allow the upper surface of the platform to be slightly above the surrounding ground, for drainage. The sleepers are laid parallel to the directrix or plane of fire, three on each side of it, at equal distances apart, so that the holes in their ends shall correspond to the holes in the front and rear deck-planks. The front deck-plank is laid first, and the eye-bolts driven to secure it; the remaining planks are driven up against it, and the last secured, like the first, with eye-bolts. At the rear end of each sleeper a securing stake is driven.

The earth, on all sides, should be raised nearly as high as the platform, and well rammed, giving it a slight inclination outwards, to allow the water to run off.

It is of the first importance that the upper surface of the platform should be level and true.

RAIL PLATFORM FOR SIEGE MORTARS.

(Fig. 4, Plate X.)

228. Dimensions, &c., of the rail platform.

| NAMES OF PIECES. | SIEGE MORTARS. | | | | | KIND OF TIMBER USED. |
|-----------------------|----------------|---------|--------|------------|---------|----------------------|
| | No. of pieces. | Length. | Width. | Thickness. | Weight. | |
| | | Inch. | Inch. | Inch. | Lbs. | |
| Sleepers..... | 2 | 60 | 11.5 | 8.5 | | } Yellow pine. |
| Rails..... | 2 | 108 | 10 | 10 | | |
| Stakes (securing).... | 14 | 48 | 3.5 | 3 | | |
| Platform complete.. | | | | | 825 | |

This platform consists of three sleepers and two rails for the shoes of the mortar to rest on. It is very strong, and easily constructed and laid.

The rails and sleepers are notched and fitted together as represented in the figure. The distance between the centre lines of the rails is equal to that between the centre lines of the cheeks of the mortar carriage. The pieces are put together at the battery, and the earth is excavated eight inches in depth, and of suitable length and width to receive the platform. The bottom of this excavation is made perfectly level. The directrix being accurately marked by stakes, the platform is placed in position, its centre line coinciding with a cord stretched between the stakes marking the directrix. The earth is filled in as high as the upper surface of the sleepers and firmly rammed; stakes are driven in the rear angles formed by the sleepers and the rails, and one at the rear end of each rail.

PLATFORMS FOR SEA-COAST MORTARS.

13-inch mortars.

229. The size of the platform is 15 feet by 15 feet by 2 feet. 2 inches.

Dimensions of parts.

| NAMES OF PIECES. | No. of pieces. | Length. | Width. | Thickness. | REMARKS. |
|-------------------|----------------|------------|----------|------------|--|
| | | Inch. | Inch. | Inch. | |
| Deck-timbers..... | 15 | 180 | 12 | 12 | The timber for these platforms to be of oak, or heart yellow pine. |
| Sleepers..... | 15 | 180 | 12 | 12 | |
| Bolts..... | 56 | 24 | 1 | r'nd | |
| Nuts..... | 56 | 1 | 2 | 2 | |
| Wood screws..... | 501 | 3 | 5.16 | r'nd | |
| Iron plates..... | 2 or 3 | 180 180 | 54 36 | 0.5 0.5 | |
| Planking..... | 15 | 180 | 12 | 2 | |

Note.—The above is the thickness of the iron plates furnished ; but they are entirely too thin, curling up with the weight of the mortar. They should be at least 0.75 inch thick.

To lay the platform, a pit is dug 2 feet deep and about 18 feet square on the bottom. The earth on the bottom is well rammed and levelled. The two-inch planking is laid level on the rammed earth, perpendicular to the directrix. The cylindrical bolts are put in the sleepers, and the sleepers, with bolt-heads down, are laid compactly on, and perpendicular to the planking and parallel to the directrix. As the deck-timbers are laid the bolts pass through the holes in them. These timbers are laid compactly upon the sleepers, perpendicular to the directrix. The nuts are put on the bolts and screwed down. Both the nut and bolt-heads are countersunk. The iron plates are laid parallel to the directrix, and secured firmly with screws to the deck-timbers, covering nine feet in the centre of the platform and leaving three feet on each side uncovered. The earth is then filled in, and rammed compactly around the platform, with a slight inclination outwards, so as to shed water. The platform for the centre-pintle chassis is 17 feet square ; the bottom of the pit must therefore be 20 feet square.

10-inch sea-coast mortar.

The size of this platform is 12 feet by 12 feet by 1 foot 8 inches.

Dimensions of parts.

| NAMES OF PIECES. | No. of pieces. | Length. | Width. | Thickness. | REMARKS. |
|-------------------|----------------|---------|--------|------------|--|
| | | Inch. | Inch. | Inch. | |
| Deck-timbers..... | 12 | 144 | 12 | 9 | The timber for these platforms to be of oak, or heart yellow pine. |
| Sleepers..... | 12 | 144 | 12 | 9 | |
| Bolts..... | 44 | 18 | 1 | r'nd | |
| Nuts..... | 44 | 1 | 2 | 2 | |
| Wood screws..... | 204 | 3 | 5.16 | r'nd | |
| Iron plates..... | 2 | 144 | 48 | 0.5 | |
| Planking..... | 12 | 144 | 12 | 2 | |

To lay the platform, a pit is dug 1 foot 6 inches deep by 15 feet square; the remainder of the operation is similar to that for the 13-inch mortar.

For descriptions of wooden platforms for *sea-coast guns*, see *par.* 635.

Part Second.

SERVICE OF THE PIECE.

The service of the piece consists of all the operations required in loading, pointing, and discharging it.

General Rules.

230. To avoid repetitions, and to secure easy reference, the following general rules are inserted collectively. The paragraphs referred to belong to some particular piece—generally the siege gun—and illustrate the application of the rule.

I. The implements and equipments required for a piece are taken to it by the detachment when going to the exercises, or they may be placed there previous to that time.

They are removed, at the conclusion of the exercises, by the same means, and returned to their proper places in the storehouse.

It is the especial duty of the chief-of-detachment to see that all that appertains to his piece is complete and in good order.

II. At the conclusion of the exercises, and previous to leaving a battery, the officer in charge will *dress* it, giving the pieces, on the same line, a uniform alignment, direction, and depression. *Pieces must never be left loaded.*

III. The detachments are marched to the battery, and the cannoneers posted at their pieces as prescribed in *par.* 106.

IV. When the equipments are distributed, the gunner buckles the strap of his pouch around his waist, wearing the pouch in such position as to interfere as little as possible with his movements.

The cannoneer who wears it, buckles on the primer-pouch in like manner.

The gunner removes the vent-cover, and clears the vent with the priming-wire.

Cartridge-pouches are carried suspended from the left shoulder to the right side. (*Par.* 256.)

V. In loading, the gunner closes the vent by applying the second finger of the left hand tightly upon it, and holding it there from the moment the sponge is introduced in the muzzle until the rammer is withdrawn after the projectile is home. (*Par.* 238.)

VI. When, in loading, the sponge or the rammer is found to

be home at the *fourth* motion, then what is prescribed for the *sixth* will be executed at the *fourth*. (*Par.* 239.)

VII. In sponging or in ramming, the knee on the side toward which the effort is made is always bent, the other straightened. The weight of the body is added, as much as possible, to the effort exerted by the arms. (*Par.* 239.)

VIII. When the sponge fits so tightly as to be difficult to move in the bore, Nos. 1 and 2 may use both hands in inserting and withdrawing it. (*Par.* 240.)

IX. Cartridges are inserted into the bore, bottom foremost and seams to the sides. (*Par.* 240.)

X. All projectiles having fuses are inserted in the bore so that the fuse shall be towards the muzzle. (*Par.* 241.)

XI. A primer is prepared for insertion in the vent by holding it between the thumb and forefinger of the left hand; the lanyard, wound upon its handle, is held in the right hand, the hook by the thumb and forefinger; the hook is attached by passing it upward through the eye of the primer; the hook and primer, thus attached, are held by the thumb and forefinger of the right hand; the primer is pushed into the vent by the thumb.

After the primer has been inserted in the vent, the cannoneer who fires the piece drops the handle, allowing the lanyard to uncoil as he steps back to the position from which he is to fire; holds the handle, with the cord slightly stretched, passing between the middle fingers of his right hand, back up, and breaks to his left and rear a full pace with the left foot, the left hand hanging naturally by his side. (*Par.* 243.)

XII. In aiming guns and howitzers, the gunner places the breech sight in its seat or socket, and aims through it; gives the proper direction by causing the trail to be moved, commanding *left* or *right*, tapping, at the same time, on the right side of the breech for the trail to be moved to the left, and on the left side for it to be moved to the right. The cannoneers at the trail will closely observe the motions of the gunner. (*Par.* 243.)

With mortars, the gunner signals, with his hands, the direction in which he wishes the carriage moved. (*Par.* 347.)

When the piece is pointed, the gunner raises both hands as a signal; the cannoneers moving the piece then unbar and resume their posts.

XIII. At the command *fire*, the cannoneer who discharges the piece turns his face from it, pulls the lanyard quickly, but steadily, and fires. Immediately after the discharge he resumes the erect position, rewinds the lanyard upon its handle, returns it to his pouch, and resumes his post. (*Par.* 244.)

XIV. The gunner, after pointing, goes where he can best observe the effect of the shot; after which he resumes his post. (*Par.* 243.)

XV. Ammunition is not used when exercising *by the numbers*. (*Par.* 244.)

XVI. At the command *cease firing*, pieces that are loaded remain so until further orders; those that are partly loaded—if with the cartridge only—the cartridge is rammed home; if the projectile has been inserted, it likewise is rammed home. In both cases the priming-wire is left in the vent, as an indication that the piece is loaded.

If the piece is not loaded, it is sponged out. All the cannoners resume their posts. (*Par.* 247.)

XVII. When ammunition is used, the instructor, before giving the command *load*, will specify: *with blank cartridges—with solid shot—with shell—with case-shot*. (*Par.* 248.)

XVIII. To *secure piece*, the gunner puts on the vent-cover, and No. 2 replaces the tompon in the muzzle. (*Par.* 249.)

XIX. Sponge and rammer staves are permanently marked with a white ring, to show—with the sponge, when it is at the bottom of the bore; with the rammer, when the projectile is home. (*Par.* 253.)

XX. Rifle projectiles are always to be lubricated previous to loading. They are then easily pushed home, and their range and accuracy are increased. (*Par.* 254.)

XXI. After each twentieth discharge (or thereabouts) with a rifled piece, the bore is washed out and sponged dry.

XXII. When an implement is taken up for any purpose it is returned to its prescribed place by the person using it, at the completion of the duty, unless otherwise specified.

XXIII. Cannoneers and the gunner resume their proper posts after the completion of any duty, unless otherwise especially directed.

XXIV. With all pieces having traversing carriages, pinch-bars are used for making delicate adjustments in pointing, and iron wheel-chocks for holding the traverse-wheels securely in position. (*Par.* 340.)

XXV. Gunners, chiefs-of-detachment, and chiefs-of-platoon, give or repeat commands only when it is so prescribed.

XXVI. The habitual post of the chief-of-detachment is as specified in *par.* 106. He has, under the instructor, or officer immediately over him, general supervision of all duties performed by his detachment. During firings he looks after the supply of ammunition, and sees that those engaged in preparing and serving it to the piece perform their duties properly.

XXVII. All ammunition must be prepared for firing at the service magazine. Projectiles will be carefully cleaned of all rust, dirt, or protuberances liable to cause them to stick, or injure the bore.

XXVIII. In the service of a battery of several pieces, the pieces are designated Nos. 1, 2, 3, &c., from right to left; these numbers are independent of the *permanent* numbers assigned to pieces in a work.

In directing the pieces to be fired, they are always designated by their *battery* numbers; as, *Number one—FIRE; Number two—FIRE, &c.*

When the wind comes from the right, the firing should commence on the left, and reciprocally.

XXIX. Under the fire of the enemy, the men will be directed to cover themselves by the parapet or traverses as much as may be consistent with the execution of their duties.

XXX. Previous to proceeding with any exercise with the pieces, and frequently at other times during the exercises, the instructor, assisted by the other officers, will explain to the men the nomenclature of everything appertaining thereto; the application and use of the various parts, machines, and implements used; the names and use of the different parts of the work adjacent to the piece; the kinds of ammunition used; charges of powder; kinds of fire; and, generally, all matters that assist in making the men efficient artillerists.

XXXI. In time of actual service, in front of an enemy, two or more detachments, for each piece, are necessary, and all should be instructed. These detachments will be designated *First relief, Second relief, &c.*; and in all battery formations, as roll-calls, parades, &c., will fall in together in the order of their numbers from right to left.

XXXII. In aiming, first get a clear view of the object, and see that the piece is approximately in the line of fire before looking through the sights; then look over or through the sights, and if the object be not in the line, instantly give the command to move the trail to the right or left.

Always aim quickly, as the eye will not then become wearied.

XXXIII. The prop upon which the sponge and rammer are supported is a low trestle, or simply a block of wood sufficiently high to prevent the sponge taking up dirt from the ground. The rammer is always laid on the side nearest the piece. (*Par. 233.*)

XXXIV. To prevent the projectile from starting forward, guns should be given at least five degrees elevation previous to being run into battery, and running into battery should be done so as to prevent sudden jar against the hurters. (*Par. 242.*)

XXXV. In case the friction-primer explodes without discharging the piece, care must be taken not to approach the piece too soon—not less than five seconds—as it may only hang fire, and the recoil would injure any one in the way of it. (*Par. 252.*)

XXXVI. Sponges, after the first fire, should always be moist-

ened. This not only assists in extinguishing any fragments of cartridge that might remain burning in the bore, but it prevents the residuum of burnt powder from hardening on the surface of the bore. Fresh water is preferable to salt for moistening the sponge.

XXXVII. In all exercises for instruction, duties should be performed as nearly as possible as in actual service, and not by pretense only. To do this, in the service of the piece a dummy cartridge should be used, together with actual projectiles. The cartridge may be made of canvas or stout gunny-sacking, filled to the proper weight with coal broken to the size of the powder used for the piece. A worm serves for withdrawing the cartridge.

A strong lanyard attached to the fuse-plug will serve to withdraw the projectile. The free end of the lanyard remains out of the muzzle as the projectile is pushed home.

SERVICE OF SIEGE GUN.

(Fig. 1, Plate XI.)

DESCRIPTION OF PIECE.

231. Gun, cast-iron; muzzle-loading rifle; twist, uniform, one turn in 15 feet.

Number, weights, and dimensions.

| DESIGNATION. | NO. | LBS. | INCH. |
|--|-------|-------|-------|
| Calibre | | | 4.5 |
| Length of piece..... | | | 133. |
| Maximum diameter..... | | | 15.6 |
| Minimum diameter..... | | | 9. |
| Length of bore (calibres)..... | 26.5 | | |
| Number of grooves..... | 9. | | |
| Width of grooves..... | | | 0.97 |
| Width of lands..... | | | 0.6 |
| Depth of grooves..... | | | 0.075 |
| Windage..... | | | 0.05 |
| Initial velocity (feet)..... | 1280 | | |
| Charge (cannon powder)..... | | 3.25 | |
| Solid shot..... | | 35.5 | |
| Shell (unfilled)..... | | 25. | |
| Weight of piece..... | | 3570 | |
| Preponderance | | 300 | |
| Carriage and limber..... | | 3650 | |
| Piece, carriage, limber, and implements..... | | 7400 | |
| Horses to transport (good roads)..... | 8. | | |
| “ “ (inferior roads)..... | 10. | | |

The nomenclature of the carriage for the siege gun and siege howitzer is similar to that for light field pieces as laid down in "Light Artillery Tactics"; it is therefore omitted in this book.

RANGES IN YARDS.

| ELEVATION. | SHOT. | SHELL. | TIME OF FLIGHT. |
|------------|-------|--------|-----------------|
| 1° 0' | 540 | 533 | 1.37 |
| 1° 30' | 790 | 781 | 2.05 |
| 2° 0' | 1017 | 1005 | 2.69 |
| 2° 30' | 1240 | 1224 | 3.32 |
| 3° 0' | 1445 | 1414 | 3.94 |
| 3° 30' | 1639 | 1593 | 4.54 |
| 4° | 1823 | 1762 | 5.14 |
| 5° | 2170 | 2071 | 6.3 |
| 6° | 2485 | 2354 | 7.42 |
| 7° | 2780 | 2610 | 8.51 |
| 8° | 3056 | 2844 | 9.57 |
| 9° | 3313 | 3061 | 10.6 |
| 10° | 3556 | 3265 | 11.59 |

The gun, on its platform, admits of 9° 30' elevation and 10° 30' depression. On level ground it admits of 12° elevation and 10° depression. By digging a trench for the trail to run in, a still greater elevation may be obtained.

In works, it is fired from a wooden platform. (*Par.* 223.) In the field, it may be fired without a platform, when the ground is level and firm; or a temporary platform may be extemporized from such beams, planks, or logs as may be at hand.

To serve the piece.

232. Eight men are required: one chief-of-detachment, one gunner, and six cannoneers.

The implements and equipments are arranged as follows:

| | |
|-----------------|---|
| Handspikes..... | } Three on each side of the piece; leaning against the parapet, in line with cannoneers. |
| Sponge..... | |
| Rammer..... | } One yard behind, and parallel to the cannoneers of the right; supported on a prop, heads turned from the epaulment. |
| | |

| | |
|--------------------------|---|
| Pass-box..... | Behind and near No. 4. |
| Primer-pouch..... | } Containing friction-primers and lanyard; suspended from cascable. |
| Gunner's pouch..... | |
| Sight-pouch..... | } Containing priming-wire; suspended from cascable. |
| Wheel-chocks..... | |
| Vent-cover..... | Containing breech sight; suspended from cascable. |
| Tompion..... | One on each side of piece, near the end of the hurter. |
| Broom..... | Covering the vent. |
| Budge-barrel..... | In the muzzle. |
| Sponge-bucket..... | } Leaning against the parapet near No. 2. |
| Fuse-gauge..... | |
| Fuse-knife..... | } Containing cartridges; at a safe and convenient place near the piece. |
| Fuse-wrench..... | |
| Fuse-reamer..... | |
| One lanyard (extra)..... | |
| | Near sponge and rammer. |

233. To each two pieces there should be

| | |
|---------------------------|--|
| One worm..... | } In filling-room of service magazine. |
| One hammer-wrench..... | |
| One gunner's quadrant... | |
| One vent-punch..... | |
| One vent-gimlet..... | |
| One gunner's level..... | |
| One gunner's pincers..... | |

When there is no parapet, the handspikes are placed, three on each side, standing between the cheeks and wheels of the carriage, in front of and resting against the axle-tree.

The solid shot are piled on the left of the piece against the parapet; the other projectiles are in the filling-room of the service magazine; the fuses, cartridges, and primers are in the service magazine.

To distribute the equipments.

234. The instructor commands: 1. TAKE EQUIPMENTS.

The gunner steps to the cascable; takes off the vent-cover, handing it to No. 2 to place against the parapet outside of his

post; gives the primer-pouch to No. 3; equips himself with the sight-pouch and his own pouch; clears the vent; levels the piece, and resumes his post.

No. 3 equips himself with the primer-pouch. *These rules are general for all guns.*

Nos. 1 and 2, after passing two handspikes each to Nos. 3 and 4, take one each, for himself. Nos. 5 and 6 receive theirs from Nos. 3 and 4.

235. The handspike is held in both hands, diagonally across the body; the hand nearest the parapet grasping it near the small end and at the height of the shoulder, back of the hand down, elbow touching the body; the other hand back up, the arm extended naturally; the butt of the handspike resting on the ground, on the side of the cannoneer farthest from the parapet, and in line with his toes.

236. When a cannoneer lays down his handspike, he places it directly before him, about six inches in front, and parallel to the alignment, the small end toward the parapet; and whenever he thus lays it down for the discharge of any particular duty, he takes it up after having completed the duty.

237. The service of the piece is executed as follows: The piece being in battery, the instructor commands:

1. FROM BATTERY.

The gunner moves two yards to his right.

Nos. 1, 2, 3, 4, 5 and 6, all facing from the parapet, embark with their handspikes; Nos. 1 and 2 under the front of the wheels; Nos. 3 and 4 through the rear spokes of the wheels, near the felly, under and perpendicular to the cheeks; Nos. 5 and 6 under and perpendicular to the manœuvring bolts.

When all are ready, the gunner gives the command: **HEAVE**, which will be repeated as often as may be necessary, and sees that Nos. 5 and 6 guide the trail in prolongation of the directrix of the embrasure, and as soon as the face of the piece is about one yard from the parapet, commands: **HALT**, at which all unbar and resume their posts. If the platform has a slope, Nos. 1 and 2 chock the wheels in front.

1. *By the numbers*, 2. **LOAD.**

238. Nos. 1, 2, 3, and 4 lay down their handspikes; No. 2 takes out the tompon, and places it near the vent-cover.

No. 1 turns to his left, steps over the sponge and rammer; faces to the piece; takes the sponge with both hands, the backs down, the right hand three feet from the sponge-head, the left

hand eighteen inches nearer to it; returns to the piece, entering the staff in the embrasure; places the left foot in line with the face of the piece, half-way between it and the wheel; breaks to the right with the right foot, the heels on a line parallel to the piece, the left leg straightened, the right knee bent, the body erect upon the hips, and inserts the sponge-head in the muzzle; the staff in prolongation of the bore, supported by the right hand, the right arm extended, the left hand hanging naturally by the side.

No. 2 steps to the muzzle, and occupies a position on the left of the piece corresponding to that of No. 1 on the right. He seizes the staff with the left hand, back down, near to and outside the hand of No. 1.

No. 3 faces about, steps over the rammer, and seizes the staff with both hands, as prescribed for No. 1 with the sponge, and stands ready to exchange staves with No. 1.

No. 4, taking the pass-box, goes for a cartridge and projectile; returns, and places himself, facing the piece, about eighteen inches to the rear and right of No. 2.

The gunner places himself near the stock, his left foot advanced; closes the vent with the second finger of the left hand, bending well forward to cover himself by the breech, and with the elevating screw adjusts the piece conveniently for loading.

This rule for closing the vent is general for all guns and howitzers.

239. In the meantime, Nos. 1 and 2 insert the sponge by the following motions, at the commands **TWO—THREE—FOUR—FIVE—SIX**:

Two. They insert the sponge as far as the hand of No. 1, bodies erect, shoulders square.

Three. They slide their hands along the staff and seize it at arm's-length.

Four. They force the sponge down as prescribed for *two*.

Five. They repeat *three*.

Six. They push the sponge to the bottom of the bore. No. 1 replaces the left hand on the staff, back up, six inches nearer the muzzle than the right; No. 2 places the right hand, back up, between the hands of No. 1, and both then quickly change their other hands so as to seize the staff with the back of the hand up.

If, in executing these motions, or the corresponding ones with the rammer, it be found that the sponge or rammer is at home at the fourth motion, then what is prescribed for the sixth motion will be performed at the fourth. *This rule is general.*

The knee on the side toward which the effort is made is always

bent, the other straightened, and the weight of the body added, as much as possible, to the effort exerted by the arms. *This rule is general.*

1. SPONGE.

240. Nos. 1 and 2, pressing the sponge firmly against the bottom of the bore, turn it three times from right to left, and three times from left to right; replace the hands by their sides, and withdraw the sponge by the same commands, but by motions contrary to those prescribed for inserting it. When the sponge fits so tightly that it is hard to move in the bore, Nos. 1 and 2 may use both hands. *This rule is general.*

No. 2 quits the staff, and turning towards No. 4, receives from him the cartridge, which he takes in both hands, and introduces it into the bore, bottom foremost, seams to the side; he then grasps the rammer in the way prescribed for the sponge.

This rule, with reference to the bottom and seams of the cartridge, is general.

No. 1, meanwhile, rising upon both legs, turns towards his left; passes the sponge above the rammer with the left hand to No. 3, and, receiving the rammer with his right, presents it as prescribed for the sponge, except that he rests the rammer-head against the right side of the face of the piece.

No. 3, as soon as the sponge is withdrawn, passes the rammer under the sponge into the embrasure with the right hand; receives the sponge from No. 1 with the left; replaces it upon the prop, and resumes his post.

No. 4, setting down the projectile and pass-box, takes out the cartridge and hands it to No. 2, the choke to the front; returns the pass-box to its place, and takes up the projectile.

Nos. 1 and 2 force home the cartridge by the same commands and motions as for the sponge.

1. RAM.

241. Nos. 1 and 2 slide their hands along the staff to the full extent of their arms; grasp it firmly; throw the weight of their bodies upon the staff and press the cartridge home. No. 2 quits the staff, and turning towards No. 4, receives from him the projectile. No. 1, meanwhile, throws out the rammer, and holds it with both hands, the head against the right side of the face of the piece.

No. 2, receiving the projectile, introduces it into the bore, base foremost, and reseizes the staff with the left hand. No. 4 resumes his post.

Nos. 1 and 2 force home the projectile by the same commands and motions as prescribed for the cartridge. At the command *ram* it is *pressed* tightly down against the cartridge. No. 2 quits the rammer; sweeps, if necessary, the platform on his own side; passes the broom to No. 1, and resumes his post. No. 1 throws out the rammer, and places it on the prop below the sponge; sweeps, if necessary, his side of the platform; returns the broom to No. 2, and resumes his post.

The gunner pricks, leaving the priming-wire in the vent; resumes his post, and adjusts the breech sight to the distance of the object to be fired at.

1. IN BATTERY.

242. Nos. 1 and 2 unchock the wheels, (if they have been chocked,) and with Nos. 3, 4, 5, and 6, all facing towards the epaulment, embar; Nos. 1 and 2 through the front spokes of the wheels, near the fellies, under and perpendicular to the cheeks; Nos. 3 and 4 under the rear of the wheels, and Nos. 5 and 6 under and perpendicular to the stock, near the trail. All being ready, the gunner commands: **HEAVE**, and the piece is run into battery, Nos. 5 and 6 being careful to guide the muzzle into the middle of the embrasure. As soon as the wheels touch the hurter, he commands: **HALT**. All unbar, and Nos. 1, 2, 3, and 4 resume their posts.

1. AIM.

243. No. 3 lays down his handspike; passes the hook of the lanyard through the eye of a primer from below upward, and holds the handle of the lanyard in the right hand, the hook between the thumb and forefinger. *This rule for preparing the primer and holding the lanyard is general.*

Nos. 5 and 6, facing towards the epaulment, embar under and perpendicular to the stock near the manœuvring bolts.

The gunner, placing himself at the stock, as at the command *load*, withdraws the priming-wire; places the breech sight in its socket; sights through it, and, aided by Nos. 5 and 6, gives the direction, causing the trail to be moved by commanding **LEFT**, or **RIGHT**, tapping, at the same time, on the right side of the breech for No. 5 to move the trail to the left, or on the left side for No. 6 to move it to the right; and by the elevating screw gives the proper elevation, rectifying, if necessary, the direction.

The moment the piece is correctly aimed, he rises on the left leg and gives the command **READY**, making a signal with both

hands, at which Nos. 5 and 6 unbar and resume their posts. The gunner, taking the breech sight, goes to the windward to observe the effect of the shot.

These rules, as to the method of aiming, are general.

No. 3 inserts the primer in the vent; drops the handle, allowing the lanyard to uncoil as he steps back to his post, holding it slightly stretched with the right hand, the cord passing between the middle fingers, back of the hand up, and breaks to his left and rear a full pace with his left foot, the left hand hanging naturally by his side.

These rules for holding the lanyard and breaking off by the cannoneer who fires the piece are general.

At the command READY, Nos. 1 and 2, laying down their handspikes, take, each, a chock in the hand nearest the epaulment, and breaking off sideways with the foot farthest from the epaulment, stand ready to chock the wheels after the recoil.

1. *Number one* (or the like), 2. FIRE.

244. No. 3, turning his face from the piece, pulls the lanyard quickly, but steadily, and fires the piece.

Immediately after the recoil of the piece, Nos. 1 and 2 chock the wheels and resume the erect position; No. 3 resumes the erect position, rewinds the lanyard upon its handle, returns it to his pouch, and resumes his post. The gunner having observed the effect of the shot, returns to his post.

These rules, as far as they relate to the cannoneer who discharges the piece, and to the gunner, are general.

Ammunition is not used when exercising by the numbers. *This rule is general.*

To load without the numbers.

245. The instructor commands: LOAD.

At this command the piece is run from battery, loaded, run into battery, and prepared for firing by the following commands from the gunner: FROM BATTERY—LOAD—IN BATTERY—AIM—READY.

The instructor commands:

1. *Number one* (or the like), 2. FIRE.

At which the piece is discharged. All of these operations are executed as before explained, except that Nos. 1 and 2 sponge and ram without the numbers.

To load and fire continuously.

The instructor commands :

1. *Commence*, 2. FIRING.

246. The gunner gives the same command as in the preceding paragraph, with the additional one of FIRE, and continues to load and fire until the instructor commands :

1. *Cease*, 2. FIRING.

247. The firing then ceases ; pieces that are loaded remain so until further orders ; those that are partly loaded—if with the cartridge only, have the cartridge rammed home ; if with the projectile, it likewise is rammed home. In both cases the priming-wire is left in the vent. If the piece has no load in it, it is sponged out ; all the cannoneers then resume their posts.

If it is intended to discontinue the firing, the instructor directs the chiefs-of-detachment to have the charges withdrawn and the pieces run into battery.

These rules are general.

The projectile may be withdrawn by depressing the muzzle and raising the trail until the muzzle knocks against the ground. Should it not then slide out, allow the piece to stand until (if the atmosphere is moist) the residuum of burnt powder in the bore becomes unctious ; then depress the muzzle and raise the trail as before. If the projectile still refuses to slide out, the piece will have to be discharged ; or if it is not desirable to discharge it, the charge may be drowned out by pouring water in at the muzzle, afterwards draining it out and pouring a small quantity of fine-grain powder in at the vent and firing it.

Cartridges are withdrawn by means of the worm.

248. Before giving the command *load*, or *commence firing*, the instructor, when ammunition is used, will specify : *with blank cartridges—with solid shot—with shell—or, with case-shot. This rule is general.*

To change posts. As explained in *par.* 112.

To secure piece.

The piece being *in battery*, the instructor commands :

SECURE PIECE.

249. No. 2 replaces the tompion in the muzzle. The gunner puts on the vent-cover, which he receives from No. 2, and depresses the muzzle. *This rule is general.*

To replace equipments.

The instructor commands :

REPLACE EQUIPMENTS.

250. Nos. 1 and 2 replace the handspikes against the parapet, those of Nos. 3, 4, 5, and 6 being passed to them by Nos. 3 and 4. The gunner hangs the pouches on the cascable.

To serve the piece with reduced numbers.

251. The smallest number of men with which a siege gun can be served with facility is five—one gunner and four cannoneers.

In this case Nos. 5 and 6 are dispensed with, and the piece is run to and from battery as explained for the siege howitzer. (*Pars.* 264 and 268.)

With four men—one gunner and three cannoneers—Nos. 1, 2, and 3, in running the piece to and from battery, perform duties as before, and the gunner that of No. 4. In loading, No. 2, in addition to his own duties, performs those of No. 4.

With three men—one gunner and two cannoneers—Nos. 1, 2, and the gunner perform duties as above. In loading, No. 1 performs the duties of No. 3 as well as his own. No. 2 performs those of No. 4, as in the preceding case.

When No. 2 serves ammunition, he goes for the cartridge, and places the pass-box behind his post before assisting No. 1. to sponge.

252. In all firings, when a primer fails, the gunner, after waiting a few moments to see that the piece is not hanging fire, steps *in front* of the left wheel and, reaching over, pricks; No. 3, reaching over the right wheel, gives him a fresh primer to which he has hooked his lanyard.

253. Sponge and rammer staves are marked with a white ring painted around them, to show—with the sponge, when it is at the bottom of the bore; with the rammer, when the projectile is home. *This rule is general.*

254. Rifle projectiles are always to be lubricated previous to loading; they are then easily pushed home, and their range and accuracy of flight increased. *This rule is general.*

ORGANIZATION OF SIEGE GUNS INTO BATTERIES FOR FIELD SERVICE.

255. It has been found from actual experience that the 4.5-inch siege gun is capable of accompanying an army in the

field with almost the same facility as the 12-pounder. Its great range, power, and accuracy endow it with many advantages when used as a heavy field-piece, and it should form a portion of the artillery of every army organized for campaign purposes.

For this service the pieces are organized into batteries of four or six guns each, and equipped after the manner of light field batteries.

Each piece is furnished with two caissons of the usual pattern, having, however, only two partitions in each half-chest; these are parallel to and 4.5 inches from each side—the outer spaces for projectiles, the inner for cartridges. This arrangement allows 16 rounds for each chest, 48 per caisson and 96 per gun. A tray in each chest serves to carry pouches, primers, and fuses. One spare wheel is carried for the caissons of each two pieces. Caissons not carrying spare wheels, carry picket-ropes and forage. The picket-rope should be in sections; each section long enough to accommodate the horses of one piece and its two caissons, together with a proportional share of spare and other horses. This requires each section to be 35 yards long. The ends of the ropes should be provided with hooks; these, besides enabling them to be used more conveniently as picket-ropes, allow of their being used as drag-ropes for extricating carriages from difficult places on the march.

Light-artillery harness is used, but, owing to the weight of the pole, breast-hooks of extra strength are provided for the wheel-horses. The swing team being attached to lead-bars, wheel-traces are required for it.

The implements for the piece are as follows:

256. Six *handspikes*; small ends under sweep-bar, resting on axle, large ends resting on splinter-bar, and secured by a leather strap passing from the hounds, through loops on the handspikes, to buckles on the fork; or by a rope passed through rings on the handspikes and around through staples on the hounds and fork.

One *short roller*; on the stock between the lunette bolts; secured by a rope passing through a hole in the axis of the roller and fastened to the stock.

One *trace-rope*; two half-hitches in the middle around the cascable; ends turned around the manœuvring bolts, and crossing to take up the slack. This secures the piece from sliding on its carriage.

The sponge and rammer heads are upon the same staff, which is cut to the shortest practicable length. Two sponges and rammers are allowed to each piece, and, together with one worm for each two pieces, are carried upon the sides of the piece, secured

by two stout leather straps buckled around the chase and the body of the gun.

The service of the piece, so far as sponging and ramming are concerned, is similar to that for light field-pieces.

The sponge-bucket is carried in the same manner as for light field-pieces. One fuse-wrench, one fuse-gauge, one fuse-knife, one fuse-reamer, and one pair of gunner's pincers for each piece are carried in the trays of the limber chests of the caisson.

A cartridge-pouch is used instead of pass-box, and is carried by No. 4 suspended from the left shoulder to the right side.

Large and heavy horses, particularly for wheel-teams, are selected for the guns. Except where the roads are unusually good, ten are allowed to each piece. Each horse, both for piece and caissons, is provided with a nose-bag, carried as for a light field battery, and one watering-bucket is allowed for each pair of horses, carried—those for the pieces on hooks attached to the rear axle; those for caissons as in light artillery.

One lifting-jack for each two pieces is carried on one of the caissons belonging to these pieces. The lifting-jack weighs 160 pounds; and is carried on a caisson having no spare wheel.

Each caisson is supplied with axes, shovels, picks, paulines, &c., as for a light field battery.

Two hundred rounds of ammunition are allowed for each piece; that not contained in the caissons is carried in transportation-wagons.

One spare gun carriage, with limber complete, drawn by six horses, accompanies each battery.

Three spare poles for the limber of the piece, ironed and fitted ready for insertion, are carried on the spare carriage.

Each battery is furnished with a battery-wagon and forge. These contain supplies as hereinafter prescribed.

The spare carriage, battery-wagon, forge, ammunition, and baggage-wagons form a train, and, on the march, usually accompany the light-artillery train.

The cannoners carry their equipments and march by the side of the piece, as in a light field battery.

In place of the shoe (which is entirely useless) a stout rope, attached to the ring-bolt of the lock-chain, is substituted. This rope, passed around the felly with two or three turns, is held by a cannoner walking by the side of the piece. In this manner he is enabled to let the wheel go as it approaches the bottom of a descent.

Composition of a siege battery of six pieces organized and equipped for campaign service.

| | Officers. | Men. | Horses. | |
|-------------------|-----------|-------|---------|--|
| Captains..... | 1 | | 1 | { Including first-sergeant, quartermaster, stable, and veteriny sergeants. } 3 blacksmiths, 2 saddlers, } 1 wheelwright. |
| Lieutenants..... | 4 | | 4 | |
| Sergeants..... | | 9 | 9 | |
| Corporals..... | | 12 | | |
| Artificers..... | | 6 | 6 | |
| Trumpeters..... | | 2 | 2 | |
| Guidon..... | | 1 | 1 | |
| Drivers..... | | 75 | 150 | |
| Cannoneers..... | | 78 | | |
| Spare horses..... | | | 18 | |
| Total..... | 5 | 183 | 191 | { For 6 pieces, 12 caissons, 1 spare carriage, 1 battery wagon, and 1 forge. |

257. On dry and firm ground the siege gun may be fired as an ordinary field-piece ; under all other circumstances it requires a platform. When time permits, a good platform may be improvised from material found in the vicinity ; but to provide against every emergency, a platform for each piece should be carried with the battery, or at least with the train, when easily accessible.

The platform is the one described in *par.* 226. These are carried in transportation-wagons, each wagon carrying three platforms.

The supply of projectiles should be about equally divided between solid shot, time, and percussion shells ; *i. e.*, one-third solid shot, one-third time-fuse shells, and the remaining third percussion shells. It is unnecessary to have either case-shot or canister.

Each piece is provided with a field-glass and telemeter.

258. The following are the supplies carried in the battery-wagon and forge for a battery of six guns :

Forge A.

| CONTENTS OF LIMBER-CHEST. (Smith's tools and stores.) | No. | Weight. Lbs. | Place. |
|--|-----|-----------------|--------------------------|
| Horseshoes, Nos. 2 and 3.....lbs.. | 100 | 100.00 | Box A 1. |
| Horseshoes, Nos. 2 and 3.....lbs.. | 100 | 100.00 | Box A 3. |
| Horseshoe nails, Nos. 2 and 3..lbs.. | 50 | 50.00 | Box A 2, large divis- |
| Washers and nuts, No. 2..... | 30 | 5.25 | [ion. |
| Washers and nuts, No. 3..... | 10 | 3.20 | } In box A 2, 91.11 lbs. |
| Washers and nuts, No. 4..... | 4 | 2.15 | |
| Nails, No. 1, C..... lbs.. | 1 | 1.00 | |
| Nails, No. 2, C.....lbs.. | 1 | 1.00 | |
| Tire-bolts..... | 10 | 5.00 | |
| Keys for ammunition chests..... | 5 | 1.80 | |
| Linch-washers (caisson)..... | 8 | 7.30 | |
| Linch-pins (caisson)..... | 12 | 8.37 | |
| Linch-pins (for piece)..... | 6 | | |
| Chains, Nos. 1 and 2.....feet.. | 2 | 1.54 | |
| Cold-shut S links, No. 3..... | 50 | 2.50 | |
| Cold-shut S links, No. 5..... | 12 | 2.00 | |
| Hand cold-chisels..... | 2 | 2.00 | |
| Hardie..... | 1 | 0.75 | |
| Files, assorted, with handles..... | 12 | 10.00 | |
| Buttress..... | 1 | 1.50 | |
| Hand-punches, round and square... | 2 | 2.00 | |
| Screw-wrench..... | 1 | 2.42 | |
| Hand screw-driver..... | 1 | 0.32 | |
| Hand vise..... | 1 | 1.00 | |
| Smith's calipers, pair..... | 1 | 0.40 | |
| Taps..... | } 4 | 1.50 | |
| Dies, pairs. } Nos. 1, 2, 3, and 4..... | | 1.83 | |
| Wood screws, 1 in., No. 14...gross.. | 1 | 2.10 | |
| Quart can of sperm oil..... | 1 | 2.70 | |
| Borax.....lbs.. | 2 | | |
| Fire-shovel..... | 1 | 3.05 | |
| Poker..... | 1 | 1.90 | |
| Split broom..... | 1 | 1.25 | |
| Hand-hammers..... | 2 | 6.50 | |
| Riveting-hammer..... | 1 | 1.05 | |
| Nailing-hammer..... | 1 | 1.80 | |
| Sledge-hammer..... | 1 | 10.50 | |
| Chisels for hot iron..... | 2 | 3.00 | |
| Chisels for cold iron..... | 2 | 3.00 | |
| Smith's tongs..... | 3 | 15.00 | |
| Fore-punch..... | 1 | 1.00 | |
| Creaser..... | 1 | 1.00 | |
| Fuller..... | 1 | 2.40 | |
| Nail-claw..... | 1 | 5.00 | |
| Round-punch..... | 1 | 2.10 | |
| Tap-wrench..... | 1 | 3.75 | |
| Die-stock..... | 1 | 6.25 | |
| Nave-bands, developed..... | 4 | 11.75 | |
| Tire-bands, developed..... | 2 | 2.75 | |
| | | | } In Box A 5, 80.05 lbs. |

Forge A.—(continued.)

| CONTENTS OF LIMBER-CHEST. (Smith's tools and stores.) | No. | Weight. | Place. | |
|--|-----|---------|---|-----------------|
| Shoing-hammer..... | 1 | 0.82 | } In shoing-box, 12.75 lbs. | |
| Pincers, pair..... | 1 | 2.00 | | |
| Rasps (12 inches)..... | 2 | 2.15 | | |
| Shoing-knife..... | 1 | 0.33 | | |
| Toe-knife..... | 1 | 0.30 | | |
| Pritchel..... | 1 | 0.85 | | |
| Nail-punch..... | 1 | 0.80 | | |
| Clinching-pin..... | 2 | 1.00 | | |
| Oil-stone..... | 1 | 1.50 | | |
| Leather aprons..... | 2 | 3.00 | | |
| Horse-tail brush..... | 1 | 1.00 | } Fastened on inside of the chest-cover with two copper clamps. | |
| Iron square..... | 1 | 2.00 | | |
| Padlock..... | 1 | 0.50 | | } On the chest. |
| Tar-bucket..... | 1 | 7.00 | | |
| Boxes..... | 6 | 53.45 | } On its hook. | |
| Tow for packing..... | .. | 5.00 | | |
| Total..... | .. | 484.38 | | |

One pound of horseshoe nails, No. 3, contains 140 nails; one pound of horseshoe nails, No. 2, contains 112 nails; one hundred pounds of horseshoes, contain 90 shoes.

Contents of forge-body.

| TOOLS AND STORES. | No. | Weight. Lbs. | Place. |
|---|-------|-----------------|--|
| Square iron, ½ in. and 1 in..... | | 100 | } In the iron-room. Bars not more than 3 feet long. Square iron in two bundles. |
| Flat iron, 1¼ in. x ½, 1 in. x ½, 1¼ in. x 1½ x ¼ in..... | | 50 | |
| Round iron, ½ in..... | | 50 | |
| Cast-steel, ½ in. square..... | | 10 | |
| English blistered-steel..... | | 5 | |
| <i>Boxes 5 and 6, containing:</i> | | | |
| Horseshoes, Nos. 2 and 3..... | | 200 | } In iron-room. |
| Horseshoe nails, Nos. 2 and 3..... | | 20 | |
| Water-bucket..... | 1 | 10 | |
| Watering-bucket (leather)..... | 1 | 8 | |
| Anvil..... | 1 | 100 | } On the fireplace. |
| Vise..... | 1 | 29 | |
| Bituminous coal..... | | 250 | } In the coal-box. |
| Coal-shovel..... | 1 | 5 | |
| Padlock..... | 1 | | |
| Tow..... | | 5 | |
| Total..... | | 842 | |

1. Anvil-block, carried on the hearth of the forge, and secured by having a hole through its axis, through which is passed a lashing-rope.

Contents of limber-chest, Battery-wagon C.

| TOOLS AND STORES. | No. | Weight. | Place. |
|--|---------------------|---------|---|
| <i>Carriage-maker's tools:</i> | | Lbs. | |
| Hand-saw..... | 2 | 4.00 | } Fastened to the in- side of chest cover. |
| Tenon-saw (14 in.)..... | 1 | 1.50 | |
| Jack-plane..... | 1 | 4.15 | } In box C 1, 17.20 lbs. |
| Smoothing-plane..... | 1 | 1.80 | |
| Brace, with 24 bits..... | 1 | 4.35 | |
| Spokeshave..... | 1 | 0.30 | |
| Gauge..... | 1 | 0.30 | |
| Plane-irons..... | 2 | 1.05 | |
| Saw-set..... | 1 | 0.25 | |
| Rule (2 feet)..... | 1 | 0.14 | |
| Gimlets..... | 12 | 0.95 | |
| Compasses, pair..... | 1 | 0.18 | |
| Chalk-line..... | 1 | 0.10 | } In box C 2, 32.23 lbs. |
| Brad-awls..... | 2 | 0.17 | |
| Scriber..... | 1 | 0.15 | |
| Saw-files (4½ in.)..... | 12 | 0.87 | |
| Wood-files (10 in.)..... | 2 | 1.12 | |
| Wood-rasp (10 in.)..... | 1 | 0.40 | |
| Trying-square (8 in.)..... | 1 | 0.60 | |
| Hand screw-driver..... | 1 | 0.32 | |
| Oil-stone..... | 1 | 1.50 | |
| Broad-axe..... | 1 | 6.00 | |
| Hand-axe..... | 1 | 5.00 | } In box C 3, 23.25 lbs. |
| Claw-hatchet..... | 1 | 2.00 | |
| Claw-hammer..... | 1 | 1.50 | |
| Pincers (small), pair..... | 1 | 1.06 | |
| Table vise..... | 1 | 3.80 | |
| Framing-chisels (1 in. and 2 in.).... | 2 | 3.00 | |
| Firmer-chisels (¾ in. and 1½ in.).... | 2 | 1.00 | |
| Framing-gouges (1 in. and 1½ in.).. | 2 | 2.60 | |
| Augers and handles (½ in., ⅝ in., ¾ in., 1 in., 2 in.)..... | 5 | 4.50 | |
| Screw-wrench..... | 1 | 2.42 | |
| Felling-axe..... | } with handles..... | 6.00 | |
| Adze..... | | 3.30 | |
| Frame-saw..... | 1 | 4.50 | |
| Quart can of sperm oil..... | 1 | 2.70 | |
| Compass-saw..... | 1 | | |
| Tacks (carpenters'), M..... | 5 | 5.00 | |
| Measuring-tape..... | 1 | | |
| Chalk..... | | 2.00 | |

Contents of limber-chest, Battery-wagon C.—(continued.)

| TOOLS AND STORES. | No. | Weight. | Place. |
|---|-------|---------------|---------------|
| <i>Saddler's tools and stores.</i> | | Lbs. | |
| Mallet | 1 | 1.75 | } In box C 4. |
| Clam | 1 | 5.00 | |
| Hammer | 1 | 0.65 | |
| Shoe-knives | 2 | 0.20 | |
| Half-round knife | 1 | 0.28 | |
| Shears, pair | 1 | 0.47 | |
| Sandstones | 2 | 0.30 | |
| Rule (2 feet) | 1 | | |
| Needles, assorted | 100 | | |
| Collar-needles | 5 | | |
| Thimbles | 4 | | |
| Awls | 36 | 0.50 | |
| Awl-handles | 6 | 0.75 | |
| Punches, assorted | 6 | 1.00 | |
| Pincers, pairs | 3 | 6.75 | |
| Pliers, pairs | 6 | | |
| Claw-tools | 2 | | |
| Creasers | 1 | | |
| Gauge-knife | 1 | 0.75 | |
| Scissors, pair | 1 | | |
| Compass, pair | 1 | 0.25 | |
| Strap-awls | 3 | | |
| Saddler's mallet | 1 | 1.75 | |
| Saddler's clam | 1 | 5.00 | |
| Bristles | | 2.00 | |
| Saddler's thread | | 2.00 | |
| Bees-wax | | 3.00 | |
| Black-wax | | 5.00 | |
| Patent thread | | 5.00 | |
| Shoe thread | | 2.00 | |
| Buckles, assorted (0.75 in. to 1.5 in.) | 3 | 1.00 | |
| Tacks (iron and copper), assorted | | 10.00 | |
| Hand-saws | 2 | 2.00 | |
| Tenon-saws | 2 | | |
| Blades for frame-saws | 4 | | |
| Total | | 173.00 | |

Contents of wagon-body.

| TOOLS AND STORES. | No. | Weight. | TOOLS AND STORES. | No. | Weight. |
|--|--------------------|---|------------------------------------|-----|---------------|
| | | Lbs. | | | Lbs. |
| Grindstone, 14-in. x 4 in... | 1 | } 60 | Fuse-wrenches..... | 3 | } In box C 6. |
| Arbor and crank for do.... | 1 | | Fuse-gauges..... | 3 | |
| Pintles (for piece)..... | 1 | Fuse-knives..... | 3 | | |
| Horse-collars (assorted)... | 10 | Fuse-reamers..... | 3 | | |
| Girths..... | 20 | Gunner's pincers..... | 3 | | |
| Lead-traces..... | 15 | Vent-punches..... | 3 | | |
| Whips (artillery)..... | 5 | Breech sights..... | 3 | | |
| Wheel-traces..... | 10 | Priming-wires..... | 12 | | |
| Currycombs..... | 15 | Gunner's gimlets..... | 6 | | |
| Horse-brushes..... | 15 | Primer-pouches..... | 3 | | |
| Nose-bags..... | 10 | Castile-soap..... | | 10 | |
| Saddle-blankets..... | 20 | Handspikes..... | 3 | 36 | |
| Spurs and straps....pairs.. | 5 | Tallow..... | | 30 | |
| Halters and straps..... | 20 | Staves—sponge and rammer (lashed to body of wagon outside)..... | 3 | 11 | |
| Watering-bridles..... | 10 | *Neat's-foot oil.....gal. | 6 | 50 | |
| Bridles (artillery)..... | 6 | *Grease, wheel (1-lb cans)..... | | 70 | |
| Hame-straps..... | 40 | Nails, (4, 6, 8, and 10-penny)..... | | 20 | |
| Harness-leather....sides... | 2 | Claw-hatchet..... | 1 | 2 | |
| Bridle-leather.....sides... | 3 | Spirit-level (carpenter's)..... | 1 | | |
| Sash-cord.....pieces... | 6 | Sperm or wax candles..... | | 5 | |
| Pole-yoke..... | 1 | Rammer-heads..... | 6 | 5 | |
| Elevating screw..... | 1 | Sponge-heads..... | 3 | 5 | |
| Saw, cross-cut (6 feet)..... | 1 | Sponges..... | 12 | 3 | |
| Rope-trace, feet... } Block (treble) for } above..... } Block (double) for } above..... } Watering-buckets..... | 200 1 1 5 | On the march these are carried on a caisson. | 6 6 4 | | |
| | | 40 | Lanyards for friction-primers..... | 6 | |
| | | | Dark lanterns..... | 3 | 3 |
| | | | Common lanterns..... | 4 | 4.60 |
| | | | Total..... | | 1100 |

* In Box C 5.

The battery-wagon here mentioned is that furnished from the arsenals; but, being cumbersome and quite unsuitable for field service, it is better to utilize its body and limber-chest by placing them on the running gear of the army transportation-wagon. The limber-chest can be attached to the front part of the wagon-body by strong iron brackets, and serves as a seat for the driver. A similar chest can be placed, in like manner, on the rear end in place of the forage-rack. In the front chest is carried the carriage-maker's outfit, and in the rear one that of the saddler.

On the middle of each side of the body may be attached a

small chest for horse medicines, or such other small articles as may be required of easy access.

When the wagon is thus arranged it is as easily drawn by four horses as the other by six, and one driver, using double lines, is sufficient.

The arrangement for attaching the draught-horses to siege-gun carriages being similar to that for the army transportation-wagon, the harness used with the latter will answer for the former. A driver is required for each pair of horses, as in light field artillery.

The officers, first-sergeant, and chiefs-of-detachment are mounted and equipped as for light artillery.

When in the presence of the enemy, the ammunition-wagons are kept out of range of his fire, but always near enough to be easily reached by the caissons for replenishing ammunition chests.

The battery should be repainted once a year, usually in the spring. To do this, a battery complete, of six pieces, requires : 120 lbs. olive paint ; 15 lbs. black paint ; 10 galls. linseed oil ; 3 galls. spirits turpentine ; 12 paint brushes (assorted).

Harness, when exposed constantly to the weather, should be oiled once in four months, requiring each time 6 gallons neat's-foot oil and 30 lbs. tallow.

The tallow is melted and mixed with the oil. The harness should be well soaked and washed, and the mixture applied warm and thoroughly rubbed in while the leather is still damp.

259. The following list contains a fair supply of horse medicines for a battery of six pieces :

| | | | |
|-------------------------|-------------|-------------------------|------------|
| Assafetida..... | 2 pounds. | Mustang liniment..... | 6 bottles. |
| Aloes..... | 2 pounds. | Nitre..... | 1 pound. |
| Adhesive plaster..... | 1 yard. | Olive oil..... | 2 quarts. |
| Aqua ammonia..... | 1 quart. | Opodeldoc..... | 6 bottles. |
| Alum..... | 1 pound. | Rosin..... | 1 pound. |
| Bluestone..... | 1 pound. | Spirits turpentine..... | 2 quarts. |
| Borax..... | 1 pound. | Spirits nitre..... | 1 quart. |
| British oil..... | 12 bottles. | Flour of sulphur..... | ½ pound. |
| Blister liquid..... | ½ quart. | Sugar of lead..... | 2 pounds. |
| Calomel..... | ½ pound. | Tartar emetic..... | ¼ pound. |
| Condition powders..... | 2 pounds. | Tar..... | 1 quart. |
| Cerate, simple..... | 2 pounds. | Whisky..... | 2 gallons. |
| Glauber salts..... | 10 pounds. | Farrier's needles..... | 4 |
| Flax-seed, ground..... | 8 pounds. | Farrier's scissors..... | 1 |
| Laudanum..... | 1 quart. | Horse-fleam..... | 1 |
| Lard..... | 5 pounds. | Lancet..... | 1 |
| Lunar caustic..... | ½ ounce. | Syringe..... | 1 |
| Mercurial ointment..... | 1 pound. | | |

These should be put up, as far as practicable, in metallic cans and in strong bottles. When the battery-wagon is arranged as

before described, they will be packed and carried in the boxes attached to the sides of the body; otherwise they will be carried in boxes inside of the body.

QUARTERMASTER'S STORES.

260. In addition to the wagons, horses, harness, &c., heretofore mentioned, there will be required for the battery the following:

- 3 wall tents.
- 3 wall-tent flies.
- 3 sets wall-tent poles and pins.
- 75 shelter tents (double).
- 10 camp-kettles.
- 10 mess-pans.
- 2 trumpets, cords and tassels.
- 1 company clothing-book.
- 1 company order-book.
- 1 company descriptive-book.
- 1 company morning report-book.

These articles, excepting the trumpets, are carried in a transportation-wagon; the same wagon will, in addition, carry two days' full rations for the men of the battery.

The forage is carried in transportation-wagons.

SERVICE OF SIEGE HOWITZER.

(Plate 12.)

DESCRIPTION OF PIECE.

261. Howitzer, cast-iron; smooth-bore; muzzle-loader.

Number, weights, and dimensions.

| DESIGNATION. | No. | lbs. | INCH. |
|---|-------|-------|-------|
| Calibre | | | 8. |
| Weight | | 2600. | |
| Length | | | 60. |
| Diameter (maximum)..... | | | 17.5 |
| Diameter (minimum) | | | 15. |
| Length of bore (calibres.)..... | 5.81 | | |
| Windage..... | | | 0.12 |
| Charge (cannon powder)..... | | 4. | |
| Shell (empty)..... | | 45. | |
| Preponderance | | 380. | |
| Weight of piece, carriage, limber, and imple'ts.. | | 6660. | |
| Horses to transport..... | 8. | | |

RANGES IN YARDS.

| ELEVATION. | SHELL. | RANGE. | TIME OF FLIGHT. |
|------------|--------|--------|-----------------|
| Degrees. | Lbs. | Yds. | Seconds. |
| 1 | 45 | 435 | 1.33 |
| 2 | 45 | 618 | 2. |
| 3 | 45 | 720 | 3. |
| 4 | 45 | 992 | 4. |
| 5 | 45 | 1150 | 5. |
| 12.5 | 45 | 2280 | |
| 15 | 45 | 2300 | |

Bursting charge of shell, 1 lb.; charge to blow out fuse-plug, 4 oz.

The howitzer on its platform admits of 13 degrees elevation and 10 degrees depression.

In works, it is fired from a wooden platform; or when the ground is level and firm, it may be fired without. It is used chiefly in field works for flank defense.

To serve the piece.

262. Six men are required: one chief-of-detachment, one gunner, and four cannoneers.

The implements and equipments are arranged as follows:

| | | |
|----------------------|---|--|
| Handspikes | } | Two on each side of piece; leaning against parapet, in line with cannoneers. |
| Sponge..... | | } |
| Rammer..... | | |
| Cartridge-pouch..... | | Suspended from cascable. |
| Primer-pouch..... | } | Containing friction primers and lanyard; suspended from cascable. |
| Gunner's pouch..... | | |
| Sight-pouch | } | Containing breech sight; suspended from cascable. |
| Wheel-chocks. | | |

| | |
|--------------------------|--|
| Vent-cover..... | Covering the vent. |
| Tompion | In the muzzle. |
| Broom | } Leaning against the parapet, near No. 2. |
| Budge-barrel..... | |
| Pair of sleeves | } Containing cartridges; at a safe and convenient place near the piece. |
| Shell-hooks..... | |
| Plummet | |
| Splints..... | |
| Sponge-bucket | Near sponge and rammer. |
| Grummet-wad..... | On end of hurter, near No. 2. |
| Fuse-gauge | } In filling-room of service magazine. |
| Fuse-knife | |
| Fuse-wrench..... | |
| Fuse-reamer | |
| One lanyard (extra)..... | |

To each two pieces there should be

| | |
|---------------------------|--|
| One worm..... | } In filling-room of service magazine. |
| One hammer-wrench..... | |
| One gunner's quadrant... | |
| One vent-punch..... | |
| One vent-gimlet..... | |
| One gunner's level | |
| One gunner's pincers..... | |

If the piece is without elevating screw, a wooden *quoin* is necessary, and this is under the breech.

For the purpose of instruction, a cartridge-bag filled with saw-dust, and a priming-wire bent into a hook, for withdrawing it, are provided, and are in the basket.

When there is no parapet the handspikes are placed, three on each side, standing between the cheeks and wheels of the carriage, in front of and resting against the axle-tree.

The projectiles are in the filling-room of the service magazine; the fuses, cartridges, and primers are in the service magazine.

To distribute the equipments.

263. The instructor commands :

1. TAKE EQUIPMENTS.

The gunner steps to the breech; takes off the vent-cover, handing it to No. 2 to place against the parapet, outside of his

post; gives the primer-pouch to No. 3, and the cartridge-pouch to No. 4; equips himself with the sight-pouch and his own pouch; clears the vent, levels the piece, and resumes his post. No. 3 equips himself with the primer-pouch.

No. 4, after equipping himself with the cartridge-pouch, assists No. 2 to put on the sleeves.

Nos. 1 and 2, after passing a handspike each to Nos. 3 and 4, take one each, for himself. The handspikes are held and laid down as prescribed in *pars.* 235 and 236. The gunner directs No. 3 to embar under and raise the breech to enable him to level the piece; applies his level to ascertain the highest point of metal at the base, which he marks with chalk. In case there is no sight upon the muzzle, he does the same at the latter place, and snaps a chalk-line between to mark the line of metal.

264. The service of the piece is executed as follows: The piece being in battery, the instructor commands:

1. FROM BATTERY.

The gunner moves two yards to his right; Nos. 1, 2, 3, and 4, all facing from the epaulment, embar; Nos. 1 and 2 through the rear spokes of the wheels, near the felly, under and perpendicular to the cheeks; Nos. 3 and 4 under and perpendicular to the manœuvring bolts. All being ready, the gunner commands: **HEAVE**, which is repeated as often as may be necessary. He sees that Nos. 3 and 4 guide the trail in prolongation of the directrix of the embrasure, and as soon as the wheels are about one yard from the parapet commands: **HALT**. If the platform has an inclination, Nos. 1 and 2 chock the wheels in front. All resume their posts.

1. *By the numbers*, 2. **LOAD.**

265. Nos. 1, 2, and 4 lay down their handspikes; No. 2 takes out the tompon and places it near the vent-cover, and resumes his post; No. 1 faces to his right, and seizes the sponge-staff at its middle with the right hand, back up; places himself at the muzzle, forces the sponge to the bottom of the bore, and grasps the staff with both hands, the back of the right up and that of the left down.

No. 3, facing towards the parapet, embars under the breech or knob of the cascable, and assists the gunner in adjusting the piece conveniently for loading.

No. 4 goes for a cartridge and shell; puts the cartridge in his pouch; takes the shell in both hands; returns and places it on the grummet-wad, and stands, facing the piece, about eighteen inches to the rear and left of No. 2.

The gunner places himself near the stock, as in *par.* 238, and closes the vent; adjusts the piece to about one degree elevation, and makes a signal for No. 3 to unbar.

1. SPONGE.

266. No. 1, pressing the sponge firmly against the bottom of the bore, turns it three times from right to left, and three times from left to right; draws it out, turns the sponge-head over towards the front, and places the rammer-head against the right side of the face of the piece, holding the staff in both hands, the back of the right down and that of the left up; as soon as the cartridge is inserted, he enters the rammer and pushes the cartridge home.

No. 4 gives the cartridge to No. 2, who, having placed himself between the wheel and piece, inserts it into the muzzle. As soon as No. 4 has given the cartridge to No. 2, he takes the shell-hooks and engages them in the ears of the shell in readiness for No. 2, who, making a face and a half to his left, takes hold of the shell-hooks, raises the shell and, making a face and a half to his right, stands in readiness to insert it into the bore as soon as No. 1 has pushed home the cartridge.

1. RAM.

267. No. 1 sets the cartridge home by pressing firmly upon it; throws out the rammer, replaces it on the prop, and resumes his post.

No. 2 introduces the shell into the bore, keeping the arms of the shell-hook in a vertical plane, and sets the shell carefully against the cartridge, taking care that the fuse is in the axis of the piece. Canister is shoved home by hand.

Double charges of canister may be fired.

If the piece is to be fired horizontally, or at an angle of depression, No. 4 hands a splint to No. 2, who presses it under the shell; replaces the tongs and, if necessary, sweeps his side of the platform; passes the broom to No. 1, and resumes his post.

No. 1 sweeps his side of the platform, passes the broom back to No. 2, and resumes his post.

No. 4, after passing the shell to No. 2, resumes his post.

The gunner pricks, leaves the priming-wire in the vent, and, resuming his post, adjusts the breech sight to the distance.

1. IN BATTERY.

268. Nos. 1 and 2 unchock the wheels, and Nos. 3 and 4, all facing towards the epaulment, embar; Nos. 1 and 2 through the front spokes of the wheels, near the felly, under and perpen-

dicular to the cheeks; Nos. 3 and 4 under and perpendicular to the stock, guiding the muzzle of the piece into the middle of the embrasure. The gunner commands: **HEAVE**, and, as soon as the wheels touch the hurter, **HALT**, when all unbar and resume their posts.

1. AIM.

269. No. 3 lays down his handspike and prepares a primer.

Nos. 1 and 4, facing towards the parapet, embar under and perpendicular to the stock, near the manœuvring bolts; No. 2, facing in the same direction, embars under the breech or knob of the cascable.

The gunner, placing himself at the stock, as at the command *load*, withdraws the priming-wire, places the centre point of the breech sight accurately upon the chalk-mark on the breech, and, sighting through it, gives the direction. Nos. 1 and 4 move the trail to the left or right at the command **LEFT** or **RIGHT** from the gunner.

The moment the piece is correctly aimed, the gunner rises, and commands: **READY**, making a signal with both hands, at which Nos. 1, 2, and 4 unbar and resume their posts.

The gunner, taking with him the breech sight, goes to a good place to observe the effect of the shot.

At the command **READY**, No. 3 inserts the primer in the vent; Nos. 1 and 2, laying down their handspikes, take each a chock in the hand nearest the parapet, and, breaking off with the foot farthest from the parapet, stand ready to chock the wheel after the recoil.

The breech sight at present used with the howitzer is one of obsolete pattern.

When sights similar to those used for siege guns are supplied, the method of aiming will be the same as for the gun.

When the piece is masked, by an epaulment, from the object, the direction is given as explained for mortars. (*Par.* 343.)

1. *Number one* (or the like), 2. **FIRE**.

270. Executed as in *par.* 244.

To load without the numbers, and to fire.

271. Executed as in *par.* 245.

To unload.

272. The piece having been run from battery, the instructor directs No. 2 to take out the shell and cartridge, No. 4 carrying them to their place in rear of the piece; No. 3, with his handspike, raises the breech until the shell rolls to the muzzle, where it is caught by No. 2, who hands it to No. 4.

To load and fire continuously.

273. Executed as in *par.* 246.

To cease firing.

274. Executed as in *par.* 247.

To secure piece and to replace equipments.

Executed as in *pars.* 249 and 250.

The howitzer is prepared for campaign service as explained for the siege gun, with such modifications as readily suggest themselves.

275. For transportation, the shells are carried uncharged. To charge them, two men and the following implements, in addition, are required, viz.: One set of *powder-measures*, one *funnel*, one *fuse-mallet*, one *fuse-setter*, one *rasp*, two *grummet-wads*, two *wipers*, one *bridge-barrel*, together with a supply of fuse-plugs and tow.

The fuse-plugs are of wood, and the tow is to stop the fuse-holes until the shells are to be taken to the piece. The shells should be well cleansed on the outside from rust and dirt. This is done at the filling-room of the service magazine.

Note.—The shells for the howitzer should be strapped to sa-bots, in which case the loading would be greatly facilitated.

The foregoing exercise is for ammunition as now furnished.

For the service of the siege howitzer, when used as a mortar, see *par.* 45S.

SERVICE OF A 10-INCH SMOOTH-BORE GUN IN BARBETTE.

(*Fig. 1, Plate 8.*)

DESCRIPTION OF PIECE.

276. Gun, cast-iron; muzzle-loader.

Number, weights, and dimensions.

| DESIGNATION. | NO. | LBS. | INCH. |
|--------------------------------|-------|--------|-------|
| Calibre..... | | | 10. |
| Length of piece..... | | | 136.6 |
| Maximum diameter..... | | | 32. |
| Minimum diameter..... | | | 16.2 |
| Length of bore (calibres)..... | 10.5 | | |
| Windage..... | | | 0.13 |
| Initial velocity (feet)..... | 1275. | | |
| Charge (cannon powder)..... | | 25 | |
| Solid shot..... | | 128 | |
| Shell (unfilled)..... | | 102 | |
| Weight of piece..... | | 15,000 | |
| Preponderance..... | | | |

Carriage, wrought-iron; front pintle, without air-cylinders or other recoil checks. The new-pattern carriage will be provided with pneumatic buffers. The top-carriage will weigh 2500 pounds, and the chassis 3500 pounds.

RANGES IN YARDS.

| ELEVATION. | SHOT. | SHELL. | TIME. | CHARGE. |
|------------|-------|--------|-------|---|
| 1° 00'' | 511 | 504 | 1.33 | 15 pounds for shot, 10 pounds for shells. |
| 1° 30'' | 724 | 708 | 1.95 | |
| 2° 00'' | 916 | 886 | 2.56 | |
| 2° 30'' | 1090 | 1048 | 3.15 | |
| 3° 00'' | 1251 | 1195 | 3.71 | |
| 3° 30'' | 1401 | 1330 | 4.25 | |
| 4° 00'' | 1539 | 1455 | 4.79 | |
| 5° 00'' | 1793 | 1680 | 5.83 | |
| 6° 00'' | 2019 | 1879 | 6.82 | |
| 7° 00'' | 2255 | 2057 | 7.78 | |
| 8° 00'' | 2414 | 2217 | 8.71 | |
| 9° 00'' | 2587 | 2363 | 9.60 | |
| 10° 00'' | 2749 | 2498 | 10.46 | |
| 15° 00'' | 3429 | | | |
| 20° 00'' | 3976 | | | |

The piece admits of 30 degrees elevation and 6 degrees depression. Its platform is a permanent portion of the fortification.

To serve the piece.

277. Eight men are necessary : one chief-of-detachment, one gunner, and six cannoneers.

The implements and equipments are arranged as follows :

- Truck handspikes (iron)... } Two on each side of the carriage, on hooks.
- Elevating-bar (iron)..... } Laid on the carriage over the rear notches, and perpendicular to the piece; handle to the left.
- Sponge..... } One yard behind the cannoneers of the right; supported upon a prop, the sponge and rammer-heads turned from the parapet and inclined slightly from the piece.
- Rammer }
- Pass-box..... One yard in rear of No. 4.

| | | |
|---------------------|---|--|
| Primer-pouch..... | } | Containing friction-primers and lanyard; suspended from ratchet-post. |
| Gunner's pouch.. .. | | Containing breech sight and priming-wire; suspended from ratchet-post. |
| Chocks (iron)..... | | One on each hurter. |
| Vent-cover..... | | Covering vent. |
| Tompion... .. | | In the muzzle. |
| Shell-hooks..... | | Behind and near No. 5. |
| Sponge-bucket..... | | Near sponge. |
| Budge-barrel..... | } | Containing cartridges; at a safe and convenient place near the piece. |

When several pieces are served together, there will be one *quadrant*, one *worm*, one *ladle*, one *hammer-wrench*, two *vent-punches*, one *gunner's pincers*, two *lanyards* (extra), and two *vent-gimlets* to each battery of not exceeding six pieces. These, together with the primers and fuses, are kept in the filling-room of the service magazine, where the shells are prepared for firing and brought to the piece as required.

The powder is kept in the service magazine.

The shells are strapped to sabots. The fuse-plug is of metal, and at the time of inserting the shell into the piece the paper or lead cap is pulled from the top of the water-cap. The solid shot are kept piled convenient to the piece. All the projectiles should be carefully cleansed of dirt, lumps of rust, or other protuberances before inserting in the gun. Stands of grape are also provided for occasional use, and are kept convenient to the piece.

To distribute the equipments.

278. The instructor commands :

1. TAKE EQUIPMENTS.

The gunner mounts upon the chassis; takes off the vent-cover, hands it to No. 2 to place against the parapet in rear of his post; gives the primer-pouch to No. 3, equips himself with his own pouch, and clears the vent. No. 4 mounts upon the chassis, takes the elevating-bar, and, under the direction of the gunner, adjusts the piece conveniently for loading and resumes his post, taking with him the bar, which he lays on the ground in rear of him, perpendicular to the piece. No. 3 equips himself with the primer-pouch. The handspikes, when not in use, remain on the hooks.

The instructor causes the service to be executed by the following commands :

1. FROM BATTERY.

279. The gunner places himself two paces in rear of the chassis and commands: **IN-GEAR.** Nos. 3 and 4 take handspikes from the hooks, embar in the eccentric sockets of the top-carriage, and, assisted by Nos. 5 and 6, throw the wheels in gear at the command **HEAVE** by the gunner. The gunner then commands: **EMBAR.** Nos. 3 and 4 withdraw their handspikes and insert them in the rear and uppermost mortises of the truck-wheels; Nos. 5 and 6 seize the handspikes with both hands above the hands of Nos. 3 and 4, all breaking to the rear with the foot nearest the carriage. The gunner then commands: **HEAVE.** Nos. 3, 4, 5, and 6, acting together, bear down upon the handspikes and move the carriage to the rear; Nos. 1 and 2 follow up with the chocks. The gunner commands: **EMBAR.** Nos. 5 and 6 let go the handspikes; Nos. 3 and 4 withdraw them, and embar as before. The gunner commands: **HEAVE,** which will be executed as before. The commands *embar* and *heave* will be repeated by the gunner until the face of the piece is about one yard from the parapet, when the gunner commands: 1. **HALT,** 2. **OUT-OF-GEAR.** Nos. 1 and 2 chock the wheels; Nos. 3 and 4 withdraw their handspikes, insert them in the eccentric sockets, and at the command **HEAVE** by the gunner throw the wheels out of gear, leaving the handspikes in the sockets. All resume their posts.

1. *By the numbers,* 2. **LOAD.**

280. No. 2 takes out the tompion, and places it by the parapet in rear of his post. The gunner mounts upon the chassis and closes the vent.

No. 1 turns to his left, steps over the sponge and rammer, faces the piece, takes the sponge-staff with both hands, backs down, the right hand three feet from the sponge-head, the left hand eighteen inches from it; returns to the piece, raising the sponge-staff over the crest of the parapet; places the left foot on the rail of the chassis, and the right foot upon the parapet, or upon a step placed for the purpose against it; inserts the sponge-head into the muzzle, the staff in prolongation of the bore, supported by the right hand, the right arm extended, the left hand hanging naturally by his side.

No. 2 takes a position on the left of the piece corresponding to that of No. 1 on the right, and seizes the staff with the left hand, back down, near to and outside the hand of No. 1.

No. 3 faces to his rear, steps over the rammer, and, facing

about, seizes the staff with both hands, as prescribed for No. 1 with the sponge; he then stands ready to exchange staves with No. 1.

No. 4, taking the pass-box, goes for a cartridge; returns and places himself, facing the piece, to the right and rear of No. 2.

No. 6, taking a handspike, goes for the shell, followed by No. 5 with the shell-hooks; No. 5 attaches the shell-hooks to the projectile, and No. 6 passes the handspike through the ring, or, if the shell is provided with a rope handle, through the loop of the handle; both seize the handspike, No. 5 in front, and, bringing the shell up on the left of the piece, place themselves parallel to the parapet, No. 5 behind and near No. 2.

In the meanwhile, Nos. 1 and 2 insert the sponge in the bore by the following motions, at the commands *two—three—four—five—six*:

TWO. They insert the sponge as far as the hand of No. 1, bodies erect, shoulders square.

THREE. They slide their hands along the staff and seize it at arm's-length.

FOUR. They force the sponge down as prescribed for *two*.

FIVE. They repeat what is prescribed for *three*.

SIX. They push the sponge to the bottom of the bore. No. 1 replaces the left hand on the staff, back up, six inches nearer the muzzle than the right; No. 2 places the right hand, back up, between the hands of No. 1; both numbers then change the other hand so as to seize the staff back up.

1. SPONGE.

281. Nos. 1 and 2, pressing the sponge firmly against the bottom of the bore, turn it three times from right to left, and three times from left to right; drop the hands farthest from the parapet by their sides, and withdraw the sponge by similar commands, but by motions contrary to those prescribed for inserting it.

No. 2 quits the staff, and, turning to No. 4, receives from him the cartridge, which he introduces into the bore; he then grasps the rammer in the way prescribed for the sponge.

In the meanwhile, No. 1, turning to his left, passes the sponge above the rammer to No. 3, and, receiving the rammer from No. 3, presents it as prescribed for the sponge, except that, retaining hold with his left hand, he rests the rammer-head against the right side of the face of the piece.

No. 3, as soon as the sponge is withdrawn, passes the rammer in front of No. 1 onto the parapet, receives the sponge from No. 1, replaces it upon the prop, and resumes his post.

No. 4 takes the cartridge from the pass-box and hands it to

No. 2, the choke to the front; returns the pass-box to its place, and resumes his post.

Nos. 1 and 2 force the cartridge home by the same commands and motions as in sponging.

1. RAM.

282. Nos. 1 and 2 slide their hands along the staff to the full extent of their arms, and, grasping it firmly, throw the weight of their bodies upon the staff to force the cartridge tightly home; No. 2 then quits the rammer, which No. 1 throws out and lays upon the parapet.

In the meantime, Nos. 5 and 6, carrying the shell as before prescribed, step between the parapet and the face of the piece; No. 6 gives his end of the handspike to No. 2; No. 5 gives his end to No. 1, and then places himself on the platform in front of the shell; Nos. 1 and 2 raise the shell until it is opposite the muzzle; No. 5, applying his hands under it, raises the sabot and inserts it into the muzzle; No. 5 then resumes his post; No. 2 withdraws the handspike and passes it to No. 6, who replaces it on the hooks and resumes his post; No. 2 passes the shell-hooks to No. 5, who replaces them.

Nos. 1 and 2, taking up the rammer, apply its head and force the shell down by commands and motions similar to those prescribed for the cartridge; at the command **RAM** it is *pressed* tightly down against the cartridge; No. 2 quits the rammer and resumes his post; No. 1 throws out the rammer, replaces it on the prop, and resumes his post.

As soon as No. 4 has delivered the cartridge, he mounts upon the chassis, embars through the ratchet-post with the elevating-bar, and, when the projectile is home, gives the piece an elevation of about 5 degrees,—this for the purpose of preventing the displacement of the projectile when the piece is run into battery; No. 4 replaces the elevating-bar and resumes his post; the gunner pricks, leaving the priming-wire in the vent.

1. IN BATTERY.

283. The gunner commands: **IN-GEAR.** Nos. 1 and 2 unchock the wheels and place the chocks on the hurters; Nos. 3 and 4 seize the handspike and, at the command **HEAVE** by the gunner, bear down slowly until the piece is in motion, regulating it by alternately throwing the wheels in and out of gear, or partially so. As soon as the carriage strikes the hurters, the gunner commands: 1. **OUT-OF-GEAR.** 2. **HEAVE.** Nos. 3 and 4 throw the wheels out of gear, withdraw their handspikes, replace them on the hooks, and resume their posts. If the carriage does not move when in gear, the gunner directs No. 3 to

slightly engage a handspike in a rear mortise of the truck-wheel and gently urge the carriage forward. Care must be exercised in this operation that the handspike does not fly forward with violence.

As soon as the carriage strikes the hurters, Nos. 1 and 2 lock the wheels with the toggles.

1. AIM.

284. The gunner commands: 1. **CHASSIS IN-GEAR**, 2. **HEAVE**. At the first command, Nos. 3 and 4 embar in the sockets of the eccentrics, and at the second command, assisted by Nos. 1 and 2, throw the chassis-wheels in gear, and, leaving the handspikes in the sockets, resume their posts; Nos. 5 and 6 embar in the traverse-wheels. The gunner withdraws the priming-wire, places the breech sight in the socket, and, sighting through it, gives the direction; Nos. 5 and 6 move the trail to the left or right at the command *left* or *right* from the gunner.

When the direction has been given, the gunner commands: 1. **CHASSIS OUT-OF-GEAR**, 2. **HEAVE**. At the first command, Nos. 1 and 2 seize the handspikes, and at the second throw the wheels out of gear, return the handspikes to their hooks, and resume their posts. Nos. 5 and 6 unbar, return their handspikes to the hooks, and resume their posts.

No. 3 passes the hook of the lanyard through the eye of a primer, holds the handle of the lanyard with the right hand, the hook between the thumb and forefinger, and stands ready to hand it to the gunner. No. 4 mounts upon the chassis and, embarring through the ratchet-post with the elevating-bar, raises or lowers the breech as directed by the gunner.

When the piece is correctly aimed, the gunner commands: **READY**, makes a signal with both hands, removes the breech sight with his left hand, and, receiving the primer from No. 3 in his right, inserts it in the vent, dismounts from the chassis, and goes where he can best observe the effect of the shot; Nos. 1 and 2 break off sideways with the foot farthest from the parapet; No. 3 drops the handle, allowing the lanyard to pass through his fingers, steps back obliquely three yards to the rear, and breaks off to his left and rear with the left foot, left hand hanging naturally by the side; No. 4 resumes his post, taking with him the elevating-bar, which he lays on the ground as before.

1. *Number one* (or the like), 2. **FIRE**.

285. No. 3, turning his face from the piece, pulls the lanyard quickly, but steadily, and fires. Immediately after the discharge, Nos. 1, 2, and 3 resume the erect position; No. 3 rewinds the lanyard and replaces it in the pouch. The gunner, having observed the effect of the shot, returns to his post.

To load without the numbers, and to fire.

As explained in *par.* 245.

To load and fire continuously, and to cease firing.

As explained in *pars.* 246 and 247.

To secure the piece.

As explained in *par.* 249.

To replace equipments.

286. Executed as in *par.* 250, except that the gunner replaces the pouches on the ratchet-post, instead of the knob of the cascade.

Note 1.—The piece may be fired with safety when the chassis is in gear. This part of the prescribed service may, therefore, be omitted.

2. The flooring-planks extend over but a portion of the chassis, making it exceedingly inconvenient to load the piece when in its proper position. To remedy this defect, cut boards to the proper length and fit them in crossways between the rails of the chassis, resting on the lower flanges of the rails.

3. Solid shot for this piece are without ears; they cannot, therefore, be carried by means of shell-hooks. The ladle for hot shot (sometimes to be found at posts) answers for carrying and lifting the shot to the muzzle.

SERVICE OF THE 100-POUNDER PARROTT.

287. The 100-pounder Parrott rifle is mounted on a carriage of similar construction to that of the 10-inch smooth-bore, and the service of it is nearly identical with the foregoing, except that, in bringing up the projectile, a rope strap is used instead of shell-hooks; and excepting, also, that in pointing, No. 4, instead of using an elevating-bar, assists the gunner in giving the elevation by means of the elevating screw.

Remarks.

288. All guns of the Parrott system are of cast-iron, reinforced at the seat of the charge by a wrought-iron jacket, which is shrunk on. The one, two, and three hundred pounders have no preponderance. The depth of grooves in all of them is 0.10 inch, with increasing twist.

The 300-pounder weighs 26,000 pounds; has 15 grooves. The 200-pounder weighs 16,300 pounds; has 11 grooves. The 100-pounder weighs 9,700 pounds; has 9 grooves. The charge for

the first is 25 pounds, for the second 16 pounds hexagonal, and for the third 10 pounds cannon powder.

Ranges : 100-pounder.

Charge : 10 pounds cannon powder. Projectile : Parrott shell, filled, 100 pounds. Initial velocity : 1.080 feet.

| | | | | | | | | | |
|--------|------------|-----------------|----------------|---------------------|--------|------------|-----------------|----------------|---------------------|
| RANGE. | ELEVATION. | TIME OF FLIGHT. | ANGLE OF FALL. | REMAINING VELOCITY. | RANGE. | ELEVATION. | TIME OF FLIGHT. | ANGLE OF FALL. | REMAINING VELOCITY. |
| Yards. | ' | Seconds. | ° | Ft.-secs. | Yards. | ' | Seconds. | ° | Ft.-secs. |
| 100 | 0 14 | 0.28 | 0 14 | 1066 | 1700 | 4 36 | 5.15 | 0 09 | 923 |
| 200 | 0 29 | 0.56 | 0 29 | 1053 | 1800 | 4 54 | 5.48 | 24 24 | 916 |
| 300 | 0 44 | 0.85 | 0 44 | 1041 | 1835 | 5 00 | 5.59 | 33 33 | 914 |
| 400 | 0 59 | 1.14 | 1 00 | 1029 | 1900 | 5 12 | 5.81 | 47 47 | 910 |
| 405 | 1 00 | 1.16 | 1 01 | 1029 | 2000 | 5 31 | 6.14 | 6 10 | 903 |
| 500 | 1 14 | 1.44 | 1 16 | 1019 | 2100 | 5 50 | 6.47 | 6 33 | 897 |
| 600 | 1 30 | 1.73 | 1 33 | 1009 | 2158 | 6 00 | 6.67 | 6 45 | 893 |
| 700 | 1 46 | 2.03 | 1 50 | 1000 | 2200 | 6 09 | 6.81 | 6 56 | 891 |
| 788 | 2 00 | 2.29 | 2 06 | 992 | 2300 | 6 28 | 7.15 | 7 19 | 885 |
| 800 | 2 02 | 2.33 | 2 08 | 991 | 2400 | 6 47 | 7.49 | 7 42 | 879 |
| 900 | 2 18 | 2.63 | 2 26 | 983 | 2470 | 7 00 | 7.73 | 7 59 | 875 |
| 1000 | 2 34 | 2.94 | 2 44 | 974 | 2500 | 7 07 | 7.83 | 8 08 | 873 |
| 1100 | 2 51 | 3.25 | 3 03 | 966 | 2600 | 7 27 | 8.18 | 8 34 | 867 |
| 1151 | 3 00 | 3.41 | 3 13 | 962 | 2700 | 7 47 | 8.53 | 9 00 | 861 |
| 1200 | 3 08 | 3.56 | 3 22 | 959 | 2767 | 8 00 | 8.76 | 9 13 | 857 |
| 1300 | 3 25 | 3.87 | 3 41 | 951 | 2800 | 8 07 | 8.88 | 9 26 | 855 |
| 1400 | 3 42 | 4.19 | 4 00 | 944 | 2900 | 8 27 | 9.23 | 9 52 | 850 |
| 1500 | 4 00 | 4.51 | 4 21 | 937 | 3000 | 8 48 | 9.58 | 10 18 | 844 |
| 1500 | 4 00 | 4.51 | 4 21 | 937 | 3056 | 9 00 | 9.78 | 10 32 | 841 |
| 1600 | 4 18 | 4.83 | 4 42 | 930 | 3100 | 9 09 | 9.94 | 10 47 | 839 |

289. When a gun, mounted on an iron carriage, is loaded, and it is not desired to fire it, the projectile may be withdrawn by running the piece from battery, depressing the muzzle as far as possible, and then allowing it to run into battery against the hurters, thus jarring the projectile forward.

The cartridge is withdrawn with the worm; should it burst, the powder is scooped out with the ladle.

290. In all carriages for heavy guns, when no means for checking the recoil are provided, the rails should be sanded, but the sand should be free from gravel.

SERVICE OF A 10-INCH SMOOTH-BORE GUN IN CASEMATE.

Description of piece.

Identical with the same gun in barbette, as given in *par.* 276.

Carriage, wrought-iron (chassis and top); front pintle; without air-cylinders or other recoil check. Weight of top-carriage, 1500 pounds; weight of chassis, 3000 pounds.

The piece, when in battery, in the ordinary casemate embrasure, admits of 7 degrees elevation and 6 degrees depression.

The new-pattern carriage and chassis will be provided with air-cylinders. The former will weigh 1459 pounds; the latter, 5310 pounds.

The ranges are identical with the same gun in barbette. (*Par.* 276.) The ammunition is the same, and is kept and served in the same manner. (*Par.* 277.)

To serve the piece.

291. Eight men are necessary: one chief-of-detachment, one gunner, and six cannoneers. The implements and equipments are arranged as specified in *par.* 277.

To distribute the equipments.

292. The instructor commands:

1. TAKE EQUIPMENTS.

The gunner steps to the side of the chassis, takes off the vent-cover, hands it to No. 2 to place against the scarp in rear of his post, gives the primer-pouch to No. 3, equips himself with his own pouch, and clears the vent. No. 4 mounts upon the chassis, takes the elevating-bar and, under the direction of the

gunner, adjusts the piece conveniently for loading, and resumes his post, taking with him the bar, which he lays on the pavement in rear of his post, perpendicular to the piece.

No. 3 equips himself with the primer-pouch. The handspikes, when not in use, remain on the hooks.

To serve the piece.

The instructor commands :

1. FROM BATTERY.

Executed as in *par.* 279.

1. *By the numbers*, 2. LOAD.

Executed as in *par.* 280, except that Nos. 1 and 3 pass the sponge and rammer staves into the embrasure, instead of over the crest of the parapet.

1. SPONGE.

Executed as in *par.* 281.

1. RAM.

Executed as in *par.* 282, except that No. 1 lays the rammer-staff upon the sole of the embrasure, instead of on the parapet.

1. IN BATTERY.

Executed as in *par.* 283.

1. AIM.

Nos. 5 and 6 embar in the rear traverse-wheels. The gunner, mounting upon the chassis, withdraws the priming-wire, places the breech sight in the socket, and gives the direction. Nos. 5 and 6 will, when necessary, be assisted by Nos. 1 and 2.

The remaining operations of pointing are as explained in *par.* 284.

1. *Number one* (or the like), 2. FIRE.

Executed as in *par.* 285.

To load without the numbers, and to fire.

To load and fire continuously, and to cease firing, and to secure the piece.

All executed as in *pars.* 245, 246, 247, and 286.

SERVICE OF A 15-INCH GUN MOUNTED ON A CENTRE-PINTLE CARRIAGE.

Description of piece.

293. Gun, cast-iron ; muzzle-loader ; smooth-bore.

| DESIGNATION. | No. | LBS. | INCH. |
|---|-------|--------|-------|
| Calibre..... | | | 15 |
| Weight..... | | 49,000 | |
| Preponderance | | 00 | |
| Length of piece..... | | | 190 |
| Length of bore (calibres)..... | 11 | | |
| Maximum diameter..... | | | 48 |
| Minimum diameter..... | | | 25 |
| Windage..... | | | 0.13 |
| Charge (mammoth or hexagonal powder) for shot..... | | 100 | |
| “ for shell..... | | 60 | |
| Solid shot..... | | 450 | |
| Shell (unfilled)..... | | 330 | |
| Initial velocity (feet)..... | 1,534 | | |
| Weight of top-carriage | | 5,800 | |
| Weight of chassis | | 15,450 | |
| Carriage—wrought-iron (chassis with two air-cylinders to check recoil)..... | | | |

RANGES IN YARDS.

| SHOT. | | SHELL. | | | | |
|------------|--------|------------|--------|-----------------|--|--|
| Elevation. | Range. | Elevation. | Range. | Time of flight. | CHARGE. | |
| Deg's. | Y'rds. | Deg's. | Y'rds. | Secs. | | |
| 1 | 769 | 1 | 600 | 1.44 | 100 pounds of mammoth powder for solid shot, and 60 pounds for shell. | |
| 2 | 1332 | 2 | 1073 | 2.79 | | |
| 3 | 1819 | 3 | 1467 | 4.1 | | |
| 4 | 2235 | 4 | 1800 | 5.28 | | |
| 5 | 2601 | 5 | 2094 | 6.44 | | |
| 6 | 2926 | 6 | 2355 | 7.58 | To fill shell: 12 pounds of mortar powder. | |
| 7 | 3221 | 7 | 2590 | 8.67 | | |
| 8 | 3491 | 8 | 2804 | 9.68 | Pressure per square inch, average, 19,500 pounds. | |
| 9 | 3735 | 9 | 3000 | 10.69 | | |
| 10 | 3959 | 10 | 3171 | 11.63 | Length of cartridge : 100 pounds=30 inches. 60 pounds=18 inches. | |
| 15 | 4890 | 15 | 3916 | 16.30 | | |
| 20 | 5579 | 20 | 4458 | 20.52 | | |

The piece admits of 25 degrees elevation and 6 degrees depression. The platform is a permanent portion of the work.

To serve the piece.

294. Twelve men are required: one chief-of-detachment, one gunner, and ten cannoneers.

The implements and equipments are arranged as follows:

| | | |
|--|-----------------------------|---|
| Counterpoise handspikes (iron)..... | } | One on each side of piece, attached to socket on front axle by a set-screw. A rope is attached to the small end of these handspikes for heaving on when running the piece from battery. When not in use, the free end of the rope is hung by an eye to a hook on the cheek of the carriage. |
| Truck handspikes (iron)... | | Two on each side of piece; on hooks upon the sides of the chassis. |
| Elevating-bar (iron) | } | Lying on the carriage, upon the rear notches, and perpendicular to the piece, handle to the left. |
| Sponge..... | | } |
| Rammer | Two yards in rear of No. 7. | |
| Pass-box..... | } | Containing friction - primers and lanyard; hung on step of the ratchet-post. |
| Primer-pouch..... | | |
| Gunner's pouch..... | One on each hurter. | |
| Chocks (iron)..... | | Covering vent. |
| Vent-cover..... | | In muzzle. |
| Tompion | | Two yards in rear of No. 10. |
| Carrying-bar (wood)..... | | Two yards in rear of No. 4. |
| Shell-hooks | | Near sponge. |
| Sponge-bucket | } | Attached to the crane. |
| Differential pulley, — or blocks and tackle..... | | |

There not being sufficient space for them when the carriage

runs from battery, neither handspikes, elevating-bar, nor any equipments will be placed on the floor-boards of the chassis.

When several pieces are served together, there will be one *quadrant*, one *worm*, one *ladle*, one *hammer-wrench*, two *vent-punches*, one *gunner's pincers*, two *lanyards* (extra), and two *vent-gimlets* to each battery of not exceeding six pieces. These will be kept in the filling-room of the service magazine.

The cartridges are in the service magazine, and are brought to the piece as wanted. The shells are in the filling-room of the service magazine, and are likewise brought up when required. The shells are strapped to sabots. The fuse-plugs are of metal, and at the time of inserting the shell into the piece the paper cap should be pulled from the top of the fuse-primer. The solid shot are kept convenient to the piece. The projectiles should be carefully freed from dirt, lumps of rust, or any other protuberances that might prevent their easy insertion into the bore of the piece.

To distribute the equipments.

295. The instructor commands :

1. TAKE EQUIPMENTS.

The gunner mounts upon the chassis, takes off the vent-cover, hands it to No. 2, who places it against the parapet, near his post; gives the primer-pouch to No. 3, equips himself with his own pouch, and clears the vent; Nos. 1 and 2 remove the plugs from the front ends of the air-cylinders.

Nos. 5 and 6 hook the ropes to the counterpoise handspikes, and, securing the free end to the hooks on the cheeks, mount upon the chassis. Under the direction of the gunner, No. 6 takes the elevating-bar, embars with it through the ratchet-post, and, assisted by No. 5, gives the piece an elevation of about one degree; replaces the elevating-bar, and, together with No. 5 and the gunner, resumes his post.

The service of the piece is executed as follows. The instructor commands :

1. FROM BATTERY.

296. The gunner mounts upon the chassis, and commands :
IN-GEAR.

Nos. 3 and 4 adjust the pawls of the counterpoise handspikes so that they will clear the ratchets of the truck-wheels; Nos. 5 and 6 take down the ropes and raise the handspikes until Nos. 3 and 4 engage the pawls in the ratchets.

In the meanwhile, Nos. 9 and 10 insert each a handspike into the sockets of the rear truck-wheels, and, mounting upon the

steps of the chassis, unlock the rear axle, and at the command **HEAVE** from the gunner, assisted by Nos. 7 and 8, throw the rear truck-wheels in gear.

Nos. 9 and 10 relock the axle, and return the handspikes to the hooks.

The gunner then commands: **EMBAR**.

Nos. 5 and 6 raise the counterpoise handspikes until nearly vertical, when Nos. 3 and 4 engage the pawls into the ratchets.

Nos. 3 and 5 seize the counterpoise handspikes, and Nos. 7 and 9 the ropes on the right of the piece; and Nos. 4, 6, 8, and 10 apply themselves, in like manner, upon the left. All take hold from front to rear in the ascending order of their numbers.

At the command **HEAVE** from the gunner, the handspikes are forced down, and the top-carriage moves a short distance to the rear.

Nos. 1 and 2 follow up the movement and keep the wheel-chocks closely applied to the wheels. The gunner gives alternately the commands *embar* and *heave*, until the muzzle of the piece is over the front part of the chassis; he then commands: **HALT**. At this command, Nos. 3 and 4 clear the pawls from the ratchets, and Nos. 5 and 6 raise the handspikes and secure the ropes to the hooks.

The gunner then commands: **OUT-OF-GEAR**. Nos. 9 and 10 mount upon the steps of the chassis, unlock the axle, and, at the command **HEAVE** from the gunner, throw the wheels out of gear, and, leaving the handspikes in the sockets, resume their posts.

1. *By the numbers*, 2. **LOAD**.

297. Nos. 1 and 2 mount upon the front of the chassis and upon the steps of the parapet wall; No. 2 removes the tompion and hands it to No. 4, who places it against the parapet, in rear of the post of No. 2.

No. 3 brings up the sponge, passes it to No. 1, and mounts upon the steps of the parapet wall, outside of No. 1, to assist Nos. 1 and 2 in sponging and ramming. The sponge-head is inserted in the muzzle.

No. 5, bringing up the rammer behind No. 1, stands ready to hand it to No. 3, and to take the sponge from No. 3 after the sponging is completed.

Nos. 7 and 9, taking the pass-box, go for the cartridge; Nos. 4, 6, 8, and 10 go for the projectile, No. 4 carrying the shell-hooks and No. 10 the carrying-bar. In returning, the projectile is brought up on the left of the piece, No. 4 in advance and the other numbers in their order in rear. The cartridge, in the pass-box, is brought up on the right of the piece.

The projectile is placed under the crane; the carrying-bar returned to its place by No. 10, who then resumes his post; the pulley is attached to the shell-hooks by No. 4; Nos. 6 and 8 run up the projectile, No. 4 steadying it. In the meanwhile—the gunner stopping the vent—the sponging is executed by Nos. 1 and 2, assisted by No. 3, at commands from the instructor of *two—three—four*, &c.

TWO. Insert the sponge as far as the hand of No. 1, bodies erect, shoulders square.

THREE. Slide the hand along the staff and seize it at arm's-length.

FOUR. Force the sponge down as prescribed for *two*.

FIVE. Repeat what was done at *three*.

SIX. Push the sponge to the bottom of the bore. No. 1 seizes the staff with the left hand, back up, six inches nearer the muzzle than the right; No. 2 places the right hand, back up, between the hands of No. 1; both then change their other hands so as to grasp the staff with backs up.

1. SPONGE.

298. Nos. 1, 2, and 3, pressing the sponge firmly against the bottom of the bore, turn it three times from right to left, and three times from left to right. The sponge is withdrawn at the commands *two—three—four—five*, &c., by motions contrary to those prescribed for inserting it. As soon as the sponge is withdrawn, No. 3, turning towards the left, passes the sponge, with both hands, behind No. 1 to No. 5, and receives from him the rammer; Nos. 1 and 2 take the cartridge from Nos. 7 and 9, and insert it in the bore; Nos. 7 and 9 replace the pass-box and resume their posts; No. 5 replaces the sponge on the prop and resumes his post; as soon as the cartridge is inserted, No. 3 places the rammer-head against it in the bore. The cartridge is forced down by Nos. 1, 2, and 3, at the commands and by the motions prescribed for the sponge.

1. RAM.

299. The cartridge is set home by strong pressure, *not by a blow*; Nos. 1 and 3 throw out the rammer; No. 2, quitting the staff, assists No. 4 in swinging the crane round to bring the projectile in front of the muzzle; the rammer-head is placed against the projectile, which is pushed into the bore by Nos. 1, 2, 3, and 4; No. 4 withdraws the shell-hooks, and resumes his post; Nos. 1, 2, and 3 force the projectile home by motions and commands as explained for the cartridge; Nos. 6 and 8 swing the crane back; secure it and the pulley against the cheek; No.

8 resumes his post, and No. 6 mounts upon the chassis. The rammer is thrown out and passed by No. 3 to No. 5, who places it on the prop; Nos. 1, 2, 3, and 5 then resume their posts. The gunner, assisted by No. 6, gives the piece an elevation of about five degrees, after which he pricks the cartridge, leaving the priming-wire in the vent. No. 6 resumes his post.

1. IN BATTERY.

300. The gunner commands: **IN-GEAR.** Nos. 1 and 2 unchock the wheels; Nos. 3 and 4 see that the handspike pawls are clear of the ratchets; Nos. 9 and 10 mount upon the steps, unlock the axle, seize the rear handspikes, and, at the command **HEAVE** by the gunner, bear down slowly (assisted if necessary by 7 and 8) until the piece is in motion, and regulate it by alternately throwing the wheels in and out of gear sufficiently for that purpose. The front wheels are not chocked by Nos. 1 and 2 unless the gunner so directs. As soon as the carriage strikes the hurter, the gunner commands: 1. **OUT-OF-GEAR**, 2. **HEAVE.** Nos. 9 and 10 throw the wheels out of gear, secure the axle with the pawl, and, returning the handspikes to the hooks on the chassis, resume their posts.

Should the carriage not move when the wheels are thrown in gear, the gunner directs Nos. 3, 4, 5, and 6 to lower the handspikes and engage the upper arm of the handspike pawl in the ratchet, and by raising the handspike urge the piece forward.

1. AIM.

301. The gunner commands: 1. **CHASSIS IN-GEAR**, 2. **HEAVE.** Nos. 7 and 8 take the handspikes, embar in the sockets of the eccentrics of the chassis, and, assisted by Nos. 9 and 10, throw the wheels in gear; they then embar with the same handspikes in the mortises of the *rear* set of the front traverse-wheels; Nos. 1 and 2 embar in the *front* set; Nos. 5 and 6 mount on the chassis to assist the gunner in giving the elevation; No. 3 passes the hook of the lanyard through the eye of a primer, and stands ready to hand it to the gunner.

The gunner places the breech sight in the socket, and, sighting through it, gives the direction, commanding: **MUZZLE RIGHT**, or **MUZZLE LEFT**, for Nos. 1, 2, 7, and 8 to traverse the chassis to the right or to the left.

The direction being given, the gunner commands: 1. **CHASSIS OUT-OF-GEAR**, 2. **HEAVE.** At the first command, Nos. 1 and 2 return their handspikes to their hooks and resume their posts; Nos. 7 and 8 embar in the sockets of the eccentrics of the chassis, and, assisted by Nos. 9 and 10, at the command

heave throw the chassis out of gear; Nos. 7 and 8 then replace their handspikes, and, with Nos. 9 and 10, resume their posts.

Note.—The piece can be fired with safety when the chassis is in gear. The omission of this part of the exercise saves much time and labor.

The gunner next causes No. 6, assisted by No. 5, to give the required elevation to the piece, and commands: **READY**. Nos. 5 and 6 resume their posts, No. 6 taking with him the elevating-bar, which he places in rear of him on the ground, perpendicular to the piece. The gunner withdraws the priming-wire, receives the primer from No. 3, inserts it in the vent, takes the breech-sight with him, and goes where he can best observe the effect of the shot.

The chief-of-detachment, or in his absence the gunner, then commands: **1. DETACHMENT REAR, 2. MARCH**. At the first command, the cannoneers, except No. 3, face from the epauletment, and, at the command *march*, they march to the rear as explained in *par.* 113; No. 3 drops the handle, allowing the lanyard to pass through his fingers, and steps back three yards obliquely from the piece, breaks off with his left foot to his left and rear, the left hand by the side.

1. *Number one* (or the like), 2. **FIRE**.

302. No. 3, turning his face from the piece, pulls the lanyard quickly, but steadily, and fires; immediately after the discharge he resumes the erect position; rewinding his lanyard, returns it to his pouch and joins his detachment. The gunner, having observed the effect of the shot, returns to his post.

As soon as the piece is discharged, unless otherwise directed, the cannoneers resume their posts by command of the chief-of-detachment, or in his absence the gunner: **1. Cannoneers to your posts, 2. Right, 3. FACE, 4. MARCH**. Executed as explained in *par.* 108.

To load without the numbers, and to fire.

303. Executed as prescribed in *par.* 245.

To load and fire continuously, and to cease firing.

304. Executed as explained in *pars.* 246 and 247.

When the piece is loaded, and it is not desired to fire it, the charge is withdrawn as explained in *par.* 289.

To secure the piece.

305. Executed as explained in *par.* 286, adding:

The gunner hangs the pouches on the ratchet-post, Nos. 1 and

2 replace the plugs in the front ends of the air-cylinders, and Nos. 5 and 6 detach the ropes from the handspikes.

SERVICE OF A 15-INCH GUN MOUNTED ON A FRONT-PINTLE CARRIAGE.

Description of piece.

306. This piece is identical with the same gun mounted on a *centre-pintle* carriage. (*Par.* 293.)

The top-carriage is the same in both cases; the chassis alone differs.

Weight of front-pintle chassis, including geared traverse-wheels, 17,000 pounds.

There are two kinds of geared traverse-wheels, differing, however, only in height and weight. The axis of the trunnions of the gun mounted on the highest is 8 feet 5.25 inches above the pintle-block, and 10 feet 11.25 inches above the terre-plein. Upon the other carriage it is 7 feet 2.25 inches above the pintle-block, and 9 feet 5.25 inches above the terre-plein.

The piece admits of 25 degrees elevation and 6 degrees depression.

The platform is a permanent part of the work.

The ranges are as given in *par.* 293.

The same number of men are required as for the gun mounted on a *centre-pintle* carriage. The implements and equipments are likewise the same.

Service of the piece.

307. Executed as for the *centre-pintle* carriage (*pars.* 295 to 305), except as follows :

1st. After what is prescribed under the head *ram* has been completed, and before the piece is run into battery, the gunner commands: 1. CHASSIS IN-GEAR, 2. HEAVE. At the first command, Nos. 3 and 4 embar with the handspikes in the sockets of the chassis eccentrics, and at the second command, assisted by Nos. 1, 2, 7, and 8, throw the wheels in gear.

2d. At the command *aim*, the direction is given (under the direction of the gunner) by Nos. 7, 8, 9, and 10, who man the cranks of the geared traverse-wheels. At the command CHASSIS OUT-OF-GEAR, HEAVE, the chassis is thrown out of gear by Nos. 1, 2, 3, 4, 7, and 8, Nos. 3 and 4 embar with the handspikes.

The piece is then run into battery as explained in *par.* 300;

after which the elevation is given as explained in same paragraph.

Note.—The piece can be fired with safety when the chassis is in gear. The omission of this part of the exercise saves much time and labor.

Remarks.

308. The foregoing instructions, for both the front and the centre pintle carriages, are for those of the most recent model. There are, however, in service, various patterns,—steps in improvement,—the chief difference between them being in the arrangement of the means for running the piece from and into battery. Only slight modifications in the foregoing instructions are necessary to adapt them to any of the patterns, and these will readily suggest themselves to the instructor.

The front axle of the top-carriage is not eccentric; the rear one is. The front part of the sole of each shoe is cut away to a point a few inches in rear of the front axle, and to a depth of about half an inch. When the rear wheels are out of gear, the front wheels do not touch the chassis rails; but when the rear wheels are thrown into gear, the rear part of the carriage is slightly raised, and the front part of the carriage is, in consequence of the soles being cut away, lowered; the front wheels then touch the chassis rails and support the weight of the front part of the carriage, and the whole moves with rolling friction upon the front and rear truck-wheels. The wheels are out of gear when the gun is fired; the recoil is then on sliding friction.

The front axle is furnished, at each end, with a brass sleeve, to which the counterpoise handspike is firmly attached. A pawl is attached to the handspike, and engages into ratchets in the truck-wheels. Bearing down upon the handspikes forces the wheels to turn, and communicates motion to the carriage.

The handspike pawls are engaged in the ratchet of the truck-wheels only when it is desired to give motion to the carriage; at all other times they must be kept clear of the ratchets. This is accomplished by a spring catch attached to each one, and manipulated by Nos. 3 and 4 on their respective sides. To prevent the rear truck-wheels of the carriage from working out of gear while the gun is being run from battery, or jumping in gear when the gun is fired, pawls are provided for locking the rear axle. The elevation is given by means of the elevating arc.

With a well-instructed detachment, the 15-inch gun can be fired twelve times in an hour, allowing time for deliberate pointing.

The carriage and chassis for the front and centre pintle have the same dimensions, viz.:

| | |
|-----------------------------------|-------------------|
| Length of chassis..... | 19 feet 7 inches. |
| Width of chassis..... | 5 feet 2 inches. |
| Depth of chassis rail..... | 1 foot 8 inches. |
| Length of carriage..... | 8 feet 8 inches. |
| Inclination of chassis rails..... | 3 degrees. |

SERVICE OF A 24-POUNDER HOWITZER MOUNTED ON A FLANK-CASEMATE CARRIAGE.

(Fig. 2, Plate 8.)

DESCRIPTION OF PIECE.

309. Howitzer, cast-iron; smooth-bore; chambered; muzzle-loader.

| DESIGNATION. | NO. | LBS. | INCH. |
|--|-------|-------|-------|
| Calibre | | | 5.8 |
| Weight | | 1475 | |
| Preponderance | | 70 | |
| Length of piece..... | | | 69 |
| Length of bore (in calibres)..... | 9.15 | | |
| Length of chamber..... | | | 4.75 |
| Diameter of chamber..... | | | 4.62 |
| Windage..... | | | 0.14 |
| Charge (cannon powder)..... | | 2 | |
| Shell (empty)..... | | 16 | |
| Weight of canister..... | | 20.5 | |
| Carriage (top and chassis), wooden; without recoil checks..... | | | |

RANGES IN YARDS.

| ELEVATION. | SHELL. | CASE SHOT. | TIME. | CHARGE 2 LBS. |
|------------|--------|------------|-------------------------------|---|
| 0° 0' | 295 | | | Canister is used for sweeping the ditch in front of the curtain; and for this the piece should be depressed 1 to 2 degrees. |
| 1° 0' | 516 | | | |
| 2° 0' | | 600 | 2 ¹ / ₂ | |
| 3° 30' | | 880 | 3 ¹ / ₂ | |
| 5° 0' | 1322 | | | |
| 5° 30' | | 1050 | 4 ¹ / ₂ | |

The piece admits of 7 degrees elevation and 9 degrees depression. The platform is a permanent part of the work.

To serve the piece.

Four men are necessary : one chief-of-detachment, one gunner, and two cannoneers.

The implements and equipments are arranged as follows :

| | |
|----------------------------|---|
| Roller handspike (iron)... | } Leaning against the scarp wall, behind No. 2. |
| Sponge and rammer..... | } Leaning against the scarp wall, behind No. 1; the rammer-head upon the pavement. |
| Gunner's pouch..... | } Containing breech sight, chalk and chalk-line, and priming-wire; suspended from knob of cascable. |
| Cartridge-pouch..... | Suspended from knob of cascable. |
| Primer-pouch..... | } Containing primers and two lanyards; suspended from knob of cascable. |
| Sponge-bucket..... | Behind and near No. 1. |
| Vent-cover..... | Covering the vent. |
| Tompion..... | In the muzzle. |
| Budge-barrel..... | } Containing cartridges; at the safest and most convenient place near the piece. |

When several pieces are served together, there will be one *worm*, one *ladle*, one *hammer-wrench*, two *vent-punches*, two *vent-gimlets*, and one *gunner's pincers* to each battery of not exceeding six pieces. These will be kept in the filling-room of the service magazine.

The rounds of canister are arranged against the scarp wall, behind No. 2. The shells are at the filling-room of service magazine, or other safe position, and are brought as required to the place prescribed for the budge-barrel. They are strapped to sabots. The fuse-plug is of wood.

To cause the equipments to be distributed.

310. The instructor commands :

1. TAKE EQUIPMENTS.

The gunner equips himself with his own pouch; gives the primer-pouch to No. 1 and the cartridge-pouch to No. 2; takes off the vent-cover, and places it against the scarp wall beside the canister; applies his level to ascertain the highest point at the breech and muzzle, and, with the assistance of No. 2, snaps

the chalk-line to mark the line of metal; clears the vent; takes the roller handspike in the right hand, and resumes his post, holding the handspike vertically by the right side, its lower end on the pavement, the arm extended naturally.

No. 1 equips himself with the primer-pouch. No. 2 equips himself with the cartridge-pouch, which he wears from the left shoulder to the right side.

The service of the piece is executed by the following commands from the instructor :

1. FROM BATTERY.

311. The gunner, embarring in the left mortise, presses the roller under the rear transom, and, holding down the handspike with his right hand, seizes the left handle with the left; Nos. 1 and 2 lay hold of the manœuvring rings and handles.

All being ready, the gunner commands: **HEAVE**, and the carriage is run to the rear until the face of the piece is about one yard from the wall, when, disengaging the roller, he commands **HALT**, leaving the handspike in the socket. All resume their posts.

1. *By the numbers*, 2. **LOAD**.

312. The gunner places himself at the breech; breaks to the rear with the right foot; closes the vent with the second finger of the right hand, and manages the elevating screw with the left.

No. 2 removes the tompon and places it against the scarp, near his post.

No. 1 seizes the sponge-staff at its middle, brings it across his body, plants the left foot opposite the muzzle, close to the carriage, and breaks off with the right foot; at the same time throwing the sponge-staff into the left hand, back down, and extending both hands towards the ends of the staff, enters the rammer-head into the embrasure, introduces the sponge into the muzzle, and drops the left hand by the side. He then forces the sponge to the bottom of the chamber with three motions, at the commands **TWO—THREE—FOUR**.

No. 2 goes for a cartridge and returns to his post. If shells are used, he brings a shell at the same time.

1. **SPONGE**.

313. No. 1, using both hands, backs up, sponges the chamber carefully, withdraws the sponge, pressing it against the lower surface of the bore; turns it over, stepping to his left for this purpose, and rests the rammer-head against the right side of the

face of the piece, back of the right hand down, that of the left up. No. 2 introduces the cartridge. No. 1 sets it home by the same commands and motions as for sponging.

1. RAM.

314. No. 1, throwing the weight of his body on the staff, forces the cartridge tightly home and throws out the rammer, holding it as before, the rammer-head against the right side of the face of the piece.

No. 2 introduces the canister or shell, and resumes his post.

No. 1 sets the canister or shell home with care; throws out the rammer, replaces it, and resumes his post.

The gunner, rising up, pricks, leaving the priming-wire in the vent, and resumes his post.

1. IN BATTERY.

315. All apply themselves to the carriage as prescribed in *par.* 311, and ease the piece into battery. As soon as it touches the hurters, the gunner commands: **HALT**, and all resume their posts.

1. AIM.

316. No. 1 makes ready a primer; No. 2 goes to the rear of the chassis, and takes hold of it to traverse it. The gunner withdraws the priming-wire; aims the piece, directing No. 2 to traverse it to the right or left; gives the command **READY**, making a signal with both hands, at which No. 2 resumes his post; takes with him the roller handspike and resumes his post. No. 1 inserts the primer in the vent and steps back obliquely three yards to the rear, and breaks off with the left foot to his left and rear.

1. *Number one* (or the like), 2. **FIRE**.

317. No. 1, turning his face from the piece, pulls the lanyard and fires it; he then resumes his post.

To load without the numbers, and to fire.

To load and fire continuously, and to cease firing.

To secure the piece.

Executed as explained for the siege gun, in *pars.* 245, 246, and 247.

Remarks.

318. In repelling assaults, double charges of canister are used; the charge of powder remaining the same.

The effective range of canister is not over four hundred yards.

SERVICE OF AN 8-INCH RIFLE (CONVERTED).

Description of gun.

(Fig. 2, Plate 3.)

319. This piece is composed, essentially, of two parts: the *case, f*, which is the 10-inch smooth-bore (described in *par.* 276) bored up to a diameter of 13.5 inches, and a *lining-tube* of coiled wrought-iron.

The tube consists of two parts, called, respectively, the A and B tubes. The former extends the entire length of the bore, and contains the rifling; the latter, or B tube, is shrunk upon the inner, or A tube, which has its exterior portion cut away for that purpose. A double tube is thus formed, extending 32.75 inches from the rear end. The two tubes, united in this manner, have the same exterior diameter throughout the entire length, and are made to fit accurately the bore of the cast-iron casing.

The bottom of the tube is closed with a wrought-iron cup-shaped plug, *p*, screwed into the A tube. The tube is inserted into the casing from the muzzle, and is secured from working out by a muzzle-collar, *s*, screwed in at the face of the piece; and from turning in the casing by a steel pin, *t*, tapped through the casing and into the tube.

A shallow and narrow gas-channel is cut spirally around the exterior of the reduced portion of the A tube, communicating with star-grooves cut in the end of the barrel, and with the gas-escape, or *indicator*, bored obliquely through the breech of the casing opposite the vent.

Should the inner tube split, under the action of firing, the fact would be indicated by the escape of gas through this hole, and timely warning thus be given of the injury sustained by the gun.

The rifling consists of fifteen lands and grooves, each of equal width, viz.: 0.8377 inches. Depth of grooves: 0.075 inches. Twist: uniform, one turn in 40 feet.

There is no chamber proper to the gun. The rifling stops at a point 10 inches from the bottom of the bore, the diameter of the unrifled portion being equal to that of the rifled portion across lands.

The old vent of the case is closed by a wrought-iron screw-plug, and 2.75 inches nearer the muzzle a new one is bored parallel to the vertical plane through the axis of the bore, and distant therefrom 2.5 inches. The axis of the vent enters the bore at 3.5 inches from the bottom.

| | |
|-------------------------|----------------|
| Length of bore..... | 117.25 inches. |
| Weight of piece..... | 16,160 pounds. |
| Counter-ponderance..... | 630 pounds. |

It has been found that the 10-inch carriage, upon which this piece is mounted, is not sufficiently stout to stand many discharges with a charge of 35 pounds.

Charges of 25 pounds will penetrate any wooden ship at ordinary ranges, but are of no effect against iron-clads. The carriages will stand this charge without serious damage.

Ranges.

Charge : 25 pounds hexagonal powder.

| RANGE. | ELEVATION. | TIME OF FLIGHT. | ANGLE OF FALL. | REMAINING VELOCITY. | DRIFT. | RANGE. | ELEVATION. | TIME OF FLIGHT. | ANGLE OF FALL. | REMAINING VELOCITY. | DRIFT. |
|--------|------------|-----------------|----------------|---------------------|--------|--------|------------|-----------------|----------------|---------------------|--------|
| Yds. | ° / | Secs. | ° / | Ft. sec. | Yds. | Yds. | ° / | Secs. | ° / | Ft. sec. | Yds. |
| 100 | 0 11 | 0.25 | 0 11 | 1184 | 1.04 | 1900 | 4 20 | 5.33 | 4 55 | 979 | 4.59 |
| 200 | 0 23 | 0.51 | 0 23 | 1168 | 0.07 | 2000 | 4 36 | 5.64 | 5 14 | 972 | 5.13 |
| 300 | 0 35 | 0.77 | 0 35 | 1152 | 0.12 | 2100 | 4 52 | 5.95 | 5 34 | 965 | 5.70 |
| 400 | 0 47 | 1.03 | 0 48 | 1138 | 0.19 | 2155 | 5 00 | 6.12 | 5 45 | 962 | 6.01 |
| 495 | 1 00 | 1.28 | 1 02 | 1124 | 0.28 | 2200 | 5 08 | 6.26 | 5 54 | 959 | 6.30 |
| 500 | 1 00 | 1.29 | 1 02 | 1123 | 0.28 | 2300 | 5 24 | 6.57 | 6 14 | 952 | 6.93 |
| 600 | 1 13 | 1.56 | 1 16 | 1109 | 0.40 | 2400 | 5 40 | 6.89 | 6 34 | 946 | 7.59 |
| 700 | 1 26 | 1.83 | 1 31 | 1096 | 0.55 | 2500 | 5 57 | 7.21 | 6 56 | 939 | 8.29 |
| 800 | 1 39 | 2.11 | 1 46 | 1082 | 0.73 | 2521 | 6 00 | 7.29 | 7 01 | 938 | 8.43 |
| 900 | 1 53 | 2.39 | 2 02 | 1070 | 0.94 | 2600 | 6 14 | 7.53 | 7 18 | 933 | 9.03 |
| 949 | 2 00 | 2.52 | 2 09 | 1064 | 1.06 | 2700 | 6 31 | 7.85 | 7 40 | 927 | 9.80 |
| 1000 | 2 07 | 2.67 | 2 18 | 1058 | 1.18 | 2800 | 6 48 | 8.17 | 8 02 | 921 | 10.61 |
| 1100 | 2 21 | 2.95 | 2 34 | 1047 | 1.44 | 2867 | 7 00 | 8.40 | 8 15 | 917 | 11.18 |
| 1200 | 2 35 | 3.24 | 2 50 | 1037 | 1.73 | 2900 | 7 06 | 8.50 | 8 27 | 916 | 11.47 |
| 1300 | 2 49 | 3.53 | 3 07 | 1027 | 2.05 | 3000 | 7 24 | 8.83 | 8 46 | 910 | 12.36 |
| 1373 | 3 00 | 3.75 | 3 19 | 1021 | 2.30 | 3100 | 7 42 | 9.16 | 9 09 | 904 | 13.29 |
| 1400 | 3 04 | 3.83 | 3 24 | 1018 | 2.50 | 3199 | 8 00 | 9.49 | 9 32 | 899 | 14.25 |
| 1500 | 3 19 | 4.13 | 3 41 | 1010 | 2.78 | 3200 | 8 00 | 9.49 | 9 32 | 899 | 14.25 |
| 1600 | 3 34 | 4.43 | 3 58 | 1002 | 3.19 | 3300 | 8 18 | 9.83 | 9 55 | 893 | 15.23 |
| 1700 | 3 49 | 4.73 | 4 17 | 994 | 3.62 | 3400 | 8 37 | 10.17 | 10 19 | 888 | 16.80 |
| 1774 | 4 00 | 4.31 | 4 36 | 988 | 3.96 | 3500 | 8 56 | 10.51 | 10 43 | 883 | 17.39 |
| 1800 | 4 04 | 4.36 | 4 36 | 986 | 4.08 | 3522 | 9 00 | 10.58 | 10 49 | 881 | 17.64 |

Length of cartridge : 35 lbs. = 24 inches ; 25 lbs. = 18 inches.

Note.—The carriages upon which these pieces are mounted are those altered from the 10-inch barbette-gun carriage, and thus far are only experimental.

DESCRIPTION OF CARRIAGE.

(Plates 13, 14.)

Distinguishing features.

320. Carriages Nos. 1 and 2 have friction-bars for checking recoil. Nos. 3 and 4 have hydraulic cylinders for the same object. Nos. 3 and 4 have a geared windlass, with cranks and handles, attached to the rear part of the chassis. Nos. 1 and 2 are without windlass. No. 1 is distinguished from No. 2 by the absence of the ratchet-post, and by having, instead, for elevating, a circular toothed arc operated by a hand-wheel and pinions upon the left cheek of the carriage. No. 2 has the ratchet-post, but no toothed arc.

Carriage No. 3 is distinguished from No. 4 by having a wedge-shaped incline bolted to the top of each rail of the chassis, near the rear end, and by having a hand-lever on the outside of each chassis rail, for the purpose of uncoupling the top-carriage from the chassis.

Specific features.

Carriages Nos. 1, 2, and 4 have, on the rear part of the top-carriage, an eccentric axle, with truck-wheels. No. 3 has, instead, two wheels or rollers, each having its own eccentric axle. In none are the *front* axles eccentric.

For checking recoil in carriages Nos. 1 and 2, the top-carriage is supplied with a box-clamp having two friction-plates, which act upon a broad wrought-iron rail, one-sixteenth of an inch thicker at its rear than at its front end. This rail is attached to the chassis in front by a transom which takes the place of the hurters; and in rear, by a rod and rubber spring which permits a slight play to prevent buckling. Rubber counter-hurters are secured to each top-rail of the chassis. When the gun is run from battery, it is retained in that position by means of the clamp; by relieving the pressure, the gun runs into battery, a slight movement of the compressor-bar stopping it when desired.

The piece is run from battery in the same manner as the 10-inch smooth-bore, except that with carriage No. 1 the position of the elevating-wheel renders it necessary to insert the left handspike into the *front* mortises of the truck-wheel.

To check recoil in carriages Nos. 3 and 4, an hydraulic buffer is securely placed in the front portion of the chassis. It consists

of a cast-iron cylinder 78 inches long, with an interior diameter of 8 inches, closed at either end by a cast-iron cap.

Near the rear end of the top of the cylinder is a hole for the purpose of filling it with water, or some non-freezing liquid. A hole in the front end, closed with a screw-plug, permits the fluid to be withdrawn.

Nine and one-half gallons (precisely) of fluid are required.

A wrought-iron piston-rod passes through the rear cap, and is secured to the rear of the top-carriage by a wrought-iron cross-head.

The piston-head, of wrought-iron, 0.25 inches thick, is pierced near its circumference, on opposite sides of the rod, with two holes seven-eighths of an inch in diameter. These holes flare out both ways 0.25 inches, allowing free passage to the fluid from the rear to the front of the piston, permitting the top-carriage to run back without strain.

Upon the top of the rear end of each rail of the chassis of No. 3, is bolted a wedge or incline, having a rise of 2.5 inches in 64 inches; near the rear end of this, is attached a brass angle-plate, to which are secured three rubber counter-hurters. A similar angle-plate with hurters is attached to the front part of the chassis.

Carriage No. 4 is likewise provided with hurters and counter-hurters of rubber.

The top-carriage of No. 3 is provided with two sets of *wheels* or *rollers*, those in rear having eccentric axles. In recoiling, the carriage starts on sliding friction, which becomes rolling friction when it accomplishes part of the rise, the ascent absorbing a considerable portion of the recoil. To prevent the carriage running into battery after striking the counter-hurters, couplings are attached to the bottom transom of the top-carriage and to the sides of the chassis rails; the top-carriage is released, and permitted to run into battery, by means of levers on the outside of the chassis rails.

Attached to the rear end of the chassis, in carriages Nos. 3 and 4, is a geared windlass, for the purpose of drawing the gun from battery.

In carriages Nos. 1, 3, and 4 the gun is elevated and depressed by means of circular toothed arcs, to which motion is transmitted by simple multiplied gearing and a hand-wheel on the left side of the carriage. Carriage No. 2 has the ordinary ratchet-post.

The chassis of carriage No. 3 is provided with rollers, resting on the pintle-plate, instead of the truck-wheels, with eccentric axle of the ordinary barbette carriage. The rollers are without eccentric axles.

Flooring-boards are dispensed with in carriages Nos. 3 and 4. A step is placed across the rear notches for the accommodation of the gunner when serving vent or sighting.

The carriage admits of $28^{\circ} 45'$ elevation and $12^{\circ} 50'$ depression.

SERVICE OF 8-INCH RIFLE.

(*Carriage No. 1.*)

321. Eight men are necessary: one chief-of-detachment, one gunner, and six cannoneers.

The implements and equipments are the same, and are arranged in the same manner, as for the 10-inch smooth-bore (*par.* 277), omitting the wheel-chocks and elevating-bar, and adding two small handspikes (iron), which are laid on the steps of the chassis, one on each side; one compressor-bar, standing against the parapet near No. 1; and blocks and fall attached to crane.

The pouches are hanging on the left eccentric socket of top-carriage.

The powder, primers, and fuses are in the service magazine.

The shells are in the filling-room of the service magazine, and, prepared for firing, are brought up to the piece as required.

The solid projectiles are kept piled convenient to the piece.

To distribute the implements and equipments.

322. Executed as in *par.* 278, except that No. 4, instead of mounting upon the chassis, takes hold of the handles of the hand-wheel and, by direction of the gunner, adjusts the piece conveniently for loading, and resumes his post.

The service of the piece is executed by the following commands:

1. FROM BATTERY.

323. The gunner places himself two paces in rear of the chassis, and commands: 1. IN-GEAR, 2. HEAVE. Nos. 3 and 4, at the first command, insert the small handspike in the eccentric sockets of the rear wheels of the top-carriage; No. 4 unkeys the axle, and at the second they throw the wheels in gear; No. 4 keys the axle; Nos. 3 and 4 replace the handspikes upon the steps, and, taking the truck handspikes, insert them in the sockets of the truck-wheels; No. 1, meanwhile, inserts the compressor-bar in one of the holes of the compressor-screw, and unclamps the friction-plates, leaving the compressor-bar in the hole; Nos. 3, 4, 5, and 6 seize the truck handspikes with both hands in the manner prescribed in *par.* 279, and the piece is

moved from battery by the commands and means specified in the same paragraph, except that Nos. 1 and 2 do not follow up with the chocks, but, instead, No. 1, by alternately tightening and slacking the compressor-screw, retains the carriage in position as it is run back.

When the muzzle of the piece is about one yard from the parapet, the gunner commands: 1. HALT, 2. OUT-OF-GEAR, 3. HEAVE. At the first command, Nos. 3 and 4 withdraw their handspikes and replace them on the hooks; at the second, they insert the small handspikes in the eccentric sockets; and at the third, throw the wheels out of gear, leaving the handspikes in the sockets. All resume their posts.

1. *By the numbers*, 2. LOAD.

324. The gunner mounts upon the chassis and closes the vent.

No. 2 takes out the tompion and places it by the parapet near his post.

No. 1 turns to his left, steps over the sponge and rammer; faces the pieces; takes the sponge-staff in both hands, the backs down, the right hand three feet from the sponge-head, the left eighteen inches from it; returns to the piece, raising the staff over the crest of the parapet; places the left foot on the rail of the chassis, the other in the most convenient position on the parapet, or on a step placed against it for the purpose, and inserts the sponge-head into the muzzle; the staff in prolongation of the bore, supported by the right hand, the right arm extended, the left hand hanging naturally by the side.

No. 2 takes a position on the left of the piece corresponding to that of No. 1 on the right, and seizes the staff with the left hand, back down, near to and outside of the hand of No. 1.

No. 3 faces to his rear, steps over the rammer and, facing about, seizes the staff with both hands, as prescribed for No. 1 with the sponge, and stands ready to exchange staves with No. 1.

No. 4 unkeys the crane, takes the pass-box to the rear for a cartridge, and, returning, stations himself to the right and rear of No. 2.

No. 5, taking the shell-hooks, and No. 6 the carrying-bar, go for the projectile; No. 5 engages the shell-hooks and steadies them while No. 6 passes the bar through the ring. They then carry the projectile, No. 5 in front and No. 6 in rear, and place it under the crane conveniently for hoisting.

No. 6 withdraws the bar and places it on the ground; No. 5 hooks the fall into the ring of the shell-hooks; Nos. 5 and 6, working upon the fall, hoist the projectile.

In the meanwhile, Nos. 1 and 2 insert the sponge in the bore by the following motions, at the commands *two—three—four—five—six* :

TWO. They insert the sponge as far as the hand of No. 1, bodies erect, shoulders square.

THREE. They slide their hands along the staff and seize it at arm's-length.

FOUR. They force down the sponge as prescribed for *two*.

FIVE. They repeat what is prescribed for *three*.

SIX. They push the sponge to the bottom of the bore. No. 1 replaces the left hand on the staff, back up, six inches nearer the muzzle than the right; No. 2 places the right hand, back up, between the hands of No. 1; both then change the other hand so as to seize the staff, back up.

1. SPONGE.

325. Nos. 1 and 2, pressing the sponge firmly against the bottom of the bore, turn it three times from right to left and three times from left to right, replace the hands by the side, and withdraw the sponge by similar commands, but by motions contrary to those for inserting it.

No. 2 quits the staff and, turning to No. 4, receives from him the cartridge, and introduces it into the bore; he then grasps the rammer in the manner prescribed for the sponge.

In the meanwhile, No. 1, turning to his left, passes the sponge above the rammer to No. 3, and, receiving the rammer from No. 3, presents it as prescribed for the sponge, except that, retaining hold with his left hand, he rests the rammer-head against the right side of the face of the piece. No. 3, as soon as the sponge is withdrawn, passes the rammer in front of No. 1 onto the parapet; receives the sponge from No. 1, replaces it upon the prop, and resumes his post.

No. 4, setting down the pass-box, takes out the cartridge and hands it to No. 2, choke to the front; replaces the pass-box, and goes to the assistance of Nos. 5 and 6, who are working upon the fall hoisting the projectile; No. 4 steadies it; Nos. 1 and 2 force the cartridge home by the same commands and motions as for the sponge.

1. RAM.

326. Nos. 1 and 2 slide their hands along the staff to the full extent of their arms, and press the cartridge firmly home; No. 2 quits the staff and steps slightly to one side; No. 1 throws out the rammer and lays it upon the parapet; No. 4, as soon as No. 2 steps aside, swings the crane so as to bring the projectile

directly in front of the muzzle; Nos. 1 and 2 insert it, base foremost, into the bore; No. 1 holds it while No. 2 disengages the shell-hooks, which he hands to No. 5, who replaces them and resumes his post.

Nos. 4 and 6 overhaul the fall; No. 6 replaces the bar; No. 4 secures the crane and fall, and both resume their posts; Nos. 1 and 2 force the projectile home by commands and motions similar to those prescribed for the cartridge, *pressing* it firmly home at the command **RAM**; No. 2 quits the staff and resumes his post; No. 1 throws out the rammer, replaces it on the prop, and resumes his post.

The gunner pricks the cartridge, leaving the priming-wire in the vent, and directs No. 4 to give the piece an elevation of about five degrees.

1. IN BATTERY.

327. The gunner commands: 1. **IN-GEAR**, 2. **HEAVE**. At the first command, Nos. 3 and 4 seize the small handspikes and No. 1 the compressor-bar; No. 4 unkeys the axle, and, at the second command, Nos. 3 and 4 throw the wheels *in gear* and withdraw their handspikes; No. 1, by slacking up on the compressor-screw, then permits the piece to run gently into battery. As soon as the carriage is against the hurters, the gunner commands: 1. **OUT-OF-GEAR**, 2. **HEAVE**. Nos. 3 and 4 replace the handspikes in the sockets, and at the command *heave* throw the wheels *out of gear*; No. 4 keys the axle; both replace their handspikes on the steps; No. 1 tightens the compressor by giving the bar a moderate pull (a pull of about 20 lbs.); withdraws the bar, returns it to its place against the parapet, and all the cannoneers resume their posts.

1. AIM.

328. The gunner commands: 1. **CHASSIS IN-GEAR**, 2. **HEAVE**. At the first command, Nos. 3 and 4 embar in the eccentric sockets of the chassis-wheels; at the second command, assisted by Nos. 1 and 2, they throw the wheels in gear, and, leaving the handspikes in the sockets, resume their posts. The gunner withdraws the priming-wire, adjusts the breech sight, and gives the direction.

In the meanwhile, Nos. 5 and 6 embar in the mortises of the rear traverse-wheels, and move the trail to the left or right at the command **LEFT** or **RIGHT** by the gunner. Nos. 1 and 2 assist Nos. 5 and 6.

The proper direction being given, the gunner commands: 1. **CHASSIS OUT-OF-GEAR**, 2. **HEAVE**. At the first command,

Nos. 1 and 2 seize the handspikes; at the second, they throw the wheels *out of gear*, replace the handspikes upon the hooks, and resume their posts; Nos. 5 and 6 unbar, replace their handspikes upon the hooks, and resume their posts; No. 3 passes the hook of the lanyard through the eye of a primer, holds the handle of the lanyard with the right hand, the hook between the thumb and forefinger, and stands ready to hand it to the gunner; No. 4 seizes the handle of the elevating-wheel and, by direction of the gunner, elevates or depresses the piece, turning the wheel to the rear to elevate, and to the front to depress. When the piece is correctly aimed, the gunner commands: **READY**, makes a signal with both hands, removes the sight, and, receiving the primer from No. 3 with his right hand, inserts it into the vent, dismounts from the chassis, and goes where he can best observe the effect of the shot; Nos. 1 and 2 break off sideways with the foot farthest from the parapet; No. 3 steps back obliquely three yards to the rear, and breaks off to his left and rear with the left foot, the left hand hanging naturally by the side, the lanyard stretched; No. 4 resumes his post.

1. *Number one* (or the like), 2. **FIRE**.

329. No. 3, turning his face from the piece, pulls the lanyard quickly, but steadily, and fires. Immediately after the discharge, Nos. 1, 2, and 3 resume the erect position; No. 3 rewinds the lanyard and replaces it in the pouch. The gunner, having observed the effect of the shot, returns to his post.

To load without the numbers, and to fire.

As explained in *par.* 245.

To load and fire continuously, and to cease firing.

As explained in *pars.* 246 and 247.

To secure the piece.

As explained in *par.* 249.

To replace equipments.

330. As explained in *par.* 250, except that the gunner replaces the pouches on the left eccentric socket of the top-carriage, instead of on the knob of the cascable.

SERVICE OF THE 8-INCH RIFLE.

(*Carriage No. 2.*)

331. Carriage No. 2 differs from No. 1 only in having the ordinary ratchet-post, instead of the toothed arc and hand-wheel,

for elevating purposes. The service of the piece with it differs from that of No. 1 only in the operation of elevating. For this purpose an elevating-bar is required, and is used as explained in *pars.* 278 and 284. (Service of the 10-inch smooth-bore gun.)

SERVICE OF THE 8-INCH RIFLE.

(*Carriage No. 3.*)

332. Eight men are necessary: one chief-of-detachment, one gunner, and six cannoneers.

The implements and equipments are arranged as follows :

| | |
|-------------------------------------|---|
| Four truck handspikes.... (iron) | } Two on the hooks, and two on the steps of the chassis. |
| Two small handspikes.... (iron) | |
| Sponge.. .. . | } One yard behind the cannoneers of the right; supported upon a prop; heads turned from the parapet and inclined slightly from the piece. |
| Rammer..... | |
| Pass-box..... | One yard in rear of No. 4. |
| Primer-pouch | } Containing friction-primers and lanyard; suspended upon the left eccentric socket of the top-carriage. |
| Gunner's pouch.. .. . | |
| Vent-cover | Covering the vent. |
| Muzzle-cover | On the muzzle. |
| Budge-barrel..... | } Containing cartridges; at a safe and convenient place in rear of the piece. |
| Windlass-rope..... | |
| Sponge-bucket..... | Near sponge. |
| Shell-hooks.. .. . | Near and in rear of No. 5. |
| Carrying-bar | Near and in rear of No. 6. |
| Blocks and falls..... | Attached to the loading crane. |

When several pieces are served together, there will be one *quadrant*, one *worm*, one *ladle*, one *hammer-wrench*, two *vent-punches*, one *gunner's pincers*, two *lanyards* (extra), and two

vent-gimlets to each battery of not exceeding six pieces. These are kept in the filling-room of the service magazine.

The shells are in the filling-room of the service magazine, and are brought up to the piece, prepared for firing, as they are required. The powder is kept in the service magazine. The solid projectiles are kept piled convenient to the piece.

To distribute the equipments.

333. The instructor commands :

1. TAKE EQUIPMENTS.

The gunner mounts upon the step of the top-carriage; takes off the vent cover, hands it to No. 2 to place against the parapet in rear of his post; gives the primer-pouch to No. 3; equips himself with his own pouch; clears the vent; directs No. 4 to adjust the piece conveniently for loading, and resumes his post. No. 4 adjusts the piece by means of the hand-wheel.

The service of the piece is executed by the following commands :

1. FROM BATTERY.

334. Nos. 5 and 6, facing to the front, seize the crank-handles with both hands (the hand farthest from the chassis at the end of the handle; the other about five inches from it), and unwind the rope; the gunner attaches the hook of the rope to the rear of the carriage, commands: 1. IN-GEAR, 2. HEAVE, and places himself in rear of the chassis. At the first command, Nos. 3 and 4 insert the small handspikes in the eccentric sockets of the rear wheels of the top-carriage, and unkey the axles; at the second, throw the wheels in gear, key the axles, replace the handspikes upon the steps, and, facing to the rear, grasp the crank-handles with both hands, the hand farthest from the chassis between the hands of Nos. 5 and 6.

The gunner then commands: HEAVE. Nos. 3, 4, 5, and 6, turning the crank, run the gun from battery until the couplings catch; Nos. 3 and 4 quit the crank-handles; Nos. 5 and 6 slightly unwind the rope until the gunner can unhook it. The gunner then commands: 1. OUT-OF-GEAR, 2. HEAVE. Nos. 3 and 4 insert the small handspikes in the eccentric sockets and throw the wheels out of gear, and, leaving the handspikes in the sockets, all resume their posts.

LOAD—SPONGE—RAM.

335. All executed identically as just explained for carriage No. 1.

1. IN BATTERY.

336. The gunner commands: 1. **IN-GEAR**, 2. **HEAVE**. At the first command, Nos. 3 and 4 unkey the axles, and at the second command throw the wheels in gear, leaving the handspikes in the sockets; at the same time, Nos. 5 and 6 grasp the coupling-levers with both hands, and at the command **UNCOUPLE**, by the gunner, let the piece run into battery.

The gunner then commands: 1. **OUT-OF-GEAR**, 2. **HEAVE**; at which Nos. 3 and 4 throw the wheels out of gear, rekey the axles, replace their handspikes on the steps, and all the cannoners resume their posts.

1. AIM.

327. The gunner withdraws the priming-wire, adjusts the breech-sight, and gives the direction.

Nos. 5 and 6, assisted by Nos. 1 and 2, embarring in the mortises of the rear traverse-wheels, move the trail to the left or right at the command **LEFT** or **RIGHT** by the gunner. At the signal from the gunner, Nos. 5 and 6 unbar, replace their handspikes on the steps, and resume their posts.

No. 3 prepares the primer; No. 4, working at the hand-wheel, elevates the piece; the gunner commands: **READY**; Nos. 1, 2, and 3 break off,—all as just explained for the same operation with carriage No. 1.

1. *Number one* (or the like), 2. **FIRE**. .

Executed as explained for carriage No. 1.

To load without the numbers, and to fire.

As explained in *par.* 245.

To load and fire continuously, and to cease firing.

As explained in *pars.* 246 and 247.

To secure the piece.

As explained in *par.* 249.

To replace equipments.

As explained in *par.* 250, except that the gunner replaces the pouches on the carriage, instead of on the knob of the cascable.

SERVICE OF 8-INCH RIFLE.

(*Carriage No. 4.*)

338. The implements and equipments for this carriage are

the same as for carriage No. 3, and are disposed of in the same manner. The number of men is likewise the same.

1. FROM BATTERY.

339. Nos. 5 and 6 apply themselves to the crank-handles; the gunner attaches the hook of the rope, and commands: 1. **IN-GEAR**, 2. **HEAVE**,—all as prescribed for carriage No. 3.

At the first command, Nos. 3 and 4 insert the small handspikes in the eccentric sockets of the rear wheels of the top-carriage; No. 4 unkeys the axle. At the second command, Nos. 3 and 4 throw the wheels in gear; No. 4 keys the axle; both replace their handspikes on the steps of the chassis, and, facing to the rear, grasp the crank-handles as for carriage No. 3.

The gunner then commands: **HEAVE**. Nos. 3, 4, 5, and 6, turning the cranks, run the gun from battery until the muzzle is one yard from the epaulment. The gunner commands: 1. **HALT**, 2. **OUT-OF-GEAR**.

Nos. 3 and 4 insert the small handspikes as before; No. 4 unkeys the axle, and at the second command the wheels are thrown out of gear; the handspikes are left in the sockets. Nos. 5 and 6 then unwind the rope until the gunner can unhook it, and all resume their posts.

All of the remaining operations are executed as prescribed for carriage No. 1, except so much as, in No. 1, relates to the compressor.

Remarks.

340. 1st. Owing to the fact that, in all of the foregoing carriages, the steps of the chassis interfere with the handspikes when traversing the carriage, each piece should, in addition, be provided with two pinch-bars; and, for the purpose of holding the traverse-wheels securely in position when delicate adjustments in pointing are required, two wheel-chocks (iron) should also be furnished. *This rule is general for all pieces having traversing carriages.*

2d. The projectiles, as now supplied, are not furnished with holes for the shell-hooks. To remedy this defect, a rope strap is used, instead of shell-hooks.

SERVICE OF A 10-INCH SIEGE MORTAR.

(Fig. 1, Plate 9.)

DESCRIPTION OF PIECE.

341. Mortar, cast-iron; smooth-bore, without chamber.

Number, weights, and dimensions.

| DESIGNATION. | No. | LBS. | INCH. |
|--|-------|-------|-------|
| Calibre | | | 10 |
| Weight..... | | 1900 | |
| Preponderance..... | | 00 | |
| Length of piece..... | | | 28 |
| Length of bore..... | | | 20.5 |
| Windage..... | | | 0.13 |
| Charge (maximum), mortar powder..... | | 4 | |
| Weight of shell (empty)..... | | 90 | |
| Charge to fill the shell (musket powder)..... | | 5 | |
| Charge to burst the shell (musket powder)..... | | 2 | |
| Charge to blow out fuse (musket powder)..... | | 0.3 | |
| Weight of carriage..... | | 1313 | |
| Weight of mortar-wagon..... | | 3185 | |
| Total weight of mortar, carriage, mortar-wagon, and implements..... | | 6600 | |
| Horses to transport..... | 8 | | |

The mortar is fired from a wooden platform. (*Par.* 225.) The carriage is of wrought-iron, and, being without chassis, rests directly upon the platform.

Ranges.

| CHARGE. | ELEVATION. | RANGE, YARDS. | | TIME OF FLIGHT. Seconds. | |
|---------|------------|-----------------|--------------------------|-----------------------------|--------------------------|
| | | Shell, 102 lbs. | Shell, 92 lbs. | Shell, 102 lbs. | Shell, 92 lbs. |
| Lbs. | Degrees. | | | | |
| 0.5 | 45 | 217 | 193 | 6.92 | 6.33 |
| 1.0 | 45 | 582 | 554 | 10.88 | 10.75 |
| 1.5 | 45 | 1056 | 922 | 15.00 | 14.9 |
| 2.0 | 45 | 1366 | 1268 | 17.2 | 16.7 |
| 2.5 | 45 | 1740 | 1613 | 19.2 | 18.0 |
| 3.0 | 45 | 1943 | 1846 | 22.33 | not taken. |
| 3.5 | 45 | 2188 | | 22.00 | |
| 4.0 | 45 | 2235 | | 24.00 | |
| 0.5 | 60 | 140 | | 7.16 | |
| 0.75 | 60 | 237 | | 9.5 | |
| 1.0 | 60 | 545 | | 15.0 | |
| 1.25 | 60 | 789 | | 19.0 | |
| 1.5 | 60 | 939 | | 19.0 | |
| 1.75 | 60 | 1072 | | 20.0 | |
| 2.0 | 60 | 1189 | | 20.4 | |
| 2.25 | 60 | 1337 | | 21.6 | |
| 2.5 | 60 | 1459 | | 23.5 | |
| 2.75 | 60 | 1582 | | 24.4 | |
| 3.0 | 60 | 1667 | | 25.4 | |
| 3.25 | 60 | 1732 | | 26.5 | |
| 3.5 | 60 | 1780 | | 27.2 | |
| 3.75 | 60 | 1935 | | 28.0 | |
| 4.0 | 60 | 2085 | | 29.0 | |
| 2.5 | 45 | | { Shell, 90 lbs. 1530 | | { Shell, 90 lbs. 19.5 |

Maximum pressure with charge of four pounds : 27,000 pounds per square inch.

To serve the piece.

342. Six men are necessary : one chief-of-detachment, one gunner, and four cannoneers.

The implements and equipments are arranged as follows :

| | | |
|---------------------------|---|--|
| Handspikes (wood)..... | } | Two on each side, lying on the manœuvring bolts ; the small ends to the front and even with the front of the cheeks. |
| Cartridge-pouch | | In the basket, between the cheeks of carriage, in rear. |
| Primer-pouch. | } | Containing the priming-wire, friction-primers, and lanyard ; in the basket. |
| Gunner's pouch | | Containing the gunner's level, chalk-line, and chalk ; in the basket. |
| Wiper | } | In the basket. |
| Quadrant..... | | |
| Plummets (3)..... | | |
| Shell-hooks | | |
| Sleeves (2 pair) | | |
| Tompion..... | | In the muzzle. |
| Sponge-bucket | } | With the basket. |
| Wiper-stake..... | | |
| Maul | | |
| Broom | | |
| Elevating-bar (iron)..... | } | Lying on the carriage, over rear notches ; handle to the left. |
| Trestles (3)..... | | Near the epaulment, in front of the piece. |

To each battery of not more than six pieces there should be one *hammer-wrench*, two *vent-punches*, one *gunner's pincers*, two *vent-gimlets*, and two *lanyards* (extra).

The powder, primers, and fuses are kept in the service magazine, and the shells, when filled, in the filling-room of the magazine. To prepare the ammunition, there will be required, at the magazine, the implements specified in *par.* 275.

The charge of powder is varied to suit the required distance, and should be carefully *weighed*. The elevation is usually constant, and 45 degrees.

The plane of sight is established by plummets : one suspended in front and another in rear of the mortar.

A convenient method of suspending the plummets is by means of trestles, made light and easy to handle. The one in rear of the mortar should be about six feet high, to permit the gunner to sight without stooping. The one in front, being on the parapet, need not be more than eighteen inches high. They should have their upper edges scored with fine saw-cuts, close together, to secure the plummets when adjusted in position.

The plummet-cord should be of fine thread or silk, and if affected by wind when suspended, the bob should swing in a bucket of water.

A third trestle and plummet is required temporarily for placing the first two in position.

To establish the plummets in position, the instructor commands :

1. PLACE THE PLUMMETS.

(*Fig. 6, Plate 16.*)

343. The gunner, assisted by No. 2, places a trestle upon the parapet near the interior crest, and suspends from it a plummet in such position that it will be approximately in the line passing through the centre of the platform and the object to be fired at. No. 3 brings up another trestle, which the gunner causes him to place a few feet in advance of the first, and in line with it and the object ; sighting by the plummet first established, he causes the second plummet to be accurately adjusted on the line to the object ; then, going to the front plummet and sighting back, he causes No. 4 to place in position the trestle in rear of the mortar, and suspend from it the plummet, being careful to have it in exact line with the two on the parapet. The front trestle is then removed by No. 3.

The trestle in rear of the mortar should be about three yards from the platform.

No. 1, meanwhile, taking the maul and wiper-stake, plants the latter in the ground one yard in rear of his post, and leaves the maul on the ground near it. All resume their posts.

Remarks.

Should the fire from the enemy endanger the plummet on the parapet, a priming-wire may be stuck there in its place to mark the line.

When, owing to the interposition of an intermediate obstacle, the object to be fired at cannot be seen from the mortar, a point must be interpolated on the required line in such position that

It can be seen from the mortar. This is most readily effected by using Paddock's interpolator, a simple and convenient instrument, consisting of two small mirrors attached to a metallic frame. One of these, termed the upper mirror, revolves on a horizontal axis; the other is called the lower mirror, and to it is attached a small spirit-level, *a*. (*Fig. 4, Plate 15.*) Hair-lines are marked on these mirrors, representing the trace of a plane normal to the axis of the level at its centre, and also to the axis of the upper mirror.

To use the instrument, the observer places himself approximately on the line from the mortar to the object to be fired at. Keeping the bubble in the centre of the level, he turns the instrument so that the mortar will be reflected from the upper mirror onto the hair-line of the lower mirror. He then revolves the upper mirror, and, catching the reflection of the object, observes on which side of the hair-line of the lower mirror it falls. He moves in that direction until both images—that of the mortar and of the object—fall upon the lower hair-line, the two hair-lines being coincident. A pin or plummet is placed in prolongation of this line to mark the required point.

To make the last part of the observation with accuracy, the instrument should be rested on some convenient object.

When the foregoing instrument is not to be had, a point may be interpolated by two persons, each using a light slender stake.

They place themselves as near as practicable on the required line, one facing towards the mortar, where he can see it, and the other towards the object, where he can see it, and both within view of each other.

Holding their stakes vertical, they sight and move them alternately, until finally they have them in such position that they range both upon the mortar and the object. The stakes or, better, plummets are then adjusted at these points, and sighting by them back to the mortar, a plummet is suspended in the usual manner behind the platform. The plummets thus established mark the desired plane of sight.

This operation is more conveniently performed by using a strip of board, ten or twelve feet long, in which is set at each end a priming-wire. The board is placed at the intermediate point in a position approximately in the plane of sight, and where the mortar can be seen by sighting past both wires back upon it, and the object can be seen by sighting forward in the same manner. Two persons, one at each end, by alternately sighting and moving the board, readily establish the wires in the required line. A plummet is then suspended, at some convenient point in front of the mortar, in line with the two wires on the board. The

plummet in rear of the mortar is suspended on the same line. The two plummets thus established determine the plane of sight.

To distribute the implements and equipments.

344. The instructor commands :

1. TAKE EQUIPMENTS.

The gunner goes to the basket ; gives to No. 1 the broom, the sponge-bucket, the wiper, and a pair of sleeves ; to No. 3, the primer pouch ; to No. 4, the cartridge-pouch ; takes himself the gunner's pouch and a pair of sleeves, and gives to No. 2 the basket. The gunner equips himself with his pouch, and, assisted by No. 4, puts on his sleeves.

No. 1 hangs the wiper upon the stake, places the broom and sponge-bucket on the ground by the side of it, and, assisted by No. 3, puts on his sleeves.

No. 2 places the basket one yard in rear of his post, and lays the shell-hooks on the ground near it.

No. 3 equips himself with the primer-pouch, assists No. 1 in putting on the sleeves, and clears the vent.

No. 4 equips himself with the cartridge-pouch, which he carries slung from the left shoulder to the right side, adjusts the piece to about 45 degrees elevation, and places the elevating-bar on the ground, one yard in rear of his post and perpendicular to the platform.

As soon as the gunner has put on his sleeves, he applies his level and marks the highest point of metal at the muzzle and near the vent ; between these points, assisted by No. 4, he snaps the chalk-line, thus marking the line of metal. The cannoneers then take their handspikes, and all resume their posts. The handspikes are held, laid down, and resumed as explained in *pars.* 235 and 236.

The mortar being *from battery*, the instructor commands :

1. IN BATTERY.

345. The gunner places himself two yards in rear of the platform, facing the piece ; Nos. 1, 2, 3, and 4, facing towards the epaulment, embar ; Nos. 1 and 2 under the front manœuvring bolts, and Nos. 3 and 4 under those in rear, engaging the butts of their handspikes about three inches ; Nos. 1 and 3 hold the small end of their handspikes in the left hand, Nos. 2 and 4 theirs in their right.

All being ready, the gunner commands : **HEAVE**, and repeats it as often as may be necessary. As soon as the piece is on the middle of the platform, he commands : **HALT**. All unbar, and resume their posts.

The mortar is moved to the rear by the command :

1. FROM BATTERY.

Executed by inverse means.

1. *By the numbers*, 2. LOAD.

346. The gunner places himself one yard in front of and facing the muzzle.

No. 2 takes out the tompion, and places it by the epaulment in rear of his post.

Nos. 1, 3, and 4 lay down their handspikes.

No. 1, turning to his right, takes the wiper with his right hand, turns to his left, and, placing himself in front of the piece, wipes out the bore, sweeps, if necessary, the platform, and resumes his post.

No. 3, as soon as the piece is wiped, clears the vent with the priming-wire, and resumes his post and handspike.

Nos. 2 and 4 go for the cartridge and shell.

No. 2 takes with him his handspike and the shell-hooks, and while No. 4 is getting the cartridge inserts the shell-hooks into the ears of the shell, and passes the handspike through the ring. In carrying the shell, they hold the handspike in their right hands, No. 4 in advance and at the small end.

Nos. 2 and 4, passing by the left side of the piece and between the muzzle and the gunner, rest the shell on the platform against the front transom of the carriage.

The gunner receives the cartridge from No. 4, and, stepping up to the piece, introduces it into the bore, and carefully pours out the powder, which he distributes evenly over the bottom of the bore; he returns the cartridge-bag to No. 4, who places it in the cartridge-pouch.

Nos. 2 and 4 lift the shell into the muzzle; the gunner steps forward, and, taking hold of the shell-hooks, assists in lowering it gently into its place. No. 2 then withdraws his handspike from the ring, and Nos. 2 and 4 resume their posts. The gunner adjusts the shell so that the fuse is in the axis of the piece, disengages the shell-hooks, which he throws to their place behind No. 2, and resumes his post.

1. AIM.

347. The gunner places himself behind the rear plummet to give the direction, and commands: MORTAR RIGHT; MORTAR LEFT; MUZZLE RIGHT; MUZZLE LEFT; TRAIL RIGHT; TRAIL LEFT, as may be required.

To throw the mortar to the right.

No. 1 embars under the right front manœuvering bolt, from the front; No. 2 embars under the left front notch; No. 4 embars under the right rear notch, from the inside; both of these numbers perpendicular to the cheeks of the carriage. When all are ready, the gunner commands: **HEAVE; STEADY.** The cannoneers remain embarred until he gives some other command, or makes a signal to unbar.

To throw the mortar to the left.

No. 2 embars under the left front manœuvering bolt, from the front; No. 1 under the right front notch; No. 3 under the left rear notch, from the inside.

To throw the muzzle to the right.

No. 1 embars under the right front manœuvering bolt, from the front; No. 2 embars under the left front notch, perpendicularly to the cheek.

To throw the muzzle to the left.

No. 2 embars under the left front manœuvering bolt, from the front; No. 1 under the right front notch, perpendicularly to the cheek.

To throw the trail to the right.

No. 4 embars perpendicularly to the cheek under the right rear notch, from the inside.

To throw the trail to the left.

No. 3 embars perpendicularly to the cheek under the left rear notch, from the inside.

In all of these operations the cannoneers face towards the gunner and observe his signals.

The direction having been given, No. 4 embars with the elevating-bar through the ratchet-post, and raises or depresses the breech at the command of the gunner. The gunner applies the quadrant to the face of the piece, giving to No. 4 the command **RAISE**, or **LOWER**, until the piece is at the required elevation—usually 45 degrees—makes a signal to No. 4, who then unbars, replaces the elevating-bar on the ground, and resumes his post. The gunner, giving the command **READY**, makes a signal with both hands, returns the quadrant to the basket, and goes where he can best observe the flight of the shell.

Nos. 1, 2, and 4, taking their handspikes with them, go four

yards in rear of the platform and face to the front; No. 4 between Nos. 1 and 2, their handspikes held erect by the right side, the right arm extended naturally.

No. 3, while the elevation is being given, pricks the vent, makes ready a primer, inserts it in the vent, moves three yards obliquely to his left and rear, holds the lanyard with the right hand, the cord slightly stretched, back of the hand up, and breaks to the left and rear a full pace with the left foot, the left hand hanging naturally by the side.

The lanyard, to keep the primer from pulling out of the vent, should be passed under the pipe of the carriage.

1. *Number one* (or the like), 2. FIRE.

348. No. 3, turning his face from the piece, pulls the lanyard quickly, but steadily, and fires.

On the discharge of the piece, all except the gunner return, without command, to their posts. As soon as the shell strikes, the gunner returns to his post.

Previous to firing the piece, any mortar near the one to be fired, if loaded or partly loaded, should have the muzzle closed with the tompon, or with a cloth laid over the face. *This rule is general.*

349. When exercising for instruction only, the instructor continues it by causing the piece to be moved toward the rear of the platform by the command FROM BATTERY. He then commands:

1. UNLOAD.

350. The gunner, receiving the shell-hooks from No. 2, attaches them to the shell. No. 2 passes his handspike through the ring of the hooks and, assisted by No. 4, raises the shell from the bore of the piece and carries it to its former place; all in the inverse order in which it was brought up. The gunner and Nos. 3 and 4 resume their posts.

351. The instructor continues the series of exercises, beginning with *in battery*.

In changing posts, No. 2 passes by the front of the piece. *This rule is general for all mortars.*

To load without the numbers, and to fire.

To load and fire continuously.

352. Executed as in *pars.* 245 and 246.

To cease firing.

Executed as in *par.* 247.

To secure piece and replace equipments.

353. The instructor causes the piece to be placed on the centre of the platform, and commands:

1. REPLACE EQUIPMENTS.

All replace their handspikes on the manœuvring bolts; No. 2 puts in the tompion and replaces the basket between the cheeks, in rear; No. 1 and the gunner take off their sleeves; the gunner receives the equipments from the cannoneers and replaces them in the basket; Nos. 3 and 4 replace the trestles and plummets.

Remarks.

354. The time of flight, in seconds, for siege-mortar shells, at an elevation of 45 degrees, with ordinary charges, is approximately equal to one-fourth the square root of the range in feet.

The range in feet is approximately equal to sixteen times the square of the time of flight. The experimental weight of charge and length of fuse required may be obtained from these rules.

The *Boulongé telemeter* is used in determining the distance at which a shell bursts; or this distance may be ascertained by multiplying the number of seconds which elapse between seeing the flash and hearing the report of the shell by 1100; the product will be approximately the distance in feet.

Fire and light balls, according to their size, are fired from mortars of corresponding calibres. With a charge of one twenty-fifth of its weight, the ball is thrown from six hundred to seven hundred yards. Shells for mortars are fired without sabots.

Siege mortars can be fired conveniently at the rate of twelve rounds an hour, but in case of need they may be fired with greater rapidity.

To prepare the mortar for transportation, see *par.* 466.

It is preferable to weigh the powder instead of measuring it, as by so doing more uniform results are obtained. For this purpose a pair of brass counter-scales are required at the magazine, in place of the prescribed set of powder-measures. The quantity of powder which a measure will contain is considerably increased by tapping and settling it; therefore, to obtain uniform results when the powder is measured, all the charges for any series of firings should be either settled or unsettled.

Every mortar should have the line of metal permanently marked on it; in which case all, in the foregoing and following, that relates to marking the line of metal with chalk will be omitted.

SERVICE OF AN 8-INCH SIEGE MORTAR.

DESCRIPTION OF PIECE.

355. Mortar, cast-iron; smooth-bore, without chamber.*Number, weights, and dimensions.*

| DESIGNATION. | NO. | LBS. | INCH. |
|--|-------|-------|-------|
| Calibre..... | | | 8 |
| Weight..... | | 1010 | |
| Preponderance..... | | 00 | |
| Length of piece..... | | | 22 |
| Length of bore (calibres)..... | 2 | | |
| Windage..... | | | 0.12 |
| Charge (maximum), mortar powder..... | | 2.25 | |
| Weight of shell (empty)..... | | 46 | |
| Charge to fill shell, musket powder..... | | 2.5 | |
| Charge to blow out fuse-plug..... | | 0.25 | |
| Weight of carriage..... | | 900 | |
| Weight of carriage, mortar, and implements. (One mortar-wagon will carry three mortars, with their carriages.) | | 1965 | |
| Horses required for above..... | 8 | | |

Ranges.

| CHARGE. | ELEVATION. | RANGE, YARDS. | | TIME OF FLIGHT. Seconds. | |
|---------|------------|----------------|----------------|-----------------------------|----------------|
| | | Shell, 52 lbs. | Shell, 46 lbs. | Shell, 52 lbs. | Shell, 46 lbs. |
| Ounces. | Degrees. | | | | |
| 8 | 45 | 399 | 433 | 9.50 | 9.65 |
| 10 | 45 | 717 | 727 | 12.45 | 12.50 |
| 12 | 45 | 955 | 1029 | 14.85 | 15 |
| 14 | 45 | 1265 | 1275 | 16.50 | 16.80 |

The piece is fired from a wooden platform. (*Par.* 225.)*To serve the piece.*

Four men are necessary: one chief-of-detachment, one gunner, and two cannoneers.

The implements and equipments—omitting *two handspikes* and adding a *grummet-wad*—are the same as for the 10-inch siege mortar, and are arranged in the same manner. The *grummet-wad* is in the basket.**356.** The service of the piece is the same as that prescribed for the 10-inch siege mortar, with the following modifications:

At the command *take equipments*, No. 1 performs the duties of No. 3, and No. 2 those of No. 4, in addition to their own. No. 2 places the grummet-wad on the platform in front of the carriage, near the transom, and assists No. 1 to put on his sleeves.

At the command *in battery*, Nos. 1 and 2 embar under the front manœuvering bolts, facing to the front.

At the command *from battery*, No. 1 embar under the right front manœuvering bolt, and No. 2 under the left rear bolt, both facing from the parapet. If the carriage has no rear manœuvering bolts, No. 2 embar under the left rear notch, nearly perpendicular to the cheek.

In loading, No. 1, having wiped out the piece, clears the vent and, if necessary, sweeps the platform.

No. 2, laying down his handspike and taking with him the shell-hooks, goes for a cartridge and shell, returns by the left of the piece, passes between the gunner and the muzzle, and, resting the shell upon the wad, gives the cartridge to the gunner.

The gunner, having poured in the powder, returns the cartridge-bag to No. 2, and distributes the powder evenly over the bottom of the bore; takes from No. 2 the shell-hooks, raises the shell and lowers it into its place in the bore. All resume their posts.

At the command *AIM*, the gunner performs the same duties and gives the same commands as with the 10-inch mortar. (*Par.* 347.)

For *mortar right*: No. 1 embar perpendicularly to the cheek under the right front notch, from within, and No. 2 similarly under the left rear notch, from without.

For *mortar left*: No. 2 embar perpendicularly to the cheek under the left front notch, from within, and No. 1 similarly under the right rear notch, from without.

For *muzzle right*: The same as for the 10-inch mortar. (*Par.* 347.)

For *muzzle left*: The same as for the 10-inch mortar. (*Par.* 347.)

For *trail right*: No. 2 embar perpendicularly to the cheek under the right rear notch, from the inside.

For *trail left*: No. 1 embar perpendicularly to the cheek under the left rear notch, from the inside.

In all of these operations Nos. 1 and 2 face towards the gunner and observe his signals.

The direction being given, the elevation is given as prescribed for the 10-inch mortar (*par.* 347), except that No. 2 performs the duties therein prescribed for No. 4, and No. 1 those for No. 3.

At the signal from the gunner, No. 1 prepares to fire as prescribed for No. 3 in the exercises for the 10-inch mortar. (*Par.* 347.)

SERVICE OF A COEHORN MORTAR.

(*Fig. 2, Plate 9.*)

DESCRIPTION OF PIECE.

357. *Mortar*, bronze; *bore*, smooth, with chamber; *calibre*, 5.8 inches; *weight of piece*, 164 lbs.; *extreme length*, 16.32 inches; *maximum charge*, 12 oz. "*mortar powder*"; *weight of shell*, empty, 16.8 lbs.; *charge to fill the shell*, 1 lb.; *to blow out fuse*, 2 oz.

The carriage is simply a block of wood, weighing 132 lbs.; total weight of piece, equipments, and carriage, 311 lbs.

Ranges.

| CHARGE. | ELEVATION. | PROJECTILE WEIGHING 17.5 LBS. | TIME OF FLIGHT. |
|---------|------------|-------------------------------------|--------------------|
| Ounces. | Degrees. | Yards. | Seconds. |
| 2.0 | 45 | 84 | |
| 4.0 | 45 | 261 | |
| 5.0 | 45 | 425 | |
| 6.0 | 45 | 548 | |
| 6.5 | 45 | 666 | |
| 7.0 | 45 | 840 | |
| 7.5 | 45 | 980 | |
| 8.0 | 45 | | |
| 8.5 | 45 | 1074 | |
| 9.0 | 45 | | |
| 9.5 | 45 | | |
| 10.0 | 45 | 1262 | |
| 10.5 | 45 | | |
| 11.0 | 45 | 1316 | |
| 12.0 | 45 | 1385 | |

The carriage or block upon which the Coehorn mortar is mounted, is provided with two handles on each side, by means of which the mortar is readily carried by four men from one part

of the work to another. They accompany troops in the field for use against an enemy covered by intrenchments.

The ground, when firm, is sufficient for the carriage to rest upon; if it is not firm, a platform can readily be extemporized from such material as may be at hand. The carriage should be level when the mortar is fired.

To serve the piece.

358. Four men are necessary: one chief-of-detachment, one gunner, and two cannoneers.

The implements and equipments are carried in a basket, which is near and in rear of the mortar. They are as follows: Primer-pouch, containing priming-wire, primers, and lanyard; gunner's pouch, containing gunner's level and a pair of small pincers; one quadrant, one sponge, one plummet, and one mallet. A small wedge is used as a quoin.

The mortar should have a permanent line of metal marked upon it; otherwise this must be marked as for the 10-inch siege mortar. (*Par.* 344.)

The shells should be strapped with tin, and be provided with cord handle. They, together with the powder and fuses, are kept in the service magazine.

The implements for preparing ammunition are the same as prescribed in *par.* 275.

The service of the piece is analogous to that for the 10-inch siege mortar. (*Par.* 342 and following.)

Remarks.

359. When Coehorn mortars accompany troops in campaign, they may be carried on ordinary field caissons; each caisson carrying one mortar, together with sixty rounds of ammunition.

The mortar is carried on the caisson body, the front chest being removed for this purpose. The piece is securely lashed with ropes through the handles. The remaining ammunition chests are arranged to carry thirty shells each. The powder is in cans, and a set of measures (from one to six ounces) should be provided. The shells should be charged and the fuse-plugs driven, ready for the insertion of the fuses.

A caisson with chests similarly arranged should accompany each piece.

The mortars may also be carried in ordinary army transportation-wagons. Each wagon will carry one Coehorn and its equipments (weighing 311 pounds), and sixteen boxes, each containing eight shells and weighing 168=2688 pounds—total, 2999 pounds: a fair load, on good roads, for four horses or six mules.

BATTERY OF SIX COEHORNS.

One captain, three lieutenants, six sergeants, six corporals, eight drivers, thirty cannoneers, and thirty-two horses.

When ordinary wagons are used instead of caissons, two one-horse carts are allowed as tenders in bringing up ammunition, &c.

An army operating in the field should be abundantly supplied with this handy and useful weapon.

SERVICE OF A 13-INCH MORTAR (ECCENTRIC AXLE).

(Fig. 4, Plate 9.)

DESCRIPTION OF PIECE.

360. Mortar, cast-iron; smooth-bore, without chamber.

| DESIGNATION. | LBS. | INCH. |
|--------------------------------------|--------|-------|
| Weight of piece..... | 17,120 | |
| Preponderance..... | 00 | |
| Extreme length..... | | 54.5 |
| Length of bore..... | | 35.1 |
| Windage..... | | 0.13 |
| Charge (maximum), mortar powder..... | 20 | |
| Weight of shell (empty)..... | 216 | |
| Charge to fill shell..... | 11 | |
| Charge to blow out fuse-plug..... | 0.3 | |
| Weight of carriage..... | 4,140 | |

The mortar is fired from a wooden platform. (*Par.* 227.) The carriage is of wrought-iron, and, being without chassis, rests directly upon the platform.

An axle, carrying at each extremity a truck-wheel, passes through the carriage near the front end; this axle is eccentric, and when thrown in gear the truck-wheels rest upon the platform; only the rear part of the shoe then rests on the platform and moves with sliding friction. Two steps are placed on the front part of the carriage for convenience in loading.

Ranges.

| CHARGE. | ELEVATION. | RANGE. | TIME OF FLIGHT. |
|---------|------------|--------|-----------------|
| Lbs. | Degrees. | Yards. | Seconds. |
| 10 | 30 | 2875 | 19 |
| 10 | 45 | 3187 | 25.8 |
| 15 | 45 | 3759 | 28 |
| 20 | 45 | 4636 | 31.75 |
| 10 | 60 | 2852 | 32.75 |
| 15 | 60 | 3378 | 36.75 |
| 20 | 60 | 3893 | 39.16 |

To serve the piece.

361. Eight men are necessary : one chief-of-detachment, one gunner, and six cannoneers.

The implements and equipments are arranged as follows :

| | | |
|-----------------------------------|---|--|
| Truck handspikes (iron).. | } | One on each side, hanging by hooks on the cheeks. |
| Manœuvring handspikes. (wood.) | | One on each side, lying on platform against the cheeks, small ends to the front and resting on the truck-wheels. |
| Elevating-bar (iron)..... | } | Lying on the carriage, over rear notches, handle to the left. |
| Wheel-chocks (iron)..... | | One on each side, on the upper step of carriage. |
| Sponge | } | On prop, one yard in rear of No. 1 ; sponge - head towards the epaulment. |
| Pass-box. | | One yard behind No. 4. |
| Quadrant..... | } | In basket, between the cheeks of the carriage, in rear. |
| Spatula..... | | |
| Plummets (three)..... | | |
| Sleeves (two pair)..... | | |
| Shell-hooks | | |
| Tompion | | In the muzzle. |
| Primer-pouch..... | } | Containing the priming-wire, friction-primers, and lanyard ; in basket. |
| Gunner's pouch | | Containing gunner's level, chalk and chalk-line ; in basket. |
| Sponge-bucket | } | With basket. |
| Broom..... | | |
| Carrying-bar (iron)..... | | |
| Trestles (three)..... | | Near epaulment, in front of piece. |

To each battery not exceeding six pieces there will be one *hammer-wrench*, two *vent-punches*, one *gunner's pincers*, two *lanyards* (extra), and two *vent-gimlets*. These are kept in the filling-room of the service magazine.

The powder, primers, and fuses are kept in the service magazine, and the shells in the filling-room of the magazine.

The implements for preparing the ammunition are those specified in *par.* 275.

To establish the plummets in the plane of sight, the instructor commands: **PLACE THE PLUMMETS.** Executed as for the 10-inch siege mortar. (*Par.* 343.)

To distribute the implements and equipments.

362. The instructor commands:

1. TAKE EQUIPMENTS.

The gunner goes to the basket; gives to No. 1 the broom, the sponge-bucket, and a pair of sleeves; to No. 3, the primer-pouch, and to No. 2 the carrying-bar and basket. No. 1 places the broom and bucket on the ground in his rear, and, assisted by No. 3, puts on a pair of sleeves.

The gunner equips himself with his pouch and, assisted by No. 4, puts on a pair of sleeves; then, applying his level, ascertains and marks the highest points of metal at the muzzle and near the vent. Between these points, assisted by No. 4, he snaps the chalk-line, thus marking the line of metal; he then resumes his post.

No. 2 places the basket one yard behind him, and lays the carrying-bar and shell-hooks on the ground near it; No. 3 equips himself with the primer-pouch and clears the vent; No. 4 places the elevating-bar behind him and perpendicular to the carriage; Nos. 5 and 6 place each a manœuvring handspike on the ground perpendicular to the carriage, the small end resting on the edge of the platform and on the side of them next the epaulment.

The truck handspikes, when not in use, remain on the hooks.

The mortar being from battery.

363. The instructor commands:

1. IN BATTERY.

The gunner places himself two yards in rear of the platform, facing to the piece, and commands: **IN-GEAR.** Nos. 3 and 4 take the truck handspikes from the hooks and embar in the eccentric sockets; Nos. 5 and 6 seize the handspikes above the hands of Nos. 3 and 4. The gunner commands: **HEAVE** and, as soon as the wheels are in gear, **EMBAR.** when the handspikes are placed in the most convenient rear mortises of the truck-wheels. The mortar is moved to the front as far as required by the alternate commands *heave* and *embar* from the gunner; he then commands: **HALT** and **OUT-OF-GEAR,** and the handspikes are again inserted in the eccentric sockets. The gunner com-

mands: **HEAVE**, the wheels are thrown out of gear, and the handspikes returned to their hooks. Nos. 3, 4, 5, and 6 then resume their posts.

1. FROM BATTERY.

Executed as above, except that the truck handspikes are inserted in the most convenient front mortises of the truck-wheels at the command *embar*.

1. *By the numbers*, 2. **LOAD.**

364. No. 2 takes out the tompion and places it by the epaulment in rear of his post. The gunner places himself one yard in front of the piece, facing the muzzle.

No. 1, facing to his right, takes the sponge-staff in his right hand, mounts upon the step, and passes the sponge to the bottom of the bore; sponges with both hands, withdraws the sponge, replaces it on the prop, and resumes his post; No. 3 clears the vent; No. 4, taking the pass-box, goes for a cartridge; Nos. 2, 3, 5, and 6 go for the shell; No. 2 takes with him the carrying-bar and shell-hooks, engages the shell-hooks in the ears of the shell, and passes the carrying-bar through the ring.

In carrying the shell, Nos. 3 and 5 are in advance, and Nos. 2 and 6 in rear; Nos. 2 and 3 are at the ends of the bar, using their right hands; Nos. 5 and 6 use their left hands. The shell is brought up by the left side of the piece, and those carrying it, passing between the gunner and the muzzle, rest it on the step; No. 4 hands the cartridge to the gunner, who pours the powder into the piece, and, using the spatula, distributes it evenly over the bottom of the bore; he then returns the cartridge-bag to No. 4, who, putting it in the pass-box, resumes his post.

The shell is raised by the numbers at the carrying-bar, and lowered into the bore until the bar rests against the face of the piece. The gunner seizes the shell-hooks, and, after No. 2 withdraws the bar, lowers the shell into its place, adjusting it so that the fuse will be in the axis of the piece; disengages the shell-hooks, which he throws behind No. 2, and then resumes his post. No. 2 replaces the carrying-bar on the ground, and resumes his post.

When necessary, the platform will be swept by No. 1.

1. **AIM.**

365. The gunner places himself behind the rear plummet to give the direction, and commands: **IN-GEAR—HEAVE—EM-BAR.** All executed as prescribed in *par.* 363.

The gunner then, sighting by the plummets, gives the direc-

tion, commanding: **MUZZLE RIGHT; MUZZLE LEFT; MORTAR RIGHT; MORTAR LEFT**, according as desired.

For *muzzle right*: Nos. 3 and 5 heave to the rear, and Nos. 4 and 6 to the front, at the command **HEAVE** from the gunner, who repeats the alternate commands *heave* and *embar* as often as may be necessary.

For *muzzle left*: Same as above, except that Nos. 3 and 5 heave to the front and Nos. 4 and 6 to the rear.

Mortar right (or *left*) is executed by giving the muzzle the proper direction and running the mortar in battery, or by giving the muzzle the opposite direction and running the mortar from battery. In either case the manœuvre is completed by throwing the muzzle in the proper direction on its platform by the commands already given.

The direction having been given, the gunner commands: **HALT**, and the eccentrics are thrown out of gear as described in *par.* 363. To prevent the carriage from moving out of line when the eccentrics are thrown out of gear, the wheels should be firmly chocked in front. This is done by Nos. 1 and 2 at the command *halt*.

If necessary to rectify the direction of the piece after the eccentrics are out of gear, the gunner causes Nos. 5 and 6, assisted by all the other cannoneers, to *embar* under the rear notches with the manœuvring handspikes and move the trail to the right or left. No. 3 pricks the vent and then prepares the lanyard and primer; No. 4 *embars* with the elevating-bar through the ratchet-post, and, assisted by No. 5, raises or depresses the breech at the command of the gunner. The gunner applies the quadrant to the face of the piece, giving the commands to No. 4, **RAISE** or **LOWER**, until the piece is at the required elevation, usually forty-five degrees, makes a signal to No. 4, who then unbars, places the elevating-bar in its place on the ground, and resumes his post. The gunner commands: **READY**, returns the quadrant to the basket, receives the primer from No. 3, and, passing the lanyard under the pipe, inserts the primer in the vent, and goes where he can best observe the shot.

The cannoneers, except No. 3, go at the command *ready* to the rear of the platform and form detachment as in *detachment rear*, leaving No. 4 uncovered; No. 3, holding the handle of the lanyard in his right hand, back of the hand up, moves three yards obliquely to his left and rear, and breaks off to his left and rear a full pace with his left foot, his left hand hanging naturally by his side.

1. *Number one* (or the like), 2. **FIRE**.

366. No. 3, turning his face from the piece, pulls the lan-

yard quickly, but steadily, and fires. On the discharge of the piece, all except the gunner return—without command—to their posts; as soon as the shell strikes, the gunner returns to his post.

When exercising for instruction only, the instructor continues it by causing the piece to be moved toward the rear of the platform by the command **FROM BATTERY**. He then commands :

1. UNLOAD.

367. The gunner, receiving the shell-hooks from No. 2, mounts upon the step of the carriage and attaches them to the shell; No. 2 puts the carrying-bar through the ring of the hooks, and, assisted by Nos. 3, 5, and 6, raises the shell from the bore of the piece and carries it to its former place.

In doing this, the cannoneers apply themselves as in bringing up the shell, but move in the reverse order. All then resume their posts.

The instructor continues the series of commands, beginning with **IN BATTERY**.

In changing posts, No. 2 passes by the front of the piece.

To load without the numbers, and to fire.

To load and fire continuously, and to cease firing.

Executed as in *pars.* 246 and 247.

To secure piece and replace equipments.

The instructor causes the piece to be placed on the centre of the platform, and commands :

REPLACE EQUIPMENTS.

368. Nos. 5 and 6 replace the handspikes on the truck-wheels; No. 2 puts in the tompion and replaces the basket between the cheeks, in rear; No. 4 assists the gunner to take off his sleeves; No. 3, in like manner, assists No. 1; the gunner receives the equipments from the cannoneers and replaces them in the basket; Nos. 3 and 4 replace the trestles and plummets.

Remarks.

If, in securing the mortar, the muzzle has been so far depressed that the elevating-bar cannot be engaged in the ratchets, a trace chain may be doubled over the ratchet and the bar engaged in the bight of the chain; or the elevating-bar may be placed in the ratchets perpendicular to the axis of the piece, and a wooden handspike engaged over the bar and under the nuts or T-plates of the cheeks, and the mortar thus elevated.

A bar known as *Piper's loading bar* is a far more convenient implement than the shell-hooks for carrying and loading the shell. It is simply a bar of round iron about two feet long, fashioned into a ring at one end for a handle, and having a screw cut on the other end, which screws into a shallow hole tapped in the shell at a short distance from the fuse-hole. When the shell is lowered into the bore and adjusted, the bar is unscrewed and removed.

To insure the ignition of the fuse of mortar shells, the end of the fuse-plug and the shell around it should be smeared with treacle, varnish, mucilage, or any other sticky substance, and after the shell is in the bore a little fine-grain powder thrown on it.

In rainy weather, great care must be observed to keep the charge dry during the operation of loading. This may be effected by covering the piece with a paulin, the front part of which can be raised while the loading is going on.

SERVICE OF A 10-INCH SEA-COAST MORTAR (ECCENTRIC AXLE).

DESCRIPTION OF PIECE.

369. Mortar, cast-iron; smooth-bore, without chamber.

| DESIGNATION. | LBS. | INCH. |
|--------------------------------------|------|-------|
| Calibre..... | | 10 |
| Weight..... | 7300 | |
| Preponderance..... | 00 | |
| Length of piece..... | | 47.05 |
| Length of bore..... | | 32.5 |
| Windage | | 0.13 |
| Charge (maximum), mortar powder..... | 12 | |
| Charge to fill shell..... | 5 | |
| Charge to burst shell..... | 2 | |
| Charge to blow out fuse..... | 0.5 | |
| Weight of carriage..... | 2924 | |

The carriage is of wrought-iron, and is provided with an eccentric axle and truck-wheels similar to the carriage for the 13-inch mortar. (*Par.* 360.) The mortar is fired from a wooden platform. (*Par.* 228.)

With heavy charges, the shell used in the 10-inch gun may be used for this mortar. The 10-inch siege-mortar shell may be used with moderate charges.

Ranges.

With 10-inch siege-mortar shells, filled with sand (weight 96.5 pounds).

| CHARGE. | ELEVATION. | RANGE. | TIME OF FLIGHT. |
|----------|------------|--------|-----------------|
| Lbs. oz. | Degrees. | Yards. | Seconds. |
| 5 0 | 45 | 2720 | 25.20 |
| 5 8 | 45 | 2983 | 26.33 |
| 6 0 | 45 | 3005 | 26.50 |
| 6 8 | 45 | 3254 | 26.75 |
| 7 0 | 45 | 3325 | 27.50 |

With 10-inch gun shells, filled with sand (weight 104 pounds).

| CHARGE. | ELEVATION. | RANGE. | TIME OF FLIGHT. |
|----------|------------|--------|-----------------|
| Lbs. oz. | Degrees. | Yards. | Seconds. |
| 7 8 | 45 | 3471 | 28.10 |
| 8 0 | 45 | 3638 | 29.60 |
| 8 8 | 45 | 3648 | 29.75 |
| 9 0 | 45 | 3677 | 30.75 |
| 9 8 | 45 | 4096 | 30.40 |
| 10 0 | 45 | 4301 | 31.25 |
| 10 8 | 45 | 4345 | 32.00 |
| 11 0 | 45 | 4458 | 33.50 |
| 11 8 | 45 | 4465 | 34.00 |
| 12 0 | 45 | 4536 | not taken. |

To serve the piece.

Six men are necessary: one chief-of-detachment, one gunner, and four cannoneers.

The implements and equipments are the same as for the 13-inch mortar (*par.* 361), omitting the sponge and adding a wiper, a wiper-stake, and a maul, and are distributed as in the service of the 10-inch siege mortar (*par.* 344), except that when there are no hooks on the cheeks for the truck handspikes, these are laid on the platform in front of Nos. 1 and 2, parallel to the cheeks, small ends to the front, and are returned to this position whenever not actually in use.

The mortar is manœvered on its platform as prescribed for the 13-inch mortar, and by the same commands. (*Par.* 363.)

The loading and firing are executed as prescribed for the service of the 10-inch siege mortar. (*Par.* 346 *et seq.*)

SERVICE OF A 13-INCH MORTAR (CENTRE-PINTLE CARRIAGE).

(*Fig.* 3, *Plate* 9.)

DESCRIPTION OF PIECE.

370. This piece differs from the one described in *par.* 360 only in the method of mounting. Both have the same carriage, but instead of the carriage resting directly on the platform, as in the first, the carriage for the centre pintle is mounted on a chassis itself resting on the platform.

The chassis is attached at its centre to the platform by a pintle, and traverses upon iron circles in the manner usual for this class of carriages.

In addition to the eccentric axle at the middle of the chassis, for throwing it in and out of gear, there is another axle, also eccentric, carrying a traverse-wheel which works between the parts of a double transom on the front end of the chassis. This wheel communicates motion to the chassis.

A crane is attached to the left cheek for hoisting the shell to the muzzle.

The chassis has an inclination to the rear of three degrees; it is of wrought-iron, and weighs 5560 pounds.

The ranges are as given in *par.* 360.

To serve the piece.

371. Eight men are necessary: one chief-of-detachment, one gunner, and six cannoneers.

The implements and equipments are arranged as follows:

| | |
|----------------------------|--|
| Truck handspikes (iron)... | } Two on each side, on the hooks of chassis. |
|----------------------------|--|

Wheel-chocks (iron) One on each side, on the hurters.

Blocks and fall. Attached to the crane.

The other implements (omitting the wooden handspikes) are the same, and are arranged in the same manner as in *par.* 360.

To prepare for pointing the mortar.

372. In every position of the piece, the plane of fire passes through and includes the axis of the pintle. The position of this axis is determined by suspending over the centre of the pin-

tle a plummet; this is most readily done by using a light trestle, about six feet high, with legs far enough apart to reach across the chassis, allowing it to be traversed about a foot in either direction.

The highest point of metal at the muzzle is determined in the usual manner. This being marked, serves the same purpose that a front sight does on a gun—the rear sight being the plummet over the pintle, or one placed in rear of the platform in the plane including the highest point of metal and the object.

If the object can be seen from the mortar, establish a plummet in rear of the platform, in line with the one over the pintle and the object. The trestle over the pintle is then removed. The aiming is accomplished by sighting on the object from the plummet in rear, and traversing the chassis until the highest point of metal falls on this line.

If, as is generally the case, the object is cut off from view by an epaulment, a point must be interpolated on the line from the object to the plummet over the pintle. This is accomplished as explained in *par.* 343. On the line thus determined, a plummet is suspended in rear of the platform, as before, and the trestle over the pintle removed.

The Lorain sight may be used on this mortar.

When Dyer's apparatus is used, the direction is given as explained in *par.* 210.

Remark.

Owing to the fact that the top-carriage has some lateral play on the chassis, it is well to have the line of metal marked in the usual way, and then, in aiming, bring this line in the plane of sight.

To distribute the implements and equipments.

373. The instructor commands :

1. TAKE EQUIPMENTS.

Executed as in *par.* 362.

To serve the piece.

374. The piece will, habitually, be in battery while being loaded. It is in battery when the soles of the cheeks are against the hurters.

375. The instructor commands :

1. IN-BATTERY.

Executed as in *par.* 363, adding, Nos. 1 and 2 will unchock the wheels of the top-carriage.

1. FROM BATTERY.

376. Executed as in *par.* 363, except that Nos. 1 and 2 follow up the movement and keep the wheel-chocks closely applied to the wheels.

1. *By the numbers*, 2. LOAD.

377. Executed as laid down in *par.* 364, with the following exceptions: When the shell is brought up it is placed under the crane, the carrying-bar withdrawn, and the pulley attached to the shell-hooks by No. 4; Nos. 5 and 6 run up the shell, No. 4 steadying it. When sufficiently raised, it is swung over the muzzle, and lowered to its place in the bore as explained in *par.* 264; No. 4 swings back the crane and keys it to the cheek. All resume their posts.

1. AIM.

378. The gunner places himself in rear of the chassis, and commands:

1. CHASSIS IN-GEAR, 2. HEAVE.

At the first command, No. 1 unlocks the eccentric of the front wheel; No. 2 embars with his handspike in the eccentric socket of this wheel, and is assisted by No. 1; Nos. 5 and 6 embar in the eccentric sockets of the truck-wheels upon the sides of the chassis. At the second command, the chassis is thrown in gear; No. 1 locks the eccentric of the front wheel, and No. 2 inserts his handspike in the uppermost mortise of this wheel, No. 1 still assisting him.

The gunner then, sighting by the plummet, commands: MUZZLE RIGHT, or MUZZLE LEFT. Nos. 1 and 2, applying themselves to the handspike in the front wheel, give the piece the right direction. If the chassis traverses with difficulty, Nos. 1 and 2 embar separately, each with a handspike in a mortise on his own side.

The direction being given, the gunner commands: 1. *Chassis out-of-gear*, 2. HEAVE.

Executed in a manner similar to that of throwing it into gear. All the cannoneers then resume their posts.

No. 3 pricks the vent, and then prepares the primer and lanyard. The elevation is given as explained in *par.* 365. The gunner commands: READY, receives the primer from No. 3, inserts it in the vent, and goes where he can best observe the effect of the shot.

The cannoneers go to the rear as explained in *par.* 365.

1. *Number one* (or the like), 2. FIRE.

Executed as in *par.* 366.

The remaining exercises are executed as explained in *pars.* 367 and 368.

When Dyer's pointing apparatus is used, the gunner, after the chassis is thrown in gear, goes to the instrument on the parapet, sights through it upon the object, notes the degree, returns and causes the piece to be traversed until the pointer on the chassis is at the same degree on the arc of the platform.

GATLING GUN.

(*Fig. 1, Plate 17.*)

379. The Gatling is a machine gun of small calibre, throwing lead projectiles. It is used for field service, and also as an auxiliary in the armament of fortifications. For both purposes, it is mounted on a traveling carriage.

Two calibres have been adopted, viz.: the 1-inch, which, in addition to solid projectiles, throws also canister; and the 0.45-inch, which uses the same cartridge as the regulation rifle-musket.

The general features of the mechanism are the same for both, consisting of a number of breech-loading rifled barrels, grouped around and revolving about a common axis, with which they are parallel. The bore of each barrel extends entirely through it, and the breech is chambered to receive a flange, centre-fire, metallic-case cartridge. The barrels are rigidly attached to a central shaft extending to their rear, and supporting a cylindrical breech-casing, which carries within it all the machinery by which the barrels are loaded and fired. A crank upon the right side of this casing is used for operating the machinery. The barrels are discharged successively as they revolve with the shaft.

Each revolution of the crank gives one discharge with the 1-inch gun; with the 0.45-inch, three discharges are made by each revolution. The former is capable of firing 150 shots per minute; the latter, 500 shots.

SERVICE OF THE 1-INCH GATLING.
DESCRIPTION OF PIECE.

| DESIGNATION. | NO. | LBS. | INCH. |
|---|-------|-------|-------|
| Extreme length of piece..... | | | 68.15 |
| Length of barrel..... | | | 33. |
| Length of breech-casing..... | | | 21.5 |
| Length of feed-case..... | | | 14.5 |
| Cartridges in each case..... | 12 | | |
| Cartridges in each ammunition chest..... | 472 | 315 | |
| Total number of rounds for each gun..... | 2592 | | |
| Gun (weight)..... | | 1008 | |
| Total weight of gun, implements, carriage and limber..... | | 3263 | |
| Number of barrels..... | 6 | | |
| Number of grooves..... | 6 | | |
| Depth of grooves..... | | | 0.01 |
| Twist: one turn in six feet..... | | | |
| Preponderance..... | | 110 | |
| Number of horses for each piece..... | 6 | | |
| Number of horses for each caisson..... | 6 | | |

The piece is mounted on the 3-inch field-gun carriage.
For field service, each piece is accompanied by one caisson.

To serve the piece.

380. Ten men are necessary: one chief-of-detachment, one gunner, and eight cannoneers.

The equipments consist of three cartridge-pouches, which are hung on the knob of the cascable.

At the command of the instructor: 'TAKE EQUIPMENTS, the gunner steps to the piece and distributes them to Nos. 4, 5, and 7, who carry them slung from the left shoulder to the right side. Nos. 1 and 2, passing around in front of the axle, assist the gunner in removing the cover, which is folded and placed on the limber chest. It should never be laid on the ground, as it would be liable to pick up sand and dirt, injurious to the working of the parts.

When the piece is unlimbered, the end of the pole, or if with horses the heads of the lead horses, are six yards from the small end of the trail handspike, the pole pointing in the direction of the piece.

Post of cannoneers, piece unlimbered.

(Fig. 2, Plate 17.)

381. The gunner is on the left of the trail handspike, nearly

touching it, heels on a line with the end; Nos. 1 and 2 are eighteen inches outside of the wheels, No. 1 on the right and No. 2 on the left, in line with the rear part of the wheels; Nos. 3 and 4 are opposite the trail handles, in line with Nos. 1 and 2, No. 3 on the right, No. 4 on the left; No. 5 is five yards to the right of No. 4, in line with Nos. 2 and 4; No. 6 directly behind the limber chest, and No. 7 two feet behind the left limber-wheel. All face toward the piece. No. 8 attends to the supply of ammunition, and is with the caisson or at the magazine.

382. The commands of the instructor are: 1st. **LOAD**; 2d. **COMMENCE FIRING**; 3d. **CEASE FIRING**; 4th. **SECURE PIECE**. These are repeated by the gunner.

The duties of the gunner are to direct the piece; observe that the shots are striking at the proper point; see that the supply of ammunition is kept up; throw the oscillating apparatus in and out of gear; remove disabled locks; see that No. 1 is relieved by No. 3 when fatigued by rapid firing; and have general supervision of the gun.

The duties of No. 1 are to turn the crank; see that the cartridges are feeding properly from the case; and use the ejecting rod when necessary.

The duties of No. 2 are to supply the piece with ammunition by inserting the feed-cases into the hopper, and to see that the cartridges are feeding properly.

The duties of No. 3 are to assist the gunner in giving the direction.

The duties of No. 6 are to give out ammunition from the limber chest to Nos. 5 and 7, who alternate in bringing it up to No. 2.

To serve the piece.

383. The instructor commands: **LOAD**.

The gunner, repeating the command, takes hold of the trail handspike at the end with the right hand and at the centre with his left; looks over the top of the piece and gives the general direction. He then steps to the breech and adjusts the rear sight to the required distance; sights through the notch of the rear sight; seizes the handles of the elevating screw and gives the proper elevation, and, assisted by No. 3 at the trail handspike, gives the exact direction. The piece being pointed, he stations himself where he can best observe the effect of the shots.

When the shots are not striking properly, the gunner places himself at the elevating screw as before, and, with the assistance of No. 3 at the trail handspike, readjusts the pointing.

No. 1 places himself rapidly between the piece and the wheel,

in rear of the axle, facing to the front; breaks to the rear with the left foot; frees the crank from its catch, and seizes the crank handle with his right hand, taking care not to turn it until the command *commence firing* is given. Nos. 1 and 3 exchange duties and numbers when so ordered by the gunner.

No. 2 stations himself at the hopper in a position similar and opposite to that of No. 1, but facing to the right; receives the full feed-cases, one at a time, from No. 5, and introduces them into the hopper, the hole to the right and projectiles to the front. He calls *case* as the last cartridge passes the hole; receives a full feed-case with his right hand from No. 5, and inserts it in the hopper as the empty case is removed by No. 4, thus keeping a continuous stream of cartridges fed to the gun. Nos. 2 and 4 exchange duties and numbers when ordered by the gunner, but without interrupting the firing.

No. 3 goes to the end of the trail handspike; seizes it with both hands as soon as the gunner goes to the elevating screw, and prepares to move it to the right or left at a signal from the gunner. He remains at the end of the trail handspike, and assists the gunner to point the piece.

No. 4 places himself in front of the axle, between the left wheel and piece, facing to the rear. When No. 2 calls *case*, he removes the empty case from the hopper, puts on its cover which he has received from No. 5, and deposits the empty case in his pouch until called for by No. 5.

No. 5 runs to the ammunition chest; receives in his pouch four full cases from No. 6; takes them to the piece, and places himself to the right and rear of No. 2, facing to the right. He then removes the cover from a case and hands it to No. 4; the case to No. 2. This he continues until his pouch is empty, when he makes a signal to No. 7 to take his place; gets the empty feed-cases from No. 4; returns them to the limber; receives full cases from No. 6, and resumes his post; meanwhile, No. 7 assumes the place and duties of No. 5 beside No. 2. When the piece is limbered up, he returns all the cases to No. 6, who replaces them in the ammunition chest.

Nos. 6 and 8 attend to the supply of ammunition. The empty feed-cases are filled at the limber or caisson, care being taken to place the projectile to the left. To fill a feed-case, rest it on the left fore-arm, inclining downwards towards the elbow, the side containing the hole uppermost, the open end supported in the palm of the left hand, the other end in the bend of the elbow. The first cartridge is introduced (point to the left) and gradually pushed to the bottom of the case by those succeeding:

it. When not otherwise engaged, the numbers from 5 to 8, inclusive, are employed filling cases.

As soon as No. 5 is supplied with full cases, No. 7 gets four full cases in his pouch and, upon the signal from No. 5, assumes the place and duties of the latter beside No. 2. As soon as he has passed all of his cases to No. 2, he signals No. 5 to take his place, gets the empty cases from No. 4, returns them to the limber, and gets full cases in his pouch ready again to relieve No. 5.

1. COMMENCE FIRING.

384. This command is repeated by the gunner. No. 1 turns the crank with a moderate uniform motion, avoiding all sudden movements or lateral wrenching, and allowing ample time for the cartridges to drop from the feed-case into the carrier. He watches the hopper to see that the cartridges are feeding properly.

Should any of the shells not be thrown out after firing, or the piece become jammed in any manner, he will at once notify the gunner, who will see that the proper means are taken to remove the obstruction.

If the gun jams, remove the feed-case at once, open the hopper, and reverse the crank until all the cartridges are taken out. This will be found to save time, unless the cause of the jamming is evident and in the immediate vicinity of the hopper.

When it is necessary to use the ejecting rod, No. 1 steps to the front, unkeys it, and, under the direction of the gunner, removes the obstruction by forcing it backwards.

1. CEASE FIRING.

385. At this command from the instructor, repeated by the gunner, No. 1 ceases to turn the crank; No. 4 removes the case, and No. 2 opens the hopper; the gunner directs No. 1 to slowly reverse the crank, while No. 2 removes the cartridges, passing them to No. 4, who restores them to the feed-case, which he gives to No. 5 to return to the chest; No. 1 secures the crank by the latch, and all resume their posts.

A partially-filled feed-case should not be put back into the ammunition chest without being filled up, as the cartridges may become inverted and jam the gun.

If, for any purpose, it is desired to temporarily arrest the firing, the instructor, or the gunner, commands: **HALT**. No. 1 stops turning the crank, and all remain at their positions until the instructor, or the gunner, commands: **COMMENCE FIRING**, or **CEASE FIRING**.

1. SECURE PIECE.

386. The gunner steps to the rear of the piece as at the command *load*, runs down the elevating screw, turns down the front and lowers the rear sight, and, with the assistance of Nos. 1 and 2, who step to the front for that purpose, places and fastens the canvas cover upon the piece; all then resume their posts.

Service of piece with reduced numbers.

387. When the number of cannoncers is reduced, the respective duties are performed as indicated by the following table :

| NUMBERS RETAINED. | DISTRIBUTION OF DUTIES. | | | | | | |
|-----------------------|-------------------------|-------------|-----|---------|-----|-----|-----|
| | Gunner. | 1 | 2 | 3 | 4 | 5 | 6 |
| G. 1..... | G. 1 | 2 3 4 5 6 7 | | | | | |
| G. 1, 2..... | G. 1 | 3 5 6 7 | 2 4 | | | | |
| G. 1, 2, 3..... | G. | 1 | 2 4 | 3 5 6 7 | | | |
| G. 1, 2, 3, 4..... | G. | 1 | 7 | 3 5 6 | 4 2 | | |
| G. 1, 2, 3, 4, 5..... | G. | 1 | 7 | 3 | 4 2 | 5 6 | |
| G. 1, 2, 3, 4, 5, 6.. | G. | 1 | 2 | 3 | 4 | 5 | 6 7 |

NOMENCLATURE OF THE 1-INCH GUN.

In view.

- | | |
|---|-------------------------|
| Main shaft, around which the barrels are clustered. | Ejector. |
| Front plate, which supports the front of the barrels. | Cartridge carrier. |
| Rear plate, which supports the rear end of the barrels. | Crank. |
| Barrels. | Elevating screw. |
| Gun frame. | Elevating-screw box. |
| Trunnions. | Elevating-screw bed. |
| Gun face. | Elevating-screw handle. |
| Front sight. | Wiping rod (brass). |
| Rear sight. | Ejecting rod (iron). |
| Breech-casing. | Lock. |
| Breech-casing screws. | Lock tube. |
| Cascable plate. | Lock hammer. |
| Hopper. | Lock spring. |
| | Firing-pin. |
| | Extractor. |

Within the breech-casing.

- | | |
|----------------------|-----------------|
| Lock cylinder. | Diaphragm. |
| Rear-guide nut. | Diaphragm plug. |
| Cocking ring. | Gear-wheel. |
| Cocking-ring clamps. | Pinion. |
| Spiral cam. | Rear-cam screw. |

To take the gun apart.

388. The piece is first dismantled and placed with its casing resting on blocks. Mounting and dismantling are best accomplished by means of a gin. In case of necessity, it may be mounted and dismantled as a field-piece, care being taken to place blocks of wood to receive the gun frame and to prevent injury to the front sight, or to the barrels.

The operations of taking apart are executed in the following order:

1st. Block up the frame and barrels.

2d. Remove the hopper.

3d. Remove the cascable plate.

4th. Take out the steady-pin; then turn the crank downwards and remove the crank shaft in that position.

5th. Remove the rear sight, and take out the large gear-wheel.

6th. Take out the rear plug in the diaphragm, and then gently revolve the gun until a lock presents itself on a line with the hole in the diaphragm, through which one lock after another is taken out.

7th. Take out the breech-casing screws, and remove the casing by drawing it off to the rear. Care is taken in this operation to have the lock cylinder and gun supported, so as to keep the axis of the main shaft parallel to the top of the frame. This is necessary to prevent the rear end of the gun from dropping when the casing is removed.

8th. Remove the pin from the large nut on the main shaft in rear of the locks, and take this nut off by turning it to the *right*; then remove the lock cylinder and carrier from the main shaft.

The spiral cam need not be taken out of the casing in order to take the gun apart.

To assemble the gun.

389. 1st. Put the main shaft in its place through the plates which hold the barrels, and then put in their proper places the carrier, lock cylinder, and large rear nut. The latter should be screwed up tight and have the taper-pin put through the nut and shaft.

2d. Place the gun within the frame, and let the front end of the main shaft rest in the hole designed for it in the front of the frame. When the gun is in this position, the cocking ring should be shoved over the lock cylinder and left for the time loosely around the carrier.

3d. Let the breech of the gun be slightly raised, when the breech-casing can be shoved over the lock cylinder to its place;

then screw the casing to the frame, putting, in the meantime, the cocking ring in its proper place. Revolve the gun to the right or left so that the places for the locks will come on a line with the hole in the diaphragm, through which one lock at a time can be inserted in its proper position; afterwards the screw plug should be inserted to close the hole.

4th. Put on the cog-wheels, replace the crank shaft, pinion, and steady-pin. Put on the rear sight, and screw on the cas-cable plate and hopper, and the gun is ready to be mounted. The piece is mounted on a 3-inch gun carriage widened between the cheeks to receive it. The ammunition chests are arranged for twelve trays.

SERVICE OF THE 0.45-INCH GATLING GUN, MOUNTED ON A CAVALRY CART.

(Fig. 3, Plate 17.)

390. DESCRIPTION OF PIECE.

| DIMENSIONS. | No. | LBS. | INCH. |
|--|-------|-------|-------|
| Extreme length of piece..... | | | 35.5 |
| Length of barrel..... | | | 18 |
| Length of breech-casing..... | | | 8.5 |
| Length of feed-case..... | | | 20.25 |
| Cartridges in each case..... | 40 | | |
| Cartridges in each chest..... | 960 | | |
| Gun (weight)..... | | 144 | |
| Total weight of gun, carriage, and implements..... | | 925 | |
| Number of barrels..... | 10 | | |
| Number of horses to draw (good roads)..... | 1 | | |
| “ “ “ “ “ (bad roads)..... | 2 | | |

To serve the piece.

391. Five men are necessary: one chief-of-detachment, one gunner, and three cannoneers.

With a greater number of cannoneers a more rapid and continuous fire can be sustained, (the additional men refilling feed-cases and bringing up ammunition,) but it is not advisable to expose more men than are absolutely necessary.

The animal being unhitched, the muzzle is pointed in the desired direction, by the gunner and Nos. 1 and '2, working—the former at the shafts and the latter two at the wheels; the shafts and prop are then allowed to rest upon the ground.

Posts of cannoneers, piece unhitched.

392. The gunner is in rear of the piece, covering it, and at the end of the shaft; No. 1 is eighteen inches outside and opposite the rear part of the right wheel; No. 2, two feet outside and opposite the rear part of the left wheel; No. 3, five yards in rear of and covering No. 1, all facing the piece.

The cover is removed from the piece by the gunner, assisted in front by No. 1, who folds and places it in the tool box, and resumes his post.

The commands of the instructor are : 1. *Load*; 2. *Commence firing*; 3. *Cease firing*; 4. *Secure piece*; and are repeated by the gunner.

The duties of the gunner and No. 1 are as prescribed for the 1-inch gun.

The duties of No. 2 are to supply the piece with ammunition, by taking the feed-cases from the ammunition chest and inserting them into the hopper, and to see that the cartridges are feeding properly.

Service.

393. The instructor commands : **LOAD.** The gunner, repeating the command, steps to the rear of the piece, throws his right leg over the shaft, reaches forward, turns up the front sight, and adjusts the rear sight for the required distance. He then gives the piece the proper elevation by means of the elevating screw, correcting the direction with the traversing screw; should any considerable change be required, he loosens both clamp screws and shifts the bed-plate, *being very careful to refasten the clamp screws.* He then resumes his post.

No. 1, as the gunner resumes his post, springs in by a side step to his left, close to the shaft, frees the crank from its latch, and seizes the handle with his right hand, being careful not to turn it until the command *commence firing* is given.

No. 2, stepping to his right and over the one nearest to him, takes his place between the shafts in rear of the left ammunition chest, opens it, takes a feed-case with his left hand, withdraws it from the chest and seizes it at the middle with the right hand, back of the hand up, turns it until the spring shall be down, the slot to the right, and inserts it into the hopper; he then takes another feed-case, seizing it as before, and stands ready to remove the empty case with his left hand, and insert the full one into the hopper with his right.

1. COMMENCE FIRING.

394. The gunner steps to the side from which he can best observe the effect of the shot.

No. 1 turns the crank with a moderate uniform motion, taking care not to derange the position of the gun by sudden jerks or lateral wrenching; should any of the shells not be thrown out after firing, or the piece become jammed in any manner, he will at once notify the gunner, who will see that the proper means are taken to remove the obstruction.

No. 2, as soon as the feed-case is empty, seizes it, and, after replacing it by a full one, returns the empty case to the chest, taking care that the spring enters first and is on the *under side*, and then proceeds as before.

The ammunition in the left chest being nearly exhausted, No. 2 notifies the gunner, who calls up No. 3, who takes his post in rear of and opens the right chest, and stands ready to pass the full cases to No. 2, *in rear* of No. 1. In taking the feed-case from the chest, No. 3 seizes it first at the end, afterwards just above the middle with the left hand, and hands it to No. 2, so that when the latter seizes it, which he does with his right hand at the middle, the spring shall be down and the slot to his right; No. 2 passes the empty case with his left hand to No. 3, who receives it with his right and places it in the chest.

1. CEASE FIRING.

395. No. 1 ceases to turn the crank; No. 2 removes the case from the hopper; the gunner steps to the rear of the piece, opens the hopper, and directs No. 1 to slowly reverse the crank, when he removes the cartridges which have not been fired, passing them to No. 2, who restores them to the feed-case and replaces it in the chest, or hands it to No. 3 if the right chest is being used; No. 1 secures the crank by the latch, and all resume their posts.

1. SECURE PIECE.

396. The gunner steps to the rear of the piece as at the command *load*, runs down the elevating screw, turns down the front and lowers the rear sight, and, with the assistance of No. 1, who steps to the front for that purpose, places and fastens the canvas cover upon the piece; both then resume their posts.

Precautions to be observed.

397. (a) Never lay the cover upon the ground, as it is liable to pick up sand and dirt, which may derange the working of the parts.

(b) A partially-filled feed-case should not be put back into the ammunition chest without being filled up, as the cartridges may become inverted and jam the gun.

(c) If the gun jams, remove the feed-case at once, open the hopper, and reverse the crank until all the cartridges are taken out. This will be found to save time, unless the cause of the jamming is evident and in the immediate vicinity of the hopper.

(d) See that all the parts are kept well oiled to prevent friction and scouring.

NOMENCLATURE OF THE 0.45-INCH GUN.

398.

Components.

| | |
|---|-------------------------------------|
| Adjustable-screw nut. | Rear-sight screws. |
| Barrels (10). | Front plate for barrels. |
| Breech-casing. | Front sight. |
| Breech-casing screws (6). | Front-sight screws. |
| Bushings (10). | Gas collar. |
| Cartridge carrier. | Gun frame. |
| Cartridge-shell ejector. | Hopper. |
| Cartridge-shell ejector screws (3). | Hopper hinge. |
| Cartridge-shell extractor block. | Hopper-hinge pin. |
| Cartridge-shell extractor-block screws (2). | Hopper-hinge screws (2). |
| Cascable plate. | Hopper latch. |
| Cocking device. | Hopper-latch screws. |
| Crank. | Lock cylinder. |
| Crank latch. | Lock-cylinder screws (2). |
| Crank shaft. | Lock extractor. |
| Diaphragm. | Lock-extractor screws. |
| Dowel-pins. | Lock-extractor sleeve. |
| Extractor-hooks (10). | Lock-extractor sleeve screws (2). |
| Firing-pins (10). | Lock main-springs (10). |
| Front cap. | Lock nuts (10). |
| Main shaft. | Lock tubes (10). |
| Oscillating thread nut and washer. | Spiral cam. |
| Rear-guide nut. | Spiral-cam screws (2). |
| Rear plate for barrels. | Trunnions (2). |
| Rear sight. | Washer for front end of main shaft. |
| | Worm. |
| | Worm gear. |

Appendages.

| | |
|----------------------------|------------------------|
| Adjusting screw-wrench. | Pin-wrench. |
| Brass wiping-rod. | Rear-guide nut wrench. |
| Clamp for worm gear. | Shell driver. |
| Feed-cases, straight (48). | Small screw-driver. |
| Lock screw-driver. | T screw-driver. |

The carriage.

| | |
|---------------------------|-----------------------------|
| Shafts. | Ammunition chests (2). |
| Eye-bolts and straps (6). | Chest handles (2). |
| Splinter-bar. | Lid. |
| Step. | Lid latch (2). |
| Hounds. | Corner plates. |
| Assembling bolts. | Angle irons. |
| Prop. | Tool box. |
| Foot-board. | Tool-box latch. |
| Floor. | Tool-box straps and hinges. |
| Bed. | Guard plate. |
| Bed-plate. | Linch-pins (2). |
| Clamp screws (2). | Washers (2). |

To take the gun apart.

399. 1st. Remove the locks.

2d. Remove the screws and take off the cascable plate.

3d. Remove the screw from the end of the crank shaft and take off the oscillating screw, drive out the steady-pin, and take out crank shaft, worm, and sleeve.

4th. Remove screw from rear end of main shaft and take off worm gear, using clamp for that purpose.

5th. Take off brass traversing apparatus, and block up gun under front of rear plates.

6th. Take out screws and remove hopper and breech-casing.

7th. Unscrew screw from lock cylinder, back out steady-pin which holds the rear guide nut, and remove the nut. (The nut works on a left-hand thread.)

8th. Take off lock cylinder and carrier block.

To remove the barrels singly, stand the cluster muzzles up, and let the rear end of the main shaft strike gently on a block; the shaft and front plate will be forced off, after which the barrels may be unscrewed with a socket-wrench.

To take the breech-casing apart, remove the screws which hold the double cam to the diaphragm and slide it out to the front.

To assemble the gun.

400. 1st. Put the breech-casing together; screw the barrels into the rear plate; replace the front plate and shaft; insert the front end of the shaft into the socket in the front of the frame, and rest the front and rear plates upon blocks.

2d. Replace the carrier blocks and lock cylinder.

3d. Put on the rear guide nut and put in steady-pin and screw.

- 4th. Put on breech-casing and hopper and replace the screws.
- 5th. Put on the brass traversing apparatus.
- 6th. Replace worm gear.
- 7th. Replace worm and sleeve and insert crank shaft, fastening the worm in its place with the steady-pin.
- 8th. Replace oscillating nut and set screw.
- 9th. Replace cascable plate and screws.
- 10th. Replace locks.

In taking the gun apart, it will be found much more convenient and expeditious to first remove the cascable plate, and then the locks by hand, and in assembling it they can be inserted in the same manner before replacing the cascable plate.

When the lock extractor is used, the breech plug is turned horizontally; the crank handle is turned until the mark upon the rear barrel plate and the arrow on the hopper coincide, when the lock is withdrawn.

HOTCHKISS REVOLVING GUN.

The Hotchkiss revolving gun is a machine gun resembling in exterior aspect the Gatling gun. It fires explosive shells, and has a range equal to modern field artillery.

The gun consists of five barrels, grouped around a common axis, which are revolved in front of a solid immovable breech block. This has in one part an opening to introduce the cartridges, and another opening through which to extract the empty shells. The cartridges are discharged singly as they present themselves by the rotary motion to the blow of the firing-pin, and while motionless in front of the solid portion of the breech.

The barrels are of steel; the breech block is of cast-iron, weighing about 385 pounds. This absorbs the greater part of the recoil.

The turning of a crank causes the automatic loading, firing, and extraction of the empty cartridge-cases, all these operations being performed continuously during the movement of the crank, the peculiar feature being that the barrels remain stationary during the discharge, thus insuring accuracy of fire.

The cartridges are fed through a trough similar to the *case* of the Gatling. The piece can be accurately aimed and fired at the rate of twenty shots per minute; when great rapidity is required, this may be increased to sixty or eighty.

The piece is served by the same number of men and in a similar manner to the 1-inch Gatling.

The ammunition consists of a centre-fire metallic cartridge of

special construction, holding in each one the powder, the projectile, and the lubricating-wad, arranged like the ammunition generally used for small-arms. Both solid shot and shell are used. Solid shot made of steel are capable of penetrating iron plating of one inch thickness at a range of 1000 yards. The shell is of cast-iron, and is generally fired with a percussion-fuse.

| | |
|---|---------------|
| Calibre..... | 1.457 inches. |
| Length of bore..... | 4.2 feet. |
| Rifling, one turn in..... | 4 feet. |
| (Twist and depth of grooves uniform.) | |
| Number of grooves..... | 12 |
| Length of shell with fuse..... | 3.66 inches. |
| Weight of shell with fuse..... | 16.05 ounces. |
| Charge of powder..... | 4.3 ounces. |
| Weight of complete cartridge..... | 25.04 ounces. |
| Length of complete cartridge..... | 6.58 inches. |
| Weight of piece..... | 1047 pounds. |
| Weight of carriage complete..... | 1092 pounds. |
| Weight of limber..... | 661 pounds. |
| Weight of 460 rounds of ammunition..... | 720 pounds. |
| Total weight..... | 3561 pounds. |

The carriage, made principally of steel, is of peculiar construction, and is well adapted both for traveling and as a stable support for the piece when firing.

Attached to the frame supporting the breech block and barrels is a turn-table, which connects the cannon to a trunnion-saddle, arranged in such manner that, without displacing the carriage, a certain amount of lateral motion as well as of elevation may be given to the piece. Thus the gun is made to sweep horizontally along a line by adjustment between each shot, or during rapid discharge.

In addition to the great value of this gun for light field service, it is peculiarly well adapted to field intrenchments and permanent fortifications, and is intended, when fully introduced into service, to replace howitzers for flank defenses.

TARGET PRACTICE.

401. Owing to the great expense attending target practice with artillery, and consequently the very limited quantity of ammunition allowed for it, every possible means should be taken to secure the greatest amount of instruction that can be had from such practice.

The purpose should be to test, from actual observation, the effective power of the piece, and to acquire skill in utilizing this power. The object for which a piece is placed in a work should be studied, and practice with it made to conform, as far as possible, to this object.

Siege guns.

402. Siege artillery is generally used against fixed objects on land; the target should therefore be placed on land.

The range for the 4.5" gun should be about 2000 yards, and for this distance a target 12 feet square would be suitable. It is made of canvas, or of light boards nailed to uprights planted in the ground, and is whitewashed. A circular bull's-eye 4 feet in diameter is painted in black in the centre of the target. About 100 feet diagonally in front of the target, a pit of suitable size for the marker is dug, the earth being thrown upon the side towards the piece. It adds greatly to the security of the marker to have splinter-proof covering for the pit. The marker is provided with a disk, about a foot in diameter, made of sheet-iron or thin board, one side of which is painted black, the other white, and provided with a staff sufficiently long to enable him to point the disk to any part of the target. The marker should be accompanied by a flagman skilled in signaling, and provided with a white or red flag, such as are supplied by the Signal Bureau. At the piece is another flagman similarly provided. Where it is possible, a hill, situated two or three hundred yards beyond the target, is advantageous for arresting the projectiles. Cleared space beyond the target is preferable to woods.

Firm ground is selected for the gun platform, which is laid with care and precision. The distance to the target is ascertained either by direct measurement, with the telemeter, or by triangulation. Previous to going out to fire, the instructor should prepare a memorandum table of elevations for each kind of projectile to be used, and the time to which fuses are to be cut for shells. The time of flight is determined by means of a stop-watch, and the distance at which shells burst by the Boulongé telemeter. Care and deliberation is exercised in loading and pointing. When the piece is ready to be fired, a signal is made by the flagman at the piece to the marker and flagman at the target, who then screen themselves in the pit. As soon as the projectile strikes, the flagman at the pit raises his flag and the marker proceeds, in case it has struck the target, to cover the hole with his disk; when a shell has been fired, the flagman signals whether it has burst short of or beyond the target. An observer at the piece, with a glass, or even with the naked eye,

can see upon which side of the target the projectile passes, and can form an approximate estimate of the distance to the right or left.

From the data thus obtained, errors of pointing and of cutting the fuse may be corrected for succeeding shots. A complete record of each fire is kept and entered on a blank form furnished by the Ordnance Department. This record, besides giving a description of the piece, contains the kind and weight of the projectile, the kind of powder and the weight of charge, the elevation and the time of flight, the kind and length of fuse, and the position of the piece, whether above or below the level of the target. In the column of remarks is entered whether the projectile struck the target, and if so, where; or if it missed, to which side, and how far; whether it fell short or went beyond; whether the shell exploded short, beyond, or did not explode. The direction of the wind, with reference to the line of fire, and its strength are noted.

Those engaged in the firing, particularly the officers, should examine and study the ground about the target, observing the effect produced by the striking of the shot; whether they penetrated or ricocheted; the depth of penetration, the character of the craters formed by bursting shells, and of the furrows made by glancing projectiles. This information is useful when constructing works of shelter against an enemy, and in the attack upon and demolition of his works.

When the allowance of ammunition that may be expended admits of it, firing at a horizontal target should be practiced. The object of this kind of firing is to group the shots as closely as possible on the ground about the target. The rectangular space inclosed by the shots is called the polygon of fire. In actual service, the purpose of such fire is to reach an enemy sheltered behind works or some intervening object, as hills or woods. This is accomplished by the *drop* of projectiles fired at long range, or at short range by reducing the charge and giving high elevation. Skill in this, the most difficult kind of firing, can be acquired only by practice.

At the close of the firing the piece and carriage should be thoroughly inspected, and every crack or breakage noted on the firing report. For the method of inspection, see subject of Inspection. *This report of target practice is general for all artillery.*

To obtain the centre of impact, the target, if an upright one, is divided into four parts by a horizontal and a vertical line passing through the centre of the bull's-eye; if the target is horizontal, as for mortar firing, one line is drawn as the trace of the

plane of fire, and the other through the centre of the target at right angles to it.

The distance in feet of each shot is measured from these lines as co-ordinates, and recorded in a table; as, *above* or *below* the horizontal line, and to the *right* or *left* of the vertical line.

The table is of the following form :

| No. of shot. | DISTANCE FROM CO-ORDINATES. | | | | DISTANCE FROM CENTRE OF IMPACT. | | | |
|--------------|-----------------------------|--------|------------------|-------|---------------------------------|--------|----------------------|-------|
| | Vertical. | | Horizontal. | | Vertical. | | Horizontal. | |
| | Above. | Below. | Right. | Left. | Above. | Below. | Right. | Left. |
| | | | | | | | | |
| 1 | 3 | | 2 | | 4 | | 1.6 | |
| 2 | | 4 | | 5 | | 3 | | 5.4 |
| 3 | | 6 | 4 | | | 5 | 3.6 | |
| 4 | 4 | | | 2 | 5 | | | 2.4 |
| 5 | | 2 | 3 | | | 1 | 2.6 | |
| | 7 | 12 | 9 | 7 | 9 | 9 | 7.8 | 7.8 |
| | $5 \div 5 = 1$ | | $2 \div 5 = 0.4$ | | $18 \div 5 = 3.6$ | | $15.6 \div 5 = 3.12$ | |

The algebraic sum of the distances in each direction, divided by the number of shots, gives the position of the centre of impact in this direction. In the above example, the position of the centre of impact is 1 foot below and 0.4 of a foot to the right of the centre of the target.

To obtain the mean deviation, it is necessary to refer each shot-hole to the centre of impact as a new origin of co-ordinates; and this is done by subtracting the tabular distance from the distance of the centre of impact, if both be on the same side of the centre of the target, and adding them, if on different sides. The sum of all the distances thus obtained in one direction, divided by the number of shots, gives the mean deviation in that direction; which in the present case is 3.6 feet vertically, and 3.15 feet horizontally.

The foregoing affords a measure for the accuracy of fire of the

piece and projectile, but it does not afford so good a test of marksmanship as the *string*, or sum of the distances of the shots from the point aimed at.

When practicable, epaulments are constructed for siege guns, howitzers, and mortars.

Siege howitzer.

403. Target practice with the 8-inch siege howitzer is conducted in the same manner as for siege guns, but the distance should not exceed 1200 yards, and the target need not be over 10 feet square.

Direct, ricochet, and rolling fire should each be practiced with this piece. To observe the flight of canister, it is best to fire it over smooth water, with an elevation not exceeding two degrees.

10-inch siege mortar.

404. The target for the 10-inch siege mortar should be about 1500 yards from the piece. The best form for the target is that of a square, inclosing the general trace of a field-work. The sides of the square should be about 100 yards, and the trace marked by stakes driven at distances of about 10 feet apart.

A large empty cask or box, placed upon a post in the centre of the figure, and whitewashed, serves as a point to aim at.

At a distance of not less than 150 yards to the right or left of the target, is constructed a strong bomb-proof for the marker and flagman.

The marker is provided with a number of small stakes, which, to make them more conspicuous, have attached to them a piece of white or red stuff. When a shell strikes the ground, the marker notes the place with a stake, marking it with a number corresponding to the number of the shot. The rules governing the flagman at the bomb-proof and at the piece are the same as those already given for the siege gun.

A convenient method of notifying those at the mortar as to the points at which the shells strike, is to describe around the centre of the target a circle with a radius of about twenty-five yards. Divide this circle into twelve equal parts, which mark conspicuously with stakes, being careful to place one of the divisions on the prolongation of the line passing through the mortar and the centre of the target. Call this point XII, and number the others around to the right similar to the dial of a clock.

Suppose the shell falls at the point C, (*Fig. 1, Plate 15,*) on the line passing through the centre B and I, and at a distance of say twenty yards from the centre. The marker steps, or otherwise measures this distance, and signals to the piece "*One*"—

“20.” Those at the piece, referring to a similar diagram made upon *diagram* paper, ascertain at a glance the approximate point at which the shell struck the ground.

Firm ground is selected for the platform, and the distance to the target is determined as for siege guns, as is likewise the time of flight of shells and the distance at which they explode.

In order to economize shells, charges sufficient only to blow out the fuse are used, and the shells are afterwards collected.

After the firing is completed, the distance from each point where a shell fell to the centre of the target is measured, and, if desirable, a diagram made of the target, showing the position of each shot.

Previous to going out to fire, the instructor should prepare a memorandum range table, so that the first shots may be approximately accurate. Subsequent shots should be rectified with care; the tendency is always to overdo the correction; as, for instance, when the shell falls short, the addition given to the charge will most likely send it far beyond; or, should it fall to one side, the correction given to the direction will probably be so great as to cause it to fall a still greater distance to the other side. Under the most favorable circumstances, mortar firing, as compared with firing from other kinds of cannon, possesses, inherently, a considerable degree of inaccuracy, and in making corrections care should be observed to discriminate between this and faulty gunnery.

When practicable, the charges of powder should be weighed; if *measured*, uniformity should be observed as to the manner of doing it, so that all shall be shaken down in the measure, or all measured loosely.

The platform should be tested frequently, to see that it does not settle unevenly. The shells should be weighed and marked with chalk, and in firing them care should be observed to commence with the lightest and go up to the heaviest, or *vice versa*. This enables the corresponding variation of the charge to be made with a greater degree of certainty. In all cases of target practice a complete record is kept for each shot, and a report, as heretofore explained for siege guns, is made.

8-inch mortar.

405. Target practice with the 8-inch mortar is conducted as just explained for the 10-inch.

Coehorn mortar.

406. Target practice with this piece is similar to the foregoing; but the distance to the target should not exceed 1000

yards, and the target may be smaller. As this piece can be moved from place to place with ease, and requires nothing more than level and firm ground for a platform, the distance to the target should be varied, thus affording practice such as frequently occurs in war service.

Sea-coast mortars.

(13-inch.)

407. These mortars are chiefly used against shipping, in the defense of harbors; a floating target should therefore be used. Any floating object, as an empty cask or a spar, anchored to mark the spot, suffices.

The distance to the target should be about 3000 yards. The practice is conducted in the same manner as for the 10-inch siege-mortar, except that for the purpose of determining the points of fall, or of explosion of the shells, plane-tables are employed in the manner hereafter explained. As the shells are not recovered after being fired, bursting charges may be used.

(10-inch.)

408. Target practice with this piece is identical with that for the 13-inch mortar.

Sea-coast guns.

409. As this class of guns are chiefly used against ships, and are fired over water, the target should be floating.

For the 15-inch smooth-bore and the 8-inch and Parrott rifles, it should be moored at a distance of about 3000 yards; for the 10-inch smooth-bore, the distance should be about 2000 yards.

Plane-tables (*Fig. 2, Plate 15*) are employed for the purpose of recording the striking points of shots, or the bursting distance of shells. The tables are stationed, one at each extremity of a line, the length of which is accurately determined either by actual measurement or by triangulation from a base-line, the measurement of which has been made with care and precision.

At every post mounting heavy artillery a base-line should be so determined and permanently marked, to be used for the various requirements of artillery firing. About 1000 yards is a suitable length for it.

The plane-tables are placed so as to have a clear view of the target, of each other, and of the guns. They should, furthermore, be so placed that the lines joining them with the target will intersect at as near a right angle as possible. This enables the position of the shot to be determined and plotted with greater

accuracy than would be the case did the lines intersect with a very acute angle.

Floating Target. (Fig. 3, Plate 15.) The best and most readily constructed target is composed of three stout boards twelve feet long and a foot broad, forming a triangle. A fourth board extends from one of the angles to the middle of the opposite side. The whole is fastened together with spikes, or, better, with screw bolts.

At the centre of the triangle, a hole is cut in the last-mentioned board; this hole is about four inches in diameter; through it passes a pole projecting about twelve feet above and three feet below.

A 10-inch shot, or equivalent weight, is secured to the lower end of the pole, and rope guys are led from the top to the angles of the platform to keep the pole upright. To these ropes are fastened triangular pieces of canvas. A bull's-eye four feet in diameter is painted on the middle of this screen, upon each side. On each side of the pole, underneath the platform, an empty water-tight barrel is lashed to the athwart-board, and a small red flag is placed on the top of the pole.

This target is suitable for even the roughest water. To hold it, under such circumstances, requires an anchor weighing not less than 200 pounds. This is attached to the target by a chain or heavy rope, secured to one angle of the base by an eye on the under end of the bolt holding the planks together.

When a single anchor is used, the chain or rope is liable to wind itself around and trip the anchor, causing it to drag. To obviate this, it is advisable to moor the target with two anchors, placed in the direction of the current. The distance of the anchors apart must depend upon the depth of the water, and should be such as to form, with the mooring-chains, about an equilateral triangle.

Figure 4, Plate 15, shows the construction of a target frequently used in smooth water.

An empty water-tight cask, painted some dark color, forms a good target or point at which to aim. The cask is secured in position by means of a small anchor or kedge attached to it by a stout rope fastened to secure lashings on the cask. Instead of an anchor, any heavy body, such as a stone or bars of iron, may be used. If the current is swift, the weight should not be less than the flotation of the cask. This latter is obtained by multiplying the number of gallons contained in the cask by ten—the approximate weight of a gallon of water.

A spar, similar to the spar buoys to be seen about harbors, forms a good target and one of easy construction. When a spar

or cask is used, a small flag of some bright-colored stuff, attached to the target, makes it more conspicuous and easy to aim at.

The target is moored in position at the commencement of the season's firing, and is left out until the firing is completed. Its distance from the two *stations* and from the gun is determined by ordinary trigonometrical methods, or by plotting from plane-table observations.

The plane-tables are the ordinary instruments described in works on surveying.

After the table is set up at its station and adjusted, the officer in charge marks upon it the line to the target, to the gun, and to the other station. These lines form the basis for the subsequent plotting of the shots.

The officer at each station is accompanied by a flagman to signal to the piece whether the shots are *short*, or *over*. By this means the error, for subsequent shots, is approximately corrected.

The officer in charge of the firing attends to the loading and aiming, sees that the charges and projectiles are weighed, and that the pressure plug (when used) is properly attached to the cartridge; also that the fuses for the shells are of the proper length. When everything is in readiness, he directs his signal flag to be raised to inform the observers at the stations that he is about to fire. The piece is then discharged. The other officers at the battery attend to the stop-watch and telemeter.

When the gun is fired, the officer at each station, sighting through the alidade, catches the point on the water where the shot strikes, or, in case of a shell, the point in the air where it explodes. He then draws a fine line to mark the direction, and gives it a number corresponding with the number of the shot.

The observations thus obtained are plotted. A suitable scale is assumed, (one of one inch to 100 yards is convenient,) and the line joining the two stations is laid off on the plotting sheet according to the scale. From this all the other lines are laid off, usually by the method of chords. The intersection of the lines to the target establishes its position, and those to the gun its position also. The distance from the gun to the target is ascertained from the scale. The lines of observation to each shot having been carefully numbered by the observers at the plane-tables, the intersection of corresponding numbers on the plot give the striking points of the shots, or bursting points of the shells.

When plane-tables are not to be had, any instruments graduated for measuring angles and provided with sights through which the shots can be observed, may be used, and the work accomplished as just described. An observer at the piece takes

the time of flight with a stop-watch, and another observer obtains the bursting distance of shells with the *Boulongé* telemeter.

The direction of the wind is determined by a vane at the piece. The most convenient and reliable method of noting it is by referring it to the dial of a watch held in such a position that the line passing through VI and XII will be parallel to the line of fire with the XII towards the target. The *direction* is that from which the wind comes. When coming directly from the front, it is noted as "*twelve o'clock*"; when from the rear, as "*six o'clock*"; when from the right, as "*three o'clock*"; when from the left, as "*nine o'clock*"; and when from intermediate points, in a similar manner.

The velocity of the wind is determined by an anemometer; but as this instrument is seldom to be found at military posts, the best that can be done is to *estimate* the velocity, and record it as explained in *par.* 204.

When it is practicable to establish telegraphic communication, all of the foregoing operations, so far as signaling is concerned, are greatly facilitated.

Gatling gun.

410. The target for this gun is made of light canvas or ordinary muslin, and is in four or more sections, each section being 8 feet long by 6 feet high. The canvas is nailed to a strong light frame, the uprights of which extend about 12 inches below the canvas, in order that they may be set in the ground.

Practice should commence at 200 yards and the distance be increased up to 1000 yards, or more. At the first distance a single section of the target is sufficient, and, as the distance increases, other sections will be added. Smooth, level, and firm ground should be selected for the gun to stand upon.

TELEMETERS.

411. The *Boulongé* telemeter is an instrument devised for ascertaining the distance to a point by means of sound proceeding from the point to the place of observation. The one used for artillery purposes consists of a glass tube about six inches in length, filled with a transparent liquid that does not freeze except with intense cold. (*Fig. 1, Plate 16.*)

In the liquid is a metallic disk, which moves freely from one end of the tube to the other. It is so adjusted that the motion will be uniform and comparatively slow. The tube is inclosed in a brass case, to which is attached a scale, after the fashion of

a thermometer. This scale is marked for each hundred yards up to 4000.

The divisions on the scale show the distance, in yards, through which sound will travel in air, during the time required for the disk to descend over the space on the scale marked by the corresponding number of yards. If, for instance, the disk passes from zero to the 500 mark, it indicates that sound would have traveled 500 yards through the air during that time.

The instrument must be held vertically, or as nearly so as possible. To arrest the motion of the disk at any point, the instrument is quickly turned to a horizontal position.

To use it for determining the time of flight of shells, it is held in the right hand, back of the hand up, with the zero of the instrument to the left; a turn of the wrist to the right brings the instrument vertical, with the zero end uppermost; the disk then descends, and a turn of the wrist to the left arrests its motion. The observer, holding the instrument as described, watches for the flash of the shell, and upon seeing it, instantly brings the instrument to a vertical position; upon hearing the report from the shell, he instantly turns it back again. The position of the disk indicates the number of yards from the observer to where the shell exploded.

To ascertain the distance to an enemy's battery, the instrument is held and turned in the same manner. The observer watches for the flash of a gun; observing which, he turns the instrument, and, when he hears the report, turns it back and reads off the distance. Each hundred yards on the scale is subdivided into quarters.

412. The telemeter invented by Captain A. Gautier, of the French army, is an instrument for measuring, with a great degree of approximation, any difference, not exceeding three degrees, which may be exhibited in the bearing of a distant object by viewing it from different points of a base-line transverse to its general direction from the observer.

The instrument, in its simplicity, accuracy, and portability, recommends itself in all cases where a knowledge of distances is desired at any moment and with the least possible delay; such, for instance, as range-finding, river-crossing, reconnoitering, and the like. A slight acquaintance with its use on such occasions enables the observer to estimate, with more than ordinary promptitude and precision, the distance which it might be all important to obtain.

The principles of this instrument are explained mathematically in Ordnance Memoranda No. 12.

The instrument (*Fig. 2, Plate 16*) resembles in shape and size

one barrel of an ordinary reconnoitering or field-glass. The case in which it is carried is fashioned so as to answer as a handle for holding the instrument when making observations. (*Fig. 3, Plate 16.*)

Within the barrel of the instrument are placed two mirrors at an angle of about 45 degrees with each other; this angle can be varied within certain limits by means of a milled-headed screw acting on one of them. The mirrors are thus made to operate upon the principle of the sextant. A slot on one side of the barrel permits the rays of light from an object to fall upon one of the mirrors, from whence they are reflected upon the other mirror, and the image is seen through the eye-glass at the small end of the instrument.

At the front or large end is fixed, in a ring surrounding the barrel, a prism, whose displacement modifies the direction of an object seen through it.

At the rear of the instrument is a small eye-glass, by means of which the observer sees, *over* the mirrors and through the prism, the object which is before him, and by double reflection *in* the mirrors the object to the side of him.

The semi-revolution of the movable ring containing the prism corresponds to a displacement of the object toward the left of about three degrees. The ring is provided with a graduated scale containing numbers, the use of which will be explained.

Method of using the instrument.

Suppose C (*Fig. 4, Plate 16*) to be the object and A the point from which the distance A C is to be determined.

Select some distant object, as M, for a *signal*, the direction A M to it making with the line A C an angle a little greater than 90 degrees. From the point A measure a base, A B, in prolongation of the line to the *signal*.

After having adjusted the telemeter upon the case, which serves as a vertical handle, turn the ring until the word "infinity" is brought opposite the fixed index or arrow. This brings the prism to its *initial position*.

A small opening in the under part of the instrument, exhibiting the mirror index, enables the observer to assure himself that the movable mirror is at its *mean position*, which is indicated by a fixed mark.

The telemeter is then ready for operation, and the observer places himself at A, so that the object C will be on his right. (The right is here chosen merely for purpose of illustration. The observation can be as easily made with the object on the left.)

The instrument is held in the left hand, the fingers of which clasp the barrel firmly to the handle (the case). The observer, facing the signal M and sighting through the eye-glass upon the signal, turns, with the right hand, the milled screw until the image of the object C coincides with the signal M. Leaving the screw in this position, he retires to the other end, B, of the base-line, where, holding the instrument as before, he sights upon the signal, and turning the graduated ring on the front end, makes the images again coincide. This done, there will be found on the ring opposite the fixed index a number, which, being multiplied by the number of units in the base-line, will give the required distance A C in terms of the unit used in measuring the base.

This is the method of a *fixed base*. Another method is by means of a *proportional base*, which is, instead of measuring a base as just described, a certain factor is selected on the ring and the instrument set to it; then by moving back in the direction A B until the images coincide, the distance thus moved over will be the base, which is then measured and multiplied by the selected factor. This method has the advantage of eliminating the errors of reading the movable ring.

A base of $\frac{1}{100}$ of the distance suffices in general for obtaining the exactness of measurement required in military operations. It is necessary always that the object and the signal be well defined and of a convenient form and size, and that the observer be sufficiently skilled with the instrument to make with precision the necessary sightings, and to make the proper alignment of the two stations upon the signal. In a case where a good natural signal is found, distances up to 2000 meters can be readily measured in less than two minutes. If the conditions are less favorable, the measurements may be effected by employing bases of $\frac{1}{50}$ or of $\frac{1}{25}$. Whatever be the method employed, the immediate result of the operation is the knowledge of the relation between the distance sought and the base. The base may be expressed according to any unit of measurement, and the distance will be correspondingly expressed. If the base is measured in yards, the distance will be yards, &c.

A good natural signal is one which best satisfies the following conditions, viz.: Perfectly visible; form well defined and symmetrical, with reference to a vertical axis; distance very great in proportion to the length of base we wish to use; height at least $\frac{1}{200}$ of its distance from us; direction, making with that of the object, an angle a little greater than 90 degrees. In case no convenient natural signal can be found, its place may be arti-

ficially supplied by an aid placing himself at 200 or 300 meters distant and holding himself immovable.

An operator who thoroughly comprehends the principle of the telemeter will in a short time acquire sufficient skill to use it to the best advantage. He will discover that the choice of the signal has a great influence on the accuracy of the operation; he will judge of the amount of care necessary in securing alignment of the stations; and, in fine, he will be able to modify or perfect, according to circumstances, the processes heretofore indicated.

The choice of the signal is a point very important to the precision of sighting. If the object and the signal are each symmetrical with reference to a vertical axis, and of a height at least $\frac{1}{200}$ of their distance from the observer, and upon nearly level ground, the sighting can be made to within 2" or 3"; while if the signal is but barely visible, or of little height, or of vague form, errors up to 2' may be committed. It is seen, therefore, that of two natural signals unequally distant from the observer, the nearest may be the more advantageous; but of this, experience will be the best guide of the observer.

The alignment of the two stations can be made in several different manners, according to requirements. The operator can take before him two natural objects, the first near and the second sufficiently far off, very distinct, and high enough not to be masked by the first. It is always of advantage to use a stake at the first station not high enough to obscure the signal; and this precaution is the more necessary if the signal is but a short distance off.

The instrument gives a very simple means of knowing whether the position of the second station is well chosen. After having established the coincidence between the reflected object and the signal at the second station, the front of the instrument should be lowered perpendicularly, so as to take in the point of first observation. This point should, if the second station is correct, appear in coincidence with the reflected object.

The operation can be performed by either facing the signal or facing the object. The first method is always preferable, as the latter necessitates the taking of the base to the side, which renders alignment more difficult. Nevertheless, if the object be indistinct or difficult to distinguish from its surroundings; it may be regarded by the second method, care being taken at the second station that the instrument is turned a little on its own axis, so as to take in the point of first observation, and that

point be found to lie in the same vertical plane with the natural signal.

PRESSURE PLUG.

413. *Rodman's pressure plug* (Fig. 5, Plate 16) is used when it is desired to ascertain the pressure per square inch exerted by the powder on the surface of the bore of a piece. To apply this instrument, it is first taken apart by unscrewing the cap and removing the piston and disk containing the knife. The whole is then thoroughly oiled with sperm oil. This done, place a copper disk in the plug, and after it the disk containing the knife, the latter being *slid* down so as not to cut the copper disk. Next pass the piston into the hole in the stem of the cap, and screw the cap into its place. For this operation the plug is held horizontally in a vise. A small copper gas-check is then inserted into the hole on top of the piston; a wooden drift is used to set the gas-check firmly in its place, and a small wad of cotton-waste is inserted over the gas-check; the plug is now put into the empty cartridge-bag, with its grooved end at the bottom and centre of the bag, and the bag tied firmly to it from the outside, with twine passing around the grooves on the bottom of the plug. The powder is next put in, care being taken to distribute it evenly around the plug. The bag is tied close to the powder so as to make the cartridge firm and compact.

When inserting the cartridge into the gun, care is taken that the plug, when at the bottom of the bore, is, as nearly as possible, in the axis of the piece.

After the discharge, the plug is removed from the bore by a rake made for the purpose; the cap is unscrewed, the copper disk removed, and, after being wiped, the cut made upon it by the knife is measured, from end to end, with a pair of dividers. The dividers are then applied to the scale and passed down the two long lines until they intersect a cross line the length of which corresponds to the width of the dividers; the figures at this point indicate the number of pounds pressure to the square inch.

Pressure plugs are of three sizes: one for the 12-inch rifle and 13-inch and 15-inch smooth-bores; one for the 100-pounder Parrott rifle and 8-inch and 10-inch smooth-bores; and one for smaller calibres.



Part Third.

MECHANICAL MANŒUVRES.

General Directions.

414. The mechanical manœuvres are the application of machines and of mechanical powers for mounting, dismounting, moving, and transporting artillery.

415. The detachment for mechanical manœuvres consists of one chief-of-detachment, one gunner, and ten cannoneers. It is formed as in *par.* 14; marched to the place of exercise as in *par.* 106, and takes post as in *par.* 107, except that the cannoneers are posted two yards from the axis of the piece or carriage; Nos. 1 and 2 opposite the muzzle or front part of the carriage, the other numbers and the gunner dressing on Nos. 1 and 2, respectively, at intervals of one yard, except between Nos. 3 and 5, where there is an interval of two yards. All face towards the piece or carriage.

The cannoneers change posts as in *par.* 112.

The chief-of-detachment is posted two yards in rear of the breech, chassis, or trail, or on the left of the pole, two yards from and opposite its end, according as the piece is dismounted, unlimbered, or limbered. During the execution of the manœuvres he goes wherever his presence may be necessary; but, in rendering assistance, will generally place himself opposite the gunner, between Nos. 3 and 5.

416. The implements and machines required for the various operations depend upon the kind and weight of the piece and the nature of the manœuvre to be performed. For each exercise, those *specially* required are given.

In every case the minimum number of each is given. When much work is to be done, due allowance must be made for wear and tear, which, with heavy material, is very considerable. Sound discretion should be exercised not to allow the wearing to go beyond the limit of safety.

Those now used for siege-pieces are such as can be found in most localities; the rollers, chocks, and, if necessary, the hand-spikes being readily shaped from sections of trees.

The following table contains implements used for siege-pieces :

(Plate 18.)

| IMPLEMENTS. | Length. | Width. | Thickness. | Weight. | REMARKS. |
|---------------------|---------|--------|------------|---------|---|
| | Inch. | Inch. | Inch. | Lb. Oz. | |
| Handspike..... | 84 | | | 12 0 | } Grooved $\frac{1}{4}$ in. deep in the middle. |
| Long roller..... | 42 | 6 | r'nd | 25 0 | |
| Short roller..... | 12 | 7 | r'nd | 12 0 | } Wedge-shape. |
| Gun-chock..... | 3.6 | 2.75 | 3.5 | 0 6 | |
| Wheel-chock..... | 7 | 6 | 3 | 2 4 | } Section a triangle. Top rounded $\frac{1}{4}$ of an inch. |
| Roller-chock..... | 7 | 5 | 2 | 1 0 | |
| Shifting-plank..... | 67 | 12 | 2.25 | 48 0 | } Ends beveled on opposite sides. |
| Trace-rope..... | 360 | r'nd | 1.25 | 8 8 | |
| Hammer-wrench..... | | | | 2 4 | } Sometimes called monkey-wrench. |
| Sling-chain..... | 156 | | | 55 0 | |

The *machines* and their uses will be described with the manœuvres for sea-coast pieces.

417. In every case the wooden handspike is required, and to avoid repetition the following general directions for its use are given. Six are the number generally used, and they are in charge of Nos. 1, 2, 3, 4, 5, and 6.

When men on opposite sides of a piece apply themselves to a handspike, the handspike used is that of one of the even numbers; the man to whom it belongs is at the smaller end, the corresponding odd number at the butt end; those who assist place themselves inside of these two numbers; the lowest numbers nearest the ends.

When two or more men work at the same end of a handspike, the man to whom it belongs is at the end, and the other men in the ascending order of their numbers from him.

When several handspikes are crossed at the muzzle in order to raise or lower it, they are applied in the order of the numbers of the men to whom they belong, those of the highest numbers nearest to the trunnions.

The handspikes used in the mechanical manœuvres are beveled on one side, as these will enter into places or under bodies where square handspikes could not be used.

When a handspike rests on a fulcrum, and the weight on one

end is to be raised by bearing down on the other, the weight should never rest on the beveled side, as the handspike would not then give a good hold, and would be liable to split. In this case the beveled side should be down. But if used for lifting, as when two handspikes are crossed under the breech or chase of a gun to heave it upward, their ends resting on the ground or platform, the beveled side should be up.

When two or more men haul together on a rope, the lowest number is next the object of resistance, and the remainder next him in ascending order of their numbers.

418. At the completion of each movement of a manœuvre, the men retain the places they are in at its conclusion, ready to proceed to the next movement, resuming their posts only at the command **TO YOUR POSTS**, which is given by the instructor at the end of each manœuvre.

419. The front, when a piece is unlimbered or dismounted, is the direction in which its muzzle points; when limbered, it is the direction in which the pole points. In the execution of the following manœuvres, when a piece is put in motion upon rollers, the terms back and forward are applied to the direction of the breech and muzzle respectively.

A body moving upon a roller gains twice the distance passed over by the roller.

The ground should be level and firm and the implements in good order.

Preparatory to manœuvering, the implements and machines required are taken to the place of exercise. The instructor explains to the detachment their names, uses, and mode of application. He then commands:

1. PREPARE TO MANŒUVRE.

420. The men take the implements, repair to their posts, and place them upon the ground in their rear; the handspikes behind Nos. 1, 2, 3, 4, 5, and 6 perpendicularly to the axis of the piece, on that side of the cannoneer toward the muzzle, the small ends on a line with their toes; the chocks equally divided, behind and near Nos. 3 and 4; the long rollers near and behind No. 4, and the short rollers, shifting-plank, trace-rope, sling-chain, and hammer-wrench in rear of the gunner.

Whenever, in the course of a manœuvre, an implement is not in immediate use, it is returned by the person using it to its designated place.

421. The instructor gives the commands and has a general supervision of the manœuvres. He sees that each man performs the duties assigned him; that everything is in a proper state of

readiness before giving the command of execution; and that particular care is taken to avoid all shocks and sudden movements.

422. The chief-of-detachment attends directly to the execution of the movements, and particularly assists and directs the gunner in all his duties.

423. The gunner gives commands when specified; places the shifting-plank; attaches and takes off the trace-rope; removes and replaces the elevating screw; places and removes chocks and the short rollers; superintends the righting of the piece; directs the pole of the limber, &c.

Nos. 1, 2, 3, 4, 5, and 6 have charge of the handspikes; Nos. 7 and 8 rig and work the windlass, Nos. 1 and 2 holding on to the rope; Nos. 3 and 4 chock and unchock the wheels, the gun, and the long rollers; take off and replace the cap-squares, and place and remove the long rollers.

Nos. 5 and 6, with their handspikes, steady and right the piece, haul on the ropes, &c. Nos. 7, 8, 9, and 10 assist the others. Nos. 7 and 8 generally assist Nos. 1 and 2, or 3 and 4. Nos. 9 and 10 assist Nos. 3 and 4, or 5 and 6; they assist in placing the implements preparatory to manœuvering; haul upon the ropes, and apply themselves by hand to move the carriage.

424. Two or more men, lifting or hauling together, must wait for the command before exerting their strength. The gunner sees that all are ready before giving the command *heave*. Then all move with a prompt but steady effort, and apply their power increasingly until the weight responds to their effort. The gunner will repeat the command *heave* as often as it may be necessary. When the movement has been sufficiently made, the gunner commands: **EASE AWAY**. Those making the effort will then desist; but in doing so will be careful to avoid all sudden shocks or strains.

The command *ease away* will be omitted in the text, for the reason that its application will, in most cases, depend upon circumstances, to be judged of by the gunner.

Every operation should be done with spirit and animation, but without bustle or confusion. Vigilance should be constantly exercised to have the piece or rollers securely chocked.

425. The limber of a siege-piece makes a powerful lever, and may be advantageously used in many cases. The pole is raised and the pintle engaged in a sling around the weight to be raised. The pole is hauled down by a trace-rope attached to the eye.

426. *Parbuckling.* (Fig. 1, Plate 19.) A rope used as a parbuckle is the best method of rolling a gun. To do this, place the gun on skids, and attach the rope by a bowline to one of the

trunnions, passing it under and around up over the gun, and hauling on the end.

If the gun is to be rolled up a slope, two ropes, of size suitable to the weight of the gun, are used. An end of each rope is made fast to some fixed object at the upper part of the slope; the other ends are carried under the chase and body respectively, and up over the gun; these ends are hauled upon by means of a capstan, or by attaching to them a fall and tackle. The muzzle is slued forward by pinching with bars, or by means of a rope and tackle attached to a roller or skid thrust into the muzzle. The piece is lowered by inverse means.

427. *To cross-lift* a piece or other object (*Fig. 2, Plate 19*) is to cross handspikes under it from opposite sides; the butt end of the handspike is on the ground, and the power is applied by lifting at the other end.

428. *To slue the trunnions* is to turn the piece on its axis so as to bring the trunnions into any required position. This is done by first placing the piece on skids perpendicular to its axis. A fulcrum is placed near the trunnion to be raised; upon this a handspike or other lever is used, the piece meanwhile being chocked on the opposite side. Or a trunnion-loop may be passed around the trunnion to be raised, and a handspike or lever passed through it, with the butt end resting on the top of the piece; the power is applied by lifting at the other end, the piece being chocked as before. Or, by passing the bight of a rope once or twice around the piece, and placing the butt of a handspike or lever through the bight, and bearing down or lifting up, using the piece as a fulcrum, the ends of the rope being held to prevent them from slipping. All three of these methods may be used at the same time.

The skids should be well greased under the piece, as likewise should be the chocks.

When the piece is of great weight, the hydraulic-jack or gin is advantageously used, provided the axes of the trunnions are not vertical. The former is placed under and the latter over the trunnion to be raised. When the axes of the trunnions are vertical, or nearly so, a rope is passed around the upper one and hauled upon by means of tackle.

429. *To pinch* a gun or other object is to move it by small heaves with a pinch-bar or handspike, without allowing it to turn on its axis. A piece is pinched one end at a time, the other being chocked. The bar or handspike is placed as a lever, with the beveled side down, and the power applied at the other end, by bearing down.

430. *To launch* a piece or other object forward or backward

is to move it in the direction of its axis. If the weight is such as to require levers or handspikes, they are placed, usually, on opposite sides, and the power applied by bearing down, at the same time carrying the free end of the lever in a direction contrary to that in which the object is to be moved.

To slue a piece or other object, *end for end*, is to turn it round, not allowing it to revolve on its longer axis.

To cut is to move the object horizontally, without rolling, by moving each end alternately in the required direction.

MANŒUVRES WITH THE SIEGE GUNS.

431. The implements required are those habitually accompanying each piece, viz.: Six *handspikes*, two *trace-ropes*, six *wheel-chocks*, one *hammer-wrench*, one *short roller*, one *sling-chain*, and four *roller-chocks*.

432. The following manœuvres are arranged on the supposition that no other implements are available. When two or more pieces are together, or planks or skids are available, as would generally be the case in the field, the manœuvres may be often simplified, as will be indicated.

The directions laid down in *par.* 417 and following will be observed. This is essential for the prevention of confusion and accidents, since directions to particular numbers are in most cases omitted.

Ordinary manœuvres.

1. To limber and to unlimber.
2. To move the carriage when limbered, with and without its piece, by hand to the front and rear.
3. To place the short roller under the chase and to remove it.
4. To place the short roller under the body of the gun and to remove it.
5. To shift the gun from its traveling bed to its firing bed.
6. To shift the gun from its firing bed to its traveling bed.
7. To side-lift the carriage.

All the other manœuvres are exceptional, and are rarely required in actual service with the guns now mounted on traveling carriages. They are, therefore, prescribed for exercise only to such an extent as may be necessary to enable officers and men to become familiar with the operations.

To limber.

(*Fig. 3, Plate 19.*)

433. When these guns are used for field service, they may

be limbered to the rear, front, right, or left. In every case the piece is in its firing bed.

To the rear. The instructor commands :

1. LIMBER UP.

Nos. 3 and 4 chock the wheels front and rear; No. 2 inserts his handspike in the bore, and is assisted to bear down by No. 1; No. 6 crosses his handspike under the stock, as near the trail as practicable, and is assisted by Nos. 3, 4, 5, 7, and 8, all facing in the direction of the trail. If the limber is not horsed, it is brought up by the chief-of-detachment, gunner, and Nos. 9 and 10. The stock is raised at the command **HEAVE** from the gunner until the pintle can be caught under the trail and the pole used as a lever to sustain it. The handspike is then shifted in rear of the lunette; Nos. 9 and 10 take hold of the limber-wheels; the gunner gives the necessary instructions to cause the pintle to enter the lunette, and when it is in, hooks the lashing-chain.

The instructor then commands : 1. **TO YOUR POSTS**; at which all take their posts as explained in *par.* 415.

To the right, or to the left. The instructor first causes the trail to be moved around to the right or to the left, so as to bring the axis of the piece perpendicular to its former position. The limber is moved to its place corresponding to the new position of the piece.

In moving the trail around, Nos. 1 and 3 at the right wheel, and Nos. 2 and 4 at the left, apply themselves as in *in battery* or *from battery*, but in contrary directions, as the case may require. Nos. 5 and 6 both imbar under and perpendicular to the stock on the side opposite that to which the trail is to be moved. The gunner commands : **HEAVE**, and repeats it as often as may be necessary. The piece is then limbered up as before.

To the front. The instructor causes the trail to be brought around so that the piece will point in the opposite direction. This may be done either to the right or left, as best suited to the ground, and is executed as in the preceding paragraph. The limber is moved to its place corresponding to the new position of the piece, and passes the piece either to the right or left, according to the nature of the ground. The piece is then limbered up as in the preceding cases.

To unlimber.

434. The instructor commands :

1. UNLIMBER.

The gunner unhooks the lashing-chain; Nos. 3 and 4 chock

the wheels front and rear, and all apply themselves as in limbering up. At the command **HEAVE** from the gunner, the trail is raised to disengage it from the pintle, the limber is moved forward, and the trail lowered to the ground. All resume their posts at the command **TO YOUR POSTS**.

When the piece is unlimbered, the habitual position of the limber is six yards in rear of the piece, measured from its axle to the trail, the pole pointing to the rear. In bringing it up for limbering, it is *backed* to its place at the trail. If the carriage is without its piece, Nos. 1 and 2 embar through the wheels and under the rear part of the cheeks, instead of as prescribed in *par.* 433.

In limbering and unlimbering a *siege howitzer*, Nos. 1 and 2 both insert handspikes in the bore.

To move a piece, or its carriage, to the front or rear.

435. The instructor commands :

1. *Forward* (or *backward*), 2. **MARCH**, 3. **HALT**.

The piece being limbered, Nos. 1 and 2 embar obliquely under the rear of the wheels of the carriage; Nos. 5 and 6, in like manner, under the limber-wheels; Nos. 3 and 4 through the spokes and under the cheeks; Nos. 7 and 8 apply themselves to the limber-wheels by hand; Nos. 9 and 10 at the splinter-bar, and the gunner and chief-of-detachment at the end of the pole; all facing to the front. The gunner commands: **HEAVE**, and repeats it as often as may be necessary.

In moving to the rear, Nos. 1 and 2 embar through the spokes and under the cheeks; Nos. 3 and 4 under the front of the wheels of the carriage; Nos. 5 and 6 under the front of the limber-wheels; Nos. 7, 8, 9, 10, and the gunner apply themselves as in moving to the front; all facing to the rear.

The carriage being limbered, but without its piece, at the command *forward* the numbers apply themselves by hand as follows: Nos. 1 and 2 at the head of the cheeks; Nos. 3, 4, 5, and 6 at the wheels of the carriage; Nos. 7 and 8 at the wheels of the limber; Nos. 9 and 10, and the gunner, as with the piece mounted. At the command *march*, the carriage is moved forward.

To move to the rear, Nos. 1, 2, 3, and 4 apply themselves by hand to the wheels of the carriage; Nos. 5 and 6 to the rear end of the cheeks; Nos. 7, 8, 9, 10, and the gunner, as with the piece mounted. At the command *march*, the carriage is moved to the rear.

In the foregoing movements, at the command *halt*, all resume their posts.

To place the short roller under the chase.

436. The piece being limbered and in its traveling bed, the instructor commands :

1. PLACE ROLLER UNDER THE CHASE.

(*Fig. 4, Plate 19.*) At this command, the cap-squares are removed and the wheels chocked by Nos. 3 and 4; the handspike of No. 2 is placed in the bore; that of No. 6 is crossed under the handspike of No. 2; No. 1 assists No. 2, and Nos. 3, 4, 5, 7, and 8 assist No. 6. The gunner stands at the head of the right cheek with the roller, and when all is in readiness gives the command **HEAVE**. The chase being raised high enough, the roller is rolled forward on the stock until its axis is within six or eight inches of the axis of the trunnions, and chocked in *rear*; the piece is then allowed to rest on it.

Note.—The roller is placed under the chase only when the piece is in its *traveling* bed, and for the purpose of shifting it.

To remove the short roller from under the chase.

437. The piece being limbered, the instructor commands :

1. REMOVE THE ROLLER.

Executed as in the foregoing paragraph, except that when the chase is raised the short roller is rested on the head of the stock by the gunner, to enable the men at the handspikes to take a new hold. The chase being raised again, the roller is withdrawn and the piece lowered into its bed.

Either of these operations can be performed, though more time is required, by successive purchases with the handspikes over the heads of the cheeks and under the chase.

To place the short roller under the body.

438. The piece being either limbered or unlimbered, the instructor commands :

1. PLACE ROLLER UNDER THE BODY.

Nos. 3 and 4 chock the wheels and remove the cap-squares; No. 2 inserts his handspike in the bore, and is assisted by No. 1 to bear down; Nos. 5 and 6 embar over the cheeks and under the gun in rear of the trunnions, and raise the breech at the command **HEAVE** from the gunner until he can place the short roller under the body of the piece, as near to the trunnions as can be effected readily. The gunner chocks the roller on the side toward the muzzle when the piece is limbered, and in rear

when unlimbered; removes the elevating screw and places it in rear of his post, resting it upon its handles.

Note.—The roller is placed under the body of the piece only when it is in its *firing bed*, and for the purpose of dismounting it, or of shifting it to its traveling bed, to a mortar-wagon, or to another carriage.

To remove the short roller from under the body of the piece.

439. The piece being either limbered or unlimbered, the instructor commands :

1. REMOVE THE ROLLER.

The gunner replaces the elevating screw, and the roller is removed as prescribed in the preceding paragraph.

Note.—All that is prescribed in the foregoing paragraphs applies likewise to the siege howitzer.

To shift the piece from its traveling to its firing bed.

(*Fig. 5, Plate 19.*)

440. The piece being limbered, the instructor causes a roller to be placed under the chase as explained in *par.* 436, and then commands :

1. SHIFT THE PIECE.

Nos. 3 and 4 remove the cap-squares; No. 2 inserts his handspike in the bore, and is assisted by No. 1; No. 6 crosses his handspike over that of No. 2, and is assisted by Nos. 3, 4, and 5. The gunner attaches the trace-rope at its middle by a double hitch to the knob of the cascable, and passes the ends over the limber to Nos. 7, 8, 9, and 10, who take a turn with each part around the manœuvering bolts. At the command **HEAVE** from the gunner, the muzzle is borne down and the piece allowed to run slowly on the roller until the trunnions are over their firing beds, when they are borne down into place and the short roller removed from the rear.

Before executing this or any similar manœuvre, the manœuvering bolts should be set tight to the stock with the wrench, to prevent accident from turning. The precaution should be taken, also, of putting a chock near the head of the stock to stop the roller, should the men at the trace-rope fail to control the piece after the trunnions have been lifted over the chin bolts.

The gunner *must* observe that the lashing-chain is hooked.

To shift the piece from its firing to its traveling bed.

441. The piece being limbered, the instructor causes the

roller to be placed under the body of the piece as explained in *par.* 438, and then commands :

1. SHIFT THE PIECE.

At this command, No. 2 inserts his handspike in the bore; the handspike of No. 4 is crossed under that of No. 2, and manned by Nos. 1, 2, 3, and 4; the gunner attaches the trace-rope at its middle to the knob of the cascable by a double hitch, and passes its ends over the limber to Nos. 5, 6, 7, 8, 9, and 10. At the command **HEAVE** by the gunner, the piece is pushed and hauled until the trunnions are over their traveling beds, when the breech is allowed to rest on the bolster. The roller is removed from the front by raising the muzzle as described in *par.* 437.

442. *Note.*—In any of the preceding manœuvres with the 8-inch howitzer, when the handspike of No. 2 is inserted in the muzzle it should be chocked about 18 inches in the bore, and again at the muzzle. When the howitzer is transported on its traveling bed, a temporary bolster should be constructed to support the breech. The short roller, resting on a piece of plank two or three inches thick and supporting the knob of the cascable, will answer for this purpose.

To side-lift a carriage.

443. For the purpose of moving a carriage a short distance to the right or left, it being unlimbered, the instructor commands :

1. SIDE-LIFT TO THE RIGHT (or LEFT).

To the right. Nos. 2 and 4 embar under and perpendicular to the left wheel, from the outside; Nos. 1 and 3 under the right wheel, from the inside, and No. 6 under and perpendicular to the trail. The gunner commands: **HEAVE**, and the carriage is lifted, short distances at a time, to the right.

To the left. Executed in the same manner, but by inverse means.

Remarks.

444. The short roller is carried as explained in *par.* 256.

When the piece is on its traveling bed, the elevating screw is run in on the lower side of the stock, and held in its place by a lashing-strap.

The sponge and rammer are lashed upon the piece, their heads projecting beyond the base of the breech. A convenient way of transporting them is by two iron collars, containing hooks, buckled upon the breech and chase.

The handspikes are carried as explained in *par.* 256.

Two trace-ropes should accompany each piece of siege artillery. They are useful not only in shifting the piece, but in lashing and in extricating the carriage or mortar-wagon from difficulties.

The sling-chain is carried wound around the stock. It may be used for a lock-chain, the one provided with a shoe being dispensed with.

The shifting-plank is carried on the stock, between the cheeks. A hole is bored in it, through which a rope passes, securing it to the stock.

The chocks and hammer-wrench are best carried in a bag slung to some part of the carriage.

445. To prepare a piece for traveling, the instructor causes the implements to be placed as above indicated. To do this, after shifting the piece to its traveling bed he commands :

1. PUT ON THE IMPLEMENTS.

The gunner places the vent-cover, short roller, elevating screw, and water-bucket ; if it is necessary to lash the piece to its bed, he is assisted by Nos. 1, 2, 3, 4, 5, and 6. No. 2 secures the tom-pion in the muzzle ; Nos. 1 and 2 fasten on the sponge and rammer, and, assisted by Nos. 3 and 4, put on the handspikes. The piece is lashed as explained in *par.* 256.

To prepare the piece for action, the instructor, before shifting it to its firing bed, commands :

1. REMOVE THE IMPLEMENTS.

The same numbers that put on the implements remove them.

446. The object of carrying the piece in the traveling bed is to equalize the load, by throwing more of the weight upon the limber, and thus relieving the rear wheels. For short distances, over smooth roads, the piece may, however, be carried in its firing bed.

OTHER MANŒUVRES WHICH MAY BE REQUIRED IN SERVICE.

To mount the siege gun on its carriage.

447. The piece is lying on the ground, vent uppermost ; the carriage unlimbered ; the elevating screw, bolster, and cap-squares removed ; the trail about two yards from the muzzle ; the stock squarely in prolongation with the gun. The instructor commands :

1. RAISE THE CHASE.

(*Fig. 1, Plate 20.*) The gunner extends the sling-chain on

the ground perpendicularly to the axis of the piece, with its middle under the neck of the cascable; No. 2 inserts his handspike in the bore, and is assisted to lift by No. 1; Nos. 3 and 4, with their handspikes, cross-lift under that of No. 2; Nos. 5 and 6 stand ready with their handspikes to thrust them under the piece as soon as it is raised. At the command **HEAVE** from the gunner, it is raised by Nos. 1, 2, 3, and 4, and the gunner places the roller under the muzzle; Nos. 5 and 6 thrust their handspikes under the chase, in the position for cross-lifting; Nos. 3 and 4 take fresh holds under the chase; the gunner commands: **HEAVE**, and the piece is raised until the gunner can place the roller under it a short distance in rear of the trunnions. The carriage is then run back, as *from battery* (*par.* 237), until the muzzle catches on a roller placed on the stock. (*Fig. 2, Plate 20.*) By cross-lifting the piece as before, the roller on the ground is removed and the piece allowed to rest on the roller on the stock.

The stock serves as an inclined plane, up which the piece moves on the roller. The carriage is now worked back, as *from battery*, as far as the trail, under the gun, will allow it to go.

The instructor commands:

1. SLING THE PIECE.

Nos. 7, 8, 9, and 10 run back the limber until the pintle is slightly in rear of the knob of the cascable, and the wheels are chocked front and rear. The wheels of the gun carriage are chocked in front.

The gunner attaches one end of a trace-rope to the eye of the limber pole, and Nos. 7, 8, 9, and 10 stand ready and raise it at the command *heave* from the gunner. (*Fig. 2, Plate 20.*)

No. 10 holds on to the rope to prevent the pole from going over too far. The pole having been raised, the gunner draws the sling-chain up tightly over the pintle and hooks it. Nos. 7, 8, and 9 go to the assistance of No. 10 at the rope, and, at the command **HEAVE** from the gunner, draw the pole down to the ground. The pole is held down and the carriage is run back, as *from battery*, until the trunnions nearly or quite touch the traveling trunnion bolts. The roller is chocked in rear, and the piece secured in this position by laying the middle of a trace-rope over it just in rear of the trunnions, carrying the ends to the front under them and making fast to the axle-tree.

The sling-chain is then unhooked and cast off from the pintle.

The instructor commands:

1. SLING THE STOCK.

The gunner doubles the sling-chain at the middle and, passing

the bight under the stock from left to right, places it over the right manœuvering bolt. Nos. 7, 8, 9, and 10 back the limber so that the end of the fork will have full play on the left of the stock when the pole is raised; chock the limber-wheels, front and rear; raise the pole as prescribed in the preceding paragraph.

The pintle should then be over and slightly to the rear of the left manœuvering bolt. Bring up both ends of the sling-chain *behind* the left manœuvering bolt, pass one end around the pintle, taking in all the slack, and fasten the hook in a convenient link of the other end. The wheels of the limber are now unchocked, and, at the command **HEAVE** from the gunner, the pole is hauled down to the ground as in the preceding paragraph. The stock should now be nearly horizontal; if it is not, support the trail with a roller, or any other convenient method, and, shortening the sling-chain, take a new lift.

The instructor commands :

1. SHIFT THE ROLLER.

(*Fig. 3, Plate 20.*) No. 2 places his handspike in the bore, and is assisted by No. 1; No. 4 crosses his under that of No. 2, and is assisted by Nos. 3, 5, 6, 7, and 8; Nos. 9 and 10 hold down the pole. At the command **HEAVE** from the gunner, the gun is raised and the roller is shifted to just in front of the trunnions.

The instructor commands :

1. SHIFT THE PIECE.

(*Fig. 4, Plate 20.*) The trace-rope is cast off from the piece; the gunner attaches it at the middle to the knob of the cascable, and passes the ends over the axle of the carriage to Nos. 3, 4, 5, and 6; No. 2, with his handspike in the bore, is assisted to lift and bear down by No. 1. At the command **HEAVE** from the gunner, the piece is hauled forward until the trunnions clear the chin bolts, when the muzzle will at once be borne down, causing the trunnions to drop into their firing beds. As the muzzle approaches the ground the handspike must be shoved into the bore. The pole is raised and the trail allowed to rest on the ground, the sling-chain disengaged, and the roller removed by the rear.

To dismount the siege gun from its carriage.

(*Fig. 5, Plate 19.*)

448. The piece being limbered and the wheels chocked, the instructor causes a roller to be placed under the body of the piece

as explained in *par.* 438. The roller is chocked on the side towards the trail. The instructor then commands :

1. DISMOUNT THE PIECE.

(*Fig. 5, Plate 20.*) The gunner attaches the trace-rope by its middle with a double hitch to the knob of the cascable, and passes the ends to Nos. 9 and 10, who take two turns with them around the manœuvring bolts and, hauling taut, stand ready to ease off when directed ; Nos. 3 and 4 remove the cap-squares ; No. 2 places his handspike in the bore, and is assisted to lift by No. 1 ; No. 4 crosses his handspike under that of No. 2, and is assisted to lift by Nos. 3, 5, 6, 7, and 8.

At the command **HEAVE** from the gunner, the muzzle is raised ; the rope is carefully slacked off ; the trunnions are eased over the eye-bolts and allowed to rest on the cheeks ; Nos. 9 and 10 ease off the rope, and allow the piece to run forward until the trunnions clear the cheeks, when the muzzle is depressed and allowed to rest on the ground, No. 2 pushing his handspike up the bore for this purpose. The rope is cast off and the wheels unchocked.

The carriage is then run forward as explained in *par.* 435, and the piece allowed to drop to the ground.

In performing this manœuvre with a single roller, the breech is sometimes jammed between the cheeks, or the head of the stock bruised by the knob of the cascable. Both of these difficulties are obviated by using two short rollers, the second one being rolled down the stock against the first before running the carriage out.

If the piece is dismounted in this manner on hard, stony soil, some material, as hay, brush, &c., should be placed to receive it in its fall.

Note.—In the above or other similar manœuvres, should no limber be available, the stock may be temporarily supported in a horizontal position by any means most convenient.

To shift the siege gun from one carriage to another.

(*Fig. 1, Plate 21.*)

449. The piece is unlimbered ; the spare carriage, limbered, with cap-squares and elevating screw removed, is placed with its pole pointing in the same direction as the trail of the piece, and two or three yards distant therefrom.

The roller is placed under the body of the piece as in *par.* 438.

The instructor commands: 1. **RAISE THE CHASE.** At this

command, No. 2 inserts his handspike in the bore, and is assisted by No. 1; No. 4 crosses his under that of No. 2, and is assisted by Nos. 3, 5, and 6; the gunner gives the command **HEAVE**, and the chase is raised until a wheel-chock, base up, or the butt end of a handspike, can be placed by Nos. 7 and 8 under each trunnion.

The instructor causes the trace-ropes to be attached by its middle, with a double hitch, to the knob of the cascable; the spare carriage is then backed accurately, wheel to wheel, against the carriage of the piece, and the wheels chocked; the ends of the trace-ropes are passed over the spare carriage to Nos. 9 and 10. The gunner then places the shifting-plank, with one end on the head of the stock of the spare carriage, and the other end, beveled side down, on the stock under the gun. The gunner commands: **BEAR DOWN THE MUZZLE**, which is done by Nos. 1, 2, 3, and 4, while the gunner places the roller on the plank about eight inches in rear of the trunnions. The instructor commands: 1. **SHIFT THE PIECE**. Nos. 5, 6, 7, and 8 go to the ropes to haul with Nos. 9 and 10. Those at the muzzle prepare to lift. The gunner commands: **HEAVE**, and the piece is moved back until the trunnions are over the beds on the spare carriage; another roller is then placed on the stock of the carriage, under the body of the gun.

The instructor commands: 1. **REMOVE THE PLANK**. Nos. 1 and 2 embar with their handspikes over the cheeks of the now free carriage and under the chase, and are assisted to bear down by Nos. 3 and 4. The gunner commands: **HEAVE**; the chase is raised; the plank and roller are removed; the roller is placed on the head of the stock of the free carriage, and the muzzle rested on it.

The instructor commands: **RUN OUT THE CARRIAGE**. Executed as in *in battery*. (*Par.* 242.) The piece drops into the trunnion beds, after which the roller under the body is removed by the rear as in *par.* 439. The cap-squares and elevating screw are replaced.

To mount the siege gun on the mortar-wagon.

(*Fig. 2, Plate 21.*)

450. The gun is lying on the ground; the mortar-wagon, unlimbered, its stakes and bolster removed, is in the prolongation of the piece; its trail on the ground about two yards from the breech.

The instructor commands:

1. RAISE THE CHASE.

Executed as in *par.* 447, except that the sling-chain is not placed under the neck of the cascable. After the roller is placed under the trunnions, tip the muzzle down, and back the mortar-wagon until the breech catches on another roller placed on the stock; the wheels are then chocked.

Note.—A limber may be used to sling the piece until the breech rests on the roller placed on the stock, and subsequently to sling the muzzle clear of the ground to prevent its dragging.

The instructor commands :

1. RIG THE WINDLASS.

(*Fig. 3, Plate 21.*) The gunner lays the middle of the trace-rope over the piece in rear of the trunnions; brings the ends under and around over the trunnions; takes two turns with each end around the middle of the windlass, the standing parts toward the ends; Nos. 1 and 2 take hold of the ends of the rope to hold on and take up the slack; Nos. 7 and 8 insert the handspikes into the ratchet-sockets, and are assisted by Nos. 9 and 10; Nos. 3, 4, 5, and 6, with their handspikes, steady the piece. At the command **HEAVE** from the gunner, the piece is drawn up the stock. When the roller under the chase becomes free, it is placed under the breech.

Draw the piece back on the wagon until the trunnions are about eighteen inches in front of the axle-tree; the gunner replaces the bolster, and Nos. 3 and 4 chock the rollers front and rear, and likewise the wheels of the wagon.

Note.—If the wheels are unchocked, the stock will work itself under the piece and considerably relieve the strain on the ropes.

The instructor commands :

1. LIMBER UP.

Executed as in *par.* 433, except that Nos. 1 and 2 hold on to the ropes and prevent them from slipping on the windlass.

The instructor commands :

1. STOW THE PIECE.

(*Fig. 4, Plate 21.*) Nos. 1 and 2 cast off the rope from the windlass and carry the ends to the front. The gunner changes the middle of it so that it will cross the gun in *front* of the trunnions. Nos. 7, 8, 9, and 10 assist Nos. 1 and 2 to haul upon the ropes; Nos. 3, 4, 5, and 6, with their handspikes, steady the piece; the rollers are unchocked. At the command **HEAVE** from the gunner, the piece is hauled forward until the breech is

over its seat in the wagon; the front roller is chocked and the muzzle borne down until the rear roller can be removed; the breech is then allowed to rest in its seat. The front roller is removed by raising the chase as explained in *par.* 436, and the chase is allowed to rest on the bolster. The stakes of the wagon are replaced in their sockets.

To dismount the siege gun from the mortar-wagon.

451. The wagon being limbered and the stakes removed, the instructor commands:

1. PLACE THE ROLLER UNDER THE CHASE.

Executed in a manner similar to that explained in *par.* 436. The roller is chocked front and rear. The numbers who lifted at the muzzle now bear it down, and another roller is placed under the body of the piece, about eighteen inches in rear of the trunnions. The bolster is removed, and the instructor commands: **RIG THE WINDLASS.** Executed as in *par.* 450. At the command **HEAVE** from the gunner, the piece is hauled back until the trunnions are about eighteen inches in front of the axle-tree; both rollers are chocked front and rear.

The instructor commands:

1. UNLIMBER.

Executed as in *par.* 434, except that Nos. 1 and 2 hold on to the ends of the ropes and prevent them from slipping on the windlass.

Note.—In this operation care must be taken that the gun is not too far to the rear, thus endangering the tipping over backwards of the wagon.

The instructor commands:

1. LOWER THE PIECE.

Nos. 1 and 2 ease off the ropes and allow the piece to descend on the stock. As the rollers become disengaged in rear they are placed under the piece in front. When the muzzle strikes the ground, the wheels may be unchocked and the carriage moved to the rear, thus permitting the piece to descend to the ground.

To shift the siege gun from its carriage to the mortar-wagon.

452. The piece and mortar-wagon are both limbered; the latter is placed in rear of the former, but faced in the opposite direction; the windlass two or three yards from the muzzle of the piece. The instructor causes the roller to be placed under the body of the piece as explained in *par.* 438.

He then commands :

1. HAUL BACK THE PIECE.

The gunner attaches the trace-rope, by its middle, to the knob of the cascable, and passes the ends to Nos. 5, 6, 7, 8, 9, and 10. Nos. 1, 2, 3, and 4 apply themselves as in *par.* 441. The gunner commands **HEAVE**, and the piece is moved back until the trunnions rest on the cheeks just behind the chin bolts.

The roller is removed by the rear as explained in *par.* 439, and the wagon is backed up to the carriage, wheel to wheel, and chocked.

The instructor commands :

1. SHIFT THE PIECE.

The gunner places the shifting-plank from the head of the stock to the mortar-wagon, and places the roller on it under the chase, working it back as far toward the trunnions as practicable, the piece being raised by successive purchases over the cheeks and under the chase. Remove the bolster (which is useful as a fulcrum); a turn is taken around each manœuvring bolt with the trace-rope, which is held by Nos. 5, 6, 7, 8, 9, and 10. At the command **HEAVE** from the gunner, Nos. 1, 2, 3, and 4 bear down on the muzzle and permit the piece to run forward onto the wagon, where the chase is received on a roller.

The roller is removed and the piece stowed as explained in *par.* 450.

Note.—The gun may be shifted to the mortar-wagon, (the piece being limbered.) without a shifting-plank, by the use of a second roller to receive the body of the gun on the mortar-wagon. The preliminaries are the same as before; the trunnions being held on the cheeks, the roller is placed well up, just in rear of them; the trace-rope taut and around the manœuvring bolts; the muzzle is raised, the wagon backed wheel to wheel, and the chase rested on a roller which is placed on the rear cross-bar plate, and receives the body of the gun as the first roller runs off the head of the stock.

To shift the siege gun from the mortar-wagon to its carriage.

453. This operation is executed by means the inverse of those explained in the preceding paragraphs.

When the trunnions are over their beds, the shifting-plank and roller are extricated by cross-lifts under the chase, and the chase allowed to rest on a roller so placed that when the mortar-wagon is run to the front the muzzle will clear the wagon as it drops from the roller; thus permitting the trunnions to fall

into their beds. Meanwhile the piece is held fast by taking one or two turns of the trace-rope round the manœuvring bolts.

To stand the siege howitzer on its muzzle.

454. The piece is lying on the ground. The instructor commands :

1. RAISE THE CHASE.

Nos. 1 and 2 insert their handspikes in the muzzle and chock them on top; No. 4 crosses his handspike under those in the muzzle, and is assisted to lift by Nos. 3, 5, and 6; Nos. 7 and 8 assist Nos. 1 and 2. At the command **HEAVE** from the gunner, the piece is raised and a shifting-plank run under it parallel to the axis; a short roller is placed on the plank under the trunnions perpendicular to the axis of the piece. The roller is chocked front and rear.

The instructor commands :

1. RAISE THE BREECH.

(*Fig. 1, Plate 22.*) Nos. 1 and 2 withdraw their handspikes; No. 2 crosses his over the muzzle, and is assisted to bear down by Nos. 1, 3, and 4; No. 6 crosses his under the neck of the cascable, and is assisted to lift by Nos. 5, 7, 8, 9, and 10. At the command **HEAVE** by the gunner, the breech is raised until the muzzle rests upon the ground. The men at the muzzle hold it in this position while the gunner attaches the middle of a trace-rope by two half hitches to the middle of a handspike, and places it under the neck of the cascable; the ends of the rope are brought up, one on each side of the cascable, and crossed on the breech; Nos. 7, 8, 9, 10, the gunner, and chief-of-detachment man the ropes and hold taut, while Nos. 1, 2, 3, 4, 5, and 6 man the handspike.

The gunner then commands: **HEAVE**; and all lift and haul until the piece stands on the muzzle.

To dismount the siege howitzer.

(*Fig. 2, Plate 22.*)

455. The piece being unlimbered, the instructor commands :

1. DISMOUNT THE PIECE.

The gunner attaches one end of a trace-rope to one of the manœuvring bolts; Nos. 3 and 4 chock the wheels front and rear; Nos. 1 and 2 lay their handspikes on the ground parallel to the axis of the piece, in such position that the muzzle, when it comes over, will rest squarely on their largest part,—or if a

shifting-plank is used, they place it instead of the handspikes; No. 10 holds on to the rope; all the other numbers lift by hand at the stock; Nos. 1 and 2 being nearest the axle-tree, and the other numbers arranged in their order towards the trail. At the command **HEAVE** from the gunner, the trail is raised until a handspike, butt end on the ground, can be placed under it by No. 9, who, following up the movement, supports the stock. The gunner repeats the command **HEAVE** until the muzzle rests squarely on the handspikes or shifting-plank; the numbers at the stock quit it as the weight passes to the front, and go to the assistance of No. 10 at the rope.

As soon as the piece rests on the muzzle, Nos. 3 and 4 remove the cap-squares.

The gunner cautions those at the rope to keep a slight strain on it, and directs Nos. 3 and 4 to move the wheel-chocks to the rear, an inch or two at a time; Nos. 5 and 6, at the wheels, move the carriage back; Nos. 1 and 2 steady the piece; Nos. 3 and 4 follow up the movement of the wheels with the front chocks. The movement is repeated, under the direction of the gunner, until the carriage is backed sufficiently far for the cheeks to clear the trunnions; No. 9, regulating the position of the handspike, supporting it at each movement of the wheels, so as to keep its preponderance to the rear without lowering it so much as to cause the key bolts to interfere with the piece. The trail is then lowered by means similar to those for raising it.

A turn with the rope around some secure object will prevent the danger of the trail falling over.

To mount a siege howitzer.

456. The piece is standing with its muzzle on a shifting-plank, or on handspikes; the carriage, unlimbered, is as close to the piece as practicable and have the heads of the cheeks clear the trunnions when the trail is raised; the wheels are chocked front and rear.

The instructor commands:

1. MOUNT THE PIECE.

The gunner attaches the trace-rope to one of the manœuvring bolts; Nos. 3 and 4 remove the cap-squares. The trail is raised as explained in the preceding paragraph until it is nearly vertical, Nos. 7 and 8 passing to the rope after the trail is supported by the handspike. The trail is raised slowly, No. 10 being careful that it does not pass the perpendicular, and No. 9 that the supporting handspike is properly placed. Nos. 3 and 4, at the direction of the gunner, move the wheel-chocks to the

front, an inch or two at a time, and Nos. 1, 2, 5, and 6, at the wheels, move forward the carriage, Nos. 3 and 4 following up the wheels with the rear chocks. The trail is kept nearly perpendicular, and the handspike adjusted by No. 9. These movements are repeated until the trunnions rest in their beds, when the cap-squares are secured by Nos. 3 and 4 and the trail lowered to the ground. Nos. 1 and 2 assist by lifting with their handspikes under the heads of the cheeks until they can embark under the muzzle. All the remaining numbers, except No. 9, haul on the rope. As the weight comes on the stock, the men, in succession, leave the trace-rope and take hold of the stock, and lower it by hand to the ground.

Note.—If the piece is standing on the ground, instead of on a plank or handspikes, raise the trail as before until the trunnions rest against the cheeks, near and, if possible, above the key bolts; put the sling-chain (*Fig. 3, Plate 22*) around the piece from behind, the ends brought to the front under the trunnions; thence up around them and through the trunnion beds, where they are hooked together; or, if the links are large enough, catch two of them on the chin bolts, the chain being in either case hauled taut. Lower the trail to the ground in the inverse manner of raising it, as just explained.

If the piece has been well slung the trunnions will rest on the cheeks, in front of their beds. To get them into their beds, limber up; place the roller under the body; attach the trace-rope by its middle to the neck of the cascable, and take a turn with the ends around the axle-tree; raise the muzzle and slacken carefully on the rope until the trunnions are in place; after which the roller is removed.

To mount the siege howitzer on its carriage as a mortar.

457. The piece is lying on the ground, vent up; the carriage, pointing in the opposite direction, is placed so that the heads of the cheeks are about two yards from the face of the piece, and then dismounted.

The instructor commands:

1. MOUNT THE PIECE AS A MORTAR.

The muzzle is raised and a roller placed under the piece, as explained in *par.* 454. On soft ground, it will be necessary to place a shifting-plank under the roller.

The body of the carriage is then moved up by embarring with handspikes under the manœuvring bolts and axle, and cross-lifting under the heads of the cheeks, until a shifting-plank can be placed, (by lifting at the muzzle,) one end on the head of the

stock, beveled side up, and the other about six inches in rear of the trunnions. At the time of placing the plank, the roller is shifted to a point about sixteen inches in front of the trunnions and chocked. The plank is shored up with the butt end of a handspike. The gunner lays the middle of the trace-rope over the piece and takes a round turn from the rear upon each trunnion with the ends of it. (*Fig. 4, Plate 22.*) Through the loop of these turns, No. 2 passes a handspike, and is assisted at the other end by No. 1 in keeping the piece from rolling while it is being hauled up the plank. The ends of the rope are drawn taut, crossed over the chase, and manned by Nos. 5 to 10 upon their respective sides. Nos. 3 and 4 embark with handspikes under the trunnions until the piece is started, and then shift, as the piece ascends, to a handspike placed crosswise under the cascable.

The gunner commands: **HEAVE**, and the piece is hauled and pushed until its trunnions rest over their beds, when the roller is chocked and the rope removed; the breech is raised, the roller and plank removed, and the trunnions lowered into their beds; the cap-squares are replaced. By raising the trail and sustaining it in that position with blocking or by a bank of earth, an elevation of about 40 degrees can be obtained, and by excavating under the breech a still higher degree. The trail may be used as a lever in pointing.

The service of the piece is almost the same as when it is mounted in the usual manner. It is found in practice that the recoil is very slight, the centre of gravity being nearly over the axle.

To dismount the howitzer.

458. Let down the trail and raise the muzzle until a wheel-chock, base up, can be placed in each trunnion bed; raise the breech and place the shifting-plank and roller on the head of the stock; the roller should be just within the cheeks and chocked in rear; raise the trail by cross-lifting until the trunnions are free from the key bolts. The chock of the roller is then knocked out by the gunner, and the piece allowed to run down the plank upon the ground. The plank should be shored up as before, and those near the piece must stand clear.

Ranges of the 8-inch howitzer mounted as a mortar.

| CHARGE. | PROJECTILE. | ELEVATION. | RANGE. | TIME OF FLIGHT. |
|---------|-------------|------------|--------|-----------------|
| Ounces. | Shell—Lbs. | Degrees. | Yards. | Seconds. |
| 4 | 45 | 45 | 330 | |
| 8 | 45 | 45 | 620 | |
| 12 | 45 | 45 | 1080 | 14.75 |
| 14 | 45 | 45 | 1135 | 15.37 |
| 16 | 45 | 45 | 1440 | 16.42 |
| 20 | 45 | 45 | 1925 | |

Spherical case can be used with great effect against troops in trenches if made to burst fifty or one hundred feet before reaching the ground.

The charge should not exceed one-half of the service charge of the piece.

To dismount a siege carriage and its limber.

459. The carriage being without its piece, and unlimbered, the wheels are removed in succession.

To remove the right wheel, the instructor commands :

1. DISMOUNT THE RIGHT WHEEL.

No. 1 crosses his handspike from the front, under the axle-tree, as near the wheel as possible, and is assisted to lift by Nos. 2, 3, and 4; Nos. 5, 6, 7, and 8 lift at the other end; Nos. 9 and 10 remove the linch-pins, and apply themselves to the wheel. The gunner commands : **HEAVE**; the wheel is removed and the axle-tree lowered to the ground, or on a block.

The left wheel is taken off in a corresponding manner.

The carriage may be *mounted* in a similar manner.

It may sometimes be advantageous to raise the carriage to the necessary height by successive purchases, with handspikes as levers, and support it on props. The limber may also be used to lift the carriage, but it will generally be found more expeditious to mount it as above described.

The *limber* is readily dismounted and mounted by passing the long handspikes between the sweep-bar and axle-tree, the butt ends resting on the splinter-bar; six men lift on the handspikes and two at each wheel.

The *mortar-wagon* may be dismounted in like manner, the

men taking hold of the rails and handspikes passed under the windlass and over the axle-tree.

To change or grease a wheel. The lifting-jack is applied under the axle-tree near the wheel to be removed, or the wheel may be removed by using handspikes as levers and blocks as fulcrums, under the axle-tree; the axle may be temporarily supported by a prop.

By using the trail as a lever, a wheel may be changed, when the piece is unlimbered, as follows: Raise the trail as in limbering, and place a prop, about thirty inches in length, under the cheek close in the rear of the axle-tree on the side on which the wheel is to be changed. Bear down on the trail and the wheel will clear the ground.

MECHANICAL MANŒUVRES WITH 10-INCH SIEGE MORTAR.

460. The implements required are those habitually accompanying each piece and the mortar-wagon, viz.: Four *handspikes* (mortar), two *handspikes* (manœuvering), one *trace-rope*, one *hammer-wrench*, two *long rollers*, four *roller-chocks*, six *wheel-chocks*, two *handspikes* (windlass).

To stand the mortar on one of its trunnions.

(Fig. 5, Plate 22.)

461. The mortar is lying on the ground or on its platform. The instructor commands:

1. STAND THE MORTAR ON THE RIGHT (OR LEFT) TRUNNION.

The gunner passes the middle of the trace-rope around one of the trunnions from underneath; the ends are carried over the mortar and manned by all the cannoneers. The gunner then commands: **HEAVE**, and the piece is pulled over on its trunnion.

To stand the mortar on its muzzle.

(Fig. 6, Plate 22.)

462. The piece is standing on one of its trunnions. The instructor commands:

1. STAND THE MORTAR ON ITS MUZZLE.

The gunner passes the middle of the trace-rope under the mortar in front of the trunnion; carries the ends back, crosses them over the breech and passes them to the front, one on each side of the upper trunnion. He then commands: **HEAVE**, and

the piece is hauled over on its muzzle by the rest of the detachment at the trace-rope.

To slue the mortar.

463. The mortar being on its muzzle, the instructor indicates the direction in which it is to be slued, and commands :

1. SLUE THE MORTAR.

Nos. 5 and 6 embar against the trunnions on opposite sides, and, at the command **HEAVE** by the gunner, turn the piece about its axis. To shift the piece when in this position, Nos. 5 and 6 embar on the same side.

To dismount the mortar.

464. The mortar is on its carriage, which is on the platform or on the ground. The instructor commands :

1. DISMOUNT THE MORTAR.

The gunner, assisted by No. 4, gives the mortar an elevation of twenty-one degrees, or, if no quadrant is at hand, brings the plane of the face of the piece tangent to the front ends of the cheeks; he then throws the bight of the trace-rope over the middle of the pipe, and, drawing the ends through the loop, passes them to the rear to Nos. 7, 8, 9, and 10, who haul on them with sufficient force, when the carriage has been raised, to keep it from falling to the front; No. 2 passes a handspike under the rear notches and *over* the rope; the cannoneers man the handspike in the following order from right to left: Nos. 1, 3, 5, 6, 4, 2, all facing to the front. The gunner commands: **HEAVE**; the cannoneers at the handspike lift on it until the face of the piece rests upon the platform or ground. (*Fig. 7, Plate 22.*) The cap-squares are removed by Nos. 3 and 4, assisted by Nos. 1 and 2, and placed in rear of their posts, the nuts on the cap-squares.

The instructor commands :

1. LOWER THE CARRIAGE.

The cannoneers man the handspike and rope as before. The gunner commands: **HEAVE**. The cannoneers haul upon the rope, and the four nearest the mortar leave it in succession, applying themselves to the handspikes as the weight comes upon it, to prevent any unnecessary shock. The cap-squares are replaced by Nos. 3 and 4; No. 2 removes the handspike, and the gunner the trace-rope.

To mount the mortar.

465. The mortar is standing upon its muzzle; the front of the carriage eighteen inches from it, on the side opposite the vent.

The instructor commands :

1. MOUNT THE MORTAR.

The cap-squares are removed by Nos. 3 and 4 and placed, with their nuts, in rear of their posts. The gunner attaches the trace-rope to the pipe, and the cannoneers apply themselves to the rope and handspike as described in the preceding paragraph. The gunner commands: **HEAVE**; and when the weight of the carriage is fairly supported by the rope, Nos. 3 and 4 take their handspikes and, embarring against the manœuvring bolts, move the bed as may be necessary until the trunnions are in their beds. Assisted by Nos. 1 and 2, they put on the cap-squares.

The instructor then commands :

1. LOWER THE MORTAR.

Nos. 3 and 4, facing to the rear, embar with their handspikes under the cap-squares, and subsequently under the front notches; the other cannoneers apply themselves at the rope and handspike, and the mortar is lowered as described in *par.* 464.

To mount the mortar upon the mortar-wagon.

466. The mortar is on its carriage; the carriage, on the platform or on the ground; the trail of the mortar-wagon, its stakes and bolster removed, is about two yards from the pipe and perpendicular thereto.

The instructor commands :

1. RAISE THE MORTAR.

Executed as prescribed in *par.* 464, except that the mortar need not be given any particular elevation, and, instead of allowing it to go over until the muzzle strikes the ground, the carriage is poised in nearly a vertical position by Nos. 1, 2, 3, 4, 5, and 6, while Nos. 7 and 8, embarring with handspikes under the stock of the wagon, guide it under the mortar carriage midway between and parallel to the cheeks; Nos. 9 and 10 working at the wheels. The stock is run under the carriage as far as practicable and the wheels chocked front and rear; the long roller is placed on it by the gunner in such position that when the carriage is lowered its point of contact with the roller will be twenty inches from the toes of the shoes; the mortar is then lowered upon the roller.

The instructor commands :

1. RIG THE WINDLASS.

The gunner lays the middle of the trace-rope across the rear notches ; Nos. 1 and 2 pass the ends underneath and around the rear manœuvring bolts, and, carrying them to the rear, take two turns with them around the windlass. The windlass is manned as explained in *par.* 450, and is worked at the command **HEAVE** from the gunner.

As soon as the mortar is in motion, the second long roller is engaged under the shoe, by Nos. 3 and 4, twenty inches from the lower roller, measuring from axis to axis. The lower roller will then disengage just as the mortar is balanced on the upper roller. Nos. 5 and 6 steady the mortar with handspikes.

As soon as the lower roller is disengaged, it is taken out by Nos. 3 and 4, who again engage it twenty inches above the other roller. The mortar is drawn back on the last roller until the heels of the shoes abut against the hurters on the rear cross-bar plate. The roller is now chocked in front, and *particularly in rear*, by Nos. 3 and 4.

The instructor commands :

1. LIMBER UP.

Executed as in *par.* 450.

The gunner then secures the lashing-chain.

In raising the stock, in limbering and unlimbering, great care must be taken not to raise it so high as to endanger the overturning of the wagon to the rear.

The instructor commands :

1. STOW THE MORTAR.

No. 4 removes the front roller-chock, and satisfies himself that the rear roller-chock is in place ; Nos. 5 and 6 embar over the side rails and under the shoes, near the rear notches, to cant the carriage to the front ; Nos. 1 and 2 ease away gently, and permit the carriage to move forward on the roller until the front notches are over the front cross-bar plate. If the carriage does not move far enough forward on the roller after canting, Nos. 5 and 6 embar over the side rails and under the front notches, and pinch the carriage forward to its place. The roller is then removed from the rear, and the carriage lowered onto the wagon by repeated purchases, the disengaged roller-chocks and bolster being placed by the gunner as fulcrums on the rear of the wagon. If the mortar is to travel, its carriage is securely lashed to the wagon.

467. The most convenient way of carrying the implements, is to fit a bed to the mortar-wagon. The bed is made of stout boards about a foot wide; those for the sides are held in place by rope becketts passed through auger holes in the boards and around the stakes of the wagon; the end boards fit between cleats nailed to the ends of the side boards; the whole forming a box about seven feet long, with a width equal to the width of the wagon. Slots are cut in the side boards for the manœuvring bolts, which project slightly beyond the side rails of the wagon.

To dismount the mortar from the wagon.

468. The mortar is unlashd; the implements, bolster, and stakes of the wagon are removed.

The instructor commands:

1. DISMOUNT THE MORTAR.

Nos. 5 and 6 embar over the side rails and under the rear notches, using chocks and bolster as fulcrums, and by repeated purchases raise the mortar carriage until a long roller can be placed under it with the points of contact two feet from the toes of the shoes.

The instructor then commands:

1. RIG THE WINDLASS.

The gunner attaches the trace-rope, and the windlass is rigged as explained in *par.* 450. At the command **HEAVE** from the gunner, the mortar is drawn back against the hurters, Nos. 5 and 6 embaring under the shoes and over the side rails, to ease the carriage when it cants to the rear; Nos. 3 and 4 chock the roller front and (*especially*) rear.

The instructor commands:

1. UNLIMBER.

Executed as explained in *par.* 451.

The instructor commands:

1. LOWER THE MORTAR.

Nos. 1 and 2 slack off on the rope, and the mortar is eased down the stock. The second long roller is engaged under the front of the carriage as soon as the mortar cants to the front, so that the distance between the rollers, measuring from axis to axis, shall be twenty inches; the rollers are shifted in this manner by Nos. 3 and 4 until the carriage rests on the ground; Nos. 5 and 6, with their handspikes, steady the mortar while

being eased down the stock; Nos. 3 and 4 unchock the wheels, and the wagon is run back by Nos. 5 and 6 at the stock, and Nos. 7, 8, 9, and 10 at the wheels. The rope is removed by Nos. 1 and 2 and the gunner. The long roller is removed as it was placed under the carriage. (*Par.* 466.)

To mount and dismount the 8-inch mortar on mortar-wagon.

Executed in a manner similar to that explained for the 10-inch mortar.

For transportation, three 8-inch mortars can be carried on the mortar-wagon. They are stowed transversely to the wagon, one pointing to the right and two to the left, or *vice versa*, and securely lashed in this position.

To dismount the 13-inch mortar, and to mount it.

469. Implements: Eight *whole blocks*, eight *half blocks*, four *quarter blocks*, four *handspikes* (manœuvering), one *sledge-hammer*, four *chocks* (roller), one *quadrant*, one *hammer-wrench*, one *nut-wrench* (large), two *nut-wrenches* (small), one *two-foot rule*.

The instructor commands:

1. PREPARE TO DISMOUNT THE MORTAR.

Remove all implements, and place them outside the platform; take off the steps, diagonal braces, eccentric sockets, wheels, axle, and cap-squares; give the mortar an elevation of five degrees, in order that it will rest level when on the blocks.

1. DISMOUNT THE MORTAR.

(*Figs.* 1 and 2, *Plate* 23.) Embar with the long handspikes under the rear notches, using blocks as fulcrums, and by successive purchases raise the carriage until a whole block can be placed under the shoes, its front directly beneath the rear transom; place two whole and one quarter block under the mortar, in rear, and the same in front of the trunnions; lower the carriage gently onto the platform, being careful to chock the mortar as soon as it touches the blocks; remove the rear transom and pipe, and lay the cheeks down upon the ground.

1. PREPARE TO MOUNT THE MORTAR.

Raise the cheeks and place them with the trunnion beds under the trunnions; put in the rear transom and pipe.

1. MOUNT THE MORTAR.

Embar as before under the rear notches, raising the carriage until the mortar is lifted clear of the blocks; remove the blocks,

and lower the carriage gently to the platform. Give the mortar an elevation of 45 degrees, and replace the cross-braces, axle, wheels, eccentric sockets, steps, cap-squares, and implements.

In this manœuvre care must be taken to raise the rear part of the cheeks equally, so that the great weight of the mortar may not sway the cheeks sideways and warp the carriage out of true shape.

470. When a garrison gin is available, the best method is to make use of it. The block is hooked into a clevis attached to the clevis lug. When there is no clevis lug a bail must be used. It is necessary to remove the upper step or transom of the carriage, and level the mortar, before hoisting.

In the absence of a gin, the mortars may be dismantled with the hydraulic-jack and blocks. The steps, diagonal braces, and transoms, excepting the pipe, are removed, and the muzzle depressed two degrees, the breech resting on the scaffolding and chocked on each side. The jack is placed under the muzzle, and the mortar is raised until its weight is off the trunnion beds. A scaffolding under the muzzle sustains the mortar in this position, and the cheeks are taken apart and removed.

To place the 13-inch mortar and carriage on rollers.

471. The following implements are necessary: Four rollers (78 inches long), four *whole blocks*, four *half blocks*, two *quarter blocks*, and four *chocks* (roller).

Embar under the rear notches perpendicular to the cheeks, and raise the rear of the carriage until a quarter block can be inserted under each shoe. These quarter blocks are worked to the front by successive purchases until half blocks can be inserted in place of the quarter blocks. The half blocks are worked to the front as before until a roller can be inserted under the shoes.

This roller is worked to the front until it is nearly under the eccentric axle, and another roller is placed behind it near the heels of the shoes. The rollers are chocked front and rear. Embar under the front notches and cant the mortar to the rear on both rollers.

The mortar may then be moved short distances by attaching blocks and tackle to it. Way-planks are placed on the ground for the rollers to run on.

To raise a 13-inch mortar from the ground and place it on blocks.

(Fig. 3, Plate 23.)

472. Build a scaffolding of blocks, about a yard from the piece, on each side of it; lay a stout skid across the mortar on

these scaffolds, and lash the mortar, by means of sling-chains, to this skid. If there is no clevis lug on the mortar, trunnion-rings or a bail must be used. Apply the jack alternately under the ends of the skid, and raise them a few inches at a time, each-time blocking up on the scaffolds.

By this means the mortar can be raised and blocks placed under it. If a jack is not available, a stout lever will answer to raise the ends of the skid.

To transport a 13-inch mortar on sling-carts.

(*Fig. 4, Plate 23.*)

473. The piece is raised, as just explained, on blocks about fifteen inches from the ground. Two sling-carts (large) are placed, one in front and the other in rear, with their poles pointing in opposite directions and their wheels about eighteen inches apart. Upon the sling-carts place two heavy skids, with a space of about six inches between them. Across the skids place a stout beam, around which suspend the mortar by means of sling-chains passing down between the skids to the clevis lug, bail, or trunnion-chains. The blocks underneath the mortar are removed either with a jack or by means of a lever.

The pole of one of the carts is attached to a field limber, to which horses are hitched. When the ground is soft, way-planks should be placed under the cart-wheels.

To obtain greater freedom of motion for turning, a temporary bolster should be placed on the front cart. A hole is made through the bolster for the screw of the cart to pass through, and to hold the bolster to the axle-tree. Notches should be made in the skids to fit the bolsters of the carts, to keep them from slipping.

MACHINES AND APPLIANCES FOR MOVING HEAVY ARTILLERY.

474. The machines and appliances usually employed for moving heavy artillery are :

| | | |
|----------------------------|-------------------|------------------------------------|
| Ropes, blocks, and tackle. | Railway truck. | Hand-cart. |
| Gins. | Cradle. | Blocks (whole, half, and quarter). |
| Hydraulic-jacks. | Gun-lift. | Way-planks. |
| Sling-carts. | Capstan. | Pinch-bars. |
| Casemate truck. | Derrick. | Mortar-wagon. |
| Truck-wagon. | Shears. | Collar. |
| | Blocks and skids. | |

These, with the implements used in the mechanical manœuvres with siege pieces, are sufficient to manage the heaviest pieces of artillery in all cases which ordinarily present themselves in service.

475. All implements and machines, before being used, should be most carefully examined in every detail, to see that they are serviceable and suitable for the operation to be performed. None should be put to uses for which they are not intended, nor subjected to strains they are not constructed to bear.

It must be borne in mind that the giving way of one part breaks and destroys other parts, frequently to an extent not readily repaired, and, furthermore, endangers those working at the manœuvre. Heavy weights must never be allowed to *drop*, even for the shortest distances; they must be lowered to rest with a gentle motion, and at the same time clocked to prevent rolling or sliding. In hoisting, they must, when practicable, be closely followed up with blocks and chocks to guard against any possible giving way. All motions with heavy bodies must be slow, so as not to generate momentum.

Supports must have a firm base, and scaffolding a level foundation, and be built up vertically. All holdfasts must be secure beyond possibility of giving way.

CORDAGE.

(Plates 24, 25, 26, 27, 28.)

476. A rope is composed of threads of hemp or other fibrous material. These threads are called *yarns*. A number of these yarns twisted together form a *strand*, and three or more strands twisted together form a rope.

The ropes in ordinary use are composed of three strands laid *right-handed*, or, as it is called, *with the sun*. Occasionally a large rope will be found laid up in four strands, also *with the sun*. This is generally used for stationary rigging, such as shrouds, guys, heavy gun-slings, &c., and is sometimes called *shroud laid*. Small halyards are sometimes laid with four strands and a core; this kind of rope runs more smoothly and wears longer.

Cable-laid rope is composed of nine strands, and is made by first laying up three ropes of three strands each, with the sun, and then laying the three ropes up together into one, against the sun.

Right-hand rope must be coiled *with the sun*, and cable-laid rope *against the sun*.

The size of rope is always given in inches and fractions, and is measured on the *circumference*, for the reason that it is seldom

possible to get a squarely-cut end in order to measure the diameter. In making requisitions for rope, it should be clearly indicated that this measure is the one considered.

Spun-yarn is made by twisting together very loosely two or more well-tarred yarns, and is designated by the number of yarns; as, two-yarn, three-yarn, &c. It is used for serving, seizings, stops, &c., and is very pliable.

Marline is also made of tarred yarns, but is tightly twisted, and is much harder and smoother than spun-yarn. It is not fit for serving when the rope served is to be bent up, as it is not pliable enough to cover the rope in such cases.

477. *The bight* of a rope is any part not an end.

A bight is formed by bending or doubling the rope so as to form a loop.

This distinction should be particularly noted, and the two terms should not be confounded.

The interstices between the strands of a rope are called the *jaw*, and rope is called long or short jawed as it is loosely or tightly laid up together.

Those ropes which are stationary are called *standing rigging*; as, guys for a gin, gun-slings, &c. Those which run through blocks or pulleys, such as gin-falls, trace-ropes, &c., are *running rigging*.

478. *Worming* a rope is filling up the divisions between the strands by passing spun-yarn along them, to render the surface smooth for parceling and serving.

Parceling a rope is wrapping narrow strips of canvas about it, well tarred, in order to secure it from being injured by rain water lodging between the parts of the service when worn. The parceling is put on *with* the lay of the rope. Parceling is also used to prevent chafing or cutting of a rope when a strain is brought against a rough surface or sharp edge. For this purpose old rope or canvas wound around is sufficient.

Serving is the laying on of spun-yarn or other small stuff in turns round the rope, close together, and hove taut by the use of a serving board for small rope and serving mallet for large rope. Small ropes are sometimes served without being wormed, as the crevices between the strands are not large enough to make the surface very uneven; but a large rope is always wormed and parceled before being served. The service is put on *against* the lay of the rope.

Whipping is securing the end of a rope with twine to prevent it from fraying out. For temporary use it may be done by winding twine about the end of the rope and securing the end of the twine by passing it under two or more turns of the twine and

pulling it tight. It is better, however, to secure the ends by sewing them through the rope, so that each stitch lies in the division between two strands. This is called a *sewed whipping*.

479. *Splicing* is putting the ends of ropes together by opening the strands and placing them into one another, or by putting the strands of the ends of a rope between those of the bight.

A short splice. Unlay the strands for a convenient length; then take an end in each hand, place them one within the other, and draw them close. Hold the end of one rope and the three strands which come from the opposite rope fast in the left hand, or if the rope be large, stop them down to it with a rope-yarn. Take the middle strand, which is free, pass it *over* the strand which is first next to it, then through *under* the second and out between the second and third from it, then haul it taut. Pass each of the six strands in the same manner; first those of one end and then those of the other. The same operation may be repeated with each strand, passing each *over* the third strand from it, *under* the fourth, and through; or, as is more usual, after the ends have been stuck once, untwist each strand, divide the yarns, pass one-half as above described, and cut off the other half. This tapers the splice.

A long splice. Unlay the ends of two ropes to a distance three or four times greater than for a short splice, and place them within one another as for a short splice. Unlay one strand for a considerable distance and fill up the interval which it leaves with the opposite strand from the other rope. Twist the ends of these two together, then do the same with two more strands. The two remaining strands are twisted together in the place where they were first crossed. Open the two last-named strands, divide in two, take an overhand knot with the opposite halves, and lead the ends over the next strand and through the second as the whole strands were passed for the short splice. Cut off the other two halves. Do the same with the others that are placed together, dividing, knotting, and passing them in the same manner. *Before cutting off any of the half strands, the rope should be got well upon a stretch.* Sometimes the whole strands are knotted, then divided, and the half strands passed as above described. This splice does not increase the diameter of the rope, and is used for splicing a fall or other rope that runs through blocks or pulleys.

An eye-splice. Unlay the end of a rope for a short distance and lay the three strands upon the standing part, so as to form an eye. Put the first end through the strand next to it. Put the second end over that strand and through the second, and put the remaining end through the third strand on the other side of

the rope. Taper them, as in the short splice, by dividing the strands and sticking them again. This is used to form a permanent loop in the end of a rope.

A grommet. Take a strand just unlaidd from a rope, with all its turns in it, and form a ring of the size you wish by putting the end over the standing part. Then take the long end and carry it twice round the ring in the crevices, following the lay until the ring is complete; then take an overhand knot with the two ends, divide the yarns, and stick them as in a long splice. Used for a trunnion loop for rolling or sluing a gun.

480. *Two half hitches.* Pass the end of a rope round the standing part and bring it up through the bight. This is a half hitch. Take it round again in the same manner for two half hitches.

A clove hitch is made by passing the end of a rope round a spar, over, and bringing it under and round behind its standing part, over the spar again and up through its own part. It may then, if necessary, be stopped or hitched to its own part; the only difference between two half hitches and a clove hitch being that one is hitched round its own standing part and the other is hitched round a spar or another rope.

Round turn and two half hitches. Take a round turn around the stakes or posts, and secure the end by two half hitches around the standing part. This is very useful in securing the guys of the gin to the stakes.

A bowline knot. Take the end of a rope in your right hand and the standing part in your left; lay the end over the standing part, and with the left hand make a bight of the standing part over it; take the end under the lower standing part up over the cross, and down through the bight. This is very useful in forming a temporary eye at the end of a rope.

Square knot. Take an overhand knot round a spar; take an end in each hand and cross them on the same side of the standing part upon which they came up; pass one end round the other, and bring it up through the bight. This is sometimes called a *reef knot*. If the ends are crossed the wrong way, sailors call it a *granny knot*.

A timber hitch. Take the end of a rope round a spar, lead it under and over the standing part, and pass two or more round turns around its own part; pass the first turn *over* the end part instead of through the bight, as in a half hitch. Used in securing the ends of the trace-ropes to the manœuvring bolts.

A rolling hitch. Pass the end of a rope round a spar; take it round the second time, nearer to the standing part; then carry it across the standing part, over and round the spar and up

through the bight. A strap or a tail block is fastened to a rope by this hitch. Used in shifting the fall from one end of the windlass to the other. (See *nipper* and *screw*.)

A blackwall hitch. Form a bight by putting the end of a rope across and under the standing part; put the hook of a tackle through it, the centre of the bight resting against the back of the hook, and the end jammed in the bight of the hook by the standing part of the rope.

A cat's-paw. Make a large bight in a rope, and spread it open, putting one hand at one part of the bight and the other at the other, and letting the standing part and end come together; turn the bight over from you three times, and a small bight will be formed in each hand; bring the two small bights together, and put the hook of a tackle through them both. This is very useful in applying a purchase or tackle to the fall of another.

A sheet bend (weaver's knot). Pass the end of a rope up through the bight of another, round both parts of the other, and under its own part. This does not jam, and is useful in tying two ropes together.

Carrick bend. Form a bight in a rope and lay the end across the standing part; stick the bight of another rope up through the loop thus formed, and carry the end over the end of the first rope, under the standing part, and through the loop formed by its own bight; stop each end to its own standing part.

Fisherman's bend (anchor knot). Take two turns around the gun-sling or spar with the end of the rope; hitch the end around the standing part and through both turns, and then pass the end over the second and under the first turn.

A sheep shank. Make two long bights in a rope which shall overlay one another; take a half hitch over the end of each bight with the standing part which is next to it. Used to shorten a rope temporarily.

A marlinspike hitch. Lay the marlinspike upon the seizing stuff, and bring the end over the standing part so as to form a bight; lay this bight back over the standing part, putting the marlinspike down through the bight, under the standing part, and up through the bight again. Very useful in putting on lashings, &c.

Stopping is fastening two parts of a rope together, as for a round seizing, without a crossing or riding.

Nippering is fastening them by taking turns crosswise between the parts to jam them, and sometimes with a round turn before each cross. These are called *racking turns*. Pass *riders* over these and fasten the end. This is a convenient way to secure a fall while it is being shifted on the windlass.

A *screw* is applied by weaving a light strap through the different parts of a fall, bringing the two ends together, and screwing the whole up tight by means of a stick or bar passed through the bights.

A *strap*, or *sling*, is formed by knotting or splicing together the ends of a short strand or rope. It is used for hooking tackles into.

Pointing. Unlay the end of a rope and stop it; take out as many yarns as are necessary, and split each yarn in two, and take two parts of different yarns and twist them up taut into *nettles*; the rest of the yarns are combed down with a knife; lay half the nettles down on the scraped part, the rest back upon the rope, and pass three turns of twine taut round the part where the nettles separate, and hitch the twine, which is called the *warp*; lay the nettles backwards and forwards as before, passing the warp each time. The ends may be whipped and snaked with twine, or the nettles hitched over the warp and hauled taut. The upper seizing must be snaked. If the upper part is too weak for pointing, put in a piece of stick. This is an elaborate way of whipping ropes, and requires considerable practice.

Frap. To pass a rope around a lashing to keep the turns together.

Seizing a rope is connecting the two parts with smaller rope, or spun-yarn. Take a piece of spun-yarn and double it; pass the bight under the two parts of the rope to be seized; put both ends through it and haul taut, using a lever applied with the marlinspike hitch; separate the ends, pass them around the rope in opposite directions until enough turns are taken, hauling each turn taut, and seeing that they lay close and smooth. Cross the seizing by passing the ends in opposite directions between the ropes and around the seizing, and finish with a square knot.

A *lashing* is applied on the same principles. After sufficient turns have been taken, the lashing is *frapped* by taking the ends around the turns, hauling them close together, and making the lashing tighter, of course.

To pass a shear lashing. Middle the lashing and take a turn round both legs at the cross; pass one end up and the other down, around, and over the cross, until half of the lashing is expended; then ride both ends back again on their own parts and knot them in the middle; frap the first and riding turns together on each side with sennit. This will be useful in rigging shears for hoisting guns, when a gin is not available. Any two spars that will support the weight can be used.

To sling a barrel with both heads in, or a box. Lay it on its side; lay a long strap under it, spreading the parts; pass one bight through the other, on top of the barrel, and hook on to it.

If one head of the barrel is out. Stand the barrel up; put one part of a strap under the middle of the bottom; take a half hitch over the top with each part, the hitches exactly opposite to each other and just above the *upper bilge* hoops. Hook on to the bight as before. Those hoops applied near the ends of a barrel are the "*chime*," and those near the centre the "*bilge*" hoops.

Table showing the weight which Manila rope in daily use will sustain, singly and when rove in tackles.

481. *Hemp rope* is about one-third stronger. Due allowance has been made for loss of strength by wear and tear.

Look for the weight to be raised, or the next larger, in the column headed with the number of sheaves in the purchase or tackle. The circumference of the rope required will be found on the same line in the left-hand column.

| CIRCUMFERENCE IN INCHES. | SINGLE. | NUMBER OF SHEAVES IN PURCHASE. | | | | |
|-----------------------------|---------|--------------------------------|--------|--------|--------|---------|
| | | 3 | 4 | 5 | 6 | 7 |
| | | 1..... | 540 | 1,080 | 1,350 | 1,485 |
| 1¼..... | 844 | 1,688 | 2,110 | 2,321 | 2,532 | 2,743 |
| 1½..... | 1,215 | 2,430 | 3,038 | 3,342 | 3,645 | 3,949 |
| 1¾..... | 1,654 | 3,308 | 4,135 | 4,549 | 4,962 | 5,376 |
| 2..... | 2,160 | 4,320 | 5,400 | 5,940 | 6,480 | 7,020 |
| 2¼..... | 2,734 | 5,468 | 5,835 | 6,519 | 8,202 | 8,886 |
| 2½..... | 3,375 | 6,750 | 8,438 | 9,282 | 10,125 | 10,969 |
| 2¾..... | 4,084 | 8,168 | 10,210 | 11,231 | 12,252 | 13,273 |
| 3..... | 4,860 | 9,720 | 12,150 | 13,365 | 14,580 | 15,795 |
| 3¼..... | 5,704 | 11,408 | 14,260 | 15,686 | 17,112 | 18,538 |
| 3½..... | 6,415 | 12,830 | 16,048 | 17,657 | 19,245 | 20,854 |
| 3¾..... | 7,594 | 15,188 | 18,985 | 20,884 | 22,782 | 24,681 |
| 4..... | 8,640 | 17,280 | 21,600 | 23,760 | 25,920 | 28,080 |
| 4¼..... | 9,753 | 19,516 | 24,393 | 26,831 | 29,259 | 31,697 |
| 4½..... | 10,935 | 21,870 | 27,338 | 30,072 | 32,795 | 35,529 |
| 4¾..... | 12,184 | 24,368 | 30,460 | 33,506 | 36,552 | 39,598 |
| 5..... | 13,500 | 27,000 | 33,750 | 37,125 | 40,500 | 43,875 |
| 5¼..... | 14,884 | 29,768 | 37,210 | 40,931 | 44,652 | 48,373 |
| 5½..... | 16,335 | 32,670 | 41,838 | 45,922 | 49,005 | 53,089 |
| 5¾..... | 17,954 | 35,908 | 44,885 | 49,373 | 53,862 | 58,350 |
| 6..... | 18,252 | 36,504 | 45,630 | 50,193 | 55,756 | 60,319 |
| 6¼..... | 19,805 | 39,610 | 49,513 | 54,465 | 59,415 | 64,367 |
| 6½..... | 21,421 | 42,842 | 53,553 | 58,908 | 64,263 | 69,618 |
| 6¾..... | 23,100 | 46,200 | 57,750 | 63,525 | 69,300 | 75,075 |
| 7..... | 24,843 | 49,786 | 62,208 | 68,418 | 74,529 | 80,740 |
| 8..... | 32,448 | 64,896 | 81,120 | 89,232 | 97,344 | 105,456 |

To ascertain the strain in pounds which a rope will bear without breaking, *multiply the square of the circumference by the tabular number.*

| DESCRIPTION. | CIRCUMFERENCE. | WHITE. | | TARRED. | |
|--------------|----------------|-----------|-----------|-----------|-----------|
| | | 3-strand. | 4-strand. | 3-strand. | 4-strand. |
| | Inches. | | | | |
| Hemp..... | 2.5 to 6 | 1140 | 1330 | 850 | 1000 |
| | 6 to 8 | 1090 | 1260 | 825 | 940 |
| Manila..... | 2.5 to 6 | 810 | 950 | | |
| | 6 to 12 | 760 | 835 | | |

For ropes in *daily use*, the unit should be diminished *one-third* to meet the reduction in strength by wear and exposure.

A safe general rule for all ropes is this : One-fourth the square of the circumference gives the breaking weight in tons of 2000 pounds.

When using tackles, multiply the weight thus found by one-half the number of sheaves in the blocks.

Straps are applied by passing them around the object, putting one bight through the other, and hooking to this ; or, after putting it through, winding all the strap around the rope or spar, and hooking to both bights.

Preservation in store. Ropes should be placed in the upper stories of buildings, coiled up and labeled ; large ropes on skids, allowing free circulation of air ; small ropes hung up to the joists, on pins or hooks. Ropes should not be coiled until perfectly dry ; they should be uncoiled every year, and stretched out for several days in the dry season. Ropes long in store lose their strength.

BLOCKS, TACKLES, &C.

(Plates 29 and 30.)

482. *Blocks* are of two kinds, *made* and *mortised*. A *made block* consists of four parts : the *shell*, or outside ; the *sheave*, or wheel on which the rope turns ; the *pin*, or axle on which the wheel turns ; and the *strap*, either of rope or iron, which encircles the whole and keeps it in its place. The sheave is generally strengthened by letting in a piece of iron or brass at the centre,

called a *bush*. Nearly all heavy blocks for ordnance purposes are made with iron shells and brass sheaves.

A *mortised block* is made of a single block of wood, mortised out to receive a sheave.

All blocks are single, double, or threefold, according to the number of sheaves in them.

There are blocks that have no sheaves, to wit: a *bull's-eye*, which is a wooden thimble without a sheave, having a hole through the centre and a groove around it; and a *dead-eye*, which is a solid block of wood made in a circular form, with a groove round it, and three holes bored through it, for the lanyards to reeve through.

Snatch blocks are single blocks, with a notch cut in one cheek, just below the sheave, so as to receive the bight of a fall without the trouble of reeving and unreeving the whole. They are generally iron-bound, and have a hook at one end.

A *tail block* is a single block, strapped with an eye-splice, and having a long end left by which to make the block fast temporarily to the rigging. This tail is usually selvaged, or else the strands are opened and laid up into sennit, as for a gasket.

483. A *tackle* is a purchase formed by reeving a rope through two or more blocks, for the purpose of hoisting.

A *whip* is the smallest purchase, and is made by a rope rove through one single block.

A *gun-tackle purchase* is a rope rove through two single blocks and made fast to the strap of the upper block. The parts of all tackles between the fasts and sheave are called the *standing parts*; the parts between sheaves are called *running parts*; and the part which is taken hold of in hoisting is called the *fall*.

A *whip upon whip* is where the block of one whip is made fast to the fall of another.

A *luff-tackle purchase* is a single and a double block; the end of the rope being fast to the upper part of the single block, and the fall coming from the double block. A luff tackle upon the fall of another luff tackle is called *luff upon luff*.

A *watch tackle*, or *tail tackle*, is a luff-tackle purchase, with a hook in the end of the single block and a tail to the upper end of the double block. One of these purchases with a short fall is kept on deck, at hand, in merchant vessels, and is used to clap upon standing and running rigging, and to get a strain upon ropes.

A *runner tackle* is a luff applied to a runner, which is a single rope rove through a single block, hooked to a thimble in the eye of a pennant.

A *single Burton* is composed of two single blocks, with a hook in the bight of the running part. Reeve the end of your rope

through the upper block, and make it fast to the strap of the fly block; then make fast your hook to the bight of the rope, and reeve the other end through the fly block for a fall. The hook is made fast by passing the bight of the rope through the eye of the hook and over the whole. This is a very quick-working tackle and a strong purchase. Used for hoisting entirely.

When a very heavy weight is to be raised, the standing parts should be attached to the slings by a fisherman's bend, instead of to the block.

The *size* of blocks is expressed by the *length* of the *shell* in inches; if ropes of unusual size are to be used, it should be specified in making requisitions for blocks.

Tackles are also designated by the number of sheaves employed; as, *twofold* (two single blocks), *threefold* (double and single block), &c.

A mousing is a seizing placed around a hook to prevent it from spreading or unhooking, and should always be applied as follows: Take several turns of yarn or spun-yarn around the point and back of the hook, and frap the ends around all the turns.

The *bight* of a hook is the middle of the bend of the hook part.

Useful suggestions.

484. A *tackle* is said to be "two blocks" when the entire fall is hauled through, so that the blocks are in contact.

To overhaul a tackle is to separate the blocks. This is best done as follows: Hook the upper block firmly, or let one or two men hold it; let one or more men take hold of the lower block and haul, while one man lights the fall through the upper block by hauling the running part through it. If necessary, let another hand light the second part through.

Rope should *always* be stopped up, either with the end or with rope-yarn stops, to prevent it getting into a snarl. When using ropes for hauling, they should never be dragged upon the ground.

To stop up a coil of rope with the end. Lay off two or three turns of the coil and take a clove hitch around all parts of one side of the coil. Do the same on the other side. If the rope should be rove in a tackle, run it "two blocks" and make the first hitch around the fall between the blocks.

Before reeving a rope in a block, the turns should be carefully taken out to prevent twisting when the weight is lifted. This is done by stretching the rope out to its full length and turning it in the opposite direction to that in which it is laid up, until all the stiffness disappears.

Blocks should be overhauled very often to see that the sheaves are working properly on the pin and that they work smoothly. If they do not, turn the pin end for end, and rub a little black-

lead (graphite) on them to lubricate them, also on the sides of the sheaves where they rub against the shell.

When hoisting with tackles they should never be allowed to twist. If they show a tendency to do so, insert a bar in the block or sling, and use it as a lever to hold it straight.

It frequently happens that the men cannot apply their full strength in the direction in which it would be most effective. In such cases hook a single block to some object about two feet above ground and reeve the end of the fall through it, so that the men can add their strength to their weight and more men can apply themselves.

Never trust the suspension of a weight to holding it by the unaided strength of men. If it is possible to get a turn around any fixed object, even in raising or hauling a weight, it is best to take a turn, as all that is gained is then saved.

Always select such blocks that the fall will run freely through them and not ride upon the edges of the sheaves. If it does, it will be certain to cut. The rope should not quite fill the score or groove on the sheave. In this way excessive friction is avoided. The sailor's maxim is, "Small ropes and big blocks."

The power gained by using tackles is as follows:

Two single blocks, or gun tackle—nearly doubled.

Luff tackle (double and single block)—doubled. If the double block is movable—trebled.

Two double blocks—power $\times 3\frac{1}{2}$.

Double and treble blocks—power $\times 4$.

Two treble blocks—power $\times 4\frac{1}{2}$.

Whip upon whip, single Burton—trebled.

When one tackle is applied to the fall of another, the power obtained is found by multiplying their respective values together.

No advantage is gained by using a greater number of sheaves than two treble blocks in one fall.

Weight and strength of iron chains.

| Diam'r of iron for links. | Weight of one foot of chain. | Breaking weight. | Proof weight. | Diam'r of iron for links. | Weight of one foot of chain. | Breaking weight. | Proof weight. |
|---------------------------|------------------------------|------------------|---------------|---------------------------|------------------------------|------------------|---------------|
| Inch. | Lbs. | Lbs. | Lbs. | Inch. | Lbs. | Lbs. | Lbs. |
| 0.1875 | 0.325 | 2,240 | 948 | 0.625 | 4.217 | 26,880 | 10,304 |
| 0.25 | 0.65 | 4,256 | 1,630 | 0.6875 | 4.833 | 32,704 | 12,544 |
| 0.3125 | 0.967 | 6,720 | 2,464 | 0.75 | 5.75 | 38,752 | 15,232 |
| 0.375 | 1.383 | 9,634 | 3,584 | 0.8125 | 6.667 | 45,696 | 17,696 |
| 0.4375 | 1.767 | 13,216 | 5,152 | 0.875 | 7.5 | 51,744 | 20,384 |
| 0.5 | 2.633 | 17,248 | 6,720 | 0.9375 | 9.333 | 58,464 | 23,520 |
| 0.5625 | 3.333 | 21,728 | 8,512 | 1. | 10.817 | 65,632 | 26,880 |

THE GIN.

(Plate 31.)

485. A gin is a tripod formed of three poles. Two of these poles, called legs, are joined together by braces of wood or iron, and contain between them the windlass. The third pole is called the pry-pole, and is joined to the legs, at the top, by a bolt. This bolt supports a clevis, to which the upper block of the tackle is hooked.

The windlass is worked by two handspikes fitting into brass sockets, one at each extremity of the windlass; the operation of the handspike is made continuous by the action of a pawl attached to the socket on the ratchet of the windlass.

To prevent the legs and pry-pole from sinking into the ground, or injuring the pavement of casemates, stout pieces of wood, called shoes, are placed under them. The hoisting apparatus consists of two blocks, through which the fall is rove. The fall is wound two or more times around the windlass.

There are three kinds of gins used for artillery purposes: the siege, the garrison, and the casemate.

The last two differ from each other only in height; the first differs from the others in construction and size. Piper's gin is an improved modification of the siege gin.

When the gin is put together and raised, that part included between the legs and pry-pole is called the inside, the outside being the part without the legs; the right corresponding to the right hand of a man standing at the middle and outside of the windlass, facing towards it, the left corresponding to his left hand.

486. The detachment is composed of one chief, one gunner, and ten cannoneers. The odd numbers are placed on the right and the even numbers on the left side of the gin, all facing inwards; Nos. 1 and 2 opposite and one yard outside of the foot of the pry-pole; No. 9 outside of and near the foot of the right leg; No. 10 outside of and near the foot of the left leg; Nos. 3, 5, and 7 are between Nos. 1 and 9, dressing on them and dividing the intervening space into equal distances; Nos. 4, 6, and 8 occupy similar positions with respect to Nos. 2 and 10. In assembling the gin, the gunner and Nos. 1 and 2 bring up the pry-pole; Nos. 3, 5, and 7 the right leg, and Nos. 4, 6, and 8 the left leg; Nos. 9 and 10, the windlass. The gunner superintends putting together the head, and the chief-of-detachment the placing of the windlass. The braces are brought up and adjusted to their places by Nos. 5, 6, 7, and 8.

The gunner, assisted by the most expert cannoneers, reeves

the fall, slings the piece, and attends to all knottings and lashings.

In working the windlass, Nos. 1 and 2 hold on to the fall and take up the slack; Nos. 7 and 9 work at the right, and Nos. 8 and 10 at the left handspike, Nos. 7 and 8 being next the windlass. All, except the old-pattern siege gin, are put together and hoisted by raising the head and bringing up the foot of the pry-pole towards the feet of the legs.

487. The siege gin (old pattern) is put together with the outside of the legs and windlass *downwards* and the pry-pole resting on the top. (*Fig. 1, Plate 32.*) It has no clevis, as other gins, and, instead of an upper block, two sheaves are inserted between the legs and secured by the bolt holding together the legs. The head of the pry-pole is terminated by a flat piece of iron, which fits between the heads of the legs above the sheaves, and is secured by another bolt.

This gin further differs from others in having three wooden braces instead of two of iron. It has the disadvantage of being exceedingly ill-contrived and unhandy.

To put the siege gin (old pattern) together.

488. The different parts of the gin having been brought to the place designated, the instructor commands :

1. ASSEMBLE THE GIN.

This is executed as indicated in *pars.* 486 and 487.

The gin being together and lying on the ground, the instructor commands :

1. REEVE THE FALL.

Nos. 1 and 2 raise the pry-pole until it clears the sheaves. The gunner, receiving from Nos. 3 and 4 one end of the fall, passes it through the left sheave from below and hands it back to them. They pass it through the sheave of the single pulley, (hooked for convenience on the middle brace,) and return it to the gunner, who passes it through the right sheave from below, and gives it to No. 3, by whom it is secured by wrapping it around the middle brace. If the gin has been raised, the instructor gives the same command, when the gunner, mounting upon the upper brace, receives from Nos. 3 and 4 one end of the fall, which he passes over the left sheave from without to within. The fall is then reeved in the manner prescribed.

To raise the gin.

The instructor commands :

1. RAISE THE GIN.

Nos. 1 and 2 take hold of the handle of the pry-pole; Nos. 9

and 10 each hold down the foot of a leg to prevent it from slipping; Nos. 3 and 4 lift at the head, and Nos. 5, 6, 7, and 8 apply themselves at the legs on their respective sides. The gunner commands: **HEAVE**; the gin is raised; Nos. 1 and 2 carry out the foot of the pry-pole about twelve feet from the windlass and place under it a shoe. A shoe is likewise placed under each leg.

To move the gin when raised.

The instructor wishing to move the gin a short distance, indicates the direction and commands:

1. *Move the gin,* 2. **MARCH.**

Nos. 1 and 2 apply themselves at the handle of the pry-pole; Nos. 9 and 10 each place a handspike under the windlass from without, and near the legs; Nos. 7 and 8 assist to lift at these handspikes from within; at the command **MARCH**, all move in the direction indicated.

To lower the gin.

The gin is lowered in a similar manner, but by inverse means to that prescribed for raising it. Nos. 1 and 2 raise the pry-pole and assist in easing the gin to the ground, the outside downwards.

489. The following are the kinds, dimensions, weights, and strengths of ropes usually required for the different kinds of gins:

| DESIGNATION. | Girth. | Length. | WEIGHT. | | Strength. | REMARKS. |
|--|--------|---------|----------------|--------------------|-----------|---|
| | | | Of one fathom. | Of the whole rope. | | |
| | Inch. | Feet. | Lb. Oz. | Lb. Oz. | Lbs. | |
| Gin fall (siege.)..... | 4.25 | 75 | 5 4 | 67 8 | 8,064 | Hemp. |
| Gin fall (garrison and casemate.)..... | 6 | 120 | 10 6 | 208 | 16,128 | Hemp. |
| Gun-sling (siege.).... | 6 | 26 | 10 6 | 44 9 | 16,128 | An eye at one end, served with leather. Hemp. |
| Trace-rope..... | 3.25 | 30 | 3 1 | 15 5 | 4,760 | Manila. |
| Lashing-line..... | 1.75 | 10 | 11 | 1 2 | 1,371 | Hemp. |
| Marline..... | | 100 | | 11 | | Hemp. |

To mount a siege gun.

490. It is immaterial upon which side of the piece the legs of the gin are placed, but, for uniformity, they are generally placed on the right. The gun is suspended either by a sling or by a bail; the latter is preferable. It consists of a stout piece of iron (*Fig. 2, Plate 32*), passing like a handle over the piece and fitting against the ends of the trunnions, to which it is fastened by iron bolts passing through the ends of the bail into holes bored for the purpose; one in the end of each trunnion.

A clevis, attached to the middle of the bail, gives a place for hooking the lower block of the tackle.

The gin being raised and placed with its tackle directly over the trunnions, and the foot of the pry-pole about twelve feet from the lower brace, the instructor commands :

1. SLING THE PIECE.

No. 1 puts a handspike in the bore, small end foremost; No. 2 passes the eye or loop end of the sling around the knob of the cascable; No. 1 passes the other end under the handspike in the bore, and hands it to No. 2, who draws it through the loop; the gunner fastens it either by a knot or with a lashing-rope, and then hooks the single pulley to the sling just in rear of the trunnions, fastening the standing end of the fall to the sling near the same place; Nos. 1 and 2 pass the running end of the fall from the outside under the windlass, and take three turns with it around the left of the windlass, and hold on by the running end or slack, No. 1 being nearest the windlass; the gunner applies himself to the handspike in the bore to steady the piece; Nos. 7, 8, 9, and 10 apply themselves at the windlass handspikes. All being in readiness, the instructor commands :

1. HOIST AWAY.

The windlass is worked until the piece is high enough to admit the carriage under it. The instructor then commands :

1. HALT, 2. RUN UP THE CARRIAGE.

All the men, except Nos. 1 and 2, bring up the carriage, as explained in *par.* 435, placing the trunnion beds directly under the trunnions.

The instructor then commands :

1. SLACK OFF.

Nos. 1 and 2 slack of the fall slowly; the gunner steadies the piece by means of the handspike in the bore, and the piece is

lowered into its position in the trunnion or traveling beds; Nos. 3 and 4 put on the cap-squares and key them.

Note.—When the bail is used, it is attached by the same numbers as for the sling. If it is not convenient to sling the piece in the manner prescribed, it may be slung by a rope passed around each trunnion, and the ends fastened together on top of the piece; or trunnion rings may be used. Hook the pulley to this sling or to the trunnion rings; bear down with one or two men on the handspike in the bore to balance the piece, and when it is raised sufficiently high run the carriage under it, and place a handspike in the trunnion beds and a block on the stock. (For casemate or barbette carriages, upon scaffolds built of blocks under the breech and chase.) Lower the gun, the trunnions directly over the trunnion beds, until the piece rests on the block and on the handspike. Remove the sling or rings from the trunnions and run the carriage, with the gun on it, back until the head of the cheeks are in rear of a perpendicular let-fall from the head of the gin. Pass the sling around the chase, hook the pulley to it, and work the gin until the weight no longer bears on the handspike in the trunnion beds; remove the handspike, and lower the trunnions to their places; bear down on the muzzle, and remove the block from under the breech.

To dismount a siege gun.

491. The gin is placed in the same position with reference to the piece as prescribed for mounting it. The instructor commands:

1. SLING THE PIECE.

The cap-squares are removed, the piece is slung, and the running end of the fall passed around the windlass as prescribed for mounting it.

The commands *Hoist away, Halt, Run out the carriage, and Slack off* are then given and executed in the manner already prescribed.

To sling and hoist a siege mortar mounted on its carriage.

492. A gun-sling or a sling-chain is used. In either case, the middle of it is passed under the front notches; the ends carried up, and, crossing over the top of the mortar, are passed under the rear notches. The gin is erected over the mortar and the lower block of the tackle hooked into the sling where it crosses the top of the mortar. The mortar is raised and lowered upon a wagon in the manner prescribed for a gun.

To shift the fall.

493. As the turns gain once the diameter of the fall at each revolution of the windlass, they will, when the weight has been raised a considerable height, come against the opposite leg. The instructor then commands: 1. **HALT**, 2. **SHIFT THE FALL**. The gunner mounts to a position where he can reach the running part of the fall, and firmly applies a nipper to two of the parts as explained in *par.* 480. The instructor then commands: **EASE AWAY**. Nos. 1 and 2 slack off and shift the turns on the windlass to the opposite end; they then tighten up the fall, the nipping is removed by the gunner, and the manœuvre is resumed.

Piper's gin.

494. In this gin, the windlass is attached by placing it in windlass seats of peculiar construction, and is secured in position by *keepers* attached to the legs. The keepers are placed under the axles of the windlass. Two stay-chains connect the pry-pole and legs at the upper brace-bands, and prevent them from spreading. They also serve to connect the parts for transportation. Two braces (upper and lower) connect and secure the legs when the gin is put together, and serve to distinguish the right from the left leg—the long brace being permanently attached to the right and the short brace to the left leg. The clevis and clevis bolt are attached to the head of the pry-pole with keys which secure the clevis bolt when the gin is assembled; double and single blocks, with fall, are used. This gin was designed by the late Captain J. W. Piper, fifth artillery.

| | |
|--------------------------------|-------------------|
| Length of legs..... | 13 feet 8 inches. |
| Length of pry-pole..... | 13 feet 8 inches. |
| Weight of gin..... | 365 pounds. |
| Weight of windlass..... | 88 pounds. |
| Weight of block and fall..... | 100 pounds. |
| Weight of bail and dowels..... | 41 pounds. |

The parts are estimated to be sufficiently strong to bear a weight of 5000 pounds. The advantages of this gin are, its superior lightness and portability, and its great facility of being assembled, taken apart, packed up, and transported.

The different parts having been brought to the place designated, the gin is put together, raised, lowered, and taken apart by the following commands from the instructor: **ASSEMBLE THE GIN**. Nos. 1 and 2 place in position the pry-pole; Nos. 3 and 5 place in position the right, and Nos. 4 and 6 the left leg; the gunner, assisted by Nos. 3 and 4, attaches the clevis and clevis

bolt, assembles the head of the gin, and hooks on the block and fall; Nos. 5 and 6 attach the braces.

The gin, in this position, is lying extended upon the ground, with the inside downwards.

The instructor commands :

RAISE THE GIN.

Nos. 9 and 10 hold down the feet of the legs to prevent them from slipping; Nos. 1 and 2 push up, applying themselves at the handle of the pry-pole. The other numbers apply themselves as in *par.* 488.

The gunner commands: HEAVE.

The gin is raised and the pry-pole brought up to within about twelve feet from the legs; Nos. 3 and 4 attach the stay-chains on their respective sides, and Nos. 9 and 10 put in the windlass.

To move the gin when raised.

Executed as explained in *par.* 488.

To lower the gin.

The gin is lowered in a similar manner, but by inverse means to that prescribed for raising it.

The stay-chains are unhooked and windlass removed before lowering.

To take the gin apart.

The gin is taken apart in a similar manner, but by inverse means to that prescribed for putting it together, and is stowed for transportation by lashing together the legs, pry-pole, and windlass with the stay-chains.

The application of this gin to the mechanical manœuvres of siege ordnance is similar to that prescribed for the siege gin (old pattern).

GARRISON AND CASEMATE GINS.

495. The garrison and casemate gins differ from the siege gin in having two cross-bars of iron instead of the three wooden cross-bars, and in having the pry-pole inserted between the legs, which are kept together by the clevis bolt. The upper block (generally treble) is hooked to the clevis.

The casemate gin is made shorter than the garrison gin, so that it may be hoisted in casemates. With the guns now usually mounted in casemates, it is essential to use a bail for slinging, in

order to gain the necessary distance from the head of the gin for the working of the tackle.

The gin is put together across the piece, or on the ground near it, and raised by moving up the legs and pry-pole towards each other as explained in preceding paragraph. The pry-pole has cleats nailed to it to enable a man to mount to the head of the gin to hook on the block and to reeve the fall.

In raising it, Nos. 9 and 10, each with a handspike, brace against the lower cross-bar near the legs to prevent them from slipping; Nos. 1 and 2 hold down the foot of the pry-pole, and at the same time push up by the handle. The remaining numbers take hold to lift by hand near the head.

The gunner commands: **HEAVE**; the head of the gin is raised as high as the men can lift, and the pry-pole pushed up; Nos. 3 and 4 go to the assistance of Nos. 1 and 2 at the handle of the pry-pole; Nos. 5, 6, 7, and 8 lift at the legs on their respective sides. The gunner repeats *heave* until, by successive efforts, the gun is raised. The pry-pole should be, for the garrison gin, about seventeen feet from the legs; for the casement gin, about thirteen feet.

The gin is next placed over the piece by moving the legs and the pry-pole each a short distance at a time. To prevent them from spreading too much, a lashing is passed from the pry-pole to the upper cross-bar.

To reeve the fall.

Fasten one end of a trace-rope to the upper block by passing it through the *shell* of the block. An expert man ascends the pry-pole to the head, and passes the free end of the rope through the clevis, from whence it is carried down to the windlass, where a couple of turns are taken. By heaving on the windlass, the block is raised and the hook passed through the clevis, with its point *towards* the pole. The fall is rove as explained in *par.* 488. The upper block may be hooked to the clevis and raised with the gin; the fall may also be rove and the whole raised together. The extra weight thus given makes the gin more difficult to lift.

The gin is lowered by gradually drawing out the pry-pole until the men can get near enough towards the head to support it; it is then lowered upon the piece or on the ground, as the case may be.

To mount a casemate gun.

496. The carriage is traversed to one side, and the gun—on blocks, or on the truck—is near the middle of the casemate, the

muzzle towards the embrasure; the gin is over the gun and carriage; the latter on the side of the pry-pole; the axis of the trunnions is horizontal and directly under the head of the gin.

The gun is slung by means of a bail or trunnion rings. The gin is worked until the gun is raised sufficiently high, when the chassis is traversed under it, and the gun carriage so placed that the trunnion beds come exactly under the trunnions. The gun is then lowered to its place, the sling removed, and the gin carried to the next casemate.

To prevent the pavement from being injured by the points, a shoe is placed under each foot.

To dismount the gun.

Executed in the inverse manner to that prescribed for mounting. The gun is placed on the truck, or on blocks.

The windlasses of gins should never be painted, as paint is liable to cause surging when easing off the fall, and surging is certain to cause breaking of parts.

To dismount a barbette gun.

497. The safest and best method of dismounting the 15-inch gun is by means of blocks, as hereafter explained, or with the gun-lift. It may, however, be dismounted by using two garrison gins, one of which is erected over the cascable and the other over the chase, midway between the trunnions and the muzzle.

The piece is slung by means of chains similar to those used with the gun-lift. The blocks and fall are those usually furnished with the gin. Everything should be perfectly sound and in good condition; for it must be borne in mind that the weight upon each gin is one-third more than it was originally intended to bear.

Ten-inch guns, and all below, are mounted and dismounted by means of *one* garrison gin. To dismount a 10-inch gun, run it from battery as in loading; erect the gin over the piece so that the head will be directly over the trunnions; the sling, which is made of 9-inch rope, is attached by passing the bight of it around the neck of the cascable, carrying the end forward over the piece and under the end of a roller thrust in the muzzle; thence back, passing it through the eye of the sling, drawing it tight, bending it into a knot, and securing it with marline. In all cases, gun-slings should be drawn as tightly as possible; otherwise the tackle will be *block and block* before the trunnions are free from the carriage. It may be necessary, especially with a new sling, to take several lifts upon it in order to take the

stretch out of it; after each lift the slack is taken up. A trace-rope is attached to the muzzle as a guy; the tackle is hooked to the sling immediately over the axis of the trunnions; the gin is worked as explained in *par.* 490 until the trunnions are sufficiently above their beds to permit the top-carriage being shoved forward from under the piece. This done, the chassis is traversed, towards the pry-pole, from under the gun; the latter is then lowered upon blocks and the gin removed. When hoisting the piece, the traverse-wheels should not be chocked.

To dismount the top-carriage from the chassis.

498. Back the limber of a field-piece against the rear ends of the chassis rails. The ammunition chest being removed, a couple of large blocks are placed on the limber; the counter-hurters are removed, and the top-carriage pulled and shoved back, off the chassis, onto the blocks upon the limber. If there is no limber or similar carriage available, a scaffolding of blocks is built at the rear end of the chassis, and the carriage moved back upon it; from this it is easily lowered to the ground.

To remove the chassis from the platform.

499. Take out the pintle key; pry and block up the front end of the chassis until it is clear of the pintle; the chassis is then overturned by attaching a trace-rope to the far side of it, chocking the near traverse-wheel, and hauling on the rope until the chassis is on its side; the rope is then carried around to the other side and the chassis eased down upon blocks placed for its reception. From this position it may be moved, if for a short distance only, by placing way-planks and cradle rollers under it; if for a considerable distance, by backing the hand sling-cart over it and slinging it with a chain. The cart is passed over the traverse-wheels by raising its wheels on way-planks placed on each side of the chassis rails.

In dismounting the top-carriage of the 8-inch rifle (converted), it is best to use the gin. The carriage is slung by the front and rear transoms with chains, the guides are removed, and it is hoisted and lowered in a manner similar to that just described for the gun. The latter should previously be removed from the platform to make room for the carriage when lowered.

With carriages Nos. 1 and 2, the top-carriage is first disconnected from the friction-bar; in Nos. 3 and 4, the piston of the cylinder is disconnected from the top-carriage. The geared elevating apparatus should be removed, or if not, great care exercised to prevent injury to it.

The chassis and top-carriage of a barbette gun are placed in

position on the platform, and the piece mounted by operations the reverse of those just explained.

To prevent spreading or breaking, the hooks of the gin tackle should be securely moused.

Dimensions and weight of gins.

| DIMENSIONS. | SIEGE. | GARRISON. | CASEMATE. |
|---------------------------------------|------------------|-----------|-----------|
| | Inches. | Inches. | Inches. |
| Length of legs and pry-pole..... | 175.5 | 256.5 | 172.5 |
| WEIGHTS. | LBS. | LBS. | LBS. |
| Of windlass..... | | 310 | 264 |
| Of pry-pole..... | 55 | 293 | 208 |
| Of leg..... | | 280 | 213 |
| Of gin complete (without blocks)..... | 455 | 1316 | 947 |
| Of pulley-blocks (iron). | { Single..... | 43 | |
| | { Double..... | 57 | |
| | { Treble..... | | 165 |
| | { Quadruple..... | | 205 |

Remarks.

The garrison gin of the regulation pattern, if perfectly sound, is capable of sustaining a weight of 17,000 pounds. It is, however, recommended that a heavier one be used for such weights when it can be procured.

Use of the gin as shears.

500. By removing the pry-pole, the legs of the gin may be used as shears. When the garrison or casemate gin is to be thus used, a block of wood of the same dimensions as the head of the pry-pole, with a hole in it to receive the clevis bolt, must be inserted in place of the pry-pole. The shears are raised and guyed as explained in *par.* 546. The fall and windlass are operated as for the gin.

THE GARRISON GIN-DERRICK (NARROW).

(Plate 33.)

501. The *derrick* consists of two legs framed together, one pry-pole, two drums or windlasses with geared wheels, and two wagon-wheels, serving the double purpose of moving the derrick

from point to point and for working the windlass. The axle-passes through one of the windlasses, and can at pleasure be geared into a wheel on the other windlass. Length of legs, 254 inches; greatest width of legs, 86 inches; weight, 1725 pounds.

It is hoisted by being pulled over to the front; the feet of the legs then rest on the ground, and the pry-pole is carried out over the object to be raised. The wheels are now free, and the method of operating the gin is similar to that for other gins, the power being applied to the wheels instead of to handspikes.

SLING-CART.

502. The sling-cart is used for moving pieces of heavy artillery, or other objects, short distances.

They are of two kinds: one, the garrison sling-cart, (*Fig. 1, Plate 34.*) for heaviest weights, is attached by its pole to a siege or field limber, and may be drawn by horses; the other, the hand sling-cart, (*Fig. 3, Plate 32.*) is designed for moving lighter weights and siege-pieces in the trenches by hand. The siege limber may also, in case of necessity, be used as a sling-cart. With the hand sling-cart, the weight is raised by first attaching to it a sling, and then applying to the sling the hook upon the rear of the axle, by raising the pole of the cart. The pole is used as a lever, the axle and wheels being the fulcrum. It may be used for any weights not exceeding 6000 pounds.

With the garrison sling-cart, the weight is raised by first attaching to it a sling, and then applying to the sling the hooks forming the lower part of a powerful screw passing up through the axle of the cart. Above the axle is the nut of the screw, provided with long handles. Power is applied to these handles and the screw is run up, thus raising the weight.

This sling-cart is capable of carrying 20,000 pounds; but with such heavy weights the handles of the screw are difficult to turn. To overcome this difficulty, a modification has been made in the cart by substituting for the screw a hydraulic-jack. (*Fig. 2, Plate 34.*)

Through the axle-body two vertical mortises are cut, each at a distance of twenty inches from the middle of the axle-body. Through these mortises slide two stout bars of iron, with hooks below for the sling-chain, and holes above for pins to support them as they are raised; the pins pass through the bars above the axle-body. A strong cross-bar connects the upright bars near their tops; under this the head of the jack is applied, the jack resting on the axle-body.

To use the hand sling-cart.

503. The implements necessary are : Two *blocks*, two *half blocks*, four *wheel-chocks*, one *sling-chain*, and one *trace-rope*. One *sling-chain* additional for a siege mortar mounted on its carriage.

To sling a siege gun, howitzer, or mortar.

The instructor commands :

BACK THE CART OVER THE PIECE.

Nos. 9 and 10 go to the end of the pole ; Nos. 5, 6, 7, and 8 apply themselves at the wheels ; the cart is then backed over the piece, the pole being in the direction of the breech and the axle directly over the trunnions ; Nos. 3 and 4 chock the wheels front and rear.

To sling the piece.

The gunner fastens the middle of the trace-rope to the eye of the pole ; Nos. 7 and 8 carry one end of the rope to the rear of the cart ; Nos. 9 and 10 raise the pole by hand, Nos. 7 and 8 applying themselves at the same time to the rope.

When the pole is nearly vertical, Nos. 9 and 10 seize the other end of the trace-rope to steady the pole. The gunner lays the middle of the sling-chain over the piece in rear of the trunnions, carries each end around the trunnions from the rear to the front, and hooks them around the axle-hooks, being careful to take up all the slack ; Nos. 9 and 10, assisted by Nos. 5 and 6, haul upon the trace-rope until the end of the pole can be reached by hand, when they seize and bear it to the ground ; Nos. 3 and 4 hook the cascable-chain around the knob of the cascable in such a manner that the piece will swing level when the pole is horizontal ; Nos. 9 and 10 raise the pole until it rests on the pole-prop.

The piece is thus raised about eight inches from the ground.

For transportation it should be ordinarily raised higher, which can readily be done by blocking up the piece and raising it again in the manner above prescribed.

To unslung the piece.

The piece is lowered to the ground in the same manner, but by inverse means to those just prescribed.

Nos. 9 and 10 bear the end of the pole to the ground ; Nos. 3 and 4 unhook the cascable-chain ; Nos. 9 and 10 allow the pole to rise gently until it is nearly vertical. If the piece does not

then rest upon the ground, it is blocked up and unslung, when, by repeating the manœuvre, it may be lowered to the ground.

After the piece has been unslung, Nos. 7 and 8 ease the pole down carefully, by means of the trace-rope, until Nos. 9 and 10 can reach it with their hands.

To sling a siege mortar mounted on its carriage.

The instructor gives the same commands, and the duties are performed by the same numbers as prescribed for a siege-piece.

The sling-cart is backed over the mortar, the pole being in the direction of the breech and the axle directly over the trunnions.

If the carriage is resting on the ground, it may be slung by first raising the pole nearly vertical, passing the sling-chain around the front manœuvring bolts, hooking it over the axle-hooks, and hauling down the pole.

The carriage is then blocked up and the sling taken off the bolts and passed under the carriage just in front of the cap-square bolts; this brings the sling a little in front of the centre of gravity of the mortar and carriage.

The pole is again raised and the hook attached to the sling; Nos. 9 and 10 bear down upon it until the end rests upon the ground; Nos. 3 and 4 remove the blocks; the gunner passes the other sling-chain around the rear manœuvring bolts and over the pole, and then hooks it in such manner that the carriage will be level; Nos. 9 and 10 then raise the pole until it rests on the pole-prop.

The carriage is thus raised about twelve inches from the ground. If necessary, it may be blocked up and raised higher by a similar manœuvre.

The breech should always slightly preponderate, in order to prevent the pole from flying up.

Sea-coast mortars and their beds are slung separately and carried on the garrison sling-cart. The trunnion-chains are passed over the trunnions and hooked to the hoisting screw.

To transport a siege-piece short distances with a limber.

504. The piece is raised upon two blocks—one under the breech, the other under the chase—and a sling-chain is attached as explained in *par.* 503.

The limber, its pole being in the direction of the breech, is run up until the pintle is over the chain, when the pole is slightly raised and the chain passed around the pintle and fastened. The pole is borne to the ground, the block under the chase removed, and a trace-rope fastened over the pole and around the

knob of the cascable. The pole is then raised and the other block removed.

To raise a piece upon blocks by a limber.

The trunnion loop, or an ordinary chain, is passed over the knob of the cascable and the pintle, and made fast while the pole is raised. The piece is then raised by bearing down the pole, and the breech blocked up. The muzzle is raised in the same manner.

The wheels should not be chocked, as they will soon find their proper bearing.

To sling a piece on two limbers for transportation with horses.

The pole of one of the limbers is removed, a block is placed under the body of the gun, and the limber run forward, with its fork over the piece, the pintle over the knob of the cascable, to which it is attached by a sling-chain; the fork is borne down to the piece and lashed with rope. The muzzle is then raised and supported on blocks; the other limber is backed over the piece until the wheels are within about a foot of the wheels of the rear limber; a sling-chain is passed under the piece and up over the pintle, the pole having been raised for this purpose; the pole is lowered to the ground, the blocks removed from under the muzzle, and the chase lashed to the forks in front of the axle-tree, so that the weight will balance the pole. To prevent the front limber from pulling away from the piece, a sling-chain is attached to the two pintles.

505. *Dimensions and weight of sling-cart.*

| DIMENSIONS. | Garrison. | Hand. |
|--|-----------|---------|
| | Inches. | Inches. |
| Length from rear of wheels to front end of pole. | 242.4 | 160.75 |
| Length of axle-trees | 92 | 75.50 |
| Height of wheels..... | 96 | 72 |
| Distance between the wheels on the ground..... | 62.75 | 60.4 |
| WEIGHTS. | Lbs. | Lbs. |
| One wheel..... | 701 | |
| Whole weight (without sling-chains) | 2302 | 1115 |
| Trunnion-chain and rings | 114 | 27 |
| Sling-chain..... | 84 | |

THE CASEMATE TRUCK.

(Fig. 4, Plate 32.)

506. This machine is intended for moving pieces and their carriages in the galleries of casemate batteries, or through posterns. It consists—old pattern, of a stout frame of wood; new pattern, of wrought-iron, mounted on three low wheels. Two of the wheels are placed at the sides, like those of a cart; the third is placed in a fork at the middle of the front end; the fork turns around its vertical axis as the direction of the truck changes. The fork and wheel are removed by raising the end of the truck and allowing the fork to drop from its socket. A tongue, likewise removable, is attached for the purpose of guiding the truck.

To place a casemate chassis on the truck.

The chassis is on the ground, the truck near it, with its front wheel and tongue removed. The chassis, either side down, is raised, by successive purchases, with handspikes, and blocked up to a height sufficient to allow the truck to go under it. The truck is then run under the chassis and turned so that its axis is parallel to that of the chassis, and is so placed that the centre of gravity of the chassis is, as near as possible, over the axle of the truck. The blocking is then removed and the chassis allowed to rest on the truck. The tongue of the truck is replaced. The truck is moved to the designated casemate, and the chassis lowered from the truck as it was placed thereon. If it is upside down, it is turned over as explained in *par.* 499, and placed properly on the traverse circles. The tongue of the chassis is then bolted to the front transom and secured by the pintle in the throat of the embrasure.

The chassis may be lowered from the truck by means of the gin.

To remove the chassis from the casemate.

The tongue of the chassis is unbolted from the front transom and the chassis raised, either by prying and blocking or with the gin; the truck is then placed under it as before.

It is generally preferable to remove the front wheel from the truck and to pry up but one end of the chassis; the truck is then worked under it from the side, and, after the chassis is lowered upon the truck, the raised end is borne down until the front wheel of the truck can be replaced.

Remark.

To prevent injury to the pavement, way-planks must be laid for the wheels of the truck to run on.

To place a top-carriage on the truck.

The carriage is on the ground, standing on the head of its cheeks; the truck near it, with its front wheel and tongue removed.

The truck is run up to the carriage, the end on the ground under the axle, and its wheels chocked; the carriage is then pulled over on it by means of a trace-ropé. The trail is borne down and the head of the carriage raised sufficiently high for the gunner and assistants to replace the truck-wheels and tongue. The carriage is then moved on the truck to its place.

To lower the carriage to the ground.

The front wheel of the truck is removed and its front transom rested on the ground. The carriage is then pulled over on the head of its cheeks.

To shift the carriage from the truck to its chassis.

The truck is run up to the rear of the chassis rails on way-planks, raised on blocks to a height sufficient to allow the carriage to be launched forward upon the rails. The front of the carriage is towards the front of the chassis; the counter-hurters are removed, and in launching the carriage forward it is so directed that the guides will take their proper places under the inner edges of the chassis rails.

The carriage may likewise be put on the chassis from the side. To do this, bring it up on the truck by the side of the chassis, so that its front end will be in the same direction with that of the chassis; remove the guide from the cheek farthest from the chassis (or, preferably, both guides); pry up the carriage and place under it, and across the chassis rails, two shifting-planks; heave the carriage sideways with handspikes until it is in proper position over the rails; then remove the planks and let the carriage rest on the chassis. Replace the guides.

To shift the carriage from its chassis to the truck.

This operation is similar to that described in the preceding paragraph.

To place a heavy gun on the truck.

The gun is raised, by means of a jack, upon blocks placed under the chase and body, until it is sufficiently high to admit the truck under it; the truck is placed so that the trunnions will be slightly in front of the axle; the gun is then lowered upon it.

A gin may be used for raising and placing the gun on the

truck. The gun is removed from the truck by means similar to those employed for putting it on.

Remark.

A 10-inch gun can be carried on the truck now furnished, but, except in very crooked galleries, the cradle is much the best means for moving such guns.

HAND-CART.

507. This is used for the transportation of light stores from one part of a work to another. That for carrying powder, fuses, and such like articles has an arched lid-cover to keep off rain and prevent accidents from fire.

TRUNNION-CHAINS.

(*Fig. 3, Plate 34.*)

508. The trunnion-chains are three in number, for light or heavy weights. They are made of a patent looped-link chain. A pair is required to carry a gun. One is passed under each trunnion and hooked on the head of the screw of the sling-cart.

No. 1, composed of one chain, 59 inches long, the ends joined by a ring; weight, 27 pounds.

No. 2, composed of two chains, each 59 inches long, the ends joined by a ring; weight, 53 pounds.

No. 3, composed of two chains, each 47 inches long, the ends joined by a ring having three branches; two for the ends of the chains composing the pair, and the third for the hook of the screw; weight, 61 pounds. Thickness of the iron composing the link, .5 inches. Length of iron for the connecting ring, 23 inches for No. 1; 24 inches for Nos. 2 and 3. Size of iron for connecting ring, 1.375 inches, round.

STORE-TRUCK.

509. This truck is used for moving boxes, &c., in store-houses and in embarking and disembarking stores.

LIFTING-JACK.

(*Fig. 5, Plate 32.*)

510. The lifting-jack is a geared screw, with a projecting foot at its lower end, for lifting heavy weights. This jack is sometimes to be found at military posts, but is becoming super-

seded by the hydraulic-jack. The jack represented in *Fig. 5* is the one carried with siege guns. It is very simple, compact, and powerful.

LEVER-JACK.

511. The lever-jack is an adjustable fulcrum with a long lever, used chiefly for greasing the axles of traveling carriages.

HAND-BARROW.

512. Wood; two side rails; the ends are rounded and form handles. Rope netting joins the side rails, passing through holes in the side rails.

MAUL.

513. This is used for driving stakes, and such like purposes. That furnished from arsenals has a cylindrical head of wood, 6 inches in diameter and 8 inches long, with an iron band around each end. The handle is 24 inches long and 1.5 inch in diameter. Weight, 10 lbs. This maul, as issued, owing to poor material and faulty construction, is of but little value. Where much service is required, it is better to make the head of tough, hard wood, with a handle considerably larger than the one of regulation pattern.

TRUCK-WAGON.

(*Plate 35.*)

514. This is a powerfully-constructed four-wheel wagon, intended for the transportation of iron gun carriages, sea-coast mortars and their carriages, and other similar heavy weights. The wheels have a diameter of 42 inches; the axles are of iron and the bolsters of heavy pieces of timber, having their upper surfaces flush with the tops of the wheels. Heavy plates of iron cover the tops of the bolsters and project slightly over the wheels. The ends of these plates are turned up, forming a projection about two inches high, to prevent the body transported from slipping off sideways. The width between these projections is just sufficient to admit the chassis of the 15-inch gun.

The wagon is capable of being coupled long or short, to suit the length of the object to be transported. The pole, like that of an ordinary road-wagon, is furnished with double-trees for attaching horses.

The method of using this wagon in the transportation of the 15-inch carriage and chassis, is explained in *par.* 536, and for transporting the 13-inch mortar, in *par.* 537.

When a 13-inch mortar *without* its bed is to be carried, two stout skids, about 12 feet long and 12 by 12 inches thick, are placed on the wagon. The skids are notched to fit the bolsters, to prevent them from sliding to the front or rear, and a shallow recess is cut in them to form a seat for the mortar. The mortar is placed on the skids with its axis parallel to the axis of the wagon; it is hoisted into this position by means of the gun-lift or the gin.

MORTAR-WAGON.

(Plate 36.)

515. This wagon is used for the transportation of siege mortars, siege guns, and heavy projectiles. The limber and wheels are the same as those for the siege-gun carriage. The body consists of a platform of rails and transoms, resting on the rear axle-tree, the two middle rails being prolonged to the front to form the stock. The side rails are prolonged to the rear, and furnish supports for the roller of a windlass, which is used for loading the wagon, the guns, mortars, &c., being drawn up the stock, which rests on the ground, forming an inclined plane. Each end of the roller is provided with pawl and ratchet, operated by a handspike, fitting into a socket after the manner of the windlass of a gin.

Over good and firm roads the mortar-wagon is capable of carrying the 100-pounder Parrott, or any other piece not exceeding in weight 10,000 pounds.

THE CRADLE.

(Plate 37.)

516. This is a machine used for transporting heavy guns short distances. It is made of oak, and consists essentially of two parallel rails 13 feet 6 inches long and 10 by 12 inches thick. These rails are united by a transom near each end and one in the middle; these transoms have such length as to make the entire width of the cradle 60 inches. A bolster is placed over each end transom; the ends of these bolsters are flush with the exterior sides of the rails. The bolsters for the support of the breech are 6 inches high and 8 inches thick; that for the chase 15 inches high and 6 inches thick; the middle part of the top

of each is slightly hollowed out to form seats for the piece. A movable bolster, having notches at each end to fit upon the rails, is intended to be placed tight up against the middle part of the gun after it has been placed on the cradle.

Diagonal braces are fitted inside between the rails and transoms. The under part of the ends of the rails, both front and rear, are beveled off, so that, in moving in either direction, the rollers can be caught under the cradle with facility. The under surfaces of the rails are shod with iron to prevent them from splintering out. A ring is attached by a link and eye-bolt to each end transom for the purpose of attaching blocks and tackle when moving the cradle and piece.

The cradle moves on wooden rollers; each roller is 78 inches long and 7 inches in diameter. From six to ten rollers are required; they rest and move on way-planks laid on the ground.

The method of using the cradle is explained in *par.* 535.

THE CAPSTAN.

(*Fig. 1, Plate 38.*)

517. This machine is used as a strong purchase in heaving or hoisting. When so employed, it is held in position by stout chains attached to holdfasts. The rope is passed two or three times around the barrel of the capstan, the free end coming off *above* the turns; the standing part is attached to the weight to be moved. The rope is drawn taut by hand, the bars inserted into the mortises, and the free end of the rope held and taken in by two men seated on the ground.

Twelve men—three at each bar—are all that can be advantageously employed. When additional power is required, the bars are swifited; that is, the ends of the bars are lashed together with ropes, by which additional men to take hold.

The method of using the capstan in hoisting a 15-inch gun by means of the derrick, is explained in *par.* 549, and for moving it on the cradle up or down a ramp, in *par.* 535.

GIN AS A CAPSTAN.

518. Put the gin together on the ground in the usual manner; place the feet of the legs toward the weight, and secure them well with stakes against the cross-bars, feet, and head of the gin; rig the fall as usual, and attach the hook of the lower block to a rope of suitable strength running to the weight to be moved; the windlass is worked in the same manner as when

the gin is standing. Or the gin, with its pry-pole in the direction of the weight to be moved, may be raised almost to its usual position for hoisting. A block is hooked to the clevis, and through it the rope is passed from the weight to the windlass; the latter is worked as usual.

HOLDFASTS.

519. Pickets. These are stout wooden stakes to be driven into the ground, and used for securing purposes and in the construction of holdfasts. The ordinary stakes for siege-gun platforms answer for most cases. When very heavy strains are to be borne, posts from five to eight feet long are required, and are set into the ground by digging holes, or with a pile-driver. When the latter is used, the post should be shod with an iron point, and have a ring upon the head to prevent splitting.

520. Pile-driver. A good form for this is an iron tube (*Fig. 2, Plate 38*) about ten feet long, with a calibre of about five inches. One end of the tube is set into a broad block of wood, forming a base. Upon each side of the top is attached a sheave, over which works a rope; these ropes are attached to the hammer, and are hauled on by hand until the hammer is at the top of the tube, when they are suddenly let go and the hammer allowed to drop upon the head of the pile. The hammer is an elongated bolt of iron, weighing from fifty to eighty pounds, and of a diameter to work freely in the tube.

To use the pile-driver, it is laid on the ground and the pile or stake introduced, head foremost, into the tube. The machine is then set up over the point where the pile is to be driven, held steady, and the ropes worked as just explained.

In the absence of an iron tube, a box of hard wood may be used in its stead.

To draw heavy pickets, a gin, a sling-cart, or a limber may be used. They may also be drawn by the application of a lever, the point being passed through a rope or chain around the picket.

In drawing pickets, care should be taken that they are drawn out in the same line as that in which they were driven.

521. The most essential points to be considered before any heavy weight is moved or suspended, are the nature and condition of the securing points, together with the strain that will be brought on them. Natural holdfasts—such as the piers of casemates, pintles for guns of position, trees, &c.—may frequently be found, around which straps may be placed. In such cases all corners should be protected by wood, or the rope itself *parceled* to prevent chafing.

In places where holdfasts can be driven or sunk, the ordinary picket post can be made use of, but only when light weights have to be dealt with.

In securing to a holdfast from which it may become necessary to ease off, at least one complete turn must be taken before making fast; otherwise, when the strain is on it, it is difficult to cast off.

Precise rules cannot be laid down as to the description of holdfast best suited for particular operations, but it should be borne in mind that it will save much time and trouble to make it in the first instance considerably more secure than seems to be absolutely necessary, as when a holdfast once begins to give, it is difficult to strengthen it. Whatever holdfast may be used, the strain should be taken by the entire structure at once; otherwise it might give way in detail when it would not do so as a whole.

Figs. 1, 2, 3, 4, 5, Plate 39, represent some of the methods of constructing holdfasts.

When the strain to be sustained is very great, the one shown in *Fig. 5* is used; *a, b, c, d* is a trench from ten to fifteen feet long and two to four feet in width and depth. It is dug in a direction perpendicular to the strain. Several heavy stakes are driven in the trench far enough from the side to admit planks being placed between them and the earth. A heavy beam, with the bight of a chain around it, is then laid on the bottom of the trench against the stakes, the ends of the chain being brought up between the planks along a trench, rising gradually to the surface so that there will be no tendency to lift the beam up when the strain is on it. The whole trench is then filled in and rammed.

Anchors or heavy cannon may be buried and used as holdfasts.

HYDRAULIC-JACK.

(*Figs. 1 to 12, Plates 40, 41.*)

522. Owing to their efficiency and simplicity, these handy and powerful machines are much used wherever ponderous weights are to be moved, and are an invaluable recourse for artillery purposes of this nature.

Fig. 1 shows the constructive points of one form of the jack, whereof *Fig. 2* is a general view. When the jack is depressed, its external appearance is that of a cylinder or pillar, but while being elevated it seems only one cylinder sliding outside another. The outer cylinder (*a*) is, however, simply a tube affixed to the head as a ground attachment, and carries a claw (*g*) to support

the weight to be raised; the head (*h*) is also applicable to this purpose. The inner cylinder (*b*) is the true cylinder, within which again is another or inmost cylinder (*c*), which is the true ram. This last cylinder is hollow, and in the enlarged head carries the pivot (*p*) of the socket (*s*) and lever-arm (*l*), whereby the force pump is worked. The internal capacity of the ram and head is the equivalent of the fluid contents of the cylinder (*b*) when the ram is raised; it is, therefore, in fact the reservoir or source of the hydraulic power. Fitting nicely into the lower part of the hollow of the ram is the piston-head with a suitable valve, and a similar valve—both of which will be given in detail further on—is fitted below it into the bottom of the ram. The necessary reciprocating motion is communicated to the piston-head by a piston-rod (*e*) passing within the ram, suitably connected with and moved by the lever handle. There are three leather packings: one (*d*) to the ram in the cylinder (*c*), one to the piston-head, and one to the pivot of the lever. By the action of the lever-arm the fluid is forced into the cylinder (*b*) beneath the ram, and simultaneously the ram and its load are raised. When the jack is lowered, the fluid simply passes back into the ram and head.

Fig. 3 is another form, having a broad base; it is the same in principle as *Fig. 1*, but does not carry the outer cylinder and claw.

The larger jacks, and in fact those most used for artillery, are shown in *Figs. 4, 5, 6, and 7*, which give the details of construction, of which *Fig. 8* is a general view. This jack differs somewhat from those mentioned, in that the ram (*a*) is a solid plunger, sliding in a simple cylinder (*b*), which is fixed to the base of the cast-iron reservoir (*k*). The force pump is contained in a similar cylinder (*c*), and the two are connected through their lower extremities by a channel not more than one-eighth of an inch in diameter, contained in the reservoir base. The course of this channel is shown in *Figs. 6 and 7*, which are views of the base, into which is let a movable brass stopper (*d*), which is the bottom of the channel and allows access to it. Screwed into the top of the reservoir, and directly above the force-pump cylinder, is a cap (*e*) carrying a ring encircling the ram, serving as a handle for moving and carrying the jack. This cap receives the piston-rod (*f*) and holds it in a vertical position, maintaining its connection with the spindle (*g*), from which a tongue (*i*) enters the square eye (*h*) formed in the rod to receive it. The spindle is suitably connected with the socket and lever-arm, from which it receives motion and actuates the piston pump, whereby the fluid is forced through the pump and channel into the cylinder

and beneath the ram, thus raising the load. When the ram is lowered, the fluid passes back into the reservoir through the same connections. There are three packings, viz. : one to the lower end of the piston-rod, one to the ram, and one to the spindle. The ram carries a movable claw as a ground attachment. (*a*, *Fig. 8*.)

The valves. The valves of the larger jack and their various functions and constructive details are shown in *Figs. 9, 10, and 11*. The piston-rod (*f*) differs from that of other forms already mentioned by its lower half being hollow, to admit of its carrying a small steel rod (*r*), which backs up the valve-plunger (*p*), and by having cut in its exterior surface two channels (*x*) in the same plane containing the square eye, and converging at the lower extremity. These channels admit the passage of the fluid into the pump-cylinder, which is usually submerged in the fluid during the ascent of the piston-rod. The upper valve is simply a plunger and cap (*v*) of brass; the latter is bored with three holes for the fluid, and is screwed into the bottom of the piston-rod; the former is solid, and has a slight play in the space formed by the convergence of the two channels and the brass cap. At the *upward* stroke this valve is *open* from the pressure of the fluid passing the channels, the plunger resting in the cap. At the *downward* stroke it is *closed*, the plunger stopping the channels at their convergence from the fluid pressure below. The lower valve is simply a plunger (*z*) of brass working in a chamber at the bottom of the pump-cylinder, and rests on a spiral spring (*s*), which is fixed to a screw passing through the base of the jack from the outside. At the *upward* stroke this valve is *closed* by the spring; at the *downward* it is opened by the pressure of the fluid, but closes, by the action of the spring, immediately upon a cessation of this pressure. It admits the passage of the fluid into the channel (*w*) connecting the ram-cylinder, thence under the ram.

A stop on the under side of the lever handle near the socket prevents the two valves from meeting at the downward stroke; by reversing this stop and pressing the handle downward gently the cap of the upper is brought in contact with the plunger of the lower valve, which it opens to an extent according to the stroke; the fluid immediately passes through, opening the upper valve, and the ram descends proportionally. This is called *tripping*. A cessation of the pressure upon the handle arrests all motion.

The valves of the other forms are essentially on the same principle, the chief difference being that the lower valve is screwed

into the bottom of the hollow ram, while the upper works in the piston-head.

Thus it is seen that one, and only one, pair of valves is effective in the various functions, viz., to raise, lower, and stop at any given point, and to miss a stroke if required; these different effects being simply realized by a mere reversal of the lever handle in its socket. In all other respects the sole secret involved is good work and fitting and proper adaptation of wearing surfaces by case-hardening metal, with care in an occasional renewal of the leather packing.

These jacks are made in sizes to rise, varying from 7 inches to 2 feet, to lift or press from 4 to 120 tons, and from 2 inches and upwards in diameter, according to power. The form first mentioned is usually employed standing or obliquely; the last named may be used in any position. They may be worked by one man only, being thus capable of raising 10 tons one foot in one and a half minutes, or in that proportion.

Fig. 12 is a hydraulic pulling-jack applicable for setting up rigging, testing chains and rope, pile-drawing, slinging heavy weights in confined spaces, &c. It differs from the lifting-jack in being extended when commencing to work, and then being contracted by fluid force.

To fill the lifting-jack.

523. Remove the small screw in the head, having the piston or ram quite down; fill the jack through the screw hole in the head with winter-strained sperm oil, alcohol, or whiskey, adding to the latter (if liable to freeze) a tablespoonful of sperm oil; work the lever while pouring in the liquid until the ram or piston is up to its full stroke; when this occurs the jack is sufficiently full. Then reverse the lever and push the ram or piston back to the bottom of the cylinder, and replace the screw in the screw hole in the head of the jack. This screw is not intended to fit tightly, and must not be screwed tight home after filling. Be careful that no dirt gets into the head of the jack while filling.

The liquid may consist of equal parts of alcohol and water, or equal parts of whiskey and water; but these liquids should not be used when the temperature is at, or likely to be at, freezing point. Neither kerosene oil nor spirits of turpentine, nor any other liquid liable to corrode the packing, is suitable for use in the jack.

To fill the hydraulic pulling-jack.

524. With the iron key unscrew and remove the screw at each end of the cylinder; if the piston is not down, push it home;

fill through the two screw holes with the same liquid as is used in the lifting-jack, and replace the screws, screwing them home, but not too tight.

To use the lifting-jack.

525. To lift. Place the head of the jack under the object to be lifted. If the object is too near the ground to admit of this, use the iron claw, placing one of its hooks under the object and the other (which has a dowel) over the head of the jack. Insert that end of the lever which is squared (or made with a journal) and has a projecting shoulder into the mortise or slot of the jack, the projection of the shoulder downward (or underneath), and pump until the object is raised to the required height. If this height is greater than the full stroke of the piston or ram, block up the object lifted, reverse the lever so that the projection of the shoulder is upward (or above), press upon it until it is at the bottom of its stroke, and then push the piston or ram down to the bottom of the cylinder; block the jack up higher; then reverse the lever, and proceed to raise the object as in the first instance.

It sometimes happens that the piston or ram cannot be pushed down after it has been run up to its full height or stroke. This difficulty can be overcome by slacking, with a few turns, the small screw in the head of the jack, and thus allowing the air with which the jack is filled to escape.

Sometimes the jack fails to work in consequence of the valve sticking in its seat. This difficulty can be overcome by striking the lever a few sharp blows up and down with a wooden mallet or stick, which will jar the valve and cause it to resume its action.

The lifting-jack can be used standing at any angle between 10 and 90 degrees above the horizontal; but great care must, at all times, be exercised that the support for its base is secure, and that its head is not permitted to slip from under the object to be raised.

526. To lower. Place the head of the jack securely under the object to be lowered, with the piston or ram run up to the distance to which the object is required to be lowered; pump until the object is raised sufficiently to remove the supports from under it; take out the lever, and reverse it so that when put back in the slot or mortise the projection of the shoulder of the lever is upward (or above); then, with a slight pressure of the hand, push the lever downward as far as it will go, when the piston will commence to descend, and will continue to lower as slowly as desired. By raising the lever slightly, the lowering can be arrested at any point. The object must not be lowered too fast,

nor the lowering checked too suddenly, or the jack will cease to work.

To use the pulling-jack.

527. Screw one end of the jack to some fixed object (the end nearest the pump is preferable); unscrew the valve in the pump by two or three turns with the key, and stretch the jack apart; attach the free end of it to the object to be moved; shut the valve by screwing back the two or three turns that were unscrewed; attach the long lever and pump away at it until the object is moved as desired. When there is not room for the long lever, the pump can be worked by the short lever. If the jack does not start at once, slack the screw in the cylinder close to the pump (which the same key fits) until a drop or two of the fluid comes out; as soon as this occurs, turn the screw immediately back. If the piston or ram will not run out to its entire length or stroke, place the jack in a horizontal position, take out the screw at each end of the cylinder, and fill through both holes with the usual liquid.

The pulling-jack can be used to pull or lift at any angle between the horizontal and the perpendicular, but the direction of its force must be in a straight line, and the force pump always at the lowest end when the jack is used in any other way than horizontally. When the pulling-jack is in use, the lever joints must be well oiled and kept free from dirt; when not in use, the piston-rod must be kept in; and when hung up, the end where the pump is must always be downward.

No greater force than that of one man (provided he applies a power of about 150 pounds) need ever be applied to the lever of either the lifting or the pulling jack, since that force is amply sufficient to work the jack to its full capacity.

The hydraulic-jacks usually employed for artillery purposes have 15-ton or 30-ton lifting capacity.

Weight and dimensions of hydraulic-jacks.

| KIND OF JACK. | HEIGHT. | HEIGHT OF LIFT. | WEIGHT (FILLED). | WEIGHT OF CLAW. |
|---------------------|---------|-----------------|------------------|-----------------|
| | Inches. | Inches. | Pounds. | Pounds. |
| 30-ton lifting..... | 20 | 12 | 230 | 90 |
| 30-ton pulling..... | 62 | 18 | 310 | ... |
| 15-ton lifting..... | 20 | 12 | 140 | 50 |

BLOCKS AND SKIDS.

528. *Blocks* are rectangular prisms of wood employed extensively in all operations connected with the movements of heavy artillery. *Skids* are rectangular beams of wood used for similar purposes. The dimensions of those used in the lighter mechanical manoeuvres are given in *par.* 416; those for heavier operations, in *par.* 534.

All blocks and skids should be sound, free from knots, and perfectly true in dimensions. When the edges become splintered and rounded by wear, they should be discarded, as with such it is impossible to erect safe and stable scaffolding and supports. They should not be painted; the thickness of each should be marked upon both ends. In erecting a scaffold or other support, a level foundation is of the first consideration; the blocks should then be laid crossing each other in alternate tiers, and the weight supported should be made to bear equally upon all sides of the base.

529. The *way-plank* is an oak plank 15 feet long, 12 inches wide, and 3 inches thick. Each end is beveled for a distance of six inches, the bevel on one end being on the side opposite the bevel of the other end. These planks are used chiefly for forming temporary tramways for roller, or for the wheels of carriages bearing heavy weights.

530. The *pinch-bar* (*Fig. 3, Plate 38*) is simply a stout hand-spike, of iron, with a round-beveled butt, turned up into a blunt edge for the purpose of catching under a gun or other similar object. It is used as a lever, by pressing down, thus *jumping* the gun forward a very short distance at a time. The butt end is of steel. The length of the bar is from five to seven feet. Those used with the 15-inch gun are of the largest size, and weigh 53 pounds; the shorter size weigh 26 pounds.

531. The *collar* (*Fig. 4, Plate 38*) is a device placed upon the chase of a gun to make its diameter equal to that of the body of the piece. This enables the gun to be rolled with facility. It is made of pieces of scantling jointed together after the manner of the staves of a cask, and hooped with stout bands of iron. It is shoved over the muzzle onto the chase, and secured with wedges of wood.

532. *Chocks* (*Fig. 11, Plate 18*) for the 15-inch gun are made of solid oak wood, of the shape and dimensions represented in the figure. The grain of the wood runs lengthwise with the chock.

When the piece is to be slued, a chock is used having the beveled side cut out slightly concave; the opposite, or flat side, is

shod with spikes, for the purpose of keeping it from slipping. The concave side is placed against the piece, and well greased, to allow the piece to turn easily upon it.

TO MOUNT AND DISMOUNT THE FLANK-CASEMATE HOWITZER.

The implements necessary are: One *half roller*, two *half-blocks*, two *skids*, four *blocks*, four *gun-chocks*, one *hammer-wrench*.

The piece being from battery.

533. The instructor commands :

1. DISMOUNT THE CARRIAGE.

Nos. 1, 2, and the gunner remove the pintle and run the carriage into battery; the gunner, assisted by Nos. 3 and 4, takes off the three nuts that hold the fork; a handspike, manned by Nos. 1, 2, 5, and 6, is passed under the chassis immediately in rear of the fork, and at the command **HEAVE** from the gunner, the chassis is raised, the fork removed, and the trail carefully lowered to the ground; Nos. 3, 4, 5, and 6 then lay the skids in rear and in prolongation of the chassis, their outer edges in line with those of the chassis; Nos. 1, 2, and the gunner then run back the carriage, applying themselves as in from battery, until the rear end of the cheeks touch the counter-hurters.

The gunner bears down on the roller handspike to raise the trail as much as possible, and, assisted by Nos. 3 and 4, who place the ends of their handspikes under the outer edges of the trail, lifts it over the counter-hurters onto the skids.

When the front rollers touch the counter-hurters, No. 2 puts his handspike into the bore and chocks it; Nos. 1 and 2, assisted by No. 5, raise the muzzle; Nos. 3 and 4 lift at the manœuvring rings, and run back the carriage until the front rollers rest on the skids; Nos. 1, 2, 3, 4, and the gunner (the latter embarring in the left mortise, and pressing the roller under the rear transom, and Nos. 1, 2, 3, and 4 laying hold of the manœuvring rings and handles) run the carriage back on the skids until the muzzle is over their front ends.

The instructor commands :

1. DISMOUNT THE HOWITZER.

Nos. 3 and 4 remove the cap-squares, and lay a block and a half block across the skids, touching the head of the cheeks; No. 2 inserts his handspike in the bore, chocks it, and, assisted by

Nos. 1 and 5, raises the muzzle high enough for No. 4 to place a half roller on top of the blocks. The chase is rested on this half roller and chocked on each side; No. 6 crosses his handspike under the knob of the cascable, No. 5 taking hold of the other end; Nos. 1 and 2 bear down on the handspike in the bore; Nos. 5 and 6 lift on that at the cascable; the gunner and Nos. 3 and 4 back the carriage until the front rollers rest on the rear ends of the skids and the trail is on the ground; Nos. 3 and 4 then place a block and a half block across the skids under the breech.

Nos. 5 and 6, bearing down on their handspikes at the cascable, and Nos. 1 and 2 lifting on theirs, raise the muzzle, and Nos. 3 and 4 remove the half block from under the half roller. The muzzle is in like manner lowered, and the half block removed by Nos. 3 and 4 from under the breech. The muzzle is again raised, and Nos. 3 and 4 remove the block from under the half roller and place the half roller under the trunnions. The muzzle is borne down, and Nos. 3 and 4 remove the block from under the breech and replace it by a half block. The piece may now be slued in any direction, rolled upon blocks, or placed in any required position.

To mount the howitzer when on the skids and resting on the half block and half roller.

The instructor commands :

1. MOUNT THE HOWITZER.

No. 2 inserts his handspike in the bore, and, assisted by No. 1, prepares to bear down on the muzzle; No. 6 crosses his handspike under the knob of the cascable, and, assisted by No. 5, prepares to lift at the breech. At the command **HEAVE** from the gunner, they lower the muzzle, and Nos. 3 and 4 replace the half block under the breech by a block. The breech is lowered on the block and chocked. The muzzle is next raised by the same numbers at the handspikes, and Nos. 3 and 4 insert a half block under the half roller, so that the front scaffold thus formed is 3 or 4 inches in front of the junction of the chase and reinforce. The muzzle is now lowered, and a half block placed by Nos. 3 and 4 on top of the block under the breech.

The muzzle is next raised, and a block placed by Nos. 3 and 4 under the half block, thus forming under the chase a scaffold consisting of a half roller, a half block, and a block; Nos. 3 and 4 now remove the cap-squares, and the gunner, assisted by these numbers, places the front of the carriage on the skids, as near the gun as convenient, the trail resting on the ground; Nos. 1

and 2 bear down on the handspike in the bore, and Nos. 5 and 6 lift at that under the knob of the cascade; Nos. 3 and 4 remove the rear scaffold, and, with the gunner, run up the carriage until the trunnion beds are under the trunnions; Nos. 1 and 2 raise on their handspike; Nos. 3 and 4 remove the front scaffold, and the trunnions are lowered into their beds; Nos. 3 and 4 put on the cap-squares. All then run the carriage forward until the front rollers touch the counter-hurters.

The instructor commands :

1. MOUNT THE CARRIAGE.

No. 2 inserts his handspike in the bore, and, assisted by Nos. 1 and 5 (the gunner bearing down on the roller handspike), raises the front of the carriage; Nos. 3, 4, and 6 at the same time push the carriage forward until the front rollers pass over the counter-hurters and the guide of the front transom enters into the guide space; No. 6, with a handspike at the trail, assisting to pass it over the counter-hurters and guiding the flanges of the roller into the guide space.

No. 6 then crosses his handspike under the knob of the cascade, and, assisted by No. 5, lifts against the base of the breech; Nos. 3 and 4 seize the trail handles, and Nos. 1 and 2 the manœuvering rings; the gunner bears down on the roller handspike. All act together and run the piece up the chassis into battery.

Nos. 1, 2, 5, and 6 now apply themselves to a handspike crossed under the rear end of the chassis, which they raise and hold up while the gunner, assisted by Nos. 3 and 4, replaces the fork and nuts. The piece is then run from battery, and the gunner, assisted by Nos. 1 and 2, puts in the pintle.

TO DISMOUNT A 15-INCH GUN FROM ITS CARRIAGE BY MEANS OF BLOCKS.

534. The implements required are: Two *hydraulic-jacks* (thirty-ton), four *pinch-bars* (large), six *handspikes* (manœuvering), eight *wheel-chocks*, four *gun-chocks* (large), one *trace-rope*, six *way-planks*, four *shifting-planks*, two *wrenches* (nut), one *sledge-hammer*, two *long rollers* (cradle), four *small rollers* (15 inches long, 1.5 inch diameter), one *ten-foot pole*, one *carpenter's rule*, one *screw-driver*; fifty *blocks*, 12 by 12 by 44 inches (hard pine); twelve *blocks*, 12 by 6 by 44 inches (hard pine); eight *blocks*, 12 by 4 by 44 inches (hard pine); ten *blocks*, 12 by 2 by 44 inches (oak); ten *blocks*, 12 by 1 by 44 inches (oak); six *whole blocks*, 8 by 8 by 20 inches (oak); four *half blocks*, 8 by

4 by 20 inches (oak); four *quarter blocks*, 8 by 2 by 20 inches (oak); two *skids*, 12 by 15 by 204 inches (hard pine or oak); six *skids*, 8 by 8 by 72 inches (oak).

A four-wheel truck-wagon is convenient for removing the top-carriage and chassis.

The following method is for a gun mounted on a *centre-pintle* carriage. Only slight changes are necessary to adapt it to a *front-pintle* carriage, and these will readily suggest themselves to any one performing the manœuvre.

To dismount the gun.

535. Twelve men are necessary: one chief-of-detachment, one gunner, and ten cannoneers.

The manœuvre is executed in the following order:

1st. Run the gun into battery and give it an elevation of zero.

2d. Remove the flooring-planks.

3d. Remove from the chassis all transoms and braces in rear of the pintle transom. This makes a clear space under the body of the gun for a "crib" to be built, as shown in *Fig. 2, Plate 42*.

4th. Remove the fulcrum post, crane, and steps of the chassis.

5th. Remove the large nuts from the rear end of the piston rods.

6th. Run the gun from battery until the top-carriage is within two or three inches of the counter-hurters.

7th. Remove the truck-wheels of the top-carriage and take out the axles of the same.

8th. Remove the counter-hurters from the chassis and the guides from the top-carriage.

9th. Place a half block crosswise on each rail against the hurters; upon each of these place one of the six-foot skids, its rear end resting on the chassis rail. This gives a horizontal foundation for the *front* scaffold to be built under the chase of the gun, and a seat for the jack, under the muzzle, to rest upon. (*Fig. 1, Plate 42*.)

10th. Build up a scaffold from the gun platform between the rails of the chassis. (*Fig. 2, Plate 42*.) This supports the body of the gun, while the *front* scaffold supports the chase. Both should be built crib-fashion, and of the 44-inch blocks. *Great care should be taken that these scaffolds are firm and true.*

11th. Place a 44 by 12 by 12 inch block on end, resting on the platform and under the fulcrum-post transom to support it. On top of this transom place blocks to support the jack when raising the breech of the gun. (*Fig. 1, Plate 43*.)

12th. Place the jacks, one under the breech and the other under the muzzle; raise until the trunnions are clear of the car-

riage, and block up the front and rear scaffolds securely under the gun. *The greatest care should be observed in this operation to place the jacks squarely under the breech and muzzle, so that the gun may not roll and thus raise one trunnion higher than the other. The jacks should be worked alternately, commencing always with the one under the breech, and only two or three inches should be gained at each lift. (Fig. 2, Plate 42.)*

13th. Remove the front transom from the carriage, so as to admit of the latter being run back clear of the rear scaffold.

14th. Place a trace-rope through the rear axle-holes of the carriage; pry up the rear of the carriage, and insert under each shoe a small ($1\frac{5}{16}$ -inch) roller.

15th. Back up the truck-wagon against the rear end of the chassis rails. The wheels of the wagon should rest on way-planks.

16th. Haul on the trace-rope and draw back the carriage, catching it on long rollers placed on two way-planks on the wagon. (*Fig. 2, Plate 42.*) The carriage can be drawn back over the counter-hurters in case the latter are not removed. When a truck-wagon cannot be used, the carriage can, in like manner, be hauled back upon a crib of blocks built in rear of the chassis, from which it may be readily lowered to the ground by means of jacks or handspikes. (*Fig. 2, Plate 43.*)

17th. The gun now being free from its carriage and resting on the scaffolds, built up as before described, is lowered, by means of jacks, until it rests on two long skids, one end of each resting on the chassis rails, while the other end rests on a crib of blocks built up on the side of the chassis to which the gun is to be moved. The skids must be horizontal and on the same level. To this end the front one should rest across and on the two six-foot skids placed as in "9th." A bar of railroad iron placed on the front skid will greatly facilitate the next operation.

18th. Roll the gun over on the skids until it rests above the cribs. The muzzle is cut forward, either by pinching or by hauling on a trace-rope attached to a block or roller in the muzzle. The gun may now be lowered to the ground by means of the jacks, or, should it be desired to move it to some other part of the works, it may be placed on a cradle. (*Fig. 1, Plate 44.*)

To do this, the cradle is placed parallel to the gun and about three feet from the cribs. The cradle rests upon five or more long cradle rollers resting on two way-planks laid on the ground directly under the rails of the cradle. (It is best to double the way-planks by laying them on each other in such manner as to break joints.) The rollers are securely chocked. The gun is now lowered, by means of the jacks, until it rests upon the two

long skids placed across the cradle, the ends under the gun resting on the cribs—now reduced in height to two blocks—while the other ends are supported by blocks on the other side of the cradle. (*Fig. 2, Plate 44.*)

The gun is next rolled until it rests squarely over the cradle, when it is again jacked up until the skids are removed, after which it is carefully lowered into its place on the bolsters of the cradle. (*Fig. 1, Plate 45.*)

The gun may be rolled over by means of pinch-bars, but more easily by parbuckling. A parbuckle-rope is used for this purpose, and is hauled upon by hand, or, better, by attaching to it a tackle secured to a holdfast or some other fixed object.

The same rope and tackle may be advantageously used for cutting forward the muzzle; attaching the rope for this purpose to a block or roller placed in the bore of the gun. (*Fig. 2, Plate 45.*)

The gun upon its cradle is moved by attaching to the front ring of the cradle a heavy rope (6 to 8 inches circumference) and hauling on it by means of a capstan, or a tackle may be used instead of a capstan, in which case a single-sheave block is hooked into the ring, and through it a rope is rove, one end of which is secured to a strong holdfast to the front, and the other hauled upon by tackle in the manner represented in *Figs. 1, 2, Plate 46.*

Way-planks are placed successively as the cradle moves forward, and as the rollers become disengaged at the rear they are placed in front, care being taken to preserve an equal bearing upon all.

In passing around curves, the rollers are kept in the position of radii of the curve. This is accomplished by placing each roller in the required position and by driving the ends backward or forward, as the case may require. By observing this, all unnecessary jerking will be avoided. The cradle should, if possible, be moved with the muzzle of the gun foremost; it then engages the rollers in front more freely, glides over inequalities with greater ease, and is more readily directed in its course,—results following from the smallest weight being in front. In going up or down inclines, the rope should be attached to the gun, by the trunnions, instead of to the cradle. This will obviate any danger of its slipping on the cradle.

When the inclination is great—as upon a ramp—tackling should be used as illustrated in *Figs. 3, 4, 5, 6, Plate 46.*

Should the railway truck be used instead of the cradle, the gun is placed on it by operations similar to those for the cradle, except that the skids must be supported entirely by the cribs at

the sides, and not allowed to rest on the truck; observing, also, that the *front* end of the truck must always be in the direction towards which the gun is to be moved.

Unless the ground is very firm and the manœuvring detachment skillful, the cradle is the safest and surest method.

To remove the chassis from its platform.

536. This may be done by jacking and blocking it up, and placing under it the cradle and rollers. A better way, however, is to use the garrison gin instead of jacks, and the four-wheel truck-wagon instead of the cradle.

The gin is placed over the chassis; a sling-chain, doubled, is passed around the latter directly in front of the pintle bolster; to this the hook of the tackle is attached.

The sling-chain should be of iron, at least seven-eighths of an inch in diameter. It is better, however, to use heavy rope for slinging. A gun-sling made of not less than 9-inch rope is most convenient, and to use it a cradle roller, or a beam of wood of like dimensions, is placed under the chassis, directly in front of the pintle bolster, its ends projecting equally on the sides. Lay the gun-sling across and over the chassis; bring both ends of it under the ends of the roller and up together on top of the chassis, where the free end is drawn through the eye, bent into a knot, and stoppered. The hook is attached to the sling by lashing with a trace-rope, not less than six turns being taken for this purpose.

Blocks of wood, with rounded edges, are placed against the sides of the chassis rails, under the sling, to prevent the sharp edges of the chassis from cutting the rope.

The chassis is then raised until the truck can be backed under it. The wheels of the truck rest on way-planks, and the truck coupled to such length that when the chassis is lowered the *rear* traverse-wheels will be in front of the front bolster, and the *front* traverse-wheels in rear of the rear bolster of the truck. (*Plate 47.*) The chassis is lowered so that the rails will rest on the bolsters between the iron projections at their ends. The truck, with the chassis, can now be moved wherever desired.

The chassis is replaced and the gun remounted by operations the reverse of the foregoing.

The precautions necessary to be observed in all mechanical manœuvres with artillery, multiply rapidly with the weight of the piece.

With the 15-inch gun, all implements and material should be of the most perfect kind, and no doubt should be allowed as to strength of parts to sustain the weight or pressure required of

them. *The utmost care should be taken to avoid all sudden shocks and jerking movements.*

537. Another method of mounting guns on iron carriages, is to block up the piece to the proper height, and then *assemble* the chassis and carriage under it.

To do this, place the piece on the platform in such position as to bring the chassis in its proper place with reference to the pintle and traverse circles; raise the muzzle and breech alternately by means of the jack, supporting the gun on two scaffolds of blocks placed in front and in rear of the trunnions; assemble the chassis in position; place one cheek of the top-carriage on the chassis rail, with the trunnion bed directly under the trunnion, and bolt the transoms to it; place the other cheek in position, and bolt it to the transoms; lower the trunnions into their holes and remove the block.

To dismount a gun, proceed in the inverse manner.

Another method, when the top-carriage has not been taken apart, is as follows: Mount the chassis on the platform and the top-carriage on the chassis, and then run the top-carriage into battery; bring the gun upon the cradle or skidding until it is parallel to a convenient portion of the chassis; roll the gun over the chassis, having the breech projecting beyond the rear end of the chassis; raise it by blocking under the breech beyond the rails and under the muzzle by a pier of blocks between the rails, or by a pier of blocks outside of each rail with a skid laid across. The piece is raised until the trunnions are high enough to permit the top-carriage being moved back under them, when the piece is lowered into the trunnion beds and the scaffolding removed.

When a pier of blocks is placed *between* the chassis rails, a gin is used for suspending the muzzle until the pier is removed and the carriage moved back under the trunnions.

A gin may be advantageously used for raising heavy guns upon blocks. To do this, supposing the piece to be lying on the ground, insert a skid or similar piece of timber into the muzzle; erect the gin over the muzzle and attach the tackle to the skid; raise the muzzle and place a block under the piece just in rear of the centre of gravity; lower the muzzle and block up under the breech; again raise the muzzle and block up on the fulcrum; lower the muzzle and block up under the breech; and continue this operation until the piece is at the required height.

TO PLACE A 13-INCH MORTAR, MOUNTED ON ITS CARRIAGE, ON A TRUCK-WAGON.

538. Implements specially required : One *gin*, of size larger than garrison gin ; one *fall*, of large size (5 to 7 inches) ; one *quadruple block*, one *triple block*, four *sling-chains* (links not less than 0.75 inch in diameter), one *four-wheel truck-wagon*, one *clevis* for mortar lug. Instead of the sling-chains, two gunslings may be used. These should be of rope not less than nine inches in circumference.

Twelve men are necessary : one chief-of-detachment, one gunner, and ten cannoneers.

Remove the upper step from the bed and depress the mortar until its axis is horizontal ; raise the gin over the mortar and rig the tackle ; attach the clevis to the clevis lug and hook the lower block to it ; pass a sling-chain under the rear notches of the bed and up over the mortar, in front of the clevis lug.—this is to prevent the rear end of the carriage from sagging when the mortar is raised ; work the windlass until the carriage is high enough to pass the wagon under it ; the wagon, having been coupled short enough to receive the mortar bed on both bolsters, is run under and the mortar lowered upon it.

Should there be no clevis lug on the mortar, two sling-chains are used, passing under the front and rear notches of the bed and crossing each other on top of the mortar. The lower block of the gin tackle is hooked at the crossing, and the operation of raising is as before described.

The mortar thus mounted on a wagon can be moved by hand short distances, and with eight horses may be transported over level and firm roads.

Instead of the gin, one trestle of the gun-lift may be used for the foregoing operation. It is set over the mortar, and the manœuvre is proceeded with as with the gin. (*Fig. 1, Plate 48.*)

DESCRIPTION OF THE GUN-LIFT.

(*Plates 48, 49.*)

539. A. *Sill*, with mortises to receive the legs of the trestles.

B. *Brace sill*, notched to fit on sill, with a bolt and key to secure it in its place and a cast-iron seat for end of adjusting screw of brace to rest in.

C. *Legs of trestle*, bolted and keyed together at top.

D. *Brace*, with adjusting screws attached to foot. One brace on each trestle has cleats to form a ladder.

E. *Cap*, with a shallow mortise near each end to receive ends of legs and braces, and a hole to receive large bolt for securing it to legs. These bolts are keyed below, and their heads project above the cap about three inches, and serve as dowels to secure the bolsters.

F. *Bolsters*, resting on cap, having a clevis at centre of gravity for hoisting it in position and a mortise for hoisting-bar to pass through.

G. *Bracket*, fastened to cap by a bolt, around which it turns.

H. *Staging-plank*, resting on brackets.

I. *Fulcrum*, resting in mortise in bolster.

J. *Lever*, one end resting in fulcrum and the other on hydraulic-jack, and having a mortise through which the hoisting-bar passes.

K. *Hoisting-bar*, with hooks on lower end for sling-chains and holes at intervals to receive supporting pins.

L. *Shears*, for hoisting into their places the bolster, levers, fulcrums, and jacks.

M. *Hydraulic-jack*, for raising end of lever, and thereby the weight.

Each gun-lift is provided with two sets of caps and bolsters. One of these sets has the mortises for the hoisting-bar through its middle; this is intended for centre-pintle carriages. The other set has mortises much nearer one end than the other, and is for front-pintle carriages. The latter arrangement is intended to permit the carriage to be traversed from under the gun, when it is raised, or under it, when it is being mounted.

When weights are not excessive—that is, not exceeding, say, fifteen tons—and can be slung with a single sling, but one trestle need be used. This would be the case with mortars, gun carriages, and like weights.

The jacks used must be of a power equal to the weight to be raised, as there is nothing gained for them by way of leverage.

Twelve men are necessary to erect the gun-lift and mount or dismount a 15-inch gun.

Implements specially required: Two *hydraulic-jacks* (30-ton, or one 30-ton and one 15-ton), two *mauls*, two *hammers*, one *measuring-rod* (12 feet), one *spirit-level* (carpenter's).

If the carriage and chassis are to be moved, the following will be required in addition: One *cradle* (or truck-wagon), six *cradle rollers*, twelve *wheel-chocks*, four *way-planks*, two *shifting-planks*.

A sufficient number of 44-inch blocks of various thicknesses should be at hand for any purpose required of such material.

To assemble and raise the gun-lift.

540. Place the sills parallel to each other at the required distance apart and on the spot where the trestle is to stand. It will be convenient to have a wooden rod of a length equal to the proper distance between the sills. Lay down the brace sills and key them; take two legs, bring together the two ends which form the mitre joint, pass the bolt through them, and drive in the key; raise one leg above the other, insert the head of the legs into the mortise in the cap, put in the bolt, and drive in the key. At the same time two other men have gone through the same operation with the other two legs.

Place the ends of the legs that are on the ground close to the mortises in the sills; all take hold of the cap and raise it, bringing the trestle on its feet and placing the legs in the mortises in the sills.

A pole with a notch in the end, or hook like a boat-hook, will be convenient in raising the trestle after the cap is too high to hold it with the hands; or the trestle may be raised by the shears in the same way as the bolster, if the party be deficient in force, or if for other reasons it be deemed desirable. Correct the position of the trestle, if it be necessary, so as to bring the mortise for the hoisting-bar directly over the centre of gravity of the weight to be raised. Put up the braces, varying their length as may be required, by turning the screw in the foot, until they shall have a good bearing when the legs are vertical, which is determined by a plumb-line or spirit-level.

To raise the bolster, a pair of light shears is provided. Place them so that when raised the head shall be over the middle of the cap of the trestle; hook the pulley-hook in the link provided for the purpose; fasten two guys to the head, one to the front and the other to the rear; raise the shears and make fast the guys; hook the pulley to the elevis of the bolster and raise it to its place on the cap; raise the staging-plank and lay them on the brackets.

Two men ascend the steps on the brace to the top of the trestle and receive the fulcrum, lever, and jack, which are hoisted to them in turn, and place them in position. The hoisting-bar is brought by the men on the ground, who insert it into the mortise in the cap and bolster, and raise it, assisted by those on the trestle, until it be in position.

To raise the weight.

Pass a sling around the weight, bringing the ends over the hook on the end of the hoisting-bar, taking in all of the slack. Bring the lever down on the head of the jack; put in the pin

over it and through a hole in lifting-bar; commence pumping, and raise the weight the full lift of the jack; insert the pin in the hole in lifting-bar above the bolster and run down the head of the jack as far as it will go; bring the lever down as at first, and continue the operation as already described. *The weight should not be left on the jack for any length of time, but on the pin.*

To mount a 15-inch gun with the gun-lift.

541. The platform is supposed to have nothing on it. Bring the gun onto the platform by means of the cradle, or truck and portable railway, the muzzle to the front, the vent uppermost, and leave it in such a position, with the muzzle about two feet in rear of where the end of the chassis will come, that when the gun shall be raised vertically the carriage can be placed on its pintle and directly under the gun; place the shears midway between the place where the two trestles are to stand; raise the trestles and place them over the gun so that one hoisting-bar shall be over the centre of the neck of the cascable and the other about two feet from the muzzle; raise the gun to its full height as already described for raising a weight; remove the truck, bring the chassis (on a truck), and run it between the legs of the trestles under the gun; remove the truck and place the chassis on the pintle; bring the top-carriage and place it on the chassis, placing the trunnion beds under the trunnions; lower the gun into its place, and remove the gun-lift.

If the gun and carriage be already on the platform, or if the peculiar position of the platform be such as to render the foregoing method impracticable, the following plan may be executed:

Place the gun in such a position that the axis of the bore shall be in the same vertical plane as the central line of the chassis when the latter shall be in place; move the chassis parallel and close to the gun, the top-carriage run well to the front; put up the trestles over the gun and chassis, both of them being between the legs of the trestles; hoist the gun, raise and slide the chassis by means of the jacks under the gun and over its pintle; run the top-carriage back under the gun, and lower it into its place.

TO DISMOUNT A 10-INCH SMOOTH-BORE (CASEMATE GUN) BY MEANS OF BLOCKS.

(Figs. 1, 2, Plate 50.)

542. The detachment consists of one chief, one gunner, and ten cannoneers.

Implements: Two *skids*, 96 by 12 by 12 inches; seventeen

blocks, 44 by 12 by 12 inches; five *blocks*, 44 by 12 by 6 inches; five *blocks*, 44 by 12 by 4 inches; five *blocks*, 44 by 12 by 2 inches; eight *whole blocks*, four *half blocks*, four *quarter blocks*, one *bar* (railroad iron), two *hydraulic-jacks*, two *pinch-bars*, two *hammer-wrenches*, two *iron wrenches*, four *long handspikes*, two *manœuvering-bars* (iron), one *two-foot rule*, two *muzzle-chocks*, two *breech-chocks*, one *large chock*, five *wheel-chocks*.

To dismount the piece.

543. Run the piece from battery until the carriage touches the counter-hurters; throw it out of gear; remove fulcrum post, rear transom, rear guides, and depress the piece as far as possible.

Under the rear of the chassis rails, and parallel to them, lay two 12-inch blocks, their front ends touching the traverse-wheels; across these place two 6-inch blocks about six inches apart, the front edge of the front one directly under the rear edge of the middle transom of the top-carriage; across these rest on each side a whole and a half block, the whole blocks one foot apart, their front ends on a line with the front edge of the 6-inch block under the middle transom; lay a half block between the whole blocks for a support for the hydraulic-jack. Under the chassis, in front, place transversely two 12-inch blocks about 15 inches apart, the rear one under the rear part of the fork; across these place a 6-inch block to support the hydraulic-jack; across the chassis rails, and resting against the hurters, place two quarter blocks; let the front ends of the 6-inch blocks rest upon these, the rear ends bearing upon the chassis; build across the rear ends of the 6-inch blocks, with 12-inch and 6-inch blocks (or thinner pieces if necessary), until the muzzle is reached; block up securely and chock the breech, and, by means of the jack, raise the muzzle until the gun has a slight elevation; then raise the breech and muzzle alternately until two whole blocks, in addition to those already placed, can be put under the former, and one 12-inch and two 6-inch blocks under the latter; run the top-carriage forward until the front ends nearly touch the blocking in front; remove eccentric sockets, wheels, axle, and right front guide; raise the carriage, and under it, front and rear and across the chassis, place two iron manœuvering-bars; back up the casemate truck, chock the wheels, and slide the top-carriage upon it. The truck having been removed, two skids are placed under the gun, front and rear, between the blocking, their inner ends resting upon both chassis rails, the outer upon cribs built of 12-inch blocks as near the chassis as possible. The gun having been lowered upon the skids, the muzzle resting upon the railroad iron so that it can be cut, it is rolled until it rests directly over the cribs, raised sufficiently to permit the skids to

be removed, and lowered to the ground or upon the casemate truck, as may be desired.

The gun is mounted by inverse means.

Precautions to be observed.

544. After the breech is sufficiently raised, the two upper whole blocks are backed up by two others placed in rear, in order to give a broader bearing and prevent the possibility of upsetting. The gun should never have much elevation when being raised by the jacks, as it is liable to slide to the rear and upset the jack. This is especially important when the gun is being mounted before the top-carriage has been run back. In remounting the gun, care must be taken that it is not too far to the rear (the distance from the rear of the chassis to a point directly under the axis of the trunnions is 5 feet 1 inch); should this occur, however, the carriage can be run farther to the rear by removing the counter-buffers. Should the gun, upon being rolled back over the chassis, have its trunnions in line, but not rest directly over the carriage, it may be moved sidewise, by raising it with the jack, and then lowering it slowly upon a large ground-chock.

If the blocking under the breech is placed too far forward, it will not allow the carriage to be run sufficiently far to the rear to receive the trunnions in the trunnion bed.

Care must always be taken to arrange the blocking and crib-work so that it will not interfere with the free manipulation of the jacks.

The foregoing is for a gun mounted on a casemate carriage. When mounted on a barbette carriage, the operation differs but little from the former.

SHEARS.

545. Shears are used for lifting heavy weights over the face of a wall or cliff, or in other situations where the gin could not be used for want of footing for the pry-pole.

All shears are constructed and erected on the same principle.

They consist of two spars of suitable size for the weight to be raised. The following will serve as a guide :

Spars.

| WEIGHT. | DIAMETER. | LENGTH. |
|-----------------|-------------------|----------|
| Tons. | Inches. | Feet. |
| 2 | Head 6 to 9 heel. | 20 to 30 |
| 5 | " 10 to 14 " | 30 to 40 |
| 12 and upwards. | " 14 to 20 " | 30 to 45 |

The upper and lower ends are respectively called the *head* and *heel*, and the part where the lashing is applied is termed the *cross*.

The stores necessary to equip a pair of shears are:

Gin tackles—Two *single blocks*, two *double blocks*.

Main tackle—One *double block*, one *treble block*, one *snatch block*.

Cordage—Main-tackle fall, 100 fathoms 3 to 5 inch Manila rope; guys, 50 fathoms 3 to 6 inch Manila rope; head lashing, 10 fathoms 3 to 4 inch Manila rope; heel lashing (two each), 10 fathoms 3 to 4 inch Manila rope; contingencies (two each), 50 fathoms 3 to 4 inch Manila rope.

Straps—Main tackle, one fathom 6-inch Manila rope; snatch block, one fathom 4-inch Manila rope; holdfasts (six), each made of one fathom 4-inch Manila rope; contingencies (six), each made of a half-fathom of 4-inch Manila rope.

Spun-yarn for mousing, stops, &c., one ball of 100 fathoms.

Two *cleats* for heels, to prevent the lashing from slipping up, made by cutting lengthwise, diagonally, a piece of 6 by 6 inch scantling 2 feet long. These cleats are spiked to the heels 6 inches from the bottom. Twelve *stakes* for holdfasts for guys, 6 feet by 6 feet by 8 inches; four *stakes* for heel-posts; two *shoes* for heels, 6-inch plank, 15 feet by 15 feet.

To rig the shears.

(Fig. 1, Plate 51.)

546. Lay the heads of the spars on a trestle about three feet high, the right leg above the left, so that they cross at about twice their thickness from the ends, with the heels in their proper position.

Pass the head lashing as described in *par.* 480, or if a very heavy weight is to be raised, as follows: Take a good piece of $3\frac{1}{2}$ or 4 inch rope, well stretched, middle it, and make fast to the shear leg, below the cross; with one end pass the requisite number of figure-of-eight turns around both spars, heaving each turn well taut, and hitch the end to the upper part of the shear leg; with the other end pass riding turns around both legs, filling up the intervals between the first turns; come up with the hitch of the first end, and pass frapping turns around all parts of the lashing between the shears; finish with a square knot, and stop the ends back with a good spun-yarn stop. If necessary, tighten up with wedges.

Lay the middle of the back guy in the cross; bring the left-hand end up around the right leg and over the head of the left leg; then carry the right-hand end around under both legs; let it

cross over the left-hand end, and seize them together with spun-yarn.

Make a bowline knot in the end of the fore guy and slip it over the head of both legs.

Lay the middle of the main-tackle strap under the cross above the fore guy; bring the ends up over the cross; hook the upper block to them under the cross below the fore guy, *and mouse it*, taking care that the splice comes in the middle of the strap and that the fall leads to the rear.

Drive the heel-posts on each side the heels about a foot toward the head, and one foot outside; lay the shoes under the heels; make a timber hitch around the inner posts with the heel lashings; pass three turns over the legs below the cleats, and hitch the lashings to the outer posts.

Drive four holdfasts for each back guy as follows: Two on each side the line of the legs prolonged, three feet apart, and two six feet in rear of these.

Lay the ends of the guy straps over the front stakes; connect each pair of front and rear stakes with a strap twisted up taut to insure the strain being distributed properly.

Drive two holdfasts for the fore guy, one in rear of the other, in the prolongation of the axis of the shears.

Hook the upper blocks of the guy tackles to a bowline in the end of the guys, and the single block to the guy strap, and *mouse them all*.

Ordinarily the fore guy can be worked without a tackle, belaying it over the holdfasts, first taking a round turn over the one next the shears.

If not too heavy, the shears may be raised by lifting the head and hauling on the guy tackles, slacking the heel lashings as required, and tending the fore guy carefully to prevent the shears falling over toward the rear.

When raised, hook the snatch block to a strap placed below the cleat on either leg.

If the shears are too heavy to raise in this way, bring both guys together at the heels; form a crutch by lashing together two poles (or use the legs of the garrison gin); place the guys in this crutch; pass the end of a small rope over *both* guys, in *front* of the crutch, down *under* the lashing, and take a rolling hitch with it around *one* of the guys in *rear* of the crutch; haul the rope well taut, and secure it to the lower end of the crutch leg.

Raise the crutch with an inclination of one-sixth to the front, and heave up the shears by the guy tackles. When the crutch ceases to act, slack it to the ground by the small rope.

In general, the inclination or *rake* of the shears should not

exceed 20 degrees, or four-elevenths of their height, and each leg should have about one-half this inclination. In this position the strain on the guys will never exceed one-half the weight. Allowance of seven or eight degrees, or one foot in eight, should be made for the stretch of the guys.

The diagram (*Fig. 2, Plate 51*) will serve as a guide in placing shears, holdfasts, &c.

$$\begin{array}{rcl} \text{Make } A & B= & \frac{1}{3} C E. \\ & C D= & \frac{1}{2} a b. \\ \left. \begin{array}{l} E F \\ E G \end{array} \right\} & = & \text{at least } 2 A C. \end{array}$$

When the locality will not admit of rigging the shears in position as described, they may be raised from the foot of the wall or cliff by means of a gin or lighter shears in the following manner: Pass the shear lashing and attach the front guy; lash a stout spar across the legs about two feet above the centre of gravity, giving the heels the proper spread; fasten a small rope to each heel to serve as guys; hook the gin tackle to a strap firmly attached to the middle of the cross-spar, and heave away, *tending the guys carefully*. As the head of the shears comes above the crest of the wall, put on the back guys and main-tackle strap, and hook on the tackle; *mouse all hooks*; raise the shears, place the heels in the shoes, pass the heel lashings, set up the guys, and lower the gin to the ground by means of its tackle, leaving the spar in position.

Use of the gin as shears.

547. When the garrison or casemate gin is used as shears, the pry-pole is replaced by a parting block of the same diameter.

The guys are attached as follows: Middle the rope for the back guys; push the bight through the clevis from below and slip it around both legs; haul the ends back tight and lay them over the head of the gin to the rear, each part lying between the nearest leg and the parting block, taking care to place canvas under the ropes to prevent chafing.

The fore guy is hitched around the clevis bolt.

A single back guy may be used, formed of a tackle of the same size as the gin tackle, hooked into a strap applied as described for the guy-ropes. *In this case particular care must be taken to bring the axis of the shears in the vertical plane containing the holdfast and the centre of gravity of the weight to be lifted.*

The shears are lowered by slacking the guys and heel-ropes, or by using small shears. When no capstan is available, a windlass may be improvised as follows:

Nail a strong cleat on the lower side of each leg, three feet

from the heel, butt end down; lay a round spar a little more than one-third the length of the shears across the legs, one foot above the butt of the cleats, and pass a strong lashing, frapping it loosely between the spar and legs, taking care to have the lashings of equal length; *grease the spar under the lashing*; pass a strap around each end of the spar, put one end through the other, take a round turn around the spar, and put a hand-spike through the free end, to be used as a lever to turn the windlass. The straps should be nailed to the spar to prevent slipping. Additional levers may be applied in the same manner if required.

The windlass is chocked by allowing the ends of two hand-spikes (or more) to touch the ground.

The officer in charge of the work should place himself where he can carefully observe the working of the entire structure, *particular attention being paid to the rake of the legs and the security of the several holdfasts.*

No person should be permitted to stand or pass under the shears while a weight is being raised.

The shears proposed by the Ordnance Department to be furnished for hoisting a 15-inch gun are represented on *Plates 52 and 53.*

DERRICKS.

(*Fig. 3, Plate 51.*)

548. The derrick is a machine used for hoisting or lowering heavy bodies to or from the top of vertical walls or similar places. It usually consists of one spar or leg; but the one employed for raising 15-inch guns consists of two legs made of round spars of yellow pine, 29 feet long, 11 inches diameter at the foot and 9 inches at the top; one sill, half round, 16 feet long and 11 inches in diameter; one cap, half round, 8 feet long and 9 inches in diameter; two iron straps, with keys and wedges for securing cap to legs. Near each end of the sill, on the square side, is a mortise, into which fits the tenon on the foot of the leg. The cap is similarly mortised to receive the top of the legs, and is held fast in this position by the straps fitting over it and keyed through the legs.

The following is a list of the stores required for it when hoisting a 15-inch gun to the top of a rampart thirty feet high:

| MATERIAL. | USE. | No. | Size. | Len'th. | | |
|----------------|-------------------------------|-----|-------|----------|--------|-------|
| | | | Inch. | Fathoms. | | |
| Hemp rope..... | Main-tackle fall..... | 1 | 5.5 | 90 | each. | |
| | Guys (single rope doubled)... | 1 | 6 | 20 | | |
| | Straps for guys..... | 2 | 6 | 10 | | |
| | Fore guy | 1 | 6 | 20 | | |
| | Lower-block lashing..... | 1 | 4.5 | 20 | | |
| | Upper-block lashing..... | 2 | 5 | 6 | | each. |
| | Leading-block straps..... | 4 | 6 | 2 | | each. |
| Manila rope... | Muzzle-tackle fall..... | 1 | 4.5 | 100 | each. | |
| | Guy-tackle fall..... | 2 | 4 | 20 | | |
| | Preventer-tackle fall..... | 2 | 4 | 20 | | |
| | Fore-guy-tackle fall..... | 1 | 4 | 30 | | |
| | Luff-tackle fall..... | 1 | 3.5 | 30 | | |
| | Muzzle-tackle lashing..... | 2 | 5 | 8 | | each. |
| | Straps for various uses..... | 8 | 4 | 1 and 2 | | each. |
| Hemp | Trace-rope for lashing..... | 3 | 3 | 5 | each. | |
| | Shear-head lashing..... | 1 | 2.5 | 6 | | |
| | Spun-yarn, 3-yarn..... | .. | | 20 | | |
| | Seizing stuff, 12-yarn..... | .. | | 5 | | |
| | Stoppers (soft plated)..... | 6 | 2.5 | | | |
| | Thimbles | 6 | 3 | | heavy. | |
| | Sling-chains | 3 | | | heavy. | |
| Wood..... | Handspikes (manœuvring).. | 6 | | 84 in. | | |
| Iron... .. | Pinch-bars..... | 2 | | 84 in. | | |

| PURCHASE BLOCKS USED. | KIND. | | | | | Number used. | Diameter, sheaves. | MATERIAL. |
|---------------------------|---------|---------|---------|------------|---------|--------------|--------------------|------------------|
| | Single. | Double. | Treble. | Quadruple. | Snatch. | | | |
| Main tackle | | | | 2 | | 2 | 14 | } Wood and iron. |
| Main tackle, leading..... | 1 | | | | | 1 | 14 | |
| Muzzle tackle..... | | | | 2 | | 2 | 10 | } Iron. |
| Muzzle tackle, leading.. | | | | | 1 | 1 | 10 | |
| Guy tackle, leading..... | | 2 | 2 | | | 4 | 10 | } 2, wooden. |
| Preventer tackle..... | | 2 | 2 | | | 4 | 8 | |
| Fore-guy tackle..... | 1 | 1 | | | | 2 | 5 | } 2, iron. |
| Fore-guy tackle, leading | | | | 1 | | 1 | 5 | |
| Luff tackle..... | 1 | 1 | | | | 2 | 6 | } Wooden. |
| Girtline | 1 | | | | | 1 | 4.5 | |

Two *capstans*, wooden; four *stakes* for securing capstan, 8 feet long, 5 inches diameter; eight *stakes* for securing capstan,

6 feet long, 5 inches diameter; two *skids*, yellow pine, 18 feet long by 12 by 15 inches; fifteen *blocks*, yellow pine, assorted (four sizes); *stakes* for securing sill, 8 feet long, 5 inches diameter.

To raise a 15-inch gun.

549. The derrick is put together on top of the rampart (or other place to which the gun is to be raised); the sill is about five feet from the edge of the wall; the main-tackle upper block is lashed to the cap near one leg, and the muzzle-tackle upper block near the other leg.

The ends of the guys (*Fig. 3, Plate 51*) are hitched to the ends of the cap; the middle laid across the legs, and a half hitch taken over each end, thus doubling them; a stout thimble is placed in the bight of each, into which the guy tackles are hooked. Secure hold-fasts must be obtained for the guys; to these the guy straps are attached, and in the bight of each a stout thimble is placed, into which the guy tackle is hooked.

One end of the fore guy is attached to the middle of the cap by a round turn and two half hitches, the end being securely stoppered to the guy.

A luff-tackle purchase is applied to the fore guy and its hold-fast, and by means of this the derrick is raised to a vertical position.

The sill is firmly secured, with stakes or by bracing with skids, against some fixed object. The girtline is attached to the cap by a strap, and having been raised with the derrick, a man is sent up by it, who, by the same means, receives the leading blocks, which he secures to the cap by means of straps.

The main-tackle fall is next rove through the blocks, and the lower block lashed to the gun 2 feet 6 inches in rear of the axis of the trunnions. The muzzle-tackle fall is rove, and the lower block lashed 3 feet in front of the axis of the trunnions. These blocks are each lashed to the gun by seven turns with the lower-block lashing, the lashing being frapped on each side of the blocks with its ends.

Two snatch blocks are attached to the sill, one near the foot of each leg, by strong straps. These straps should be laid on the ground under the sill previous to raising the derrick, and if the ground is gravelly they should be protected from chafing by canvas laid under them.

Through these snatch blocks the main and muzzle tackle falls are severally led, each to one of the capstans.

The capstans are manned by sixteen men each. A strain is brought upon the falls, and the guy tackles hauled upon until

the head of the derrick is almost vertically over the edge of the wall.

The capstans are worked and the gun is hoisted, care being observed to work the capstans so as to keep the piece in a horizontal position. One or more shifting-planks are let down by ropes against the side of the wall to prevent the gun from chafing against it and to ease it over the coping.

When the gun reaches the top of the coping, preventer tackles are hooked to straps around the breech and muzzle. When the piece is sufficiently high, the guy luff tackles are hauled upon and the piece landed on cribs or blocks. The preventer tackles are likewise used to assist in bringing in the piece and landing it in a proper position.

If it is desired to place the gun on the cradle, the falls are slacked off and the sill of the derrick moved far enough back to admit the cradle. The gun is again raised and landed in its bed on the cradle.

The derrick should not be allowed to assume an inclination of less than four upon one.

To lower a 15-inch gun.

550. The piece is brought to the edge of the wall on the cradle; the derrick is erected over it; the gun-sling and the tackling attached, all in the manner explained for hoisting; the capstans are worked; the piece lifted and eased to near the edge of the wall by the preventer tackles. The cap of the derrick having been placed directly over the piece, the strain will increase its inclination sufficiently to allow the gun to be eased to the edge of the wall. In this position the piece is allowed to rest on blocks or skids, the cradle is removed, and the sill of the derrick moved up close to the gun.

The gun is then hoisted, eased over the edge, and lowered to the foot of the wall.

The derrick is dismantled in the inverse order in which it was put up.

Note.—One capstan, if powerful enough, is sufficient for lowering or hoisting the gun, in which case the lower block is lashed to the piece at the centre of gravity. The lashing is executed as before explained.

The capstan usually issued to artillery posts is, however, not sufficiently powerful, and it will invariably require two of them.

Care must be taken to keep the guys hauled upon so that the cap and sill remain always parallel to each other; the derrick is thus prevented from twisting.

By omitting the cap and then lashing the heads of the spars

together with shear lashing, the derrick may be used as shears. In this case, only the main tackle can be used.

When spars can be procured of sufficient length to construct shears high enough, it is best to place the shears at the foot of the wall instead of on top. The shears should be not less than 20 feet higher than the wall. This method permits the piece to be raised and eased over to the terre-plein with less inclination, and consequently less strain upon the legs of the shears and on the guys.

Part Fourth.

CARE AND PRESERVATION OF ARTILLERY MATERIAL.

551. All cannon and other artillery material are either manufactured or purchased by the Ordnance Department and turned over to the artillery arm for use.

It is the duty of the artillery to care for and preserve such property, and to return to the Ordnance Department for repairs such as may require it.

Officers in charge of permanent works will keep, as far as possible, the armament complete and in serviceable condition, and will also keep on hand a proper quantity of ammunition and other supplies.

552. A book is furnished to each post for the "*record of artillery*" and "*record of firing.*" In the front of this book are printed instructions fully explaining how it is to be kept. Under appropriate headings, in the part set aside for record of artillery, each gun is described by its number and marks; when received and where from; whether mounted or dismounted; if mounted, in what part of the work, stating its platform number. The result of each inspection, made as hereinafter described, will be entered for each piece in this part of the book.

In the portion of the book devoted to record of firing, each piece has a separate page, which, when filled, is carried on to another. Each shot fired is duly recorded as to date of fire, kind and weight of projectile, kind and quantity of powder, elevation, time of flight, range, &c. When a piece is transferred from one post to another a complete record is sent with it, and the previous number of fires is entered in the book at the last post, so that the firing may not go beyond the limit prescribed as the endurance of the piece; this has been fixed at one thousand service rounds for cast-iron cannon.

553. Marks. All cannon are required to be marked with the weight in pounds, the number of the piece, the initials of the inspector's name, the initials or name of the foundry, and the year of fabrication. All pieces manufactured since 1861 have these marks on the face; those of previous date have them dis-

tributed on the ends of the trunnions, the face, the breech, and the top.

The numbers for each kind and calibre at each foundry are in separate series.

Cannon that have been inspected and condemned are marked on the face X C.

554. Ordnance-sergeant. The ordnance-sergeant of a post has, under the commanding officer, immediate charge of all the artillery material at the post. It is his special duty to see to its care and preservation, and to keep the books and records relating thereto. He takes an account of receipts and expenditures, makes a memorandum of all breakages and damages, and keeps the commanding officer informed as to the condition of the armament of the post and the extent of the supplies.

555. Preservation of artillery. Cast-iron cannon, whether mounted or dismounted, should be lacquered once a year. The lacquer used is coal-tar of the best quality, mixed with sufficient spirits of turpentine to make it work freely with a paint brush. It should be applied only in warm weather.

The muzzle of the piece should always be depressed so that water may not stand in the bore, the tompion kept in, and the vent closed. At least once a month, especially after a rainy period, the bore should be sponged dry and oiled by passing down it a sponge saturated with sperm oil; especial attention in this respect should be given to rifled guns. In cold weather a little kerosene oil is mixed with the sperm. The vent at the same time is examined and oiled, and if the piece is not in use, stopped with putty or a plug of soft wood. When the piece is mounted, the trunnions and trunnion beds are kept from rusting by pouring a small quantity of the same oil into the beds and elevating and depressing it several times.

Once a month the carriage should be traversed so as to change its place of rest on the traverse circle. At the same time the pintle and axle journals are oiled with sperm oil, and pieces with hydraulic or pneumatic buffers run from battery and the pistons cleaned and oiled. If the pistons are found rusted, the rust is removed with fine emery-cloth, and the surface polished smooth with rotten-stone and oil. Such pieces ought always to be kept *in battery* and the air holes in the cylinder heads carefully closed with the plugs.

The axles of the truck-wheels are cleaned and cared for in the same manner as the pistons. Elevating screws, when not in use, are kept in the store-house, and are cleaned and oiled in the same way. Guns, especially rifled pieces, in batteries exposed to blowing sand, should, in addition to the tompion, be provided with

canvas hoods placed over the muzzle. When firing, this is a useful precaution.

Cannon not mounted should be placed together, according to kind and calibre, on skids of stone, iron, or wood laid on hard ground, well rammed and covered with a layer of cinders or gravel to prevent vegetation. The pieces should rest on the skids in such a manner as to be rolled over when necessary for lacquering, the muzzle depressed and in such position as to be readily got at with the sponge. The place selected should be free from shade of either buildings or trees.

Siege mortars may be placed on their muzzles, resting on thick planks or pavement.

556. Carriages. Iron carriages should be painted once a year, and this in dry, warm weather. The best paint for preservation of iron is red-lead, but this being comparatively expensive, the kind generally used is *oriental red paint*. It is supplied ready mixed, and is applied in the usual manner of painting. If it should require thinning down, this is effected by adding turpentine and linseed oil, the latter either boiled or raw.

Before painting, all blisters, rust, or accumulation of old paint should be removed with a scraper. The top of the chassis rails should neither be painted nor oiled, but kept clean by dry scraping. All iron handspikes, elevating-bars, and similar implements are painted black, using for this purpose common black paint. Heads of bolts and edges of rails may likewise be painted black.

The damp location of most artillery posts is particularly favorable to the rapid decay of material. Rust gradually eats away iron parts of carriages and machines. These defects are frequently hidden by repeated coats of paint or lacquer, making them extremely liable to lead to accident or disaster. Such parts should be carefully examined by means of punches and hammers, and no such material be suffered to remain where it is dangerous.

The wooden parts of gun carriages and machines frequently become dry-rotted, while the exterior, covered with paint, continues a shell apparently quite sound. Sounding such parts with a hammer, and searching into cracks and flaws, will indicate the defects.

Wooden implements become brittle from age, by having the "life seasoned out." This is readily detected, by those familiar with wood, by the appearance of the fracture, the weight, the elasticity, and by the resonance of the article.

557. Siege-pieces are scraped off and painted once a year with black paint or Japan varnish, they being dismantled for this

purpose. The carriages are scraped to remove all blisters and lumps of old paint, and then painted with olive paint. The iron parts are painted black.

If possible, siege-gun carriages should be kept under cover in well-ventilated sheds.

The following is the method pursued in the Navy for blacking and polishing guns. Whenever the number of men in charge of pieces admits of it, the same care should be observed in the land service.

The piece is first scraped clean and then scrubbed well with fresh water and sand; when dry it is washed with spirits of turpentine, and a coat of well-ground red-lead, mixed with boiled linseed oil, is applied; this is well and smoothly rubbed in, allowed a couple of days to harden, and then rubbed down with sand-paper, after which another *thin* coat of red-lead and oil is applied; this is allowed to dry, and is then rubbed until smooth. A coat of well-mixed and strained black paint is now applied, as smoothly as possible, and allowed to dry, after which a polish of the following preparation is used, viz.: 4 lbs. of good bees-wax and 1 lb. of spermaceti are melted together in a clean vessel free from grit; while hot this is strained through a cotton or woollen cloth. To this mixture is added 1 oz. of dry ground Prussian blue, 0.75 lb. of ivory-black, or the same quantity of lamp-black, and 1 gallon of spirits of turpentine. All these ingredients are mixed well together while warm, and thoroughly rubbed in with the hand; the rubbing is finished by working the hand around the piece—not lengthwise. The first coat is allowed to stand a day and then rubbed lightly with a cotton cloth, after which a second coat is applied and rubbed with the cloth until a brilliant polish results.

In case the mixture is not put on smoothly, it may be necessary to cork the surface; this is done by rubbing with a flat piece of cork about half the size of the hand. Scratches are generally corked out, care being taken to avoid all dust or grit.

To brown a gun. Scrape clean; scrub with fresh water, sand, and canvas; allow to dry; wipe off; apply a strong solution of salt and vinegar three or four times a day for two days, or until a good coat of rust is formed; allow to dry, then rub lightly with old canvas; apply a thin coat of the following mixture, rubbing it in well: 4 lbs. bees-wax, melted and strained; 0.50 oz. pure vitriol (white), or 1 oz. of pulverized alum; 1 gallon spirits of turpentine; allow to dry until next day; then put on another thin coat, and when dry rub with a clean cotton cloth.

In case of a dull appearance, by reason of having been handled,

rub over with a cotton cloth and spirits of turpentine, and then with a dry cloth.

558. Injuries. The injuries to which heavy cannon are liable are confined almost entirely to the interior. Rusting produces roughness and an enlargement of the bore, and increases any cavities or honey-combs that exist in the metal.

In smooth-bore guns, the principal injuries arise from the wearing away of the metal on the upper and lower surfaces of the bore at the seat of the projectile and the enlargement of the interior orifice of the vent. This enlargement of the bore can be measured with accuracy only by means of the star gauge; but as this instrument is seldom to be had at artillery posts, reliance must be placed upon such inspection as can be made with a mirror or small lamp. When the enlargement is sufficiently great to be manifest by such inspection, the piece should not be further used until it can be gauged and the full extent of the injury determined.

The enlargement of the vent is determined by means of an impression of it taken with wax or soft gutta-percha, applied by pressing it up against the bore at the vent as hereinafter described. The appearance of a vent (*Fig. 4*) enlarged by much firing is irregular and angular, with its greatest diameter in the direction of the axis of the bore. When the fissures of this enlargement exceed an inch in any direction, the piece is no longer serviceable, and further use of it should be discontinued until a new vent can be bored and the old one stopped with melted zinc. One vent in a cast-iron piece will stand five hundred service rounds. Other enlargements, or cracks in the vent, may be discovered by means of a searcher made of a piece of bent wire. The service to which a cast-iron piece has been subjected can generally be approximately determined by the appearance of the vent.

All cracks and flaws, in any part of the piece, should cause it to be laid aside until it can be inspected with the proper instruments.

Rifle cannon. These become injured by the wearing away of the lands, especially upon the driving side.

Any serious damage to the lands can be ascertained by examining the bore with a mirror. It will also manifest itself in firing by inaccuracy and frequent tumbling of the projectiles.

Slight cracks in the surface of the bore, particularly about the seat of the charge, indicate the approaching fracture of a piece, and should be sufficient warning to cause a discontinuance of its use.

The bursting of shells in the bore, particularly in rifled pieces,

frequently causes dents and abrasions. Such burstings or premature explosions are, however, less frequent now than formerly, owing probably to the fact that milder and slower powders are now used behind the projectile; still, such accidents occasionally take place, and the causes which lead to their occurrence are often obscure and require close investigation to discover.

Most prominent among those usually assigned are the following: 'Too great quickness of burning in the powder charge of the gun; defects in the working or placing of the fuses; imperfections in the metal of the shells themselves, due to faulty casting; thinness of the walls or of the butt; concussion and friction of the powder within the shell itself when the piece is fired; insufficient quantity of powder in the shell.

Most of these causes take effect at the instant of ignition of the powder charge of the gun, and it is probable that most shells that fail receive their injuries before they are unseated, or their inertia fully overcome.

It has been found that roughness on the interior of shells or the presence of grit contributes to the frequency of premature explosions, by shock and attrition with the grains of the bursting charge; hence it is important to remove, by scraping, all such gritty substances. It is recommended to coat the interior of shells with some elastic composition. A very good kind is composed of: Soap, (common yellow,) 16 ounces; tallow, 7 ounces; rosin, 7 ounces. The tallow should be melted first; then melt and add the rosin, and lastly the soap, bringing the mass to a heat that will make it *very* fluid.

The shells having been first thoroughly cleaned, fill them about one-third full of the composition, roll them slowly so as to spread the mixture over the whole interior surface, and then pour off the residue. This coating should be about one-tenth (0.1) of an inch in thickness, except at the bottom of the shell, where it should be about three-quarters of an inch thick. To obtain these thicknesses, the operation of coating should be performed twice; then pour into the shell enough of the composition to produce the desired thickness at the bottom, the shell standing on its base. After the composition is perfectly cool, immerse the shell in hot water at as high a temperature as the composition will stand without "running"—about 170 degrees. This second heating of the composition in the bath toughens it, and causes it to adhere more closely to the shell.

Another method of meeting this difficulty, as also that arising from friction and packing from the *set-back* of the grains of the bursting charge, is to place the charge in a bag. The material for the bags is the same as for cartridges; they are made in the

same way, and of a size suitable for the charge. In charging a shell in this manner, the bag is pushed into the cavity with a slender stick, leaving the mouth of the bag projecting out of the fuse hole; this is securely held while the powder is introduced through a funnel, and worked and settled into the bag with the stick. When the bag is nearly full the funnel is withdrawn, the neck of the bag tied, and pushed down to one side of the fuse-hole.

On the occurrence of a premature explosion, or the rupture of a shell in a gun, the bore must be carefully examined with the mirror, and by taking impressions, especially about the place of explosion. A close examination should be made for cracks. These may not at first be discoverable, but will develop with subsequent firings. It is important, therefore, that frequent examinations be made of guns in which shells have exploded.

Inspection of cannon.

559. Every artilleryman should know how to examine the weapon with which he works, and should understand what defects in guns are serious and what may be disregarded. It is of great importance that the examination of both guns and fittings should be very searching and exact; otherwise, a small flaw left unnoticed may endanger the life of the piece in future.

Guns, upon being accepted into service, are inspected as prescribed in the regulations for the Ordnance Department.

The following rules are given for subsequent inspections in service.

Every gun must be examined after firing the following number of rounds with projectiles:

Smooth-bore cast-iron guns.—Firing 50-lb charges and upwards, 50; 10-lb up to 50-lb charges, 100; under 10-lb charge, 200.

Rifles.—10-inch and upward, 50; 8-inch, 100; under 8-inch, 150.

In the record-book of firing, (see *par.* 552,) on the pages where the shots are recorded should be entered the inspections, their dates, by whom made, and a full description of any defects that may be found, and particularly whether those discovered at previous examinations are increasing, and if so, to what extent.

Instruments for inspecting cannon.

560. 1. *Star-gauge.* Used for measuring the diameter of the bore at any point.

2. *Cylinder-staff.* Used to measure the length of the bore. It is supported in the centre of the muzzle by a T-rest, and the

extremity inserted in the gun is furnished with a measuring point and guide plate.

3. *Cylinder-gauge.* This is a hollow cylinder of cast-iron, turned to the least allowed diameter of the bore, and one calibre in length. When used, it is attached to the cylinder-staff.

4. *Searcher,* consisting of four flat springs turned up into points at their ends, and attached to a socket which is screwed on the end of the cylinder-staff. It is used to feel for cavities in the surface of the bore.

5. *Trunnion-gauge.* Used to verify the diameter of the trunnions and rimbases.

6. *Trunnion-square.* Used for verifying the position of the trunnions with reference to the bore.

7. *Trunnion-rule,* for measuring the distance of the trunnions from the base of the breech.

8. *Calipers,* for measuring exterior diameters.

9. *Standard rule,* for verifying other instruments.

10. *Vent-gauges* of steel wire, with shoulders to prevent them from slipping into the vent. There are three, differing in size by 0.005 of an inch; one is the exact size of the vent, and one larger and one smaller than the exact size. To ascertain the wear of a vent there should be several others, increasing in size by the above dimensions.

11. *Vent-searcher* is a steel wire of the length of the vent, bent to a right angle at the lower end and pointed. It is used to detect cavities in the sides of the vent.

12. *Wooden rule,* to measure exterior lengths.

13. *Mirror,* for reflecting the sun's rays into the bore.

14. *Spirit lamp,* attached to a staff, used in examining the bore when the mirror cannot be used.

15. Machine for taking impressions of the bore.

561. To ascertain injuries to cannon in service, only those of the foregoing list numbered 1, 2, 4, 10, 11, 13, 14, and 15 are required.

The star-gauge (*Fig. 1, Plate 54*) is composed of the staff, the handle, and a set of four steel points for each calibre.

The staff is a brass tube, made in three pieces, for convenience of stowage, and connected together, when required, by screws. The end that goes into the gun expands into a head (*a*), in which are placed four steel sockets, at equal distance from each other, which receive the points. Two of the sockets opposite each other are secured permanently; the other two are movable. A tapering plate or wedge (*b*), the sides of which are cylindrical, runs through a slot in the head; an aperture in the inner ends of the movable sockets embraces the cylinder, so that when the

wedge is moved forward the sockets are forced outwards, and when moved backwards the sockets are withdrawn. The sides of the wedge incline 0.35 inch in a length of 22 inches, so that by pushing the slide in the thirty-fifth part of this distance, the distance between the two sockets is increased 0.01 inch.

A square sliding rod (*c*) is connected with the wedge, and runs through the whole length of the tube, projecting a few inches beyond the outer end. This rod is in three parts, like the staff, and, like them, connects by screws. The sections of the rod are prevented from falling out of their proper section of the staff by pins. When screwing the joints of the staff together, if the ends of the rod are pressed up to each other they become connected by the same motion.

The staff is graduated into inches and quarters, so that the distance of the point from the muzzle of the piece may always be known.

The handle (*Fig. 2, Plate 54*) is made to fit over the outer end of the staff, and to connect with the sliding rod by a screw having a milled head at the outer extremity of the handle. It may be used on either joint, as most convenient for the length of the bore. The socket of the handle slips over the end of the staff made smaller for the purpose, and has a slot in it, allowing the staff to be seen through it. A scale on one side of the slot is graduated to show the distance that the rod moves to throw the points 0.01 apart.

That part of the handle containing the slot and scale is separated from the other part, but is made to fit closely over it. On one side there is a mill-headed screw for clamping the parts together. Seen through the slot is a small plate of silver inserted in the staff, and a fine mark upon it to show the place of the zero when the points are adjusted. The zero mark on the scale is made to correspond with it by means of the screw just mentioned.

A set of *adjusting rings* belongs to the instrument—one for each calibre—reamed out to the exact minimum diameter of the bore. To adjust the gauge for any calibre, the handle is loosened by means of the clamp screw, the proper measuring points are screwed in, the adjusting ring placed over them, and the slider pushed out until all the points touch the inner circumference. The zero of the scale is then made to coincide with the mark on the tube, and the handle clamped; the instrument is then ready for use.

The arms of the T-rest (*Fig. 3, Plate 54*) are adjusted for the particular calibre. It is placed in the muzzle to keep the instrument in the axis of the piece. A centre line, starting from the

centre of one of the permanent sockets, is marked on the staff throughout its length. In joining the sections together care must be taken to secure coincidence of this centre line. When the gauge is in the bore the centre line should be uppermost; the movable points are then horizontal, and measure the diameter of the bore only in a horizontal plane. To make a thorough measurement in every direction, the piece should be on skids, and then by rolling it over different elements of the bore will be brought uppermost, and can be measured in succession. When the piece cannot be rolled over, and it is desirable to obtain measurements all round at any part of the bore, the gauge may be inserted with the movable points in the direction in which it is required to make the measurement. The centre line of the staff will indicate the direction of the measuring points.

To ascertain thoroughly the condition of the bore, measurements should be made at intervals of 0.25 inch in the part occupied by the charge and shot; at intervals of one inch in the rest of the bore in rear of the trunnions, and at about one calibre intervals from the trunnions to the muzzle.

In the original inspection of the piece, no variation greater than 0.03 inch beyond the true dimensions was allowed; therefore anything exceeding this is an enlargement caused by service. The scale upon the handle of the instrument is marked to correspond to hundredths of an inch of movement of the measuring points. The divisions are numbered both ways from the zero. Those towards the handle indicate excess of diameter; those in the other direction indicate deficiency. Rifled pieces are measured across from the lands—not from the grooves. In doing this, a special instrument is required for guiding the measuring points so that they will follow the lands as they proceed along the bore. The hexagonal hole (*Fig. 4*) in the centre is fitted on to that portion of the end of one of the measuring points which is similarly shaped. Two small arms on either side of the guide-piece face each other, and can be moved toward or from each other by means of sliding plates to which they are attached. For this adjustment, finely-divided scales are marked on the sliding plates. When in the bore the two small arms rest in two contiguous grooves, and embrace between them the land which the measuring point is forced to follow.

To prevent obstructing the motion of the measuring point when it is shoved out by the slider, the arms rest upon light springs, which are simply compressed during the measurement.

The hexagonal socket is made to turn within the rest of the guide-piece to allow the necessary freedom to the arms.

Before and after each set of measurements, the rings must be applied to the points and the instrument adjusted.

Instruments for taking impressions.

562. The machine (*Fig. 1, Plate 55*) for taking the interior impression of the vent consists of a wooden head (*a*), one-half the length of which is cylindrical and the other half rounded off to the shape of the bottom of the bore. The diameter of the head is rather smaller than the bore. A staff (*b*), flat on the upper side and rounded on its under side to fit the curve of the bore, is mortised into the cylindrical part of the head so that the rounded side will be coincident with the circumference. A mortise (*c*) is cut through the head, extending several inches in rear and front of the position of the vent. Into this mortise a loose block is fitted, capable of free upward and downward motion. The top of the block is pierced with holes to secure the composition spread over its surface. This movable piece rests on a wedge (*d*) attached to a flat rod running through a slot in the head. To prevent this rod and the wedge from coming entirely out of the head, a slot, about four inches long, is cut in it, through which passes a pin (*e*) attached to the staff.

To use the instrument, withdraw the rod as far as the slot will permit; this allows the block to drop below the surface of the head, and protects the composition which has been spread on it; push the head to the bottom of the chamber, and arrange the position of the staff so that the movable piece will cover the vent; then press the end of the rod home. This motion will throw out the block with the composition, and a distinct impression of the vent and of fire-cracks (should there be any) will be left upon its surface; draw the rod back as far as the slot will allow, and withdraw the instrument; the impression, being protected thereby, will come out uninjured.

Gutta-percha impressions of a portion of the bore of a gun can be taken by means of wooden blocks or wedges. For this purpose use two blocks (*a b, Fig. 2, Plate 55*), one about two-thirds the length of the other, the longer block to carry the gutta-percha for the impression, the shorter one to be driven as the wedge, each block with a staff or handle longer than the bore of the gun, so as to enable the operator at the muzzle to place the blocks in any desired position in the bore; also for driving the wedge and withdrawing the blocks. These blocks are so shaped that when in one position they form an imperfect cylinder, whose diameter is less than that of the bore, thus enabling the longer block to carry the gutta-percha to the required place in the bore; then, by driving the wedge, the diameter of this cylinder is increased nearly to that of the bore, the gutta-percha is caught between the surface of the bore and its carry-

ing block, and is thus forced by the driven wedge to take note of whatever it finds there.

To take an impression, the gun should be thoroughly washed out and then oiled with an oiled sponge; the gutta-percha is softened by means of hot water, just under the boiling point, to the required consistency, about that of putty; is then placed on the block, which is well oiled (sperm oil is the best), and worked and kneaded with oil until it is spread over the required portion of the block; the blocks are well oiled, particularly the surfaces which come in contact; the two blocks are put together at the muzzle so as to enable the carrying block to carry the gutta-percha to the desired place; when both blocks together are pushed into the bore, the distance may be marked on the handle of the carrying block; the carrying block is then held steady by its handle, while the wedge block is driven in by several blows of a sledge on the end of its handle; from two to five minutes is sufficient time to allow it to set. The wedge-block is withdrawn first, and the carrying block with the impression afterwards. To withdraw the wedge block, run an iron pin through the handle near the end, and strike against that with a sledge until it starts, when it is easily withdrawn; the carrying block will generally fall or release itself by its own weight, bringing the impression with it. If the impression is taken anywhere in the upper half of the bore, and for this reason, and also that it is easier to work the blocks, it is always better to turn the gun over, so as to take the impression above the block. When this cannot be done, and an impression is wanted from the bottom of the bore, a small block or rider is pushed in at the same time as the carrying block, so as to keep the gutta-percha from touching the surface of the bore while being pushed into place. Afterwards the rider block is withdrawn, the wedge driven, and after the wedge is withdrawn the rider block is pushed back close to the carrying block, and acts as a fulcrum by which the impression is raised free from the bore, when both are withdrawn together. In taking an impression on the side, it is better to push in the blocks as if the impression was above, and then to turn the blocks to the place. Unless the block under the gutta-percha is well oiled, some difficulty may be experienced in releasing the impression from the block. The carrying block should have a slight raised edge on each side of the upper surface to prevent the gutta-percha from spreading out too much when undergoing the pressure from the wedge, and also to protect it when turning the blocks for side impressions.

In cases where there is any doubt as to the state of the bore

of rifled guns, impressions should be taken of the whole length with gutta-percha, and for doing this the blocks just described should be long enough to reach from the bottom of the bore to a foot or more beyond the muzzle. They are, in fact, scantling rounded off and made wedge-shape.

A convenient size to obtain the gutta-percha, is in slabs twenty inches long, five wide, and five-eighths thick. Each slab will make ordinarily two or three impressions. It can be used over and over again, and need never be thrown away if a little fresh material be added occasionally to prevent it from becoming brittle. It must be kept free from dust or grit, and should be preserved in water when not in use.

As a proper set of instruments is rarely or never to be obtained at artillery posts, a substitute for taking impressions with the wax composition may be made by using a block of wood about a foot in length, one side of which is rounded off so as to have the curvature of the bore; to the block is attached a strong staff or handle. To use it, a biscuit-shaped ball of the composition is placed on the rounded surface of the block, which is then inserted to the flaw and pressed against the bore, using chocks inside the gun as a fulcrum and the handle as a lever.

Impressions of the vent may also be taken with lead. The implements required for this are a piece of soft fine wire, about twice the length of the piece; a stout lever, about the same length, and shod to suit the curve of the bore; and a small button of *soft* lead, judged to be of sufficient size to fill the vent at least one inch from the bore. This is pierced lengthwise to receive the wire.

To take the impression. Shove the wire through the vent; let it pass along the bore and out at the muzzle; put it through the leaden button and tie a knot at the end; draw the wire back through the vent until the button is introduced firmly into the inner orifice; apply the lever, making its shoe bear on the button, and force it well in by repeated blows, the muzzle being the fulcrum, or, better, a block of wood placed in the bore as far as the arm will reach. The button is disengaged by pushing in the vent-punch.

In taking impressions of the vent and cracks, each button in turn is used as a pattern for moulding its successor.

All impressions, however they may be taken, should be most critically examined with a magnifying glass; otherwise the most important indications will escape observation.

Water-proof. Cannon, when inspected upon being received into service, are subjected to an hydraulic proof of about 30 pounds to the square inch. This requires a special apparatus

not usually found at posts. Nevertheless, useful application of the principle may be made by giving the piece as much elevation as possible, stopping the vent, and filling it with water. Allow it to stand thus for a few hours, draw off the water, wipe the bore perfectly dry, and examine with a mirror or lamp. Water seen oozing from any part of the bore indicates a crack or a cluster of cavities, a sure sign of serious defects.

563. *Mode of examination.* The bore should be thoroughly cleaned to detect small defects. If care has previously been taken in keeping a gun tolerably clean, it will probably be sufficiently prepared for examination by washing and drying with tow, cotton-waste, or a clean sponge. Should there be hard rust which will not yield, or a thick coating of grease, the bore may be cleaned by firing (if circumstances permit of it) one or two scaling charges of about one-third the full service charge, without projectiles; this will usually loosen the scale. The same may be effected by using hot water and potash, in the following manner: About a gallon of boiling water is poured on one pound of ordinary black potash, and an old sponge, covered with a cloth to make it fit tightly to the bore, is dipped into the solution, and the bore rubbed with it till the dirt is loosened, when a hard brush will remove it; it is then wiped dry and slightly oiled. The potash water must be used very hot and the sponge made to fit tightly, or the process is ineffectual. The hard brush is made of wire, and is similar to those used for fowling-pieces. Brushes of bristles—Turk's-heads—are also used. No sharp-edged or pointed scrapers should be employed for cleaning the bores of rifled guns, as they would be liable to injure the rifling.

The bore, being thus cleaned, should be examined by the aid of a lamp, or if there be bright sunlight, with a mirror. If the bore be slightly wet, the detection of defects is greatly facilitated. A sharp-pointed pricker is used to ascertain the extent and position of any flaw, the staff being graduated in inches so that the distance from the muzzle may be readily ascertained. A spring searcher is also used to detect defects, and, with rifles, in such manner that each groove shall be traversed in succession by one of the points.

Should a flaw be found, an impression is taken of it. This is done in the manner just described, with gutta-percha, or by using a mixture composed of *bees-wax*, two parts; *treacle*, one part; *soft soap*, one part. The wax should be melted over a slow fire in an iron pot; the treacle is then added and mixed well by stirring; and lastly the soft soap, a little at a time. The mixture must be kept in motion, and when thoroughly stirred poured out, cooled, and made into balls. This compo-

sition being soft, is always ready for use, but the impression is easily destroyed by handling.

The gun should be so placed that the impression will be taken upwards.

In recording the position of any defect, its distance from the muzzle is given in inches, and noted as "up," "right of up," "right of down," &c., the vent always being considered up, and the right or left the sides as they would appear to an observer looking into the muzzle. (*Fig. 3, Plate 55.*) Impressions of the vent and of the bottom of the bore can be taken properly only by the use of the appropriate instrument; nevertheless, by the exercise of a little skill and ingenuity, tolerably fair results may be obtained with the improvised instruments just described. Considerable practice is required to get good smooth impressions, and, with the vent, several have sometimes to be taken before one is obtained which can be relied on to show hair-lines. When it is desirable to preserve an impression for future reference or comparison, a label is gummed to its back, giving the number of the gun, date of taking it, and the position of the flaw.

Should any defects be discovered in the bore (not including the immediate vicinity of the vent) they need not be considered serious, unless, in the case of smooth-bore guns, they are 0.1 inch deep in rear of or 0.2 inch deep in front of the trunnions, or unless they have jagged edges likely to retain pieces of ignited cartridge; and in the case of rifled guns, unless, in addition, they are new defects not shown in the memorandum of former inspections, or old ones which have materially increased. Generally speaking, the depth of a defect is of more importance than its extent. With the converted gun, should a defective weld run a considerable distance around the tube of the bore, it would be liable to part at that point, and the piece should be considered unserviceable. The best method of testing a gun is to take an impression of the defect; then to fire a few rounds with service charges and take another impression. If, on comparing these impressions, the defect does not appear to have increased, the piece may be considered serviceable. As a precaution against accident, in case of the splitting of the inner tube of converted rifle guns, a *gas escape* or *indicator* is provided. This is a small hole similar to the vent bored through the cast-iron case on the side opposite the vent, and connecting with a shallow spiral groove cut around the outer tube near the seat of the charge. Should the tube split, smoke will be seen issuing from the hole, and firing should be discontinued.

Examination of the vent. Especial care should be given to

this, for the reason that the amount of firing to which a piece has been subjected is pretty well indicated by the wearing away of the vent.

The standard gauge (0.2 inch) will be used to ascertain the general enlargement, and the searcher to detect defects that may have been developed in firing. The vent channel is first thoroughly cleaned and then tested with a set of cylindrical gauges differing from each other by 0.01 of an inch.

The greater the calibre and the heavier the charges, the more rapidly is the wear manifested on the interior and exterior of the vent. The following, however, is the average wearing of the vent for the heavier classes of cast-iron guns.

| | | | | | |
|-----------------------|------|------|------|------|------|
| Number of rounds..... | 100 | 200 | 300 | 400 | 500 |
| Diameter of vent..... | 0.24 | 0.26 | 0.30 | 0.35 | 0.40 |

These, combined with examination of the interior orifice, will enable a very correct judgment to be formed of the probable number of fires sustained and the duration of the gun.

The enlargement does not extend very far from the lower orifice until the enlargement on the exterior has reached a diameter of 0.3 of an inch.

So long as the wear is regular and the fissures, although numerous, do not exceed 0.5 of an inch, the indications are good. If the cracks are few or diminish in number, running into each other and extending rapidly, it is a very unfavorable sign.

Should it be found that the vent has enlarged so as to admit the 0.4-inch gauge, the vent is either bushed or is filled with zinc and a new one bored, as the character of the gun may require. A clean impression should be taken of the bottom of the vent. Unless the proper instrument is provided for doing this, it will be found to be a difficult operation, and should be repeated several times. If the vent be unbushed, the effect of service is seen by a gradual increase of the channel and by an irregular wearing away of the bottom (*Fig. 4, Plate 55*) and the formation of fissures and hair-lines radiating from the edges of the orifice. The extent of these defects is measured on the impression, and if found to be less than half an inch in extent from the original centre, the piece will be reported for bushing or to have a new vent bored; if greater than this, the piece should be reported as unserviceable.

The defects usually found around the vents of bushed guns are the giving way of the iron around the bush from the gas getting in between the two metals (*Fig. 5*), and the fissures or hair-lines which radiate in the iron from the edge of the bush. (*Fig. 6*.) The metal around the bush gives way almost immediately after a gun is bushed, forming a hollow ring around it.

which gradually increases. So long as this wear is uniform and the edges are not jagged, it is of little importance, and guns need not be rebushed or condemned for this cause until the ring has become 0.1 of an inch deep or 0.1 of an inch wide. If, however, the edges are jagged, or if one side has given way much more than the other, so as to be likely to hold pieces of unconsumed cartridge, the examiner must use his discretion as to condemning the gun, it being impossible to lay down fixed rules suitable for all cases. Fissures or hair-lines radiating in the iron from the edge of the bush, should be carefully traced on the gutta-percha impression, and if they extend more than one-twentieth of the circumference of the bore in any direction, measured from the original centre, the pieces should be condemned.

564. *Disabling cannon.* This is either permanent or temporary. The first is accomplished by bursting, or if the piece is rifled, by scoring the surface of the bore so as to destroy the efficiency of the rifling.

To burst a piece, load it with a double charge; musket or other violent powder is the best; put in a projectile and ram down around it iron wedges, the more tapering the better; throw sand in to make the wedges take hold, and fire the piece. If wedges are not at hand, large spikes or similar pieces of iron will answer the purpose; or load the piece as before, fill it full with its own projectiles, and fire at a high elevation.

To fire the piece, when electrical primers are not to be had, prime with fine-grained powder, and place over the vent a piece of port-fire long enough to permit the man firing it to reach a place of safety before the charge explodes. The port-fire is held in position by being set in clay or putty, or it may be tied to the piece with twine.

If port-fire is not at hand, a slow match can, in a few minutes, be made of any ordinary paper by saturating it with a solution of saltpetre (gunpowder dissolved in water will answer); after drying, cut it into strips, and slightly twist them; place one end of a twist in contact with the priming of the vent, and apply fire to the other.

To disable a piece by scoring the bore, load it with a charge of powder and a shell filled with powder. The shell is without a fuse, and the fuse hole is closed sufficient only to keep the powder from spilling out; the shell is inserted with the fuse-end foremost and the piece fired. The bursting of the shell in the bore and the scoring effect of the fragments will most likely tear away the lands and render the piece unserviceable.

Cannon are temporarily disabled to prevent them from being immediately used by the enemy, and also when they are ex-

pected to be retaken. This operation is accomplished by means of a spike.

A spike is made of hardened steel, with a soft point that may be clinched on the inside of the piece. A nail without a head, or the point of a file, may be used instead of a regular spike.

To spike a piece. Drive in the spike flush with the outer surface of the vent, and clinch it on the inside with the rammer. To prevent the spike from being blown out, wedge a shot in the bottom of the bore by wrapping it with cloth, or by means of wedges driven in with a bar.

To unspike. If the bore is unobstructed and the spike be not screwed or clinched in, put a heavy charge of powder in the piece and ram junk-wads tightly over it, laying on the bottom of the bore a strip of wood, with a groove on the under side, for a strand of quick match, by which fire is communicated to the charge. When the bore is obstructed, endeavor to drive the spike into the bore with a punch. If this succeeds, introduce fine-grain powder into the vent to blow the obstacle out. If, after several trials, neither of these methods succeeds, drill out the spike or drill a new vent.

A gun upon an iron carriage is readily dismantled and the carriage disabled by removing the counter-hurters, running the piece from battery, throwing the axles in gear, and then firing it. The recoil will carry the top-carriage off the chassis, and the fall will smash it to pieces. If the pintle key be removed, the chassis will also be thrown off and injured. When it is not desirable to fire the piece, the top-carriage may be hauled off by means of a tackle.

PRESERVATION OF PROJECTILES.

565. Projectiles for rifle guns should be neither lacquered nor painted, for the reason that either of these substances would adhere to and foul the grooves of the piece. When practicable, they should be kept under cover, in a dry place, and if unboxed, should be oiled once a year with sperm oil. They are piled, according to kind and calibre, on their sides, in tiers of convenient height. The fuse holes should be stopped with tow or cotton-waste. Great care should be taken when handling them to avoid injuring the sabot. No shells of any description should be kept habitually charged. This is done, as occasion requires, when firing.

Rifle projectiles for all calibres above 4.5-inch are packed separately in boxes. The boxes have rope handles, and are marked with the kind of projectile. Projectiles thus packed should be

stored in a dry place, and not removed from their boxes until required for use.

Projectiles for siege guns are packed in boxes, painted different colors to indicate their contents. Those for solid shot are painted *olive*; for shell, *black*; for case-shot, *red*; for canister, *light drab*. The kind of ammunition is furthermore marked, on each end of the box, in large white letters, and the place and date of fabrication on the inside of the cover. Each box for siege-gun ammunition contains four projectiles and weighs about 145 pounds. The box is 20 inches long by 11.5 inches wide and 13.5 inches deep, outside measurement; it has two partitions across it, the space between the partitions holding the cartridges; the two outside spaces, two projectiles each. The boards of which the partitions are formed are thick enough to allow of a recess being cut in each, in which are carried the requisite number of fuses and friction-primers. The boxes have rope beackets on their ends for convenience of handling.

Ammunition for the 3.5-inch guns is put up in a similar manner, each box containing ten rounds and weighing about 135 pounds.

When projectiles of any kind are received at a post, they should be carefully examined and gauged, to see that they are of the proper calibre and quality required for the particular piece.

Spherical projectiles are lacquered. This is done as soon as possible after they are received. The lacquer used is coal-tar, applied with a brush, as for guns. All rust should be carefully removed, by scraping and wiping, before the lacquer is applied.

The projectiles are assorted as to kind and calibre and piled in a dry locality where there is a free circulation of air. The ground is prepared for the base of the pile by raising it above the surrounding level so as to drain off the water; it is made level, rammed well, and covered with a layer of sand. The bottom tier of the pile is made of unserviceable balls, buried about two-thirds of their diameter in the sand; this base may be made permanent. The pile is then formed, putting the fuse holes of shells downward in the intervals, and not resting on the shells below. The bed may also be made of brick, concrete, or stone pavement, with borders and braces of iron; or the bed and border may be made of heavy plank and scantling. These, however, in consequence of decay, will require renewing every six or seven years. When for this or any other purpose the pile is taken down, the projectiles should be freshly lacquered. It is generally sufficient that the projectiles be lacquered, without disturbing the pile, by applying it to those on

the outside. This is done once a year in warm, dry weather. When the lacquer accumulates so that the projectiles will not pass through the large gauge or into the piece, it must be removed. This is done by rolling and scraping; or for those of 10-inch and upwards it may be burned off, provided the burning be quick, so as not to heat the projectile to any great extent.

Piles of projectiles should not exceed eight feet in width. Square piles are to be preferred where there is room; where this is wanting, the piles may be extended in length. The piles should be examined every spring to see that the projectiles are not rusting; this can be sufficiently done by removing a few from each pile and looking through the crevices.

To find the number of balls in a pile. Multiply the sum of the number of balls in the three parallel edges by one-third of the number in a triangular face. In a square pile, one of the parallel edges contains but one ball; in a triangular pile, two of the edges have but one ball each.

STORE-HOUSES.

566. Every post furnished with heavy artillery has one or more store-houses for the preservation and safe-keeping of equipments, implements, and such machines as should not be exposed to the weather. They should be light, dry, well ventilated, and furnished with shelves, racks, and tables for the accommodation of the stores kept therein. The articles are sorted according to their natures and arranged in appropriate places. These places are distinctly labeled, and, furthermore, each article, as far as possible, should be marked, so that under no circumstance there may be mistakes or confusion.

Cartridge-bags are preserved from moths by packing them with an hydraulic press; by enveloping them in paper bags hermetically sealed, the paper being similar to that used for preserving army clothing; or by heading them up in tight casks. A mild infusion of colocynth will preserve them from moths. The bags are steeped in it, afterwards dried, and then packed away.

Sponges are preserved from moths and packed away in the same manner as cartridge-bags. They should not be kept on the heads of sponges in store, as they are then always damaged by rats and moths. Sponge-covers must never be put on the sponge-head unless both are clean and dry; after use the sponge should be washed clean and dried, and then the cover put on.

Sponges, rammers, worms, and ladles are generally placed on racks, with supports, not over three feet apart, to prevent the staves from warping.

Articles composed of brass are spread out on shelves, and are kept clean and free from verdigris. It is forbidden by regulations to use oil or grease upon them; alcohol or vinegar, with rotten-stone and afterwards whiting, are the most suitable polishing materials for them; all scouring is to be avoided. A good lacquer for brass articles is composed of: Alcohol, 95 per cent., 2 ounces; seed-lac, 1 ounce. Put the mixture in a glass vessel for five or six days, exposed to the light; shake well once each day; apply with a brush while the article is as hot as it can be made without injury.

Steel or iron implements should be painted black or kept bright, according to the use for which they are intended. For polishing, use crocus-cloth, oil, and rotten-stone; after which, oil with sperm oil.

For the preservation of the bright parts of machinery, elevating screws, &c., when not in use, the following preparation is used, viz.: One pound white-lead and 0.25 pound tallow or lard oil, heated and mixed together. This is applied warm with a brush or cloth. It is removed by rubbing off with a cloth, using a little turpentine.

Leather equipments are hung on pegs in a cool, airy place. Those of russet leather should be taken down three or four times a year and brushed off to prevent accumulation of mould. Those of black leather should, once or twice a year, be washed with castile soap and water, well rubbed, and before thoroughly dry oiled with a mixture of neat's-foot oil and tallow; lamp-black may be added to the oil for blacking.

Fuses, friction-primers, and water-caps are kept, as far as possible, in their original packages, and are stored in the driest and safest place in the store-house; it is preferable to store such articles as indicated in *par.* 567.

Ropes are stored and cared for as explained in *par.* 481.

Pulley-blocks are hung up or piled where they have free circulation of air; those of wood are occasionally oiled with raw linseed oil. The *hooks, cheeks, and partitions of iron blocks* are painted black. *Journals* should be coated with black-lead, or if this is not available, lubricating oil must be applied before using. The greatest care must be observed to keep them free from sand or other gritty substance.

Rollers, manœuvring blocks, shifting-planks, chocks, cradles, capstans, and capstan-bars are stored in dry places. They should not be painted, but occasionally oiled with raw linseed oil.

Gins are painted olive, with the iron parts black. The windlass, however, should never be painted, but oiled with linseed oil.

As strict uniformity is not observed in the construction of gins, each one should be numbered and its parts so marked that if parts of different gins become mixed they may be readily separated. Each gin should be placed by itself, the braces fastened to the legs by their bolts and keyed up; the clevis and clevis bolt are left on the pry-pole.

Trunnion rings, sling-chains, &c., are hung on pegs and preserved from rust by a thin coat of black paint.

Hydraulic-jacks should be kept filled. The ram or piston and the journals are frequently oiled to prevent rusting, but when used, the head of the ram, to prevent slipping, must be free from oil or grease. The outside of the jack may be painted.

Gatling guns are kept in dry store-houses, and require the greatest care to preserve them from rust. The use of emery-cloth or other scouring material must be avoided. They must be kept covered, and well oiled with a mixture of about equal parts of sperm and kerosene oil. Every two or three days they should be wiped off, a rag passed through the barrels, and fresh oil applied. The journals are oiled through the oil holes in the breech casing. The carriages, limbers, and caissons are painted and cared for as other wooden carriages.

Gun-lifts are painted olive, and when not in use are kept under cover.

Hand-carts, sling-carts, garrison trucks and wagons are painted the same as siege carriages, and should be kept under sheds. The small sling-cart, being entirely of iron, excepting the pole, is painted the same as iron carriages.

Paints, turpentine, oils, lacquers, &c., are kept in a room separate from other stores; a cellar or casemate is preferable. The floor should be covered with two or three inches of fine sand, which should be renewed occasionally. Sawdust should *never* be used for the floor.

Volatile oils, such as kerosene or benzine, must not be kept stored in the paint and oil room, but in such place that the least possible damage will arise from it should it take fire.

Paint brushes, when new, and before using, should be wrapped, or, as painters term it, bridled with strong twine, and soaked in water to swell them. After using, they should be cleaned with spirits of turpentine and put away in a vessel containing water to keep them from drying and becoming unpliant.

567. The following table gives the quantity of material required for the preservation of the armament of a fort. It is made upon the basis of what is required annually for ten pieces, carriages, &c., of each kind:

ARMAMENT OF WORKS.

568. The kind, calibre, and number of cannon constituting the armament of a permanent work, as likewise the emplacement of the piece, is determined by the Engineer Bureau. The different parts of a work receive their specific designation from the same source, which likewise numbers, in regular series, the position of the pieces occupying each part. These numbers, running from right to left as you look outwards, are placed on the parapet opposite the platform.

It is the duty of the Engineer Bureau to furnish each work with a chart showing the water channels, with their soundings, and other approaches to the work. From this it is the duty of each artillery officer in charge of pieces to study and familiarize himself with the method of using them so as to make them most effective in carrying out the object for which they were placed in the work.

Supply of ammunition.

The amount of ammunition which should constitute a supply for artillery in a permanent work, depends so much upon circumstances that no fixed rule can be laid down for it. A place liable to close siege should be more amply supplied than one which can be replenished, and less would be required to repel attacks from vessels than from a besieging force on land. Two hundred rounds per piece may be taken ordinarily as a good supply for 15-inch guns and the heavier calibres of rifles; greater amounts are required for smaller calibres.

For all guns, the projectiles should be about equally divided between shell and solid shot.

The amount of ammunition for siege guns, when used in campaign as heavy field-pieces, is 200 rounds per piece, together with a small reserve.

PRESERVATION OF POWDER.

569. Powder is kept in magazines constructed with the works. The number of these magazines depends on the number and calibre of pieces in the work and the probable amount of ammunition required for each.

Magazines are of two kinds, viz.: *storage* and *service*. The former are for the accommodation of powder in bulk; the latter are smaller than the former, and are placed as convenient as practicable to the pieces to be served, and contain only sufficient powder for immediate use. Adjoining or convenient to each service magazine is a filling-room, in which cartridges are made

up and shells filled. Powder is brought from the magazine for this purpose, but only in such quantities, at a time, as may be necessary. In the filling-room are kept the filling implements and such small articles of equipment as are required to be near the pieces.

The storage magazines of a post are conspicuously marked A, B, C, &c.; the service magazines are numbered 1, 2, 3, &c., and, in addition, are marked for the particular pieces they are to serve.

A magazine of sufficient size, and fitted up with shelves, tables, and racks, is set aside for the storage of rockets, port-fires, fuses, primers, slow and quick match, and other similar articles. No such stores will be permitted in a magazine with powder.

The keys of the storage magazines are kept by the commanding officer of the post. Those of the service magazines, unless otherwise ordered, are in possession of the officers having charge of the particular pieces to be served from them, a competent non-commissioned officer being assigned to the immediate care of each. The ordnance-sergeant of the post will have charge of the storage magazines and of the one containing fuses, port-fires, &c.

Powder is stored in barrels containing 100 pounds each; the heads of the barrels are painted black, so as to show more plainly the marks, which are stenciled in white. Each barrel is marked on both heads with the number of the barrel, the name of the manufacturer, year of fabrication, and the kind of powder—*cannon, mortar, musket, mammoth, or hexagonal*; the mean initial velocity, and the pressure per square inch on the pressure piston. Each time the powder is proved the initial velocity is marked below the former proof-marks, and the date of trial opposite it. Each manufacturer has, in addition, certain private marks—initial letters—denoting the particular grade to which the powder belongs. A book is kept, by the ordnance-sergeant, which shows, besides all these marks, when the powder was received, where stored, and how much on hand.

Barrels of different kinds of powder are piled separately, and, besides being recorded in the magazine-book, each parcel is marked with a card, showing the kind and the entries and issues.

In the magazine, the barrels are placed on their sides, generally three tiers high, or four tiers if absolutely necessary. Small skids are placed on the floor and between the several tiers, and the barrels chocked at intervals to prevent rolling. The tiers must be so arranged that the marks can readily be seen and any particular kind reached. There should be an unobstructed space

of several square yards at the door, and this space, as likewise the alleys, should be covered with carpet or matting. The magazine is provided with a well near the door; into this the sweepings are put; they should never be swept out at the door. For the preservation of the magazine, it is of the greatest importance to keep unobstructed the circulation of air, under as well as above the flooring. The magazine should be opened and aired only in clear, dry weather, when the temperature of the air outside is *lower* than that inside of the magazine. It should not be opened in damp weather if it can be avoided. The ventilators must be kept free and no shrubbery or trees allowed to grow so near as to screen the building from the sun. The magazine yard should be of sand or clay and well drained. The moisture of a magazine may be absorbed by chloride of lime kept in an open vessel and renewed from time to time. Quick-lime is dangerous, and should not be used.

Candles, in lanterns, are used for lighting the magazine. No one should enter without first removing his shoes or putting india-rubbers over them. No cane, sword, or anything which might occasion sparks, must be carried in.

Barrels of powder not be rolled in transportation; they should be carried in hand-barrows, or in slings made of rope, canvas, or leather. All implements used in the magazine or on the barrels should be of copper or wood. The barrels must never be repaired in the magazine. When it is necessary to roll them for the better preservation of the powder and to prevent its caking, this is done, with a small number at a time, on boards in the yard.

Occasionally, especially in the spring, the barrels should be inspected, and, as far as possible, brushed off, to prevent insects from destroying the hoops. A light brushing over with carbolic acid will be good for this.

When practicable, a sentinel should be posted over the magazine, to keep unauthorized persons away and to prevent smoking or fire within dangerous proximity. The lightning-rods must never be out of repair.

Should a fire occur near the magazine, the ventilators and windows must be immediately closed, and the building covered, if possible, with paulins, blankets, or carpets saturated with water. It is extremely hazardous to attempt to remove the contents at such a time.

Neither loaded shells, fire-works, nor composition for fire-works will be stored in a magazine with powder. Shells should be filled in the filling-room of the service magazine.

Transportation. In wagons, the barrels of powder must be

packed in straw, secured in such a manner as not to rub against each other, and the load closely covered with canvas. Sufficient guard should accompany the train to prevent all smoking or fire near the wagons. No camp-fires should be allowed near the park. On railroads, each barrel should be tightly boxed and packed so as to avoid friction; the cars, if practicable, should have springs similar to those for passenger cars.

570. *Filling cartridge-bags.* Cartridges for all pieces larger than the siege gun should be made up only as required for use, and when any are left over after firing, they are stored away in the service magazine on shelves. The cartridges are filled in the *filling-room* of the service magazine. Under no circumstances will filling be done in a powder magazine. The powder, in barrels, is carried from the storage magazine to the service magazine in powder-carts or hand-barrows.

To fill the cartridges, the implements required are: One *copper hammer*, one *wooden drift*, one *counter brush*, one *scoop*, one *counter scales and weights* (brass or copper), one *filling funnel*, one *set powder measures, cartridge-bags*, and *twine*.

The barrels are opened by first loosening the upper hoops, when the heads can be taken out easily. Care should be taken not to handle the barrels or powder roughly.

Should the powder be caked or lumpy, caution should be exercised in breaking the lumps. When the lumps are small and not very hard, they may be broken by pressing them with the hands; but when large and hard, requiring more force to break, the powder is taken to some safe place away from the magazine, spread upon a paulin, and broken with a mallet. The grains must be separated, but not crushed.

When cartridges are to be used with projectiles, the powder is carefully weighed; for blank cartridges, it is measured. When the piece for which the cartridges are to be prepared has a calibre of less than 7 inches, the filling funnel is used, one man holding open the mouth of the bag while another pours the powder into it through the funnel. The bag is then tied with twine close to the powder. For cartridges of more than 7 inches diameter, the powder is poured into the bag by means of the scoop; the bag is tied as before. When cartridges are filled, each one should be marked with a pencil or by stenciling, showing the kind and weight of powder and for what kind of piece it is to be used.

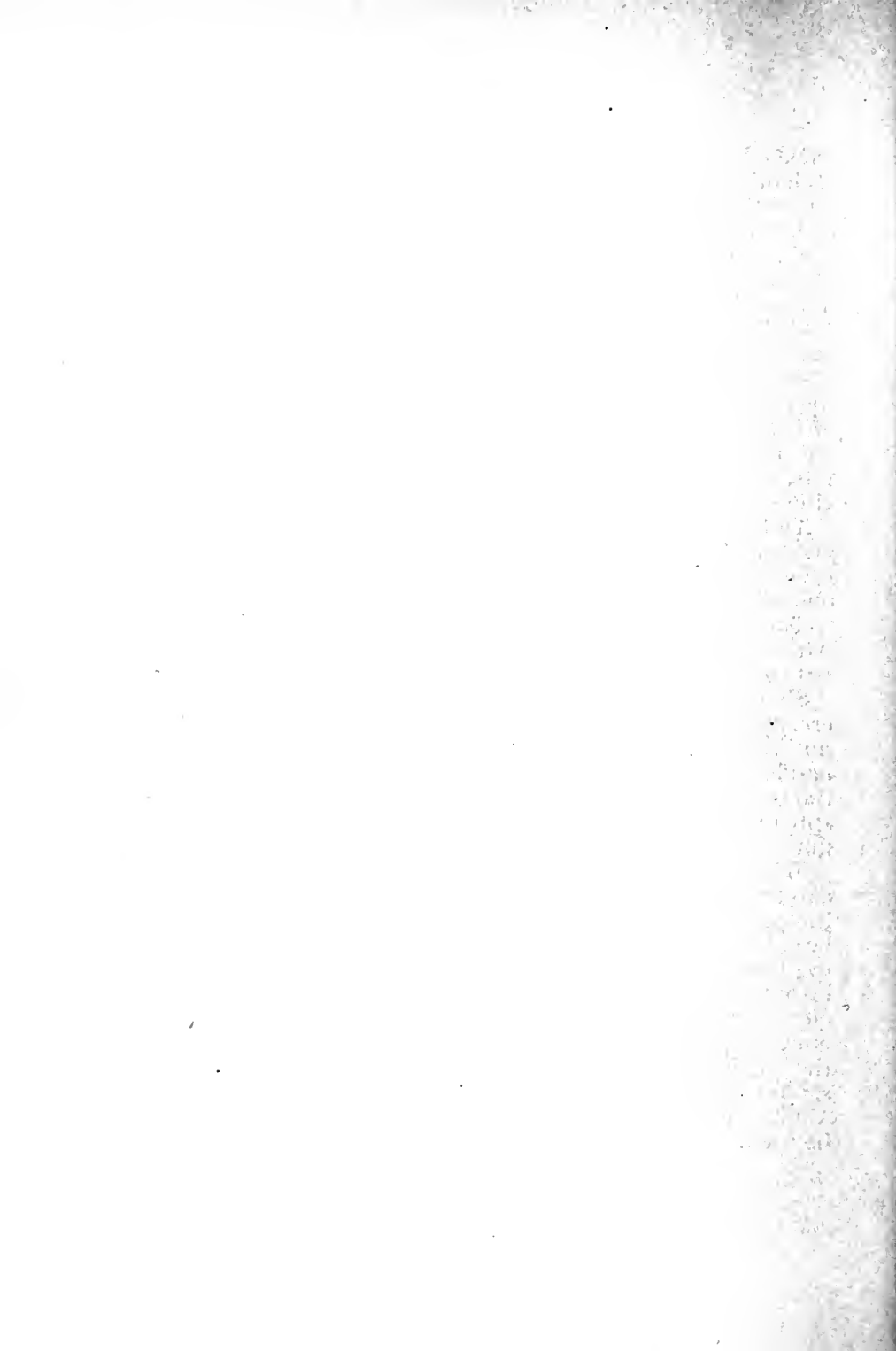

Part Fifth.

TRANSPORTATION OF ARTILLERY.

To Embark and Disembark Artillery and Artillery Stores.

General Rules.

571. When artillery and its stores are to be shipped for an expedition, prepare first a list of all the articles, stating their number, individual weight, and the total weight of each kind.

In estimating the weights, allow double for that of bulky articles which occupy much space without weighing much.

Divide the total quantity to be transported among the vessels, and make statements in duplicate of the articles on board each vessel, one of which lists should go with the vessel and the other remain with the officer shipping the stores.

The articles must be divided among the vessels according to the circumstances of the case; but, as a general rule, place in each vessel everything necessary for the service required at the moment of disembarkation, so that there will be no inconvenience should other vessels be delayed.

If a siege is to be undertaken, place in each vessel with each piece of artillery its implements, ammunition, and the carriages necessary to transport the whole or a part; the platforms, tools, instruments, and materials for constructing batteries; skids, rollers, scantling, and plank.

If a particular calibre of gun is necessary for any operation, do not place all of one kind in one vessel, to avoid being entirely deprived of them by an accident to it.

Dismount the carriages, wagons, and limbers by taking off the wheels and boxes and, if absolutely necessary, the axletrees. Place in the boxes the linch-pins, washers, &c., with the tools required for putting the carriage together again. Number each carriage, and mark each detached article with the number of the carriage to which it belongs.

The fixed ammunition must be carefully packed in its prescribed boxes; the cartridge-bags, fuses for shells, and their ammunition, either in substantial boxes with rope handles or in

barrels; powder in barrels, in a magazine constructed in a vessel to hold it.

Sponges, rammers, worms, and ladles should be united in bundles; other implements, intrenching tools, levels, rules, &c., in bundles or boxes; implements, in bundles and boxes of complete sets, as far as practicable.

Small-arms should be in their prescribed boxes.

The contents of each box, barrel, or bundle should be marked distinctly upon it. The boxes should be made small for the convenience of handling, and have rope handles to lift them by.

The position of the different articles in each vessel should be noted in a column in the list on board.

Place the heaviest articles below, beginning with the shot and shells, (empty,) then the guns, platforms, carriages, wagons, limbers, ammunition-boxes, &c. Boxes of small-arms and ammunition in the driest and least exposed part of the vessel. The skids, scantling, and boards may be in the more exposed parts, or in the run.

Articles required to be disembarked first should be put in last, or so placed that they can be readily got at.

If the disembarkation is to be performed in front of the enemy, some of the field-pieces should be so placed that they can be disembarked immediately with their carriages, implements, and ammunition; also the tools and materials for throwing up temporary intrenchments on landing.

When there are several vessels laden with artillery and stores for the expedition, each vessel should have on each quarter and on a signal at mast-head a number that can be easily distinguished at a distance. The same number should be entered on a list of supplies shipped in each vessel. The commander can then know exactly what resources he has with him. Some vessels, distinguished by particular signal, should be laden solely with such powder and ammunition as may not be required for the immediate service of the pieces.

If it is necessary to reshipe or leave any articles on board the vessels, care should be taken to note them on the list.

Boats of proper capacity must be provided for the disembarkation, according to the circumstances in each case.

It may be necessary to establish temporary wharves on trestles, and to erect shears, cranes, or derrickes.

On a smooth sandy beach, heavy pieces, &c., may be landed by rolling them overboard as soon as the boats ground, and hauling them up with sling-carts.

572. Railroad transportation. The most suitable car for carrying horses, especially in warm weather, is the "slaf stock-

car," built of slats and open all around, but tight in roof. Another kind, known as the "combination car," is made with five doors on each side and one at each end, which may be closed tight for stores, or with iron grates when carrying horses. These are suitable for either warm or cold weather.

Both kinds are usually 27 feet 4 inches long, 7 feet 9 inches wide, and 6 feet 8 inches high, inside measurement. Each car will carry fourteen artillery or sixteen common horses or mules.

The horses all face towards the same side of the car, and are hitched by their halters to the frame-work. If the journey is to be continued beyond eighteen or twenty hours, the horses will require to be watered and fed. Nose-bags are generally used for the grain. If the drivers are attentive, they, by taking advantage of the short halts made by the train, can feed grain and hay quite easily by hand. Half rations will be sufficient under any circumstances. Before placing the horses on the cars, they should be thoroughly groomed and cooled; they should have nothing more on them than their halters.

If the journey is to continue for several days, (but never beyond four without unloading,) the horses should stand lengthwise of the car, facing each other, and hitched to two bars placed for the purpose across the car. The bars have space between them sufficient for feeding purposes and for a man to remain in charge. When thus arranged only about one-half as many can be carried in each car as in the other case. By loading in this way, close "box"-cars may, even in hot weather, be used, the doors being left open for ventilation.

Horses are best loaded and unloaded from a "stock shute," but where this convenience is not available, and there is no platform, a ramp or shute may be improvised, using for it planks about 12 feet long and from 2 to 3 inches thick, depending on the strength of the wood.

The ramp should be about four feet wide, with the planks firmly fastened together with transverse battens. These battens, furthermore, prevent the horses from slipping. A strong trestle or crib of logs supports the end of the ramp next the car, while the other rests on the ground and is secured from slipping by strong stakes. An intermediate trestle or a support of logs should be placed to prevent the planks from springing with the weight of the horses. Three or four posts of suitable height are set in the ground on each side, to which side rails are lashed or spiked for the purpose of keeping the horses from stepping off. A board should be placed on each side to prevent the horses' feet from slipping over the edges of the planks. When planks

are not procurable, a ramp of earth, supported by means of logs or stone on the end next the track, may be constructed.

The cars are brought up in succession to the ramp to be loaded or unloaded. Mules and ordinary horses are usually driven in loose and stand unhitched.

In the field, where no chute or ramp is to be found at the place of unloading, material ready prepared for constructing one should be carried with the train.

Artillery carriages and transportation-wagons are carried on platform or "flat" cars.

These cars are generally 28 feet long by 8 feet wide. When properly loaded each will carry two field guns and two caissons complete. To load them the carriages are unlimbered and the spare wheels removed from the caissons; the rear train of a caisson, its stock to the rear, is run to the front end of the car and its stock rested on the floor; another rear train is run forward in like manner until its wheels strike or overlap those of the first, when its stock is rested on the floor. A limber is then placed on the car with its pole to the front, resting on the rear train; the second limber is backed on and its pole held up until a gun, trail foremost, is run under it; the trail of the gun is rested on the floor and the pole of the limber on the gun carriage. The other gun is run on in the same manner, and its trail rested on the floor under the first gun; a limber is next run on and its pole rested on the last gun; the remaining limber is run on with its pole under the preceding limber. All of the carriages are pushed together as closely as possible and firmly lashed. Where the carriages are liable to chafe each other, they are bound with gunny-sacking or other stuff.

A side platform, such as are found in depots, is the best for loading. The carriages are first run onto a spare car; from this they are crossed over on planks to the one upon which they are to be carried, and arranged on it as already described. When there is no side platform, the carriages are run up at the end of the car by means of way-planks.

Siege guns can be loaded and carried in a similar manner, but when there is no side platform, blocks and tackle will be required for hauling them up the way-planks. Two siege guns with their carriages and limbers complete can be carried on one car, and, in addition, boxes of ammunition or stores may be piled between and underneath the carriages. One "flat" car will carry two army transportation-wagons standing, besides a large quantity of other material. If the wagons are "knocked down," the same car will carry four.

Twenty-four thousand pounds is considered a safe load for one

car on a good track. Baggage, harness, forage, &c., are usually carried in box-cars. These cars have the same dimensions as heretofore given for those carrying horses.

The average size passenger car will seat sixty men, but a small car will seat only fifty. The men must be provided with cooked rations for the whole trip. Each car must be liberally supplied with drinking water, lights at night, and all other conveniences, to make it unnecessary for the men to leave them during stoppages of the train.

The officer in command of troops on a train will act in harmony with the railroad officials, and must not interfere in any manner whatever with the *running* of the train.

Ten to fifteen passenger or sixteen to twenty-two freight cars go to make up a train drawn by one locomotive; but when the grades are light and but little curvature in the road, the maximum weight of trains may reach double these figures.

Passenger trains generally travel at the rate of about twenty-two miles per hour, and freight trains about fifteen, including customary stoppages. Troop trains should not be dispatched from a station with less intervals than ten minutes between them.

The experience gained during the war of the rebellion shows that to supply an army of 100,000 men in the field by means of a single line of rails, the proportion of rolling stock should be—engines 0.25 and freight cars 6.0 to every mile of road. This does not provide for the conveyance of troops. In calculating the amount of rolling stock available for use, a deduction of 50 per cent. for locomotives and 30 per cent. for all other carriages must be made for those usually undergoing repairs.

From the foregoing data, a small calculation will give the amount of railroad transportation required for any given number of troops, artillery, or material, and the capacity of a road for performing the work.

573. *Transportation of artillery by sea.* In the United States service there are no vessels fitted up especially for transportation of troops, horses, or artillery material. Even during the four years of the war of the rebellion no attempt was made towards it further than temporary arrangements for some particular voyage. The voyages were short, lasting generally only two or three days, never exceeding eight. Embarking and disembarking were usually accomplished with wharf facilities. In only three or four instances were the movements of an expeditionary character, requiring these operations to be performed on an open beach or in front of the enemy. As desirable and advantageous as it would have been to have had suitable transports properly

fitted up, the absolute necessity for it was never felt, and consequently they were never adopted. It may not always occur that the same conditions will exist, and it is therefore well to collect such information on the subject as may be needed.

The horses and material belonging to artillery require so great an amount of space in proportion to that required for the men, the latter need scarcely be taken into account when estimating for ship room. Any vessel capable of carrying horses and guns will accommodate the men belonging to them in those parts where neither horses nor guns can be stowed.

Guns, caissons, ammunition, and other material of this character are carried in the same manner as ordinary merchandise. When once within reach of the ship's tackle, the officers and crew of the vessel will know how to stow and take care of them to the best advantage. When practicable, it is not only the most expeditious, but altogether the best way to leave the carriages mounted. The length of the voyage and the character and capacity of the vessel will determine whether or not this should be done, and in what part of the ship stored. Other considerations, such as facilities for embarking and disembarking, will likewise go to determine these questions.

The horses are more difficult to provide for, and it is with reference to their accommodation and safety that vessels for the transportation of artillery should be selected.

During the rebellion a species of transportation was employed upon the Chesapeake Bay, and even for short voyages at sea, which proved very successful, and which might again find useful application.

This consisted in embarking the horses on large schooners and the batteries on steamers, (frequently ferry-boats,) which, taking the schooners in tow, conducted them to their destination. Each schooner carried upon an average fifty horses; three were therefore required for one battery. The ferry-boat carried easily the material of two batteries. The advantage of this kind of transportation consisted chiefly in the ease of loading and unloading the vessels. Their light draught enabled them to lie up to almost any kind of wharf. Strong gang-planks were provided, over which the horses were led to the decks of the schooners, upon which they stood, facing outwards. To prevent them from gnawing and injuring the gunwales, stout boards were temporarily nailed thereon. The batteries were run by hand onto the ferry-boats, the carriages unlimbered and stowed, the whole occupying but a few minutes of time. Disembarking was accomplished with equal facility.

Each schooner carried its due proportion of the men of the battery, who looked after the horses.

When the voyage is to extend beyond six or seven days at sea, the vessel should have room between decks where stalls can be fitted up in the manner hereinafter described. But if the voyage is of shorter duration, stalls are not absolutely necessary. In this case the vessel best adapted is a long low steamer, with a clear upper deck for the accommodation of the horses. The guns, carriages, harness, and baggage are stowed between decks, where likewise the men find ample room. In many steamers a large gangway on each side leads to the main deck, through which the carriages can be run by hand. In vessels not so provided they have to be lowered by means of tackle down the main hatch,—a slow and laborious process.

Horses, in all cases, should stand athwart-ship; in this position they better accommodate themselves to the rolling motion of the vessel. When on the upper deck they should face inwards; this, for the reason that the spray will not then strike them in their faces, and, besides, when facing each other in this manner they will suffer less from fright and nervous excitement.

A vessel of not less than 25 feet beam will accommodate two rows of horses, leaving a space between the rows, and between the croups of the animals and the sides of the ship, ample for the proper care of the horses. These spaces are, furthermore, necessary as gangways for working the vessel. The average artillery horse occupies a deck space of 8 feet by 2 feet 4 inches. It results, therefore, that the whole length of the deck in feet divided by the last dimension will give the number that may be accommodated in each row. As they stand better when close together, side by side, no allowance need be made for vacant space between them.

The horses are secured by their halters to hitching-bars (B B, *Fig. 1, Plate 56*), of strong scantling, running longitudinally in two lines along the deck. A space of about five feet is left between the lines for the gangway before mentioned. These bars should be about four feet from the deck, and supported by stanchions (A A) secured to the deck by strong angle-irons fastened with screws. The bars are braced from the sides of the vessel with stout scantling (C C). These braces are arranged so that the spaces between them will include five horses, (more or less, depending upon the strength required to give entire security to the structure,) and are fastened with bolts and nuts, so that in loading they may be removed and replaced successively as the horses are put in their places. They must be smoothed off, or wrapped with gunny or other material, to prevent their

chafing the horses. Holes are bored or rings attached to the hitching-bars for the halter-straps. The horses should be hitched short, and when putting them on board care should be observed to have those accustomed to each other placed together. Kicking and vicious animals are placed, as far as practicable, where they can do least mischief.

All stalls, hitching-bars, or whatever other arrangement for securing horses, must be strong beyond any possibility of giving way. The living force exerted by a row of horses as they swing with the motion of a ship in a heavy sea-way, is very great, and it is better to have no securing arrangements whatever than to have those that, by giving way, will wound and injure the animals in the wreck.

If the transport is to be used in very inclement weather, the spar deck, over the horses, should be covered. Canvas stretched over a secure frame is better than boards, as the latter, in a severe storm, might be carried away, and its wreck would cause disaster among the horses.

During heavy weather, horses sometimes become exhausted and fall. The best thing that can be done in such cases is to back out the horse on each side, so as to give the fallen horse plenty of room. The next horses adjoining are prevented from trampling him by having placed against them braces such as heretofore described. There should be several of these braces *spare* for this special purpose. The fallen horse should be protected from rain and spray by a paulin, and great care and tenderness exercised towards him; otherwise he is very liable to perish. The horses may be fed from nose-bags, but it is better to have for each one a small trough, suspended to the hitching-bar by means of two iron hooks passing over the bar. The troughs are moved out of the way when not in use. Hay can be fed to them by tying it up tightly in bundles with rope-yarn and fastening the bundles to the hitching-bar. It may also be fed in small quantities by hand, and the more attention the horses receive in this way from the men, the less fretful and uneasy they become.

When the embarkation takes place from a wharf, and the vessel is not too high, it is best to use gang-planks and lead the horses on board. The gang-plank leading up from the wharf to the gunwale should be about 20 feet long by 10 wide, and be made very strong. This width admits of its being used for gun carriages. It should be provided with ropes at the corners, rollers, side rails, and boards upon the sides to prevent the horses from getting their feet over the edges. Another similar gang-plank, but not so long, leads from the gunwale to the

deck, the two being securely fastened together by their ropes. These gang-planks should be carried by the vessel, ready for disembarking. Every provision for this latter operation should be thoroughly looked after before starting on the voyage.

When it is not practicable to use gang-planks, the horses are hoisted on board by means of a sling and lifting tackle.

574. Sling. This is made of stout web, or double No. 1 canvas. It is 5 feet long and 2 feet wide, secured at each end by a stick of strong wood 2 inches in diameter. The sides are bound with strips of canvas doubled, thus making the edges four thicknesses. Loops of 4-inch rope are attached to each stick. (*Fig. 2, Plate 56.*)

The loop attached to one stick is 9 inches long; that attached to the other is 2 feet 11 inches, and has an iron eye—3 inches, inside measurement—fixed in the end. Breast and breech ropes (2-inch) 9 feet long are fixed to each side, and are tied together when the sling has been put under the horse. The slings should be tested by an excess of weight. A donkey-engine is used for hoisting.

Five men are required to sling a horse quickly and well. One man holds the head guy, which is attached to a neck-collar; two men, one on each side of the horse, pass the sling under his belly; both then hold up the ends over his back, passing the long loop through the shorter one and hooking on the eye of the former to the lifting tackle, continuing to hold up the sling until the horse's legs leave the ground; another man stands at the breast and fastens the breast-rope, while the fifth stands at his rump and fastens the breech-rope. The officer superintending commands: **HOIST AWAY.** The first man slacks away at the guy-rope, holding it just sufficiently taut to keep the horse's head steady. When hoisting, no delay should be permitted; it should be done in the shortest time compatible with safety. At the commencement, after a certainty that all is right, it should be done rapidly, to raise the horse off his feet and free him from surrounding objects before he has time to do any injury by kicking. After attaining the necessary height, he is carefully and steadily lowered to the deck. Care should be taken to have two or three careful and active men stationed to seize the horse and prevent his plunging until the slings are removed. While one holds him by the head-stall, another rapidly unhooks the tackle purchase, and two others let loose the breech and breast bands, or ropes. When the horses are to be lowered through a hatch to a deck below, the combings of the hatch, as well as stanchions about it, should be well padded. As an additional precaution, a head-collar should be provided, with a large pad on top to pre-

vent injury should the horse strike his head against the deck beams when lighting on his feet. Everything being in readiness and skillfully managed, an average lot of one hundred horses can be hoisted on board in from two to three hours. Hatches for horses must be at least 10 by 10 feet.

Allowing 1100 pounds as the average weight of artillery horses and 150 pounds as that of men, and estimating for ten days' supply of food, water, and forage, the total weight of a field battery of six pieces, fully equipped and provided for field service, and including two baggage-wagons loaded with camp equipage and baggage, will be 329,000 pounds, or about 165 American tons. Horses embarked as described—*i. e.*, without stalls—require each a space equal to 3.5 tons, marine measurement; therefore about 550 tons will be required for the horses alone. It is thus seen that the actual weight of a battery forms but a small proportion of the shipping tonnage required for it. The class of sea-going steamers usually chartered for transportation service are those that ply between points along the sea-board. They are generally propellers, and vary in tonnage from one to two thousand tons. Owing to the fact that a considerable part of their room is usually taken up with passenger accommodations, they are seldom able to carry more than one full battery. A steamer of 2000 tons burden, with a free spar and main deck, is capable of carrying two complete batteries.

575. Stalls. The extensive experience of the British Army during the Crimean war and in the Canadian, East Indian, and other colonial service, has enabled the English to arrive at great perfection in fitting up transports for horses. The following is the method adopted: Each horse is provided with a stall; these are placed in two rows, one on each side of the ship, with the heads of the horses facing inwards. (*Fig. 3, Plate 56.*) The rear end of the stall is not less than two feet from the side of the vessel; three feet is allowed when breadth of deck admits of it. The stalls in each row are built together, so as to be continuous. They are 6 feet long from inside of padding on the breast-piece to the inside of haunch-piece, and 2 feet 2 inches between the padding on the side bales; ten per cent. are 2 inches narrower, and five per cent. are 6 inches longer.

To construct the stalls, two lines of scantling (A and B) are laid down parallel with the keel of the ship, and 7 feet 5.5 inches apart; the outer line is at the required distance (2 to 3 feet) from the ship's side; the scantling are 5 by 5 inches, and are secured to the deck by 1-inch screw bolts of wrought-iron. They are scored three-fourths of an inch deep on the inside, at intervals of 2 feet 6.5 inches (from centre to centre of score), to re-

ceive the heels of the stanchions (C and D). These stanchions are of scantling the same as the stringers, and are cut to the exact height from deck to deck; they rest below on the deck, fitting into the scores of the stringers; they are secured to the deck above by means of cleats fastened with heavy spikes; the stanchions are secured, in addition, both above and below, with spikes driven obliquely into them and the deck; against the rear side of the front stanchions are placed short pieces of scantling (E) for the purpose of securing the breast-piece and side bales; these pieces are 4 feet long, 7 by 6 inches thick, and of good strong wood; in the top are two slots for the reception of the ends of the breast-piece and side bale; they are secured to the front stanchion by a 0.75-inch bolt at 12 inches from the top; below they are secured by spikes toed into the deck and by the flooring cut away to receive them.

The flooring is of 2-inch plank spiked to the deck; the spikes are driven so that they are covered by the cross-battens; the planks are laid lengthwise, not across the stall, extending from the front scantling (A) to within 7 inches of the rear one (B), with intervals between them of 0.75 inch. The upper edges are beveled off half an inch. These intervals are for the purpose of drainage.

Six battens (FFF) of hard wood, 2 by 3 inches, are laid across the planks, beginning 9 inches from the rear ends of the planks; the others at intervals of 12 inches. These battens are continuous, running the entire length of the stalls; scantling 5 inches deep by 3 inches wide and 6 feet 9 inches long are laid along each side of the stall, fitting tightly between the front and rear stanchions, and scored underneath to fit on the cross-battens; each is secured by spikes driven through the floor-planks into the deck. These pieces are for the purpose of holding the cross-battens beyond any possibility of breaking away.

To facilitate cleaning the stalls without at the same time weakening the construction, these pieces are sawed through at 6 inches from the hind stanchions, and a strap-hinge fastened on top so that the short end can be thrown back when it is necessary to sweep the stalls. A clear drainage space is thus left along the whole line of stalls.

The haunch-piece (G) is a continuous piece of scantling 9 inches deep by 5 inches thick; it is secured to the inside of the rear stanchions by bolts, with its top 3 feet 8 inches above the floor-planks; the top and inside surface are rounded off and smoothed, so as not to chafe the horse; opposite each stanchion a mortise is cut in the haunch-piece for the reception of the side bale.

The breast-piece (H) is of hard wood 6 inches thick by 9

inches deep; it is hollowed out in the middle and rounded so as to conform to the breast of the horse. The breast-piece of each stall is removable; its ends, cut to the proper shape, rest in the slots of the short uprights (E); a wooden key (J), turning on an iron bolt, secures both the breast-piece and side bale from lifting out; the upper edge of the breast-piece is 3 feet 11 inches above the floor-planks.

The side bales are of 9 by 3 inch wood; in front, they are on a level with the breast-piece; in rear, with the haunch-piece; behind, they are tenoned into the haunch-piece; in front, they slide into the slot in the short uprights, being kept there by the key (J); they are smoothed off and padded with sheepskin long in wool, put on double. The same kind of padding is used for the breast-piece; none is put on the haunch-piece. About 15 per cent. of spare side bales are provided.

The manger (L) is made of inch boards 18 inches long, 15 inches wide at top and 12 at bottom, and 9 inches deep, inside measurements; it is lined with tin or zinc; an iron band passes underneath and up over the ends, terminating in two holes, by means of which the manger is suspended to two iron pins fixed to the front stanchions.

Zinc or iron hooping is nailed around the stanchions wherever horses can get at them to gnaw.

The horse's head is secured by means of a head-halter, the strap of which is fastened to a ring attached to the front stanchion. It is best to have two straps to each halter, one fastened to each side.

Kicking boards are provided for such horses as require them; they are attached to the inside of the rear stanchions with screws.

Four pulley blocks for the ropes of the horse-hammocks are placed, two over each side bale, one at 12 inches from the front stanchion and the other 2 feet 3 inches from the hind stanchion. Those in front are double, the hind ones single. These blocks are screwed to the deck above.

576. The horse-hammock is similar to the sling before described, except that the sticks at the ends project on each side 3 inches beyond the canvas. A 2-inch rope 30 feet long is passed around each stick in a single clove hitch, (Fig. 4, Plate 56,) the hitch being secured at its crossing with spun-yarn. The end of the rope from the rear side of the hammock is 3.5 feet longer than that from the front side, and passes up through the rear block and over one of the sheaves of the front block; the front end of the rope passes over the other sheave; both are carried forward and secured by an iron belaying cleat fastened to the

deck above. The hammock is kept in position on the horse by a breast-band 40 inches long and a breeching 56 inches long and 4 inches wide. These straps are held in position by a wither and a croup strap, both of which are united along the back by another strap. All of these straps are made of canvas or strong webbing, and secured with buckles.

There must be ten per cent. of spare stalls, and there should be a loose box constructed near a hatchway to admit of a sick horse lying down. Each stall is numbered, the side bales, breast-pieces and mangers being marked with the number of the stall to which they belong.

It is advisable to have as many stalls on the upper deck as possible, unless extremely bad weather is anticipated. They are constructed like those already described, except that they are covered in above by a sloping roof laid upon rafters connecting the stanchions.

The *Himalaya*, of 3500 tons burden, fitted up in the manner described, successfully carried, during the Crimean war, 3000 horses with a loss of only *three*. They were arranged: 200 on the spar deck; 130 on the main deck; 50 on the orlop deck,—making 380 carried at a trip.

On the spar deck, the platforms of the stalls were placed 2 inches above the deck to admit of cleaning, draining, and washing. The platform was in sections of two stalls each, and could be shifted.

The horses, when put aboard, were led, the first one to the most distant stall; then the side bale was put in place, another horse brought and placed alongside, and so on until the embark-ing was completed.

When a horse becomes sick or disabled at sea, and it is found necessary to move him from his stall, the feed-box is unhooked, the breast-piece unshipped, and he is taken into the narrow passage or gangway separating the two rows of stalls.

577. *Care of horses at sea.* For the first few days on ship-board food is to be given rather sparingly, and bran is to form a large portion of it; but after the horse becomes accustomed to his new situation and his appetite increases, he is to be more liberally fed. A bran mash, or oats and bran mixed, is to be given to him every other day.

The spare stalls admit of the horses being shifted, rubbed down, their feet washed, and the stalls cleaned out every day when the weather permits. Hand-rubbing the legs is of the greatest consequence to the comfort and well-being of the horse, and is to be practiced, if possible, every day, or whenever the horses change stalls.

Horses are to be slung in smooth weather, and allowed to stand on their legs in rough and stormy weather. In smooth weather, they will rest their legs and feet by throwing their whole weight into the slings. To sling a horse in rough weather, whereby he is taken off his feet, would only have the effect of knocking him about with the roll of the ship. Horses standing, accommodate themselves to the motion of the vessel. They are not to be placed in the horse-hammock until they have been at sea for a week, as some would only be made uneasy by the attempt to do so.

The hammock is to be placed around the centre of the horse's belly, and then the breast-band and breeching fastened to the required length and degree of tightness. When everything is in readiness, and not before, the horse is quickly raised until all, or nearly all, of his weight is off his legs. He will very soon learn the relief the hammock affords him, and will not be slow in availing himself of it by throwing his weight into it. With some horses it is necessary to use great quickness in making the ropes fast before they throw their whole weight into the hammock.

When the horses are between decks, too much attention cannot be paid to the constant trimming of the wind-sails, so as to insure plenty of fresh air. The wind-sails should be well forward, and extend down to within two or three feet of the deck. When a horse between decks becomes ill, and the weather is at all fine, he should be removed to the upper deck, where the fresh air and change will probably soon bring him right again.

Besides the ordinary grooming utensils for stable service, there should be a plentiful supply of stable brooms, hoes, and shovels for cleaning out the stalls, and baskets or other light vessels for removing the manure. The ship must be well lighted and the guards attentive; sea-sick men must not be intrusted with this important duty.

Disinfectants, such as chloride of lime and of zinc, copperas, powdered gypsum, &c., should be freely used, and upon embarking the artillery commander will see that they are supplied.

The feed-troughs and nostrils of the horses are washed every morning and evening with diluted vinegar.

Water is allowed at the rate of six gallons a day per horse and one gallon per man.

During the voyage the artillery commander will make it his especial study to act in harmony with the master of the vessel. There must of necessity be divided authority and responsibility. Order and neatness among the men and cleanliness with the horses are to be looked after by the commander of the troops. In attending to these duties, care will be observed not to inter-

fare needlessly with the duties of the crew, nor with the belongings of the ship.

Officers are always to be furnished with cabin accommodations and the men with proper messing arrangements. This should be specified in the charter, and should be clearly understood by all parties previous to setting out on the voyage.

The fitting-up of the vessel is generally done by the Quartermaster's Department, but the commander of the artillery to be embarked will, as the one most concerned, give his special attention to see that the work is thorough and complete.

Masters and owners of vessels always dislike to have them bored, spiked, and bolted into in the manner necessary for fitting them up for artillery transports. To remove all causes of complaints and objections, and of contentions between the master of the vessel and the officer embarking his troops, arising on this score, the charter party should clearly specify the extent and nature of the work required to be done.

When an expedition of considerable size is to start out, a steamer suitable for the purpose should be converted into a workshop, containing forges capable of doing heavy work, together with carpenter and shipwright facilities. She should carry a plentiful supply of such material as will probably be required.

A steam pile-driver should always form part of the outfit of an expedition.

578. *Disembarking.* When this can be done at a wharf, it is simply the reverse operation of embarking.

When wharf accommodations are not available, arrangements will have to be made for transferring the men, horses, and material from the vessel to the shore.

An army or other considerable body of troops embarked for an expedition, to be landed under such circumstances, will be provided with general means for disembarking, and the artillery, which usually constitutes an important feature of the outfit, shares with the rest in these general arrangements; but, owing to its nature, much of a special character is required for it, demanding the most careful consideration and attention from artillery officers.

Such expeditions usually embark at sea-ports where there are accommodations that make the operation comparatively simple and easy, and for this reason the many preparations necessary for landing on an open shore are apt to be overlooked, or to be inadequately provided for. It becomes the especial province of the artillery commander to look out for this, and to give his advice and make his wants known to the army commander, so that the latter may cause proper provision to be made.

The following method for the disembarkation of an army corps proved successful during the war of the rebellion, and the same, or some modification of it, will apply in every case.

The essential articles for forming a landing-place were, several canal-barges; a number of pontoon-boats, with balks, chess, oars, anchors, &c., complete; a number of gang-planks; a plentiful supply of lumber, and the necessary amount of ground tackle, cordage, and tools.

The canal-barges were about 14 feet wide and 70 to 80 feet long, (drawing, when loaded, 5 feet of water; when light, 2 feet,) and of about 80 tons burden.

The gang-planks were from 12 to 30 feet long and 10 feet wide, and very strong; ropes were attached to their corners, and the larger ones furnished with rollers.

By lashing two of the canal-barges together, placing the boats some 12 feet apart, and throwing a false or additional deck over the whole, a platform was formed about 40 feet wide and 45 feet long, capable of holding all the pieces and caissons of a six-gun field battery, or from forty to fifty horses. This boat or raft, when thus loaded, drew about 4 feet of water.

Several of these rafts were prepared for the purpose of forming a *wharf-head*, alongside of which vessels could lie and discharge.

From this wharf-head to the shore a pontoon-bridge was constructed. (*Fig. 5, Plate 56.*)

The wharf-head was formed by bringing up as near the shore as possible one of the lightest of the double canal-boats just described; this was securely moored in proper position at high water, when it at once grounded. Outside of and parallel to it, at a distance of some twenty feet, was placed, and in like manner securely moored, the double canal-boat next heaviest in draught of water; the space between the two being bridged by one of the largest gang-planks.

In the same manner was placed a third double canal-boat, alongside of which was moored a light draught steamer, which formed the pier-head to the wharf and secured depth of water sufficient for the transports to come alongside.

From the double canal-boat first put in position, a roadway to the shore was made by constructing a pontoon-bridge in the usual manner.

The operation of disembarking consisted in bringing the transports alongside of the wharf-head, placing a gang-plank from the deck to the gunwale, and another from the gunwale to the wharf-head. Over these gang-planks the horses were led and taken ashore. The guns, caissons, and other carriages were

run down the gang-plank and over the bridge by hand. In this way but two or three hours were consumed in disembarking an entire battery.

For disembarking artillery by this method, or indeed by any method, smooth or comparatively smooth water is a *sine qua non*. Infantry, and even artillery material, may be landed with small boats or lighters through a heavy surf, but a smooth sea is required for horses.

When it is not considered expedient to construct a wharf-head and bridge as just described, and the water near shore is of sufficient depth, double canal-boats may be used for rafts to disembark both horses and material. The rafts must have railing around them; this should be strong, the stanchions extending into the boats and secured throughout with bolts and nuts. The horses are loaded from the vessel onto the raft either by means of gang-planks or by slinging them. The raft is towed to the shore by small boats or, better, by a small steam-tug; a gang-plank is run out and the horses led ashore. The guns and caissons are brought ashore in the same manner.

When canal-barges are not to be had, small coasting schooners may, by removing their deck hamper, be used instead. Large decked-over scows, such as are to be found in sea-port towns, make excellent rafts. When the distance from the vessel to the shore does not exceed 1000 yards or thereabouts, a warp-line may be used for bringing back and forth the raft. Every exertion should be made to erect a wharf, rough and temporary though it be, using for the purpose any kind of boats or scows that can be obtained. It may sometimes be advisable to sacrifice a ship for the purpose of forming a wharf-head, by scuttling and sinking her in such depth of water as to leave her spar deck three or four feet above high water. With a sandy or muddy bottom, a ship might be sunk by loading her down until she rests firmly on the bottom. If the weather is calm she will suffer no great injury, and can be floated off when no longer required.

The business of constructing rafts and wharfs as described, belongs, as a general rule, to the engineers; but should the artillery commander of an expedition anticipate, even in the remotest degree, a failure to provide the requisite means for disembarking, it becomes his duty to look after it, and he cannot be too zealous in doing so. The best plan under such circumstances is for each transport to carry along with it an outfit capable of discharging its cargo.

The most useful boat for lightering, that can be carried, is the wooden pontoon, such as is used for military bridges. It is 31

feet long, 5.5 feet wide at top, 4.5 feet wide at bottom, and 2.5 feet deep. Besides the three men required for managing it, it is capable of carrying 40 infantrymen with their arms and knapsacks, and it will very readily carry six horses. It is better, however, when disembarking artillery, to form rafts by uniting two boats in the usual manner for a bridge, except that a double number of balks should be used. The platform may be twice the width allowed for the roadway of a bridge; thus formed, it will be 24 feet long by 20 wide, and capable of carrying two field-pieces and caissons complete, or from 15 to 20 horses.

The platform must be provided with a secure railing. All of the parts should be fitted and numbered previous to embarking, and the men practiced until they become skillful in putting the raft together. In consequence of the lowness of this platform, it is impracticable to use gang-planks from the decks of ordinary vessels, and the horses have therefore to be lowered onto it by slinging. A warp-line to the shore is the best means of taking it back and forth.

Each transport should carry four pontoon-boats and all the equipment for two rafts. If there is not sufficient room on deck for the boats, they may be carried stowed flat to the sides of the ship, bottom outwards, resting on strong solid chocks bolted to the wales. A strong parbuckle-sling passes around each, with which it is hoisted into place by the yard and stay purchases, and secured by lashings; by the same means it is lowered into the water.

With several transports, each carrying the above-described outfit, it is generally practicable, by combining all, to form a bridge: Suitable vessels can nearly always be obtained for forming the wharf-head.

When there are several transports unloading at the same time, conspicuous and well-understood signal marks must be placed opposite each, on the beach, so that it may be known to what points to direct the boats and rafts without confusion. A strong party for each should be on shore to secure the rafts upon touching, to haul up the guns and caissons, and to take care of the horses.

Unless there is some special reason to the contrary, horses will always be landed first. This gives them an opportunity of resting and recovering from the trip while the material is being landed.

When pontoon-boats are not available, scows, fishing-smacks, or other small craft must be collected and used instead.

As a last resort, the horses may be swum ashore, and the material landed in the ship's boats,—a very tedious operation. The horses are lowered over the side by slinging; a boat must be in

attendance below to unhook the fall and clear the sling. The sling for this purpose must be without breast or breech straps, and the loops should be closed up with canvas, so that there may be no possibility of the horse getting his legs entangled in any part of it. A very slight embarrassment of this kind will cause the horse to drown. A man in the small boat takes him by the halter and, conducting him a short distance, gives him the proper direction to the shore; without this precaution, horses sometimes become bewildered and swim around the vessel until exhausted. Horses will very readily swim, in smooth water, half a mile. When the deck of the vessel is low, say not over ten feet, and there is a gangway, the horses may be backed off into the water without slinging. This method should not, however, be resorted to if it can possibly be avoided; it is liable to strain and injure the animal, and will ever after make him timid and shy about taking the water when it is necessary to cross streams on the march.

Siege guns are embarked and disembarked in the same general manner as light field-pieces. When gang-planks are used, they are hauled up or let down by means of tackle. When embarking from a wharf or raft without gang-planks, the piece is run with its carriage under the ship's tackle; the gun is slung and hoisted aboard and lowered onto the deck or into the hold. In disembarking, the carriage is first put upon the wharf or raft under the ship's tackle, and the piece then lowered onto it.

When it is necessary to land heavy guns by means of lighters, or from small vessels, the latter may be beached at high tide; the pieces are raised by blocking and skids until they can be rolled down two inclined skids from the vessel to the beach, where they are received upon skids or blocks of sufficient size to prevent them from burying themselves in the sand. At low tide they are removed from the beach.

Sieges, and similar operations calling for the use of the heavier classes of ordnance, are usually of such a protracted nature as to allow of substantial wharves being constructed, and cranes, derricks, and shears provided for unloading weighty material. It is but loss of time and labor, often ending in failure, to proceed with imperfect arrangements of this kind. It is the duty of the artillery commander to study the situation and see that proper facilities are prepared. Such preparations require considerable time to make, and he should therefore anticipate the probable wants of the service in this direction, and not wait until the vessels carrying the material arrive, or the demand for it becomes urgent.

579. The disembarkation of an army must be considered under two heads: 1st. When made without any chance of inter-

ruption from an enemy; 2d. When made in presence of an enemy, or where an attack is possible.

So far as artillery is concerned, the first of these conditions has been discussed in the foregoing paragraphs.

With regard to the latter, all questions, political, strategical, or otherwise, entering into the object of the expedition, having been settled by the proper authorities, and the army for carrying it out having been organized, embarked, and the transports arrived within the general limits of the field of operations, the first thing to be decided upon is the exact place or places where the various parts of the command are to be put ashore. Many local circumstances will influence this decision; among the most important of which will be to secure good anchorage and depth of water near the shore, a general configuration of ground in front which will admit of its being swept by the fire of the fleet, a firm and commodious beach, and freedom from prevailing winds or currents which may interrupt the disembarkation.

The fire of the fleet must clear the country in front. The infantry is first landed and pushed out sufficiently far to keep the enemy beyond cannon range of the landing-place; here it intrenches itself, forming a *tête-de-pont* around the landing.

Meanwhile preparations will be made for landing the batteries. All the boat-rafts will be put together, and if a wharf-head and floating bridge is to be constructed it will be commenced at once. Steam-tugs must be in attendance for towing the rafts, carrying orders, and other miscellaneous duties. The artillery commander designates the order in which the batteries are to disembark, and will see that the transports take proper positions for effecting this without causing intervals of unnecessary delay.

If the attacks of the enemy are formidable and persistent, demanding the immediate service of artillery, the guns of several or of all the batteries may be landed without their horses, and taken to positions on the line by hand, or by the horses of one of the batteries landed for that special purpose. The cannoners will accompany their guns.

If the resistance of the enemy cannot be overcome at this period, the expedition is a failure, and the army will have to be reëmbarked. To accomplish this a strong defensive work should be constructed, and well armed with such artillery as may be required.

The remainder of the disembarked artillery is next put aboard the transports; afterwards the infantry and, if possible, all the artillery. The fire of the fleet should cover the reëmbarkation, and keep the enemy at such distance that he will not be able to use his artillery upon the transports or the place of landing.

When the expedition is large and the number of transports, store-ships, &c., great, the worst of confusion will arise unless some system of marking and distinguishing them is adopted. The best method is for each one to carry, instead of her own burgee, the distinguishing flag of the corps to which the troops on board belong. This will show at a glance whether they are infantry, artillery, or cavalry, and to what corps, division, and brigade they belong. Besides this, each vessel should have a number painted, as large as possible, on each quarter. When embarking, a memorandum is kept and furnished to commanding and staff officers showing what troops are on board of each transport.

The chief-of-transports, who should be a quartermaster selected for his practical capacity in such business, designates the anchorage-ground for each part of the command, and sees that they move up at the proper time and in the required order to the place of debarkation. It is with him that the artillery commander communicates in reference to the movements of the artillery transports.

When boats are to be used either for lightering, rafting, or bridging, it is important to know their sustaining capacity. With small craft, this is best ascertained by calculating the area of several cross-sections, from which a close approximation of the cubic contents in feet is obtained; this, multiplied by 62.5, gives the weight in pounds of the displaced water.

If the boat can be put in the water, the operation is simplified and made more accurate by calculating the volume of that part between the water-line when the boat is empty and the line to which it can be safely sunk when loaded.

When boats of different sizes are to be used in a bridge, the largest should be where the current is swiftest, so as to have there the greatest space possible between the boats. Anchors for ordinary ships' boats should weigh from 50 to 100 pounds; for regulation pontoons, they should weigh 150 or 200 pounds.

The length of the cable should always be at least ten times the depth of water in which the boat is anchored. The anchor should be taken out in a boat and dropped over at the required spot.

Weight brought on a bridge by the passage of troops. Infantry marching by fours cause a load of 225 pounds for each lineal foot of roadway. When crowded by a check in front, the load is increased to about 550 pounds.

Cavalry in column of twos, each man and horse weighing about 1400 pounds, and occupying 12 feet of bridge, cause a

load of about 230 pounds per lineal foot of roadway. When crowded by a check, this is increased to about 350 pounds.

When artillery carriages cross a bridge, the weight is not equally distributed. With the carriages of light field batteries, the weight is about 400 pounds per lineal foot. The 4.5-inch siege gun and carriage, equipped for traveling, weighs 7400 pounds, and has a distance of 8 feet between bearing parts of hind and fore wheels, giving 925 pounds per lineal foot of bridge. The 100-pounder Parrott, carried on a mortar-wagon, gives 1737 pounds per lineal feet.

A 10-inch siege mortar mounted on its carriage and carried on a mortar-wagon causes a load of 800 pounds per lineal foot.

To each running foot of bridge must be added about 100 pounds as weight of superstructure.

When heavy carriages are to be crossed, a substantial tramway made of long way-planks should be laid, and the carriages moved on it by hand.

In constructing a bridge with ordinary boats, great care must be observed not to allow the balks to rest on the gunwales; they must be supported from the middle of the boat.

Ice, when from 3 to 4 inches thick, will sustain infantry marching in single file. With a thickness of 4.5 inches, cavalry and light guns can pass over; with 6 inches, heavy field-pieces; 8 inches will support siege guns, but, for greater security, the wheels should be locked and secured upon way-planks which slide upon the ice, the pieces being moved by hand.

In very cold weather the thickness of the ice may be increased by covering it with a layer of straw or brush and throwing water over it, or two rows of logs may be laid at a distance apart equal to the width of the roadway; a layer of earth is spread between them and water thrown on and allowed to freeze. This operation is repeated until a solid roadway is formed.

Ice, when very thick, and therefore difficult to remove, may be broken up by charges of powder in water-tight cans or bags, fixed underneath or placed in holes bored in it. Charges of from five to ten pounds of powder placed in ice two feet thick will break up an area twenty feet in diameter. Eight ounces of dynamite will produce a like result.

Part Sixth.

HARBOR DEFENSES.

580. The entrance to a harbor may be considered, and is in fact, a defile, the defense of which follows the rules applicable to defiles generally.

The means usually employed to prevent the passage of hostile ships are divided into three classes, viz.: 1st. Forts and land batteries; 2d. Submarine mines; 3d. Floating defenses.

The latter class, which includes monitors and offensive torpedoes, is under the exclusive control of the Navy.

Submarine mines will be considered further on.

The first class is the one now to be considered, and this consideration of it is intended to refer especially to the use of guns on land against armored ships.

581. *Position of batteries.* Whenever practicable, batteries should be well strung out in groups, the strength of which should increase as they are approached from the outside. This arrangement has a peculiarly discouraging effect on an enemy. The first batteries will at least damage him and cause confusion, thus weakening his attack on the stronger; and when his discomfiture finally takes place, the batteries already passed will prevent his return and insure his total destruction. The islands, headlands, and narrows usually found at the entrances of harbors will generally, to a greater or less degree, enable this arrangement to be carried out.

Experience teaches that where the channel is unobstructed steam vessels can run past shore batteries, however well the latter may be served. But, on the other hand, where obstructions to their rapid transit exist, they have not the endurance and aggressive power to effect much damage to land defenses. In the smoke of battle and tide-way of the channel they become unmanageable, get aground, or collide with each other. The most effective class of channel obstructions are submarine mines; the position, planting, and working of which are explained under the head of *Submarine Mines*.

It is a well-settled fact that a hostile fleet, by concentrating its fire on an open work, may temporarily silence its guns. For

this reason the accumulation of guns in works exposed to such concentration should be avoided by distributing them in batteries, each containing but a few pieces, due regard being had to their security from assault and capture by any force that may be landed for that purpose. The best arrangement is to place them in detached batteries of, say, two, four, or six pieces each, well secured from the enemy's fire by earthen epaulments and traverses. This arrangement makes it difficult for the enemy to discover the exact position of the guns, and every peculiarity of ground should be taken advantage of to increase this difficulty. Whatever tends to make batteries difficult to see, and consequently to hit, is as much a protection as that which makes them capable of resisting a hit when made. Guns thus dispersed have greater freedom of lateral range of fire, and do not interfere so much with each other by reason of their smoke as when concentrated,—a matter of no little importance with heavy artillery, which emits such volumes as, in certain conditions of the atmosphere, to greatly interfere with accuracy of aim.

When batteries are extended, a larger area will be swept by their converging fire than when the guns are assembled *en masse*. An additional advantage conferred by distributing the guns is, that while obtaining concentrated fire on an important or decisive point, a similar fire cannot be directed on the guns in return.

This arrangement would, furthermore, tend to neutralize the power which a fleet might have of forming on a wide arc of a circle, and moving slowly under steam, so as to render the task of hitting the individual ships more difficult, throw a converging fire upon the works on shore.

In the design of such works, it is of primary importance that conjoint action of the various parts should be maintained; and to prevent the individual batteries from being captured by *coup de main*, small inclosed earth-works, heavily stockaded to resist escalade, and each armed with field, siege, and machine guns, and siege mortars, should be constructed so as to have complete command over all land approaches.

These earth-works should contain the infantry supports. In this manner most of the existing sea-coast forts may be utilized, making of them protecting works for exterior earthen batteries.

The defenses of a harbor should, in every instance, be capable of repulsing all attacks that the enemy is likely to make on them. The power and persistency of these attacks will depend upon the importance to him of the object to be gained. Large and opulent cities, naval establishments, and ship-yards are among the first prizes sought for. The aggressive power of modern

navies is such as to make it quite impracticable to effectually guard every harbor on an extended coast. It is, therefore, better to entirely abandon those that are unimportant to the enemy, for whatever use he may make of them, than by feebly guarding them to invite his attacks and thus afford him the moral effect and consolation of cheap victories, and to the country the mortification and disadvantage of defeat and loss of prestige.

582. *Number of troops required for harbor defense.* The number of troops required for the manning of a work erected for harbor defense depends chiefly upon the nature and amount of armament contained therein. Works of this nature are armed principally with pieces of the heaviest calibre, but, for reasons hereafter given, all kinds should generally find place. The amount of armament depends upon the extent of the work and the part it is to play in the scheme of defense.

Three full detachments are necessary for each piece. Knowing the number of pieces in the work and the number of men required for the service of each, the entire strength required is obtained. Three relief detachments are necessary, for the reasons that the labor of manipulating and serving heavy artillery is very great, and when a rapid and continuous fire is to be maintained, strong fatigue parties are required in carrying ammunition from the service magazines to the pieces; damages done to the works during the day have to be repaired at night, and casualties occurring, whether from the fire of the enemy or from accidents, must be provided against, so that at any moment an efficient detachment may be at every piece.

As a general rule, batteries should not be incumbered by an attempt to include musketry defense within their limits. The place for this arm is on the flanks of the batteries, and in strength sufficient to prevent an enterprising enemy from landing and assaulting the work, and from approaching to keep down the fire of the guns while his vessels run by it.

However well it may have answered with the old style of artillery to have the troops serving batteries charged, in addition, with musketry duty, it certainly is not advisable with the artillery of the present. Steam-propelled iron-clads, carrying guns of enormous power, range, and accuracy, demand the undivided attention in action of those using the only weapons effective against such adversaries.

The labor of handling and caring for the kind of artillery, ammunition, material, and machines now used, together with the construction, preservation, and repair of batteries, will require all the time and the whole attention of the troops serving

guns in war. The care of infantry arms and equipments, together with the drills and parades incident thereto, have a tendency to draw away the attention of officers and men and prevent them from keeping in an efficient state of readiness, the only safeguard that stands between an enemy and the object for which he may desire to enter a harbor.

When a work containing batteries for harbor defense is inclosed, the amount of musketry necessary for it is determined by allowing two muskets for each lineal yard of parapet not occupied by the batteries.

583. Artillery being the main feature in such works, the command should be vested in an artillery officer. Where there are several forts and batteries guarding the entrance to a harbor or constituting a line of works, they should, for the purpose of administration and command, be united in groups, each group being under an artillery officer of appropriate rank, and the whole combined and commanded by the senior officer of artillery present. By this means thorough coöperation is secured throughout the entire system.

584. In order to avoid the weakening effect of divided responsibility, submarine mines, when employed in conjunction with a fort for the defense of a channel, should be under the control of the commandant of the fort, who should select from his command the proper number of officers and men to be instructed in the method of working this branch of defense.

No more troops than are necessary to carry out the foregoing rules should be crowded into a work; otherwise, unnecessary casualties from the fire of the enemy will be added, stores consumed, and unhealthiness engendered; and, besides, in time of war, when troops are not required at one place, their services are generally needed elsewhere.

The high standard of practical gunnery required of artillery troops demands a proportional degree of intelligence and capacity for instruction in the individual soldier. Artillerymen should be selected with a special view to this, artisans and mechanics forming a large proportion. Steam-power and the application of labor and time saving machinery should, wherever practicable, be introduced to assist in making the defensive ability of fortified places more perfect.

In conducting the defense of a work, too much importance should not be attached to the battering of it by an enemy; for experience teaches that a place is formidable, if resolutely defended, long after it has lost all semblance of the form and symmetry possessed by it when it came from the hands of the constructing engineer.

585. *Elevation of batteries.* Against unarmored vessels, ricochet firing, owing to the greater chances of hitting the object, is the most effective; and in order to secure flattened ricochets, so that the shot, in bounding, may not pass over the hostile vessel, batteries should be placed as low as possible; but since the introduction of iron-clads, special importance is given to the kind of fire most effective against them.

Ricochet firing with elongated projectiles is exceedingly uncertain, and the loss of power from ricochet with spherical shot is so great as to make this kind of firing of little or no avail against armored vessels as now constructed. Direct hits must be resorted to, and these, too, from rifled guns of heavy calibres. Direct hits can be made as well from a moderate elevation as from near the level of the water; and, besides, the chances of striking the deck—always the most vulnerable part of an iron-clad—are thus considerably increased. An elevation of fifty feet above the water will deprive the enemy of the advantage of ricochet firing, which, although not effective against iron-clad vessels, is nevertheless very damaging to defensive works on land. The interior of the work is obviously more sheltered from the missiles of the enemy when it is above his level than when low down; his projectiles then either lodge in the epaulment or pass over the work far to the rear, with greatly diminished chance of hitting the guns, either in barbette or in embrasure. (See table, *par.* 210.)

586. *Artillery against armor.* Rifled guns of heavy calibres are, for reasons hereafter given, the only kind capable of inflicting much damage upon iron-clad ships. This damage is effected by shot penetrating through the iron shield and reaching the active enemy within—the men, guns, and the machinery.

The first thing, therefore, to be considered in this connection, is the power of rifled guns to penetrate armor. A vast amount of experimental firing, by various nations, has been done to ascertain this and to arrive at the laws governing the effect produced by the impact of cannon shot against metal plates. These laws have been formulated, and the results obtained therefrom agree, with remarkable precision, with those obtained by observation from actual practice.

These experiments have been more exhaustive abroad than in the United States, and as the English system of rifled ordnance includes all the calibres of the United States system, and is likewise muzzle-loading, the diagram on *Plate 76* is inserted to show the penetrating power of rifles.

The following table, from calculation, gives the penetrating power of projectiles fired from smooth-bore guns against backed

armor, for the velocity, charge, and weight of projectiles set opposite :

| GUN. | PROJECTILE. | CHARGE. | VELOCITY. | PENETRATION. | FOOT TON FOR 1" OF CIRCUM- FERENCE. | |
|------|-------------|---------|-----------|--------------|---|-------------------|
| In. | Lbs. | Lbs. | Ft. | In. | | |
| 20 | 1070 | 200 | 1400 | 13 | 234 | Prismatic powder. |
| 15 | 450 | 100 | 1487 | 10.15 | 143 | Prismatic powder. |
| 10 | 127 | 28 | 1600 | 7.30 | 73 | Cannon powder. |

The penetration above given is for the velocity at the muzzle; but as the velocity for smooth-bores rapidly diminishes, the penetration likewise diminishes, and to such a degree as to render this class of guns almost powerless to perforate modern armor at the distances usually required of guns on shore.

It will be observed from the foregoing diagram that iron-clads are classified with reference to their armor—chiefly as to the thickness of the plating. The thickness and arrangement of the wood backing has more reference to the strength of the vessel to resist racking than to power of resisting penetration by shot; for the best oak timber possesses only about one-sixteenth of the resisting power of wrought-iron.

The foregoing penetrations are for impacts normal to the surface of the plates. When the impact is not normal, the penetrating effect is diminished increasingly with the obliquity of the direction of the shot. Flat-headed projectiles *encastrent* and penetrate at as low an angle as 45 degrees, but ogival-headed or spherical projectiles glance from the surface when the angle reaches about 20 degrees from the normal at the point of impact.

The full penetrating power of rifle projectiles requires that the armor should be struck perpendicularly to its surface. This can never occur in action except by rare accident. The trajectory of the shot forms one angle; the curvature of the ship's side forms another; the inclination of the ship's course forms a third, all of which are constantly varying by reason of the motion of the vessel.

587. Besides monitors, which of themselves form a distinct class of iron-clads, bearing little or no resemblance to any other, there are many varieties of armored vessels. The following, however, is a fair *type* of the class that, in the event of war,

would probably prove most troublesome to our harbor defenses: Length of hull, 300 feet; breadth, 56 feet; height of main deck above water, 6.5 feet. The entire hull is protected by armor from 6.5 feet below the water-line to the main deck, thus covering not only the middle part of the ship where the machinery and turrets are placed, but also the quarters for officers and men. The thickness of the armor opposite the turrets is 8 inches; that on the remainder of the midships is 7 inches, which is slightly reduced towards the ends of the vessel. The plates rest on a backing of hard wood 12 inches thick, through which they are bolted to the iron skin, 1.5 inches thick, the whole being supported by the massive frame-work of the ship, 10 inches deep.

The upper deck, which, as before stated, is at a level with the top of the armor on the sides, is covered with iron plating 4 inches thick for the length of the turret spaces, and with about half the latter thickness over the remainder. The plating is laid on a deck of hard wood 6 inches thick, the whole being supported by iron beams 14 inches deep. The draught of such a vessel is about 26 feet.

The turrets, two in number, project through circular openings in the upper deck, that part above the deck being covered with armor plates 10 inches thick about the ports and for one-third of the circumference, with 9 inches for the remainder. The part below the deck and all the gearing is protected by the 8-inch armor of the sides of the hull. The height of the guns in the turrets is 10 feet above the water-line.

A vessel of this description carries an armament, usually, of six guns, four of which are in the turrets and are 12-inch rifles; the other two are 100-pounder rifles, and are carried on the upper deck, fore and aft, as chase guns. The turrets are about 27 feet in diameter.

The hull of such a vessel, when broadside-on, presents, exclusive of the turrets, a vertical target, above water, 300 feet long and 6.5 feet high; any part of which, at a range of 2000 yards, if fairly struck, is vulnerable to the racking effect of shot from the 15-inch smooth-bore, or to penetration from rifles of not less than 10 inches calibre; and it would not require many such hits to disable her or cause her to withdraw from action.

When bow-on, the hull presents a vertical target, above water, 56 feet long by 6.5 feet high, alike vulnerable to the same shots. The difficulty of striking normally the curved surface thus presented would be partly compensated for by the large horizontal target presented by the deck of the vessel when in this position. This target would be 360 feet long in the direction of the shots, with an average width of about 45 feet. The

angle of fall due to shot at the distance usually employed against iron-clads would give them a very considerable striking power, enabling them, most probably, either to penetrate or seriously rack the deck. It is thus seen that in whatever position the vessel may be with reference to the batteries on shore, she will present no inconsiderable mark to fire at.

Rifle projectiles are not liable to ricochet upon water, and will, especially those that are pointed, pass through it to a distance of fifteen to twenty feet with but small diminution of force. Against this class of projectiles, the target presented by the vessel is increased by at least three feet below the water-line. At ranges not exceeding 2000 yards, ricochet from the 15-inch gun is formidable, and with anything like good practice, shots striking short would stand a good chance of hitting the vessel upon the first rebound.

Line-of-battle cruisers of the broadside class present greater dimensions, as a target, than the turreted vessels of the type just given. At the same time, they carry no greater thickness of armor, and are consequently more vulnerable. The best protection for harbors upon the American side of the Atlantic against 100-ton guns carried in vessels protected by two feet or more of armor, will be the clumsiness and unseaworthiness of such vessels themselves. As armor increases in thickness, the belt of it that can be carried diminishes in width; and thus what is protection in one sense may be regarded as weakness in another.

It is important with artillerists to know the character of vessels opposed to them. To enable them to ascertain this, it is the duty of the proper department of the government, in the event of hostilities with a maritime power, to supply diagrams showing the general appearance of each of the enemy's iron-clads, or at least of each class, and by a brief description to point out the most vulnerable parts. This would enable the artillerist to determine not only the proper guns and projectiles to be used, but where his shots may be aimed to the best advantage.

588. A vessel moving at the rate of 10 miles an hour passes over a distance of nearly 15 feet per second. The time of flight of a rifle projectile for a range of 3000 yards is within a fraction of 9 seconds. Allowing one second to elapse from the time the gun is aimed to the moment of being fired, the time required for the projectile to reach its object at the above range will be 10 seconds; in which time the vessel will have passed over a space of 150 feet, or half the length of the average iron-clad. If she is at the above distance, and moving at that rate of speed directly across the line of fire, it will be necessary, in order to strike her amidship, to aim directly at her bow.

If she is moving at the rate of 15 miles an hour, she will in the same time pass over a distance of 220 feet; and to strike her amidship, it will be necessary to aim 70 feet, or about one-fourth of her length, in front of her bow.

The time of flight of a projectile from the 15-inch smooth-bore for this distance is about one second greater than the rifle shot. It will thus be seen that the problem of aiming becomes greatly complicated by the motion of the vessel. Her distance; the direction in which she is moving, whether perpendicular or oblique to the line of fire; her rate of speed; her size, and the time of flight of the projectile fired, are all elements of the problem, to be determined on the instant, by the judgment of the artilleryman. Both officers and men should be thoroughly instructed and practiced in these matters for the particular guns they are serving.

Almost every locality will afford stations for obtaining cross bearings, by means of which, with telegraphic and other arrangements, the exact position of a vessel at any moment may be known at the piece. The method of doing this is explained under the head of *Submarine Mines*.

By this means guns and mortars, trained upon any particular point of a vessel's course in a channel, may be fired at the precise moment when the vessel is at the point.

589. *Vital points of iron-clads.* The most vital part of an iron-clad, or, indeed, of any ship as against shot, is the water-line, where, if an irreparable leak can be effected, she must inevitably go to the bottom. Shot holes of small calibre may, especially in wooden vessels, be plugged; but projectiles capable of piercing modern armor make breaches impossible to stop in this manner. The projectile always makes a hole larger than its own diameter, and the plating at the exit of the shot is usually bulged, cracked, and carried away to a still greater extent. The wood backing is torn, splintered, and racked for several feet around, in such a manner as to make immediate repair impossible. An iron-clad penetrated in this way, by even a single shot, is at once put *hors de combat*. Her well-known want of buoyancy, although provided, as most are, with watertight compartments, will cause the most resolute crew to desist the fight and look to their own safety.

The machinery of sea-going iron-clads is always below the water-line, and is generally protected by an additional thickness of armor. It is consequently difficult to reach, but should a shot enter there, especially into a boiler, the most serious calamity to the vessel must follow. It not only destroys the locomotive power of the vessel, leaving her without the means of

manœuvring or possibility of escape from stranding, but it is likely to cause great destruction of life. The position of the machinery and boilers of a steamer is pretty well indicated by that of the smoke-stack.

When the vessel is broadside-to, fire should be directed so as to strike her at or just below the water-line, opposite the machinery.

Experience teaches that the most vulnerable part of a turret is its lower circumference, which, when once jammed, totally disables it for the fight. If, from weight of armor, the vessel is known to be invulnerable to the guns employed against her, their fire should be directed with a view to jamming her turrets.

The ports of a turret are generally each 2 feet 2 inches wide by 3 feet 7 inches high, thus forming no inconsiderable target, through which a projectile entering would destroy, at one blow, half of her armament without possibility of repair. The ports of broadside iron-clads are generally about two inches in both directions greater than those of turrets, and in number average ten for each side. It will therefrom be seen that a considerable area of the ship's side is thus vulnerable.

The accuracy of fire at objects on water is generally superior to that at objects as they usually occur on land; this, for the reason that the distance of the object, though it may be moving, is more readily determined by its relative position to known objects, the position of which are well understood beforehand. The effect of the shot can be more easily observed on water than on land. The size of the object, if a vessel, is large, and its appearance generally well defined.

590. *Phenomena of impact.* When a heavy beam of wrought-iron—one, say, twelve or fourteen inches square—is struck by a heavy shot at high velocity, the beam snaps short off, as though it were cast-iron. The same shot, striking a wrought-iron plate backed in the usual manner of armor, penetrates or perforates it in a manner similar to the action of a hand-punch on a sheet of iron laid on a block of wood. The effect is entirely local; the hole is made without bending or twisting the plate in one case, or the sheet in the other. The same projectile, propelled with a low velocity, will bend the beam and produce the ordinary fracture of wrought-iron, and in case of the plate, the latter will be distorted, strained, and loosened from its fastenings.

A simple way of explaining these phenomena is as follows: In the case of the high velocity the effect is wholly *local*, because the surrounding material has not *time* to propagate the vibration of impact throughout the mass. In other words, the cohesion of the material is not sufficient, in the time allowed, to overcome

the inertia of the surrounding mass. The *distribution* of the effect in the other case is due to the low velocity, wherein a certain length of *time* is consumed in accomplishing the blow. During this interval, all surrounding particles of iron have time to sustain the point struck; the force of the blow is thus spread over a large surface and the cohesion of the particles is undisturbed, since each particle is enabled to contribute the force of its attraction towards uniting the whole. These two distinct effects are called, respectively, *punching* and *racking*.

The work done by a shot is represented by its weight multiplied by the square of its velocity at the moment of impact; from which it will be seen that a small projectile moving with great velocity is capable of doing the same amount of work as a large projectile with low velocity. The *character* of the work is, however, as above explained, entirely different. In case of a given projectile, whatever power is employed in racking the side of the vessel does nothing towards penetration, and *vice versa*.

Racking. The theory in favor of the *racking* system is, that heavy projectiles may be fired with low velocities without straining the gun; that blows given in this way waste no power in punching mere holes, but that the entire work will be expended in straining, loosening, and dislocating the armor and breaking its fastenings, tearing it off and exposing unprotected spots easily vulnerable to shells, at the same time racking and breaking the ribs and sides of the vessel to such extent as to render her unseaworthy. For producing these effects the 15-inch gun, throwing solid cast-iron balls, is quite as formidable as the powerful rifle expending costly bolts; but the accuracy of fire from the rifle is so greatly superior to that from the smooth-bore, as to leave a large margin in its favor. Spherical shot, and slow shot of any form, will do very little execution under water. The concussion from racking blows, although it may not seriously injure the vessel, stuns and temporarily paralyzes many of the crew, and, spreading terror to all, greatly interferes with the efficient working of the ship and of her armament.

Punching. The theory in favor of punching is, that the vital parts of the vessel and the active enemy within—the men, guns, and machinery—are reached at once. A projectile piercing the armor of a vessel carries with it portions of the broken plate, which, together with bolts, nuts, and fragments of wood from the backing, form a species of *langrage*, the effect of which is not less to be feared on a crowded deck, or in a turret, than the explosion of the most formidable shell. But to produce this result the projectile must penetrate entirely through. A projectile moving with a punching velocity has only local effect,

penetrating without racking the armor. If it goes but partly through, it does no damage either to the ship or to the enemy within. Therefore, whether from the greatness of range, the thickness of the armor, or want of power in the gun, entire perforation cannot be effected, it is only a waste of ammunition to use it in simply indenting armor.

Although a spherical projectile may have, upon starting, greater velocity than a rifle projectile of equal calibre, and consequently may have greater punching power stored up in it at this part of its flight, nevertheless, owing to its greater cross-sectional area in proportion to its weight, it will lose its velocity more rapidly, and the rifle projectile will soon overtake it in its flight and go far beyond it in range.

At the distances that iron-clads usually engage land batteries, smooth-bore projectiles would possess no punching power; therefore for this kind of work rifles are the only suitable armament for such batteries. They should be powerful enough to do the work effectually.

When heavy enough for this, all additional weight is rather a detriment than an advantage, from the fact that light guns are less cumbersome, can be fired more rapidly, are more easily replaced when disabled, and less costly in ammunition. They likewise stand greater relative charges and yield higher velocities with safety.

The 8-inch rifle, carrying a projectile 185 pounds in weight, fired with a charge of 35 pounds hexagonal powder, is the minimum calibre that can be successfully used against the present style of sea-going iron-clads.

591. *Armor-punching projectiles.* Spherical solid shot of cast-iron, as usually furnished, almost invariably break into many fragments upon striking armor plates. When made with particular care as to quality of metal and mode of casting, they will penetrate, provided the velocity is not too much reduced by range, but in doing so have a tendency to break after entering the armor,—a circumstance, however, rather in their favor when they pass entirely through, as they then scatter their fragments in the interior of the ship. Spherical shells of cast-iron have not strength to penetrate unimpaired armor, and are useful against iron-clads only when they chance to strike a weakened part of the vessel. They nevertheless have other uses; their large fragments may enter the ports and do the work of solid projectiles within; an unremitting fire with them will blind the enemy by their explosion and bewilder and distract him to such an extent as to render his fire scattering and uncertain. The best material for rifle projectiles for punching purposes is Bessemer steel, but as it is too expensive for ordinary service, chill-

ed cast-iron is used. The form of head best suited for the perforation of plates, whether direct or oblique, is the ogival or pointed arch. The flat-headed projectile possesses some advantage over the ogival in taking hold of the plate at a greater angle of obliquity, but this advantage is counterbalanced by less range and accuracy of flight. The effect of striking a plate obliquely is diminished, as regards power of perforation, in the proportion of the sine of the angle of incidence to unity. Elongated shells of good metal and thickness have a power of penetration but little inferior to corresponding solid projectiles.

The heat generated by impact against armor will usually ignite the charge, and the bursting takes place about the time the shell reaches the backing of the armor. The head and walls of the shell require to have sufficient thickness to resist crushing by the force of the blow.

592. *Strength and composition of batteries.* In determining the armament necessary to protect a harbor from an enemy's fleet, it may be laid down that no iron-clad carrying a certain number of guns can successfully attack a battery on shore properly situated and armed with a like number of guns of calibre equal to the task of racking or punching her armor. But as vessels are capable of moving, and can pass by and out of range of batteries on shore in a given period of time, the chance of their being crippled or disabled will be in direct proportion to the number of guns employed against them; hence this number should be as large as circumstances will admit.

Assuming 4000 yards as the maximum effective range against a vessel, 8000 yards would be the distance she would have to pass over in running by and beyond the range of a battery. At a rate of speed of 15 miles an hour, she would accomplish this in a little less than 18 minutes; at 10 miles, in a little over 27 minutes. Supposing everything in the battery to be in the most complete order and state of readiness, not more than three shots from the 15-inch smooth-bore or 12-inch rifle could be fired in the first interval, and not over five in the second. Twice this number might, however, be fired from pieces of less calibre. The movement of the vessel would greatly diminish the chances of hitting her, and, besides, it is by no means every hit that seriously injures an iron-clad. This suggests that the number of guns should be as great as possible.

The pieces in each battery should, as a rule, be of the same calibre and kind; but the batteries themselves should be mixed as to armament. The smaller calibres are more easily worked, and are capable of rapid fire. This would be effective against wooden vessels assisting in the passage or attack. When a vessel is stopped by an obstacle in the channel, fire should be con-

centrated upon it, for the reason that in this position it is most liable to be disabled, and, being disabled, will embarrass the remainder of the fleet and tend to frustrate the plans of the enemy.

To guard against ships taking advantage of night to run by a work, the guns should be trained upon the channel-way, preferably that portion exposed to enfilade fire, and the traverse circle so marked that the pieces can be readily aimed after each discharge. The marking should be done in such a manner as to be readily used in the dark. This may be effected by placing a straight-edge against one side of the fork of a traverse-wheel, and making a nick in the traverse circle with a cold-chisel; the straight-edge placed in the same position will show when the gun has the same direction. The chances of hitting a vessel being greatly diminished by darkness, it is most advantageous under such circumstances to use shells. This kind of firing carries with it at night a peculiar moral effect which may greatly interfere with the navigation of the vessel. When the vessel arrives within easy range, round shot, fired in ricochet, will be found effective.

593. *Mortars against iron-clads.* Vertical fire is effective when it is desirable to prevent an enemy from occupying certain anchorage. The deck of a ship is as completely vulnerable to falling shells as the bottom is to submarine mines and torpedoes. Judiciously-placed batteries, if armed with a sufficient number of mortars throwing showers of shells, would make it perilous for an enemy to remain within their reach. But mortar firing from smooth-bore mortars is at best somewhat wild, and depends on quantity for its effectiveness. It is, however, safe to say that no fleet nor vessel can remain under well-directed fire from heavy mortars. A battery of one hundred heavy mortars will keep at bay all the iron-clads that can manœuvre or anchor within their range. The moral effect of mortar firing is appalling, and increases vastly with the numbers of mortars used.

The armor that a vessel is capable of carrying on her deck, in addition to that upon other parts, is not sufficient to resist the crushing power of a 13-inch shell with maximum velocity—419 feet per second. The 10-inch mortar is serviceable only against unarmored decks, or those very slightly protected. In firing at iron-clads the shells should not burst before striking; in fact, it is best to fill the shells with sand instead of powder. Solid shot would be preferable to either.

Mortars mounted on the centre-pintle traversing chassis, and provided with the pointing apparatus described on page 64, are capable of following the course of a moving vessel with the same facility as a gun.

Part Seventh.

FIELD INTRENCHMENTS.

594. In active service it is frequently necessary for artillery troops to construct works for the emplacement of their weapons. Such troops should therefore be instructed in the art of selecting sites, laying out and erecting batteries, magazines, bomb-proofs, traverses, and other works immediately connected with the efficient service of their special arm.

When positions are to be taken up and lines of intrenchments or detached works are to be constructed, it is the duty of artillery officers, in coöperation with those of engineers, to select positions for batteries and determine the kind and amount of armament therefor. It is therefore necessary that they should be thoroughly conversant with the principles of military engineering, especially those of *field intrenchments*.

The object of every fortification is to shelter the troops occupying it from the view and fire of an assailant, and at the same time to afford them a commanding view and sweeping fire over their enemy.

Earth is the principal material employed on land for resisting the fire of artillery. Wood, iron, and masonry are used in conjunction with it, principally for sustaining purposes.

As a material for fortifications, earth possesses advantages over all other, in being found ready at hand in almost all localities where wanted for such purposes, in being easily handled, and in possessing unrivaled properties of resistance as a covering mass against projectiles.

595. Penetration. At moderate distances there is but little difference between the penetrating power of rifle and smooth-bore guns throwing projectiles of equal weight; but as the rifle has great superiority in range, its penetrating power at long distances greatly exceeds that of the smooth-bore.

The following tables, the result of actual firing, show the maximum penetration, for various calibres, in different earths, and convey a good idea of the enormous power of modern artillery.

Since the dates of these firings, great improvement has been made in the character of powder used with the heavier classes of guns, whereby much larger charges are used and greater range and penetrating energy gained.

In a bluff bank of natural soil of clay and sand.

| KIND OF PIECE. | CALIBRE. | WEIGHT OF PROJECTILE. | CHARGE OF POWDER. | RANGE. | PENE-TRATION. | DATE. |
|-------------------------|----------|-----------------------|-------------------|--------|---------------|-------|
| | Inches. | Pounds. | Pounds. | Yds. | Feet. | |
| 100-pdr. rifle (Par't.) | 6.4 | | | 1800 | | |
| Solid shot..... | | 98.5 | 10 | | 15 | 1863 |
| Siege gun (rifle.)..... | 4.5 | | | 1800 | | |
| Shell..... | | 27 | 3.5 | | 11 | 1863 |
| Brooks rifle..... | 7 | | | 2700 | | |
| Shell..... | | | | | 16 | 1864 |
| Parrott rifle..... | 12 | | | 200 | | |
| Solid shot..... | | 597 | 35 | | 31.5 | |

In a well-settled parapet of clay and sand.

| KIND OF PIECE. | CALIBRE. | WEIGHT OF PROJECTILE. | CHARGE OF POWDER. | RANGE. | PENE-TRATION. | DATE. |
|-------------------------|----------|-----------------------|-------------------|--------|---------------|-------|
| | Inches. | Pounds. | Pounds. | Yds. | Feet. | |
| 100-pdr. rifle (Par't.) | 6.4 | | | 383 | | |
| Solid shot..... | | 98.5 | 10 | | 18 | 1863 |
| Shell..... | | 92 | | | 16 | 1863 |
| 30-pdr. rifle (Par't.) | 4.2 | | | 383 | | |
| Solid shot..... | | 30.5 | 3.5 | | 12 | 1863 |
| Shell..... | | 27.5 | | | 12 | 1863 |
| 20-pdr. rifle (Par't.) | 3.67 | | | 383 | | |
| Solid shot..... | | 16 | 2 | | 10 | 1863 |
| Shell..... | | 14.25 | | | 9 | 1863 |
| 10-pdr. rifle (Par't.) | 3 | | | 383 | | |
| Shell..... | | 10.6 | 1 | | 10 | 1863 |

In a parapet of pure quartz sand, well rammed.

| KIND OF PIECE. | CALIBRE. | WEIGHT OF PROJECTILE. | CHARGE OF POWDER. | RANGE. | PENE-TRATION. | DATE. |
|----------------------|----------|-----------------------|-------------------|--------|---------------|-------|
| | Inches. | Pounds. | Pounds. | Yds. | Feet. | |
| U. S. rifle..... | 12 | | | 175 | | |
| Solid shot..... | | 630 | 70 | | 20 | 1867 |
| Shell..... | | 485 | | | 18 | |
| U. S. rifle..... | 10 | | | 400 | | |
| Solid shot..... | | 298 | 30 | | 15.1 | 1866 |
| Shell..... | | 266 | 25 | | 16.1 | |
| U. S. rifle..... | 8 | | | 400 | | |
| Solid shot..... | | 141 | 14.5 | | 14.1 | 1866 |
| Shell..... | | | | | 11 | |
| U. S. smooth-bore... | 15 | | | 200 | | |
| Solid shot..... | | 451 | 100 | | 22 | 1867 |

In a parapet of clay, well rammed.

| KIND OF PIECE. | CALIBRE. | WEIGHT OF PROJECTILE. | CHARGE OF POWDER. | RANGE. | PENE-TRATION. | DATE. |
|----------------------|----------|-----------------------|-------------------|--------|---------------|-------|
| | Inches. | Pounds. | Pounds. | Yds. | Feet. | |
| U. S. rifle..... | 12 | | | 175 | | |
| Solid shot..... | | 625 | 70 | | 36 | 1867 |
| Shell..... | | 485 | | | 34 | |
| U. S. smooth-bore... | 15 | | | 175 | | |
| Solid shot..... | | 450 | 100 | | 38 | 1867 |
| Shell..... | | 330 | 55 | | 24 | |

In a parapet of clay and sand, well rammed.

| KIND OF PIECE. | CALIBRE. | WEIGHT OF PROJECTILE. | CHARGE OF POWDER. | RANGE. | PENE-TRATION. | DATE. |
|-------------------------|----------|-----------------------|-------------------|--------|---------------|-------|
| | Inches. | Pounds. | Pounds. | Yds. | Feet. | |
| U. S. rifle..... | 12 | | | 175 | | |
| Solid shot..... | | 625 | 70 | | 34 | |
| 200-pdr. rifle (Par't.) | 8 | 150 | 18 | 24 | 18.5 | |
| U. S. smooth-bore... | 15 | | | 175 | | |
| Solid shot..... | | 450 | 100 | | 22 | 1867 |

English guns.

| KIND OF PIECE. | Parapet of clay and sand, well rammed. Range, 1060 yds. | | Natural bank of clay and sand. Range, 1060 yards. | | Calibre. In. | | | | |
|----------------------|--|--------|--|--------|---------------------|-----|-----|-----|------|
| | Shot. | Shell. | Shot. | Shell. | | | | | |
| | Ft. | In. | Ft. | In. | Ft. | In. | In. | | |
| 100-pdr. Armstrong. | 21 | 3 | 16 | 8 | 10 | 3 | 10 | 5 | 7.09 |
| 70-pdr. Armstrong... | 14 | 4 | ... | ... | 5 | 9 | ... | ... | 6.48 |
| 40-pdr. Armstrong... | 14 | 11 | 11 | 8 | 7 | 2 | 5 | 9 | 4.84 |
| 20-pdr. Armstrong... | 10 | 10 | 11 | 1 | 4 | 7 | 5 | 5 | 3.84 |
| 12-pdr. Armstrong... | ... | ... | 4 | 0 | ... | ... | 2 | 7 | 3.07 |
| 10-inch smooth-bore | ... | ... | 11 | 5 | ... | ... | 6 | 7 | 9.84 |
| 8-inch smooth-bore.. | ... | ... | 11 | 6 | ... | ... | 4 | 10 | 7.85 |
| 68-pdr. smooth-bore. | 19 | 11 | 14 | 10 | 9 | 3 | 7 | 6 | 7.85 |
| 32-pdr. smooth-bore. | 13 | 0 | 9 | 5 | 3 | 9 | 2 | 8 | 6.17 |

The foregoing tables, both American and English, are abstracts from many shots, from which it will be seen that, even with smooth-bores, penetration is quite variable. It will be observed also that there is a great difference in the resisting properties of the various earths, pure clay possessing the least and sand the greatest. It may here be stated that the resistance of dry sand is slightly greater than that of wet, and dry clay very much greater than moist.

Spherical projectiles are much more uniform in penetration than elongated. With the latter, it depends in a great degree upon the direction preserved by the axis of the shot; when this remains so that the projectile strikes directly, point foremost, the penetration is greatest, but a very slight object will frequently cause it to turn while penetrating, and thereby diminish the penetration, sometimes nearly one-half. When the medium is homogeneous, the tendency of the projectile after entering it is to turn to the right or in the direction of the twist, to curve upwards, and to lodge with the base towards the left. After the primary impact it does not, as a general rule, continue to penetrate point foremost; this, in earth, causes it to have a ploughing effect not possessed in so great a degree by spherical projectiles. Percussion shells attain fully three-fourths of their entire penetration before bursting. Time-fuses, unless protected by water-caps, are liable to be extinguished upon entering earth. Percussion shells should, therefore, be preferably employed against magazines, where, by entering and bursting, they will cause an explosion.

As a general rule, penetration, both for smooth-bores and for rifles, increases with the calibre of the piece and the weight of the projectile.

The craters formed by the explosion of shells are much greater in clayey earths than in sand. In fact, but little impression is made on the latter, as the sand, when thrown up by the explosion, settles back almost in its former position.

The ratio of increase of craters is generally in excess of the increase of weight of the shells or of the bursting charges. A rifle projectile tears a long furrow previous to explosion, scattering the earth to either side, and on bursting uplifts and displaces a large mass of earth, whereas spherical shells merely bury themselves and raise up a comparatively small quantity of earth, the larger portion of which falls back into the crater. Hence the rifle is superior to the smooth-bore for demolishing earth-works.

When a projectile, spherical or elongated, strikes a slope, as, for instance, the superior slope of a parapet, and takes a direction approximately parallel to it, it makes an *open* furrow, provided the depth below the surface is not greater than about four times the diameter of the shot. This indicates, what experience has proved, namely, that the best method of breaching earth-works is to direct a concentrated fire of shells from rifle guns, with full service charges, upon the parapet in such manner as to cut it gradually down from the superior slope to the base. The great accuracy of rifle guns enables this to be done. The shells, after having performed their work in the parapet, send their fragments beyond and carry destruction to the interior of the work. A few heavy pieces are far more effective in accomplishing this object than a greater number of smaller calibres, although the aggregate of metal thrown may be in favor of the smaller guns.

In this connection it may be mentioned that a vigilant and active garrison, by taking advantage of the darkness of night, will repair an earth-work faster than the most powerful artillery can reduce it. Nevertheless it is possible to maintain such a fire during the day as will cut down the parapet and uncover the interior of the work sufficiently to allow of the destruction of magazines, bomb-proofs, and other arrangements for defense not so readily repaired, and the destruction of which may eventuate in the loss of the work.

For the purpose of retarding as much as possible repairs during the night, the assailants should maintain upon that part of the work a constant shower of shells from mortars.

596. To provide a safe margin against the cutting-down effect of the enemy's fire and to preserve the interior revet-

ments of a work from destruction or injury by the impact of shot or explosion of shells, the epaulment must be made considerably thicker than the actual penetration of the projectiles used against it. Formerly this additional thickness was put down at one-half, but this is manifestly greater than is necessary for the artillery now in use.

An addition of one-third of the maximum penetration is ample. Assuming this as the rule, parapets constructed of ordinary earth—*i. e.*, clay and sand mixed and well rammed—should have the following thicknesses: *Range 1500 yards*—To resist 12-inch rifle, 45 feet; 10-inch rifle, 35 feet; 8-inch rifle, 25 feet; 6.4-inch rifle, 22 feet; 15-inch smooth-bore, 30 feet. *Range 1000 yards*—To resist 4.5-inch rifle, 16 feet; 3.67-inch rifle, 15 feet; 3-inch rifle, 14 feet.

For parapets constructed of sand: *Range 1500 yards*—To resist 12-inch rifle, 30 feet; 10-inch rifle, 25 feet; 8-inch rifle, 20 feet; 6.4-inch rifle, 18 feet; 15-inch smooth-bore, 25 feet.

Common earth, (mixture of clay and sand,) loosely thrown up, offers much less resistance to penetration than when settled; with sand the difference is not so great.

Interior revetments of ordinary thickness, whether of masonry, sods, or gabions, give but little additional resisting power to a parapet, and should not therefore be taken into account when estimating its thickness.

From experiments made for the purpose of determining the best form and dimensions for masonry breast-height walls, it was found that 15-inch smooth-bore projectiles fired at a butt 200 yards distant, after passing through 20 feet of well-rammed sand, overturned a wall of best-laid granite masonry $\frac{1}{2}$ feet thick and 5 feet high. The penetration was but little inferior to that of similar shot fired into unsupported sand. The projectiles, although not coming in actual contact with the wall, (in most instances lodging several feet from it,) transmitted the force of their impact through the intervening sand, each one forcing the wall more and more from the perpendicular, until at the sixth it fell bodily.

With a parapet of 12 feet of well-rammed sand against a breast-height wall of concrete 6.5 feet high, 5 feet thick at top and 7 feet 2 inches at bottom, projectiles from the same gun, with a range of 430 yards, demolished the wall; not, however, as in the preceding case, by overturning it, but by cracking and crumbling it. In this case the shot penetrated to the concrete and destroyed it by direct impact.

With a parapet of 9 feet of sand against a concrete breast-height wall 8 feet thick at top and 10 feet 2 inches at bottom,

projectiles from a 12-inch rifle, at a range of 430 yards, demolished the wall in a manner similar to the foregoing case.

With a parapet of 7 feet of sand against a concrete breast-height wall 10 feet thick at top and 12 feet 2 inches at bottom, projectiles from a 15-inch smooth-bore gun (the range being as above) cracked the wall, but did little or no other damage to it.

In these experiments it was demonstrated that when the wall is stout enough to resist the projectiles, the latter invariably glance upwards and, passing out through the interior crest, fall within the parapet at distances varying from a few yards up to a thousand or more. After thus glancing they are still capable of doing considerable damage to the interior of a work.

These facts go to prove that however massive a sustaining wall may be, there should be sufficient earth in front of it to arrest the projectiles the same as though there were no wall at all. Hence it will be economy of labor, material, and space to have revetments as slight as is consistent with the object of holding up the earth of the parapet.

597. *Penetration of shells from mortars.* In sand and in compact clayey earths, such as would generally be employed for the coverings of magazines and bomb-proofs, the penetration of mortar shells falling with maximum velocities is about three-times their diameters; but in order that the lining of the magazine or bomb-proof may not be injured by their impact, double this thickness should be given.

Shells fired from guns at high elevation possess many of the properties of mortar shells; but as the velocity is much greater, the penetration also is greater, and their effect upon striking is more destructive; consequently, additional thickness of earth is required for magazines and bomb-proofs exposed to this kind of fire.

In clayey earth the mouth of the crater formed by the explosion of a mortar shell is about four times the diameter of the shell; in sand it is considerably less.

The maximum velocity of a descending mortar shell is 419 feet per second, or about one-third that of the striking velocity of projectiles fired from guns at ordinary distances. This accounts for the comparatively small penetration of the former.

Shells of any kind striking on marshy ground bury themselves so deeply as to produce but little effect by explosion.

598. *Penetration of rifle-musket.* Recorded experiments give somewhat conflicting results on this head, but, to be on the safe side, the following thicknesses appear to be needful to give security against infantry fire: Clay, loosely thrown up, 4 feet; sandy or gravelly earth, loosely thrown up, 3 feet; sand-bags

filled, 1.25 feet; gabions (wicker), filled with earth, 1.75 to 2 feet; pine (soft), 16 to 18 inches; oak and elm (green), 6 inches; ash (green), 4.5 inches; sap-roller and fascines (green), 12 to 15 inches; brick-work, 4.5 inches; boiler-plate, $\frac{1}{8}$ inch.

The above are for distances not exceeding 100 yards; beyond that, penetration diminishes rapidly with the range. At a distance of twenty yards a rope mantlet 4 inches thick is proof against a rifle-musket shot. As weight is a consideration in mantlets, they need not be given a greater thickness than this to insure all necessary security from such fire.

599. Field intrenchments may be classified as follows: 1. Intrenched camps; 2. Intrenched lines of battle; 3. Detached works; 4. Lines of works; 5. Works auxiliary to permanent fortifications; 6. Works for siege operations.

600. So far as artillery is concerned, the first object to be considered is position, the general principles of which are the same for each of the above classes, and which may be briefly stated as follows:

1st. Artillery should, if possible, overlook all the ground within range over which an enemy might advance, and the pieces be so placed as to sweep the entire surface with their fire, those of longest range occupying the most commanding positions.

2d. All the lines of approach of the assailant should be swept not only by the frontal, but by the flank or cross-fire of the assailed.

3d. The features of the ground should screen the assailed from the assailant's view, and afford cover from his fire whilst that of the assailed can be delivered with full effect.

4th. The position should, if possible, present natural obstructions to the advance of the assailant.

5th. It should offer no obstructions to the free movements of the assailed, either for the offensive or defensive, and should afford facilities for active offensive movements at the opportune moment.

6th. It should have secure supports, both on its flanks and in the rear.

7th. It should afford every convenience for encamping and being supplied.

601. *Intrenched camps.* Troops, when within striking distance of the enemy, should, to avoid the consequences of a surprise, be encamped always in order of battle. The modern practice of armies is to intrench, if encamped even for one night. Such intrenchments are usually of the slightest and most hastily-constructed kind, merely sufficient to afford shelter against a night attack. The artillery in this case is only that usually ac-

companying troops on the march, and for it gun-pits will suffice. These are made by simply throwing up the earth in front of each piece so as to form for it a crescent-shaped epaulment. If rails or any similar material are convenient, a slight revetment may be constructed to support the earth on the side towards the piece. In dry weather the earth may be dug from the inside and thrown up in front, thus forming a depressed position or hole for the piece to stand in. The chest of the limber will hold sufficient ammunition for immediate use. To protect it, the limber is turned with its pole *from* the piece, and is covered with an epaulment similar to that for the gun; or, removing the horses, it may be backed up near to and on one side of the piece, occupying with the latter a portion of the gun-pit. The caissons, horses, and other material of the battery may be placed in some sheltered position a little way to the rear. The positions occupied by artillery on such a line ought to be those that would be selected for it on any well-arranged line of battle.

When, in consequence of attack by the enemy, or of his threatening attitude, the army stands upon the defensive, the slight intrenchments of a temporary camp are increased and strengthened until they become a strong *intrenched line of battle*.

602. The gun-pits, which before were separate for each piece, are now united by a continuous epaulment, and an interior revetment of logs, rails, watling, or sods is given to it. All woods within musket range in front of the line are slashed, for the double purpose of destroying them as cover for the enemy and for transforming them into an entanglement difficult for him to pass. This work is done by the infantry, the artillery having its full share of labor in intrenching the batteries.

An army taking up a defensive position, intrenches itself in the manner above described. When such a line is attacked, and the assault is repulsed, the assailing force falls back to the nearest cover, and there, hugging the ground closely, usually intrenches itself. To accomplish this, the men use their bayonets, tin cups, or in fact anything for loosening and throwing up the soil. Only a few minutes are thus required by veteran soldiers for covering themselves. This line grows by degrees into a formidable epaulment, along which, in positions the most advantageous, the discomfited assailant places his artillery, the intrenchments for which are similar to those just described.

In these positions the opposing forces remain, usually expending, without much effect, a large amount of ammunition, until one or the other withdraws for the purpose of making a new move. The operation of withdrawing is one of great delicacy,

and is generally performed at night with all possible secrecy. The artillery commanders at such times have to exercise great care and foresight, that their batteries may take the proper routes and not obstruct their own movements or those of other troops. An officer from each battery should make himself familiar with the road to be taken by it, and act as its guide.

603. *Detached works* are those that are situated beyond the range of fire of any other works, and which, for their security, have to rely upon their own strength and resources.

The object of such works is to defend and hold isolated points that are of importance; such as railroad or other bridges, mountain passes, narrow defiles, fords, points upon rivers to close them against the passage of hostile vessels, &c. The character and extent of a work of this class will depend upon the degree of importance attached to the object for which it is constructed, the amount of force available for its occupancy, and the nature of the locality. In every instance, artillery would form an important element in its means of defense, and the position of the work should be selected so as to allow free use of it.

Works of this kind may be classified under three heads:

1st. Those which, being secure on the flanks and in the rear, are assailable only in front. Under this class may be placed open batteries located on the banks of rivers, or at the entrance of harbors, to prevent the passage of an enemy's vessels.

2d. Those which are assailable in front and on the flanks, but not in rear.

3d. Those which are assailable on all sides.

604. *First class.* This is applicable to narrow defiles where the flanks are secure against being turned. (*Fig. 1, Plate 57.*)

When the width of the defile is not greater than 1800 yards, the line may be a straight one (A B) for infantry, with short advanced lines on the flanks, as represented in the figure, for artillery. Should the conformation of the ground be not suitable for placing artillery precisely as represented in the figure, then the most commanding position on some other part of the line will be selected for it, bearing in mind always to secure as far as possible cross-fire over the ground in front. When the defile exceeds 1800 yards in width, a *crémaillère* or *serrated* line is adopted, and on it the artillery is disposed as represented in *Fig. 2, Plate 57.*

605. *Second class.* The plan of works of the second class admits of great variety, depending on the extent of the position. The most simple is that of a work of only two faces, the salient being towards the assailant's line of approach. This work is termed a *redan*. (*Fig. 3, Plate 57.*) A B, gorge; A C and B D, faces; C D, *pan-coupée*; B E, a small flank sometimes used.

The faces should receive such direction as to sweep the approaches to the flanks of the position. As many pieces as possible are placed in the salient, and others disposed along the faces in the most commanding positions for sweeping the ground in their front. The angle formed at the salient by the faces should never be less than 60° . *This rule is general for all salients.*

606. When the flank approaches extend somewhat to the rear, (as in *Fig. 4, Plate 57,*) a flank is added to each face of the redan; it then becomes a *lunette*. The flanks receive such directions as will sweep by their fire that portion of the flank approaches which cannot be reached from the faces except by a very oblique fire. BC and CD are the faces; AB and DE, the flanks.

The artillery is placed in position at the salients, in each of which is a *pan-coupée*.

607. *Third class.* The works comprised in this class are termed inclosed works; as, being assailable on all sides, they must, for security, present a complete line throughout to any assault.

These works may be divided into three orders: 1st. *Polygonal works, or redoubts*; 2d. *Tenailed works, or star forts*; 3d. *Bastioned works.*

608. *Redoubts.* These are polygonal figures having any number of sides; and when the site is horizontal, or sensibly so within cannon range, there is no reason for adopting any other than a *regular polygon* for a plan. The most simple, and the one usually taken, is the square, (*Fig. 5, Plate 57,*) the angles of which are formed into *pan-coupées* for the reception of artillery.

The size to be given to a redoubt, or generally to any inclosed work, will depend upon the number of men available for its defense, taking it as an established rule that it is better to have a force concentrated than too much distributed, and therefore injudicious to make works of a greater extent than can be well manned and vigorously defended. The number of men will depend upon the particular circumstances of the case; as, for instance, its situation with regard to distance from the enemy; whether it is likely to be attacked by a powerful force or only by raiding parties; whether it is of such vital importance as to require it to be held at all hazards, and its distance from supporting force.

609. *Strength of garrison.* One double-rank file—that is, two men—is required for the defense of every lineal yard of parapet; the number of yards in the crest-line of any redoubt should not, therefore, exceed half the number of men to be con-

tained in it. This number makes allowance for the sick and the various details and duties which deplete the effective strength of garrisons.

For the actual defense of lines, with modern arms, one man per lineal yard is ample.

Every man in an inclosed work requires for lodging-room 3 square yards of the interior space; that space, clear of the banquette, magazines, gun spaces, and traverses, must not therefore contain less than three times as many square yards as the number of men to be contained in it. From these considerations it follows: 1st. To find the least number of men sufficient to man the parapet of an inclosed work, multiply the number of yards in the crest-line by 2. 2d. To find the greatest number of men that an inclosed work can accommodate, find in square yards the area, clear of the banquette, magazines, and traverses, and divide this number by 3.

Each gun requires 300 square feet; this multiplied by the number of guns must be subtracted from the whole interior space.

In estimating for the number of men required for any given length of interior crest-line, no account is taken of the space taken up by guns, as the number of men required for each piece is about equal to the infantry allowance, *i. e.*, two for each lineal yard occupied by the piece.

The minimum length of side for a square redoubt capable of holding artillery is 40 yards; this gives a work capable of containing one field-piece at each angle and about 250 men.

The redoubt has sectors without fire, except that delivered from the *pan-coupées*, and is without flanking arrangements.

610. *Star forts.* A star fort in plan consists of a polygon having alternately salient and reëntering angles. The object of this disposition is to obtain cross-fires on the approaches to the salients. The simplest form of the star fort is planned by placing redans on the middle of the faces of a square redoubt; (*Fig. 6, Plate 57,*) thus giving alternate salients of 90 degrees and 60 degrees. *A B C D*, square redoubt; *a b c d*, redans.

The guns would naturally occupy the *pan-coupées* of the attached redans, and likewise those of the square. The star fort, from its imperfect flanking dispositions, is but little, if at all, superior in strength to the redoubt. For the same interior space for the uses of the garrison, the star fort presents a much longer line of parapet to be defended than the redoubt. It is therefore only on irregular sites or broken ground that application of it will be found advantageous.

Remarks.—Since the introduction of modern improved arms,

but little regard has been given to flanking arrangements in field-works, experience having developed the fact that they are of very little practical advantage. Lines and groups of works are now laid out so as to cover each other by flank and cross-fire.

A work entirely detached should, however, have within itself flanking arrangements.

611. *Bastioned forts.* The bastioned fort has been devised to remedy the defective flanking dispositions of the preceding classes of works.

This fort may consist of a polygon of any number of sides, but for field forts the square and pentagon are generally preferred, on account of economy of labor in construction. To plan a work of this kind, a square (A B K, &c., *Fig. 1, Plate 58*) or a pentagon is laid out, and the sides bisected by perpendiculars; a distance (C D) equal to one-eighth of the side is set off on the perpendicular in the square, or one-seventh in the pentagon; from the angular points of the polygon, lines (A G and H B) are drawn through the points thus set off; these lines give the direction of the *lines of defense*; from the salients of the polygon distances (A E and F B) equal to two-sevenths of the side are set off on the directions of the lines of defense, giving the *faces*; from the extremity of the faces the *flanks* (E H and F G) are drawn perpendicular to the line of defense of the other face of the same front; the extremities of the flanks are connected by a straight line termed the *curtain*.

A B is the exterior side; H, the angle of the curtain; C D, the perpendicular; H B, the line of defense; A, the salient angle; A E, the face; F, the shoulder angle; E H, the flank; B P, the capital; H G, the curtains; G O, the gorge of bastion; C A E, the diminished angle.

The side of the polygon is termed the *exterior side*; the line bisecting it, the *perpendicular*; the angle at the salient is the *flanked angle*; the one formed by a face and flank, the *shoulder angle*; the one between the flank and curtain, the *angle of the curtain*; the line bisecting a bastion, the *capital*; the portion of the work included between the capitals of two adjacent bastions is denominated a *bastioned front*, or simply a *front*; the interior space of the work not included in the bastions is called the *parade*.

Remark.—The foregoing nomenclature applies also to permanent works. In the latter class the parapet is generally much above the parade. The space behind the parapet for the accommodation of the guns is termed the *terre-plein*, which is united with the parade by earthen slopes or vertical walls. Communication with the parade and terre-plein is generally provided for

by means of roadways termed *ramps*. The whole mass of structure thus raised above the parade is called the *rampart*.

An examination of the arrangement of a bastioned front shows that there are neither dead angles nor sectors without fire; that the salients, and all the ground within range of fire, are protected by columns of direct, flank, and cross fire.

Permanent fortifications are, when the site admits of it, constructed on the bastioned-front principle, and generally have auxiliary outworks, which are usually omitted in field-works. The object for which permanent works are erected is to afford a powerful artillery fire, and the entire interior crest may, therefore, be occupied by cannon. In field-works the proportion of artillery is less, and is usually disposed of by placing a piece in each *pan-coupée*, two or more on each face and one on each flank, leaving the curtains entirely free for infantry. Siege howitzers, when used, are placed on the flanks, where their capacity for firing canister is most serviceable in sweeping the ditch in front of the opposite face. Machine guns occupy a like position.

The sides of the polygon upon which a bastioned fort is laid off should not exceed 600 yards, nor be less than 125 yards. If greater than the former, the range from the flanks will be too great to cover properly the salients of the bastions; if less than 125 yards, the flanks will be too short for efficiency, and the bastions too restricted in space for artillery.

Calling the exterior side *X*, the parts of the front will be as follows:

| | | | |
|-----------------|------------|-------------------|---------------|
| Line of defense | =0.71804 X | Diminished angle | =14° 2' 10'' |
| Face . . . | =0.2857 X | Salient angle . . | =61° 55' 40'' |
| Flank . . . | =0.10808 X | Shoulder angle . | =118° 4' 20'' |
| Curtain . . | =0.39320 X | Curtain angle . | =104° 2' 10'' |
| Gorge . . . | =0.18279 X | | |

The entire front is equal to *X* multiplied by 1.1824.

With a pentagon the above numbers are slightly changed, but so slightly as to make no appreciable difference when estimating the dimensions of the sides of a polygon for a bastioned work to accommodate a specified number of men. In making an estimate for the number of men required to man the parapet of a work, no allowance is made for the space occupied by guns; this, for the reason that the number of men so required is about equal to that of infantry for the same space; that is, two men for each lineal yard of interior crest.

The foregoing is expressed by
$$X = \frac{F}{S \times N \times 1.1824}$$

In which *F* = the number of men; *S* = the number of sides

of the polygon; and N = the number of men per yard of interior crest; X being, as before, the exterior side.

In actual field service, it seldom happens that the ground will admit of a bastioned work constructed on a regular polygon; but whatever it may be, the foregoing principles will apply and give a close approximation to the size of the required work.

To ascertain the number of men required to man a given work, measure the interior crest (in yards) and multiply by 2.

Allowing two men for each yard of parapet, the exterior sides of a square bastioned fort to accommodate 4000 men would be 422.8 yards.

A fair proportion of artillery for a work requiring 4000 men would be 36 guns, disposed of as represented in the figure—*i. e.*, one in the salient of each bastion; one on each flank; one in the shoulder angle, and two on each face.

A bastioned work constructed on a square of 125 yards will accommodate about 1180 men and an armament of 8 pieces.

612. For ordinary field-works the pieces would generally be those on traveling carriages, and consequently readily moved from one part of the work to another, as required by the nature of the attack. As a general rule, the heaviest pieces would be placed in the salients, and howitzers, if used, in the flanks to sweep the ditch with canister.

Machine guns are especially adapted to the defense of field-works, and should never be omitted as part of the armament. Being breech-loading and easily handled, they require but little exposure either for themselves or the cannoneers. The oscillating apparatus with which they are provided allows the fire to be delivered in a horizontal line, which is superior to the cone of dispersion of canister from howitzers or guns. When practicable, the machine gun should be fired from a platform; but as the piece is light and the recoil small, the platform may be slight and laid without counter-slope. As a general rule, all platforms for pieces on traveling carriages should be laid horizontally, as this enables them to be fired in any direction with equal facility. A bag of earth placed at a proper distance behind each wheel will check recoil.

Since the fire of the Gatling gun is that of infantry alone, its introduction should not diminish the amount of artillery properly requisite for a work. Machine guns may partly replace infantry, but not artillery.

Whenever practicable, mortars should constitute a part of the armament of field-works. These should be placed in such positions, usually behind traverses, as not to prevent, by their blast,

any portion of the parapet from being occupied by guns or infantry.

In actual service it seldom occurs that the configuration of the ground admits of works being laid out with the exact dimensions and figures above described. These are intended to illustrate general principles capable of being modified and adapted to suit each particular case. The plan of the work should be adapted : 1st. To the natural form of the site, taking advantage of all undulations to diminish the labor of construction ; 2d. To the object in view ; 3d. The time available for construction and the number of men to form the garrison.

The prolongation of all the principal lines of a work should be directed as much as possible on ground inaccessible to the enemy, or at least where he cannot obtain an enfilade fire with his artillery.

When circumstances permit, a field fort should be constructed with such care that the enemy will be forced to abandon an attempt to storm it and be obliged to resort to the method of regular approaches used in the attack of permanent works. To effect this, no ground around the fort within range of cannon should offer shelter to the enemy from its fire ; the ditches should be flanked throughout, and the relief be so great as to preclude any attempt at scaling the work. Approaches to it, particularly on the salients, should be obstructed by abattis, fraise, wire entanglements, &c.

613. *Lines of works.* (Figs. 2 to 5, Plate 58.) When it is necessary to hold for a time a line of considerable extent by a force inferior to that which may be brought against it, the line should be fortified by intrenchments, consisting of a series of works laid out according to the foregoing principles. The kind of work for any particular position on the line will depend upon the nature of the locality it is to occupy and the manner in which it will combine with those adjacent in securing mutual support throughout. Such lines are frequently from fifteen to twenty, or even thirty miles in length, extending over every variety of country, and in their construction call for the highest skill in military engineering.

They are constructed, usually, either for the protection of important towns, cities, and depots ; or to make secure the base of operations and lines of communications of an army manœuvring in the field ; or, by stretching across peninsular regions, to restrict the theatre of operations of the enemy ; or for surrounding and besieging a place ; or for the purpose of holding the enemy in position with a part of an army while the remainder makes a flank or other strategic movement. The civil war

of 1861-65 afforded numerous instances of each of these conditions.

The same general principles apply to lines as to other field-works; but from their great extent they usually receive only a slight relief, and the simplest angular figures are adopted for their plan. In laying them out, advantage should be taken of all the natural features presented by the position, so as to diminish the labor of erecting artificial ones.

The flanks of a line or position are generally weak points. When possible, one or both should rest on natural points of support. A flank not so supported must be secured by strong works especially well garnished with artillery.

A point that has not a clear field of fire is a weak point, and should be strongly intrenched, so that the enemy may not have advantage of hills, ravines, or other shelters in approaching the line. Care should be exercised in determining the kind of artillery for such positions. The field of fire being contracted, long range is not of so much importance as ability to search behind the enemy's shelter, or to throw a great mass of projectiles in a limited time. Mortars, howitzers, and machine guns will be found serviceable.

In establishing a line of works, the main object should be to cover every portion of the front within range with direct or cross fire. To accomplish this, all prominent points along the line are fortified, each with a work having a trace most suited to the conformation of that particular site. The most important of these should be inclosed works upon the bastion-front principle, and of considerable size, capable of enduring an independent attack.

Smaller inclosed works, such as redoubts and star forts, occupy the secondary points. Between the works thus located extend *rifle-trenches* capable of sheltering infantry. The line is therefore composed of a series of works mutually supporting each other and covering every avenue of approach.

The artillery, of which there should be an abundance, will naturally be placed in the works occupying the most commanding and salient positions. These works should never be so far apart as to be out of mutual flanking range of the artillery with which they are armed. It is the duty of officers of artillery to coöperate with those of engineers in selecting the positions of the works that are to be armed with artillery, and to determine the kind and quantity to be placed in each.

As infantry troops constitute the chief garrison of works of this nature, they will be required to construct them, leaving to the artillery the construction of magazines, embrasures, plat-

forms, and other accessories pertaining to their special arm. Generally these works are thrown up very hastily, and often when an immediate attack is apprehended; this, to a considerable extent, decides not only the nature of the works, but the parts of them that require the first attention. Subsequently, if time permits, they are strengthened, improved, and worked into better shape.

As far as practicable, the line should be composed of inclosed works, for the reason that should the enemy concentrate and break through at any point, he will not be able to sweep the line to the right and left by taking it in flank and rear. To storm and capture each work in succession would be an operation too costly for him to undertake.

It is advisable in most instances to have in front of the line, within easy musket range, a line of small redans or lunettes at intervals of about 1500 yards. Each of these should be capable of holding from one to two hundred infantry and four to six field-pieces. This line of outworks would form, as it were, a species of picket line, keeping the enemy from closely observing and harassing the main line, and would constitute an advanced line of battle, against which the first shock of the enemy is partially thrown away, and he dare not attempt to neglect them; for an endeavor to penetrate through the intervals would expose his flanks to a close and deadly flank and cross fire. The redans being open towards the main line, could not be held if captured by the enemy.

A somewhat similar line of works should be established in rear of the main line. They should, however, have their gorges stockaded or otherwise closed to prevent the enemy, should he succeed in forcing his way through the main line, from obtaining easy possession of them by the rear. Sites for them should be selected with a view of obtaining from them a searching fire of the front line in reverse. This line of works, although apparently inert in rear, must be kept fully armed and manned, ready to drive the enemy from any part of the main line that he may succeed in obtaining possession of.

Prominent salients in the main line are especially inviting to the enemy; behind these a second line should be prepared, so placed, if possible, that should the enemy obtain the main line he will be within musketry range of the second, and be forced with wearied troops to undertake the capture of it.

614. An approximate estimate of the number of troops required to man such a system of intrenchments may be obtained by allowing 300 men per mile for the first or redan line, 4000 for

the main line, 300 for the rear line, and 1200 for reserves; making a total of 5800 per mile of actual fighting force.

The amount of artillery required will depend upon such circumstances as the kind employed; the kind and quantity brought up by the enemy; the nature of the country, and the quality of the troops on either side. From four to five pieces per thousand infantry is a fair estimate.

To break a line of works the enemy would secretly concentrate as powerful a force as possible and assault some particular part of the line. As it would be impracticable to have at every part of the line a force capable of successfully resisting such a concentration, the probabilities are that he would succeed in his assault, if vigorously made. To dislodge him from any portion he might thus capture, it is advisable to hold strong reserves of both artillery and infantry at central and convenient points in rear of the line of works. One reserve of say 5000 infantry and 20 field-pieces for each four miles of line would make it almost impossible for an enemy of ordinary strength to hold any part of it that he might capture. Telegraphic communication should be established from one reserve to another and to every part of the line. This would insure a prompt coöperation of all the forces.

In tracing field-works, care must be taken to direct, as much as possible, their faces upon ground least accessible to an enemy, so as to reduce to a minimum the effect of his enfilade.

615. When the importance of the case demands it and the means are available for carrying it out, lines of field-works sometimes assume—as was the case during the rebellion—a semi-permanent character. These are laid out with great care and constructed with skill and nicety; they are furnished with substantial and commodious magazines and bomb-proof; the slopes are sodded and the revetments constructed for endurance. Works of this character are frequently armed with the heaviest classes of ordnance, the emplacement, care, and preservation of which, together with the ammunition therefor, will be governed by the same rules as for permanent works.

616. The camps, parks, trains, hospitals, depots, &c., should be sufficiently far to the rear to be out of range from the fire of the enemy, and should have through communication to the various parts of the line by means of well-constructed roads. These roads should be laid out in such manner as to be, as much as possible, out of view of the enemy. The horses of the artillery in the works, with their drivers, and all parts of the batteries not absolutely required for the efficient service of the guns, should be encamped, as above, in rear. The cannoncers, offi-

cers, and non-commissioned officers will invariably remain in the works, ready for action at any moment.

617. *Distance of works from towns, cities, &c.* Rifled artillery, of large calibre, is capable of doing great damage to towns, cities, dock-yards, and other objects of large extent, up to a distance of five miles. A few pieces of enormous calibre have been constructed capable of throwing huge projectiles to a distance of about nine miles. These are, however, exceptions, and as they can be made available only by means of a certain class of almost impracticable vessels, it is not necessary, at present, to embrace them in this consideration. Five miles being the limit within which the enemy must not be allowed to establish his batteries, the distance of defensive works within this limit will depend upon the character and power of the artillery with which they can be armed. Heavy calibres are more capable of keeping an enemy at a distance than small calibres, and rifles are superior to smooth-bores. About two miles is the limit of effective range against ships of war, and beyond this distance it would be impossible to prevent an enemy from carrying on operations by land; this, therefore, is the maximum distance that it is admissible to subtract from the five-mile limit of the enemy. In other words, if an enemy is able to bring heavy rifle guns against a large object, as a city or a dock-yard, works for its protection should be at least three miles distant therefrom. No such area can therefore be surrounded and protected by a line of works of less extent than 18 miles; generally it would be much more, depending upon the size of the city, town, or other objects.

618. *Parapet.* In field fortifications the main features are the covering masses of earth of which they are constructed, and which are intended to shelter the assailed from the view and fire of the assailant. When the covering mass is so constructed as to afford the assailed a view and fire over the assailant's line of approach, it is termed a *parapet*; when intended simply as a screen or cover from the fire of the enemy, it is termed an *epaulement*; and when used to cover troops or guns from an enflading fire on the flank or in the rear, a *traverse*.

The simplest form of work is the *rifle-trench* or *pit*. (*Figs. 1 and 2, Plate 59.*)

In this, the parapet is formed by throwing the earth from a trench within to the front. The earth thus thrown up, together with the depth of the trench, affords the desired shelter. The troops stand or squat in the trench and deliver their fire over the bank of earth in front. This method of intrenching affords the speediest means of obtaining cover, and is the one resorted to when troops are under fire, or when they intrench their camp

or position for a temporary stay. Rails, logs, in fact, almost anything at hand may be used as a rough interior revetment for sustaining the earth. For artillery, the trench is made somewhat wider than is necessary for infantry.

619. In the more elaborate class of field fortifications, such as the inclosed works previously mentioned, the earth to form the parapet is taken from the exterior, thus forming in front of the parapet a ditch which makes a formidable obstacle in the way of an assailant attempting to enter the work by escalade.

Fig. 3, Plate 59, shows the usual form of the profile of such an intrenchment in ordinary soil.

B C D E F G, profile of parapet; H I K L, profile of ditch; M N O, profile of glacis; A B, terre-plein, or parade; B C, banquette slope, having a slope of one upon two; C D, tread of the banquette, having a slope to the rear of two inches; D E, interior slope, having a slope of three upon one; E F, superior slope, having a slope of one upon four to six; F G, exterior slope, having a slope of one upon one; G H, berm; H I, scarp, having a slope of about two upon one; I K, bottom of ditch; K L, counterscarp, having a slope of about two upon one; B, foot of the banquette slope; C, crest of the banquette; D, foot of the interior slope; E, interior crest; F, exterior crest; G, foot of the exterior crest; H, crest of the scarp; I, foot of the scarp; K, foot of the counterscarp; L, crest of the counterscarp; M, foot of the glacis; N, crest of the glacis; *a b*, thickness of the parapet. The tread of the banquette is placed 4 feet 3 inches below the interior crest.

The following table, giving the *slope* for various degrees of elevation, will prove useful.

By referring to tables of ranges, and bearing in mind that the angle of fall of a projectile is always greater than the elevation of the piece, the table will also afford useful suggestions and data with reference to defilading works.

In seeking protection from the fire of an enemy, either by natural or artificial cover, the *drop* of the projectile must be taken into account. This depends upon the range, kind of piece used, and nature of fire employed.

The table, furthermore, furnishes useful assistance, when studying defensive positions, as to locating batteries and determining the kind of artillery to be placed at the various points for reaching ground that may be occupied by the enemy, and which is sheltered by undulations or by timber growth from view from the work.

In connection with this, see *par.* 650 and tables of ranges for the 8-inch and 100-pounder rifles.

| ANGLE. | RISE. | ANGLE. | RISE. | ANGLE. | RISE. | ANGLE. | RISE. |
|--------|---------|--------|---------|--------|---------|--------|---------|
| Deg. | One on. | Deg. | One on. | Deg. | One on. | Deg. | One on. |
| 1 | 57.3— | 9 | 6.3+ | 17 | 3.2+ | 25 | 2.1 |
| 2 | 28.6+ | 10 | 5.7+ | 18 | 3.0+ | 26 | 2.0 |
| 3 | 19.0+ | 11 | 5.1+ | 19 | 2.9— | 27 | 1.9 |
| 4 | 14.3— | 12 | 4.7+ | 20 | 2.7+ | 28 | 1.85 |
| 5 | 11.4+ | 13 | 4.3+ | 21 | 2.6 | 29 | 1.80 |
| 6 | 9.5— | 14 | 4.0+ | 22 | 2.5— | 30 | 1.75 |
| 7 | 8.1+ | 15 | 3.7+ | 23 | 2.3+ | | |
| 8 | 7.1+ | 16 | 3.5— | 24 | 2.2 | | |

The dimensions of the parapet will depend upon the kind of earth used and the time and means that can be employed in its construction, together with the time that the work is to remain occupied, and, finally, with the time and means the enemy can dispose of in the attack, and the degree of resistance the work should offer. The relief, which is the vertical height ($E a$) of the parapet above the terre-plein, should not be less than 8 feet, and it will be seldom necessary or expedient to exceed 12 feet. Its thickness, which is the horizontal distance ($a b$) between the interior and exterior crests, is regulated by the kind of earth used and the kind of attack it is expected to meet. If it is to resist artillery, the thickness is that given in *par.* 596, in which the minimum is laid down at 14 feet.

The *relief* of a work, or of any part of a work, is its height above the ground on which it stands.

The *command* of a work is its elevation with reference to the surrounding country, especially that within striking distance, which may be occupied by an enemy.

620. Ditch. The dimensions of the ditch should be regulated to furnish the earth for the parapet. To present a respectable obstacle to the enemy, its depth, however, should not be less than 6 feet, nor its width at the top less than 12 feet. For approximate purposes, the dimensions of a ditch to supply earth necessary for a given parapet may be obtained by assuming the depth of the ditch and dividing the area of the profile of the parapet by it to obtain the width.

In turning the salients, keeping the dimensions of the ditch the same, there will be an excess of earth, — a circumstance which may be taken advantage of by making the parapet thicker in these parts. Due allowance must be made for this when laying out the work. The salients should always be the thickest and strongest.

621. Tracing. In laying out the figure of a work on the

ground, which operation is called *tracing*, the interior crest is taken as the governing line; all other lines are laid off with reference to it.

Profiling. The trace being laid off and marked by stakes at the angles, *profiles* of the parapet, (*Fig. 1, Plate 60,*) constructed of strips of light wood, are set up at the angles, and at other points along the parapet where long stretches of the latter occur. The method of establishing these profiles will readily suggest itself.

When strips of wood are not easily obtained, stout cord may be used instead, the cord being attached to the uprights at the points where the strips of wood are or would be nailed.

When a sufficient portion of the profiling is completed, working parties are set to work excavating the ditch and forming the parapet. The latter, as the work progresses, should be well rammed. If the soil is stony, the vegetable mould on the surface should be removed, and reserved to form the top of the parapet. This should always be free from stones to a depth of at least three feet, to prevent injury to the troops from the effect of shot striking and scattering the pebbles and fragments.

Those portions of an earth-work within effective range of the enemy's artillery, and upon the endurance and integrity of which depend the support and safety of valuable batteries or magazines, should be made strongest by additional thickness and height. The material and workmanship should be of the best quality.

It is almost impossible to make a breach in a work constructed of sand of sufficient thickness to prevent penetration through and through it and having flat slopes towards the breaching batteries of the assailant. In such cases the sand displaced by successive shots falls back again and again within the area attempted to be breached.

622. *Revetments.* A revetment consists of a facing of stone, wood, sods, or other material to sustain an embankment which has a slope steeper than the natural slope of the particular kind of earth used.

In field-works, revetments are used only for the interior slope of the parapet and for the scarp. For the first, sods, palisades, fascines, logs, gabions, and plank are chiefly used; and for the last, timber.

623. *Sod revetment.* Sod-work forms a strong and durable revetment. The sods should be cut from a well-clothed sward, with the grass of a fine short blade and thickly-matted roots. If the grass is long it should be mowed before the sod is cut.

The more tenacious the soil the better will be the sods. Those cut from sandy localities are of but little value.

Sods are of two sizes: one, termed *strechers*, are 12 inches square and $4\frac{1}{2}$ inches thick; the other, termed *headers*, are 18 inches long, 12 inches broad, and $4\frac{1}{2}$ inches thick.

The sod revetment (*Fig. 2, Plate 60*) is commenced as soon as the parapet is raised to the level of the tread of the banquette. A course of sods is then laid, either horizontal or a little inclined from the banquette. The course consists of two stretchers and one header alternating, the end of the header being laid to the front; the grass side is laid downwards, and the sods should protrude a little beyond the line of the interior slope, for the purpose of trimming the course even at top, before laying another, and to make the interior slope regular. The course is firmly settled by tapping with a spade each sod as it is laid, and the earth of the parapet is packed closely behind the course. A second is laid on the first so as to break joints with it. The top course is laid with the grass side up, and in some cases pegs are driven through the sods of two courses to connect the whole more firmly. When cut from a wet soil, the sods should not be laid until they are partially dried; otherwise they will shrink and the revetment crack in drying. In hot weather the revetment should be watered frequently until the grass puts forth. Sod revetment, on account of its durability and freedom from splinters, is the best of all revetments.

Log revetment. (*Fig. 3, Plate 60.*) This revetment is made of trunks of small trees or saplings laid horizontally one on the other and supported by posts set into the banquette. At frequent intervals tie beams are dovetailed between the logs, and, extending six or eight feet into the parapet, are secured to horizontal anchoring logs. For intrenchments hastily thrown up, this is the most usual form, rails or timber of any kind being used.

624. *Fascine revetment.* A *fascine* (*Fig. 4, Plate 60*) is a bundle of twigs closely bound together. There are two sizes of fascines: one size is 9 inches in diameter and about 10 feet long; the other, which is generally termed a *soucisson*, is 12 inches in diameter and 20 feet long. It is chiefly used for the revetments of batteries.

To make a fascine straight twigs are selected, between the thickness of the little finger and thumb,—the longer the better. They should be stripped of the smaller twigs. A support, termed a *fascine-horse*, (*Fig. 5, Plate 60.*) is put up by driving two stout stakes obliquely into the ground about two feet, so as to cross each other about two feet above the ground, where they

are firmly lashed together. As many of these supports as may be required are put up in a straight line, about 18 inches apart. This forms the horse, on which the twigs are laid to be bound together.

A machine (C D) termed a *fascine choker* is formed of two stout levers about 5 feet long, connected near their extremities by a chain or strong rope, which must be long enough to pass once around the fascine and be drawn tight by means of the levers.

The twigs are laid on the horse with their large and small ends alternating; the choker is applied to bring them together, and they are bound by wire, or by withes made of tough twigs, properly prepared by twisting over a blaze, so as to render them pliable. The ties are placed 12 inches apart, and every third or fourth one should be made with an end about three or four feet long, having a loop at the extremity to receive a stake through it. This stake is termed an *anchoring stake*, its object being to secure the fascine firmly to the parapet.

To form the revetment, the first row of fascines is imbedded (*Fig. 4, Plate 60*) about half its thickness below the tread of the banquette, and is secured by means of the anchoring stakes, and also by several stakes driven through the fascine itself about 12 inches into the earth. The knots of the ties are laid inside, and the earth of the parapet is well packed behind the fascine. A second row is laid on the first, so as to give the requisite interior slope; it should break joints with the first row, and be connected with it by several stakes driven through them both. The other rows are laid with similar precautions, and the parapet is usually finished at the top by a course of sods.

625. *Post revetment.* (*Fig. 6, Plate 60.*) This is constructed of posts from 4 to 6 inches in diameter, cut into lengths of 5.5 feet, and set with proper slope, in close contact, in a trench two feet in depth, at the foot of the breast-height. The tops of the posts, if not already so, are sawed off level, to receive a horizontal capping piece, which is spiked on. Anchor ties are dovetailed into the cap and secured to an anchor log imbedded in the parapet. On top of the cap are laid several courses of sods, raising the interior crest to the proper height. With a good quality of timber this revetment is durable. It is easily constructed, and next to sods is the best.

626. *Gabion revetment.* (*Fig. 7, Plate 60.*) The gabion is a basket of a cylindrical form, open at each end. Its height is usually 2 feet 9 inches, and diameter 2 feet.

To form a gabion, a *directing circle* is made of two hoops, the difference between their radii being such that, when placed con-

centrically, there shall be about $1\frac{3}{4}$ inches between them. They are kept in this position by placing small blocks of wood between them, to which they are tied with pack-thread. The directing circle is placed on the ground, and seven or nine stakes, about 1 inch in diameter and 3 feet long, are driven slightly into the ground between the hoops, at equal distances apart; the directing circle is then slipped up midway from the bottom, and tied in that position. Twigs about half an inch in diameter, and as long as they can be procured, are wattled between the stakes like ordinary basket-work. When finished to within about 2 inches of the top, the gabion is placed with the other end up, the directing circle taken off, and the gabion completed to within 2 inches of the other extremities of the stakes. The wicker-work at the two ends is secured by several withes, and the ends of the pickets are sharpened. The gabion is then ready for use.

To form the revetment, a fascine is first laid partly imbedded below the tread of the banquette; (*Fig. 4, Plate 60*;) the gabion, which is placed on end, rests on this, so as to give it the requisite slope; it is then filled with earth; others are placed in like manner, and the parapet is raised behind them; another fascine is laid on top, and in some cases two.

In making gabions, iron hoops, similar to barrel hoops, may be used instead of wattling. The number of stakes should be increased to eleven or thirteen. Gabions made either of wattlings or hoops are not good for holding dry sand.

Sheet-iron is preferable to either iron hoops or brush for gabions. For this purpose rectangular sheets of suitable dimensions to form cylinders of the same height and diameter as the ordinary gabion, are prepared with three holes punched near to and parallel with the shorter sides of the sheets. These are to secure the ends with wire when the sheet is bent into the cylindrical form. The advantages of this description of gabion are greater strength, lightness, and durability than either of the other two, offering great facility for transportation, and resisting better the blast of guns when used for reveting the cheeks of embrasures. Galvanized iron is less liable to rust than plain iron; when not galvanized, the gabions should be lacquered with coal-tar.

627. *Plank revetment.* This may be made by setting stout posts of scantling about 3 feet apart, 2 feet below the tread of the banquette, giving them the same inclination as the interior slope. Behind these stakes boards are nailed to sustain the earth. The posts should be securely anchored into the parapet with wire and stakes.

628. *Sand-bags* are sometimes used for revetments when

other materials cannot be procured; though their object in most cases is to repair damages done by the enemy's fire. They are made of canvas, or a good quality of gunny-cloth, sewed with cotton twine with lock-stitch; the bag, when empty, is 2 feet 8 inches long and 1 foot 4 inches wide. When filled and laid they occupy a space of 6 by 10 by 24 inches, and contain 0.85 of a cubic foot of sand, weighing about 85 pounds. Thirty-two make a cubic yard.

The bags are laid as headers and stretchers, either in the English or Flemish bonds. They should not be more than three-fourths full when laid; if full, they do not lay well, and are more liable to burst on becoming wet, or under great pressure. When time is of importance, the bags need not be tied, but the throat is given a twist and turned under the end of the bag as it is laid. To prevent decay, they should be payed with coal-tar before being filled or before being laid; this, furthermore, renders them less liable to take fire when dry. One hundred and forty-four sand-bags, laid as above, make ten superficial yards of revetment.

Sand-bag reveting requires less anchoring to make it stand than any other. If the reveting is kept wet, the sand will not so readily escape through rents, nor will the bags take fire from the blast of the pieces; this, however, hastens their decay. From six to ten months, depending upon usage, is the duration of reveting made of sand-bags. When used near the muzzle of the piece in the revetment of embrasures, they soon wear away, from the blast of the piece, unless well protected.

629. *Scarp revetment.* (Fig. 1, Plate 61.) This revetment is serviceable where the foot of the scarp is subject to wash, as in a wet ditch. It is formed of a frame-work of heavy timber, and is used chiefly for important field forts. A piece, termed a *cap*, is imbedded in a trench made along the line of the berme; other pieces, termed *land-ties*, are placed in trenches perpendicular to the cap, with which they are connected by a dovetail joint; they are about 8 or 10 feet apart. Cross-pieces are halved into the land-ties near their extremities, and two square piles, about 5 feet long, are driven in the angles between the land-ties and cross-pieces; inclined pieces, serving as supports to the cap, are mortised into its under side at intervals of 8 or 10 feet. These supports usually receive a slope of ten perpendicular to one base; they rest on a *ground-sill* at the bottom of the ditch, to which they are mortised, this sill being held firm by square piles.

Behind this frame-work thick plank or heavy scantling are placed horizontally, having the same slope as the supports; or else a rabbet may be made in the cap and ground-sills, and the scant-

ling let in between these two pieces, serving as a support to the cap. This is the more difficult construction, but the better, since, should the heavy supports be cut away, the cap will still be retained in its place.

In constructing the scarp revetment the cap-sill and land-ties are first laid, and then a narrow trench is dug to the bottom of the ditch to allow the ground-sill and frame-work to be set in.

In many of the earth-works constructed during 1861-65 the berme was dispensed with, the exterior slope being continued down to the bottom of the ditch. This plan worked successfully.

When circumstances admit of it, all the slopes of an earth-work should be sodded, or else be manured and sowed with grass seed.

630. *Interior arrangements.* Under this head come *batteries, magazines, traverses, bomb and splinter proofs, and interior redoubts.*

631. *Batteries.* The term battery, in this connection, is usually applied to a place in a work prepared for the accommodation of several guns. It is also used when speaking of the arrangements made of a parapet to enable the guns to fire over it or through openings in it; as, a barbette battery, an embrasure battery, &c.

632. *Barbette.* This is a construction by means of which a piece can fire over a parapet. It consists of a mound of earth thrown up against the interior slope; the upper surface is level, and 2 feet 9 inches below the interior crest, for light field-pieces, and from 4 to 6 feet for heavy guns. If the barbette is raised behind a face, its length should be sufficient to allow 16 (or 18) feet along the interior crest for each gun; and its depth, or the perpendicular distance from the foot of the interior slope to the rear, should be 24 feet. The earth of the barbette at the rear end receives the natural slope. To ascend the barbette a *ramp* is made of earth, connecting the top of the barbette with the terre-plein. The ramp is 10 feet wide on the top, and its slope is six base to one perpendicular. The earth at the sides receives the natural slope. The ramp should be at some convenient point in the rear, and take up as little room as possible.

633. As barbettes are usually placed in the salients, an arrangement is made for guns to fire in the direction of the capital. The construction in this case is somewhat different from the preceding. A *pan-coupé* (*ab*) of 11 feet (*Fig. 2, Plate 61*) is first made, and from the foot of its interior slope a distance of 24 feet is set off along the capital; at the extremity of this line a perpendicular is drawn to the capital, and 5 feet are set off on this perpendicular on each side of the capital; from these

points on the perpendicular a line is drawn perpendicular to each face, respectively; the hexagonal figure thus laid out is the surface of the barbette for one gun. The ramp (*c*) in this case is made along the capital.

If three or more guns are placed in the salient, a *pan-coupé* is formed as in the last case, (*Fig. 3, Plate 61.*) and 24 feet are, in like manner, set off on the capital; but instead of proceeding as in the last case, a perpendicular is drawn from this point to each face, and the pentagonal space thus inclosed is taken for the gun in the salient; from the perpendicular last set off, as many times 16 (or 18) feet will be set off on the interior crest of each face as there are guns required. This gives the length of the barbette along each face; the depth is made 24 feet, and the two are united in the salient. One or more ramps may be made, as most convenient.

The advantages of the barbette consist in the commanding position given to the guns, and in a very wide field of fire. On these accounts the salients are the best positions for them. Their defects are, that they expose the guns and men to the enemy's artillery and sharp-shooters.

634. Embrasures. The embrasure (*Fig. 4, Plate 61*) is an opening made in the parapet for a gun to fire through. The bottom of the embrasure, termed the *sole*, is 2 feet 9 inches, or from 4 to 6 feet above the ground, on which the wheels of the carriage rest, according to the size of the gun and the kind of carriage. It usually slopes outward to allow the gun to be fired at a depression. The base of this slope should never be less than six times the altitude. In most cases it may be horizontal, or even have a slight slope to the rear. The interior opening, termed the *mouth*, is from 18 to 36 inches wide, according to the calibre of the gun, and is of a rectangular or trapezoidal form.

The line which bisects the sole in the direction of the line of fire is called the *directrix*. The sides of the embrasure are termed the *cheeks*; these widen out towards the exterior, which widening is termed the *splay*, the inclination upon each side from the directrix being one upon ten. They furthermore have an inclination outwards from the vertical; this inclination, at the line of the exterior crest, is three upon one.

When the directrix is perpendicular to the interior crest, the embrasure is termed *direct*; (*Fig. 4, Plate 61.*) when oblique, the embrasure is termed *oblique*. (*Same figure.*) In order that the part of the embrasure which is next to the muzzle of the gun may be nearly of the same width in both the direct and

oblique embrasures, the mouth of the latter is wider in proportion to the obliquity.

Embrasures are reveted with the same material and in the same manner as described for the interior slope.

If the exact position for the embrasure is known, it is best to lay it out and make it while the parapet is being constructed. As soon as the latter is built up to the sill of the future embrasure, a light stake is planted in line with the interior slope on each side of the directrix, in such position as to represent the sides of the mouth of the embrasure; a strip is nailed across at the proper height to represent the sill, and another above on the line of the interior crest. The earth being smoothed off to give the desired slope to the sole, the directrix is marked out on it by means of a cord; the splay of the cheeks is obtained by giving the sides an inclination of one-tenth with the directrix. These lines being laid off on the sole, the revetment is placed along them and is given an inclination corresponding with the two profile stakes at the mouth, and three upon one at the exterior crest. Should gabions be used for reveting the cheeks, fascines are first partly imbedded along the edges of the sole, and the gabions placed on them in such manner as to obtain the proper flare. The gabions are held in position by being anchored with telegraph wire to a beam of timber imbedded in the parapet parallel to and about 8 feet from the cheeks of the embrasure. The beams are held by securing stakes. Revetments made of other material are secured in a similar manner. This precaution should be thoroughly looked after in the first instance, because when the revetment is broken by the blast of the gun or the shots of the enemy it is difficult to repair it, and the necessity for repairing would probably come at a time when it could not be done.

If the embrasure is to be cut out after the parapet is completed, the mouth is marked off with stakes and strips as before; the earth is removed so as to obtain approximately the sole, which is then laid off and the work completed as just described.

The sole of the embrasure should be secured from being worn away by the blast with boards, poles, or some similar material running lengthwise with the embrasure. Raw-hides will greatly assist in preserving the revetments of the cheeks from the effects of abrasion produced by firing. For this purpose the hide, while green, is stretched, with the flesh side outward, over the part to be protected, and is there confined by stakes driven through it into the parapet.

The best method, however, for securing the mouth of the embrasure, and the sole and sides for 5 or 6 feet from the mouth,

as a lining made of $\frac{1}{4}$ -inch boiler iron. (Fig. 5, Plate 61.) The plates are cut to the proper form to fit the sole and cheeks, and are fastened together with angle-irons and rivets. Wings, about a foot wide, extend out on each side against the interior slope to prevent the lining from being moved to the front by the blast. A round bar of iron passes across the top about 18 inches from the throat; to this a door of sheet-iron is suspended, forming a mantlet against musketry. In the centre of this door is a cut or slot, about a foot high and 6 inches wide, for the double purpose of allowing the rammer to pass through while loading the piece, and for sighting it. A vertical lever of wood or iron is fastened to one side of the door; to this a rope is attached, so that by pulling on it the door is thrown up to allow the piece to be fired.

That part of the interior slope lying below the mouth of the embrasure is termed the *genouillère*. The mass of earth between two embrasures is termed a *merlon*.

The advantages of embrasures are, that the men and guns are less exposed than in a barbette battery. Their principal defects are: they have a very limited field of fire; they weaken the parapet, and present openings through which the enemy may penetrate in an assault. Owing to their limited field of fire, they are generally used for the protection of particular points; as, to flank a ditch, protect a salient, enfilade a road, &c. The most suitable position for them in a work is on the flanks.

635. Platforms. When a gun mounted on a traveling carriage is fired often in the same direction, the ground under the wheels is soon formed into ruts. It is to prevent this that platforms of timber are used in such cases. Those for field service are described in *par.* 254, *et seq.*

The shape of the platform for works is usually a rectangle; in some cases, where a wide field of fire is required, the form is a trapezoid. The rectangular platform is 10 feet wide and 17 feet long for siege-pieces, and 9 feet wide and 15 feet long for field guns. It consists of three *sleepers* of 6-inch scantling, either 15 or 17 feet long, laid parallel to the directrix of the embrasure and covered with 2-inch plank cut into lengths of nine or ten feet. Between the ends of the sleepers and the foot of the *genouillère* a piece of 8-inch scantling 9 feet long, termed a *hurter*, is laid; it should project about 6 inches above the platform and be bisected by the directrix. The object of the hurter is to prevent the wheels from striking against the revetment.

To lay a platform, the earth on which it is to rest should be well rammed and leveled. Three trenches are then made for the sleepers, two of which should be under the wheels and the middle one under the trail. The sleepers are laid flush with the

ground and firmly secured by stakes driven at their sides and ends, and the earth is solidly packed around them. The planks are then laid and secured by nails.

When the piece is to be fired habitually in the same direction, a platform may be constructed of three pieces of timber, one under each wheel and one under the trail, firmly secured by stakes and connected by cross-pieces, into which they are halved.

Guns and mortars in field-works are best in pairs, with traverses between each set of pairs. A good platform for guns may be made of 3-inch plank laid on timbers 3 feet apart. If lumber is abundant, it is best to have the planks extend over the whole space occupied by each pair of guns.

636. In many field-works, especially those erected for the defense of rivers and the entrances to harbors against armed vessels, artillery of the heaviest calibre is mounted. The general features of works for such an armament are the same as those previously described for light armament, but in many of the details—notably in the method of mounting the guns—there are differences of especial interest to artillerymen. As such works are intended to resist fire from the heaviest artillery, they should receive the maximum thickness of parapet. (*Par.* 596.) The parapet is much higher, the merlons being simply masses of earth thrown up in mound shape and reveted on the interior slope, without any attempt at arrangement for infantry fire. The magazines, traverses, and splinter-proofs are of greater size and thickness. The guns are mounted on iron carriages the same as for permanent fortifications; the height of these carriages admits of from five to seven feet from the interior crest, or from the sill of the embrasure to the top of the platform. Each piece requires 18 feet in width of clear space, and in most cases a splinter-proof traverse should be placed between each gun, or pair of guns, and its neighbor.

The gun platforms are constructed of heavy beams of timber in two or three layers, crossing each other and firmly secured together with iron bolts. *Plate 62* shows in detail the construction of the platform for the 8-inch converted rifle, which is also the same for the 100-pounder Parrott and 10-inch smooth-bore.

For the 12-inch rifle, the platform represented in *Plate 63* has been proposed by the Engineer Bureau.

The platform adopted for the 15-inch smooth-bore (front pindle) is shown in *Plate 64*. This platform is designed for a carriage with depressed traverse circles, admitting of the terre-plein being 11 feet below the interior crest, thus giving increased security to the cannoneers.

Plate 64 shows the details of construction of the platform

adopted for the 15-inch smooth-bore, mounted on a centre-pintle carriage.

These platforms are supplied, when needed, by the Engineer Department. To lay one, a pit of the proper size is dug; the bottom of it is thoroughly settled by ramming, and the platform is laid in it, and the earth filled in and well rammed about the timbers. Great care should be observed to have the circles perfectly level. Previous to laying the platform the timbers should be coated with coal-tar.

In case of war with any maritime power, it would be necessary to erect earth-works of the foregoing character for the protection of our harbors. The permanent works constructed and intended for that purpose were designed when the 10-inch *Columbiad* represented artillery of the greatest power. Since then artillery of a new type and vastly greater power has been introduced, against which fortifications of old style are capable of offering but feeble resistance. The construction of these old works, furthermore, does not, except to a small degree, admit of the changes that would be necessary to adapt them for receiving armaments of modern artillery. An officer in command of the defenses of a harbor being called upon to place them in a state of efficiency, would, therefore, select positions exterior to the permanent works, and erect thereon earth-works of the character just described, and arm them with appropriate artillery. The new works would, generally, be simply uninclosed batteries bearing upon the channel. They should, if possible, hold defensive relationship with the old works and the latter be utilized as redoubts, armed with light guns and musketry, to prevent the enemy from landing and assaulting the new works in rear. The old works would, furthermore, serve as places of arms and depots secure from capture by *coup de main*.

Whenever railroad or water transportation is available, artillery of heavy calibre is made use of in siege operations. Guns thus used are mounted on wooden platforms of the foregoing models, and placed in earth-works of the character herein described.

637. Powder magazines. The main objects to be obtained in constructing a powder magazine are, to place it in a position convenient to the pieces to be served, and one least exposed to the fire of the enemy; to make it shot-proof, and to secure the contents from moisture.

Magazines are of two kinds: the *storage magazine*, in which is kept the general supply of powder for the work, and *service magazines*, which are small, containing only a limited supply for the immediate use of a few pieces. The latter should be

near the pieces to be served; generally they would be placed in the traverses separating guns, or else close in rear of the platforms.

Storage magazine. The size of the storage magazine will depend upon the number and calibre of pieces in the work and the number of charges to be kept for each. This data being known, the amount of storage room required will be determined by allowing 5780 cubic inches for each barrel containing 100 pounds of powder.

Projectiles and cartridges for siege and field guns are put up in boxes, as explained in *par.* 565, and are stored in magazines kept especially for this kind of ammunition. Each box of siege-gun ammunition contains four projectiles and four cartridges, and measures about 2950 cubic inches. Each box of field-gun ammunition contains ten projectiles and cartridges, and measures about the same. From this it is easy to obtain the storage capacity required for any amount of these kinds of ammunition.

The dimensions of the interior of the magazine should be so regulated as to entail no unnecessary loss of space in storing its contents. The exterior dimensions of a powder barrel are: Length, 20 inches; diameter at bilge, 17 inches. With the barrels stored in the usual way, on the side, (*Fig. 1, Plate 65,*) a magazine 6 feet 6 inches high would afford space for four tiers, leaving 8 inches on top for handling room. A magazine 10 feet wide will give room for four rows, leaving 40 inches for passage-way; therefore each 17 inches of length of a magazine 10 feet wide by 6.5 feet high will contain 16 barrels. A magazine of this height and width and 30 feet long would store 400 barrels and leave a space of about one yard in width, extending across it, at the entrance.

At the rate of 100 rounds for each 15-inch gun, a fair allowance for such guns in field-works, a magazine of the foregoing dimensions will give storage for a supply of powder for four pieces. The number of rounds per gun should increase as the calibre diminishes. It would, however, seldom be necessary to have more than 300 rounds for any calibre above 100-pounders. An ordinary packing-box containing the number of rounds before specified measures, in exterior dimensions, 19 inches in length, 13.5 inches in width, and 11.5 inches in height. These dimensions allow the boxes to be compactly packed in a magazine of any ordinary shape, and it requires only a small calculation to determine the storage room required for any given number of rounds for guns of these calibres.

It is best not to exceed, for any one magazine, the dimensions

above laid down, namely, 30 by 10 by 6.5 feet. When greater storage room is required, two or more should be constructed.

Precautions to secure drainage are of the utmost importance. Generally the ground is sufficiently undulating to effect this by means of a covered drain leading from the bottom of the magazine. Where this is not practicable, the bottom of the excavation must be formed so as to collect the water at one point, whence it may be removed by pumping or bailing.

Figs. 1 and 2 illustrate the best method of constructing a storage magazine. The sides of the interior of the magazine are formed of 12-inch logs, either square or round, placed vertically in juxtaposition, and resting on a ground-sill. These are capped on top by a 2-inch plank, a strip of the same being spiked on within the cap. The roof is formed of 15-inch logs, laid across, in juxtaposition, each having a shoulder of 3 inches to fit it to the cap and inside strip. Longitudinal logs with varying diameters are laid on these, so as to give a proper pitch to the roof. Earth is solidly packed upon the top and between the roof logs, receiving the proper slope for the roofing boards. These boards, carefully joined, are laid on in two thicknesses, each being covered with a coating of asphalt or coal-tar; upon these boards rest the covering of earth. The flooring is of joists and boards. The sides of the magazine are surrounded with an air-chamber formed of inclined logs supported on a ground-sill and resting against the top logs; these are placed at three or four feet apart, each one being braced at the middle to resist flexure from the pressure of the earth. The air-chamber is covered in by saplings laid upon each other horizontally. Ventilators are placed between the magazine and the air-chamber, near the top, and also between the latter and the external air, the two not being opposite, and the usual precautions to guard against sparks, by covering the mouth with wire cloth or perforated tin, are taken. The whole is covered with earth, the thickness of which will depend on the character of the enemy's artillery. In no case should it be less than 14 feet on the exposed side; 10 feet will be sufficient for the other sides and the top. The entrance may be either upon an end or side, depending upon how the magazine has been located with reference to the enemy. In all cases the entrance must be on the side from the enemy, and should be secured by a bomb-proof covering. The magazine chamber should, if practicable, be placed at least two-thirds of its height below the surface of the ground. The ammunition is stored and cared for as explained in *par. 569*.

In this and all similar structures railroad iron is a highly serv-

iceable material for roofing, the bars being laid in juxtaposition in place of the logs before mentioned.

Service magazines. The size of these will depend upon the number of rounds it is desirable to have ready for immediate use; usually, twenty rounds for sea-coast guns, and from fifty to a hundred for those of smaller calibre, will be sufficient. The capacity of the magazines to hold this amount or any other that may be fixed upon will be determined by the rules just given. If the magazine is to hold barrels, it should be 6.5 feet high and 7.5 wide; this will accommodate four tiers of three rows, leaving a passage-way of 30 inches. The length will depend upon the number of barrels, and this will be governed by the number and calibre of pieces to be provided for; generally, 15 feet will be ample.

A magazine of this description is usually constructed of *coffer-work*.

A coffer-work is formed by making frames (*Fig. 1, Plate 66*) corresponding in dimensions with the cross section of the magazine; each frame is composed of two uprights, termed stanchions, and a cap and sill of stout timber or scantling, not less than 6-inch. The cap and sill pieces are slightly notched to fit the stanchions, and all secured together with nails or spikes. These frames are placed upright and parallel to each other, about 2 feet apart; they are covered on the top and sides with 2-inch plank, termed a sheeting. The magazine, otherwise, is constructed as in the last case.

A very good magazine, and one easiest of construction, is made of logs notched together at the corners after the fashion of a log cabin. (*Fig. 2, Plate 66.*) Other logs are laid in juxtaposition across the top, and the whole covered over with earth. This is the most substantial for those placed in traverses.

For field and siege pieces the magazines are not required to be so large. A height and width of 6 feet with a length of 12 feet will generally be sufficient.

Magazines of this size may be made as just described, or they may be made of gabions. (*Fig. 3, Plate 66.*) When the latter are used, a hole is usually dug in the ground to form part of the magazine; the gabions are placed in three rows, side by side, around the hole, and are filled with earth. The top is formed of timbers laid across in juxtaposition and covered with fascines, the whole being covered with a proper thickness of earth. The bottom is covered by a flooring of joists and boards, a shallow ditch being left under the flooring to carry any water to a drain outside. This, at best, is but an inferior method of constructing a magazine.

Entrances to magazines must always be on the side from the enemy, and protected by a splinter-proof shelter large enough to afford easy access to the door.

Splinter-proofs are usually constructed of scantling or trunks of trees cut into suitable lengths and placed in an inclined position over the magazine door. (*Fig. 4, Plate 66.*) The timbers are placed side by side, and covered with at least two feet of earth or sods.

To prevent rain from percolating through the earth on top, the magazine is covered with a paulin laid on the earth and secured with pickets. To prevent rapid decay of the paulin, it should be payed with a mixture of tar and grease boiled together—about two parts of tar to one of grease; this composition is applied to both sides. In dry weather the paulin should be removed to let the earth dry.

Boards, bark, or shingles may be used instead of paulins.

Adjoining or near the service magazine is a filling-room, in which the powder barrels are opened and the cartridges made up and the shells filled. A room 10 feet square by $6\frac{1}{2}$ feet high will generally be sufficiently large. It is constructed in the same manner as the magazine, and is fitted with shelves, &c., for the convenient keeping of primers, fuses, implements, and other small articles required in making up cartridges and preparing shells.

While being convenient to the magazine, it should be so situated that an explosion taking place in it will not communicate fire to the magazine. *Fig. 2, Plate 65*, represents the ground plan of one form that may be adopted.

The powder is carried from the magazine to the filling-room in canvas or leather stretchers, and only in such quantities at a time as may be necessary for keeping the pieces served.

638. Traverses. Those which are placed between guns or on their flanks to cover them from an enfilade fire, are usually termed *gabionades*.

To form a gabionade, gabions are placed in a row (*Fig. 5, Plate 66*) side by side, inclosing a rectangular space of about 15 feet in width from out to out, and about 24 feet in length, perpendicular to the parapet. A second row is placed within this and touching it, and a third row inside of the second. The area thus inclosed is filled in with earth to a level with the top of the gabions. Six rows of large fascines are next laid on the gabions to support a second tier consisting of two rows. The second tier is filled in like the first, and the earth is heaped up on top. Four rows of large fascines are placed on these to support a third consisting of one row, making the gabionade nearly 12 feet

high. The ends are inclosed by filling in with gabions, as for the sides. A passage-way of about two feet is left between the end of the traverse and the parapet. This space may be roofed over with logs and earth to form a cover in which the cannoners may shelter themselves against fragments of shells.

Splinter-proof traverses may be made by placing two thicknesses of gabions side by side filled with earth, with a second tier of one thickness on top. When a service magazine is to be placed in a gabionade, the rows of gabions are set farther apart, and the excavation for the magazine is made between them. The chamber of the magazine is constructed in one of the ways heretofore described.

639. *Bomb-proof shelters.* These are for the protection of the troops when not on duty. They should be located on the parade, convenient to the pieces to be served, yet not so near as to interfere with the defense. They are usually constructed in half excavation of logs built up like a log house, or of a framework in the manner shown in *Fig. 1, Plate 67*, the exterior side being of heavy logs placed vertically in juxtaposition, resting on a ground-sill and capped at top. Parallel to this is another row, forming the other side, which may also be placed side by side or at short intervals apart, and capped like the outside row. The roof, consisting of heavy logs laid in juxtaposition and covered with thick boards joined, rests on the capping, the whole covered over on the side of the enemy with earth to a depth of at least 14 feet from the wood-work. To prevent this mass of earth from pushing the structure over to the rear, one in every two or three of the roof-logs are cut of sufficient length to extend about 8 feet beyond the front of the wall, and dovetailed to a longitudinal log held in position by vertical posts, the anchor-log being sufficiently covered with earth to protect it from injury by shot from the enemy.

These bomb-proofs are made to serve the purpose of traverses, and are frequently arranged with a staging or gallery along the rear side for the accommodation of infantry, who deliver their fire over the top, arranged for this as a parapet.

In all interior arrangements, system and regularity should be observed from the first; otherwise the work will grow into a labyrinth of confusion greatly opposed to efficiency and comfort.

640. *Splinter-proofs* made after the foregoing plan, but smaller, may be placed against the parapet between the guns. These not only afford shelter for the men, but give a place to keep implements and a few rounds of ammunition ready for immediate use. Another convenient form of splinter-proof may

be made by leaning logs or railroad-iron bars against the sides of traverses and covering them over with earth.

Works exposed to anything like constant and protracted artillery fire, should be provided with bomb and splinter proof shelters sufficient to comfortably lodge the entire garrison. This is made more necessary now than formerly, from the very great range and searching power of modern artillery, which makes it impossible for a garrison to obtain rest without going to too great a distance from the work.

As a general rule, troops should, for sanitary reasons, be quartered as much as possible outside of the works.

The importance of protecting guns and their carriages with traverses and epaulments bears an increasing ratio to the size of the piece.

Formerly, when guns were comparatively light, works were garnished with them in great numbers, and the fact of having a few of them disabled was of but little consequence; it required but simple appliances and only a few hours to replace them by others. With modern heavy artillery, it is impracticable to have many pieces in a work, and when one is disabled it requires days instead of hours, and the employment of much machinery and labor, to replace it.

641. Batteries. The field-work that artillery troops are most frequently called upon to construct is the battery. This may be for one piece or for several. *Fig. 2, Plate 67*, represents a battery for four siege-pieces.

In this instance, the parapet (A) is made of earth taken from the front, thus forming a ditch (C). To protect the pieces (XXXX) from flank fire, the parapet is continued around on one or both ends, forming epaulments (BB). The guns are in pairs, separated by a traverse (D). The interval between the axes of the embrasures of each pair is 16 feet for guns on traveling carriages, and from 18 to 22 feet for sea-coast guns. Between the two middle pieces, this distance is increased by the thickness of the traverse, generally about 15 feet. The entire length of the interior crest of the parapet, from *a* to *b*, will therefore be 79 feet. This and other given dimensions are not absolute, but indicate the method of obtaining the data necessary for laying out *any* battery. The length of the flank epaulments will depend upon the direction of the enemy's fire; in all cases, it must be sufficiently great to give full protection to the whole interior from an enfilading fire; generally it would be about 24 feet. The thickness of the parapet and epaulments will depend upon the power of the artillery they are expected to resist.

(See *par.* 596.) The details of the various parts are the same as heretofore given.

When the earth is thrown up from the rear to form the parapet and epaulments, the work is termed a *sunken* battery. The ditch (C) is then dispensed with. In many instances a ditch is of but little importance, and for economy of labor the earth may be taken from both front and rear.

Embrasures for guns firing with great angles of elevation may receive a counter-slope, giving the sole nearly the same inclination from the sill upwards as the least angle of elevation under which it may be required to aim the piece. (*Fig. 4, Plate 61.*)

Batteries for even the heaviest pieces may be constructed on marshy ground by laying a grillage of timber over the surface and building up the parapet on it with sand-bags. To prevent the parapet from settling over towards the front, the grillage should extend several feet beyond it in that direction. In order that the platform of the piece may not be moved from its true horizontal position by any settling of the parapet, the space to be occupied by it is inclosed with strong sheeting piles. In this inclosed space several layers of fascines are laid, crossing each other at right angles; on these earth or sand is rammed, and the platform laid in the usual manner. If sand is used on top of the fascines, two or three thicknesses of paulins should be spread over them to hold the sand. Magazines in such localities must, of necessity, be entirely above ground, and supported on grillage in the same manner.

642. Batteries are classified according to their construction, use, and armament, as follows: *Covered battery*, intended for a vertical fire and concealed from the enemy; *breaching battery*, intended to breach the works of the enemy; *joint batteries*, uniting their fire against the same object; *counter-battery*, one battery opposed to another; *cross-batteries*, forming a cross-fire on an object; *oblique battery* forms an angle of 20 degrees or more with the object against which it is directed, in contradistinction to *direct battery*; *raised battery*, one whose terre-plein is elevated considerably above the ground; *sunken battery*, where the sole of the embrasure is on a level with the ground, and the platform consequently sunk below it; *enfilading battery*, when the projectiles sweep along a line of troops, a channel, road, or part of a work; *horizontal battery*, when the terre-plein is that of the natural level of the ground; *open battery*, without epaulment or other covering—wholly exposed; *indented battery*, or battery *à crémaillère*, one constructed with salient and reëntering angles for obtaining an oblique fire as well as a direct fire, and to afford shelter from the enfilade fire of the enemy; *reverse bat-*

tery, that which fires upon the rear of a work or line of troops; *ricochet battery*, that whose projectiles, being fired at low elevation, graze and bound along without burying themselves; *masked battery*, artificially concealed until required to open upon the enemy; *mortar batteries*, *gun batteries*, &c.

643. *Mortar batteries.* These have the principal features of batteries for guns. It is desirable that they should be located where good views of the enemy's position may be had; this, in order that the gunner may himself see the effect of his shot, and not, as is too frequently the case, have to depend upon the imperfect report of a distant observer. For siege mortars, the platforms are placed the same distance apart as for siege guns, viz., 16 feet; for sea-coast mortars, the distance is the same as for sea-coast guns, viz., 18 to 22 feet. They are usually placed in pairs, with traverses between each set of pairs. Embrasures are not required, and as the platform must be at such distance from the parapet that the blast will not injure the interior crest, it is not necessary torevet the interior slope, the earth being allowed to assume its natural slope.

The siege-mortar platform furnished for field purposes is too light to sustain much firing. For fixed batteries, they should be constructed of heavy timbers, and, to insure anything like accuracy in firing, must be both level and stable. The sea-coast platforms (*par.* 229), when properly laid, are in every respect efficient. A good kind of rail platform may be made by using two pieces of timber (*Fig. 4, Plate 67*) 12 to 15 inches square and 9 feet long for the rails, to which planks 2 or 3 inches thick and 8 or 9 feet long are spiked. The rails are parallel, and have their centres 28 inches apart for the 10-inch mortar, and 22 inches for the 8-inch. A pit is dug large enough to receive this structure, and the bottom being made perfectly level, it is placed in it with the planks *down*. Earth is filled in on top of the planking. This kind of platform is particularly well adapted to sandy localities. If the mortar is intended to be fired in various directions, a sufficient number of rails are used to extend over the whole surface, the planks being spiked to all of them.

644. *Wire entanglements, abattis, &c.* Every approach which an enemy might use to reach a work, should be so obstructed as to keep him as long as possible under a close fire of musketry. The best thing for this purpose is wire entanglement, made by planting stout stakes, (*Fig. 5, Plate 67,*) about $3\frac{1}{2}$ feet long, 2 feet in the ground and 7 feet apart, in quincunx order and in three or four lines. Around the tops of these stakes, at from 12 to 18 inches from the ground, in notches prepared for the purpose, telegraph or other strong wire is securely

wound, extending from one stake to another. This obstacle is rapidly made, is difficult to remove, and can be injured but little by the fire of the enemy.

645. *Abattis* is formed of the large limbs of trees, or of small trees themselves; the small branches are chopped off and the ends, pointed and interlaced, are presented to the enemy. The large end of the limb or tree is secured to the ground by stakes. Obstacles should be in two or more lines, and not too close to the work; the first line should be about 100 yards in front, and the others beyond, at about 50 yards intervals.

646. *Torpedoes*, if used, would be placed in these intervals. These weapons depend for their utility more upon their deterring than upon their actual destructive power. Men who will march bravely up through a blaze of musketry will walk timidly over ground in which they suspect the hidden mine. Torpedoes may be simply shells charged with powder and slightly buried in the ground; or they may be wooden boxes, kegs, or any other vessel capable of holding and keeping dry a charge of powder. Shells produce their effect from their fragments, and likewise, if large, from the blast of the explosion. Charges otherwise inclosed produce effect only by the blast; consequently the greater the quantity of powder the greater will be the effect.

The chief difficulty in planting torpedoes is in the arrangement for igniting them at the proper moment. This may be done by electricity, as for submarine mines, or by a self-acting device whereby the charge is exploded by the tread of an enemy passing over it. The device used by the Russians at Sebastopol is perhaps the best of many that have been tested. The case consisted of a cubical wooden box (*a b c d*, *Fig. 1, Plate 68*) large enough to contain a charge of 10 to 20 pounds of powder. This box was contained in another box (*A B C D*), leaving a space between of about 2 inches, which was filled with pitch, rendering the powder in the inner box secure from moisture. The top of the exterior box was placed 6 or 8 inches below the surface of the ground, and on it rested a board about the size of the top; this board stood on four legs of hoop-iron about 4 inches high. The top of this board was near the surface of the earth, and covered slightly so as not to be perceived. On any slight pressure upon the board, such as a man treading upon it, the hoop-iron supports yielded and the board came in contact with a glass tube (*X*) containing sulphuric acid; the tube breaking liberated the acid, which came in contact with a priming of potassa chlorate and loaf-sugar within the box, causing instant combustion and, as a consequence, explosion of the powder. The glass tube is placed within another of lead, tin, or other metal which bends

readily, yet strong enough to afford a certain degree of protection to it. The metal tube conducts the acid to the interior after the glass is broken. Instead of the interior box, a shell filled with powder may be used. Other devices for exploding the charge are frequently employed. They are constructed upon the principle of a plunger striking upon fulminating composition, but these are difficult to construct so that moisture will not enter and destroy either the fulminate or charge. When torpedoes are planted, the position of each one should be so marked as to be known to friend, but not to the enemy. They should not be planted in front of any work from which sorties are to be made. They are useful along beaches to prevent the enemy from landing.

647. Mantlets. A mantlet is a shield placed over the mouth of an embrasure to prevent musketry bullets and fragments of shells from flying through and injuring those serving the piece. A hole in the lower part allows the muzzle of the piece to pass through into the embrasure when it is to be fired. The size of these openings will depend upon the dimensions of the piece. Rope is the best material for constructing mantlets. The usual size of a mantlet is 5 feet high, 4.5 feet across, and 4 inches thick. For siege guns the opening is 1.6 feet high by 1.3 feet across. Three-inch rope is a suitable size; it is laid in three or five thicknesses, each of the two outer layers being in one piece bent vertically. (*Fig. 2, Plate 68.*) The inner layers are bent and laid horizontally, and the whole well tied together. The mantlet is hung on a horizontal pole supported by forked uprights set in the ground, on each side of the embrasure, at the foot of the interior slope. The elasticity thus afforded by the supports greatly increases the resistance of the mantlet. A small hole or slit is pierced in the mantlet to allow the piece to be aimed.

Mantlets of this size weigh about 400 pounds.

A small ring mantlet of rope (*Fig. 3, Plate 68*) placed upon the chase of the gun is sometimes used.

When rope cannot be obtained, one of similar shape may be made of wood.

Mantlets may be made of wood or of iron, or of wood and iron combined. Those of the latter kind furnished for the siege of Yorktown were made of two thicknesses of $\frac{1}{4}$ -inch wrought-iron spiked to 3-inch oak plank. On the head was a 2-inch square iron bar riveted to the edge of the iron plates, against which the oak planks abutted. The ends of this bar projected 6 inches, and were rounded, serving as supports to rest upon upright stakes or timbers standing against the interior slope of the parapet.

Mantlets, when supplied at all, are supplied by the Engineer Department.

648. *Gun-shields.* When railroad iron can be obtained, shields, with embrasures in them, can be made as represented in *Fig. 1, Plate 69.* One thickness of iron is sufficient protection against projectiles from field guns, two from siege guns, and four from pieces of the 8-inch rifle class.

The same material may be used for constructing field casemates.

Block-house. (*Fig. 2, Plate 69.*) This is a species of small redoubt, usually built of wood, and intended for an isolated point which can be approached by stealth or stratagem, requiring the garrison to be constantly on the alert, with their arms in hand. It is at once a house and a fort. They are usually constructed for the defense of bridges against cavalry raids. They are also used in the Indian country as a defense against savages, in which case they are usually placed at opposite angles of a stockade for flanking purposes.

They are made 10 feet high in the clear, and from 20 to 25 feet square. Logs 16 to 18 inches in diameter are used; these are hewed on two sides and placed together, their hewed sides in contact. They may be built up in the manner of a log-house, but it is preferable to set them up vertically. The roof is made of heavy logs extending over the walls about 18 inches on all sides. On these logs a covering of earth is placed 4 feet thick at the crown and running down to a depth of 6 inches at the eaves. This earth is thoroughly rammed, and in it are imbedded pur-lins, upon which is constructed a roof of boards or shingles. Loop-holes for musketry are cut through the walls, the splay being on the *inside*, and the height above the floor 8 feet. A banquette of plank 3.5 feet from the floor and 6.5 feet in width is carried around the interior; this serves also as a substitute for bunks.

Machine guns are eminently adapted for block-houses; next to these are howitzers, or other pieces effective with canister. Each house should be supplied with two or more such pieces, embrasures for which are cut so as to sweep the main avenues of approach. The throats of the embrasures are closed when not in use by heavy timber doors, barred on the inside. The embrasures are cut at a proper height from the floor for the carriage used, and the banquette made in movable sections behind each embrasure.

Around the outside is dug a V-shaped ditch, the earth being thrown up against the sides of the house, at an angle of 45 degrees, as high as the soles of the loop-holes. The cheeks of the

embrasures through this bank are of hewn timber, and a roof of the same is laid across to sustain the slope just mentioned. A small magazine is placed below the floor. A well-constructed abattis and wire entanglement should surround the work at a distance from it of about 100 yards. A block-house thus constructed is pretty secure against any artillery accompanying cavalry raids.

The general idea of a block-house may be utilized in the construction of bomb-proof covers or casemates for guns in field-works.

Part Eighth.

ATTACK AND DEFENSE OF POSITIONS.

649. In the attack upon intrenched positions, the points regarded as the most advantageous are those in which the general combination of the defensive line forms a salient with reference to adjacent parts. Such positions can receive but little support from collateral portions, and can, to a greater or less degree, be enveloped by a line of intrenchments of much greater extent than itself, affording opportunities for establishing enfilading and other batteries, the fire from which will be convergent upon the point of attack.

Fig. 3, Plate 69, illustrates some of the advantages to be gained by the selection of a salient as the point of attack. The full line represents the trace of a regular work following theoretically the general contour of the salient to be attacked. An inspection of the figure shows that A, upon the prolongation of the face EF, will be the best possible position for the attacking artillery; as from this position the projectiles, after grazing the parapet at the point E, will rake the entire face EF. It is quite impossible to protect such a line by traverses and at the same time maintain a stout defense against a front attack.

From the point B, within the prolongation of the face, the latter is struck in reverse under so small an angle as to weaken but slightly the advantage of enfilade. It becomes less efficient as its distance from the prolongation of the face is increased. The next most advantageous position is at C, on the other side of the prolongation of the face, striking its exterior direct but under a small angle, thus taking in flank the embrasures of the face and more readily destroying them without being exposed to direct fire from the face.

The locality sometimes renders it obligatory to make the artillery attack a direct one, as at D. This is the least advantageous of all.

The dotted line of the figure represents more nearly actual lines of field-works. The principles, however, remain the same.

In determining positions for batteries, those nearest the enemy are not necessarily the best; in fact, the greater the range the more searching will be the fire. The projectiles will not have the same power of penetration and destruction at long as at

short range; nevertheless, for ordinary warfare they possess sufficient of these qualities to perform the work required of artillery against field intrenchments.

650. The following table, showing the *drop* of projectiles at various ranges, indicates the importance of this factor in actual warfare. *Fig. 1, Plate 70*, illustrates this graphically, and, furthermore, furnishes useful suggestions as to defilading works by means of traverses and epaulments. See also table and remarks in *par. 619*.

Drop of projectiles.

| RANGE. | RIFLE-MUSKET. | | VELOC- ITY. | 8-INCH RIFLE. | 100-PDR. PARROTT. | |
|--------|---------------|-------|----------------|------------------|-------------------|--|
| | Yards. | Drop. | Seconds. | Feet. | Drop. | Drop. |
| 200 | 85 | 0.5 | 1120 | | | The numbers in the columns Drop denote the number of units of horizontal distance to one unit of verti- cal. |
| 400 | 50 | 1. | 915 | | 57.3 | |
| 600 | 30 | 1.75 | 800 | | | |
| 700 | 25 | | | 57.3 | 28.6 | |
| 800 | 20 | 2.5 | 700 | | | |
| 1000 | 14 | 3.75 | 625 | | | |
| 1100 | ... | | | | 19.0 | |
| 1200 | ... | | 558 | 28.6 | | |
| 1400 | ... | | | | 14.3 | |
| 1500 | ... | | 506 | | | |
| 1600 | ... | | | 19.0 | | |
| 1700 | ... | | | | 11.4 | |
| 1900 | ... | | | | 8.1 | |
| 2000 | 4 | | 412 | 14.3 | | |
| 2500 | ... | | | 11.4 | 7.1 | |
| 3000 | ... | | | 8.1 | 5.8 | |
| 3500 | ... | | | 6.3 | | |
| 4000 | ... | | | 5.1 | | |
| 4600 | ... | | | 4.1 | | |

When the distance to the object can be determined and the range is such as to require considerable elevation, it is by no means necessary that the object should be seen from the gun, provided range-points can be accurately established, as in mortar firing. This is illustrated by *Fig. 2, Plate 70*. In many cases it will be a great advantage to locate guns in this manner, for the reason that the enemy will probably not be able to ascertain their position with sufficient accuracy to do them much damage.

Should the distance behind which cover can be obtained be quite short, as represented in *Fig. 3, Plate 70*, the charges for guns may be reduced so as to allow the necessary elevation to be given to carry the projectiles over the cover, and at the same time drop them into the enemy's works. A few trial shots will enable the artillerist to accomplish this with certainty. Siege howitzers are used advantageously in this way.

651. In nearly all cases the attack has the advantage over the defense, in the amount of fire that can be brought to bear upon any particular point. When a position can be completely surrounded, as is frequently the case in sieges, there is no limit to the amount of fire that may be brought to bear upon it, except the limit of ability to obtain the requisite quantity of pieces and ammunition. It is therefore possible to throw into the place such a hail of projectiles as to make it impossible for the defenders to show any resistance. In most cases, however, the place can be but partly surrounded; nevertheless, the great range and ability for concentration possessed by artillery enable it to accomplish like results. It is very certain that, under such circumstances, the endurance of a place is only a matter of time.

The belief at present prevails, to a considerable extent, that it is almost impossible to carry by assault intrenched positions, if resolutely defended by troops armed with the breech-loading musket. Such being the case, the only alternative for dislodging an enemy so situated, and who cannot be starved out, is by the use of artillery,—a fact that calls for the more liberal use of this arm and the most skillful handling of it.

652. With sufficient artillery an enemy can be driven, as before stated, from any position he may occupy. But as there is a practical limit to the amount that can be supplied—and this may fall below what is necessary for actually dislodging him—all that can be expected of it is, to so extinguish the fire of the enemy as to enable the infantry to gain possession of the works, as formerly, by assault.

In preparing to make such an attack, the first thing to be done, after determining the particular part of the work to be assaulted, is to establish the batteries and ascertain by experimental firing how to use them so as to make every shot tell. Every available piece should be put in, and other parts of the line stripped temporarily in order to make the assault certain of success.

653. The infantry, in the meanwhile, has intrenched itself on a line as near as practicable to the enemy, and organizes into three lines for the assault. The artillery opens and keeps up an incessant fire. When it is seen that the enemy have been driven to cover, the first line of infantry advances as a thick line of skirmishers composed of detachments, each detachment being under control of its chief. If the enemy show themselves, this line opens fire and assists the artillery in suppressing them. The men of each detachment keep together, and the detachments, taking advantage of every accident of ground for cover, rush forward from point to point as opportunity offers. This line is constantly fed and strengthened from the next line in rear, each detachment sent forward gaining ground until the reverse

side of the enemy's work is gained; seeing which, the second or main line rushes forward, and the whole clamber over the works and drive out or capture the enemy.

The second or main line is formed in company columns, and follows the first, or line of skirmishers, at a distance of about 500 yards—less when possible. The third, or reserve, is about 300 yards in rear of the second, and is massed by battalions ready to be moved where required. The lines of infantry are about of equal strength; *i. e.*, each one-third of the assaulting force.

654. The artillery at first uses shell, but as the infantry advances, and it becomes necessary to fire over it, only solid projectiles will be used; and fire with these must be discontinued when the infantry has approached so as to be in danger from it. This is the most critical moment; but if positions for the batteries have been selected with skill, those on the flanks will be able to keep up a cross-fire until the final rush is made. The artillery commander must have this matter so in hand as to be able to commence or stop the fire from any battery at any moment. To accomplish this each battery should be in telegraphic communication with him, and he must have a position where he will have a clear view and knowledge of what is going on at the point of assault.

As a general rule, it is well for the batteries, instead of suspending their fire, to increase the elevation so as to throw their projectiles beyond. This, besides checking and disorganizing reinforcements coming up to the enemy from the rear, will have a salutary moral effect upon him at the point of assault.

When, as is generally the case, the front of the work is protected by abattis or other obstructions, pioneers must accompany the first line to clear ways for the company columns of the second line to pass through.

The artillery commander will select a proper number of detachments, placed under suitable officers, to advance with the second line for the purpose of turning upon the enemy such pieces as may be captured with the works. These detachments will carry with them sponges, rammers, primers, and lanyards. Ammunition will generally be found with the captured pieces.

The most precise instructions are usually given to division, brigade, and battalion commanders as to what they are to do after getting possession of the work; otherwise the troops take no precautions against a counter-attack. As soon as practicable, the artillery commander moves batteries forward to establish a new line on the works just captured. It is his duty to take possession of all captured artillery material. An accurate and complete inventory must be made of it, together with an account of the part it had in the defense of the place; this, in order that

there may be no uncertainty as to the honors due to various parts of the capturing force.

Assaults should be made early in the day, so that the assaulting force will have time by daylight to push and make permanent its success. If night intervenes, the assailed may take advantage of it to reorganize a new line as strong as the first.

A dense fog is most favorable for an assault, as the assaulting force is then able to see plainly that which is immediately around it, without itself being seen by the assailed. For the same reason, if made at night, bright moonlight is favorable.

It may here be mentioned that artillery of batteries in position possesses an advantage over all other arms, in being able to be used as well by night as by day; and this is one powerful element in its favor when protracted operations are carried on against an enemy established in works.

If the strength of the works is such that they cannot be carried in the manner just described, then recourse must be had to regular approaches and siege operations.

SIEGES.

655. A place is said to be closely besieged when it is so invested as to prevent those within receiving succor from without. When such an investment can be effected and maintained, time alone will effect, by starvation, the work of reduction. When the operations against the place are confined to a simple interruption of communications, it is termed a *blockade*.

In most cases, however, a place can be but partly invested. The besieging operations then consist in regular approaches against particular parts of line of the besieged, reducing them in succession so as to force him to abandon the place which he has attempted to defend.

No siege can be successfully prosecuted unless the resources of the attacking army, especially in artillery, are superior to those of the besieged.

656. When a siege is to be carried on by regular approaches, the work so attacked should be enveloped as far as possible by a line of batteries containing the heaviest pieces within the resources of the besieging party. These batteries are connected by a rifle trench for the accommodation of the infantry supports, and to form a covered communication from one end of the line to another. It also serves as a secure and convenient place for the accumulation of material for the prosecution of further operations. The line thus formed is called the *first parallel*; its distance from the besieged work depends, in a great measure, on the character of the ground; if this is undulating and broken, so as

to form natural approaches to the batteries, the distance may be much less than when the country is level and open to the fire and view of the besieged. As a rule, it should be just without the zone of very destructive fire from small-arms. This, with the present rifle-musket, is about 1500 yards, a distance permitting of the effective use of the artillery mounted along the line. The batteries containing guns, especially those of heavy calibre, should be located on the flanks of the line, leaving the intermediate batteries for mortars; this, for the reason that guns so situated will not be masked and have their fire checked by subsequent operations. Mortars can at all times maintain their fire over the heads of troops occupying advanced positions.

If the enemy occupy intrenched positions in front of the main work to be attacked, fire must be concentrated first upon one and then another of these positions until he is successively driven from them into his main work.

Every piece of artillery capable of throwing a projectile into the works should be brought into requisition, and a superiority gained as soon as possible over the artillery of the besieged.

657. In the meanwhile preparations have been made, by the accumulation of material, for the establishment of a second parallel, several hundred yards in advance of the first. This should be done under cover of night by a line of infantry throwing up a rifle trench. This trench is enlarged until it forms, like the first, a covered way secure from the view and fire of the besieged. Communication with the first parallel is secured by means of zigzag trenches, technically called *boyaux*. (*Fig. 1, Plate 71.*) The branches of these boyaux are so laid out that the enemy will not have an enfilading fire along them. Batteries are constructed along the second parallel; the boyaux are enlarged to accommodate artillery carriages; the batteries are then armed. Gun-shields, mantlets, and all similar devices must be employed for the protection of the guns and cannoneers of these batteries. The distance of this line will admit of the use of the smaller class of mortars, and an abundance of them should be put in it. As a rule, it is not advisable to place in this line pieces of a heavier calibre than siege guns; this, for the reason that heavier calibres are more difficult to serve, and, besides, the range from the first parallel is quite within the limits of effective fire from heavy calibres.

An unremitting fire is kept up upon the besieged place. During the day the guns will be directed so as to sweep along the faces of the works, disabling the guns of the enemy and demolishing his traverses, magazines, and bomb-proofs. During the night an incessant shower of mortar shells must be kept falling, to prevent repairs and to keep the garrison constantly harassed.

658. Using the second parallel as a secondary base, the boyaux are pushed forward towards the salients of the work; when advanced to within about half the distance from the second parallel to the work, a third parallel is constructed by running trenches to the right and left of the heads of the boyaux. The third parallel is for the accommodation of strong guards of infantry supporting the working parties, who, under this protection, contrive to push forward the boyaux. They also use their fire to suppress musketry fire from the works and to prevent the enemy from serving his guns. An abundance of small mortars should be placed in the third parallel and vigorously served.

As the boyaux are continued, it may be found advisable to establish a fourth parallel.

Fire from adjacent or collateral works must be attended to, so as to prevent it from interfering with the progress of the approaches.

If the artillery of the besiegers is sufficiently numerous and powerful, the foregoing arrangements will enable it, if vigorously served, to drive to cover the garrison of the place, and to so destroy the means of defense as to make further resistance of little avail. The garrison will either capitulate or withdraw; or if they still hold out, an assault made by infantry from the advanced parallels will have a fair prospect of success. The batteries having prepared the way for assault, render assistance to it by the most spirited fire. This must, however, be directed so as not to interfere with the assaulting force as it enters the work. The practice which the batteries have had up to this time will enable them to direct their fire with precision, and each one must have pointed out to it the precise duty it has to perform.

Instead of an assault, sapping and mining may be resorted to, and the work made untenable by these means. These operations are conducted by engineers, the functions of the artillery, meanwhile, being confined to what has heretofore been laid down.

659. Masonry revetments readily crumble under blows from heavy rifle projectiles. The precision with which the firing can be done, and the drop of the projectile at long range, enable the artillerist to reach scarp walls without, as in former times, establishing batteries on the crest of the glacis. The *débris* from the scarp, whether the latter be of masonry or earth, and that from the parapet resulting from constant hammering, will generally make a ramp practicable for assaulting parties.

The particular work to be attacked by siege operations should be selected with a view to the effect that its capture will have on other parts of the line; in other words, that its capture, when accomplished, will be productive of decisive results, such as leading to the capture or abandonment of other works in the

line, the uncovering of communications important to the besieged, or securing lines of approach to the besiegers.

660. The defense of works attacked by regular approaches calls for the most active and vigilant exertions on the part of the besieged, especially so from the artillery. So soon as the operations of the besieger indicate what work of a line, or the particular part of a work, is his objective, every effort must be made to restrict the extent of his lines of envelopment. To this end, adjacent and collateral works must be armed with pieces of the heaviest calibre, so situated as to take the lines of approaches as much as possible in flank. These batteries will give special attention to the long-range batteries of the besiegers. Every available piece of artillery must be brought forward and placed in battery so as to strike the besiegers at some point or other. Unremitted fire must be maintained against the heads of the approaches; these, from their open character, are peculiarly vulnerable to mortar fire. As many mortars as possible should be placed in batteries established for this special purpose. It is not advisable to crowd artillery into the objective point of the enemy, but rather to the right and left of it; this secures a cross-fire, and at the same time withdraws the pieces from the points upon which the besieger concentrates his fire.

If an assault is to be apprehended, batteries, especially of machine guns, should be established so as to sweep the ditch and prevent the enemy from making a lodgment by digging into the scarp and parapet. These batteries must be well secured by means of bomb-proof covers and gun-shields. Traverses must be thrown up to protect the guns, and bomb and splinter proofs constructed to shelter the cannoneers. An interior line of intrenchments should be constructed in rear of that part of the main work attacked. This should be well supplied with light pieces of artillery, which may be kept under cover until the proper moment and then run up to drive the enemy from his lodgment on the main work.

The supply of ammunition must be closely attended to, and under no circumstances, where it is possible to avoid it, should it be allowed to fall below the probable needs.

All of the operations of the artillery in the defense, as well as in the attack, should be directed by one head.

661. From the foregoing sketch it will be perceived that the operations of a siege may be classed under two heads: those which are necessary to prevent the besieged from obtaining succor, and those which are required to gain possession of the works.

The line established by the besieging army to prevent succor from without, is called the *line of circumvallation*; that established for carrying on the approaches against the work, is called

the *line of countervallation*. Between these two lines the besieging army is established.

As a rule, the engineers have charge of the planning and construction of the parallels and boyaux; the artillery, of locating, constructing, arming, and serving the batteries. All of these operations are minutely connected with each other, and proceed together. It is, therefore, the duty of officers having them in charge to act in accord in carrying them out.

662. No specific rules can be laid down regarding the amount of artillery required for siege operations.

The most remarkable sieges that have taken place since the introduction of the present style of artillery and small-arms have employed about 6500 fighting men per mile of investment, with 5 pieces per thousand men, or 33 per mile.

The conditions of each particular case must govern as to the kind and calibre of pieces and the number of each, together with the quantity of ammunition necessary. As a general rule, a large proportion of the pieces should be of heavy calibre. In some cases the means of transportation will admit of none heavier than can be carried on traveling carriages. When railroads are available still heavier classes may be brought up, while with water transportation there is no limit.

The object of the siege must likewise be considered. If it is intended to simply cut the place off from supplies and reduce it by starvation, an intrenched line of battle armed with ordinary field artillery will be sufficient. If the place besieged is a town or city to be reduced by bombardment, long range and heavy calibres are most desirable; the same class would also be required for a work approachable only on one side, to be destroyed by battering. When a work of this nature is to be reduced by regular approaches, there will be required, in addition to guns and mortars of heavy calibres for long range, a large proportion of regular siege artillery capable of being readily moved up as the works of the besiegers approach the enemy.

The amount of ammunition required will depend upon the character of the work to be done and the duration of the siege. If the source of supply is certain and regular, the quantity to commence with may be small compared with what should be provided under other conditions. Considering the source of supply reasonably certain, about 200 rounds per piece for sea-coast and 1000 rounds per piece for other classes will be a fair allowance.

663. When a siege is determined upon, the chief engineer and artillery officers must study every condition of the particular case and decide upon what seems to be the best for carrying out the general plan. Nothing must be omitted to make the preparation complete.

In commencing siege operations, the first thing necessary is to gain possession of a large area of ground as near as possible to the place to be besieged, for the purpose of establishing depots, artillery parks, hospitals, and camps. This area must be made entirely secure by intrenchments, after the manner of an intrenched camp.

Depots, parks, camps, &c., should be screened as much as possible from the view of the enemy, and a thorough system of roads and telegraphic communication established between them and with the batteries on the line. When practicable a railroad should be laid, forming a main artery from one end of the line to the other. Wharves are constructed for the unloading of vessels, and depots established convenient thereto. These will consist of buildings for the accommodation of engineer and quartermaster's stores and subsistence supplies, together with workshops for repairs.

The water supply must be carefully looked after, not only as to quantity, but as to purity. This is demanded upon sanitary grounds. All springs, wells, and running brooks should be guarded so that they may not be fouled by the watering of animals or by bathing and washing of clothes. Reservoirs should be constructed to prevent loss of water at night.

In localities where the supply is not convenient, water-carts should be used for bringing it to where it is required for use. This prevents straggling and idling.

The site for the artillery park and depot should be easily accessible from all parts of the line. Magazines for powder and fixed ammunition must be constructed in the safest places. Artillery carriages will be parked systematically in such manner as to allow of any being withdrawn when required. The artillery transportation trains, parked in the same manner, consist of a number of wagons sufficient to carry supplies to the artillery depot and to keep the batteries along the line supplied with ammunition.

Materials required in the construction of batteries, such as gabions, fascines, mantlets, and sand-bags, together with those for platforms and magazines, are usually supplied from the engineer depot.

664. The character of the artillery employed in a siege will determine the nature of the machines, implements, and stores required. Supposing that the heavier as well as the lighter calibres can be used, a fair allowance for each 100 pieces, large and small, would be as follows: Six *traveling forges*, with stores as per *par.* 258; six *battery-wagons*, with stores as per *par.* 258; five *sling-carts* (large), ten *sling-carts* (hand), twenty *hand-carts*, five *truck-wagons* (heavy), ten *mortar-wagons*, one hundred *hand-barrows*, two hundred *paulins*, ten *garrison gins* with tackle

complete, five *siege gins* with tackle complete, five 30-ton *hydraulic-jacks*, five 15-ton *hydraulic-jacks*, two *gun-lifts*, five *cradles* with rollers, two hundred and fifty *way-planks*, and five sets of *blocks, skids, &c.*, as specified in *par.* 534.

Each piece of artillery is furnished with the implements and equipments heretofore specified in connection with its service and mechanical manœuvres.

Each service magazine will be supplied with a set of appropriate scales, measures, funnels, &c., and each battery with a field-glass and set of signal flags.

One or more officers will be detailed to ascertain the distances from the various batteries to the objects to be fired at, and will be furnished with the necessary instruments for the purpose.

Each artillery officer will provide himself with a pocket compass, a pair of dividers, a protractor scale, and pencils; also paper for notes and field-sketching. The instruments are conveniently carried in a shoulder-pouch, as represented in *Fig. 2, Plate 71.*

Intrenching tools are furnished from the engineer depot.

665. The preparations for the siege having sufficiently progressed, and the engineers having laid out the lines of intrenchments, the artillery commander will select sites for the batteries, determine their armament, and designate the troops to construct, arm, and serve them.

The teams of the light batteries are used for transporting artillery from the landing-place to the park, and thence to the batteries on the line of investment.

Important works along the line are named, open batteries are numbered in regular order, and the whole line and system of communications mapped, so that there may be no confusion in distributing material and supplies.

666. When the siege is fully opened, the question of supplying the batteries with ammunition is by no means a small one, and requires thorough systematizing to prevent an undue accumulation at some points and deficiency at others.

The allowance of ammunition for the immediate use of each piece varies to suit circumstances; those batteries in most prominent positions have the greatest supply, 100 rounds being about the maximum and 50 the minimum. The number of rounds per piece diminishes as the calibre increases. The supply is maintained by means of a train of wagons kept specially for the purpose.

In order that the daily expenditure may be known at the depot, the commanding officer of each battery on the line will each morning make out and forward to the depot a report of the following form:

Ammunition report of battery....., commanded by....., for the.....day of....., 18....

| ARMAMENT. | GUNS. | | MORTARS. | | | | | REMARKS. |
|-----------|-------------------|-------|----------|----------------|---------|----------|--|----------|
| | Kind. | Kind. | Kind. | 10-Inch. | 8-Inch. | Coehorn. | | |
| | Shells. | | | Shell. | | | | |
| | Case-shot. | | | Rifle powder. | | | | |
| | Solid shot. | | | Rifle powder. | | | | |
| | Canister. | | | Fuse-plugs. | | | | |
| | Percuss'n plugs. | | | Mortar powder. | | | | |
| | Time-plugs. | | | Shell. | | | | |
| | Cartridges. | | | Mortar powder. | | | | |
| | Percuss'n shells. | | | Rifle powder. | | | | |
| | Fuse shells | | | Rifle powder. | | | | |
| | Case-shot. | | | Fuse-plugs. | | | | |
| | Canister. | | | Shell. | | | | |
| | Cartridges. | | | Mortar powder. | | | | |
| | Percuss'n shell. | | | Rifle powder. | | | | |
| | Fuse shell. | | | Shell. | | | | |
| | Case-shot. | | | Mortar powder. | | | | |
| | Canister. | | | Rifle powder. | | | | |
| | Cartridges. | | | Fuse-plugs. | | | | |
| | | | | Shell. | | | | |
| | | | | Mortar powder. | | | | |
| | | | | Rifle powder. | | | | |
| | | | | Fuse-plugs. | | | | |
| | | | | Mortar powder. | | | | |
| | | | | Shell. | | | | |
| | | | | Rifle powder. | | | | |
| | | | | Mortar powder. | | | | |
| | | | | Shell. | | | | |
| | | | | Rifle powder. | | | | |
| | | | | Mortar powder. | | | | |
| | | | | Shell. | | | | |
| | | | | Rifle powder. | | | | |
| | | | | Mortar powder. | | | | |
| | | | | Shell. | | | | |
| | | | | Rifle powder. | | | | |
| | | | | Mortar powder. | | | | |
| | | | | Shell. | | | | |
| | | | | Rifle powder. | | | | |
| | | | | Mortar powder. | | | | |
| | | | | Shell. | | | | |
| | | | | Rifle powder. | | | | |
| | | | | Mortar powder. | | | | |
| | | | | Shell. | | | | |
| | | | | Rifle powder. | | | | |
| | | | | Mortar powder. | | | | |
| | | | | Shell. | | | | |
| | | | | Rifle powder. | | | | |
| | | | | Mortar powder. | | | | |
| | | | | Shell. | | | | |
| | | | | Rifle powder. | | | | |
| | | | | Mortar powder. | | | | |
| | | | | Shell. | | | | |
| | | | | Rifle powder. | | | | |
| | | | | Mortar powder. | | | | |
| | | | | Shell. | | | | |
| | | | | Rifle powder. | | | | |
| | | | | Mortar powder. | | | | |
| | | | | Shell. | | | | |
| | | | | Rifle powder. | | | | |
| | | | | Mortar powder. | | | | |
| | | | | Shell. | | | | |
| | | | | Rifle powder. | | | | |
| | | | | Mortar powder. | | | | |
| | | | | Shell. | | | | |
| | | | | Rifle powder. | | | | |
| | | | | Mortar powder. | | | | |
| | | | | Shell. | | | | |
| | | | | Rifle powder. | | | | |
| | | | | Mortar powder. | | | | |
| | | | | Shell. | | | | |
| | | | | Rifle powder. | | | | |
| | | | | Mortar powder. | | | | |
| | | | | Shell. | | | | |
| | | | | Rifle powder. | | | | |
| | | | | Mortar powder. | | | | |
| | | | | Shell. | | | | |
| | | | | Rifle powder. | | | | |
| | | | | Mortar powder. | | | | |
| | | | | Shell. | | | | |
| | | | | Rifle powder. | | | | |
| | | | | Mortar powder. | | | | |
| | | | | Shell. | | | | |
| | | | | Rifle powder. | | | | |
| | | | | Mortar powder. | | | | |
| | | | | Shell. | | | | |
| | | | | Rifle powder. | | | | |
| | | | | Mortar powder. | | | | |
| | | | | Shell. | | | | |
| | | | | Rifle powder. | | | | |
| | | | | Mortar powder. | | | | |
| | | | | Shell. | | | | |
| | | | | Rifle powder. | | | | |
| | | | | Mortar powder. | | | | |
| | | | | Shell. | | | | |
| | | | | Rifle powder. | | | | |
| | | | | Mortar powder. | | | | |
| | | | | Shell. | | | | |
| | | | | Rifle powder. | | | | |
| | | | | Mortar powder. | | | | |
| | | | | Shell. | | | | |
| | | | | Rifle powder. | | | | |
| | | | | Mortar powder. | | | | |
| | | | | Shell. | | | | |
| | | | | Rifle powder. | | | | |
| | | | | Mortar powder. | | | | |
| | | | | Shell. | | | | |
| | | | | Rifle powder. | | | | |
| | | | | Mortar powder. | | | | |
| | | | | Shell. | | | | |
| | | | | Rifle powder. | | | | |
| | | | | Mortar powder. | | | | |
| | | | | Shell. | | | | |
| | | | | Rifle powder. | | | | |
| | | | | Mortar powder. | | | | |
| | | | | Shell. | | | | |
| | | | | Rifle powder. | | | | |
| | | | | Mortar powder. | | | | |
| | | | | Shell. | | | | |
| | | | | Rifle powder. | | | | |
| | | | | Mortar powder. | | | | |
| | | | | Shell. | | | | |
| | | | | Rifle powder. | | | | |
| | | | | Mortar powder. | | | | |
| | | | | Shell. | | | | |
| | | | | Rifle powder. | | | | |
| | | | | Mortar powder. | | | | |
| | | | | Shell. | | | | |
| | | | | Rifle powder. | | | | |
| | | | | Mortar powder. | | | | |
| | | | | Shell. | | | | |
| | | | | Rifle powder. | | | | |
| | | | | Mortar powder. | | | | |
| | | | | Shell. | | | | |
| | | | | Rifle powder. | | | | |
| | | | | Mortar powder. | | | | |
| | | | | Shell. | | | | |
| | | | | Rifle powder. | | | | |
| | | | | Mortar powder. | | | | |
| | | | | Shell. | | | | |
| | | | | Rifle powder. | | | | |
| | | | | Mortar powder. | | | | |
| | | | | Shell. | | | | |
| | | | | Rifle powder. | | | | |
| | | | | Mortar powder. | | | | |
| | | | | Shell. | | | | |
| | | | | Rifle powder. | | | | |
| | | | | Mortar powder. | | | | |
| | | | | Shell. | | | | |
| | | | | Rifle powder. | | | | |
| | | | | Mortar powder. | | | | |
| | | | | Shell. | | | | |
| | | | | Rifle powder. | | | | |
| | | | | Mortar powder. | | | | |
| | | | | Shell. | | | | |
| | | | | Rifle powder. | | | | |
| | | | | Mortar powder. | | | | |
| | | | | Shell. | | | | |
| | | | | Rifle powder. | | | | |
| | | | | Mortar powder. | | | | |
| | | | | Shell. | | | | |
| | | | | Rifle powder. | | | | |
| | | | | Mortar powder. | | | | |
| | | | | Shell. | | | | |
| | | | | Rifle powder. | | | | |
| | | | | Mortar powder. | | | | |
| | | | | Shell. | | | | |
| | | | | Rifle powder. | | | | |
| | | | | Mortar powder. | | | | |
| | | | | Shell. | | | | |
| | | | | Rifle powder. | | | | |
| | | | | Mortar powder. | | | | |
| | | | | Shell. | | | | |
| | | | | Rifle powder. | | | | |
| | | | | Mortar powder. | | | | |
| | | | | Shell. | | | | |
| | | | | Rifle powder. | | | | |
| | | | | Mortar powder. | | | | |
| | | | | Shell. | | | | |
| | | | | Rifle powder. | | | | |
| | | | | Mortar powder. | | | | |
| | | | | Shell. | | | | |
| | | | | Rifle powder. | | | | |
| | | | | Mortar powder. | | | | |
| | | | | Shell. | | | | |
| | | | | Rifle powder. | | | | |
| | | | | Mortar powder. | | | | |
| | | | | Shell. | | | | |
| | | | | Rifle powder. | | | | |
| | | | | Mortar powder. | | | | |
| | | | | Shell. | | | | |
| | | | | Rifle powder. | | | | |
| | | | | Mortar powder. | | | | |
| | | | | Shell. | | | | |
| | | | | Rifle powder. | | | | |
| | | | | Mortar powder. | | | | |
| | | | | Shell. | | | | |
| | | | | Rifle powder. | | | | |
| | | | | Mortar powder. | | | | |
| | | | | Shell. | | | | |
| | | | | Rifle powder. | | | | |
| | | | | Mortar powder. | | | | |
| | | | | Shell. | | | | |
| | | | | Rifle powder. | | | | |
| | | | | Mortar powder. | | | | |
| | | | | Shell. | | | | |
| | | | | Rifle powder. | | | | |
| | | | | Mortar powder. | | | | |
| | | | | Shell. | | | | |
| | | | | Rifle powder. | | | | |
| | | | | Mortar powder. | | | | |
| | | | | Shell. | | | | |
| | | | | Rifle powder. | | | | |
| | | | | Mortar powder. | | | | |
| | | | | Shell. | | | | |
| | | | | Rifle powder. | | | | |
| | | | | Mortar powder. | | | | |
| | | | | Shell. | | | | |
| | | | | Rifle powder. | | | | |
| | | | | Mortar powder. | | | | |
| | | | | Shell. | | | | |
| | | | | Rifle powder. | | | | |
| | | | | Mortar powder. | | | | |
| | | | | Shell. | | | | |
| | | | | Rifle powder. | | | | |
| | | | | Mortar powder. | | | | |
| | | | | Shell. | | | | |
| | | | | Rifle powder. | | | | |
| | | | | Mortar powder. | | | | |
| | | | | Shell. | | | | |
| | | | | Rifle powder. | | | | |
| | | | | Mortar powder. | | | | |
| | | | | Shell. | | | | |
| | | | | Rifle powder. | | | | |
| | | | | Mortar powder. | | | | |
| | | | | Shell. | | | | |
| | | | | Rifle powder. | | | | |
| | | | | Mortar powder. | | | | |
| | | | | Shell. | | | | |
| | | | | Rifle powder. | | | | |
| | | | | Mortar powder. | | | | |
| | | | | Shell. | | | | |
| | | | | Rifle powder. | | | | |
| | | | | Mortar powder. | | | | |
| | | | | Shell. | | | | |

| | | | |
|---|--|-----------|--------|
| Projectiles. | Took grooves..... | Perussion | |
| | Tumbled..... | | |
| | Uncertain..... | | |
| | } Fuses. | | |
| | Burst well..... | | |
| | Burst short..... | | |
| | Burst long..... | | |
| | Did not burst..... | | |
| | Uncertain..... | | |
| | Perussion | | Fuse. |
| | Combination. | | Solid. |
| | Perussion. | | Fuse. |
| Case. | Combination. | | |
| Case. | Solid. | | |
| Perussion. | Wooden. | | |
| Case. | Wooden. | | |
| Combination. | Wooden. | | |
| Borman. | Wooden. | | |
| Solid. | Paper. | | |
| No. of shots fired from either gun. | No. of shells fired from either gun. | | |
| Ordnance number of gun. | Ordnance number of gun. | | |
| No. of shots fired from either gun or mortar. | No. of shells fired from either gun or mortar. | | |
| Ordnance number of gun or mortar. | Ordnance number of gun or mortar. | | |

..... Commanding Battery.

The officer in charge of the ammunition at the depot loads his wagons with the amount required, and gives to each teamster a ticket stating the contents of his wagon and to which battery it is to go.

The train, under competent wagon-masters, starts out before night-fall and proceeds so as to reach the batteries after dark. Guides from the several batteries meet the train at appointed places and direct the particular wagons to the proper batteries. Upon the arrival of the wagons, an officer of the battery gives his personal supervision to the unloading, and signs the ticket brought by each driver, noting any discrepancy. The ticket is returned by the driver to the officer at the depot.

All articles that have become unserviceable or are useless in the battery, together with all empty packing-boxes and barrels, are returned by the wagons to the depot, a list of them being sent back with the teamster.

To simplify accountability, the officer at the depot will be responsible for all the artillery, ammunition, and material. Battery commanders give him memorandum receipts, and are held accountable for any loss. The ammunition fired is expended by the depot officer upon the reports made by the officers commanding the several batteries.

As a general rule, cartridges will be made up at the depot, and sent to the batteries either in hudge-barrels or in chests of convenient size made for the purpose.

The latter part of the report on the foregoing form is for the information of the commandant of artillery, and for the purpose of keeping a complete history of the artillery firing. From the daily reports a monthly abstract is made for each piece upon the following form :

Monthly report of artillery firing, siege of....., May 18...

| KIND OF | | No. fired. | Took grooves. | Uncertain. | Tumbled. | Burned well. | Burned short. | Burned long. | Did not burn. | Uncertain. | REMARKS. |
|---------------------------|------------------|------------|---------------|------------|----------|--------------|---------------|--------------|---------------|------------|----------------|
| GUN. | PROJECTILE. | | | | | | | | | | |
| No. and calibre of piece. | | | | | | | | | | | |
| | Percuss'n shell. | 10 | 8 | 1 | 1 | 7 | 2 | ... | 1 | ... | Where located. |
| | Fuse shell..... | 6 | 5 | ... | 1 | 6 | ... | ... | ... | ... | |
| | Solid shot..... | 4 | 4 | ... | ... | ... | ... | ... | ... | ... | |
| | Canister..... | ... | ... | ... | ... | ... | ... | ... | ... | ... | |
| | Case-shot..... | 4 | 3 | 1 | ... | 2 | ... | ... | 2 | ... | |

The command of the entire artillery is vested in an officer of that arm of service, who, besides other necessary qualifications, should have rank commensurate with the importance of his position.

The line of works is divided into sections, each of a size capable of close supervision by the officer assigned to the command of it.

DEFILES.

667. A defile, in a military sense, is any narrow place the passage of which can be made by troops only when undeployed.

Mountain passes, river crossings, narrow isthmuses, and roads through close forests represent the usual forms of defiles. They necessarily imply obstacles in the way to the free movement of armies, and are therefore important features in a theatre of war, and consequently points demanding special attention by way of defensive arrangements. For these no precise rules can be laid down; nevertheless some general principles may be stated.

The chief advantage offered by a defile is, that with but comparatively slight intrenchments a small force is able to hold a position against a much greater; this, for the reason that, owing to the essential nature of a defile, the attacking force must operate in a constrained position, not admitting of much development of fire. The main object, therefore, is to secure such a column of fire over the defile as to make it impossible for the enemy to stem it; this is best accomplished by selecting such points as will give an enfilade fire. They should be selected with a view to mutual support, and intrenched in such manner as to be secure against capture by *coup de main*. The enemy must be compelled to make his attacks with divided forces and inferior numbers. This is best accomplished by occupying several positions within flanking distance of each other. He will, probably, not be able to attack all simultaneously, and it will be a costly operation for him to attack them in detail.

The positions should be so chosen as to allow them to concentrate their artillery fire upon any point where it might be advantageous for the enemy to establish batteries, and the artillery of the defense should be of such power as to preclude all possibility of his doing so. All hollow approaches, such as would be formed by ravines in a mountain pass, must be searched by the fire of artillery. This, as a rule, will require pieces to be placed in open batteries exterior to the inclosed works. Such batteries must be well supported by infantry sheltered in rifle trenches. The whole system should be so connected as to leave

no part isolated or without the support of other parts, and the defense of each point must be stubborn in the extreme to prevent the enemy from gaining possession of advantageous positions.

All parts of the line or group of works must be in communication by telegraph, telephone, or signaling, or by all three. This is a matter of the greatest moment in securing not only the physical, but also the moral support of the parts.

In every case artillery should form a chief feature in the means of defense; the kind of pieces for the different parts of the system will depend upon the character of the ground and of the nature of the attacks that may be expected. As a rule, all approaches must be covered by fire; wherever horizontal fire cannot be made to reach, mortars must be used. However much the pieces may be scattered, they must be capable of concentrating their fire upon any position the enemy may assume.

As defensive works in defiles are required to be self-sustaining, frequently for long periods, the supply of ammunition must be ample for all probable wants.

If a defile is to be held for the purposes of an army either advancing or retiring in front of an enemy, the head of it towards the enemy must be secured by a line similar to a *tête-de-pont*; this, for the purpose, if advancing, of giving room for the army to deploy after passing the defile, and to prevent the enemy from striking it while defenseless in column; if retreating, the same disposition is necessary to hold the pursuing army in check while the troops are defiling to the rear. In both cases, as the object is to keep the enemy from closing in for a pitched battle, artillery must be freely used.

In the attack upon a defile, intrenched, armed, and defended as it should be, artillery will be the most important weapon; this, for the reason that, from the very nature of defiles, other arms can act but feebly, while artillery possesses the power of reaching its object beyond intermediate obstacles. As much artillery should be brought to act as possible, and, although it may be widely dispersed, its fire must be concentrated upon some particular work in the system of defenses. The work must be attacked with such vigor and persistency as to insure its destruction and easy capture. Other works, successively, are attacked in the same manner.

The operations upon both sides thus partake of the nature of a siege, and are governed by the same principles.

RIVERS.

668. Rivers traversing the theatre of war occupied by hostile armies have a marked influence on the operations of each. Whenever they are to be crossed in the presence of an enemy, either in advancing or retiring, the use of artillery and of field-works becomes of great importance; this, for the reason that the operation of crossing necessarily consumes considerable time, during which the army is divided—astraddle, as it were, the stream—and requires the aid of that arm which, from a fixed position, possesses the power of covering at long range the movements of other troops.

The place of crossing, whether bridge, ferry, or ford, is simply a defile through which the army has to pass, and which must be completely covered from the fire of the enemy, who must not be permitted to establish batteries within range of the crossing. This is best effected by covering every point accessible to him with the fire of artillery.

A river in front of an army operating on the defensive, stands to it, somewhat, as a wet ditch does to a fortification, and should be so guarded as to make the crossing of it a difficult, if not a hazardous, operation to an advancing enemy. Points at which the communications of a country converge are those most advantageous for an enemy to select for crossing. These should be secured by strong inclosed works, armed with artillery of such power as to cause him to make a long detour and to adopt a less advantageous point.

If the stream is navigable, such works form a place of refuge for the craft that ply on it, and which, falling into the hands of the enemy, would furnish him with means of crossing and assist him in carrying on his operations.

The size of the work will, to a great degree, depend upon the force that can be detached from the main body for garrisoning it; but, generally, a well-constructed work containing a thousand men, adequately supplied with artillery, will prove a formidable obstacle to the crossing army. Points thus established should not be so numerous as to cripple the efficiency of the defending army by dispersion. They should be rather in the nature of bases for temporary points of observation along the river, secure against capture by *coup de main*, and threatening to the flanks and rear of the crossing army.

Tête-de-pont. A bridge is protected by a *tête-de-pont*, the nature and extent of which will depend upon the character of the attacks to be expected. Against mere raiding parties, a redan or lunette—as represented in *Fig. 1, Plate 72*—is sufficient.

Two or three pieces of artillery may be put in it, but it is preferable to locate batteries, as at B and C, on the opposite side of the river, to flank the redan and cross their fire in front of it.

Against a large force well supplied with artillery, a *line of works* (*ab*) must be thrown up and well armed with artillery, for the purpose of keeping him beyond artillery range from the bridge. Batteries of heavy pieces are placed, as at *c d*, to flank the line.

The operation of crossing a river by an army in presence of a vigilant enemy, is one of great delicacy, as it necessarily consumes considerable time, during which it is more or less divided and subject to every disadvantage. Judicious use of artillery is of the first importance. The first thing to be done is to gain a footing on the opposite side. This is usually accomplished by stratagem or by surprise. Before a large opposing force can arrive, batteries must be established on the side from which the crossing is made to cover with their fire a large area of ground opposite. Every available piece must be put in, and the enemy kept back until bridges can be laid and a strong line of infantry passed over and intrenched. Siege guns, owing to their great range and power, are the best adapted for this service. The batteries should be extended up and down the stream for three or more miles on each side of the crossing-place; this, for the purpose of enfilading the flanks of the enemy and preventing him from bringing his artillery to bear upon the crossing. The place for crossing should be selected, as far as practicable, with a view to advantageous positions for batteries. The convex side of a curve (*Fig. 2, Plate 72*) with hills dominating the opposite side gives every advantage. This secures a cross-fire upon the opposite peninsula, under cover of which the infantry line and light field batteries can be thrown forward to a distance of two or three thousand yards and established in an intrenched line as represented in the figure.

If the enemy has gun-boats on the river, especially if they are iron-clads, provision against them must be made by laying across the channel lines of submarine mines, with heavy batteries established for their protection. These batteries must be strongly intrenched.

The operation of crossing a river by an army pressed in rear by another, is the reverse of that just described.

When practicable, the concave side of a bend is selected, across which a line of temporary intrenchments is constructed; batteries are established on the opposite side, and the army withdrawn under protection of their fire. The batteries should cover themselves with gun-pits, and give special attention to such

artillery as the enemy may bring forward for the purpose of reaching the place of crossing.

DEMOLITION.

669. Buildings. In military operations it sometimes becomes necessary to destroy buildings, bridges, &c. Wooden structures are readily and effectually destroyed by burning. Ordinary dwelling-houses of stone or brick may be blown down by placing against the walls charges of from 25 to 50 pounds of powder, each contained in a bag, box, or any convenient vessel, and exploded by means of an electric primer, a slow-burning time-fuse, or a piece of slow match. The effect of the explosion is to blow away a portion of the foot of the wall, that above settling down without, as a rule, toppling over. An inside angle or corner of the building is the most advantageous place for the charge, for the reason that, being confined on two sides, the explosive force acts more powerfully than when against a plain surface, and also because the angle or corner of the building, being a point of greatest support, when blown away leaves the remaining parts greatly weakened.

Against strong and massive walls, such as are generally found in large public edifices, charges of powder, unless very heavy, have but little effect when simply exploded against the wall without tamping. Inside angles should, if possible, be taken, or when the building has buttresses, the angles formed by them are advantageous for confining the explosive force and causing it to take effect on the wall. The powder is placed in a box or keg and covered with earth and stones. When placed five or six feet above the foot of the wall the effect is greatly increased.

In all cases where demolition is to be produced, dynamite may be used instead of gunpowder. Its destructive effect is about thirty times that of powder, weight for weight.

Bridges. To destroy the arches of a masonry bridge, excavate a hole down to the crown or haunch of the arch, place in it a charge of one or two hundred pounds of powder, according to the thickness of the arch, tamp it well with earth and stones, and explode it.

The amount of powder is determined from the formula $X = \frac{2}{3} A^2 \times B$: in which X is the charge in pounds, A the line of least resistance through the arch, and B the breadth of the bridge, both in feet.

When the width of the arch is over 25 feet, two charges should be placed, to prevent the chance of blowing a hole through the

middle without bringing down the sides. These should be exploded simultaneously, if possible.

When the side walls are lightly built, it is better to pull enough of the stone away to allow a tunnel being run on top of the arch to the middle of the roadway. This does not interfere with the use of the bridge during the operation, and if it is not desired to destroy the bridge immediately, the charge may be kept in its place ready for use at any moment. In this case the charge should be in a tight box or barrel, well pitched to protect it against moisture.

The charge may be exploded by means of an electric primer, the ordinary fuse used in blasting, or with a powder hose. This latter is made of canvas or any stuff that will hold fine-grained powder, and is inclosed in a trough to protect it from the moisture of the earth.

The ordinary blasting fuse is known in this country under the name of the *safety fuse* and Toy's fuse; in England, as Bickford's fuse.

It consists essentially of a column of fine-grained gunpowder inclosed in flax, hemp, or cotton, and made up with different coverings, according to the use to which it is applied. When intended for immediate use on light work in dry sand, it is unprotected by additional coverings; when intended for use in wet ground or under water, it is covered with varnished tape or gutta-percha.

These fuses are somewhat uncertain in their rate of burning, but average about one yard in a minute.

The ordinary varieties must be kept in a cool, dry place, and preserved from contact with oil.

Wooden bridges are easily burnt; but if great secrecy is necessary, a hole may be bored with an auger in a main-brace and a charge of powder or dynamite exploded therein, blowing it to pieces. Charges should be placed in several of the braces and exploded as near simultaneously as possible.

During the war of the rebellion a small torpedo was devised for this purpose. It consisted of a tin cylinder 1.75 inch in diameter and about 7 inches long. Both ends of the cylinder were open, and through it passed a bolt of 0.75-inch iron, with a stout head at one end and a nut at the other, each having a diameter of 2 inches. A washer of the same size as the head was placed under the nut; through a hole in the washer passed a strand of slow match to communicate fire to the powder with which the cylinder was filled. A coat of varnish protected the powder from moisture. To use it, a hole 2 inches in diameter was bored

in the timber; into this the torpedo was driven, head downwards, and the fuse ignited.

The most effectual way of destroying an iron bridge is to attack the abutments by mining down so as to get behind the masonry a large charge of powder or dynamite, which being exploded, destroys the supports of the superstructure. When time and means permit, remove as many bolts as possible, so as to weaken the parts, after which build a strong fire and heat the main-braces to make the bridge sag and warp out of shape, or to come down entirely.

Canals. These may be temporarily disabled by cutting embankments. The most effectual way, however, is to blow up a lock, which may be done by digging down behind a facing wall and placing against it a charge of two or three hundred pounds of powder or a few pounds of dynamite, tamping well and exploding it. A lock destroyed in this manner requires a long time to repair. The arches of an aqueduct may be broken by drilling holes and blasting.

An army depending upon a railroad for its supplies should be provided with an organized construction corps, fully equipped with every means for making speedy repairs. Damages done to railroads are easily repaired, in comparison with those done to canals.



Part Ninth.

SUBMARINE MINES.

670. The term *torpedo*, when used in a military sense, designates those contrivances for producing explosions calculated to act destructively against an enemy coming into their immediate vicinity.

They are chiefly used for obstructing rivers and entrances to harbors, and are either stationary or capable of movement. When stationary they are called *submarine mines*, leaving the term *torpedo* for all offensive and movable combinations of this nature. The use and application of the latter fall more particularly to the province of the Navy, the former to the Army, and, being employed as auxiliary to shore batteries, constitute a branch of service naturally belonging to or intimately connected with the artillery arm.

Submarine mines are applicable to almost any situation liable to be attacked by ships, but in every instance they should be so arranged as to be covered by the guns of forts or detached batteries, so that, while acting as outworks of these latter, they will be protected from destruction by boats from a hostile fleet.

The comparatively small cost of this species of defense allows of its extensive use as an agent to deter an enemy from approaching a fortified position, and to cause him to begin the tedious and dangerous operation of clearing the channel, or to land and attempt to capture the place without the aid of his ships. This in most cases would enable the defenders to hold out until the arrival of a relieving force.

The materials required for most submarine mines are articles of commerce easily procurable, or capable of being kept on hand without damage or loss, and a system of defense by such means can be carried on by a comparatively small number of men.

671. *Submarine mines* may be briefly described as charges of gunpowder, or other explosive agents, inclosed in water-tight cases of iron or other material, and placed under water at such depths that, by their explosion, they may sink or seriously damage a vessel passing in their vicinity. They are classed under two heads, viz.: *Mechanical*, those which depend for the explosion of the charge on mechanical means, such as the simple per-

cussion of a vessel coming in contact with them; and *Electrical*, those which are fired by electrical agency, either by the vessel closing the circuit, or at will from the shore.

The former class, or mechanical mines, are capable only of very limited use. When once placed in a channel they make it equally impassable to friend and foe. They are, therefore, only applicable to certain cases; as, for example, when it becomes necessary to block up a channel completely, that is to say, to render it altogether impassable till the mines have been removed. They might, however, be employed on a flat beach, dry at low water, to cover the flanks of electrical mines defending the navigable channel. In such case they could be planted or removed at low water with comparative security. The number of electrical cables, &c., required would be reduced by such an arrangement. Mechanical mines are not applicable to harbors of refuge, in which merchant ships might run to avoid an enemy.

It would, furthermore, be absolutely necessary to make some arrangement by which they could be exploded at will, as the most effectual way of getting rid of them when it became necessary to clear the channel, as the process of removal in the ordinary way, by boats, would be far too dangerous an operation to undertake. On the other hand, submarine mines of this description possess the advantage of capability of being kept in store and ready for use at short notice; they require no knowledge of electricity in their management, and they might be used with advantage in certain cases where electrical submarine mines are not obtainable.

The second class of submarine mines, those to be fired by electrical agency, admit of a very much larger field for their employment. They may be fired either at will by an observer, who, judging of the position of the vessel, closes the circuit, so that the charge may be exploded at the right moment; or the vessel herself may be made to complete the circuit, causing a current to pass and fire the charge.

The disadvantages of electrical submarine mines, as compared with those fired mechanically, are the multiplicity of wires required and the necessity of having a certain number of especially trained men. This number, however, is comparatively small.

The advantages of electrical mines are, that they are always absolutely under the control of the observer in charge of them. By simply detaching the battery used in firing them they become perfectly harmless, and friendly vessels may pass over them with safety, which is not the case with those arranged for mechanical ignition. Again, they can be rendered active at a moment's

notice by reconnecting the battery. By means of electrical contrivances, arrangements are so effected that vessels passing over mines give notice of their presence without exploding the mine. In this respect electrical submarine mines are a great safeguard against attack by surprise, and against vessels passing at night, or in a fog. Nor can they be tampered with by an enemy without its being immediately known, and exactly what mine. In the electrical system, when a mine is exploded, or becomes ineffective from any cause, another can be laid down in its place, without danger, by simply making the neighboring mines inactive for the time being. Another important advantage of this system is the power of testing electrically, without going near it, the condition of each separate charge at any time after submersion, and of ascertaining, with almost absolute certainty, whether it can be fired or not. None of these advantages appertain to mines of the mechanical system.

672. *Position of submarine mines.* The following general rules govern in selecting sites for these mines:

1st. They may be used in combination with floating obstructions, as booms, or with grounded obstructions, as sunken vessels, piles, &c., or without them.

2d. They should be placed in such positions that their explosions will not injure any passive obstructions combined with them, or destroy the electric cables of adjoining mines.

3d. At least two, and, where practicable, more, rows of mines should be arranged across the channel to be defended.

In deep water, it is more necessary to employ several lines of mines than in shallow, because in the latter case a vessel sunk by a mine would herself offer an impediment to others following; but in deep water the explosion of a mine leaves a gap, through which there is a safe passage.

4th. Submarine mines should be placed in the channels through which large vessels only can pass; the shallower places being, in all cases where such a course is practicable, rendered impassable by passive obstructions resting on the bottom.

5th. Submarine mines should be placed in the narrowest part of a channel. The advantages of such a position are evident, as a smaller number will answer the purpose.

6th. When the depth of the water and other circumstances admit of it, a submarine mine should always rest on the bottom. Under such circumstances, all complications originating in mooring arrangements are avoided; its position is more easily defined, and it is not so easily displaced by accident, or discovered and destroyed by an enemy.

7th. No indication of their position should be allowed to appear

on the surface of the water. Under certain conditions it may be impracticable to conceal them altogether; as, for example, where there is a large rise and fall of tide. Under such circumstances, the smallest possible indication of their position must be allowed.

8th. When, from the depth of the water, the charges cannot be placed on the bottom, they should be so moored as to float from 15 to 40 feet below the surface. In places where there is a considerable rise and fall of tide, special arrangements would be necessary for this.

9th. The place in which batteries and instruments connected with the ignition of electrical submarine mines are arranged, should be in those portions of the defensive works which are likely to be held longest, so that a command may be kept over the mines to the latest possible moment in the defense.

10th. Great care should be taken to lay the electric cables in such positions as to render their discovery by an enemy as difficult as possible, and likewise to secure them against every accident.

11th. The position of the mines should be well covered by the fire of the guns of the forts or shore batteries of the place to be defended, to prevent their destruction by boats.

12th. Submarine mines should not be thrown away by firing them at small boats, except under very exceptional circumstances, but should be reserved for larger vessels.

673. *Arrangement of system.* The object to be obtained in arranging any system of mines for the defense of a channel, is to place them in such a position that a vessel passing along that channel must, at some one moment, whatever course she may take, come within the radius of destructive effect of one of the mines. This would be attained by placing the mines in a single row across the channel, so that their circles of destructive effect may at least touch each other. To this simple arrangement there are, however, practical difficulties; among which is the danger of entanglement between the mooring cables of adjacent mines, or their electric cables, especially when there is an ebb and flow of the tide. When mines are very close together, it is impossible, with the most perfect mooring arrangements, to prevent entanglements of this nature, particularly when laying down the mines and arranging the gear in connection therewith.

The difficulty of grappling for and raising a mine for examination is greatly increased by this very close approximation. Again, when mines are very close to each other the explosion of one is very likely to injure its neighbor; or, where an electrical system is adopted, to disturb the particular mechanism of the system. It becomes necessary, therefore, to allow some lati-

tude, in order to obviate these difficulties and at the same time to preserve the theoretical precision and closeness of a single line. This is effected by placing the mines in two or more lines, at a distance from each other something greater than the radii of destructive effect of the mines. *Fig. 3, Plate 72*, explains this method.

In this figure, *a b* represent the theoretical line required to close the channel, and it is only necessary to move back every second mine to the line *c d*, and every third mine to the line *e f*, to secure the object required. A fourth line (*g h*), or even a fifth (*i k*), may be added with advantage, taking care that these last shall cover the intervals left between those in advance of them in such a way that a vessel passing obliquely through the intervals of the first three lines may come in contact with a mine in the fourth or fifth. This arrangement overcomes the great objection that attaches to a single line, which, in case a breach is once effected, affords a safe passage until repaired. It likewise makes it more difficult for an enemy to discover the limits to the area of danger, and consequently weakens the efforts of the enemy by the moral effect of uncertainty.

The arrangement in lines is the best, both for facility in laying the mines so as to space the area with certainty, and for finding their positions when it becomes necessary to raise them for examination. It also affords facility in determining what particular mine it is necessary to explode to strike a vessel attempting the passage.

So much depends upon local circumstances—such as the nature of the channel or roadstead to be defended, the probable means of attack at the disposal of an enemy, the draught of water of the vessels of a hostile fleet, &c.—that a great deal must be left to the officer commanding the defense.

The size, strength, and character of the vessels to be guarded against will determine the power of the mines to be used, and this, again, will decide the distance between the lines and the intervals thereon of the mines.

674. Neither experiments nor observations in actual warfare have yet determined, except approximately, the size of charges necessary to perform the work required of mines under the various circumstances that would arise in service. The stronger the vessel the greater, manifestly, will be the charge required to destroy it. As a general rule, the strength of vessels increases with their size, as likewise does their draught; therefore a mine of sufficient power to destroy a large vessel will evidently destroy a smaller one, and this notwithstanding the charge be

placed at a depth suitable for the larger vessel and of the consequent intervening cushion of water.

The depth of water in a channel decides very closely the character of vessels that can pass; this, for war vessels, may be placed at 15 feet for the minimum. Furthermore, it has been decided that a charge of 2000 pounds of gunpowder, if properly placed, is sufficient to destroy the largest vessel. This, therefore, is laid down as the maximum charge to be used in any one mine. A rule for approximately determining the charge for depths of water from 15 to 40 feet is, that the square of the depth in feet gives the quantity in pounds of gunpowder required. Gunpowder being the most common and best known of the explosives, is taken as the standard. So far as known, the explosive effect of gun-cotton, when used for submarine mines, is about four times, and that of dynamite about ten times that of gunpowder, weight for weight. The character of the bottom on which submarine mines are planted has considerable effect on their destructive power, a yielding, muddy bottom being much less favorable than a hard and resisting one. In the foregoing rule, about ten per cent. should be added to the charges when the bottom is soft, or when the mines do not rest on the bottom. It is evident that the nearer the lines of mines are to each other the less will be the chances of a vessel passing through safely; they should, however, be so far apart as to enable the electric cables connected with them to be laid in a safe position when carrying them to the electrical-room from which the system is to be worked. The distance likewise should be sufficiently great to enable the observers, taking cross-bearings, to determine with certainty when a vessel is over any particular line. These conditions will, as a rule, give 100 yards as a minimum and 200 yards as a maximum.

The distance apart at which two mines on the same line may be placed so that the explosion of one will not injure the other, depends upon the size of the charges employed. For the maximum charge—2000 pounds—this interval should not be less than 200 feet; for charges not exceeding 500 pounds the interval may be reduced to 100 feet. This necessary interval between the charges in a line is one reason which renders the employment of two or more lines of mines essential to a proper maintenance of the defense. It also sufficiently explains the object to be attained in placing them in such a way that the charge in the second line shall cover the intervals in the first, and those in the third shall cover the intervals in the second, and so on.

675. Explosives. The explosives used for submarine mines

are confined almost exclusively to gunpowder, dynamite, and gun-cotton.

Gunpowder has already been discussed in PART FIRST, *pars.* 180 *et seq.*

Dynamite. This explosive compound is merely a preparation in which nitro-glycerine is itself presented for use, its explosive properties being those of the nitro-glycerine contained in it, as the absorbent is an inert body. Dynamite is formed of 75 parts of nitro-glycerine absorbed by 25 parts of "kieselguhr," a porous siliceous earth.

In appearance dynamite is a loose, soft, readily-moulded substance, of a buff color. It is prepared by simply mixing, with a wooden spatula, the nitro-glycerine with finely-powdered kieselguhr in a leaden vessel. It freezes at 39°—40° F., and when solidly frozen cannot be exploded; but if in a pulverized state, it can be exploded, though with diminished violence. It is easily thawed by placing the vessel containing it in hot water.

Friction or moderate percussion does not explode it. Its firing point is 356° F. If flame be applied to it, it burns with a strong flame. It is fired by means of fulminate of mercury, and its explosive force is about seven times that of gunpowder.

This explosive compound is now most extensively used for general blasting purposes all over the world, especially for submarine work, where, for removing rocks, it is exploded by simply placing it on the surface of the rock, the water forming the tamping.

For ground and buoyant mines, where actual contact between the hostile vessel and the torpedo will be rarely achieved, this being, next to nitro-glycerine, the most violent of all known explosive agents, and being cheaply and readily procured, is the very best explosive for such torpedoes.

Dualine. This is prepared by mixing nitro-glycerine with sawdust and saltpetre. It possesses the principal qualities of dynamite, though inferior to it.

Lithofracture. This is prepared by mixing nitro-glycerine, kieselguhr, charcoal, soda, saltpetre, and sulphur. It likewise is inferior to dynamite.

Nitro-glycerine. This is an explosive compound formed by the action of nitric acid upon glycerine at a low temperature. At ordinary temperature it is an oily liquid, having a specific gravity of 1.6. Freshly made, it is creamy white and opaque, but clears and becomes colorless on standing for a certain time, depending on the temperature.

It does not mix with, nor is it affected by, water. It has a

sweet aromatic taste, and produces violent headache when placed on the tongue.

The opaque, freshly-made nitro-glycerine does not freeze until the temperature is lowered to 3° — 5° below zero F., but when cleared it freezes at 39° — 40° F. It freezes to a white crystalline mass, and in this state it can be thawed by placing the vessel containing it in water at a temperature not over 100° F.

If flame is applied to freely-exposed nitro-glycerine, it burns slowly without explosion. When in a state of decomposition it is very sensitive, exploding violently when struck, even when unconfined. When pure it is not sensitive to friction or moderate percussion. If struck with a hammer, only the particles receiving the blow explode, the remainder being scattered.

The firing point of nitro-glycerine is about 365° F., though it begins to decompose at a lower temperature. The mode of firing it usually employed is by means of a fulminate-of-mercury detonating fuse. In a frozen state it cannot be fired even by large charges of fulminate.

It is kept in tight tin cans of 40 to 50 pounds each, and should not be transported or handled except when in the frozen state.

It is the most violent of all known explosive agents, its force being about ten times that of gunpowder.

Gun-cotton. This is formed by the action of concentrated nitric acid and raw cotton. When thus acted on the cotton is little changed in appearance, though more brittle and slightly harsher to the touch.

If a flame be applied to it in a loose, dry state, it flashes up without explosion; if compressed, it burns rapidly, but quietly. Moist compressed gun-cotton under the same circumstances burns slowly.

In the compressed state in which it comes from the hydraulic-press it contains about 15 per cent. of water; in this condition it may be cut, sawed, bored, or perforated with a red-hot iron with perfect safety. If placed on a fire, a feeble transparent flame flickers over the surface from time to time as the exterior becomes sufficiently dry to inflame; in this way it burns away very gradually.

This comparative safety of wet gun-cotton, coupled with the fact that its detonation in that state may be readily accomplished through the agency of a small quantity of dry gun-cotton termed a *primer*, which, by means of a fulminating fuse or detonator, is made to act as the initiative detonating agent, gives it important advantages over other violent explosive agents, when used for purposes which involve the employment of a considerable

quantity of the material, on account of the safety attending its storage and necessary manipulation.

Gun-cotton is not sensitive to friction or percussion. Its firing point is about 360° F. It is insoluble in and unaffected by water. When not in water it is liable to spontaneous decomposition, which, under favorable conditions, may result in explosions.

Compressed gun-cotton is free from such danger, as it may be kept and used saturated with water. It is stored in the wet state, care being taken that it is not exposed to a temperature that will freeze the water in the cakes, as this would disintegrate the cakes by the expansion of the water in freezing.

Compared with dynamite, it is not so violent, and occupies more space, weight for weight, and also requires a more complicated means of detonating it. On the other hand, gun-cotton is infinitely safer to store and manipulate, and is not so subject to detonation by concussion as dynamite.

The explosive effect of dynamite and gun-cotton is a rending or a shattering one, while that of gunpowder is an uplifting or heaving one, and always in the line of least resistance—differing in this respect from the first two substances, in which the explosive effect is nearly equal in every direction. This property of dynamite and gun-cotton makes them most suitable for demolitions. (See *Demolition*, par. 669.)

Gun-cotton, while in the pulpy state, is pressed into cylinders of about 3 inches in length by 2.5 inches in diameter. For transportation these cylinders are placed in boxes, each containing about three dozen; the box is filled with water, which, after remaining a few minutes, is drained off and the box closed.

Fulminate of mercury. This is the composition used in the detonating primers employed for the ignition of dynamite and gun-cotton. It is the substance in percussion caps that detonates and produces fire when the cap is struck a sharp blow.

Dry fulminate of mercury explodes violently when heated to 367° F., by the electric spark, or when struck. When wet it is in explosive, and therefore it is always kept wet, being dried in small amounts when required for use. Great care is requisite in handling it.

For the purpose of detonating nitro-glycerine or its preparations, 15 grains of the fulminate are sufficient, but to detonate gun-cotton 25 grains are necessary. The fulminate in detonating fuses should be inclosed in a copper case or cap, and must never be loose. The fulminate should be wet when charging the detonators, and afterwards dried.

676. Case. Whatever may be the form and construction of

the case which contains the charge of a submarine mine, the following conditions are essential :

1st. It must be water-tight, to prevent damage to the charge by leakage.

2d. It must be sufficiently strong to bear handling without danger of becoming leaky by straining, and must be able to sustain the external pressure due to the depth of water at which it is to be placed.

3d. When gunpowder, or gun-cotton fired with an ordinary fuse, is used, it must be sufficiently strong to hold the charge together, as it were, for an instant at the moment of ignition, so that its full effect may be obtained by as thorough a combustion as possible of the charge.

4th. In the case of a buoyant mine, it must be capable of being arranged with a large excess of flotation, so that when moored it may remain as stationary as possible at the required point.

5th. It should be of such form as to be capable of being handled and moored conveniently.

6th. It should be of such form as to secure the thorough ignition of the charge with the smallest possible number of fuses.

7th. It should be easy of construction, and not too costly.

First, with reference to the form of the case. This generally is either conical, spherical, or cylindrical. The former is the best for self-acting buoyant mines. The apex (*a*, *Fig. 1*, *Plate 73*) of the cone forms a convenient point to which the mooring cable may be attached, while the base, terminating by a curved portion (*b*), serves as an air-chamber, giving the necessary buoyancy to keep the mooring cables taut and to hold the mine in a comparatively stationary position in a current or tide-way. The nipples (*c c*) containing the fulminating composition are placed on the rim uniting the base with the conical surface. In this position they are most likely to be struck by a passing vessel. There should be four or more of these nipples, depending upon the size of the case.

For all other cases, except the one just mentioned of a floating mine, intended for small charges to be exploded by mechanical means, the cylindrical form is best, and the one most frequently adopted for both ground and buoyant mines containing heavy charges. *Fig. 2*, *Plate 73*, represents the form so successfully used by the Confederates, 1861-65; *Fig. 3* represents that of the Austrians; *Fig. 4* that of the English for small buoyant mines, in which *J* is a wooden jacket, giving buoyancy and protection to the case; *C* is the circuit-closer.

For large ground mines, the best form of case seems to be that of the turtle mine, represented in *Fig. 5*. A heavy charge

may be contained in it; it forms its own anchor, and it would withstand an explosion of an adjacent mine without sustaining any injury. This is the best form for resisting strong currents.

The difficulty and cost of making spherical cases have heretofore debarred their adoption on a large scale, but recently General Abbott, U. S. Engineers, has simplified the process of manufacture and made them practicable. This process consists in pressing circular disks of steel into hemispherical segments, which are united by flanges, as represented in *Fig. 6*.

As regards the material of which the cases may be most advantageously constructed, several substances have been tried and used; such as wood, iron, and vulcanized India rubber. For actual war service, regularly-constructed torpedoes or mines would generally be turned over to the posts ready for use; but it might become necessary to improvise cases out of such materials as would be available. Tight barrels and hogsheads, when properly strengthened, are a good substitute for even the most improved form of case. The barrel or cask is simply an external shield for the protection of the charge, which is contained in a water-tight envelope, and may be an India-rubber bag or a tin or zinc can. The strengthening of the cask is to guard against collapsing when submerged in deep water. Under ordinary circumstances the depth of the water will not be so great as to require strengthening of good casks beyond stout hoops of iron. As the charge must generally remain a considerable time—perhaps many months—under water before explosion, it is most essential to have the case, whatever it may be, completely water-tight; and with this view the cask is coated, both inside and outside, with a composition of pitch and tar. The envelope containing the charge within the cask should be firmly fixed, so that no independent motion may disturb the connections of the electrical apparatus.

677. Mooring. This is the most difficult operation connected with submarine mines. It is a problem containing so many conditions that it is impossible to give more than general suggestions concerning its solution.

In order to possess a maximum of efficiency, no indication of the position of a mine should appear on the surface of the water, and yet the spot, to within a few feet of where it is deposited, must be known to the defenders of the channel in which it is used. In certain cases—as when there is considerable rise and fall of the tide—it is impossible to totally conceal the position of a system of mines. When such is the case, the very smallest indication possible should be allowed to appear on the surface of the water. It has been found that the least cur-

rent, or so much roughness as only a moderate breeze would cause, renders the placing of even a single mine in a definite position a matter of very considerable difficulty. When a series of mines are to be moored in proper relative position, this difficulty is much increased, and it is, furthermore, augmented in proportion to the depth of the water.

The objects to be obtained in mooring are as follows :

1st. That the charge should be kept as nearly as possible stationary at the point where it is required to act. This is particularly necessary where there is a tide which, flowing first in one direction and then in another, tends to cause the mine to shift its position, and is indispensable in the case of mines intended to be fired by judgment.

2d. The moorings should be so arranged that there shall be as little twisting as possible, which might break or injure the insulation of the electrical cables.

3d. The anchors or heavy weights used should be suited to the nature of the holding ground or bottom.

4th. Mooring cables should be so arranged that they may not be likely to become twisted together or entangled.

The best special mooring apparatus for general purposes is the *mushroom anchor*. (Fig. 1, Plate 74.) It is decidedly so for a soft, muddy bottom. On a hard, rocky bottom the dead-weight of the mooring must be depended upon to keep a mine stationary, and if a heavy mushroom anchor is used, its edges should be furnished with toes or points to catch in the crevices of the rocks. The weight of the anchor would depend on the buoyancy to be overcome, and would usually be from 500 pounds upwards. Ordinary mooring-chains and hemp cables may generally be employed in connecting the charges or circuit-closers with the anchors. Where there is any tendency to twist, a wire cable is the best to counteract it. Any considerable amount of twisting must be checked, as it is liable to entangle the moorings and to rub and injure the electric cables.

Next to the mushroom sinker the ordinary anchor is the best. For make-shifts, any heavy weights—as large stones, pigs of metal, or bars of iron—may be used. These must necessarily be sufficiently heavy to hold a mine in position simply by their dead-weight. The material just mentioned can be fastened to frames of wood, and the whole sunk as one mass.

The weight necessary for a mooring, whether anchor, sinker, or other apparatus, will depend upon the buoyant force of the mine, the nature of the bottom, and the currents.

The buoyancy of a mine is its excess of flotation over its weight. This would be measured by the number of pounds

required to sink it, and no more. When wooden casks are used the buoyancy may be roughly taken as equal to the weight of the charge of powder. With heavy metallic cases their weight must, in all cases, be taken into consideration.

In water free from currents twice its buoyancy is considered necessary to keep the mine in a vertical position over the mooring; this, therefore, would be the weight required for the mooring. Where there is a current, additional weight to keep it from swinging off with it is required, and this increases with the strength of the latter. When the mine is moored by a single cable, a convenient rule, approximating closely to results from experiments, is to allow one additional buoyancy for each mile per hour of current; *i. e.*, two buoyancies being allowed for still water, three would be allowed for a current of one mile; four for two miles; five for three miles, and so on. These represent the weights for the mooring in each instance. In a tide-way where there is a current of more than five miles an hour, two anchors may be advantageously used, placed up and down stream at a considerable distance apart, depending upon the force of the current and the distance from the bottom at which the mine is to float. It is extremely difficult to moor mines in proper lines and depths by this means.

When the mine is small, say one containing a charge not greater than 200 pounds, a single large barge may suffice for placing it. The anchors can be let down at a suitable distance apart from the extremities of two outriggers, one from each end of the barge. The mine, attached to the middle of the cable connecting the anchors, is weighted down by a heavy saddle, which, after the anchors are down, is hoisted in and the mine permitted to rise to the proper depth from the surface.

In order to place a large buoyant charge of, say, 1000 pounds and upwards, three of these large boats are required to carry it and its anchors, one for each anchor or mooring sinker, and one for the charge itself. They are connected by a rope, which, if kept stretched, would insure the anchors being placed at the proper distance apart. The sinkers and mine are carried out and lowered from the davits at the stern of each boat. Skillful boatmen and sailors are required for all operations connected with the placing of mines, and a handy steam-tug is the most convenient craft to use.

The floating mine is used where the depth of water is so great that, if placed on the bottom, the mine would require for efficiency an excessively large charge. In this case it is held to the bottom by moorings in such position as not to rise to the surface at low tide, nor at high tide be so deep as to be beyond

effective range of over-passing vessels. To arrive at this exact point, it is best to haul the mine down towards the sinker. For this purpose there are various contrivances, some one of which would be supplied with the rigging furnished with the mine.

When the mines are to rest upon the bottom, they are lashed to some heavy object sufficient to sink and hold them in position, and then lowered to their places.

678. Lines. Submarine mines will generally, if not always, be moored in straight lines. In practice, the greatest difficulty is experienced in mooring any object in a particular spot, especially when two mooring-chains are required, as will sometimes be the case, to prevent twisting. To overcome these difficulties it is suggested that instead of anchors a heavy chain cable be employed to moor the mines.

“A section of the channel to be defended having been made from soundings, the line assumed by a chain could be laid down to scale. The positions of the mines and their distances apart, depth from the surface, &c., having been arrived at by calculation, could also be laid down on the section. The points where the small mooring-chains of each mine meet the large chain would appear on the drawing, and the distance of each point from either extremity having been measured off, the scale could be marked on the chain.

“Before sinking the heavy chain the small mooring-chains should be rove through the links at the places marked, and the ends buoyed, sufficient length being allowed for the buoys to reach the surface.

“The conducting wires could next be laid and the ends attached to the same buoys which support the mooring-chains. In this way everything could be prepared, the cables tested, &c., before the mines were required at all; indeed, if the operation of fixing the same were practiced beforehand, it could be left out until there was considerable probability of the mines being required for use. By keeping the mines ready loaded in suitable magazines, and having the cables frequently tested, the probability of injury would be greatly diminished.

“The great advantage of using a heavy chain would be the absolute certainty of having all the mines in their proper places; it would also simplify the moorings by doing away with a multiplicity of anchors and anchor buoys.

“A 2.5-inch chain cable weighs 400 pounds per fathom. The mines would probably never be nearer than 70 or 80 feet apart, so it is evident that the chain would be quite heavy enough to counteract any flotation which would in practice be given to the mine.

“In a current of any strength it would be necessary to use two parallel chains across the current to prevent the mines swinging with the change of tide, but the same advantages would hold good.”

Instead of a chain cable, a strong hempen cable may be stretched across the channel. Previous to immersion, this cable is marked at intervals, at the points where it is subsequently intended to lay down the mines. To place the moorings in position, the cable is slacked up sufficient to allow of its being underrun. At each point marked upon it to indicate the position of a mine, one end of a branch hawser is bent onto it, and the other extremity made fast to a mushroom anchor, the necessary amount of slack being left to allow the anchor to be passed into its proper position. A buoy is attached to the mooring cable fastened to the anchor; the latter is then carried out to one side of the directing cable and dropped into its place. Any further arrangement for attaching the charge, the electrical cable, and circuit-closer may be carried on without difficulty.

Fig. 2, Plate 74, represents this method of planting mines; *a*, *b*, *c*, *d*, &c., are the mooring-chains attached to the hawser *H H*.

This plan affords considerable facilities for the examination of charges after they have been submerged, as it would be necessary only to underrun the main hawser until the required branch hawser is reached, and then by it raise the mooring anchor, and with it the mine to be examined. In the event of the main hawser being broken, it would not be a very difficult operation to grapple it and bring it to the surface for repair.

679. Ignition of charge. For mechanical mines various contrivances have been used. All those constructed on the principle of the gun-lock have, however, been found to soon become worthless from oxidation and incrustation of the more delicate parts. A very simple form is the nipple, upon which is placed a percussion cap, but this is apt to become damaged when immersed. Another kind is “the well-known sulphuric-acid fuse, formed on the principle of ignition by sulphuric acid dripped upon a mixture of equal parts of chlorate of potash and loaf-sugar. The sulphuric acid is placed in a small glass globe, which is so arranged as to be broken by the blow given on touching the side of a vessel, and the acid set free, falling on the mixture of chlorate of potassa and loaf-sugar, produces the required ignition.” The ignition produced by this means is comparatively slow; it has, however, been found that an addition of one-third of ferro-cyanide of potassium to the mixture of equal parts of chlorate of potash and loaf-sugar produces an ignition as rapid as that of gunpowder. The glass globe is best inclosed in a lead

tube, which, by bending or being crushed by the blow, breaks the glass. This is the fuse sometimes used for land torpedoes. (*Par.* 646.)

To secure the fuse and charge from moisture, a composition made of 1 part of tallow, 8 of pitch, and 1 of bees-wax will be found good. To this may be added a little gutta-percha, which will have a tendency to harden it. This composition, when softened by heat, is pressed around the fuse-plug.

The great superiority of electrical fuses over mechanical, causes the latter to be employed only under exceptional circumstances. The universal use of the electric telegraph makes it easy to obtain all material and apparatus necessary for firing submarine mines; even fuses are an article of commerce, and there is no difficulty, if required, in obtaining the services of electricians or other operators capable of arranging and manipulating all parts of it.

680. *An electrical fuse* consists essentially of a priming of ordinary sporting powder, gun-cotton, or of a mixture of the two, in contact with which is the conducting wire of a galvanic battery arranged at this point in such manner as to generate heat by the passage of the electric current. The fuse is imbedded in the charge of the mine, and the conducting wires passed out from it through a water-tight plug or bung-stopper in the case, and are connected with the electrical cable passing to the operating casemate of the fort.

The platinum fuse is formed of a very fine piece of platinum wire $\frac{3}{10}$ of an inch long, to the extremities of which are soldered the two ends of the conducting wire; the priming is secured in contact with the platinum, which latter is fused by the passage of the electric current.

This fuse requires a battery producing a current of *large quantity*. Grove's, Bunsen's, and Walker's are among those most suitable for such fuses.

Platinum may be dispensed with by bringing the ends of the conducting wires so close together as barely to be apart, thus forming a break or interval in the conductor. The ends of the wire are held in exact position, usually by being passed through a short plug of wood. Around this plug is wrapped paper, which, projecting at the end where the conductor is broken, forms an envelope for the priming. This wrapping or cap is afterwards covered with a strong shellac varnish.

When regularly-manufactured fuses cannot be obtained, it may become necessary to improvise them. This may be done in several ways, one of which is to take a small cylinder of hard wood (*Fig. 3, Plate 74*) about an inch in diameter and half an inch

long; this is provided with a groove around its circumference, in which is tied the paper envelope before mentioned. Two holes about a quarter of an inch apart and of suitable size to receive two moderately-fine pieces of copper wire are made lengthwise through the cylinder. One extremity of both of these wires is sharpened with a file, and about a quarter of an inch of the wire bent over at right angles, and slightly flattened with a hammer, the extreme point being bent over in the form of a hook. The straight ends of the wire are then passed through the holes in the cylinder, and the flattened heads are fixed in the wood by driving the pointed extremities into the latter. In this way the broad, thin metal surfaces which form the poles of the fuse are fixed in a parallel position on the surface of the wood, and should be as close together as possible without actually touching. Before, however, the wires are thus placed in position, the surface of the cylinder, upon which the poles are to be fixed, is brushed over lightly with a solution of ordinary photographic collodion. When the poles have been fixed into the cylinder thus prepared, the small surface of wood which intervenes between them is coated with graphite by drawing a pointed black-lead pencil across it two or three times. A cap of paper is then tied round the cylinder so as to inclose the poles of the fuse; this cylinder is filled compactly with fine gunpowder, and the open end is then choked.

The protruding wires of the fuse, which serve to connect it with the conducting wires, are coated to within a short distance of their extremities by moulding ordinary bees-wax around them with the fingers, and then tightly wrapping the wax with thin strips of tape or rag, which is secured to the ends with thread. The entire fuse, except the bare ends of the wires, is then coated with shellac or lacquer.

This fuse may be fired by means of a constant battery of sufficient power, or by a magnetic exploder, the former of which generates a continuous current, and the latter a rapid succession of short currents. Currents of this character are required to produce the heating power over the plumbago bridge necessary to ignite the priming.

681. *Position of the fuse in a charge.* "It has been already stated that, in order to develop the full explosive effect of even a small charge of powder when fired under water, a very strong case is required; with very small charges this is quite practicable, but for large charges of 500 pounds and upwards it is quite impossible to make cases proportionately strong, because they would become enormously heavy. This difficulty, however, to a certain extent, may be overcome by igniting the charges, when

of a large size, at several points, providing, in fact, centres of ignition, and thus burning as much as possible of the charge and converting it into gas before the envelope is broken and the water admitted.

“The radius of ignition due to a single fuse, when fired under the circumstances above described, is supposed to be about one foot, and starting with this basis, the maximum charge to be fired from a single centre of ignition is at once determined to be about 250 pounds. Therefore a single centre of ignition may be used for all charges of less than 250 pounds of powder, adding a fresh fuse, suitably placed, for each additional 250 pounds or fraction of 250 pounds in the charge to be fired.

“This has reference to gunpowder fired with an ordinary fuse. When gun-cotton and a detonating fuse are used, a much greater bulk may be exploded from a single centre of ignition.

“The distribution and holding in proper relative position of a number of fuses in a large charge of powder is a matter of some little nicety, and, in addition, there is the increased difficulty of testing the fuses after being placed in the charge, and the increased chance of failure and trouble in replacing a defective fuse or adjusting any accidental derangement of the conducting wires should a defect occur in the heart of the charge itself, which would render the emptying out of the case necessary.” In order to obviate these defects, it is suggested to use a brass tube and a single fuse primed with powder.

The brass tube should be sufficiently long to run the whole length of the charge, and should have an internal diameter of about 1 inch. Slits 0.5 inch wide and 1.5 inches long are cut at central intervals of 3 inches, following a spiral line around the tube. These slits should be covered with a brass-wire gauze, of a mesh sufficiently small to exclude the powder of the charge. One end of this tube is closed and the other arranged to receive and hold the fuse.

A fuse primed with about one-fourth of an ounce of powder is placed in the end of the tube and well secured. The tube is then put in the central line of the charge and secured so that it shall not vary its position. On igniting the fuse, jets of gas and flame are driven from the openings in the tube and fire the powder within reach. The result is the complete ignition of the outlying portions even before the gas evolved by the grains first ignited has time to rupture the case and let in water. Two or more fuses may be attached to the same tube, so that in the event of one of them failing, ignition may be secured through another.

Instead of using a tube, a pound or two of gun-cotton may be placed in actual contact with the fuse; and this substance being

much quicker of ignition than gunpowder, the gas and flame produced are sufficient to permeate the interstices between the grains of the latter and thus secure a thorough combustion of the charge.

682. *Electric cables.* The qualifications required for these are as follows :

“1st. Capacity to bear a certain amount of strain without breaking.

“2d. Good insulation, composed of such a substance that it may be readily stored and kept for a considerable time without being injured. This is essential, as the lines will only be submerged while actually in use in time of war, for which purpose they must consequently be kept in store, and always ready in sufficient quantities.

“3d. For situations where there is a rocky or shingly bottom, they must be provided with an external covering capable of protecting the insulation from destruction. Special precautions must, of course, be taken to secure the cables at points where they may be necessarily exposed to a considerable wash of the sea, such as the places where they may be led into a fort, &c.; but as there are others where no such special precautions can be applied, an external protecting covering over the insulation must be provided.

“4th. Pliability, so that it may be wound or payed out from a moderately-sized drum without injury. The conducting wire is either soft iron or copper. The best substance for covering it to effect insulation, is vulcanized India rubber; this is capable of standing any degree of heat likely to occur to a cable, and does not harden and crack as does gutta-percha. The conductor should, however, be galvanized and covered with a thin coating of raw India rubber, to protect it from the action of the sulphur of the vulcanized rubber.

“India-rubber insulation possesses one defect as compared with gutta-percha, viz., that it does not adhere to the metallic conductor; and that, consequently, if the India rubber is once cut through, any strain on the cable has a tendency to pull the conductor away and increase the fault. This does not occur with gutta-percha, which seems to cling to it and prevent such a result. Gutta-percha cracks and perishes unless considerable care is exercised in preserving it, which is best done by keeping it under water. India rubber possesses higher dielectric properties than gutta-percha.”

Ordinary gutta-percha and India-rubber insulated wire is an article of commerce, and is the kind that in most cases would be used for submarine mines; but, as before stated, where there-

is any strain, or any chance for abrasion against rocks or gravelly bottom, an exterior covering is necessary for protection. The ordinary American form of submarine cable is the most suitable. The smallest size, such as is used for crossing rivers and harbors, is quite sufficient, except, perhaps, in some cases.

A multiple cable may in many cases be found convenient where it is required to carry a large number of wires in a compact form into a fort.

It is composed of seven distinct cores, each of which consists of a strand of copper or iron wire insulated with rubber or gutta-percha. For a rocky bottom, or situation where the cable is liable to injury, a further external covering of iron wires and tarred hemp, laid on as usual for the protection of submarine cables, becomes necessary.

Frictional electricity must not be used with such cables, as it would be nearly certain that every mine attached to the cable would explode by induction.

683. *Bung-stoppers* are the contrivance for closing the hole in the case through which the charge is inserted, and through which the insulated wires pass from the fuse to the cable leading to the fort. The essential condition to be fulfilled is to have it water-tight and keep the arrangement in proper condition for ignition at any moment required; it should likewise be capable of being unscrewed, so that the fuse may be taken out for examination and replacement if defective.

Various forms of stoppers have been devised, the principal feature of each being a stuffing-box, in which gutta-percha packing is used. When regularly-constructed mines are supplied for service, stoppers will accompany them. For extemporized mines, any device which will hold the insulated wires and at the same time keep the water from the charge will answer. A composition composed of 1 part of tallow, 8 of pitch, and 1 of bees-wax will be found good for tightening the joints. It becomes plastic at about 150° F. The addition of a little gutta-percha hardens the composition, and renders it less liable to be affected by atmospheric heat.

684. *Joints.* This is a very important point in connection with a system of mines. In many instances it will be found necessary to join either two lengths of cable, or an insulated wire and a cable, together, in both of which cases great care must be used in making the joints, so that the insulation and the continuity of the circuit may be perfect.

In making a joint, the great object is to totally exclude the ingress of water, or even moisture, which would at once afford a path for the current and cause a loss or a leak in the cable.

Various methods of forming joints are in use and prove effective. These are explained in works on submarine telegraphy, and are well known to those engaged in that business.

685. *Buoys.* These are used for temporarily marking the positions of mines, circuit-closers, &c. Small nut-buoys of iron are the best, but when these are not to be had, empty casks, such as beer-kegs, well lashed with rope, are convenient to handle, and answer every purpose. In all cases they must be sufficiently large, or have enough of flotation to secure the mooring cable or other object which they are intended to hold.

686. *Laying submarine mines.* "The position of the mines having been first determined, should be marked off by means of buoys arranged to correspond with the mines to be subsequently placed in position, and points on shore are marked to guide the vessels employed in laying them. A complete chart of the whole is made to guide in subsequent operations. The moorings may either be first placed in position, and the mines and circuit-closers hauled down to them, or the whole (moorings, mines, and circuit-closers) may be launched overboard, attached together in proper relative positions, at the same time. In deep water it would probably be found preferable to adopt a system of hauling down to moorings previously placed, while in shallow water it would, under certain circumstances, be found quicker and more convenient to adopt the latter mode of proceeding. The cases ready charged and with the electrical cables, &c., attached, having been lowered into position at such intervals as may be required, according to the size of the charges to be used, and each carefully marked with a numbered buoy, the paying out of the electrical cables may be proceeded with. The cable attached to each having been previously arranged on a drum, is placed on board a launch, which proceeds to pay it out in a line as nearly as possible perpendicular to the line of the mines. (*Fig. 4, Plate 74.*) Each boat should be provided with a small testing battery and astatic-galvanometer, by which the insulation and electrical resistance of the system is tested at intervals from the moment of submerging the mine till the other extremity of the cable is safely lodged in the testing-room. Any defect likely to cause a failure in firing at the proper moment would in this way be immediately discovered during the operation of submergence. As the boat, in paying out the cable, passes the position marked out for the second or covering line of mines, care should be taken to have it as nearly as possible midway between two adjacent mines in this line. In passing this line the position of the electric cables should be marked off by buoys as a guide to those laying down the second line of mines, which, as soon as the work of the first has pro-

ceeded thus far, may at once be commenced. In order to distinguish between the buoys marking the positions of the mines from those indicating the direction of the cables, different colors are used. As the third line of mines would be placed to cover the intervals of the second, it would be necessary, after proceeding in a direct line for about 100 yards in rear of the second line of mines, to change the direction in which the cable is to be laid by carrying it perpendicularly to the direction hitherto followed till a point directly in rear of some one of the mines of the second line is reached, when it is again turned inward to a position to pass safely through the centre of an interval between two mines of the third line, as it had previously passed through those of the second. In passing this third line of mines it should again be buoyed for guidance in laying the mines belonging thereto, and so on till the extremity of the cable is connected to its corresponding wire in the multiple cable, or if taken in singly, till safely landed in the fort in which the operating-room is placed, when it is attached to its proper binding-screw, and its insulation and resistance carefully tested and registered.

“The same process is gone through with every charge, the utmost care being taken to so lay the cables that they shall be as far as possible away from the mines in the vicinity of which they may be required to pass. By the arrangement just described they are also in a favorable position for underrunning and picking up, should such an operation become necessary. A certain amount of slack, depending on the depth of water, should be allowed in laying the cables to facilitate this operation.

“The position of each mine should be identified by means of bearings taken by two theodolites, from points well situated for the purpose, and marked in position on the plan, with the number of each mine, as a guide to facilitate its discovery at any future time. This done, and the whole system having been proved to be electrically correct, all the surface buoys should be removed, to prevent any indication of their position being given to an enemy. Dummies to deceive an enemy may be judiciously arranged in a manner not too ostentatious, but they should never be placed in such a position as might, in ever so remote a manner, lead to the discovery of a real mine. The cables should be laid as far as possible parallel, and never be allowed to cross directly over each other; otherwise the operation of underrunning will be much complicated.

“The arrangement of cables just described is that in which the shortest possible length would be consumed. In certain cases, however, it might be desirable to carry them by a detour to the fort, as, for example, around the flank of the second and

third lines of mines, and there is no difficulty in this, always bearing in mind that they should, in the first instance, be carried directly back for about 100 yards, so as to be safe from injury due to the explosion of their own line of mines, and that their subsequent course should be so arranged as to keep them safe from damage from the explosion of any other mine in the system.

“In selecting any line to be taken, places where the cables would be subjected to a wash of the sea should be, as much as possible, avoided; and when it becomes necessary to place them in positions where they are necessarily subjected to the friction and rubbing consequent upon the motion of the water, special precautions must be employed for their protection. A good method of doing this is to lash the cable securely to a chain heavy enough to keep it in position on the bottom. A wire-covered cable of ordinary size will have weight of itself sufficient to hold it steady on the bottom.”

In all cases the cables should be laid where they will be subjected to the greatest amount of supervision, and where they can be most easily defended from injury by an enemy.

Lines of mines should, when practicable, be directed on a point where an observer can, in security, observe the crossing of the lines by a vessel of the enemy. This point should be in electrical communication with the fort containing the operating-room; if not by electrical communication, then by signaling. The bearing of each mine is taken from the operating-room as it is put down. By means of observation from these two points it is determined when the vessel is over any particular mine, and then the charge is exploded.

The direction of a line of mines may be determined by two poles previously erected on the shore. These serve as ranges. The interval between the mines on the line are best determined with a cord measured and marked to the exact length. In many positions it may be practicable to erect range-poles, the lines of which, intersecting the line of the mines, will establish the points for the respective mines. It is impossible to lay down rules for each case which may arise in service; the ingenuity of those in charge must be relied upon to solve the particular problem.

687. *Planting the mines.* The following will indicate, generally, the manner of planting the mines. The positions having been determined as just explained, soundings are taken at each one, and the length of the mooring-line for each charge determined accordingly. The anchor is suspended from the davits of the working-boat, and everything made ready to let it go with

a run. The electric cable is stoppered to the mooring-line between the charge and the anchor, and a strong mooring-chain or wire rope is provided to connect the charge to the circuit-closer, so that, by this chain, both the charge and anchor may be raised if required. The electric cable between the circuit-closer and charge should be stoppered from the chain to the wire rope in the same manner as from the charge to the anchor. The length of the electric cables, from the anchors of the different charges to the point where they are united to go into the fort, are determined, and each one coiled on a small portable drum, so that it may be easily moved in and out of the boat.

“To place the first charge, the boat (with the anchor connected to the charge and circuit-closer by moorings of proper length, as above described, and suspended from the davits at the stern) is turned out into the exact alignment of the poles marking the line of mines, proceeding only fast enough to obtain steerage-way; as soon as the stern of the boat arrives at the point marked out for the mine, ‘let go’ is given, and immediately anchor, charge, and circuit-closer are dropped into position. The electric cable is then payed out, at first directly away from the charge, and finally taken to the fort. The next charge, with all its attachments complete, having been arranged as before, the boat is again moved slowly across the channel along the alignment till her stern arrives at the point for the next mine, the anchor is let go, and the cable disposed of as before. Thus all the charges of a line are deposited.”

It is advantageous to have, during the operation, a boat anchored at some central point about 100 yards in rear of the rear line of mines. To this boat all the electric cables of each line of mines are brought. This dispenses with the use of long cables, and consequently unwieldy drums. Furthermore, from this point to the fort a multiple cable may be used, or if single, they may be tied together with spun-yarn and laid out as one. When everything is completed the boat is removed, its position having been previously determined by bearings, to facilitate any future search for the cables at that point. All range-poles are removed, their positions having been carefully marked, but without leaving any indications to guide the enemy in ascertaining the locality of the mines.

The first line of mines having been completed, the next is laid in the same manner, and so likewise the third.

In working from a chain or hawser on which the distances have been marked, as heretofore described, ranges are used in the same manner, to guard against any error caused by the sagging of the chain or cable.

Junction-boxes. When it is necessary to employ a multiple cable, a junction-box is used to facilitate the connection of the several separate wires diverging from the extremities of such a cable. In one angle of such a box the multiple cable is introduced, while the separate cables make their exit on the opposite sides and pass to different mines.

The ends of the cables are secured from pulling out by hooked nippers. Each multiple cable is composed of seven cores, and each of these is connected by means of joints with the mine cables within the junction-box. The boxes are usually made of cast metal, and must, as an essential condition, be perfectly water-tight. They are of various forms, depending upon the object for which each is to be used. They would be supplied with the other apparatus for laying mines.

A junction-box should be placed in such a position as to be easily attained, even in the presence of an enemy, and its buoy should, if possible, not be seen. It is also very essential that it should be in a safe and guarded position, for any injury to the junction-box or multiple cable would be fatal to the group of mines in connection.

688. "The next point to be considered is the best mode of introducing the cables into a fort. In doing so they should be protected to the utmost, not only from injury by an enemy, but from the friction and rubbing necessarily caused by the wash of the sea. Bearing these objects in view, advantage must be taken of local circumstances, which, presenting an endless variety of conditions, must be met by expedients suited to the nature of each particular case. As already stated, they should be carried into such forts and positions as are likely to hold out longest in any system of defense, and not, as a matter of course, into those nearest to them. They must be covered to the utmost from an enemy's fire, and, as far as possible, be protected from his interference in any way, as his great object would be to break and destroy the electrical current."

689. *The testing-room* is in the most secure part of the work. It should be about 16 feet square, with a suitable store-room attached. From the testing-room a gallery, about 4 feet wide by 5 high, passes out through or under the fort. In this gallery are placed frames for supporting the cables, so arranged that there will be no confusion as to the identity of the cables. The frames should be of bronze; iron is apt to oxidize, and wood is liable to decay and render constant repairs necessary. The frames occupy half the breadth of the gallery, leaving the other half for access and examination of the cables. Each cable is

attached to a binding screw of the testing-table, the binding screws being numbered to correspond with the mines.

In the testing-room is the apparatus for producing the agent by which the mines are to be exploded. This may be frictional electricity, a magnet current generated by a dynamo-electrical machine, but usually it is a galvanic current similar to that for electric telegraph purposes. The main conditions for such a battery are, that it should remain constant—that is, that it should be capable of being allowed to remain mounted and ready for use for say a month—and that it shall generate a sufficient quantity of electricity to allow of a certain amount of leak or fault in a cable and yet fire a fuse beyond the leak.

The *Leclanché battery* is the one best adapted and most generally used. The advantages possessed by it are, the absence of chemical action when the battery circuit is not complete, and consequently there is no waste of material. It requires but little looking after. It may be kept ready for action in store without in any way deteriorating, and, finally, it is comparatively inexpensive.

690. Firing. The efficiency of a mine or system of mines depends upon the accuracy and certainty with which they may be discharged at the right moment, this moment being when the hostile vessel is directly over any particular mine of the group. This may be done at will, the position of the ship having been determined by intersection, or the vessel herself may be made to complete the circuit by striking a circuit-closer.

When the mines are placed in position, accurate bearings of each one are taken from two secure points of observation. These stations should be within the defensive works, and selected so that the lines passing from them over each mine shall intersect in such a manner as to give as nearly as possible a right angle, or at least an angle not too acute. The mines have each a number, and the intersecting lines are correspondingly numbered; it is therefore obvious that when a ship is observed from both stations to be upon a line having the same number, she will be at the intersection of the two lines, or over the mine having a like number.

The simplest form is where one of the stations is on the prolongation of the line of mines, as at A, (*Fig. 1, Plate 75,*) and the other directly in rear of the mines, as at B. C represents the galvanic battery, from which runs a conducting wire through the station A to station B, and connects at the latter point with a series of keys, through which the current can be closed to each of the mines 1, 2, 3, &c. Till the key at A is pressed down, no current can pass from the battery C past the station A; but di-

rectly it is pressed down, the circuit is so far completed and the line is charged up to the station B. From the station B is a series of electric cables (B 1, B 2, B 3, &c.) attached to a series of contact points, perfectly distinct and carefully insulated from each other; these cables pass to the mines (1, 2, 3, &c.) through the fuses in connection with them and to earth. At the second station B we have, therefore, a second break in the electrical current, and it is easily seen that in order to pass the current through and fire any particular fuse, both these breaks must be bridged over, under which circumstances the current of the battery will be completed and the mine fired.

Let it now be supposed that a vessel is approaching this line of mines. As her bow passes across the prolongation of the line B 7 the observer at B puts down key No. 7 in connection with mine 7; but as the ship has not come onto the line from A passing through the line of mines, the observer at A does not put down his key, a break still exists in the circuit, and no current can pass to fire the mine 7. When the vessel passes the line B 7 the observer at B allows the key to spring up and break the connection. As the vessel passes the line B 6 the observer at B presses down key No. 6, but as she is still not on the intersection of the lines B 6 and A 6, the same result as before is obtained, and the mine 6 will not be fired. Let it now be supposed that she passes on in her course till she arrives over the mine 3; in this position she is on the intersection of the two visual lines A 3 and B 3; the observers at A and B in this case both put down their respective keys simultaneously, the current of the battery is completed through the mine 3, and that mine will be fired.

As before mentioned, it is advantageous to have the lines of mines all directed on one point (A). The mines of the second and third lines are connected to the station B precisely as are those of the first line. In the case of a vessel passing through an interval of any two mines of the first line, at such a distance as to be out of the radius of destructive effect of either of them, as, for instance, at the point Y, between 3 and 4, it is easily seen that at the moment of passing the first line of mines, when the observer at A would have his key down, she would not be on the prolongation of any of the visual lines from the station B to any of the first line of mines, and as the observer at B would not under such circumstances press down any key, she would pass on to the second line and run upon the mine at H, which would be exploded as just explained. Instead of having the wire and key at A, as above explained, an ordinary signal flag may be used for transmitting preconcerted signals. This, how-

ever, would require the observer at B to have an assistant to look out for the flag, and is altogether inferior to the former method. It likewise has the disadvantage of informing the enemy of the position of the lines of mines.

As in many cases it would not be practicable to have a station on such a position as A, so far advanced towards the point of attack, with the corresponding danger of being cut off by an enemy, another combination becomes necessary; this is shown in *Fig. 2, Plate 75*.

Two stations, A and B, well within the defensive works, are selected in such a position that the lines passing from them over the mines shall intersect in such a manner as to give a large angle. When the mines were placed in position, accurate bearings were taken to each from both of these stations. The galvanic battery is placed at A, one pole being connected to earth, while the other is connected with a centre from which radiate a series of contact keys. From the contact points of these keys a series of cables, corresponding in number to the numbers of the mines, pass to the similar contact points of a like set of keys at station B, and from the pivots of the keys at B an electrical cable passes to each charge. In this case, therefore, each mine has a separate key at station A as well as at station B, each perfectly distinct from any other and well insulated therefrom, but the whole culminating at A in the single battery C. In each circuit, corresponding to any particular mine, there are, therefore, two breaks, one at its particular contact key at station A, and the other at its corresponding key at station B, and till these breaks are bridged over, by pressing down the contact keys simultaneously, the circuit of the battery will not be closed and the mine will not be fired. In this way it is easily seen that if key No. 1, for example, is put down at station A, and key No. 2 at station B, there still remains a break in each of these circuits; in circuit No. 1 at B and in circuit No. 2 at A, and neither of these mines will be fired. The object of this arrangement is seen by tracing the course of the vessel (X) approaching the line of mines. She first arrives on the line of 5 from station A and simultaneously on that of 1 from station B; the observer at A puts down key No. 5 and the observer at B key No. 1, without, of course, firing any mine. Again, as she reaches the position Y, the observer at A puts down key No. 4 and the observer at B key No. 2, without any circuit being closed. When she arrives at 3 both observers put down keys No. 3 simultaneously, and the mine is fired and the vessel struck.

“In carrying out the system above described, it has been found that with a series of very small wooden pickets, placed in

a radiating form from a central point of observation, at a distance of about 20 feet, and with pieces of twine passing from the centre over the pickets in the direction of the mines to indicate the bearings more accurately, very good practice has been obtained. The observer, with his eye at the central picket and his hand on the contact keys, puts the corresponding one down as the object passes the bearings of each. A man soon learns by practice the distance he may allow on one side or other of the bearing line, and with ordinary care and nerve is soon able to make contact at the right moment.

“In using the keys, it is necessary to press them firmly down and hold them firmly, in order to insure good contact at the proper moment.

“To work efficiently, it does not seem desirable that more than six keys should be intrusted to the management of any one man.

“The system of pickets above described for giving the bearings might probably be used effectually up to half a mile, but at greater distances a more accurate means of obtaining the intersections becomes necessary; the pickets have, moreover, the disadvantage of being easily disturbed and difficult to replace in an accurate position if once moved. In order to obviate as far as possible these defects, an instrument has been devised having a telescope, with cross-wires, mounted in connection with a series of contact points and a movable key, as shown in *Fig. 3, Plate 75*. It consists of a heavy cast-iron stand (*a*), on which is placed an iron upright (*b*) arranged to carry the telescope (*c*), allowing it a horizontal motion around the upright; it has also a vertical motion. Concentric with the upright is a circular arc (*d*), described with a radius of about 18 inches. On this arc are arranged the contact points for the cables running to the mines or to the other station. Attached to the upright, below the telescope, is a horizontal arm (*e*), which moves around with the telescope. To this arm is attached a contact key (*f*), adjusted to touch the contact points on the arc. The arc is graduated into divisions, by means of which the position of the contact points may be registered, so that in the event of their being accidentally displaced they may again be fixed in true relative position with facility.”

To place the instrument in position, a point from which the lines of mines are clearly distinguishable should be chosen. This point should be as far as possible from heavy guns and have a solid foundation. The iron stand of the instrument having been leveled by means of leveling screws, the telescope is directed on some fixed and well-defined object, and the number of the

division under the spring of the lever registered. The telescope is then directed on each buoy marking the mines of each line, in succession, and one of the contact arrangements brought into proper position for each and keyed firmly up, and the number of the mine and the number of the division on the graduation are registered. This having been done at both stations, the buoys marking the positions of the mines are removed. The points where the leveling screws of the iron stand rest should be carefully marked, so that the whole may be placed in the same position if accidentally disturbed.

The observations are made through the telescopes, and when a vessel comes in range with any mine, as indicated by the registered degree, the corresponding key is put down, the operation being in every other respect as before described.

691. *Mechanical circuit-closers.* These are arrangements by which submarine mines are fired electrically by the vessel herself closing the circuit.

They are of two classes, one being that in which the charge and the circuit-closer are in the same case, and the other is where the circuit-closer is in a separate case, but connected with the charge of the mine by an electrical cable. In both ways, the conducting cable is electrically charged from the battery on shore up to the circuit-closer; when this latter is closed by contact with a hostile vessel, the current passes through the fuse in the charge and the mine is exploded. A great number of different forms of both classes have been invented, all of which are more or less complicated and require special description and study to understand.

To render mines thus provided with circuit-closers harmless to friendly vessels passing, it would be necessary only to detach the firing battery—an operation usually performed by the operator simply removing a small plug. In this case the circuit-closer, if strongly made, may be struck time and again without injury. This power to resist heavy blows is essential to the efficiency of any form of circuit-closer, as, when in position in a channel through which there is much traffic, they are always liable to be struck with considerable force by blades of screws, floats of paddles, and other hard and sharp bodies. Another especial consideration is, that the apparatus for closing the circuit shall not be set in action by agitation of the water, but only by impact with a floating body. The circuit-closer must furthermore have sufficient size to give the required amount of inertia. When the circuit-closer and charge are combined in the same case, this is assured; but when they are separate, it is effected by inclosing the mechanism in buoys made of wood or metal. The greater

the size and weight of the circuit-closer, the greater will be the chances of the effective working of the apparatus.

The destructive power of a mine decreases rapidly as the distance from it increases. The circuit-closer should not, therefore, be beyond the effective range of the mine. Forty to fifty feet should be the maximum distance for the heaviest charges.

692. The arrangement of a system of submarine mines in lines possesses the disadvantage that if the enemy has once ascertained the position of one mine of a line, whether by explosion or by any accidental circumstance, he would know within what limits the others were to be looked for. In order to obviate this disadvantage, it would always be necessary to scatter a few mines in irregular intervals in front of the advanced line—to set them as skirmishers, retaining the line formation for the main defense. These advanced mines might either be simply electro-self-acting, or arranged for ignition on the same principle as those of the main system, as circumstances required. As it is not advisable to expend heavy charges against small boats, these advanced mines should be comparatively small, so as to be used against the boats of an enemy seeking for the mines and circuit-closers.

“The first object of an enemy would be to clear a passage of sufficient width through the system to enable him to pass freely in; and for this purpose he would probably employ drifters, with or without dragging grapnels, for the purpose of either firing some of the charges by striking the circuit-closers, or grappling and destroying the electrical cables and other gear. These drifters may be boats allowed to float in with the tide or wind. In order to stop such a system of attack, a light boom or strong fishing-nets would be useful, and should be employed whenever circumstances permit. To stop drifters with dragging grapnels, it is a good plan to lay three or four heavy chain cables at intervals across the channel, in advance of the system of mines. The grapnels would catch in these, and the weight of the chains would be sufficient to bring up the drifters before arriving at the mines.

“The night would unquestionably be the safest time for the enemy to carry on operations of this nature, and it would be necessary to employ boats to row guard in order to watch his proceedings. The mode of communication with these boats is a matter of considerable importance, and some means of rapidly transmitting intelligence is absolutely necessary. This can, of course, be done by the system of flashing signals, but the lights in such case would be a disadvantage, as they would indicate to the enemy the position of the guard-boat. In order to obviate

this, a system has been devised by which a boat rowing guard can be put in electrical telegraphic communication with a fort or guard-ship, by simply paying out an insulated wire attached to a telegraph instrument in the fort or ship, and carrying a second instrument on board the boat. Should the guard-boat be pursued, it would only be necessary to detach the electric cable from the instrument and throw it overboard, with a buoy and line attached to it, and pull away.

“Several systems have been devised for illuminating channels at night by means of the electric light, the Drummond light, magnesium light, &c., and there is no doubt that, when practicable, such devices should always be used.”

693. Testing. In the electrical-room of the fort are kept the instruments for testing the electrical cables of the mines, for the purpose of seeing that they are in condition to perform their work efficiently. The most essential instruments are the test-table and galvanometers. With these the cables are, from time to time, examined to ascertain if their insulation is effective, and if they have a sufficient amount of electricity; if the firing battery is in a condition to insure certain ignition; if the electrical connections of the circuit-closers are correct; if the electrical resistance of the fuse is such as to indicate certainty of ignition, and other similar information.

A separate galvanometer should be used for each mine, and a special battery, distinct from the firing battery, employed in connection with the testing circuits; thus obviating the necessity of detaching the firing battery while testing,—an important matter likely to occur at the critical period when vessels are attempting to break through the lines.

Should a leak be discovered in a cable, the extent of it is shown by the galvanometer; and if considerable, the defective cable is detached from the battery and the fault repaired. When a mine is fired, it is important that its cable should be disconnected at once from the firing battery, to prevent loss of power through the broken end of the conductor.

When a separate galvanometer is supplied for each cable of a system of a mines, it furnishes a constant indicator to point out the fact of a circuit-closer being struck by a ship, and in many cases it may be convenient, or even necessary, to perform the operation of throwing in the firing battery without the aid of a personal operator. A self-acting apparatus has been devised for doing it. By making the apparatus purely self-acting, all chances of error consequent upon the inattention or want of dexterity of the man in charge is, of course, eliminated. No mine or circuit-closer can be tampered with by an enemy without the

fact being instantly known in the testing-room, and precisely what mine.

As it is of importance to be assured of the condition of the charge in the mine, whether dry or wet, an apparatus for this purpose has been devised, and it is of easy application. The use of it obviates the necessity of the great labor, time, and trouble that would be required to raise each mine and, by opening it, ascertain in that way the condition of the charge.

“The firing battery should be suited to the nature of the fuses employed, and should possess considerable excess of power in order to overcome accidental defects; such as increased resistance in the communications, or defective insulation in the electric cable in connection with the mine. A battery just sufficiently powerful to fire a fuse on shore, with the electric cable, &c., in circuit, but not submerged, would not be unlikely to fail after the cable has been submerged in sea-water. In such a case it is recommended that the battery power determined by such an experiment on shore be doubled for actual work. For all practical purposes this test can be made by firing a fuse of known quality through a resistance equivalent to that of the cable. Double the number of cells necessary to effect this would be required for the submerged cables, &c.

“When a system of mines is to be laid, each component part should be tested before being placed in position and, afterwards, as the parts are successively combined in the form in which they are to be used before submersion, and the whole should again be tested immediately after submersion.

“As a preliminary to all electrical testing, it is necessary to ascertain if the instruments, batteries, &c., used in making the tests are themselves in good working order; otherwise defects which exist in the testing instruments may produce results which might be mistaken for defects in the apparatus under trial.”

The cases are tested at the time of manufacture to ascertain if they are thoroughly water-tight and capable of bearing the external pressure to the extent required, according to the depth to which they are to be submerged. A very practical test for this is to close the case with its proper mouth-piece as for service, and then submerge it to a depth somewhat exceeding that at which it is eventually to be used. After remaining thus submerged for about forty-eight hours, it is lifted, opened, and carefully examined to see that it has remained perfectly dry inside.

A careful record should be kept of the results of all electrical tests applied, as by preserving the electrical history of any combination a defect in its electrical condition may be readily discovered, and the nature, position, and extent of such defect

indicated with a considerable degree of accuracy, without the necessity of raising the mine out of water, or in any way disturbing the arrangements employed.

The foregoing will suggest to officers charged with harbor defenses the capabilities of submarine mines as an auxiliary to land defenses. It also furnishes an idea of the kind and quantity of material required for establishing a system of mines, and indicates the method of applying and using it.

Dexterity in the use of testing instruments—in fact, all the electrical manipulations connected with submarine mines—is to be acquired only by practice, with the aid of treatises on such subjects. Experience has proved that, with persons of good intelligence, the necessary qualifications may be acquired in a period of six months.

694. The following table gives the maximum surface current for some of the principal harbors upon the Atlantic sea-board. It will be useful in determining the kind of moorings necessary for securing submarine mines in these channels :

| LOCALITY. | Maximum velocity of surface current in miles per hour. | |
|---|--|-------|
| | Ebb. | Flow. |
| Portsmouth, N. H., in the channel off Fort Constitution. Boston Harbor, Mass. : | 1.00 | 1.5 |
| 1. Boston Light-house bearing N., distant $\frac{1}{2}$ mile ; depth of water 33 feet..... | 1.6 | 1.5 |
| 2. Broad Sound Channel, Long Island Light-house bearing S. by W., distant $\frac{1}{2}$ mile ; depth of water 58 feet..... | 1.1 | 1.1 |
| Entrance to Narragansett Bay, main channel..... | 0.5 | 0.4 |
| New York Harbor, Narrows ; Fort Lafayette bearing N. E., distant $\frac{1}{4}$ mile ; depth of water 90 feet..... | 1.2 | 1.8 |
| Delaware Bay, in the channel abreast of Brandywine Shoal. (No observations were made near Fort Delaware)..... | 1.4 | 1.3 |
| Hampton Roads, Va., Old Point Comfort Light-house bearing N. $\frac{1}{4}$ E., distant $\frac{1}{4}$ mile ; depth of water 78 feet..... | 1.7 | 1.9 |
| Beaufort, N. C., Fort Macon wharf bearing S., distant $\frac{1}{2}$ mile ; depth of water 26 feet..... | 2.8 | 3.0 |
| Cape Fear River, west entrance, Fort Caswell bearing N. W., distant $\frac{1}{2}$ mile ; depth of water 30 feet..... | 1.4 | 1.4 |
| Winyah Bay, S. C., Georgetown Light-house bearing S. E., distant 2 miles ; depth of water 24 feet..... | 2.4 | 2.1 |
| Charleston Harbor, Fort Sumpter bearing W., distant $\frac{1}{2}$ mile ; depth of water 29 feet..... | 2.5 | 2.5 |
| Savannah River, Ga., Tybee Knoll Light-vessel bearing west, distant $\frac{1}{4}$ mile ; depth of water 16 feet..... | 1.4 | 1.6 |
| St. Mary's River, Fla., Fort Clinch wharf bearing S., distant $\frac{1}{2}$ mile ; depth of water 26 feet..... | 2.1 | 2.1 |

Part Tenth.

OUTLINES OF THE GENERAL PROPERTIES OF PERMANENT WORKS.

Plate 77.

The term *permanent fortification* belongs to that branch of the *art of fortification* where means of a durable character are used to strengthen a position. Permanent differs from temporary fortification, not only in the character of the means used, but also in offering a more formidable obstacle to the enemy from the greater strength of its profile.

Permanent works may be divided into two general classes, *fortresses* and *forts*. The term fortress is applied to fortified towns alone, and the term fort to a work containing only a garrison.

The character of the fortification is the same in both classes, consisting in its most simple form of an elevated and wide mound of earth, termed the *rampart*, which incloses the space fortified; of an ordinary parapet surmounting the rampart, and of a wide and deep ditch which surrounds the whole.

These parts of the profile serve the same purposes as the corresponding parts in the profile of a field-work; the most striking difference between the two consists in the rampart, which, from its height, gives a very commanding position to the parapet, and greatly increases the obstacle presented to the enemy.

To give both strength and durability, the scarp and counter-scarp are reveted with walls of masonry which sustain the pressure of the earth, protect it from the effects of the weather, and by their height and steepness present an insurmountable obstacle to an assault by storm.

A fortification thus constituted would be sufficient for the protection of troops within it, but would not admit of exterior operations, because it affords no shelter beyond the ditch. Therefore, to procure the facility of manœuvring on the exterior, a low work, in the form of a glacis, is thrown up a few yards in front of the ditch, and completely enveloping it. The space between

this work and the ditch is termed the *covered-way*, because it is covered from the enemy's view.

The simplest form, then, of an effective profile for permanent fortification, consists of a covered-way; a wide and deep ditch, with a scarp and counterscarp of masonry; and a rampart, which, from its height and width, will give a commanding position to the parapet, and sufficient room behind the parapet for the necessary manœuvres of the troops whilst in action.

The problem presented for the solution of the engineer consists in making such a disposition of his works that no point within the range of their cannon shall afford a shelter to the enemy; that they shall inclose the greatest space with the smallest perimeter, without sacrificing the reciprocal protection of the parts, afforded by a flanking arrangement within the medium range of arms; that no defensive dispositions which can be destroyed by the enemy's distant batteries, shall be exposed to their fire; and finally, that the works shall be secure from an attack by storm.

To satisfy these conditions, the space to be occupied must necessarily be inclosed by a series of bastions connected by curtains; that the line of fortification must be continuous, and consist of a wide and deep ditch, and a high and steep scarp of masonry, to be perfectly secure from an escalade; and that the masonry of the scarp, which is the only part that can be destroyed by a distant fire, must be covered from this fire by the glacis of the work which forms the covered-way.

From the range of the fire-arms that are used in the defense, the distance between the salients of the bastions should not exceed six hundred yards, and that for a reciprocal flanking arrangement, the length of the curtains should not be less than twelve times the absolute relief. (See *par.* 611.)

To secure the work from escalade, experience has fully proved that the scarp wall should not be less than thirty feet high, and that the top of it should not be above the crest of the glacis.

The width of the *terre-plein*, or that part of the top of the rampart behind the parapet, is, for the accommodation of modern artillery, about thirty-five feet, and its height should give the parapet a command of at least twenty feet over the exterior ground.

The dimensions of the parapet are the same as those for the profile of field-works of the strongest class. (See *par.* 596.)

The fortification by which the space fortified is immediately enveloped, is termed the *body of the place*, or the *enceinte*. It is seldom that a permanent work consists simply of an *enceinte*, with its ditch and covered-way, particularly if some of its points

are, from their locality, weaker than the rest. Other works are usually added to strengthen these weak points; they are termed *outworks* when they are enveloped by the covered-way, and *detached* or *advanced works* when placed beyond it.

The object of these works is to lengthen the defense by forcing the enemy to gain possession of them before he is able to make a breach in the enceinte.

The principal outwork is one in the form of a redan, termed the *demi-lune*, which is placed in front of the curtain. This work adds to the main defense by a cross-fire on the bastion salients, which are the weak points of the enceinte, and when there are demi-lunes on adjacent curtains, the bastions between them are placed in strong reënterings, thereby forcing the enemy to gain possession of the demi-lunes before he can penetrate, without great labor and loss of life, into these reënterings. The main entrances to the work are usually through the curtains, which, being the most retired parts, are also the most secure; the demi-lunes also serve to cover these entrances, and to guard them from a surprise.

The ditch of the demi-lune is sometimes on the same level with the main ditch; sometimes it is higher, but in all cases the communications between the two, and also with the demi-lune itself, are arranged so as to be easy and secure.

Situated between the two flanks of the bastions, and directly in front of the curtain, a small low work, termed the *tenaille*, serves to mask the scarp-wall of the curtain and flanks from the enemy's batteries. This mask is of very great importance, since, by preventing the enemy from making a breach in either the flanks or curtain, it will force him to make it in the face of the bastion; the flanks will thus be preserved for the defense of the breach, and the enemy will not be able to turn the temporary or permanent works, which may be constructed within the bastion to prevent him from gaining possession of the main work, by an assault of the breach, which he would be able to do could he effect a breach at the same time in the curtain or flanks.

The covered-ways of the bastion and demi-lune form a strong reëntering at their point of junction, of which advantage is taken to arrange a small redan whose faces flank the glacis of the two covered-ways. The space inclosed by this work, which is a part of the covered-way itself, is termed the *reëntering place of arms*.

The parts of the covered-ways in front of the salients of the bastion and demi-lune, are termed the *salient places of arms*.

The places of arms are so called because they serve for the assemblage of bodies of troops who are to act on the exterior.

Small permanent works, termed *redoubts*, are placed within

the demi-lune, and the reëntering place of arms, for the purpose of strengthening those works.

It is a received military principle, that the garrison of a work is no longer in safety, when it can be carried by storm, unless they are provided with a secure point of retreat. It is to effect this purpose that redoubts are constructed. The one in the reëntering place of arms secures the covered-ways from an attack by storm; and that in the demi-lune forces the enemy to advance gradually, and with the greatest precaution, to gain possession of the breach in the demi-lune; and being provided with flanks, which, from their position, have a reverse fire on the breach in the bastion face, the enemy is forced to make himself master of it before he can venture to assault the breach in the bastion.

Works, termed *interior retrenchments*, which have the same properties as a redoubt, are constructed within the bastion. When the interior retrenchment is sufficiently elevated to command the exterior ground, it is termed a *cavalier*.

The protection afforded by a redoubt to another work, is not by offering a place of safety into which the garrison of the work can retire when driven out of it, but in covering the retreat of the garrison by a warm fire, which will check the advance of the enemy, and enable it to retire behind the redoubt, and there reform to resist further advance of the enemy into the works.

The crest of the glacis is broken into an indented line for the purpose of obtaining a flank and cross fire on the ground in front of the places of arms.

Traverses are placed at intervals along the covered-ways; they serve to intercept the projectiles which enfilade the covered-ways, and also to defend them foot by foot, enabling the troops to retreat from one part of the covered-way behind the traverse under the protection of its fire.

The principal communications consist of *ramps, stairs, posterns, gateways, bridges*, and, for wet ditches, sometimes *dikes*.

Ramps for the use of artillery, or other vehicles, have a width on top of 10 to 15 feet, and an inclination from $\frac{1}{6}$ to $\frac{1}{5}$.

Stairs, except for temporary purposes, are constructed of stone, and are usually placed along the counterscarp and gorge walls of the outworks, forming a communication for infantry only, between the ditch and the terre-plein of the work to which they lead. They are also used within the enceinte in positions where there is not sufficient room for ramps.

Posterns are arched bomb-proof passage-ways, constructed under the ramparts, forming communications between the parade and the main ditch, or between the ditches and the interior of the outworks.

For artillery, the width is usually 10 feet and the height 8 feet. For infantry, these dimensions may be much less. A strong wooden door is placed at each end of the postern. These doors should be loop-holed for musketry.

Gateways. In works with large garrisons, where the means of frequent communications with the exterior are required, posterns are constructed of sufficient width to admit of at least a single carriage-road with a narrow foot-path on each side.

An arched chamber is generally placed on one side of the postern, and the wall between is loop-holed, so as to secure a musketry fire on the doorway of the postern. The arched chamber serves as a guard-room. As a further precaution against surprise, a machicoulis defense is sometimes arranged at the top of the scarp-wall just above the doorway of the postern.

Bridges. The communication across the main ditch leading from the gateway to the country is usually an ordinary wooden bridge. The bay of this bridge at the gate is spanned by a draw-bridge of timber, which, when drawn up, closes and secures the gateway. A barrier, termed a *portcullis*, which can be lowered or raised vertically by machinery, is sometimes added to secure the passage-way from surprise.

In recent works, the portcullis, and even the doors preceding them, have been constructed of a strong lattice-work of wrought-iron bars. This is a great improvement, both as to durability and defense. All passage-ways should be placed in the most secure part of the works, and under such flanking arrangements as to cover them with close musketry fire, or with that from machine guns.

With regard to the relief of the outworks, as a general principle those most advanced should be commanded by those most retired. This principle is applied in all the works, except the tenaille and the redoubt of the reëntering place of arms. The former must not mask the fire of the bastion flanks along the main ditch, and the latter must not mask the fire of the bastion faces upon the glacis of the demi-lune covered-way. To satisfy these conditions, the two works must be commanded by the demi-lune, which is more advanced than either of them; but, by the process of defilement, they are both so arranged that the enemy will not have a plunging fire into them from the demi-lune.

All the fortification comprehended between the capitals of two adjacent bastions and the glacis, is termed a *front of fortification*, or simply a *front*. It is taken as the unit in permanent fortification.

The usual method of effectually protecting any point, is by a flank fire; but, owing to the locality, or to some other cause, it

may not be practicable to make a flanking arrangement. To supply its place, dispositions, termed *counterscarp galleries*, are made behind the counterscarp, with loop-hole defenses for a reverse fire. This arrangement approximates the nearest to the military solution of the problem *to see without being seen*, since, from the position of these galleries, the enemy will not be able to bring his batteries to bear on them, whilst they will present a formidable impediment to all of his operations in the ditches.

For sea-coast defenses, embrasures are made through the scarp-wall, and the artillery is protected from shells by an arched bomb-proof covering overhead. This arrangement is termed a *defensive casemate*. This method of defense is only efficacious against a sea attack; for on the land side, where the enemy can approach regularly, casemates would be rapidly destroyed by his batteries, and the loss of life would be far greater in them than in an open defense, owing to the fragments of stone which each shot striking an embrasure would cause.

The arch of the casemate is supported by piers extending back from the scarp-wall. These piers are usually about six and a half feet thick, and, a few feet back from the scarp-wall, are pierced by arched passage-ways, which, besides securing free communication from one casemate to another, gives the gun-carriage a wider traverse by allowing the rear end to run under this opening.

The arches of the casemates are of brick, and have a thickness of three feet exclusive of the roof-shaped capping, which is generally of rubble and béton, and covered on top by the earth of the rampart and parapet. At least six feet of earth is necessary to give full security against shells.

Arched recesses are made in the scarp-wall at the embrasure to permit the gun being well run out to prevent the smoke from entering the casemate.

The embrasure is in the centre of the recess, the sole being at the proper height for the easy service of the piece.

In some casemates, flues for ventilation and carrying off rapidly the smoke of discharge run from the top of the carriage recess through the masonry of the scarp-wall, and have their outlet in the top of the wall outside. In others, the flues run from the casemate arch to the top of the scarp-wall.

Beneath the embrasure, a recess, termed the *tongue-hole*, is made to receive the tongue of the chassis. The tongue is confined in its place, and the chassis traversed around a pintle, which is received into the *pintle-hole* made at the centre point of the throat of the embrasure, and extending into the masonry below the tongue-hole. When the casemate serves also as quar-

ters for the garrison, the rear, towards the parade, is closed by a masonry wall, which forms the front of the quarters. A brick partition wall separates the quarters from the *gun-room*.

Built up with this wall are fire-places, with flues extending to the parapet above.

The front or parade end of the quarters is suitably finished, with doors and windows.

In contracted situations, where it is desirable to secure greater fire in a fixed direction than can be had from a single tier of casemates, one or more tiers are added, the parapet being retained as before. The arches of the top tier are alone bomb-proof; those of the lower tiers being of sufficient strength to receive the armament and admit of the service of the guns with safety.

Mortars being placed behind the ramparts or traverses to secure them against horizontal fire, are protected from vertical fire by arches covered with earth, as in the preceding case. The arch rises towards the front to give room for the shell in its flight. The front end of the casemate is walled up to a height of about six feet. This permits the mortar to be fired over the wall, and the interior of the casemate is protected to a great degree from falling shells and splinters.

Casemates are also used simply as bomb-proof shelters for the troops and material. These may be constructed in the ramparts of land fronts, where guns are used only in barbette.

Upon land fronts, where it is important to have the masonry covered by earth from the fire of stationary batteries, embrasures are made in the parapet after the manner prescribed in *par.* 634. The arch of the casemate is united to the interior slope-wall, as, in the preceding case, it was to the scarp-wall. Its covering of earth extends down in front, forming the merlons of the parapet, thus covering all the masonry except that of the embrasure. The front portion of the arch of the casemate is conoidal, and descends down to the top of the embrasure.

Magazines (see *pars.* 569, 637) for permanent works are constructed usually in connection with the enceinte, being placed in the most secure part of the work. They are built with strong, full centre bomb-proof brick arches, supported on heavy masonry piers, which form the outward walls. The arches are covered with not less than eight feet of earth.

The interior of the magazine, the floors, and the doors and windows are built with a view to security from fire, and to preserve the powder from dampness by a good system of drainage around the foundations, and of ventilation by means of air-holes

made through the piers and panels of copper pierced with small holes placed in the doors.

No iron or steel is allowed in any part of the structure, bronze being used where it is necessary to employ metal.

The exterior openings for air-holes are covered with copper mesh-work to prevent combustible material or rats or mice penetrating to the interior of the magazine.

Heavy guns are usually placed in pairs, with a traverse between each set of pairs. In this traverse is built the service magazine for the adjacent pieces.

Advanced works are those placed beyond the outworks, and are so under the fire of either the main work or the outworks as to have the ground in advance of them swept by this fire; their ditches flanked by it, and their interior so exposed to it, that if the work were seized by the enemy he could be driven from it by this fire.

Detached works are those which, although having an important bearing on the defense of the main work, are so far from it as to have to depend solely on their own strength in case of assault.

EXPLANATIONS OF PLATE 77.

Plan of a regularly fortified front :

- AA . . A is the enceinte, or body of the place.
- BB, the bastions.
- CC . . C, the main ditch, or ditch of the enceinte.
- DD . . D, the bastion and demi-lune covered-ways.
- EE, the reëntering places of arms.
- FFF, the salient places of arms.
- G, the demi-lune.
- H, the demi-lune ditch.
- J, the demi-lune redoubt.
- LL, the ditch of the demi-lune redoubt.
- MM, the redoubts of the reëntering places of arms.
- aa . . a, traverses of the covered-way.
- o, the tenaille.

Fig. A shows a section of the enceinte, main ditch, and covered-way.

- A is the rampart; of which *ab* is the slope, and *bc* the terre-plein.
- B is the parapet; of which *cdegh* is the outline.
- C is the main ditch.
- D, the scarp wall.
- E, the counterscarp wall.
- F, the embankment of the covered-way; of which *mn* is the terre-plein, *nop* the outline of the banquette, interior slope, and glacis.

Part Eleventh.

SALUTES AND CEREMONIES.

This subject is introduced under the following authority :

NAVY DEPARTMENT, WASHINGTON, Nov. 20, 1879.

SIR: Referring to your letter of the 30th ultimo, transmitting the manuscript of a "Chapter on Artillery Salutes in General," by Major Tidball, of the United States Army, I have the honor to inform you that the officers of the Navy to whom it was submitted report that it conforms to naval usage and the conventions with foreign powers with respect to the etiquette of visits and salutes.

The manuscript is herewith returned.

Very respectfully,

(Signed)

R. W. THOMPSON,
Secretary of the Navy.

HON. GEORGE W. MCCRARY, Secretary of War.

Approved:

By order of the Secretary of War.

(Signed)

JOHN TWEEDALE,
Acting Chief Clerk.

WAR DEPARTMENT, Nov. 26, 1879.

695. A salute with cannon is a certain number of guns fired in succession with blank cartridges, in honor of a person, to celebrate an event, or to show respect to the flag of a country.

The rapidity with which the pieces are discharged depends upon their calibre. Field guns should have intervals of five seconds between discharges; siege guns, eight; and guns of heavier calibre, ten.

The minimum number of pieces with which salutes can be fired is two for field, four for siege, and six for sea-coast guns.

Mortars, as a rule, are not used for saluting purposes.

696. Personages entitled to salutes, if *passing* a military post, as also foreign ships-of-war, are saluted with guns of heavy calibre, the most suitable being the 10-inch smooth-bore.

When troops are drawn up for the reception of a dignitary, and it is practicable to have a battery of field guns on the ground, a salute from it should form part of the ceremony; otherwise guns in position are used.

The national salute, and minute-guns upon funeral occasions, are, when practicable, fired from heavy pieces.

697. The pieces used for a salute should, if possible, be of the same or equivalent calibre; and when the number on the front of a work admits of it, the entire number required, and two or three over, should be loaded and made ready previous to commencing the salute; the detachments are then dispensed with, and a single cannoneer at each piece discharges it at the proper time. When the number of pieces is insufficient for the entire salute, as many as possible should be used, so as to avoid frequent reloadings.

698. The pieces are numbered from right to left,—*one, two, three*, and so on,—and each detachment or the cannoneer, as the case may be, is made to clearly understand the number of the piece. To insure regularity of intervals, the officer in charge of the firing should habituate himself to uniformity in giving the commands to fire.

At the proper moment the officer in charge commands: *Number one, FIRE*, and observing the proper interval, *Number two, FIRE*, and so on to the left piece, when he returns to the first and repeats the same commands until the entire number required for the salute is discharged. In order to preserve regularity in the fires, he will not concern himself with the running number, but will have a capable person to keep the count and notify him when the required number of discharges are made. In giving the command *fire*, he looks towards the piece to be fired, and gives it in such a pronounced manner, accompanied by a signal with his sword, as to be unmistakable; the cannoneer discharging a piece, when its number is called casts his eyes to the officer, and, observing the signal as well as the command, pulls the lanyard with promptness and decision. The officer will be careful to avoid excitement in himself or to cause it in the men firing the pieces. Should a piece miss fire, he immediately commands the next to fire, and allows the piece that has missed to remain undischarged until its proper turn again comes. Immediately after each piece is discharged it is reloaded and made *ready*. The cartridges are withdrawn from the pieces that remain loaded at the conclusion of the salute.

699. *Salvos* are simultaneous discharges from several cannon. They correspond to volleys of musketry, and are fired, by way of salute, only over the graves of officers at the time of burial.

The order designating a funeral escort prescribes whether the fire shall be three volleys of musketry or three salvos of artillery.

The following are prescribed salutes :

NATIONAL SALUTES.

700. The *national salute* is one gun for each State in the Union.

The *international salute*, or the salute to a national flag, is 21 guns.

PERSONAL SALUTES.

701. *To civil and diplomatic authorities.*

| | |
|---|----------|
| The President of the United States receives a salute, to be given both on his arrival at and final departure from a military post or station provided with artillery, of..... | 21 guns. |
| The Vice-President of the United States..... | 19 guns. |
| Members of the Cabinet, the Chief Justice, the Speaker of the House of Representatives, the Governors within their respective States or Territories..... | 17 guns. |
| A committee of Congress officially visiting a military post or station..... | 17 guns. |
| The Sovereign or Chief Magistrate of a foreign State, to be given both on arrival at and final departure from a military post or station provided with artillery..... | 21 guns. |
| Members of the Royal Family, <i>i. e.</i> , the Heir-apparent and Consort of the reigning sovereign of a foreign State..... | 21 guns. |
| The Viceroy, Governor-General, or Governors of provinces belonging to foreign States..... | 17 guns. |
| Ambassadors Extraordinary and Plenipotentiary..... | 17 guns. |
| Envoys Extraordinary and Ministers Plenipotentiary.. | 15 guns. |
| Ministers Resident accredited to the United States..... | 13 guns. |
| Chargés d' Affaires, or subordinate diplomatic agents left in charge of missions in the United States..... | 11 guns. |
| Consuls-General accredited to the United States..... | 9 guns. |

702. *To military and naval officers.*

| | |
|--|----------|
| The General-in-Chief, Field Marshal, or Admiral..... | 17 guns. |
| Lieutenant-General or Vice-Admiral..... | 15 guns. |
| Major-General or Rear-Admiral..... | 13 guns. |
| Brigadier-General or Commodore..... | 11 guns. |

Officers of volunteers and militia, only when in the service of the United States, the salute specified for their rank.

Officers of foreign services visiting any military post or station provided with artillery, are saluted in accordance with their rank.

In addition to the foregoing, occasions of a public nature frequently arise when salutes are both desirable and proper. Orders will govern in such cases. Personal salutes are, however, strictly confined to the foregoing, and are fired but once, unless otherwise specified herein.

703. Salutes are fired only between *sunrise* and *sunset*, and, as a rule, never on Sunday.

The national color must always be displayed at the time of firing salutes.

The *national salute* is fired at noon on the anniversary of the Independence of the United States at each military post or camp provided with artillery.

704. The *international salute* is the only salute which is returned, and this is invariably done as soon as possible. The time intervening must never exceed twenty-four hours. The failure to return such salute is regarded as a discourtesy or lack of friendship justifying the other party in asking explanation.

In the presence of the President of the United States, however, no salute, other than the *national salute*, and that specified for him, is to be fired.

705. It is the custom for saluting vessels-of-war upon anchoring in presence of a fort, to hoist at the fore the flag of the country in whose waters they are, and to fire the first salute. A failure to do so is a proper subject for explanation.

Notice of an intention to salute the flag is usually given by the vessel direct to the fort; but as giving notice involves delay, vessels frequently salute without it. Vessels mounting less than ten guns do not fire salutes requiring the guns to be reloaded. Surveying vessels, store-ships, or transports do not salute.

If there be several forts or batteries in sight, or within six miles of each other, one of them is designated in orders to return international salutes. Either of the others receiving notice from a saluting vessel of intention to salute the flag, immediately notifies the one designated as the saluting fort, and informs the vessel of the fact. If a vessel salutes without giving notice, the fort designated as the saluting fort returns it.

United States vessels return salutes to the flag in United States waters, only where there is no fort or battery to do so.

United States vessels do not salute United States forts or posts.

Salutes to the flag are in no sense to be considered as personal.

706. The President of the United States, the Sovereign or Chief Magistrate of a foreign country traveling in a public capacity, is saluted when *passing* in the vicinity of a military post.

A vessel-of-war on which the President of the United States is traveling displays the national ensign at the main. In the case

of foreign sovereigns, vessels display the royal standard of the sovereign in like manner.

707. Personal salutes, in compliment to foreign diplomatic authorities, are to be fired only for those whose nations pay the same compliments to United States diplomatic ministers in their territories.

Personal salutes at the same place and in compliment to the same person, whether civil, diplomatic, military, or naval, are never to be fired oftener than once in twelve months, unless such person shall have been, in the meantime, advanced in rank.

Officers on the retired list, whether military or naval, are not to be saluted. This, however, does not apply to funeral ceremonies.

An officer, whether civil, military, or naval, holding two or more positions, either of which entitles him to a salute, receives only the salute due to the highest grade. In no event is the same person to be saluted in more than one capacity.

When several persons, each of whom is entitled to a salute, arrive together at a post, the one highest in rank or position is alone saluted. If they arrive successively, each is saluted in turn.

An officer assigned to duty according to brevet rank receives the salute due to the full rank of the grade to which he has been assigned.

As a rule, a personal salute is to be fired when the personage entitled to it enters the post.

When the troops at a military post are to be reviewed by a personage entitled to a salute, it is most appropriate to fire the salute from field guns at the place of review, and at the time, just previous to the review, when the personage arrives on the ground.

OFFICIAL COURTESIES.

708. The interchange of official compliments and visits between foreign military or naval officers, and the authorities of a military post, are international in character.

In all cases it is the duty of the commandant of a military post, without regard to his rank, to send a suitable officer to offer civilities and assistance to a vessel-of-war (foreign or otherwise) recently arrived.

After such offer it is the duty of the commanding officer of the vessel to send a suitable officer to acknowledge such civilities, and request that a time be specified for his reception by the commanding officer of the post.

The commanding officer of a military post, after the usual offer of civilities, is always to receive the first visit without regard to rank. The return visit by the commanding officer of

the military post is made the following day, or as soon thereafter as practicable.

709. When a military commander officially visits a vessel-of-war he gives notice of his visit to the vessel previously thereto, or sends a suitable officer (or an orderly) to the gangway to announce his presence, if such notice has not been given. He is then received at the gangway by the commander of the vessel, and is accompanied there on leaving by the same officer. The officer who is sent with the customary offer of civilities is met at the gangway of a vessel-of-war by the officer-of-the-deck; through the latter he is presented to the commander of the vessel, with whom it is his duty to communicate.

A vessel-of-war is approached and boarded by commissioned officers, by the starboard side and gangway, when there are gangways on each side.

In entering a boat, the *junior* goes first and other officers according to rank; in leaving a boat, the *senior* goes first. The latter is to acknowledge the salutes which are given at the gangway of naval vessels.

Naval vessels fire personal salutes to officers entitled to them when the boat containing the officer to be saluted has cleared the ship. It is an acknowledgment for his boat to "lie on her oars" from the first until the last gun of the salute, and for the officer saluted to uncover, then at the conclusion to "give way."

The exchange of official visits between the commanding officers of a post and vessel, opens the door to both official and social courtesies among the other officers.

710. To a boat with the flag of an admiral, vice-admiral, or rear-admiral, or the broad pennant of a commodore, boats with narrow pennants "lie on their oars" or "let fly their sheets," and boats without pennants "toss their oars." In both cases officers in them salute.

In the case of two boats meeting or passing each other, each with the same insignia of a commanding officer, the junior is the first to salute.

Officers of inferior grade to a commanding officer passing him in a boat, "lie on their oars" or "let fly their sheets," and salute. All other officers passing each other in boats are to exchange salutes, the junior saluting first.

Cockswains steering boats are, whenever commissioned officers are saluted, to stand up and raise their caps, and whenever warrant officers are saluted they raise their caps only.

The officer or cockswain of a loaded boat, or of boats engaged in towing, salute a boat with the flag of an admiral, vice-admiral, or rear-admiral, or the broad pennant of a commodore, by standing and raising their caps.

When boats are rowing in the same direction, an inferior is not to pass a superior in grade unless he is on urgent duty, or authorized by the superior.

When boats are pursuing opposite directions, the rule of the road to prevent fouling is, that both shall "put their helms to port"—*i. e.*, to pass to the right, circumstances permitting.

When boats are approaching the same landing or vessel, an inferior is always to give way to a superior in rank.

Boats about leaving a ship's side or landing are to give way in ample time to others approaching.

It is not proper to land over another boat without permission, and only when it cannot be avoided is permission to be asked.

Boats display their ensigns when they shove off, and keep them flying until their return.

711. To distinguish officers in boats, commanding officers of fleets, squadrons, or divisions carry the distinguishing marks of their rank on the bow of their barges. Flags and pennants distinguishing rank are also worn at the bows of boats.

An admiral's flag is a blue flag bearing four white stars; that of a vice-admiral bears three stars; a rear-admiral, two stars; a commodore's pennant, one star, and is a swallow-tailed flag.

The narrow pennant is worn by commanding officers of lesser rank. In addition, captains in the Navy wear a gilt ball on the end of their boat staffs, and commanders a gilt star.

To the ships, boats, and officers of the United States Navy, as well as foreign officers, the foregoing is due; and courtesy between the land and naval services is indispensable to good order and discipline, as well as necessary to the national dignity and honor. Military officers of assimilative rank are entitled to and should carry the above boat insignia.

Navy regulations require officers and men never to omit, on any occasion, to extend the same compliments to officers of the Army as are paid by them to officers of the Navy.

712. When a civil functionary entitled to a salute arrives at a military post, the commanding officer meets or calls upon him as soon as practicable. The commanding officer will tender him a review, provided the garrison of the place is not less than four batteries of artillery, or their equivalent of other troops.

When an officer entitled to a salute visits a post within his own command, the troops are paraded and he receives the honor of a review, unless he directs otherwise.

When a salute is to be given an officer junior to another present at a post, the senior will be notified to that effect by the commanding officer.

Military or naval officers, of whatever rank, arriving at a mil-

itary post or station, are expected to call upon the commanding officer.

Under no circumstances is the flag of a military post *dipped* by way of salute or compliment.

FUNERALS.

713. When the funeral of an officer entitled, when living, to a salute, takes place at or near a military post, minute-guns are fired while the remains are being borne to the place of interment; but the number of such guns is not to exceed that which the officer was entitled to as a salute when living. After the remains are deposited in the grave, a salute corresponding to the rank of the deceased officer will be fired—three salvos of artillery, or three volleys of musketry.

In the event of a flag-officer of the Navy, whether of the United States or of a foreign country, dying afloat, and the remains are brought ashore, minute-guns are fired from the ship while the body is being conveyed to the shore. If it be in the vicinity of a military post, the flag of the latter is displayed at half-staff, and minute-guns are fired from the post while the procession is moving from the landing-place. These minute-guns are not to exceed in number that which the officer was entitled to, as a salute, when living.

During the funeral of a civil functionary entitled, when living, to a salute, the flag is displayed at half-staff, and minute-guns fired as before; but neither salute nor salvos are fired after the remains are deposited in the grave.

On the death of an officer at a military post, the flag is displayed at half-staff, and kept so, between the hours of reveille and retreat, until the last salvo or volley is fired over the grave, or, if the remains are not interred at the post, until they are removed therefrom.

During the funeral of an enlisted man, the flag is displayed at half-staff, and is hoisted to the top after the final volley or gun is fired.

All military posts in sight, or within six miles of each other, display their flags at half-staff upon the occasion of either one doing so. The same rule is observed toward a vessel-of-war.

On all occasions where the flag is displayed at half-staff, it is *lowered* to that position from the top of the staff. It is afterwards *hoisted* to the top *before* being finally lowered.

714. Should it occur that salutes which are due to any foreign official or dignitary have not been provided for in the foregoing paragraphs, he may receive the salutes and honors which are awarded him in his own country. If time permits, however, special instructions from the War Department should be sought.

APPENDIX.

All weights and dimensions in the foregoing pages are given in English denominations.

The only *legalized unit* of weight or measure in the United States is a *troy pound*, brought from England, by Captain Kater, in 1827. This pound is a standard at 30 inches of the barometer and 62° of the Fahrenheit thermometer.

The standard avoirdupois pound is the weight of 27.7015 cubic inches of distilled water at 30 inches of the barometer and 62° F.

The following table shows the relation between the troy pound and the avoirdupois pound :

| | | |
|-------------------|---|-------------------------|
| 7000 grains troy | = | 1 pound avoirdupois. |
| 5760 grains troy | = | 1 pound troy. |
| 175 pounds troy | = | 144 pounds avoirdupois. |
| 175 ounces troy | = | 192 ounces avoirdupois. |
| 437.5 grains troy | = | 1 ounce avoirdupois. |

In the United States artillery, the troy grain (7000 to the pound) is taken as the standard.

2240 pounds avoirdupois make a ton (long).

2000 pounds avoirdupois make a ton (short).

The former is used by the English for all purposes.

Both of these tons are in common use in the United States. Where precision is required, as in making contracts, &c., it is customary to state, in pounds, which ton is meant.

A box 16 × 16.8 × 8 inches, contains 1 bushel.

12 × 11.2 × 8 inches, contains $\frac{1}{2}$ bushel.

8 × 8.4 × 8 inches, contains 1 peck.

6 × 6 × 6.4 inches, contains 1 gallon, } liquid meas-

4 × 4 × 3.6 inches, contains 1 quart, } ure.

METRIC SYSTEM.

By an act of Congress approved July 28, 1866, the *metric system* of weights and measures is made optional in the United States, and the act provides that the tables in a schedule annexed shall be recognized "as establishing, in terms of the weights and measures now in use in the United States, the equivalents of the weights and measures expressed therein in terms of the metric system; and said tables may be lawfully used for computing, determining, and expressing, in customary weights and measures, the weights and measures of the metric system."

Schedule annexed to act of July 28, 1866.

MEASURES OF LENGTH.

| Metric denominations. | Values in metres. | Equivalents in denominations in use. |
|-----------------------|-------------------|---------------------------------------|
| Myriametre..... | 10000. | 6.2137 miles. |
| Kilometre..... | 1000. | 0.62137 mile, or 3280 feet and 10 in. |
| Hectometre..... | 100. | 328 feet and 1 inch. |
| Decametre..... | 10. | 393.7 inches. |
| Metre..... | 1. | 39.37 inches. |
| Decimetre..... | 0.1 | 3.937 inches. |
| Centimetre..... | 0.01 | 0.3937 inch. |
| Millimetre..... | 0.001 | 0.0394 inch. |

25.39954113 millimetres..... = 1 inch.
 0.30479449356 metres..... = 1 foot.
 0.91438348 metres..... = 1 yard.
 1.6093149 kilometres..... = 1 mile.

MEASURES OF SURFACE.

| Metric denominations. | Values in sq. metres. | Equivalents in denominations in use. |
|-----------------------|-----------------------|--------------------------------------|
| Hectare..... | 10000 | 2.471 acres. |
| Are..... | 100 | 119.6 square yards. |
| Centare..... | 1 | 1550 square inches. |

1 square centimetre..... = 0.15500591 square inches.
 1 square decimetre..... = 0.107642993 square feet.
 1 square metre..... = 10.7642993 square feet.
 1 square metre..... = 1.19604326 square yards.
 1 square metre..... = 0.0002471 acre.
 1 square inch..... = 645.13669 square millimetres.
 1 square foot..... = 0.092899683 square metre.
 1 square yard..... = 0.83609715 square metre.
 1 square mile..... = 2.58989447 square kilometres.

MEASURES OF CAPACITY.

| Metric denominations and values. | | | Equivalents in denominations in use. | |
|----------------------------------|----------------|--------------------|--------------------------------------|-------------------------|
| Names. | No. of litres. | Cubic measure. | Dry measure. | Liquid or wine measure. |
| Kilolitre or stere..... | 1000. | 1 cubic metre.... | 1.308 c. yds..... | 264.17 gallons. |
| Hectolitre ... | 100. | 0.1 c. metre..... | 2 bus. 3.35 pks. | 26.417 gallons. |
| Decalitre ... | 10. | 10 c. decimetres. | 9.08 quarts..... | 2.6417 gallons. |
| Litre | 1. | 1 c. decimetre.... | 0.908 quart..... | 1.0567 quarts. |
| Decilitre..... | 0.1 | 0.1 c. decimetre. | 6.1022 c. inch.. | 0.845 gill. |
| Centilitre.... | 0.01 | 10 c. centimetres | 0.6102 c. inch.. | 0.338 fluid oz. |
| Millilitre.. | 0.001 | 1 c. centimetre.. | 0.061 c. inch.... | 0.27 fluid dr'm. |

| | |
|----------------------------------|--------------------------------------|
| 1 cubic centimetre (c. c)..... = | 0.0610270515194 cubic inches. |
| 1 cubic decimetre..... = | 61.0270515194 cubic inches. |
| 1 cubic metre..... = | 61027.0515194 cubic inches. |
| 1 cubic metre..... = | 35.31658074 cubic feet. |
| 1 cubic metre..... = | 1.3080215 cubic yards. |
| 1 cubic inch..... = | 16.3861759 cubic centimetres (c. c.) |
| 1 cubic foot..... = | 0.0283153119 cubic metre. |
| 1 cubic yard..... = | 0.7645135 cubic metre. |

WEIGHTS.

| Metric denominations and values. | | | Equivalents in denominations in use. |
|----------------------------------|--------------------|--|--------------------------------------|
| Names. | Number of grammes. | Weight of what quantity of water at maximum density. | Avoirdupois weight. |
| Millier, or tonneau. | 1000000. | 1 cubic metre..... | 2204.6 pounds. |
| Quintal..... | 100000. | 1 hectolitre..... | 220.46 pounds. |
| Myriagramme..... | 10000. | 10 litres..... | 22.046 pounds. |
| Kilogramme, or kilo | 1000. | 1 litre..... | 2.2046 pounds. |
| Hectogramme..... | 100. | 1 decilitre..... | 3.5274 ounces. |
| Decagramme..... | 10. | 10 cubic centimetres | 0.3527 ounce. |
| Gramme..... | 1. | 1 cubic centimetre..... | 15.432 grains. |
| Decigramme..... | 0.1 | 0.1 cubic centimetre..... | 1.5432 grains. |
| Centigramme..... | 0.01 | 10 cubic millimetres..... | 0.1543 grain. |
| Milligramme..... | 0.001 | 1 cubic millimetre..... | 0.0154 grain. |

Additional Metrical Equivalents.

| | | |
|-------------------------------------|--------------------|-----------|
| 1 surveyor's chain in metres..... = | 20.11662 ... log.= | 1.3035550 |
| 1 metre in surveyor's chain..... = | 0.04971*... log.= | 8.6964450 |
| 1 square foot in square metres.. = | 0.09290*... log.= | 8.9680221 |
| 1 acre in hectares..... = | 0.40467*... log.= | 9.6071100 |
| 1 square mile in hectares..... = | 258.994 ... log.= | 2.4132900 |
| 1 square metre in square feet... = | 10.76410 ... log.= | 1.0319779 |
| 1 hectare in acres..... = | 2.47109 ... log.= | 0.3928900 |
| 1 hectare in square miles..... = | 0.00386*... log.= | 7.5867100 |
| 1 cubic foot in steres | 0.02831*... log.= | 8.4520332 |
| 1 cord in steres..... = | 3.62445 ... log.= | 0.5592432 |
| 1 stere in cubic feet..... = | 35.31561 ... log.= | 1.5479668 |
| 1 stere in cords..... = | 0.27590*... log.= | 9.4407568 |
| 1 grain in grammes..... = | 0.064798*... log.= | 8.8115680 |

To avoid negative characteristics, 10. has been added to the logarithms of the numbers marked * in the above table.

Miscellaneous.

Length.—Gunter's chain = 66 feet = 4 poles = 100 links of 7.92 inches.

1 fathom = 6 feet; 1 cable-length = 120 fathoms.

1 hand = 4 inches; 1 palm = 3 inches; 1 span = 9 inches.

Solid.—1 cubic foot = 1728 cubic inches.

1 cubic yard = 27 cubic feet = 46656 cubic inches.

1 reduced foot (board-measure) = 1 square foot \times 1 inch thick = 144 cubic inches.

1 perch of masonry = 1 perch ($16\frac{1}{2}$ feet) long \times 1 foot high \times $1\frac{1}{2}$ foot thick = 24.75 cubic feet; 25 cubic feet has generally been adopted for convenience.

1 cord fire-wood = 8 feet long \times 4 feet high \times 4 feet deep = 128 cubic feet.

1 chaldron coal = 36 bushels = 57.25 cubic feet.

Paper.—24 sheets = 1 quire.

20 quires = 1 ream = 480 sheets.

The *units of capacity measure* are the *gallon* for liquid and the *bushel* for dry measure. The gallon is a vessel containing 58372.2 grains (8.3389 pounds avoirdupois) of the standard pound of distilled water, at the temperature of maximum density, (39°.83 Fahrenheit,) the vessel being weighed in air at 62° F., the barometer standing at 30 inches.

The bushel is a measure containing 543391.89 standard grains (77.6274 pounds avoirdupois) of distilled water, weighed as above.

The gallon is the wine-gallon, of 231 cubic inches, nearly; and the bushel, the Winchester bushel, nearly.

WEIGHTS AND VOLUMES OF VARIOUS SUBSTANCES.

METALS.

| SUBSTANCES. | CUBIC FOOT. | CUBIC INCH. |
|--|-------------|-------------|
| | Pounds. | Pounds. |
| Brass { Copper.....67 } Zinc.....33 } | 488.75 | .2829 |
| Brass, gun-metal..... | 543.75 | .3147 |
| Copper, cast..... | 547.25 | .3179 |
| plates..... | 543.625 | .3146 |
| Iron, cast..... | 450.437 | .2607 |
| gun-metal..... | 466.5 | .27 |
| wrought bars..... | 486.75 | .2816 |
| Lead, cast..... | 709.5 | .4106 |
| rolled..... | 711.75 | .4119 |
| Mercury, 60°..... | 848.7487 | .491174 |
| Steel, plates..... | 487.75 | .2823 |
| soft..... | 489.562 | .2833 |
| Tin..... | 455.687 | .2637 |
| Zinc, cast..... | 428.812 | .2482 |
| rolled..... | 449.437 | .2601 |

WOODS.

| SUBSTANCES. | CUBIC FOOT. | CUBIC FEET IN A TON. |
|-------------------------|-------------|----------------------|
| | Pounds. | |
| Ash..... | 52.812 | 42.414 |
| Cedar..... | 35.062 | 63.886 |
| Chestnut..... | 38.125 | 58.754 |
| Hickory, pig-nut..... | 49.5 | 45.252 |
| shell-bark..... | 43.125 | 51.942 |
| Lignum vitæ..... | 83.312 | 26.886 |
| Mahogany, Honduras..... | { 35. | 64. |
| | { 66.437 | 33.714 |
| Oak, Canadian..... | 54.5 | 41.101 |
| English..... | 58.25 | 38.455 |
| live, seasoned..... | 66.75 | 33.558 |
| white, dry..... | 53.75 | 41.674 |
| upland..... | 42.937 | 52.169 |
| Pine, yellow..... | 33.812 | 66.248 |
| Spruce..... | 31.25 | 71.68 |
| Walnut, black, dry..... | 31.25 | 71.68 |
| Willow, dry..... | 30.375 | 73.744 |

MISCELLANEOUS.

| SUBSTANCES. | CUBIC FOOT. | CUBIC FEET IN A TON. |
|-------------------------|-------------|----------------------|
| | Pounds. | |
| Air | .075291 | |
| Brick, fire..... | 137.562 | 16.284 |
| mean..... | 102. | 21.961 |
| Coal, anthracite | { 89.75 | 24.958 |
| bituminous, mean..... | { 102.5 | 21.854 |
| cannel..... | 80. | 28. |
| Cumberland..... | 94.875 | 23.609 |
| Coke..... | 84.687 | 26.451 |
| Cotton, bale, mean..... | 62.5 | 35.84 |
| pressed..... | 14.5 | 154.48 |
| | { 20. | 114. |
| | { 25. | 89.6 |
| Earth, clay..... | 120.625 | 18.569 |
| common soil,..... | 137.125 | 16.335 |
| gravel..... | 109.312 | 20.49 |
| dry sand..... | 120. | 18.667 |
| loose..... | 93.75 | 23.893 |
| Granite, Quincy..... | 165.75 | 13.514 |
| Susquehanna..... | 169. | 13.254 |
| Limestone..... | 179.25 | 12.462 |
| Marble, mean..... | 167.875 | 13.343 |
| Mortar, dry, mean..... | 97.98 | 22.862 |
| Water, fresh..... | 62.5 | 35.84 |
| salt..... | 64.125 | 34.931 |
| Steam | .036747 | |

Alloys.

Bronze Gun-metal.—90 copper and 10 tin.

Bell-metal.—78 copper and 22 tin.

Fine brass.—2 copper and 1 zinc.

Brass for parts of gun-carriages.—80 copper, 17 zinc, and 3 tin.

Sheet brass.—3 copper and 1 zinc.

Silver solder.—4 silver and 1 copper; or 2 silver and 1 brass wire.

Hard solder.—1 zinc and 2 brass.

Plumber's solder.—1 tin and 1 lead.

Tinner's solder.—1 tin and 2 lead.

Pewterer's solder.—2 tin and 1 lead.

Fusible alloy.—2 tin, 3 lead, 5 bismuth; melts at 197°.

Type-metal.—11 lead, 2 antimony, and $\frac{1}{4}$ tin.

German silver.—40 $\frac{1}{2}$ copper, 31 $\frac{1}{2}$ nickel, 25 $\frac{1}{2}$ zinc, 2 $\frac{1}{2}$ iron.

German silver for casting.—60 copper, 20 zinc, 20 nickel, 3 lead.

Pewter.—4 tin and 1 lead.

An alloy that expands in cooling.—9 lead, 2 antimony, and 1 bismuth; useful for filling small cavities in cast-iron.

Babbitt's metal, for journal-boxes.—9 tin and 1 copper.

To ascertain the Weight that a Shear Spar will Sustain Without Breaking.

The case is that of a cylindrical beam inclined upward and supported at each end, the weight applied at a distance m from one end.

For a square beam in this position the formula will be:

$$W = \frac{S l d^3}{m(l-m)} \times \frac{l^2}{c^2}; \text{ in which}$$

W = the weight

S = the value of the timber for general use, or

| | |
|---------|--------|
| Oak | $S=50$ |
| Y. pine | $S=50$ |
| W. pine | $S=45$ |

l = the length between supports in feet. (A B.)

d = the diameter or side of the beam in inches. (A E.)

m = the distance in feet from either point of support to the point where the weight is suspended.

c = the inclination of the shears or the horizontal distance between the heel and upper point of support in feet. (B C.)

For a cylindrical beam the result must be multiplied by .78124.

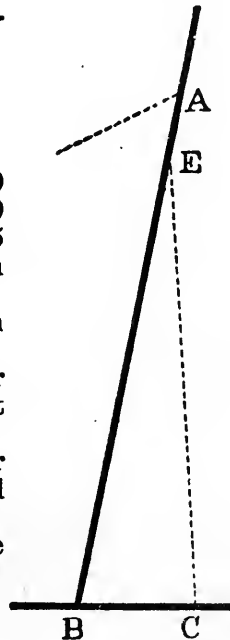

Example.—Having $S = 50$, $l = 27'$, $d = 10''$, $m = 2'$, $c = 10$,
 $S l^3 d^3$

then $W = \frac{S l^3 d^3}{m(l-m) c^2} \times .78124 =$

$$\frac{50 \times 19683 \times 1000 \times .78124}{2 \times 25 \times 100} =$$

$$19683 \times 7.8124 = 154771. \text{ lbs.}$$

This is only calculated for a steady strain; the result should

be diminished at least one-half to allow for the surge of the fall around the capstan, both when hoisting and lowering.

To ascertain the Strain on the Guys and Spars.

From actual measurement of the ground, &c., construct a diagram as follows :

- AB. The shears at their ultimate inclination.
- AC. The guys.
- AD. A vertical line representing the weight suspended.

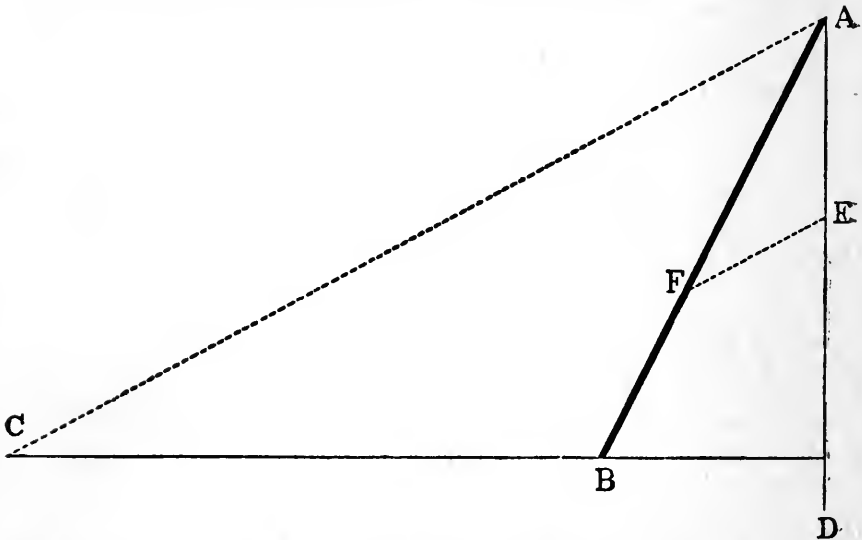

With any scale of equal parts lay off on the line AD the distance equal to the number of units of weight ; say, represent 25 tons by 25 inches ; through the point E thus found draw EF parallel to AC. Then, the distance EF measured by the same scale will represent the strain on the guys, and AF the thrust on the spars.

Precaution.

In selecting spars for shears, it must be borne in mind that the strain on the shears is equal to the weight lifted plus the force required at the end of the fall to suspend the weight.

MENSURATION.

Area of a triangle..... = base \times $\frac{1}{2}$ altitude.

Area of a parallelogram..... = base \times altitude.

| | | |
|---|---|--|
| Area of a trapezoid..... | = | { altitude $\times \frac{1}{2}$ the sum of parallel sides. |
| Area of a trapezium..... | = | { divide into two triangles, and find area of the triangles. |
| Circumference of a circle... | = | diameter $\times 3.1416$. |
| Diameter of a circle..... | = | circumference $\times .3183$. |
| Area of circle..... | = | (diameter) ² $\times .7854$. |
| Area of sector of circle..... | = | length of arc $\times \frac{1}{2}$ the radius. |
| Area of segment of circle.. | = | { area of sector of equal radius, less area of triangle. |
| Area of circular ring..... | = | { diameter of the two circles \times difference of diameter, and that product by .7854. |
| Side of square that shall equal area of circle..... | = | { diameter $\times .8862$, or circumference $\times .282$. |
| Diameter of circle that shall contain area of a given square..... | = | { side of square $\times 1.1284$. |
| Area of an ellipse..... | = | { product of the two diameters $\times .7854$. |
| Area of parabola..... | = | base $\times \frac{2}{3}$ altitude. |
| Area of regular polygon ... | = | { sum of its sides \times perpendicular from its centre to one of its sides, $\div 2$. |
| Surface of cylinder..... | = | { area of both ends $+$ length \times circumference. |
| Contents of cylinder..... | = | area of ends \times length. |
| Surface of sphere..... | = | diameter \times circumference. |
| Contents of sphere..... | = | (diameter) ³ $\times .5236$. |
| Surface of pyramid or cone. | = | { circumference of base $\times \frac{1}{2}$ of the slant height. |
| Contents of pyramid or cone..... | = | { area of base $\times \frac{1}{3}$ altitude. |
| Surface of frustrum of cone or pyramid..... | = | { sum of circumference at both ends $\times \frac{1}{2}$ slant height $+$ area of both ends. |
| Contents of frustrum of cone or pyramid..... | = | { multiply areas of two ends together and extract square root. Add to this root the two areas and $\times \frac{1}{3}$ altitude. |

Contents of a wedge..... = area of base $\times \frac{1}{2}$ altitude.

Contents of a ring..... = $\left\{ \begin{array}{l} \text{thickness} + \text{inner diameter} \times \\ \text{square of thickness} \times 2.4674. \end{array} \right.$

To ascertain the distance to an inaccessible object; as, for instance, the breadth of a river: (*Fig. 4, Plate 75.*)

1st. The line AB (the distance to be determined) is extended upon the bank to D , from which point, after having marked it, lay off equal distances, CD and Cd ; produce BC to b , making $Cb = CB$; then extend the line db until it intersects the prolongation of the line CA at a . The distance ab is equal to AB , or the width of the river.

2d. Lay off any convenient distance, BC , perpendicular to AB ; erect a perpendicular, DC , to AC ; note the point D where it intersects AB produced; measure BD ; then—

$$AB = \frac{BC^2}{BD}.$$

CAPABILITIES OF THE HORSE.

The average weight of a horse is about 1000 pounds; for artillery purposes he should average 1100 pounds. In ranks he occupies a front of 40 inches, a depth of 10 feet; in a stall, from 3.5 to 4.5 feet front.

The load for a light-artillery horse is 700 pounds, including carriage; for heavy field artillery, 1000 pounds, including carriage. This is less than that allowed for the ordinary horse in civil service, in consequence of bad roads, scant forage, and frequently forced marches.

Including the weight of carriage, four horses can draw, on roads such as are considered in America good, 3000 pounds; six horses, 4000 pounds; eight horses, 5000 pounds; and ten horses, 6000 pounds. This allowance diminishes rapidly as the roads become bad.

A horse will pack from 250 to 300 pounds, 20 miles per day—eight hours. The mule is superior to the horse as a pack animal. An ordinary march is about 15 miles per day of eight hours, depending upon the state of the roads, condition of the horses, and various other circumstances. The rate of march, with horses starting fresh and resting for a few minutes each half-hour, would be 2.5 miles for the first hour, 4 miles for the next two hours, and 8.5 miles for the remaining five hours.

A horse carrying a rider marches, at a walk, at the rate of 3.75 miles per hour; at a trot, at the rate of 7.50 miles per hour; at a gallop (slow), at the rate of 11 miles per hour.

A horse requires, per day, 4 gallons of water and 12 pounds of short and 14 pounds of long forage.

IRON.

Strength. The mean strength of American wrought-iron is 55,900 pounds to the square inch; of English, 53,900 pounds. The working strain is from one-sixth to one-fourth the mean strength.

The ultimate extension of wrought-iron is $\frac{1}{800}$ th part of its length.

Test quality. If the fracture gives long, silky fibres of leaden-gray hue, fibres cohering and twisting together before breaking, the iron may be considered *tough and soft*. A medium even grain, mixed with fibres, is a good sign. A short, blackish fibre indicates badly-refined iron. A very fine grain denotes a *hard, steely iron*, apt to be cold-short, hard to work with the file.

Coarse grain, with brilliant crystalline fracture, yellow or brown spots, denotes a *brittle* iron, cold-short, working easily when heated and easily welded.

Cracks on the side of a bar denote hot-short iron.

Good iron is readily heated, soft under the hammer, and throws out but few sparks.

STEEL.

The tensile strength of good steel is 120,000 pounds per square inch. The properties are: After tempering, not easily broken; welds readily; does not crack or split; bears a very high heat; can be hardened after repeated workings; is magnetic, and, as distinguished from iron, when once magnetized does not lose its polarity at ordinary temperatures.

CAST-IRON BALLS.

| DIAMETER. | WEIGHT. | DIAMETER. | WEIGHT. | DIAMETER. | WEIGHT. |
|-----------|---------|-----------|---------|-----------|---------|
| Inches. | Lbs. | Inches. | Lbs. | Inches. | Lbs. |
| 2 | 1.09 | 5 | 17.04 | 8 | 69.81 |
| 2½ | 2.13 | 5½ | 22.68 | 8½ | 83.73 |
| 3 | 3.68 | 6 | 29.45 | 9 | 99.40 |
| 3½ | 5.84 | 6½ | 37.44 | 10 | 136.35 |
| 4 | 8.73 | 7 | 46.76 | 11 | 181.48 |
| 4½ | 12.42 | 7½ | 57.52 | 12 | 235.65 |
| | | | | 15 | 450.28 |

ROUND CAST-IRON.
Weight of a lineal foot

| DIAMETER. | WEIGHT. | DIAMETER. | WEIGHT. | DIAMETER. | WEIGHT. |
|-----------|---------|-----------|---------|-----------|---------|
| Inches. | Lbs. | Inches. | Lbs. | Inches. | Lbs. |
| 2 | 9.82 | 5 | 61.36 | 8 | 157.08 |
| 2½ | 15.34 | 5½ | 74.25 | 8½ | 177.33 |
| 3 | 22.09 | 6 | 88.36 | 9 | 198.80 |
| 3½ | 30.07 | 6½ | 103.70 | 10 | 245.44 |
| 4 | 39.27 | 7 | 120.26 | 11 | 296.98 |
| 4½ | 49.70 | 7½ | 138.06 | 12 | 353.43 |
| | | | | 15 | 552.23 |

The foregoing tables furnish means of determining approximately the weight of elongated projectiles, thus: Ascertain from the second table the weight of the cylindrical portion of the projectile, and add to it half the weight of a solid shot of corresponding calibre taken from the first table.

APPENDIX 2.

[3397 A. G. O., 1884.]

HEADQUARTERS OF THE ARMY,
ADJUTANT-GENERAL'S OFFICE,
WASHINGTON, July 31st, 1884.

Lieutenant-Colonel JOHN C. TIDBALL, 3d Artillery,
Commanding U. S. Artillery School, Fort Monroe, Va.

SIR: Referring to your letter of the 27th instant, I have the honor to inform you that the Lieutenant-General Commanding the Army authorizes the insertion of the enclosed paragraph, from "A" to "F," inclusive, in the new edition of the "Manual of Heavy Artillery Service," about to be issued by the publisher of that work.

Very respectfully, your obedient servant,

C. MCKEEVER,
Acting Adjutant-General.

[1 encl.]

(A.) For single-rank formations, full detachments will, as a rule, consist of six cannoneers. A detachment falling short of this number will be formed as prescribed in *par.* 13, and will be the left detachment of the battery.

(B.) In battalion formation, when ranks are opened, the post of a captain is four yards in front of the centre of his battery, and the line of subalterns is three yards in front of the front rank.

(C.) When circumstances shall have caused officers to take post in the line of file-closers when the ranks are closed, (*see par.* 34,) they will, at the command "*Rear open order*," place themselves on the right and left of the front rank of their battery, and at the command "*March*," take post in the line of subalterns, opposite their original places in line.

(D.) At dress-parade, subalterns, at the command "*Parade is dismissed*," will, after returning swords, step into the line of captains and then face to the left or right, as their position may be, for closing on the centre.

(E.) Chiefs-of-detachment, guides, and file-closers will always execute *order arms*, *fix* and *unfix bayonets*, and *carry arms*. In rendering honors they execute the *present*, *reverse*, and *rest on arms*. On drill they execute the *support* and *right shoulder arms*, except the guide of each subdivision in column when marching in common or quick time, and the guides who mark the line of battle during its formation. They execute the other movements of the manual only when specially directed.

(F.) Color-bearers will execute *order arms* and *parade rest* with the colors.

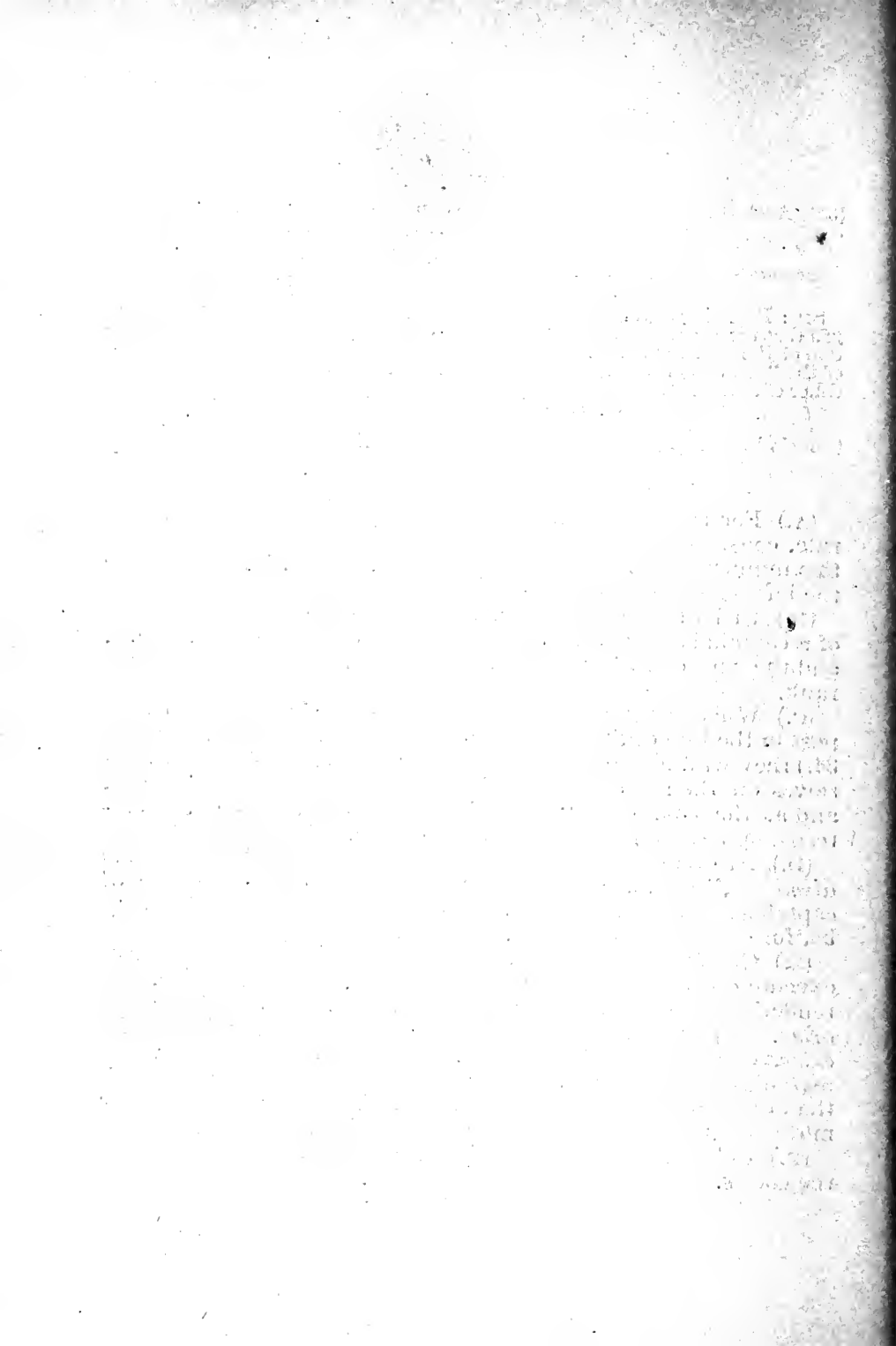

INDEX.

[NOTE.—The plain figures refer to the pages of this volume. The full-faced figures refer to paragraphs.]

- ABATTIS, 397, **644**; 398, **645**.
—— to clear away, 406, **654**.
- Aiming, (see Ranges; Sights; Traversing,) 59, **207**; 80, **230**,
XII; 81, **230**, XXIV; 81, **230**, XXII; 90, **243**;
145, **340**.
—— at moving vessels, 350, **588**; 355, **592**.
—— at night, 356, **592**.
—— at unseen objects, 404, **650**.
—— effect of mirage, 58, **206**.
—— of mortars, 63, **212**; 63, **213**; 64, **213**; 148, **342**,
343; 149, **343**; 163, **365**; 167, **372**; 170, **378**;
356, **593**.
- Air-cylinders, 68, **218**.
- Ammunition, 41, **180**.
—— for defense of defiles, 418, **667**.
—— for field service, 93, **255**; 101, **258**.
—— for field-works and sieges, 316, **568**; 390, **637**; 410,
660; 411, **662**; 413, **666**; 416, **666**; 418, **667**.
—— for permanent works, 316, **568**.
—— preparation of, 81, **230**, XV, XX, XXI, XXVII; 90,
244; 108, **275**; 110, **277**; 121, **294**.
—— reports of, 413, **666**; 414, **666**; 415, **666**.
- Anchors as holdfasts, 264, **521**.
—— for targets, 190, **409**.
—— mushroom, 436, **677**.
- Angle of fall, 39, **161**; 377, **619**.
Angle of fire, (see Sights; Range-tables,) 40, **173**.
Annual supplies of armaments, 315, **507**.
Armament of works, 316, **568**; 343, **581**.
Armor, artillery against, 347, **586**; 353, **590**; 354, **591**.
Armored vessels, (see Iron-clads,) 348, **587**; 351, **589**.
—— vital points, 351, **589**.
- Artillery against armor, 347, **586**.

[NOTE.—The plain figures refer to the pages of this volume. The full-faced figures refer to paragraphs.]

- Artillery command in defenses, 346, **583**; 410, **660**; 411, **661**;
411, **663**; 417, **666**.
- garrison, sea-coast, and siege distinguished, 1, **4**; 1, **5**;
1, **6**; 2, **8**.
- in connection with torpedo service, 425, **670**.
- in constructing lines, 373, **613**; 410, **660**; 411 **661**.
- in attacking intrenched positions, 403, **649**; 404, **650**;
405, **651-653**.
- in defense of besieged places, 410, **660**.
- in defense of defiles, 417, **667**; 418, **667**.
- in defense of river-crossings, 419, **668**; 420, **668**.
- in harbor defenses, 343, **581**; 345, **582**.
- proportion of, in sieges, 411, **662**.
- to accompany assaulting parties, 406, **654**.
- material, annual supply to preserve, 315, **567**.
- care and preservation of, 293, **551**; 294, **555**; **312**,
566.
- projectiles, 310, **565**.
- required for sieges, 412, **664**; 413, **664**.
- storage of gunpowder, 316, **569**.
- store-houses, 312, **566**.
- transportation, 321, **571**; 325, **573**.
- ——— disembarkation, 335, **578**.
- ——— railroad, 322, **572**.
- weight of field battery, 330, **574**.
- Assault. (See Attack.)
- defense against, 410, **660**.
- Atmosphere, pressure upon projectiles, 57, **206**; 58, **206**.
- Attack and defense of positions, 403, **649**; 405, **652**.
- advantages of attack, 405, **651**.
- of defiles, 417, **667**; 418, **667**.
- of river-crossings, 419, **668**; 420, **668**.
- of submarine mines, 455, **692**.
- selection of point of attack, 409, **659**.
- Axis, 35, **134**.
- BACKWARD, defined, 201, **419**.
- Balls, iron, weight of, 477, Appendix.
- Barbette batteries, field, 384, **633**.
- guns, handled with gins, 250, **497**.
- Barrels, gunpowder, to sample, 46, **182**.
- Barrow, hand, 260, **512**.
- Base-line, permanent, for target practice, 189, **409**.

[NOTE.—The plain figures refer to the pages of this volume. The full-faced figures refer to paragraphs.]

- Base of breech, 35, **138**.
- Battalion, artillery, formation, 28, **116**; 29, **117-123**; 30, **124, 125**; 31, **125, 126**; 32, **126**.
- to form, 32, **127**; 33, **127-130**.
- Batteries. (See Field Intrenchments.)
- barbette, 384, **633**.
- classified, 396, **642**.
- commanding defiles, 417, **667**; 418, **667**.
- commanding rivers, 419, **668**; 420, **668**.
- designation in sieges, 413, **665**.
- dispersion, 344, **581**.
- distances from, in defense of towns, 376, **617**.
- elevation of, 347, **585**.
- embrasure, 385, **634**; 396, **641**.
- intrenched positions, 403, **649**.
- location of, 364, **600**; 366, **603, 604**; 373, **613**; 388, **635**; 408, **656**.
- materials for, 357, **594**; 412, **664**; 413, **664**.
- mortar, 397, **643**.
- pan-coupée, 384, **633**.
- penetration of, 357, **595**; 358, **595**; 359, **595**; 360, **595**; 362, **596**; 363, **596, 597**; 364, **598**.
- positions of, in attack of intrenched places, 403, **649**.
- selection of, 371, **612**.
- strength and composition, 355, **592**; 411, **662**.
- to construct, 395, **641**.
- traverses for, 376, **618**; 388, **635**.
- troops, number for, 345, **585**.
- Battery, commands in, 8, **31**; 8, **35**; 10, **42**.
- field, weight of, 330, **574**.
- posts of officers, non-commissioned officers. &c., 7, **24-30**; 24, **103**.
- siege-gun, composition of, 92, **255**.
- ——— ammunition for, 316, **568**.
- siege mortar, Coehorn, 159, **359**.
- subdivisions of, 6, **19-23**; 8, **32-34**; 10, **48**.
- substituted for "company" in foot-drill commands, 34, **130**.
- to change posts, 27, **112**.
- to form at the pieces, 26, **107, 108**.
- to form the, 8, **37**.
- to leave the pieces, 27, **113**; 28, **114, 115**.
- to load a, on cars, 324, **572**.

[NOTE.—The plain figures refer to the pages of this volume. The full-faced figures refer to paragraphs.]

- Battery to march to the pieces, 25, **106**.
 ——— to rest, 27, **110**.
 ——— to resume the exercise, 27, **111**.
 ——— wagons for the siege, 100, **258**.
 ——— what, 6, **19**.
- Beds for piling projectiles, 311, **565**.
 Bickford's fuse, 422, **669**.
 Bight, 232, **477**.
 Blockades, 407, **655**.
 Block-house, 400, **648**.
 Blocks, 270, **528**; 238, **482**.
 ——— storage of, 313, **566**.
 Blowing-charges, 188, **404**.
 Boats, compliments, 464, **709, 710**; 465, **711**.
 Body of piece, 35, **140**.
 Bomb-proofs, 394, **639**.
 Books. (See Records.)
 Bore, 35, **132**; 36, **144**; 38, **153**.
 ——— inspection of, 300, **561**.
 ——— record of defects of, 307, **563**.
 Bottom of bore, 36, **143**.
 Boulengé telemeter, 192, **409-411**.
 Boyaux, 408, **657**; 409, **658**.
 Brass implements, preservation of, 313, **566**.
 Breaching earth-works, 361, **595**.
 ——— walls, 409, **659**.
 Breech, 34, **137**.
 Breech sight, 59, **207**; 60, **208, 209**.
 Bridges, covered by têtes-de-pont, 419, **668**.
 ——— demolition of, 421, **669**; 422, **669**; 423, **669**.
 ——— for disembarkations, 335, **578**; 341, **579**.
 ——— weight of troops on, 341, **579**.
 Browning of guns, 296, **557**.
 Budge-barrels, 54, **205**.
 Buffers. (See Recoil Checks.)
 ——— hydraulic, 68, **218**; 294, **555**.
 ——— pneumatic, 69, **219**; 135, **320**; 294, **555**.
 Buildings, demolition of, 421, **669**.
 Bung-stoppers for submarine mines, 444, **683**.
 Buoys, 445, **685**.
 Bursting of shells in bore, 298, **558**.
 Bushing of vent, 36, **142**.
 Butler projectile, 49, **190**.

[NOTE.—The plain figures refer to the pages of this volume. The full-faced figures refer to paragraphs.]

- CABLES**, electric, 443, **682**; 445, **686**; 446, **686**; 447, **686**.
 ——— to lead into forts, 449, **688**, **689**.
 ——— for bridges, 341, **579**.
- Caissons**, for siege-gun batteries, 93, **255**.
 ——— for siege mortars, 158, **359**.
- Caked gunpowder**, to test, 47, **183**.
- Calibre**, 38, **153**.
- Calipers**, 300, **560**.
- Camps**, entrenched, 364, **601**; 375, **614**, **616**; 412, **663**.
- Canal-boats as lighters**, 336, **578**.
- Canals**, demolition of, 423, **669**.
- Canister**, 49, **192**.
 ——— double charges, 131, **318**.
- Cannon**, construction of, 34, **131**; 36, **144**; 37, **146-150**;
 38, **154**.
 ——— marks on, 293, **553**.
 ——— powder, 42, **180**; 43, **180**.
 ——— to disable, 309, **564**.
- Cannoneers**, in lines of works, 375, **616**.
 ——— posts of, 81, **230**, **XXII**, **XXIII**, **XXV**, **XXVI**.
 ——— reliefs, in service, 82, **230**, **XXXI**.
- Canvas muzzle-hoods**, 295, **555**.
- Capstan**, 262, **517**; 275, **535**; 276, **535**; 290, **549**.
 ——— storage of, 313, **566**.
 ——— to use a gin as, 262, **518**.
- Carcass**, 40, **194**.
- Carriages**, artillery, in general, 65, **215**, **216**; 66, **216**; 67,
217; 68, **217**, **218**; 69, **219-221**; 70, **221-223**;
 71, **223**.
 ——— barbette, described, 1, **7**; 2, **8 n.**; 67, **217**; 109, **276**;
 115, **286**, **288**; 119, **293**; 126, **306**; 127, **308**.
 ——— care of, 295, **555**, **557**.
 ——— casemate, described, 1, **7**; 67, **217**; 117, **290**.
 ——— ——— platforms, 71, **224**.
 ——— centre-pintle, 67, **217**; 120, **293**.
 ——— depressing, 69, **221**.
 ——— 8-inch new rifled gun, 135, **320**; 136, **320**; 137, **320**.
 ——— field-gun, platforms for, 74, **226**.
 ——— flank-casemate, 70, **223**; 128, **309**.
 ——— front-pintle, 67, **217**; 126, **306**.
 ——— Gatling gun. 0.45-inch, 181, **398**.
 ——— Hotchkiss gun, 183, **400**.
 ——— mortar, 1, **7**; 2, **8 n.**; 70, **222**; 157, **357**; 158, **359**.

[NOTE.—The plain figures refer to the pages of this volume. The full-faced figures refer to paragraphs.]

- Carriages, mortar platforms, 71, **224**; 75, **227**; 76, **228**; 77, **229**; 78, **229**.
 ——— recoil checks, 41, **179**; 117, **290**.
 ——— siege-gun, 1, **7**; 2, **8 n.**; 84, **231**.
 ——— ——— platforms, 71, **224**; 72, **225**; 73, **225**; 84, **231**.
- Cars, to load with horses, 322, **572**.
 ——— ——— siege-guns, guns, or wagons, 324, **572**.
- Cartridge-bags, 47, **185**; 154, **354**; 298, **558**.
 ——— preservation in store, 312, **566**.
- Cartridge-pouch, 55, **205**; 79, **230, IV**.
- Cartridges, dummy, 83, **230, XXXVII**; 104, **262**.
 ——— to be filled at depots, 416, **666**.
 ——— to fill and prepare, 154, **354**; 319, **570**.
 ——— to insert, 80, **230, IX**; 88, **240**; 151, **346**.
 ——— to withdraw, 81, **230, XVI**; 91, **247**; 117, **289**; 125, **304**; 153, **350**.
- Cascable, 35, **139**.
- Casemate guns, handled with casemate trucks, 257, **506**.
 ——— ——— gins, 249, **496**.
- Casemates, iron, field, 400, **648**; 401, **648**.
- Casemate truck, 257, **506**.
 ——— to use, 257, **506**; 258, **506**.
- Case-shot, 48, **189, 190**; 49, **190, 191**.
- Cease firing, 81, **230, XVI**; 90, **244**; 91, **247**; 117, **289**; 125, **304**.
- Chains, iron, weight and strength, 241, **484**.
- Chamber, 36, **144**.
- Charge, 36, **144**; 131, **318**.
- Charging shells, 108, **275**; 165, **368**; 298, **558**.
 ——— blowing charges, 188, **404**.
- Chase, 35, **141**.
- Chassis, 67, **217**.
- Cheeks of carriages, 66, **216**.
- Chocks, 200, **416**; 210, **444**; 270, **532**.
 ——— storage of, 313, **566**.
- Circuit-closers for mines, 452, **691**.
- Circumvallation, line of, 410, **661**.
- Coehorn mortar battery, 159, **359**.
- Collar, for chase, 270, **531**.
- Combination fuse, 51, **199**.
- Command of artillery in defenses, 346, **583**; 410, **660**; 411, **661**; 411, **663**.

[NOTE.—The plain figures refer to the pages of this volume. The full-faced figures refer to paragraphs.]

- Command of artillery in sieges, 346, **583**; 410, **660**; 411, **661**; 411, **663**; 417, **666**.
- Commands, 8, **31**; 10, **42, 43**; 81, **230, XXV**; 82, **230, XXVIII**.
- “battery” for “company,” 34, **130**.
- “detachments” to replace “fours,” 34, **130**.
- Compressor-bars, 135, **320**.
- Concussion-fuse, 51, **199**.
- Conversion of cannon, 34, **131**; 35, **132**; 132, **319**.
- Cordage, 231, **476**.
- preservation of, 238, **481**.
- strength of, 237, **481**; 238, **481**.
- Counter-hurters, 68, **217**.
- Countervallation, line of, 410, **661**.
- Coupling for top-carriage and chassis, 135, **320**.
- Courtesies, official, 463, **708**.
- Cradle, 261, **516**; 275, **535**.
- storage of, 313, **566**.
- Cross-lifting, 203, **427**.
- Cubical (pellet) powder, 42, **180**; 46, **181**.
- Cutting guns, (mechanical manœuvres,) 204, **430**.
- Cylinder-gauge, 300, **560**.
- Cylinder-staff, 299, **560**.
- DAMPNESS** of powder. (See Gunpowder tests.)
- Defense of besieged positions, 410, **660, 661**.
- of defiles, 417, **667**; 418, **667**.
- of river-crossings, 388, **636**; 419, **668**; 420, **668**; 425, **670**.
- Defenses of harbors, 343, **581**; 388, **636**.
- distances from towns, (see Submarine Mines,) 376, **617**.
- number of troops required, 345, **582**.
- position of batteries, 343, **581**.
- strength of batteries, 355, **592**; 356, **593**.
- submarine, 346, **584**.
- Defensive intrenchments. (See Field Intrenchments.)
- distances from towns, 376, **617**.
- Defilading field-works, 377, **619**; 378, **619**.
- Defiles, 417, **667**; 418, **667**.
- rivers considered as, 419, **668**.
- Demolition of bridges, 421, **669**; 422, **669**; 423, **669**.
- buildings, 421, **669**.
- canals, 423, **669**.

[NOTE.—The plain figures refer to the pages of this volume. The full-faced figures refer to paragraphs.]

- Demolition, explosives for, 430, **675**.
 Depots, siege, 413, **666**; 416, **666**.
 Depression, 39, **163**.
 Derricks, described, 288, **548**; 289, **548**.
 ——— garrison, gin, 252, **501**.
 ——— in landing heavy guns, 339, **578**.
 ——— to lower 15-inch gun, 291, **550**.
 ——— to raise 15-inch gun, 290, **649**.
 Detachments replace "fours" in commands, 34, **130**.
 ——— to change posts, 27, **112**.
 ——— to form at the pieces, 26, **107**; 26, **108**.
 ——— ——— for artillery service, 5, **14-17**; 6, **21**; 6, **23**;
 8, **37**; 9, **38-41**.
 ——— ——— for fatigue, 9, **40**.
 ——— ——— for leaving the pieces, 26, **107**; 26, **108**.
 ——— ——— for marching drill, 9, **41**.
 ——— ——— to march to the pieces, 26, **107, 108**.
 ——— ——— to prepare for mechanical manœuvres, 201,
 419, 420.
 ——— what, 5, **12**; 5, **13**.
 Deviation, 41, **177**; 56, **206**; 57, **206**; 58, **206**; 59, **206**;
 186, **402**; 192, **409**.
 Directrix, 41, **179**.
 Disabling cannon, 309, **564**.
 Dispart, 37, **145**.
 Distances, for Coehorn mortar target, 188, **406**.
 ——— for sea-coast gun targets, 189, **409**.
 ——— for sea-coast mortar targets, 189, **407**; 189, **408**.
 ——— for siege-gun targets, 184, **402**.
 ——— for siege-howitzer targets, 187, **403**.
 ——— for siege-mortar targets, 187, **404**; 188, **404**.
 ——— of defensive works from towns, 376, **617**.
 ——— to ascertain, 184, **402**; 191, **409**.
 ——— ——— by telemeter, 192, **411**; 193, **411, 412**.
 Ditches, 378, **620**; 400, **648**.
 Drift, 41, **178**.
 Drill. (See Manœuvres, Mechanical; Manœuvres, Tactical.)
 Drop of projectile, table, 404, **650**.
 Dualine, 431, **675**.
 Dyer's pointing apparatus, 63, **213**; 64, **213**; 168, **372**; 170,
 378.
 Dynamite, 431, **675**.
 ——— in demolitions, 421, **669**; 431, **675**.

[NOTE.—The plain figures refer to the pages of this volume. The full-faced figures refer to paragraphs.]

- EARTH-WORKS**, (see Field Intrenchments,) 357, **594**, **595**.
 ——— penetration of, 358, **595**; 359, **595**; 360, **595**; 362, **596**; 363, **596**, **597**.
 ——— revetments, 362, **596**; 363, **596**; 377, **618**; 379, **622**, **623**; 380, **624**; 381, **625**, **626**; 382, **627**, **628**; 383, **629**.
 ——— thickness, 362, **596**.
 ——— to breach, 360, **595**; 361, **595**.
Eccentric rollers, 136, **320**.
Effect of projectiles, striking, 352, **590**; 353, **590**.
 ——— how to be observed, 185, **402**.
Electrical submarine mines, 425, **671**; 426, **671**.
 ——— testing-rooms, 449, **689**; 456, **693**.
Electric batteries, 450, **689**.
 ——— cables, 443, **682**; 445, **686**; 446, **686**; 447, **686**.
 ——— ——— to lead into forts, 449, **688**, **689**.
 ——— fuses, 440, **680**.
 ——— primers, 51, **201**.
 ——— ——— in demolitions, 421, **669**.
Elevating-arc, 60, **208**; 60, **209**; 138, **320**.
Elevating-bar, 56, **205**; 66, **216**.
Elevating-screw, 67, **216**; 294, **555**.
Elevation, 39, **162**; 82, **230**, XXXIII, XXXIV.
 ——— of batteries, 377, **585**.
Embarkation of artillery, 321, **571**.
 ——— horses, 328, **573**; 329, **574**; 333, **576**.
 ——— of unsuccessful expeditions, 340, **579**.
Embrasure batteries, 385, **634**.
Energy of projectiles, 39, **167**.
Engineers, functions in besieging positions, 411, **661**; 411, **663**.
Entanglements, 397, **644**.
 ——— to clear away, 406, **654**.
Epaulments, 376, **618**.
Equipments, 53, **203**.
 ——— for officers, 413, **664**.
 ——— preservation of, 313, **566**.
Explosion, 41, **180**.
Explosives, (see Dualine; Dynamite; Gun-cotton; Gunpowder; Lithofracteur; Nitro-glycerine,) 41, **180**; 430, **675**.
FASCINES for revetments, 380, **624**.
Feeding horses at sea, 328, **573**.

[NOTE.—The plain figures refer to the pages of this volume. The full-faced figures refer to paragraphs.]

- Field-glass for each siege gun, 95, **257**.
 Field-gun platforms, 74, **226**.
 Field intrenchments, 357, **594**.
 ——— attack and defense, 403, **649**.
 ——— bastioned works, 369, **611**; 370, **611**; 371, **611**.
 ——— batteries, barbette, 384, **632**.
 ——— ——— embrasure, 385, **634**; 396, **641**.
 ——— ——— pan-coupée, 384, **633**.
 ——— besieging, 407, **656**.
 ——— block-houses, 400, **648**.
 ——— bomb-proofs, 394, **639**.
 ——— camps, to lay out, 364, **601**; 375, **616**.
 ——— classified, 396, **642**.
 ——— defiles, 417, **667**; 418, **667**.
 ——— detached works, to lay out, 366, **603**, **605**; 367, **606**—
608; 368, **610**.
 ——— ditches, 378, **620**.
 ——— entanglements, 397, **644**.
 ——— fascine revetments, 380, **624**.
 ——— garrisons for, 367, **609**; 368, **609**; 370, **611**; 374,
614.
 ——— gun batteries, location of, 364, **600**; 388, **635**.
 ——— guns and mortars for, 371, **612**.
 ——— interior arrangement, 384, **630**.
 ——— lines of battle, to lay out, 364, **602**; 372, **613**.
 ——— lines of works, to lay out, 372, **613**; 373, **613**; 374,
613, **614**; 375, **614**, **615**.
 ——— magazines, service, 392, **637**.
 ——— ——— storage, 390, **637**.
 ——— mortars in, 397, **643**.
 ——— parapets, ditches of, 378, **620**.
 ——— ——— form of, 376, **618**; 377, **618**, **619**; 378, **619**.
 ——— ——— penetration of, 358, **595**; 359, **595**; 360, **595**;
362, **596**; 363, **596**, **597**.
 ——— ——— slopes of, (tables,) 377, **619**; 378, **619**; 379,
621.
 ——— ——— thickness of, 362, **596**; 378, **619**.
 ——— platforms for batteries, 387, **635**; 388, **636**; 397,
643.
 ——— profiling, 379, **621**.
 ——— revetments, 362, **596**; 363, **596**; 377, **618**; 379,
622, **623**; 380, **624**; 381, **625**; 381, **626**; 382,
627, **628**; 383, **629**.

[NOTE.—The plain figures refer to the pages of this volume. The full-faced figures refer to paragraphs.]

Field intrenchments, river-crossings, attacking, 420, **668**.

——— defending, 419, **668**.

——— sea-coast, 388, **636**.

——— splinter-proofs, 393, **637**.

——— to breach, 361, **595**; 379, **621**.

——— tracing, 379, **621**.

——— traverses, 376, **618**; 388, **635**; 393, **638**; 394, **638**.

Fire, armor against, 347, **586**.

——— curved or vertical, 38, **156**; 356, **593**.

——— direct or horizontal, 38, **155**; 347, **585**.

——— earth-works, to breach, 361, **595**.

——— kinds, during attack, 406, **654**.

——— magazines, to destroy, 360, **595**.

——— night repairs, to prevent, 361, **595**.

——— plunging, 39, **159**.

——— rapidity of, 127, **308**.

——— ricochet, 38, **157**; 347, **585**; 350, **587**.

——— rolling, 38, **158**.

——— to, 80, **230**, XIII; 90, **243**, **244**; 91, **247**; 115, **286**; 125, **301**; 153, **348**.

——— vessels, moving, 350, **588**; 355, **592**.

Fire-ball, 50, **195**.

Fire-works, storage of, 317, **569**; 318, **569**.

Firing at night, 356, **592**.

——— mines, 450, **690**; 451, **690**; 452, **690**; 453, **690**.

——— reports of, during sieges, 416, **666**.

——— rules for target, 183, **401**.

——— salutes, 460, **698**.

Flag at half-staff, 466, **713**.

——— never dipped at posts, 466, **712**.

Forces acting on projectile, 57, **206**.

Formula, cordage, to find strength of, 238, **481**.

——— guys, to find strain, 474, App.

——— lighters, to find capacity, 341, **579**.

——— parapet, to find number of men for, 345, **582**; 367, **609**; 368, **609**; 370, **611**.

——— powder, to find charge for bridge demolitions, 421, **669**.

——— projectile, to compute energy, 39, **167**.

——— to compute number in piles, 312, **565**.

——— to find weight of, 478, App.

——— ranges, to find elevation, 61, **210**.

——— to find for mortars, 154, **354**.

——— shears, to find strength of, 473, App.

[NOTE.—The plain figures refer to the pages of this volume. The full-faced figures refer to paragraphs.]

- Forts, bastioned, 369, **611**; 370, **611**; 371, **611**.
 ——— command of artillery in, 346, **583**.
 ——— complements of men for, 345, **582**; 367, **607**; 368, **607**; 370, **611**; 374, **614**.
 ——— distances from towns, 376, **617**.
 ——— submarine defenses, 346, **584**.
- Forward, defined, 201, **419**.
- Friction against bore, influencing projectile, 58, **206**.
- Friction-bars, 69, **220**.
- Friction-primers, 51, **200**.
 ——— preservation of, 313, **566**.
- Front sight, 59, **207**; 60, **208**; 60, **209**.
- Fulminate of mercury, 433, **675**.
- Funeral honors, 466, **713**.
- Fuse-block, 55, **205**.
- Fuse-gauge, 55, **205**.
- Fuse-hole in elongated shells, 49, **190**.
 ——— in spherical shells, 48, **188**.
- Fuse-knife, 55, **205**.
- Fuse-plug extractor, 55, **205**.
- Fuse-plugs, 110, **277**.
- Fuse-reamers, 55, **205**.
- Fuses, 50, **196**.
 ——— blasting, 422, **669**.
 ——— combination, 51, **199**.
 ——— concussion, 51, **199**.
 ——— electric, 440, **680**.
 ——— ignition, to secure in mortar, 165, **368**.
 ——— mortar fuse-plugs, 51, **197**; 165, **368**.
 ——— paper time, 51, **197**.
 ——— percussion, 51, **198**.
 ——— position in mine charges, 441, **681**.
 ——— preservation of, 313, **566**.
 ——— sulphuric acid, 439, **679**.
 ——— time, 50, **197**.
 ——— water-cap fuse-plug, 50, **197**.
- Fuse-setter, 54, **205**.
- Fuse-wrench, 55, **205**.
- GABION revetments, 381, **626**; 386, **634**; 393, **638**.
 Gabions, 382, **626**.
 Garrison gin-derrick, (narrow,) 252, **501**.
 Garrison trucks, painting and storage, 314, **566**.

[NOTE.—The plain figures refer to the pages of this volume. The full-faced figures refer to paragraphs.]

- Gatling guns. (See Guns, Gatling.)
 ——— against assaults, 410, **660**.
 ——— for block-houses, 400, **648**.
 ——— not substitutes for artillery, 371, **612**.
- Gauging bores, 297, **558**.
- General rules for service of piece, 79, **230**; 86, **234-236**;
 87, **238, 239**.
 ——— for target practice, 183, **401**.
 ——— for traversing in aiming, 81, **230, XXIV**; 145, **340**.
- Gins as capstans, 262, **518**.
 ——— as shears, 252, **500**.
 ——— described, 242, **485**.
 ——— dimensions, weights, &c., 252, **499**.
 ——— garrison and casemate, 248, **495**; 249, **495**.
 ——— painting and storage, 313, **566**; 314, **566**.
 ——— Piper's, 247, **494**.
 ——— ropes for, 244, **489**.
 ——— to lower, 244, **488**.
 ——— to move, 244, **488**.
 ——— to put together, 243, **488**.
 ——— to raise, 243, **488**.
 ——— to shift the fall, 247, **493**.
 ——— with barbette guns, 250, **497**.
 ——— with casemate guns, 249, **496**.
 ——— with siege guns, 245, **490**.
 ——— with siege mortars, 246, **492**.
- Grape-shot, 49, **193**.
- Grommet, 234, **479**.
- Gun-cotton, 432, **675**.
- Gun-lift, described, 279, **539**.
 ——— storage, 314, **566**.
 ——— to assemble and raise, 281, **540**.
 ——— to mount 15-inch gun, 282, **541**.
 ——— to raise a weight, 281, **540**.
- Gunner's level, 53, **205**; 105, **263**; 129, **310**; 150, **344**;
 161, **362**.
- Gunner's pouch, 55, **205**; 78, **230, IV**.
- Gunner's quadrant, 53, **204**.
- Gunpowder, barrels, marks, 44, **180**.
 ——— ——— sampling, 46, **182**.
 ——— ——— to open, 319, **570**.
 ——— caked, to break, 319, **570**.
 ——— cartridges, bags, 47, **185**.

[NOTE.—The plain figures refer to the pages of this volume. The full-faced figures refer to paragraphs.]

- Gunpowder, cartridges, to weigh or measure charges, 188, **404**.
- charges to destroy vessels, 430, **674**.
- demolition by, 421, **669**.
- grain, size of, 42, **180**; 43, **180**.
- granulation irregular, (cannon, mammoth, musket,) 42, **180**; 46, **181**.
- ——— regular, (cubical and molded,) hexagonal, 42, **180**; 45, **181**.
- pellet, 42, **180**; 46, **181**.
- prismatic, 42, **180**; 46, **181**.
- hardness, 43, **180**.
- incorporation, 44, **180**.
- initial velocity, 43, **180**.
- inspection, 44, **180**.
- materials, 42, **180**.
- moisture tests, 43, **180**.
- naval classification, 46, **181**.
- preservation, 316, **569**.
- pressure, 47, **184**; 147, **341**.
- pressure-plug, 197, **413**.
- qualities, 42, **180**.
- special, 44, **181**; 45, **181**.
- specific gravity, 43, **180**.
- storage, 317, **569**; 318, **569**; 390, **637**.
- strain on guns, 43, **180**.
- tests, flashing, 47, **183**.
- ——— of moisture, 43, **180**.
- ——— sampling, 46, **182**.
- transportation, 318, **569**.
- Guns, ammunition for, 316, **568**; 390, **637**; 410, **660**; 411, **662**; 413, **666**; 416, **666**.
- designation of, in batteries, 82, **230**, XXVIII.
- for field-works, 371, **612**.
- ——— location of, 388, **635**.
- ——— space for, 368, **609**.
- Gatling, 0.45-inch, description, 170, **379**; 177, **390**.
- ——— ——— carriage, 181, **398**.
- ——— ——— nomenclature, 180, **398**.
- ——— ——— precautions, 179, **397**.
- ——— ——— service, 177, **391**.
- ——— ——— to assemble, 181, **400**.
- ——— ——— to take apart, 181, **399**.
- ——— 1-inch, description, 170, **379**; 171, **379**.

[NOTE.—The plain figures refer to the pages of this volume. The full-faced figures refer to paragraphs.]

- Guns, Gatling, 1-inch, nomenclature, 175, **386**.
 _____ service, 171, **380**.
 _____ storage, 314, **566**.
 _____ to assemble, 176, **389**.
 _____ to take apart, 176, **388**.
 _____ Hotchkiss, revolving, description, 182, **400**.
 _____ suitable for block-houses, 400, **468**.
 _____ in attack of positions, 403, **649**; 404, **650**.
 _____ injuries of, 132, **319**; 297, **558**.
 _____ inspection of, 299, **559**.
 _____ location in field-works, 388, **635**.
 _____ marks on, 293, **553**.
 _____ on skids, 295, **555**.
 _____ Parrott. (See below.)
 _____ quantity in sieges, 411, **662**.
 _____ rifles best against armor, 354, **590**.
 _____ selection of, for besieging batteries, 408, **657**.
 _____ siege, care of, 295, **557**.
 _____ space for, in field-works, 388, **635**.
 _____ to brown, 296, **557**.
 _____ to disable, 309, **564**.
 _____ to load on cars, 324, **572**.
 _____ what, 36, **144**; 37, **146**; 38, **154**.
 Guns of U. S. system, 4.5-inch rifle, described, 2, **8**; 83, **231**.
 _____ carriages, 83, **231**; 84, **231**.
 _____ dismount carriage and limber, 222, **459**.
 _____ from mortar-wagon, 214, **450**.
 _____ the gun, 212, **448**.
 _____ with the gin, 246, **491**.
 _____ with sling-cart, 254, **503**.
 _____ firing to traveling bed, 208, **441**.
 _____ forward or backward, 206, **435**.
 _____ mechanical manœuvres, 204, **431**.
 _____ mount on mortar-wagon, 214, **450**.
 _____ the gun, 210, **447**.
 _____ with the gin, 245, **490**.
 _____ prepare for action, 210, **446**.
 _____ for traveling, 210, **445**.
 _____ ranges, 84, **231**.
 _____ remove short roller from under the body, 208, **439**.
 _____ the chase, 207, **437**.
 _____ service of, 83, **231**.

[NOTE.—The plain figures refer to the pages of this volume. The full-faced figures refer to paragraphs.]

- Guns of U. S. system, 4.5-inch rifle, shift carriages, 213, **449**.
 ——— from carriage to mortar-wagon, 216, **452**.
 ——— from mortar-wagon to carriage, 217, **453**.
 ——— short roller under body, 207, **438**.
 ——— under chase, 207, **436**.
 ——— side-lift carriages, 209, **443**.
 ——— to limber, 204, **433**.
 ——— to unlimber, 205, **434**.
 ——— traveling to firing bed, 208, **440**.
 ——— 10-inch rifled, 2, **8**.
 ——— 12-inch rifled, 2, **8**.
 ——— 13-inch smooth-bore, 2, **8**; 2, **8 n**.
 ——— 15-inch smooth-bore, 2, **8**; 2, **8 n**.; 119, **293**; 126, **306**.
 ——— carriages, 119, **293**; 126, **306**; 127, **308**.
 ——— dismount by blocks, 273, **534**.
 ——— the gun, 274, **535**; 275, **535**; 276, **535**.
 ——— lower with derrick, 291, **550**.
 ——— mount with gun-lift, 282, **541**.
 ——— other methods mounting and dismounting, 278, **537**; 282, **541**.
 ——— ranges, 119, **293**; 126, **306**.
 ——— raise with derrick, 290, **549**.
 ——— remove chassis, 277, **536**.
 ——— replace chassis, 277, **536**.
 ——— service of, 120, **294**; 126, **307**.
 ——— 20-inch smooth-bore, 2, **8**; 2, **8 n**.
 Guns not of U. S. system, but in service, 4.2-inch (30 pdr.) Parrott, 2, **8**.
 ——— 6.4-inch (100 pdr.) Parrott, 2, **8**; 115, **288**.
 ——— ranges, 116, **288**.
 ——— service of, 115, **288**.
 ——— 8-inch (200 pdr.) Parrott, 2, **8**; 115, **288**.
 ——— service of, 115, **288**.
 ——— 8-inch rifled, 2, **8**; 132, **319**.
 ——— carriages, 134, **319**; 135 n.; 135, **320**; 137, **320**.
 ——— indications of injury, 132, **319**.
 ——— ranges, 133, **319**; 134, **319**.
 ——— service of, carriage 1, 137, **321**.

[NOTE.—The plain figures refer to the pages of this volume. The full-faced figures refer to paragraphs.]

- Guns not of U. S. system, but in service, 8-inch rifled, service of,
 carriage 2, 141, **331**.
 ——— ——— ——— carriage 3, 142, **332**.
 ——— ——— ——— carriage 4, 144, **338**.
 ——— 8-inch smooth-bore, 2, **8**.
 ——— 10-inch smooth-bore, 2, **8**; 108, **276**.
 ——— ——— barbette carriage, 109, **276**.
 ——— ——— ranges, 109, **276**.
 ——— ——— service of, 109, **277**.
 ——— ——— to dismount, 282, **542**; 283, **543**; 284, **544**.
 ——— ——— (300 pdr.) Parrott, 2, **8**; 115, **288**.
 ——— ——— service of, 115, **288**.
 Gun-shields, 400, **648**; 408, **657**.
 Guys, formula to compute strains on, 474, App.
- HAMMER-WRENCH, 200, **416**; 210, **444**.
 Hammocks, horse, 332, **576**; 334, **577**.
 Hand-barrows, 260, **512**.
 Hand-carts, 259, **507**.
 —— painting and storage, 314, **566**.
 Handspikes, 56, **205**; 86, **235**, **236**; 93, **256**; 200, **417**;
 201, **417**.
 Harbors, defenses of, (see Submarine Mines,) 343, **580**; 388,
 636; 389, **636**.
 —— arrangement of mines, 428, **673**.
 —— lighting, 456, **692**.
 —— position of mines, 427, **672**.
 —— strength of batteries, 355, **592**; 356, **593**.
 —— submarine mines, 346, **584**; 425, **671**; 426, **671**.
 —— table of surface currents, 458, **694**.
- Harness, care of, 101, **258**.
 —— for siege-gun batteries, 93, **255**; 101, **258**.
- Hitches, 234, **480**; 235, **480**.
 Holdfasts, 263, **519**; 263, **521**; 264, **521**.
 Horse batteries, 101, **259**.
 Horses, capabilities of, 476, App.
 —— care of, at sea, 101, **258**.
 —— disembarkations, 338, **578**.
 —— embarkations, 328, **573**; 329, **574**; 333, **576**.
 —— feeding, at sea, 328, **573**.
 —— for batteries in lines of works, 375, **616**.
 —— for siege-gun batteries, 94, **256**; 413, **665**.
 —— hammocks for, at sea, 332, **576**; 334, **577**.

[NOTE.—The plain figures refer to the pages of this volume. The full-faced figures refer to paragraphs.]

- Horses, medicines for, siege-gun batteries, 101, **259**.
 ——— transportation of, by rail, 322, **572**.
 ——— ——— by sea, 327, **573**; 330, **575**.
 Hotchkiss. (See Guns, Hotchkiss.)
 Howitzers, 5.8-inch, 2, **8**; 128, **309**.
 ——— ——— carriage, 128, **309**.
 ——— ——— dismount carriage, 271, **533**.
 ——— ——— ——— howitzer, 271, **533**.
 ——— ——— mount carriage, 273, **533**.
 ——— ——— ——— howitzer, 272, **533**.
 ——— ——— ranges, 128, **309**; 131, **318**.
 ——— 8-inch, (siege,) 2, **8**; 102, **261**.
 ——— ——— at short ranges, 404, **650**.
 ——— ——— defined, 36, **144**; 37, **147**.
 ——— ——— doubly charged to repel assaults, 131, **318**.
 ——— ——— mechanical manœuvres, 208, **439**.
 ——— ——— ranges, 103, **261**; 222, **458**.
 ——— ——— service of, 102, **261**.
 ——— ——— shells, to charge, 108, **275**.
 ——— ——— target practice, 187, **403**.
 ——— ——— to dismount, 218, **455**.
 ——— ——— ——— as a mortar, 221, **458**.
 ——— ——— ——— carriage and limber, 222, **459**.
 ——— ——— to mount, 219, **456**.
 ——— ——— ——— as a mortar, 220, **457**.
 ——— ——— to stand on its muzzle, 218, **454**.
 ——— ——— uses in ricochet firing, 65, **214**.
 Hurters, 68, **217**.
 Hydraulic buffers, 69, **219**; 135, **320**.
 ——— jacks. (See Jacks.)
 ICE as bridges, 342, **579**.
 Impact, effect of obliquity, 348, **586**.
 ——— phenomena, 352, **590**.
 ——— to record centre of, 185, **402**; 186, **402**.
 Implements, 53, **203**; 199, **416**; 200, **416, 417**; 201, **417-419**.
 ——— care of, 295, **555**; 312, **566**.
 ——— to replace, 92, **250**; 81, **230, XXII**.
 ——— to take to and from the battery, 79, **230, I**; 81, **230, XXII**; 201, **419**.
 Impressions of the bore, 303, **562**.
 Infantry, coöperation in attack of positions, 405, **653**.

[NOTE.—The plain figures refer to the pages of this volume. The full-faced figures refer to paragraphs.]

- Infantry, coöperation in defending defiles, 418, **667**.
 ——— in constructing lines of works, 373, **613**.
 ——— in harbor defenses, 345, **582**.
 Injuries of guns, 297, **558**.
 ——— of vents, 307, **563**.
 Inspections, by impressions of bores, 303, **562**.
 ——— instruments for, 299, **559**.
 ——— of guns, 299, **559**.
 ——— of injuries, 297, **558**.
 ——— of projectiles, 311, **565**; 312, **565**.
 ——— of vents, 307, **563**.
 ——— to be made after target firing, 185, **402**.
 ——— to record defects, 307, **563**.
 Instruments for inspections, 299, **559**.
 Interpolator, Paddock's, 149, **343**.
 Intrenched camps, 364, **601**.
 ——— lines of battle, 365, **602**.
 Intrenching tools, 413, **664**.
 Intrenchments, (see Field Intrenchments,) 403, **649**.
 Iron-balls, weights, 477, App.
 Iron-clads, charges to destroy, by mines, 430, **674**.
 ——— extreme ranges of, 376, **617**.
 ——— in defense of river passages, 420, **668**.
 ——— mortar fire against, 356, **593**.
 ——— rate of movement, 355, **592**.
 ——— submarine mines against, 425, **670**; 426, **671**; 427, **672**; 428, **673**; 429, **674**.
 ——— vital points, 351, **589**.
 Iron implements, preservation of, 313, **566**.
 Iron, round, cast, weights of, 478, App.
 Iron, strength of, 477, App.
- JACKS, hydraulic, 264, **522**; 265, **522**; 267, **522**; 269, **527**.
 ——— lever, 260, **511**.
 ——— lifting, 259, **510**.
 ——— ——— to lift, 268, **525**.
 ——— ——— to lower, 268, **526**.
 ——— pulling, 267, **522**.
 ——— ——— to fill, 267, **524**.
 ——— ——— to use, 269, **527**.
 ——— storage of, 314, **566**.
 ——— valves, 266, **522**; 267, **522**.
 ——— weights and dimensions of, 269, **527**.

[NOTE.—The plain figures refer to the pages of this volume. The full-faced figures refer to paragraphs.]

KING gun-carriage, 70, **221**.

Knots and splices, 231, **476**.

LACQUER for guns, 296, **557**.

—— for projectiles, 311, **565**; 312, **565**.

—— annually required, 315, **567**.

Ladle, 54, **205**; 115, **286**.

Landing sea expeditions, 339, **579**.

Lanyard, 55, **205**; 90, **243**, **244**.

Launching guns, 203, **430**.

Leather equipments, preservation of, 313, **566**.

Le Clanché electric battery, 450, **689**.

Level, gunner's, 53, **205**; 105, **263**; 129, **310**; 150, **344**;
161, **362**.

Leverage of limbers, 202, **425**.

Life of a piece, 38, **154**.

Lifting, (mechanical manœuvres,) 202, **424**.

—— projectiles, 115, **286**; 115, **287**; 145, **340**; 165,
368.

Lighters in disembarkations, 336, **578**.

—— to find capacity, 341, **579**.

Line of fire, 40, **172**.

Line of metal, 40, **168**; 59, **207**; 60, **209**; 154, **354**.

Line of sight, artificial, 40, **170**.

—— natural, 40, **169**.

Lines of works, 372, **613**; 373, **613**; 374, **613**.

—— to man, 374, **614**; 375, **614**.

Lithofacteur, 431, **675**.

Load, to withdraw. (See Unload.)

Loading guns, &c., 81, **230**, XVI-XXI; 80, **230**, VI-X; 82,
230, XXXIV; 88, **240**; 91, **248**; 92, **252**-
254; 94, **256**.

Loading-bar, Piper's, 165, **368**.

Loading cars, with guns, 324, **572**.

—— with horses, 322, **572**.

—— with siege guns, 324, **572**.

—— with wagons, 324, **572**.

Loading for drill, 83, **230**, XXXVII; 117, **289**; 154, **354**;
164, **367**.

Location of batteries, 364, **600**.

Log revetments, 380, **623**.

Lorain's trunnion sights, 62, **211**; 168, **372**.

[NOTE.—The plain figures refer to the pages of this volume. The full-faced figures refer to paragraphs.]

- MAGAZINES**, care of, 317, **569**; 318, **569**.
 ——— classified, 316, **569**; 389, **637**.
 ——— marked, 317, **569**.
 ——— of earth-works, to destroy, 360, **595**.
 ——— records, 317, **569**.
 ——— service, 392, **637**.
 ——— storage, 390, **637**.
Mammoth powder, 42, **180**; 43, **180**; 46, **181**.
Manœuvres, mechanical, garrison and casemate gins, 248, **495**;
 249, **495**.
 ——— ——— ——— with barbette guns, 250, **497**.
 ——— ——— ——— with casemate guns, 249, **496**.
 ——— ——— garrison gin-derricks, 252, **501**.
 ——— ——— gins, 242, **485**.
 ——— ——— ——— with siege guns, 245, **490**.
 ——— ——— ——— with siege mortars, 246, **492**.
 ——— ——— barbette guns, 15-inch, to dismount by blocks,
 273, **534**.
 ——— ——— ——— ——— to dismount by other methods,
 278, **537**.
 ——— ——— ——— ——— to dismount the gun, 274,
535; 275, **535**; 276,
535.
 ——— ——— ——— ——— to lower with derrick, 291,
550.
 ——— ——— ——— ——— to mount by other methods,
 278, **537**; 282, **541**.
 ——— ——— ——— ——— to mount with gun-lift, 282,
541.
 ——— ——— ——— ——— to raise with derrick, 290,
549.
 ——— ——— ——— ——— to remove chassis, 277, **536**.
 ——— ——— ——— ——— to replace chassis, 277, **536**.
 ——— ——— casemate guns, 10-inch, to dismount with blocks,
 282, **542**; 283, **543**.
 ——— ——— ——— ——— precautions, 284, **544**.
 ——— ——— siege guns, 204, **431**.
 ——— ——— ——— forward and backward, 206, **435**.
 ——— ——— ——— to dismount carriage, 222, **459**.
 ——— ——— ——— from mortar-wagon, 216, **451**.
 ——— ——— ——— the gun, 212, **448**.
 ——— ——— ——— ——— with the gin, 245,
490.

[NOTE.—The plain figures refer to the pages of this volume. The full-faced figures refer to paragraphs.]

- Manœuvres, mechanical, siege guns, to dismount the gun with the sling-cart, 254, **503**.
- _____ to limber, 204, **431**.
- _____ to mount on mortar-wagon, 214, **450**.
- _____ the gun, 210, **447**.
- _____ with the gin, 245, **490**.
- _____ to prepare for action, 210, **446**.
- _____ for traveling, 210, **445**.
- _____ to put short roller under body, 207, **438**.
- _____ under chase, 207, **436**.
- _____ to remove short roller from under body, 208, **439**.
- _____ from under chase, 207, **437**.
- _____ to shift carriages, 213, **449**.
- _____ from carriage to mortar-wagon, 216, **452**.
- _____ from firing to traveling bed, 208, **441**.
- _____ from mortar-wagon to carriage, 217, **453**.
- _____ from traveling to firing bed, 208, **440**.
- _____ to side-lift the carriage, 209, **443**.
- _____ to unlimber, 205, **434**.
- _____ flank-casemate howitzers, to dismount carriage, 271, **533**.
- _____ the howitzer, 271, **533**.
- _____ to mount the carriage, 273, **533**.
- _____ the howitzer, 272, **533**.
- _____ siege howitzer, to dismount, 221, **458**.
- _____ carriage and limber, 222, **459**.
- _____ the howitzer, 218, **455**.
- _____ to mount as mortar, 220, **457**.
- _____ the howitzer, 219, **456**.
- _____ to stand on muzzle, 218, **454**.
- _____ with sling-cart, 254, **503**.
- _____ 8-inch siege mortar, 228, **468**.
- _____ 10-inch siege mortar, to dismount, 224, **464**.
- _____ from wagon, 227, **468**.
- _____ to mount, 225, **465**.
- _____ on mortar-wagon, 225, **466**.

[NOTE.—The plain figures refer to the pages of this volume. The full-faced figures refer to paragraphs.]

- Manceuvres, mechanical, 10-inch siege mortar, to sling and hoist with the gin, 246, **492**.
 _____ to slue, 224, **463**.
 _____ to stand on muzzle, 223, **462**.
 _____ to stand on one trunnion, 223, **460**.
 _____ with sling-cart, 254, **503**.
 _____ 13-inch mortar, to dismount, 228, **469**; 229, **470**.
 _____ to place, with carriage on rollers, 229, **471**.
 _____ to raise and place on blocks, 229, **472**.
 _____ to shift from carriage to truck-wagon, 279, **538**.
 _____ to transport on sling-cart, 230, **473**.
 _____ sling-cart, with siege gun, howitzer, or mortar, 254, **503**.
 _____ definition, 199, **414**.
 _____ detachments for, 199, **415**.
 _____ duties of chief-of-detachment, 202, **422**.
 _____ of detachment, 202, **423**.
 _____ of gunner, 202, **423**.
 _____ of instructor, 201, **421**; 231, **475**.
 _____ handspikes, and their uses, 200, **417**; 201, **417**.
 _____ implements, machines, &c., 199, **416**; 200, **416**; 230, **474**; 241, **484**.
 _____ leverage by limbers, 202, **425**.
 _____ to cross-lift, 203, **427**.
 _____ to cut a piece, 204, **430**.
 _____ to launch a piece, 203, **430**.
 _____ to lift, 202, **424**.
 _____ to parbuckle, 202, **426**.
 _____ to pinch, 203, **429**.
 _____ to prepare for, 201, **419**; 201, **420**; 231, **475**.
 _____ tactical, alignments, 11, **53**.
 _____ by battalion, 28, **116**.
 _____ to change posts, 27, **112**.
 _____ to double rank, 25, **104**, **105**.
 _____ to single rank, 24, **101**, **102**.
 _____ to close ranks, 11, **52**.
 _____ to dismiss, 12, **55**.
 _____ to halt the line, 12, **57**.

[NOTE.—The plain figures refer to the pages of this volume. The full-faced figures refer to paragraphs.]

- Mancœuvres, tactical, to leave the pieces, 27, **113**; 28, **114**, **115**.
- to march by detachments, 18, **80**; 19, **81-86**;
20, **87, 88**; 22, **93-96**; 23, **97**.
- by platoons, 14, **66, 67**; 15, **68, 69**,
16, **73**; 17, **75-79**.
- by the flank, 14, **64, 65**.
- detachments into line, 20, **89**; 21,
90-92.
- in columns of files, 14, **64**; 16, **73**;
17, **74**; 23, **99**; 24, **100**.
- in line, 12, **56**; 23, **98**.
- in route step, 23, **100**.
- obliquely, 12, **58**; 14, **65**; 22, **96**.
- platoons into line, 15, **70**; 16, **71, 72**.
- to the pieces, 25, **106**; 26, **107**.
- to the rear, 23, **98**.
- to open ranks, 10, **49**.
- to rest, 12, **54**; 27, **110**.
- to resume the exercise, 27, **111**.
- to take posts at pieces, 26, **108**.
- to wheel, 13, **60-63**.
- Material, artillery, annual supply to preserve, 315, **567**.
- care and preservation of, 293, **551**; 294, **555**;
312, **566**.
- of projectiles, 310, **565**.
- required during sieges, 412, **664**; 413, **664**.
- store-houses for, 312, **566**.
- Mechanical submarine mines, 425, **671**; 426, **671**.
- Mensuration, 474, 475, App.
- Metrical equivalents, 469, App.
- Metric tables, 467, 468, 469, App.
- Mines, (see Submarine Mines,) 425, **671**; 426, **671**.
- Mortar fuse-plug, 51, **197**.
- Mortar platforms, 71, **224**; 75, **227**; 76, **228**; 77, **229**; 78,
229; 155, **355**; 158, **357**; 159, **360**; 188, **404**.
- Mortar powder, 42, **180**; 43, **180**; 154, **354**.
- Mortars, 36, **144**; 37, **148**.
- against iron-clads, 356, **593**.
- batteries of, 397, **643**; 408, **656**.
- on skids, 295, **555**.
- penetration of shells, 363, **597**.
- positions in field-works, 371, **612**; 388, **635**.

[NOTE.—The plain figures refer to the pages of this volume. The full-faced figures refer to paragraphs.]

- Mortars, target practice, 188, 406; 189, 407.**
 ——— to aim, 63, **212, 213**; 64, **213**; 148, **342, 343**;
 149, **343**; 163, **365**; 167, **372**; 170, **378**.
 ——— to prevent night repairs, 361, **595**.
 ——— to select shells for, 188, **404**.
 ——— uses in ricochet firing, 65, **214**.
 ——— weighing powder charges, 154, **354**; 188, **404**.
 ——— 5.8-inch Coehorn, 2, **8**; 157, **357**.
 ——— ——— carriage, 157, **357**; 158, **359**.
 ——— ——— ranges, 157, **357**.
 ——— 8-inch siege, 2, **8**; 155, **355**.
 ——— ——— ranges, 155, **355**.
 ——— ——— target practice, 188, **405**.
 ——— ——— to manœuvre, 228, **468**.
 ——— ——— to sling and hoist, with gin, 246, **492**.
 ——— ——— with sling-cart, 254, **503**.
 ——— 10-inch sea-coast, 2, **8**; 165, **369**.
 ——— ——— carriage, 165, **369**.
 ——— ——— ranges, 166, **369**.
 ——— ——— service, 166, **369**.
 ——— ——— target practice, 187, **404**.
 ——— 10-inch siege, 2, **8**; 145, **341**; 146, **341**.
 ——— ——— bed or wagon, 146, **341**.
 ——— ——— ranges, 146, **341**; 154, **354**.
 ——— ——— service, 147, **342**.
 ——— ——— to dismount, 224, **464**.
 ——— ——— ——— from wagon, 227, **468**.
 ——— ——— to mount, 225, **465**.
 ——— ——— ——— on mortar-wagon, 225, **466**.
 ——— ——— to sling and hoist, with gin, 246, **492**.
 ——— ——— to slue, 224, **463**.
 ——— ——— to stand on muzzle, 223, **462**.
 ——— ——— ——— on one trunnion, 223, **460**.
 ——— ——— with sling-cart, 254, **503**.
 ——— 13-inch, 2, **8**; 159, **360**; 167, **370**.
 ——— ——— carriage, 159, **360**; 167, **370**.
 ——— ——— ranges, 159, **360**.
 ——— ——— service, 160, **361**; 167, **371**.
 ——— ——— to dismount, 228, **469**; 229, **470**.
 ——— ——— to mount, 228, **469**; 229, **470**.
 ——— ——— to place on rollers, 229, **471**.
 ——— ——— to raise and place on blocks, 229, **472**.
 ——— ——— to shift from carriage to truck-wagon, 279, **538**.

[NOTE.—The plain figures refer to the pages of this volume. The full-faced figures refer to paragraphs.]

- Mortars, 13-inch, to transport, on sling-cart, 230, **473**.
 Mortar-wagons, 261, **515**.
 Motion of projectiles, 56, **206**; 57, **206**; 58, **206**; 59, **206**.
 Mounting siege-gun batteries, 101, **258**.
 Musket ball, penetration of, 363, **598**.
 Musket powder, 42, **180**.
 Muzzle, 35, **133**.
 ——— canvas hoods, 295, **555**.
- NAVAL classification of gunpowders, 46, **181**.
 Night firing, 356, **592**; 407, **654**.
 Nitro-glycerine, 431, **675**.
- OBSTRUCTIONS to channels, 343, **581**.
 Official courtesies, 463, **708**.
 Oils, painting, required annually, 315, **567**.
 ——— ——— storage, 314, **566**.
 ——— volatile, storage of, 314, **566**.
 Ordnance sergeants, 294, **554**; 317, **569**.
 Organization of siege-gun batteries, 92, **255**.
- PADDOCK'S interpolator, 149, **343**.
 Paint, annual supply, 315, **567**.
 ——— brushes, storage, 314, **566**.
 ——— for siege guns, 101, **258**; 295, **557**.
 ——— storage, 314, **566**.
 Pan-coupée, 384, **633**.
 Paper time-fuse, 51, **197**.
 Parallels, siege, 408, **656**; 411, **661**; 411, **663**.
 Parapets, forms, 376, **618**; 377, **619**; 378, **619**.
 ——— penetration of, 358, **595**; 359, **595**; 360, **595**; 362, **596**; 363, **596-598**.
 ——— revetments, 362, **596**; 379, **622**, **623**.
 ——— slopes, 377, **619**; 378, **619**.
 ——— thickness, 362, **596**; 378, **619**.
- Parbuckling, 202, **426**.
 Parcelling, 232, **478**.
 Parks, location, 375, **614-616**; 412, **663**.
 Parrott guns, 115, **287**; 115, **288**; 116, **288**.
 Pass-box, 54, **205**.
 Pellet gunpowder, 42, **180**; 46, **181**.
 Penetration, action of projectiles, 360, **595**; 361, **595**.
 ——— effect of revetments on, 362, **596**; 363, **596**.

[NOTE.—The plain figures refer to the pages of this volume. The full-faced figures refer to paragraphs.]

- Penetration of armor, 347, **586**.
 ——— of batteries, 357, **595**.
 ——— of mortar shells, 363, **597**.
 ——— of rifle-musket balls, 363, **598**.
 ——— tables of. 358, **595**; 359, **595**; 360, **595**.
- Percussion-fuse, 51, **198**.
- Pickets for holdfasts, 263, **519**.
 ——— to draw, 263, **520**.
- Piece, defined, 5, **10**; 34, **131**.
- Pile-driver, 263, **520**.
- Piles of projectiles, to compute number of balls, 312, **565**.
- Piling projectiles, 311, **565**; 312, **565**.
- Pinch-bar, 270, **530**.
- Pinching guns, 203, **429**.
- Pintle, 67, **217**.
- Pintle-key, 67, **217**.
- Pintle-plate, 67, **217**.
- Piper's gin, 247, **494**.
- Piper's loading-bar, 165, **368**.
- Plane of sight, 40, **174**; 148, **342**.
 ——— tables, 187, **409**.
- Plank revetments, 382, **627**.
- Platforms, 41, **179**; 71, **224**; 72, **225**; 73, **225**; 74, **226**;
 75, **227**; 76, **228**; 78, **229**; 84, **231**; 184, **402**;
 188, **404**; 387, **635**; 388, **636**; 397, **643**.
 ——— barbette, 10-inch gun, 109, **276**.
 ——— ——— centre-pintle, 15-inch gun, 120, **293**.
 ——— ——— front-pintle, 15-inch gun, 126, **306**.
 ——— Coehorn mortar, 158, **357**.
 ——— howitzer, 103, **261**.
 ——— mortar, 13-inch, 165, **369**.
 ——— suitable for field-works, 387, **635**; 388, **636**; 397,
643.
- Platoons, 6, **18-22**; 10, **42**.
- Plotting, results of target practice, 191, **409**.
- Pneumatic buffers, 68, **218**.
- Pointing. (See Aiming.)
- Point of fall, 39, **160**.
- Pontoons, dimensions, 337, **578**; 341, **579**.
 ——— in disembarkations, 336, **578**; 338, **578**.
 ——— weight of troops on, 341, **579**.
- Port-fire composition, in shells, as carcasses, 50, **194**.
- Post revetment, 381, **625**.

[NOTE.—The plain figures refer to the pages of this volume. The full-faced figures refer to paragraphs.]

- Posts of cannoneers, 81, **230**, XXII, XXVI.
 Powder. (See Gunpowder.)
 Powder-measure, 55, **205**; 154, **354**.
 Preponderance, 38, **154**.
 Pressure of gunpowder, 47, **184**; 147, **341**; 197, **413**.
 Primers, electric, 52, **201**.
 ——— friction, 51, **200**; 433, **675**.
 Primer-pouch, 55, **205**; 79, **230**, IV; 86, **234**.
 Priming, general rules, 80, **230**, XI; 82, **230**, XXXV; 89, **243**; 92, **252**.
 Priming-wire, 54, **205**; 79, **230**, IV; 59, **206**; 81, **230**, XVI.
 Prismatic gunpowder, 46, **181**.
 Profiling, 379, **621**.
 Projectiles, action of, against earth-works, 360, **595**; 361, **595**; 362, **596**.
 ——— amount and proportions required, 316, **568**; 390, **637**; 410, **660**; 411, **662**; 413, **666**.
 ——— armor penetration, 347, **586**.
 ——— ——— punching, 354, **591**.
 ——— Butler, 49, **190**.
 ——— canister, 49, **192**.
 ——— carcass, 49, **194**.
 ——— case-shot, 48, **189**.
 ——— classified, 37, **150**; 47, **186**.
 ——— cored-shot, 49, **191**.
 ——— drop of, tables, 404, **650**.
 ——— effect of, racking or punching, 353, **590**.
 ——— elongated, 48, **190**.
 ——— energy of, 39, **167**.
 ——— fire-ball, 50, **195**; 154, **354**.
 ——— forces of gravitation, 57, **206**.
 ——— forces acting on, 56, **206**.
 ——— for drill, 83, **230**, XXVII; 90, **244**; 117, **289**.
 ——— friction, effect on, 58, **206**.
 ——— grape-shot, 49, **193**.
 ——— hollow, 48, **188**; 49, **191**.
 ——— inspection of, 311, **565**.
 ——— lacquer for, 311, **565**; 312, **565**.
 ——— mortar, penetration of, 363, **597**.
 ——— packing, 311, **565**.
 ——— penetration of, in armor, 347, **586**.
 ——— ——— in earth, 358, **595**; 359, **595**; 360, **595**.

[NOTE.—The plain figures refer to the pages of this volume. The full-faced figures refer to paragraphs.]

- Projectiles, penetration of mortar shells, 363, **597**.
 ——— preparation of, 81, **230**, XVII, XXI, XXVII; 110, **277**; 165, **368**; 188, **404**.
 ——— preservation of, 310, **565**.
 ——— resistance of the air, 57, **206**; 58, **206**.
 ——— rifle, 49, **191**.
 ——— ——— ring for, 52, **202**.
 ——— ——— to be lubricated, 81, **230**, XX; 92, **254**.
 ——— rifling, resistance of, 58, **206**.
 ——— sabot for, 52, **202**; 154, **354**.
 ——— solid, 47, **187**; 188, **404**.
 ——— spherical, best for ricochet, 65, **214**.
 ——— to ascertain time of flight, 184, **402**.
 ——— to charge hollow, 108, **275**; 121, **294**; 165, **368**; 188, **404**.
 ——— to compute number in piles, 312, **565**.
 ——— to determine weight, 478, App.
 ——— to lift in loading, 115, **286**; 115, **287**; 145, **340**; 165, **368**.
 ——— to select, 188, **404**.
 ——— to withdraw, 91, **247**; 117, **289**; 125, **304**.
 Prop, sponge and rammer, 82, **230**, XXIII.
 Pulley-blocks, storage, 313, **566**.
 Punching, 353, **590**, **591**.
- QUADRANT, gunner's, 53, **204**.
 Quartermaster's stores for siege-gun batteries, 102, **260**.
- RACKING, 353, **590**, **591**.
 Railroad construction corps, 423, **669**.
 ——— in sieges, 412, **663**.
 ——— rolling-stock required, 325, **572**.
 ——— speed, 325, **572**.
 ——— transportation of artillery, 322, **572**.
 ——— ——— of guns, 324, **572**.
 ——— ——— of horses, 322, **572**.
 ——— ——— of men, 325, **572**.
- Rammer, 54, **205**; 82, **230**, XXXIII; 312, **566**.
 Range, 39, **174**.
 ——— extreme, 39, **165**; 376, **617**.
 ——— greatest, 39, **165**; 376, **617**.
 ——— of canister, 49, **192**.
 ——— point-blank, 41, **176**.

[NOTE.—The plain figures refer to the pages of this volume. The full-faced figures refer to paragraphs.]

- Range tables, formula to find elevations, 60, **210**; 61, **210**.
 _____ of guns, 4.5-inch siege, 84, **231**.
 _____ 8-inch rifled, 133, **319**; 134, **319**.
 _____ 10-inch smooth-bore, 109, **276**; 117, **290**.
 _____ 15-inch smooth-bore, 119, **293**.
 _____ 100-pdr. Parrott, 116, **288**.
 _____ of howitzers, 5.8-inch flank easemate, 128, **309**;
 131, **318**.
 _____ 8-inch siege, 103, **261**; 222, **458**.
 _____ of mortars, 5.8-inch Coehorn, 157, **357**.
 _____ 8-inch siege, 155, **355**.
 _____ 10-inch siege, 146, **341**; 154, **354**.
 _____ 13-inch sea-coast, 159, **360**.
 Rear sights, 59, **207**; 60, **208**, **209**.
 Recoil, 41, **179**; 117, **290**; 135, **320**.
 _____ checks, 68, **217**, **218**; 72, **225**; 74, **226**; 117, **290**;
 135, **320**; 136, **320**.
 Record of ammunition, in sieges, 413, **666**; 414, **666**; 415, **666**.
 _____ of artillery, 293, **552**.
 _____ of defects of bore and vent, 307, **563**.
 _____ of electric-cable tests, 457, **693**.
 _____ of firing during sieges, 416, **666**.
 _____ of gunpowder storage, 317, **569**.
 Reëmbarkations, 340, **579**.
 Reliefs, of cannoneers, 82, **230**, **XXXI**.
 Reports of ammunition, in sieges, 413, **666**; 414, **666**; 415, **666**.
 _____ of firing during sieges, 416, **666**.
 _____ of target firing, 185, **402**.
 Reserves for lines of works, 375, **614-616**; 412, **663**.
 Retreating after repulse, 365, **602**.
 Revetments for embrasures, 386, **634**.
 _____ for parapets, 362, **596**; 376, **618**; 377, **618**.
 _____ of fascines, 380, **624**.
 _____ of gabions, 381, **626**.
 _____ of logs, 380, **623**.
 _____ of planks, 382, **627**.
 _____ of posts, 381, **625**.
 _____ of sand-bags, 382, **628**.
 _____ of sods, 379, **622**, **623**.
 _____ for scarps, 383, **629**.

[NOTE.—The plain figures refer to the pages of this volume. The full-faced figures refer to paragraphs.]

- Ricochet firing, 64, **214**; 65, **214**; 347, **585**; 350, **587**.
 Rifle projectiles. (See Projectiles.)
 Rimbases, 34, **136**.
 River defenses, 388, **636**; 419, **668**; 420, **668-670**.
 Rivers, influence on operations, 419, **668**.
 ——— to attack crossings, 420, **668**.
 ——— to defend crossings, 419, **668**; 425, **670**.
 Rodman's pressure-plug, 197, **413**.
 Rollers, 93, **256**; 200, **416**.
 ——— storage, 313, **566**.
 Rolling-stock for railroad transportation, 325, **572**.
 Ropes for gins, (see Cordage,) 244, **489**.
 ——— strength of, 237, **481**; 238, **431**.
 ——— to man, 201, **417**.
- SABOTS, 52, **202**; 154, **354**.
 Salutes and ceremonies, 459, **695**; 463, **707**.
 ——— at funerals, 466, **713**.
 ——— for boats, 464, **709**.
 ——— for war vessels, 462, **705**.
 ——— international, 462, **704**.
 ——— national, 459, **696**; 461, **700**; 462, **703**.
 ——— personal, civil or diplomatic, 461, **701**; 462, **705**,
 706; 463, **707**; 464, **709**; 465, **712**.
 ——— ——— military or naval, 461, **702**.
 ——— to fire, 460, **698**.
- Salvos, 460, **699**.
 Sand-bag revetments, 383, **628**.
 Sand-bags, 382, **628**.
 Saps. (See Boyaux.)
 Scarp revetments, 383, **629**.
 Sea-coast mortars. (See Mortars.)
 Searcher, 300, **560**.
 Service of the piece, general rules, 79, **230**; 80, **230**; 81, **230**;
 86, **234-236**; 87, **238**, **239**.
 ——— guns, 4.5-inch siege, 84, **232**; 94, **256**.
 ——— ——— 8-inch rifled, carriage 1, 137, **321**.
 ——— ——— ——— carriage 2, 141, **331**.
 ——— ——— ——— carriage 3, 142, **332**.
 ——— ——— ——— carriage 4, 144, **338**.
 ——— ——— 10-inch smooth-bore, barbette, 108, **276**.
 ——— ——— ——— casemate, 117, **290**.
 ——— ——— 15-inch smooth-bore, centre-pintle, 120, **294**.

[NOTE.—The plain figures refer to the pages of this volume. The full-faced figures refer to paragraphs.]

- Service of guns, 15-inch smooth-bore, front-pintle, 126, **306**.
 ———— Gatling, 0.45-inch, 177, **391**.
 ———— ———— 1-inch, 171, **380**.
 ———— Parrott, 100-pdr., 115, **287**; 115, **288**; 116, **288**.
 ———— howitzer, 5.8-inch flank casemate, 129, **309**.
 ———— 8-inch siege, 102, **261**.
 ———— mortars, 5.8-inch Coehorn, 158, **358**.
 ———— 8-inch siege, 155, **356**.
 ———— 10-inch sea-coast, 165, **369**.
 ———— 10-inch siege, 147, **342**.
 ———— 13-inch sea-coast, 160, **361**.
- Serving, 232, **478**.
 Shears, described, 284, **545**; 285, **545**.
 ———— formula to compute strength, 473, App.
 ———— in landing heavy guns, 339, **578**.
 ———— to rig, 285, **546**; 286, **546**; 287, **546**.
 ———— to use as a gin, 287, **547**; 288, **547**; 252, **500**.
- Shell-hooks, (see Loading-bar,) 55, **205**.
 ———— expedients for, 115, **286**, **287**; 145, **340**.
- Shells, (see Projectiles,) against earth-works, 358, **595**; 359, **595**; 360, **595**; 361, **595**.
 ———— cartridge-bags for, 298, **558**.
 ———— coating for interior surface, 298, **558**.
 ———— ignition, 48, **188**, **190**; 49, **190**, **191**; 355, **591**.
 ———— penetration of mortar, 363, **597**.
 ———— to charge, 108, **275**; 110, **277**; 121, **294**; 188, **404**; 318, **569**.
 ———— to select and weigh, 188, **404**.
- Shifting-planks, 200, **416**; 210, **444**.
 ———— storage, 313, **566**.
- Ships, armored, (see Iron-clads,) 348, **587**; 351, **589**.
 ———— vital points, 351, **589**.
 ———— extreme ranges, 376, **617**.
- Shot, (see Projectiles,) 37, **150**; 47, **186**, **187**; 65, **214**.
- Siege guns, (see Battery and Manceuvres, Mechanical,) ammunition, 316, **568**.
 ———— batteries, 92, **255**.
 ———— care of, 295, **557**.
 ———— carriages, 1, **7**; 2, **8 n.**; 92, **255**.
 ———— description, 83, **231**.
 ———— platforms, 71, **227**; 75, **227**; 76, **228**; 146, **341**; 155, **355**; 387, **635**; 388, **636**; 397, **643**.

[NOTE.—The plain figures refer to the pages of this volume. The full-faced figures refer to paragraphs.]

- Siege guns, projectiles, packing of, 311, **565**.
 ——— ranges, 84, **231**.
 ——— service of, 83, **231**.
 ——— target practice, 184, **402**; 185, **402**; 186, **402**.
 ——— transportation by rail, 324, **572**.
- Siege howitzers. (See Howitzers.)
- Siege-mortar field batteries, 159, **359**.
- Siege mortars, carriages, 1, **7**; 2, **8 n.**; 70, **222**; 146, **341**;
 158, **359**.
 ——— described, 155, **355**.
 ——— platforms, 71, **224**; 75, **227**; 76, **228**; 146, **341**;
 155, **355**; 387, **635**; 388, **636**; 397, **643**.
 ——— ranges, 146, **341**; 154, **354**; 155, **355**; 157, **357**.
- Sieges, 407, **655**.
 ——— ammunition reports, 413, **666**; 414, **666**; 415, **666**.
 ——— artillery and engineers, 410, **660**, **661**; 411, **661**,
662.
 ——— defensively, 410, **660**.
 ——— investing works, 407, **656**; 408, **656**, **657**.
 ——— proportion of artillery, 411, **662**.
 ——— transporting ammunition, 413, **666**.
 ——— ——— guns, 413, **665**.
- Sighting of howitzers, 107, **269**.
 ——— of mortars, 63, **212**, **213**; 64, **213**; 148, **342**, **343**;
 149, **343**; 167, **372**; 170, **378**.
- Sights, 59, **207**; 60, **208**, **209**; 62, **211**.
 ——— to verify, 60, **208**; 62, **211**.
- Sight-pouch, 56, **205**.
- Signalling. (See Telegraph.)
- Signals for target practice, 184, **402**; 187, **404**.
 Skids, 200, **416**; 270, **528**; 273, **534**; 295, **555**.
- Sling for disembarking horses, 338, **578**.
 ——— for embarking horses, 329, **574**.
 ——— for horses at sea, 332, **576**; 334, **577**.
- Sling-carts, 230, **473**; 253, **502**; 256, **505**.
 ——— painting and storage, 314, **566**.
 ——— to use, 254, **503**.
- Sling-chain, 200, **416**; 210, **444**.
- Slopes for parapets, 377, **619**.
 ——— tables of, 378, **619**.
- Sluing, 203, **428**; 204, **430**; 270, **532**.
- Smooth-bores in ricochet firing, 65, **214**.
- Sod revetments, 379, **623**.

[NOTE.—The plain figures refer to the pages of this volume. The full-faced figures refer to paragraphs.]

- Spars, to compute strains, 474, App.
 Spiking guns, 310, **565**.
 Splicing, 233, **479**.
 Splinter-proofs, 393, **637**; 394, **638-640**.
 Sponge, 53, **205**; 81, **230**, XIX; 82, **230**, XXXIII; 92, **253**; 209, **444**.
 ——— bucket, 94, **256**.
 ——— cover, 54, **205**.
 ——— preservation, 312, **566**.
 Sponging, 80, **230**, V, VII, VIII; 81, **230**, XVI, XXI; 82, **230**, XXXVI; 88, **240**; 94, **256**; 294, **555**.
 Spun-yarn, 232, **476**.
 Stalls for transports, 330, **575**; 333, **576**, **577**.
 Standard rule, 300, **560**.
 Star gauge, 299, **560**; 300, **561**.
 Steel implements, preservation of, 313, **566**.
 ——— qualities, 477, App.
 Store-houses for artillery material, 312, **566**.
 Store-truck, 259, **509**.
 Strength of cordage, 237, **481**; 238, **481**.
 ——— of gins, 252, **499**.
 ——— of horses, 476, App.
 ——— of iron, 477, App.
 ——— of spars, 473, App.
 Striking point of shots, to find, 185, **402**; 186, **402**; 187, **404**; 189, **407-409**.
 Submarine defenses, 346, **584**; 425, **670**.
 ——— arrangement of, 428, **673**; 430, **674**.
 ——— attack and defense, 455, **692**.
 ——— bung-stoppers, 444, **683**.
 ——— buoys, 445, **685**.
 ——— charges of mines, 429, **674**; 430, **674**.
 ——— circuit-closers, 454, **691**.
 ——— electric batteries for, 450, **689**.
 ——— ——— cables, 443, **682**; 449, **688**, **689**.
 ——— ——— fuses, 440, **680**.
 ——— ignition of charge, 439, **679**; 440, **679**.
 ——— joints, 444, **684**.
 ——— junction-boxes, 449, **688**.
 ——— lines, 438, **678**; 451, **690**.
 ——— of rivers, 420, **668**; 425, **670**.
 ——— positions, 427, **672**; 430, **674**.
 ——— ——— of fuse in charge, 441, **681**.

[NOTE.—The plain figures refer to the pages of this volume. The full-faced figures refer to paragraphs.]

- Submarine surface currents, 458, **694**.
 ——— testing-rooms, 449, **689**.
 ——— tests of cables, 456, **693**; 457, **693**.
 ——— to fire, 450, **690**; 451, **690**; 452, **690**; 453, **690**.
 ——— to lay cables, 445, **686**.
 ——— to plant the mines, 447, **687**; 448, **687**.
 Supplies for preserving artillery material, 315, **567**.
 ——— for siege-gun batteries, 96, **258**.
 ——— of ammunition for field-works, 316, **568**; 390, **637**;
 410, **660**; 411, **662**; 413, **666**; 416, **666**; 418,
667.
 ——— of material, 315, **567**.
 Swimming horses, 338, **578**.
 Sword manual, 10, **46-48**; 12, **59**.
 TABLES, metric, 467, App.
 ——— miscellaneous, 470, App.
 ——— of alloys, 472, App.
 ——— of annual armament supplies, 315, **567**.
 ——— of armor penetration, 347, **586**.
 ——— of atmospheric pressure, 57, **206**.
 ——— of drop of projectiles, 404, **650**.
 ——— of harbor surface currents, 458, **694**.
 ——— of metrical equivalents, 469, App.
 ——— of penetrations of parapets, 358, **595**; 359, **595**; 360,
595.
 ——— of ranges. (See Ranges.)
 ——— of slopes for parapets, 377, **619**; 378, **619**.
 ——— of strength of cordage, 237, **481**.
 ——— of thickness of parapets, 362, **596**.
 ——— of strength and weight of iron chains, 241, **484**.
 ——— of strength of cordage, 237, **481**.
 ——— of U. S. artillery, 2, **8**.
 ——— of weights and measures, 467, App.
 ——— of weights and volumes of metals, 471 App.
 ——— ——— miscellaneous, 471, App.
 ——— ——— woods, 471, App.
 ——— to obtain centre of impact, 186, **402**.
 Tackles, 239, **483**; 240, **484**.
 ——— power gained by, 241, **484**.
 Tactics, (see Manœuvres, Mechanical, and Manœuvres, Tactical.)
 in battalion formation and skirmishing, 34, **130**.
 Target practice and targets, 183, **401**; 191, **409**.

[NOTE.—The plain figures refer to the pages of this volume. The full-faced figures refer to paragraphs.]

- Target, floating, 190, **409**.
 ——— guns, Gatling, 192, **410**.
 ——— ——— sea-coast, 189, **409**.
 ——— ——— siege, 184, **402**; 185, **402**; 186, **402**.
 ——— horizontal, 185, **402**.
 ——— howitzers, siege, 187, **403**, **404**; 188, **405**.
 ——— mortars, Coehorn, 188, **406**.
 ——— ——— sea-coast, 189, **407**; 189, **408**.
 ——— ——— siege, 187, **404**; 188, **405**.
 ——— plotting results, 191, **409**.
 ——— presented by ships, 349, **587**; 350, **588**; 351, **589**.
 ——— record of, 185, **402**; 191, **409**; 299, **559**.
 Teams in sieges, (see Horses,) 413, **665**.
 Telegraphic communication, importance during attacks, 406, **654**.
 ——— in defending defiles, 418, **667**.
 ——— with guard-boats in defending submarine mines, 456, **692**.
 Telemeters, Boulongé's, 192, **411**; 193, **411**.
 ——— Gautier's, 193, **412**.
 ——— one for each siege gun, 95, **257**; 192, **409**.
 Telephone. (See Telegraph.)
 Tests, flashing, of powder, 47, **183**.
 ——— of defective guns, 307, **563**.
 ——— of gunpowder, to sample, 46, **182**.
 ——— of submarine mines and cables, 449, **689**; 456, **693**; 457, **693**.
 Tête-de-pont, 416, **667**; 418, **668**.
 Time-fuses, 50, **197**.
 Time of flight, to ascertain, 184, **402**; 192, **409**.
 Tompions, 294, **555**.
 Tools, intrenching, 413, **664**.
 Torpedoes, (see Submarine Mines,) 398, **646**.
 ——— defined, 425, **670**.
 ——— for bridge demolitions, 422, **669**.
 ——— fuses, 439, **679**; 440, **679**.
 Towns, distance of defenses, 376, **617**.
 Toy's fuse, 422, **669**.
 Trace-rope, 93, **256**; 200, **416**; 210, **444**.
 Tracing field-works, 379, **621**.
 Trains, hauling ammunition in sieges, 413, **666**; 416, **666**.
 ——— parking, 412, **663**.
 Transportation by rail, 322, **572**.

[NOTE.—The plain figures refer to the pages of this volume. The full-faced figures refer to paragraphs.]

- Transportation by sea, 321, **571**; 325, **573**.
 ——— disembarking, 335, **578**.
 ——— horses, by sea, 327, **573**.
 ——— ammunition in sieges, 413, **666**; 414, **666**.
 ——— stalls, sea transports, 330, **575**; 333, **576**; 333, **577**.
 ——— weight of field battery, 330, **574**.
 Transports, marks, 341, **576**.
 Traverses, 376, **618**; 388, **635**; 393, **638**; 394, **638**.
 Troops, number for harbor batteries, 245, **582**; 368, **607**;
 370, **611**; 374, **614**.
 Trucks, casemate, 257, **506**.
 ——— garrison, 314, **566**.
 ——— store, 259, **509**.
 ——— wagon, 260, **514**; 277, **536**; 279, **538**.
 Trunnion beds, 66, **216**; 294, **555**.
 ——— chains, 259, **508**.
 ——— gauge, 300, **560**.
 ——— rings, 314, **566**.
 ——— rule, 300, **560**.
 ——— sights, 62, **211**; 168, **372**.
 ——— squares, 300, **560**.
 Trunnions, 34, **135**; 294, **555**.
 UNLOAD, to, 81, **230**, XVI; 91, **247**; 117, **289**; 125, **304**;
 153, **350**; 164, **366**.
 VELOCITY, 39, **166**.
 Vent, 35, **142**; 294, **555**.
 ——— to inspect, 297, **558**; 307, **563**.
 Vent-cover, 79, **230**, IV.
 ——— gauge, 300, **560**.
 ——— gimlet, 54, **205**.
 ——— piece, 36, **142**.
 ——— punch, 54, **205**.
 ——— searcher, 300, **560**.
 ——— stopped, 79, **230**, V; 87, **238**.
 Verification of sights, 60, **208**; 62, **211**.
 Vessels, armored. (See Iron-clads.)
 Vital points of iron-clads, 351, **589**.
 WAGON, mortar, 261, **515**.
 Water-cap fuse-plug, 50, **197**.
 Water caps, preservation of, 313, **566**.

[NOTE.—The plain figures refer to the pages of this volume. The full-faced figures refer to paragraphs.]

- Water supply during sieges, 412, **663**.
 Way-planks, 270, **529**.
 Weights and measures, 467, App.
 ——— and volumes, miscellaneous, 472, App.
 ——— ——— of alloys, 472, App.
 ——— ——— of elongated projectiles, 478, App.
 ——— ——— of iron balls, 477, App.
 ——— ——— of metals, 471, App.
 ——— ——— of round cast-iron, 478, App.
 ——— ——— of woods, 471, App.
 ——— of field artillery, 330, **574**.
 ——— of troops on bridges, 341, **579**.
 Wharves, temporary, 335, **578**; 341, **579**.
 Windage, 38, **152**.
 Wind pressure, 57, **206**; 58, **206**; 192, **409**.
 Wire entanglements, 397, **644**.
 Worm, 54, **205**; 312, **566**.
 Worming, 232, **478**.

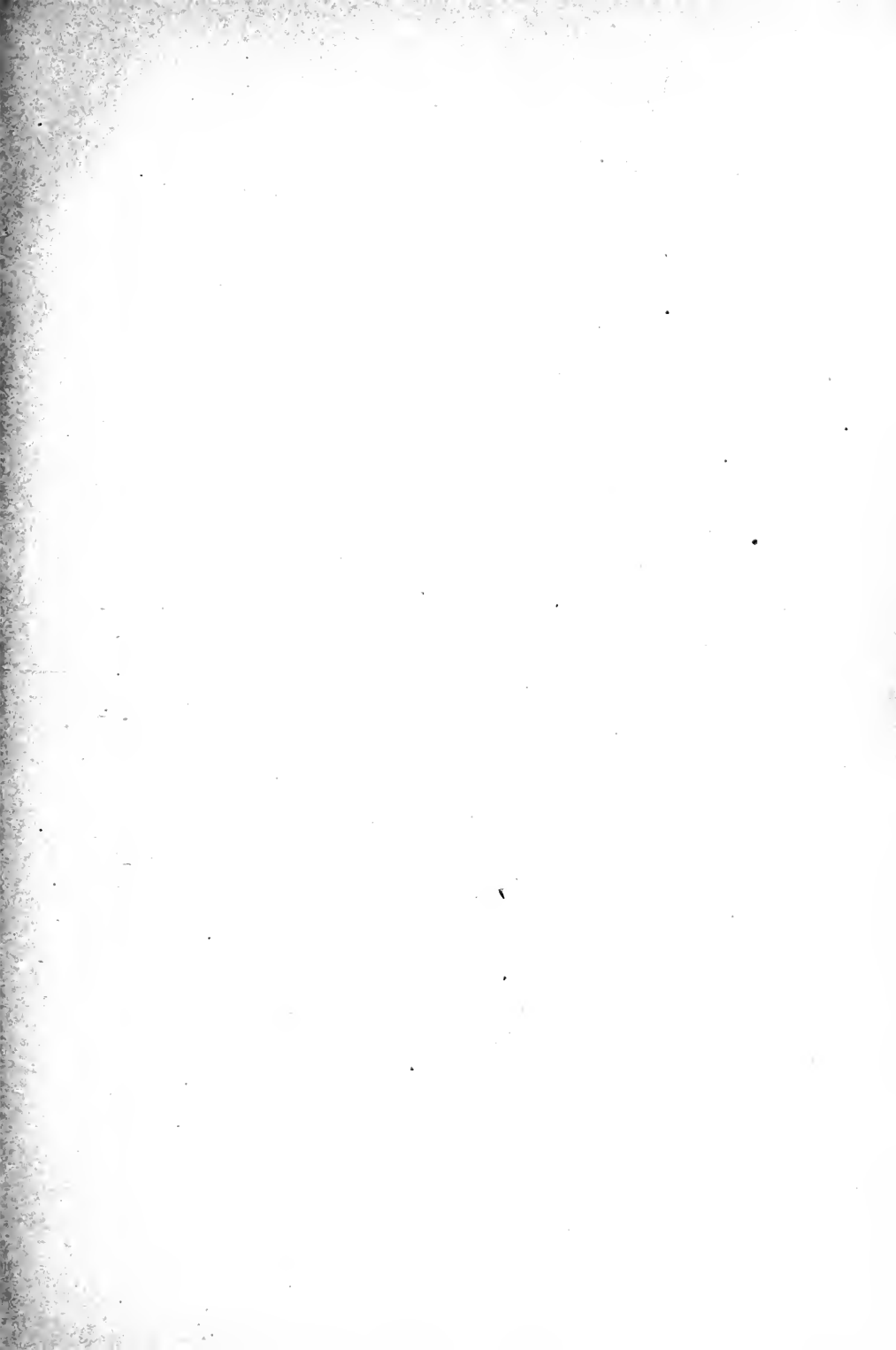

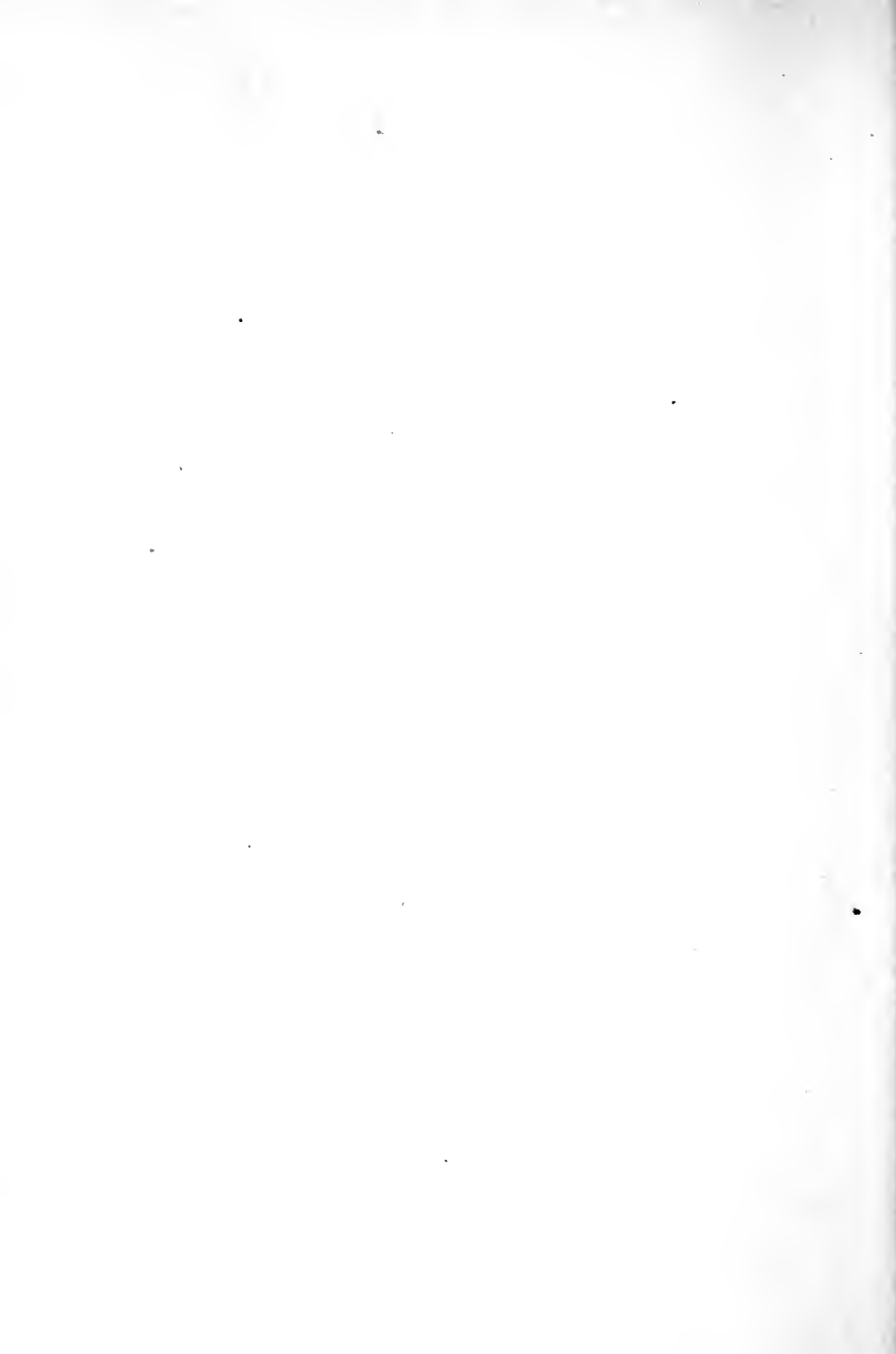

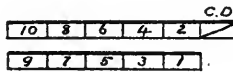
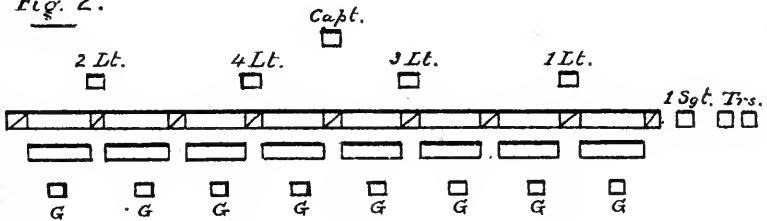

Fig. 1.

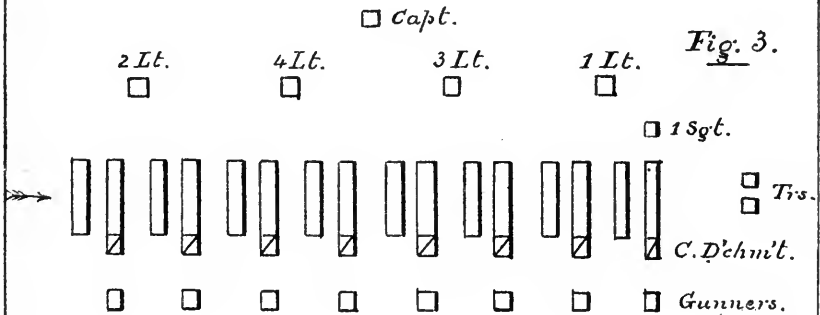

Fig. 2.



Capt.

Fig. 3.



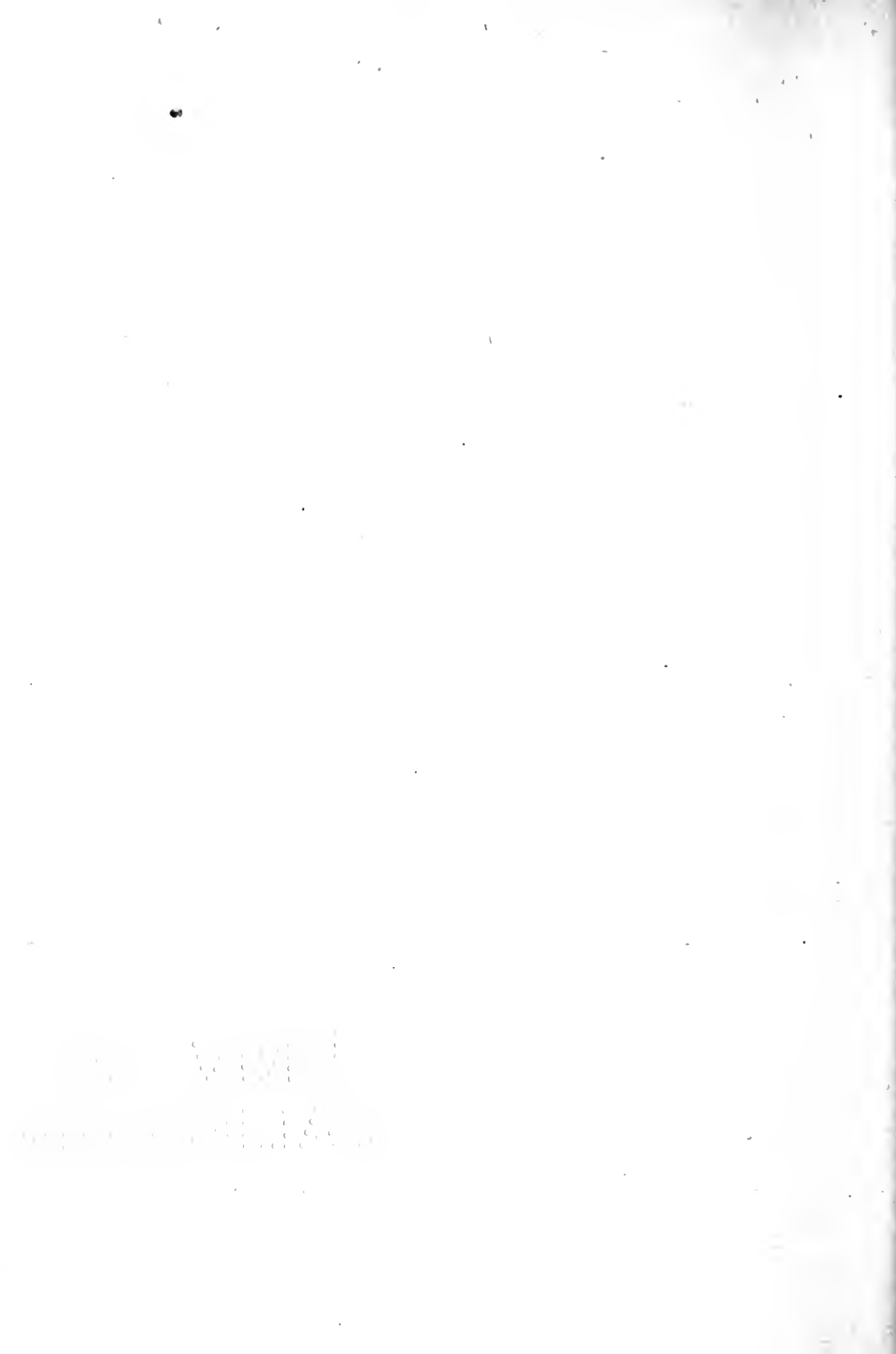

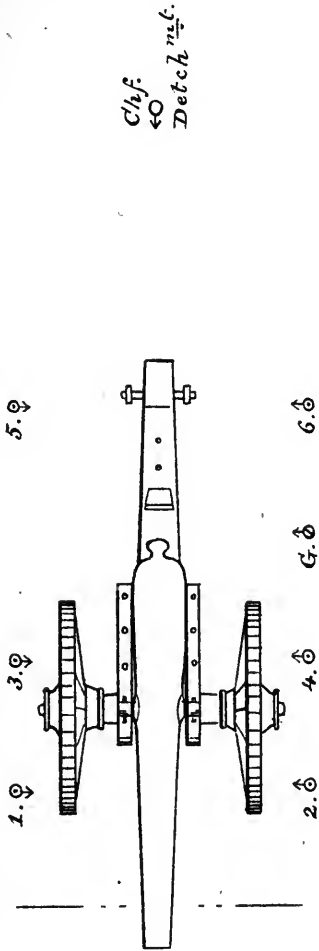

Fig. 4.

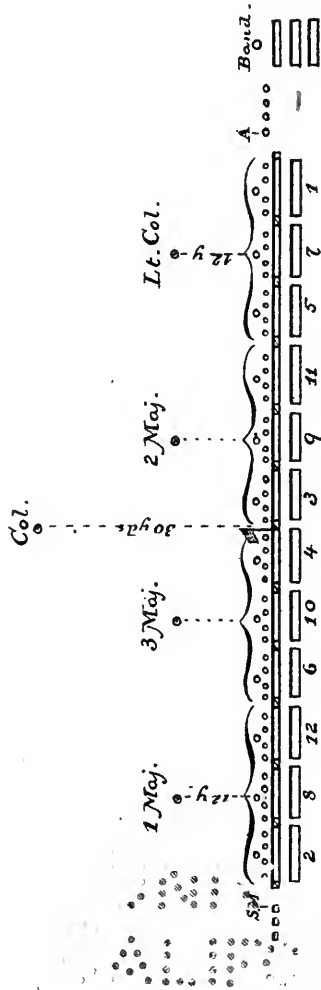

Fig. 5.

THE
MUSEUM OF
ART AND HISTORY
OF THE
CITY OF
NEW YORK

Fig. 1.

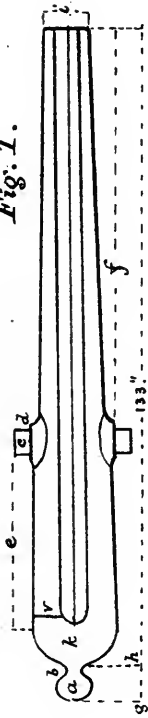

Fig. 1.

- a Knob.
- b Neck.
- c Transition.
- d Rimbase.
- e Body.
- f Chase.
- g Cascabel.
- h Face.
- k Base of breech.
- l Vent.

Fig. 2.

- a Cascabel.
- b Neck.
- c Transition.
- d Rimbase.
- e Chase.
- f Case.
- g "A" Tube.
- h "B" Tube.

Fig. 2.

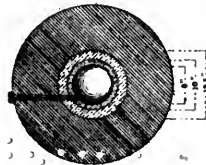
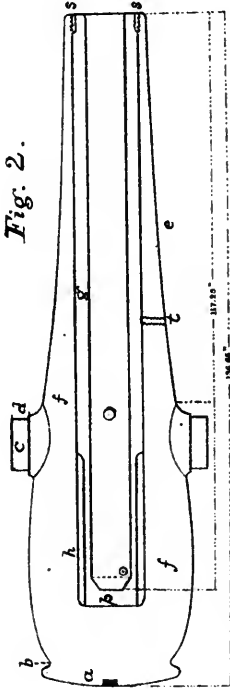

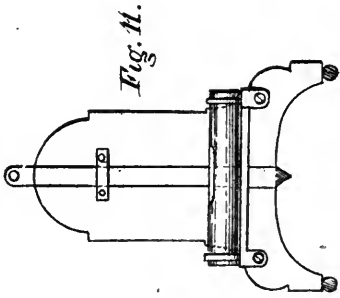
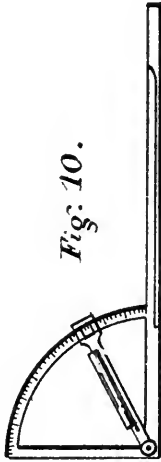
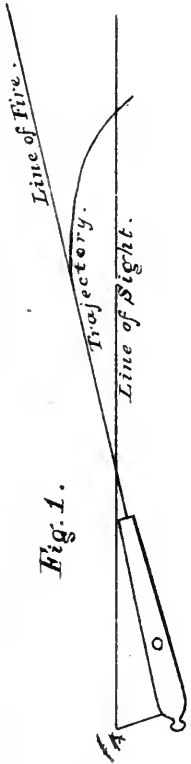
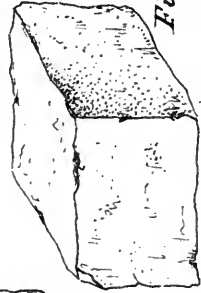
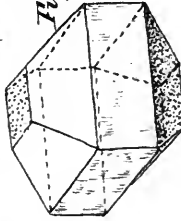
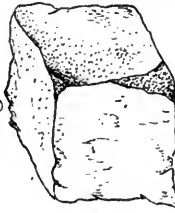
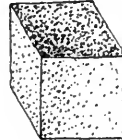

Fig. 3.



1/2 Size. Powdr.

1998
1999
2000
2001
2002
2003
2004
2005
2006
2007
2008
2009
2010
2011
2012
2013
2014
2015
2016
2017
2018
2019
2020
2021
2022
2023
2024
2025
2026
2027
2028
2029
2030
2031
2032
2033
2034
2035
2036
2037
2038
2039
2040
2041
2042
2043
2044
2045
2046
2047
2048
2049
2050
2051
2052
2053
2054
2055
2056
2057
2058
2059
2060
2061
2062
2063
2064
2065
2066
2067
2068
2069
2070
2071
2072
2073
2074
2075
2076
2077
2078
2079
2080
2081
2082
2083
2084
2085
2086
2087
2088
2089
2090
2091
2092
2093
2094
2095
2096
2097
2098
2099
2100

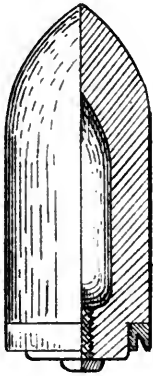

Fig. 1.



Fig. 3.



Fig. 2.

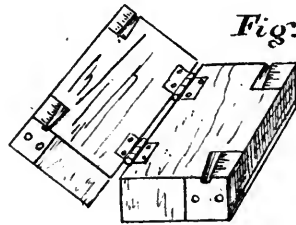

Fig. 8.

Fig. 4.



Fig. 5.



Fig. 6.



Fig. 7.



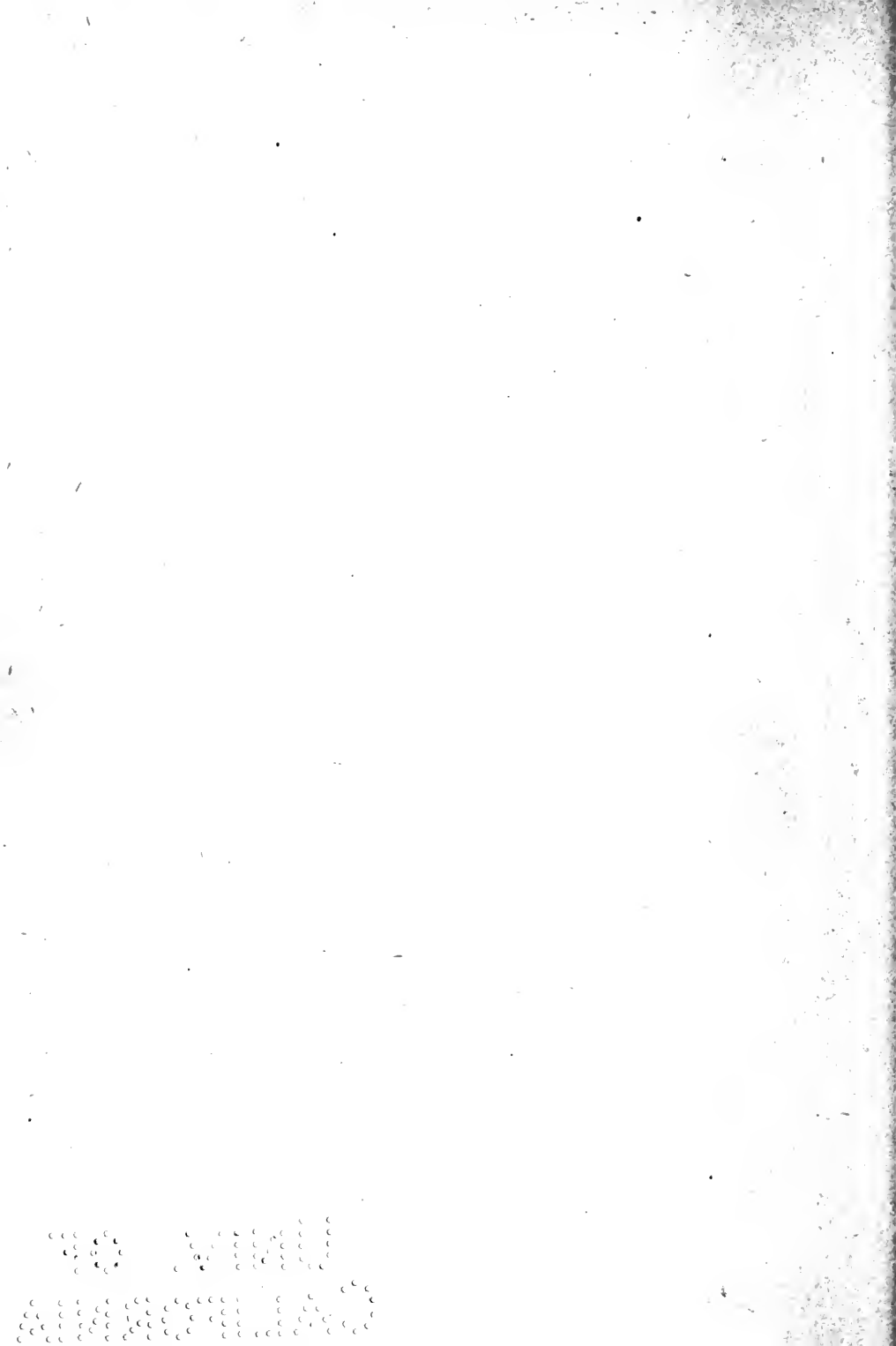
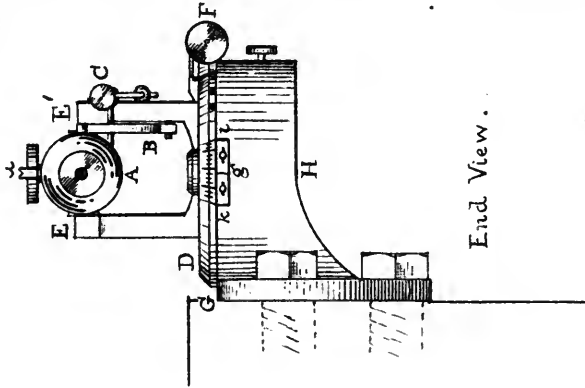
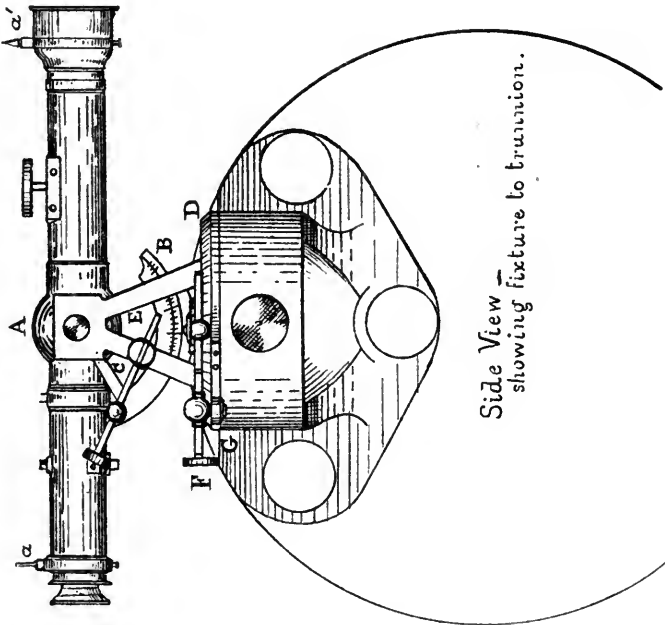

PLATE 6.



End View.



Side View —
showing fixture to transition.

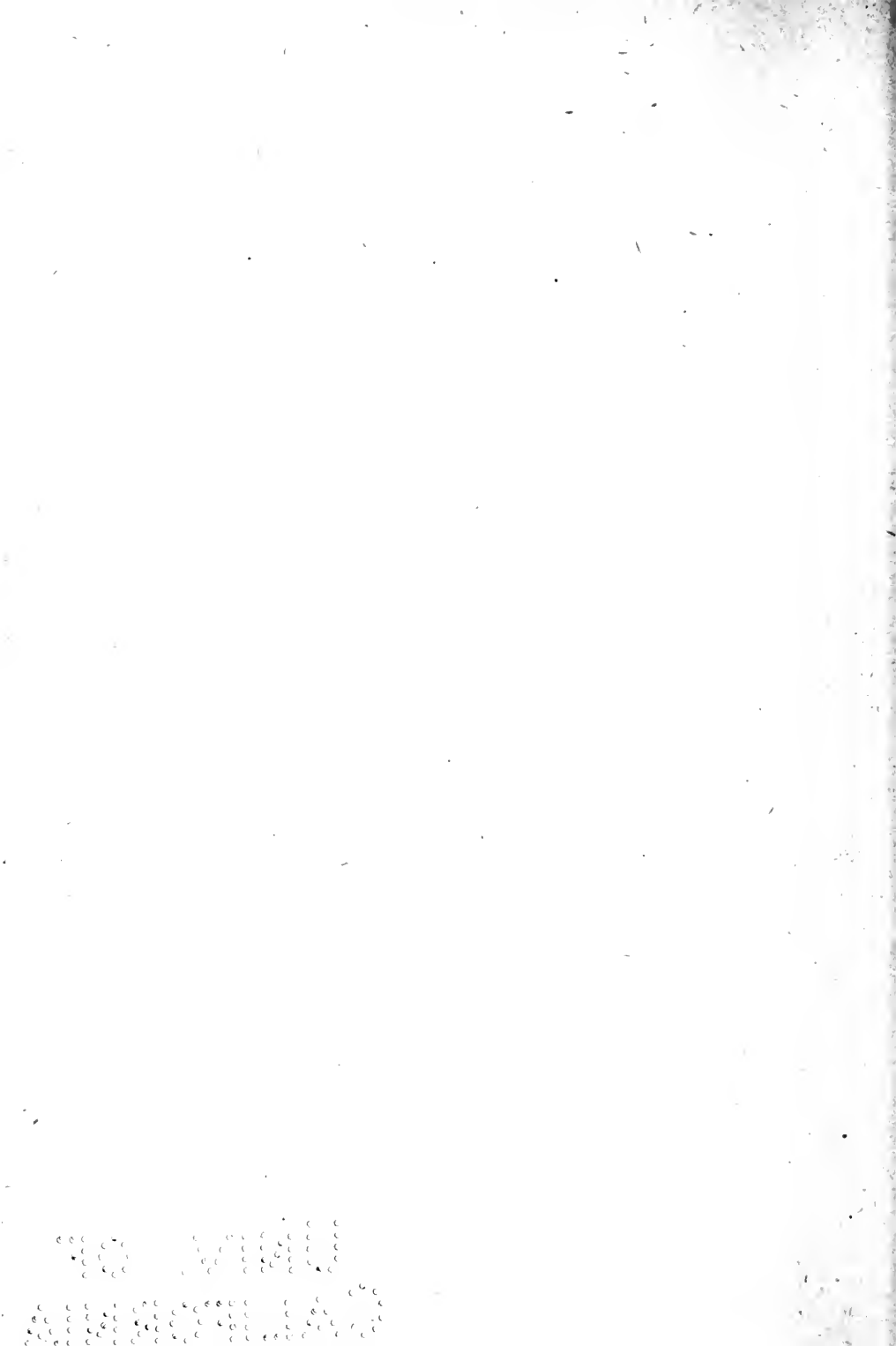

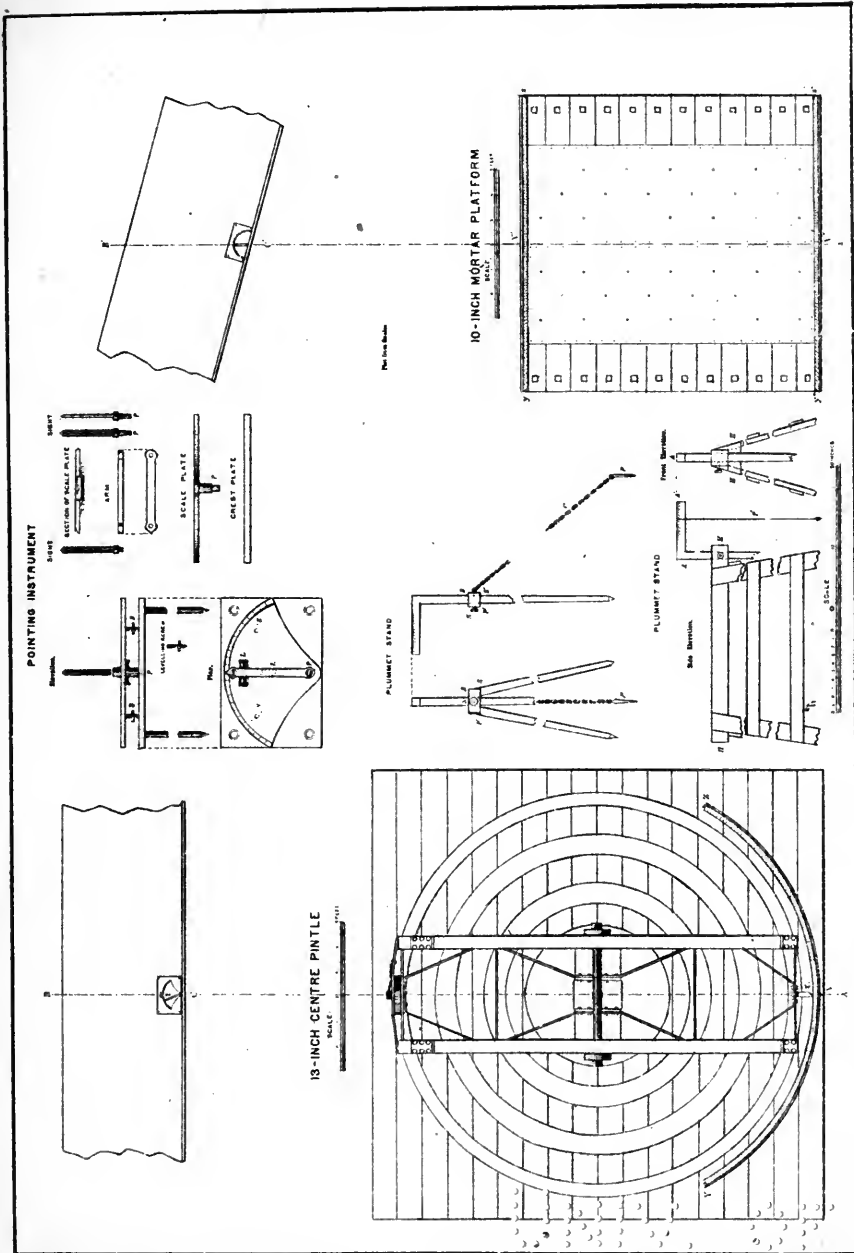

See p. 63 par. 213;

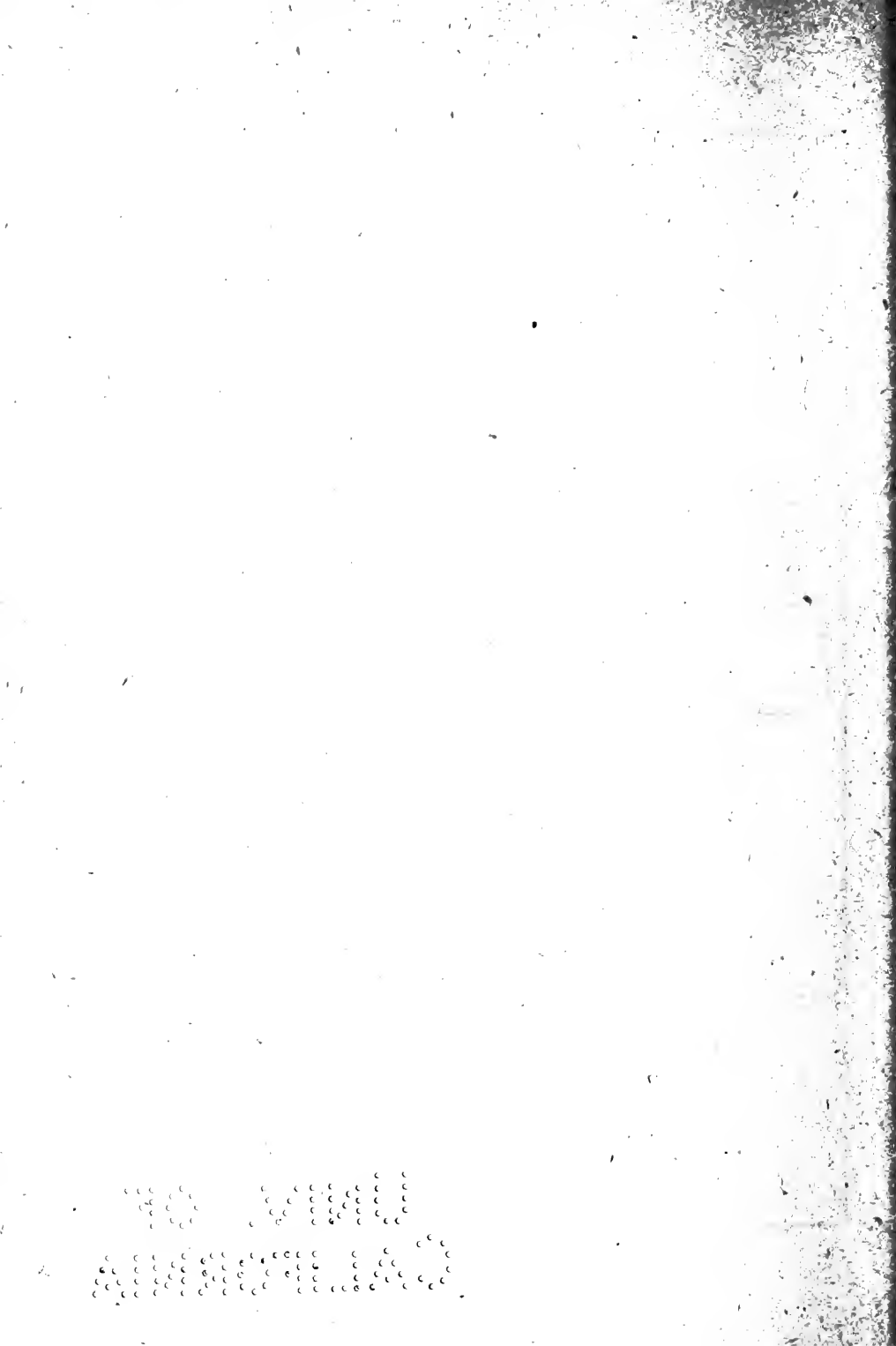

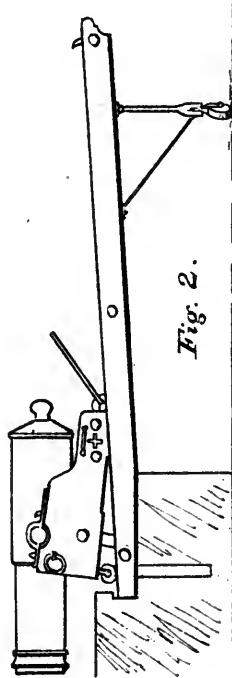
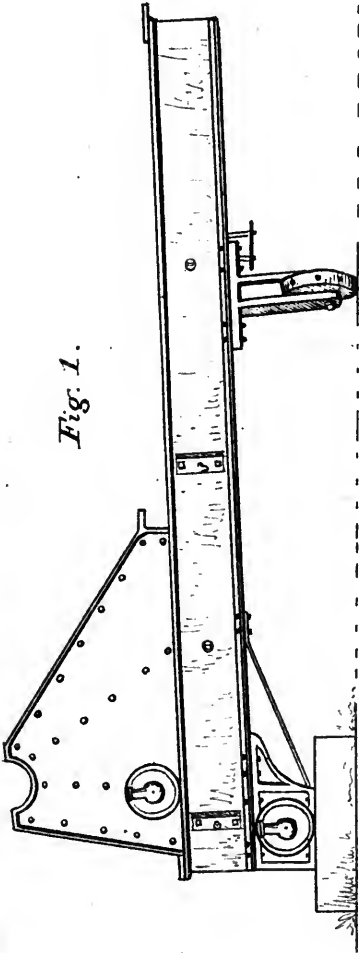

THE UNIVERSITY OF CHICAGO
PRESS

Fig. 1.

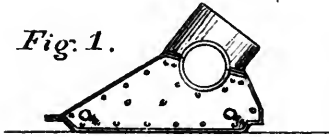

Fig. 2.

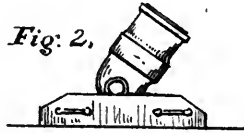

Fig. 3.

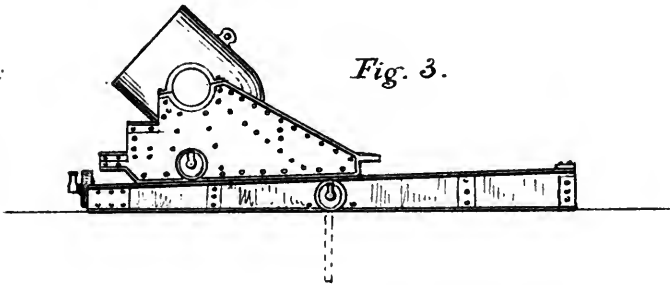
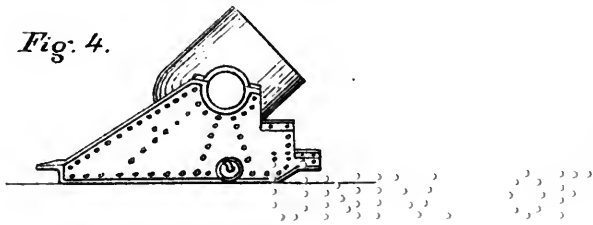

Fig. 4.



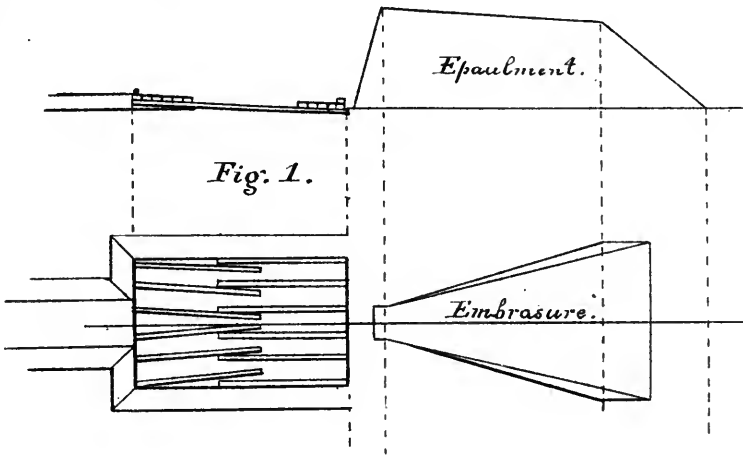

Fig. 1.

Epaulment.

Embrasure.

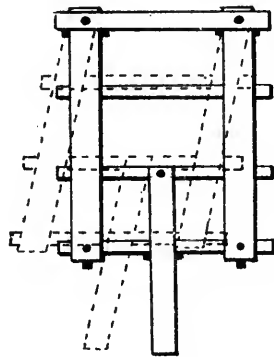

Fig. 2.

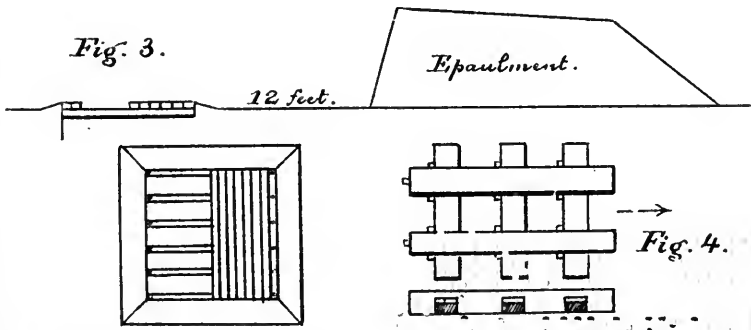
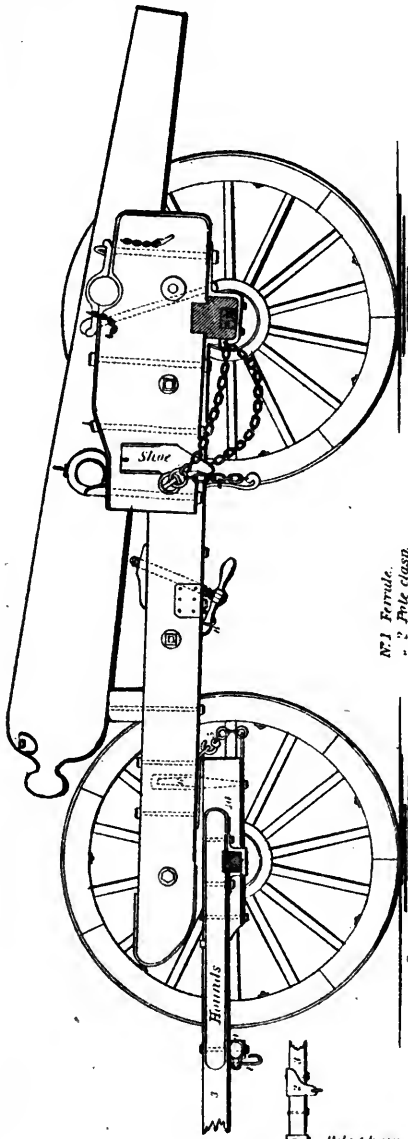

Fig. 3.

Epaulment.

12 feet.

Fig. 4.



- 1 Ferrule.
- 2 Pole clasp.
- 3 Pole.
- 4 Trace hook.
- 5 Lashing chain.
- 6 Fridge.
- 7 Under strap.
- 8 Strap and buckle.
- 9 Spreader bar.
- 10 Fork.

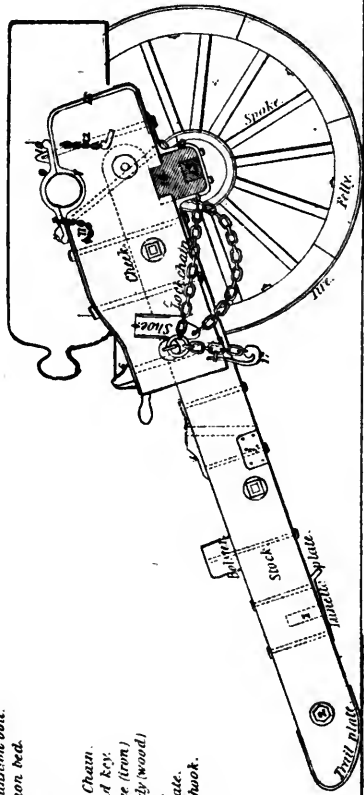

- 177 Trade hole.
- 2 Adjusting bolt.
- 3 Wheel guard plate.
- 4 Elevating Screw Box.
- 5 Elevating Screw.
- 6 Turvillan transom bolt.
- 7 Firing transom bed.
- 8 Cap square.
- 9 Chin bolt.
- 10 Key bolt.
- 11 Cap square Chain.
- 12 Key Chain and Key.
- 13 One axle-tree (iron).
- 14 One axle-body (wood).
- 15 Under strap.
- 16 Transom plate.
- 17 Lock chain hook.

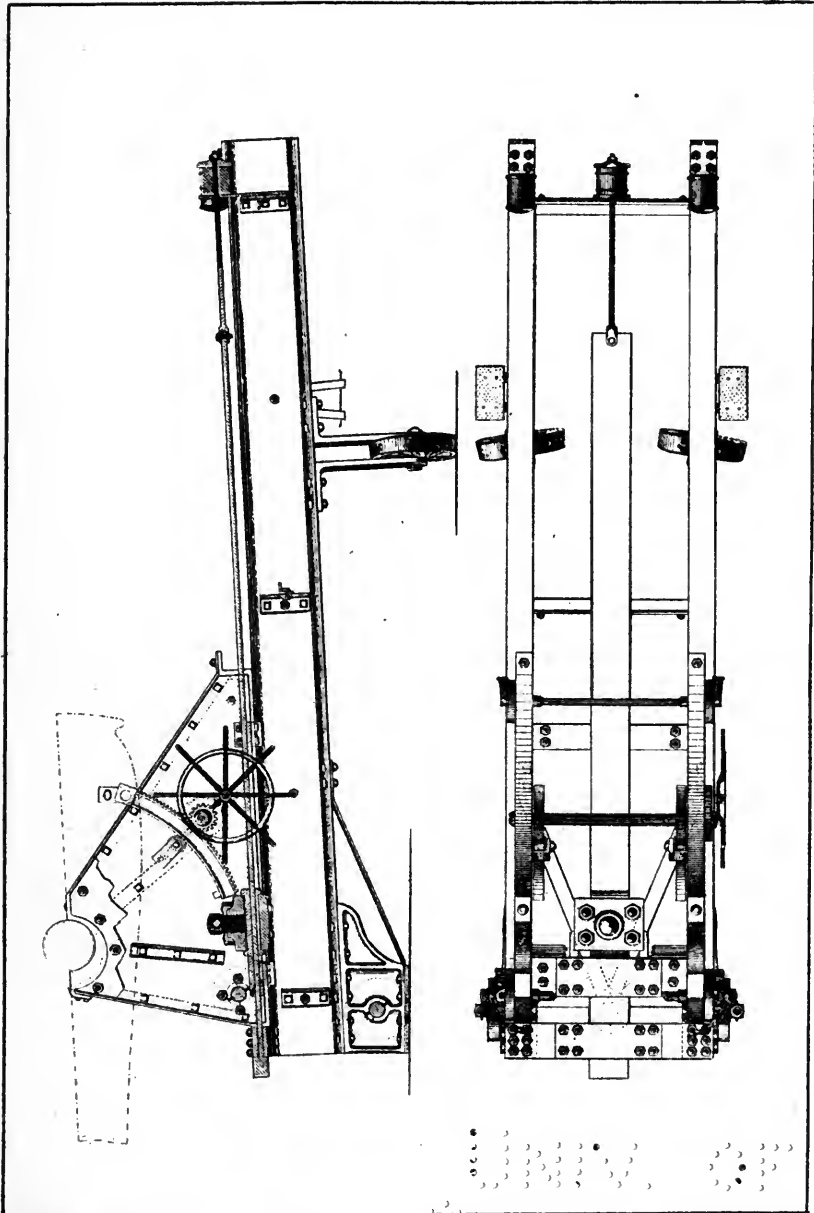

Chase, Del.

See - p. 135. p. 320.

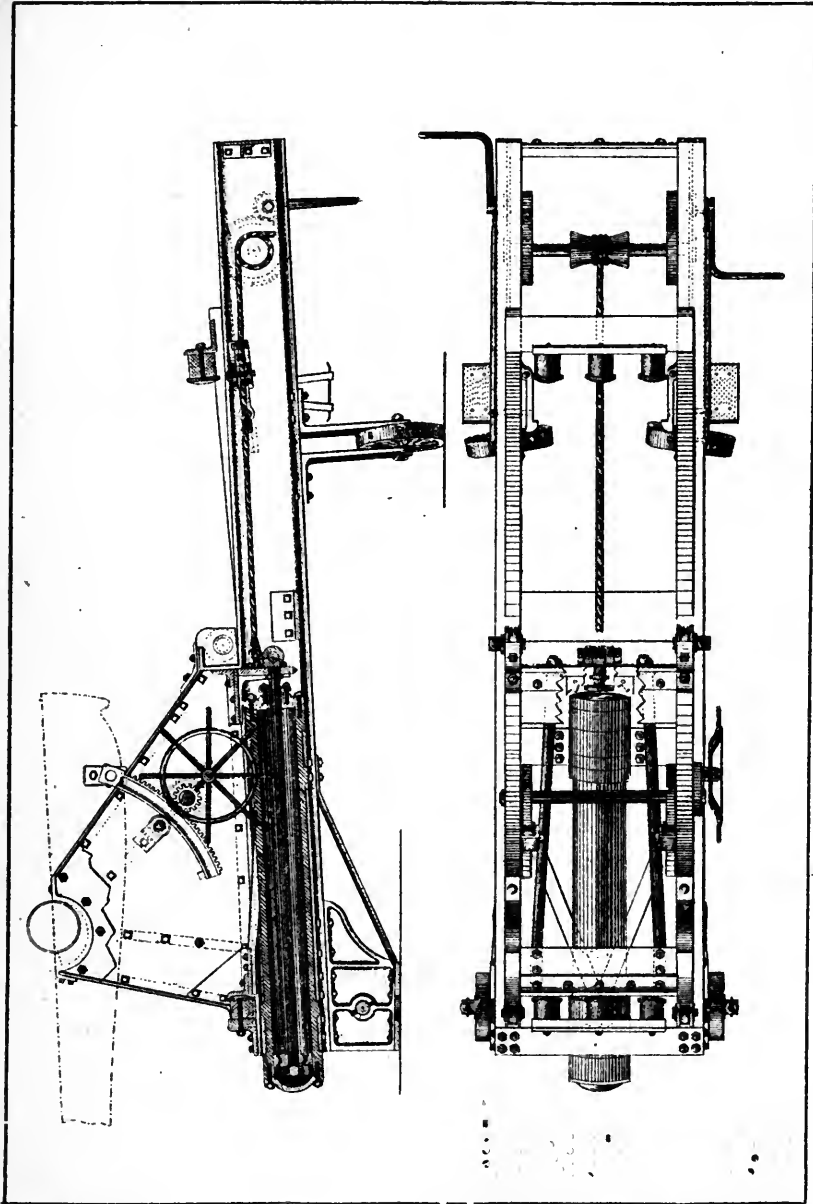

Chase, Del.

See p. 135 for 320.

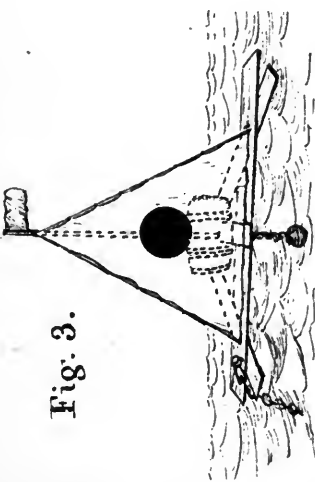

Fig. 3.

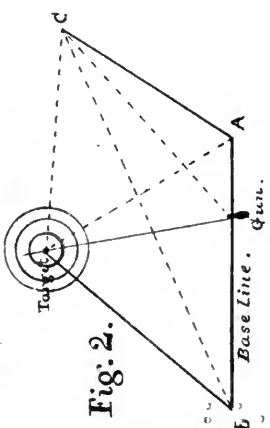

Fig. 2.

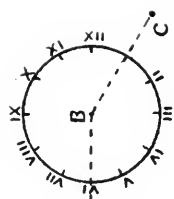

Fig. 1.

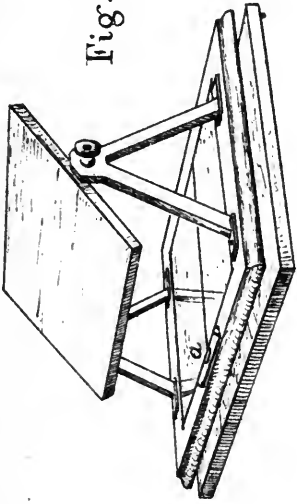

Fig. 5.

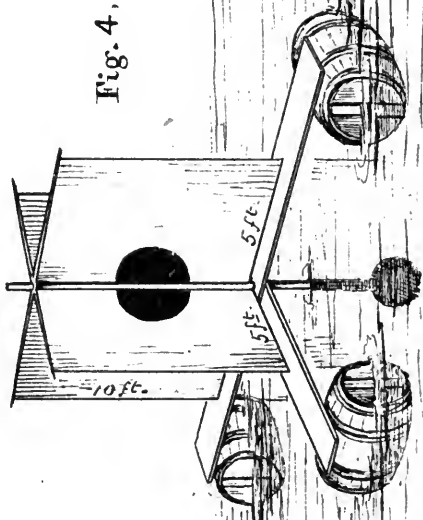

Fig. 4.

Fig. 1.

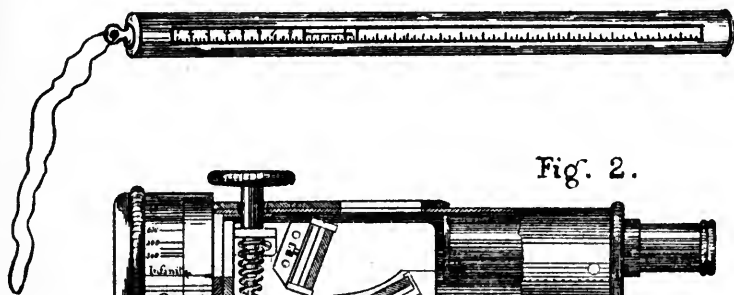

Fig. 2.

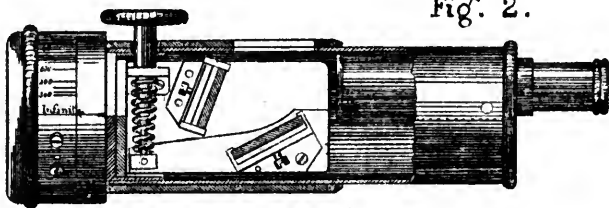

Fig. 4.

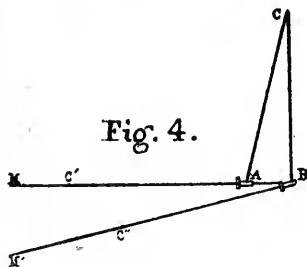

Fig. 3.

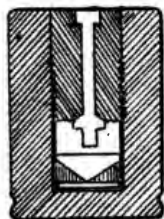
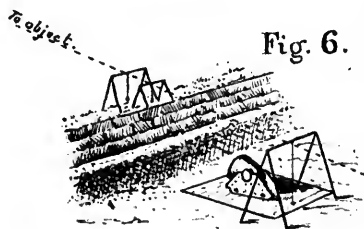

Fig. 5.

Fig. 6.



NO. 1111
ANNEXED TO

Fig. 1.

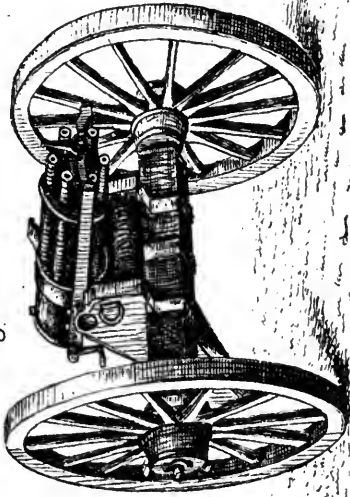

Fig. 3.

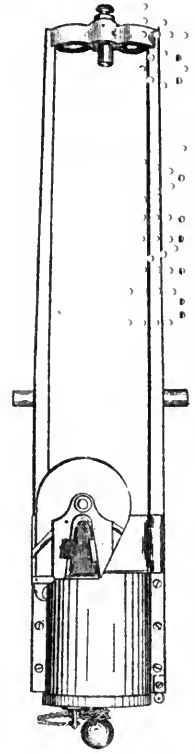
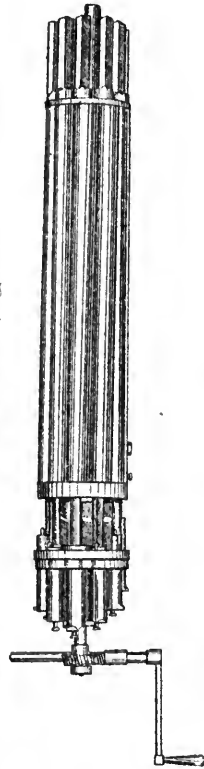
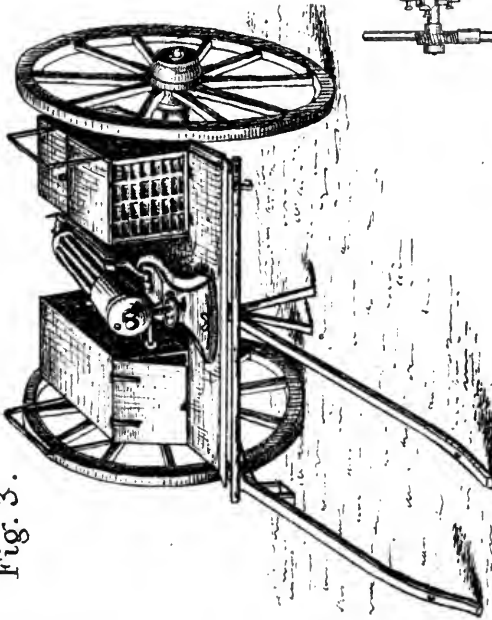
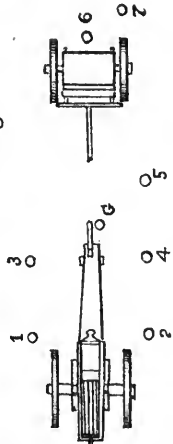
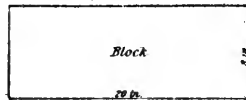

Fig. 2.





Wheel Check.



Gun Check.



Roller Check.

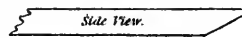
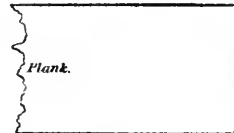
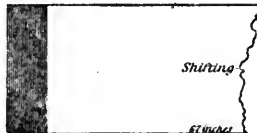

Division Loop.

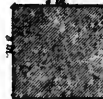

Maneuving Handspike.

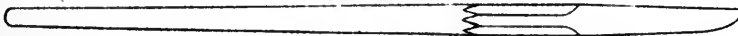

58.6 inches — For Mechanical Measurements 7 Act.

Fig. 1.

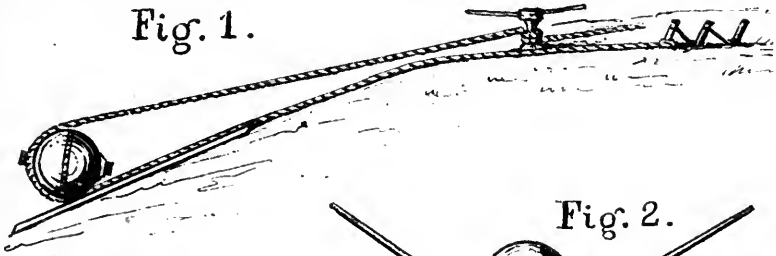

Fig. 2.

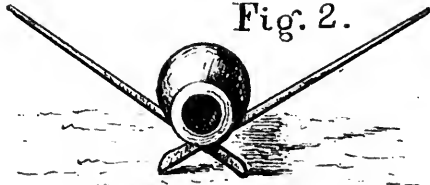

Fig. 3.

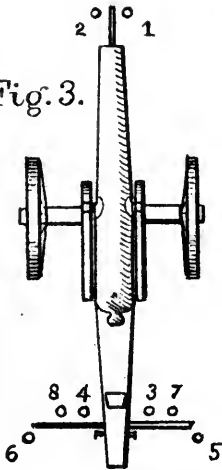

Fig. 4.

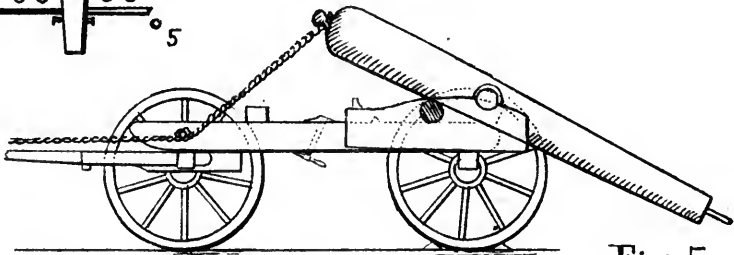
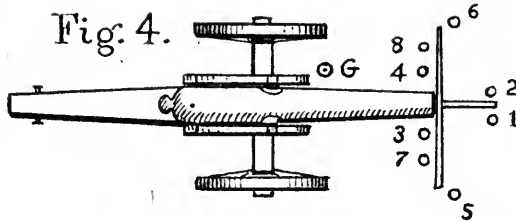
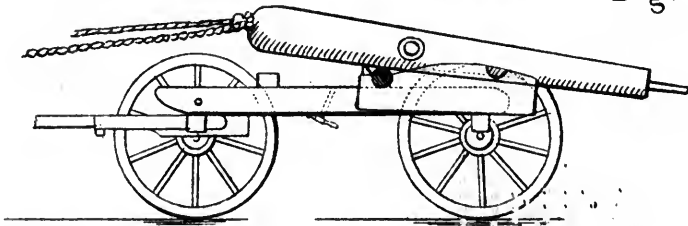

Fig. 5.



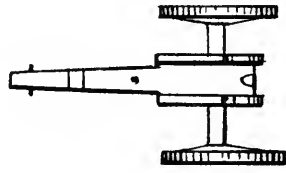
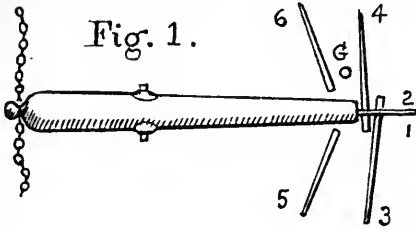

Fig. 2.

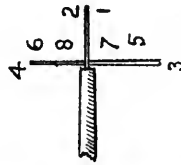
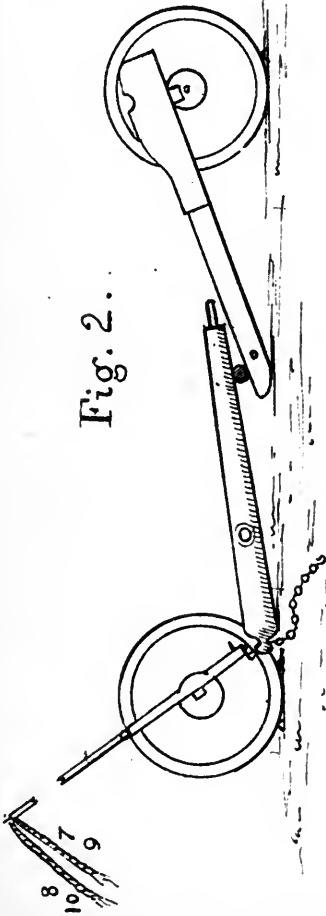

Fig. 3.

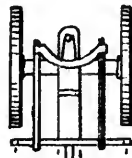

Fig. 4.

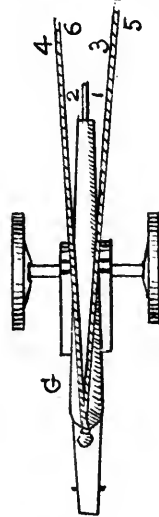

Fig. 5.

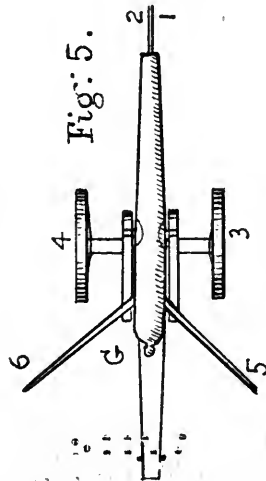

Fig. 1.

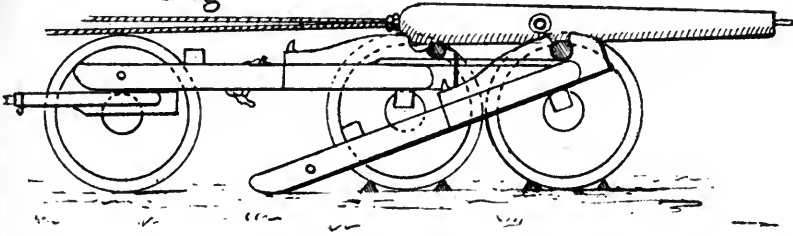

Fig. 2.

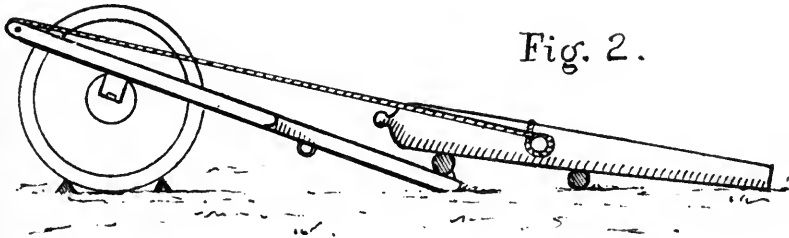

Fig. 3.

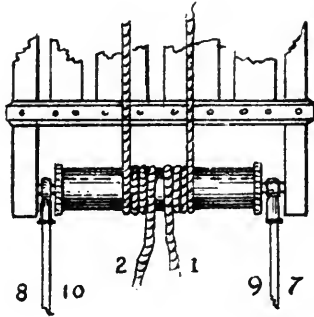
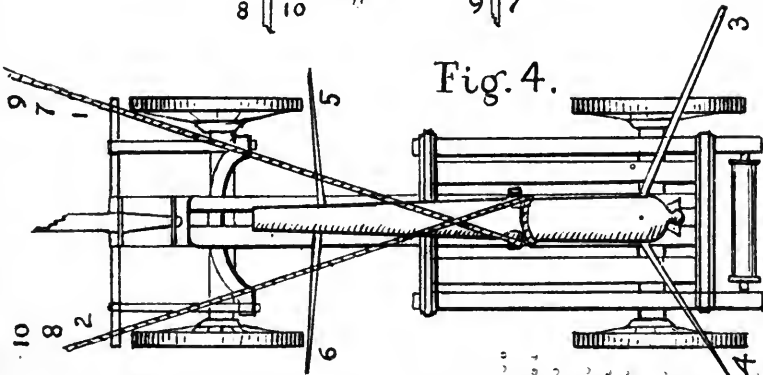

Fig. 4.



Chase, Del.

See - pp. 213, 214, 215.

pp. 449, 450.

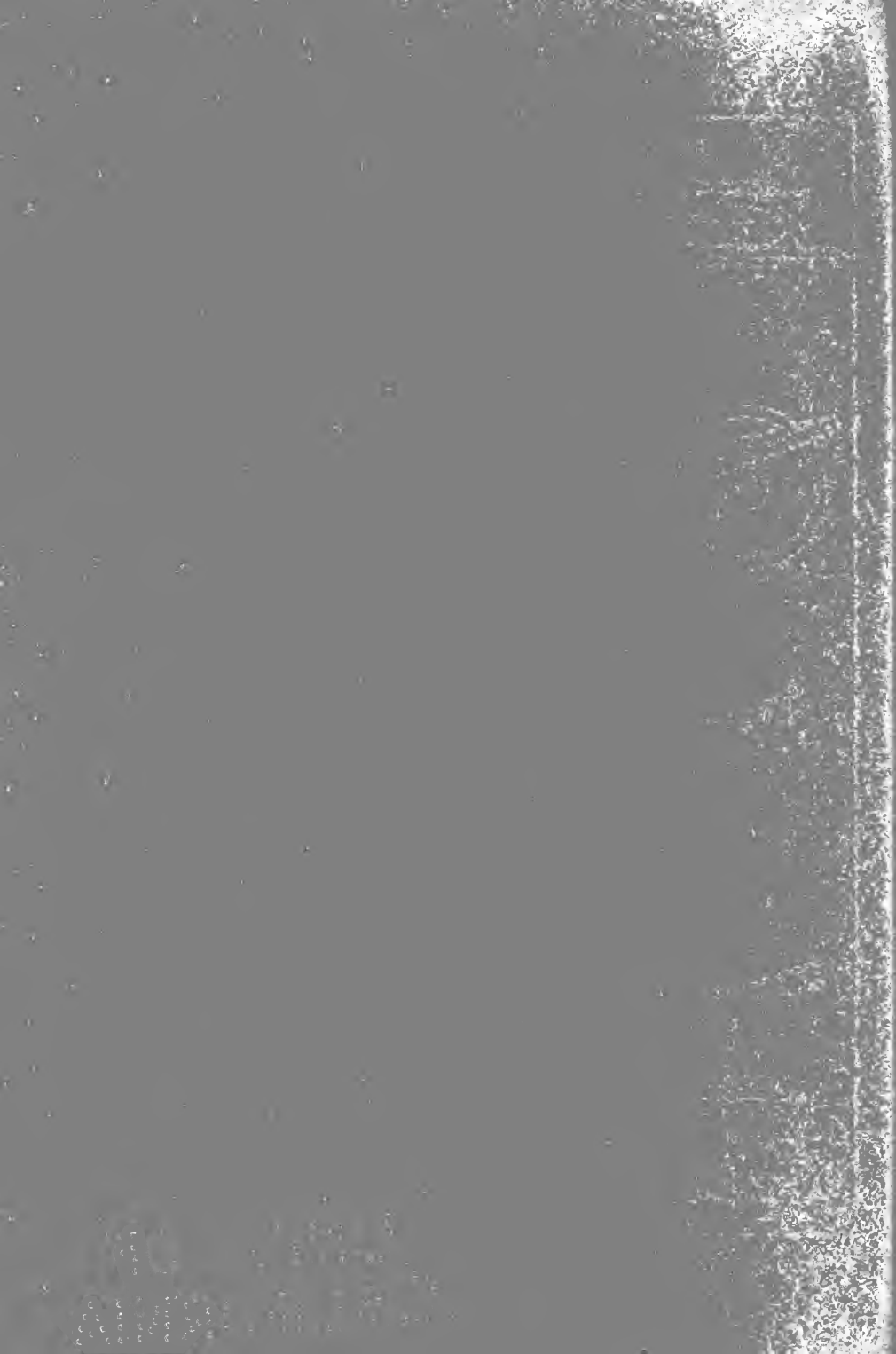

Fig. 1.

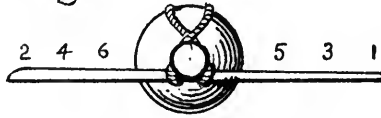

Fig. 2.

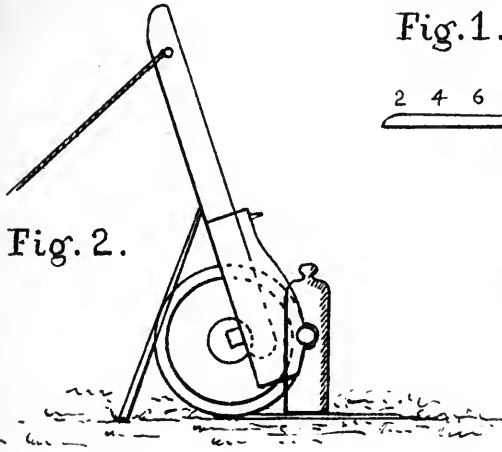

Fig. 3.

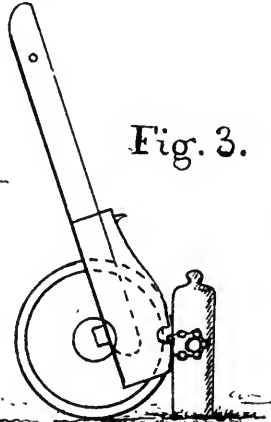

Fig. 5.

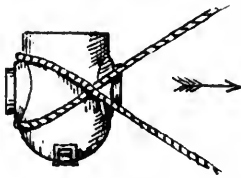

Fig. 4.

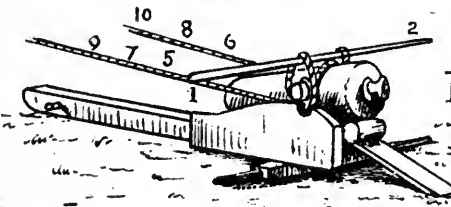

Fig. 7.

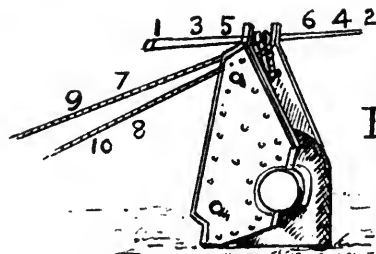

Fig. 6.

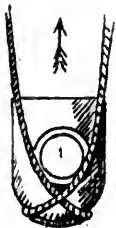

Fig. 1.

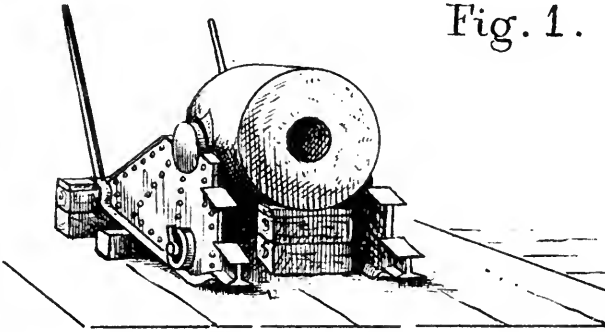

Fig. 2.

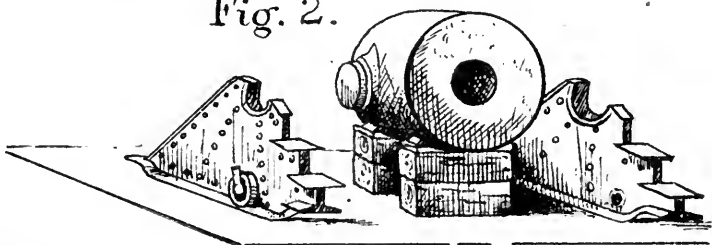

Fig. 3.

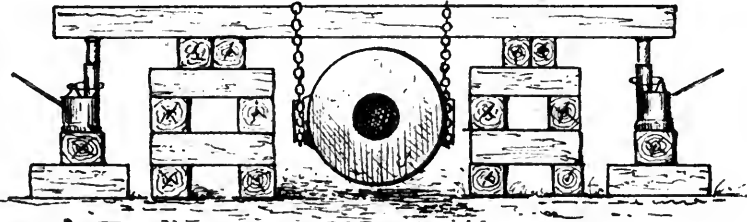
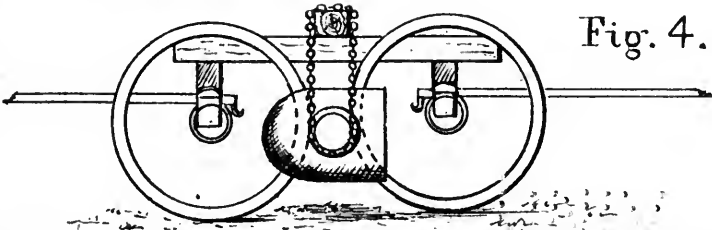
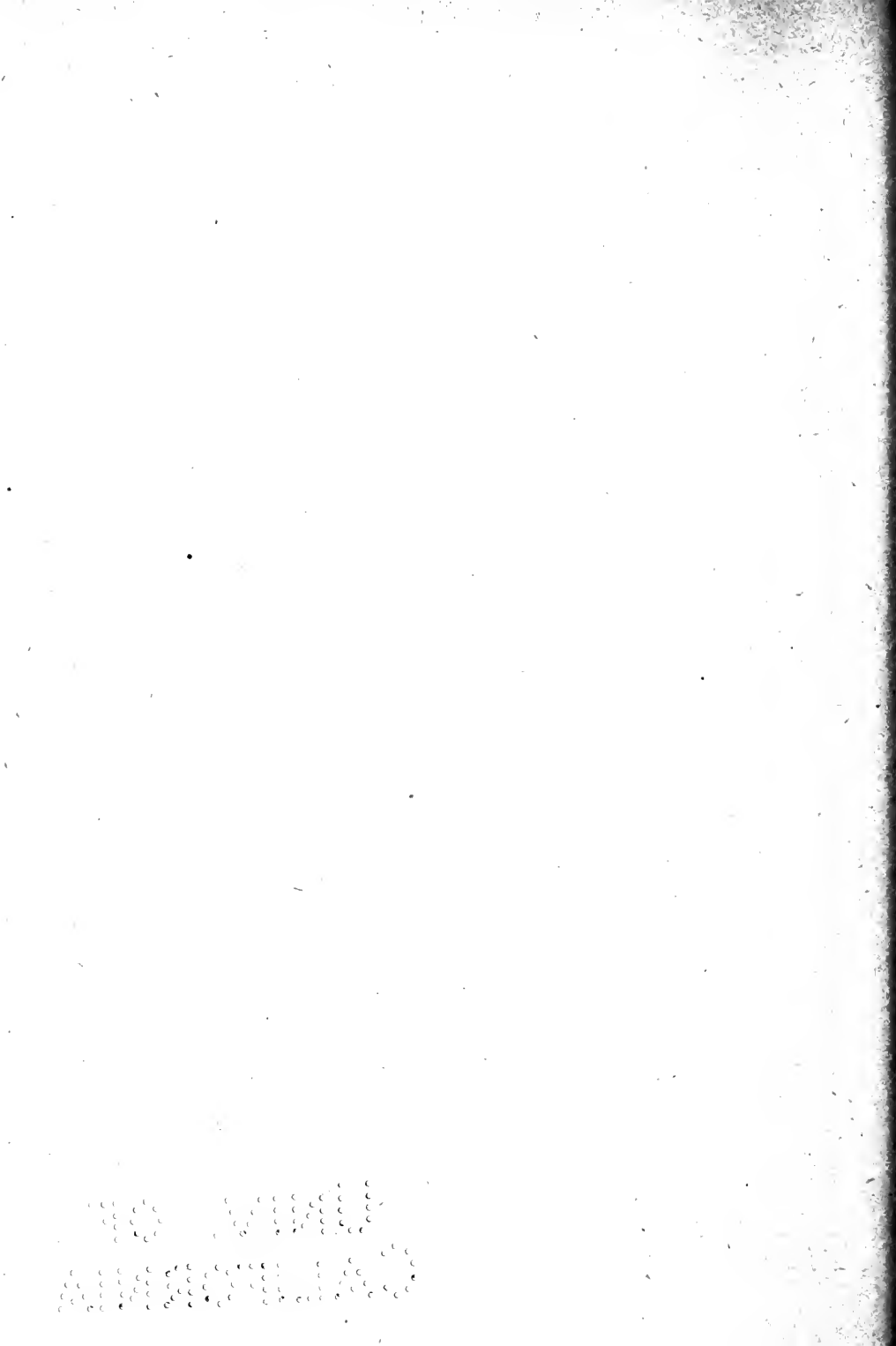
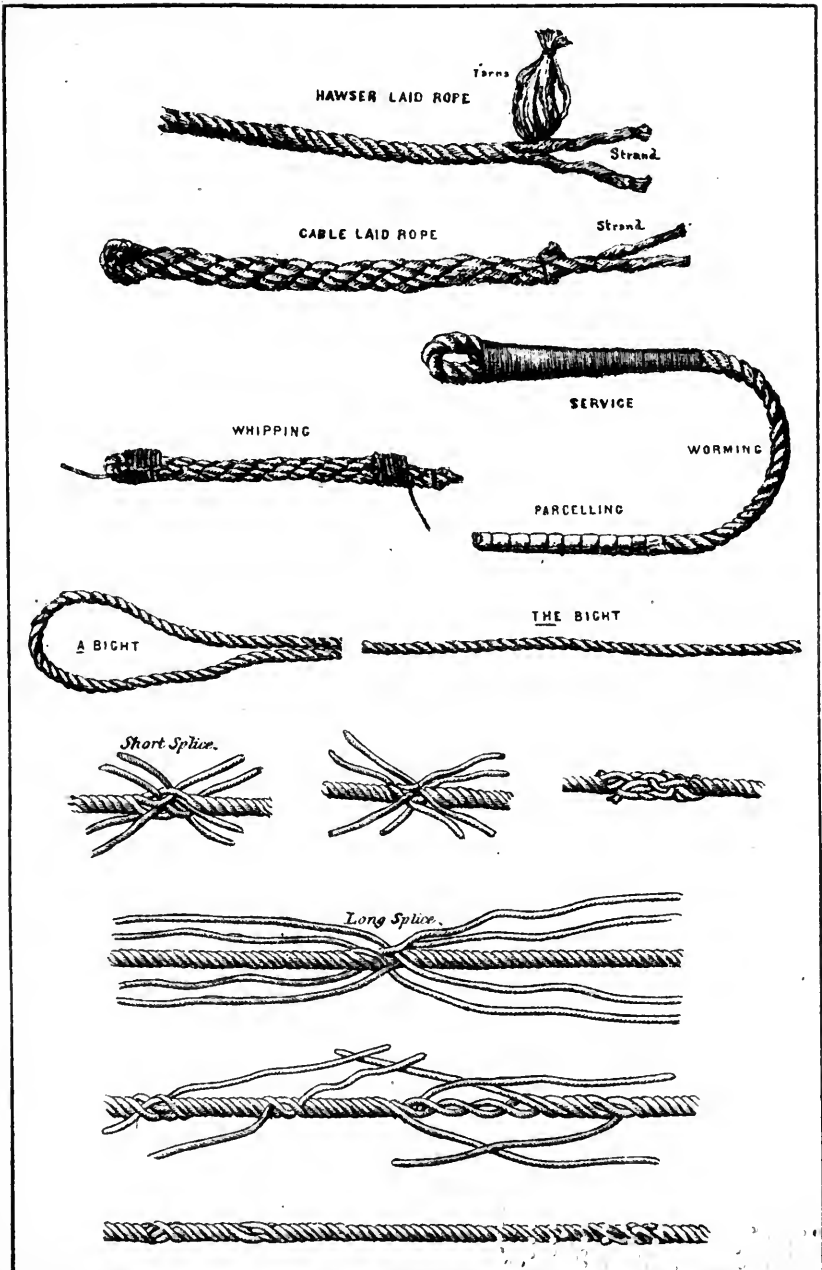

Fig. 4.







Chase, Del.

See — p. 231. par. 476.
et seq.

PLATE 25.

EYE SPLICE



GROMMET



TWO HALF HITCHES.



CLOVE HITCH.



BOWLINE.



ROUND TURN AND TWO HALF HITCHES.



GRANNY.



SQUARE.



BLACK-WALL



ROLLING.



CATSPAW.



SHEET BEND.



TIMBER HITCH.



FISHERMAN BEND.



CARRICK BEND



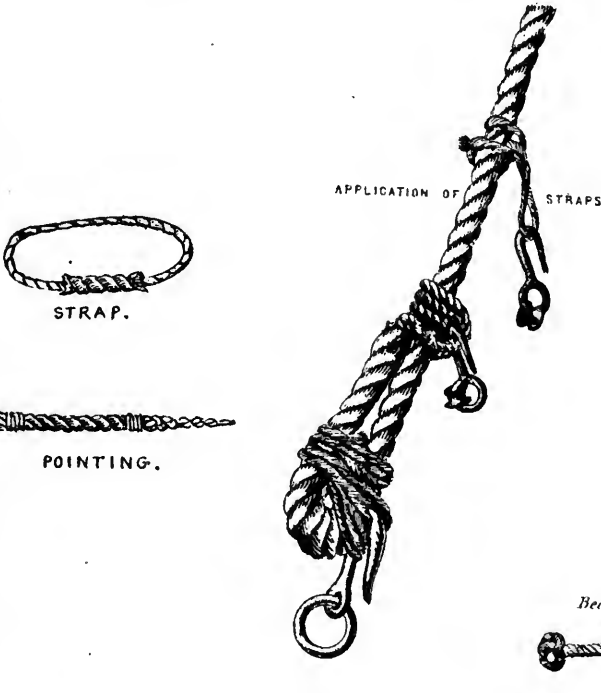
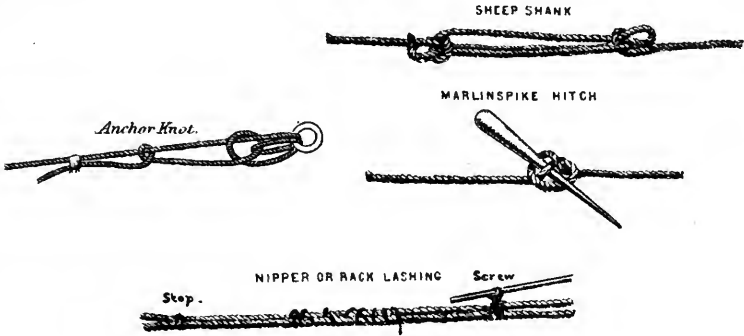

70 2111
ABR 1940

PLATE 27.

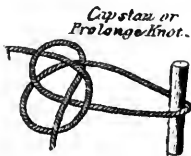
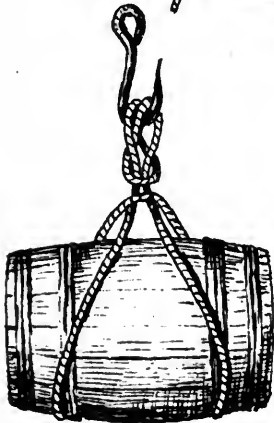
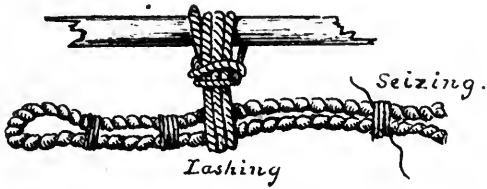

1 2 3 4 5 6 7 8 9 10 11 12 13 14 15 16 17 18 19 20 21 22 23 24 25 26 27 28 29 30 31 32 33 34 35 36 37 38 39 40 41 42 43 44 45 46 47 48 49 50 51 52 53 54 55 56 57 58 59 60 61 62 63 64 65 66 67 68 69 70 71 72 73 74 75 76 77 78 79 80 81 82 83 84 85 86 87 88 89 90 91 92 93 94 95 96 97 98 99 100 101 102 103 104 105 106 107 108 109 110 111 112 113 114 115 116 117 118 119 120 121 122 123 124 125 126 127 128 129 130 131 132 133 134 135 136 137 138 139 140 141 142 143 144 145 146 147 148 149 150 151 152 153 154 155 156 157 158 159 160 161 162 163 164 165 166 167 168 169 170 171 172 173 174 175 176 177 178 179 180 181 182 183 184 185 186 187 188 189 190 191 192 193 194 195 196 197 198 199 200 201 202 203 204 205 206 207 208 209 210 211 212 213 214 215 216 217 218 219 220 221 222 223 224 225 226 227 228 229 230 231 232 233 234 235 236 237 238 239 240 241 242 243 244 245 246 247 248 249 250 251 252 253 254 255 256 257 258 259 260 261 262 263 264 265 266 267 268 269 270 271 272 273 274 275 276 277 278 279 280 281 282 283 284 285 286 287 288 289 290 291 292 293 294 295 296 297 298 299 300 301 302 303 304 305 306 307 308 309 310 311 312 313 314 315 316 317 318 319 320 321 322 323 324 325 326 327 328 329 330 331 332 333 334 335 336 337 338 339 340 341 342 343 344 345 346 347 348 349 350 351 352 353 354 355 356 357 358 359 360 361 362 363 364 365 366 367 368 369 370 371 372 373 374 375 376 377 378 379 380 381 382 383 384 385 386 387 388 389 390 391 392 393 394 395 396 397 398 399 400 401 402 403 404 405 406 407 408 409 410 411 412 413 414 415 416 417 418 419 420 421 422 423 424 425 426 427 428 429 430 431 432 433 434 435 436 437 438 439 440 441 442 443 444 445 446 447 448 449 450 451 452 453 454 455 456 457 458 459 460 461 462 463 464 465 466 467 468 469 470 471 472 473 474 475 476 477 478 479 480 481 482 483 484 485 486 487 488 489 490 491 492 493 494 495 496 497 498 499 500 501 502 503 504 505 506 507 508 509 510 511 512 513 514 515 516 517 518 519 520 521 522 523 524 525 526 527 528 529 530 531 532 533 534 535 536 537 538 539 540 541 542 543 544 545 546 547 548 549 550 551 552 553 554 555 556 557 558 559 560 561 562 563 564 565 566 567 568 569 570 571 572 573 574 575 576 577 578 579 580 581 582 583 584 585 586 587 588 589 590 591 592 593 594 595 596 597 598 599 600 601 602 603 604 605 606 607 608 609 610 611 612 613 614 615 616 617 618 619 620 621 622 623 624 625 626 627 628 629 630 631 632 633 634 635 636 637 638 639 640 641 642 643 644 645 646 647 648 649 650 651 652 653 654 655 656 657 658 659 660 661 662 663 664 665 666 667 668 669 670 671 672 673 674 675 676 677 678 679 680 681 682 683 684 685 686 687 688 689 690 691 692 693 694 695 696 697 698 699 700 701 702 703 704 705 706 707 708 709 710 711 712 713 714 715 716 717 718 719 720 721 722 723 724 725 726 727 728 729 730 731 732 733 734 735 736 737 738 739 740 741 742 743 744 745 746 747 748 749 750 751 752 753 754 755 756 757 758 759 760 761 762 763 764 765 766 767 768 769 770 771 772 773 774 775 776 777 778 779 780 781 782 783 784 785 786 787 788 789 790 791 792 793 794 795 796 797 798 799 800 801 802 803 804 805 806 807 808 809 810 811 812 813 814 815 816 817 818 819 820 821 822 823 824 825 826 827 828 829 830 831 832 833 834 835 836 837 838 839 840 841 842 843 844 845 846 847 848 849 850 851 852 853 854 855 856 857 858 859 860 861 862 863 864 865 866 867 868 869 870 871 872 873 874 875 876 877 878 879 880 881 882 883 884 885 886 887 888 889 890 891 892 893 894 895 896 897 898 899 900 901 902 903 904 905 906 907 908 909 910 911 912 913 914 915 916 917 918 919 920 921 922 923 924 925 926 927 928 929 930 931 932 933 934 935 936 937 938 939 940 941 942 943 944 945 946 947 948 949 950 951 952 953 954 955 956 957 958 959 960 961 962 963 964 965 966 967 968 969 970 971 972 973 974 975 976 977 978 979 980 981 982 983 984 985 986 987 988 989 990 991 992 993 994 995 996 997 998 999 1000

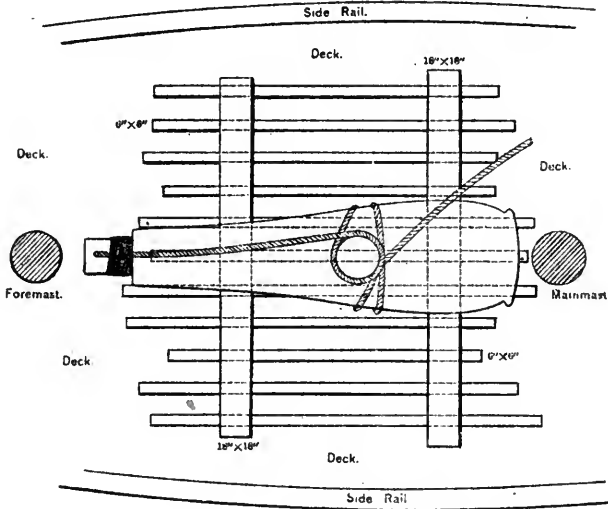

TO MOVE A HEAVY GUN
FROM A VESSEL'S DECK.

Hawser Knot.

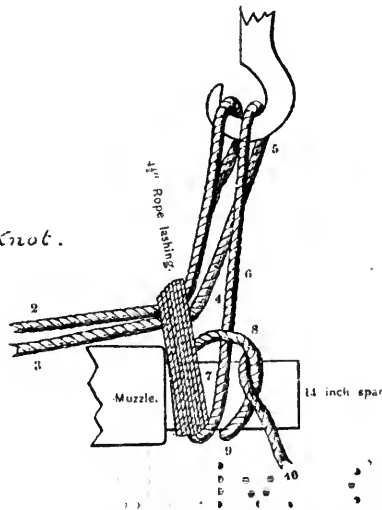
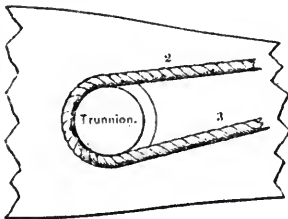

TO THE
MEMBERS OF THE
COMMISSION ON THE
FUTURE OF THE
NATIONAL DEFENSE
UNIVERSITY



Shell.



Sheave.



Pin.



Strap.

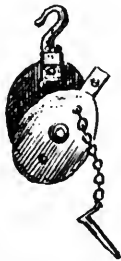

Snatch Block.

Tail Block.

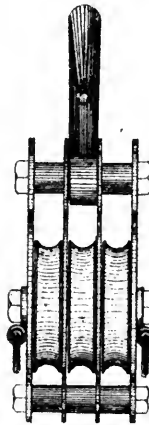

Iron
Blocks
single, double
treble, quadruple
for heavy guns

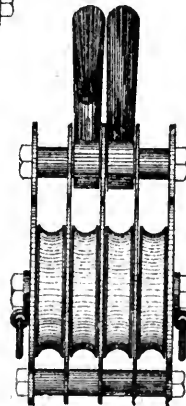
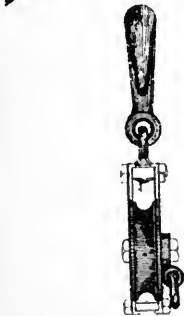

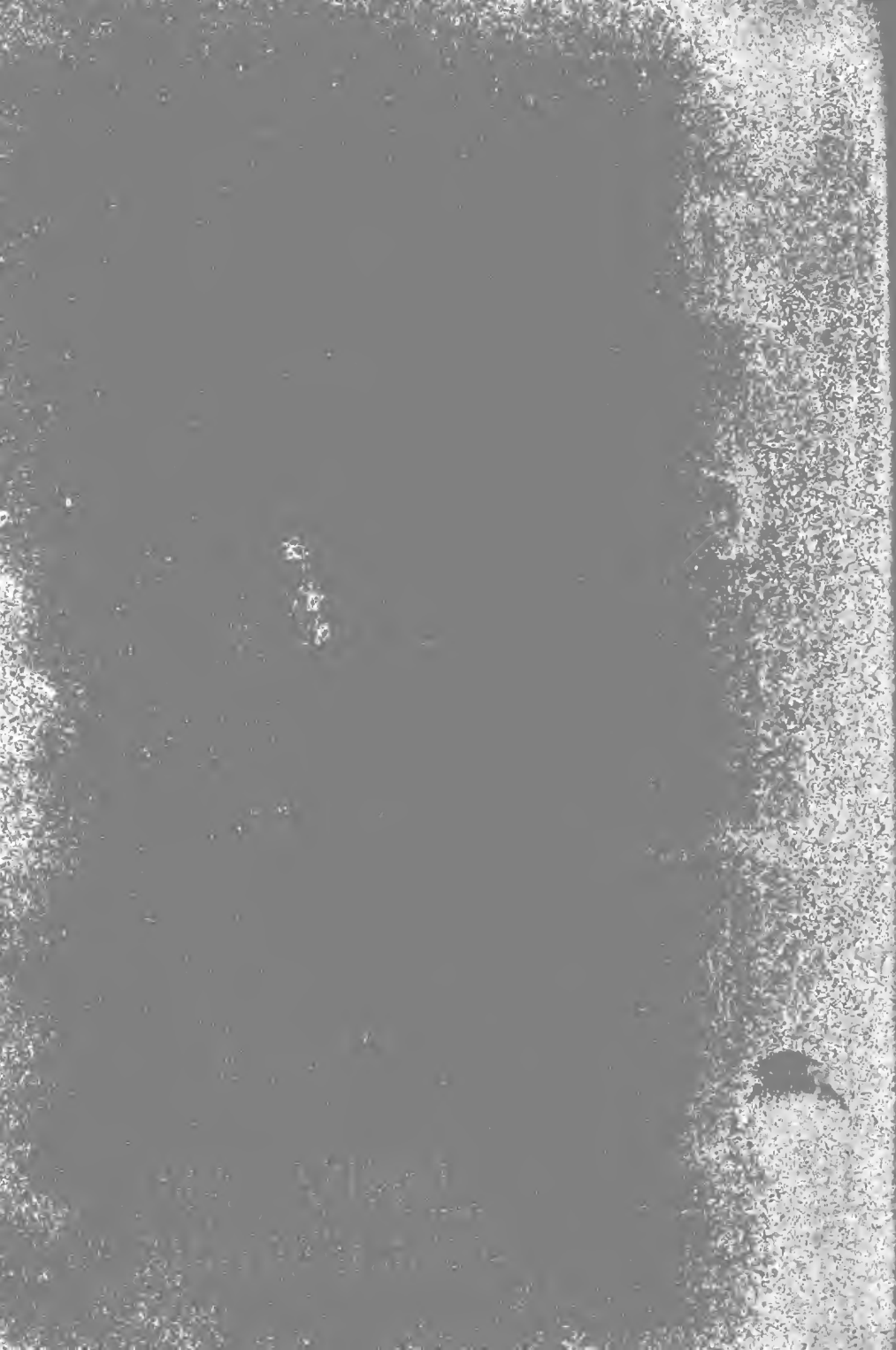

Whip.

Gun Tackle.

Luff.

Runner.

Burton.

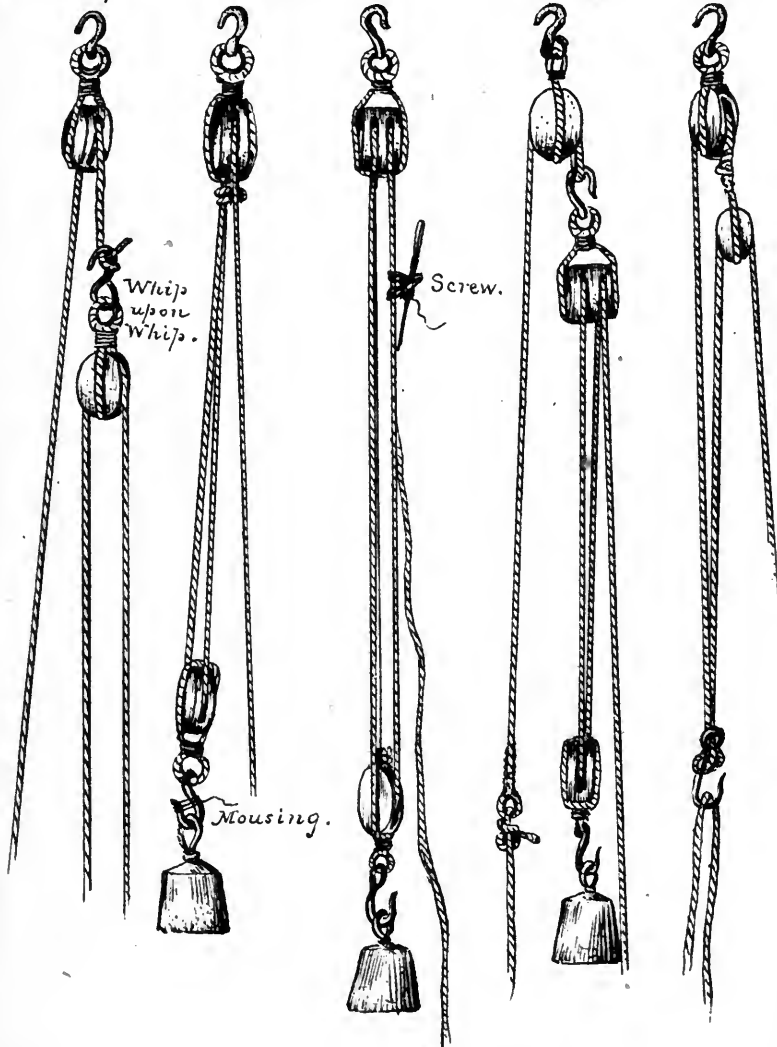

11
12
13
14
15
16
17
18
19
20
21
22
23
24
25
26
27
28
29
30
31
32
33
34
35
36
37
38
39
40
41
42
43
44
45
46
47
48
49
50
51
52
53
54
55
56
57
58
59
60
61
62
63
64
65
66
67
68
69
70
71
72
73
74
75
76
77
78
79
80
81
82
83
84
85
86
87
88
89
90
91
92
93
94
95
96
97
98
99
100

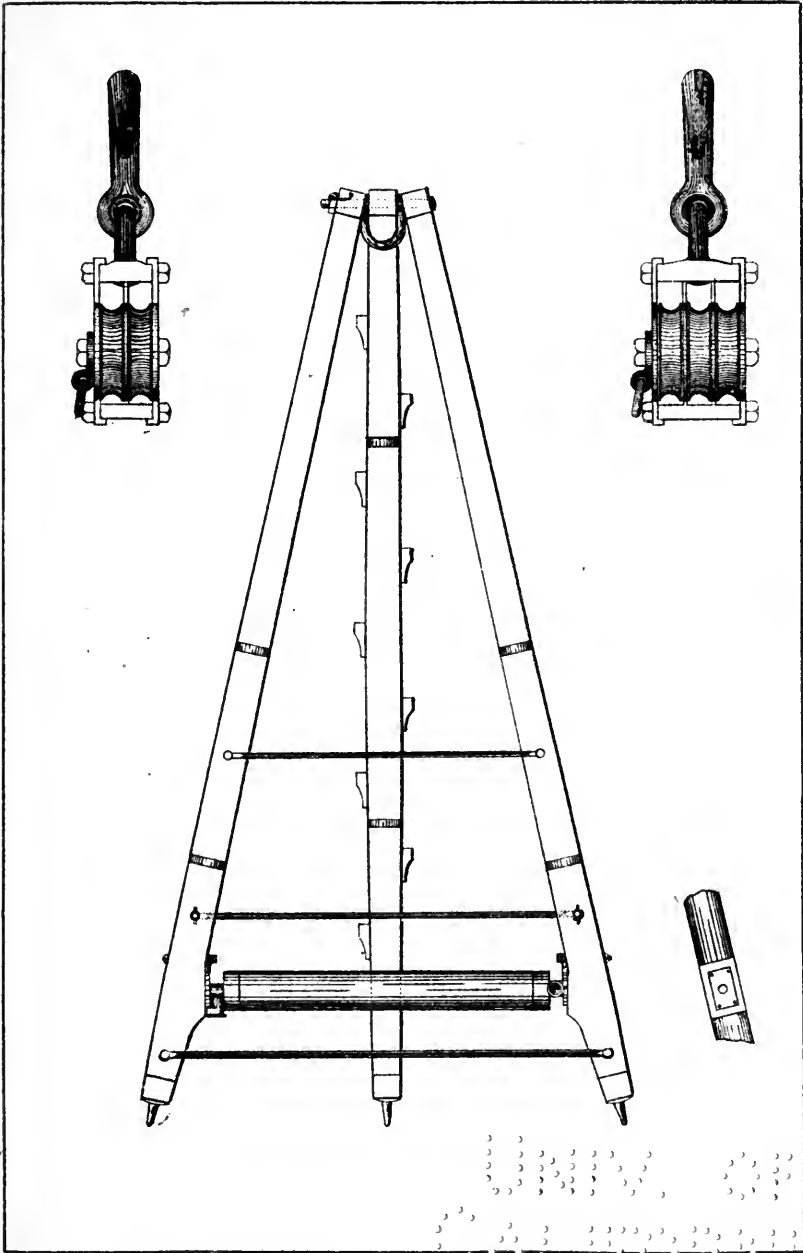

Chase, Del.

See - p. 242. par. 485.

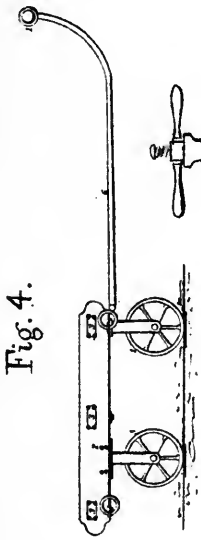

Fig. 4.

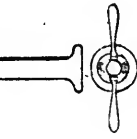

Fig. 6.

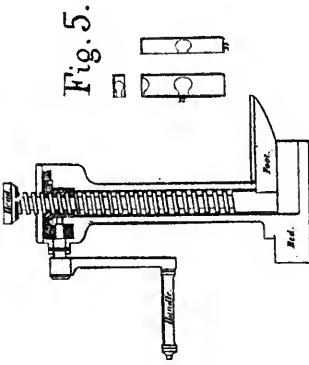

Fig. 5.

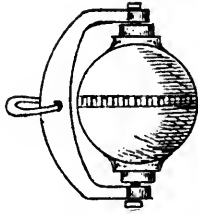

Fig. 2.

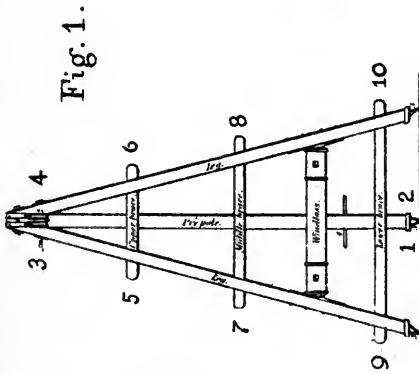

Fig. 1.

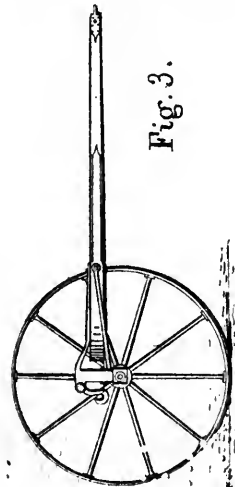
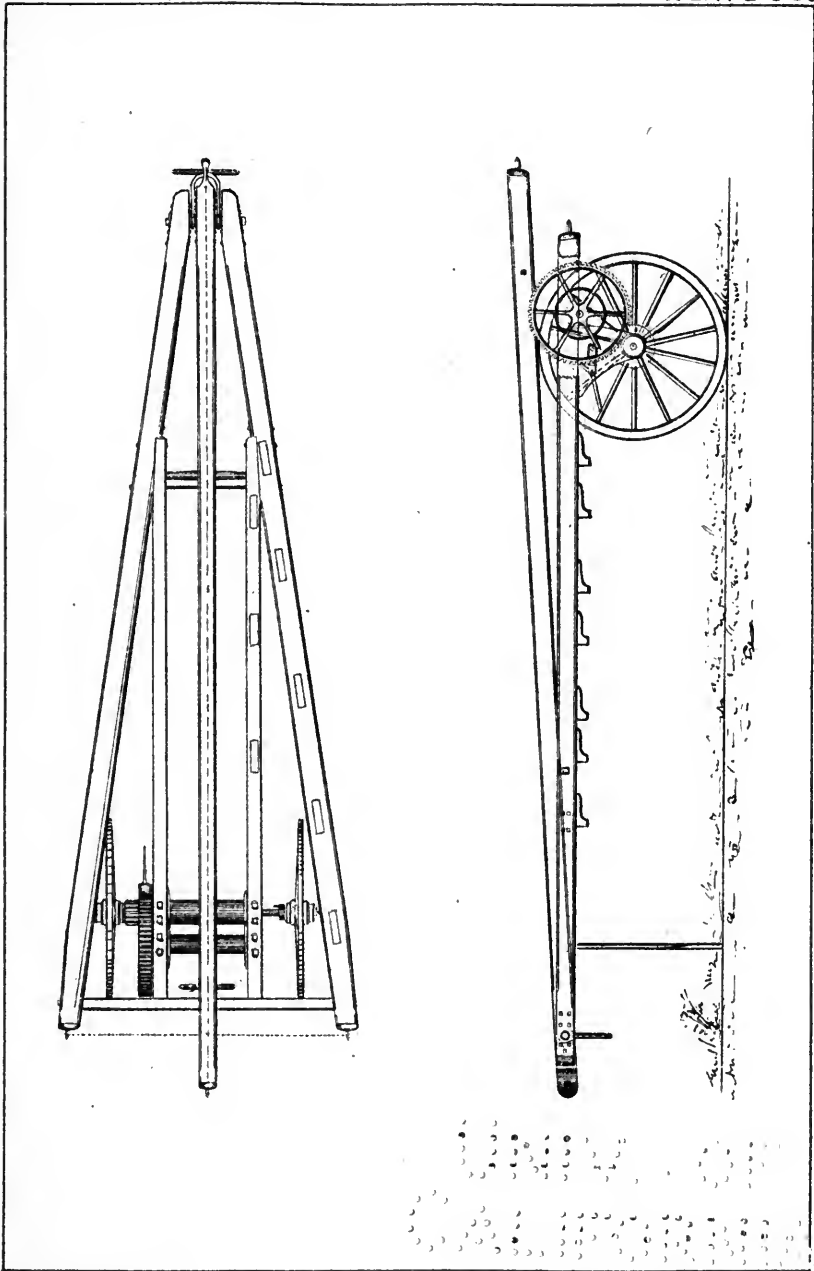

Fig. 3.

1940
1941
1942
1943
1944
1945
1946
1947
1948
1949
1950
1951
1952
1953
1954
1955
1956
1957
1958
1959
1960
1961
1962
1963
1964
1965
1966
1967
1968
1969
1970
1971
1972
1973
1974
1975
1976
1977
1978
1979
1980
1981
1982
1983
1984
1985
1986
1987
1988
1989
1990
1991
1992
1993
1994
1995
1996
1997
1998
1999
2000
2001
2002
2003
2004
2005
2006
2007
2008
2009
2010
2011
2012
2013
2014
2015
2016
2017
2018
2019
2020
2021
2022
2023
2024
2025



THE UNIVERSITY OF CHICAGO
LIBRARY

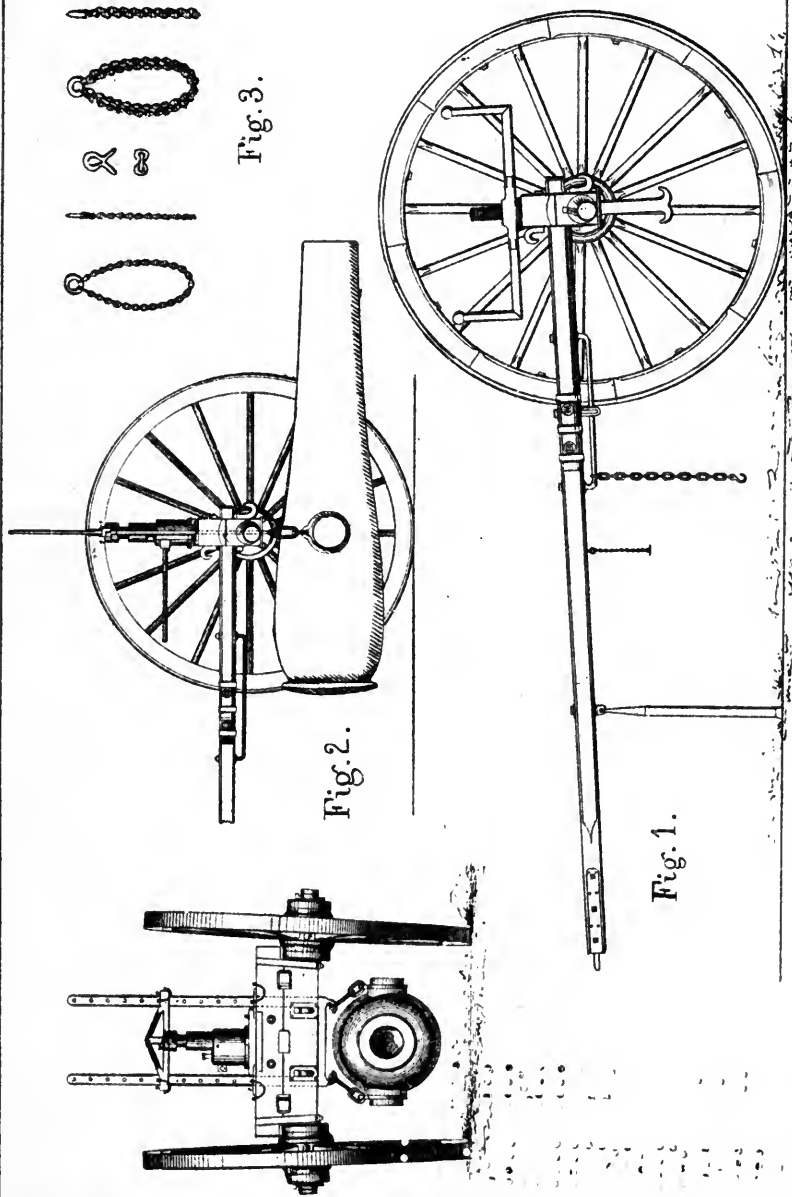

Fig. 3.

Fig. 2.

Fig. 1.

1948
1949
1950
1951
1952
1953
1954
1955
1956
1957
1958
1959
1960
1961
1962
1963
1964
1965
1966
1967
1968
1969
1970
1971
1972
1973
1974
1975
1976
1977
1978
1979
1980
1981
1982
1983
1984
1985
1986
1987
1988
1989
1990
1991
1992
1993
1994
1995
1996
1997
1998
1999
2000
2001
2002
2003
2004
2005
2006
2007
2008
2009
2010
2011
2012
2013
2014
2015
2016
2017
2018
2019
2020
2021
2022
2023
2024
2025

TRUCK WAGON.

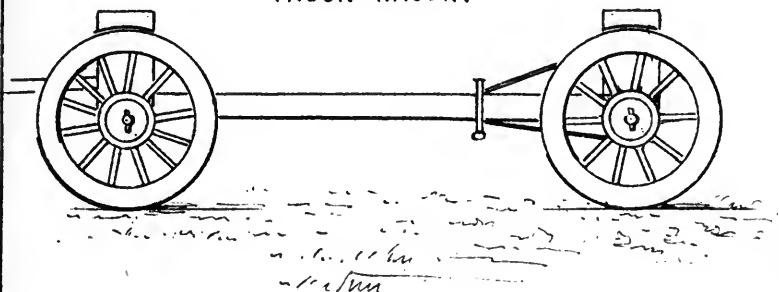

RAILWAY TRUCK.

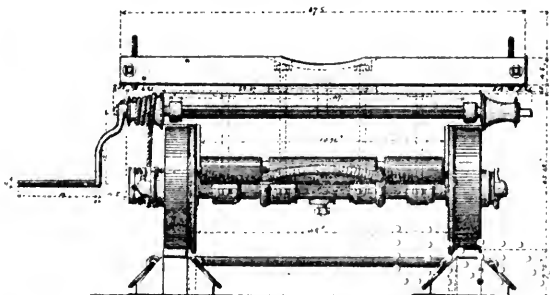
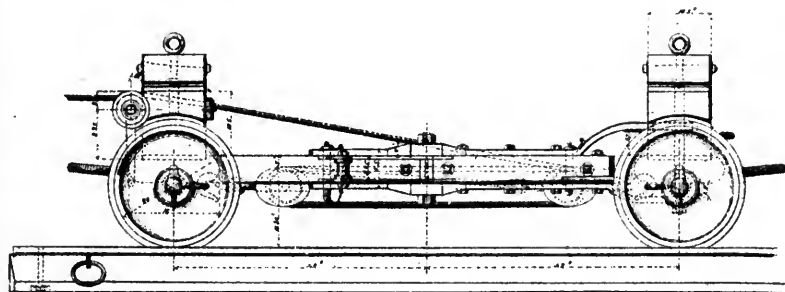

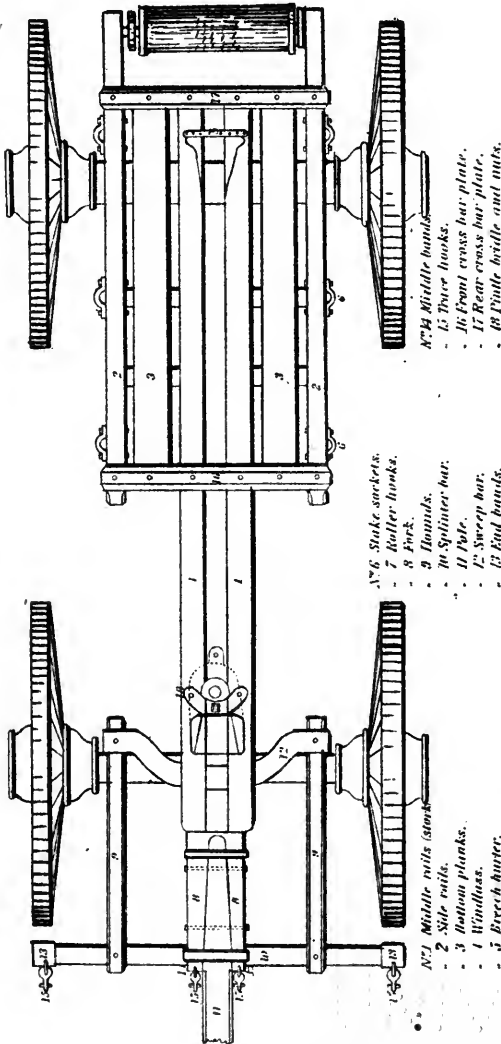

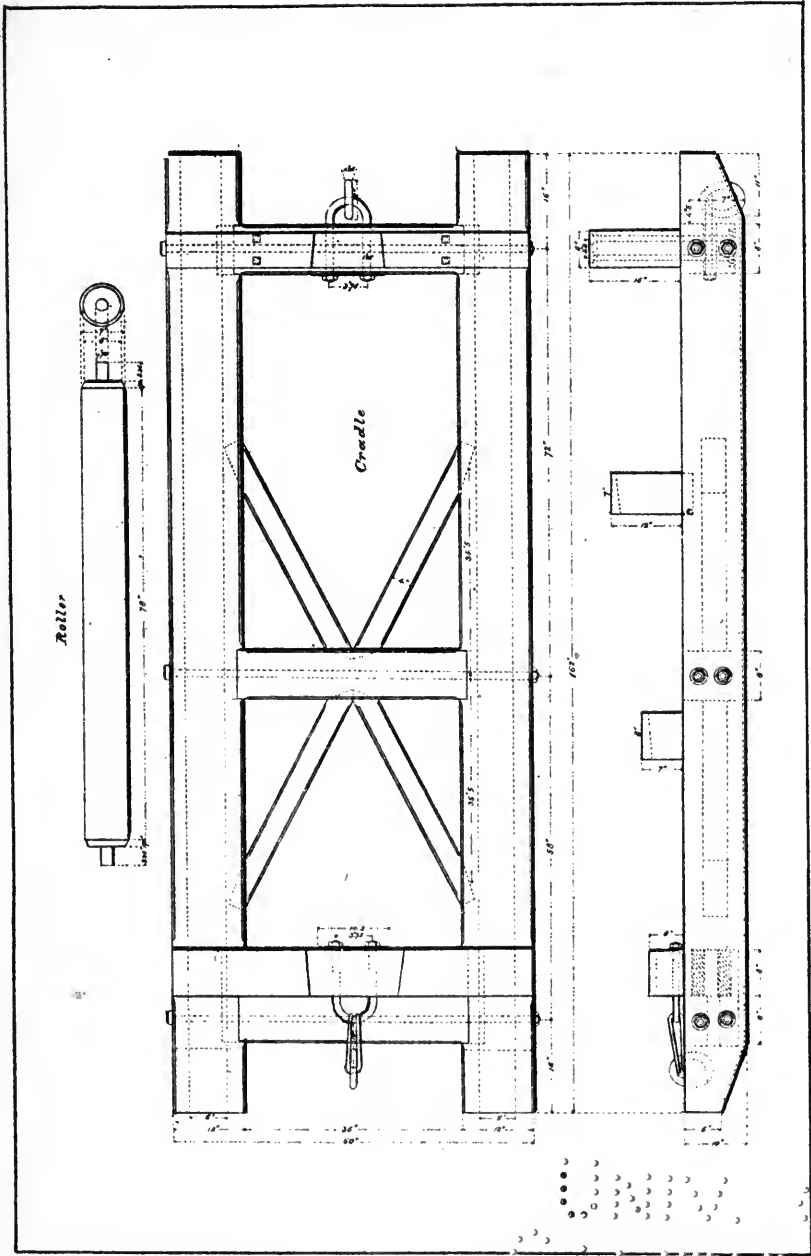

Chase, Del.

See p. 261. par. 5/6.

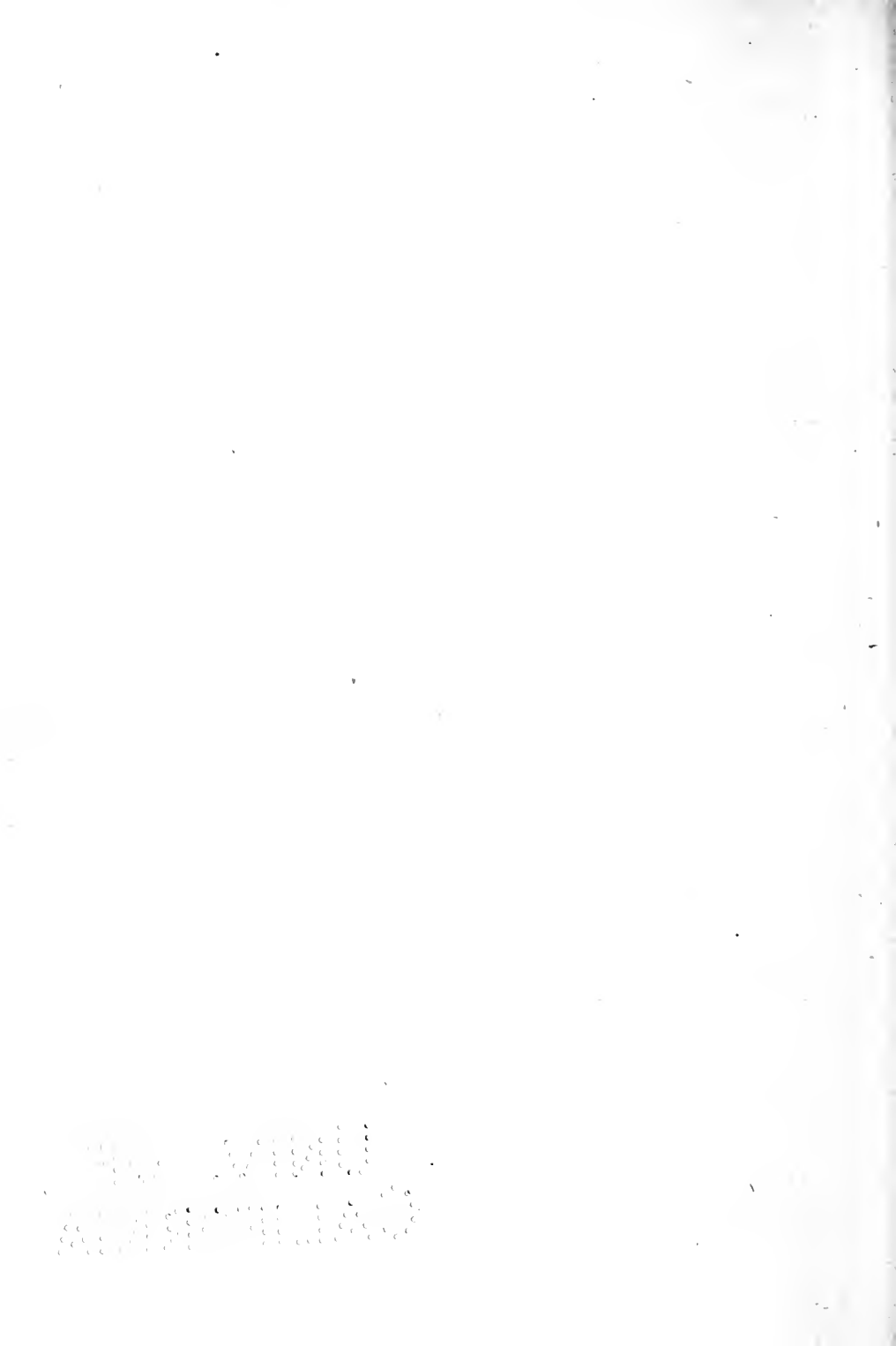

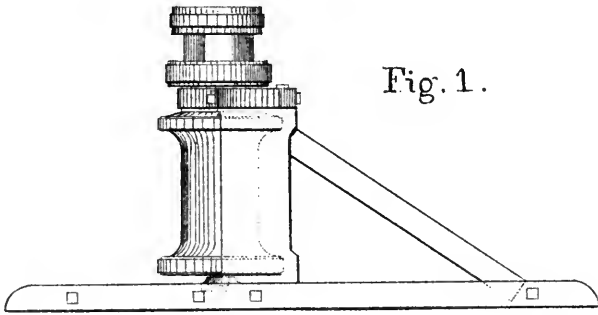

Fig. 1.

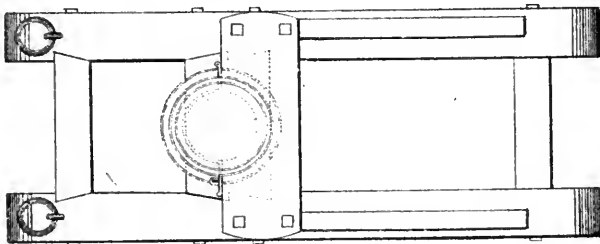

Fig. 2.

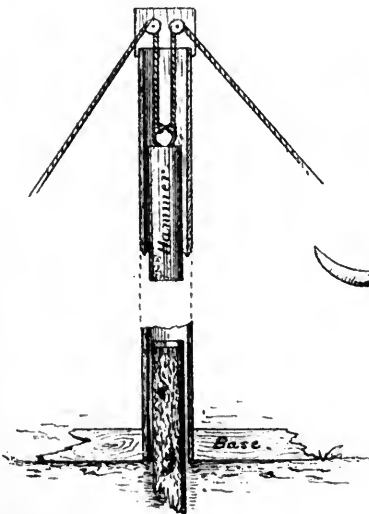

Fig. 3.

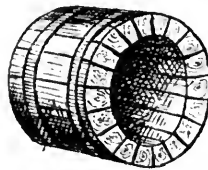

Fig. 4.

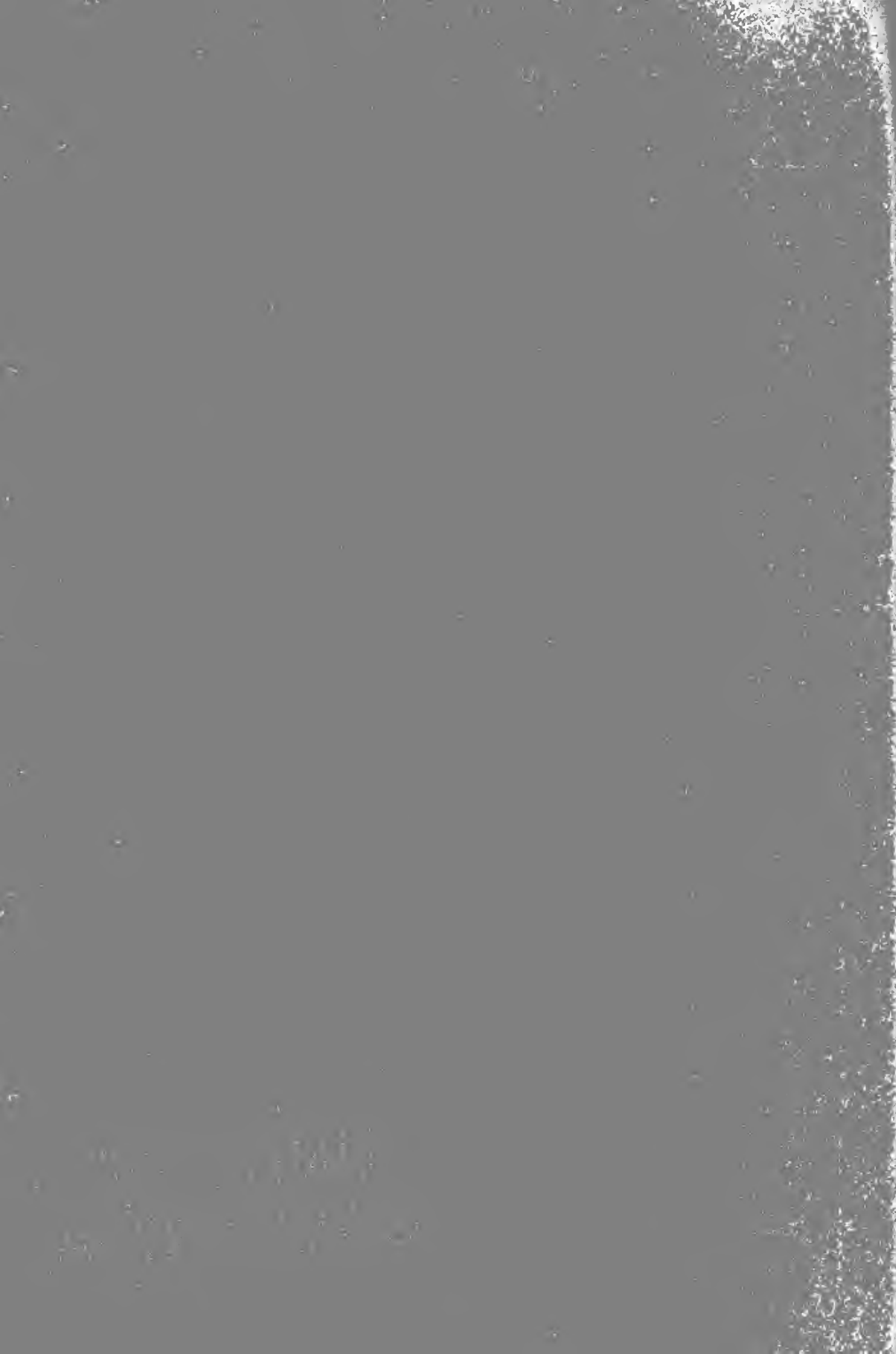

Fig. 1.



Fig. 2

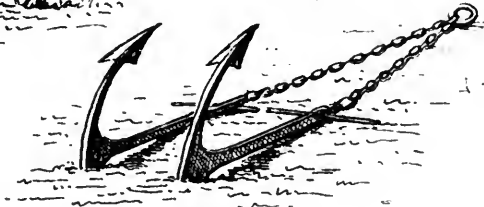

Fig. 3.

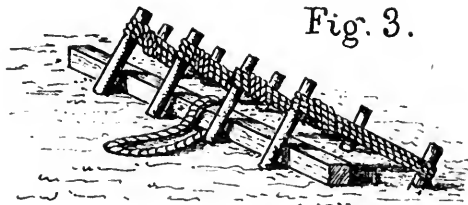

Fig. 4.



Fig. 5.

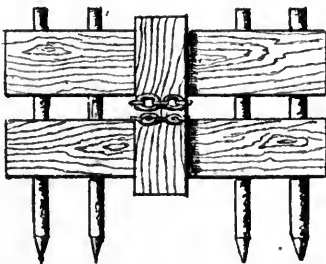
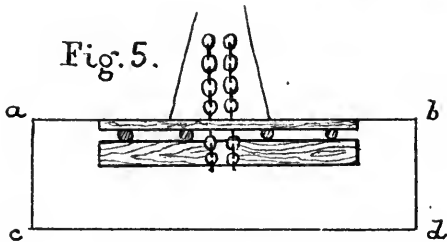
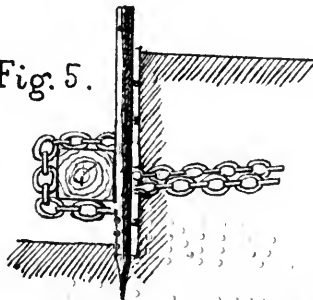
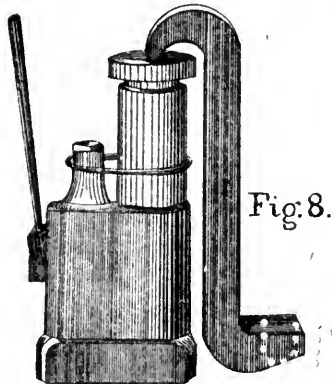
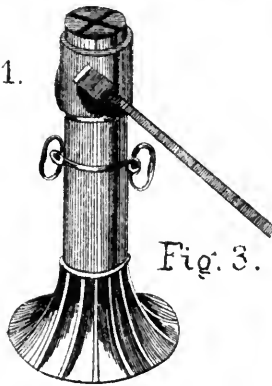
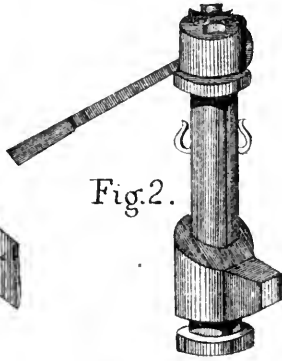
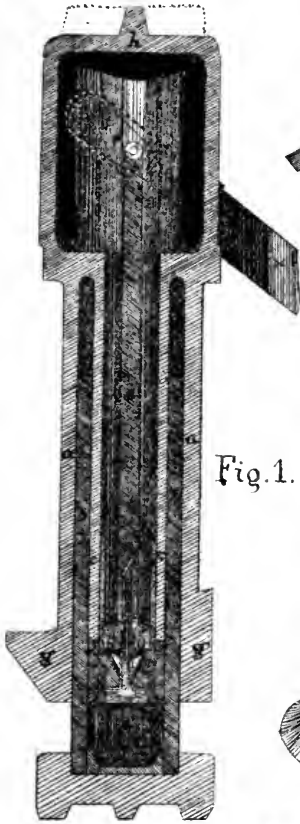

Fig. 5.



1944



Small, faint, illegible markings or artifacts at the bottom of the page, possibly bleed-through from the reverse side.

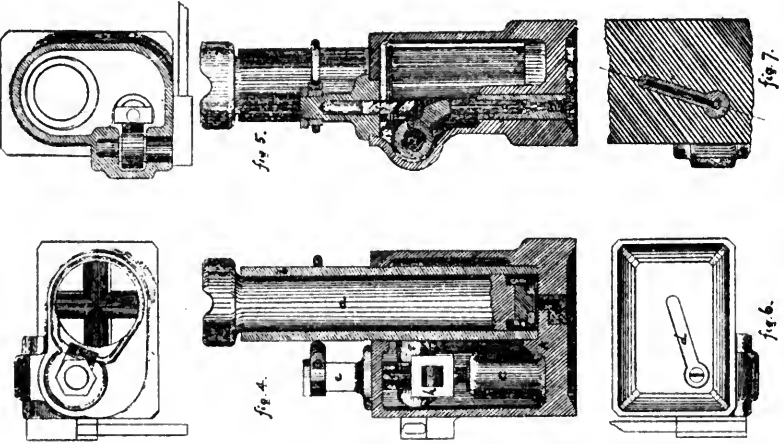
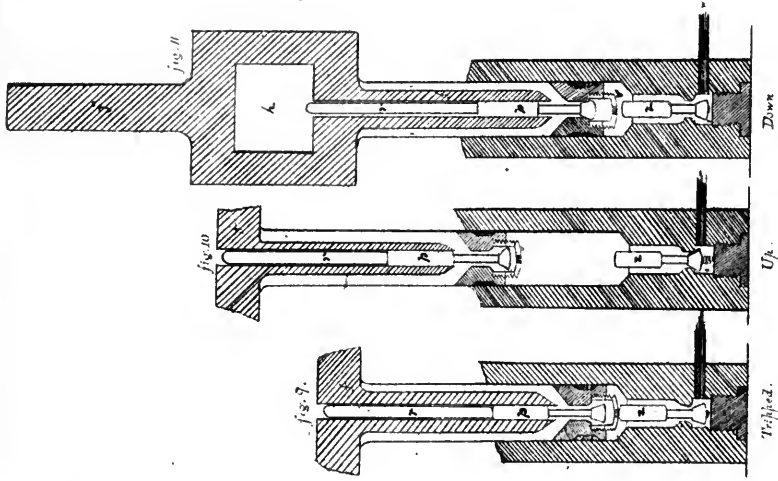

Fig. 1.

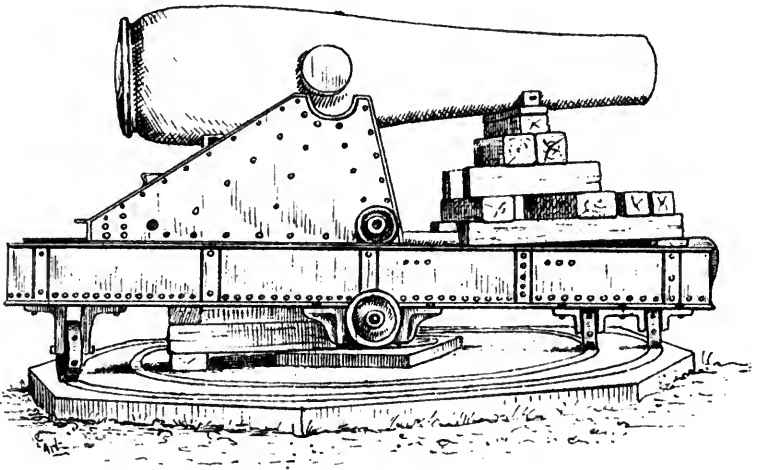
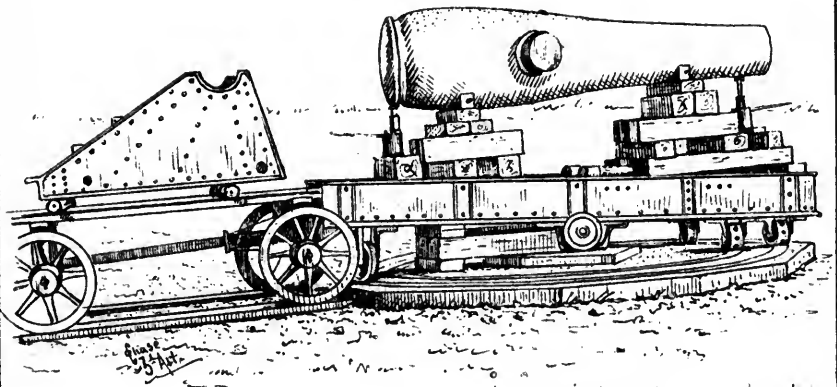

Fig. 2.



Chase, Del.

See - p. 273 to 276.

para. 534, 535.

cc c c c c c c
c c c c c c c c
c c c c c c c c c

c c c c c c c c c c c c
c c c c c c c c c c c c
c c c c c c c c c c c c
c c c c c c c c c c c c

Fig. 1.

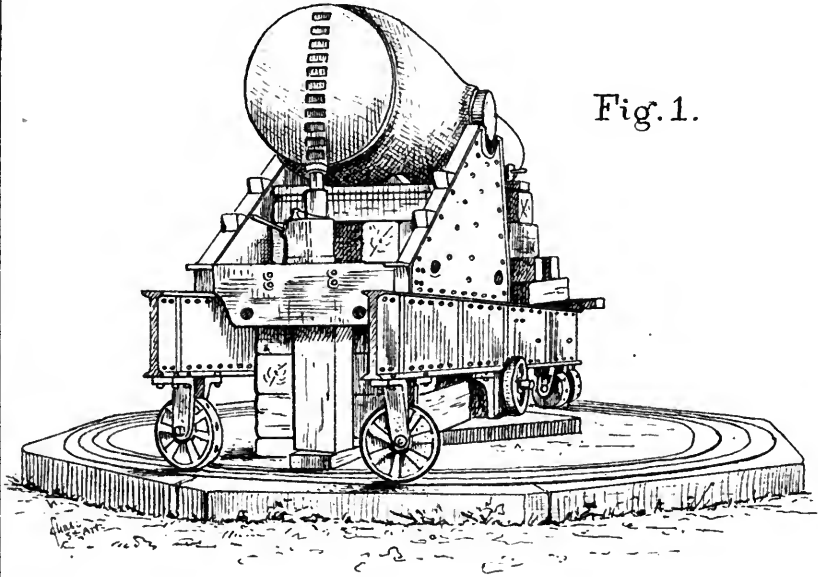

Fig. 2.



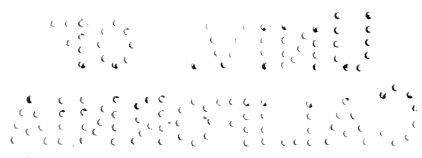

Fig. 1.

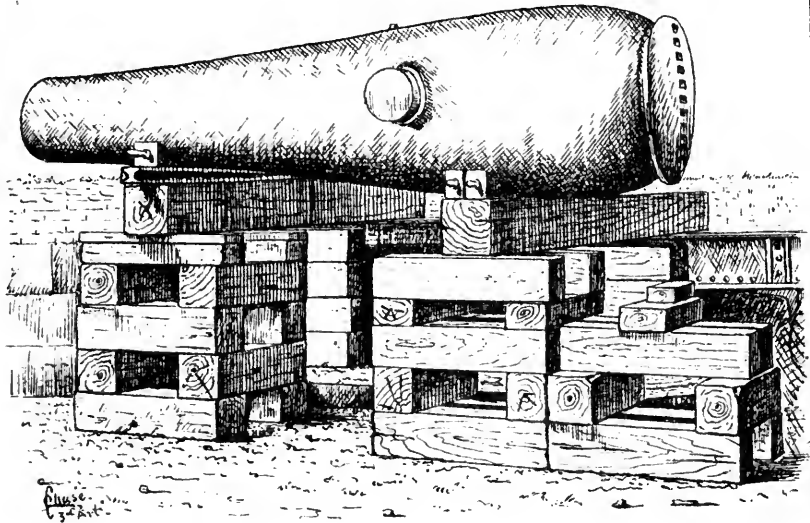

Fig. 2.

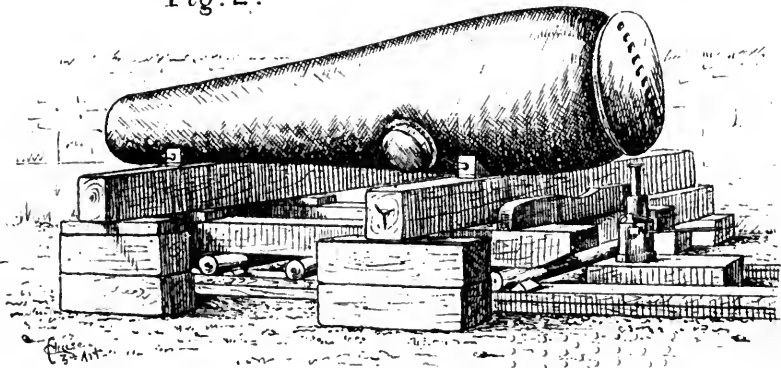

Fig. 1

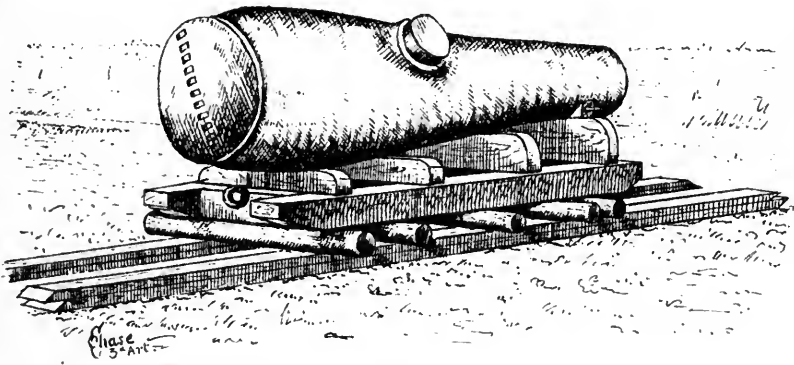
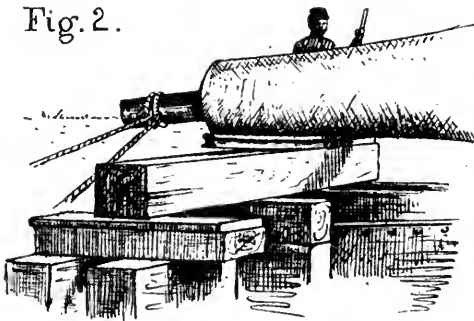
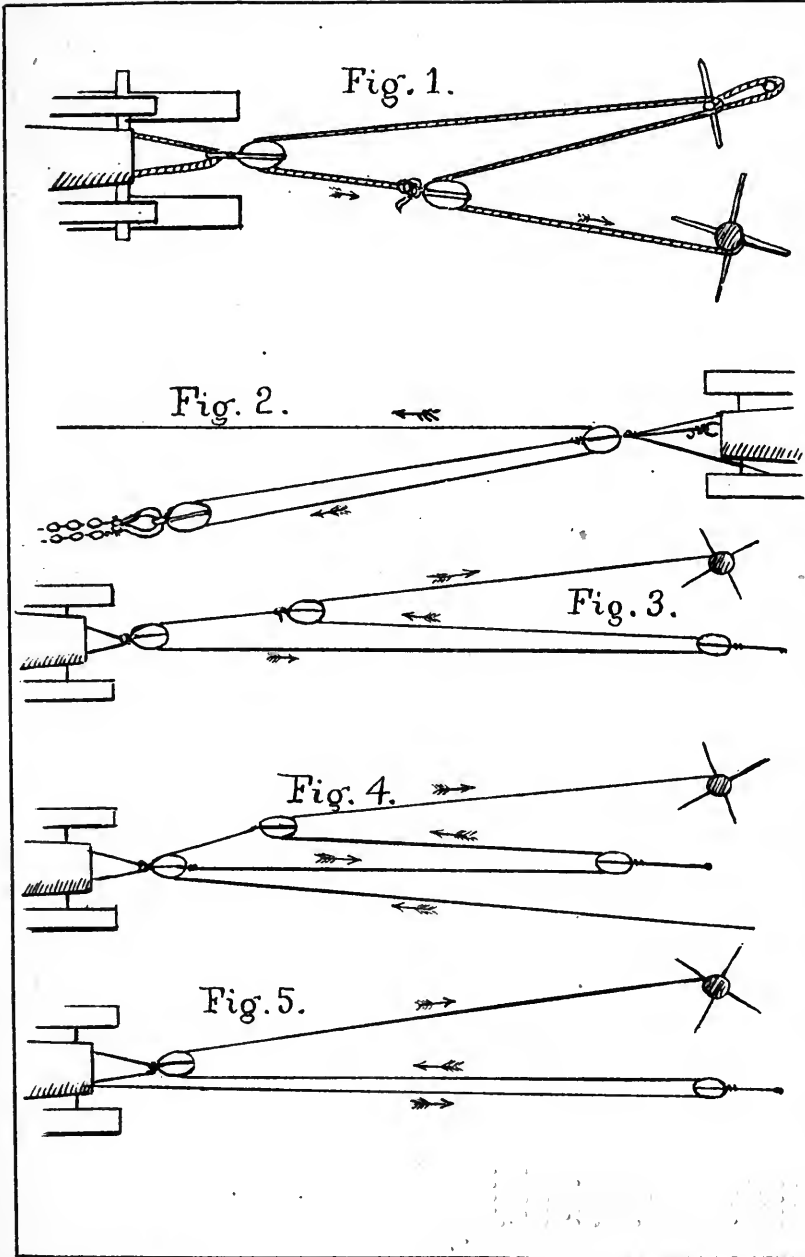

Fig. 2.



11
12
13
14
15
16
17
18
19
20
21
22
23
24
25
26
27
28
29
30
31
32
33
34
35
36
37
38
39
40
41
42
43
44
45
46
47
48
49
50
51
52
53
54
55
56
57
58
59
60
61
62
63
64
65
66
67
68
69
70
71
72
73
74
75
76
77
78
79
80
81
82
83
84
85
86
87
88
89
90
91
92
93
94
95
96
97
98
99
100



11
12
13
14
15
16
17
18
19
20
21
22
23
24
25
26
27
28
29
30
31
32
33
34
35
36
37
38
39
40
41
42
43
44
45
46
47
48
49
50
51
52
53
54
55
56
57
58
59
60
61
62
63
64
65
66
67
68
69
70
71
72
73
74
75
76
77
78
79
80
81
82
83
84
85
86
87
88
89
90
91
92
93
94
95
96
97
98
99
100

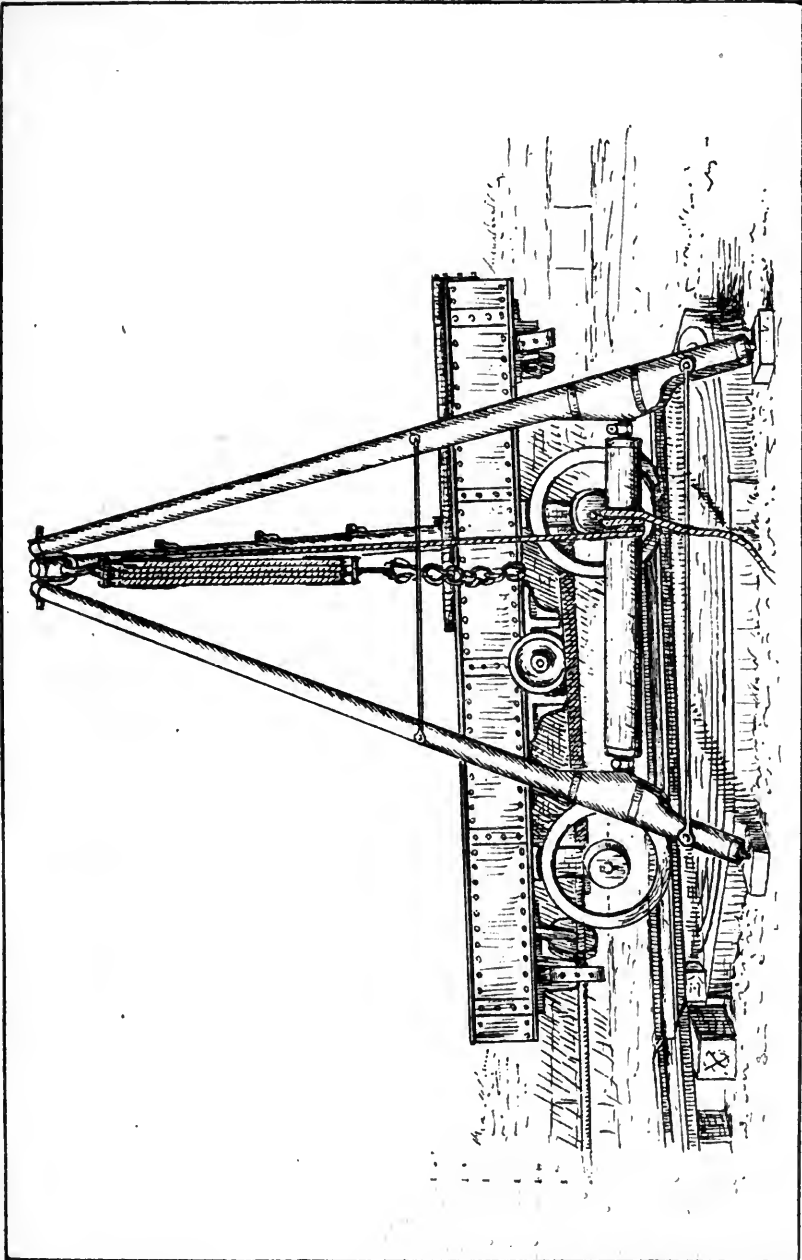

Small, faint, illegible markings or artifacts at the bottom of the page, possibly bleed-through from the reverse side.

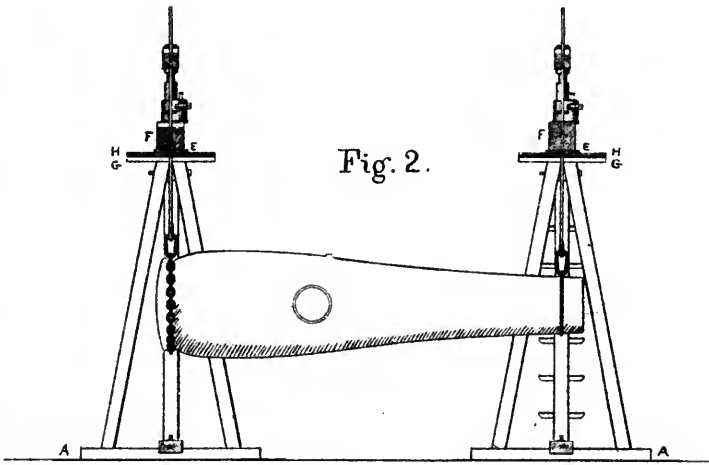

Fig. 2.

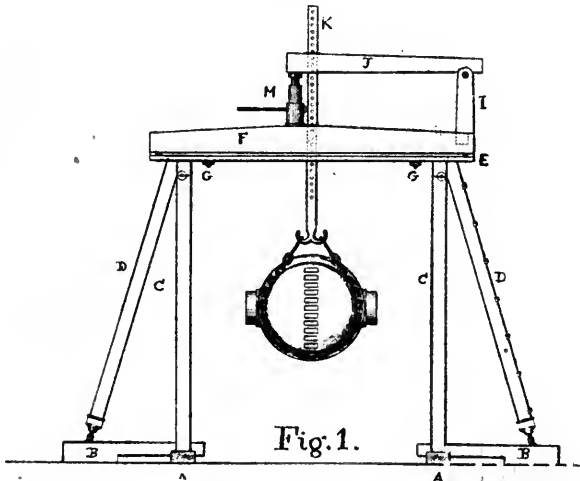
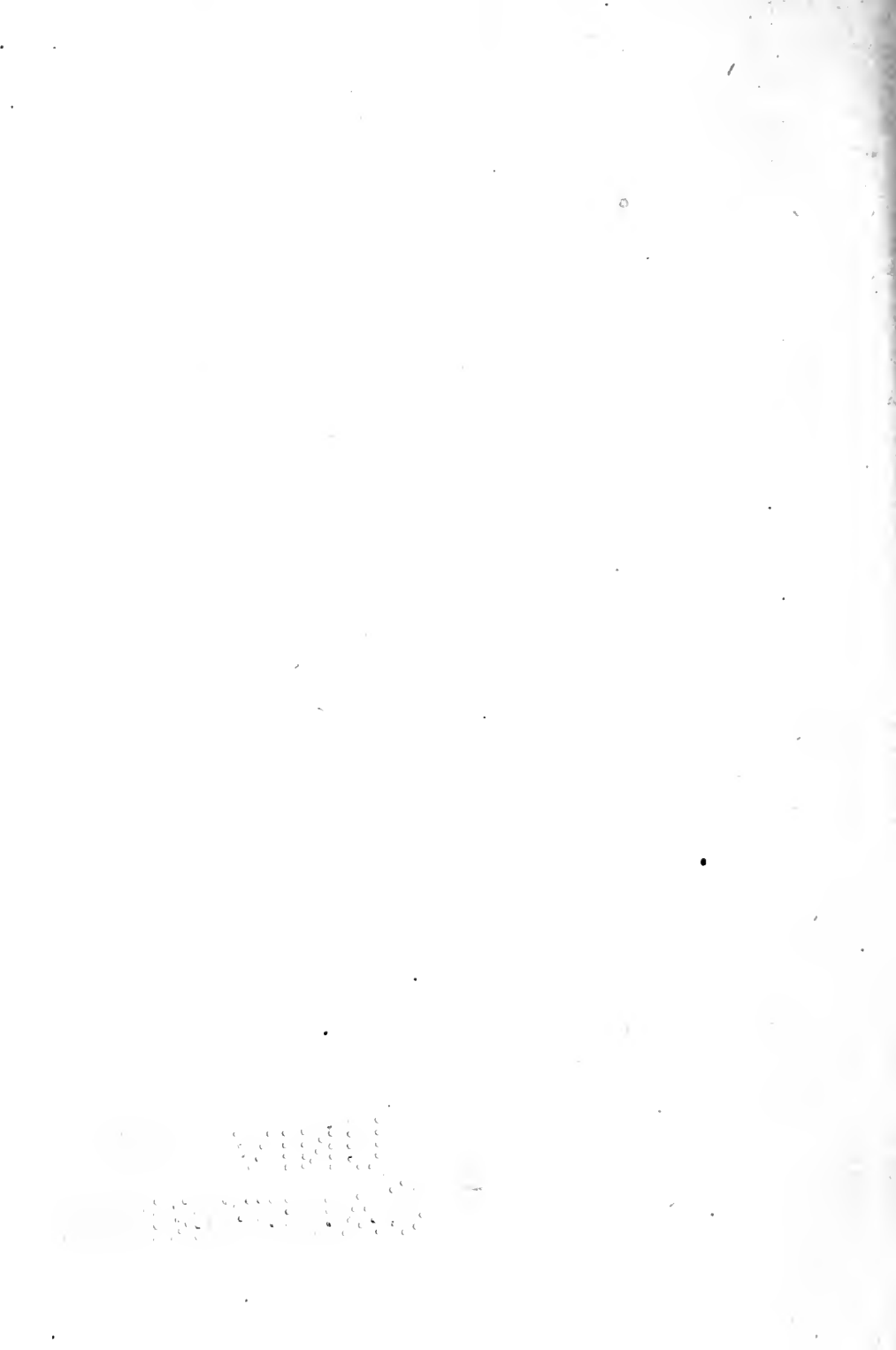
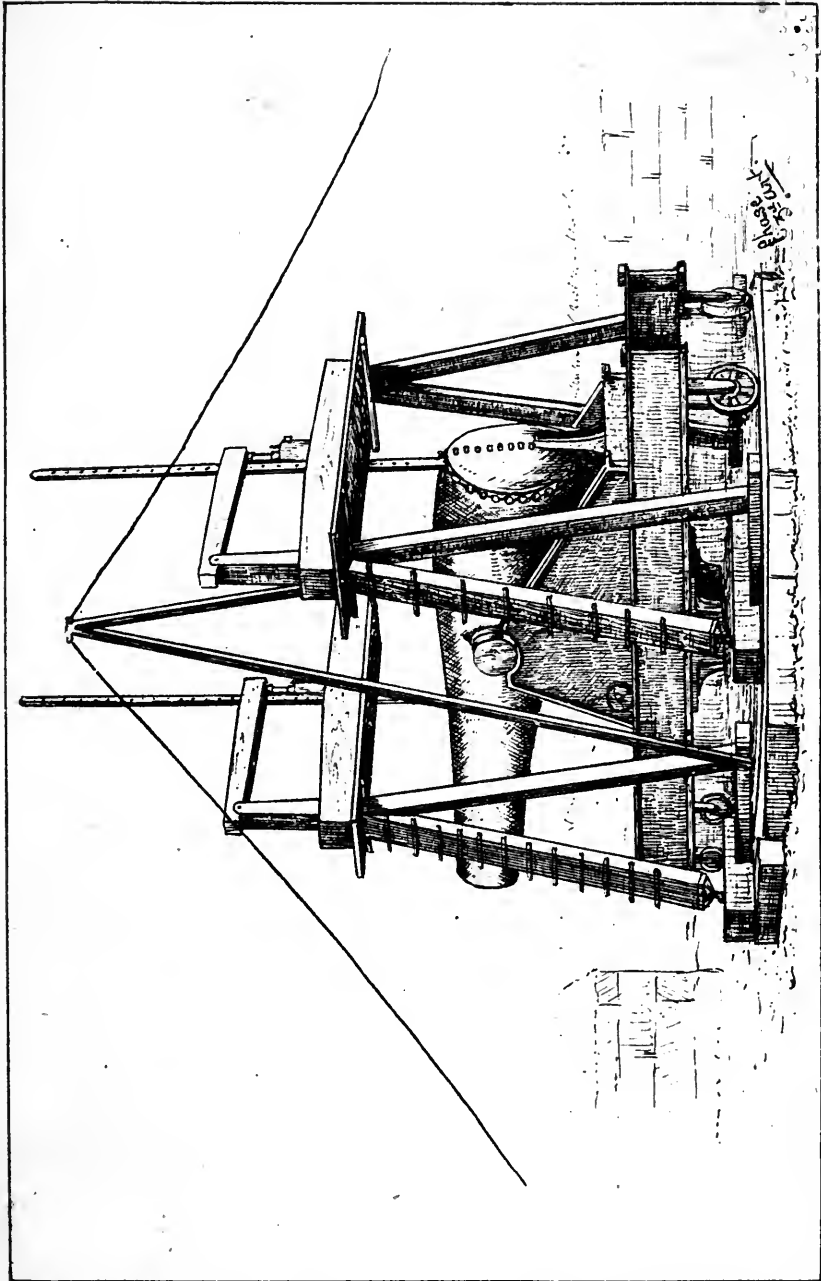

Fig. 1.





c c c

c c c

c c c c

c c c c

c c c c

c c c c

c c c c

c c c c

c c c c

c c c c

c c c c

c c c c

c c c c

c c c c

c c c c

c c c c

c c c c

c c c c

c c c c

c c c c

c c c c

c c c c

c c c c

c c c c

c c c c

c c c c

c c c c

c c c c

c c c c

c c c c

c c c c

c c c c

c c c c

c c c c

c c c c

c c c c

c c c c

c c c c

c c c c

c c c c

c c c c

c c c c

c c c c

c c c c

c c c c

c c c c

c c c c

c c c c

c c c c

c c c c

c c c c

c c c c

c c c c

c c c c

c c c c

c c c c

c c c c

c c c c

c c c c

c c c c

c c c c

c c c c

c c c c

c c c c

c c c c

c c c c

c c c c

c c c c

c c c c

c c c c

c c c c

Fig. 1.

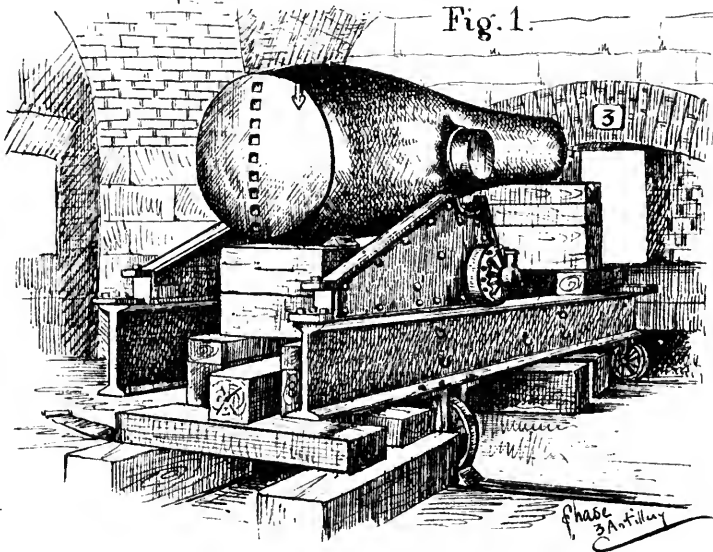
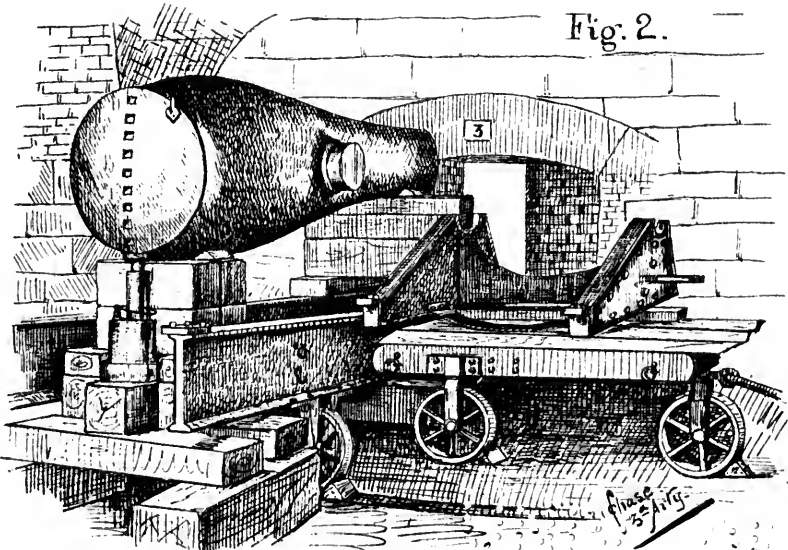

Fig. 2.



11
12
13
14
15
16
17
18
19
20
21
22
23
24
25
26
27
28
29
30
31
32
33
34
35
36
37
38
39
40
41
42
43
44
45
46
47
48
49
50
51
52
53
54
55
56
57
58
59
60
61
62
63
64
65
66
67
68
69
70
71
72
73
74
75
76
77
78
79
80
81
82
83
84
85
86
87
88
89
90
91
92
93
94
95
96
97
98
99
100
101
102
103
104
105
106
107
108
109
110
111
112
113
114
115
116
117
118
119
120
121
122
123
124
125
126
127
128
129
130
131
132
133
134
135
136
137
138
139
140
141
142
143
144
145
146
147
148
149
150
151
152
153
154
155
156
157
158
159
160
161
162
163
164
165
166
167
168
169
170
171
172
173
174
175
176
177
178
179
180
181
182
183
184
185
186
187
188
189
190
191
192
193
194
195
196
197
198
199
200
201
202
203
204
205
206
207
208
209
210
211
212
213
214
215
216
217
218
219
220
221
222
223
224
225
226
227
228
229
230
231
232
233
234
235
236
237
238
239
240
241
242
243
244
245
246
247
248
249
250
251
252
253
254
255
256
257
258
259
260
261
262
263
264
265
266
267
268
269
270
271
272
273
274
275
276
277
278
279
280
281
282
283
284
285
286
287
288
289
290
291
292
293
294
295
296
297
298
299
300
301
302
303
304
305
306
307
308
309
310
311
312
313
314
315
316
317
318
319
320
321
322
323
324
325
326
327
328
329
330
331
332
333
334
335
336
337
338
339
340
341
342
343
344
345
346
347
348
349
350
351
352
353
354
355
356
357
358
359
360
361
362
363
364
365
366
367
368
369
370
371
372
373
374
375
376
377
378
379
380
381
382
383
384
385
386
387
388
389
390
391
392
393
394
395
396
397
398
399
400
401
402
403
404
405
406
407
408
409
410
411
412
413
414
415
416
417
418
419
420
421
422
423
424
425
426
427
428
429
430
431
432
433
434
435
436
437
438
439
440
441
442
443
444
445
446
447
448
449
450
451
452
453
454
455
456
457
458
459
460
461
462
463
464
465
466
467
468
469
470
471
472
473
474
475
476
477
478
479
480
481
482
483
484
485
486
487
488
489
490
491
492
493
494
495
496
497
498
499
500
501
502
503
504
505
506
507
508
509
510
511
512
513
514
515
516
517
518
519
520
521
522
523
524
525
526
527
528
529
530
531
532
533
534
535
536
537
538
539
540
541
542
543
544
545
546
547
548
549
550
551
552
553
554
555
556
557
558
559
560
561
562
563
564
565
566
567
568
569
570
571
572
573
574
575
576
577
578
579
580
581
582
583
584
585
586
587
588
589
590
591
592
593
594
595
596
597
598
599
600
601
602
603
604
605
606
607
608
609
610
611
612
613
614
615
616
617
618
619
620
621
622
623
624
625
626
627
628
629
630
631
632
633
634
635
636
637
638
639
640
641
642
643
644
645
646
647
648
649
650
651
652
653
654
655
656
657
658
659
660
661
662
663
664
665
666
667
668
669
670
671
672
673
674
675
676
677
678
679
680
681
682
683
684
685
686
687
688
689
690
691
692
693
694
695
696
697
698
699
700
701
702
703
704
705
706
707
708
709
710
711
712
713
714
715
716
717
718
719
720
721
722
723
724
725
726
727
728
729
730
731
732
733
734
735
736
737
738
739
740
741
742
743
744
745
746
747
748
749
750
751
752
753
754
755
756
757
758
759
760
761
762
763
764
765
766
767
768
769
770
771
772
773
774
775
776
777
778
779
780
781
782
783
784
785
786
787
788
789
790
791
792
793
794
795
796
797
798
799
800
801
802
803
804
805
806
807
808
809
810
811
812
813
814
815
816
817
818
819
820
821
822
823
824
825
826
827
828
829
830
831
832
833
834
835
836
837
838
839
840
841
842
843
844
845
846
847
848
849
850
851
852
853
854
855
856
857
858
859
860
861
862
863
864
865
866
867
868
869
870
871
872
873
874
875
876
877
878
879
880
881
882
883
884
885
886
887
888
889
890
891
892
893
894
895
896
897
898
899
900
901
902
903
904
905
906
907
908
909
910
911
912
913
914
915
916
917
918
919
920
921
922
923
924
925
926
927
928
929
930
931
932
933
934
935
936
937
938
939
940
941
942
943
944
945
946
947
948
949
950
951
952
953
954
955
956
957
958
959
960
961
962
963
964
965
966
967
968
969
970
971
972
973
974
975
976
977
978
979
980
981
982
983
984
985
986
987
988
989
990
991
992
993
994
995
996
997
998
999
1000

Fig. 1.

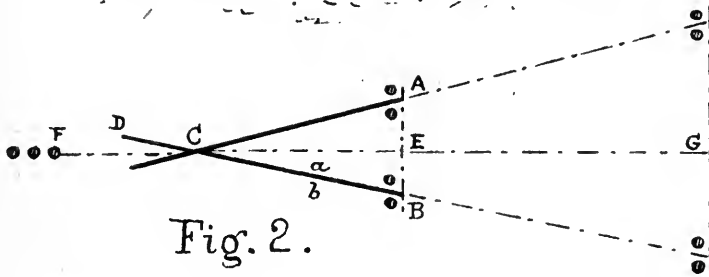
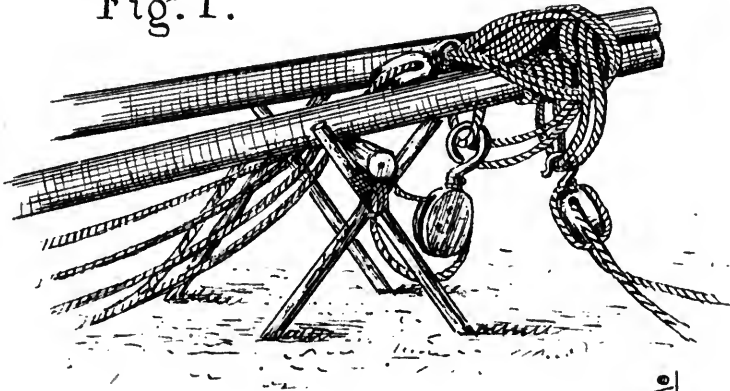
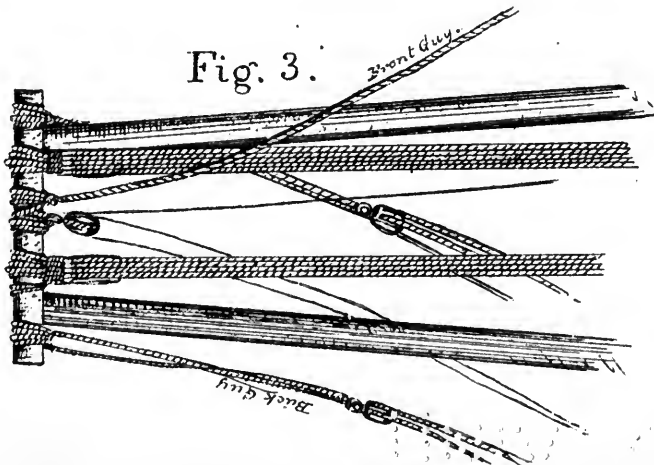

Fig. 2.

Fig. 3.



Chase, Del.

See - Nos. 285, 287, 288.
290.
pars. 546, 548, 549.

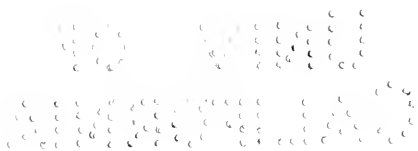

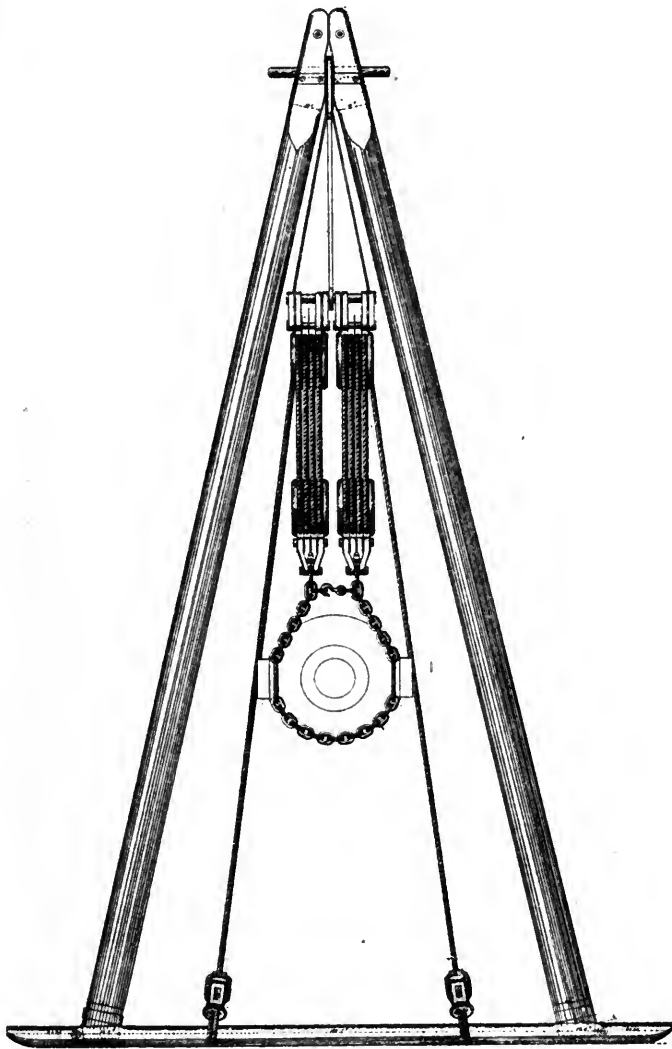

Small, faint markings or text at the bottom of the page, possibly bleed-through from the reverse side. The markings are arranged in a grid-like pattern of small characters, likely a table or list of data.

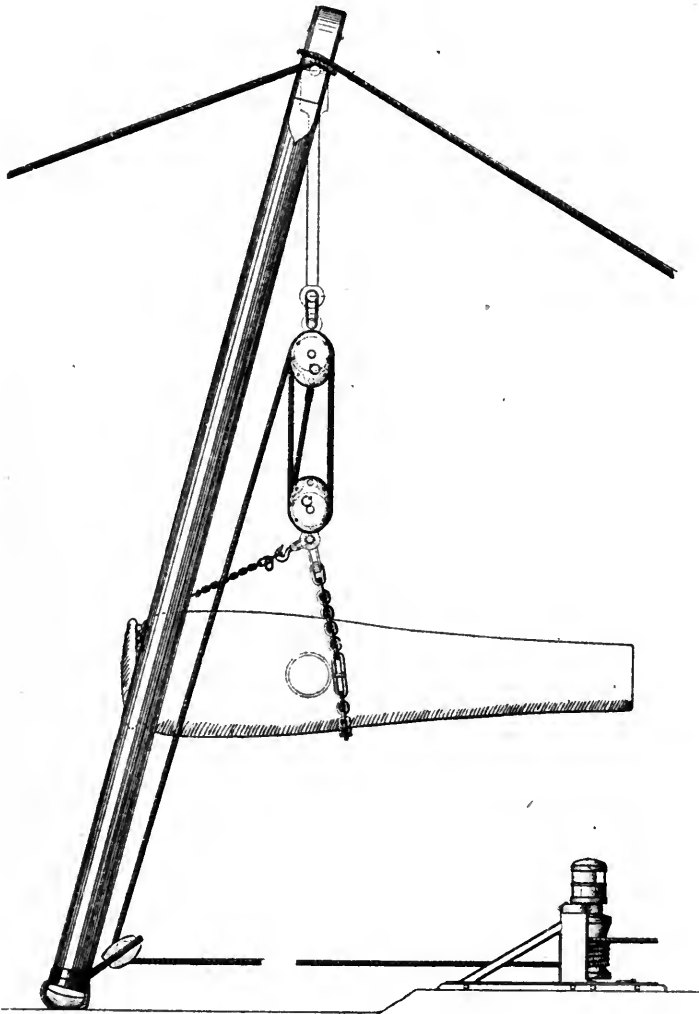

1945

| | | | | | | | | | | | | | | | | | | | | | | | | | | | | | | | | | | | | | | | | | | | | | | | | | | | | | | | | | | | | | | | | | | | | | | | | | | | | | | | | | | | | | | | | | | | | | | | | | | | |
|---|---|---|---|---|---|---|---|---|----|----|----|----|----|----|----|----|----|----|----|----|----|----|----|----|----|----|----|----|----|----|----|----|----|----|----|----|----|----|----|----|----|----|----|----|----|----|----|----|----|----|----|----|----|----|----|----|----|----|----|----|----|----|----|----|----|----|----|----|----|----|----|----|----|----|----|----|----|----|----|----|----|----|----|----|----|----|----|----|----|----|----|----|----|----|----|----|----|----|-----|
| 1 | 2 | 3 | 4 | 5 | 6 | 7 | 8 | 9 | 10 | 11 | 12 | 13 | 14 | 15 | 16 | 17 | 18 | 19 | 20 | 21 | 22 | 23 | 24 | 25 | 26 | 27 | 28 | 29 | 30 | 31 | 32 | 33 | 34 | 35 | 36 | 37 | 38 | 39 | 40 | 41 | 42 | 43 | 44 | 45 | 46 | 47 | 48 | 49 | 50 | 51 | 52 | 53 | 54 | 55 | 56 | 57 | 58 | 59 | 60 | 61 | 62 | 63 | 64 | 65 | 66 | 67 | 68 | 69 | 70 | 71 | 72 | 73 | 74 | 75 | 76 | 77 | 78 | 79 | 80 | 81 | 82 | 83 | 84 | 85 | 86 | 87 | 88 | 89 | 90 | 91 | 92 | 93 | 94 | 95 | 96 | 97 | 98 | 99 | 100 |
|---|---|---|---|---|---|---|---|---|----|----|----|----|----|----|----|----|----|----|----|----|----|----|----|----|----|----|----|----|----|----|----|----|----|----|----|----|----|----|----|----|----|----|----|----|----|----|----|----|----|----|----|----|----|----|----|----|----|----|----|----|----|----|----|----|----|----|----|----|----|----|----|----|----|----|----|----|----|----|----|----|----|----|----|----|----|----|----|----|----|----|----|----|----|----|----|----|----|----|-----|

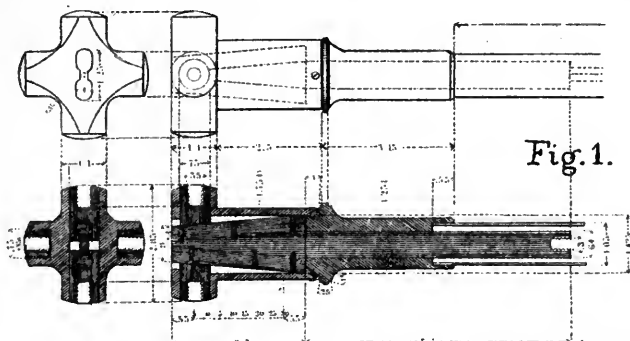

Fig. 1.

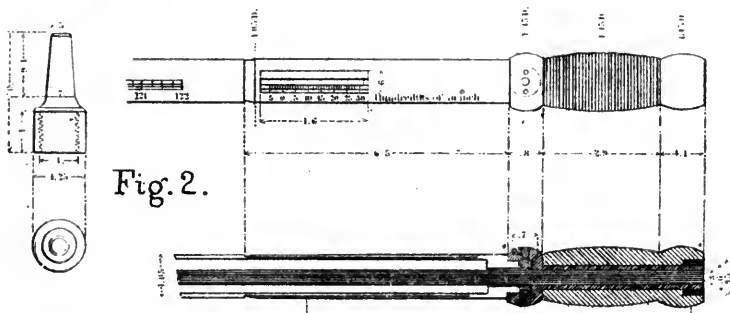

Fig. 2.



Fig. 4.

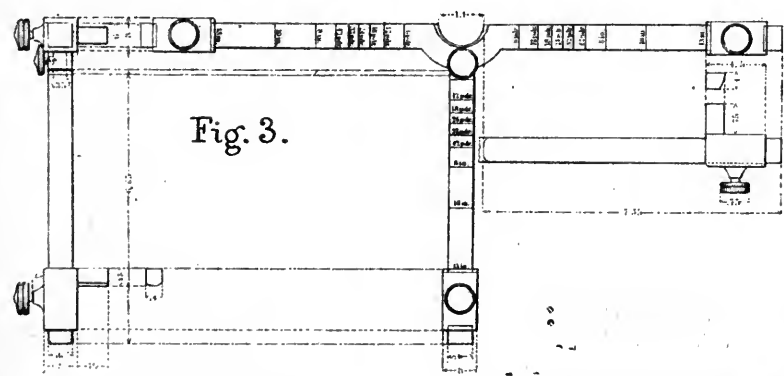

Fig. 3.

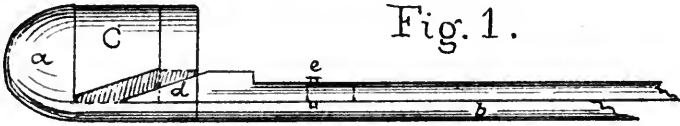

Fig. 1.



Fig. 2.

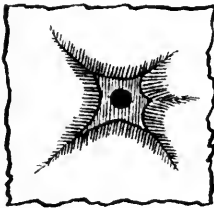

Fig. 4.

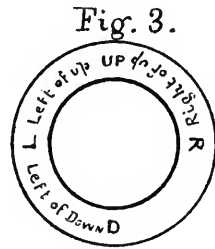

Fig. 3.

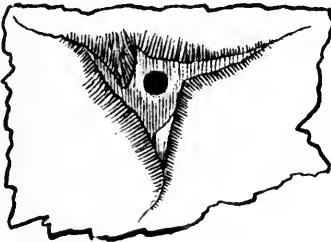
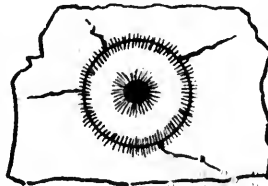
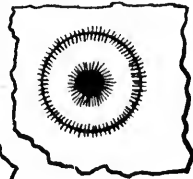

Fig. 5.



Fig. 6.





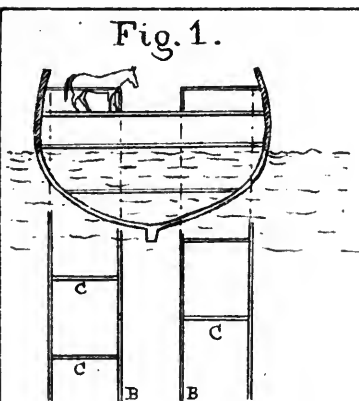

Fig. 1.

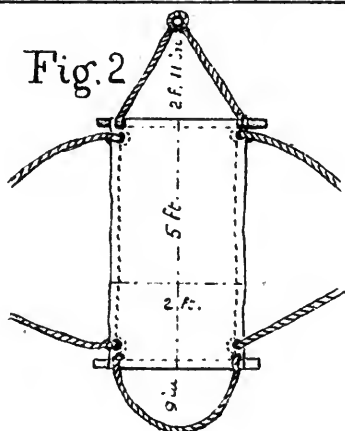

Fig. 2.

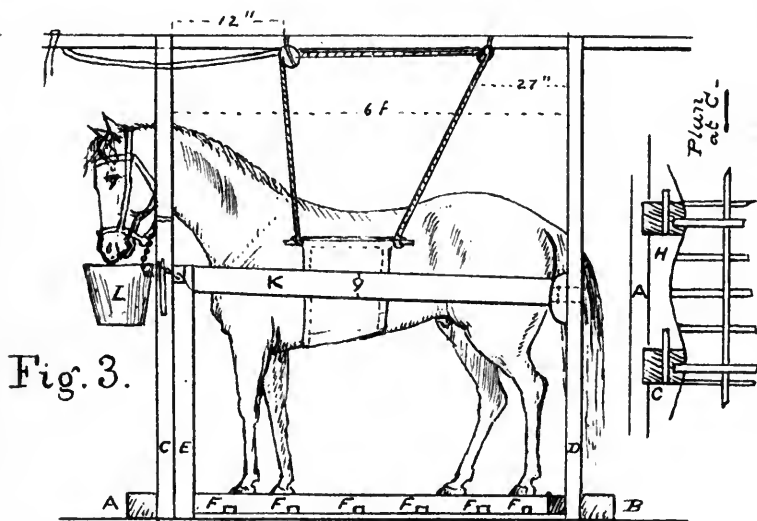

Fig. 3.

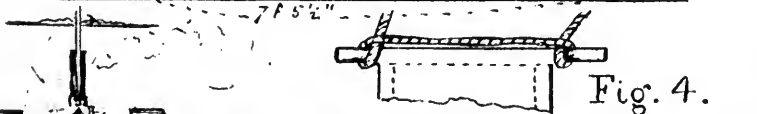

Fig. 4.

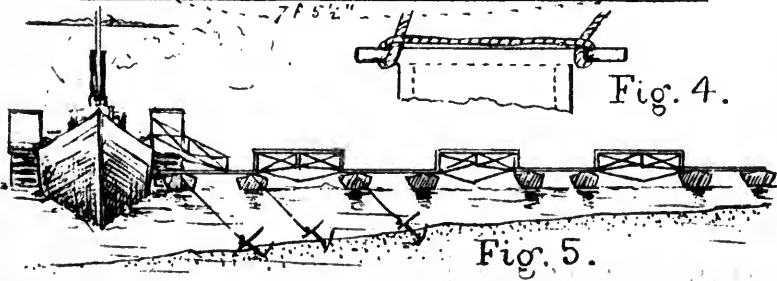

Fig. 5.

Chase, Del.

See -- pp. 327. 329. 330.

332. 336.

pp. 573. 574. 575.

576. 578.

Fig. 1.

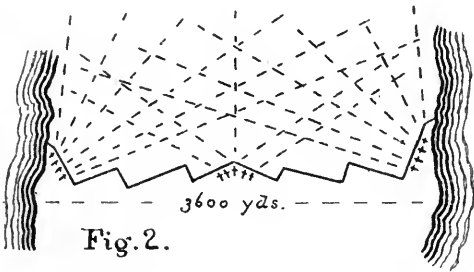
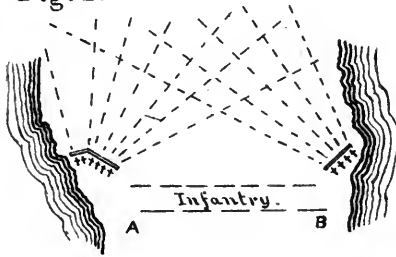

Fig. 2.

Fig. 4.

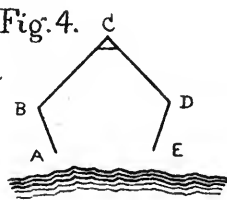

Fig. 3.

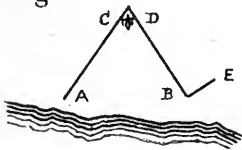

Fig. 5.

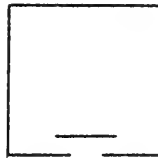
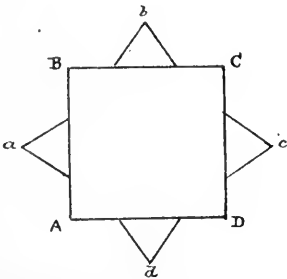

Fig. 6.



•

CC CC CC CC CC CC CC CC CC
CC CC CC CC CC CC CC CC CC
CC CC CC CC CC CC CC CC CC
CC CC CC CC CC CC CC CC CC

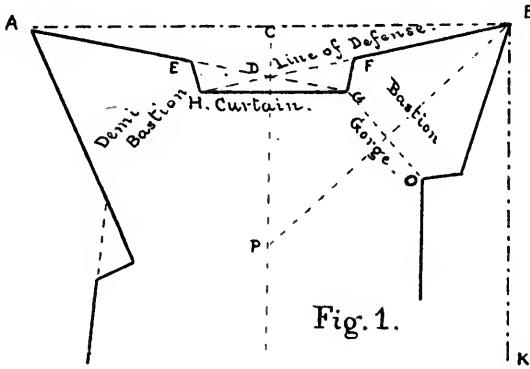

Fig. 1.

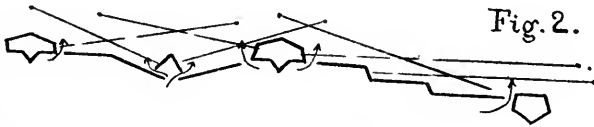

Fig. 2.

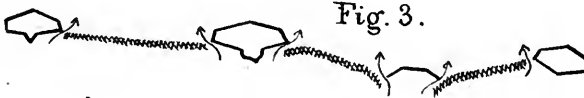

Fig. 3.

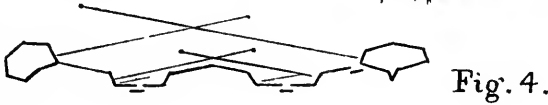

Fig. 4.

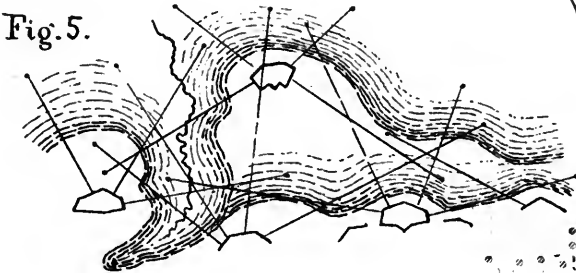

Fig. 5.

THE UNIVERSITY OF CHICAGO
LIBRARY
540 EAST 57TH STREET
CHICAGO, ILL. 60637
312 937 1375

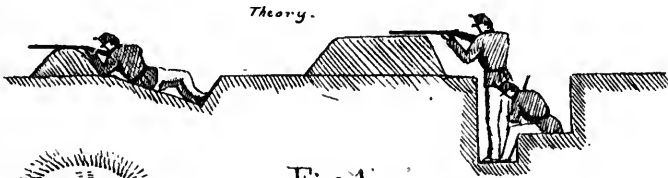

Fig. 1.

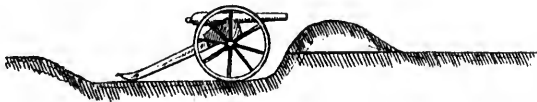
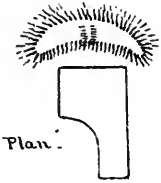

Fig. 2.

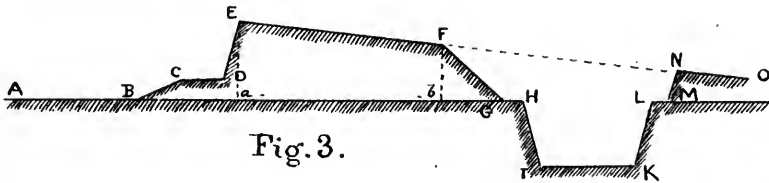

Fig. 3.

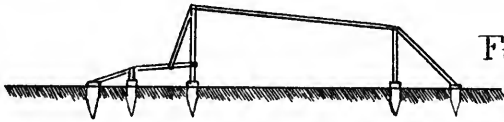

Fig. 1.

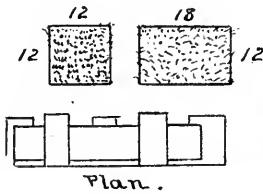

Fig. 2.



Fig. 3.



Fig. 6



Fig. 5.

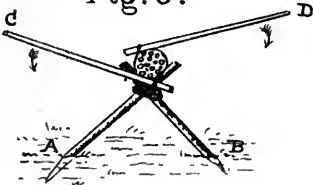

Fig. 4.



Fig. 8.

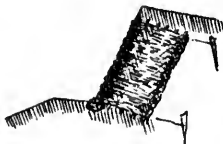
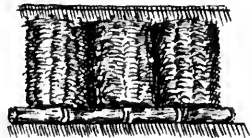

Fig. 7.



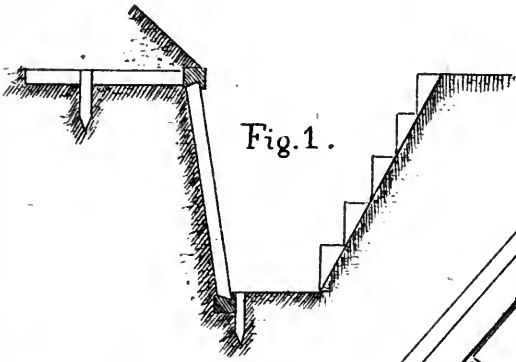

Fig. 1.

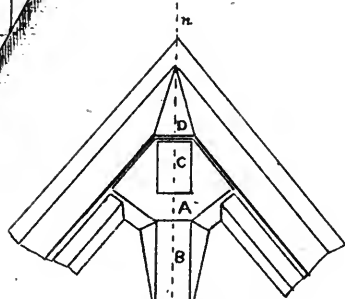

Fig. 2.

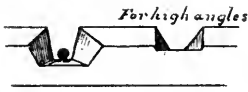

Fig. 4.

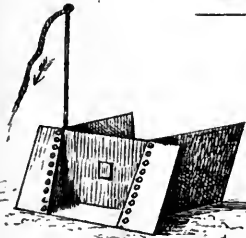

Fig. 5.

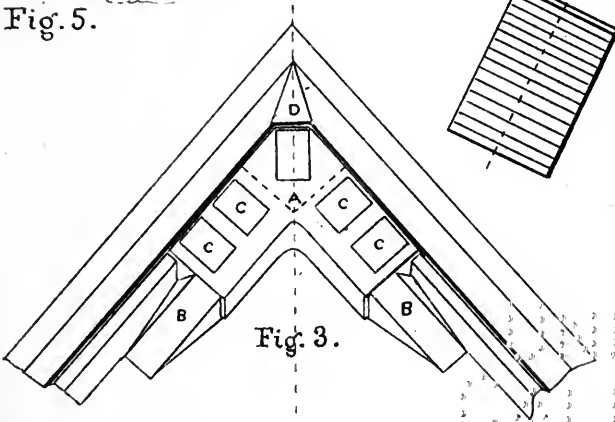
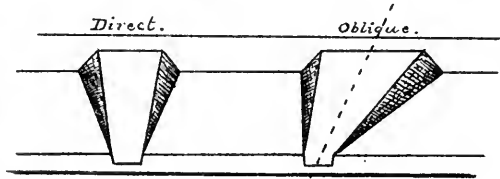
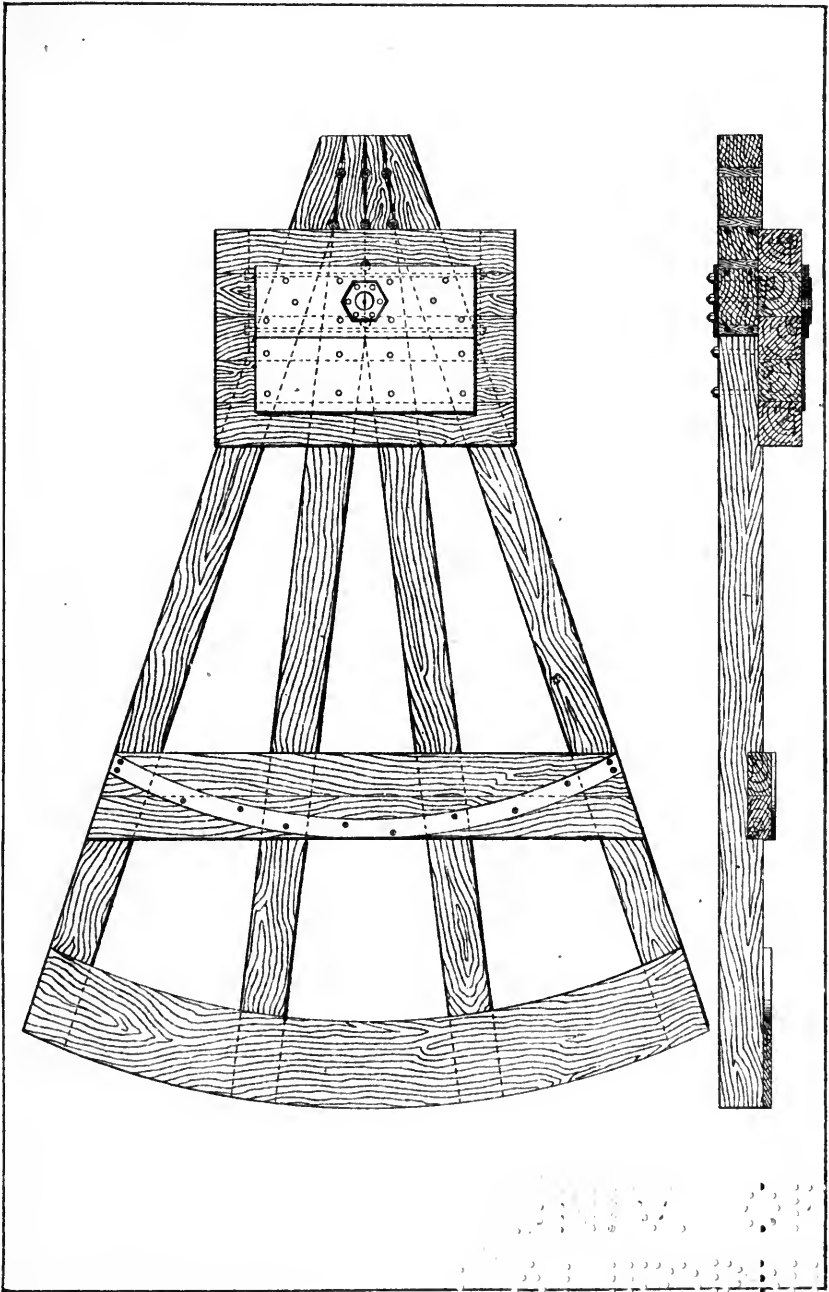
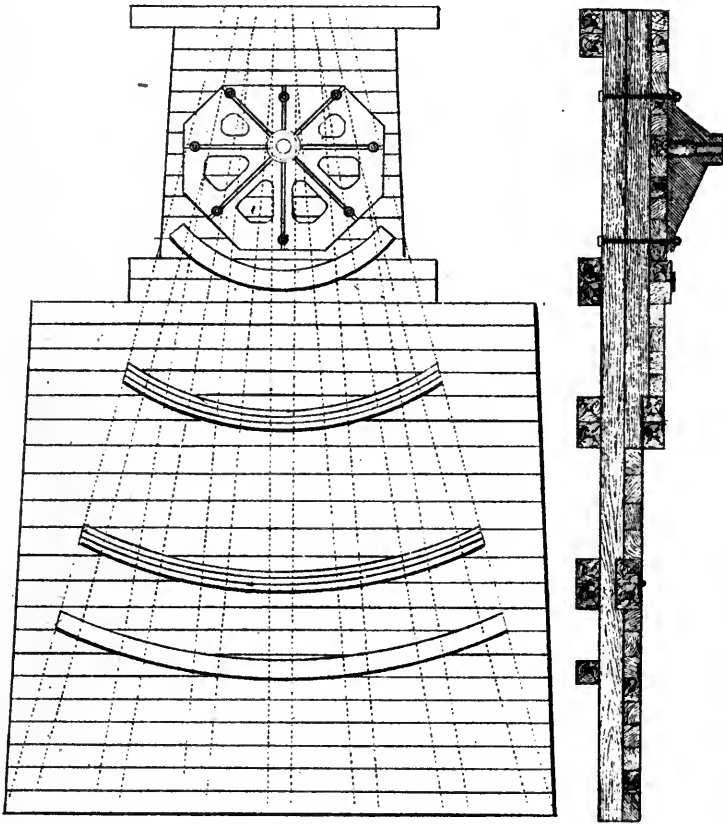

Fig. 3.

1
2
3
4
5
6
7
8
9
10
11
12
13
14
15
16
17
18
19
20
21
22
23
24
25
26
27
28
29
30
31
32
33
34
35
36
37
38
39
40
41
42
43
44
45
46
47
48
49
50
51
52
53
54
55
56
57
58
59
60
61
62
63
64
65
66
67
68
69
70
71
72
73
74
75
76
77
78
79
80
81
82
83
84
85
86
87
88
89
90
91
92
93
94
95
96
97
98
99
100



TO THE
MEMBERS OF THE



See — p. 388. par. 636.

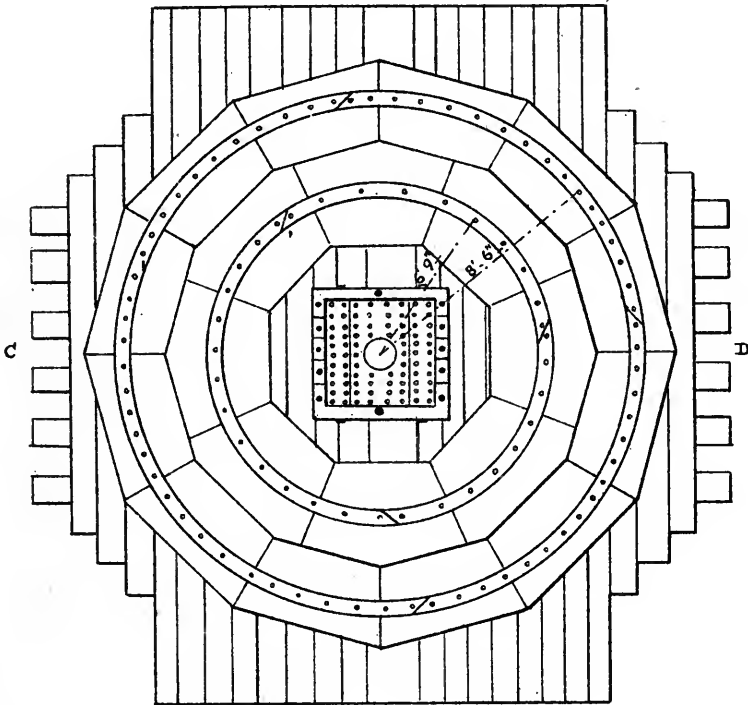
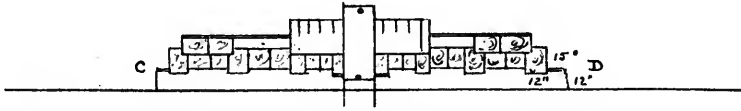

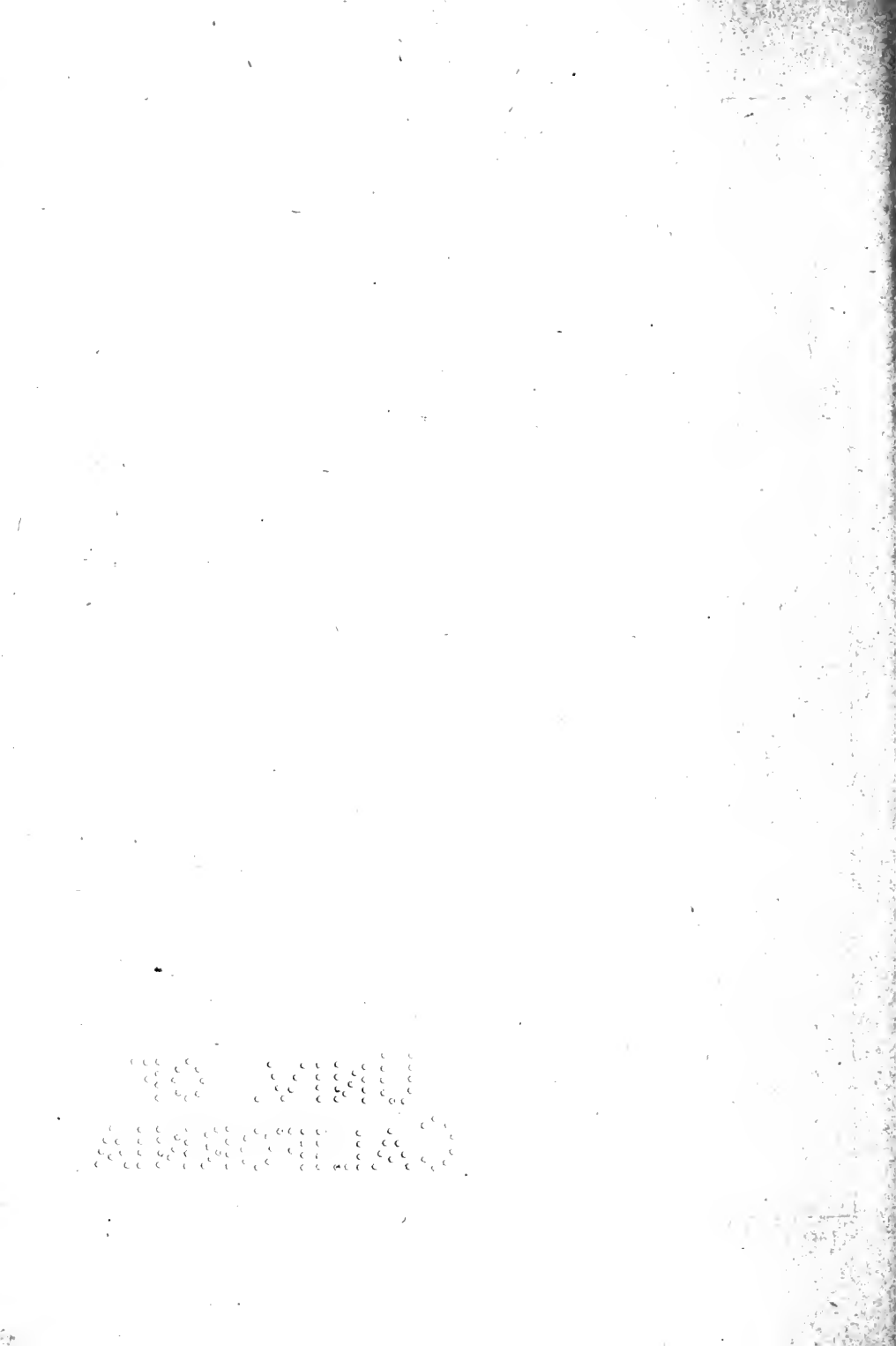

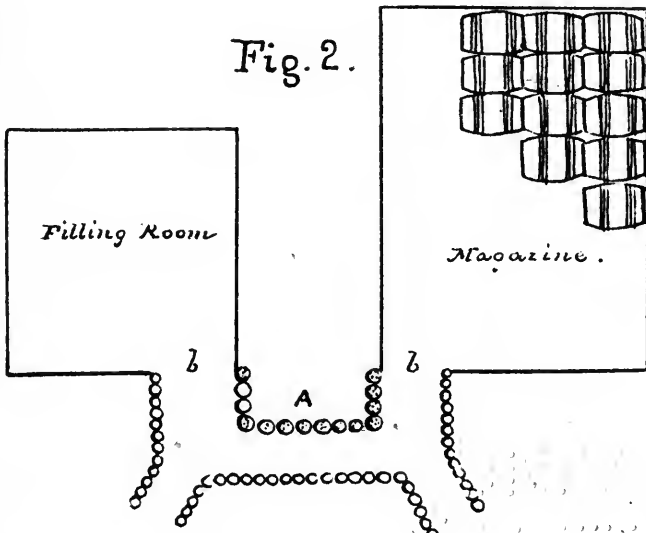
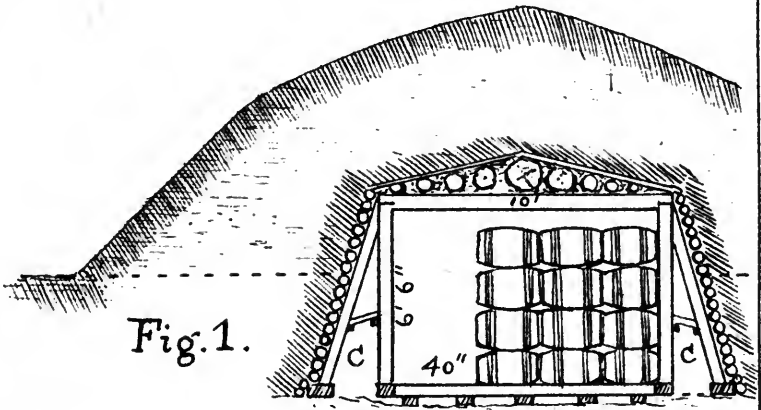

Fig. 1.

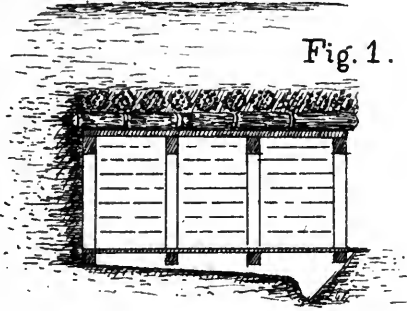

Fig. 4.

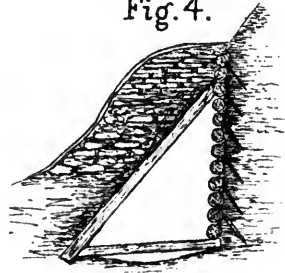

Fig. 2.

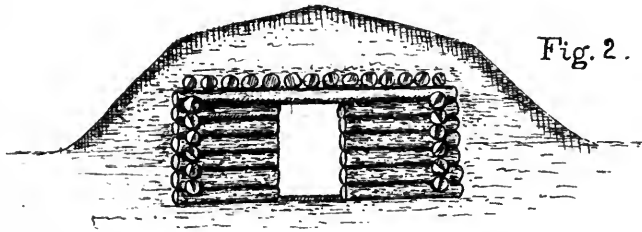

Fig. 3.

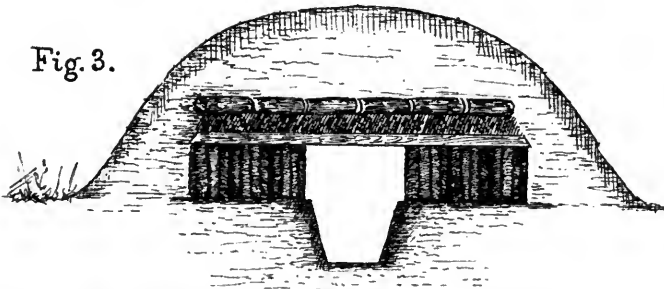
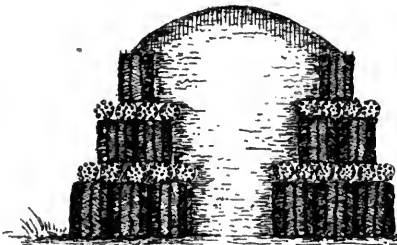

Fig. 5.



1 2 3 4 5 6 7 8 9 10 11 12 13 14 15 16 17 18 19 20 21 22 23 24 25 26 27 28 29 30 31 32 33 34 35 36 37 38 39 40 41 42 43 44 45 46 47 48 49 50 51 52 53 54 55 56 57 58 59 60 61 62 63 64 65 66 67 68 69 70 71 72 73 74 75 76 77 78 79 80 81 82 83 84 85 86 87 88 89 90 91 92 93 94 95 96 97 98 99 100

Fig. 1.

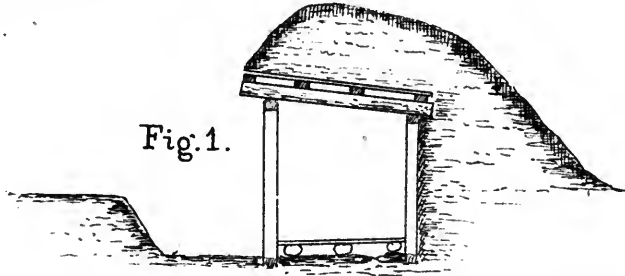

Fig. 4.

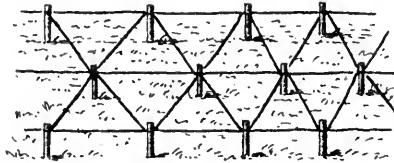

Fig. 5.

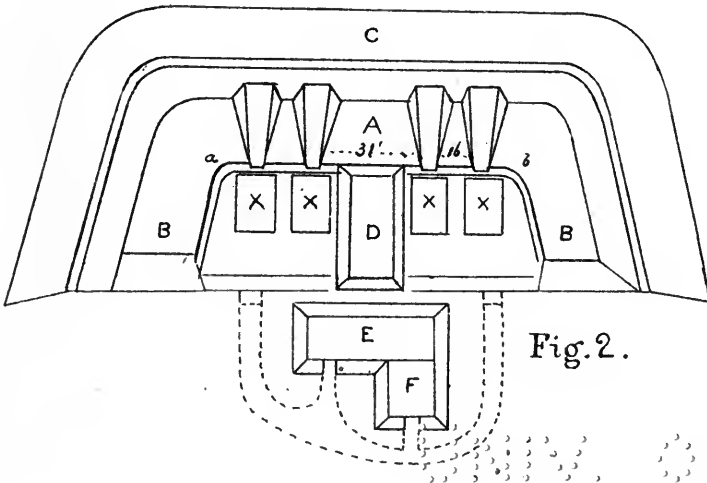

Fig. 2.

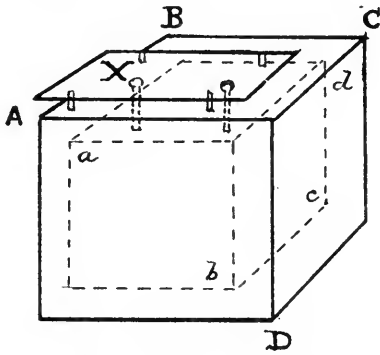

Fig. 1.

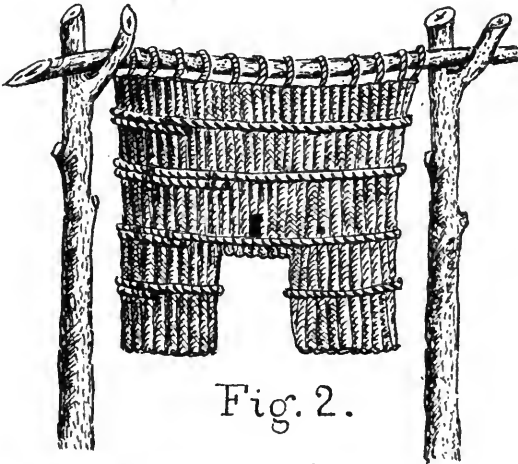

Fig. 2.

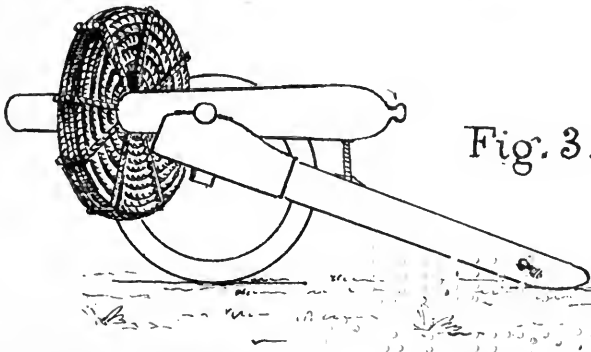
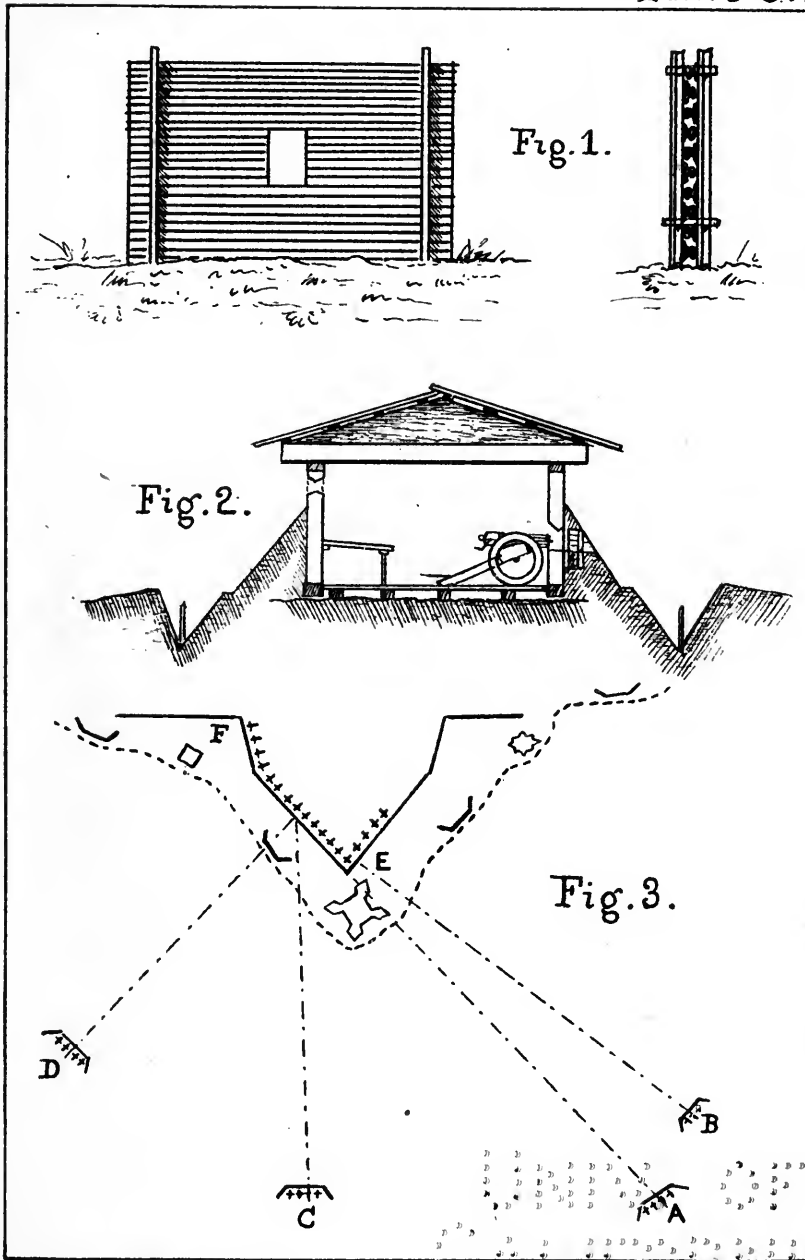

Fig. 3.

1944
1945
1946
1947
1948
1949
1950
1951
1952
1953
1954
1955
1956
1957
1958
1959
1960
1961
1962
1963
1964
1965
1966
1967
1968
1969
1970
1971
1972
1973
1974
1975
1976
1977
1978
1979
1980
1981
1982
1983
1984
1985
1986
1987
1988
1989
1990
1991
1992
1993
1994
1995
1996
1997
1998
1999
2000
2001
2002
2003
2004
2005
2006
2007
2008
2009
2010
2011
2012
2013
2014
2015
2016
2017
2018
2019
2020
2021
2022
2023
2024
2025
2026
2027
2028
2029
2030
2031
2032
2033
2034
2035
2036
2037
2038
2039
2040
2041
2042
2043
2044
2045
2046
2047
2048
2049
2050
2051
2052
2053
2054
2055
2056
2057
2058
2059
2060
2061
2062
2063
2064
2065
2066
2067
2068
2069
2070
2071
2072
2073
2074
2075
2076
2077
2078
2079
2080
2081
2082
2083
2084
2085
2086
2087
2088
2089
2090
2091
2092
2093
2094
2095
2096
2097
2098
2099
2100



Chase, Del.

See - pp. 400-403.
pars. 648-649.

...

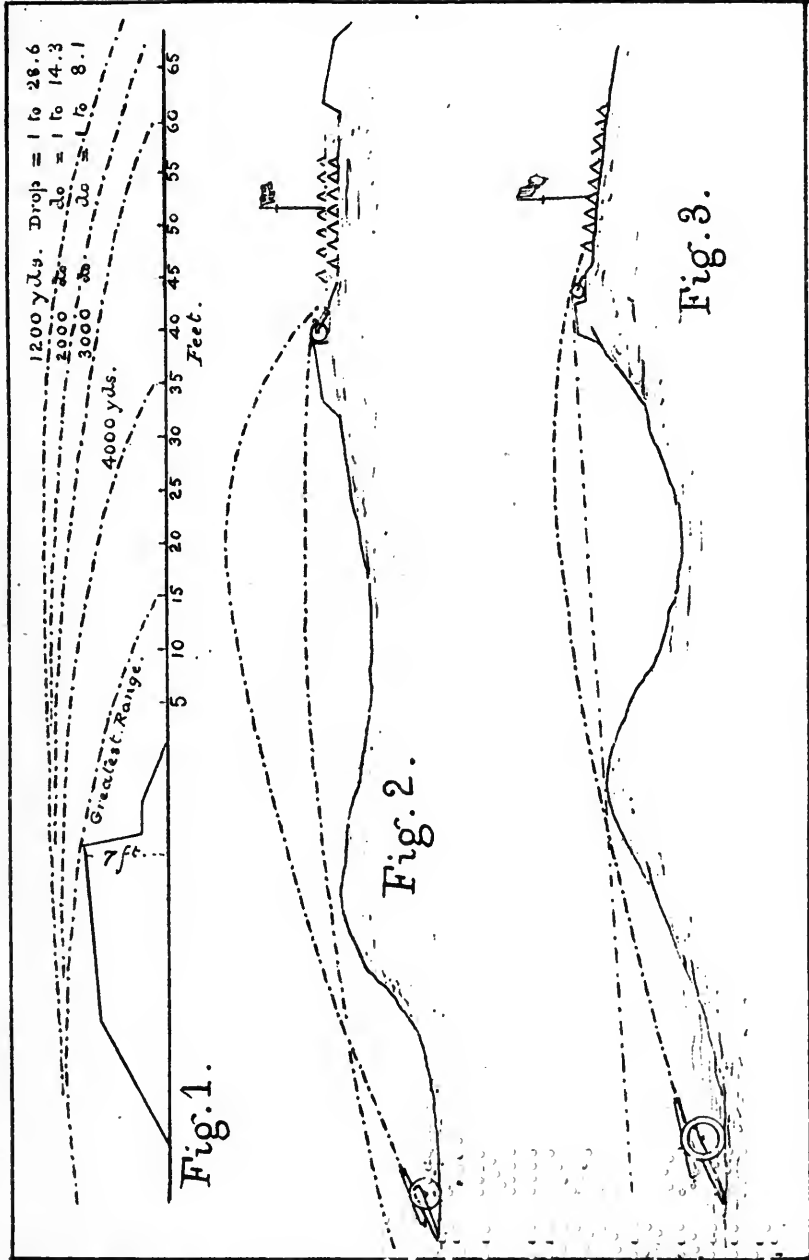

Chase, Del.

See - p. 404.
 par. 650.

© 1981 by
© 1982 by
© 1983 by
© 1984 by
© 1985 by
© 1986 by
© 1987 by
© 1988 by
© 1989 by
© 1990 by
© 1991 by
© 1992 by
© 1993 by
© 1994 by
© 1995 by
© 1996 by
© 1997 by
© 1998 by
© 1999 by
© 2000 by
© 2001 by
© 2002 by
© 2003 by
© 2004 by
© 2005 by
© 2006 by
© 2007 by
© 2008 by
© 2009 by
© 2010 by
© 2011 by
© 2012 by
© 2013 by
© 2014 by
© 2015 by
© 2016 by
© 2017 by
© 2018 by
© 2019 by
© 2020 by
© 2021 by
© 2022 by
© 2023 by

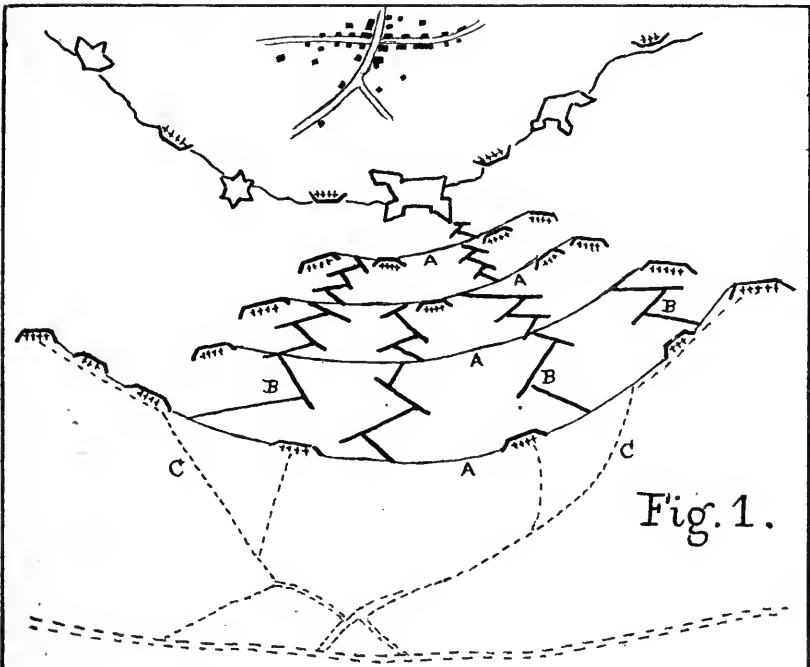

Fig. 1.

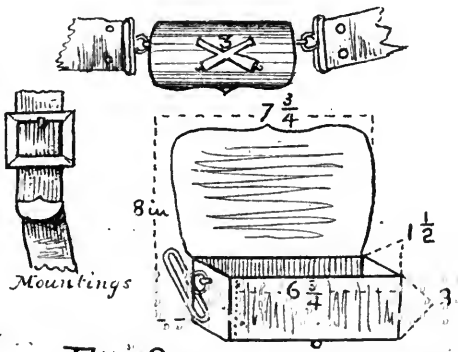
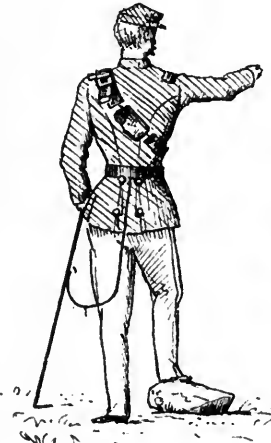
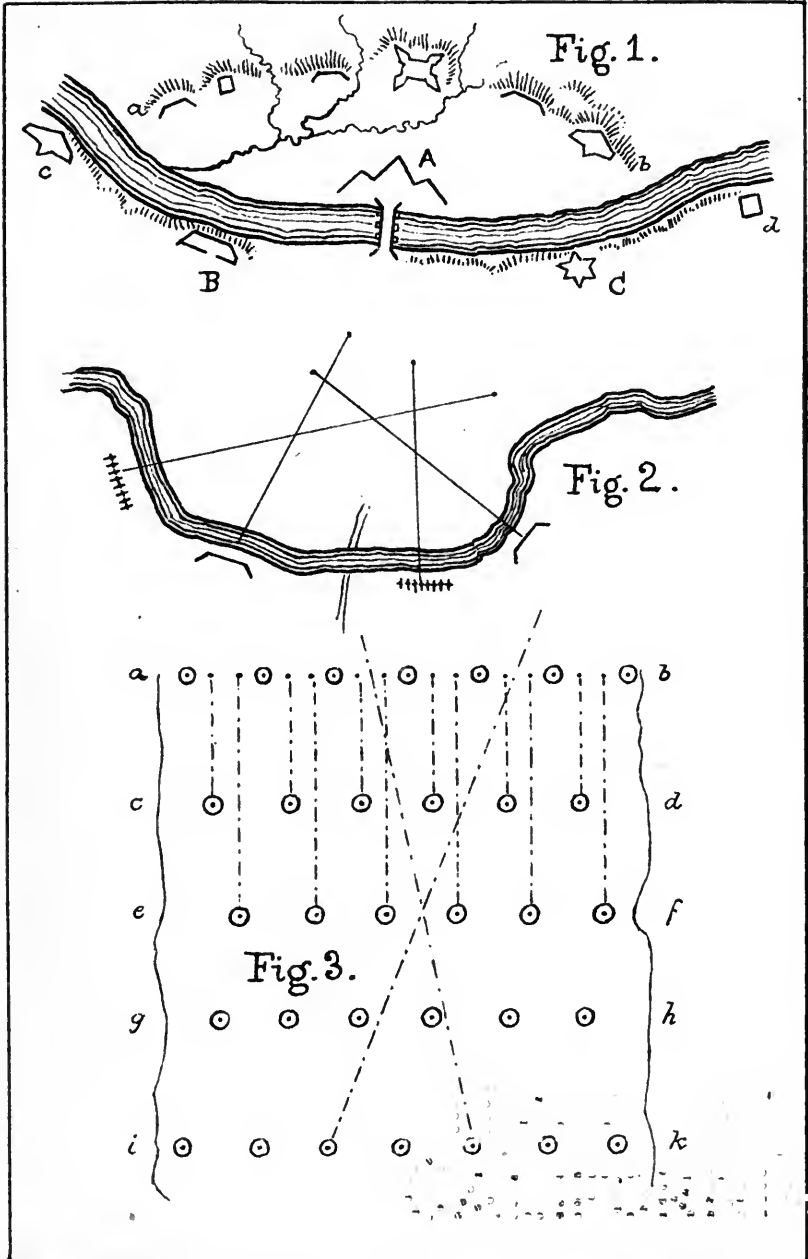

Fig. 2.

Chase, Del.

See - p. 408. 413.
pars. 657. 664.



Chase, Del.

See - pp. 419. 429.
pars. 668. 673.

© 1988 by the
American Psychological Association
0893-3200/88/010000-01
\$02.00

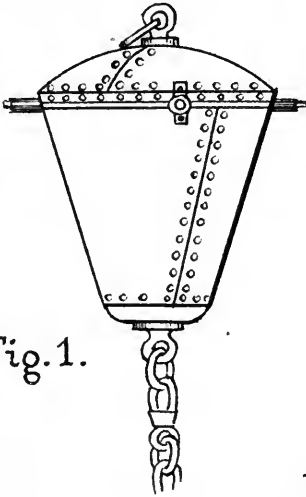

Fig. 1.

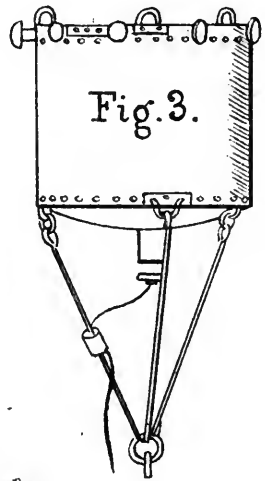

Fig. 3.

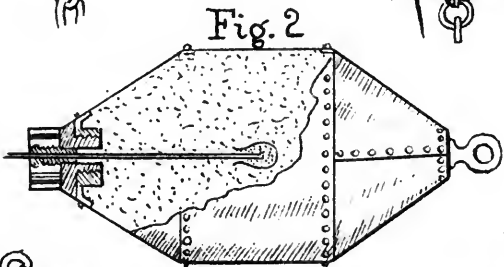

Fig. 2.

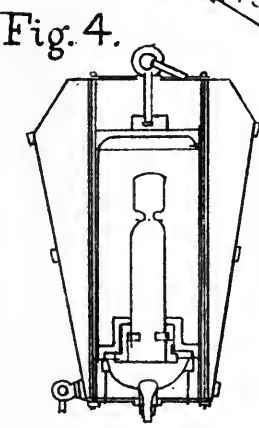

Fig. 4.

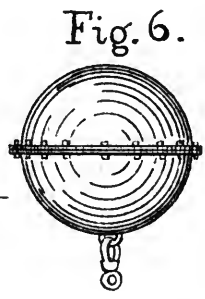

Fig. 6.

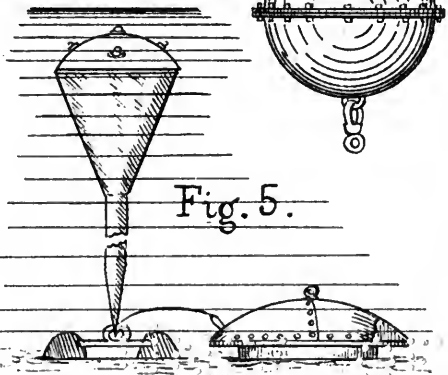

Fig. 5.

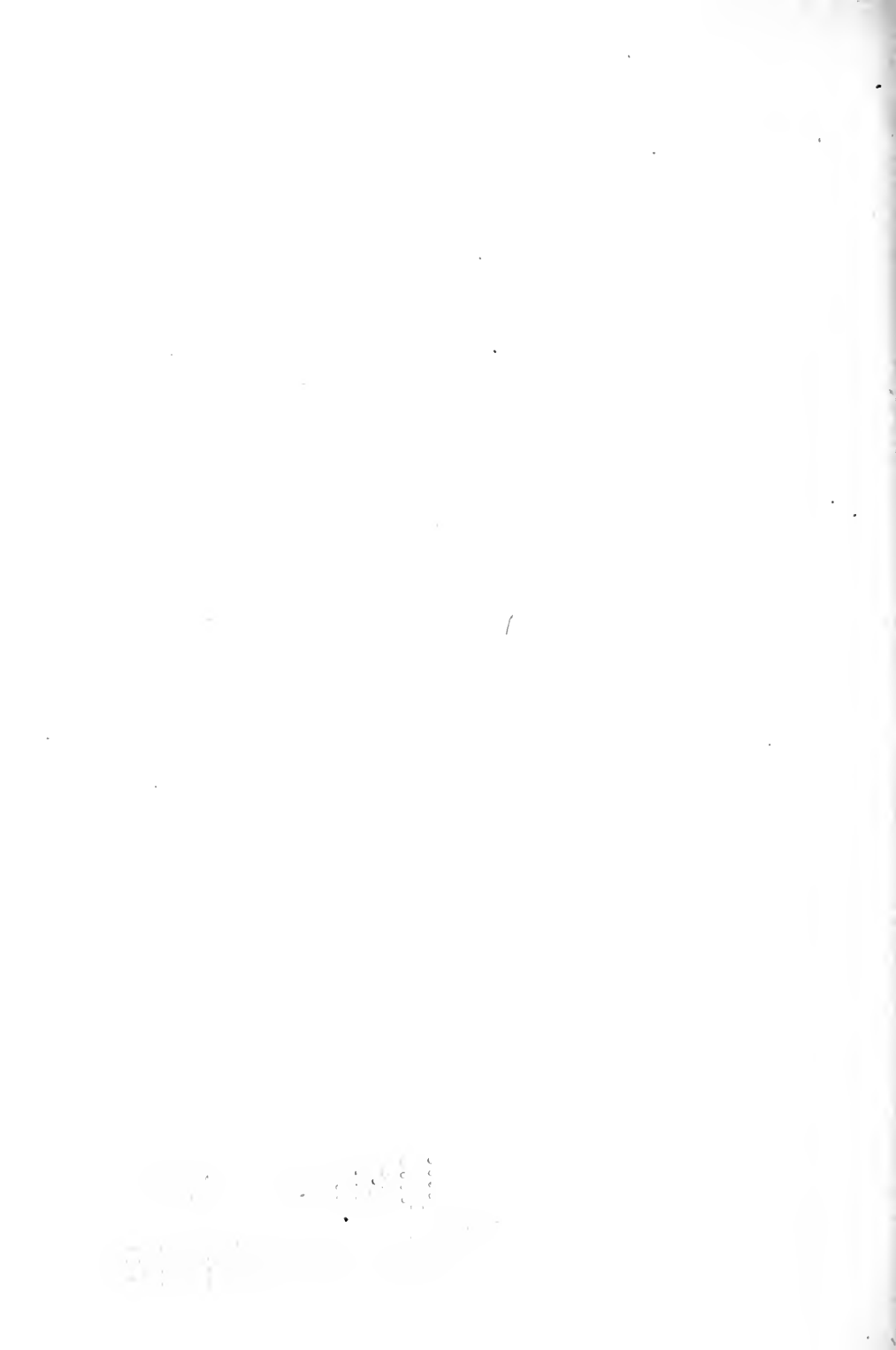

Fig.1.

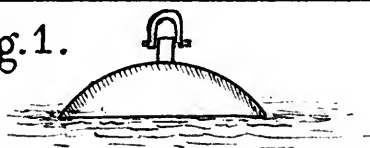

Fig.2.

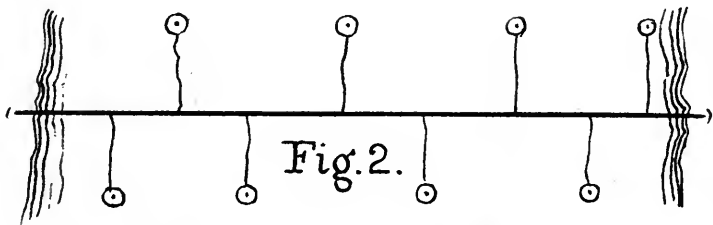

Fig.3.

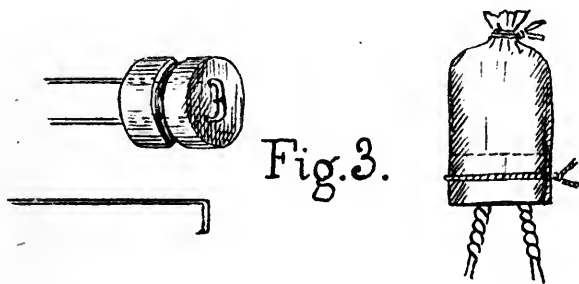
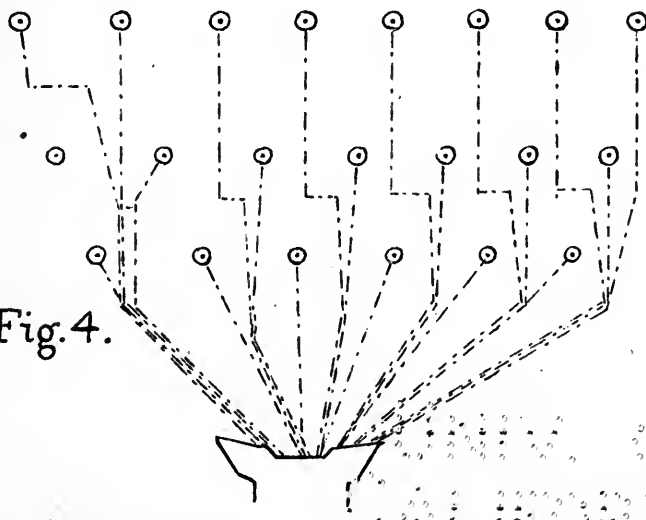

Fig.4.



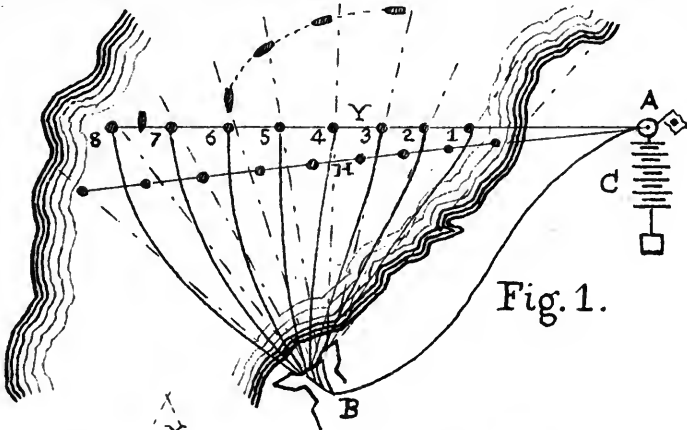

Fig. 1.

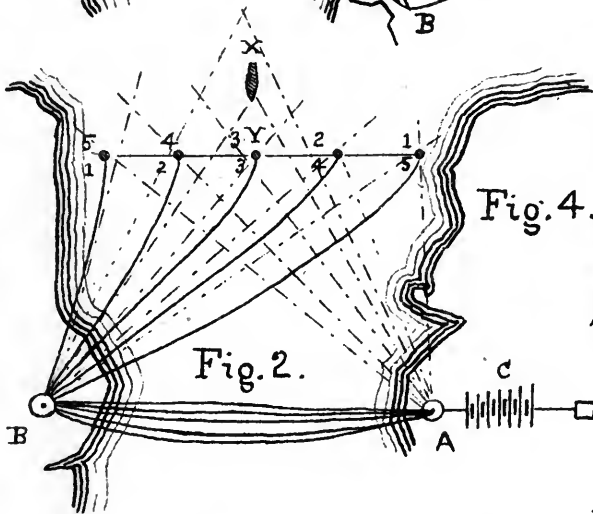

Fig. 2.

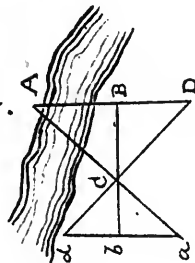

Fig. 4.

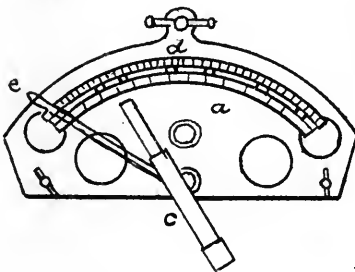
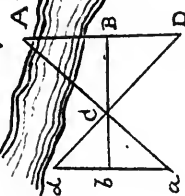
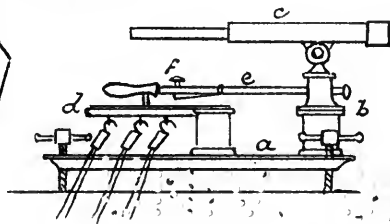
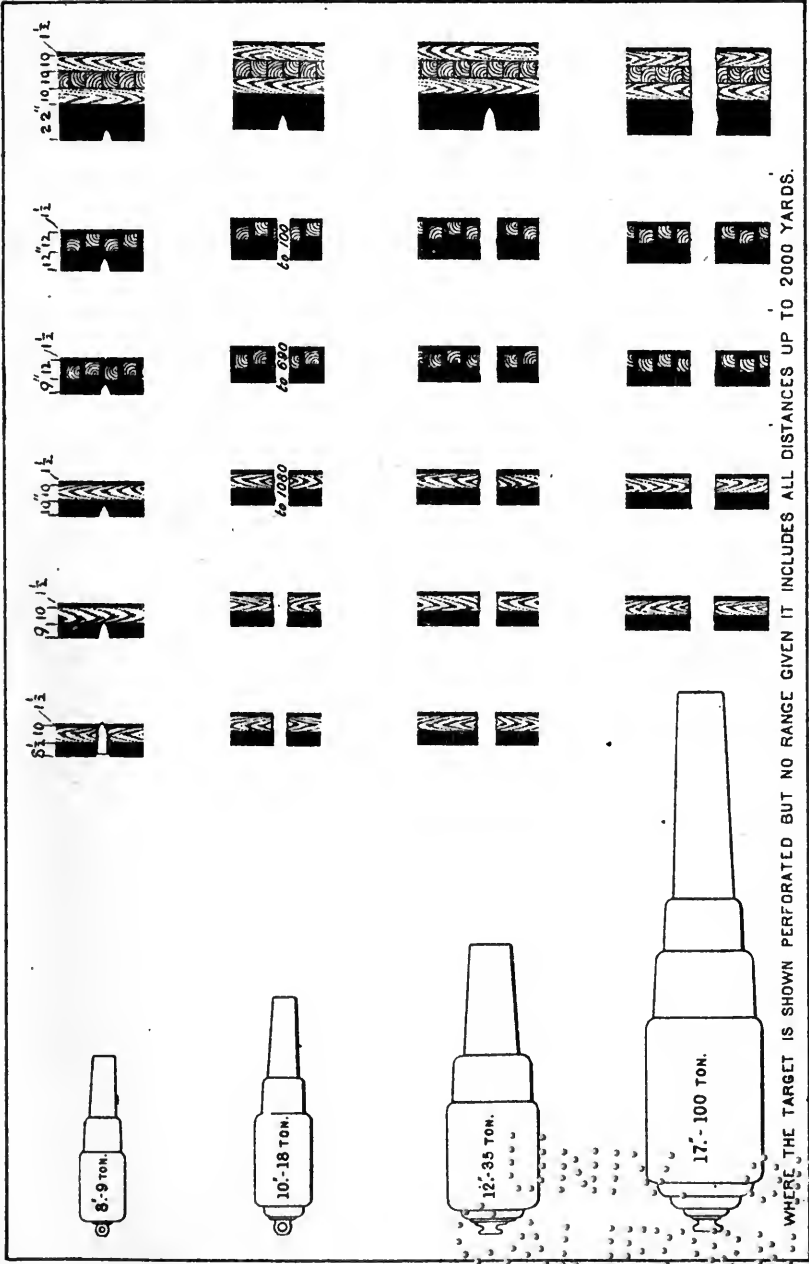

Fig. 3.



ccccc
cccccc
cccccccc
cccccccc
cccccccc



WHERE THE TARGET IS SHOWN PERFORMED BUT NO RANGE GIVEN IT INCLUDES ALL DISTANCES UP TO 2000 YARDS.

See - p. 347.
pat. 586.

1
2
3
4
5
6
7
8
9
10
11
12
13
14
15
16
17
18
19
20
21
22
23
24
25
26
27
28
29
30
31
32
33
34
35
36
37
38
39
40
41
42
43
44
45
46
47
48
49
50
51
52
53
54
55
56
57
58
59
60
61
62
63
64
65
66
67
68
69
70
71
72
73
74
75
76
77
78
79
80
81
82
83
84
85
86
87
88
89
90
91
92
93
94
95
96
97
98
99
100

Fig: A

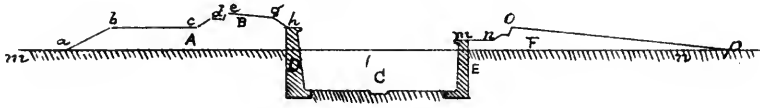

Section thro' line *m.n*

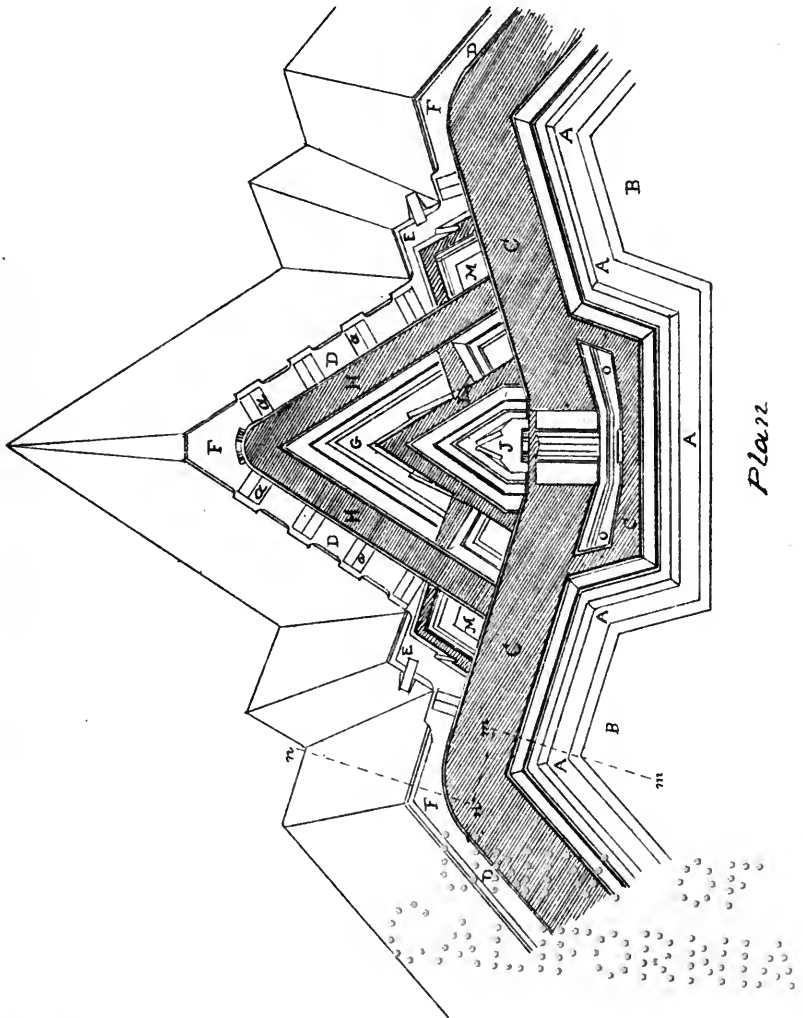

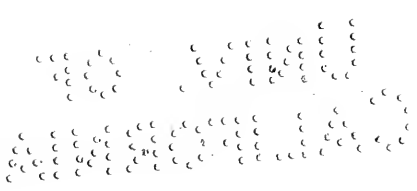

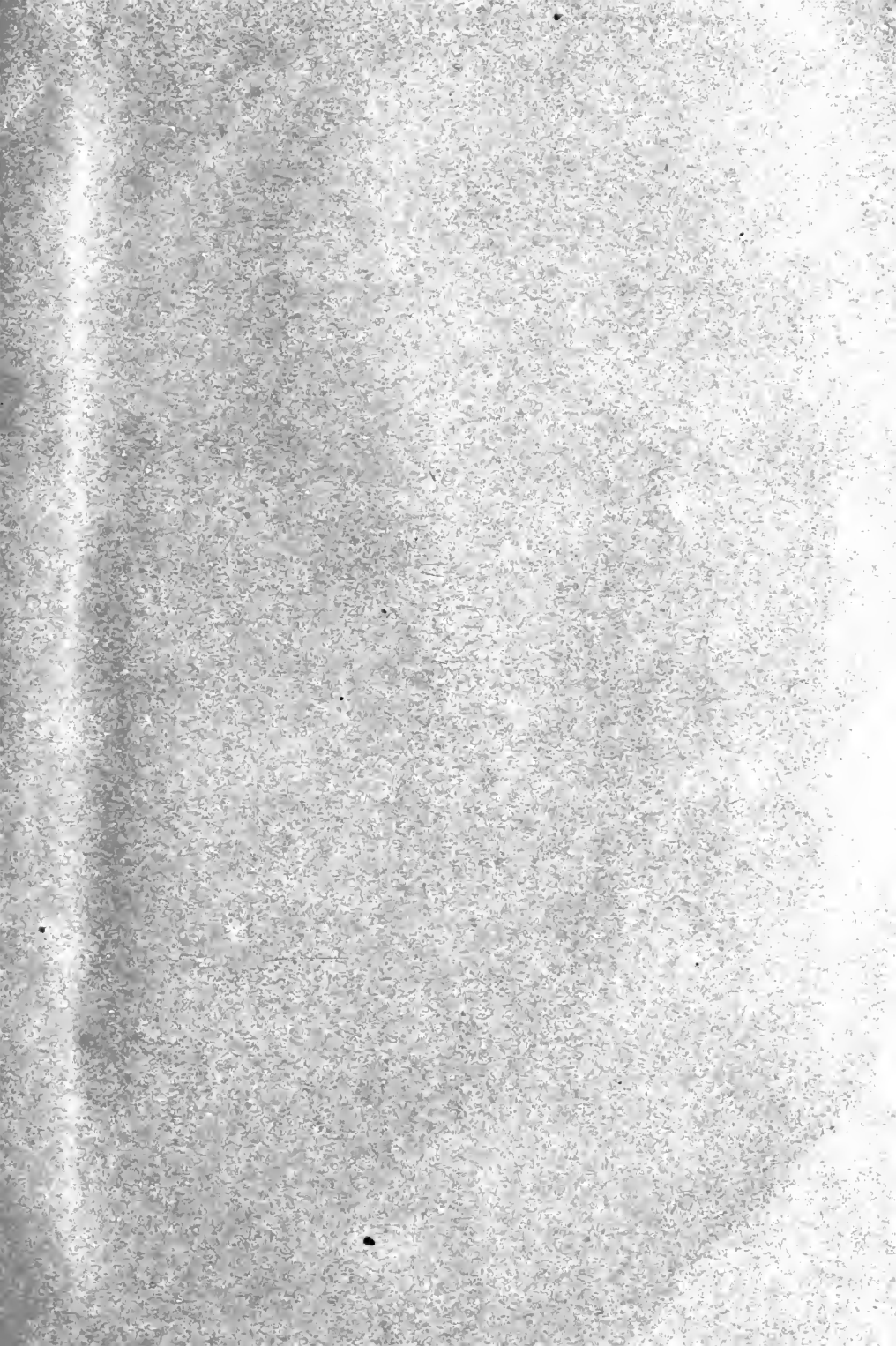

14 DAY USE
RETURN TO DESK FROM WHICH BORROWED
LOAN DEPT.

This book is due on the last date stamped below, or
on the date to which renewed.

Renewed books are subject to immediate recall.

3 Jul '58 FC

RECEIVED

JUL 11 1958

JUN 09 1989

AUTO. DISC.

MAY 18 1989

U.C. BERKELEY LIBRARY



C00528266J

M44344

UF153

T5

1884

THE UNIVERSITY OF CALIFORNIA LIBRARY

