



MBL/WHOI



0 0301 0015747 5











A

MANUAL OF THE INFUSORIA.

---

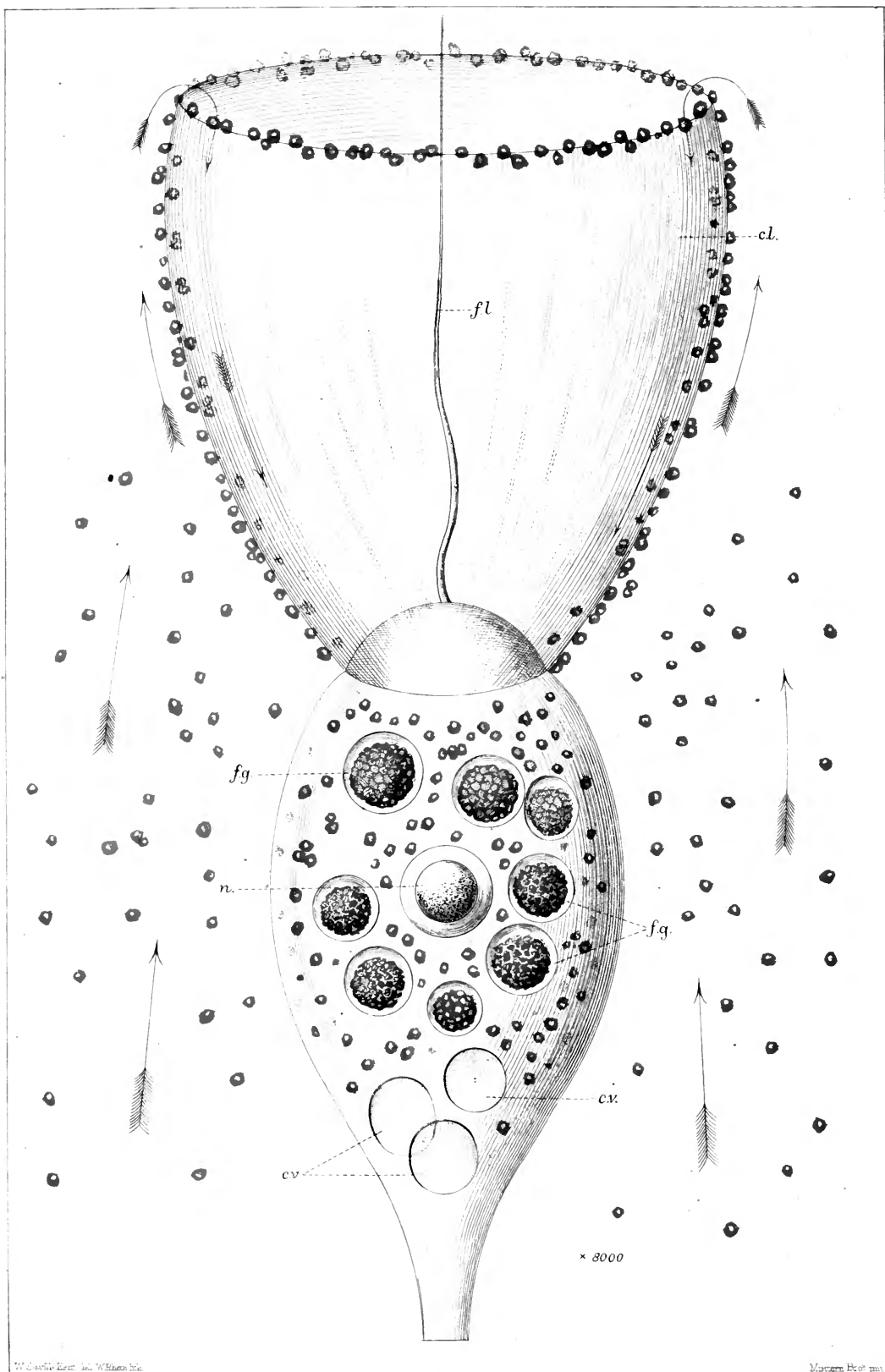
VOLUME III. PLATES.



“Our little systems have their day,  
They have their day and cease to be ;  
They are but broken lights of Thee,  
And Thou, O Lord, art more than they.”

TENNYSON, *In Memoriam*.





## A COLLARED MONAD. — MONOSIGA GRACILIS, S.K.

Artificially fed with *Cornine*. The Arrows denote the direction of the current induced by the rotatory motion of the Flagellum, and the course taken by the Food particles on striking against and adhering to the extended Collar. — cl. Collar. fl. Flagellum. fg. Food globules. n. Endoplast or Nucleus. cv. Contractile vesicles.



A

535  
K 41

# MANUAL OF THE INFUSORIA:

INCLUDING A DESCRIPTION OF ALL KNOWN

FLAGELLATE, CILIATE, AND TENTACULIFEROUS PROTOZOA,

BRITISH AND FOREIGN,

AND AN ACCOUNT OF THE

ORGANIZATION AND AFFINITIES OF THE SPONGES.

BY

W. SAVILLE KENT, F.L.S., F.Z.S., F.R.M.S.,

FORMERLY ASSISTANT IN THE NATURAL HISTORY DEPARTMENTS OF THE BRITISH MUSEUM.

VOLUME III. PLATES.



LONDON:

DAVID BOGUE, 3 ST. MARTIN'S PLACE,

TRAFALGAR SQUARE, W.C.

1880-1882.

N 75 (3)

## PLATE I.



The following abbreviations retain the same significance throughout the present and succeeding Plates :—

*n.* Nucleus or endoplast.  
*cv.* Contractile vesicle.  
*f.* Flagellum.

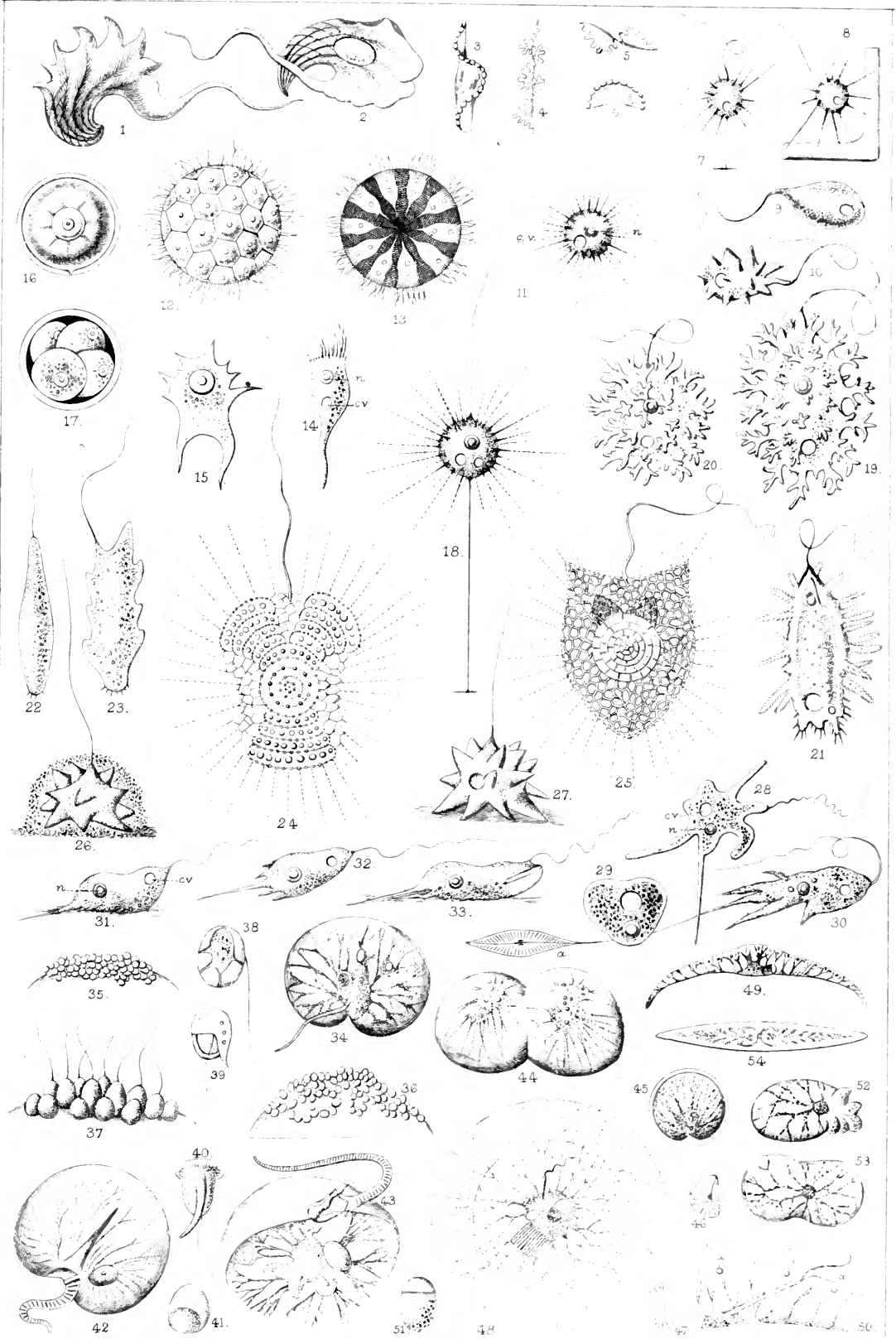
*cl.* Collar.  
*o.* Oral aperture.  
*an.* Anal aperture.

Where the figures are borrowed from another authority, the name of such authority is bracketed ; where no bracketed name appears the figures are derived from the author's original investigation.



## EXPLANATION OF PLATE I.

- FIG.
- 1, 2. *TRYPANOSOMA SANGUINIS*, Grube,  $\times 600$  (Ray Lankester).
  - 3-6. *TRYPANOSOMA EBERTHI*, S. K.,  $\times 1200$  (Eberth).
  - 7, 8. *ACTINOMONAS PUSILLA*, S. K.—7, Zooid attached by a single stalk-like filament ;  
8, zooid attached by a number of its ray-like pseudopodia,  $\times 800$ .
  - 9-11. *ACTINOPHRYS SOL*, Ehr.—Successive developmental phases out of a primary  
monadiform germ, as observed by the author,  $\times 600$ .
  - 12-17. *MAGOSPHERA PLANULA*, Hkl.—12, Adult spheroidal colony-stock,  $\times 240$ ; 13,  
ideal optical section of the same ; 14, a single isolated zooid derived from the  
disintegration of the social colony-stock ; 15, a similar zooid having assumed  
an amœboid phase ; 16 and 17, encysted zooids, the one at 17 having divided  
by segmentation into four spheroidal sporular bodies (Haeckel).
  18. *ACTINOMONAS MIRABILIS*, S. K.,  $\times 800$ .
  - 19, 20. *MASTIGAMÆBA RAMULOSA*, S. K., extended and contracted conditions,  $\times 400$ .
  21. *MASTIGAMÆBA ASPERA*, Sczl.,  $\times 170$  (Schulze).
  - 22, 23. *MASTIGAMÆBA MONOCILIATA*, Carter sp., dimensions unrecorded (Carter).
  24. *EUCHITONIA VIRCHOWII*, Hkl.,  $\times 370$  (Haeckel).
  25. *SPONGOCYCLIA CHARYBDEA*, Hkl.,  $\times 72$  (Haeckel).
  - 26, 27. *RHIZOMONAS VERRUCOSA*, S. K. — 26, Animalcule enclosed within granular  
gelatinous sheath,  $\times 750$ ; 27, example devoid of such covering.
  - 28, 29. *PODOSTOMA FILIGERUM*, C. & L.—28, Animalcule with flagelliferous pseudo-  
podia extended ; 29, example with appendages entirely retracted,  $\times 250$   
(Clap. and Lach.).
  30. *MASTIGAMÆBA SIMPLEX*, S. K.—Having attached by a posteriorly extended  
thread of sarcode the frustule of a diatom, probably ejected from its body,  
 $\times 800$ .
  - 31-33. *REPTOMONAS CAUDATA*, S. K.—31, Normal animalcule, profile view,  $\times 800$  ;  
32, Dorsal view of example with short posterior pseudopodal extensions ;  
33, a similar example in the act of ingesting food by the peripheral exten-  
sion of its body-sarcode.
  - 34-44. *NOCTILUCA MILIARIS*, Suriray.—34, Normal adult animalcule,  $\times 40$  ; 35 and  
36, peripheral regions of two animalcules having variously developed masses  
of germinal bodies,  $\times 50$  (Cienkowski) ; 37, a similar germinal patch more  
highly magnified, and showing its composition of unflagellate monadiform  
elements (Cienk.) ; 38-40, isolated monadiform germs in different aspects and  
phases of development,  $\times 500$  (Cienk.) ; 41, more abnormal zoospore-like  
germ,  $\times 500$  (Cienk.) ; 42, entire adult animalcule, dorsal view, showing  
median groove, stylate rod, and tooth-like process (Huxley) ; 43, latero-  
inferior view, showing oral cavity with tooth-like process and contained  
cilium (Huxley) ; 44, conjugation of two animalcules (Cienk.).
  45. Encysted condition of *Noctiluca*, figured by Wyville Thomson as a new diatom,  
*Pyrocystis pseudo-noctiluca*,  $\times 30$  (Wyv. Thom.).
  - 46-53. *LEPTODISCUS MEDUSOIDES*, Hwg. (Hertwig).—46 and 47, Two animalcules with  
edges variously folded, nat. size ; 48, animalcule extended,  $\times 40$  ; 49,  
zooid in vertical section, showing the thicker central and more attenuate  
peripheral regions ; 50, segment of a similar section more highly magnified,  
showing oblique tubular oral fossa, superiorly attached flagellum, and at  
*aaa* superficial oil-like globules ; 51, endoplast or nucleus of adult animal-  
cule,  $\times 100$  ; 52 and 53, supposed developmental phases of *Leptodiscus*,  
with, in the former instance, one-half of the cyst-like body-wall contracted.
  54. *PYROCYSTIS FUSIFORMIS*, Wyv. Thomson.—Probably the encysted condition  
of *Leptodiscus*,  $\times 35$  (Wyv. Thom.).





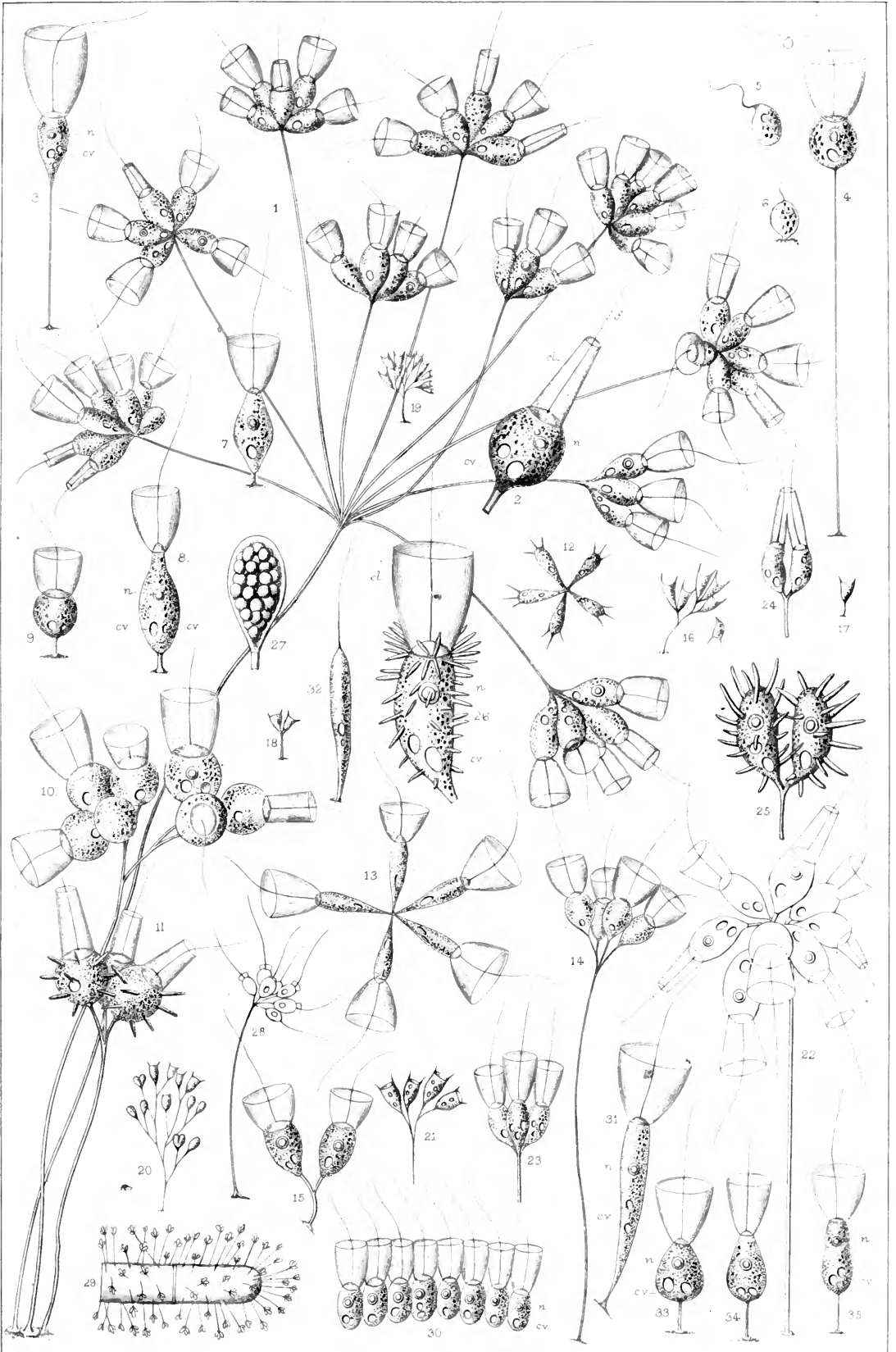




*PLATE II.*

EXPLANATION OF PLATE II.

- FIG.
- 1, 2. CODOSIGA ALLOIDES, S. K.—1, Umbellate adult colony-stock, or zoodendrium, bearing numerous terminal clusters of associated collared zooids,  $\times 650$ ; 2, a single zooid or animalcule with its body spherically, and collar conically contracted,  $\times 800$ .
3. MONOSIGA GRACILIS, S. K.,  $\times 1200$ .
- 4-6. MONOSIGA GLOBULARIS, S. K.—4, Adult zooid,  $\times 1500$ ; 5, free-swimming monadiform germ; 6, subsequent attached condition of free-swimming germ, the characteristic collar and pedicle being as yet undeveloped.
- 7-9. MONOSIGA BREVIPES, S. K.—Exhibiting diverse protean contours,  $\times 1200$ .
- 10, 11. CODOSIGA GROSSULARIA, S. K.—10, Normal adult colony-stock,  $\times 1000$ ; 11, smaller colony of three zooids only, having their collars conically contracted, and protruding numerous lateral, digitiform, pseudopodic processes.
- 12, 13. ASTROSIGA DISJUNCTA, From. sp.—12, Free-floating colony as imperfectly delineated by De Fromentel, the lateral margins of the collars and bases of the enclosed flagella only being represented,  $\times 600$ ; 13, the same colony further enlarged, the details missing in the preceding figure being added by the author.
14. CODOSIGA PYRIFORMIS, S. K.,  $\times 1200$ .
- 15-19. CODOSIGA FURCATA, S. K.—15, Colony of two zooids as observed by the author,  $\times 1200$ ; 16-19, imperfectly observed colony-stocks of various dimensions, as figured by Stein in the year 1854 ('Die Infusionsthier,' Taf. iii. figs. 42 and 43), as probable young conditions of *Epistylis digitalis* or *Zoothamnium parasita*,  $\times 450$ .
- 20, 21. CODOSIGA STEINII, S. K., figured by Stein (Wiegmann's 'Archives,' 1849), as probable young conditions of *Epistylis (Opercularia) nutans*,  $\times 300$ .
- 22-29. CODOSIGA (EPISTYLIS) BOTRYTIS, Ehr. sp. (*C. pulcherrima*, Jas.-Clk.).—22, Colony-stock with pendulous zooids diagrammatically outlined,  $\times 1000$ ; 23, smaller colony with three erect zooids; 24, single zooid dividing by longitudinal fission, the process having already extended through the body and the proximal region of the contracted collar; 25, two zooids assuming an amœboid condition, their collars and flagella being entirely retracted and digitiform pseudopodia protruded from all parts of their periphery; 26, a single zooid emitting similar but more slender pseudopodic processes, the collar and flagellum remaining extended,  $\times 2000$ ; 27, sporocyst with contained spores derived from the encystment and segmentation of a single zooid; 28, earliest illustration of the species in which the existence of the characteristic membranous collars is clearly indicated, as given by Fresenius in the year 1858; 29, associated colony-stocks crowded upon a confervoid filament,  $\times 120$ .
30. DESMARELLA MONILIFORMIS, S. K.—A free-floating colony-stock of eight laterally united zooids,  $\times 1200$ .
- 31, 32. MONOSIGA ANGUSTATA, S. K.—31, Normal adult zooid,  $\times 2500$ ; 32, immature or larval condition with the collar as yet undeveloped.
- 33-35. MONOSIGA OVATA, S. K.—33 and 34, Typical zooids,  $\times 1200$ ; 35, zooid abnormally prolonged preparatory to dividing by transverse fission.



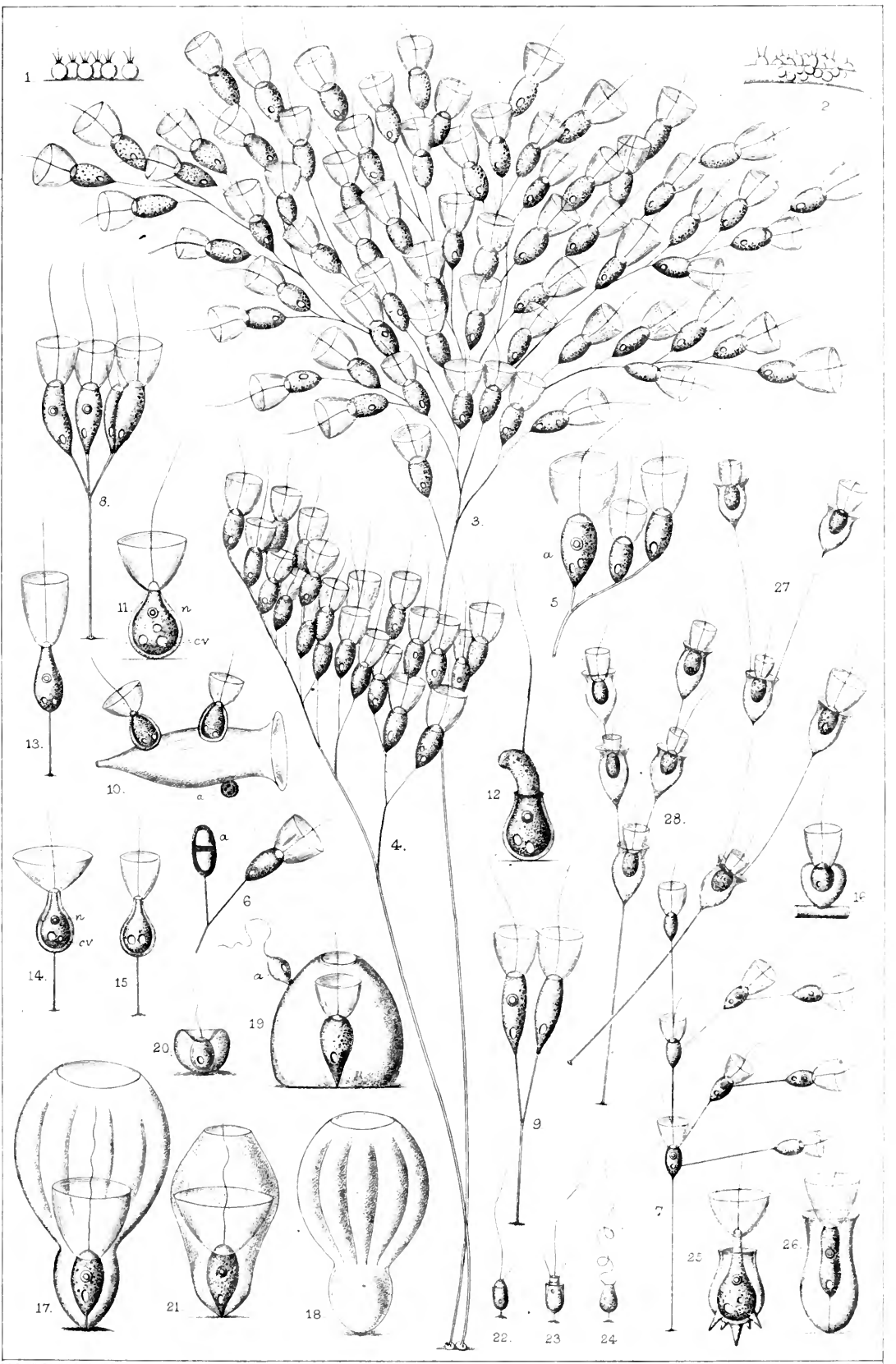


*PLATE III.*

EXPLANATION OF PLATE III.

- FIG.
1. SALPINGŒCA or MONOSIGA sp.—Figured in Mr. Carter's MS. note-book without description, Bombay, Aug. 1855.
  2. SALPINGŒCA or MONOSIGA sp.—Figured by R. Greeff (Wiegmann's 'Archiv,' Heft vi., 1870) as minute Flagellata attached to pedicle of *Epistylis flavicans*.
  - 3-7. CODOSIGA CYMOSA, S. K.—3 and 4, Fully developed colony-stocks, or "zoodendria,"  $\times 1250$ ; 5, branchlet with three zooids, the one at *a* being of abnormal size; 6, branchlet with two zooids, the one at *a* having encysted and separated by segmentation into two equal halves; 7, apparent abnormal colonial growth of the same species?
  - 8, 9. CODOSIGA CANDELABRUM, S. K.,  $\times 800$ .
  - 10-12. SALPINGŒCA MINUTA, S. K.—10, Two adult zooids and a single undeveloped germ (*a*) attached to an empty lorica of *Dinobryon sertularia*,  $\times 1000$ ; 11, a single zooid further enlarged; 12, a zooid with collar withdrawn presenting a semi-amœboid condition.
  - 13-15. SALPINGŒCA MARINA, J.-Clk.—13, Early and naked condition; 14 and 15, adult zooids with loricae developed,  $\times 1800$ .
  16. SALPINGŒCA PYXIDIUM, S. K.,  $\times 1000$ .
  - 17-21. SALPINGŒCA AMPULLA, S. K.—17, Adult zooid with fully developed lorica,  $\times 1250$ ; 18, empty lorica; 19, zooid with lorica imperfectly developed and as yet mucilaginous in consistence, at *a*, a monoflagellate collarless germ attached to the exterior of the lorica; 20, a germ which has become attached and commenced to develop its collar and protective lorica; 21, a more advanced growth of the same zooid.
  - 22-24. Minute flagellate and apparently collar-bearing loricatè monads (*Salpingœca*), attached to pedicle of *Epistylis flavicans*, as delineated by Greeff,  $\times 300$ .
  25. LAGENGŒCA CUSPIDATA, S. K.,  $\times 1500$ .
  26. SALPINGŒCA PETIOLATA, S. K.,  $\times 1250$ .
  - 27, 28. POLYNGŒCA DICHOTOMA, S. K.—Two social colony-stocks or polythecia,  $\times 1000$ .





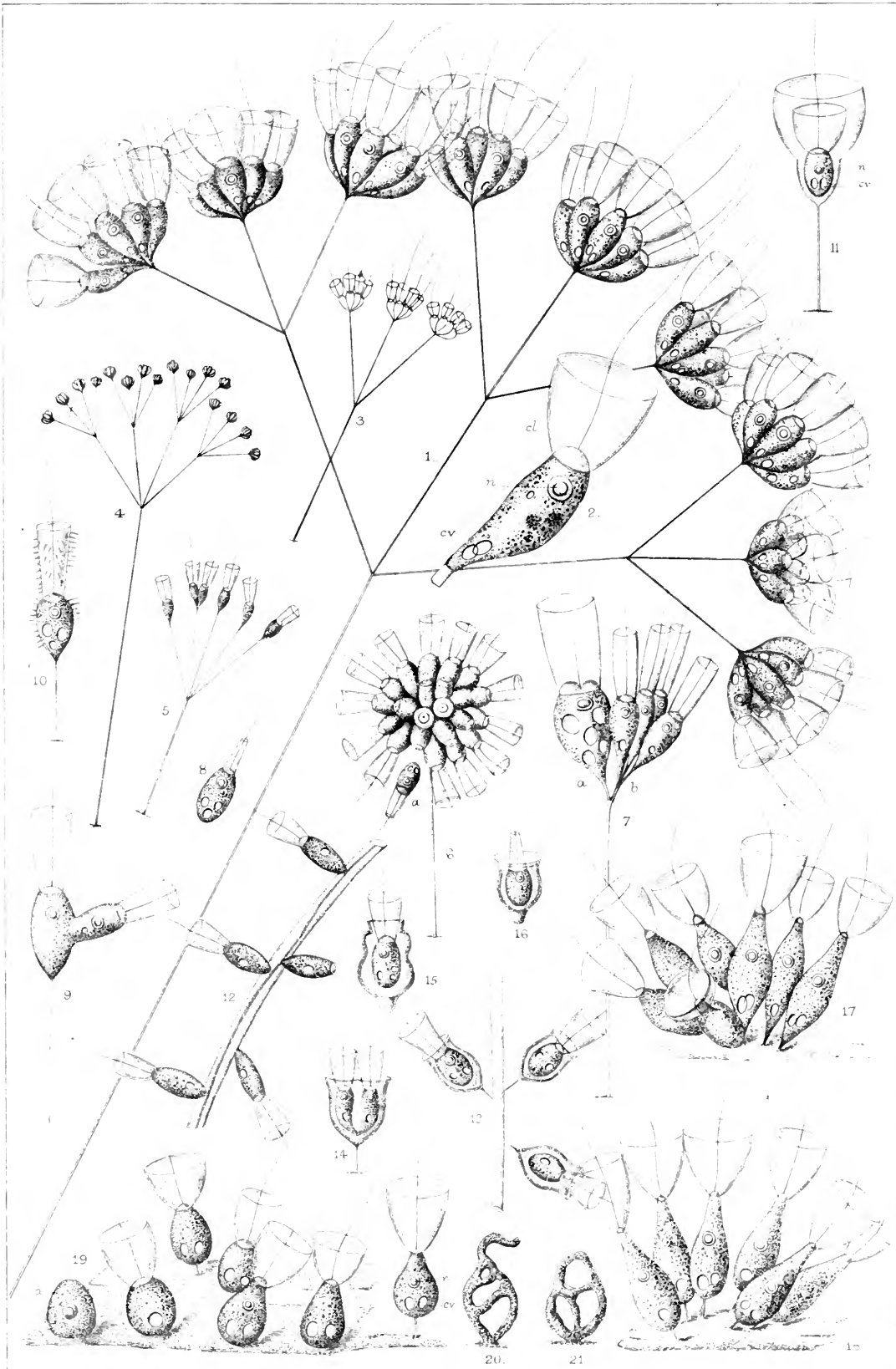


*PLATE IV.*

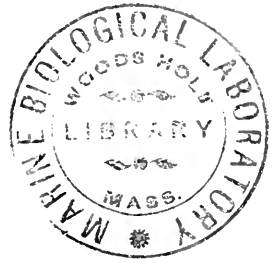
#### EXPLANATION OF PLATE IV.

FIG.

- 1-5. *CODOSIGA UMBELLATA*, Tatem sp.—1, More normal and adult colony-stock with compound pedicle or zoodendrium, tripartitely branched,  $\times 625$ ; 2, a single zooid,  $\times 1250$ ; 3, a simpler growth of the same fundamental formula; 4, an example with the pedicle quadripartitely branched (Tatem); 5, an abnormal type with five primary subdivisions of the supporting pedicle (Stein).
- 6-10. *CODOSIGA (EPISTYLIS) BOTRYTIS*, Ehr. sp. (Stein).—6, An abnormally luxuriant colony with a spheroidal cluster of associated zooids, at *a* one of the latter detached from the parent stock,  $\times 650$ ; 7, a colony-stock in which at *a* a larger zooid is dividing by longitudinal fission, the group of four smaller ones at *b* having been derived from similar repeated subdivision of an original single zooid; 8, a free-swimming zooid detached from a sedentary colony; 9, coalescence or conjugation of a similar free swimming zooid with a normal sedentary form; 10, a zooid emitting minute pseudopodic processes which present the aspect of adherent *Bacteria*.
11. *SALPINGÆCA CAMPANULA*, S. K.,  $\times 1250$ .
12. *MONOSIGA STEINII*, S. K.—Five zooids attached to a stalk of *Vorticella convallaria*,  $\times 650$  (Stein).
- 13-16. *SALPINGÆCA CONVALLARIA*, Stein (Stein).—13, Three normal zooids attached to stem of an *Epistylis*,  $\times 650$ ; 14, a zooid dividing by longitudinal fission; 15, zooid with lorica of an irregular and abnormal form; 16, a detached and free-swimming zooid.
17. *MONOSIGA FUSIFORMIS*, S. K.—A social group,  $\times 1800$ .
18. *MONOSIGA LONGICOLLIS*, S. K.,  $\times 1800$ .
- 19-21. *MONOSIGA SOCIALIS*, S. K.—19, A group showing at *a* a zooid with collar and flagellum withdrawn about to enter upon an encysted state, and to the extreme right an example with a short pedicle,  $\times 1500$ ; 20 and 21, zooids with collars and flagella retracted and assuming a vacuolar amœboid phase.





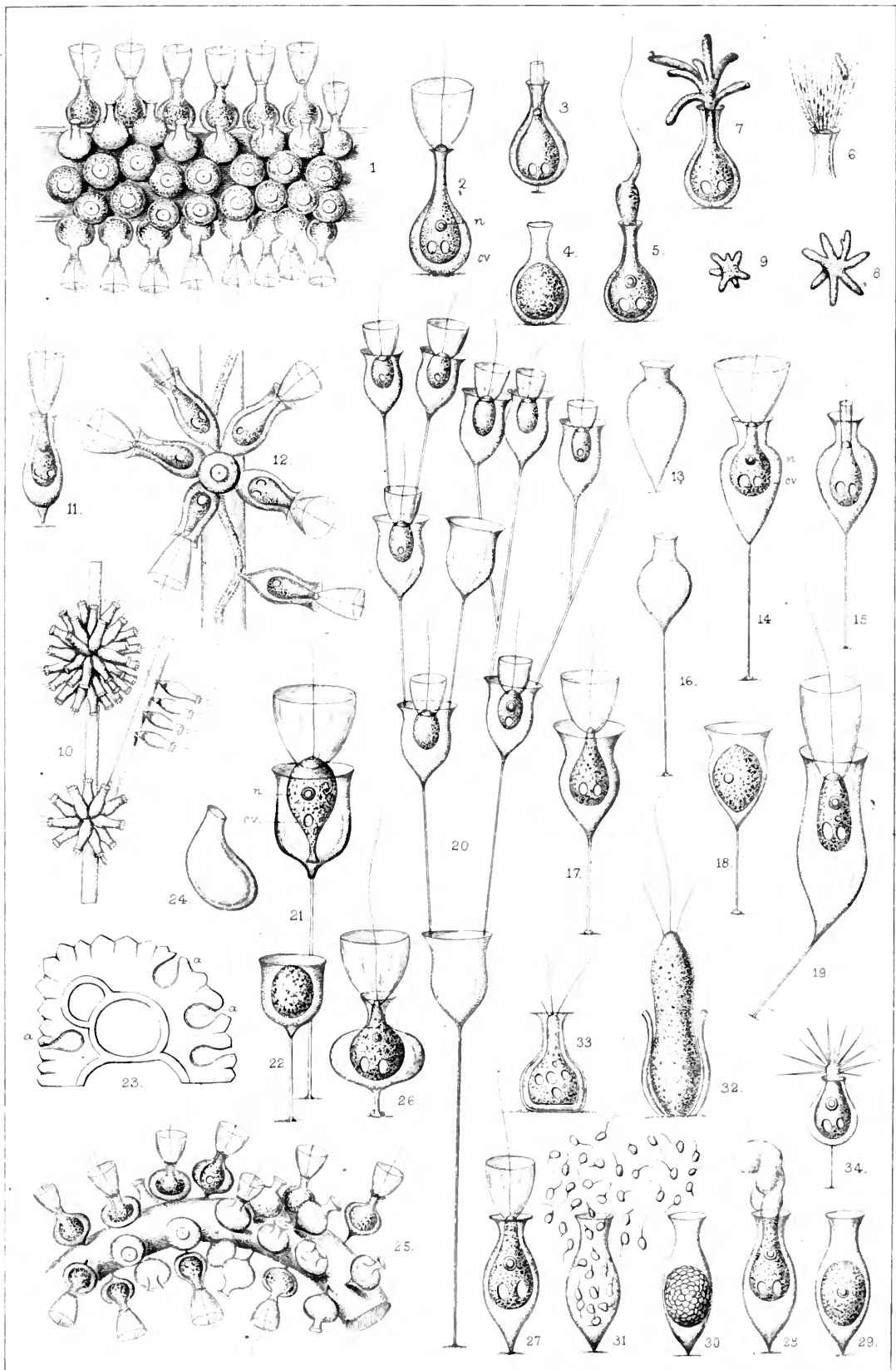


*PLATE V.*

EXPLANATION OF PLATE V.

- FIG.  
1-9. SALPINGŒCA AMPHORIDIUM, J.-Clark.—1, Social colony attached to confervoid filament,  $\times 625$ ; 2, a separate and normal zooid with collar fully expanded,  $\times 1250$ ; 3, a zooid with collar contracted, and with lorica supported on a rudimentary pedicle; 4, zooid encysted within its lorica; 5, zooid with collar entirely retracted, the flagellum remaining, but much thickened at its base, and the body-sarcode protruding in a lobose form; 6, anterior region of zooid, showing its protrusion from the lorica in the form of a fascicle of filamentous pseudopodia; 7, a zooid in which the protruded sarcode has assumed a branched, pinnatifid, contour; 8, the protruded sarcode of the same zooid having become detached, and resembling a stellate floating amœba,  $\times 1250$ ; 9, a more minute stellate amœba-like body found floating in the same vicinity, and probably possessing a similar derivation.
- 10-12. SALPINGŒCA STEINII, S. K.—10, two rosette-shaped colonies, and four more isolated zooids attached to the pedicle of *Epistylis anastatica*,  $\times 300$  (Stein); 11, a single zooid (Stein); 12, a colony, as found by the author, attached to the pedicle of *Vorticella campanula*,  $\times 1000$ .
13. SALPINGŒCA AMPHORA, S. K.,  $\times 1500$ .
- 14-16. SALPINGŒCA URCEOLATA, S. K.; 14 and 15, zooids with collar extended and contracted; 16, empty lorica,  $\times 1500$ .
- 17, 18. SALPINGŒCA RINGENS, S. K.—At 18 an example encysted,  $\times 1500$ .
19. SALPINGŒCA CURVIPES, S. K.,  $\times 2000$ .
20. POLYNŒCA DICHOTOMA, S. K.,  $\times 1500$ .
- 21, 22. SALPINGŒCA TINTINNABULUM, S. K.—22, Encysted state,  $\times 2000$ .
- 23, 24. SALPINGŒCA (?) WALLICHI, S. K.—23, Remains of loricae at *a a a* embedded within shell substance of a *Globigerina*; 24, a single isolated lorica, highly magnified.
- 25, 26. SALPINGŒCA NAPIFORMIS, S. K.—25, A social colony in vegetable fibre,  $\times 800$ ; 26, a single zooid more highly magnified.
- 27-31. SALPINGŒCA FUSIFORMIS, S. K.—27, A normal, fully expanded zooid,  $\times 1500$ ; 28, a zooid with collar and flagellum retracted, assuming an amœboid state; 29, an encysted zooid; 30, similar encystment, with body broken up into numerous spore-like bodies; 31, spore-like bodies further developed, and being discharged from the lorica as monoflagellate germs.
32. A form of SALPINGŒCA, apparently near *S. FUSIFORMIS*, dividing by transverse fission (after Bütschli).
33. A probable variety of SALPINGŒCA AMPHORIDIUM, the lorica having a flattened base, the collar imperfectly delineated (after Bütschli).
34. SALPINGŒCA MARINA, J.-Clk.—An example with the collar and flagellum withdrawn, emitting ray-like pseudopodia,  $\times 1800$ .





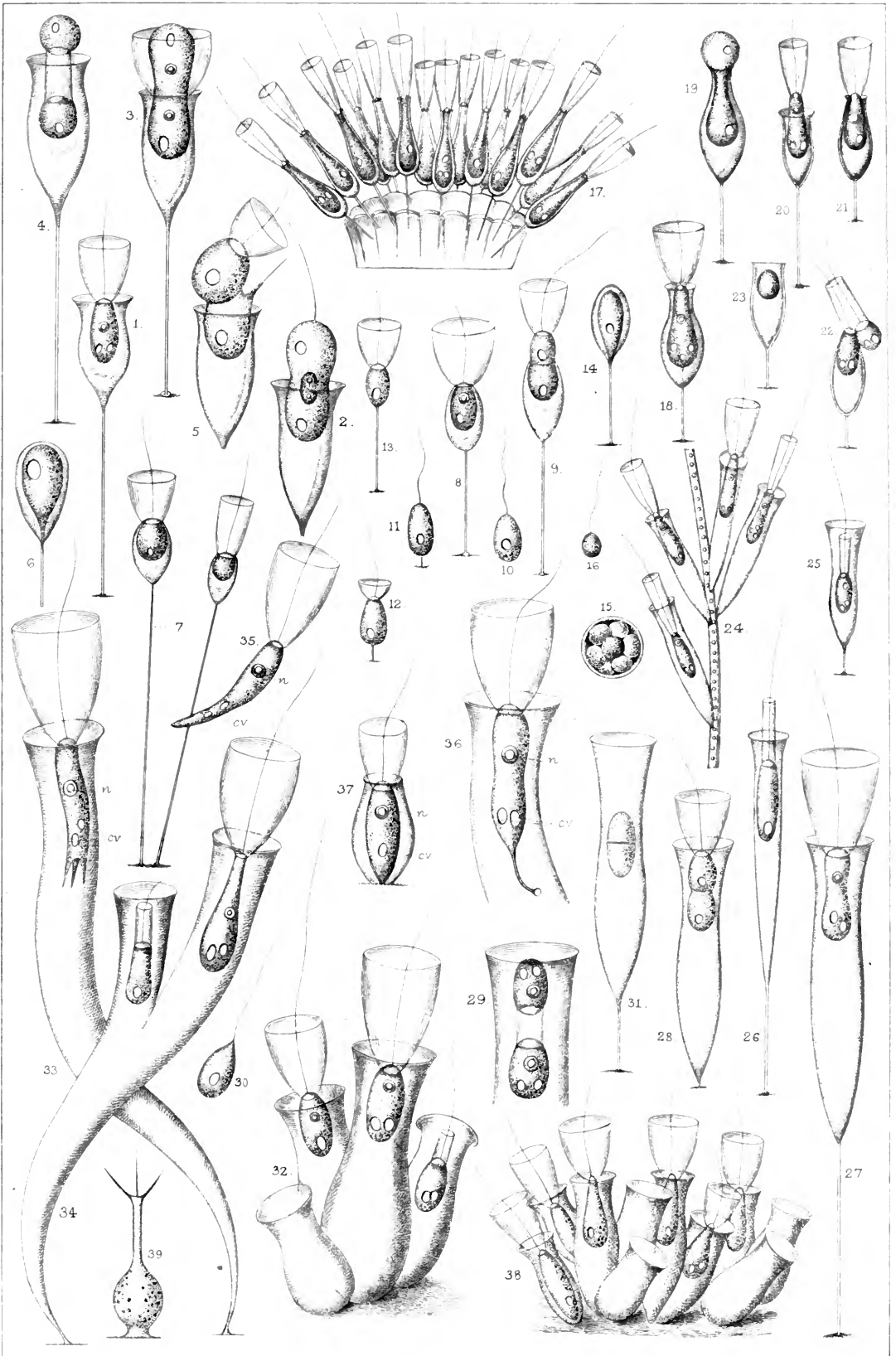


*PLATE VI.*

## EXPLANATION OF PLATE VI.

FIG.

- 1-6. SALPINGŒCA INQUILLATA, S. K.—1, Zooid in its normal and fully extended state,  $\times 1250$ ; 2-5, showing various phases accompanying the process of transverse fission; 6, a recently attached collarless zooid commencing to excrete its protective lorica.
7. SALPINGŒCA LONGIPES, S. K.—Two zooids,  $\times 1250$ .
- 8-16. SALPINGŒCA INFUSIONUM, S. K.—8, Normal adult zooid,  $\times 800$ ; 9, zooid dividing by transverse fission; 10, distal separated half of the same zooid presenting the form of a simple uniflagellate monad; 11, the same monadiform zooid attached by its posterior extremity, and having already developed a short pedicle; 12 and 13, further progressive phases, showing in the latter instance the zooid fully developed, but as yet wanting a lorica; 14, the same zooid, with collar and flagellum retracted, secreting its lorica; 15 and 16, sporocyst and liberated monadiform germ of the same species.
- 17-19. SALPINGŒCA CLARKII, Stein (after Stein).—17, A social colony attached to the anterior extremity of a Rotifer (*Philodina hirsuta*),  $\times 650$ ; 18 and 19, larger examples obtained from the roots of duckweed, the zooid in the latter instance with collar and flagella retracted and assuming an amœboid phase,  $\times 650$ .
- 20-23. SALPINGŒCA OBLONGA, Stein (after Stein).—20 and 21, Normal zooids,  $\times 650$ ; 22, exhibiting an apparent conjugative process between a normal sedentary and a naked free-swimming zooid; 23, an encysted zooid.
24. SALPINGŒCA VAGINICOLA, Stein.—Apparently an intermediate variety of *S. gracilis*, J.-Clk. (after Stein),  $\times 650$ .
- 25-32. SALPINGŒCA GRACILIS, J.-Clk.—25, Early condition of short-stalked variety (after Stein); 26 and 27, adult long-stalked varieties,  $\times 1250$ ; 28, zooid dividing by transverse fission within posteriorly pointed but non-pedicellate lorica; 29, another phase of transverse fission, the original collar and flagellum being retracted; 30, anterior half of the same zooid liberated as a free-swimming monadiform germ; 31, a zooid encysted within its lorica, and marked by a transverse divisional line; 32, a cluster of zooids having sessile and posteriorly rounded loricae,  $\times 1250$ .
- 33-36. SALPINGŒCA CORNUTUM, S. K.—33, Normal adult form, the zooid adherent to the side of its lorica by several pseudopodic posterior processes,  $\times 1000$ ; 34, an abnormal variety, in which the second zooid derived by fission has remained closely associated with the parent one, and produced a pseudo-compound lorica; 35, an isolated zooid, having an attenuate vermicular contour; 36, a zooid attached to the wall of its lorica by a simple pedicle-like posterior prolongation.
37. SALPINGŒCA CYLINDRICA, S. K.,  $\times 2000$ .
38. SALPINGŒCA TUBA, S. K.—A social colony,  $\times 1500$ .
39. SALPINGŒCA CARTERI, S. K.—Monad with so-called "ear-like points," as originally figured and described by Mr. Carter,  $\times 1500$ .





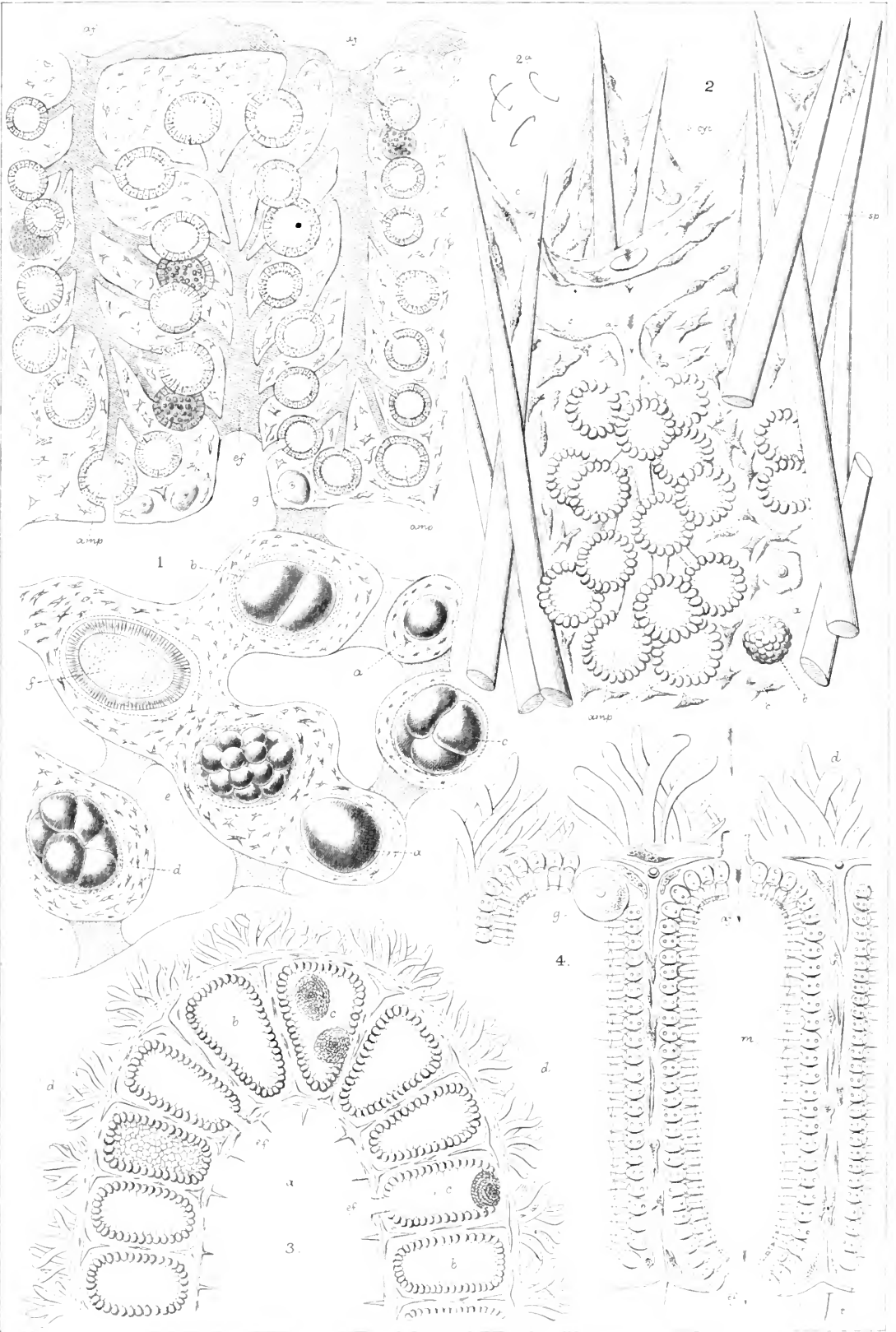
*PLATE VII.*

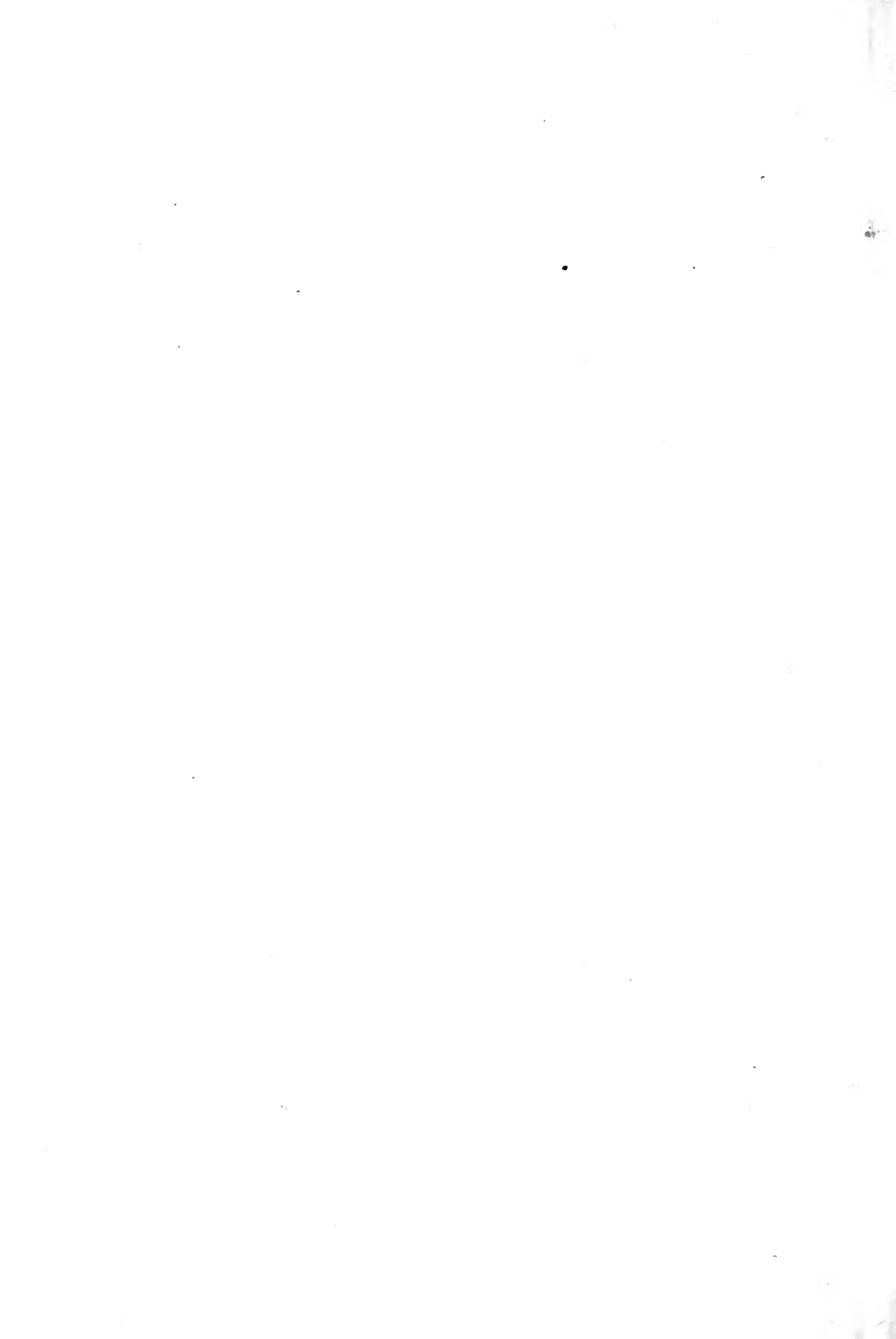
## EXPLANATION OF PLATE VII.

FIG.

1. HALISARCA LOBULARIS, Duj., a spicule-less sponge, in vertical section, after F. E. Schulze,  $\times 75$ .—*af*, apertures of afferent canals or pores leading to the spheroidal monad-lined chambers or ampullaceous sacs, *amp.*; *ef*, debouchement of efferent canal conducting from the ampullaceous sacs to the deeper interstitial canal-systems, which finally open upon the larger excurrent orifices or oscula; *a, b, c, d, e, f*, progressive phases of development by segmentation of swarm-gemmules in the deeper substance of the sponge, these occupying the positions previously filled by the ampullaceous sacs, and from which, by metamorphosis, they are obviously derived; *g*, younger and more rudimentary phase of these bodies, embedded in the cytotblastema adjacent to the ampullaceous sacs.
2. ESPERIA sp., a siliceous-spiculed sponge, in vertical section, showing grape-like arrangement of the ampullaceous sacs round a single afferent or pore system,  $\times 500$ .—*af*, entrance of afferent canal or pore, the arrows denoting the course followed by the incurrent stream of water; *s. cyt.*, superficial cytotblastematous layer, bounding the sponge-periphery and extended canopy-wise over the distal extremities of the spicula; *sp.*, acerate spicula; *amp.*, ampullaceous sacs; *c*, amœbiform cytoblasts; *a b*, imperfectly developed ampullaceous sacs in the deeper substance of the cytotblastema; *2 a*, minute bihamate spicula from the structureless cytotblastema,  $\times 800$ .
- 3, 4. GRANTIA COMPRESSA, Bowerbank, a calcareous-spiculed sponge.—3, Segment of an entire transverse section,  $\times 300$ , showing at *a* central cavity or cloaca receiving currents passed through the surrounding ciliated or monad-lined chambers *b, b*; *c, c*, two such monad-lined chambers containing respectively one and two ciliated swarm-gemmules; *d*, external fringe of recurvate-clavate defensive spicula. 4, One entire, and a portion of a second monad-lined chamber,  $\times 600$ ; *af*, afferent canal or pore by which currents are received from the external water; *ef*, efferent canal conducting to the central cloacal chamber; *m*, collar-bearing monads; *d*, external defensive spicula; *i*, internally projecting triradiate spicula; *g*, swarm-gemmule in its earlier amœboid and non-segmented phase of development.





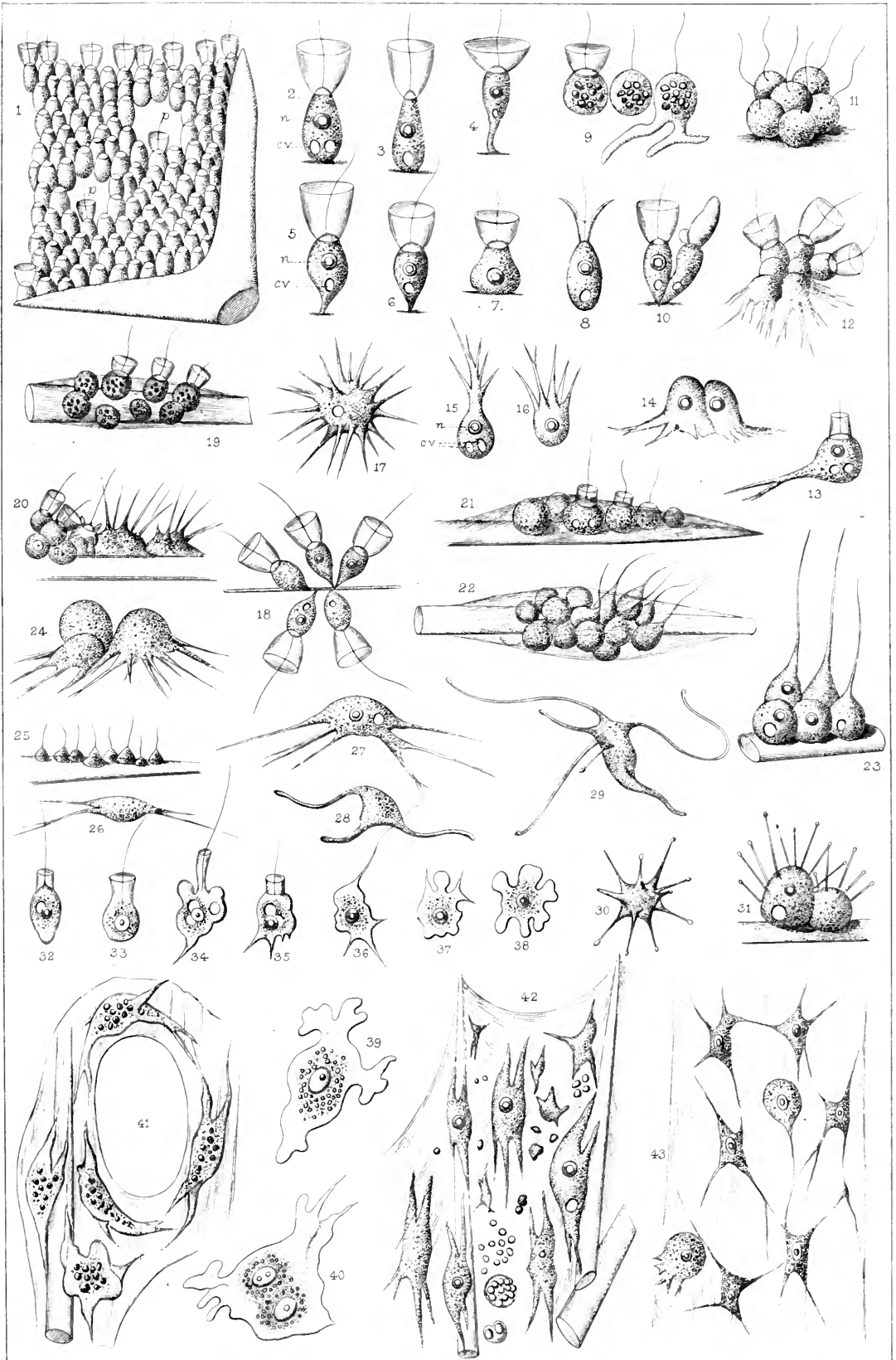


*PLATE VIII.*

## EXPLANATION OF PLATE VIII.

FIG.

- 1-17. *GRANTIA COMPRESSA*, Bowerbank, a calcareous-spiculed sponge.—1, Small intraspicular area, showing pavement or tessellated arrangement of collared monads;  $p, p$ , pore apertures,  $\times 800$ ; 2-8, various polymorphic forms assumed by the collared monads,  $\times 1600$ ; 9-12, small isolated groups of collared monads from the same sponge, exhibiting various conditions of metamorphosis, some of them with simply the collars withdrawn and flagella remaining extended, others with both these organs retracted and the body sarcode produced in form of pseudopodia, and in consequence presenting an amœbiform contour; at 9, the monads' bodies filled with ingested carmine particles; 13, an isolated monad with collar and flagellum retained in combination with a long, bifurcated, posteriorly produced pseudopodium; 15 and 16, amœbiform phases of collared monads of the same sponge; 17, a metamorphosed collared monad, with radiating pseudopodia, presenting an Actinophrys-like aspect.
- 18-31. *HALICHONDRIA PANICEA*, Johnston, a siliceous-spiculed sponge.—18, Group of collared monads attached to a slender acerate spicule,  $\times 1000$ ; 19-23, groups of collared monads attached to spicula, and in most instances partially immersed within a thin stratum of structureless cytoblastema, exhibiting various phases of metamorphosis; 24, a group of metamorphosed collared monads presenting an amœboid aspect; 25, very young, simply monoflagellate, collared monads attached to a spiculum,  $\times 1000$ ; 26-31, isolated amœbiform phases of collared monads of the same species, those in the last three instances having capitate pseudopodia, and presenting an Acineta-like contour.
- 32-40. *ASCETTA PRIMORDIALIS*, Hkl., a calcareous-spiculed sponge (after Haeckel).—32-38, Metamorphosed collared monads,  $\times 700$ ; 39 and 40, amœbiform zooids or cyto blasts, from the cyto blastema, the example in the latter instance possessing two nuclei or endoplasts, and representing either two recently coalesced zooids, or one about to divide by fission,  $\times 700$ .
41. *LEUCOSOLENIA CORIACEA*, Bwbk.—Portions of transparent cyto blastema surrounding a poral aperture, and containing amœbiform cyto blasts enclosing ingested carmine particles,  $\times 800$ .
42. Portion of cyto blastema of *HALICHONDRIA PANICEA*, containing amœbiform cyto blasts in various stages of development, those of the smallest order originating from sporular bodies,  $\times 1500$ .
43. *APLYSILLA SULFUREA*, F. E. Schz.—Associated cyto blasts, with attenuate and interconnecting pseudopodia,  $\times 400$  (after F. E. Schulze).





## PLATE IX.

### EXPLANATION.

FIG.

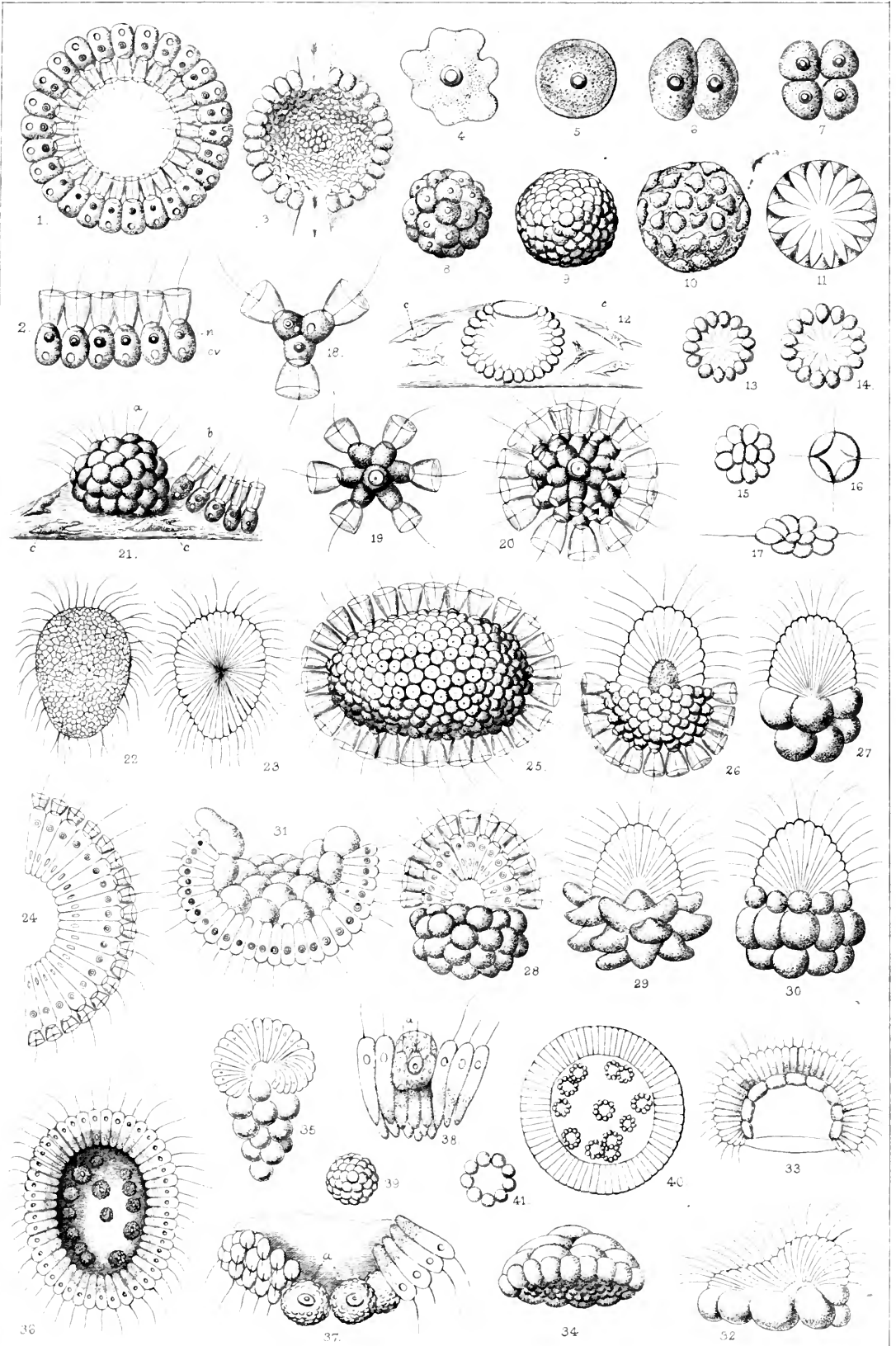
- 1-12. *HALISARCA DUJARDINII*, Johnston sp.—1, Spheroidal monad-chamber or ampullaceous sac, as seen in optical section without intersecting an afferent or efferent aperture,  $\times 800$ ; the introversion of this monad-chamber is alone required to produce a rosette-gemmule or ordinary swarm-gemmule as delineated at Figs. 20, 24, and 25; 2, six laterally attached collared monads from an ampullaceous sac of the same sponge, these corresponding remarkably in their isolated condition with the moniliform colonies of the collared monad *Desmarella moniliformis* represented at Pl. II. Fig. 30,  $\times 1000$ ; 3, ampullaceous sac of the same type as seen in optical section, and intersecting, where indicated by the arrows, an afferent and efferent aperture; 4-11, progressive phases of development of an ampullaceous sac by segmentation from a primitive amœboid body,  $\times 400$ ; at 10 the segmented products present the aspect of simple amœbiform corpuscles possessing no flagellate appendages, and held together by intervening hyaline cytoblastema; at 12 the same elements closely approximated have developed internally-projecting flagella, but still want the characteristic collars; 12, profile view of matured ampullaceous sac, with surrounding cytoblastema; at *c*, enclosed cyto blasts.
- 13-17. *HALISARCA LOBULOSA*.—13 and 14, Detached ampullaceous sac,  $\times 400$  (after Metschnikoff); 15-17, subspheroidal, freely detached cell-aggregations, with externally-projecting flagella, as figured and described by Metschnikoff under the title of "rosette-cells,"  $\times 400$  (Metsch.).
- 18-21. *HALISARCA DUJARDINII*.—18-20, Spheroidal cell-combinations, or rosette-gemmules, more fully developed, as observed by the author, and shown to consist of various numerical aggregations of typical collared monads,  $\times 800$ ; 21, portion of the same sponge with, at *a*, earlier and undetached condition of a similar rosette-gemmule, the externally projecting units possessing flagellate appendages, but as yet no collars; at *b*, portion of an adjacent ampullaceous sac; *c*, *c*, cyto blasts immersed within surrounding cyto blastema,  $\times 800$ .
- 22-29. *GRANTIA COMPRESSA*, Bwbk. Swarm-gemmules or so-called ciliated larvæ, exhibiting various phases and modifications of development, as observed by the author.—22 and 23, simple "planuloid" variety of such swarm-gemmule, as viewed superficially and in longitudinal optical section, and shown in the latter instance to be composed of similar closely apposed, conical, uniflagellate elements,  $\times 350$ ; 24, portion of longitudinal section of a more advanced swarm-gemmule, each constituent uniflagellate element being characterized by the possession of a distally developed rudimentary collar, which embraces

EXPLANATION OF PLATE IX. (*continued*).

FIG.  
22-29  
(*continued*).

- the base of the projecting flagellum ; through the enlargement and expansion outwards of these constituent units the common body now possesses a distinctly developed central cavity ; 25, more matured developmental phase of the same planuloid type of gemmule, in which the common body is shown to be composed of a symmetrically ovate aggregation of typical collared monads or spongozoa,  $\times 600$  ; 26-29, diverse varieties and phases of development of the "amphiblastuloid" type of swarm-gemmule from the same sponge, produced through the uneven growth of the constituent collared monads or spongozoa in the neighbouring halves of the common body ; in 27, 28, and 29, the collared monads of the posterior region have developed so much in advance of those of the opposite extremity as to have withdrawn their collars and flagella, assumed an amœboid condition, and coalesced more or less completely with one another,  $\times 600$ .
30. *GRANTIA* (*SYCON*) *CILIATUM*, Bwbk.—Variety of "amphiblastuloid" type of swarm-gemmule, as represented by Barrois, in which an equatorial ring of metamorphosed spongozoa presents an intermediate condition of development as compared with the series above and below it.
- 31, 32. *GRANTIA COMPRESSA*.—Irregularly developed "amphiblastuloid" swarm-gemmules. At 31 (after O. Schmidt) the more matured amœboid units have become invaginated within the primitive central cavity of the common body.
- 33-35. *SYCANDRA RAPHANUS*, Hkl.—33 and 34, "Amphiblastuloid" swarm-gemmules, as represented by F. E. Schulze ; in the first of these the amœboid units are invaginated within the uniflagellate, or so-called ectodermal elements, while in the second one an entire opposite process, or the invagination of the so-called ectodermal elements, is in course of progress ; 35, irregularly developed amphiblastuloid swarm-gemmule (after O. Schmidt).
- 36-39. *ASCETTA PRIMORDIALIS*, Hkl.—36, "Planuloid" swarm-gemmule as seen in optical section, with internally contained cell-spherules ; 37 and 38, portions of lateral wall of a swarm-gemmule of the same sponge, showing at *aa* cell-spherules derived by metamorphosis from the constituent uniflagellate elements ; these assuming an amœboid condition and apparently coalescing with one or more neighbouring units, creep into and occupy the common central cavity, as shown in the preceding figure ; 39, one such cell-spherule further enlarged, subdivided by segmentation into spore-like elements (Oscar Schmidt).
- 40, 41. *HALISARCA LOBULARIS*, Duj.—40, Optical transverse section of "planuloid" swarm-gemmule, showing enclosed closely corresponding and similarly derived cell-spherules, which are identified by Metschnikoff with the primitive condition of the rosette-gemmules represented at Figs. 15-17 ; 41, one such cell-spherule further enlarged (Metschnikoff).







## PLATE X.

### EXPLANATION.

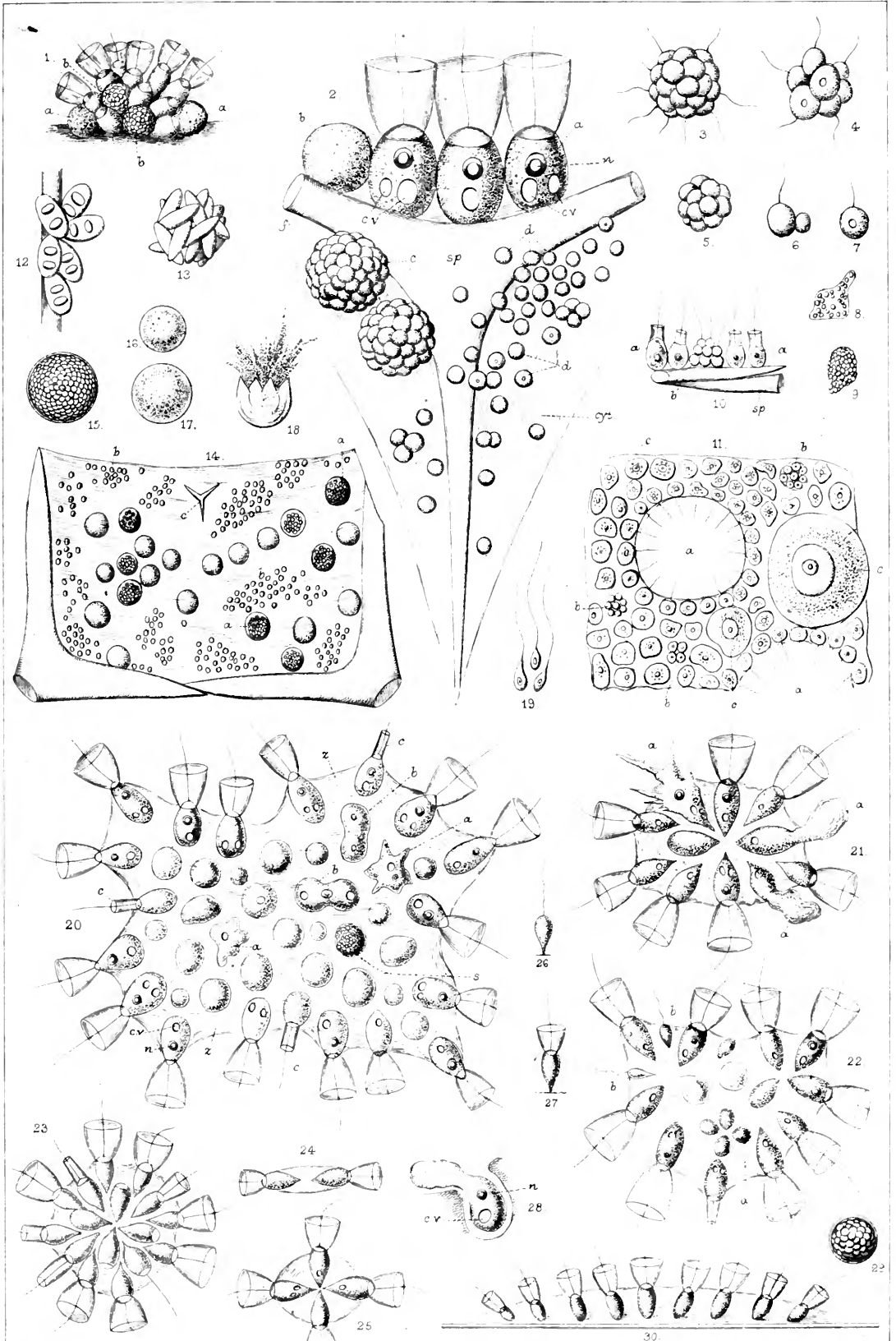
FIG.

- 1-9. LEUCOSOLENIA CORIACEA, Bwbk.—1, Group of collared monads or spongozoa, certain of them at *aa* having withdrawn their collars and flagella and assumed a quiescent state, and others at *bb* become divided by segmentation into innumerable sporular elements,  $\times 800$ ; 2, small area of the same sponge magnified 2500 diameters, as viewed by the author with a  $\frac{1}{30}$ -inch objective; *a*, ordinary collared monads; *b*, one such monad with collar and flagellum withdrawn, having entered upon a quiescent or encysted state; *c*, spore-spheres, produced by the segmentation of the metamorphosed collared monads; *dd*, spores derived from the disintegration of the spore-spheres, and scattered irregularly through the common mucilaginous cytoblastema, *cyt*; *sp*, triradiate spicule; 3-7, spores in aggregate and isolated conditions liberated from the investing cytoblastema, and in most instances possessing single terminal flagella,  $\times 2500$ ; 8 and 9, spore-masses figured as entoderm cells by Metschnikoff,  $\times 400$ .
10. ASCORTIS FRAGILIS, Hkl., showing at *aa* collared monads, and at *b* a group of sporular elements with flagellate appendages (figured by Haeckel as spermatozoa),  $\times 400$ .
11. ASCETTA PRIMORDIALIS, Hkl.—A portion of the inner or lining wall; *aa*, pore-apertures circumscribed by flagelliferous monads; *bb*, spore-groups derived by metamorphosis from the ordinary collared monads, interpreted by Haeckel as sperm-cells; *cc*, large amœboid bodies derived from the metamorphosis and coalescence of similar collared cells, which develop later into the characteristic ciliated swarm-gemmules,  $\times 350$  (Haeckel).
12. Spore-like bodies, found by the author associated with a species of *Halichondria*,  $\times 600$ .
13. Spore-like mass from the interstitial substance of a species of *Hymeniacidon*,  $\times 500$ .
- 14, 15. LEUCOSOLENIA BOTRYOIDES, Bwbk.—14, An intraspicular area, consisting of a film-like expansion of transparent and structureless cytoblastema in which are immersed collared monads in an encysted state, those at *aa* having become divided by segmentation into sporular elements; at *bb*, similar spore-masses disintegrated and dispersed within the substance of the cytoblastema; *c*, a minute triradiate spiculum, developed within the cytoblastema,  $\times 600$ ; 15, an isolated sporocyst with contained spores from the same sponge,  $\times 1200$ .
- 16-18. Sporocysts of a species of *Halichondria*, that at Fig. 18 burst and discharging minute granular spores,  $\times 600$ .

EXPLANATION OF PLATE X. (*continued*).

FIG.

19. ASCETTA PRIMORDIALIS, Hkl.—Three uniflagellate spores, or so-called spermatozoa, as figured by Ernst Haeckel,  $\times 1600$ .
- 20-30. PROTOSPONGIA HÆCKELI, S. K.—A collared monad which excretes and socially inhabits a common gelatinous matrix or "zoocytium" resembling the cyto-blastema of an ordinary sponge; 20, a social colony of about forty monads,  $\times 800$ ; at *a a*, zooids which, withdrawing their collars and flagella, have assumed an aspect corresponding with the amœbiform cytoblasts of a sponge-body; *b b*, examples with collars and flagella retracted, dividing by transverse fission; *c c*, normal zooids, with their collars contracted; *s*, spore-mass; *z z*, hyaline mucilaginous zoocytium; 21, smaller colony of eleven zooids only, those at *a a a* exhibiting an amœbiform aspect, and in one instance extending slender pseudopodia; 22, small social colony, including at *a* four spore-like bodies produced by the subdivision of a metamorphosed collared zooid, and at *b b* two minute, monadiform germs; 23, small symmetrical colony-stock of sixteen zooids, derived from the even and continued segmentation of a single primary unit; 24 and 25, still younger colonies of two and four zooids only; 26, solitary attached monadiform germ, having as yet developed neither a collar nor investing zoocytium,  $\times 1000$ ; 27, more advanced phase of the same zooid, having a well-developed collar and mucilaginous investing sheath, and corresponding at this stage with the earlier phases of *Salpingoeca ampulla*, S. K., represented at Plate III. Figs. 19 and 20; 28, metamorphosed collared zooid, projecting a lobose extension of its anterior border beyond the margin of the zoocytium; 29, spore-mass, as at 21 *s*,  $\times 1000$ ; 30, social colony viewed in longitudinal optical section.





## PLATE XI.

### EXPLANATION.

Figs. 1-19, ILLUSTRATING DEPOSIT AND DEVELOPMENT OF INFUSORIAL GERMS ON HAY-FIBRE, AS DESCRIBED AT CHAPTER IV. PAGE 136 *et seq.*

FIG.

1. Fragment of hay-fibre examined after six hours' maceration, showing at *a a* encysted *Vorticellæ*, and at *b b b* masses of microspores of *Heteromita lens*,  $\times 800$ .
2. Fragment of hay-fibre, wetted and immediately examined; at *a a a*, microspores of *Heteromita lens*; at *b*, four macrospores of *Oikomonas mutabilis*; at *c*, macrospores of *Heteronema caudata*; and at *d*, macrospores of an undetermined type,  $\times 800$ .
3. Fragment of hay-fibre, showing at *a* a mass of microspores of *Heteromita lens* lodged in crevice formed by the serration of its surface,  $\times 800$ .
4. Fragment of hay-fibre encrusted with spore-masses of the single type *Heteromita lens*.
5. Fragment of hay-fibre examined after two weeks' maceration, showing bacterial film and monad spores depending in grape-like clusters from its lower surface. Minute monads developed from these spores, mixed with vibrios and *Bacteria*, swimming beneath,  $\times 8000$ .
- 6-17. HETEROMITA LENS, Müll. sp.—6, 7, Two isolated patches of microspores,  $\times 800$ ; 8, 9, free-swimming monadiform germs developed from the patches of microspores,  $\times 800$ ; 12-15, similar monadiform germs in their primarily attached and variously aggregated free-swimming states, as seen with a  $\frac{3}{8}$ -inch objective,  $\times 2500$ ; 16 and 17, succeeding biflagellate condition of the same germs,  $\times 800$ .
18. HETERONEMA CAUDATA, Duj. sp., developed from the mass of the macrospores delineated at Fig. 2 *c*,  $\times 800$ .
19. HETEROMITA LENS.—Adult monad,  $\times 800$ .

Figs. 20-46, ILLUSTRATING THE PROTOZOIC NATURE OF THE MYXOMYCETES OR MYCETOZOA, AS DISCUSSED AT CHAPTER II. PAGE 41 *et seq.* (FIGS. 32-35 AND 45-47 AFTER CIENKOWSKI, THE REMAINDER AFTER A. DE BARY).

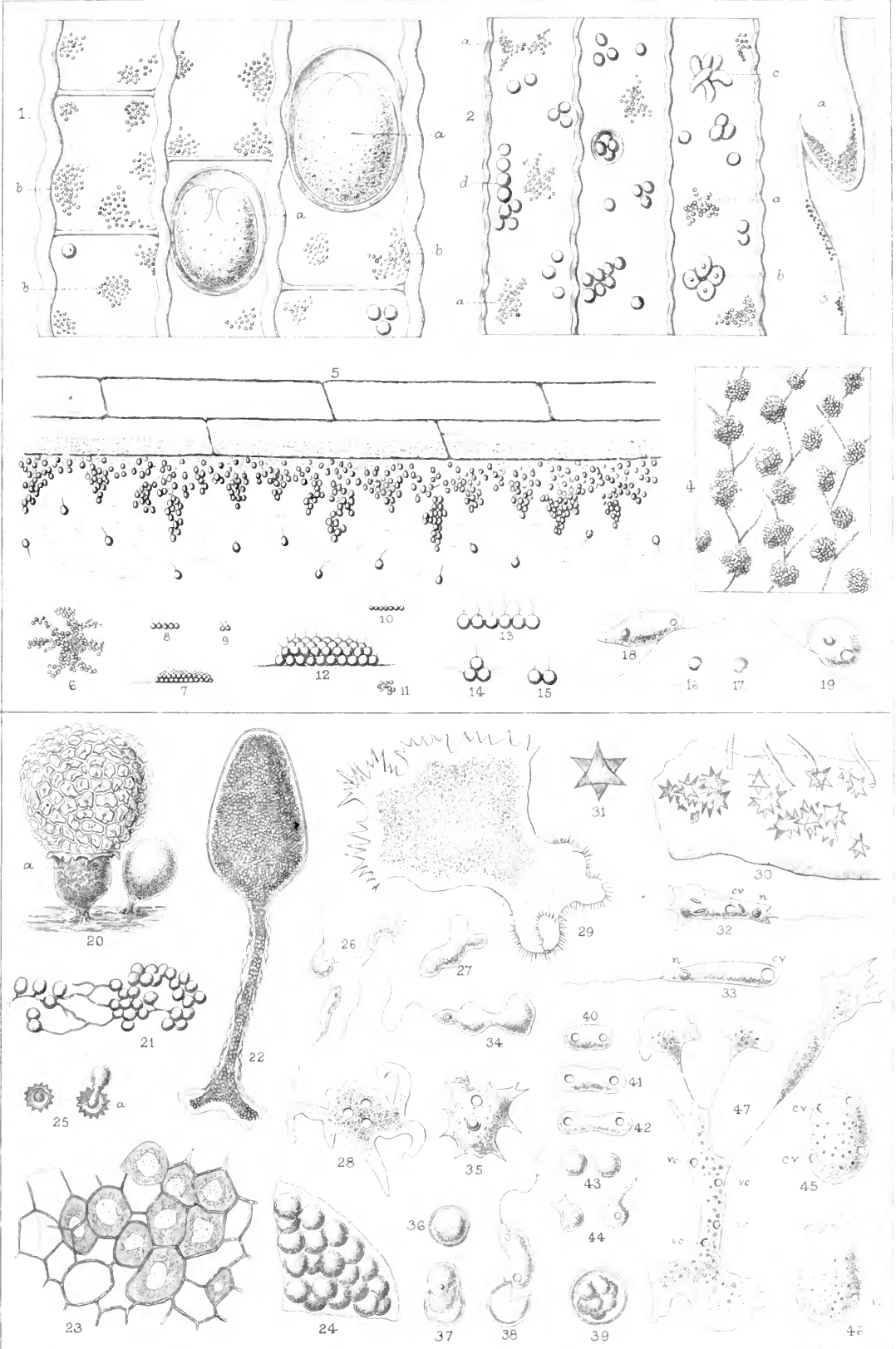
20. ARCYRIA INCARNATA, Pers.—Two sporocysts or sporangia; the one at *a* burst and protruding its sporiferous rete or capillitium,  $\times 15$ .
21. PHYSARUM PLUMBEUM, Fries.—Numerous associated sporangia, slightly enlarged.

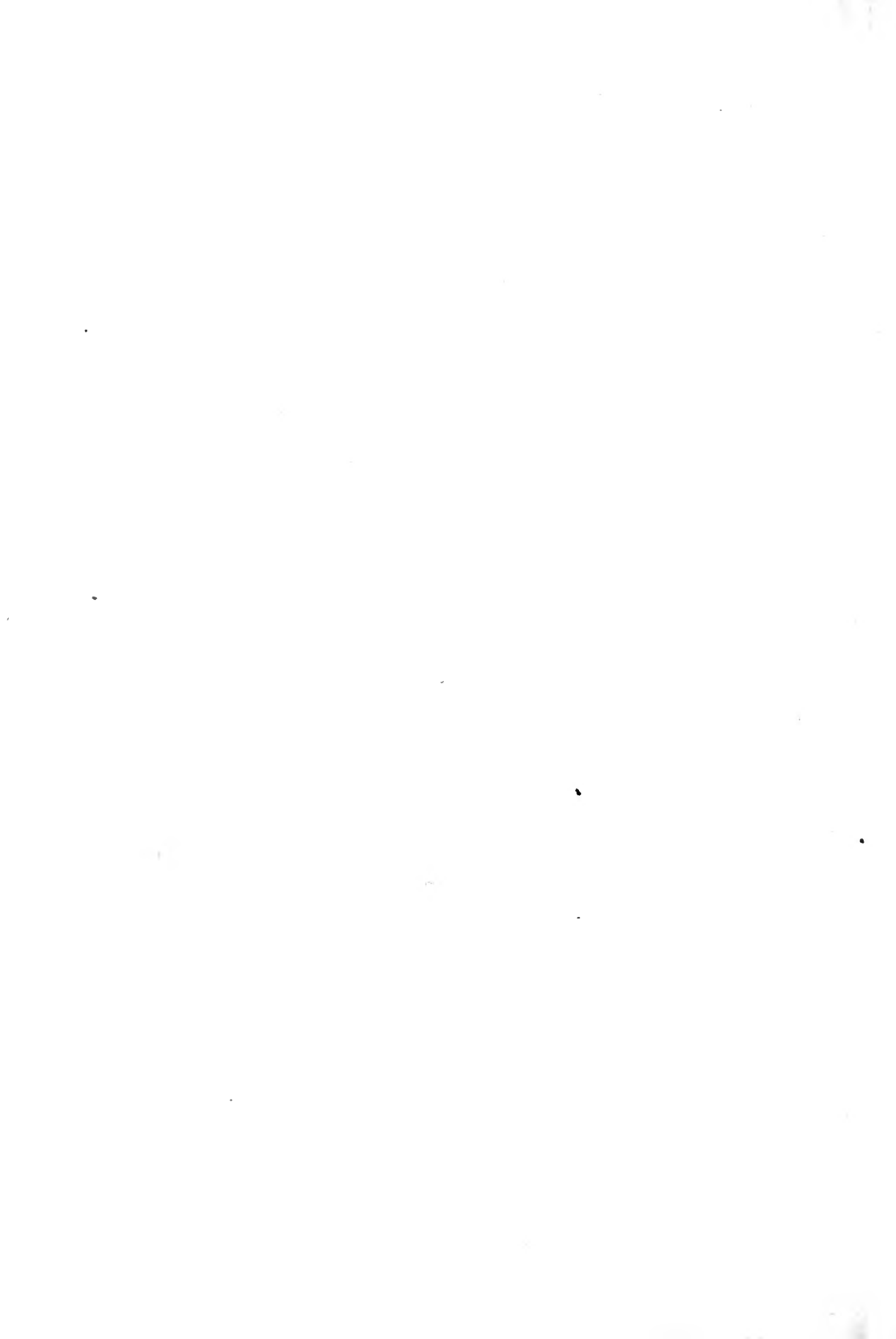
EXPLANATION OF PLATE XI. (*continued*).

FIG.

22. *ARCYRIA CINEREA*, Fries.—A single sporangium, completely filled with half-matured spores,  $\times 25$ .
23. *PHLEBOMORPHA RUFA*, de Bary.—Portion of horny rete or capillitium, with enclosed spores,  $\times 390$ .
24. *DIDYMIUM SERPULA*, Fries.—Section of sporangium, showing contained spores.
- 25-28. *LYCOGALA EPIDENDRON*, Fries.—25, Two isolated spores; the one at *a* bursting and liberating its monadiform germ,  $\times 390$ ; 26, three fully developed, free-swimming, highly polymorphic monadiform zooids, developed from the spores represented in the preceding figure,  $\times 390$ ; 27, amœboid condition assumed by the same monadiform zooids, representing the first step towards the development of the compound plasmodium; 28, Young repent amœbiform plasmodium formed by the coalescence of several of the smaller amœboid particles.
29. *ÆTHALIUM SEPTICUM*, Fries.—Young repent plasmodium,  $\times 200$ .
- 30, 31. *DIDYMIUM FARINACEUM*, Fries.—30, Fragment of peridium or indurated outer wall of sporangium, containing substellate calcareous spicula,  $\times 390$ ; 31, an isolated spicule from the same peridium further enlarged.
- 32-35. *DIDYMIUM SERPULA*, Fries.—32, 34, Polymorphic monadiform zooids, the example at 32 with ingested food-particles; *n*, nucleus or endoplast; *c v*, contractile vesicle,  $\times 350$ ; 35, amœbiform condition of a similar monadiform zooid,  $\times 350$ .
- 36-38. *TRICHIA VARIA*, Pers.—36, Isolated spore,  $\times 390$ ; 37 and 38, the same spore with its wall ruptured, and giving exit to a free-swimming monadiform zooid.
39. *DIDYMIUM LIBERTIANUM*, Fres.—Minute subaqueously developed sporangium, with nine or ten contained spores,  $\times 390$ .
- 40-44. *STEMONITIS OBTUSATA*, Fries.—Successive phases of multiplication by fission of a monadiform zooid,  $\times 390$ .
- 45-47. *DIDYMIUM LEUCOPUS*, Fres.—Young repent amœbiform plasmodia, containing (*c v*, *v c*) numerous contractile vesicles, the plasmodia at 45 and 46 being in a contracted, and at 47 in a fully extended state,  $\times 350$ .





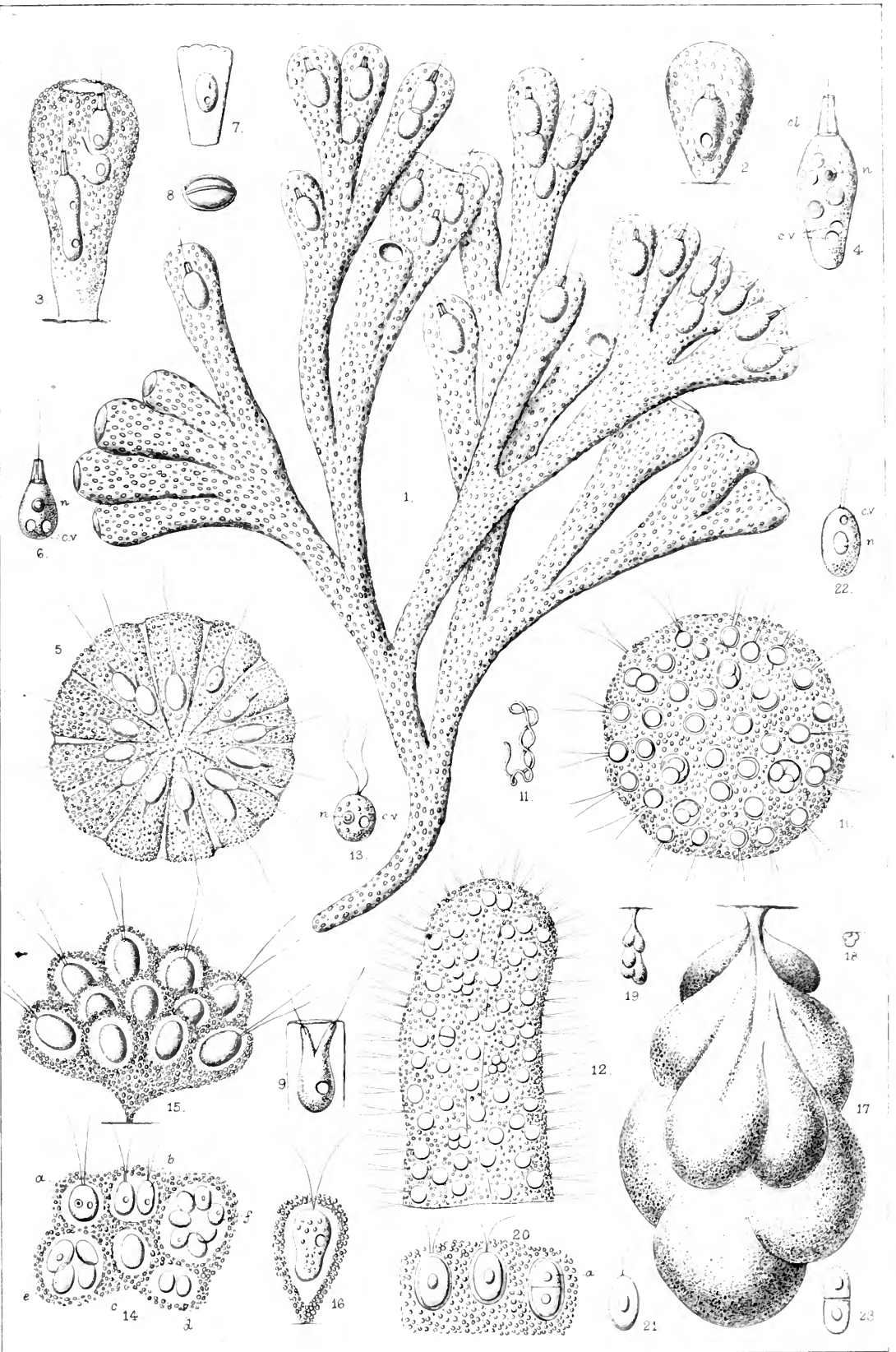


*PLATE XII.*

EXPLANATION OF PLATE XII.

FIG.

- 1-4. PHALANSTERIUM DIGITATUM, St. (after Stein).—1, Adult branching mucilaginous zoocytium,  $\times 450$ ; 2-3, early conditions of a similar zoocytium; 4, a single animalcule,  $\times 1200$ ; *cl*, rudimentary collar.
- 5-9. PHALANSTERIUM CONSOCIATUM, Cienk.—5, Adult discoidal colony,  $\times 650$  (after Stein); 6, an isolated animalcule further enlarged; 7 and 8, encysted zooids (after Cienkowski), the one at Fig. 8 having developed a hard tricarinate capsule; 9, an animalcule dividing by longitudinal fission.
10. SPONGOMONAS DISCUS, St.,  $\times 650$  (after Stein).
- 11-14. SPONGOMONAS INTESTINUM, Cienk. sp.—11, Filamentous adult colony, natural size (Cienk.); 12, extremity of similar colony enlarged, showing disposition of contained animalcules; 13, an isolated monad,  $\times 650$ ; 14, fragment of gelatinous granular zoocytium, showing at *a* normal zooid; *b*, two zooids derived from the longitudinal fission of such as *a*; *c*, a retracted and encysted zooid; *d*, *e*, *f*, various multiplicative phases by which a primary quiescent or encysted zooid has become divided into two, four, or eight spore-like bodies,  $\times 650$  (12-13 after Stein).
- 15, 16. SPONGOMONAS UVELLA, St. (Stein).—15, An adult colony,  $\times 650$ ; 16, initial condition of such a colony as founded by a single animalcule.
- 17-23. SPONGOMONAS SACCULUS, S. K.—17, Adult colony,  $\times 10$ ; 18 and 19, showing proportionate growth of same colony in three days as observed by the author, natural size; 20, fragment of granular zoocytium, containing two normal biflagellate and a single encysted subdividing zooid,  $\times 1200$ ; 21 and 22, isolated zooids,  $\times 1200$ ; 23, encysted zooid dividing by transverse fission.





## PLATE XIII.

### EXPLANATION.

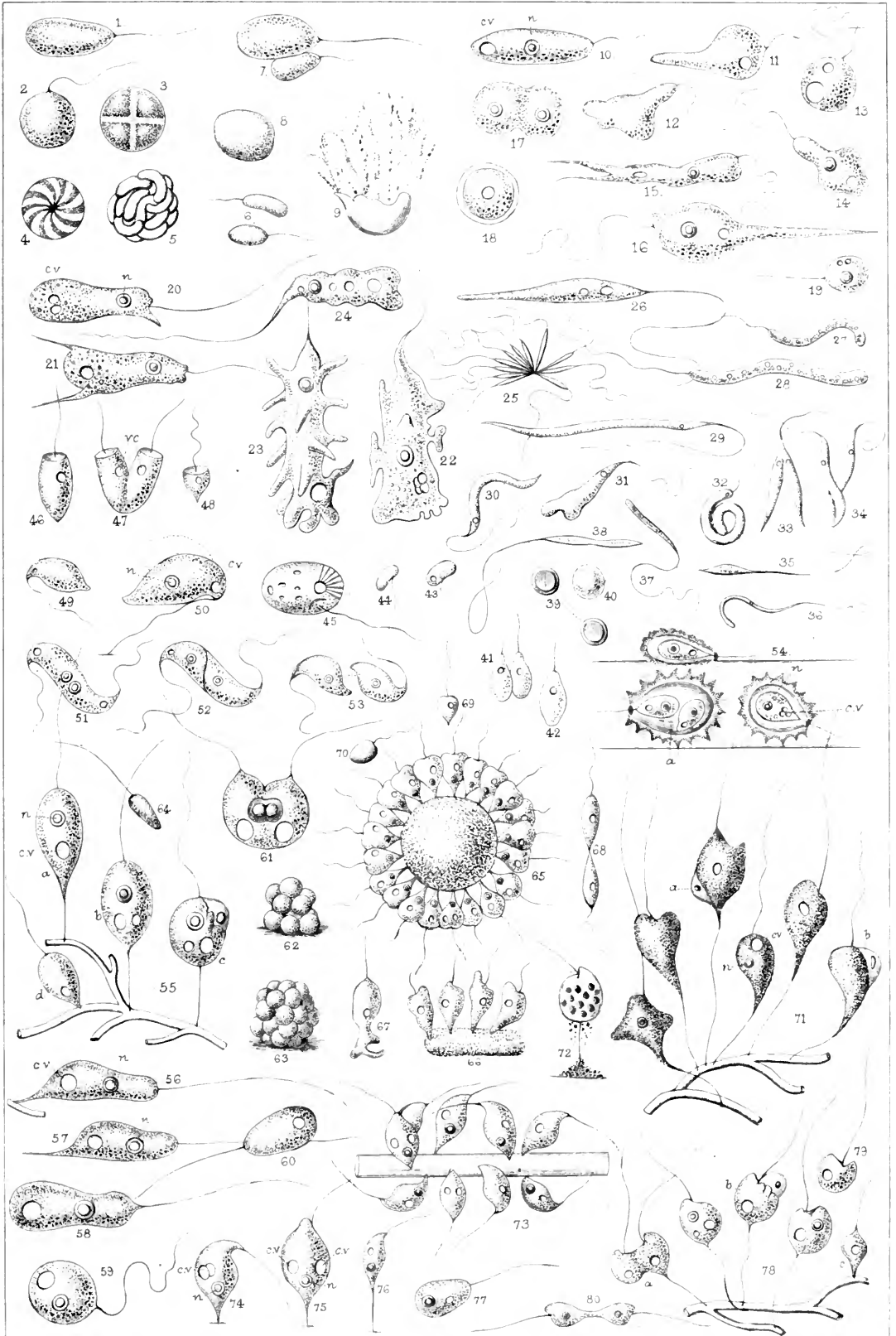
- FIG.  
1-9. *MONAS DALLINGERI*, S. K. (after Dallinger and Drysdale).—1, Normal adult form,  $\times 2000$ ; 2, monad preparing to assume an encysted state; 3, 4, 5, progressive phases following upon encystment, and resulting in the production of a spherular aggregation of elongate vermicular macrospores; 6, the same macrospores liberated as simple monads resembling the parent, but of smaller size; 7, conjugation of larger and smaller monads; 8, encystment resulting from such conjugation; 9, the compound cyst bursting and liberating infinitesimally minute microspores.
- 10-18. *MONAS FLUIDA*, Duj.—10, Typical adult monad,  $\times 1000$ ; 11-16, metamorphic forms of similar adult monads; 17, congregation of two zooids; 18, their encystment.
19. *MONAS IRREGULARIS*, Pty. (Cienkowski),  $\times 350$ .
- 20, 21. *MONAS OBESA*, Stein sp.,  $\times 650$  (Stein).
- 22-24. *MONAS RAMULOSA*, Stein sp.  $\times 600$  (Stein).
- 25, 26. *LEPTOMONAS BUTSCHLI*, S. K. (Bütsch.).—25, A group attached by their posterior extremities,  $\times 600$ ; 26, a free-swimming monad,  $\times 1500$ .
- 27, 28. *OPHIDOMONAS JENENSIS*, Ehr.,  $\times 600$  (Ehr.).
- 29-34. *HERPETOMONAS MUSCÆ-DOMESTICÆ*, Burnet sp. (Stein).—29-32, Polymorphic phases of the adult monads,  $\times 650$ ; 33 and 34, monads dividing by longitudinal fission.
- 35-40. *HERPETOMONAS LEWISII*, S. K. (Lewis).—35-38, Various contours of the adult organism,  $\times 800$ ; 39, two red and forty-one colourless corpuscles of the rat's blood which they inhabited, equally magnified to show proportionate size.
- 41, 42. *SCYTOMONAS PUSILLA*, St.,  $\times 650$  (Stein).
- 43, 44. *PLEUROMONAS JACULANS*, Pty.,  $\times 500$  (Perty).
45. *MEROTRICHA BACILLATA*, Meresch. (Dimensions unrecorded) (Mereschkowski).
- 46, 47. *CYATHOMONAS ELONGATA*, From.—47, Dividing by longitudinal fission, 600 (De Fromentel).
48. *CYATHOMONAS TURBINATA*, From.,  $\times 400$  (De Fromentel).
- 49-53. *ANCYROMONAS SIGMOIDES*, S. K.—49, Free-swimming animalcule,  $\times 1500$ ; 50, animalcule fixed by distal termination of the single flagellum, the dotted outline indicating the position alternately assumed by the body with relation to the flagellum in the course of its rapid oscillations,  $\times 2500$ ; 51-53, showing the several progressive phases of oblique fission.

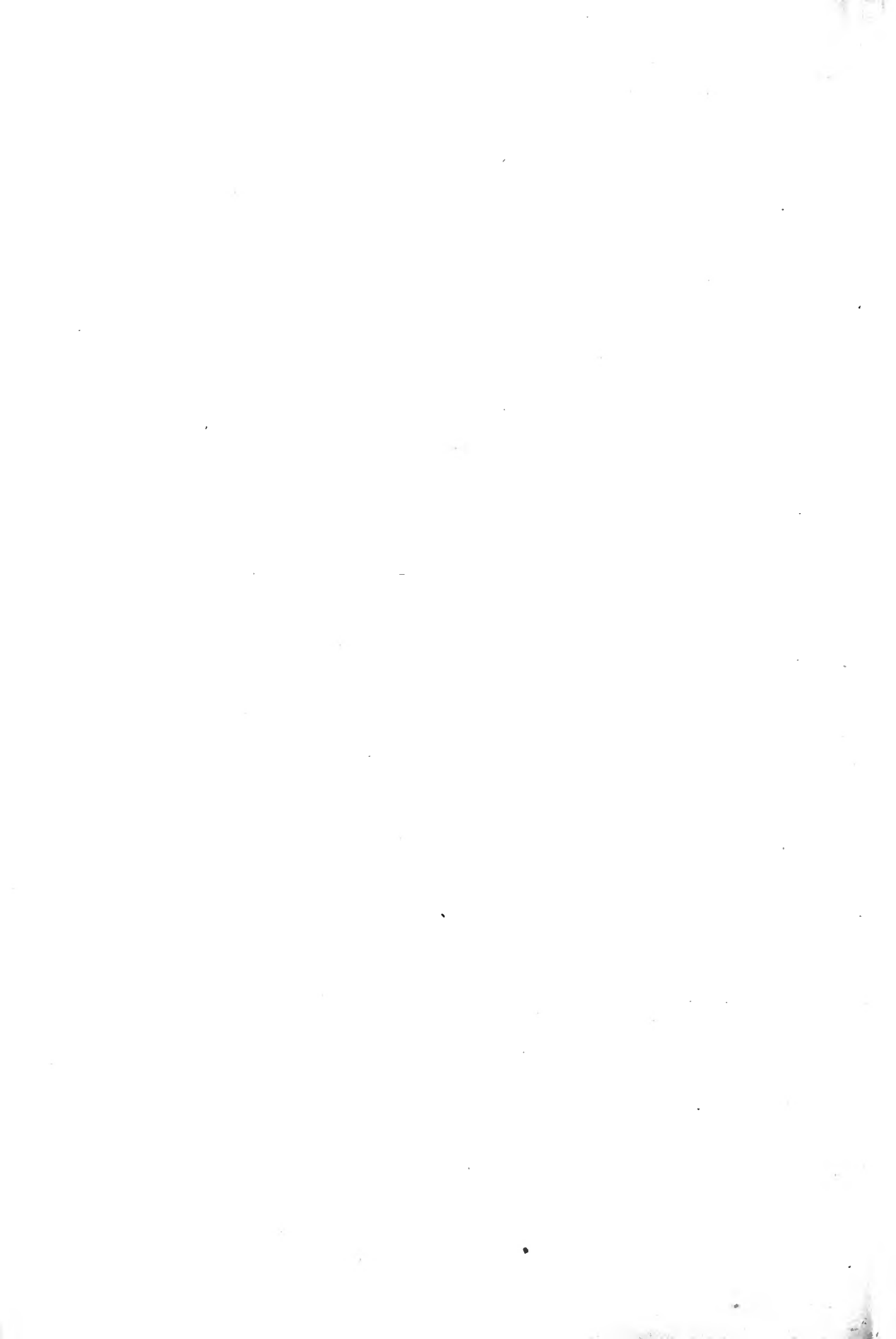
EXPLANATION OF PLATE XIII. (*continued*).

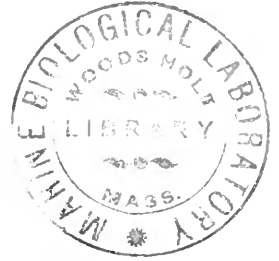
FIG.

54. *PLATYTHECA MICROPORA*, St.—Three loricae with their contained animalcules attached to a joint of conferva; at *a* two zooids, the result of fission, occupy the same lorica,  $\times 650$  (Stein).
- 55-64. *OIKOMONAS MUTABILIS*, S. K.—55, A group of four monads attached to vegetable fibre, showing at *a* and *b* normal sedentary forms, at *c* an example ingesting food-matter at its lateral periphery, and at *d* a young and recently adherent example, not having yet developed a filiform pedicle,  $\times 800$ ; 56, an adult monad about to exchange its sedentary for a free-swimming condition; 57, the same monad detached and free-swimming, still retaining an attenuation of its posterior and previously fixed extremity; 58, typical free-swimming zooid; 59 and 60, more aberrant forms; 61, a motile zooid dividing by longitudinal fission; 62 and 63, spore-masses produced by segmentation of encysted animalcules; 64, a young monad developed from a spore.
- 65-70. *OIKOMONAS STEINII* (S. K.)—65, A group of monads attached to a spheroidal bacterial mass,  $\times 650$ ; 66, four monads similarly attached, exhibiting a considerable irregularity of contour; 67, a free-swimming animalcule with branched posterior extremity; 68, a free-swimming animalcule dividing by transverse fission; 69 and 70, young free-swimming monads (Stein).
71. *OIKOMONAS QUADRATUM*, S. K.—A group of five monads; at *a* and *b*, zooids ingesting food at opposite regions of the periphery,  $\times 800$ .
72. *OIKOMONAS OBLIQUUS*, S. K., filled with artificially administered carmine-particles, a portion of which it is discharging from its posterior extremity,  $\times 2500$ .
- 73-77. *OIKOMONAS ROSTRATUM*, S. K.—73, A group of monads attached to a vegetable-fibre,  $\times 800$ ; 74 and 75, two attached monads, the one with and the other without a posteriorly developed pedicle,  $\times 1000$ ; 76, an example with an abnormally long pedicle; 77, a free-swimming monad with pedicle retracted.
- 78-80. *OIKOMONAS TERMO*, J.-Clark sp.—78, A group attached to vegetable fibre, showing at *a* a zooid dividing by longitudinal fission, at *b* an example ingesting food-matter, and at *c* a young, recently attached and almost stalkless zooid,  $\times 1000$ ; 79, a free-swimming monad; 80, a free-swimming zooid dividing by fission.





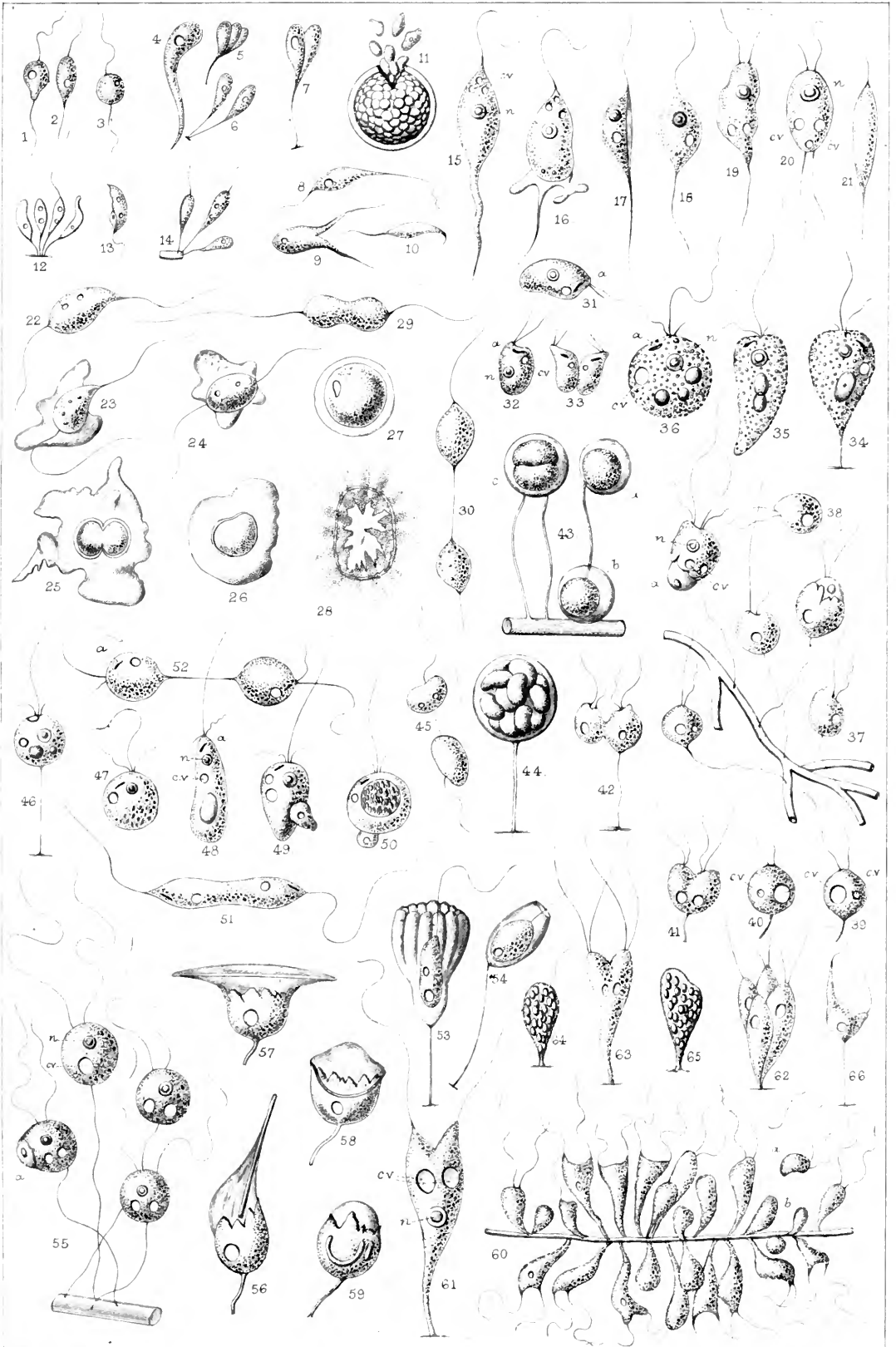


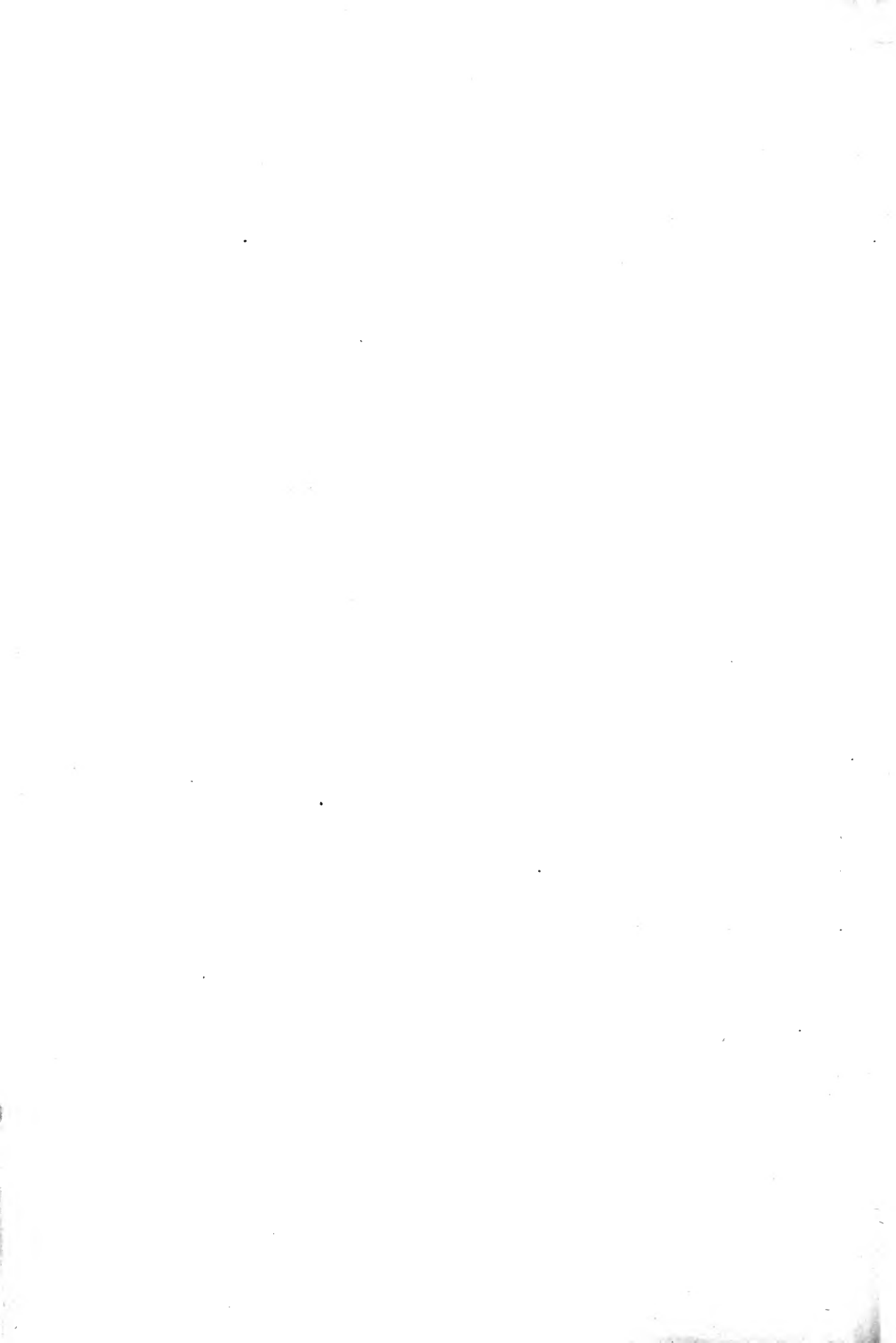


*PLATE XIV.*

EXPLANATION OF PLATE XIV.

- FIG.  
 1-3. BODO JULIDIS, Leidy,  $\times 750$  (Leidy).  
 4-6. BODO MAXIMUS, Schmarda,  $\times 300$  (Schm.).  
 7-8. BODO URINARIUS, Hassall,  $\times 400$  (Hass.).  
 9-11. BODO LYMNÆI, Stiebel sp.—9 and 10, motile zooids,  $\times 600$ ; 11, Sporocyst with escaping germs,  $\times 250$  (Ecker).  
 12, 13. BODO (CRYPTOBIA) HELICIS, Leidy,  $\times 400$  (Leidy).  
 14. BODO INTESTINALIS, Ehr.,  $\times 400$ .  
 15, 16. CERCOMONAS CRASSICAUDA, St.—At 16, with posterior irregular pseudopodic extensions,  $\times 600$  (Stein).  
 17-20. CERCOMONAS LONGICAUDA, Duj.—17 lateral, 18 dorsal view; 19 and 20, progressive stages of longitudinal fission,  $\times 600$  (Stein).  
 21. CERCOMONAS CYLINDRICA, Duj.,  $\times 1200$  (Dujardin).  
 22-30. CERCOMONAS TYPICUS, S. K. (Dallinger and Drysdale).—22, normal adult monad,  $\times 1750$ ; 23 and 24, amœboid phases of matured monads; 25 and 26, successive results of coalescence of two amœboid monads; 27, sporocyst ultimately derived from foregoing coalescence; 28, sporocyst burst and liberating minute spores; 29 and 30, progressive phases of transverse fission.  
 31-33. GONIOMONAS TRUNCATUS, Fres. sp.—At *a*, eye-like pigment-band,  $\times 600$  (Stein).  
 34-36. SPUMELLA VIVIPARA, Ehr. sp. (Stein).—34 attached, 35 and 36 free-swimming conditions; at *a*, eye-like pigment-band or supposed oral aperture,  $\times 600$ .  
 37-45. PHYSOMONAS SOCIALIS, S. K.—37, A group of five monads attached to vegetable fibre, showing at *a* and *b* examples incepting food-matter at opposite regions of their periphery,  $\times 1000$ ; 38, a free-swimming monad; 39 and 40, illustrating the alternating systole and diastole of the two medianly located contractile vesicles; 41 and 42, phases of longitudinal fission; 43, an encysted group, showing at *a* a stalked and at *b* a stalkless cyst; at *c*, two stalks connected with a single and larger cyst, indicating its derivation from the conjugation or coalescence of two zooids,  $\times 1500$ ; 44, a sporocyst with ripe spores,  $\times 2000$ ; 45, monadiform germs released from the same sporocyst,  $\times 2500$ .  
 46-52. SPUMELLA GUTTULA, Ehr. sp. (Stein),  $\times 600$ .—46, normal attached monad; 47 and 48, free-swimming monads; 49 and 50, illustrating conjugative process of larger and smaller monads; 51 and 52, successive phases of longitudinal fission.  
 53. CODONÆCA COSTATA, J.-Clk.,  $\times 1000$  (J.-Clark).  
 54. CODONÆCA OBLIQUA, S. K.,  $\times 800$ .  
 55-59. AMPHIMONAS GLOBOSA, S. K.—55, a group of four monads, one, at *a*, incepting food on its lateral periphery,  $\times 800$ ; 56-59, successive phenomena observed during the inception of a large Bacillus, and in the preliminary phases of which process (Figs. 56 and 57) a film-like expansion of sarcode was extended over the captured prey.  
 60-65. DELTOMONAS CYCLOPUM, S. K.—60, a social group attached to hair of a species of *Cyclops*; at *a*, a free-swimming animalcule, and at *b* a young non-flagellate germ,  $\times 1500$ ; 61, a single monad,  $\times 3000$ ; 62, a group of four monads united by their posterior extremities; 63, longitudinal fission; 64 and 65, sporocysts with spores.  
 66. AMPHIMONAS DIVARICANS, S. K.,  $\times 2500$ .



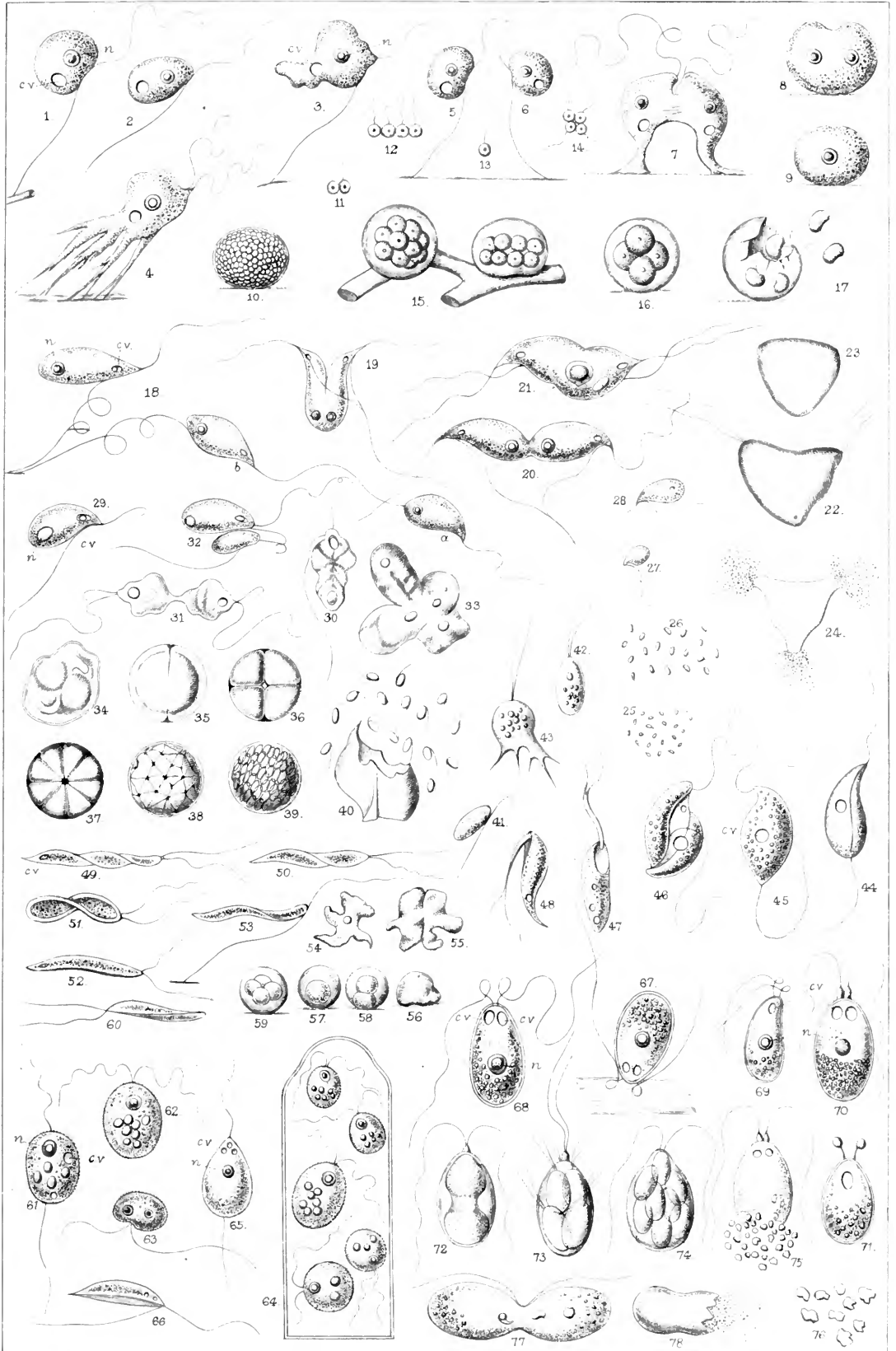


*PLATE XV.*

EXPLANATION OF PLATE XV.

- FIG.  
 1-17. *HETEROMITA LENS*, Müll. sp.—1 and 2, normal adult monad in the fixed and free-swimming conditions,  $\times 800$ ; 3 and 4, irregular-shaped amœbiform conditions; 5 and 6, two monads attached close to each other and about to coalesce; 7, coalescence or conjugation; 8 and 9, phases succeeding conjugation, productive in the last instance of a spheroidal sporocyst; 10, sporocyst, with contents consisting of innumerable microspores; 11-14, minute, uniflagellate, monadiform germs, developed from such microspores, and either single or adherent in diverse combinations,  $\times 2500$ ; 15, two sporocysts, containing eight or sixteen macrospores; 15, a sporocyst with four macrospores only; 17, the same sporocyst burst open and giving birth to four biflagellate germs differing only in size from the parent animalcule,  $\times 1000$ .
- 18-28. *HETEROMITA ROSTRATA*, S. K. (Dallinger and Drysdale).—18, attached condition of adult monad, the outlines at *a* and *b* indicating the positions to which the body is projected by the uncoiling and extension of the posterior and adherent flagellum,  $\times 1500$ ; 19 and 20, successive phases of longitudinal fission; 21 and 22, conjugation of two monads; 23, triangular sporocyst resulting from such conjugation; 24, the same sporocyst bursting at its angles and releasing the enclosed microspores,  $\times 2000$ ; 25 and 26, development at phases of the released microspores, liberated from the triangular sporocyst,  $\times 2500$ ; 27 and 28, further progressive stages towards the attainment of the parent form at the end of eight and ten hours,  $\times 2500$ .
- 29-41. *HETEROMITA UNCINATA*, S. K. (Dall. and Drysd.).—Normal adult monad,  $\times 1500$ ; 30, irregular semi-amœboid phase, preceding fission; 31, fission; 32, conjugation of two monads of diverse size; 33, conjugation of four monads; 34-39, sporocyst resulting from conjugation with successive phases of segmentation of its contents, producing finally a mass of minute microspores; 40, bursting of sporocyst and release of contents as minute uniflagellate germs; 41, one such germ a few hours later, having nearly attained the parent form.
- 42, 43. *PSEUDOSPORA VOLVOCIS*, Cienk.,  $\times 400$ .—Natatory and repent conditions of the same zooid (Cienkowski).
44. *HETEROMITA ADUNCA*, Meresch.,  $\times 1500$  (Meresch).
- 45, 46. *COLPONEMA LOXODES*, St.—45, dorsal, and 46, ventral aspect,  $\times 600$  (Stein).
- 47, 48. *PHYLLIMITUS UNDULANS*, St.,  $\times 600$  (Stein).
- 49-60. *SPIROMONAS ANGUSTATA*, Duj. sp.—49-52, Free-swimming monads, with their bodies in all cases, excepting 52, variously contorted,  $\times 1500$ ; 53, an adherent monad; 54, amœbiform condition; 55, two amœbiform monads conjugating; 56-59, successive phases of encystment and spore-production; 60, free-swimming monad, as represented by Dujardin.
- 61-64. *HETEROMITA GLOBOSUS*, St. sp. (Stein).—61-63, Normal adult monads,  $\times 600$ ; 64, a number of monads tenanted the cell of an *Cedogonium*, and feeding on its contents.
- 65, 66. *HETEROMITA OVATA*, Duj.—Dorsal and lateral aspects,  $\times 600$  (Stein).
- 67-78. *POLYTOMA UVELLA*, Müll. sp.—67-69, Animalcules showing loop-like flexure of the basal region of the flagella, the example in the first instance being attached by this loop-like coil, as observed by the author,  $\times 800$ ; 70 and 71, examples with supposed basal inflations of the flagella, or independent knobbed appendages, as represented by Messrs. Dallinger and Drysdale; 72-74, successive phases of multiplication by complete segmentation of the internal contents (Dallinger and Drysdale); 75, multiplication by the breaking up of the endoplasm of the posterior region only into minute angular germs (D. and D.); 76, the same angular germs, more highly magnified (D. and D.); 77, conjugation of two animalcules (D. and D.); 78, rupture of sporocyst resulting from such conjugation, and release of microspores,  $\times 800$  (D. and D.).





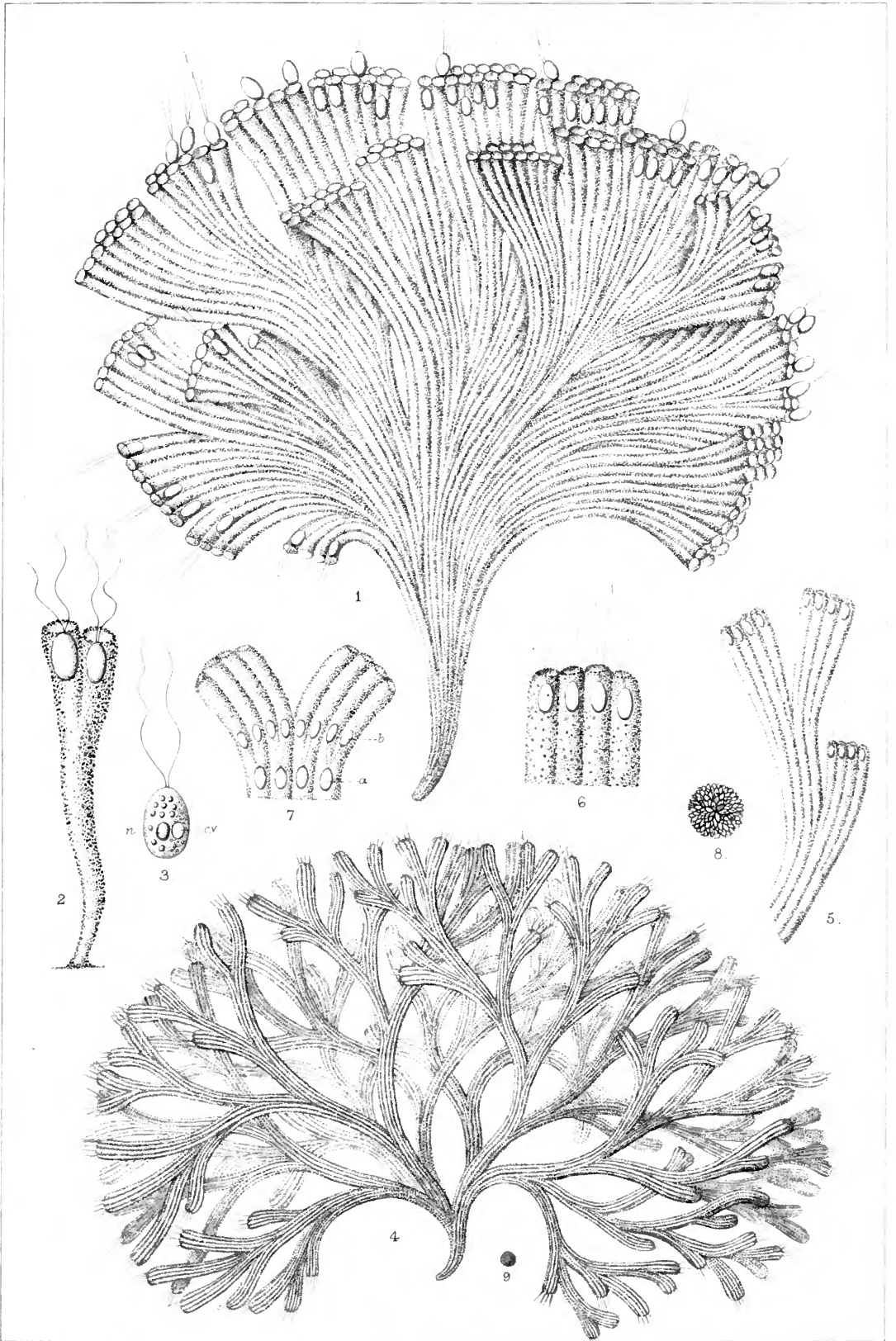


*PLATE XVI.*

### EXPLANATION OF PLATE XVI.

FIG.

- 1-3. *RHIPIDODENDRON SPLENDIDUM*, St. (Stein).—Flabelliform compound colony-stock or zoothecium, consisting of several hundred closely-united tubules, the entire structure representing the product by repeated subdivision and excretion of a primarily single monadiform animalcule,  $\times 400$ ; 2, young zoothecium, constructed up to the point of bifurcation by a single monad, which then dividing by longitudinal fission, has produced two parallel tubes  $\times 600$ ; 3, an isolated monad,  $\times 1150$ .
- 4-8. *RHIPIDODENDRON HUXLEYI*, S. K.—4, Detached ramiscule from an adult branching zoothecium,  $\times 170$ ; 5, portion of branchlet, showing quadruple tubular construction,  $\times 300$ ; 6, distal termination still more magnified, showing contained monads,  $\times 800$ ; 7, diagrammatic illustration of mode in which the characteristic branching zoothecium is produced, the four primary monads, as at *a*, dividing by longitudinal fission, the right and left halves of such total product then parting, as at *b*, and forming their respective tubules at divergent angles; 8, symmetrically developed adult zoothecium,  $\times 5$ ; 9, an adult zoothecium, natural size.





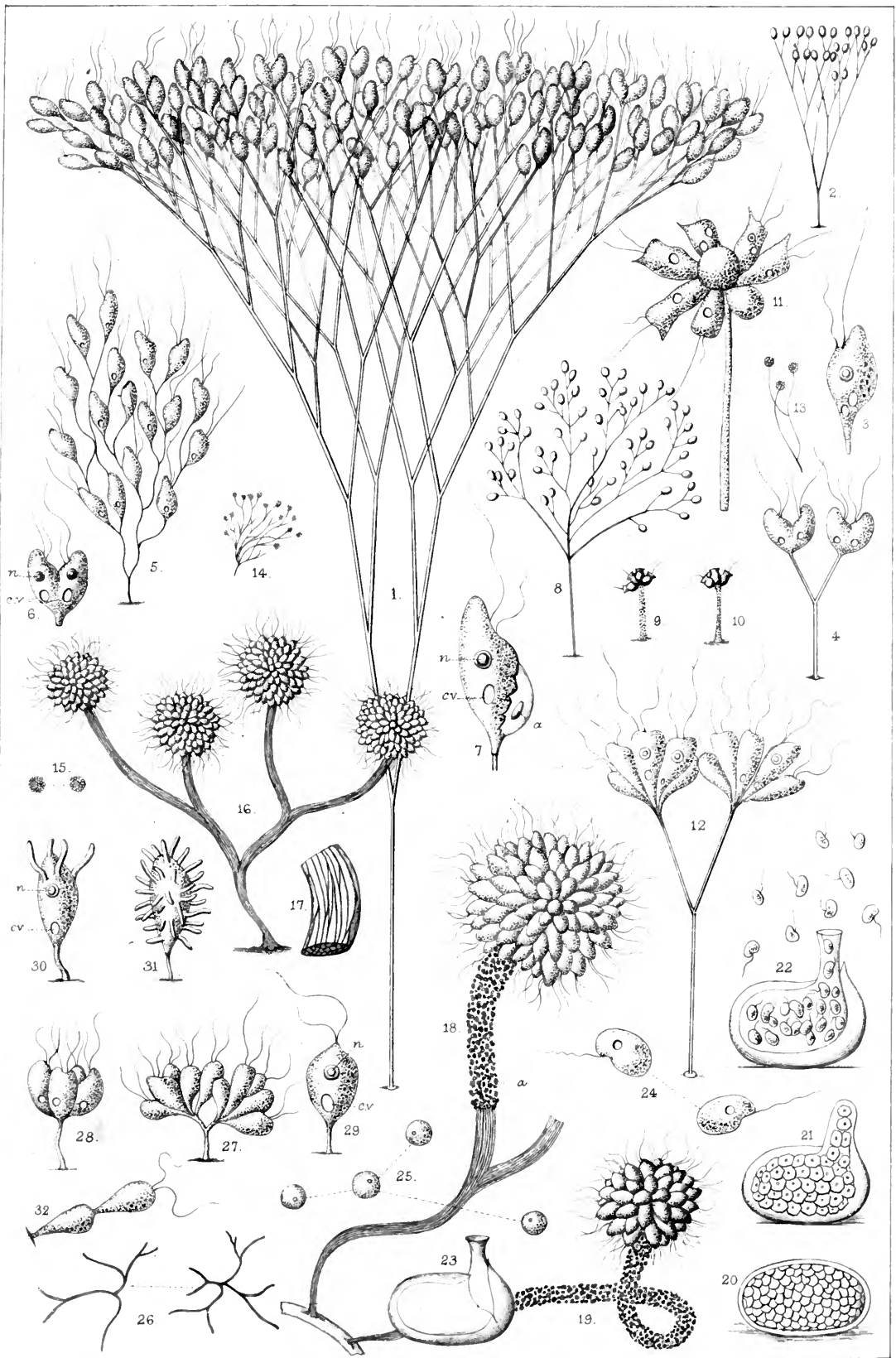
*PLATE XVII.*

## EXPLANATION OF PLATE XVII.

FIG.

- 1-4. *DENDROMONAS VIRGARIA*, Weisse sp., vol. i. p. 266.—1, Adult colony-stock or zoodendrium,  $\times 800$ ; 2, younger and less ramified zoodendrium, as figured by Stein, 'Wiegmann's Archives,' 1849, as a probable young condition of *Epistylis anastatica*; 3, an isolated monad,  $\times 2000$ ; 4, colony of two monads in process of division by longitudinal fission.
- 5-7. *CLADONEMA LAXA*, S. K., vol. i. p. 265.—5, adult colony,  $\times 1000$ ; 6, a monad dividing by longitudinal fission; 7, a single monad ingesting a food-particle towards the posterior region of its periphery,  $\times 3000$ .
8. *DENDROMONAS PUSILLA*, Schmard. sp., vol. i. p. 266,  $\times 250$ .
- 9-11. *ANTHOPHYSA SOCIALIS*, From., vol. i. p. 272.—9 and 10, Colony-stocks, after De Fromentel,  $\times 350$ ; 11, head of colony-stock, including centrally an encysted monad,  $\times 1500$ , after Bütschli.
12. *CEPHALOTHAMNIUM CUNEATUM*, S. K., vol. i. p. 273,  $\times 1250$ .
- 13-26. *ANTHOPHYSA VEGETANS*, Müll. sp., vol. i. p. 267.—13-15, Branching colony-stocks and detached monad clusters, or cænobia, as originally delineated by O. F. Müller,  $\times 50$ ; 16, a typical, erect, shortly branching colony-stock, with four terminal monad-clusters or cænobia,  $\times 400$ ; 17, a portion of common stem, showing its compound or fibrous nature; 18 and 19, two colonies in which the monads, being fed with carmine, have after passing it through their bodies, incorporated the pigment from the points *a*, into the substance of the common stem,  $\times 800$ ; 20-22, sporocyst, showing progressive phases resulting in the liberation of the contents in the form of simple monadiform germs,  $\times 800$ ; 23, the empty sporocyst, showing its composition of an outer firmer and inner more delicate and elastic membrane; 24, monadiform germs liberated from sporocyst,  $\times 2000$ ; 25, subsequent resting condition of the same germs; 26, branching zoodendria derived from these resting spores, the monad clusters having become detached.
- 27-32. *CEPHALOTHAMNIUM CÆSPITOSA*, S. K., vol. i. p. 272.—27 and 28, Adult compound colony-stocks,  $\times 1200$ ; 29-31, single stalked monads, those in the last two figures emitting pseudopodia from within the distal region only, or from the entire surface of their periphery,  $\times 1800$ ; 32, a zooid dividing by transverse fission.—The size of the zooids in the descriptive account of this species has been accidentally set down as 1-5000", instead of 1-3000."



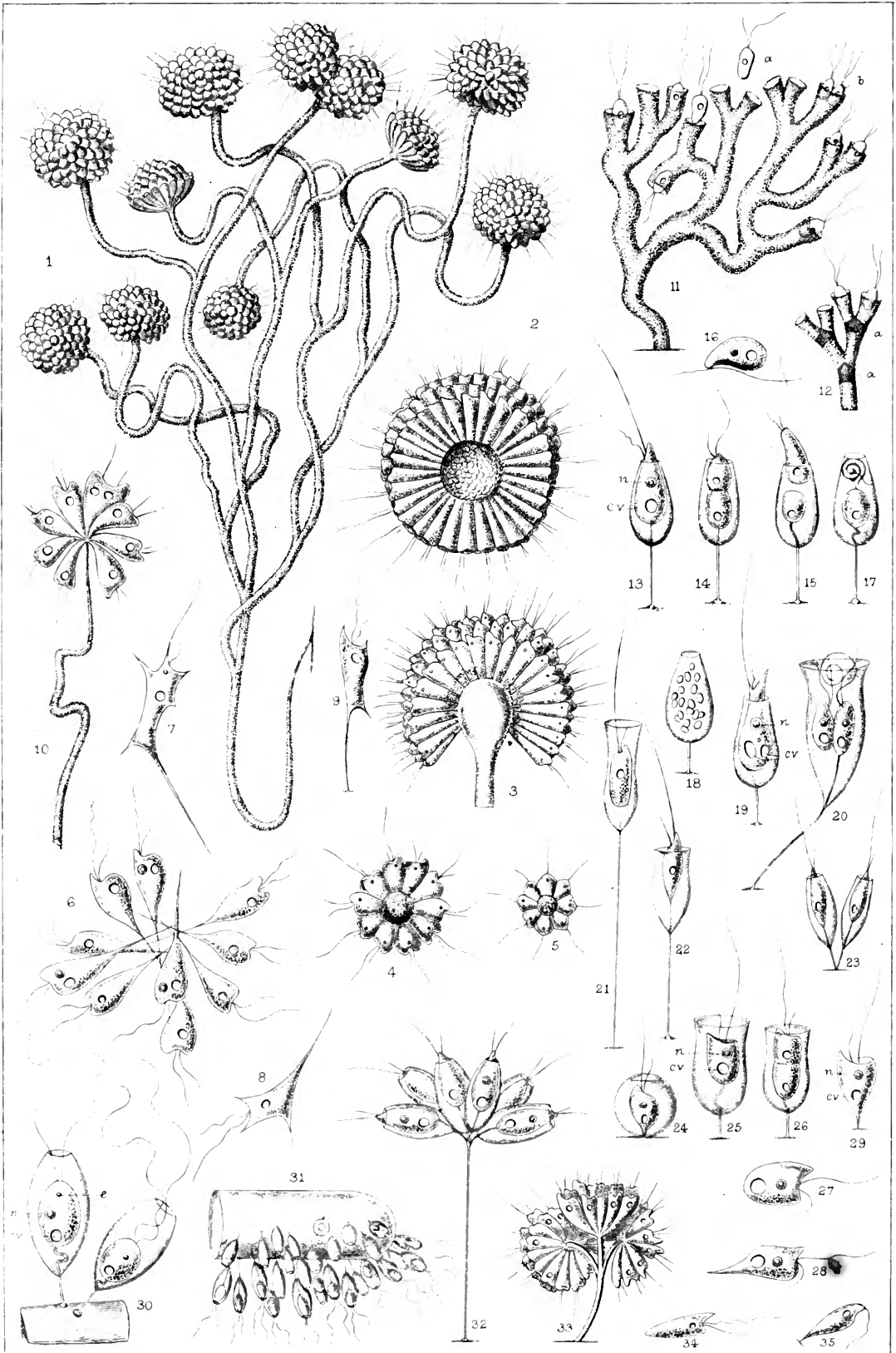


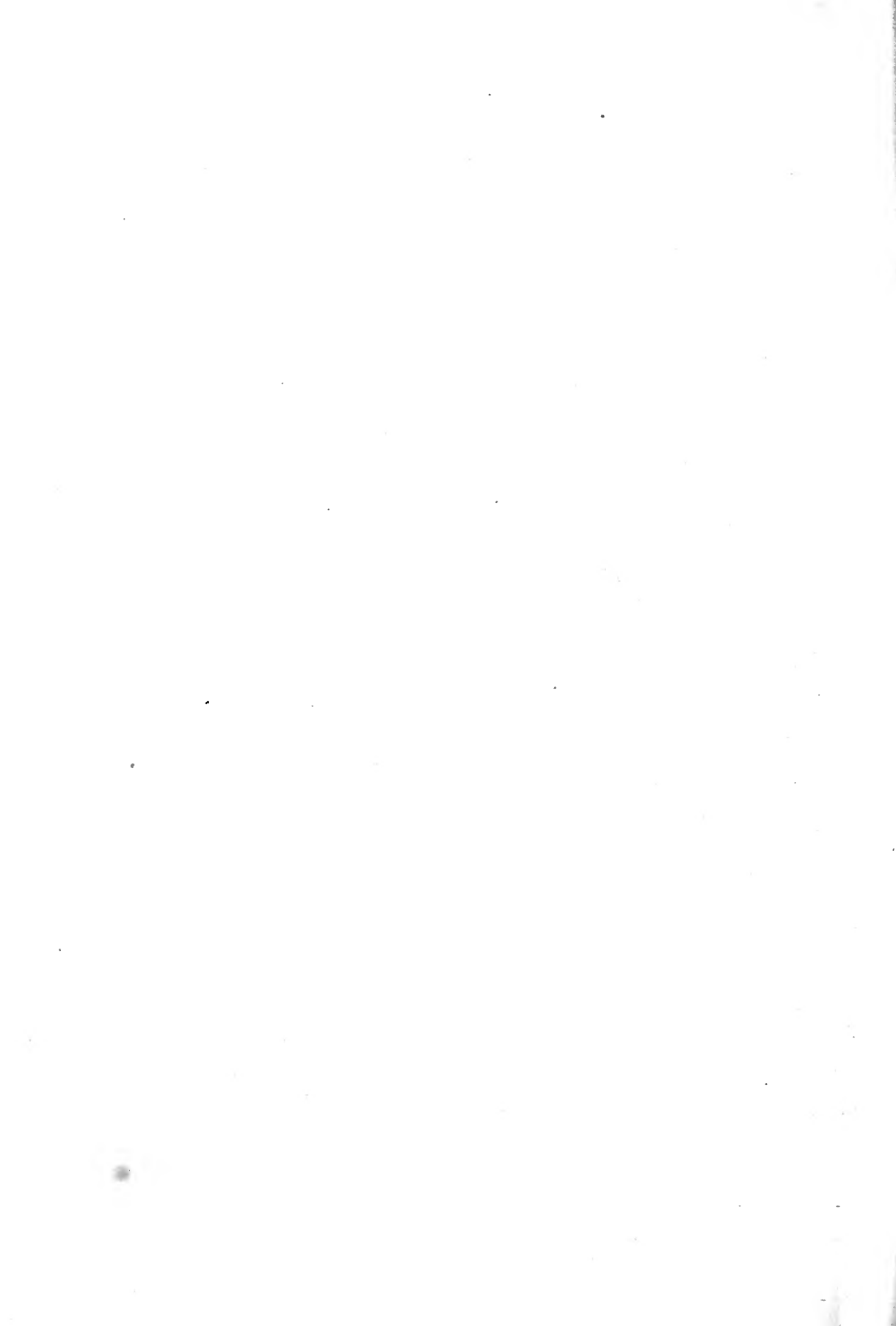


*PLATE XVIII.*

EXPLANATION OF PLATE XVIII.

- FIG.  
 1-10. ANTHOPHYSA VEGETANS, Müll., vol. i. p. 267 (Stein).—1, Prolific colony-stock, with lax homogeneously-granulate branching stem,  $\times 500$ ; 2, detached monad cluster, or "cœnobium," seen from below; 3, cœnobium, showing its relationship to supporting pedicle, as seen in vertical optic section,  $\times 1000$ ; 4 and 5, free-swimming cœnobia, composed of a small number of monads only; 6, disintegrated cœnobium, the monads with tail-like posterior prolongations,  $\times 1000$ ; 7 and 8, independently motile monads, with pseudopodic processes, derived from breaking up of the adult cœnobium; 9, one such motile zooid, fixed by a posterior pseudopod-like extension; 10, early condition of sedentary colony-stock, bearing a single cœnobium of eight monads only.
- 11, 12. CLADOMONAS FRUTICULOSA, vol. i. p. 284 (Stein).—11, Adult tubular colony-stock or zoothecium, showing at *a* a detached monad, and at *b* two monads, the result of longitudinal fission, temporarily inhabiting the same tube,  $\times 650$ ; 12, terminal branchlet of variety having dark-coloured band-like internodes.
- 13-19. BICOSÆCA LACUSTRIS, vol. i. p. 275, J.-Clk.—13, Adult monad in lorica,  $\times 1250$ ; 14 and 15, successive phases of transverse fission; 16, distally separated, free-swimming integer of fission process, presenting a Heteromita-like aspect; 17, monad with spirally-coiled flagella, retracted within its lorica; 18, lorica with sporular contents; 19, adult monad in lateral aspect, showing eccentric development of thread-like footstalk, and lip-like prolongation of the anterior region,  $\times 1250$ .
20. BICOSÆCA CURVIPES, S. K.—Contained monad dividing by longitudinal fission or conjugating with an externally derived zooid,  $\times 1500$ .
- 21, 22. BICOSÆCA GRACILLIPES, J.-Clk., vol. i. p. 276.—21, normal form; 22, example with shorter pedicle and more exert zooid,  $\times 1250$ .
23. BICOSÆCA TENUIS, S. K., vol. i. p. 276,  $\times 1500$ .
24. HEDRÆOPHYSA BULLA, S. K., vol. i. p. 274,  $\times 1500$ .
- 25-29. BICOSÆCA POCILLUM, S. K., vol. i. p. 277.—25, Typical adult form,  $\times 1000$ ; 26, monad dividing by transverse fission; 27 and 28, obtusely and acuminately pointed free-swimming monads derived from the fission process; 29, a similarly derived monad adherent by its posterior extremity, but as yet wanting the characteristic protective lorica.
- 30, 31. DIPLOMITA SOCIALIS, S. K., vol. i. p. 289.—30, Social group attached to a confervoid filament; 31, two monads within their stalked loricae,  $\times 1500$ , at *e* eye-like pigment-spots.
32. STYLOBRYON EPISTYLOIDES, S. K., vol. i. p. 279,  $\times 1500$ .
- 33-35. CEPHALOTHAMNIUM CÆSPITOSA, S. K., vol. i. p. 272 (Stein).—33, Adult colony-stock,  $\times 1000$ ; 34 and 35, free-swimming and attached isolated monads.



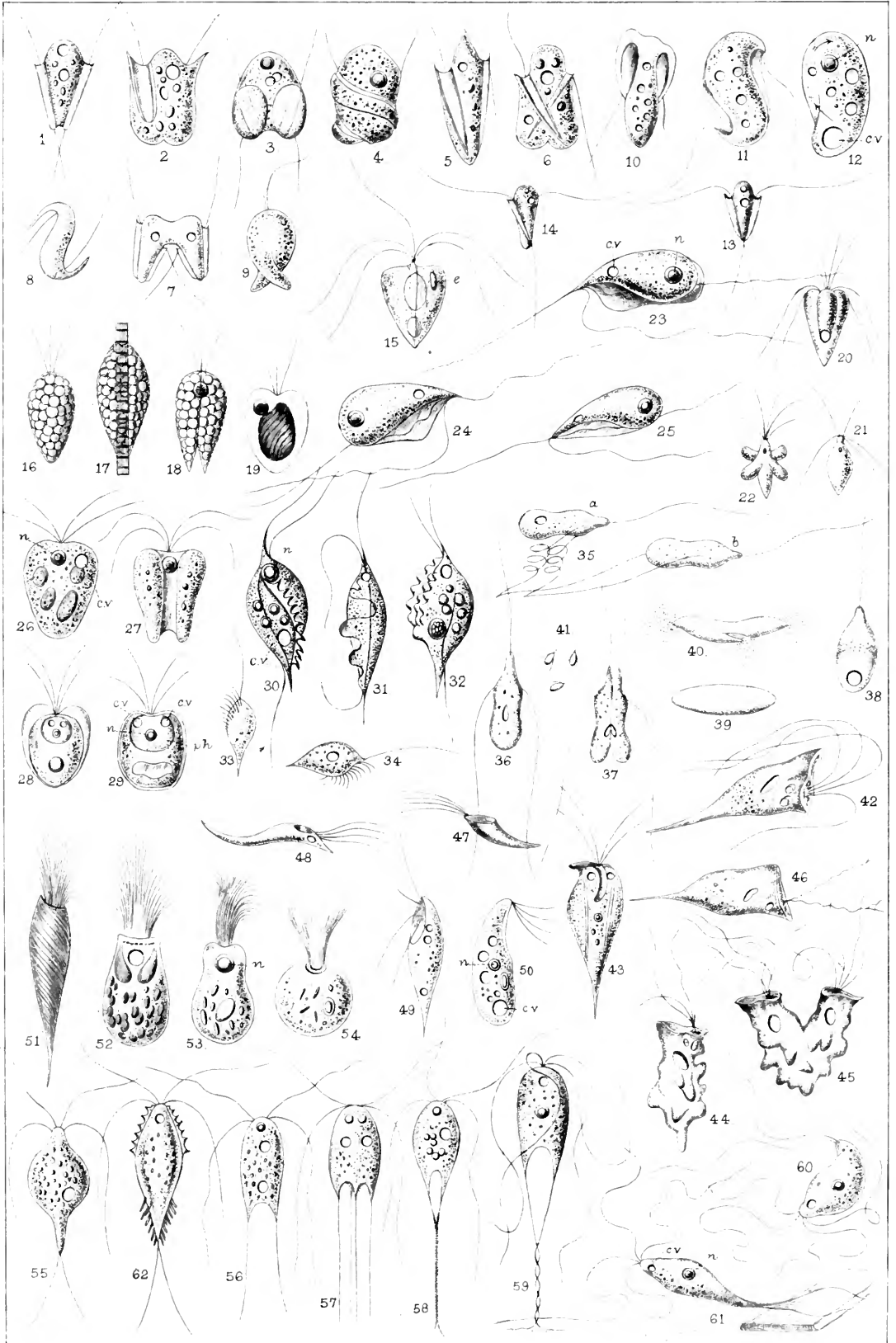


*PLATE XIX.*

## EXPLANATION OF PLATE XIX.

- FIG.  
1-14. *TREPOMONAS AGILIS*, Duj., vol. i. p. 300.—1-8, Animalcule from various points of view, and with the body straight or twisted upon itself, as represented by Stein, at 7 an example dividing by longitudinal fission,  $\times 650$ ; 9, characteristic aspect as given by Perty; 10-12, other phases, as delineated by O. F. Bütschli, the arrows in the last instance indicating the course followed by the circulatory motion of the endoplasm; 13 and 14, young animalcules after Stein.
15. *CHLORASTER AGILIS*, S. K., vol. i. p. 317,  $\times 1250$ .
- 16-19. *CALLODICTYON TRICILIATUM*, Carter, vol. i. p. 307.—17, an animalcule enveloping a vegetable filament,  $\times 400$  (Carter).
20. *CHLORASTER TETRARHYNCHUS*, Schm., vol. i. p. 316,  $\times 350$  (Stein).
- 21, 22. *CHLORASTER GYRANS*, Ehr., vol. i. p. 316,  $\times 250$  (Stein).
- 23-25. *TRIMASTIX MARINA*, S. K., vol. i. p. 312.—23 and 24, lateral, 25, oblique view,  $\times 1250$ .
- 26, 27. *TETRAMITUS SULCATUS*, St., vol. i. p. 314,  $\times 430$  (Stein).
- 28, 29. *TETRASELMIS CORDIFORMIS*, Carter sp., vol. i. p. 315,  $\times 450$  (Stein).
- 30-32. *TRICHOMONAS BATRACHORUM*, Pty., vol. i. p. 308,  $\times 650$  (Stein).
- 33, 34. *TRICHOMONAS VAGINALIS*, Duj., vol. i. p. 309,  $\times 1000$  (Dujardin).
- 35-41. *DALLINGERIA DRYSDALI*, S. K., vol. i. p. 310 (Dallinger and Drysdale); 35, animalcule fixed by two posterior flagella, and showing at *a* and *b* respective positions occupied by the body during the alternate extensions and spiral contractions of these appendages,  $\times 2000$ ; 36, free-swimming animalcule, seen from above; 37, example dividing by longitudinal fission; 38, animalcule with posterior flagella retracted and about to enter upon an encysted state; 39, encystment; 40, sporocyst bursting and liberating clouds of microspores,  $\times 2000$ ; 41, triffagellate monads developed from the liberated microspores.
- 42-48. *TETRAMITUS ROSTRATUS*, Pty., vol. i. p. 313 (43, 47, and 48 after Stein, the remainder after Dallinger and Drysdale).—42, Normal free-swimming animalcule,  $\times 1000$ ; 43, ventral view, showing groove-like channel; 44 and 45, successive phases of longitudinal fission, accompanied by the assumption of an irregular amoebiform contour; 46, biflagellate animalcule derived by fission with flagella in process of further subdivision, so as to reproduce the normal number; 47 and 48, young animalcules,  $\times 650$ .
- 49, 50. *TETRAMITUS DESCISSUS*, Pty., vol. i. p. 314,  $\times 1500$  (Bütschli).
51. *LOPHOMONAS STRIATA*, Bütschli, vol. i. p. 322,  $\times 800$  (Bütschli).
- 52-54. *LOPHOMONAS BLATTARUM*, St., vol. i. p. 321.—52 after Bütschli, 53 and 54, after Stein,  $\times 650$ .
55. *HEXAMITA ROSTRATA*, St., vol. i. p. 320,  $\times 650$ .
- 56-59. *HEXAMITA INFLATA*, Duj., vol. i. p. 319 (56-58 after Stein).—56, normal adult animalcule,  $\times 650$ ; 57, animalcule about to divide by longitudinal fission; 58, example with posterior flagella entangled in floccose matter; 59, animalcule fixed by the extremities of its posterior flagella, and gyrating upon the same, as observed by the author,  $\times 1000$ .
- 60-62. *HEXAMITA INTESTINALIS*, Duj., vol. i. p. 318.—60, free-swimming animalcule,  $\times 1000$ ; 61, example anchored by the posterior flagella, and actively vibrating the four anterior ones; 62, an example with toothed antero-lateral borders and pseudopodic posterior prolongations (Stein).







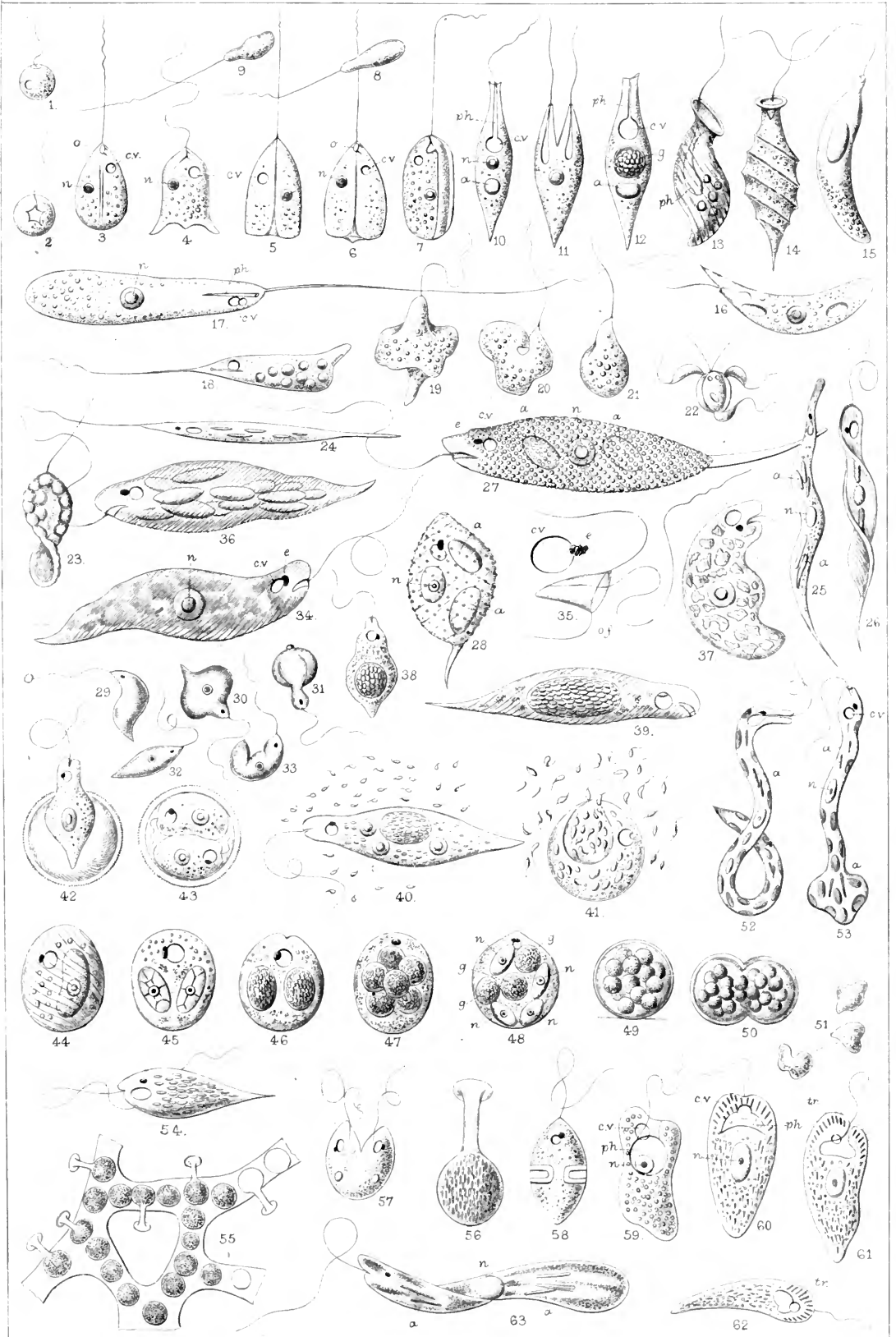
## PLATE XX.

### EXPLANATION.

- FIG.
1. PARAMONAS GLOBOSA, From. sp., vol. i. p. 370, × 400 (Fromentel).
  2. PARAMONAS STELLATA, From. sp., vol. i. p. 370, × 400 (Fromentel).
  3. PETALOMONAS MEDIOCANELLATA, St., vol. i. p. 371, × 350 (Stein).
  4. PETALOMONAS SINUATA, St., vol. i. p. 372, × 400 (Stein).
  - 5, 6. PETALOMONAS ABCISSA, Duj. sp., vol. i. p. 371, dorsal and ventral views, × 500 (Stein).
  7. PETALOMONAS ERVILIA, St., vol. i. p. 372, × 400 (Stein).
  - 8, 9. PETALOMONAS IRREGULARIS, St., vol. i. p. 372, × 1250.
  - 10-12. ATRACTONEMA TERES, St., vol. i. p. 373.—11, Animalcule dividing by longitudinal fission; 12, example without flagellum, and with the endoplast enlarged and broken up into germinal elements, × 640.
  - 13, 14. PHIALONEMA CYCLOSTOMUM, St., vol. i. p. 373, × 500.—14, Variety with spirally ribbed cuticle (Stein).
  - 15, 16. MENOIDIUM PELLUCIDUM, Pty., vol. i. p. 374.—15, As observed by the author; 16, after Stein, × 600.
  - 17-21. ASTASIA TRICHOPHORA, Ehr. sp., vol. i. p. 376.—17, Typical adult zooid, after Bütschli, × 600; 18, example with internal germ-like bodies, after Carter; 19-21, various polymorphic forms.
  22. COLPODELLA PUGNAX, Cienk., vol. i. p. 378.—Three animalcules parasitically attached to a cell of *Protococcus*, × 500 (Cienkowski).
  23. SPIROMONAS DISTORTUM, Duj. sp., vol. i. p. 298, × 600 (Dujardin).
  - 24-25. EUGLENA ACUS, Ehr., vol. i. p. 383.—25 and 26, after Stein, × 300.
  26. EUGLENA OXYURIS, Schm., vol. i. p. 383, × 200 (Stein).
  - 27, 28. EUGLENA SPIROGYRA, Ehr., vol. i. p. 382.—27, Normal extended animalcule, as observed by the author, at *a a*, amylaceous corpuscles, × 240; 28, contracted phase (Stein).
  - 29-51. EUGLENA VIRIDIS, Ehr., vol. i. p. 381.—29, Animalcule with a bulbous distal termination to the flagella, after W. H. Robson; 30-33, polymorphic contours assumed at will by the same animalcule, × 200; 34, typical form, × 600; 35, anterior extremity, with *o f*, funicular oral fossa, *c v*, contractile vesicle, and *e*, eye-like pigment-spot; 36, animalcule with large ovate internally developed germs; 37, an example with enclosed irregularly shaped amœbiform germinal bodies; 38 and 39, transparent varieties (*E. hyalina*,

EXPLANATION OF PLATE XX. (*continued*).

- FIG.  
29-51  
(*continued*). Ehr.) containing large central modified endoplasts or germ-spheres (after Stein); 40 and 41, similar animalcules giving exit by rupture of their germ-spheres to swarms of minute monadiform germs (Stein); 43, an animalcule emerging from a temporary encystment (Stein); 43, an example of fission as accomplished during the encysted state (Stein); 44-48, various phases of encystment accompanied with the production of internal germ-spheres, (Stein); 49 and 50, examples of encystment observed by the author, in which the entire endoplasmic contents have become divided into spheroidal spore-like bodies, at 50 a double sporocyst formed apparently by the conjugation of two animalcules; 51, repent amœbiform germs developed from the preceding sporocysts,  $\times 600$ .
- 52, 53. EUGLENA DESES, Ehr., vol. i. p. 383,  $\times 500$ .—At 53, a young non-flagellate zooid (Stein).
- 54-56. EUGLENA TUBA, Carter, vol. i. p. 385.—54, Normal free-swimming animalcule,  $\times 300$ ; 55, flask-shaped encystments associated in mucous reticulation; 56, a single flask-shaped body, more highly magnified (Carter).
57. EUGLENA VIRIDIS dividing by longitudinal fission,  $\times 300$  (Carter).
58. EUGLENA ZONALIS, Carter, vol. i. p. 388,  $\times 300$  (Carter).
59. CÆLOMONAS GRANDIS, Ehr. sp., vol. i. p. 393,  $\times 400$  (Stein).
- 60-62. RAPHIDOMONAS SEMEN, Ehr. sp., vol. i. p. 392.—At 61, example with hair-like trichocysts extended,  $\times 400$  (Stein).
63. AMBLYOPHIS VIRIDIS, Ehr., vol. i. p. 386,  $\times 200$  (Ehrenberg).
64. EUGLENA AGILIS, Carter, vol. i. p. 384.—Encysted animalcule, having by the abnormal process of serial subdivision become separated into four lineally disposed, equal-sized segment masses,  $\times 300$  (Carter).





## PLATE XXI.

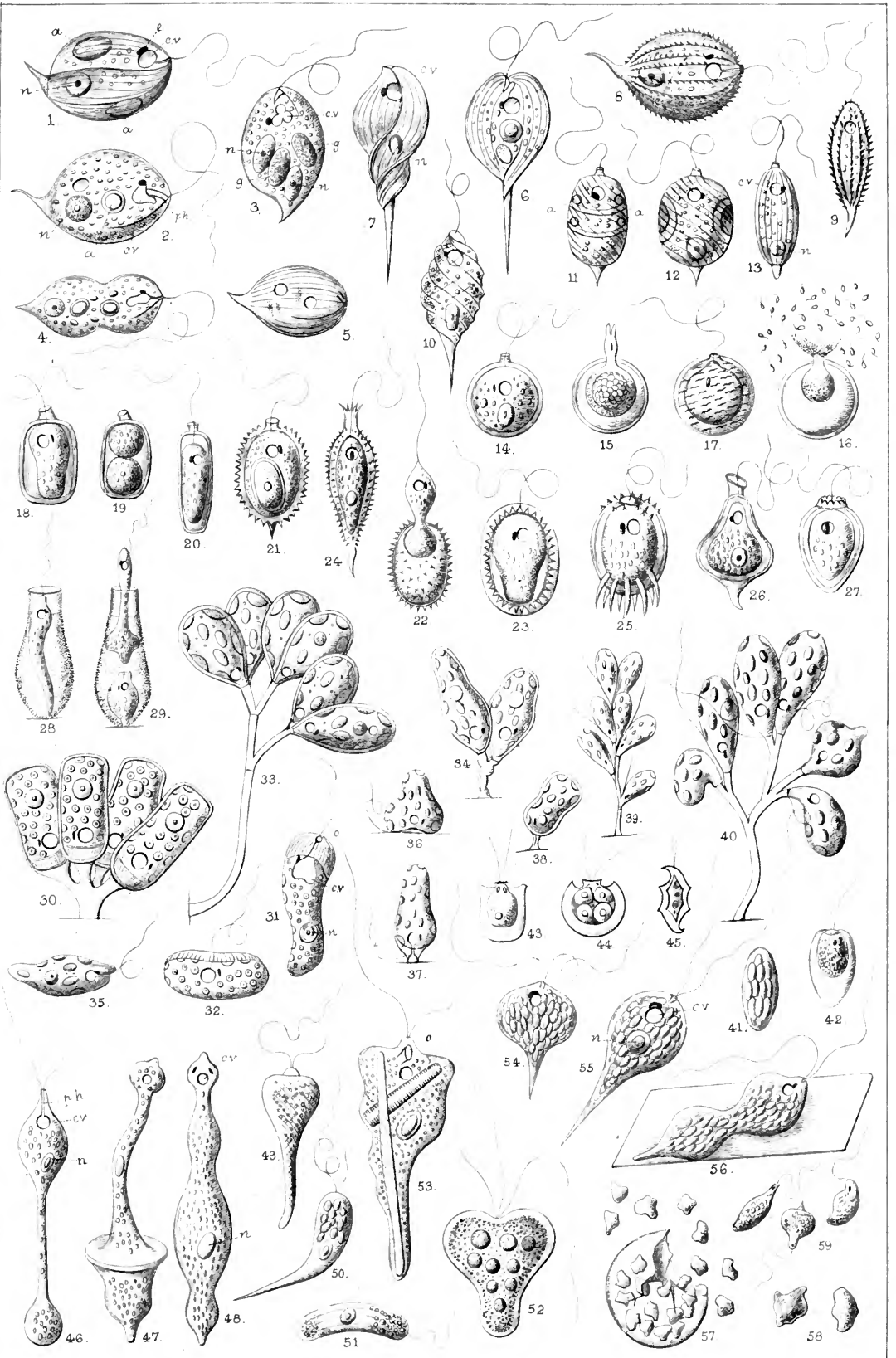
### EXPLANATION.

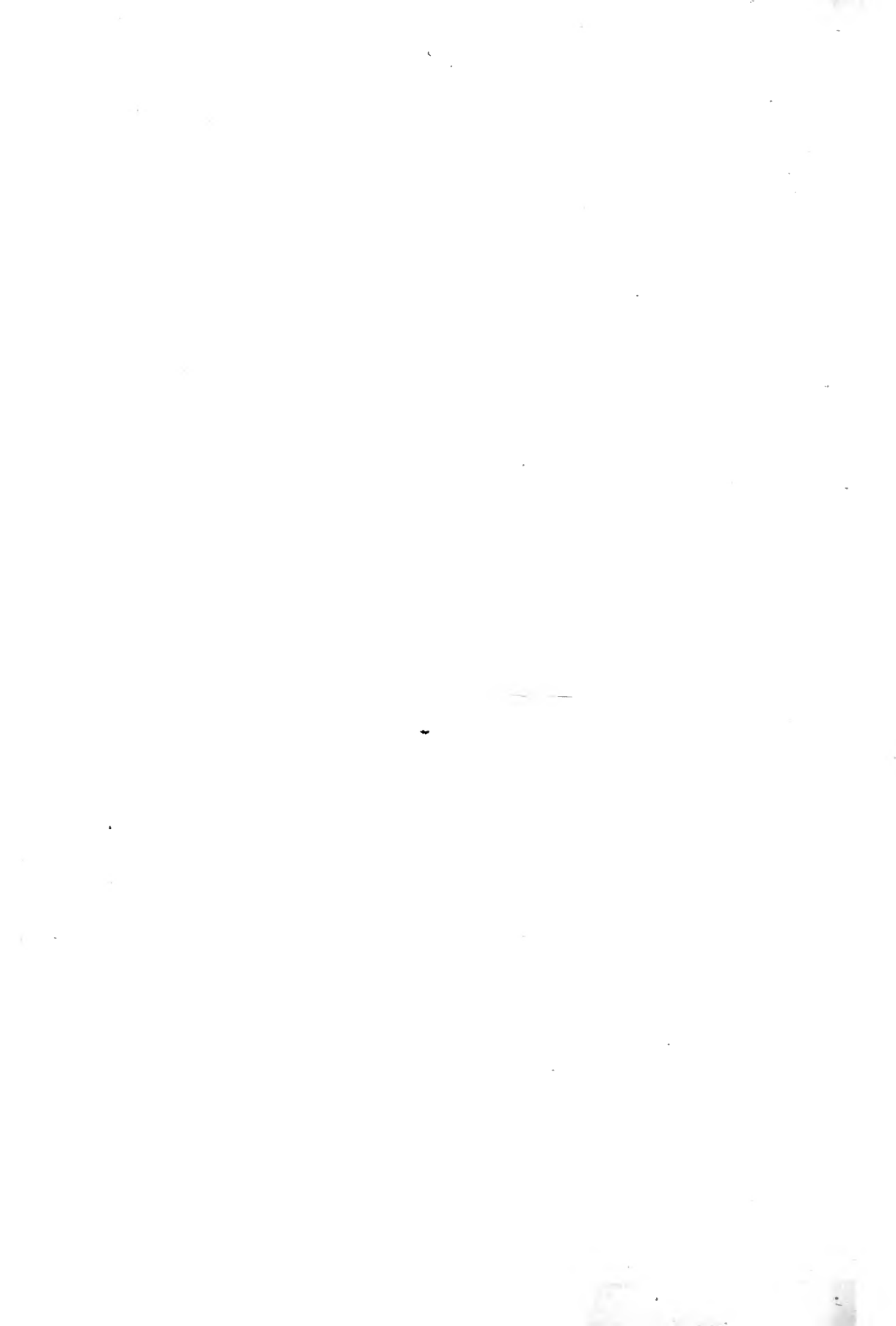
- FIG.
1. PHACUS TRIQUETER, Ehr. sp., vol. i. p. 387.—*aa*, Amylaceous corpuscles; *e*, eye-like pigment-spot,  $\times 600$  (Stein).
  - 2-5. PHACUS PLEURONECTES, Ehr. sp., vol. i. p. 386 (Stein).—2, Normal animalcule,  $\times 600$ ; 3, example with the nucleus or endoplast divided into four fragments, those at *gg* being further separated into germinal elements, constituting the so-called "germ-sacs" or "germ-spheres" of Professor Stein; 4, an instance of transverse fission; 5, indurated membrane or carapace left after the decay of the enclosed body-substance.
  - 6, 7. PHACUS LONGICAUDUS, Ehr. sp., vol. i. p. 387 (Stein).—6, More normal form; 7, spirally twisted non-flagellate example,  $\times 300$ .
  - 8, 9. CHLOROPELTIS HISPIDULA, Eichwald, vol. i. p. 388.—8, Lateral, 9, ventral aspect,  $\times 600$  (Stein).
  10. PHACUS PYRUM, Ehr. sp., vol. i. p. 387,  $\times 600$  (Stein).
  - 11-13. CHLOROPELTIS OVUM, Ehr., vol. i. p. 388.—*a a*, Amylaceous corpuscles; 13, subcylindrical variety,  $\times 600$  (Stein).
  - 14-16. TRACHELOMONAS VOLVOCINA, Ehr., vol. i. p. 389 (Stein).—14, Normal type,  $\times 500$ ; 15, animalcule with flagellum retracted, emerging from its lorica; 16, example bursting and liberating monadiform germs.
  17. TRACHELOMONAS RUGULOSA, St., vol. i. p. 389,  $\times 500$  (Stein).
  - 18, 19. TRACHELOMONAS LAGENELLA, Ehr. sp., vol. i. p. 389 (Stein).—19, Encysted example with body divided by transverse fission,  $\times 500$ .
  20. TRACHELOMONAS CYLINDRICA, Ehr., vol. i. p. 390,  $\times 600$  (Stein).
  - 21-23. TRACHELOMONAS HISPIDA, Pty. sp., vol. i. p. 390 (Stein).—21, Necked variety,  $\times 500$ ; 22, neckless variety, with animalcule emerging from its lorica; 23, example with lorica invested with an outer mucilaginous covering.
  24. TRACHELOMONAS CAUDATA, Ehr. sp., vol. i. p. 391,  $\times 500$  (Stein).
  25. TRACHELOMONAS ARMATA, Ehr. sp., vol. i. p. 390,  $\times 500$  (Stein).
  26. TRACHELOMONAS ACUMINATA, Schmarda, vol. i. p. 391,  $\times 450$  (Stein).
  27. TRACHELOMONAS EURYSTOMA, St., vol. i. p. 390,  $\times 500$  (Stein).
  - 28, 29. ASCOGLENA VAGINICOLA, St., vol. i. p. 393 (Stein).—28, Normal form,  $\times 500$ ; 29, example divided by transverse fission, the anterior segment emerging from the parent lorica.

EXPLANATION OF PLATE XXI. (*continued*).

- FIG.
- 30-32. COLACIUM CALVUM, St., vol. i. p. 395 (Stein).—30, Social colony-stock,  $\times 400$ ; 31 and 32, detached, free-swimming animalcules in extended and contracted states.
33. COLACIUM ARBUSCULA, St., vol. i. p. 394.—Tree-like colony-stock,  $\times 500$  (Stein).
- 34-38. COLACIUM VESICULOSUM, Ehr., vol. i. p. 395 (Stein).—34, Sedentary colony-stock,  $\times 600$ ; 35, detached, free-swimming animalcule; 36-38, successive developmental phases following on the attachment of a motile zooid, and resulting, through further subdivision, in the building up of a more or less extensive sedentary stock.
- 39-41. COLACIUM STEINII, S. K., vol. i. p. 395.—39, Erect colony-stock,  $\times 350$ ; 40, arborescent stock,  $\times 700$ , showing variety of contracted or contorted forms assumed at will by the component animalcules; 41, animalcule in an encysted state, with the body-contents divided into sporular elements.
42. CRYPTOGLAENA CONICA, Ehr., vol. i. p. 419,  $\times 500$  (Ehrenberg).
- 43-45. CRYPTOGLAENA ANGULOSA, Carter, vol. i. p. 420 (Carter).—43, Normal aspect; 44, example enclosing four endogenously developed germinal bodies; 45, lateral aspect,  $\times 500$ .
- 46-51. DISTIGMA PROTEUS, Ehr., vol. i. p. 418 (Stein).—46, Normal biflagellate animalcule,  $\times 500$ ; 47 and 48, old, non-flagellate, and repent zooids (*Proteus tenax*, O. F. Müller?); 49 and 50, young free-swimming animalcules; 51, still younger monoflagellate example (*Monas punctum*, Ehr.).
- 52, 53. ZYGOSELMIS NEBULOSA, Duj., vol. i. p. 417 (Stein),  $\times 1000$ .—53, Example with body distended by ingested diatoms.
- 54-59. EUTREPTIA VIRIDIS, Pty., vol. i. p. 416.—54 and 55, Normal free-swimming animalcules,  $\times 250$ ; 56, repent example; 57, sporocyst burst and liberating green amœbiform germs,  $\times 400$ ; 58, amœbiform germs more highly magnified; 59, young monoflagellate zooids,  $\times 250$ .





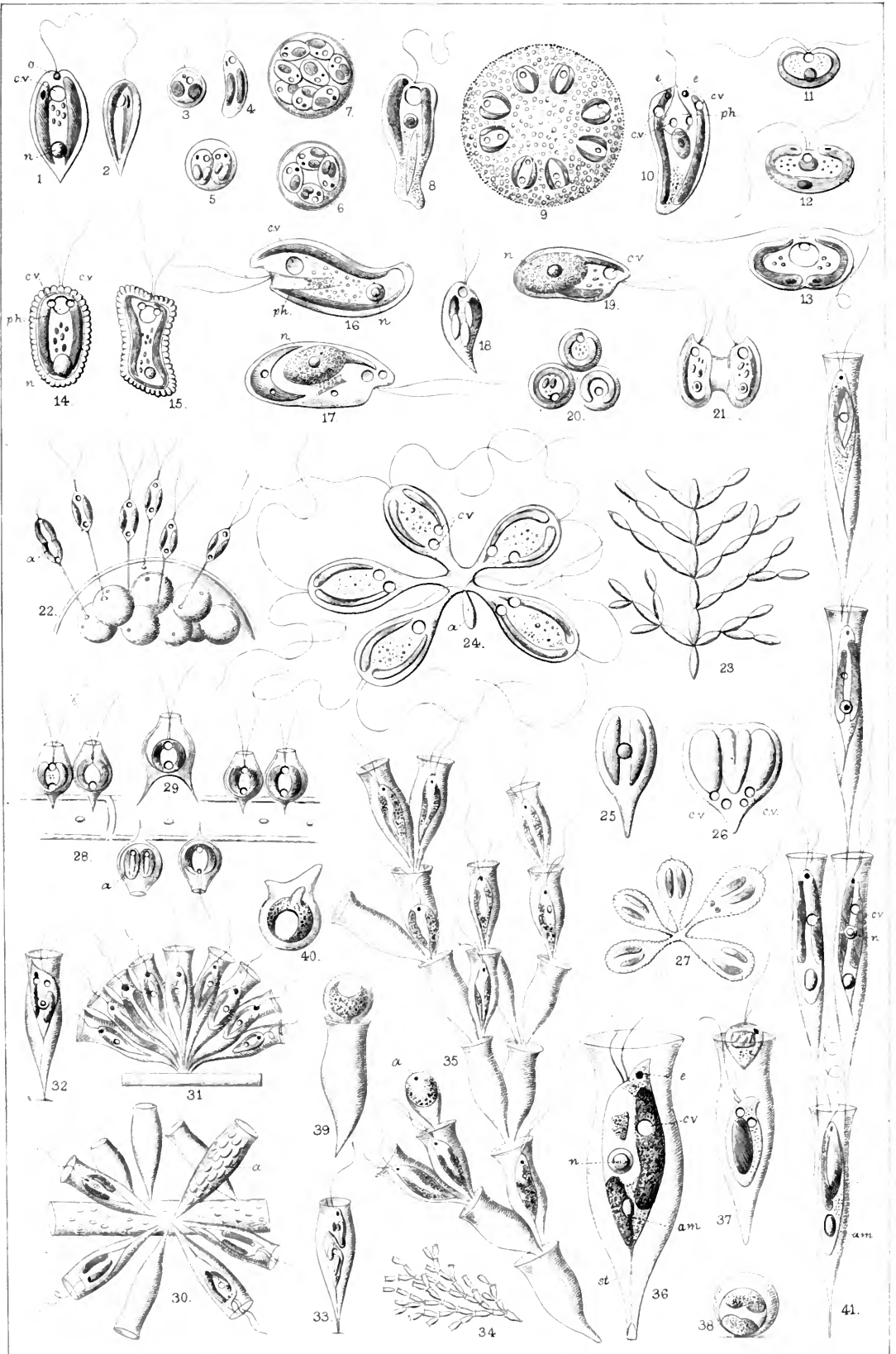


*PLATE XXII.*

EXPLANATION OF PLATE XXII.

FIG.

- 1, 2. CHLOROMONAS PIGRA, Ehr. sp., vol. i. p. 401.—Vertical and profile aspects, × 1500 (Stein).
- 3-7. CHRYSOMONAS OCHRACEA, Ehr. sp., vol. i. p. 402 (Stein).—3 and 4, Normal free-swimming animalcules, × 600; 5-7, resting or encysted conditions, accompanied by multiplication by segmentation into two, four, or eight spore-like daughter-cells.
- 8, 9. CHRYSOMONAS FLAVICANS, Ehr. sp., vol. i. p. 402 (Stein).—8, Normal free-swimming animalcule, × 600; 9, resting or encysted reproductive phase.
10. MICROGLENNA PUNCTIFERA, Ehr., vol. i. p. 403, × 600 (Stein).
- 11-13. NEPHROSELMIS OLIVACEA, St., vol. i. p. 405, × 600 (Stein). ✓
- 14-15. HYMENOMONAS ROSEOLA, St., vol. i. p. 408, × 600 (Stein).
- 16-18. CRYPTOMONAS OVATA, Ehr., vol. i. p. 404 (Stein).—16 and 17, Adult animalcules, × 600; 18, young example.
- 19-21. CRYPTOMONAS EROSA, Ehr., vol. i. p. 404 (Stein).—19, Adult animalcule enclosing large ovate germ-mass, × 600; 20, encysted animalcules; 21, example dividing by longitudinal fission.
22. STYLOCHRYSALIS PARASITA, St., vol. i. p. 405.—Social group attached to the cell-wall of a *Eudorina*, one example at *a* dividing by transverse fission, × 500 (Stein).
23. DINOBRYON JUNIPERINUM, Eichw., vol. i. p. 411, dimensions unrecorded (Eichwald).
- 24-26. UVELLA VIRESCENS, Ehr., vol. i. p. 406 (Bütschli).—24, Socially united cluster of five zooids, × 1200; 25, example treated with acetic acid, showing central spheroidal nucleus or endoplast, and two laterally developed pigment-bands; 26, an animalcule dividing by longitudinal fission.
27. SYNURA (RHODESSA) GRIMSELINA, Pty. sp., vol. i. p. 412, × 300 (Perty).
- 28, 29. CHRYSOPYXIS BIPES, St., vol. i. p. 408 (Stein).—28, Colony fixed to a node of *Mougeotia*, × 600; 29, isolated example showing the two spine-like posterior prolongations of the lorica, by which adhesion to the confervoid algal is secured.
- 30-33. EPIPYXIS UTRICULUS, Ehr., vol. i. p. 409 (Stein).—30, Social colony, × 600, at *a* lorica with network-like markings, probably indicating the presence or previous existence of sporular elements; 31, a more abnormal and closely aggregated colony; 32, an isolated animalcule with its protective lorica more highly magnified; 33, an example dividing by oblique fission, as observed by the author.
- 34-40. DINOBRYON SERTULARIA, Ehr., vol. i. p. 409.—34, Compound detached polythecium, × 250; 35, a similar but smaller colonial aggregation, × 1000, at *a* an animalcule derived by recent fission, attached to the margin of the parent lorica, and constructing for itself by exudation a new protective sheath; 36, an isolated animalcule with its investing lorica, × 2500; *e*, coloured eye-like pigment-spot; *am*, amylaceous corpuscle; *st*, thread-like contractile pedicle or footstalk; *n*, nucleus or endoplast; *cv*, contractile vesicle; 37, example dividing by transverse fission (Bütschli); 38, encysted example (Bütschli); 39 and 40, examples of encystment, after Stein.
41. DINOBRYON STIPITATUM, St., vol. i. p. 410, × 500 (Stein).





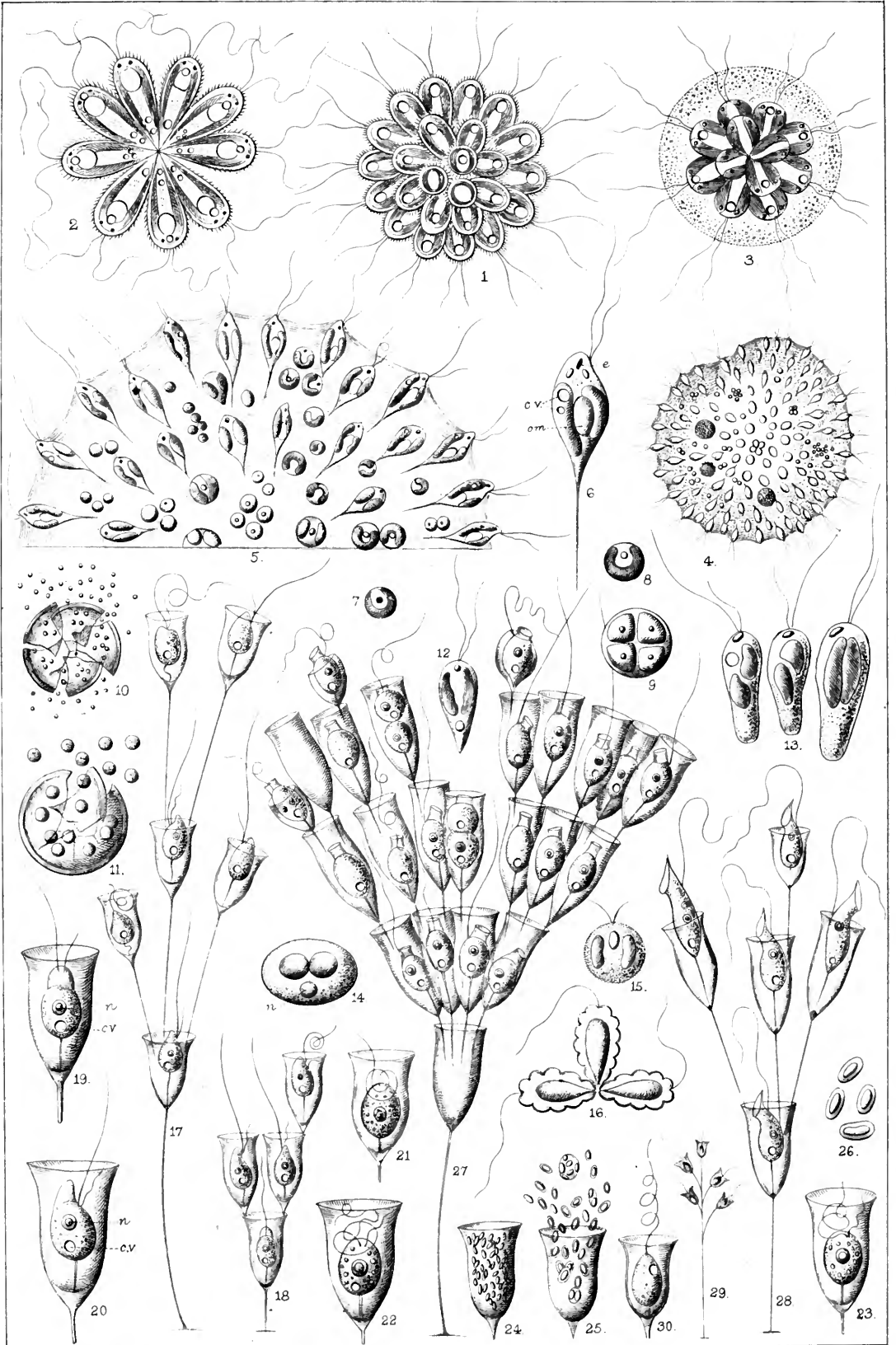
*PLATE XXIII.*

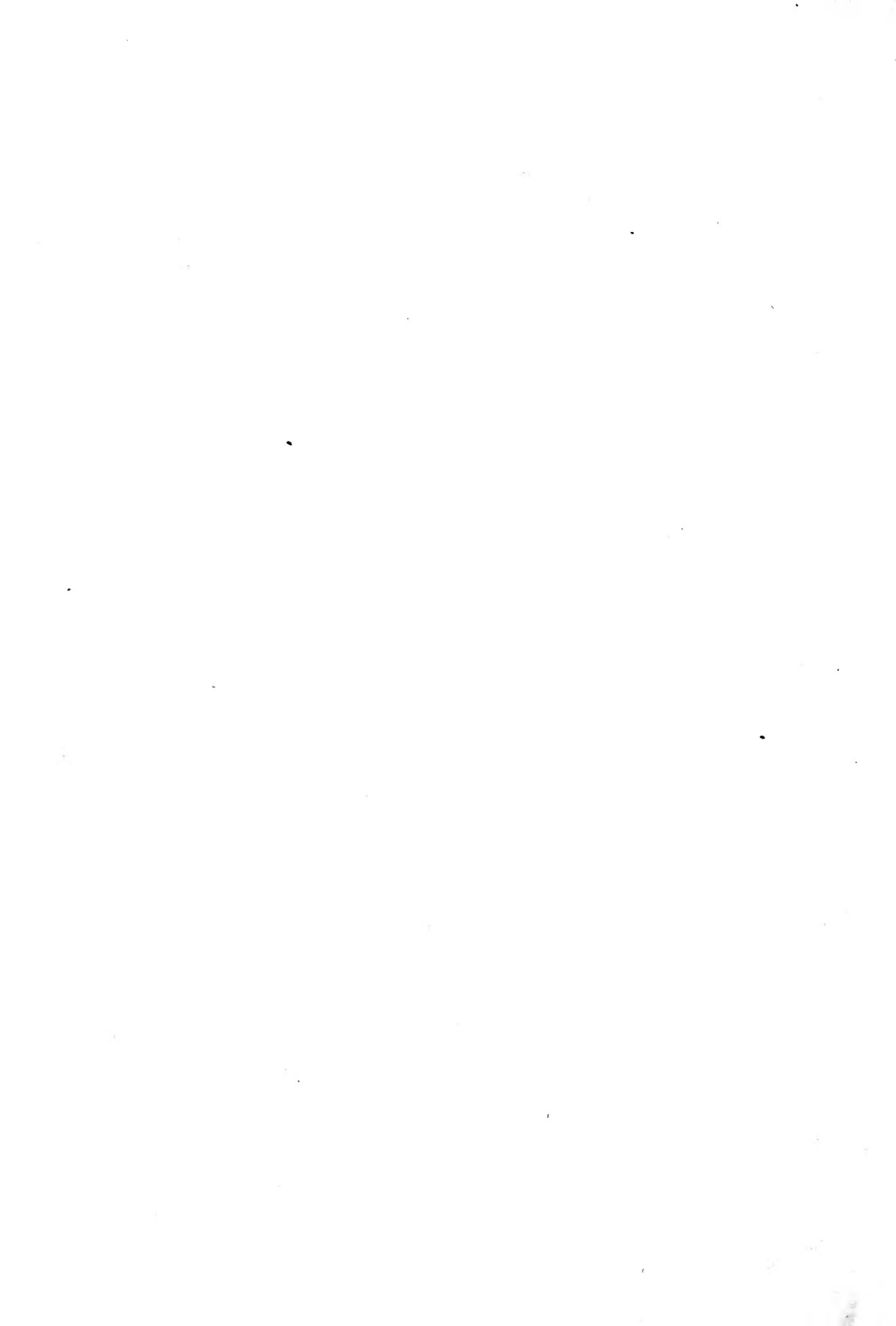
EXPLANATION OF PLATE XXIII.

FIG.

- 1-2. *SYNURA UVELLA*, Ehr., vol. i. p. 412 (Stein).—1, Adult spheroidal colony-stock, composed of animalcules possessing no eye-like pigment-specks,  $\times 350$ ; 2, smaller colony of variety having two anterior eye-like pigment-specks.
3. *SYNCRYPTA VOLVOX*, Ehr., vol. i. p. 413,  $\times 200$  (Stein).
- 4-15. *UROGLENA VOLVOX*, Ehr., vol. i. p. 414.—4, Subspheroidal colony-stock,  $\times 150$ ; 5, segment of a similar colony, more highly magnified, containing sporular elements in various phases of development; 6, a single animalcule; *e*, eye-like pigment-speck; *cv*, contractile vesicle; *am*, refringent amylaceous corpuscle; 7 and 8, isolated spores,  $\times 1200$ ; encysted zooid, with body-mass divided by segmentation into four sporular elements; 10 and 11, sporocysts fractured by artificial pressure, and liberating their contained sporular elements,  $\times 400$ ; 12, animalcule as represented by Stein; 13, three zooids of the same species, after Bütschli; 14-15, examples treated with acetic acid and carmine, after Bütschli and Stein.
16. *SYNURA (UVELLA) FIMBRIATA*, From. sp.,  $\times 400$  (De Fromentel).
- 17-30. *STYLOBRYON PETIOLATUM*, Duj. sp., vol. i. p. 278.—17, Colony-stock of six zooids, as observed by the author, having very long, slender pedicles to their loricae,  $\times 400$ ; 18, colony-stock, in which the pedicles of the distal series are rudimentarily developed; 19 and 20, animalcules in dorsal and profile view, as examined in living state,  $\times 800$ ; 21-23, example from another colony preserved with osmic acid, the longer flagellum being variously convoluted; 24 and 25, examples with entire body-substance separated into sporular elements; 26, isolated spores,  $\times 1200$ ; 27 and 28, colony-stocks of the same type, after Stein; 29 and 30, colony-stock and isolated animalcule of the same species, as figured and described by De Fromentel under the title of *Stylobryon insignis*.







## PLATE XXIV.

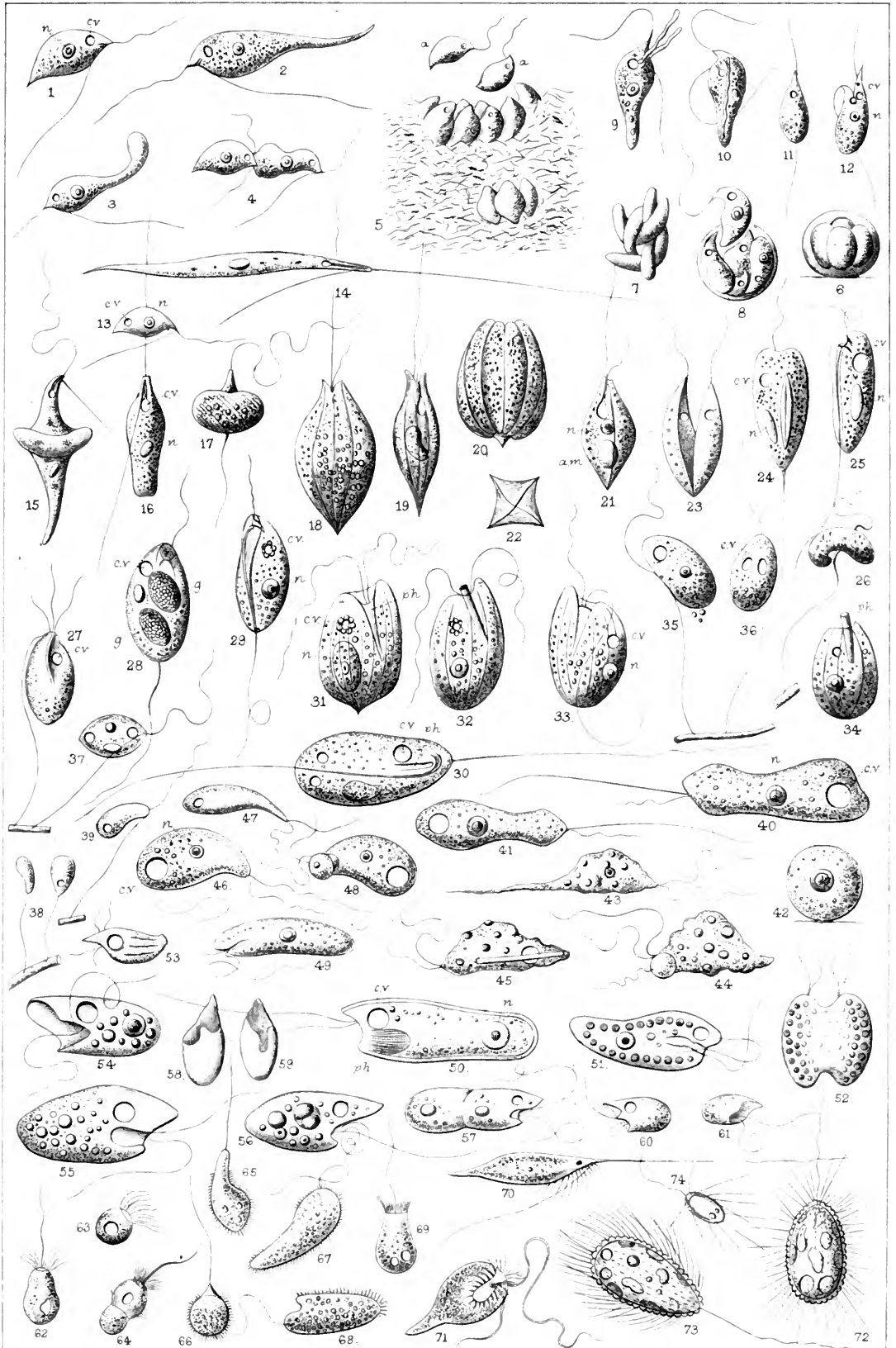
### EXPLANATION.

- FIG.
- 1-10. *DIPLOMASTIX CAUDATA*, Duj. sp., vol. i. p. 432.—1, Typical adult form,  $\times 800$ ; 2 and 3, examples with prolonged posterior extremities; 4, conjugation of two animalcules; 5, spore-groups, imbedded in decaying hay-fibre, at *aa* two uniflagellate, monadiform germs, produced from the same,  $\times 1000$ ; 6, sporocyst with four rounded macrospores,  $\times 1000$ ; 7, group of elongate spores, with cyst-wall dissolved,  $\times 1000$ ; 8, sporocyst with germ emerging, after Stein; 9 and 10, animalcule ingesting and having ingested a bacillus filament, after Stein.
- 11, 12. *DIPLOMASTIX SALTANS*, Ehr. sp., vol. i. p. 433,  $\times 800$  (Stein).
13. *DIPLOMASTIX AFFINIS*, S. K., vol. i. p. 433,  $\times 800$ .
- 14, 15. *HETERONEMA ACUS*, Ehr. sp., vol. i. p. 430,  $\times 400$  (Stein).
- 16, 17. *HETERONEMA GLOBULIFERUM*, Ehr. sp., vol. i. p. 430,  $\times 400$  (Stein).
- 18-20. *SPHENOMONAS OCTOCOSTATUS*, St., vol. i. p. 438 (Stein).—18 and 19, Lateral and ventral aspects,  $\times 400$ ; 20, quiescent or encysted phase.
- 21-23. *SPHENOMONAS QUADRANGULARIS*, St., vol. i. p. 438 (Stein).—21, Normal adult type,  $\times 400$ ; 22, the same viewed vertically to its long axis; 23, zooid dividing by longitudinal fission.
- 24, 25. *ANISONEMA TRUNCATUM*, St., vol. i. p. 435 (Stein).—24, Dorsal, 25, ventral, aspects,  $\times 450$ .
- 26-30. *ANISONEMA GRANDE*, Ehr. sp., vol. i. p. 434.—26, Axial, and 27, dorsal, aspects,  $\times 400$ , the four flagella present in the last figure indicates approaching fission (after Jas.-Clark); 28 and 29, dorsal and ventral aspects, the zooid in the first instance containing two germinal masses,  $\times 450$ , after Stein; 30, zooid after O. Bütschli.
- 31-34. *ENTOSIPHON SULCATUM*, Duj. sp., vol. i. p. 437 (Stein),  $\times 400$ .—31, Zooid enclosing ovate germ-mass; 32, living, and 34, dead examples, with their horny pharyngeal tubes protruding.
- 35, 36. *ANISONEMA LUDIBUNDUM*, S. K., vol. i. p. 435,  $\times 1200$ .—35, Animalcule in lateral view discharging faecal matter from its posterior extremity; 36, dorsal aspect, showing the two anteriorly located contractile vesicles.
- 37-39. *ANISONEMA INTERMEDIUM*, S. K., vol. i. p. 436.—37 and 39, dorsal and lateral aspects,  $\times 1200$ ; 28, two young animalcules, possessing as yet only a single posterior anchoring flagellum, or gubernaculum,  $\times 1200$ .
- 40-42. *STERROMONAS FORMICINA*, S. K., vol. i. p. 420.—40 and 41, Dorsal and lateral aspects,  $\times 1200$ ; 42, encysted state.

EXPLANATION OF PLATE XXIV. (*continued*).

FIG.

- 43-45. *DINOMONAS TUBERCULATUS*, S. K. vol. i. p. 422.—43, Animalcule with prolonged caudal extremity,  $\times 1800$ ; 44, an animalcule devouring a smaller monad; 45, an example with ingested *Bacillus*.
- 46-48. *DINOMONAS VORAX*, S. K., vol. i. p. 422.—46, Normal adult type,  $\times 1200$ ; 47, more attenuate early condition; 48, example in the act of devouring a smaller monad.
49. *CHILOMONAS AMYGDALUM*, S. K., vol. i. p. 426,  $\times 1800$ .
50. *CHILOMONAS CYLINDRICA*, Ehr. sp., vol. i. p. 425,  $\times 500$  (Bütschli).
- 51, 52. *CHILOMONAS PARAMECIUM*, Ehr., vol. i. p. 424 (Bütschli).—51, Normal adult form,  $\times 650$ ; 52, example dividing by longitudinal fission.
- 53-61. *OXYRRHIS MARINA*, Duj., vol. i. p. 427.—53, A reproduction of Dujardin's original figure; 54-56, right and left side aspects, as observed by the author,  $\times 800$ ; 57, an example of transverse fission; 58 and 59, empty membranous carapaces; 60 and 61, delineations of the same animalcule as given by Cohn.
- 62-64. *ASTHMATOS CILIARIS*, Sals.,  $\times 400$  (Salisbury).
- 65, 66. *TRICHONEMA HIRSUTA*, From.,  $\times 400$  (Fromentel).
- 67, 68. *MITOPHORA DUBIA*, Pty.,  $\times 350$  (Perty).
69. *STEPHANOMONAS LOCELLUS*, From. sp.,  $\times 400$  (Fromentel).
- 70, 71. *HETEROMASTIX PROTEIFORMIS*, J.-Clk.—70, extended, and 71, contracted, phases,  $\times 500$  (Jas.-Clark).
- 72, 73. *MALLOMONAS PLOSSLI*, Pty.,  $\times 800$ .
74. *MALLOMONAS FRESENI*, S. K.,  $\times 350$ .





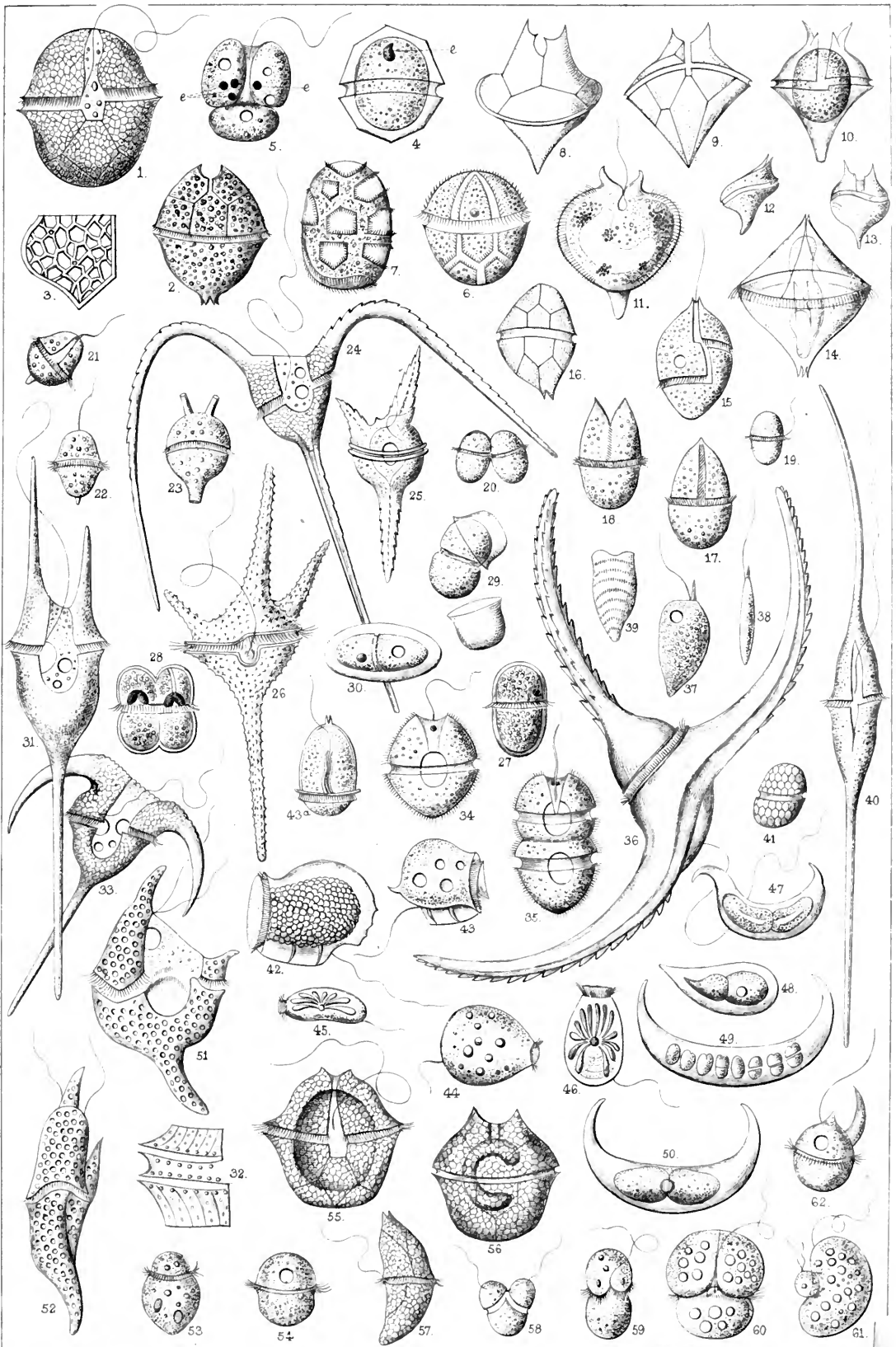


*PLATE XXV.*

EXPLANATION OF PLATE XXV.

- FIG.  
 1-5. PERIDINIUM TABULATUM, Ehr., vol. i. p. 448.—1, Variety with rounded poles or apices and no eye-like pigment-spot, ventral aspect,  $\times 350$  (Claparède and Lachmann); 2, variety with pointed apices, dorsal aspect (Ehr.); 3, separate reticulated plate from cuirass,  $\times 600$ ; 4, encysted example, with eye-like pigment-spot (C. & L.); 5, example with four pigment-spots, its cuirass cast off (C. & L.).
- 6, 7. PERIDINIUM APICULATUM, Ehr. sp., vol. i. p. 449,  $\times 400$  (Ehr.).
- 8-13. CERATIUM DIVERGENS, C. & L., vol. i. p. 453.—8 and 9, Empty cuirass, dorsal and ventral aspects, showing form and disposition of its component plates,  $\times 500$  (C. & L.); 10, encysted animalcule (C. & L.); 11, example with carapace cast off (C. & L.); 12 and 13, the same species as figured by Bailey under the title of *Peridinium depressum*.
14. PERIDINIUM ÆQUALIS, S. K., vol. i. p. 451.—Dimensions unrecorded (Will.-Suhm).
- 15, 16. PERIDINIUM SPINIFERUM, C. & L., vol. i. p. 449,  $\times 400$  (C. & L.).
- 17, 18. GYMNODINIUM FUSCUM, Ehr., vol. i. p. 443,  $\times 300$  (Ehr.).—18, Example of conjugation or longitudinal fission.
- 19, 20. GYMNODINIUM PULVICULUS, Ehr. sp., vol. i. p. 443,  $\times 500$  (Ehr.).
- 21, 22. GLENODINIUM ACUMINATUM, Ehr., vol. i. p. 446,  $\times 250$  (Ehr.).
23. CERATIUM MICHAELIS, Ehr. sp., vol. i. p. 453,  $\times 300$  (Ehr.).
24. CERATIUM TRIPOS, Müll. sp., var. MACROCEROS, vol. i. p. 454,  $\times 250$  (C. & L.).
25. CERATIUM KUMAONENSE, Carter, vol. i. p. 458,  $\times 190$  (Carter).
26. CERATIUM LONGICORNE, Perty, vol. i. p. 457,  $\times 300$  (Carter).
- 27, 28. GLENODINIUM CINCTUM, Ehr. sp., vol. i. p. 446,  $\times 400$  (Ehr.).—28, An example of longitudinal fission or conjugation.
- 29, 30. PERIDINIUM sp., encysted examples, vol. i. p. 447,  $\times 250$  (C. & L.).
- 31, 32. CERATIUM FURCA, Ehr. sp., vol. i. p. 445,  $\times 350$ .—32, Central region, showing more minute structure of the cuirass,  $\times 600$  (C. & L.).
33. CERATIUM TRIPOS, Müll. sp., normal short-armed type,  $\times 250$  (C. & L.).
- 34, 35. MELODINIUM UBERRIMUM, Allman sp., vol. i. p. 445.—34, Normal animalcule,  $\times 300$ ; 35, example dividing by transverse fission (Allman).
36. CERATIUM TRIPOS, Müll. sp., var. ARCTICUM, vol. i. p. 454,  $\times 300$ .
- 37-39. PROROCENTRUM MICANS, Ehr., vol. i. p. 461.—37 and 38, Lateral and dorsal aspects; 39, empty cuirass,  $\times 303$  (C. & L.).
40. CERATIUM FUSUS, Ehr. sp., vol. i. p. 456,  $\times 300$  (C. & L.).
41. PERIDINIUM RETICULATUM, C. & L., vol. i. p. 449,  $\times 300$  (C. & L.).
42. DINOPHYSIS VENTRICOSA, C. & L., vol. i. p. 459,  $\times 350$  (C. & L.).
43. DINOPHYSIS ACUMINATA, C. & L., vol. i. p. 459,  $\times 300$  (C. & L.).
44. DINOPHYSIS OVATA, C. & L., vol. i. p. 460, ventral aspect,  $\times 350$  (C. & L.).
- 45, 46. AMPHIDINIUM OPERCULATUM, C. & L., vol. i. p. 461,  $\times 300$  (C. & L.).
- 47-50. PERIDINIA sp., encystments, vol. i. p. 448, with contents variously divided, that at 49 with the contained protoplasmic mass separated into eight minute naked Peridinia,  $\times 300$  (after Claparède and Lachmann).
- 51, 52. DIMASTIGOAULAX CORNUTUM, Ehr. sp., vol. i. p. 462, front and lateral aspects,  $\times 300$ .
53. GYMNODINIUM ROSEOLUM, Schmarda sp., vol. i. p. 444,  $\times 350$  (Schmarda).
54. GYMNODINIUM INERME, Schmarda sp., vol. i. p. 444,  $\times 600$  (Schmarda).
- 55-57. PERIDINIUM TABULATUM, Ehr., vol. i. p. 448, brown variety with cleft anterior border,  $\times 300$ .—55, Ventral, 56, dorsal, 57, lateral aspects, the example at 56 enclosing a recurved band-like endoplast.
- 58, 59. GYMNODINIUM LACHMANNI, S. K., vol. i. p. 444.—At 58 an example dividing by longitudinal fission,  $\times 300$  (C. & L.).
- 60, 61. GYMNODINIUM MARINUM, S. K., vol. i. p. 444,  $\times 600$ .—At 61 an example devouring a smaller monad.
62. CERATIUM BICORNE, Schmarda sp., vol. i. p. 453,  $\times 400$  (Schmarda).







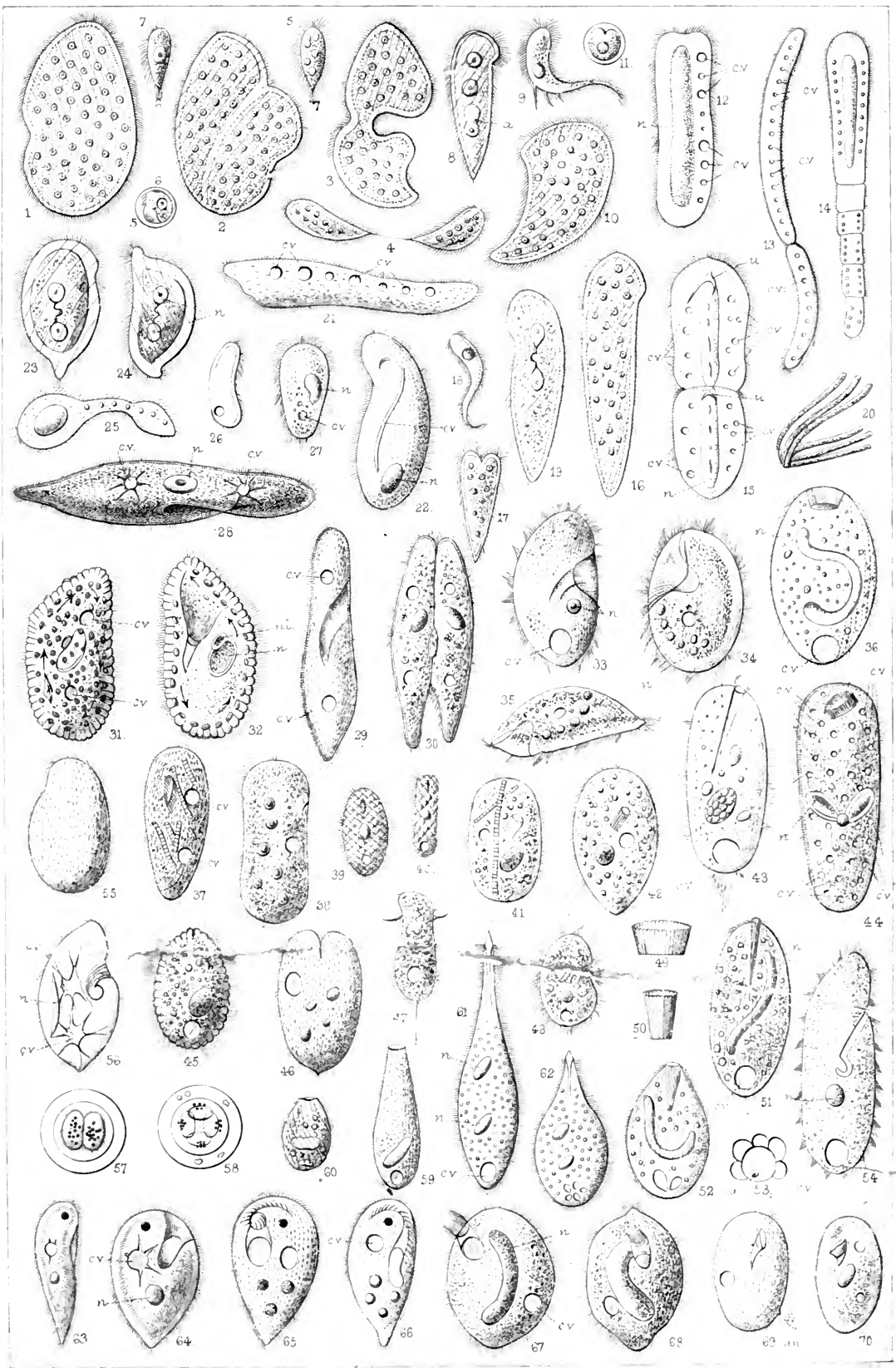
## PLATE XXVI.

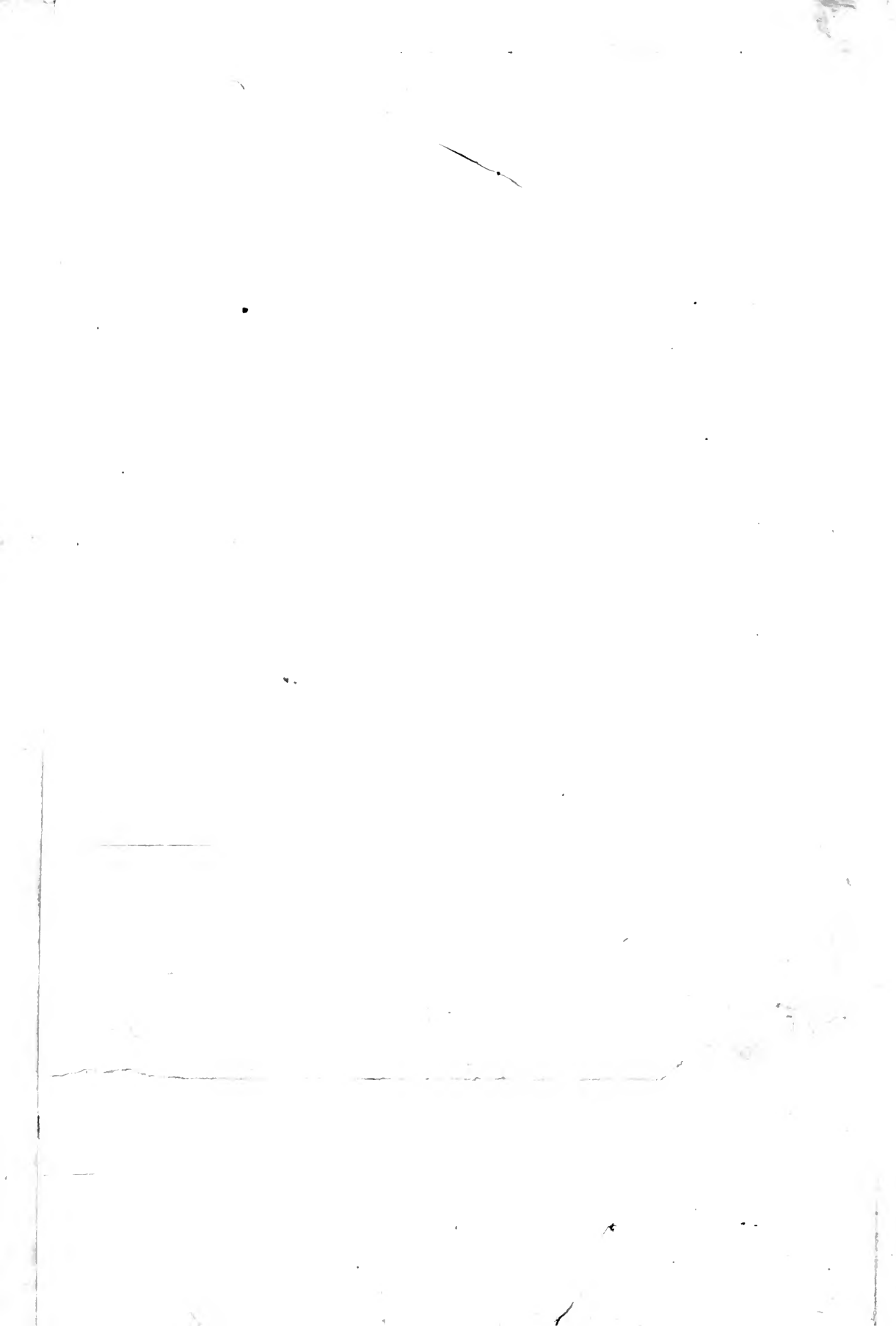
### EXPLANATION.

- FIG.
- 1-9. *OPALINA RANARUM*, Purkinge, vol. ii. p. 559.—1, Adult animalcule,  $\times 100$ ; 2-5, successive phases of segmentation terminating in the production of minute ovate zooids possessing but a few nuclei or endoplasts,  $\times 100$ ; 6, succeeding encysted condition of No. 5,  $\times 200$ ; 7 and 8, successive developmental phases of zooid that has re-emerged from the encysted state, the one at 7 possessing but a single endoplast, and that at 8 three such structures, the lowermost of which, at *a*, is in the act of subdividing; 9, a young zooid with ragged pseudopodium-like lateral extensions (1-8 after Ernst Zeller, 9 after T. W. Engelmann).
  - 10-11. *OPALINA OBTIGONA*, Stein, vol. ii. p. 562.—10, Adult zooid,  $\times 100$ ; 11, minute encystment,  $\times 200$  (Ernst Zeller).
  12. *ANOPLOPHRYA NAIDOS*, Duj. sp., vol. ii. p. 563.—Adult zooid,  $\times 200$  (Ray Lankester).
  13. *ANOPLOPHRYA FILUM*, C. & L., vol. ii. p. 567,  $\times 120$  (Claparède & Lachmann).
  14. *ANOPLOPHRYA PROLIFERA*, C. & L., vol. ii. p. 564.—Adult example with five incompletely separated posterior segments,  $\times 120$  (Clap. & Lach.).
  15. *HOPLITOPHRYA LUMBRICI*, Duj. sp., vol. ii. p. 571.—Adult zooid in the act of dividing by transverse fission, at *u, u*, horny uncini,  $\times 200$  (Stein).
  - 16-18. *OPALINA DIMIDIATA*, Stein, vol. ii. p. 561.—16, Adult animalcule,  $\times 100$ ; 17, minute zooid, produced through successive fission of adult unit, commencing to subdivide again in a longitudinal direction; 18, elongate zooid, containing but a single endoplast, recently emerged from a minute encystment (Ernst Zeller).
  19. *OPALINA INTESTINALIS*, Ehr. sp., vol. ii. p. 562,  $\times 100$  (Ernst Zeller).
  20. *OPALINA RANARUM*, Purk., vol. ii. p. 559.—Fragment of cuticular fibrillæ treated with acetic acid,  $\times 200$  (Zeller).
  21. *ANOPLOPHRYA CLAVATA*, Leidy sp., vol. ii. p. 566,  $\times 150$  (Leidy).
  22. *HOPLITOPHRYA RECURVA*, C. & L. sp., vol. ii. p. 573,  $\times 130$  (Clap. & Lach.).
  - 23, 24. *OPALINA CAUDATA*, Zeller, vol. ii. p. 563.—Dorsal and lateral aspects,  $\times 120$  (Zeller).
  25. *ANOPLOPHRYA COCHLEARIFORMIS*, Leidy sp., vol. ii. p. 566,  $\times 150$  (Leidy).
  - 26, 27. *ANOPLOPHRYA MYTILI*, Quenn. sp., vol. ii. p. 565.—Lateral and dorsal aspects,  $\times 250$  (Quennerstedt).
  - 28-30. *PARAMÆCIUM AURELIA*, Müller, vol. ii. p. 483.—28 and 29, Lateral and ventral aspects,  $\times 200$ ; 30, two conjugating zooids.

EXPLANATION OF PLATE XXVI. (*continued*).

- FIG.  
 31-32. PARAMÆCIUM BURSARIA, Ehr. sp., vol. ii. p. 486.—Dorsal and ventral aspects  
 × 250. The arrows in each case indicate the direction of the endoplasmic  
 current or cyclosis.
33. CONCHOPHTHIRUS ANODONTÆ, Ehr. sp., vol. ii. p. 490, × 200 (Engelmann).
- 34, 35. CONCHOPHTHIRUS STEENSTRUPII, Stein, vol. ii. p. 490.—Ventral and lateral  
 aspects, × 200 (Quennerstedt).
36. PRORODON NIVEUS, Ehr., vol. ii. p. 492, × 75 (Ehrenberg).
37. CYRTOSTOMUM LEUCAS, Ehr. sp., vol. ii. p. 497, × 150 (Ehrenberg).
38. ISOTRICHA MICROSTOMUM, C. & L. sp., vol. ii. p. 498, × 250 (Clap. & Lach.).
- 39, 40. PLACUS STRIATUS, Cohn, vol. ii. p. 490.—Ventral and lateral aspects, × 450  
 (Cohn).
41. NASSULA AMBIGUA, Stein, vol. ii. p. 495, × 200 (Stein).
42. NASSULA ORNATA, Ehr., vol. ii. p. 494, × 100 (Ehrenberg).
43. PRORODON EDENTATUS, C. & L., vol. ii. p. 493, × 260 (Clap. & Lach.).
44. PRORODON MARGARITIFER, C. & L., vol. ii. p. 493, × 120 (Clap. & Lach.).
45. HOLOPHRYA OVUM, Ehr., vol. ii. p. 498, × 200 (Clap. & Lach.).
46. HOLOPHRYA LATERALIS, S. K., vol. ii. p. 500, × 100 (Carter).
47. LOXOCEPHALUS GRANULOSUS, S. K., vol. ii. p. 489, × 300.
48. CHASMATOSTOMA RENIFORME, Eng., vol. ii. p. 540, × 200 (Engelmann).
49. PRORODON NIVEUS, Ehr., vol. ii. p. 492.—Pharyngeal rod-fascicle, × 120  
 (Ehrenberg).
50. NASSULA ORNATA, vol. ii. p. 494.—Pharyngeal rod-fascicle, × 200 (Ehrenberg).
- 51-53. ENCHELYODON FARCTUS, C. & L., vol. ii. p. 503.—51, Extended, 52, contracted  
 states, × 120; 53, contractile vesicle at full diastole, with its lateral sinuses  
 and at a central pore-like opening (Wrzesniowski).
54. HELICOSTOMA OBLONGA, Cohn., vol. ii. p. 501, × 150 (Cohn).
- 55-58. OTOSTOMA CARTERI, S. K., vol. ii. p. 500.—55 and 56, Adult animalcules, that at  
 56 showing the band-like endoplast and stellate contractile vesicles, × 100;  
 57 and 58, successive phases of subdivision into sporular elements (Carter).
- 59, 60. HOLOPHRYA TARDA, Quenn., vol. ii. p. 499.—Extended and contracted states,  
 × 200 (Quennerstedt).
- 61, 62. TRACHELOPHYLLUM APICULATUM, Perty sp., vol. ii. p. 502.—Extended and  
 contracted states, × 200 (Wrzesniowski).
- 63, 64. OPHRYOGLA ATRA, Ehr., vol. ii. p. 532.—Lateral and ventral views, × 200  
 (Ehrenberg).
- 65, 66. PANOPHRYS FLAVICANS, Ehr. sp., vol. ii. p. 534.—Ventral and lateral views,  
 × 150 (Ehrenberg).
- 67, 68. CYCLOTRICHA CITREUM, C. & L. sp., vol. ii. p. 535.—Lateral and ventral  
 aspects, × 230 (Clap. & Lach.).
69. PLAGIOPYLA (?) CARTERI, S. K., vol. ii. p. 538, × 100.
70. PLAGIOPYLA (?) FUSCA, Quenn. sp., vol. ii. p. 539, × 150 (Quennerstedt).





## PLATE XXVII.

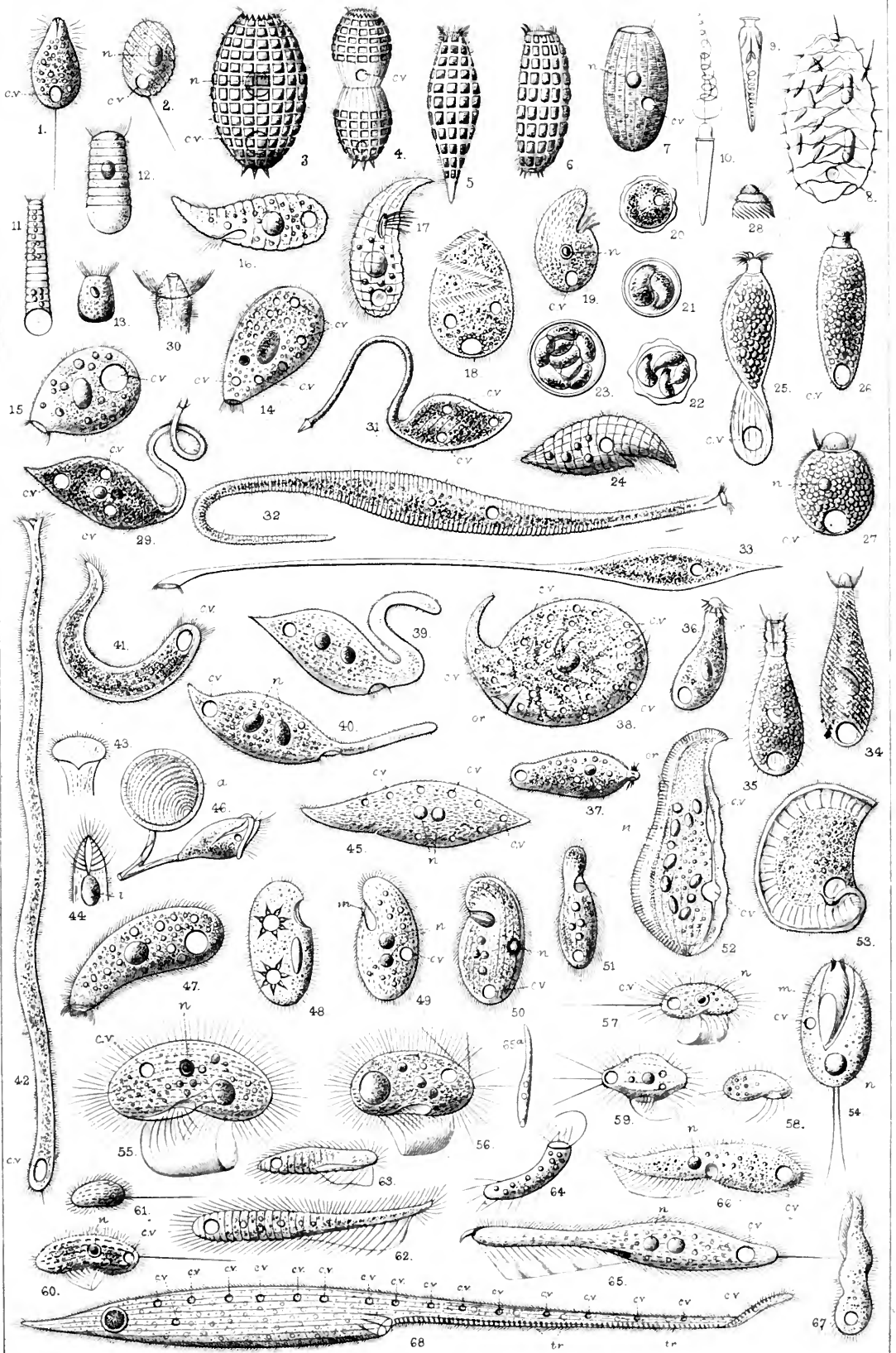
### EXPLANATION.

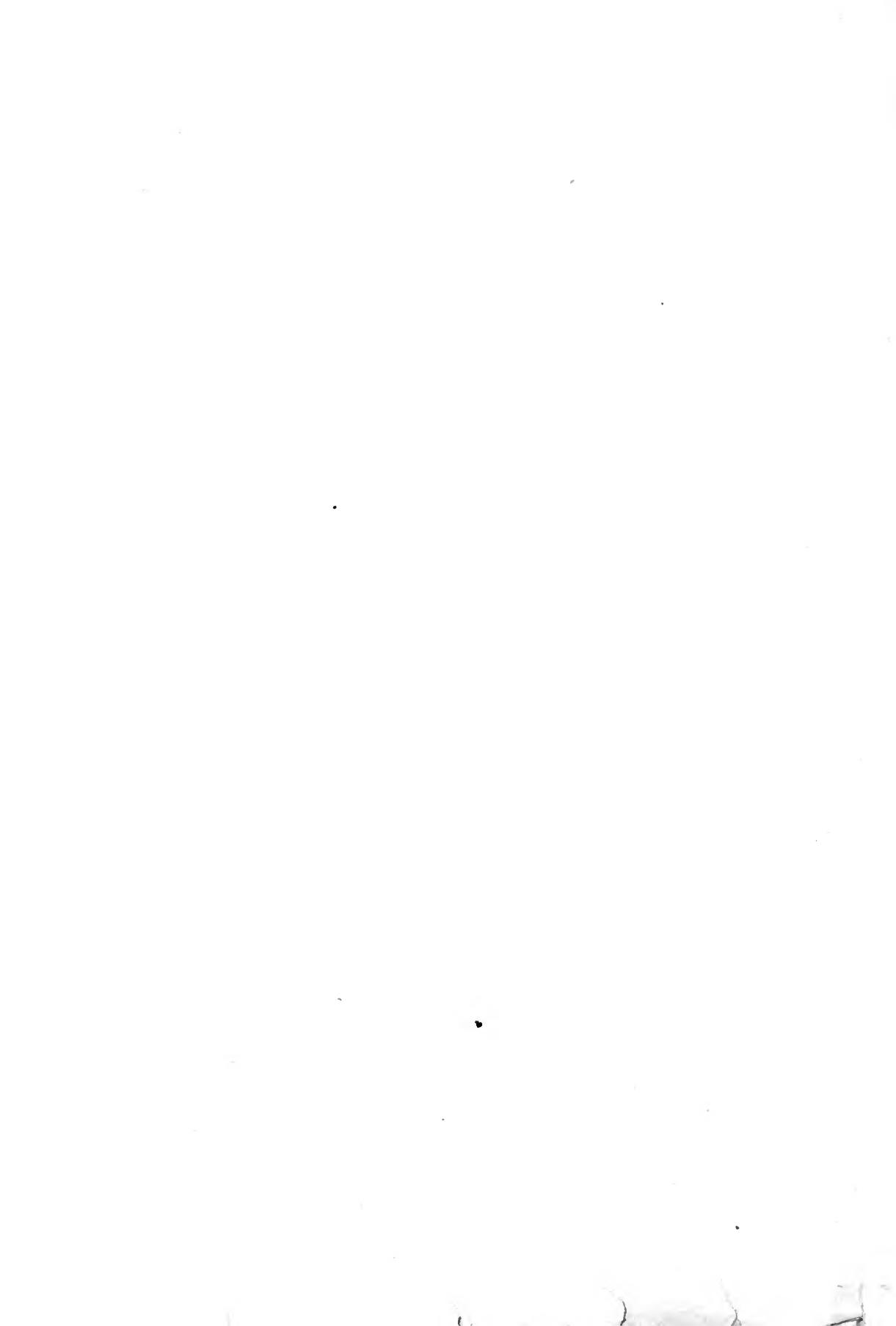
- FIG.
1. *UROTRICHA LAGENULA*, Ehr. sp., vol. ii. p. 505, × 300.
  2. *UROTRICHA FARCTA*, C. & L., vol. ii. p. 505, × 350 (Claparède & Lachmann).
  - 3, 4. *COLEPS HIRTUS*, Ehr., vol. ii. p. 506.—3, Adult animalcule, × 400; 4, example dividing by transverse fission.
  5. *COLEPS FUSUS*, C. & L., vol. ii. p. 507, × 350 (Clap. & Lach.).
  6. *COLEPS UNCINATUS*, C. & L., vol. ii. p. 507, × 350 (Clap. & Lach.).
  7. *PLAGIOPOGON COLEPS*, Ehr. sp., vol. ii. p. 508, × 250 (Perty).
  - 8-10. *POLYKRIKOS SCHWARTZII*, Bütschli, vol. ii. p. 508.—8, Adult example, × 200; 9 and 10, supposed trichocysts with thread-like filament in the retracted and extended states, × 600 (Bütschli).
  - 11-13. *METACYSTIS TRUNCATA*, Cohn, vol. ii. p. 511.—11 and 12.—Adult examples, × 400; young zooids as yet devoid of transverse annulation (Cohn).
  14. *ENCHELYS ARCUATA*, C. & L., vol. ii. p. 510, × 300 (Clap. & Lach.).
  15. *ENCHELYS FARCIMEN*, Ehr., vol. ii. p. 510, × 600.
  - 16, 17. *ANOPHRYS SARCOPHAGA*, Cohn, vol. ii. p. 512, × 400 (Cohn).
  18. *PERISPIRA OVUM* (?) Stein, vol. ii. p. 511.—Dimensions unrecorded (Carter).
  - 19-23. *COLPODA CUCULLUS*, Ehr., vol. ii. p. 512.—19, Adult animalcule, × 200; 20-23, mucous phases of encystment and sporular mode of multiplication (Stein).
  24. *COLPODA PIGERRIMA*, Cohn, vol. ii. p. 513, × 600 (Cohn).
  - 25-27. *LACRYMARIA COHNII*, S. K., vol. ii. p. 518.—At 25 example with the body contorted into a screw-like form, × 250; at 27 an animalcule spherically contracted (Cohn).
  28. *LACRYMARIA CORONATA*, C. & L., vol. ii. p. 518.—The distal extremity only showing the double ciliary wreath, × 350 (Clap. & Lach.).
  - 29-31. *TRACHELOCERCA OLOR*, Müller sp., vol. ii. p. 515.—29 and 31, Adult animalcules, × 300; 30, distal extremity more highly magnified, displaying oral structure.
  32. *TRACHELOCERCA PHŒNICOPTERUS*, Cohn, vol. ii. p. 516, × 300 (Cohn).
  33. *TRACHELOCERCA VERSATILIS*, Müll. sp., vol. ii. p. 516, × 200.
  34. *LACRYMARIA LAGENULA*, C. & L., vol. ii. p. 517, × 350 (Clap. & Lach.).
  35. *LAGYNUS ELEGANS*, Eng. sp., vol. ii. p. 521, × 300 (Engelmann).

EXPLANATION OF PLATE XXVII. (*continued*).

- FIG.
36. PHIALINA VERMICULARIS, Ehr., vol. ii. p. 519, × 200 (Ehrenberg).
37. PHIALINA VIRIDIS, Ehr., vol. ii. p. 519, × 200 (Ehrenberg).
38. TRACHELIUS OVUM, Ehr., vol. ii. p. 522, × 80.
- 39, 40. AMPHILEPTUS ANSER, Ehr., vol. ii. p. 525, × 120 (Ehrenberg).
- 41-44. CHENIA TERES, Duj. sp., vol. ii. p. 521.—41, 42, Animalcule in a contracted and extended condition as observed by author, × 200; 43, 44, oral region in its expanded and contracted states as delineated by Quennerstedt; *i* in Fig. 44 represents an ingested food-particle.
- 45, 46. AMPHILEPTUS MELEAGRIS, Ehr. sp., vol. ii. p. 526.—45, Adult animalcule, × 100 (Ehrenberg); 46, showing at *a* an example which has affixed itself to and become encysted upon the branching pedicle of a *Zoothamnium*, the former occupant of which it has first devoured (after D'Udekem).
47. TRICHODA PURA, Ehr., vol. ii. p. 535, × 700.
48. MENISCOSTOMUM STOMOPTYCHA, Ehr. sp., vol. ii. p. 539, × 200 (Eckhard).
49. COLPIDIUM CUCULLUS, Schrank sp., vol. ii. p. 537, × 200.
- 50, 51. PLAGIOPYLA NASUTA (?) Stein, vol. ii. p. 538.—Lateral and ventral aspects, × 200 (Quennerstedt).
52. LOXOPHYLLUM MELEAGRIS, Ehr. sp., vol. ii. p. 528, × 110 (Wrzesniowski).
53. LOXOPHYLLUM ARMATUM, C. & L., vol. ii. p. 529, × 150 (Clap. & Lach.)
54. LEMBADION BULLINUM, Perty, vol. ii. p. 537, × 200.—*m*, Undulating membrane (Clap. & Lach.).
55. PLEURONEMA CHRYSALIS, Ehr. sp., vol. ii. p. 543, × 250.
56. PLEURONEMA CORONATA, S. K., vol. ii. p. 544, × 200.
- 57, 58. CYCLIDIUM GLAUCOMA, Ehr., vol. ii. p. 544.—57, Normal zooid, × 600; 58, immature example, being as yet deficient of the oral membrane that distinguishes the adult type.
59. CYCLIDIUM CITRELLUS, Cohn. sp., vol. ii. p. 545 × 300 (Cohn).
1. URONEMA MARINA, Duj., vol. ii. p. 546.—60, Adult, and 61, immature examples, × 600.
- 62, 63. LEMBUS VELIFER, Cohn, vol. ii. p. 547.—62, Adult, and 63, immature example, × 400 (Cohn).
64. BÆONIDIUM REMIGENS, Perty, vol. ii. p. 546, × 350 (Fresenius).
- 65, 65a. PROBOSCELLA VERMINA, Müll. sp., vol. ii. p. 549.—65, Example as observed and delineated by the author, × 500; 65a, illustration of apparently the same species as given in Müller's 'Animalcula Infusoria,' tab. viii. fig. 1, 1786.
- 66, 67. LEMBUS SUBULATUS, S. K., vol. ii. p. 548, × 700.
68. AMPHILEPTUS GIGAS, C. & L., vol. ii. p. 526.—Attenuate variety, having the contractile vesicles disposed in linear order along the dorsal border, × 100; *tr*, trichocysts (Wrzesniowski).







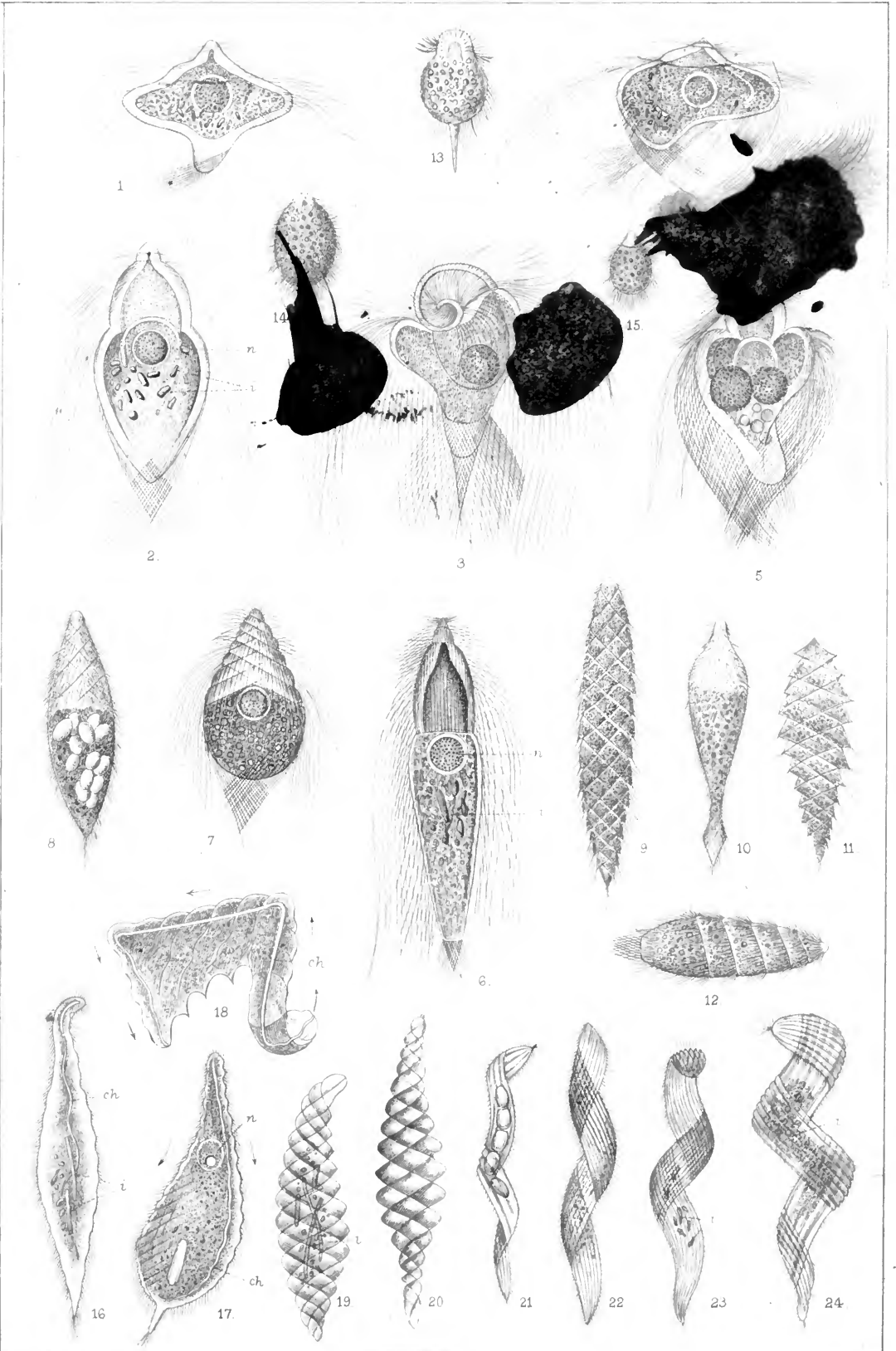
*PLATE XXVIII.*

### EXPLANATION OF PLATE XXVIII.

All the figures in this plate are reproduced from Dr. Joseph Leidy's "Parasites of the Termites," contained in the 'Journal of the Academy of Natural Sciences of Philadelphia,' vol. viii., 1881.

FIG.

- 1-15. *TRICHONYMPHA AGILIS*, Leidy, vol. ii. p. 552.—1 and 2, Bilaterally symmetrical animalcules as seen immediately after escaping from the intestine of their host,  $\times 450$ ; at *i* ingested food-particles; 3-5, symmetrical examples, that at 3 having the anterior or distal region of the body spirally involute, those at 4 and 5 with the entire body contorted into respectively shorter and longer helicoidal contours,  $\times 450$ ; 6, bilaterally symmetrical example in a condition of fullest extension,  $\times 450$ ; 7-12, supposed immature examples of the same species, those at 7, 10, 11, and 12,  $\times 666$ , those at 8 and 9,  $\times 450$ , the example at Fig. 7 containing numerous spore-like bodies; 13-15, youngest observed examples,  $\times 666$  (Leidy).
- 16-20. *PYRSONYMPHA VERTENS*, Leidy, vol. ii. p. 554.—16 and 17, distinctly ciliated animalcules, that at 16 containing at *i* numerous ingested particles of wood fibre, *ch* undulating cord-like structure,  $\times 666$ ; 18-20, examples in which no cilia are visible, the periphery of the body presenting a more or less jagged and membranous aspect,  $\times 666$ ; Fig. 19 containing at *i* numerous ingested food-particles (Leidy).
- 21-24. *DINENYMPHA GRACILIS*, Leidy, vol. ii. p. 555.—Various more or less contorted examples, Fig. 21 containing a row of spore-like bodies, and 23 and 24 at *i i* ingested food-particles,  $\times 666$  (Leidy).



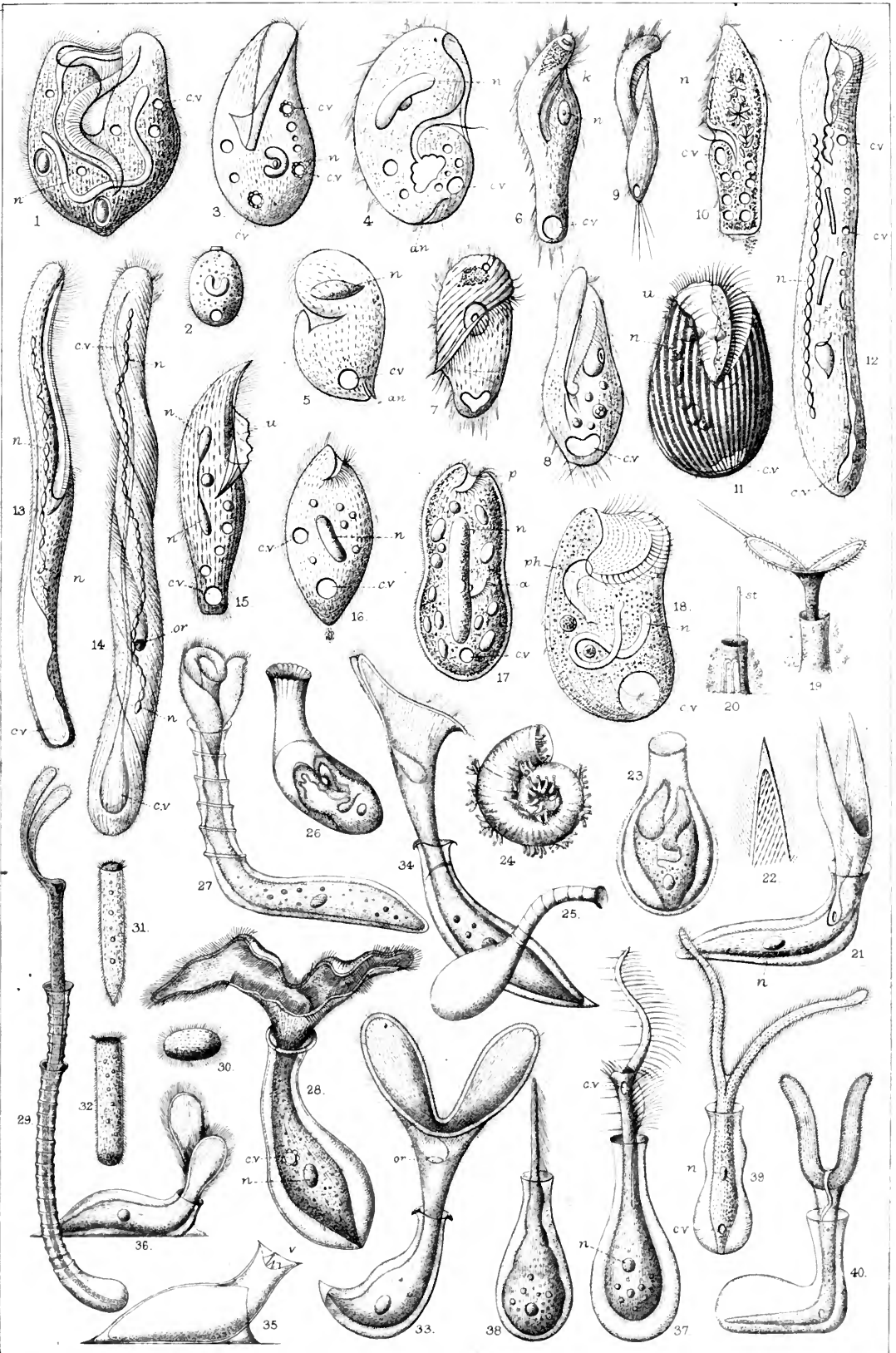


*PLATE XXIX.*

EXPLANATION OF PLATE XXIX.

- FIG.  
 1-2. *BURSARIA TRUNCATELLA*, Müller.—1, Adult animalcule, × 50; 2, supposed young condition, × 200 (Stein).  
 3. *BALANTIDIUM ENTOZOON*, Ehr. sp., × 100 (Stein).  
 4. *NYCTOTHERUS CORDIFORMIS*, Stein, × 150.—*an*, anal aperture (Stein).  
 5. *NYCTOTHERUS VELOX*, Leidy, × 200 (Leidy).  
 6-9. *METOPUS SIGMOIDES*, Clap. & Lach.—6 and 8, Extended, 7 and 9, spirally contorted animalcules, × 200 (Stein).  
 10. *PLAGIOTOMA LUMBRICI*, Duj., × 200 (Stein).  
 11. *CONDYLOSTOMA STAGNALIS*, Wrz., × 150.—*u*, Undulating membrane (Wrzesniowski).  
 12. *CONDYLOSTOMA PATENS*, Müll. sp., × 150 (Stein).  
 13, 14. *SPIROSTOMUM AMBIGUUM*, Ehr.—13, An extended, 14, a spirally contorted zooid, × 150 (Stein).  
 15. *BLEPHARISMA UNDULANS*, Stein, × 150.—*u*, Undulating membrane (Stein).  
 16, 17. *BALANTIDIUM COLI*, Malmsten sp., × 200.—At 17 an example preparing to divide by transverse fission, and having already developed at *p* 2 a second peristome (Stein).  
 18. *LEUCOPHRYS VIRENS*, Ehr. sp., × 150.—*ph*, pharyngeal passage (Stein).  
 19, 20. *FOLLICULINA STYLIFER*, St. Wrght. sp.—In each instance the anterior region of the lorica is alone represented, the peristome lobes of the contained animalcule in Fig. 19 being fully expended, while in Fig. 20 they are entirely withdrawn, leaving the stylate appendage only projecting beyond the orifice of the lorica. Dimensions unrecorded (Strethill Wright).  
 21-28. *FOLLICULINA AMPULLA*, Müller sp.—21 and 22, Entire animalcule and distal region of peristome of var. *ACULEATA*, Clap. and Lach.; at 24 numerous examples crowded on a shell of *Spirorbis nautiloides*, × 20; 25-27, examples showing the diverse plans of ornamentation of the lorica; 28, normal type in its fully extended state, × 200 (Stein).  
 29-32. *FOLLICULINA PRODUCTA*, St. Wrght. sp.—29, Adult animalcule in its fully extended state, × 200; 30-32, embryonic condition (Strethill Wright).  
 33-35. *FOLLICULINA ELEGANS*, Clap. & Lach. sp.—33 and 34, Adult animalcules, ventral and lateral aspects, × 200 (Stein); 35, empty lorica showing at *v* valvular elements (Clap. & Lach.).  
 36. *FOLLICULINA BOLTONI*, S. K., × 200.  
 37, 38. *CHÆTOSPIRA MUELLERI*, Lachmann, extended and partially retracted states as observed by the author, × 300.  
 39. *FOLLICULINA HIRUNDO*, S. K., × 200.  
 40. *FOLLICULINA AMPULLA*, Müller sp., var. *VIRIDIS*, St. Wrght., × 150 (Strethill Wright).



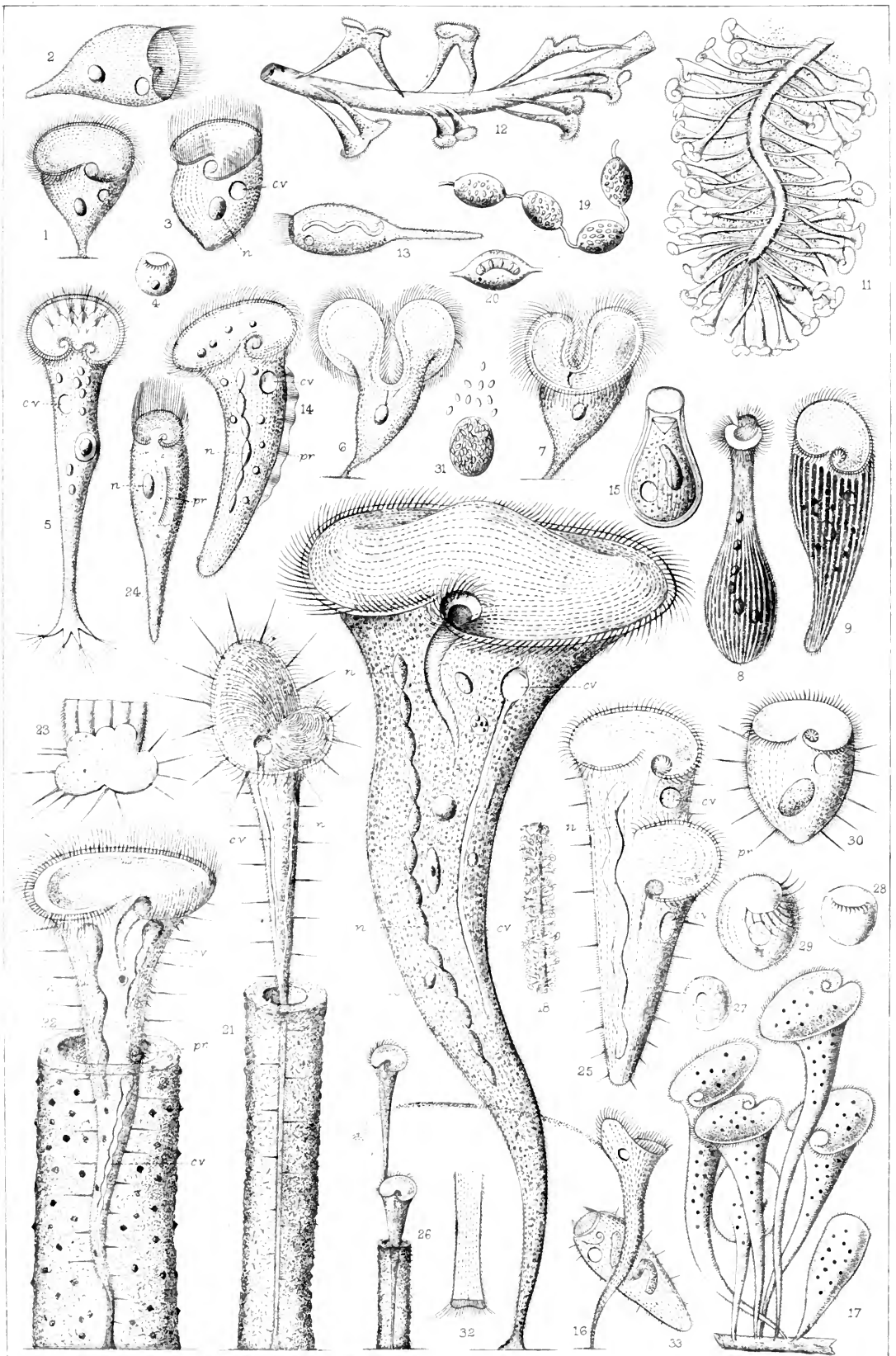




*PLATE XXX.*

### EXPLANATION OF PLATE XXX.

- FIG.
- 1-4. *STENTOR IGNEUS*, Ehr.—1, Attached, fully extended animalcule,  $\times 70$ ; 2 and 3, free-swimming conditions; 4, embryo released by the disintegration of the parent zooid.
5. *STENTOR PEDICULATUS*, From.,  $\times 250$  (De Fromentel).
- 6, 7. *STENTOR AURICULA*, S. K., ventral and dorsal aspects,  $\times 120$ .
- 8, 9. *STENTOR MULTIFORMIS*, Stein,  $\times 200$  (Stein).
- 10-20. *STENTOR POLYMORPHUS*, Müller sp.—10, Attached, fully extended animalcule,  $\times 120$ ; 11, a social colony, colourless variety, attached to a rootlet of *Anacharis*, which has built up through excretion a common mucilaginous basis,  $\times 15$ ; 12, examples conjugating with their neighbours, as delineated by Balbiani; 13, free-swimming zooid with attenuated posterior region; 14, example with, at *pr*, a laterally developed membranous crest, representing the initial condition of the peristomal ciliary cirlet of a future zooid (Ehrenberg); 15, an encysted example (Stein); 16, an animalcule discharging faecal matter, as observed by the author; 17 and 18, groups of the green variety, natural size, and  $\times 50$ , after Ehrenberg; 19 and 20, portion of the nucleus or endoplast, showing in the former instance the union of the component granular nodules by an interconnecting cord or funiculus; at 20 an isolated nodule with an enclosed elongate vacuolar structure,  $\times 300$  (Stein).
21. *STENTOR BARETTII*, Barrett.—Fully extended animalcule,  $\times 100$ .
- 22-23. *STENTOR ROESELII*, Ehr.—22, Fully extended example affixed within its excreted mucilaginous sheath,  $\times 80$ ; at *pr*, initial condition of a second peristome (Clap. & Lach.); 23, basal or pedal region with pseudopodic peripheral extensions (after Simroth); 24, clavate free-swimming zooid with at *pr* secondary peristome in progress of development (Stein); 25, more advanced condition of fissure, the second peristome, *pr*, having attained a contour and proportions that correspond closely with those of the primary one (Clap. and Lach.); 26, last phase of fissive process, the anterior moiety being now almost completely separated from the posterior one (from a MS. drawing by H. E. Forrest); 27-30, progressive developmental phases, after Claparède and Lachmann; 31, supposed germ-sphere as delineated by Stein; 32, foot or basal region with tuft of longer setose cilia, after Stein; 33, free-swimming semi-contracted animalcule (Stein).





## PLATE XXXI.

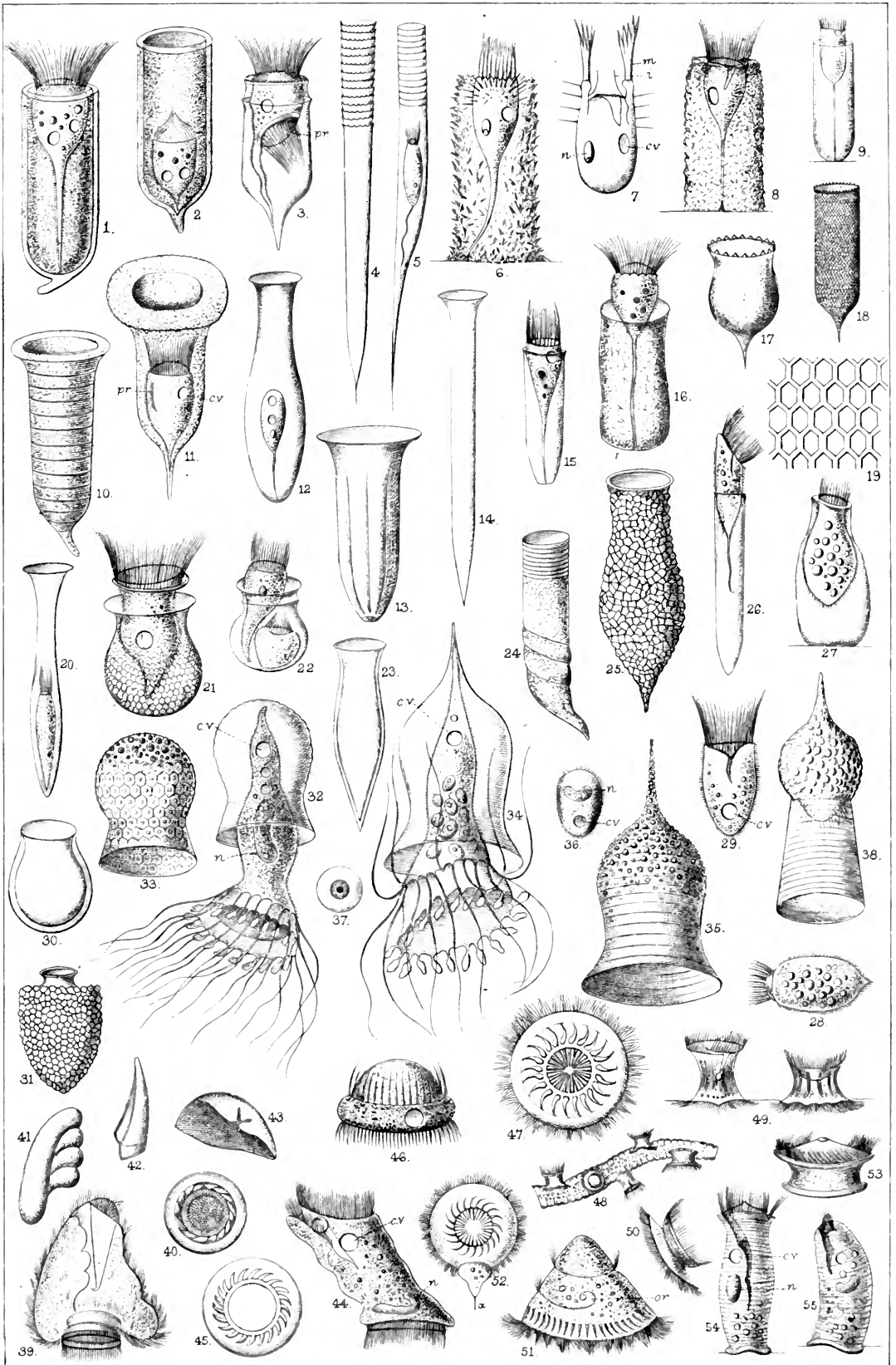
### EXPLANATION.

- FIG.  
1, 2. TINTINNUS EHRENBERGII, C. & L., extended and contracted states,  $\times 150$  (Claparède & Lachmann).  
3. TINTINNUS URNULA, C. & L.,  $\times 150$ .—At *pr*, a second peristome in process of development (Clap. & Lach.).  
4. TINTINNUS USSOWI, Meresch., empty lorica,  $\times 400$  (Mereschkowsky).  
5. TINTINNUS SUBULATUS, Ehr.,  $\times 250$  (Ehrenberg).  
6, 7. TINTINNIDIUM SEMICILIATUS, Sterki sp.—At 7 an animalcule isolated from its lorica, viewed in optical section, and showing at *m* outer wreath of furcately branched cirrose cilia or membranellæ, and at *i* inner circlet of ordinary vibratile cilia,  $\times 200$  (Sterki).  
8. TINTINNIDIUM FLUVIATILIS, Stein sp.,  $\times 200$ .  
9. TINTINNIDIUM MARINUM S. K.,  $\times 200$  (Ehrenberg).  
10. TINTINNUS CINCTUS, C. & L., empty lorica,  $\times 250$  (Clap. & Lach.).  
11. TINTINNUS CAMPANULA, Ehr.,  $\times 150$ .—At *pr*, a second peristome is in course of development,  $\times 150$  (Clap. & Lach.).  
12. TINTINNUS AMPHORA, C. & L.,  $\times 150$  (Clap. & Lach.).  
13. TINTINNUS QUADRILINEATUS, C. & L., empty lorica,  $\times 150$  (Clap. & Lach.).  
14. TINTINNUS ACUMINATUS, C. & L., empty lorica,  $\times 200$  (Clap. & Lach.).  
15. TINTINNUS INQUILINUS, Ehr.,  $\times 300$  (Clap. & Lach.).  
16. TINTINNUS MUCICOLA, C. & L.,  $\times 150$  (Clap. & Lach.).  
17. TINTINNUS sp.—Empty lorica,  $\times 250$  (Clap. and Lach.).  
18, 19. TINTINNUS DENTICULATUS, Ehr.—18, Empty lorica,  $\times 150$ ; 19, portion of the same,  $\times 800$  (Clap. & Lach.).  
20. TINTINNUS STEENSTRUPII, C. & L.,  $\times 200$  (Clap. & Lach.).  
21, 22. TINTINNUS LAGENULA, C. & L.—21, normal example,  $\times 300$ ; 22, lorica containing two zooids (Clap. & Lach.).  
23. TINTINNUS sp., C. & L.,  $\times 150$  (Clap. & Lach.).  
24. TINTINNUS HELIX, C. & L., empty lorica,  $\times 150$  (Clap. & Lach.).  
25. TINTINNUS ANNULATUS, C. & L., empty lorica,  $\times 150$  (Clap. & Lach.).  
26. TINTINNUS OBLIQUUS, C. & L.,  $\times 300$  (Clap. & Lach.).

EXPLANATION OF PLATE XXXI. (*continued*).

- FIG.
- 27, 28. *VASICOLA CILIATA*, Tatem.—27, Animalcule contained within its lorica,  $\times 150$ ; 28, free-swimming zooid (Tatem).
29. *STROMBIDINOPSIS GYRANS*, S. K.,  $\times 200$ .
30. *TINTINNUS* sp., C. & L., empty lorica,  $\times 150$  (Clap. & Lach.).
31. *TINTINNUS VENTRICOSUS*, C. & L., empty lorica,  $\times 200$  (Clap. & Lach.).
- 32, 33. *CODONELLA GALEA*, Hkl.—32, Animalcule fully extended beyond the orifice of its lorica,  $\times 200$ ; 33, empty lorica, showing its tessellated character (Haeckel),
- 34-37. *CODONELLA CAMPANELLA*, Hkl.—34, Fully extended animalcule enclosing centrally numerous ovate germs,  $\times 200$ ; 35, empty lorica; 36, ovate germ, with contained endoplast and contractile vesicle; 37, earlier spore-like condition (Haeckel).
38. *CODONELLA ORTHOCERAS*, Hkl.,  $\times 180$  (Haeckel).
- 39-43. *TRICHODINOPSIS PARADOXA*, C. & L.—39, Adult animalcule, profile view,  $\times 200$ ; 40, ventral acetabulum with plicate horny ring,  $\times 300$ ; 41-43, internally developed corneous elements (Clap. & Lach.).
44. *TRICHODINA MITRA*, Stein sp.,  $\times 300$  (Clap. & Lach.).
45. *TRICHODINA STEINII*, C. & L.—Acetabulum with denticulate ring,  $\times 250$  (Clap. & Lach.).
- 46, 47. *TRICHODINA SCORPÆNA*, Robin, lateral and ventral views,  $\times 400$  (Robin).
- 48-52. *TRICHODINA PEDICULUS*, Ehr.—48, Examples adherent in various positions to the portion of a tentacle of a *Hydra*; 49, two animalcules in lateral view,  $\times 150$ ; 50, depressed free-swimming zooid; 51, conically contracted animalcule showing at *or* oral aperture, as delineated by Busch; 52, apparent example of conjugation between a large and small zooid, *a*, after Busch.
53. *TRICHODINA*-like larva, or Trochosphere of Polyzoon, *Alcyonidium gelatinosum*, as delineated in note-book placed at the author's disposal by H. E. Forrest.
- 54, 55. *SCYPHIDIA PHYSARUM*, C. & L., expanded and contracted zooids,  $\times 200$  (Quennerstedt).



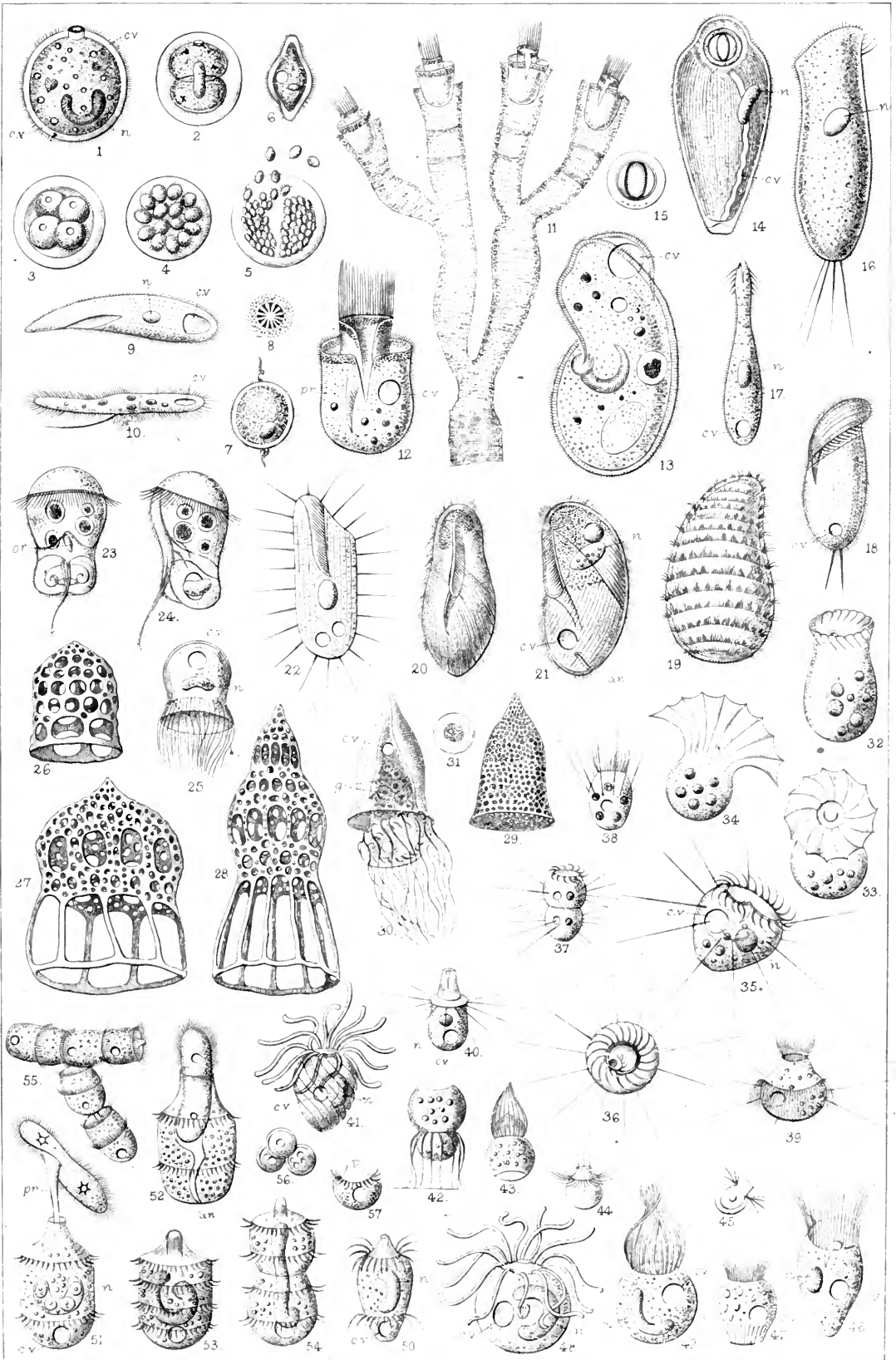




*PLATE XXXII.*

EXPLANATION OF PLATE XXXII.

- FIG.  
 1-8. *ICHTHYOPHTHIRIUS MULTIFILIIS*, Fouquet.—1, Adult animalcule,  $\times 120$ ; 2-5, successive phases of segmentation following upon encystment, and resulting in the subdivision of the entire body-mass into a swarm of minute ciliated germs; 6, ciliated germ,  $\times 350$ ; undeveloped germ with twisted thread-like cuticular extensions of the opposite poles; 8, oral apparatus viewed from above (Fouquet).
9. *PARAMÆCIUM MARINUM*, S. K.,  $\times 250$ .
10. *LEMBUS ELONGATUM*, C. & L. sp.,  $\times 300$  (Claparède & Lachmann).
- 11, 12. *MARYNA SOCIALIS*, Gruber.—11, Social colony within branched granular zoothecium,  $\times 60$ ; 12, isolated animalcule,  $\times 120$  (Grüber).
13. *TILLINA MAGNA*, Gruber,  $\times 190$  (Gruber).
- 14, 15. *HAPTOPHYRYA GIGANTEA*, Maupas.—14, Adult animalcule, ventral aspect,  $\times 33$ ; 15, acetabulum,  $\times 50$  (Certes).
16. *LOXOCEPHALUS LURIDUS*, Eberhard,  $\times 100$  (Eberhard).
17. *ENCHELVDON ELONGATUS*, C. & L.,  $\times 150$  (Clap. & Lach.).
18. *METOPIDES CONTORTA*, Quenn.,  $\times 275$  (Quennerstedt).
19. *OPALINA RANARUM*, Purk.—Showing temporarily assumed parallel disposition of the cilia as observed by the author,  $\times 100$ .
- 20, 21. *NYCTOTHERUS GYGERVANUS*, Stein.—Ventral and lateral aspects,  $\times 200$  (Stein).
22. *BALANTIDIUM MEDUSARUM*, Meresch.,  $\times 600$  (Mereschkowsky).
- 23, 24. *CALCEOLUS CYPRIPIEDUM*, J.-Clk. sp.—Ventral and lateral aspects,  $\times 200$  (Jas.-Clark).
- 25, 26. *DICTYOCYSTA MITRA*, Hkl.—26, Empty lorica,  $\times 230$  (Haeckel).
27. *DICTYOCYSTA TEMPLUM*, Hkl.—Empty lorica,  $\times 400$  (Haeckel).
28. *DICTYOCYSTA TIARA*, Hkl.—Empty lorica,  $\times 400$  (Haeckel).
- 29-31. *DICTYOCYSTA CASSIS*, Hkl.—29, Empty lorica, showing cribrate structure,  $\times 165$ ; 30, extended animalcule, containing germinal bodies *g*, depending from its lorica,  $\times 165$ ; 31, isolated germ,  $\times 300$  (Haeckel).
- 32-34. *TORQUATELLA TYPICA*, Lankester.—32, Animalcule with oral membrane contracted; 33 and 34, examples, viewed laterally and from above, with this structure variously expanded. Dimensions unrecorded (Ray Lankester).
- 35-38. *HALTERIA GRANDINELLA*, Müll. sp.—35 and 36, Lateral and ventral aspects,  $\times 600$ ; 37, animalcule dividing by transverse fission; 38, example with its springing-setæ deflected in the act of leaping.
39. *HALTERIA VOLVOX*, Eichwald,  $\times 250$  (Claparède & Lachmann).
40. *MESODINIUM ACARUS*, Stein,  $\times 400$ , as observed by the author.
41. *ARACHNIDIUM CONVOLUTUS*, S. K.,  $\times 400$ .
- 42, 43. *ARACHNIDIUM BIPARTITA*, From. sp.—42, Ambulatory, and 43, free-swimming examples,  $\times 400$  (De Fromental).
44. *MESODINIUM PULEX*, C. & L. sp.,  $\times 350$  (Clap. & Lach.).
45. *ACARELLA SIRO*, Cohn,  $\times 250$  (Cohn).
46. *STROMBIDIUM CLAPAREDI*, S. K.,  $\times 200$ .
47. *STROMBIDIUM SULCATA*, C. & L.,  $\times 200$  (Clap. & Lach.).
- 48, 49. *ARACHNIDIUM GLOBOSUS*, S. K.—Examples with tentacles extended and contracted,  $\times 1200$ .
- 50-57. *DIDIINIUM NASUTUM*, Müll. sp.—50, Normal aspect of natatory animalcule, as observed by the author,  $\times 200$ ; 51 and 52, illustrating the seizure and engulfment of a *Paramæcium* as delineated by Balbiani; 53 and 54, aspects antecedent to and attending transverse fission (Balbiani); 55, example of abnormal multiple subdivision as delineated by Eberhard; 56 and 57, embryonic conditions, after Balbiani.





## PLATE XXXIII.

### EXPLANATION.

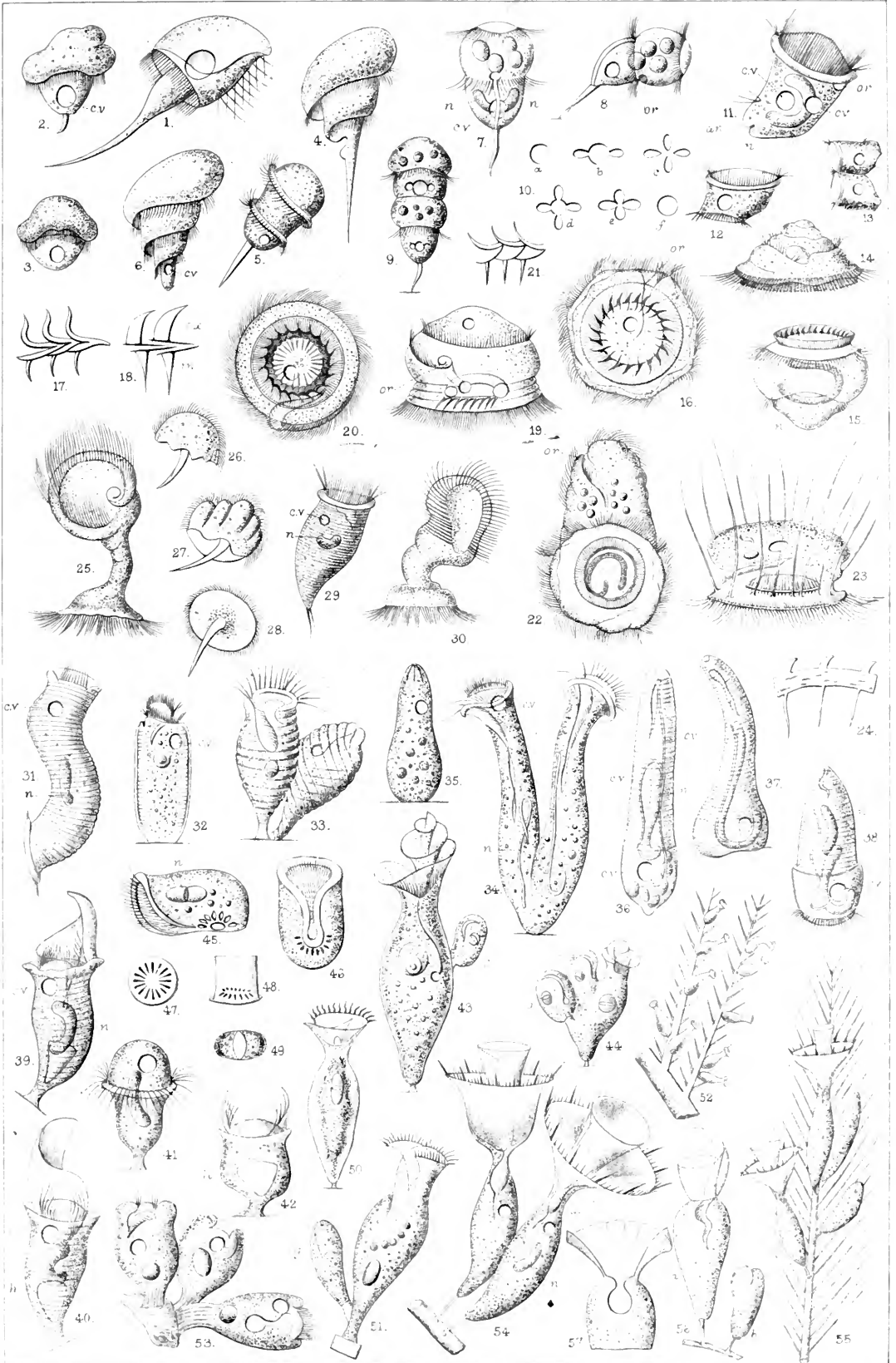
- FIG.
- 1-6. *GYROCORIS OXYURA*, Stein, vol. ii. p. 640.—1, Adult, and 2, 3, undeveloped zooids, × 300 (after Tatem); 4-6, adult animalcules as delineated by Eberhard.
- 7-10. *UROCENTRUM TURBO*, Müller sp., vol. ii. p. 641.—7 and 8, Free-swimming and posteriorly adherent zooids, × 300; 9, an example dividing by transverse fission; 10, *a-f*, showing consecutive contours exhibited by the contractile vesicle.
- 11-13. *TELOTROCHIDIUM CRATERIFORME*, Müll. sp., vol. ii. p. 643.—11, Normal example, × 200; 12, zooid with abruptly truncate posterior border; 13, example dividing by longitudinal fission.
- 14-18. *TRICHODINA PEDICULUS*, Ehr., vol. ii. p. 646.—14-16, Lateral and ventral aspects × 300 (after Stein); 17, denticles of adherent disc (after Quennerstedt); 18, the same structures as interpreted by the author; *ex.* external, and *in.* internal elements, × 800.
- 19-21. *TRICHODINA BALTICA*, Quenn., vol. ii. p. 649.—19 and 20, Lateral and ventral views, × 350; 21, denticles of adherent apparatus more highly magnified (Quenn.).
22. *URCEOLARIA MITRA*, Stein, vol. ii. p. 650, × 600 (Stein).
- 23, 24. *CYCLOCHÆTA SPONGILLÆ*, Jackson, vol. ii. p. 650.—23, Adult animalcule in profile view, × 400; 24, portion of denticulated ring of acetabulum more highly magnified.
25. *LICNOPHORA COHNII*, Claparède, vol. ii. p. 652, × 400 (Cohn).
- 26-28. *CÆNOMORPHA MEDUSULA*, Perty, vol. ii. p. 641, × 150 (Perty).
29. *ASTYLOZOOON FALLAX*, Eng., vol. ii. p. 654, × 250 (Engelmann).
30. *LICNOPHORA AUERBACHII*, Clap., vol. ii. p. 651, × 500 (Cohn).
31. *SCYPHIDIA PHYSARUM*, C. & L., vol. ii. p. 658, × 300 (Claparède & Lachmann).
32. *SCYPHIDIA LIMACINA*, Lach., vol. ii. p. 658, × 300 (Lachmann).
33. *SCYPHIDIA RUGOSA*, Duj., vol. ii. p. 659.—Expanded and contracted examples, × 280 (Dujardin).
- 34, 35. *GERDA FIXA*, D'Udk., vol. ii. p. 657.—34, Expanded zooid almost completely divided by longitudinal fission; 35, contracted example, dimensions unrecorded (D'Udekem).
- 36-38. *GERDA GLANS*, C. & L., vol. ii. p. 657.—37, An adherent zooid; 38, a free-swimming example with adventitious posterior ciliary circlet, × 150 (Clap. & Lach.).

EXPLANATION OF PLATE XXXIII.—*continued.*

FIG.

- 39-42. SPIROCHONA TINTINNABULUM, S. K., vol. ii. p. 661.—39 and 40, Adult fully extended zooids,  $\times 600$ ; 41, example with subcentral ciliary cirlet preparing to divide by transverse fission; 42, posterior moiety of subdivided zooid, the membranous funnel being as yet imperfectly developed; *h*, hyaline triangular interspace.
- 43-49. SPIROCHONA GEMMIPARA, Stein, vol. ii. p. 660.—43, Adult fully extended zooid with at *g* a single germinal bud,  $\times 350$ ; 44, example with two laterally attached germs; 45 and 46, detached germs in lateral ventral aspect, showing rudimentary stellate acetabulum and hypotrichous plan of ciliation; 47 and 48, acetabuliform adherent apparatus of adult zooid; 49, endoplast and nucleus (43 and 44, after Stein; 45-49, after Hertwig).
- 50-52. SPIROCHONA SCHEUTENII, Stein, vol. ii. p. 661.—50 and 51, Spirit-preserved zooids,  $\times 300$  (after Stein); 52, colony attached to branched hair of *Gammarus marinus* (after Westwood & Bates).
53. SCYPHIDIA FROMENTELLII, S. K., vol. ii. p. 659,  $\times 200$  (De Fromentel).
- 54, 55. STYLOCHONA CORONATA, S. K., vol. ii. p. 663.—54, Two adult fully extended zooids,  $\times 600$ ; 55, adult and imperfectly developed zooids attached to branched hair of *Gammarus* sp.
- 56, 57. STYLOCHONA NEBALINA, S. K., vol. ii. p. 662.—56, *a*, Adult, and *b*, immature zooid,  $\times 500$ ; 57, distal region of spirit-preserved example with membranous funnel unrolled.



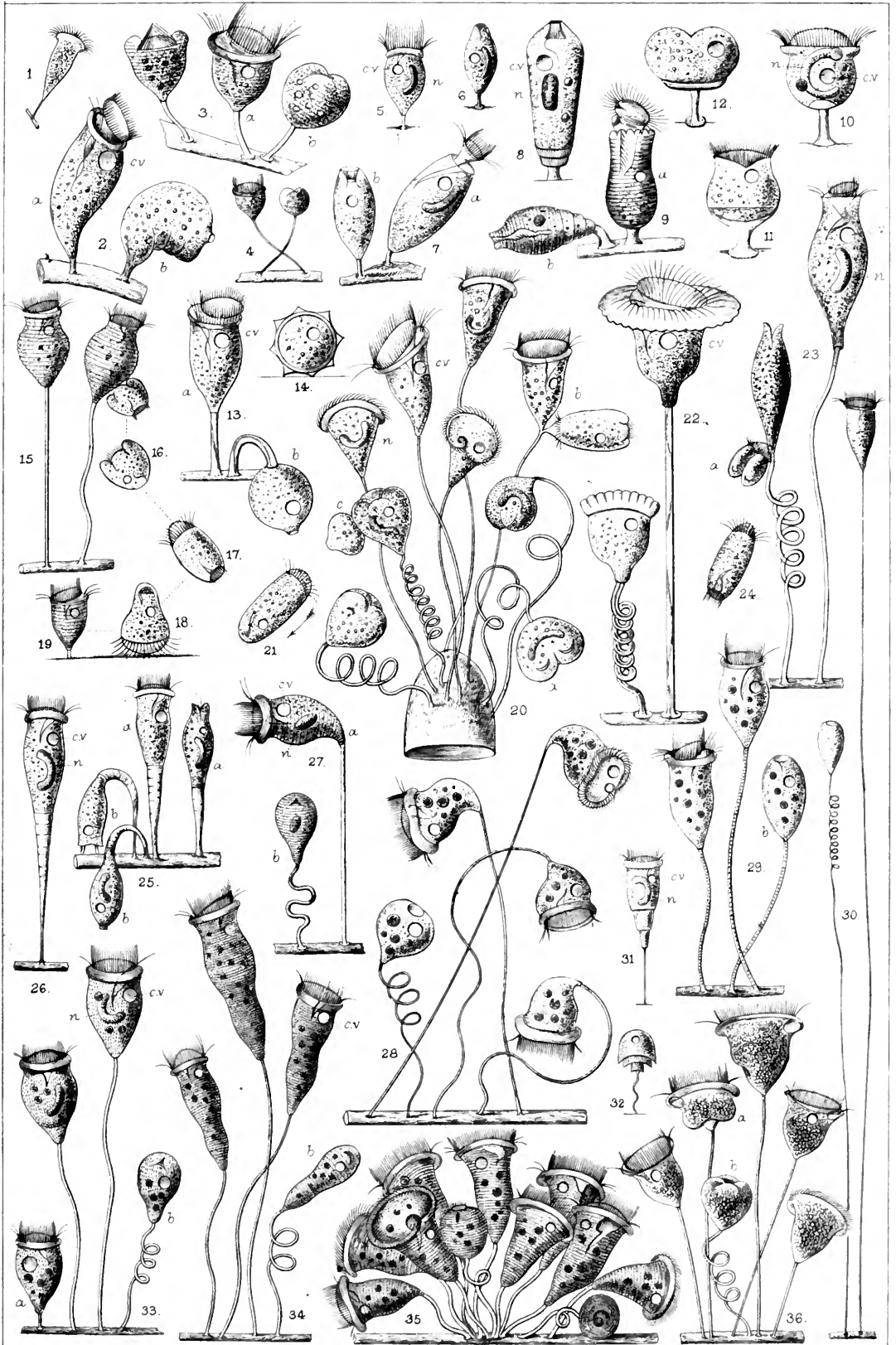




*PLATE XXXIV.*

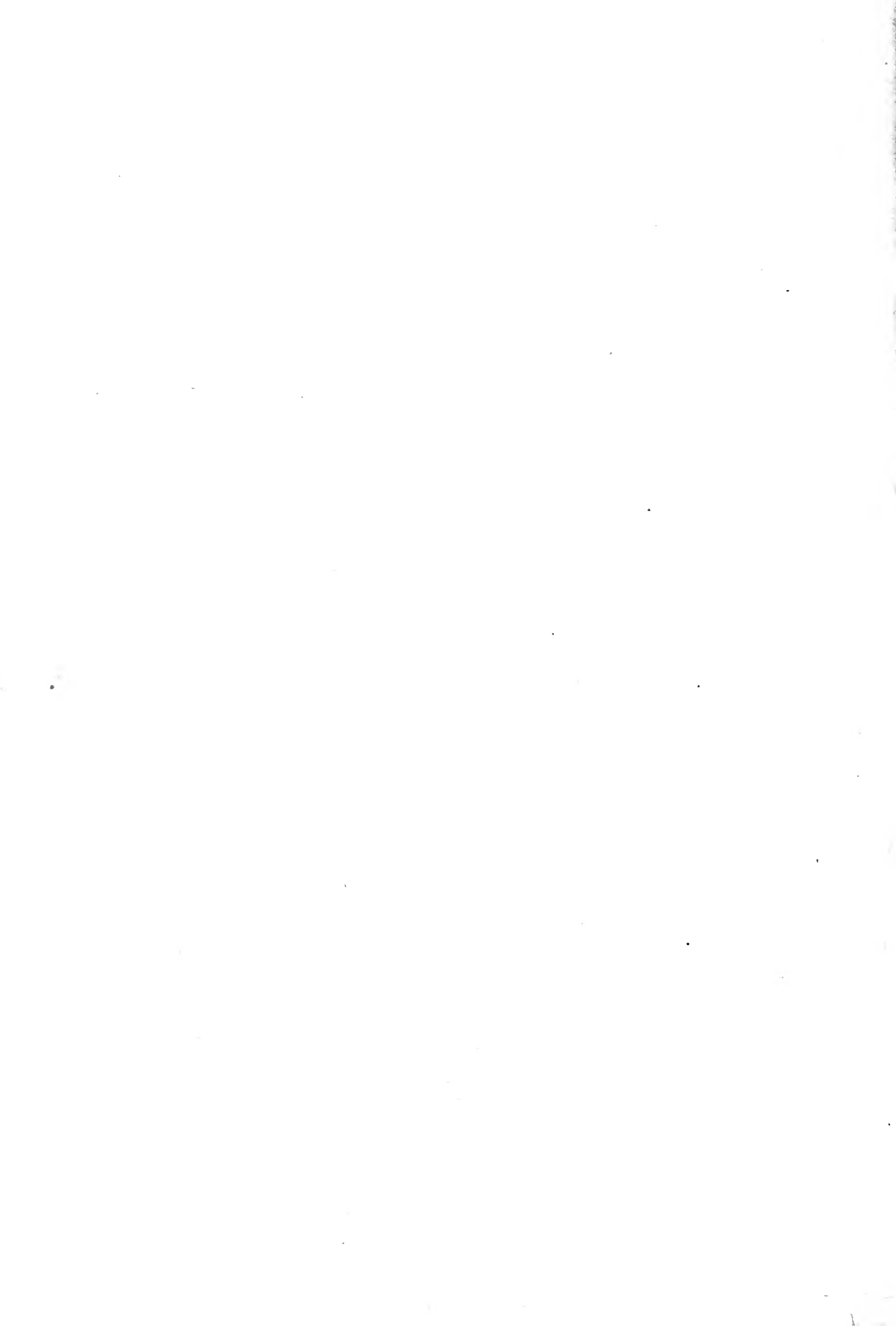
EXPLANATION OF PLATE XXXIV.

- FIG.
1. RHABDOSTYLA RINGENS, From. sp., vol. ii. p. 666,  $\times 150$  (De Fromentel).
  2. SCYPHIDIA INCLINANS, D'Udk. sp., vol. ii. p. 659.—*a*, Extended, and *b*, contracted zooid, dimensions unrecorded (D'Udekem).
  - 3, 4. RHABDOSTYLA SERTULARIUM, S. K., vol. ii. p. 665.—3, Short-stalked, and 4, long-stalked varieties,  $3 \times 300$ .
  - 5, 6. RHABDOSTYLA OVUM, S. K., vol. ii. p. 664.—Expanded and contracted zooids,  $\times 250$ .
  7. PYXIDIUM COTHURNOIDES, S. K., vol. ii. p. 667,  $\times 350$ .
  8. RHABDOSTYLA BREVIPES, C. & L. sp., vol. ii. p. 665,  $\times 300$  (Claparède & Lachmann).
  9. PYXIDIUM INCLINANS, Müll. sp., vol. ii. p. 667.—*a*, Expanded, and *b*, contracted zooids,  $\times 250$  (De Fromentel).
  10. RHABDOSTYLA SPHÆROIDES, From., vol. ii. p. 666,  $\times 200$  (De Fromentel).
  - 11, 12. RHABDOSTYLA NEBULIFERA, From., vol. ii. p. 665.—12, Example dividing by longitudinal fission,  $\times 100$  (De Fromentel).
  - 13, 14. VORTICELLA BREVISTYLA, D'Udk., vol. ii. p. 675.—13, *a*, Expanded, and *b*, contracted zooid,  $\times 200$ ; 14, encysted example (D'Udekem).
  - 15-19. VORTICELLA STRIATA, Duj., vol. ii. p. 684.—15, Two zooids, the one with a lateral gemmule the product of longitudinal fission,  $\times 300$ ; 16-19, successive phases of detached germ, resulting in the last instance in the attachment and development of a pedicle.
  - 20, 21. VORTICELLA NEBULIFERA, Ehr., vol. ii. p. 673.—20, Social group, showing at *a* and *b* successive phases of longitudinal fission, and at *c* contracted zooid with conjugating germ,  $\times 200$ ; 21, free-swimming zooid the product of longitudinal fission (D'Udekem).
  22. VORTICELLA CRATERA, S. K., vol. ii. p. 679.—Expanded and contracted zooid,  $\times 250$  (D'Udekem).
  - 23, 24. VORTICELLA PUTRINUM, Müll., vol. ii. p. 684.—23, Expanded and contracted zooid, the latter at *a*, two basally attached migrant zooids, the product of repeated longitudinal fission,  $\times 300$ ; 24, free-swimming migrant zooid (fine cross-striation of the cuticle accidentally omitted by the artist).
  - 25, 26. VORTICELLA CRASSICAULIS, S. K., vol. ii. p. 676.—*a a*, Extended, and *b b*, contracted zooids,  $\times 300$ .
  27. VORTICELLA HAMATA, Ehr., vol. ii. p. 687.—*a*, Expanded, and *b*, contracted zooids,  $\times 300$ .
  28. VORTICELLA NUTANS, Müll., vol. ii. p. 679,  $\times 300$ .
  29. RHABDOSTYLA LONGIPES, S. K., vol. ii. p. 666.—At *b* fully contracted zooid,  $\times 200$ .
  30. VORTICELLA LONGIFILUM, S. K., vol. ii. p. 677,  $\times 200$ .
  - 31, 32. VORTICELLA TELESCOPICA, S. K., vol. ii. p. 677.—31, Extended, and 32, contracted zooid;  $\times 250$ .
  33. VORTICELLA ALBA, From., vol. ii. p. 676.—At *a* example with rudimentary pedicle, *b* contracted zooid,  $\times 200$ .
  34. VORTICELLA QUADRANGULARIS, S. K., vol. ii. p. 685.—At *b* contracted zooid,  $\times 125$ .
  35. VORTICELLA SPECTABILIS, S. K., vol. ii. p. 687.—Social group,  $\times 100$ .
  36. VORTICELLA CAMPANULA, Ehr., vol. ii. p. 678.—At *a* expanded example, with the cuticle irregularly puckered, at *b* contracted zooid,  $\times 100$ .





*PLATE XXXV.*

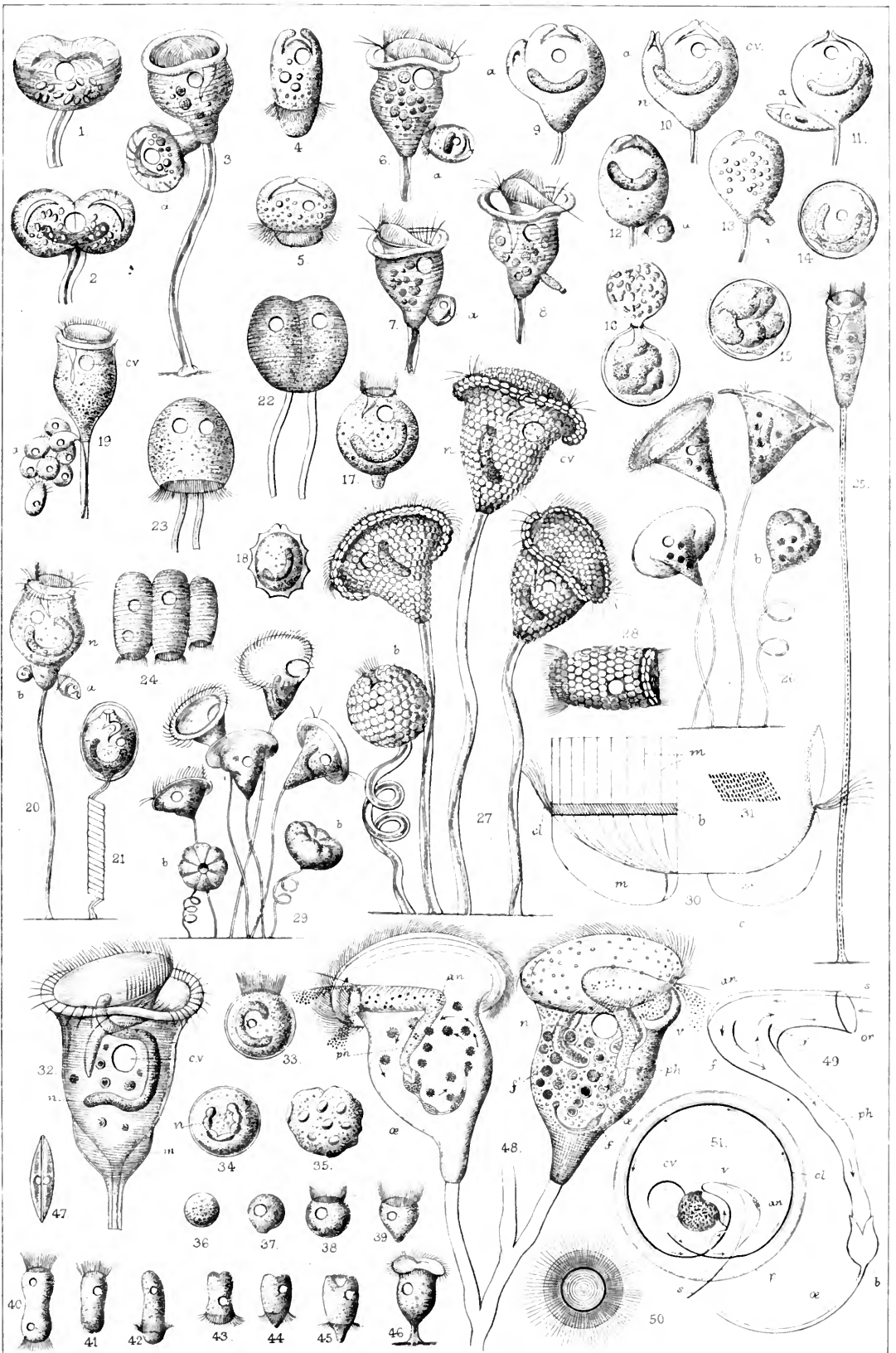




*PLATE XXXV.*

EXPLANATION OF PLATE XXXV.

- FIG.
- 1-8. *VORTICELLA MARINA*, Greeff, vol. ii. p. 685.—1-3, Successive phases of longitudinal fission resulting in the production of the free-swimming zooids, Figs. 4 and 5; 6-8, successive phases illustrative of the conjugation of a free-swimming microzooid with a normal sedentary animalcule,  $\times 200$  (Greeff).
- 9-24. *VORTICELLA MICROSTOMA*, Ehr., vol. ii. p. 683.—9-11, Showing production of microzooid by uneven longitudinal fission; 12 and 13, conjugation of microzooid with normal animalcule resulting in the disintegration of the endoplast or nucleus (after Greeff); 14-16, encysted zooids apparently developing, in the two latter instances, endoparasitic organisms (Stein); 17, normal detached sedentary animalcule as observed by the author; 18, encysted zooid; 19, example of production of eight microzooids through repeated fission of primarily segmented moiety (after D'Udekem); 20, zooid with two basally attached microzooids; 21, zooid encysted upon its contracted pedicle (after Stein); 22-24, conjugating adult zooids,  $\times 300$  (after Claparède & Lachmann).
25. *VORTICELLA ELONGATA*, From., vol. ii. p. 686,  $\times 200$ .
26. *VORTICELLA PATELLINA*, Müll., vol. ii. p. 679,  $\times 170$ .
- 27, 28. *VORTICELLA MONILATA*, Tatem, vol. i. p. 688.—At *b* contracted zooid; 28, detached free-swimming animalcule,  $\times 300$ .
29. *VORTICELLA CITRINA*, Ehr., vol. ii. p. 678,  $\times 150$ .
- 30, 31. *CARCHESIUM POLYPINUM*, Linn. sp., vol. ii. p. 690.—30, Hinder portion of body that to the left viewed in perspective, that to the right in optic section; *cl*, temporarily developed posterior ciliary girdle; *b*, obliquely striated band that gives origin to these cilia; *mm*, fibrillæ of muscular or myophan layer, *c*, cuticulum; *ec*, contracted ectoplasm; 31, obliquely striated band, *b* of preceding figure,  $\times 2000$ , showing its granular consistence (after T. W. Engelmann, from a specimen prepared with a one-half per cent. solution of osmic acid).
- 32-47. *VORTICELLA NEBULIFERA*, Ehr., vol. ii. p. 673.—32, Body of adult zooid, showing at *m* outline of myophan layer continuous with the contractile fibrilla of the pedicle,  $\times 400$ ; 33-35, successive phases following upon detachment and encystment resulting in the subdivision of the endoplast or nucleus into nodular fragments; 39-46, successive phases illustrating the development of a nodular endoplastic fragment through a *Strombidium*-like condition (Figs. 38-41) into an ordinarily attached zooid, the example at 40 dividing by transverse fission; 47, lenticular protective encystment (after Everts).
- 48-50. *EPISTYLIS FLAVICANS*, Ehr., vol. ii. p. 702.—48, Terminal branchlet with two zooids; *v*, vestibulum; *ph*, pharynx; *a*, œsophagus; *f*, food-mass passing through the tubular œsophagus; *f'*, food-globules discharged into the internal parenchyma or endoplasm; *an*, anal aperture,  $\times 200$ ; 49, alimentary tract isolated and further enlarged; *or*, oral aperture; *b*, bulbous enlargement of œsophagus; *s*, vestibular seta; *f*, flap-like developments of pharyngeal walls; other lettering as in preceding figure; 50, basal region of body, showing radiating muscular fibrillæ and concentric striæ of the cuticulum,  $\times 300$  (after R. Greeff).
51. *CARCHESIUM POLYPINUM*, Linn. sp., vol. ii. p. 690.—Diagrammatic outline of peristome and oral system; *p*, peristome; *cl*, ciliary wreath; *v*, vestibulum; *s*, vestibular seta; *cv*, contractile vesicle; *an*, anal aperture (R. Greeff).



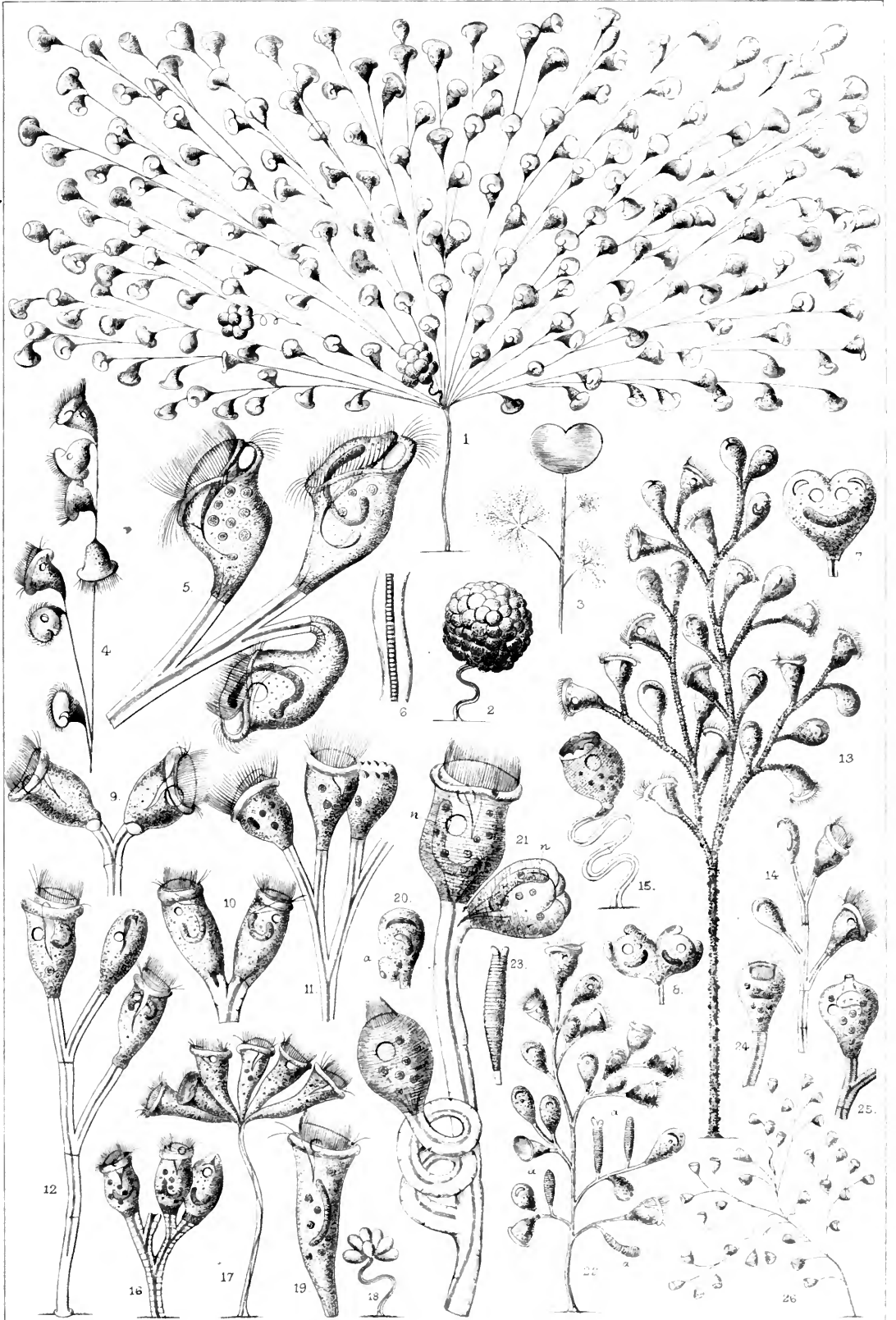


*PLATE XXXVI.*

EXPLANATION OF PLATE XXXVI.

FIG.

- 1-8. *CARCHESIUM POLYPINUM*, Linn. sp., vol. ii. p. 690.—1, Adult colony-stock,  $\times 100$ ; 2, a similar stock completely retracted; 3, three colony-stocks attached to a rootlet of *Lemma*, natural size, as delineated by Schäffer (1754); 4, termination of branchlet showing unilateral plan of disposition of the zooids,  $\times 150$ ; 5, terminal branchlet with three zooids, showing independent relationship of the contractile element of their respective pedicles,  $\times 350$  (after Stein); 6, fragment of pedicle, showing apparent transverse striation of the central muscular cord, as delineated by H. E. Forrest; 7 and 8, successive phases of longitudinal fission.
9. *ZOOTHAMNIUM NUTANS*, C. & L., vol. ii. p. 698,  $\times 200$  (Claparède & Lachmann).
10. *CARCHESIUM ASELLI*, Eng., vol. ii. p. 693,  $\times 125$  (Engelmann).
11. *ZOOTHAMNIUM MARINUM*, Meresch., vol. ii. p. 700,  $\times 125$  (Mereschkowsky).
- 12-14. *CARCHESIUM EPISTYLIDIS*, C. & L., vol. ii. p. 692.—12, Small colony-stock (after Clap. & Lach.),  $\times 300$ ; 13 and 14, large colony-stock and terminal branchlet of the same, as delineated by H. E. Forrest.
15. *ZOOTHAMNIUM NUTANS*, C. & L., vol. ii. p. 698.—Isolated zooid during contraction,  $\times 200$  (Clap. & Lach.).
16. *ZOOTHAMNIUM AFFINE*, Stein, vol. ii. p. 698,  $\times 150$  (Stein).
- 17-20. *ZOOTHAMNIUM SIMPLEX*, S. K., vol. ii. p. 700.—17, Adult colony-stock,  $\times 150$ ; 18, retracted condition; 19, isolated zooid,  $\times 300$ ; 20, conjugation of migrant microzooid  $\alpha$  with an ordinary sedentary animalcule.
21. *CARCHESIUM LACHMANNI*, S. K., vol. ii. p. 691,  $\times 200$  (Clap. & Lach.)
- 22, 23. *ZOOTHAMNIUM ALTERNANS*, C. & L., vol. ii. p. 695.—22, Colony-stock with at *aaa* subcylindrical microzooids, as observed by the author; 23, isolated microzooid,  $\times 400$ .
- 24, 25. *ZOOTHAMNIUM GLENISCUM*, C. & L., vol. ii. p. 697.—Expanded and contracted zooids,  $\times 200$  (Clap. & Lach.).
26. *CARCHESIUM SPECTABILE*, Ehr., vol. ii. p. 691.—Colony-stock, as figured by Rösel (1755), dimensions unrecorded.





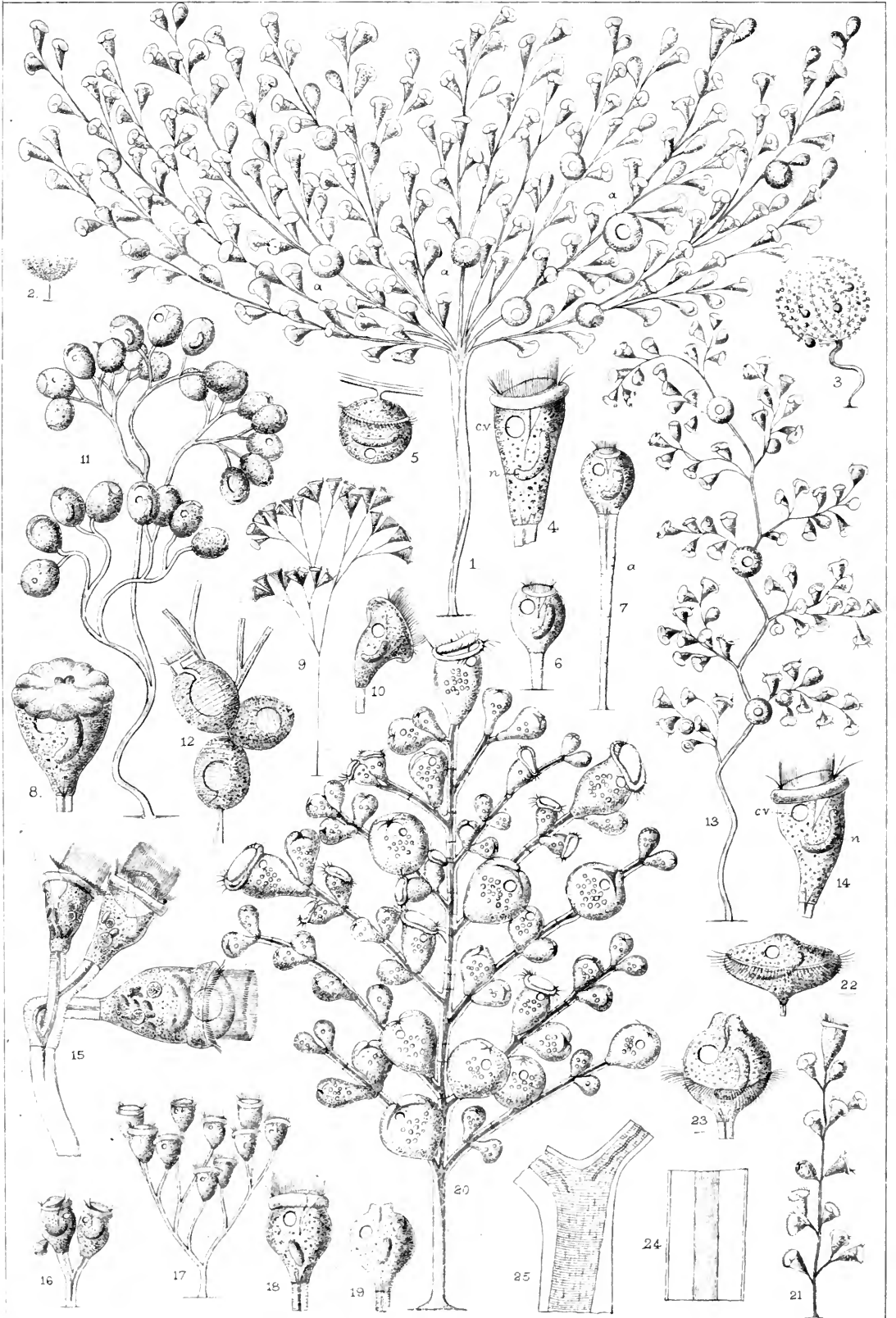


*PLATE XXXVII.*

EXPLANATION OF PLATE XXXVII.

FIG.

- 1-8. *ZOOTHAMNIUM ARBUSCULA*, Ehr., vol. ii. p. 694.—1, Fully extended adult colony-stock with at *aa* large subspheroidal reproductive zooids,  $\times 100$ ; 2, a similar colony-stock, natural size; 3, colony-stock in a semi-contracted state; 4, isolated conical zooid,  $\times 350$ ; 5, spheroidal reproductive zooid, as delineated by H. E. Forrest; 6 and 7, successive phases of growth of a reattached reproductive zooid; 8, ordinary conical zooid with the anterior border plicately contracted.
- 9-12. *ZOOTHAMNIUM DICHOTOMUM*, Wright, vol. ii. p. 697.—9, Adult colony-stock,  $\times 50$ ; 10, an isolated zooid,  $\times 200$ ; 11, colony-stock in semi-contracted state; 12, scarcer reproductive zooids,  $\times 200$ .
- 13, 14. *ZOOTHAMNIUM NIVEUM*, Ehr., vol. ii. p. 694.—13, Adult colony-stock,  $\times 50$ ; 14, isolated zooid,  $\times 200$ .
15. *ZOOTHAMNIUM CIENKOWSKII*, Wrz., vol. ii. p. 696,  $\times 400$  (Wrzesniowski).
16. *ZOOTHAMNIUM PARASITA*, Stein, vol. ii. p. 698,  $\times 100$  (Stein).
- 17-19. *ZOOTHAMNIUM CARCINI*, S. K., vol. ii. p. 700.—17, Adult colony-stock,  $\times 80$ ; 18 and 19, expanded and contracted zooids,  $\times 200$ .
- 20-24. *ZOOTHAMNIUM ALTERNANS*, C. & L., vol. ii. p. 695.—20, Adult colony-stock with various sized zooids, as delineated by Greeff,  $\times 125$ ; 21, attenuate undeveloped colony-stock, as observed by the author; 22 and 23, larger reproductive zooids with subcentrally developed supplementary ciliary girdles; 24, portion of pedicle with finely striate central cord, as observed by the author; 25, a portion of the same structure, as delineated by H. E. Forrest.



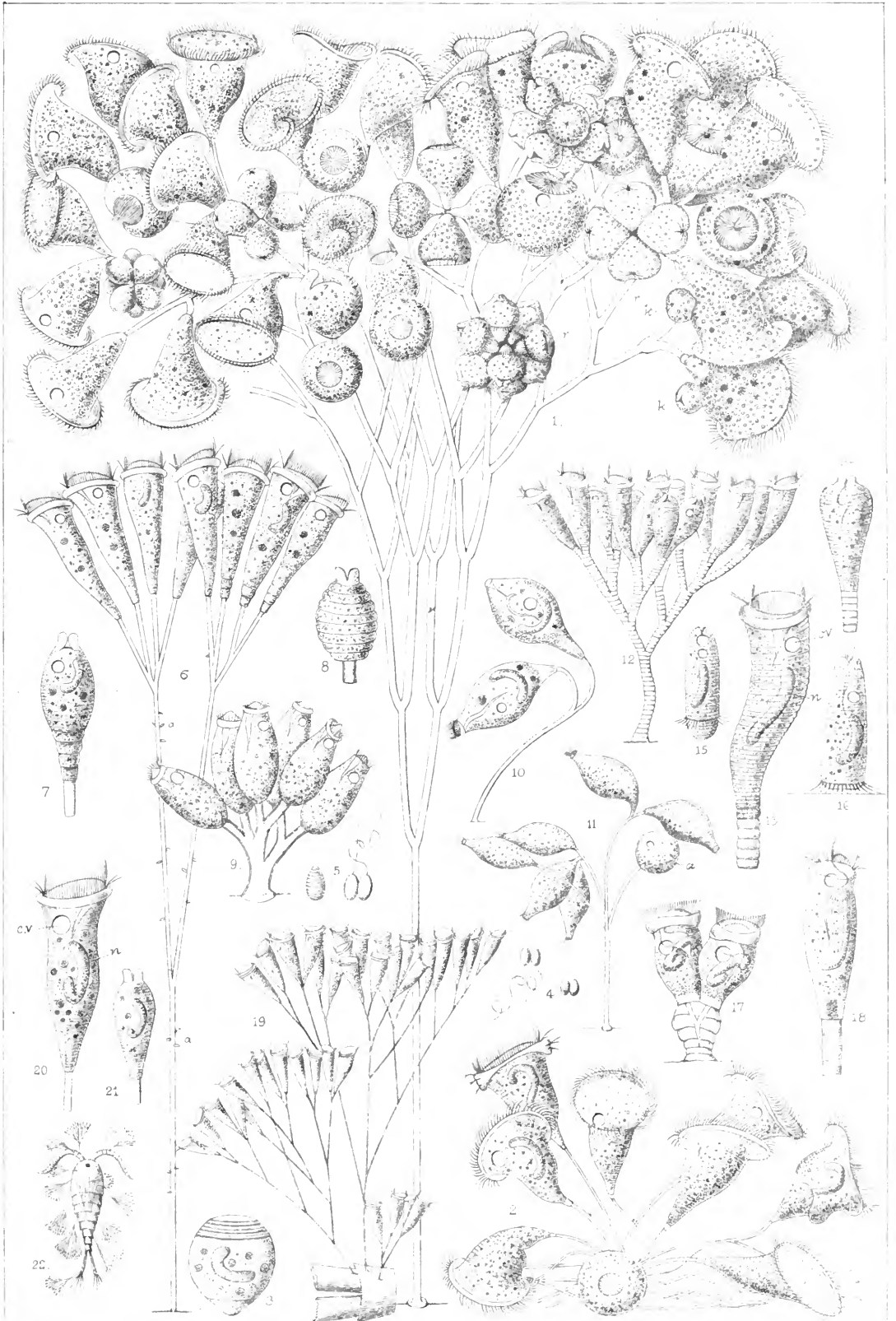


*PLATE XXXVIII.*

### EXPLANATION OF PLATE XXXVIII.

FIG.

- 1-5. *EPISTYLIS FLAVICANS*, Ehr., vol. ii. p. 702.—Adult erect colony-stock, with at *rr* rosette-like groups of microzooids produced through the repeated segmentation of the ordinary animalcules; at *kk* detached microzooids laterally adherent to and conjugating with ordinary sedentary animalcules,  $\times 100$ , after Greeff (as originally delineated by Greeff, the right-hand half of the colony is alone portrayed, the left one has been filled by the author, in keeping with the same, for the purpose of symmetry); 2, decumbent colony-stock; 3, zooid after death, the cilia having fallen away, but showing concentric lines of ciliary circlets; 4 and 5, trichocyst-like bodies, as delineated by Greeff,  $\times 600$ .
- 6-8. *EPISTYLIS PLICATILIS*, Ehr., vol. ii. p. 701.—6, Adult colony-stock,  $\times 150$ ; at *aa* commensally attached Flagellata, *Monosiga*; 7 and 8, contracted zooids,  $\times 200$ .
9. *EPISTYLIS UMBILICATA*, C. & L., vol. ii. p. 706,  $\times 250$  (D'Udekem).
- 10, 11. *EPISTYLIS COARCTATA*, C. & L., vol. ii. p. 706.—10, Colony-stock, as delineated by Claparède & Lachmann,  $\times 150$ ; 11, more luxuriant colony, as figured by H. J. Slack; at *a* an apparently encysted zooid.
- 12-16. *EPISTYLIS DIGITALIS*, Ehr., vol. ii. p. 704.—12, Adult colony-stock,  $\times 150$ ; 13, isolated zooid,  $\times 300$ ; 14, contracted zooid; 15 and 16, migrant zooids detached from the parent stock, that at 16 progressing on the ground after the manner of a *Trichodina*.
17. *EPISTYLIS STEINII*, Wrz., vol. ii. p. 708,  $\times 300$  (Wrzesniowski).
18. *EPISTYLIS NYMPHARUM*, Eng., vol. ii. p. 708.—Isolated zooid,  $\times 160$  (Engelmann).
- 19-22. *EPISTYLIS ANASTATICA*, Linn. sp., vol. ii. p. 701.—19, Colony-stocks attached to limbs of *Cyclops*,  $\times 100$ ; 20, isolated zooid,  $\times 300$ ; 21, contracted animalcule. *Cyclops* with numerous colony-stocks attached,  $\times 10$ .



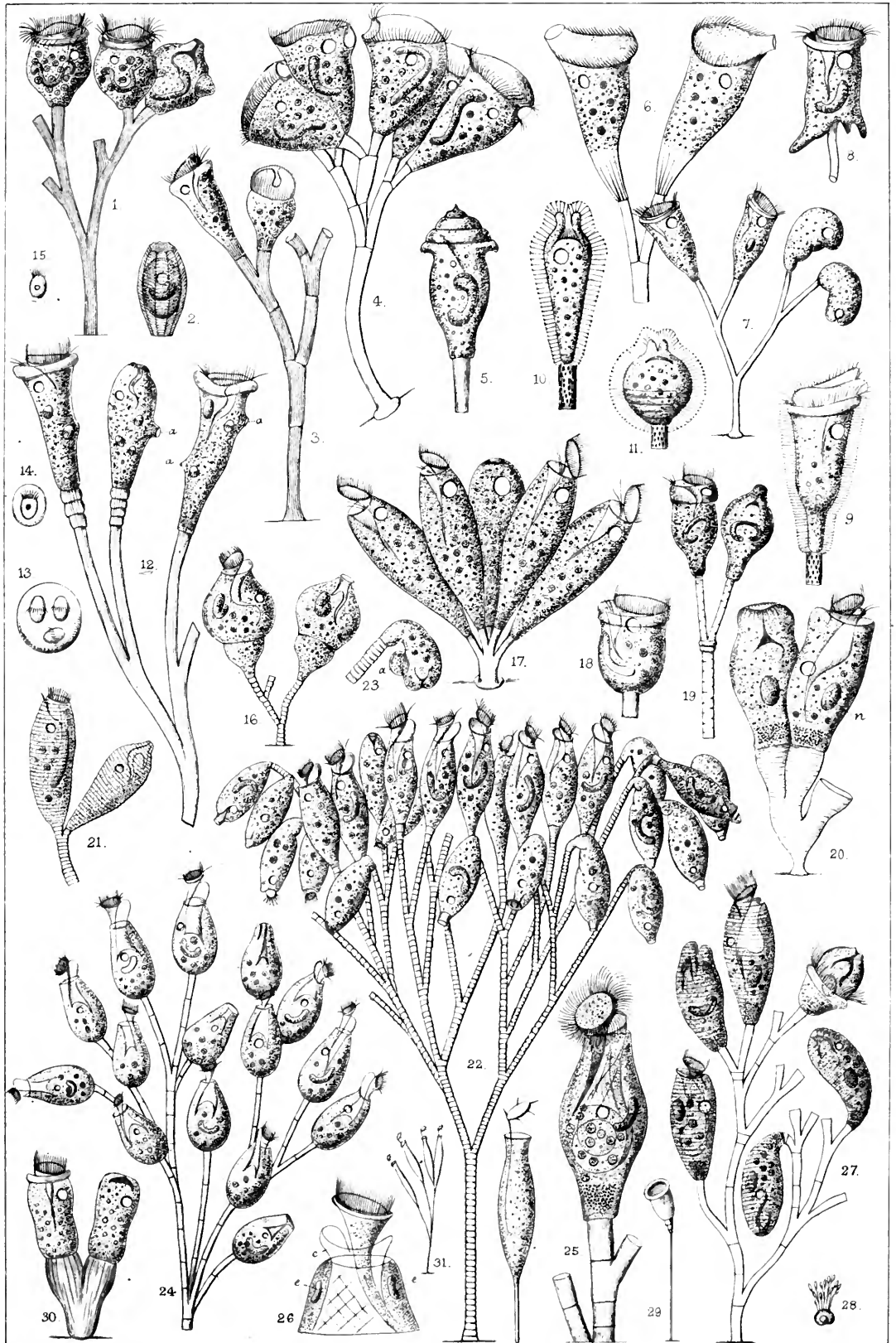




*PLATE XXXIX.*

EXPLANATION OF PLATE XXXIX.

- FIG.  
 1, 2. *EPISTYLIS BRANCHIOPYLA*, Perty, vol. ii. p. 705.—1, Fragment of colony-stock, × 200; 2, encysted zooid, × 200 (Stein).  
 3. *EPISTYLIS ARTICULATA*, From., vol. ii. p. 707, × 200 (De Fromentel).  
 4. *EPISTYLIS LEUCOA*, Ehr., vol. ii. p. 704, × 100 (Ehrenberg).  
 5. *EPISTYLIS BALANORUM*, Meresch., vol. ii. p. 709.—Isolated zooid, × 240 (Mereschkowsky).  
 6. *EPISTYLIS GALEA*, Ehr., vol. ii. p. 701.—Terminal branch with two zooids, × 120 (Ehrenberg).  
 7, 8. *EPISTYLIS TUBIFICIS*, D'Udk., vol. ii. p. 707.—7, Adult colony-stock, × 120; 8, zooid with irregularly developed posterior prolongations (D'Udekem).  
 9-11. *OPERCULARIA HOSPES*, From., vol. ii. p. 714.—9, Expanded, 10 and 11, contracted zooids, × 200 (De Fromentel).  
 12-15. *EPISTYLIS PLICATILIS*, Ehr., vol. ii. p. 701.—12, Three zooids containing ciliated embryos derived through the disrapture of the endoplast, × 200; at *aaa*, spout-like apertures whence similar embryos have made their escape; 13, fragment of endoplast enclosing three embryos; 14 and 15, isolated embryos more highly magnified (Claparède & Lachmann).  
 16. *OPERCULARIA MICROSTOMA*, Stein, vol. ii. p. 713, × 200 (Stein).  
 17. *OPERCULARIA STENOSTOMA*, Stein, vol. ii. p. 712, × 200 (D'Udekem).  
 18. *EPISTYLIS INVAGINATA*, C. & L., vol. ii. p. 706.—Isolated zooid, × 200 (Clap. & Lach.)  
 19. *EPISTYLIS CRASSICOLLIS*, Stein, vol. ii. p. 705.—Fragment of branch with two zooids, × 200 (Stein).  
 20. *OPERCULARIA LICHTENSTEINII*, Stein, vol. ii. p. 712, × 200 (Stein).  
 21. *OPERCULARIA CYLINDRATA*, Wrz., vol. ii. p. 713.—Terminal branchlet with two zooids, × 300 (Wrzesniowski).  
 22, 23. *OPERCULARIA NUTANS*, Ehr. sp., vol. ii. p. 710.—22, Adult colony-stock, × 300; 23, isolated animalcule with at *a* a conjugating migrant zooid, as delineated by Ehrenberg.  
 24-26. *OPERCULARIA ARTICULATA*, Ehr. sp., vol. ii. p. 711.—24, Portion of adult colony-stock, × 150; 25, isolated zooid; 26, distal extremity showing membranous collar *c*, and stalked ciliary disc more highly magnified; *ee*, kidney-shaped corpuscles of undetermined nature (after Stein).  
 27. *OPERCULARIA BERBERINA*, Linn. sp., vol. ii. p. 711, × 200 (Stein).  
 28, 29. *VORTICELLA ANNULARIS*, Müll., vol. ii. p. 689.—28, Group, natural size, attached to a small *Planorbis*; 29, isolated zooid, × 10 (O. F. Müller).  
 30. *ZOTHAMNIUM MACROSTYLUM*, D'Udk., vol. ii. p. 699.—Dimensions unrecorded (D'Udekem).  
 31, 32. *OPERCULARIA* sp., apparently allied to *O. stenostoma*, vol. ii. p. 712.—31, Fragment of colony-stock; 32, isolated zooid, as figured by Henry Baker, 'Employment for the Microscope,' 1785, pl. xiii. figs. 13 and 14, dimensions unrecorded.





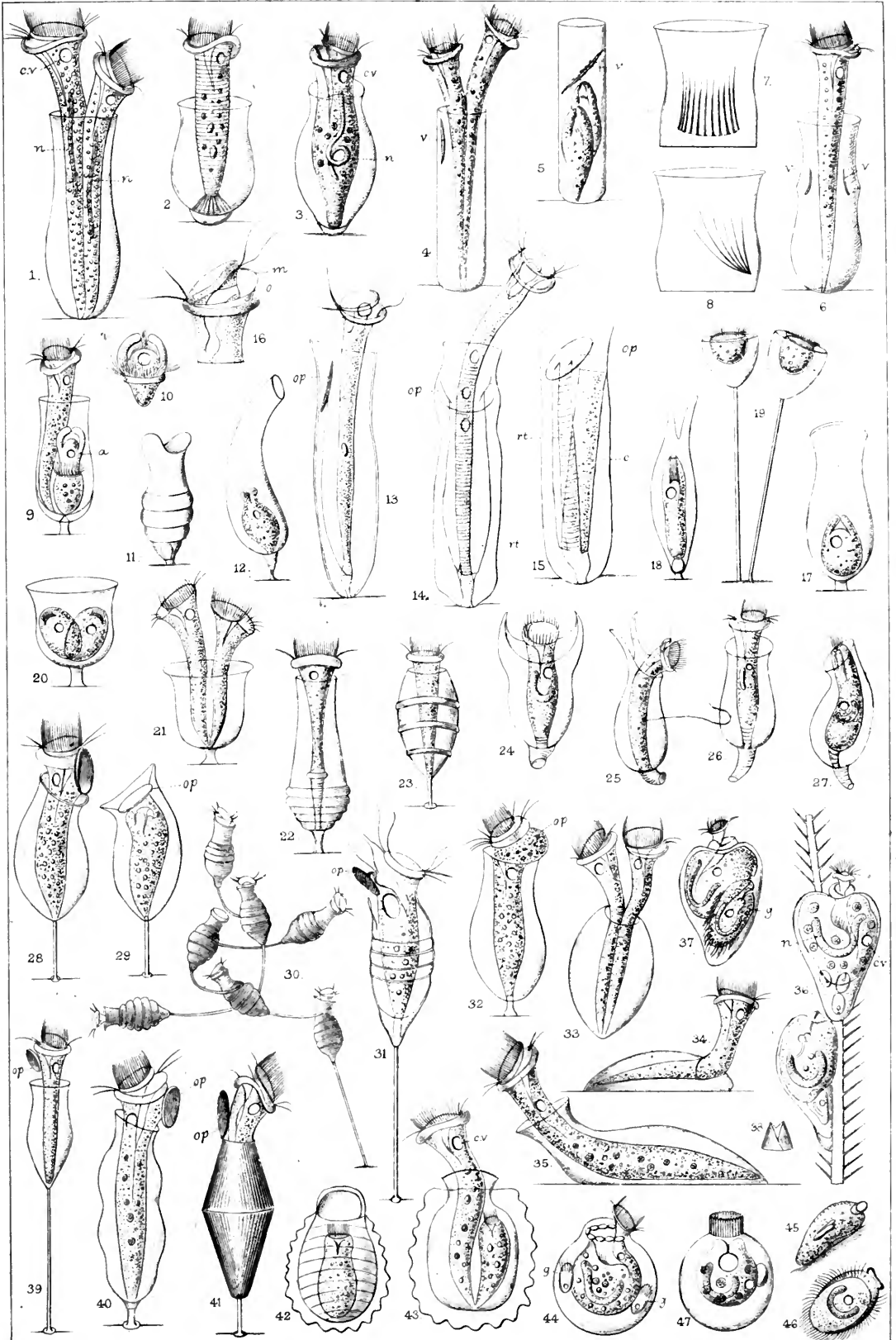
## PLATE XL.

### EXPLANATION.

- FIG.
1. VAGINICOLA CRYSTALLINA, Ehr., vol. ii. p. 715.—Lorica containing two zooids, × 200.
  2. STYLOCOLA STRIATA, From., vol. ii. p. 730, × 300 (De Fromental).
  3. VAGINICOLA GLOBOSA, D'Udk., vol. ii. p. 716, dimensions unrecorded (D'Udekem).
  - 4, 5. THURICOLA VALVATA, Wright sp., vol. ii. p. 718.—Loricæ with two zooids in an expanded and contracted state; *v*, valvular structure, × 200 (Str. Wright).
  - 6-8. THURICOLA FOLLICULATA, Müll. sp., vol. ii. p. 718.—6, Fully extended zooid with at *vv* lateral edges of pectinate valve, × 200; 7 and 8, distal region of lorica showing pectinate structure of valve, × 400.
  - 9, 10. COTHURNIA IMBERBIS, Ehr., vol. ii. p. 720.—9, Lorica containing two zooids, that at *a* in a contracted condition, having developed a subcentral ciliary girdle preparatory to migration, × 200; 10, detached migratory zooid (Greeff).
  11. COTHURNIA PONTICA, Meresch., vol. ii. p. 725.—Empty lorica, × 150 (Mereschkowsky).
  12. COTHURNIA GRACILIS, S. K., vol. ii. p. 724.—Zooid contracted, × 250.
  - 13-15. THURICOLA OPERCULATA, Gruber sp., vol. ii. p. 719.—13 and 14, Expanded zooids, showing at *op* valve-like operculum, and at *l* retractile ligament that connects the same with the body at the bottom of the lorica; 15, basal region with the operculum and retractile ligament diagrammatically represented (Gruber).
  16. PYXICOLA SOCIALIS, Gruber sp., vol. ii. p. 728.—Distal region of expanded zooid with at *m* collar-like membrane, dimensions unrecorded (Gruber).
  - 17, 18. COTHURNIA COMPRESSA, C. & L., vol. ii. p. 722.—Front and lateral aspects, × 170 (Claparède & Lachmann).
  19. COTHURNIA HAVNIENSIS, Ehr., vol. ii. p. 720, × 100 (Ehrenberg).
  - 20, 21. COTHURNIA PATULA, From., vol. ii. p. 722.—Lorica with two zooids in their expanded and contracted states, × 200 (De Fromental).
  22. COTHURNIA COHNII, S. K., vol. ii. p. 723, × 400 (Cohn).
  23. COTHURNIA PUPA, Eichw., vol. ii. p. 724, dimensions unrecorded (Eichwald).
  - 24, 25. COTHURNIA SIEBOLDII, Stein, vol. ii. p. 720.—Ventral and lateral aspects, × 150 (Stein).
  26. COTHURNIA ASTACI, Stein, vol. ii. p. 721, × 150 (Stein).
  27. COTHURNIA CURVA, Stein, vol. ii. p. 721, × 300 (Stein).

EXPLANATION OF PLATE XL.—*continued.*

- FIG.
- 28, 29. PYXICOLA AFFINIS, S. K., vol. ii. p. 727.—Expanded and contracted zooids ; *op*, operculum,  $\times 250$ .
- 30, 31. PYXICOLA SOCIALIS, Gruber sp., vol. ii. p. 728.—30, Social group,  $\times 90$  ; 31, isolated zooid,  $\times 250$  ; *op*, operculum (Gruber).
32. PACHYTRICHA COTHURNOIDES, S. K., vol. ii. p. 729.—Extended zooid with at *op* fleshy operculum,  $\times 500$ .
- 33, 34. PLATYCOLA DECUMBENS, Ehr. sp., vol. ii. p. 731.—Dorsal and lateral aspects, the lorica at 33 containing two zooids,  $\times 280$ .
35. PLATYCOLA LONGICOLLIS, S. K., vol. ii. p. 732,  $\times 300$  (De Fromentel).
- 36-38. LAGENOPHRYS VAGINICOLA, Stein, vol. ii. p. 733.—36, Two zooids attached to a branched hair of *Canthocamptus minutus*,  $\times 350$  ; 37, example with at *g* posteriorly separated germ ; 38, membranous valve of oral region.
39. PYXICOLA OPERCULIGERA, S. K., vol. ii. p. 725.—Extended zooid with at *op* discoidal operculum,  $\times 250$ .
40. PYXICOLA CARTERI, S. K., vol. ii. p. 729,  $\times 400$ .—*op*, Operculum.
41. PYXICOLA PYXIDIFORMIS, D'Udk. sp., vol. ii. p. 726.—Extended zooid with at *op* lid-like operculum,  $\times 150$  (D'Udekem).
42. PLATYCOLA STRIATA, From., vol. ii. p. 732,  $\times 300$  (De Fromentel).
43. PLATYCOLA DILATATA, From., vol. ii. p. 731,  $\times 300$  (De Fromentel).
- 44-46. LAGENOPHRYS AMPULLA, Stein, vol. ii. p. 733.—44, Extended zooid with at *gg* detached ciliated germs,  $\times 300$  ; 45 and 46, detached germs more highly magnified, showing hypotrichous plan of ciliation (Stein).
47. LAGENOPHRYS NASSA, Stein, vol. ii. p. 733.—Retracted zooid,  $\times 300$  (Stein).





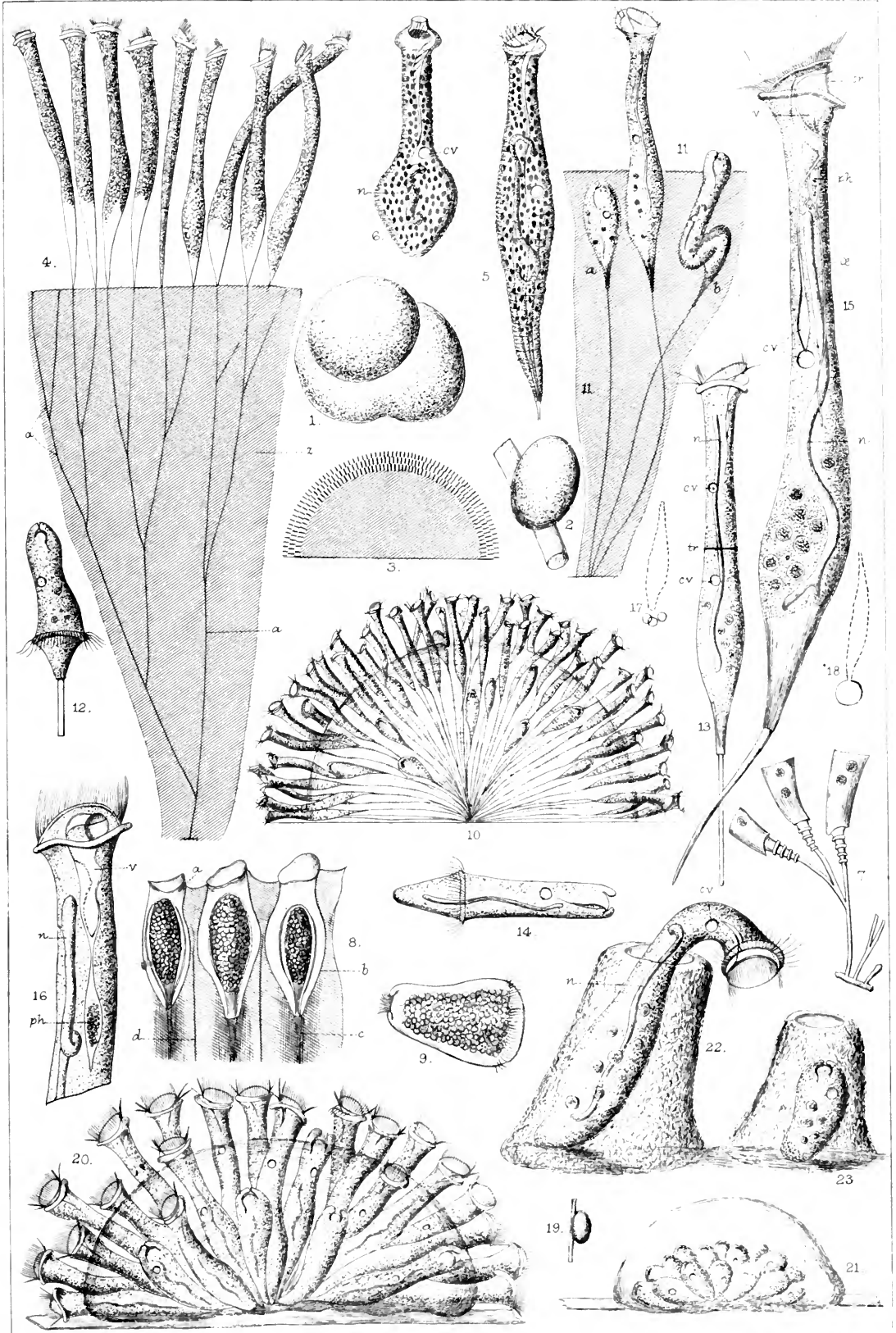


*PLATE XLI.*

EXPLANATION OF PLATE XLI.

FIG.

- 1-9. *OPHRIDIUM VERSATILE*, Müll. sp., vol. ii. p. 735.—1 and 2, Colony-stocks, natural size (after Ehrenberg); 3, portion of a similar colony-stock, as seen in optical section slightly magnified; 4, fragment of a colony-stock with fully extended zooids, showing at *aa* the thread-like branching pedicle with its surrounding common gelatinous matrix or zoocytium *z*,  $\times 100$  (after Wrzesniowski); 5 and 6, extended and contracted zooids,  $\times 200$  (after Stein); 7, basal region of three zooids of a variety in which the relatively short pedicles are distinctly annulate at their distal ends (Wrzesniowski); 8, fragments of a colony-stock treated with hæmatoxylin and osmic acid, showing at *a* the urceolate cavities in the zoocytium into which the zooids retreat; *b*, a retracted zooid; and *c*, the pedicle; the lines at *d* indicate the boundaries of the zoocytial element exuded by the individual zooids,  $\times 150$  (Wrzesniowski); 9, a detached free-swimming zooid having a posteriorly developed supplementary girdle of cilia.
- 10-17. *OPHRIDIUM EICHORNII*, Ehr., vol. ii. p. 737.—10, a moderate-sized colony-stock with fully extended zooids, as observed by the author,  $\times 50$ ; 11, a fragment of the same stock with, at *a, b*, contracted zooids,  $\times 150$ ; 12, a zooid with posteriorly developed ciliary girdle preparing to enter upon the free-swimming state; 13, a zooid exhibiting the rare phenomenon of subdivision by transverse fission, the line at *tr* indicating the region of separation; 14, a detached free-swimming zooid; 15 and 16, whole and portion of a normal zooid  $\times 400$  (as delineated by Wrzesniowski); *or*, oral entrance; *v*, vestibular fossa; *ph*, pharynx; *æ*, œsophageal tube; 17 and 18, outlines of the contractile vesicle.
- 19-21. *OPHRIDIUM SESSILE*, S.K., vol. ii. p. 738.—19, colony-stock attached to vegetable filament, natural size; 20, a colony-stock with fully extended zooids,  $\times 100$ ; 21, a similar stock with the zooids retracted within their common gelatinous zoocytium.
- 22, 23. *OPHIONELLA PICTA*, S.K., vol. ii. p. 734.—22, extended, and 23, contracted zooid,  $\times 300$ .







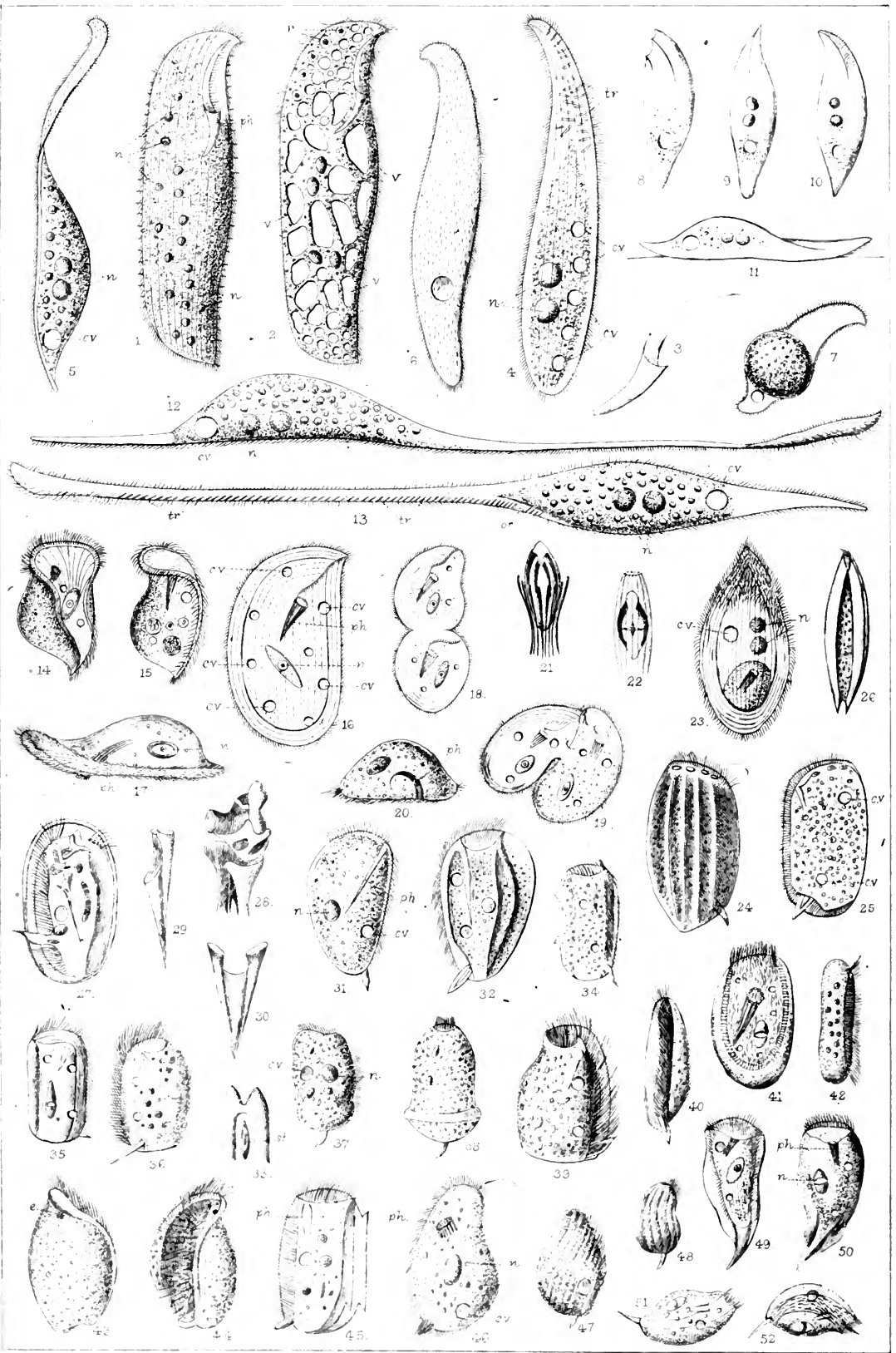
## PLATE XLIII.

### EXPLANATION.

- FIG.  
1-3. *LOXODES ROSTRUM*, Ehr., vol. ii. p. 748.—1, zooid as viewed superficially, showing cuticular striæ, marginal setæ, and endoplastular spherules; *ph*, sickle-shaped pharyngeal tube,  $\times 200$ ; 2, a similar zooid more deeply focussed, showing the reticulate or cancellate structure of the internal parenchyma; *v*, vacuolar spaces; *r*, refringent corpuscles; 3, indurated pharynx,  $\times 300$  (after Wrzesniowski).
4. *LITONOTUS VARSAVIENSIS*, Wrz., vol. ii. p. 744,  $\times 500$ .—*tr*, trichocysts (Wrzesniowski).
- 5-11. *LITONOTUS FASCIOLA*, Ehr. sp., vol. ii. p. 743.—5, lateral view, and 6, ventral aspect,  $\times 500$  (Wrzesniowski); 7, example abnormally dilated with ingested food; 8-11, successive developmental phases of a single zooid (as observed by the author).
- 12, 13. *LITONOTUS WRZESNIOWSKII*, S. K., vol. ii. p. 742.—12, Lateral, and 13, ventral aspects,  $\times 400$ ; *tr*, trichocysts.
- 14, 15. *PHASCOLODON VORTICELLA*, Stein, vol. ii. p. 746.—Ventral and lateral aspects,  $\times 250$  (Stein).
- 16-22. *CHILODON CUCULLULUS*, Müll. sp., vol. ii. p. 746.—16 and 17, Ventral and lateral aspects,  $\times 200$  (Stein); 18, example dividing by transverse fission; 19, conjugation of two independent zooids (Stein); 20, zooid with abnormally developed pharyngeal tube, drawn from a preserved example supplied to the author by Mr. Charles Stewart; 21 and 22, pharyngeal rod-fascicles, showing extended and contracted conditions during the ingestion of a diatom frustule.
23. *OPISTHODON NIEMECCENSIS*, Stein, vol. ii. p. 750.—Ventral aspect,  $\times 150$  (Stein).
- 24-26. *IDUNA SULCATA*, C. & L., vol. ii. p. 752.—Dextral, sinistral, and ventral aspects,  $\times 175$  (Claparède & Lachmann).
- 27-30. *DYSTERIA ARMATA*, Huxley, vol. ii. p. 752.—27, Sinistral aspect,  $\times 250$ ; 28-30, corneous elements of pharyngeal apparatus further enlarged (after Huxley).
- 31-33. *CYPRIDIUM LANCEOLATUM*, C. & L. sp., vol. ii. p. 754.—31 and 32, Dextral and sinistral aspects,  $\times 350$ ; 33, ventral view of posterior region, showing the union of the lateral valves, and at *st* caudal style (Claparède & Lachmann).

EXPLANATION OF PLATE XLII. (*continued*).

- FIG.
34. *CYPRIDIUM SPINIGERUM*, C. & L., vol. ii. p. 754.—Dorsal aspect, × 300 (Claparède & Lachmann).
- 35, 36. *ÆGYRIA MONOSTYLA*, Ehr. sp., vol. ii. p. 755.—Dextral and sinistral views, × 200 (Stein).
- 37, 38. *HUXLEYA CRASSA*, C. & L., vol. ii. p. 758, × 300 (Claparède & Lachmann).
- 39, 40. *ÆGYRIA ANGUSTATA*, C. & L., vol. ii. p. 755.—Dextral and ventral aspects, × 300 (Claparède & Lachmann).
- 41, 42. *CHLAMYDODON MNEMOSYNE*, Ehr., vol. ii. p. 750.—Ventral and lateral aspects, × 250 (Stein).
- 43, 44. *ÆGYRIA OLIVA*, C. & L., vol. ii. p. 756.—Dextral and sinistral aspects, × 250; *e*, eye-like pigment-speck (Claparède & Lachmann).
45. *CYPRIDIUM ACULEATUM*, C. & L. sp., vol. ii. p. 754.—Sinistral aspect, × 250 (Claparède & Lachmann).
46. *TRICHOPUS DYSSTERIA*, C. & L., vol. ii. p. 758, × 200 (Claparède & Lachmann).
- 47, 48. *TROCHILIA SIGMOIDES*, Duj., vol. ii. p. 757.—47, as figured by Claparède & Lachmann, under the title of *Huxleya sulcata*, × 500; 48, after Dujardin.
- 49, 50. *SCAPHIDIODON NAVICULA*, Stein, vol. ii. p. 750.—Ventral and dorsal aspects, × 240 (Stein).
- 51, 52. *TROCHILIA PALUSTRIS*, Stein, vol. ii. p. 757.—Dorsal and ventral aspects, × 400 (Stein).



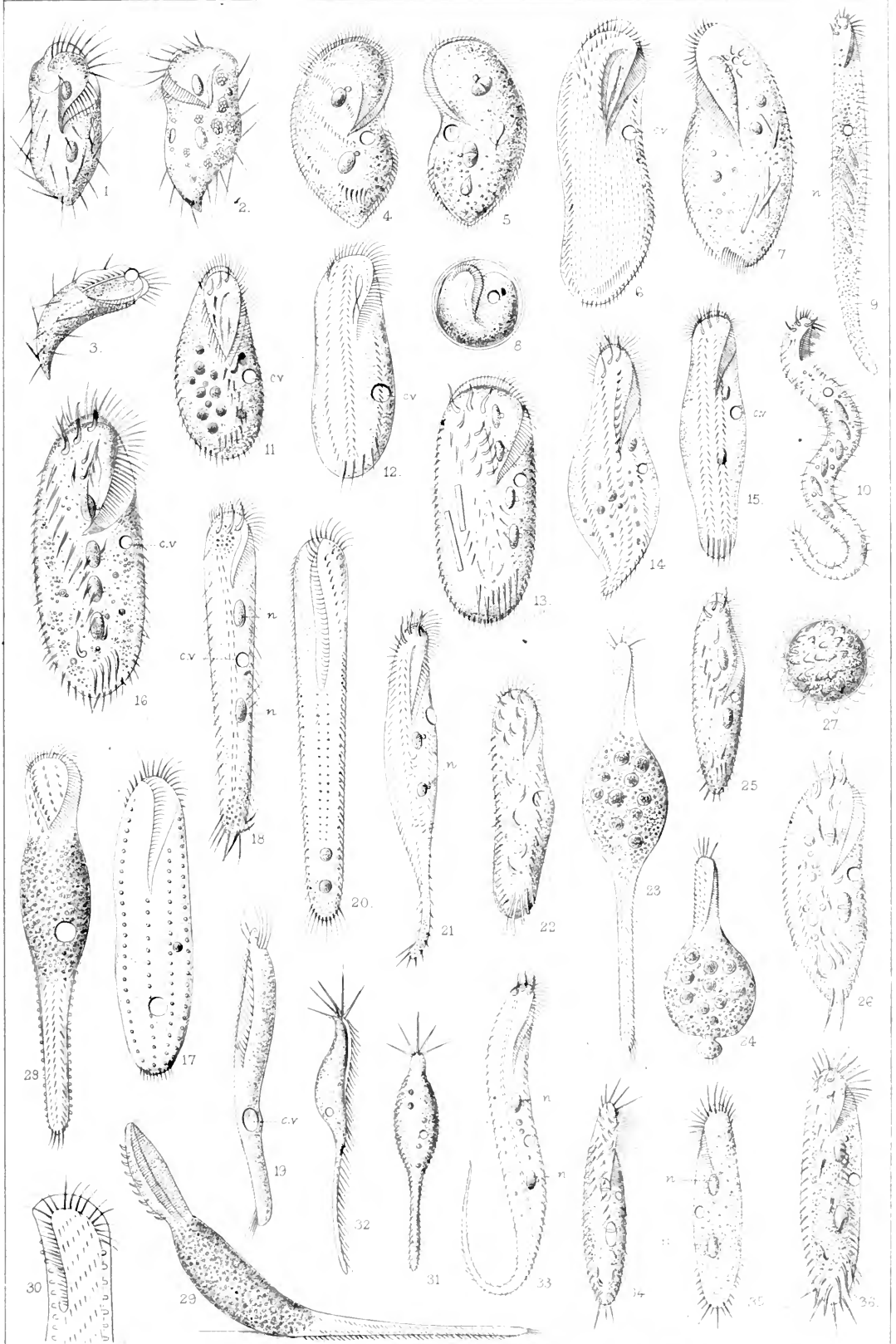


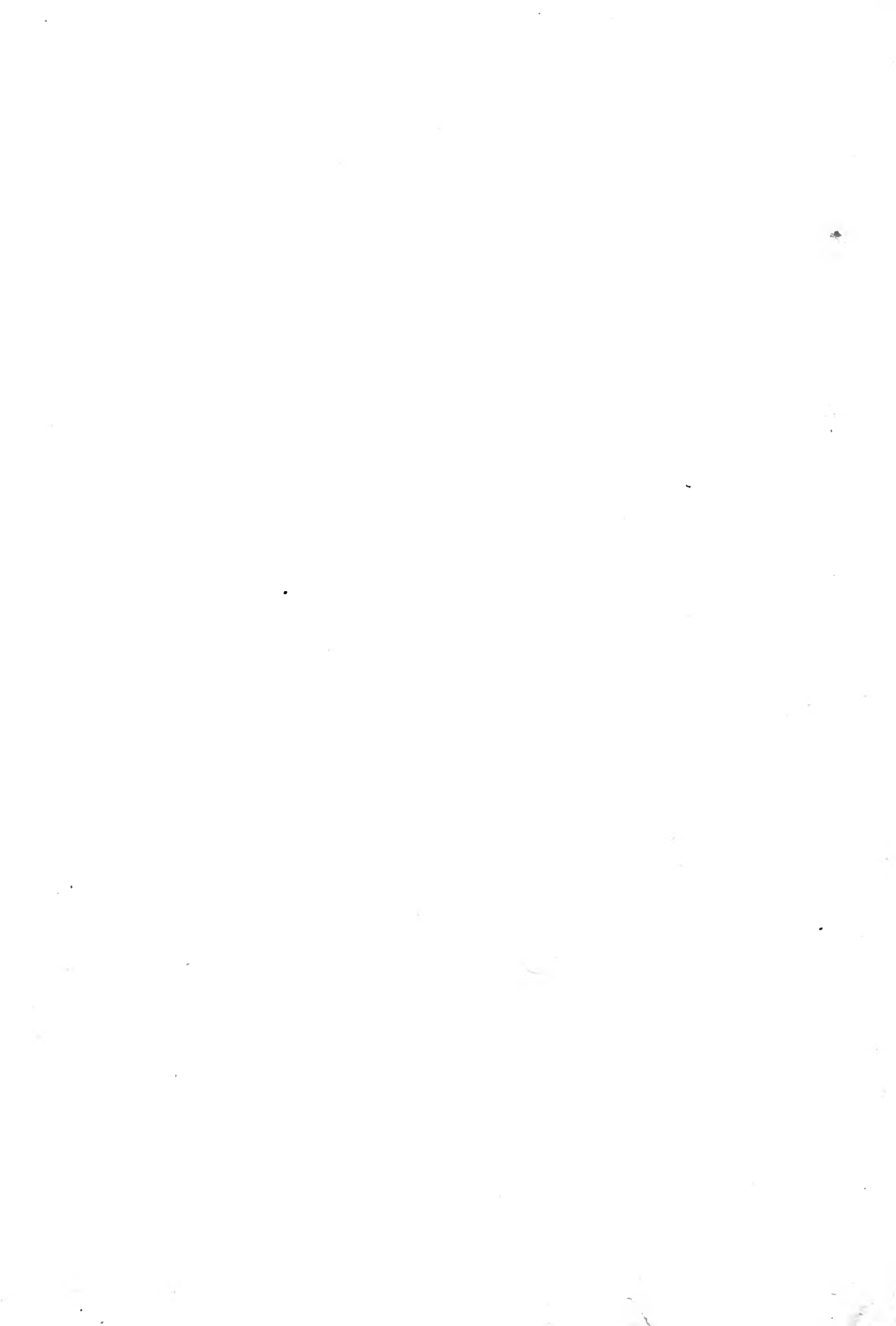


*PLATE XLIII.*

EXPLANATION OF PLATE XLIII.

- FIG.  
 1-3. *PSILOTRICHA ACUMINATA*, Stein, vol. ii. p. 762.—1, Ventral, 2, dorsal, and 3, lateral aspects,  $\times 300$  (Stein).  
 4-5. *KERONA POLYPORUM*, Ehr., vol. ii. p. 763.—Ventral and dorsal aspects,  $\times 200$  (Stein).  
 6-8. *UROSTYLA GRANDIS*, Ehr., vol. ii. p. 765.—6, Elongate example in ventral aspect ; 7, shorter zooid, dorsal view,  $\times 100$  ; 8, encysted zooid (Stein).  
 9-10. *UROLEPTUS MOBILIS*, Eng., vol. ii. p. 781.—Extended and contracted examples,  $\times 150$  (Engelmann).  
 11. *HOLOSTICHA MYSTACEA*, Stein sp., vol. ii. p. 769.—Ventral aspect,  $\times 150$  (Stein).  
 12. *AMPHISIA PERNIX*, Wrz. sp., vol. ii. p. 768.—Ventral aspect,  $\times 300$  (Wrzesniowski).  
 13. *ONYCHODROMUS GRANDIS*, Stein, vol. ii. p. 766.—Ventral aspect,  $\times 150$  (Stein).  
 14. *UROLEPTUS MUSCULUS*, Müll. sp., vol. ii. p. 779.—Ventral aspect,  $\times 150$  (Stein).  
 15. *AMPHISIA GIBBA*, Müll. sp., vol. ii. p. 767.—Ventral aspect,  $\times 200$  (Stein).  
 16. *GASTROSTYLA STEINII*, Eng., vol. ii. p. 784.—Ventral aspect,  $\times 200$  (Engelmann).  
 17. *HOLOSTICHA RUBRA*, Ehr. sp., vol. ii. p. 770.—Ventral view,  $\times 300$  (Cohn).  
 18. *UROLEPTUS VIOLACEUS*, Stein, vol. ii. p. 781.—Ventral aspect,  $\times 200$  (Stein).  
 19, 20. *HOLOSTICHA FLAVA*, Cohn sp., vol. ii. p. 769.—19, Lateral, and 20, ventral aspects,  $\times 250$  (Cohn).  
 21. *UROLEPTUS PISCIS*, Müll. sp., vol. ii. p. 780.—Ventral aspect,  $\times 100$  (Stein).  
 22. *PLEUROTTRICHA ECHINATA*, C. & L. sp., vol. ii. p. 783.—Ventral aspect,  $\times 300$  (Claparède & Lachmann).  
 23, 24. *EPICLINTES RETRACTILIS*, C. & L. sp., vol. ii. p. 774.—23, Extended, and 24, contracted conditions, ventral view,  $\times 500$  (Claparède & Lachmann).  
 25. *PLAGIOTTRICHA AFFINIS*, Stein sp., vol. ii. p. 772.—Ventral aspect,  $\times 300$  (Stein).  
 26, 27. *PLEUROTTRICHA LANCEOLATA*, Ehr. sp., vol. ii. p. 783.—Ventral aspect,  $\times 150$  ; 27, encysted zooid (Stein).  
 28-30. *EPICLINTES AURICULARIS*, C. & L. sp., vol. ii. p. 773.—28, Ventral view ; 29, repent animalcule in lateral aspect,  $\times 200$  (after Claparède & Lachmann ; 30, anterior region more highly magnified, as delineated by Mereschkowsky).  
 31, 32. *EPICLINTES RADIOSA*, Quenn. sp., vol. ii. p. 774.—31, Dorsal, and 32, lateral aspects,  $\times 300$  (Quennerstedt).  
 33. *UROLEPTUS RATTULUS*, Stein, vol. ii. p. 780.—Ventral aspect,  $\times 150$  (Stein).  
 34. *PLAGIOTTRICHA STRENUA*, Eng. sp., vol. ii. p. 772.—Ventral view,  $\times 180$  (Engelmann).  
 35, 36. *OPISTHOTTRICHA PARALLELA*, Eng. sp., vol. ii. p. 785.—35, Dorsal, and 36, ventral aspects,  $\times 150$  (Engelmann).

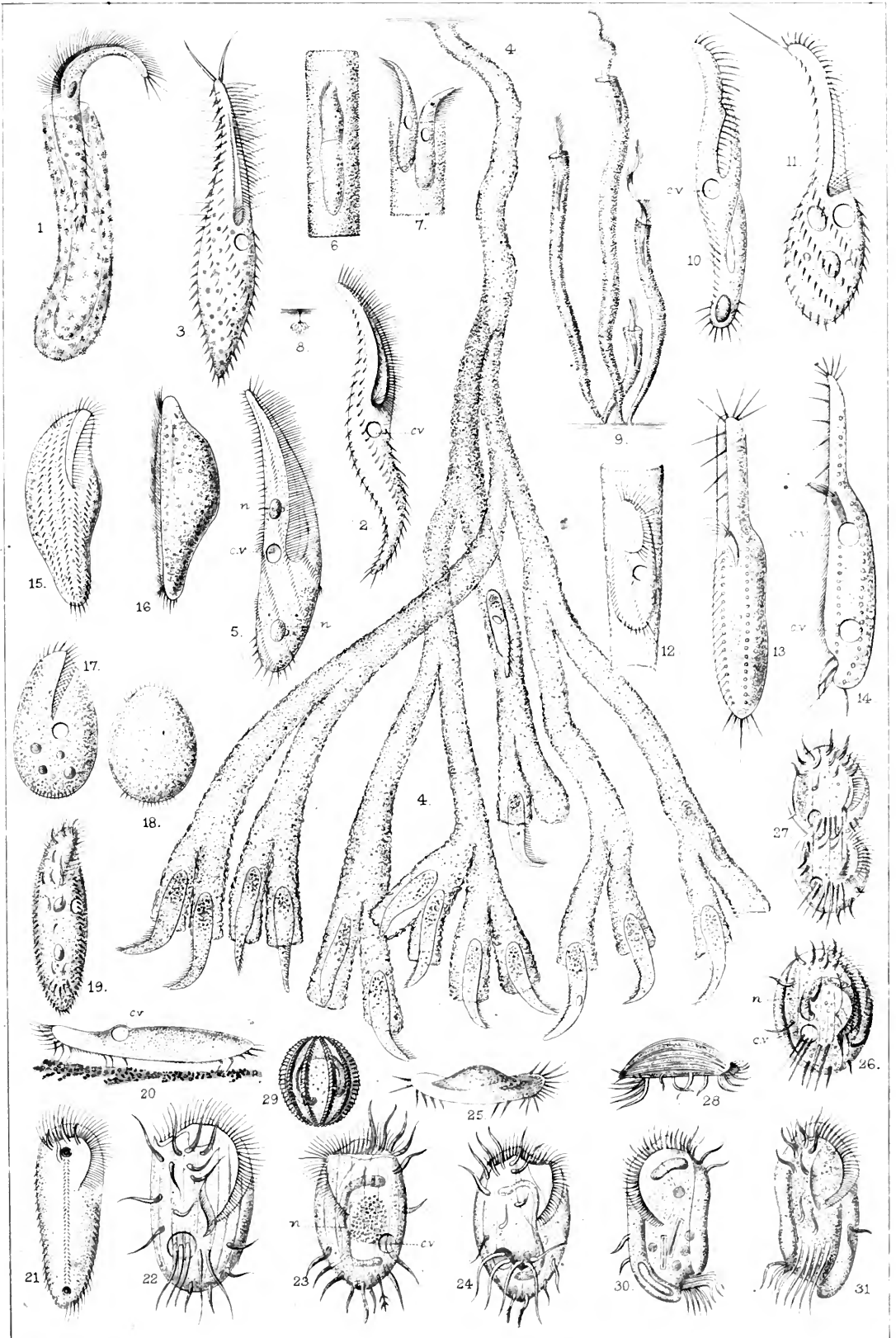




*PLATE XLIV.*

EXPLANATION OF PLATE XLIV.

- FIG.
- 1, 2. *STICHOTRICHA SECUNDA*, Perty, vol. ii. p. 776.—1, Zooid projecting from its mucilaginous sheath; 2, isolated animalcule in ventral aspect,  $\times 250$  (Stein).
  3. *STICHOTRICHA ACULEATA*, Wrz., vol. ii. p. 777.—Ventral aspect  $\times 500$  (Wrzesniowski).
  - 4-8. *SCHIZOSIPHON SOCIALIS*, Gruber sp., vol. ii. p. 778.—4, pendent dichotomously branching colony-stock or zoothecium with terminally enclosed zooids,  $\times 60$ ; 5, an isolated animalcule,  $\times 240$ ; 6, an example dividing by transverse fission within its tube; 7, termination of tube temporarily occupied by two zooids; 8, a colony-stock, natural size (Gruber).
  - 9, 10. *STICHOTRICHA REMEX*, Hudson, vol. ii. p. 777.—9, Animalcules projecting in various positions from their cylindrical sheaths,  $\times 40$ ; 10, an isolated zooid,  $\times 150$  (C. S. Hudson).
  11. *STICHOTRICHA CORNUTA*, C. & L., vol. ii. p. 776.—Zooid in ventral aspect,  $\times 400$  (Claparède & Lachmann).
  12. *OXYTRICHA TUBICOLA*, Gruber, vol. ii. p. 789.—Zooid enclosed within its tube,  $\times 200$  (Gruber).
  - 13, 14. *STICHOCHÆTA PEDICULIFORMIS*, Cohn, vol. ii. p. 775.—13, Ventral, and 14, lateral aspects,  $\times 500$  (Cohn).
  - 15, 16. *AMPHISIA GIBBA var. CRASSA*, C. & L. sp., vol. ii. p. 768.—Ventral, and lateral aspects,  $\times 200$  (Claparède & Lachmann).
  - 17, 18. *OXYTRICHA SCUTELLUM*, Cohn, vol. ii. p. 788.—Extended and contracted zooids,  $\times 360$  (Cohn).
  - 19, 20. *OXYTRICHA ÆRUGINOSA*, Wrz., vol. ii. p. 787.—19, Ventral and 20, lateral aspects,  $\times 150$  (Wrzesniowski).
  21. *HOLOSTICHA OCLATA*, Meresch. sp., vol. ii. p. 770.—Ventral aspect, dimensions unrecorded (Mereschkowsky).
  22. *EUPLOTES HARPA*, Stein, vol. ii. p. 799.—Ventral aspect,  $\times 150$  (Stein).
  - 23-25. *EUPLOTES PATELLA*, Ehr., vol. ii. p. 798.—23, Dorsal, and 24, ventral aspects,  $\times 200$  (after Stein); 25, lateral aspect (Dujardin).
  - 26-29. *EUPLOTES CHARON*, Müll. sp., vol. ii. p. 799.—26, Ventral view,  $\times 300$ ; 27, example dividing by transverse fission; 28, encysted zooid (Stein).
  - 30, 31. *STYLOPLOTES APPENDICULARIS*, Ehr. sp., vol. ii. p. 800.—Dorsal and ventral aspects,  $\times 300$  (Stein).



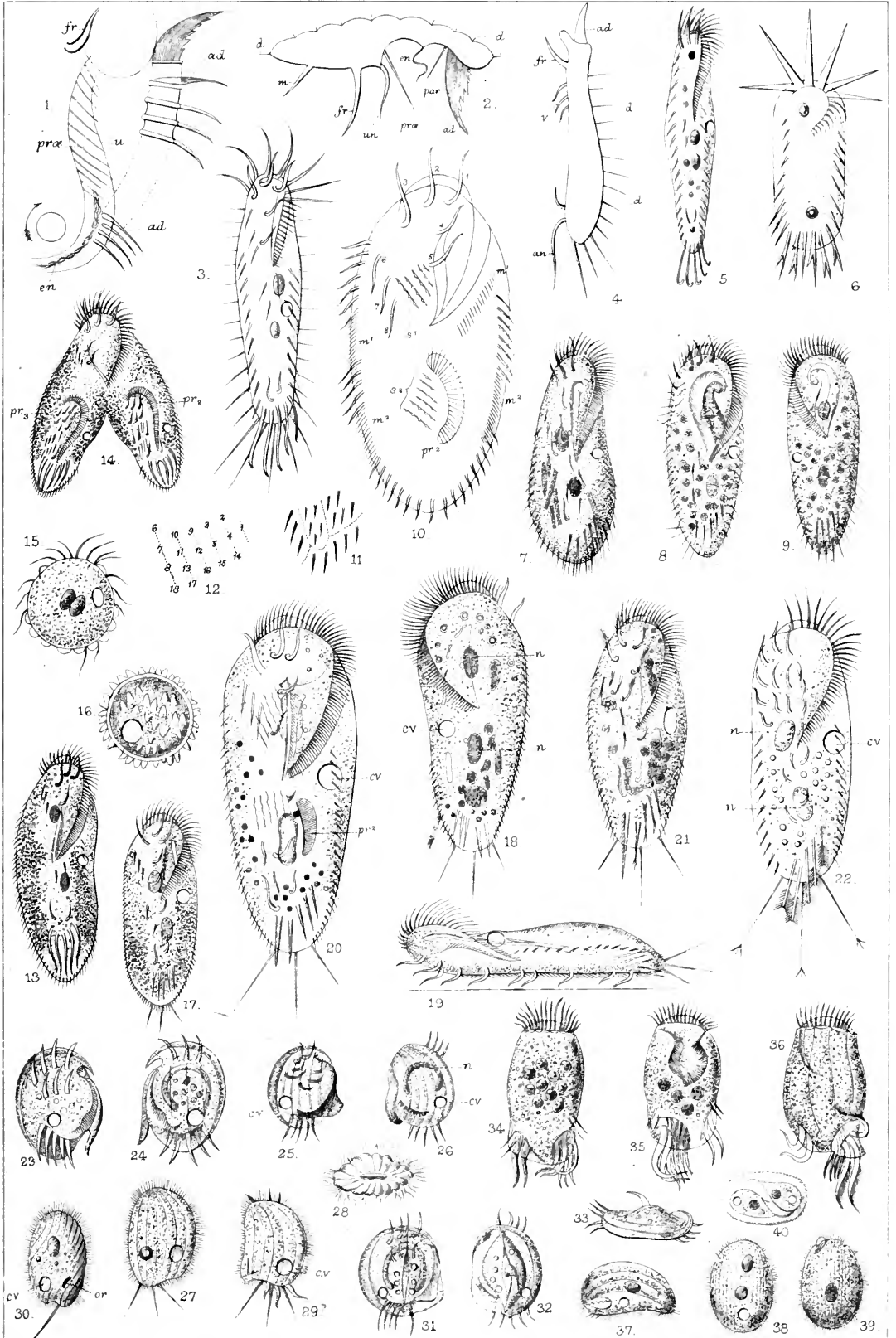




*PLATE XLV.*

EXPLANATION OF PLATE XLV.

- FIG.
1. STYLONYCHIA MYTILUS, Ehr., vol. ii. p. 790.—Diagrammatic plan of oral ciliary system : *ad*, adoral cilia or membranette; *præ*, præoral, and *en*, endoral cilia; *u*, undulating membrane; *fr*, frontal style (Sterki).
  2. GASTROSTYLA, sp. (Sterki).—Diagrammatic optic section showing disposition of the several ciliary systems; *d*, dorsal, and *m*, marginal setæ; *par*, paroral cilium; the other lettering as in the preceding figure.
  - 3-5. OXYTRICHA PELLIONELLA, Müll. sp., vol. ii. p. 786.—3, Ventral aspect, × 400; 4, diagrammatic longitudinal section : *ad*, adoral, *fr*, frontal, *v*, ventral, *an*, anal, and *d*, dorsal cilia or setæ (after Sterki); 5, ventral aspect (after Stein).
  6. ACTINOTRICHA SALTANS, Cohn, vol. ii. p. 790, × 360 (Cohn).
  7. OXYTRICHA FALLAX, Stein, vol. ii. p. 787.—Ventral aspect, × 170 (Stein).
  - 8, 9. OXYTRICHA PLATYSTOMA, Ehr. sp., vol. ii. p. 787.—Ventral and dorsal aspects × 300 (Stein).
  - 10-12. HISTRIO sp. (Sterki).—10, diagrammatic outline of zooid antecedent to sub-division by transverse fission, showing at *s*<sub>1</sub> and *s*<sub>2</sub> the newly-growing ventral ciliary series, at *pr*<sub>2</sub>, the second peristomal fringe, and at *m*<sub>1</sub>, *m*<sub>2</sub>, the new elements of the first and second marginal series; 11 and 12, showing disposition and numerical order of development of the newly developing frontal, ventral, and anal series (after Sterki).
  - 13, 14. HISTRIO STEINII, Müll. sp., vol. ii. p. 789.—13, Ventral aspect, × 200; 14, example dividing by transverse fission, with at *pr*<sub>2</sub> and *pr*<sub>3</sub> newly developing secondary and tertiary peristomal ciliary systems (Stein).
  - 15-17. STYLONYCHIA PUSTULATA, Ehr., vol. ii. p. 791.—17, Ventral aspect, × 150; 15, zooid disintegrating by diffluence; 16, encysted animalcule (Stein).
  - 18-21. STYLONYCHIA MYTILUS, Ehr., vol. ii. p. 790.—18 and 19, ventral and lateral aspects, × 150; 20, zooid preparing to divide by transverse fission, the rudimentary second peristomal fringe *pr*<sub>2</sub> being already developed; 21, variety having the frontal, ventral, and anal styles and setæ distinctly fimbriated (Stein).
  22. STYLONYCHIA FISSISETA, C. & L., vol. ii. p. 791.—Ventral aspect, × 300 (Claparède & Lachmann).
  - 23, 24. ASPIDISCA LYNCASTER, Stein, vol. ii. p. 793.—23, Ventral and, 24, dorsal aspects, × 250 (Stein).
  - 25-29. ASPIDISCA COSTATA, Duj. sp., vol. ii. p. 794.—25 and 26, ventral and dorsal aspects, × 300 (Stein); 27-29, developmental phases as observed by the author and described at p. 794.
  30. GLAUCOMA MARGARITACEUM, Ehr. sp., vol. ii. p. 796, × 150 (Clap. & Lach.)
  - 31-33. ASPIDISCA TURRITA, C. & L., vol. ii. p. 793.—Ventral, dorsal, and lateral aspects, × 209 (Stein).
  - 34-36. URONYCHIA TRANSFUGA, Müll. sp., vol. ii. p. 797.—34 and 35, Dorsal and ventral aspects; 36, example with fimbriated anal uncini, × 250 (Stein).
  37. MICROTHORAX SULCATUS, Eng., vol. ii. p. 796, × 220 (Engelmann).
  - 38-40. GLAUCOMA SCINTILLANS, Ehr., vol. ii. p. 795.—38 and 39, Ventral aspect, with at 39, vibratile membrane extended, × 150; 40, encysted zooid dividing by oblique fission (Stein).





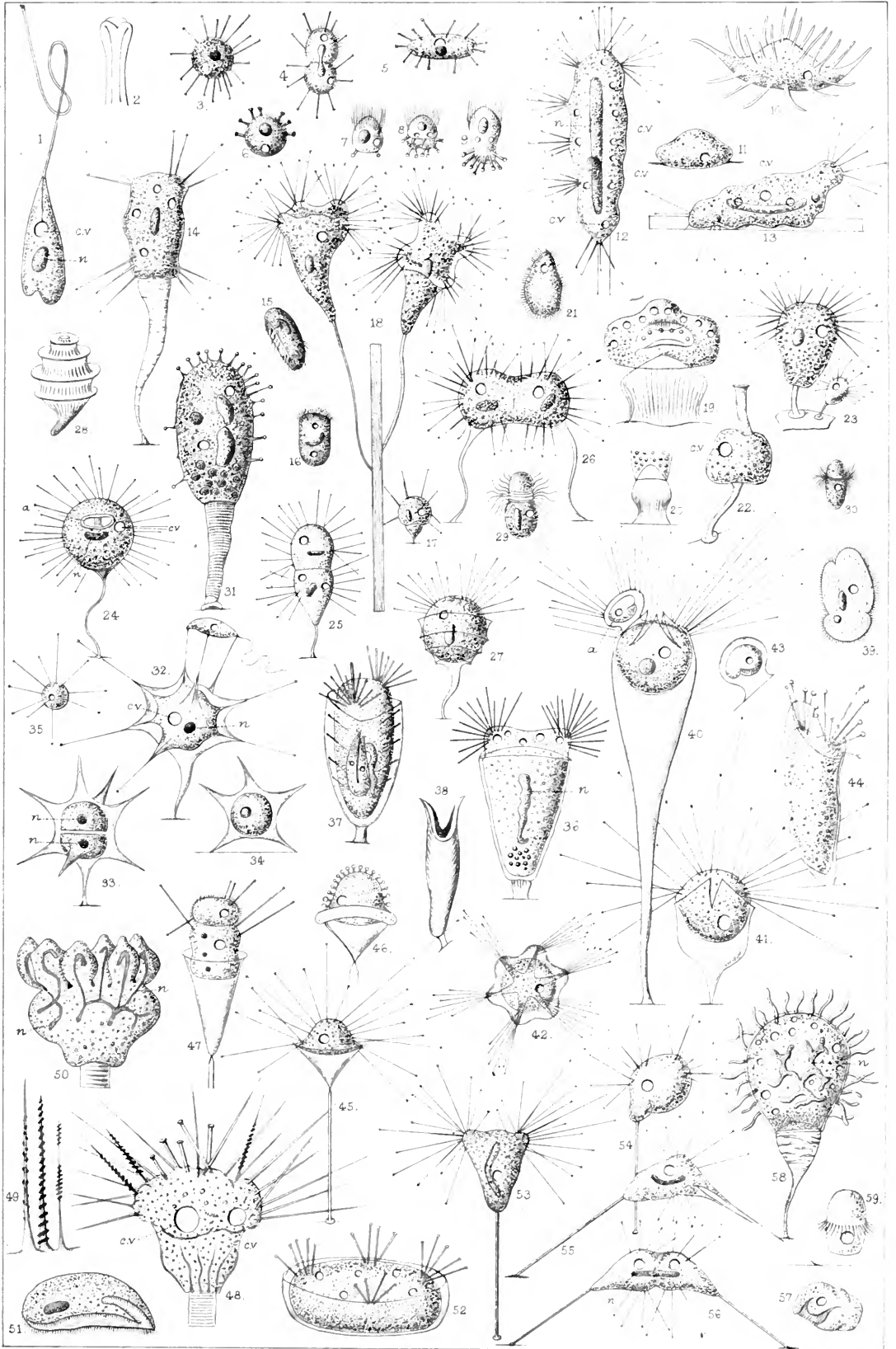
## PLATE XLVI.

### EXPLANATION.

- FIG.
- 1, 2. RHYNCHETA CYCLOPUM, Zenker, vol. ii. p. 806.—1, Adult animalcule,  $\times 150$  ; 2, extremity of single tubular sucker,  $\times 600$  (Zenker).
  - 3-5. SPHÆROPHRYA UROSTYLÆ, Maupas, vol. ii. p. 809.—3, Normal adult zooid ; 4, example dividing by transverse fission, the anterior moiety with temporarily developed cilia ; 5, a zooid elongated and with cilia developed preparatory to subdivision,  $\times 200$  (Stein).
  6. SPHÆROPHRYA PUSILLA, C. & L., vol. ii. p. 808,  $\times 150$  (Claparède & Lachmann).
  - 7-9. SPHÆROPHRYA STENTOREA, Maupas, vol. ii. p. 808,  $\times 200$  (Stein).
  - 10, 11. TRICHOPHRYA DIGITATA, Stein sp., vol. ii. p. 812.—10, Adult animalcule,  $\times 300$  ; 11, non-tentaculate germ (Stein).
  - 12, 13. TRICHOPHRYA EPISTYLIDIS, C. & L., vol. ii. p. 811.—12, Dorsal ; 13, lateral aspects,  $\times 150$  (Clap. & Lach.).
  - 14-17. PODOPHRYA ASTACI, C. & L., vol. ii. p. 819.—14, Adult animalcule,  $\times 200$  ; 15 and 16, ciliated embryos ; 17, earliest phase of fixed condition (Stein).
  18. PODOPHRYA QUADRIpartita, C. & L., vol. ii. p. 820.—Two examples attached to stalk of *Epistylis plicatilis*,  $\times 150$  (Stein).
  - 19-22. PODOPHRYA FERRUM-EQUINUM, Ehr. sp., vol. ii. p. 813.—19 and 20, Front and profile views showing compressed form of body and proportionate size of pedicle,  $\times 100$  (after Clap. & Lach.) ; 21, ciliated embryo ; 22, earliest fixed condition possessing only a single tentacle as represented by Zenker.
  23. PODOPHRYA CYCLOPUM, C. & L., vol. ii. p. 818,  $\times 150$ .
  - 24-30. PODOPHRYA FIXA, Müll. sp., vol. ii. p. 813.—24, Adult animalcule containing at a ciliated embryo,  $\times 200$  ; 25, an example dividing by transverse fission ; 26, conjugation of two adjacent animalcules ; 27, animalcule forming a membranous encystment (Stein) ; 28, encystment as found within body of *Stylonychia mytilus* (Engelmann) ; 29 and 30, ciliated embryos.
  31. PODOPHRYA WRZESNIOWSKII, S. K., Stein sp., vol. ii. p. 817,  $\times 150$  (Wrzesniowski).
  - 32-35. ACINETA STELLATA, S. K., vol. ii. p. 838.—32, Adult animalcule,  $\times 1000$  ; 33 and 34, encysted examples, the body contents in the first instance divided into two equal halves ; 35, free-swimming Sphærophrya-like embryo.
  - 36-39. ACINETA LINGUIFERA, C. & L., vol. ii. p. 831.—36 and 37, Adult zooids, front and profile views,  $\times 150$  ; 38, empty lorica ; 39, ciliated embryo (Stein).

EXPLANATION OF PLATE XLVI. (*continued*).

- FIG.
- 40-43. ACINETA MYSTACINA, Ehr., vol. ii. p. 834.—40 and 41, Long and short pedicled varieties, the former with, at *a*, a germinal bud  $\times 150$ ; 42, lorica with contained animalcule seen from above; 43, a germinal bud with contained ciliated embryo further enlarged.
44. ACINETA NOTONECTÆ, C. & L., vol. ii. p. 833,  $\times 150$  (Clap. & Lach.).
- 45-47. ACINETA PATULA, C. & L., vol. ii. p. 835.—45 and 46, Animalcules with tentacles extended and contracted,  $\times 100$ ; 47, example with elongate lorica giving birth to a ciliated embryo (Clap. & Lach.).
- 48-51. HEMIOPHRYA GEMMIPARA, Hertwig sp., vol. ii. p. 823.—48, Distal extremity of pedicle bearing animalcule with extended tentacles of two orders, suctorial and prehensile,  $\times 150$ ; 49, prehensile rib tentacles more highly magnified, showing spirally disposed granular external sheath; 50, example with six terminal buds, into each of which is produced a prolongation of the branching endoplast, the tentacles not represented; 51, an hypotrichously ciliated embryo,  $\times 400$  (Hertwig).
52. SOLENOPHRYA CRASSA, C. & L., vol. ii. p. 828,  $\times 150$  (Clap. & Lach.).
- 53-56. PODOPHRYA MOLLIS, S. K., vol. ii. p. 821.—53 and 54, Adult animalcules,  $\times 150$ ; 55 and 56, successive phases of transverse fission of the same zooid, first manifested by the extension and fixture of two ordinary suctorial tentacles to a more remote point, these two ultimately fusing together and joining the pedicle of the newly produced animalcule.
57. ACINETA MYSTACINA, vol. ii. p. 834.—Ciliated embryo,  $\times 300$  (Stein).
- 58, 59. PODOPHRYA STEINII, C. & L., vol. ii. p. 815.—58, Adult zooid,  $\times 150$  (Stein); 59, ciliated embryo,  $\times 300$  (Stein).



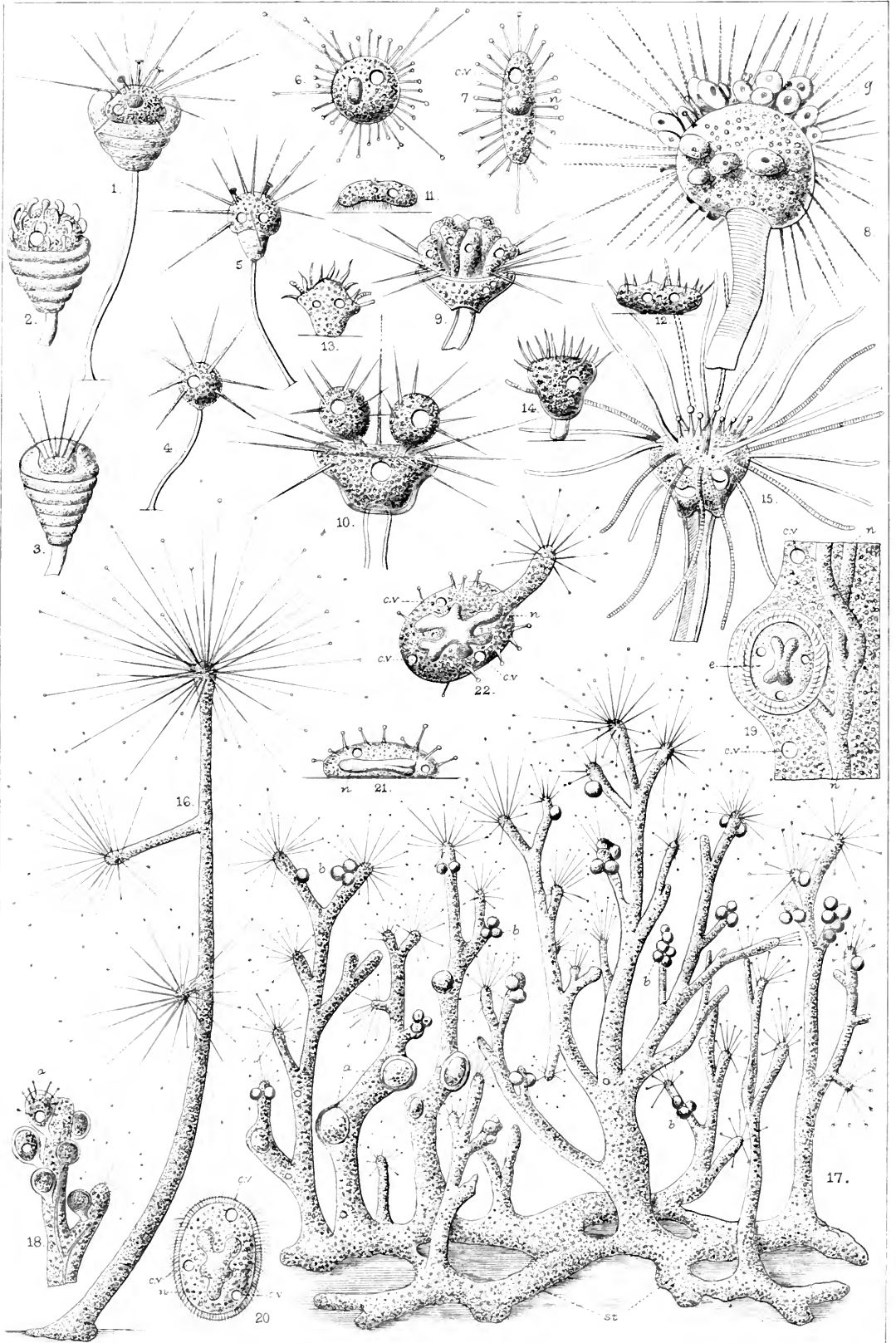




*PLATE XLVII.*

## EXPLANATION OF PLATE XLVII.

- FIG.
- 1-5. *PODOCYATHUS DIADEMA*, S. K., vol. ii. p. 827.—1, Adult zooid, with tentacles fully extended,  $\times 300$ ; 2, zooid with tentacles retracted; 3, zooid of abnormally minute size as compared with that of the lorica, being probably the relict of a recent fissive process; 4 and 5, successive developmental forms.
- 6, 7. *SPHÆROPHRYA SOL*, Mecz., vol. ii. p. 810.—6, Normal zooid,  $\times 250$ ; 7, elongate shape assumed preparatory to division by transverse fission (Mecznikow.).
8. *HEMIOPHRYA CRUSTACEORUM*, Haller sp., vol. ii. p. 826.—Zooid with numerous ovate gemmules and distal end of pedicle,  $\times 300$  (Haller).
- 9-14. *HEMIOPHRYA GEMMIPARA*, Htwg. sp., vol. ii. p. 823.—9 and 10, Distal end of pedicle, with zooid at 9 bearing as many as eight elongate ciliated gemmules, and at 10 with two subsphæroidal tentaculiferous embryos,  $\times 200$ ; 11-14, phases of development from a free-swimming hypotrichously ciliated embryo towards the parent form (Robin).
15. *HEMIOPHRYA BENEDENI*, Fraip. sp., vol. ii. p. 824.—Zooid with extended tentacles and distal region of pedicle,  $\times 200$  (Fraipont).
- 16-22. *DENDROSOMA RADIANS*, Ehr., vol. ii. p. 841.—16, Erect, slender zoocaulon of young colony-stock, having but three tentaculiferous ramuscules, as delineated by Mr. Thomas Bolton,  $\times 150$ ; 17, luxuriantly developed colony-stock as supplied to the author by Mr. Bolton, the decumbent stolon, *st*, giving origin to numerous erect, variously branching zoocaula, some of these, as at *a*, enclosing internally developed ciliated embryos, and others, as at *b b*, with more minute externally developed reproductive capsules,  $\times 50$ ; 18, distal region of zoocaula with exogenous germs, that at *a* having short capitate tentacles,  $\times 150$ ; 19, portion of zoocaulon with enclosed ciliated embryo *e*, and a portion of the cord-like endoplast,  $\times 400$ ; 20, free-swimming ciliated embryo,  $\times 600$ ; 21, earliest adherent condition of embryo, the cilia being absorbed and short capitate tentacles developed in their place; 22, more advanced growth of the same embryo, a single short tentaculiferous prolongation being developed at one extremity,  $\times 600$ .





## PLATE XLVIII.

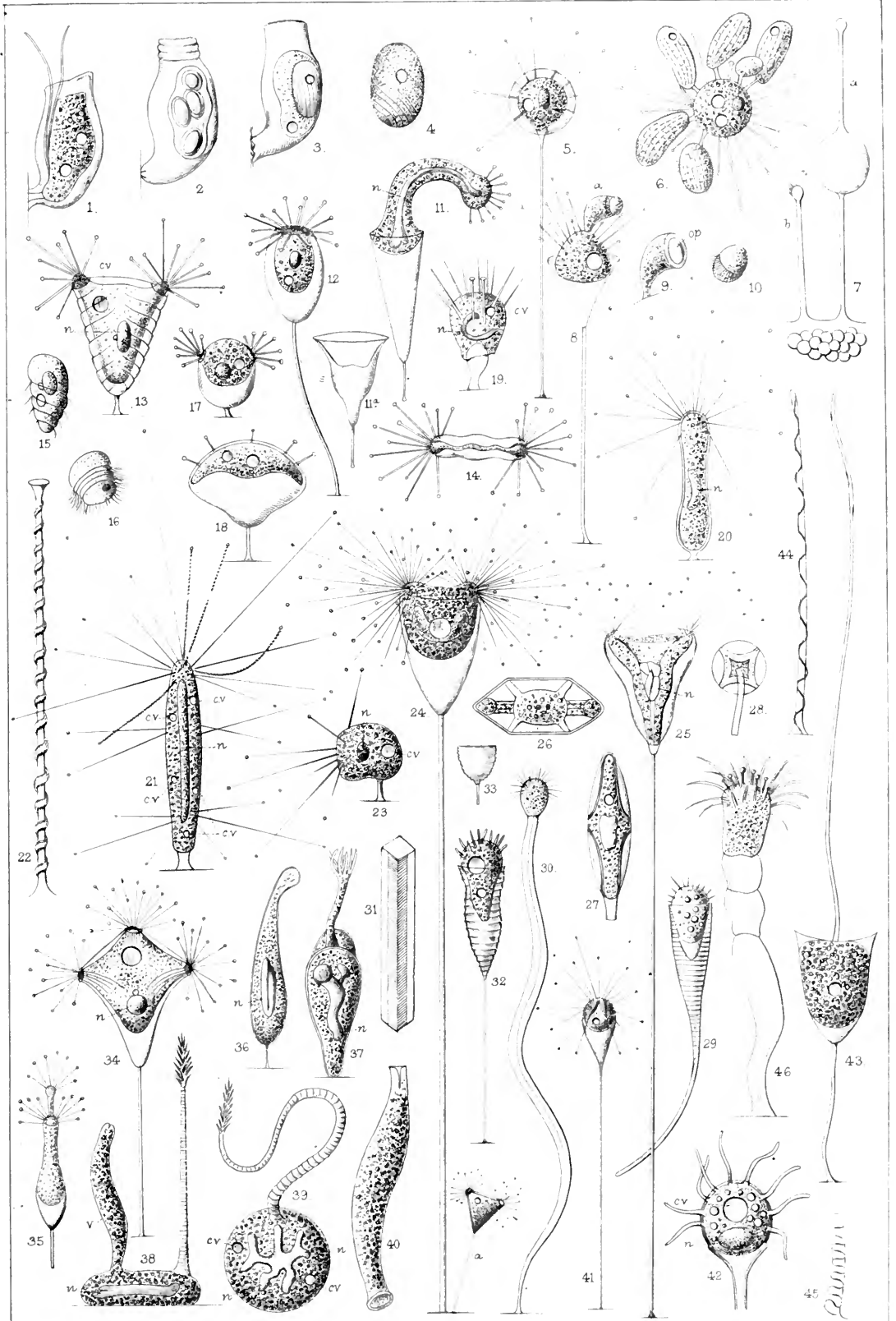
### EXPLANATION.

- FIG.  
1-4. URNULA EPISTYLIDIS, C. & L., vol. ii. p. 807.—1, Normal zooid with extended tentacula,  $\times 200$ ; 2, zooid in a resting or encysted state, its body-substance having subdivided into four germinal fragments; 3, example with contained ciliated embryo; 4, isolated ciliated embryo,  $\times 300$  (Clap. & Lach.).
5. PODOPHRYA LIMBATA, Maupas, vol. ii. p. 816.—Typical zooid with peripheral gelatinous film,  $\times 200$  (Maupas).
- 6, 7. SPHÆROPHRYA MAGNA, Maupas, vol. ii. p. 808.—6, Zooid having seized and in the act of devouring by suction half a dozen examples of *Colpoda parvifrons*,  $\times 300$ ; 7, two tentacles, that at *a* with a central hyaline vacuosity, and that at *b* having the substance of its terminal sucker lacerated through the temporary adhesion and subsequent escape of a ciliated infusorium,  $\times 1280$  (Maupas).
- 8-11*a*. ACINETA DIVISA, Fraipont, vol. ii. p. 836.—8, Normal zooid with, at *a*, a single anteriorly developed, pyriform germ-capsule, from which a ciliated embryo is in the act of emerging,  $\times 300$ ; 9, germ-capsule with, at *op*, operculum-like differentiation through which the embryo ultimately emerges; 10, ciliated embryo,  $\times 600$ ; 11, abnormally elongated zooid with central band-like endoplast; 11*a*, empty lorica with, at *s*, platform-like horizontal septum upon which the body of the animalcule ordinarily reposes (Fraipont).
12. ACINETA LIVADIANA, Meresch., vol. ii. p. 828.—Adult zooid,  $\times 250$ , as observed by the author.
- 13-17. ACINETA FŒTIDA, Maupas, vol. ii. p. 832.—13, Normal adult animalcule,  $\times 580$ ; 14, lorica with tentacular fascicles as seen from above; 15 and 16, ciliated embryos; 17, young zooid with imperfectly developed lorica (Maupas).
18. ACINETA EMACIATA, Maupas, vol. ii. p. 837,  $\times 300$  (Maupas).
19. HEMIOPHRYA THOULETI, Maupas, vol. ii. p. 826,  $\times 200$  (Maupas).
20. PODOPHRYA CYLINDRICA, Perty, vol. ii. p. 814,  $\times 250$  (Mereschkowsky).
- 21, 22. PODOPHRYA ELONGATA, C. & L., vol. ii. p. 820.—21, Normal zooid, with at *aaa* tentacles partially retracted and exhibiting a spirally convolute aspect;  $\times 150$ ; 22, one such tentacle as observed by the author,  $\times 800$ , showing that the spiral aspect is due to the presence of a superficial spirally developed granular crest or film.
23. PODOPHRYA CARCHESI, C. & L., vol. ii. p. 818,  $\times 200$ .

EXPLANATION OF PLATE XLVIII. (*continued*).

FIG.

24. ACINETA GRANDIS, S. K., vol. ii. p. 831.—Adult zooid,  $\times 100$ ; affixed near the base of this species, see letter *a*, is delineated an ordinary example of *Acineta lemnarum* found associated with it, under a similar magnification, for the purpose of indicating the relative proportions of these two forms.
- 25–28. ACINETA TUBEROSA, Ehr., vol. ii. p. 829.—25, Long-stalked variety,  $\times 400$ ; 26, example as seen in horizontal optical section showing the four points of attachment of the body to the lorica and the bases of the tentacular fascicles; 27, a similar body as seen in vertical section; 28, horizontal optical section immediately above the junction of the pedicle with the lorica (Fraipont).
29. ACINETA SAIFULÆ, Meresch., vol. ii. p. 836.—Spirit-preserved example,  $\times 200$  (Mereschkowsky).
- 30, 31. HEMIOPHRYA BENEDENI, Fraipont, vol. ii. p. 824.—30, Zooid,  $\times 70$ ; 31, portion of pedicle,  $\times 300$ , showing quadrangular contour and transversely striated central core.
- 32, 33. ACINETA CRENATA, Fraipont, vol. ii. p. 837.—Zooid with elongate lorica,  $\times 600$ ; 33, shorter lorica, with distal region only of the pedicle (Fraipont).
- 34, 35. ACINETA JOLYI, Maupas, vol. ii. p. 835.—34, Front and, 35, lateral view,  $\times 200$  (Maupas).
- 36, 37. OPHRYODENDRON BELGICUM, Fraipont, vol. ii. p. 853.—36, Vermiform and, 37, proboscidiform zooids,  $\times 400$  (Fraipont).
- 38–40. OPHRYODENDRON SERTULARIÆ, Str. Wright sp., vol. ii. p. 851.—38, Ordinary proboscidiform zooid in lateral view, bearing at *v* a single vermiform germ,  $\times 200$ ; 39, proboscidiform zooid from above, showing, after treatment by the author with osmic acid, orbicular contour of body and enclosed branching endoplast; 40, detached vermiform zooid more highly magnified, showing acetabular character of the basal region.
42. ACINETA VORTICELLOIDES, Fraipont, vol. ii. p. 837.—Distal region showing rudimentary development of the lorica,  $\times 300$  (Fraipont).
- 43–45. ACINETOPSIS RARA, Robin, vol. ii. p. 855.—43, zooid with extended tentacle,  $\times 200$ ; 44 and 45, tentacle in various states of contraction more highly magnified and showing externally developed spiral fibrilla (Robin).
46. HEMIOPHRYA TRUNCATA, Fraip., vol. ii. p. 825.—Adult zooid,  $\times 250$  (Fraipont).



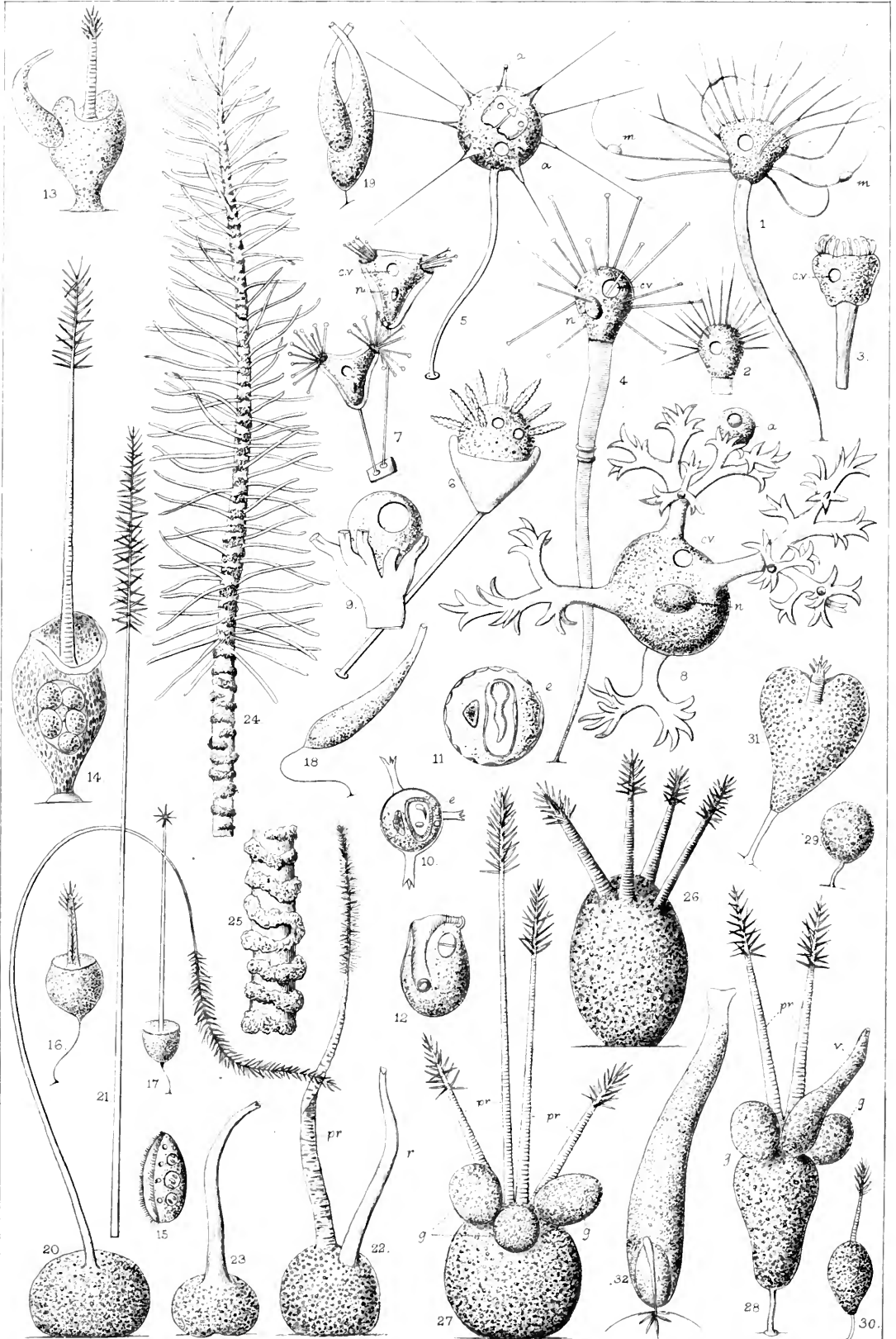




*PLATE XLVIII.*

EXPLANATION OF PLATE XLVIII A.

- FIG.  
 1-3. EPHELOTA CORONATA, Str. Wright, vol. ii. p. 846.—1, 2, Animalcules with tentacles extended, at *m m* captured monads,  $\times 200$ ; 3, tentacles retracted.  
 4. PODOPHYRYA CONIPES, Meresch., vol. ii. p. 815,  $\times 250$  (Mereschkowsky).  
 5. EPHELOTA TROLD, C. & L., vol. ii. p. 847,  $\times 175$  (Claparède & Lachmann).  
 6. ACTINOCYATHUS CIDARIS, S. K., vol. ii. p. 848,  $\times 300$ .  
 7. ACINETA TUBEROSA, Ehr., vol. ii. p. 829.—Two zooids with tentacles in a fully extended and partially retracted state,  $\times 200$ .  
 8-12. DENDROCOMETES PARADOXUS, Stein, vol. ii. p. 839.—8, Adult animalcule,  $\times 400$ , one of the branched tentacles at *a* grasping a captured monad; 9, the same tentacle,  $\times 1200$ , and showing the tubular perforations of the distal terminations; 10, a young recently attached animalcule; 11, animalcule enclosing a ciliated embryo; 12, a detached ciliated embryo (Wrzesniowski).  
 13-15. OPHRYODENDRON ABIETINUM, C. & L., vol. ii. p. 850.—13, Probosciform zooid with proboscis retracted and with vermiform zooid attached to one side,  $\times 100$ ; 14, probosciform zooid with proboscis extended; 15, ciliated embryo,  $\times 200$  (Clap. & Lach.).  
 16-19. OPHRYODENDRON PEDICELLATUM, Hincks, vol. ii. p. 852.—16 and 17, Probosciform zooids with proboscis extended and retracted; 18 and 19, two vermiform zooids, the one in the latter instance having a second example sessilely attached to its body, dimensions unrecorded.  
 20-25. OPHRYODENDRON PORCELLANUM, S. K., vol. ii. p. 852.—20, Zooid with probosciform appendage extended and recurved,  $\times 200$ ; 21, the same appendage more completely extended in a rectilinear direction; 22, a zooid bearing both a probosciform and vermiform appendages; 23, an example having only a vermiform appendage; 24, distal extremity of proboscis highly magnified,  $\times 800$ ; 25, distal region of shaft of the proboscis,  $\times 1200$ , showing its transverse corrugation.  
 26-31. OPHRYODENDRON MULTICAPITATUM, S. K., vol. ii. p. 854.—26, Sessile zooid bearing four probosciform organs,  $\times 300$ ; 27, sessile example with four probosciform organs *pr*, and three ovate gemmules *s*; 28, stalked example with two probosciform organs, two gemmules, and one vermiform appendage; 29-31, young pedicellate zooids; 30 and 31, bearing each a single probosciform organ only, this structure in the latter instance being retracted; 29, representing a still younger zooid entirely destitute of appendages, and, except for the presence of a pedicle, corresponding with the gemmular bodies represented in figures 27 and 28.  
 32. OPHRYODENDRON ABIETINUM, C. & L., vol. ii. p. 850.—Vermiform larva with basal chitinous rod,  $\times 400$  (after Robin).

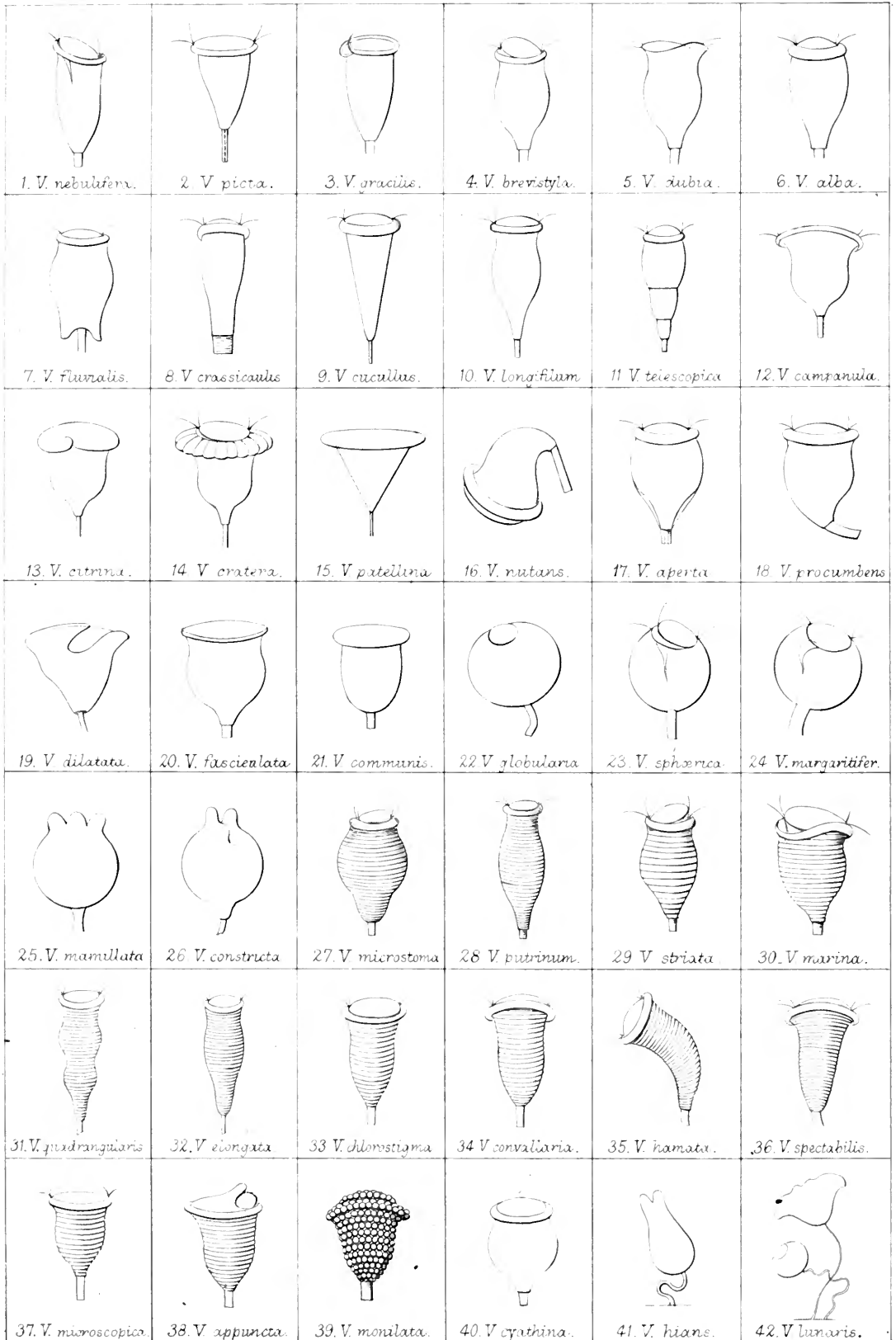




*PLATE XLIX.*

#### EXPLANATION OF PLATE XLIX.

Constituting a key to the numerous species of the genus *Vorticella*, each specific form being represented in diagrammatic outline at its most typical condition of extension and in accordance with the scheme suggested in vol. ii. p. 672. To facilitate identification the specific name is appended to each type.







## PLATE L.

Illustrating the more important modifications of the nucleus or endoplast and nucleolus or endoplastule as developed among the Infusoria.

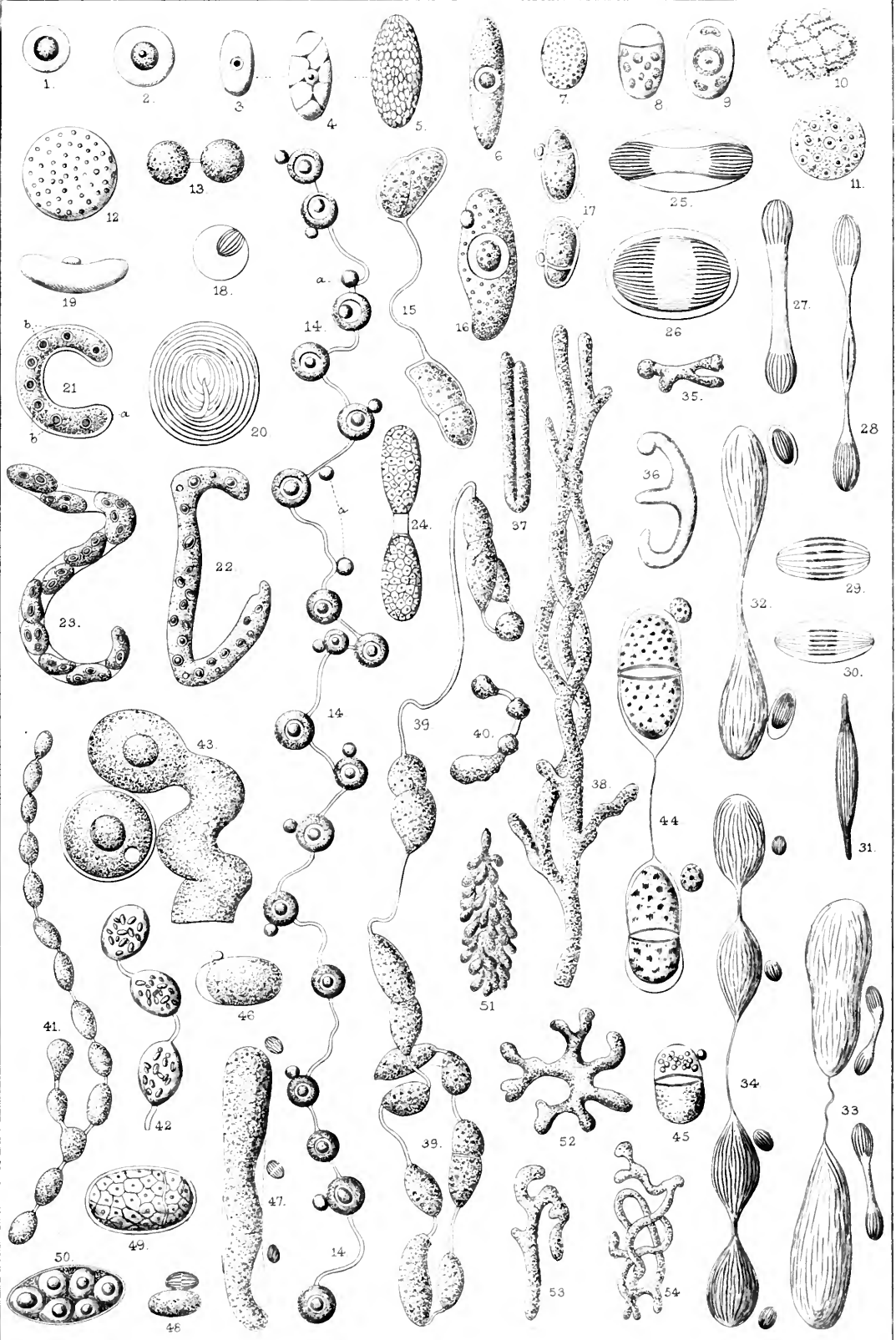
### EXPLANATION.

FIG.

1. Simple spheroidal nucleus or endoplast, with enclosed nucleolus or endoplastule, of a collared monad, *Codosiga*, the same type being distinctive of the majority of the Flagellata.
2. A single germinal fragment or spore, with contained endoplast and endoplastule, of *Dictyocysta cassis*,  $\times 1000$  (Haeckel).
- 3-5. Modifications of the endoplast of *Euglena viridis*.—3, representing the normal form; 4 and 5, progressive phases resulting in the subdivision of its entire mass into sporular elements  $\times 600$  (Stein).
6. Fusiform endoplast, with centrally enclosed endoplastule, of *Chilodon cucullulus*,  $\times 480$  (Wrzesniowski).
- 7-9. Various modifications of the endoplast of *Leptodiscus medusoides* (Hertwig).
10. Ovate endoplast having a reticulate granular consistence, with laterally attached endoplastule, of *Acineta fetida*,  $\times 1280$  (Maupas).
11. Subspheroidal endoplast, with numerous enclosed endoplastules, of *Acineta Jolyi*,  $\times 900$  (Maupas).
12. Spheroidal granular endoplast of Rhizopod *Pelomyxa villosa*,  $\times 1000$  (Leidy).
13. Twin endoplasts, with connecting cord or funiculus, of *Litonotus fasciola*,  $\times 480$  (Wrzesniowski).
14. Endoplastic system of *Loxodes rostrum*, consisting of numerous spheroidal endoplasts with both enclosed and externally developed endoplastules connected together by a thread-like funiculus. In some instances, *a a*, the external endoplastules are attached to the funiculus,  $\times 600$ , and treated with acetic acid and iodine (Wrzesniowski).
15. Twin endoplasts with connecting funiculus of *Litonotus diaphanus* after treatment with acetic acid and iodine,  $\times 600$  (Wrzesniowski).
16. Endoplast of *Chilodon cucullulus* with both an internally developed and laterally attached endoplastule,  $\times 400$  (Wrzesniowski).
17. Twin endoplasts, with laterally attached endoplastules, of *Stichotricha aculeata*,  $\times 600$ , + acetic acid (Wrzesniowski).
18. Endoplastule of *Pleuronema chrysalis* after treatment with acetic acid (Bütschli).
- 19, 20. Modifications of the endoplast of *Nyctotherus cordiformis*.—19, normal form, with laterally attached endoplastule; 20, endoplast become greatly enlarged and metamorphosed into an elaborately convoluted coil (Stein).
21. Band-like endoplast with *a*, investing membrane and *b, b*, contained endoplastules of *Vorticella microstoma*,  $\times 450$  (Stein).
- 22, 23. Band-like endoplasts of *Carchesium polybinum*, subsequent to conjugation; at 22, earlier phase with numerous enclosed endoplastules; at 23, more advanced stage in which the internal substance has become separated into as many as ten germinal masses which are held together only by the delicate bounding membrane of the originally continuous and homogeneous endoplast,  $\times 1000$  (Greef).

EXPLANATION OF PLATE L. (continued).

- FIG.
24. Conjoint endoplasts of *Amphileptus anas* after treatment with acetic acid, their substance being thus shown to be divided up into numerous polygonal fragments, each with a minute central refringent corpuscle,  $\times 600$  (Bütschli).
  - 25-28. Endoplastules or nucleoli of *Paramæcium putrinum*; 25 and 26, normal forms,  $\times 2000 +$  acetic acid; 27 and 28, successive phases during the process of subdivision or fission (Bütschli).
  - 29-31. Endoplastules of *Carchesium polypinum*; 29, living condition; and 30, after treatment with acetic acid,  $\times 1500$ ; 31, example elongated preparatory to subdivision (Bütschli).
  32. Endoplast of *Paramæcium bursaria*, during process of subdivision, the normal, single, laterally attached endoplastule having already separated into two,  $\times 800$  (Bütschli).
  33. Twin endoplasts of *Stylonychia mytilus*; aspect exhibited at the commencement of the fission process, the endoplastules in the vicinity of each endoplast also commencing to subdivide,  $\times 600$  (Bütschli).
  34. Twin endoplasts of *Stylonychia mytilus* in a more advanced stage of subdivision, the endoplasts having already separated into four, both these and the endoplasts presenting a striated aspect,  $\times 500$  (Bütschli).
  - 35-37. Various branched endoplast of *Ophryodendron belgicum*; 35 and 36 derived from proboscidiform, and 37 from a vermiform zooid,  $\times 800$  (Fraipont).
  38. Ramifying endoplast from an erect main trunk of *Dendrosoma radians*, as observed by the author,  $\times 800$ .
  39. Endoplastic system of *Loxophyllum meleagris*, consisting of numerous irregularly ovate nodular endoplasts, united to each other by a delicate thread-like funiculus,  $\times 600$ , + acetic acid, iodine, and picrocarmine (Bütschli).
  40. Irregular nodular endoplast of *Hemiophrya Thouletii*,  $\times 500$  (Fraipont).
  - 41, 42. Moniliform endoplast of *Stentor polymorphus*; 41, the entire structure,  $\times 200$ ; 42, a fragment more highly magnified showing internal refringent corpuscles and connecting funiculus (Stein).
  43. Anterior region of undulating band-like endoplast of *Stentor Ræselii*, from the extremity of which one germ-sphere or embryo, with a central endoplastule (the future endoplast) and incipient contractile vesicle, has become already constricted off, a second similar germ-sphere being in an advanced state of development,  $\times 500$  (Claparède and Lachmann).
  44. Twin endoplasts of *Stylonychia mytilus*, normal aspect, showing a distinct investing membrane, connecting funiculus, and laterally attached endoplastules,  $\times 600$  (Bütschli).
  - 45, 46. Single endoplastic elements, with attached endoplastules, of *Stylonychia mytilus*.—45, Showing distinct differentiation of the anterior and posterior moieties; 46, exhibiting at one extremity the delicate investing membrane,  $\times 400$  (Stein).
  47. More abnormal elongated endoplast of *Stylonychia mytilus* showing distinct bounding membrane and three striated laterally located endoplastules,  $\times 400$  (Stein).
  48. Single endoplast, with striated laterally attached endoplastule, of *Kerona polyporum*,  $\times 300$  (Stein).
  49. Single endoplast of *Oxytricha* sp., whose substance has divided up into numerous polygonal germs,  $\times 600$  (Bütschli).
  50. Single endoplast, with contained germ-spheres, of *Urostyla grandis*,  $\times 600$  (Bütschli).
  51. Compound racemose endoplast of *Plagiotoma lumbrici*,  $\times 400$  (Stein).
  52. Branching endoplast of young zooid of *Dendrosoma radians* as observed by the author,  $\times 800$ , + osmic acid and picrocarmine.
  - 53, 54. Branching, convoluted endoplast of *Acineta mystacina*,  $\times 600$  (Fraipont).





## PLATE LI.

### EXPLANATION.

FIG.

- 1-5. Illustrating the apparatus employed by Messrs. Dallinger and Drysdale during their prolonged investigation of the life-histories of various monads referred to at vol. i. p. 116, originally figured and described in the 'Monthly Microscopical Journal for March 1874.—1, *a a*, glass plate adapted to fit the stage of the microscope; *b*, circular aperture cut in the plate, a thin piece of glass *c, d, e, f* being cemented over it to permit the near approach of the achromatic condenser; *g g g*, brass socket with ring attached which is fixed with marine glue to the projecting arm of the glass plate *a*, and supports a cylindrical reservoir of water, Fig. 4; *h h h h*, outline of position of bibulous paper having central aperture and tongue-like projection which dips down into the reservoir fitted to the socket *g*; 2, bibulous paper cut to fit the glass stage, the portion *b c* leading into the reservoir *g* of Fig. 1; 3, moist chamber consisting of a short piece of glass tubing *a*, having the bottom edge *e* carefully ground, the top having over it a thin elastic film with a minute central perforation *c*, and securely fastened to the sides at the groove *d*; 4, cylindrical glass reservoir fitting into the socket *g* of Fig. 1, and into which the projecting arm of the bibulous paper dips; 5, the entire apparatus in working order, the object glass *g* being racked down through the central perforation of the elastic film *f* of the moist chamber *ch*; *a a* section of glass stage; *b*, aperture in the same; *c*, the glass cemented over the aperture; *d*, covering glass over object examined; *e*, walls of moist chamber.
6. Chamber invented by Professor Tyndall, referred to at vol. i. p. 130, originally figured and described in the 'Transactions of the Royal Society,' 1877, for the perfect isolation and cultivation of organic infusions and equally suited for a similar culture of Infusoria. *c*, central box or chamber, the front being removed showing the windows *w, w*, for the admission of light; *t*, six test-tubes fitting with an air-tight packing into the floor of the chamber; *a, b*, sinuous glass tubing permitting the access of air but not of germs to the chamber; *p*, pipette with stuffed funnel, fitting into a pin-hole perforation in a piece of indiarubber and stuffing-box containing cotton-wool moistened with glycerine, and thus permitting its insertion and withdrawal without the introduction of adventitious germs.

EXPLANATION OF PLATE LI. (*continued*).

FIG.

- 7, 8. Illustrating the arrangement of the microscope and lamp employed by the author for obtaining the most satisfactory illumination and definition of minute flagellate organisms, when working with object-glasses of 1-16th to 1-50th inch nominal focal distance, for which he is chiefly indebted to a most kind and painstaking demonstration by Mr. E. M. Nelson, F.R.M.S. The mirror *m* being turned to one side, the microscope and lamp are so disposed that the central ray of light *ax* from the *narrow edge* of the lamp flame passes through the optical axis of the achromatic condenser *a c*, and is then focussed upon the field of view, by means of the substage rackwork, in such a manner that employing a 1-inch object-glass, a sharply defined image of the lamp-flame, edge on, is projected upon the centre of the field in company with the objects under examination as shown at Fig. 8. If the 1-inch object-glass is now detached, and a 1-16th, 1-25th or 1-50th substituted, and focussed into place, a slight readjustment of the centering of the achromatic condenser being perhaps required, it will be found that the entire field is brilliantly illuminated, and the most minute objects defined with an amount of sharpness rarely obtained under other conditions. In addition to the ordinary graduating diaphragm placed immediately beneath the lenses of the achromatic condenser as at *d*<sup>1</sup> in Fig. 7, the author has derived considerable advantage from the interposition of a second diaphragm at *d*<sup>2</sup>, or the lowest point in the substage arrangement.
- 9, 10. Trichocysts of *Bursaria (Panophrys) leucas* (see vol. i. p. 82), as interpreted by Professor G. J. Allman; Fig. 9, trichocysts, *tr*, *in situ*, disposed in an even vertical layer immediately beneath the cuticle and locomotive cilia *c*,  $\times 1000$ . Fig. 10, the same trichocysts projected irregularly from the entire periphery as hairlike filaments or setæ with recurved distal ends, on the application of acetic acid or forcible compression (after Allman, 'Quarterly Journal of Microscopical Science,' vol. iii., 1855).

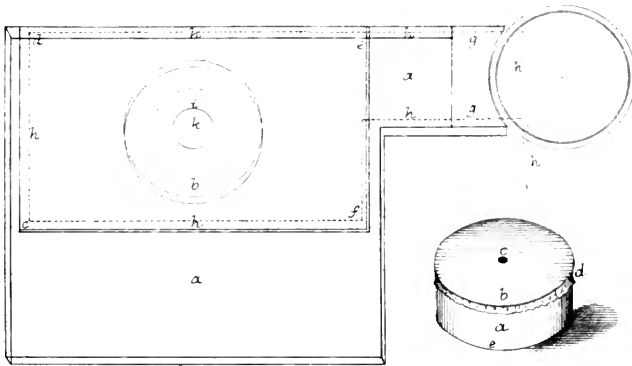


Fig. 1.

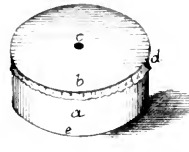


Fig. 3.

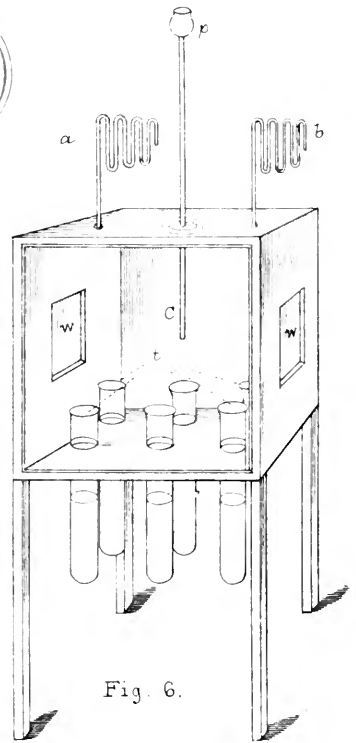


Fig. 6.

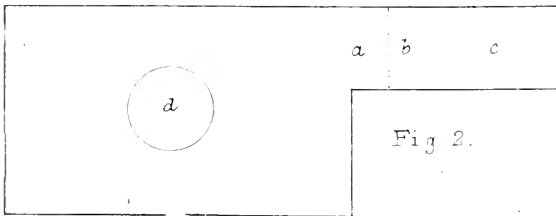


Fig. 2.

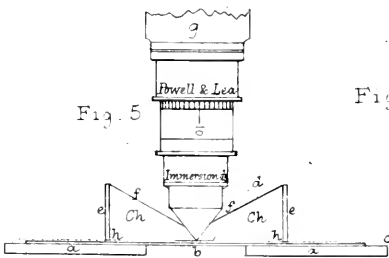


Fig. 5.



Fig. 4.

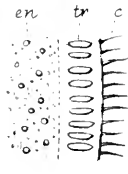


Fig. 9.

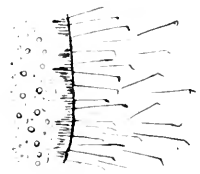


Fig. 10.

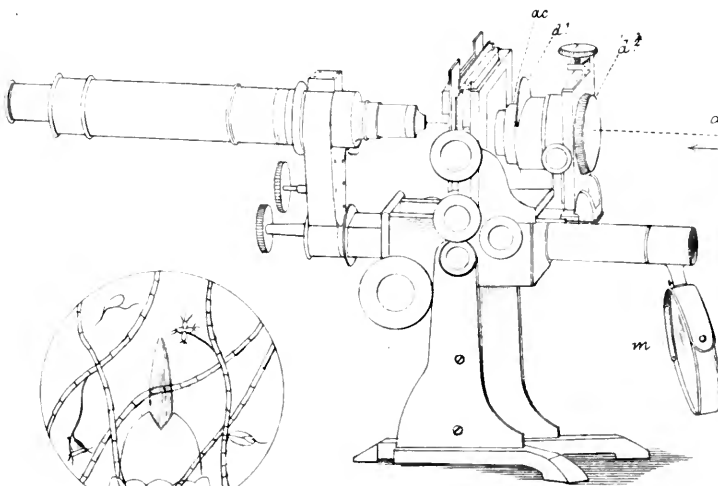


Fig. 8.

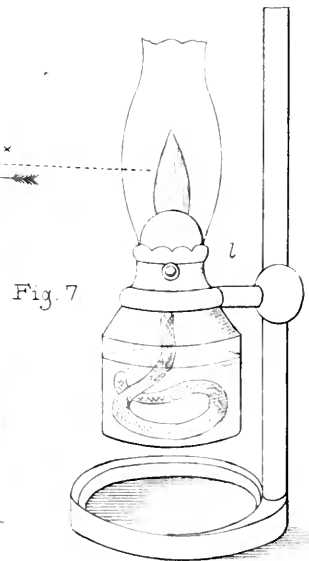


Fig. 7.

EXPLANATION OF PLATE LI. (*continued*).

FIG.

- 7, 8. Illustrating the arrangement of the microscope and lamp employed by the author for obtaining the most satisfactory illumination and definition of minute flagellate organisms, when working with object-glasses of 1-16th to 1-50th inch nominal focal distance, for which he is chiefly indebted to a most kind and painstaking demonstration by Mr. E. M. Nelson, F.R.M.S. The mirror *m* being turned to one side, the microscope and lamp are so disposed that the central ray of light *ax* from the *narrow edge* of the lamp flame passes through the optical axis of the achromatic condenser *ac*, and is then focussed upon the field of view, by means of the substage rackwork, in such a manner that employing a 1-inch object-glass, a sharply defined image of the lamp-flame, edge on, is projected upon the centre of the field in company with the objects under examination as shown at Fig. 8. If the 1-inch object-glass is now detached, and a 1-16th, 1-25th or 1-50th substituted, and focussed into place, a slight readjustment of the centering of the achromatic condenser being perhaps required, it will be found that the entire field is brilliantly illuminated, and the most minute objects defined with an amount of sharpness rarely obtained under other conditions. In addition to the ordinary graduating diaphragm placed immediately beneath the lenses of the achromatic condenser as at *d*<sup>1</sup> in Fig. 7, the author has derived considerable advantage from the interposition of a second diaphragm at *d*<sup>2</sup>, or the lowest point in the substage arrangement.
- 9, 10. Trichocysts of *Bursaria* (*Panophrys*) *leucas* (see vol. i. p. 82), as interpreted by Professor G. J. Allman; Fig. 9, trichocysts, *tr*, *in situ*, disposed in an even vertical layer immediately beneath the cuticle and locomotive cilia *c*,  $\times 1000$ . Fig. 10, the same trichocysts projected irregularly from the entire periphery as hairlike filaments or setæ with recurved distal ends, on the application of acetic acid or forcible compression (after Allman, 'Quarterly Journal of Microscopical Science,' vol. iii., 1855).



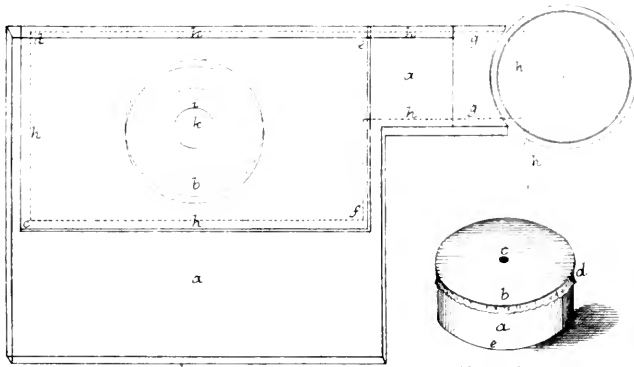


Fig. 1.

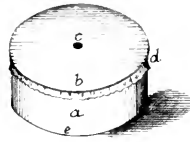


Fig. 3.

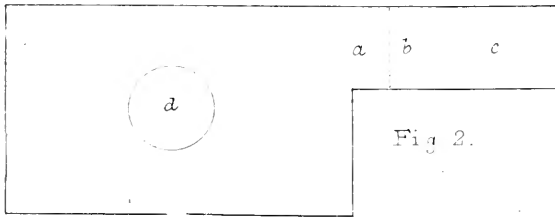


Fig. 2.

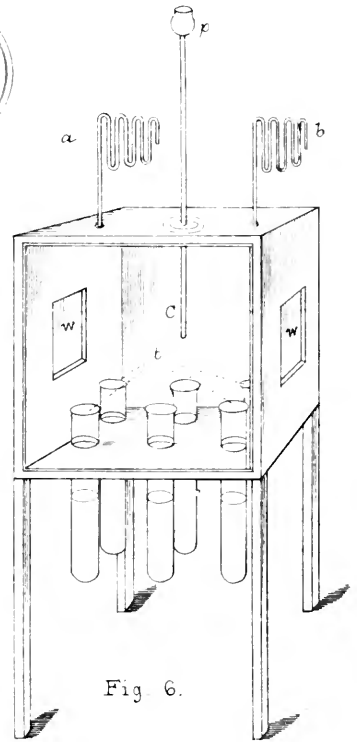


Fig. 6.

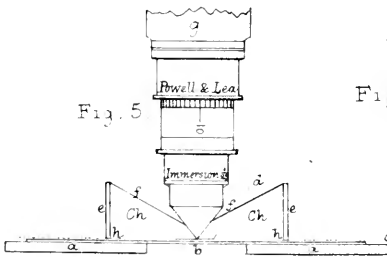


Fig. 5.

Fig. 4.

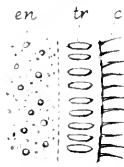


Fig. 9.

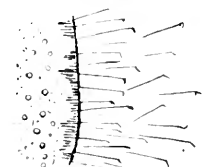


Fig. 10.

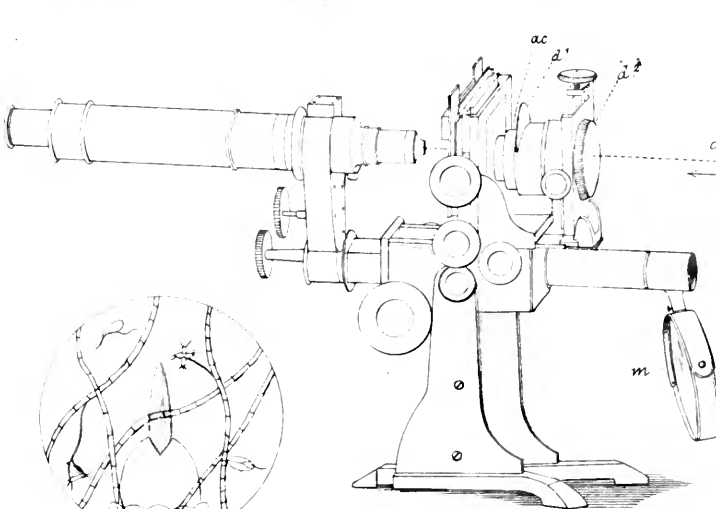


Fig. 8.

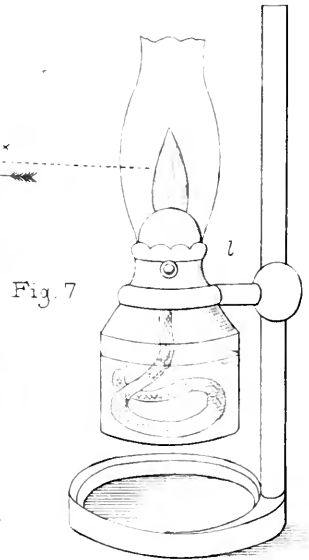


Fig. 7.







