

TELEPHONE LONG DISTANCE BLACK 1311

THIRD EDITION

OF THE

MANUAL

OF

Modern Surveying Instruments

AND THEIR USES,

CONTAINING USEFUL INFORMATION FOR THE
CIVIL ENGINEER AND SURVEYOR.

TOGETHER WITH A

CATALOGUE AND PRICE LIST

OF

SCIENTIFIC INSTRUMENTS,

PARTICULARLY THOSE OF THE CIVIL ENGINEER AND SURVEYOR.

MADE BY

THE A. LIETZ COMPANY,

422 SACRAMENTO STREET,

SAN FRANCISCO, CALIFORNIA.

1899.

PRICE, 50 CENTS.

PUBLISHED BY THE COMPANY.

ALL RIGHTS RES.

INFRINGEMENTS WILL BE PROSECUTED.

ESTABLISHED 1882.

\$8 27 926



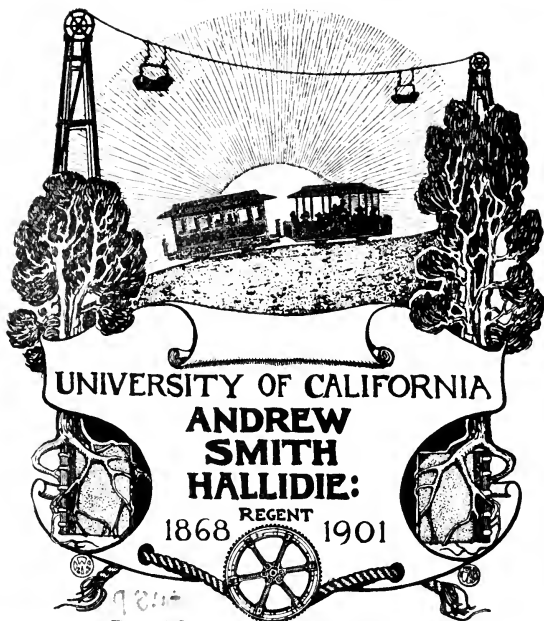

THIS MANUAL was written expressly for this Company,
and the matter therein contained is protected by a
copyright. Parties infringing will be prosecuted.

TESTIMONIALS.

U. S. COAST AND GEODETIC SURVEY,
Sub Office, June 2, 1888.

A. LIETZ Co., San Francisco, Cal.:

Gentlemen—I have your note of 1st June, asking me to express an opinion of your character as Mathematical Instrument makers.

For the six years since you succeeded to the business of Carl Rahsskopff, I have been so well satisfied with the character of your workmanship upon the various kinds of instruments which I have intrusted to your care that I have seen no reason whatever to make any change.

In the matter of new instruments and novel devices you have fully comprehended the wants of the observer and have intelligently supplied them.

Very respectfully,

GEORGE DAVIDSON.

SAN FRANCISCO, May 14, 1888.

A. LIETZ Co., San Francisco:

Gentlemen—My acquaintance with your establishment for the manufacture of Nautical and Field Instruments, and the knowledge I have of your excellent appliances for such work, prompts me to a statement thereof, especially as you have furnished me with a substantial proof of your workmanship in the Transit purchased of you some months ago. This instrument has since been constantly used in important surveys in an extremely rough mountainous country, and I am informed by my son, who has been operating with it, that it is in every respect exceedingly accurate in all operations for which a Transit is designed. I am glad to express my satisfaction of its results and consider it a high recommendation of your ability to make superior instruments.

Respectfully yours,

CALVIN BROWN, C. E.

BERKELEY, CAL., May 24, 1888.

A. LIETZ Co., San Francisco, Cal.:

Gentlemen—Having your Transit in use, I take pleasure in expressing my satisfaction. I am pleased particularly with the Tripod Coupling, it saving much time.

Respectfully,

R. E. BUSH,
Civil Engineer.

SAN JOSE, CAL., June 4, 1888.

A. LIETZ Co., San Francisco:

Gentlemen—It is with great pleasure that we add our testimony to the excellence of your Instruments. The two Transits and one large Y-level bought of you, are in every respect as good and serviceable as the instruments made by the most reputed of eastern firms, and as a purely California or home production deserve the greatest credit.

The graduations made on your own graduating machine are clear, sharp and exact, the glasses of the very best make and power, and the needles much superior to the general run of needles.

Your Tripod Coupling is at once simple, effective and safe, and we consider it better than any other coupling used by other makers.

We can but congratulate you upon your success in the production of A No. 1 California made instrument, and heartily recommend you to the profession.

Very truly yours,

HERMANN BROS.,
Surveyors and Civil Engineers.

LA PORTE, CAL., June 5, 1888.

A. LIETZ Co., San Francisco:

Gentlemen—I take pleasure in stating that the Mountain Transit with which you have provided me in April, 1887, has proved excellent. In regard to accuracy of the graduation, stability of tripod, reliability of instrument in its adjustments and strength combined with lightness, it gives entire satisfaction.

Very respectfully,

WM. SCHULD,

U. S. Deputy Mineral Land Surveyor.

OAHU RAILWAY AND LAND COMPANY,

HONOLULU, H. I., December 1, 1892.

A. LIETZ Co., San Francisco, Cal.:

Gentlemen—In 1890 this Company bought one of your Transits (No. 204). It has been in use in a variety of work and gives excellent satisfaction. It has several improvements on former instruments. All the parts are conveniently arranged. The verniers are in the right place.

Yours truly,

C. H. KLUEGEL, Chief Engineer.

MAXWELL, CAL., July 15, 1891.

A. LIETZ Co., San Francisco:

Dear Sirs—The Transit made for me by you is all that an instrument should be. It is almost perfect. Have used it as a level and it is as good as most 18-inch levels.

I am now making a survey which tests its qualities very closely, and the results obtained are excellent. Stadia measurements of distances up to seven hundred feet frequently check within two feet. It is faster and cheaper than chaining.

Very respectfully,

A. J. BUTLER, Civil Engineer.

Referring to Repairs made to a Leveling Instrument.

STOCKTON, CAL., December 15, 1891.

A. LIETZ Co., San Francisco:

Dear Sirs—* * * * * The work was well and satisfactorily done and charges moderate, and I shall be pleased to recommend you to any friends requiring work in your line.

Very truly yours,

E. E. TUCKER, Civil Engineer.

SAN FRANCISCO, Dec. 23, 1891.

A. LIETZ Co., San Francisco:

Gentlemen—It gives me great pleasure to certify to the merits of Transit, No. 202, which I purchased from you in August, 1890. I used it on town and water works surveys, and found it in every respect a first-class instrument.

Very truly yours,

H. S. DAVIDSON, Civil Engineer.

VIRGINIA, NEV., October 28, 1892.

A. LIETZ Co., San Francisco:

Gentlemen—We take pleasure in stating that the instruments, Transits and Levels, which you have furnished us, have given the utmost possible satisfaction.

The two transits have been in constant use for three years, and have proven themselves well adapted to mountain and underground work. They are light without weakness, and possess an extraordinary degree of accuracy; and, furthermore, we must acknowledge the promptness you have displayed in filling our sometimes imperious orders. We are, gentlemen,

Yours very respectfully,

HELLMANN & HAIST, Civil and Mining Engineers.

SAN FRANCISCO, October 29, 1892.

A. LIETZ Co., San Francisco:

Sirs—I have used the Y-level, No. 231, made by you, and I take great pleasure in stating that it has given entire satisfaction. It is absolutely accurate and in every way reliable.

The same merit can be claimed by your Transits. I have used one of them for five months, and it is fair to state that I have never handled a better instrument.

Yours respectfully,

FRANCIS BRIDGES, Civil Engineer.

ASPEN, COLORADO, October 31, 1892.

A. LIETZ Co., San Francisco:

Sirs—It is with great pleasure that I avail myself of the opportunity presented me to say a kind word for you and your work. The Transit made by you and used by me for the last three years, I am certain is not excelled by any other in this State or elsewhere.

In convenience, accuracy of centering, and graduation, it leaves nothing to be desired. That it is to-day in as good a condition as when it left your shop, speaks well of its construction in other directions than accuracy alone.

Yours truly,

C. S. BATTERMAN.

WOODLAND, YOLO Co., CAL., November 3, 1892.

A. LIETZ Co., San Francisco:

Sirs—Regarding Level No. 224, which I purchased of you, I have to say that the year I have owned the same has not made it a bad name. I like it even better than I did when I purchased it. For very accurate work in either still or windy weather I have never used its equal.

Very respectfully yours,

P. N. ASHLEY, City Engineer.

AGENCY SIERRA BUTTES GOLD MINING COMPANY, LIMITED,
SAN FRANCISCO, CAL., November 5, 1892.

A. LIETZ Co., San Francisco:

Dear Sirs—I take pleasure in stating that the Level I bought of you is a first-class instrument, and gives perfect satisfaction.

Yours respectfully,

WM. JOHNS.

WARDNER, IDAHO, December 8, 1892.

A. LIETZ Co., San Francisco:

Gentlemen— * * * * * I prefer your instruments to any I have seen yet.

Respectfully yours,

JOSEPH P. KEANE.

MODESTO IRRIGATION DISTRICT,
LA GRANGE DAM, January 11, 1893.

A. LIETZ Co., San Francisco:

Gentlemen—I take pleasure in certifying that the Transit and Level bought of you three years ago have given perfect satisfaction, the adjustments remaining longer than in any instrument I have used in twenty-five years practice. The inverting telescopes that I ordered I consider superior to the erecting form, and for hard usage and accurate work I know of no make of instrument superior to your Company's.

Very truly yours,

C. D. RHODES, Civil Engineer.

CLIPPER MILLS, BUTTE Co., CAL.,
February 3d, 1895.

A. LIETZ Co.:

Gentlemen—You would hardly believe it, but I have used your transit (No. 235) for over a year without having to adjust it, as it has retained perfect adjustment. I am very careful with it.

Yours respectfully,

H. W. CADWELL, C. E., E. M.

Sec. Con. Gentle Anna Mining Co.

EUREKA, Feb. 1st, 1894.

A. LIETZ Co., San Francisco:

Gentlemen—I have had the pleasure of standing behind one of your improved levels, and am free to say, "she's a bird."

Very respectfully,

A. T. SMITH,

U. S. Deputy Surveyor

CANDELARIA, NEVADA, March 20, 1893.

A. LIETZ Co., San Francisco:

Dear Sirs—I am highly pleased with my Transit No. 254, made by you, which I have been using constantly for over a year. It is thoroughly reliable, and I consider it one of the best in use. I have had occasion to use it a great deal in long leveling practice, and my limit of error per mile has never exceeded one-tenth of a foot. It is a combination of accuracy, strength and lightness, and I can safely recommend the same in every particular to the engineering profession.

Yours truly,

JOHN G. BOOKER,
U. S. Deputy Mineral Surveyor for Nevada.

LAKE GREENO, CAL., March 27, 1893.

A. LIETZ Co., San Francisco:

Gentlemen—Over two years ago I purchased one of your 18-inch Y-levels. It has been in constant use ever since, sometimes subjected to very severe handling, and I desire to say that in over fifteen years' practice in the field, using instruments from most of the standard makers, yours is the peer of any in design, workmanship, action and all of the attributes of a first-class instrument. The ease of manipulation and constancy of adjustment are qualities possessed by it in a marked degree, and the improvements are just what are needed.

In short, I would not exchange mine now for an instrument of the same grade from any other maker. I expect soon to lay aside all others and to use none but Lietz instruments in all branches of my field work covered by them.

It is a great pleasure to me to show the good points of my level to my professional brothers.

Yours respectfully,

P. M. NORBOE,
Civil Engineer.

JUNEAU, ALASKA, January 14, 1893.

A. LIETZ Co., San Francisco:

Gentlemen—I take pleasure in stating that the Mountain Transit purchased from you and used the past season has proven excellent. The graduations are clean and sharp. In regard to accuracy of the graduation, reliability of instrument in its adjustments—the tripod not only simple and safe, but always rigid—and strength combined with lightness, it proves entirely satisfactory.

Yours truly,

CHAS. W. GARSIDE,
U. S. Deputy Mineral Surveyor for
Alaska, and Mining Engineer

SAN JOSE, CAL., June 17, 1893.

A. LIETZ Co., San Francisco:

Sirs—In regard to the Simplified Transit bought of you last Fall, permit me to say that I have used it continually since I have had it and am very much pleased with it. It is light, handy, easily kept in adjustment and very accurate. In short it is all you represented it to be. Will be pleased to recommend the instrument to any one.

Very truly,

N. C. PARKER.

SAN FRANCISCO, March 10th, 1895.

A. LIETZ Co., San Francisco :

Gentlemen—In the prosecution of my work in opening up the gravel mines of the Playa de Oro Mining Company, in Ecuador, South America we had occasion to use one Lietz transit, one Y-level, and one dumpy level.

These instruments were covered with water-proof cloth, and despite constant rain and exposure incident to such work, and in such a wet climate, proved thoroughly satisfactory, and I can most strongly recommend them.

Very truly,

MARK B. KERR,
Civil and Mining Engineer.

THE FOLLOWING

Testimonials

WHO HAVE

USED OUR

ALUMINIUM

INSTRUMENTS

ALUMINIUM INSTRUMENT TESTIMONIALS.

SAN JOSE, CAL., April 14th, 1895.

A. LIETZ Co.

Gentlemen—We have used one of your aluminium mountain transits for nearly a year, for all kinds of engineering work, in places exposed to great heat and strong winds, and find that it gives us better results and more satisfaction than heavy transits of brass.

We find that its small weight allows an easier and quicker handling in rough, mountainous places, and also keeps the instrument in better adjustment and more free from accidents. In fact, we don't see how we got along so far without it, and why engineers and surveyors, who have a great deal of mountain work to do and carry their own instrument, insist upon breaking their backs with a 25-pound instrument, when they can get one which weighs 7 pounds, and does the work fully as well.

Respectfully yours,
HERRMANN BROTHERS,
Surveyors and Civil Engineers.

THE MINERAL FARM CONSOLIDATED MINING Co.,

Aspen, Colorado, April 30, 1895.

A. LIETZ Co.

Dear Sirs—I have been using for several months a transit of your make, having inclined standards.

The standards and telescope are of your aluminium alloy, and give perfect satisfaction, as does the entire instrument, which is of special make throughout. This makes two transits of your manufacture that I have used.

Yours truly,
C. S. BATTERMAN,
Manager.

SAN FRANCISCO, May 7th, 1895.

A. LIETZ Co.

Dear Sirs—Your small aluminium transit, No. 342, proves to be for my purposes the most convenient and satisfactory instrument I have yet had in use.

It is well constructed and large enough for all ordinary underground and surface surveys, and being very light is particularly handy for rapid work.

Yours truly,
ROSS E. BROWNE,
Mining and Hydraulic Engineer.

UNIVERSITY OF CALIFORNIA,
DEPARTMENT OF CIVIL ENGINEERING AND ASTRONOMY.

BERKELEY, May 10th, 1895.

A. LIETZ Co., San Francisco.

Gentlemen—The plane-table alidade made by you for the University several years ago has always given satisfaction.

We have instruments made by several of the first-class makers in this country, and your alidade compares very favorably with these.

Very respectfully,
H. I. RANDALL,
Instructor in Civil Engineering,
University of California.

FERNDALÉ, CAL., May 15th, 1895.

A. LIETZ Co., 422 Sacramento St., San Francisco.

Dear Sirs—I desire to state that I am well pleased with your small aluminium transit, which I purchased from you about two years ago. It is small, light and accurate. Being light it is particularly adapted for mountain field work.

There is no question but that the aluminium transit is the one for the engineer, as it combines accuracy with lightness.

Yours respectfully,

J. A. SHAW,
Civil Engineer and State Licensed Surveyor.

BOARD OF STATE HARBOR COMMISSIONERS,
No. 10 California St.

SAN FRANCISCO, May 29th, 1895.

A. LIETZ Co.

Gentlemen—With regard to the aluminium Y-level, No. 304, made by your Company for the Board of State Harbor Commissioners, I take pleasure in informing you that it has given perfect satisfaction, and I will state that if it were not possible otherwise than by paying double the price of the old style brass instrument, I would willingly do so in order to get one of aluminium manufacture.

One only has to use such an instrument for a day to appreciate the difference.

As to the workmanship of the above level, I have never seen better in my experience as an engineer.

Yours respectfully,

HOWARD C. HOLMES,
Chief Engineer.

Digitized by the Internet Archive

in 20 COUNTY SUPERVISORS OFFICE, SANTA CRUZ COUNTY.

Microsoft Corporation SANTA CRUZ, CAL, June 1, 1895.

A. LIETZ Co., San Francisco.

Gentlemen—I take great pleasure in informing you that I have used the aluminium transit, No. 320, made for me by your firm about a year ago, on all kinds of city and county work, and find it in every way the equal of any old style (bronze) instrument I have ever used.

It holds its adjustments very well, and is as steady in the wind as any of the heavier instruments, while the saving of labor in carrying it is a gain that cannot be over-estimated. I think that when it has been once thoroughly tested by any engineer, he will abandon his old instrument in its favor in every instance.

The graduations and workmanship are in all respects excellent.

Yours truly,

CHAS. L. PIODA,
City Engineer.

SAN FRANCISCO, Sept. 6th, 1894.

I have had occasion to use a small aluminium transit, weighing $4\frac{1}{2}$ pounds, continuously for about six months, and during that time I made it a point to use it in very severe and stormy weather.

I recall a very strong breeze near a California mountain town, when the local engineer of the work, upon which I was then engaged, and I were operating together, he with a large transit weighing $17\frac{1}{2}$ pounds, without the tripod. Although my instrument trembled, its motion was not a violent one, and I could still read a stadia rod at 400 feet distant, when it was utterly impossible for him to manage his heavy instrument at all. The amplitude of its vibrations was longer, and its larger superficial area gave the wind more surface to act upon. Whenever there was a lull in the wind, my transit would stop trembling at once, while the heavy instrument would continue shaking until the next gust would strike it again.

It was proven to our satisfaction that the small aluminium transit was by far steadier than the large instrument, although the latter exceeded it 13 pounds in weight; it was not as top-heavy and the wind had less effect upon it.

The local engineer referred to, who had had quite an objection to a $4\frac{1}{2}$ -pound transit, became fully converted to aluminium instruments after our first mutual experience in the wind, and is today as firm a believer in this metal as I am myself.

MOUNTAIN HOME, ELMORE CO., IDAHO, May 5, 1894.

THE A. LIETZ COMPANY, 422 Sacramento Street,
San Francisco, Cal.

Gentlemen: The instruments ordered (Aluminium Transit and Level) came to hand in due course of time all O. K., and I have neglected writing you on account of press of business and wanting to have an opportunity to test the transit in different ways.

What can I say in praise of the same? Words are useless. Money could not buy them if I could not replace the same. I think that will give you an idea of my appreciation of your instruments.

The objection was raised by several engineers that the transit would shake in heavy wind. I know better, and experience is the best of knowledge. Example: Having a placer claim to survey, situated upon a low flat island in Snake River, I crossed the island when the waves were rolling about three feet high, and each roller helped to make it uncomfortable by washing into the boat; commenced at lower end of island, stake No. 1, and ran around the island sixteen courses and angle corners, and closed within three ft. on Stake No. 1, by calculation Lat. & Dept. Area 93 Acres. Now any instrument that will do such work as that in a windy day on Snake River (and it just know how to blow there), I think is beyond criticism.

Having many levels to run I have used the telescope for running the same on one of our canal lines. Preliminary survey. Ran south on Twp. line, and at 700 ft. set stake on lower side of ravine. Returned to starting point and ran south-easterly, crossed ravine in narrow place for flume, and ran down south bank of ravine to stake at 700 ft. and closed; looked at other paper on which I had taken levels on Twp. line and found that readings were the same for that point. Elevation 9.40 ft. Such an instrument will answer for me; those who want a better one can hunt for it.

The level is a *Daisy* and meets all requirements.

An Engineer or Surveyor can carry it all day and not feel like leaving it wherehe stops at night. I would recommend the same to any one of my profession, and advise them to go and do as I did: buy the same from A. Lietz Company.

Yours Respectfully

SAMUEL G. RHODES,
U. S. Dep't. Surveyor for Idaho.

TESTIMONIALS

REFERRING TO THE

NEW CYCLOTOMIC TRANSIT

(PATENTED MARCH 1896)

MADE BY

A. LIETZ CO.

MANUFACTURERS OF SCIENTIFIC INSTRUMENTS

422 SACRAMENTO STREET

SAN FRANCISCO, CAL.

EXPLANATORY NOTE.

IN the following pages we present a few testimonials, referring to our Cyclotomic Transits. We have chosen three to each grade of instrument, although we might have supplemented this number by many more of the same character, were we not of the opinion that a repetition of the same statement is useless.

There is no doubt that the Cyclotomic Transit is a successful innovation. We were fully aware of this when we began building these instruments, but we have thus far withheld all expression of opinion regarding them, deeming it advisable to allow sufficient time to test their qualities in every way in actual field practice. During the last two and a half years quite a number of instruments of this character have been sold by our Company, and the time has come when we are prepared to substantiate the claims we originally made.

We beg to refer our readers to the following testimonials, and will ask them to compare these flattering expressions with the statements made by us in our first description of the Cyclotomic Transit.

Referring to

High-Grade Cyclotomic Transits

No. 18

SECURITY MINING AND DEVELOPMENT CO.
Prescott, Arizona, July 5th, 1897.

A. LIETZ CO.

422 Sacramento Street, San Francisco.

Gentlemen:—The Cyclotomic Transit, No 375, purchased from you one year ago, has been in constant use in a variety of work by myself, including inside and outside mine surveys, mill-work, road grading, stadia measurements, topographic surveys, etc. I have had no trouble with it, but have found it wholly reliable in complicated shaft and tunnel work and in every way as accurate as other styles of instruments heretofore used by me. In all particulars in which you claim superiority, as to convenience, stability and non-liability to injury from rough usage, my experience coincides fully with your statements. My transit was set up some months ago in a very unstable position on a mountain slope, and fell in such manner as to give it a jar sufficient to ruin one of the old-style instruments; but I have had it in use constantly since that date, on work requiring strict accuracy. The only damage from the accident was a very slight throwing out of adjustment of the horizontal limb at one point, which was readily corrected.

I regard the cyclotomic principle as one of the most important improvements of the age, as it is one of the most simple when one is once accustomed to its manipulation.

Yours very respectfully,
(Signed) THEO. B. COMSTOCK.

1614 BRODERICK STREET,
San Francisco, Cal., July 16th, 1897.

A. LIETZ CO.,

Dear Sirs:—I take pleasure in sending you a few lines in reference to the "Cyclotomic Transit," No. 378, which I purchased from you in August of last year; it has given perfect satisfaction. Not only is it more steady in high winds than any instrument I have used before, but it keeps in better adjustment.

The instrument is accurate and of easy and rapid manipulation. Its chief charm is its lightness, which in no way detracts from its usefulness.

Yours truly,

[Signed] L. S. QUIMBY.

OFFICE OF P. N. ASHLEY,
County Surveyor, Yolo County.
City Engineer, Woodland.
State Licensed Surveyor for California.

Woodland, California, July 24th, 1897.

A. LIETZ CO.,

San Francisco.

Gentlemen:—Cyclotomic Transit, No. 376, bought from you last winter, has proven very satisfactory to me. Graduations are clear and easily read, instrument steady, and the solar attachment gives very close definitions to true directions of lines run, thereby obviating the necessity of keeping up long and expensive transit deflections on extended surveys in brushy country.

Very respectfully

[Signed] P. N. ASHLEY.

Referring to

High-Grade Cyclotomic Transits
No. 18a

DEPARTMENT OF PUBLIC WORKS, }
Office of the Commissioner. }

Mount Vernon, New York, May 25th, 1897.

A. LIETZ CO.,
422 Sacramento Street, San Francisco.

Gentlemen:—I take pleasure in saying the Cyclotomic Transit Theodolite fully meets my expectation. It does all the work of a larger and heavier one and is so much less burdensome to carry. the cyclotomic feature is quite as readily manipulated as the double center and in every way equal, unless repetition of angles is required.

My assistants who use the instrument are delighted with it, while I regard the devices for attaching to tripod and shifting center as excellent. It is also in all other respects an up-to-date machine.

Yours respectfully,
[Signed] F. S. ODELL, Commissioner.

W. W. WAGGONER,
U. S. Deputy Mineral Surveyor
and Civil Engineer.

Nevada City, Calif., July 3d, 1897.

A. LIETZ CO.,
San Francisco.

Gentlemen:—Your small aluminium Cyclotomic Transit, No. 464, purchased by me last March has given good satisfaction. It is especially adapted for rapid mountain work, and in surveys through upraises and cramped openings in mines, where a heavy instrument is inconvenient and difficult to handle. With surface work I have had no trouble in making closings of 1 in 5000.

Very truly,
[Signed] W. W. WAGGONER.

CONTINENTAL MINE,
Globe, Arizona, July 10th, 1897.

A. LIETZ CO.,
San Francisco.

Gentlemen:—In answer to your favor of the 1st inst., I may say that I am perfectly satisfied with your Cyclotomic Transit, No. 476 which makes a strong instrument very well adapted to ordinary mining use, and which after a little practice can be handled quicker than the usual, or repetition transit.

Very truly yours,
[Signed] EDMOND DE STOUTZ,
For the North American Exploration Co., Ltd.

Referring to

Cyclotomic Reconnaissance Transits

No. 18b

San Francisco, September 2nd, 1896.

A. LIETZ CO.,

I send you to-day the Cyclotomic Transit, No. 410, (Reconnaissance) and beg you to clean it, because it has made long surveys with rain and dust. During these operations, I could verify the perfect accuracy and the easy use of the transit, and I have the pleasure to mark my satisfaction.

With my distinguished civilities,

[Signed] JE. RIGAUD,

Ancien ingenieur en chef des Mines.

Ancien directeur de l'école des mines d' Alais.

San Francisco, Cal., July 2d, 1897.

MESSRS. A. LIETZ CO.

422 Sacramento Street, San Francisco.

Gentlemen:—Replying to your inquiry of the 1st inst., I am pleased to say that the "Cyclotomic" Reconnaissance Transit purchased from you by the California Wire Works, some nine months ago, has given entire satisfaction.

Yours very truly,

[Signed] E. I. PARSONS, C. E.

Merced Falls, July 5th, 1897.

A. LIETZ CO.,

San Francisco.

Gentlemen:—The Cyclotomic Reconnaissance Transit, made for me last winter, I regard as an excellent instrument for the general work of a surveyor in rough regions - It is very light and convenient, and sufficiently accurate for all but the finest work.

Respectfully yours,

[Signed] G. P. KELSEY.

FOR DESCRIPTION
OF THE

CYCLOTOMIC TRANSIT

AND

PRICE LIST

Pages 121-126 and 153-156b.

THIRD EDITION
OF THE
MANUAL
OF
Modern Surveying Instruments
AND THEIR USES,

CONTAINING USEFUL INFORMATION FOR THE
CIVIL ENGINEER AND SURVEYOR.



TOGETHER WITH A

CATALOGUE AND PRICE LIST

OF

SCIENTIFIC INSTRUMENTS,

PARTICULARLY THOSE OF THE CIVIL ENGINEER AND SURVEYOR.

MADE BY

THE A. LIETZ COMPANY,

422 SACRAMENTO STREET,

SAN FRANCISCO, CALIFORNIA.

1899.

PRICE, 50 CENTS

PUBLISHED BY THE COMPANY.

WRITTEN AND EDITED BY OTTO VON GELDERN.

COPYRIGHTED.

ESTABLISHED 1882.

Hall's
copy

NOTICE.

THIS Manual supersedes the former edition of our catalogue, and is carefully revised and corrected to date.

The articles manufactured by this Company are quoted at prices consistent with the quality of workmanship, and no deductions will be made. We endeavor to place before the public an equivalent of the very best that can be obtained in this country, without imitating in shape or design any make whatever. All our articles are of the most recent standard, with every known improvement.

Distant purchasers will please remit by check, money order, or registered letter, or order C. O. D.

According to the rules of Wells, Fargo's Express Company, a surveying instrument, carefully placed in its case and in a packing box, is shipped as merchandise and charged at "single rate." "Three rates" will be charged if this precaution be not taken. The customer should not omit, therefore, to pay strict attention to this rule of the Express Company, and avoid unnecessary overcharges.

Packing boxes are furnished by us at a nominal rate.

PREFACE.

WE issue this book for the benefit of the engineering profession. This statement is justified in every way. Comparatively few are aware that scientific instruments are made on the Pacific Coast, and if it were generally known, it would require considerable effort to remove the doubt, whether our home industry work could possibly compare with that of the Eastern maker. It is difficult to see why such disparaging opinions should exist, but, as they do, we have endeavored to remove that prejudice by publishing a careful description of what we are able to produce — not only that, but just how we produce it — so that the public may have that confidence which an earnest effort, honest labor and skilful handiwork deserves. We benefit the profession if we can accomplish this object.

Considerable information has been published herewith. The details of every instrument are carefully enumerated, and the functions of every part minutely described, so that the book really becomes a pocket companion for the engineer.

And we would advise our patrons to consult this Manual frequently; it will be noticed that every adjustment and make-shift repair has found special mention and careful consideration. Refer to the index, and look up the subject before undertaking anything that may lead to more serious trouble afterwards.

The Manual is divided into four parts.

Part I contains a full description of our establishment and its methods of working.

Part II deals with the manufacture of Engineering Instruments, their uses, repair, adjustments and proper methods of

handling them, so that they may retain their fine qualities for an indefinite time.

Part III contains a number of professional papers, written by well-known men. They furnish considerable information of value, and we would ask you to give them your attention. The article on Stadia Surveying has been written for this Manual, and from it this method of measuring may be readily acquired by any surveyor. No expense has been spared to make these papers complete in every particular, including useful tables that cannot be had in any other book of this kind.

Part IV has a full price list of every article manufactured and sold by the Company. The customer may find any information, and arrange his purchase to the money he may desire to spend.

Nothing more need be said under this head. Whether we deserve success is now left with the profession; we will guarantee to do our share as carefully and honestly as the Manual states it to you. To those who are yet strangers to our work, we take this opportunity of asking them to give us a fair trial.

There is another point upon which we desire to make a few statements, which are more particularly addressed to the general public, however.

The ordinary purchaser is not aware of the fact that it is far more satisfactory to go at once to the manufacturer when an optical, nautical or surveying instrument is required. A regular practitioner, who knows what he wants, may order by means of the catalogue of any dealer, but there are frequent occasions when the farmer, the grader, contractor, street builder, forester, irrigator or mountaineer wants an instrument for some special purpose; and in such case it is always better that he should go to a reputable instrument-making firm at once, instead of making his inquiries of the dealer, who can not possibly understand his wants.

There is nothing unreasonable in calling the attention of the public to this fact. We deal in articles with the manufacture and functions of which we are fully conversant. Education, training and experience have given us advantages over the mere dealer, which it is not only our privilege but our duty to proclaim.

THE A. LIETZ CO.

INTRODUCTION.



WHEN the present business of manufacturing scientific instruments was established in San Francisco some fifteen years ago, it was realized that in order to compete with other makers it would be necessary to produce an article equal to the very best Eastern or European manufacture. And in no other branch of the business did this become more apparent than in that devoted to the construction of instruments for the civil engineer. With this object constantly in view, the present establishment has been gradually built up by Mr. Adolph Lietz, and it has now gained the confidence and the favor of our Pacific Coast practitioners.

It is with great pride that the firm looks upon its success, for it has given to the Coast an industry that in results is not excelled anywhere. The motto has been: "WE CAN BUILD ANYTHING IN OUR LINE 'OUT HERE' AS WELL AS THEY DO EAST, AND WHY NOT?" And with strict devotion to the profession, and straightforwardness in commercial dealings, the firm has proven the maxim a sound one.

In order to expand the scope of this establishment a stock company was organized in March 1892, known as "The A. Lietz Company," and in the Board of Directors of this Company Mr. Lietz associated with himself men of known professional experience, both practically and theoretically. Three civil engineers, Mr. C. E. Grunsky, Mr. D. C. Henny and Mr. Otto von Geldern, all well known on the Coast, represent the advisory board of the Company, for upon their suggestions, based upon practical experiences, the various engineering instruments in use by the profession have been brought up to that modern standard of excellence required of an instrument at the present time. For this is also a policy of the company: to adopt at once any form of improvement which, after a careful consideration, has shown itself worthy of adoption.

Experiments incorporating new ideas are never postponed, but at once carried out and tested as to possible merit.

In this wise the present forms of theodolite, transit, level, etc., have been evolved; and it is the purpose of this illustrated catalogue not only to show its readers the detailed construction of the instruments, but also to dwell upon individual parts, and to explain the methods of construction and the appliances that are used in creating a modern instrument of precision.

The incorporated Company announced its new departure to the public in a circular letter dated March 1st, 1892, from which we beg to publish the following extracts :

We take pleasure in informing the public that the well-known firm of A. Lietz & Co. has been incorporated as a stock company, which will be known as

“THE A. LIETZ COMPANY.”

The names of the men associated with this enterprise are a guarantee that the business will be conducted on a sound basis, that the articles manufactured will be of the best quality, and that all work done by the Company will be of superior workmanship.

The Lietz surveying instruments are too well known to require special mention. We shall endeavor to please our customers, and will give them the assurance that our constant aim shall be to produce instruments of precision with every improvement known to the art.

We pride ourselves on the established fact that the firm has succeeded in developing a HOME-MADE engineering instrument that is first-class in every particular, and especially designed in its details for the requirements of the Pacific Coast. We do not hesitate to say that this instrument will be found SUPERIOR to ninety per cent. of the imported articles, in every respect.

We should deem it a particular favor if our patrons would call upon us personally, so that we may show them the articles manufactured, and the particular merit claimed in each individual case. We have closely followed the wants of the engineer, and have constantly endeavored to supply his needs as they became apparent from time to time. In this we shall continue under the advice of our directors, three of whom are practical field engineers well known to the profession on the Pacific Coast.

We are also in the position to manufacture and repair scientific instruments of any character for astronomical, philosophical, nautical and similar purposes.

Particular attention is called to our graduating machine, which is of the most approved pattern, enabling us to graduate circles or arcs to any degree of minuteness; and to our new adjusting apparatus, where, by means of collimators, adjustments are possible that cannot be obtained in the field, or by any other method, with the accuracy and refinement required of first-class instruments.

Repairs will have our personal supervision, and will be promptly executed.

We shall keep on hand an assortment of field and office supplies for the Civil, Mining, Irrigation, Hydraulic, Military and Mechanical Engineer, and most respectfully solicit the patronage of our friends and the public.

Adding our thanks for past favors, we remain,

Respectfully yours,

THE A. LIETZ CO.

SAN FRANCISCO, CAL., March 1, 1892.

TO OUR PATRONS.

We would call your attention to our complete price list in Part IV. After reading the information given in Part II, the customer will be convinced that *the price of an article should not govern his purchase*. High-grade engineering work requires a first-class tool to work with, and the matter of twenty dollars, more or less, in original outlay will amply pay for itself in the end.

NOTICE!!

It has been asserted that the VARIATION OF THE COMPASS cannot be laid off accurately upon a Lietz Transit. We wish to call especial attention to the fact that the VARIATION MAY BE LAID OFF TO THE MINUTE WITH MORE THAN ORDINARY PRECISION.

For Method see page 24.

THE ITINERARY

The following itinerary is for the purpose of providing a general outline of the route to be followed by the expedition. It is not intended to be a detailed plan, as the route may be modified in accordance with the requirements of the expedition.

Continued

Continued

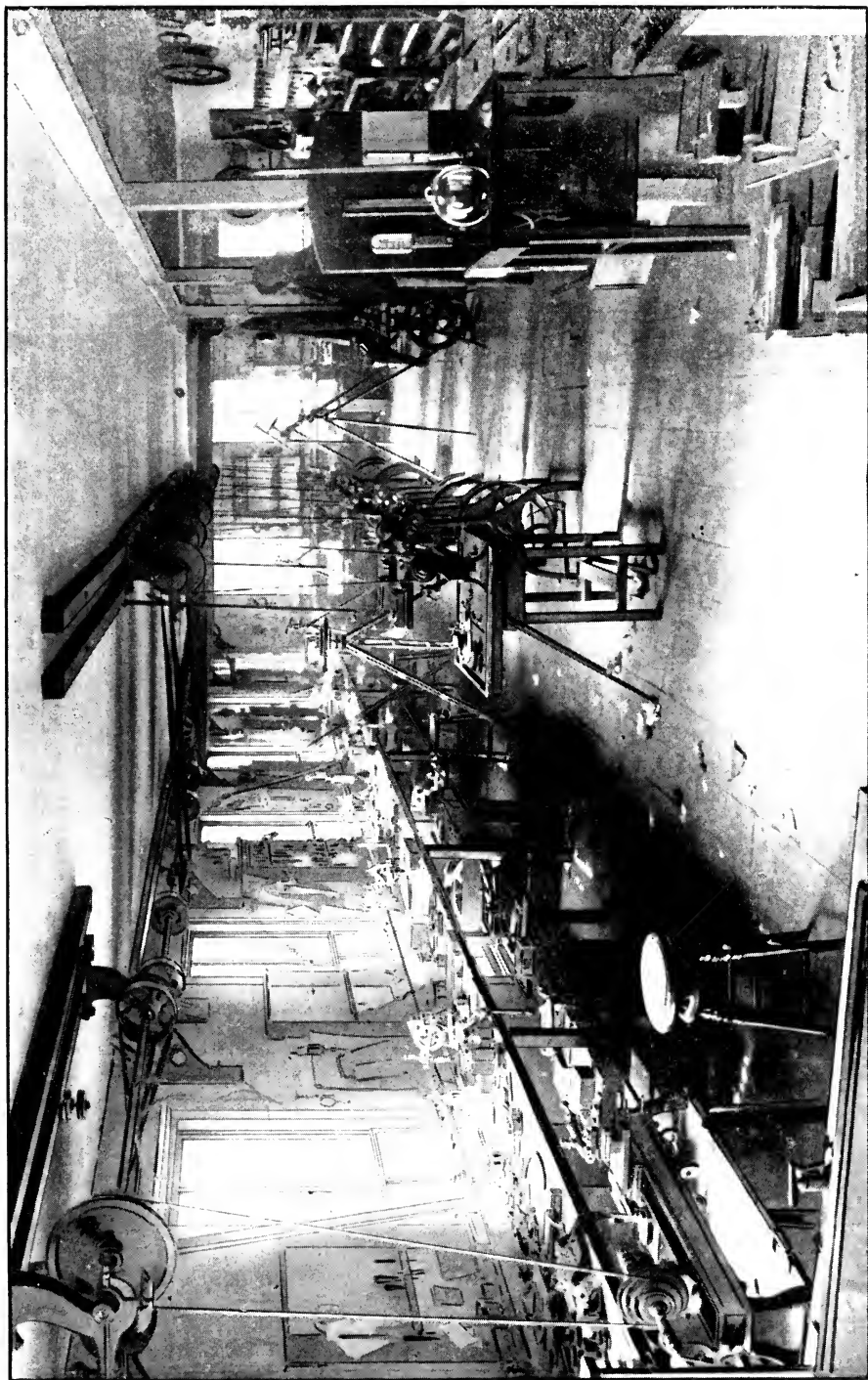

CAUTION!

In order to prevent changes in the magnetism of the Needle, do not bring your transit instrument into juxtaposition with objects generating or transmitting strong electric currents, such as *dynamos, electric car lines, etc.* If absolutely necessary to be within the influence of strong currents, allow the needle to swing freely. Avoid riding in electric cars with your transit, if possible.

**See the description of our CYCLO-
TOMIC TRANSIT, the Fin de Siecle
instrument, combining the greatest
simplicity with the greatest rigidity
and absolute completeness in work-
ing parts. An innovation in the in-
strument-maker's art.**

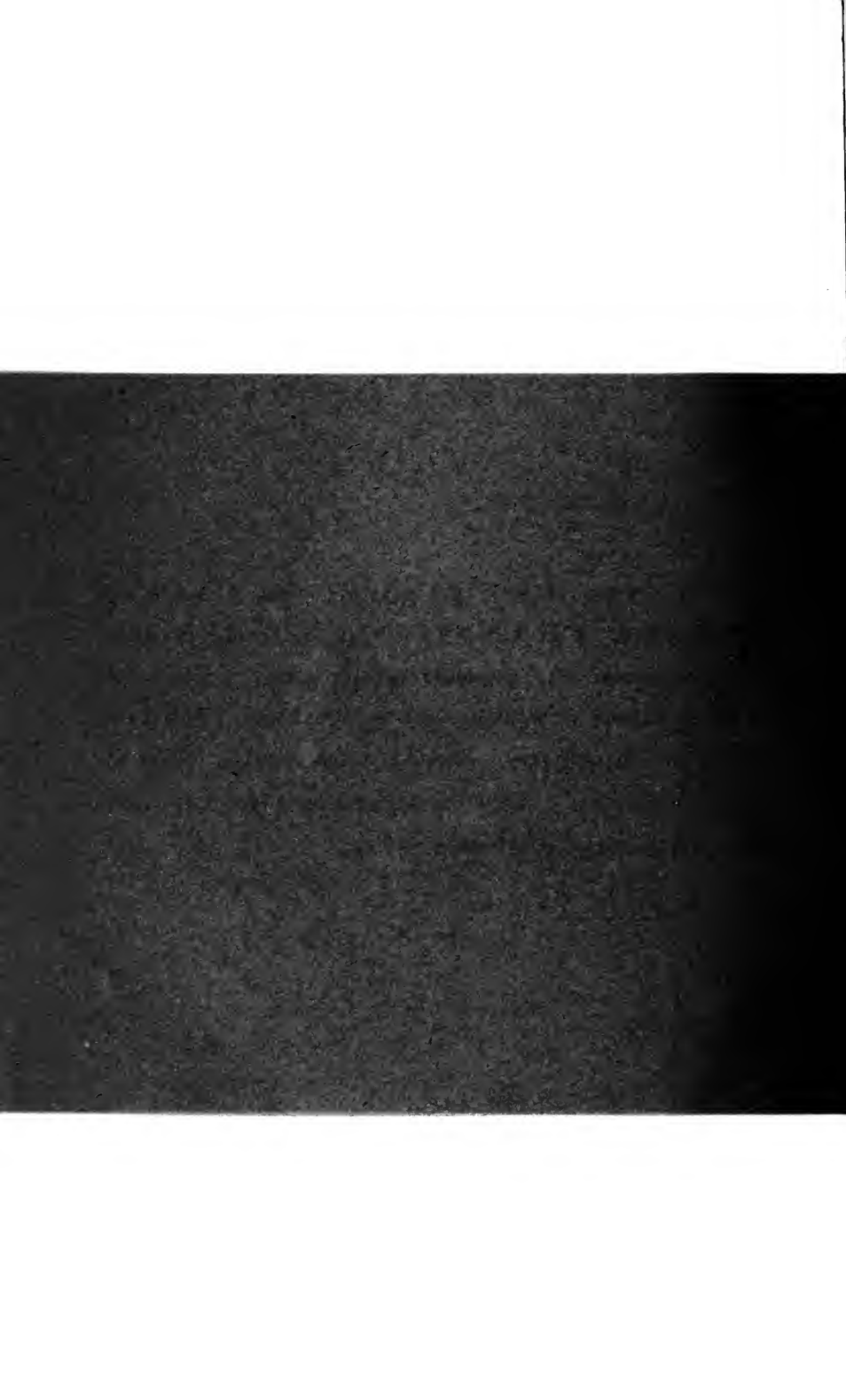

PART I.

DESCRIPTION OF THE ESTABLISHMENT.

THE A. LIETZ COMPANY,

SAN FRANCISCO.



PART I.

DESCRIPTION OF THE ESTABLISHMENT.

The location of the workshop and salesroom occupies the upper or third floor of the building on the northeast corner of Sansome and Sacramento streets, San Francisco.

The various departments of the business consist of the shop, the business office, the foundry, the graduating and adjusting room, and the special nautical department.

In the large and commodious workshop a number of busy lathes, driven by steam power, are going from morning until evening, and at long workbenches under the light of a dozen windows the workmen are employed—some in the exclusive manufacture of new instruments for the market, others in the repair of such that are constantly received from all parts of the country. No expense has been spared to add to the shop every mechanical facility to increase its efficiency.

Plate I is an illustration intending to show the interior view of the shop as seen from the business entrance.

Directly in front of the work-room is the part devoted to the commercial interests of the establishment. A number of large glass showcases contain articles on sale, consisting of new theodolites, transits, Y-levels, dumpy levels, microscopes, telescopes, hand levels, barometers, thermometers, sextants, compasses, drawing instruments of all descriptions, tape lines, scales, planimeters, chains, odometers, pedometers, field glasses, mining apparatus, mechanical contrivances, etc., etc.

In the rear of the office is the foundry, which has recently been added to the establishment. It is more particularly used

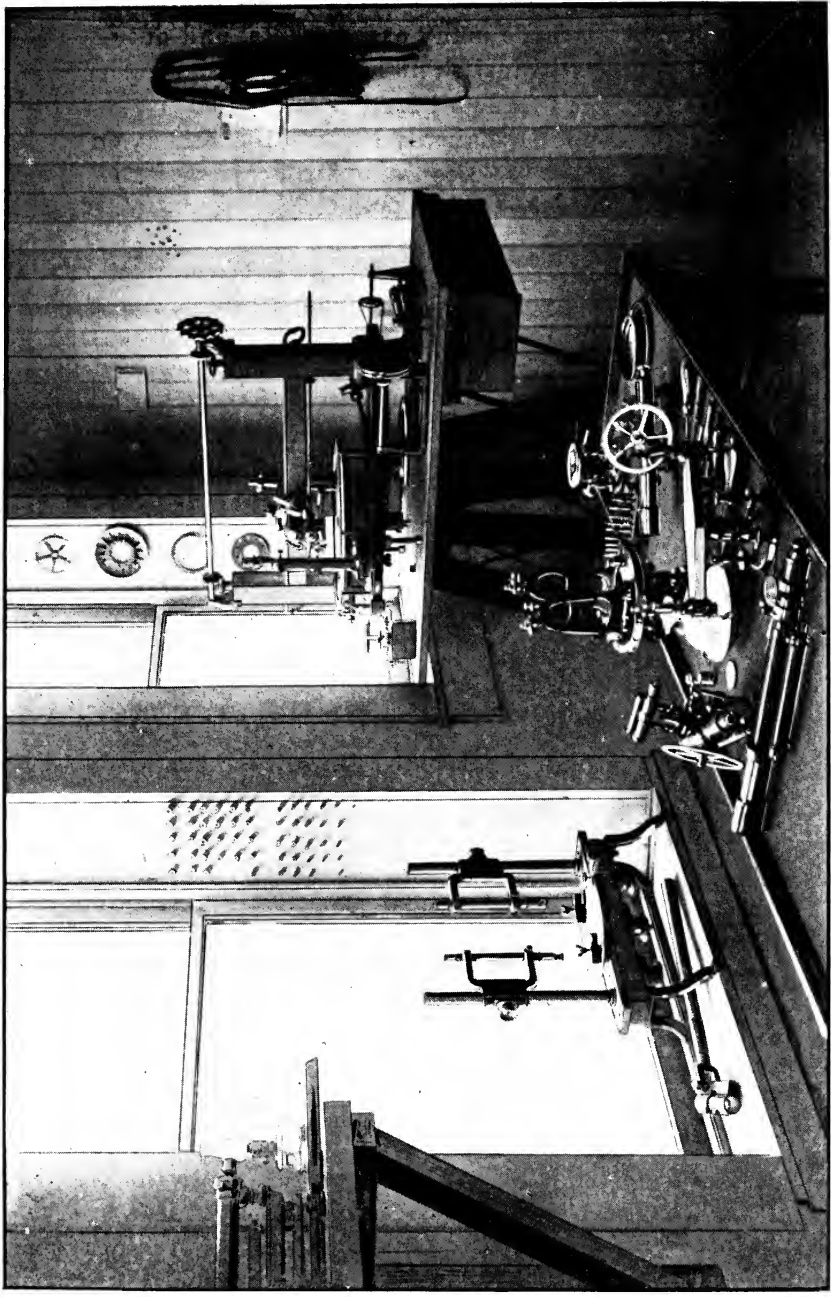

PLATE II. INTERIOR OF GRADUATING AND ADJUSTING ROOM.

and designed for aluminium castings, with which metal the company has lately made many experiments, and out of which the remarkably light transits and levels have been made, which shall be noticed more in detail further on.

From the foundry a stairway leads to the roof, upon which the ranges for testing telescopes and other useful measuring and accessory apparatus are located.

The most vital part of the establishment is the graduating and adjusting department, which contains the large circular dividing engine for graduating circles and plates to any required degree of precision. It also contains certain valuable apparatus for testing the individual parts of an instrument, and the mural collimators for adjusting an instrument with an amount of exactness that cannot be obtained in the field under the very best circumstances. In plate II is seen the end of one of the collimator levels as photographed with the interior view of the graduating and adjusting room. Plate VI shows the method employed in adjusting by means of collimators. It is so apparent to the eye that it will hardly require any further explanation. With it all the necessary adjustments are at once readily and precisely accomplished.

Plate III shows the large circular dividing engine, built by the firm, with which all the graduations are made. The Company has been frequently complimented on the absolute accuracy of its divisions, and on the sharpness with which the vernier contact may be observed under a magnifying power.

In a paper read before the Technical Society of the Pacific Coast on December 5th, 1890, entitled: *Some Practical Hints on How to Tell a Good Surveying Instrument*, Mr. Lietz brought to the notice of the Society his experiences in graduated circles, wherein he refers to the true line as made by a proper cutting apparatus, and as to what constitutes a good and sharply defined line. This professional paper has been added herewith, and may be found in full in Part III of this catalogue. It is republished with the Society's permission, and the reader's attention is called to this short résumé of the instrument maker's art.

Plate IV shows a centering apparatus for testing the accuracy of graduations, and also the Company's small dividing

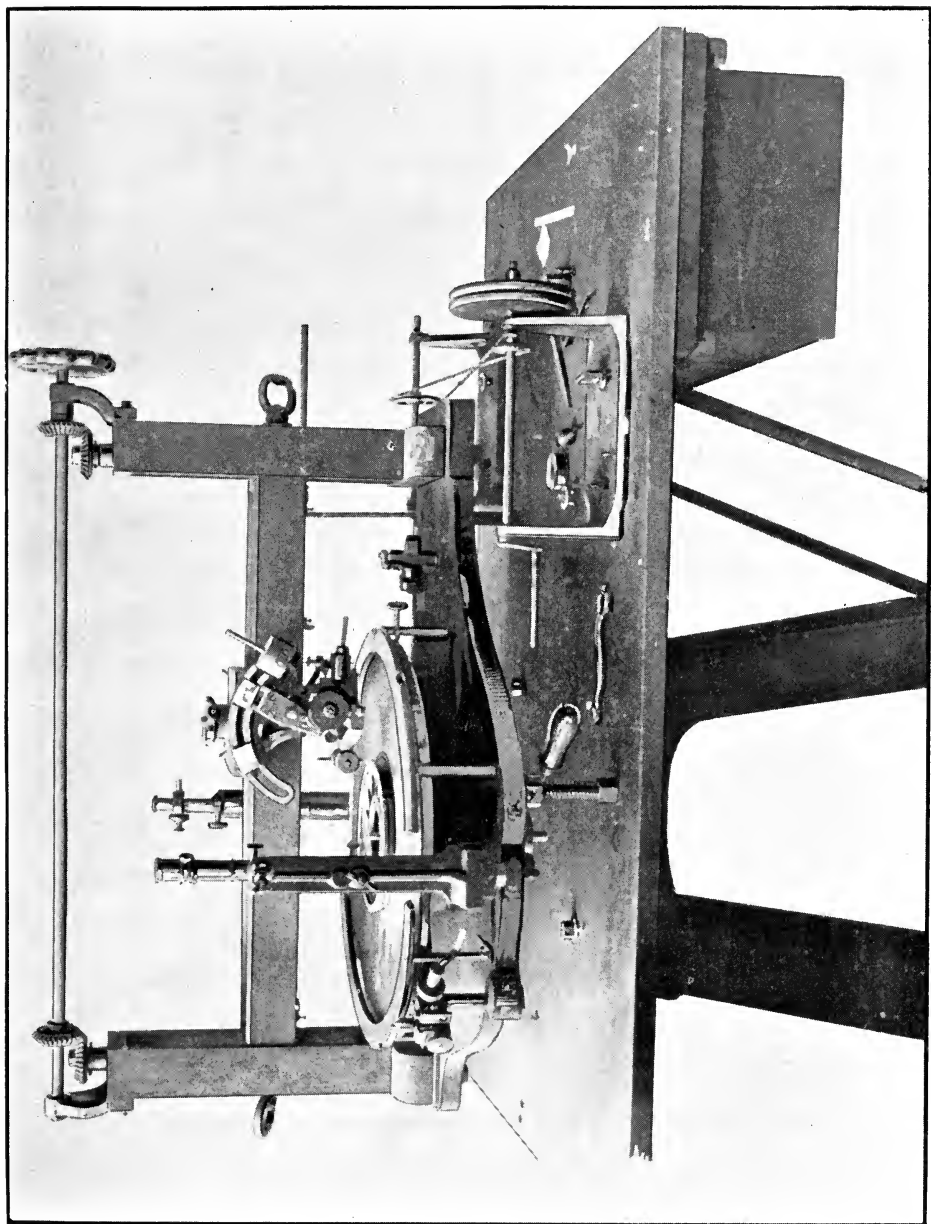

PLATE III. CIRCULAR DIVIDING ENGINE. BUILT BY THE A. LIETZ CO. FOR THE GRADUATING DEPARTMENT.

apparatus for linear graduations. The former is one of the most useful accessories of the graduating department, where-with the most crucial tests of the locus of the center of the graduated plate are made.

Plate V has the level tester, which is used in determining the degree of sensitiveness of the curvature of the glass. With this apparatus it is possible to obtain an accurate value of a division of the graduated bubble in seconds of arc.

The same plate shows also an apparatus used for determining the influence of the metal on the magnetic needle.

The NAUTICAL DEPARTMENT has been made a special feature of the establishment, which possesses the facilities for manufacturing and repairing compasses, sextants, logs, and all the usual mathematical appliances of the navigator. The shop has adequate means for repairing mercurial and aneroid barometers of the finest grade; an air-pump for testing an aneroid to any degree of atmospheric pressure, in connection with a standard mercurial instrument, is one of the features of this department.

We are able to extend these barometrical examinations and repairs to those of the very finest and most delicate make, including the beautiful Goldschmid Aneroid, with which such remarkable hypsometric results have been obtained in the Alpine regions of Switzerland, to which reference will be made in the third part of this catalogue.

Another branch of the business is that exclusively devoted to the making of mechanical devices, of models, or contrivances requiring accurate and delicate fittings. Work of this character has been done in the electrical line, by building apparatuses intended for a practical or scientific purpose. Similarly has this field been extended to philosophical, meteorological, astronomical, photographic, optical and other apparatus, from the most simple to the most delicate in character.

The Company's IMPORTATIONS of lenses and spirit-levels are of the very best European make.

Mr. Lietz spent several months on the European continent recently, in order to obtain the finest articles in this line, and there is every reason to congratulate the firm upon the success of this investigation.

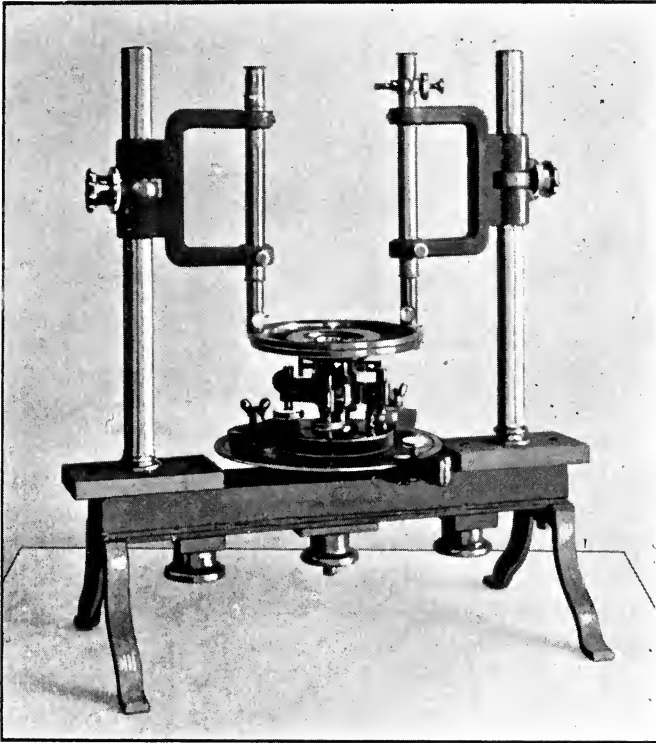

CENTERING APPARATUS FOR TESTING GRADUATIONS,
IN THE ADJUSTING ROOM.

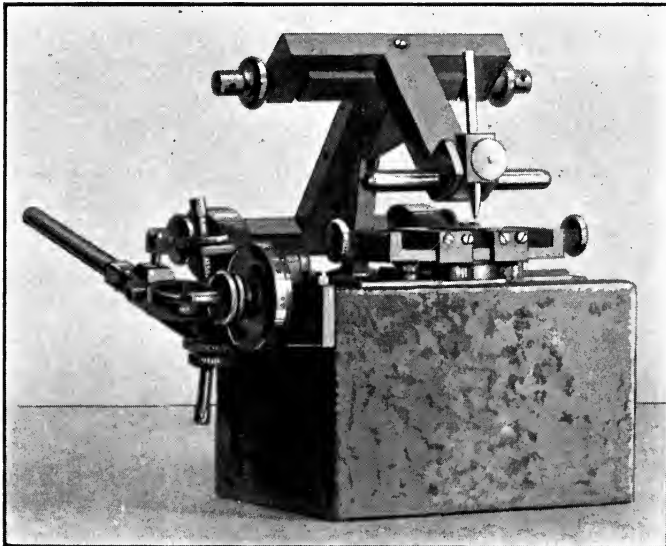

LINEAR DIVIDING ENGINE
IN GRADUATING DEPARTMENT.

Reference will again be made to these parts in the description of the instruments.

The object has been to manufacture every detail in the San Francisco shop; but those parts which cannot be made, and which are generally imported by the best makers, must be of the very finest quality obtainable, and for this particular purpose Mr. Lietz's recent European trip was undertaken.

It would be tedious to our readers to enumerate every detail of the numerous appliances made use of in the manufacturing and repairing. Enough has been shown to convince any fair-minded man that this Company is enabled to manufacture instruments as well as any Eastern firm. And upon this fact we wish to lay particular stress. WHY SHOULD OUR ENGINEERS SEND EAST, WHEN THEY CAN DO AS WELL AT HOME? By examining our price list they will find that the prices correspond to those of reputable Eastern firms; but the saving lies in the charge of expressage, which must necessarily be greater if imported from a longer distance.

All that is asked by this Company is a fair trial. If engineers visiting San Francisco will take the trouble to inspect the shop, we have every reason to believe that they can be convinced of what we have announced.

We have taken pains to add a few testimonials of well-known men, from the large number that are on file. If anyone will take the trouble to peruse them he will find all our assertions fully endorsed.

The *Irrigation Age*, published in Chicago, and one of the most popular serials in the West, has often referred to the Lietz Company as one worthy of the patronage of our professional engineers. With the permission of that journal we beg to quote from its March (1893) number as follows:

The A. Lietz Company was organized in the early part of the year 1892, having been previously successfully engaged in the manufacture of scientific instruments. Particular attention has been given to surveying instruments, and it is safe to say that there is not a transit, theodolite or level in the market to-day that can excel the articles made by this Company. From the time the business was founded by Mr. Adolph Lietz, some ten years ago, this gentleman was fully aware of the rapid progress made in the manufacture of surveying instruments, and, alive to every improvement, skilled and trained in his profession, he has always been first and foremost in adopting every

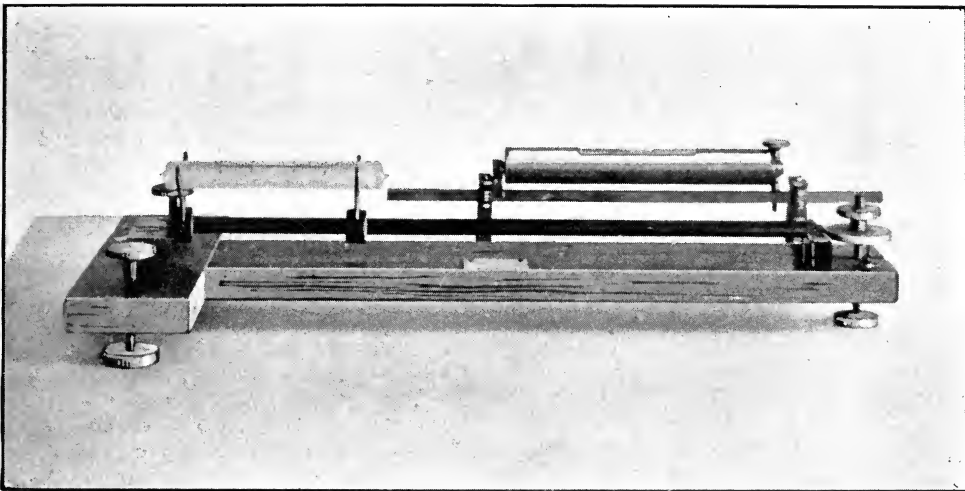

LEVEL TESTER,
ADJUSTING DEPARTMENT.

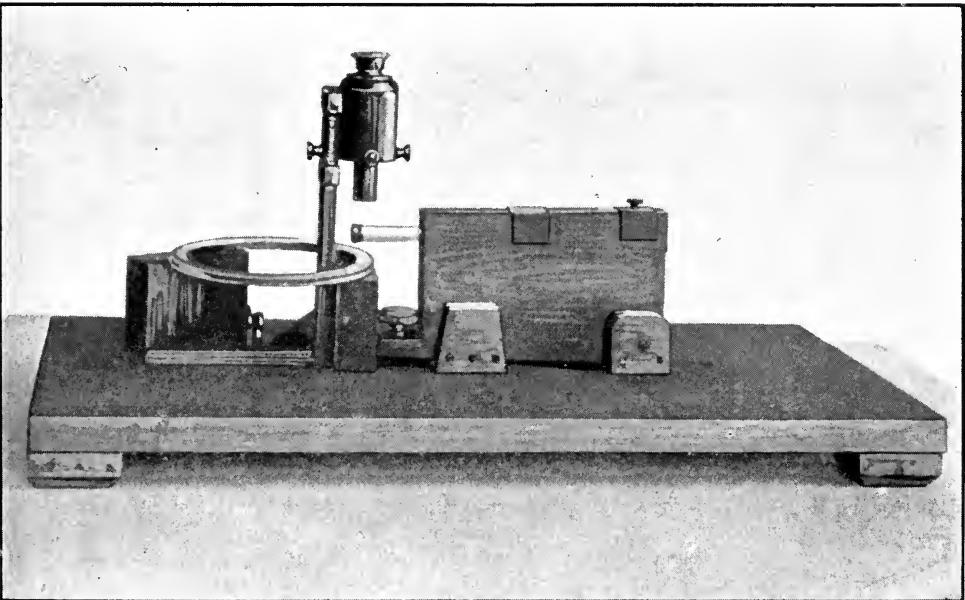

APPARATUS FOR DETERMINING THE MAGNETIC INFLUENCE OF METAL,
ADJUSTING DEPARTMENT.

particular that could raise the standard of the article. The consequence has been the production of an instrument that seeks its equal anywhere.

Every detail has had the most careful consideration. Of lenses and spirit-levels only the most perfect and accurate are used. In the matter of graduations Mr. Lietz has made every effort to achieve results that cannot possibly be excelled anywhere. The graduating machine, built in the establishment, divides circles to any required refinement, and with a perfection in which a wavering line, an unsteady cut, or an error in division have never been known. The fitting of the centres is an operation to which a great deal of time and attention is given. It is known that one workman has been exclusively employed for that particular part of the work.

Every modern accessory to an instrument is made and attached. The gradienter screw, for determining slopes and their degree by means of divisions on a head attached to the tangent-screw of the vertical movement; shifting centers; variation plates, for laying off the deviation of the needle; slide protectors; dust caps to leveling screws; verniers placed immediately under the eye of the observer; all these are advantages that the Lietz instrument is never without. The new tripod coupling, invented by Mr. Lietz, has found great favor with all engineers who have used it. It gives an instrument rigidity, and insures perfect safety. The attachment of the transit or other instrument to its tripod is made quickly by means of three jaws that fit into corresponding grooves. Testimonials from many of our most capable engineers are convincing without further reference to the matter.

The Company respectfully requests that all visitors to the Pacific Coast, interested in the articles manufactured, call at the shop on the northeast corner of Sansome and Sacramento streets, San Francisco. Great pains will be taken to show everybody what the Pacific Coast can produce in this line of delicate and beautiful instruments of precision.

There is the workshop, with its lathes and mechanical facilities; the graduating department, for the finer work of the establishment; the adjusting room, with its collimators for the most accurate adjustments possible; the nautical room, for the repair of compasses and sextants; and the foundry, in which the most careful castings are made for the use in the shop.

This latter department was added to admit of aluminium castings, of which the Lietz Company has made a specialty. In order to keep up with the advancement of the times it was absolutely necessary to make provisions for building instruments of that new metal, which is beautifully adapted for this kind of work. They are now in the position to manufacture any instrument of this material. Up to the present time the Company has not placed aluminium articles in the market, but in due time a special announcement will be made of a new line of goods that has not seen its equal anywhere.

The Pacific Coast is not behind the times in the building of scientific instruments of precision, and we can assure our readers that they will find every satisfaction by giving the A. Lietz Company a chance to do their work.

Repairs are carefully made of all kinds of articles in this line. The firm counts among its customers the best engineers of California, and we can cheerfully recommend these gentlemen to the public as worthy of patronage and consideration.

Irrigation companies about to fit out for field work will find it to their interest to consult with this Company before sending East, where nothing better can be purchased, where the prices for high-grade goods are not any less, and the freight considerably more.

It is quite needless to say more in behalf of the Company and of the extent of its work. It is the patronage of our pro-

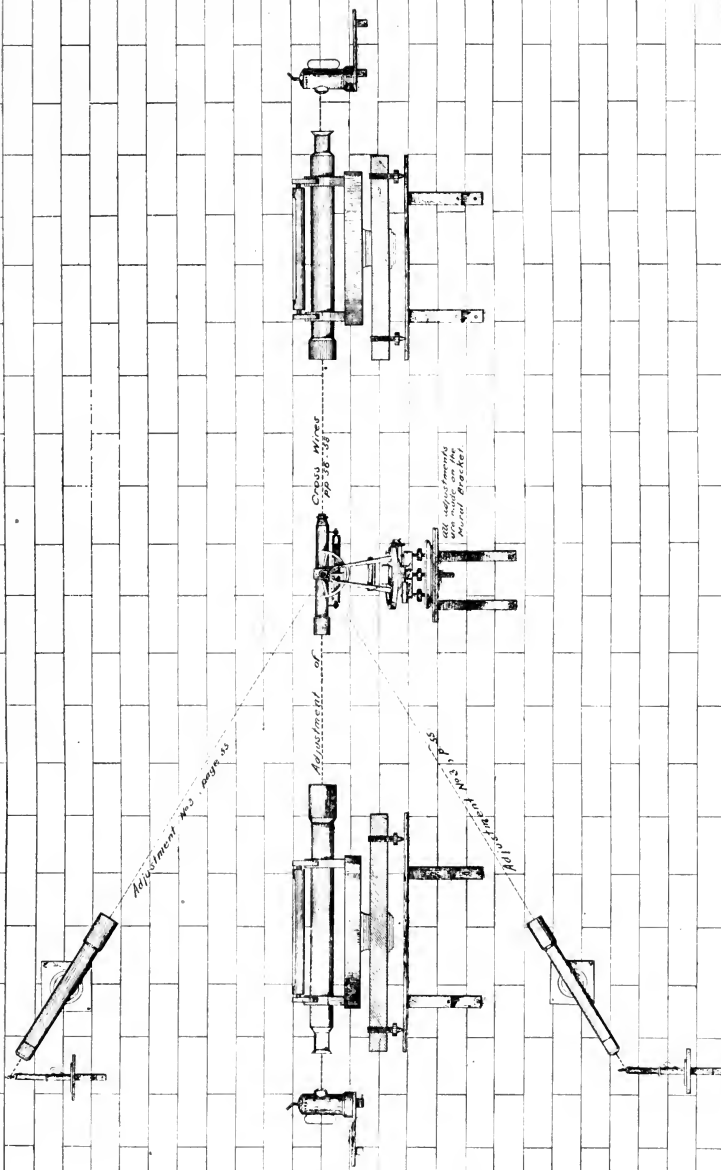

A. Lutz Co.
San Francisco

MURAL COLLIMATOR APPARATUS

In the Adjusting Room.

professional engineers that we particularly desire, and their goodwill and confidence that we wish to obtain. For that reason we shall devote a large portion of this catalogue to the description of surveying instruments.

It is to this subject that we wish to call your attention now; and if you will be pleased to follow us, you will find that we have not neglected any individual point in covering this broad field. It is our object to show you what we are doing and how we are doing it.

PART II.

DESCRIPTION OF INSTRUMENTS

MANUFACTURED BY

THE A. LIETZ COMPANY,

SAN FRANCISCO.

With Remarks on their proper Use, Care, Preservation
and Adjustments.

PART II.

DESCRIPTION OF THE LIETZ INSTRUMENTS,

INCLUDING REMARKS ON THEIR USE, HANDLING, CARE,
PRESERVATION AND ADJUSTMENTS.

THE ENGINEER'S TRANSIT OR THEODOLITE.

In reviewing the different parts of the transit and theodolite, it will answer our purpose to include them, for the present, under one head, using both terms as synonymous—the word theodolite having been defined as an instrument of angular measure, possessing two graduated circles, normal to each other, which during manipulation are set in horizontal and vertical planes respectively. Bauernfeind says that it is generally believed that the word theodolite (theodolith) is a combination of *θεα* sight, *ὁδός* road, and *λίθος* stone. He says that in order to understand this derivation it must be known that formerly all supports upon which theodolites were placed were made of stone. This meaning, however, seems somewhat ambiguous, and other derivations have been sought. The etymology of the word is uncertain.

In classifying there appear two distinct groups of theodolites: the simple theodolite (called by us the simplified transit), in which the lower clamp and tangential movement is neglected; and the repeating theodolite, possessing the double horizontal movement on spindle and plate, which is the principal feature of all complete field instruments made for the engineer at the present time.*

The various parts of the transit or theodolite may be grouped under the following heads, viz.:

Beginning from the base-plate we have:

1—The tripod connection with the leveling, plumbing and centering apparatus;

* Since this was written, Mr. Lietz has introduced his Cyclotomic Transit, which will find special treatment hereafter.

- 2—The centers;
- 3—The graduated plate and verniers;
- 4—The compass and variation plate;
- 5—The standards with the vertical arc and its movements;
- 6—The gradienter;
- 7—The spirit levels;
- 8—The telescope.

I. The Tripod Connection.

An important feature of all Lietz instruments is that they are attached to the tripod by an *entirely new device*.*

It has been customary to accomplish this, heretofore, in two different ways. One is to attach the instrument to the tripod by means of a screw at the base-plate, whereby it remains complete in all its parts and is never separated above the leveling screws. This is the method employed by the best makers, but it is somewhat tedious and unsafe, as every engineer has had occasion to find out. It is often the case that the screw will not catch, and there is always a loss of time and patience in trying to enter the thread properly. Another point is that while turning it on, the entire weight of the instrument rests upon the screw thread, with a constant tendency to wear it away.

The second method of fastening the transit to the tripod is by means of the center, making it attachable or detachable above the leveling screws. In most cases the foot screws may also be turned from the tripod head, but it is not unusual to have them remain as a fixed part of it. This mode of coupling seems to us very defective. The exposed center is liable to injury in many ways. Dust particles accumulate, and it moves with difficulty in consequence, if it does not cause fretting. But its greatest fault is the incumbent necessity of providing for it what is called the *flat center*, for turning the upper plate. In such an instrument the plates stand too high above the leveling screws, which causes unsteadiness. We believe it to be very difficult, if not impossible, to do accurate work with such an instrument, to which point we shall refer again hereafter.

* It has been claimed by some that the Lietz Coupling embraces the principles of the old Strassburger Coupling, and is not new. We take the opportunity here of correcting this impression. Any one who will examine and compare the two will find the latter a *screw-coupling*, while our design is a *friction-coupling*, based upon an entirely different principle. We are not aware that there is another friction-coupling in the United States to-day, and as far as we know, we always have been and are to this day the only manufacturers of this friction device in the country.

These substantial reasons have caused Mr. Lietz to invent a *new tripod coupling*, which is regarded as the most successful innovation by all who have had occasion to use it.

The accompanying cut fully illustrates this simple but most effectual device.

On the tripod head, instead of the ordinary screw, there are three jaws. The base plate of the instrument is swallow-tail-shaped on the inside (as shown at *F*), and is provided with the spring case *C*. The coupling of the two is done by letting one of the grooves on the base plate meet any one of the jaws on the tripod head, when one-third of a revolution to the right will make the connection; at the same instant the spring *C* will fall into a hole on the tripod head, which thus prevents any possible disconnection; the latter is effected by lifting the spring *C* and turning to the left. If the tripod head should have been worn or bent by accident, the movable jaw *D*, which is worked by the side-screw *E* (with a large adjusting pin), will again give the coupling friction enough to hold the instrument perfectly firm on the tripod.

FIGURE I.

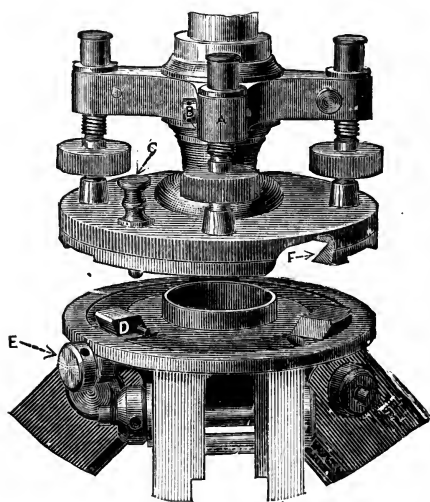

The chief merit of our arrangement is that it enables one to attach or detach the instrument to or from its tripod more

rapidly, firmly and safely than by any other device so far known, and that, too, without dividing the instrument proper into two parts, which is always injurious to its accuracy and stability, as we have just pointed out. To this we may add that it is more durable, easier to keep clean and cannot get out of repair.

The movable jaw, once set for the instrument, need not again be interfered with. It is absolutely needless to adjust the friction every time the instrument is placed on the tripod.

We feel quite confident in saying that every engineer who has once used this new coupling will readily detect its great merits, and will never be without it. All the large-sized transits and levels of the Lietz make fit the same tripod head, and are instantly adjusted.

a. Leveling Screws.

As these are used more than any other part of the instrument, it is evident that they should be very durable. Those of the Lietz make possess a very deep thread, rounded a little on the edge, which insures a very smooth motion and greater durability than sharp-edged threads. The screws are made of composition metal.

The lower construction of the transit is made with the view of affording the greatest steadiness under all conditions. For that reason the leveling screws are not run through a thin metal disc, with a common nut attached for their operation, but an extra strong, star-shaped casting, made in one piece, is provided, through which the screws are passed and in which they operate. This "star piece" *A* (see the preceding engraving, Figure I), is slotted, so that any lost motion of the leveling screw may be taken up by the clamp screw *B*. This feature is of great importance in leveling instruments or transits used for leveling.

The whole construction of this part is intended to insure the absolute steadiness of the instrument, and to give it rigidity even in a strong wind. Any other construction, with a light disc parallel to the base plate, cannot afford that stability which a first-class transit or level should possess; and, since this is one of the prerequisites of an instrument of precision,

we have laid particular stress upon our leveling arrangement, which is of the most approved modern design.

The screws are protected by dust caps, if desired, which is a necessary addition, adapted to the climate of the dry summer of certain of our Coast localities.

For instruments of the greatest precision, as those used in triangulation or geodetic work, it may be an advantage to arrange the base with three leveling screws instead of four. These changes will always be made upon application. While the ordinary complete transit is more compact and of greater utility with four screws, in a specially designed instrument for the finest work it will always be well to consider the advantages of the three-screw system, universally adopted in European instruments.

b. Shifting Center for Facilitating Plumbing and Centering.

All our complete instruments are furnished with shifting plates for the purpose of setting them precisely over a point, after having approximately done so by the tripod legs. This arrangement is of the greatest utility to the field man, and we are convinced that those who have adopted it will never again dispense with it.

While it does not make the instrument less rigid or portable, it is so easily manipulated, and becomes a great labor-saving factor. In order to center the instrument accurately, two of the leveling screws require a slight loosening, when the transit may be shifted upon the tripod until the center of the plumb-bob is directly over the point to be occupied. The screws are then turned down and the instrument leveled up in the usual manner, when it will stand as firm upon its base as required. We have placed a thin metal plate under the leveling screws, intended to prevent the accumulation of dust between the two shifting plates.

2. The Centers.

In manufacturing this all-important feature, the very backbone of the instrument, too much care and attention cannot be bestowed.

It is essential that both of these metal axes should have the same absolute center as the graduated plate and the horizontal telescope axis, whichever way the instrument may be turned. This is accomplished by the A. Lietz Company by making this detail a specialty. The carefully chosen material for the vertical axes, the exact method of turning and fitting them, and the precision reached in the manner of centering them, together with the subsequent scrutinizing test to determine the slightest eccentricity, have accomplished results as perfect as mechanical means and human ingenuity can achieve.

Eccentricity has been a source of annoyance and error to the engineer, to determine which a number of practical methods have been invented and put to use. One of the most ingenious has been inserted in this catalogue, which will be found in full elsewhere.

But with our modern transit, if used with ordinary care, this source of error has been eliminated, or at least reduced to the lowest possible minimum.

The length of our centers is from $2\frac{3}{4}$ to 4 inches, according to size and style of instrument. To our best belief, this is more than the instruments of any of the many different makers possess, having constantly handled a great many of them in repairing. Yet, by examining our illustrations, it will be noticed that with us the limb and vernier plates are nearer to the tripod head than in those of other make, owing to the judicious placing of the centers, which reach down into the base, thus insuring the utmost stability. By comparing our cuts with those in other catalogues, the reader will obtain a pretty fair idea of what we mean to impress upon him—such a comparison being better than any argument by either ourselves or others based upon mere assertion.

Examine carefully our construction of the centers, and you will be soon convinced that our claim for rigidity and stability is fully warranted.

3. The Graduated Plate.

We have now come to the most essential part—the very soul of the instrument. It is needless to dwell upon the neces-

sity of an accurate graduation; it is self-evident, and it becomes the instrument-maker's pride to make it so.

We guarantee our work in this particular as perfectly reliable, the graduation lines straight, thoroughly black and of uniform width.

The plate is accurately centered and free from eccentricity, as already explained.

The horizontal circle is graduated from 0 to 360 degrees, with two sets of figures running in opposite directions (unless ordered differently). They are large and distinct, and, to avoid errors in reading, the figures of these two sets, and those on their corresponding verniers, are inclined on opposing slants, thus indicating the direction in which the vernier should be read.

We recommend graduations on a solid *silver* ring, as that metal offers many advantages for the purpose—in fact, its great permanency and smoothness renders it the only satisfactory surface for fine graduations. However, they are made as the customer desires; but since the additional outlay for silver graduation is only \$10, we seldom have any difficulty in impressing the purchaser with its advantages.

It is customary with us to graduate circles so that they may be read to thirty seconds or twenty seconds of arc. We make any degree of refinement called for, but our manufactured goods are always on hand in the two vernier divisions named.

a. *The Vernier.*

This consists of a small sliding scale, movable upon a larger one, so graduated that n parts thereof shall include either $n + 1$, or $n - 1$ parts of the larger scale. The scale may be applied to either straight lines or arcs, and aids to determine the smaller divisions of measure between the lines on the larger scale.

A tedious method for measuring small values of arc by means of concentric circles was given in the early part of the sixteenth century by a Portuguese, Pero Nuñez (Nonius), and after him the name of *nonius* is still applied in Germany and other countries to what we exclusively call a *vernier* here.

This term was justly given it in honor of the Dutch captain, Peter Werner, who gave to the scale the sliding shape in which we now apply and use it practically. Signing himself "Pierre Vernier" in a discussion of the "Nonius," written by the inventor in the French language and published in Brussels in 1631, gave rise to the term we now almost universally employ.

The graduations on a vernier are usually so made that n divisions thereof shall equal $n - 1$ divisions on the circle.

It becomes a simple problem to determine the value of n from the following equation:

Let l = length of one division on circle,
 l_1 = length of a vernier division, it is evident that
 $l(n-1) = l_1 n$, or

$$n = \frac{l}{l-l_1},$$

The value of any quantity in the equation may then be readily expressed in terms of the other; $l - l_1$, or the smallest readable division, being equal to $\frac{l}{n}$.

It is customary to graduate the circles of the Lietz transits in 20-minute divisions, reading to either 20 or 30 seconds on the vernier. The value of n in these cases is $\frac{20 \times 60}{20}$, or 60 in the former, and $\frac{20 \times 60}{30}$, or 40 in the latter; or, in other words, 59 and 39 divisions on the circle will correspond to 60 and 40 on the vernier respectively. Instruments reading to one minute of arc are divided to 30 minutes on the plate; in that case 29 circle spaces are equal to 30 vernier spaces.

Every good instrument should have two verniers; they should be covered with glass to protect them from exposure, and for ease in reading they should be provided with ground glass shades.

Our verniers are in such position that the observer need not step aside in order to read them, for we place them about 30 degrees from the line of collimation. The method of thus placing them has been pronounced objectionable, because the size of the plate level, which is at right-angles to the line of collimation, and the more important of the two, has to be re-

duced. By examining our instruments, however, anyone will see that we have attained the object without reducing its length, without placing it over the vernier, and without allowing it to extend beyond the circumference of the plate—all of which would be very objectionable features, indeed.

The space between the circle and the vernier must appear, through a magnifying glass, like a fine black line. No accurate reading can be taken if the space appears wider than a mere line of *uniform* thickness under the revolution of the plate.

b. *Clamp and Tangent Screws.*

The lower clamp screw of our transit is of the best devised shape and arrangement. It is strong and rigid, and answers the slightest touch.

The upper clamp does not come in contact with the limb, but grasps the sleeve of the outside center. This is far preferable to the old method of pressing together the two plates by means of a screw placed at some point on the circumference.

The tangent screws are *single* only, and operate in metal cases against opposing springs. Great care has been bestowed in eliminating all lost motion of these screws. We consider double tangent screws, working against a tongue, as entirely obsolete. Any instrument sold to-day with double opposing tangent screws may be set down as antiquated and behind the times. It is absolutely necessary that everything tending to create lost motion must be carefully avoided. While adjusting the line of collimation, this source of error becomes very annoying, for, in revolving the telescope, the plate is liable to turn slightly and the operator is never sure whether the cross-hairs are in adjustment or not.

The arrangement of our tangent screws combine simplicity with absolute reliability. Being single, they require but one hand in manipulation, and their judicious location and spring case arrangement make them active and operative at any instant.

4. The Compass.

Our needle differs somewhat in shape from others, being a little smaller in the center than towards the ends, for the reason

that the magnetic influence is manifested at the ends only, so that all the central metal may be called dead weight. Compared with those of other makers, the Lietz needle is, therefore, a little lighter, which conditions the increased durability of the point upon which it poises.

Hard steel has the capacity of retaining magnetism longer and better than when tempered, and for that reason we have adopted the plan of leaving one-half inch on both ends perfectly hard.

The closest attention is given to the center cap—which contains an agate setting—and to the pin upon which the needle rests, for the accuracy or sensitiveness depends principally upon these two details. These needles possess that degree of sensitiveness required in a high-grade instrument. A sluggish needle—one that will hang like a dead load—is not fit for the observation of a reliable azimuth.

The center pin must occupy the true center of the graduated circle, and must stand normal to its plane. We utilize precise instruments with high magnifying power to obtain the absolute true position of the pin, in order to avoid all errors due to eccentricity.

The *lifting arrangement* is applied with the view of raising and lowering the needle gently and gradually, as any sudden drop to the pin, or any quick action of arresting its motion, is sure to cause a rapid wearing of the point and the cap.

The *Compass* is divided into 30-minute divisions, and numbered from 0 to 90 degrees in each quadrant from the north and south points. This is done to conform with the usual practice of surveyors in this country to record bearings in the four quadrants. But any desired method of numbering the compass, either from 0 to 180 degrees, or from 0 to 360 degrees, may be had upon application.

In order to record at once the true bearings in the field, instead of the magnetic, the complete instrument is provided with a *variation plate, i. e.*, an arrangement for laying off the local deviation of the needle by a movement of the graduated compass ring, so that the indicated course of a line shall show at once its relation to the true meridian. It is so made that

the variation may be laid off with precision to the minute, by the aid of the instrument's vernier.

This is done in the following manner:

Having set the plate vernier to zero, adjust the instrument and, with the aid of a good reading glass, place it in such a direction that the north end of the needle shall point to the zero of the compass ring, which latter must coincide with the little pointer provided for that purpose. Having carefully set the instrument thusly by means of the lower clamp and its tangent screw, which can certainly be done to the nearest minute of arc, we release the clamp of the plate and proceed to lay off the amount of the local deviation of the needle in degrees and minutes by means of the plate-vernier—to the left if the variation be east. The instrument is now again in a fixed position, the telescope pointing to the true north, or as much to the left of the needle as the magnetic variation is east. We now detach the little screw on the side of the compass ring, and proceed to turn the ring until its zero shall coincide exactly with the north end of the needle, when every subsequent reading of the compass, in any position, will indicate the bearing of the vertical telescope axis from the true meridian.

This simple little device is fully up to the standard of accuracy required, for with care in setting the needle we can always obtain results correct within the nearest minute. We find that by this method the additional vernier, usually placed inside of the compass ring, becomes superfluous, as the plate and vernier of the transit are perfectly capable of taking care of the duties of this unnecessary accessory.

The variation plate has proven a great labor-saving device, as the observed courses require no reduction to the true meridian subsequently. It is now almost universally called for; and for those practitioners with whom land surveying is a specialty we should, by all means, recommend it as an indispensable feature. No complete instrument is without it.

5. The Standards and Vertical Arc.

The standards are so constructed as to give the maximum support to the telescope, commensurate with the size of the plate. They are light, but rigid and strong.

To avoid unequal expansion of the metal in the standards by exposure in the hot sun, which has a tendency to elevate one end of the telescope axis and to depress the other, vitiating the adjustment, they are now what is called cloth-finished. This finish, being a non-conductor of heat, reduces to a minimum this source of possible error, which, in very sensitive instruments, is of sufficient moment to be guarded against. Other parts of our instruments are also finished in the same manner, particularly level telescopes, which we shall have reason to mention again hereafter.

The bearings for the telescope axis are made with extra care and attention.

The axes of the Lietz transit telescopes are cut to conical bearings, which is a feature altogether preferable to the corrugated shape frequently found in surveying instruments. The advantage of the former is very evident, in that there is less friction than by any other contact; and, in addition to that, it affords a much finer fitting by reason of its conical shape. But it is *very essential* that the *hardest metal* should be used for this purpose, as a material of insufficient hardness would soon wear, and the axes would become elliptical.

One of the standards is supplied with an adjusting screw, to regulate any inaccuracy in the motion of the telescope in the true vertical plane, when the centers of the instrument stand vertically.

One standard carries the arc for observing vertical angles, which may be either a full or a half-circle, as the customer desires. It is usually made to read to minutes, but may be graduated finer if so ordered. A clamp and tangent screw are provided on the right-hand standard, which are made like those already described for the horizontal movement. Every part of the vertical measuring apparatus is strongly and accurately made and fitted, to insure the best results in its practical application.

6. The Gradienter.

The head of the tangent screw of the vertical arc movement is made somewhat larger, properly silvered and graduated into a number of equal parts on its circumference, the thread

of the screw being cut with great precision, so that its revolution may be accurately recorded by the divisions of the micrometer head.

One complete revolution of the screw corresponds to $\frac{5}{100}$ of a foot of difference in level in 100 feet. Since the head is divided into fifty parts, it follows that one division equals a difference of $\frac{1}{100}$ of a foot in 100 feet.

With this attachment grades may be established very quickly. It is only necessary to set the screw head to zero, level and clamp the telescope, and turn the screw up or down as many spaces as there are hundredths of a foot of rise or fall in one hundred feet of the grade to be laid out. With the small scale over the screw thrown back, the gradienter is used as an ordinary tangent screw. It is one of the most useful accessories, is easily applied, and adds nothing to the weight of the instrument.

This attachment is also useful in the determination of horizontal distances, it being obvious that the difference in rod reading between two complete revolutions of the screw will indicate at once the distance of the rod from the observer. Where the ground is level, or nearly so, the simple difference in rod reading will suffice; but when this is not the case, the necessary corrections will have to be applied to obtain the true horizontal distance.

7. The Spirit Levels.

We have already noted that for our purposes we import the very best article obtainable in Europe.

An instrument of precision, capable of measuring delicate differences, requires delicate and sensitive levels. This is so obvious that we ought not to call attention to it here, were it not for the fact that we are frequently approached by surveyors who wish to impress upon us the idea that this or that make of instrument met with their approval because its bubbles would stay in place when once adjusted. For this reason we want to repeat that it is no claim for superiority of a spirit level because it works sluggishly. An engineer in the field must know when his instrument is absolutely level, and its bubbles should indicate to him at once when this is not the case. If they do not

do so, then the instrument does not come up to the required standard of a precise tool. It would hardly do to place a carpenter's level on a transit, yet we have no doubt that its excellent qualities of remaining stationary would find admirers.

Remember, also, that sluggish levels are cheaper, and that it is not to the instrument-maker's financial benefit to put in a delicate and, therefore, much more costly article.

There is, of course, a limit to the degree of sensitiveness, and that we never exceed, adapting it in all cases to the work demanded of the particular instrument in hand.

Our levels are ground to the proper curvature, and each is carefully tested upon our *level tester* before it is attached anywhere.

8. The Telescope.

We have now reached another most essential feature of the instrument—that which may be compared to the head of the body, containing the delicate organ of sight—the lens.

a. The Lenses.

We have already called attention to the fact that our optical accessories are imported from Europe, and that we take great pains to obtain the best article for the purpose.

Without going into the detail of optical mathematics and formulæ, that can be readily found in any text-book on physics, we all know that it has been the constant aim to produce lenses as free from spherical and chromatic aberration as it is possible to make them. The lenses of the Lietz telescopes are of the now celebrated Jena glass—an achievement in theoretical and practical science that ten years ago was unknown, and of which it would be interesting to make some explanation here.

THE JENA GLASS WORKS.

The far-famed glass melting works for optical and scientific purposes of Schott and Associates, in Jena, was founded in 1884 by men who were of eminent scientific attainments, and who based the magnificent industry upon long continued research in this particular field. Our information comes from a short description furnished by the leading men of the enterprise,

which was published some time ago in connection with a list of the glass varieties manufactured.

The industry originated from a series of scientific investigations made for the purpose of determining, from their chemical combinations, the resulting optical properties of fusible compositions having an amorphous congelation. These experiments were undertaken by Professor Abbé and Dr. Schott, to obtain information regarding the chemical and physical principles underlying the manufacture of optical glass. This work began in January, 1881, and was prosecuted in accordance with a pre-arranged plan in such wise: that Dr. Schott made the necessary melting tests at his home in Witten, while the optical investigations of the samples obtained were carried on in Jena by Professor Abbé, or his assistant, Dr. Riedel, by means of spectroscopic analysis.

The melting tests were made at that time on a very small scale (not over 300 to 900 grains in bulk), and were solely directed to the one object of studying carefully the influences of all chemical elements that may possibly obtain in any form in amorphous fusible compositions, upon the power of refraction and dispersion in their manifold combinations.

By carefully continuing the investigations in this manner to the end of the year 1881, a number of facts and data had been collected regarding the specific optical effect of certain masses, which gave promises of new glass combinations that, for certain purposes, would possess more advantageous characteristics than those offered by the ordinary crown and flint.

In order to utilize these results in practical optics as much as possible, it was decided to continue the work on a new plan, and that was: to combine systematically glass fusions on the optic-chemical principles established by the preceding experiments that should possess, as far as possible, all the desirable optical properties, together with other physical qualities fitting them specially for practical use, such as hardness, unchangeableness, freedom for color, etc.

With this end in view, Dr. Schott removed his residence to Jena in the spring of 1882, where a special laboratory, with every facility for melting, was fitted up in a building rented for the purpose.

With the aid of gas furnaces and modern blowing apparatus, it became possible to make melting tests on an amply large scale, up to quantities of about 25 pounds.

With the assistance of another chemist for the analytical investigations, which had to be carried on simultaneously with the synthetical work, and one workman, the tests were continued in this laboratory until the end of the year 1883, whereby two special lines of investigation were closely followed, which practical optics had laid out as the principal directions of research.

The first problem considered the making of crown and flint glass couples, possessing as near as possible a proportional dispersion in the various sections of the spectrum, for the purpose of obtaining a higher degree of achromatism than had heretofore been possible by employing the usual optical glass; that is, it was sought to obviate, or to reduce the very considerable secondary aberration, which the silicate glasses still permit in all their achromatic combinations, and which is due to the disproportionate dispersive powers in crown and flint.

The second problem—considered of no less importance, although the subject involved had, generally speaking, not been deemed a necessary feature in optics up to that time—consisted in obtaining a greater variety of gradations or modifications of the two principal constants in optical glasses, viz.: the exponent of refraction and the mean dispersion.

The silicate glasses in use at that time, true to the simplicity and uniformity of their chemical constituents, show images of a simple series in which, ascending from the lightest crown to the heaviest flint, the dispersion increases in the same measure as the exponent of refraction increases, up to very small and practically immaterial deviations.

But the theoretical consideration of dioptric questions establishes without doubt, that it would simplify greatly this problem, in which numerous conditions are to be fulfilled at the same time, if the optician had his choice of *such* glasses, in which the dispersion with the same index of refraction, or the index of refraction with a constant dispersion, could be made to undergo a very considerable gradation. In this direction it

must be looked upon as a progressive step, that the systematic use of a greater number of chemical elements in glass fusions makes it possible to create the varying grades referred to—that is, it enables one to extend the variety of glasses at disposal, in some places at least, in two dimensions, which heretofore had been essentially linear in character; but the realization of this advance in practice may only be expected gradually, because of the necessity of supplying further theoretical and mathematical bases for these productions.

The experiments led to the most satisfactory results, which, for the purpose of our catalogue, it would be unimportant to elaborate in further detail; suffice it to say that the faithful endeavors of these men were universally appreciated, and that their conclusions gained the fullest confidence of those who were best able to judge of the value of their labors.

The results were reached in the autumn of 1883, and the entire research would have been completed then, had it not been for the instigation on the part of several prominent scientists, that the investigators take hold of the practical application of their theoretical achievements themselves, and to begin the industrial production of this article immediately in connection with the preceding laboratory research.

This finally led to the erection of glass melting works at Jena, with all the facilities for successful practical operation, established with the coöperation of Doctors Carl and Rod. Zeiss, who had previously given valuable assistance in the preliminary investigations. In the autumn of 1884 the factory was in condition to prepare for the production of optic glass on a large scale—both of the kind previously in use, as well as that of the newly created combinations.

To carry out the necessary and very expensive experiments on a factory scale, it was fortunate that means were furnished by a number of liberal appropriations granted from the Prussian State Treasury, which received the hearty endorsement of all scientific circles.

After surmounting great and numerous difficulties, naturally retarding the progress in a new technical field, in which the enterprise is thrown entirely upon its own resources, without

any assistance from previous experience, the Jena factory has now become a successful industry that has made its way to remain as a valuable permanent feature. Its capabilities have been sufficiently tested during the last eight years, in the intercourse with most of the optical works in Europe, so that it is now fully able to compete with them on a commercial basis.

These remarks on the Jena glass factory will convince the reader that the article deserves that general preference which is universally given it—its evolution is one based upon a true scientific foundation—for, in this case, the practical application depended entirely upon a previous theoretical research, and theory and practice must work hand in hand to achieve lasting results. A new era in optics began when the Jena glass became a merchantable article. And this new optical advance was not without effect upon those fields of science in which optical apparatus is used, for the achievements in one particular line alone—in microscopy—received a fresh impulse from that time, which was again felt in other departments, as in physiology, biology, bacteriology, hygiene—those most important to the welfare of man.

This short diversion leads us again to the subject of the telescope for engineering purposes, with which we are more particularly concerned.

b. The Object Glass.

Arrangements have been made by which our lenses are specially ground for us in Europe, and not one is accepted that will not stand the most critical test. We receive objectives and eye-pieces in sets at stated periods, so that we are always in position to supply our demand. Neither time, trouble nor expense has been spared to produce a telescope up to the standard of the most approved pattern, that shall possess all the refinement required of an instrument designed for scientific work.

The objective is formed by a combination of two lenses, a crown and a flint glass, one of which is bi-convex, the other plano-concave. The inner faces have the same curvature. As the concave lens has the longer focal length, this combination maintains the characteristics of one convex lens. The

focal lengths are so proportioned that the dispersion caused by the crown-glass lens is corrected by the flint—the well-known principle of counteracting the dispersion of light of one lens by interposing another of a different glass is made use of.

Our objectives possess these achromatic lenses, made of the Jena glass, with special care, by the most skilful opticians. The focal lengths of these objectives vary from $17\frac{1}{2}$ inches, in the case of the large Y-level, to 10 inches, in the large transit, and to $7\frac{1}{2}$ inches in the smaller instrument.

In mounting the two lenses in the cell, great care is taken that their axes are made to coincide. Should this important point be neglected, an indistinctness of image would be likely to result.

c. The Eye-Piece.

The simplest form is the so-called Ramsden eye-piece, in which two plano-convex lenses are mounted so as to turn the convex surfaces towards each other. The distance between them is such that the chromatic aberration of one lens is corrected by the other—which, however, is not fully accomplished.

Another form of eye-piece was invented by the optician Karl Kellner, of Wetzlar, and fully described in a paper published in 1849. It was called the orthoscopic ocular (from *ορθος* straight, and *σκοπεω* observe), by reason of its principal advantageous feature of furnishing of every object a straight, perspectively correct, and, in every extent, sharp and well defined image. The Kellner eye-piece also consists of two lenses: a biconvex collective, of which the flatter curvature is turned towards the objective, and an achromatic eye-glass, whose construction is similar to the Fraunhofer achromatic lens. According to the inventor's description, the three lenses used in this eye-piece possess only four reflecting surfaces, and the two lenses composing the eye-glass must therefore come in absolute contact with each other. There may be two forms of the eye-lens: a plano-convex, with the curved face towards the collective; and the doubly-convex.

An ocular of this order, wherein both the collective and the eye-lens are compound, is the Steinheil eye-piece, which is doubly achromatic, but which gives a very flat field.

These forms of positive eye-pieces, wherein the focus of the objective lies in front of the combination, together with several of the negative form (the Huyghens and the Airy), wherein the objective's focus lies between the two lenses, give an inverted image, which is considered by many as an undesirable feature in surveying instruments. Nevertheless, they possess many valuable points in their favor, and for that reason they are universally adopted in Europe. In the first place this form admits of a greater amount of light than the erecting eye-piece. It also allows a longer focal length to the object glass, which is very important in correcting spherical aberration, besides increasing the magnifying power, which is a value dependent upon the ratio of the focal lengths of the object glass and eye-piece.

We have always considered this inverting form the more advantageous of the two; and we are convinced that if our engineers would accustom themselves to its use, it would finally be preferred. There is absolutely no difficulty in the inverted position of objects, and it is remarkable with how little effort the mind adjusts itself to it, so that the work may be done just as expeditiously as though the observer saw the objects erect.

But, as the erecting eye-piece is in general demand, we do not intend to introduce the inverting one; all that we wish to point out is that the latter possesses many advantages not generally sufficiently considered, and that seeing objects upside down is not an obstacle at all, for upside down and right side up are only relative impressions, which impose no task upon the brain. If the professors of civil engineering in our colleges would draw more attention to these facts, the results would soon be quite gratifying.

The erecting or terrestrial eye-pieces require four lenses, placed so as to correct the chromatic aberration. In this form the inverted image of the object glass is again inverted, and an erect one is created between the third and fourth lens, which is viewed and magnified by the fourth. This is the form used for our transits and levels, and we can again insure our patrons that in this line nothing better is produced. The optical powers of the telescope are in perfect keeping with the accuracy of

the centers, graduation and spirit levels, insuring a complete reliability and harmony in every part of the instrument for the most refined surveying work.

The eye-piece (always erect unless specially ordered) is so arranged as to permit its easy removal, if necessary, by simply unscrewing it. In replacing, it should always be well tightened up. It is movable in and out by a revolving motion, turning the cap about one-sixth of a revolution backward or forward—a manner which affords a finer and more precise focusing of the cross-wires than by means of a rack and pinion.

Having reviewed generally the optical details of the telescope, we shall describe in a few words the mechanical construction of its other parts.

d. Other Parts of Telescope.

The *slide*, to which the object is attached, fits directly in the outside or body of the tube. Particular attention is paid to this part to prevent even the slightest *shake*, and still procure an equal and sure motion, which is absolutely necessary, as no true adjustment of the line of collimation is possible otherwise. The motion is given by a rack and pinion.

The sliding tube is protected from dust and dirt by an exterior metal cylinder, called the *slide protector*.

A *sun shade* is provided for the objective, which should always be attached, as the telescope, when focused to mean distance, is balanced with it; and a cap is provided for the protection of the objective when not in use.

The *cross-wire frame* is suspended in the tube by four capstan-headed-screws, by which it is adjusted, the frame being so constructed that the cross-wires cannot be torn, in case the adjusting screws are tightened too much.

The *spider web* used for our instruments is properly treated to avoid all twist, and to prevent its lengthening and becoming crooked in damp weather; it cannot become loose, as it is well secured.

For mining and tunnel transits we can provide proper means for *illuminating* the cross-wires—an arrangement that is readily supplied upon application.

Quite a number of *glass diaphragms* have been cut by us for the United States Coast and Geodetic Survey. Instead of the spider webs, a small disc of very thin glass is fastened to the diaphragm, on which fine lines have been drawn with a diamond. It is readily seen that these cannot get out of shape, and for stadia measurements we think them of great advantage. The only drawback is that small particles of dust may settle on the glass disc, and, as they are in the focus of the eye-piece, they will be constantly visible to the observer.

We make no extra charge for putting these diaphragms into our new instruments, if ordered in time.

Stadia hairs are placed in all our transits (and levels), unless ordered without. We have superior facilities for setting them with great precision to any desired ratio between distance and rod reading. It is customary to place them so that they shall read 1 foot on the rod for a distance of 100 feet, and to this measure we always have them in our stock on hand.

The stadia hairs may be *fixed* or *adjustable*. We advise the fixed, as they are less liable to change their distance. In an adjustable set the observer is never certain that the position of the wires has remained unchanged. We have constructed a delicate optical and mechanical apparatus for fixing stadia hairs accurately to any proportion; and by means of our powerful telescope, which has superior optical qualities, we can safely say that, with proper care and a little experience in that method of measuring, very satisfactory results may be obtained. The facilities for measuring across inaccessible places, and the speed with which it enables one to get distances, has brought this method into deserved prominence with our engineers. For topographical surveys it is indispensable.

For the benefit of our patrons we have added a short treatise on stadia measurements, together with a table for correcting the observed reading to the horizontal distance and difference in level, which see in Part III.

When purchasing a new instrument, it is advisable to get one that has fixed stadia wires, which increases the cost only \$3, while we charge \$10 to put them into a transit sent to us subsequently.

In sighting with the telescope it is of considerable advantage to have it *reversible*, and our transits are made so as to allow this free revolution in a vertical plane. The telescope balances accurately when in focus to mean distance, the friction in the bearings being shaded to such a degree of nicety that it shall neither work too hard nor too loose—a feature which ought to have very close attention.

c. General Remarks about Telescopes.

When selecting or examining an instrument, the engineer should be particularly careful to test the qualities of the telescope.

It should have sufficient magnifying power to correspond with the finer qualities of the graduation, axis, centers, spirit levels, etc., of the instrument. There can be no doubt that the excellencies of each detail must compare with that of any other.

Now, by using a low-power telescope, the *defects* of an *inferior instrument may be hidden, or left undiscoverable*, and for this reason they will always be found in articles of lower grade. Had such an instrument lenses of sufficient magnifying power, the defects would become apparent to the engineer at once. We lay the greatest importance upon these facts, and for this reason call particular attention to them. *Scrutinize the optical abilities of the telescope, and you will obtain the character of the whole instrument.*

For obvious reasons, some makers—but more especially dealers—give the magnifying power of the telescopes of their instruments much higher than it really is. An engineer should, therefore, be careful to convince *himself* of the real magnifying power before making a purchase. He will find it much to his interest to do so.

We have found that the power of first-class instruments should be about twice as many diameters as the length of telescope expressed in inches. In inverting telescopes it may be materially increased, which shows again that they are of considerable importance in very high grade instruments.

In another place we have added a practical method for finding the magnifying power of a telescope, to which we would

advise our engineers to give some attention, and to make use of when about to choose an instrument.

We have already pointed out the importance of perfectly centering the lenses, especially the objective. If this is not properly attended to, the adjustment can never be perfected for long and short distances.

We have heard many complaints from engineers about the change in adjustment, and after careful examination we have found that the adjustments remained intact, but that the fault lay in the objective, which had not been correctly centered. We take great pains to center our object glasses perfectly, and to insert the lenses in such a manner that if taken out they may be replaced in the old position, which is secured by a notch and a pin. It is not advisable for engineers, however, to take these lenses from the cell, as their cleaning may be effected without removing them.

Reverting again to the magnifying power of telescopes, it may be asserted that an increase thereof reduces the field. This is no defect, if the size of the latter is retained large enough to admit of stadia lines so placed as to read 1:100. We often leave the field much larger, however, in which case there appears just a slight dimness at the extreme border; this is unimportant, for it does not retract any of the virtues of the glass, and possesses, if anything, an advantage of finding an object more readily:

The quality of some of the telescopes of our best makers has often been questioned by competent engineers on account of a peculiar haze ascribed to the glass. This was found to be caused by a small film of moisture, which settles between the crown and the flint, and is not visible to the naked eye. We have been convinced, by advising with our optician, that the crown and flint glasses should always be connected with balsam. This does not decrease the amount of light, as formerly thought, but, on the contrary, it has advantages of clearness, in that it prevents foreign matter from settling between the lenses, which always destroys the image; the refrangibility, too, is under more favorable conditions in the balsam.

Extra Accessories for the Transit.

There are a number of additions made for transits used for special purposes, and these we keep on hand, and supply them when called for.

For *laying off right-angles*, for instance, we can make any provision, if the customer will order it in time. In fact, any of the accessories, not usual in the ordinary complete field instrument, will be made as an extra if our patrons will notify us.

For the *solar attachment* we provide a block with a thread on the telescope axis to receive the beautiful little apparatus known as the "*Saegmuller Solar*," of which a complete description will be found in Part III.

The Finish.

This is made to give the instrument an elegant, tasteful appearance, without adopting a color glaring to the eye. Our instruments are finished in a number of hues, and may be bronzed to the special taste of the purchaser, if he chooses to order it.

Size of Transit.

The dimensions and proportions of the several parts of the transit are given in Part IV of this catalogue, where the different sizes and varieties of instruments made are described more in detail.

Packing.

This is not at all an unimportant feature. Our transit is easily taken from the tripod by means of the Lietz friction coupling already described, and set upon a wooden slide, to which it is fastened by means of two thumb screws and wooden clutches—a manipulation requiring but a moment's time. Nothing is taken from the instrument except the shade—it remains a complete whole from the base-plate to the top of the telescope. The board slides into the box with the transit in an upright position, with the clamps secured to keep it from turning. An extra place is provided for the solar attachment, if there be one. The door may then be locked, and the instrument is absolutely safe, with the least effort of packing and adjusting in the box.

Rubber cushions are provided at the bottom of the case, to take up any sudden jar or jolt to which it may be exposed during transportation.

A rubber bag, or a silken one, may be had as an extra to each instrument, as well as a bottle of fine watch oil for lubrication of centers, etc., and camel-hair brushes for dusting. Likewise are a number of adjusting pins supplied.

The Tripod.

We have adopted the new form of *split leg*—a construction which combines the greatest stiffness and strength with the least weight. The old form of the heavy solid leg has long since been abandoned, and we no longer make such a tripod, unless specially ordered by some conservative customer, or for very small instruments. We aim to reduce the weight of everything, without sacrificing steadiness or strength in any particular, and that the split leg meets these conditions better than the solid one must stand to reason.

The very best white ash is chosen and carefully worked. Instead of fitting the leg between two brass cheeks, we fit one cheek in the leg. In the older construction it frequently happened, in drawing the bolts closer to tighten a loose leg, that the cheeks would spring the plate, or weaken the screws that hold it. This is entirely obviated by the new arrangement of these parts, for the tightening can no longer affect the plate in the least. While in the former the leg would only fit at the lower part of the cheeks when drawn in by the bolt, it will always fit the whole surface of the cheek in the plan we follow, and after ten years' use it will be just as steady as when new.

The *shoes* are made on a gradual taper to a sharp point, and securely fastened to the leg. They are provided with a projection for pressing upon with the foot when setting up.

The large transit and the level fit the same tripod—in fact, any Lietz instrument may be readily fitted upon the tripod we manufacture, for the adjustment of the friction coupling allows a perfect accommodation to any slight variation in the parts of the base-plate.

LEVELING INSTRUMENTS.

The A. Lietz Company manufactures two different varieties, which are constantly kept in stock, the *Y-level* and the *dummy level*.

In the manner of making these instruments, much that has been said of the transit will hold good here, and need not be repeated.

The three main qualities to be secured in a level are: *stability*, a *sensitive bubble* and a *powerful telescope*.

To secure the first, we need only refer to the solid construction of the star-shaped casting through which the leveling screws operate, already described in speaking of that feature in the transit. The Lietz coupling, too, plays an important part here, for we can make the tripod connection absolutely rigid.

The *center*, or spindle, is almost three and one-half inches long, and is continued through the clamp up to the bar, which enables us to bring the center of gravity as near as possible to the tripod-head. Great care is exercised in fitting the center to the socket, and, being made of steel, it must be apparent that it is an utter impossibility to wear out these parts even by fifty years' constant use. The liability of bending the spindle, so common an accident with instruments having brass centers, and the fretting of the same, also likely to happen at times, is altogether avoided by a steel center. The fact is, every level ought to have one, and its omission is simply due to the fact that it is more expensive to manufacture.

The reasons for having a *sensitive bubble* have also been carefully set forth heretofore. Accurate work cannot be done with a sluggish bubble. No matter how much the virtues of the staying qualities may be extolled by some men, they are not fit for refined work if they do not answer the slightest touch of the leveling screw. If you can give a screw a twist or two before the bubble loses its peaceful equanimity, the work in hand would not be likely to inspire any great confidence.

Our level tube is curved, so as to give for every two minutes of arc a one-inch motion of the bubble. A refined level of this character, however, will only do good service in

an instrument having perfect steadiness and a powerful and sharply defining telescope. If placed in a level so constructed as to be topheavy, or in one whose center is frequently exposed by being a part of the tripod head—and therefore liable to collect dust both on the cone and in the socket, introducing sources of error after every detachment—then it will indeed prove very annoying, should an active bubble accompany such an instrument. These structural defects are probably the cause why many of our engineers are prejudiced against sensitive levels, and prefer a sluggish or dull one. We can only assure the reader again that a lively bubble, even if a little out of center by reversing the instrument, will still accomplish better results than an inactive one—one that gives the instrument an appearance of steadiness, which in reality it is far from possessing. An engineer only deceives himself if he trusts to a slowly-acting level, which gives apparent satisfaction by concealing the errors that a sensitive one would soon indicate. A well-made instrument never suffers by having its qualities exposed by a high-grade bubble.

The level *telescope* should have power and definition. It is hardly necessary to make that statement, after all that has been said on this subject in a previous chapter. It has been our earnest endeavor to obtain these results, without increasing the dimensions of the telescope and the other parts of the instrument, beyond the proper limits for steadiness and portability. A length of eighteen inches we have found to give the most advantageous results. Experience has shown us, that although an increased length adds to the magnifying power, it would only be of value if the other parts of the instrument were enlarged in proportion, which, on the other hand, would make it too heavy for convenience in carrying. While in some exceptional cases such an instrument might be preferable, we believe that with our 18-inch level even the most extensive requirements in engineering are fully met.

Our new and improved eye-piece, and the use of an objective of larger diameter than ordinarily found, enable us to obtain a magnifying power of 33. An increase of diameter adds very little to the weight of the telescope, and does not

require a longer bar and larger plates, as an increase in length necessarily would, to retain steadiness. An aperture of $1\frac{3}{8}$ inches, used to its full value, affords a high illumination with the above-mentioned power, as the tube is large enough to let all the rays proceeding from the object glass pass through to the field of view—an important point disregarded by a number of manufacturers.

The diameter of the aperture of the object glass divided by the power, gives the diameter of the pencil of light entering the eye. In our telescope we obtain, therefore, $1\frac{3}{8} \div 33 = \frac{1}{24}$ of an inch, which shows that power and brightness are in accordance with optical law. To force the power beyond these limits we cannot conscientiously do, as that would be allowable only under certain circumstances—such as a perfectly clear atmosphere with a strong illumination of the object.

The *collars*, upon which the telescope rests in the Ys, are made of the hardest bell metal, and admit of a position in either direction, that is, the telescope is reversible. The very first requisite is that these collars must be of exactly *equal diameter* and *perfect cylinders*. If this be not the case, the line of collimation will not be parallel to a tangent of the bubble's curve at its highest point, when the latter indicates a horizontal position, and, for this reason, a true level cannot be obtained with such an instrument.

It is very often believed that in the course of adjusting the Y-level, by reversal of telescope and revolving on center, the bubble will indicate any inequality of the collars, but this is by no means true. If the Ys are both filed out to the same angle (this is generally the case, or at least very nearly so, as most makers file them out by means of gauges), the *inequality* of the collars may be quite appreciable, and yet the instrument will be adjustable in all its parts; in other words, it may be so adjusted that the bubble on all reversals in the Ys and revolutions on centre, will always give the same reading at both ends, that is, indicate a true horizontal position. A final test is necessary, therefore, after the instrument is properly adjusted, to ascertain the equality of the collars. This will be mentioned further on under the head of adjustments.

Similar causes for error are introduced if a particle of sand lodges between the collar and Y, which illustrates the necessity of keeping these parts free from all dust and dirt.

It is readily demonstrated to what considerable differences any slight inequality in the diameters of the collars may give rise to, but the space here will not permit of a mathematical discussion of the subject.

We have carefully explained this defect, owing to the conviction on our part that it is a much more common one than is generally suspected. Numerous cases have come under our observation, where this fault existed in a remarkable degree. And in the perusal of many works on engineering and surveying, we have noticed very few that call attention to this material defect, and still less that give a correct test for it.

We are aware that accurate leveling may be done with a level out of adjustment, if the utmost precaution is taken to have equi-distant fore-and back-sights. But looking at it from this point of view, why not use the dumpy level then, instead of the more costly Y-level?

The Finish is made to give the instrument an elegant appearance, and yet obtain all the qualities alluded to in a previous discussion of the same subject. The telescope is usually *cloth finished* to avoid that unequal expansion of the metal heretofore mentioned. This finish is of a color pleasing to the eye, is applied so that it remains intact for a long time, and if somewhat worn after a long period of exposure, it can be readily re-applied without difficulty at a trifling expenditure. The cloth finish is a modern feature, and one that is so universally preferred, that we have no hesitation in recommending it to our patrons as worthy of their consideration. However, we keep in stock the bronzed and lacquered, as well as the cloth-finished level telescopes, so that the customer may have his choice in the matter.

The level telescope is supplied with a *slide protector* and with a *sunshade*; the latter should always be put on to balance it evenly. A cap is also provided for the objective and a shutter for the eye-lens.

In all other matters the transit details obtain here also.

Fixed stadia wires are supplied, set to read 1:100, for which an extra charge is made.

The center movement is checked and regulated by a *clamp* and *tangent screw*, exactly similar to those of the transit.

Other useful accessories are attached, but any feature not usually found in the Y-level, must be ordered beforehand. If desired, we place *agate fittings* in the Ys for the collar contact, but for this we also make an extra charge.

We are likewise in a position to make, but upon order only, *levels of precision* for the most exact work that the geodetic surveyor is called upon to perform. These are provided with all the delicate details that such an instrument must possess. We invite correspondence upon the subject of geodetic instruments, and will cheerfully furnish prices after consulting with our patron upon the nature and character of the instrument required.

The *packing* in the case has been made so as to assure safety in transportation, with the least trouble and inconvenience to the operator. The level is taken from the tripod by a third of a revolution of the base plate, which undoes the Lietz Coupling. It is let down to stand upright in the box, the telescope having been removed from the Ys and placed with its collars upon padded brackets at the side of the case, when the closing of the lid holds everything firmly in place. In all minor details the level box is similar to the transit case, every means being employed to insure absolute safety.

The Dumpy Level.

In this instrument the aim has been to construct it in such a manner that it shall be as compact as possible by dispensing with certain features of the Y-level, not absolutely necessary in order to do good and reliable work.

The principles governing its construction are the same as those that obtain in the more elaborate Y-instrument.

The telescope is permanently held by two vertical arms attached to the level bar, and cannot be taken therefrom. The level tube rests upon these arms, over the telescope, and is also fixed. The telescope tube is thereby brought as close as pos-

sible to the tripod head, which is a desirable characteristic. All the other features remain the same as in the Y-level construction.

This instrument, which is almost exclusively used in Europe, has not yet met with that favor by American engineers, which its simplicity and accuracy so justly deserve. This is due partly to its greater inconvenience in adjusting as compared with the Y-level, and partly on account of defective construction, inferior telescope and other neglected details, which usually obtain in instruments of this kind.

We are confident that a dumpy level possessing a good telescope, sensitive bubble and stability, will do *just as good* work as the more costly Y-level. While the adjustment of the latter is made more readily, the former will *retain* it longer.

Our dumpy level has a bronze center, a 15-inch telescope, and a vial of such curvature, as to give for each inch of motion of the bubble an angle of three minutes.

There is no clamp or tangent screw to this form unless ordered by the customer.

Bar, telescope and vial case are cloth finished, and the latter may be provided with a folding mirror, which acts as an important protection to the more exposed spirit level when shut down, or as an indicator to the observer at the eye-piece, of the exact position of the bubble, when elevated.

The stadia hairs may also be supplied to the dumpy level.

Other Levels on Sale.

In addition to the high grade instruments manufactured in our shop, we keep on hand a supply of smaller and less costly goods, imported from Germany. With these instruments work may be done by the ditcher, irrigator, contractor, grader, farmer, dike builder, gardener, plumber, architect, forester and military man, sufficiently precise for many ordinary purposes, wherein great accuracy is not required.

For a more detailed description of these instruments, see Part IV of this catalogue, containing a price list of articles on sale.

Remarks.

In the foregoing we have endeavored to give the reader a fair idea of the principal engineering instruments made by this firm. We desire to convince our future customers—our old patrons we have long since convinced—that we are building conscientiously upon scientific principles, that every part and detail has been carefully studied to meet the requirements of our engineering fraternity, of the climate, and of all those conditions that influence the shape and character of every feature of the surveying instrument. It must permit of all operations at the least expenditure of time, it must be compact, it must be light, it must be absolutely accurate, it must be rigid, it must be stable and it must possess strength. And wherever a possible improvement is suggested in any detail, it must be applied at once and tested as to its probable merits, and if it prove of value, no time must be lost in introducing it. These are the principles that have governed the manufacture of the articles which we have brought to your notice.

New improvements have always had our attention, without any regard of the expenses incurred in experimenting. We need only refer to the recent introduction of aluminium in the manufacture of surveying instruments, which, we are fully convinced, has been crowned with success, to prove to our patrons that we never allow any conservative notion to rule the establishment. The particulars of this new field of manufacture will be found in another chapter of this part of the Manual.

With the object constantly in view to make only the very best article that can be procured anywhere, and ever ready to introduce improvements and to experiment with suggestions that may lead to them, our instruments are held at a price that is commensurate with their qualities. Their values are rated by those current among first-class instrument makers; they are *no more*, but they are *no less*. We do not handle cheap goods, and the trade that we are most anxious to please is that *willing to pay a fair price for a number-one article*. With us the value of an instrument depends upon the features involved and the accessories supplied, and *never* upon the workmanship; that is

always first-class, from the simplest compass transit to the most improved transit theodolite.

It was our purpose to describe in this catalogue only the instruments for which there exists the greatest demand, and for this reason we do not intend, at this time, to enter into any detail of the manufacture of other scientific apparatus that we are in position to furnish upon due notice.

Theodolites of the highest grade for the most exact purpose, reading with micrometers to the most refined division, will be made upon order to any desired shape and design, and with every required accessory. This also holds good for all nautical apparatus, such as sextants, three-armed station pointers, logs, barometers, compasses, marine glasses, etc., etc.

We also manufacture the topographer's *plane-table*, either in its simplest form, as recently perfected by the highest authorities, or in its most delicate arrangement of parts, as devised for work of the greatest precision capable of being put on paper. A number of plane-tables made for our institutions of learning, and for surveying departments of the U. S. Government, have given absolute satisfaction, as shown by testimonials in our possession.

The modern improved plane-table alidade is a particular specialty, to which we have given considerable time and attention. This instrument has been constructed by us of aluminium, which has been a perfect success, proven by the fact that one of them has been almost daily in use for some time, under very trying conditions, without giving rise to the first complaint. Under the head of *Aluminium for Surveying Instruments*, this will be again referred to. By a combination of aluminium and aluminium bronze, the center of gravity of the alidade may be brought close to the foot of the standard, which is a very essential point in its construction.

ALUMINIUM FOR SURVEYING INSTRUMENTS.

A great deal has been said and written about this comparatively new metal of late, so that its characteristics have become generally known.

Its color is a dull white, similar to silver, and rather pleas-

ing to the eye. It embodies many qualities that make it a very valuable material in the mechanic arts. It is quite soft, but possesses malleability, tenacity and ductility, so that it may be made into very thin sheets, or drawn out into fine wire. It is a conductor of heat and electricity. One of its principal features is that it does not oxydize in the atmosphere, and that it does not lose its brightness under conditions that would tarnish silver and blacken it, for sulphuretted hydrogen or sulphide of ammonium do not influence its color. But the greatest advantage is its remarkable light weight, the specific gravity being only 2.6, or one-fourth of that of silver, and for this particular quality its use has been sought in the manufacture of articles requiring small weight, ever since the cost of its production has justified it.

One of the many alloys is the so-called aluminium bronze, which unites hardness with malleability, and is therefore extensively used for many purposes. This alloy, however, gains little in lightness as compared with the ordinary metals.

Since it has been the constant aim to produce field instruments that shall combine strength with the least practical weight, there could not have been found a better application for aluminium than in the instrument-maker's art.

It was necessary to experiment with it in different directions, particularly as to the proper alloy—it being much too soft in its pure state—that shall give the required tensile strength and stiffness, make it workable without fretting, and yet add little to its weight. An alloy with silver is now made that fully satisfies these conditions.

One of the principal objections urged against it in the manufacture of surveying instruments is, that on account of extreme lightness they would not be steady enough in the wind. This firm has built a number of transits and levels of aluminium, and, in our opinion, they are quite as rigid as any other, if properly constructed, care being taken to adhere to the old material in such details where it cannot be dispensed with.* We have found that the stability of an instrument depends more particularly upon the construction of its lower parts. If the combination of base-plate and leveling apparatus be made

* See Testimonials for instruments made of our aluminum alloy, on fly-leaves.

so that the instrument can be rigidly held, a little more or less of wind surface is not so important, as long as every part is equally strong. The center of gravity, too, may be brought down a little lower, and that in itself would tend to increase its stability.

Aluminium transits are made by the A. Lietz Company in two sizes, being complete field instruments with every accessory. The large transit weighs $7\frac{1}{2}$ pounds, and the small one $4\frac{1}{2}$ pounds, which reduces the weight about one-half. The construction is precisely the same as in the instruments already described.

The base-plate is of composition metal, the inner center of the hardest bell metal, and the outer center of bronze. The leveling screws are also of composition, as well as the bearings of the telescope axis. That means, that wherever any part is subjected to particular wear and friction, the old metal has been retained, while all the rest of the instrument is made of aluminium.

These transits may either be left in the beautiful natural color of the metal, or other shades may be applied. The standards are cloth-finished.

The *Saegmüller Solar Attachment* is now made of aluminium, which can only be an improvement in any direction, whether its weight be added to the top of a transit made of the old red metal, or to one of the new metal. Lightness in the solar attachment is a very desirable feature, and that may be easily obtained now.

In the *Y-level* the base-plate and leveling screws are of composition metal, the centers steel, the collars the hardest bell metal, and the rest aluminium. It has an 18-inch telescope, its weight being $5\frac{1}{2}$ pounds.

In the *dummy level* the same features obtain, except that the centers are of hard bell metal. Its length of telescope is 15 inches, and its weight $4\frac{1}{2}$ pounds.

Both levels are cloth-finished, similar to those already described.

We also manufacture a *plane-table alidade* of aluminium, with a ruler of aluminium bronze. This instrument, although of the same weight as one of the ordinary metal of the same

size, possesses the particular advantage of having its center of gravity as low as it can possibly be brought to the table, and that when placed upon the board it will be absolutely stable, and will not be influenced by the wind, which causes the ordinary alidade to tremble and travel on the paper.

And this is the reason why we should object very strongly to an aluminium rule in a plane-table alidade. This part of the alidade should be of heavy material, as well as the lower part of the standard, while the rest may be constructed as lightly as possible. In this case little or nothing may be gained in the weight, but very much is gained in stability, when compared with an instrument made of one metal throughout. Under no condition should the RULE, which is the BASE of the structure, be made of a light material.

After several years of experience in the construction of aluminium surveying instruments, we are ready to advocate the *judicious* use of this material. We have applied it in transits and levels, and have accomplished a saving in weight of about 50 per cent. Great care is exercised in the proper distribution of the metal. We have already stated that in a transit aluminium is never used in the construction of the base-plate, centers, leveling screws, clamps, bearings of telescope, and all minor parts having threads. The principal horizontal members, the plates, are of aluminium, strongly ribbed.

Much has been written about its high coefficient of expansion, and particular stress has been laid upon the effect of unequal expansion necessarily induced by the use of different metals. If this matter be considered for one moment, however, it will soon be seen that practically there can be no serious result from this source. In the first place, the difference between the coefficients of brass and aluminium is altogether too small * that the effect of any possible distortion in material judiciously placed need necessarily be feared. Glass plays a very important part in the make-up of a transit. The coefficient of expansion in glass is very low (0.8 mm. per meter, raised 100° C) and a metal best adapted for our purpose would be one having the same coefficient. Now, as far as brass and aluminium are concerned, it is readily seen that there is practically no difference in them when compared with

* (The Physical Laboratory of the German Empire has established the following: for brass 1.88 mm. per meter of length, raised in temperature 100° C; for aluminium 2.34. Our reductions are made from these data.)

glass. As long as glass is used, one may as well employ aluminium as brass for the constructive parts, for while the expansion of the latter exceeds that of glass 0.000072 inches per linear foot for 1° Fahrenheit, that of the former does so only by 0.000103.

Unequal expansion, therefore, is not a source of error that need reasonably be feared. In an astronomical instrument intended for the greatest possible precision, we are willing to concede every element of structural refinement; but in an engineer's transit, where a limit of twenty seconds of arc is seldom exceeded, and one of thirty to sixty seconds all that is ordinarily required, the possible disadvantage of an excess of $\frac{3}{1000}$ part of an inch in expansion per linear foot, in a change of temperature of 100° Fahrenheit, is entirely overcome by the very great advantage of the reduction of the weight of the whole. A small red metal transit with a 5-inch plate will weigh $14\frac{1}{2}$ pounds with the tripod. If this load can be reduced to $10\frac{1}{2}$ pounds, we are giving to the field engineer something that he will appreciate far more than the possible error due to the unequal expansion.

The more vital objection to a light instrument — its greater unsteadiness in the wind when compared with a heavier make — is something we have already referred to. We have sold quite a number of aluminium transits and levels, and every one has been a proof of our statement made two years ago: that the stability depends more upon the construction of its base and connection with the tripod than it does upon the weight of what may be called its superstructure — the part above the leveling head.

We intend to furnish the proof of this by a systematic test, as we are now experimenting with instruments of the same make, same superficial area, but of different weights, in strong wind.

It may also be mentioned incidentally that a fall will injure an aluminium instrument less than if made of red metal. Not only is this theoretically correct, but our actual experience in this line has proven to us the fact that from ordinary accidents the lighter instruments are always less seriously injured than the heavier ones.

The testimonials from our customers will show the public that the aluminium instruments made by our firm have given the fullest satisfaction, and have not disappointed our expectations.

We are firmly convinced of the adaptability of aluminium for surveying instruments, and for that reason our firm has gone extensively into that branch of manufacture, for which every facility has been added recently to the capacities of the shop. The aluminium instrument is fifty per cent. lighter than the other, is just as strong, is just as precise in its workings, possesses every requisite detail of a complete field instrument, and, *we claim*, is just as stable. Those of the engineering fraternity who have to carry the transit all day, the mining and railway men, who climb the mountain sides during the long summer days from early until dark, will not be long in finding out these advantages and in putting them to a severe test in every direction.

CARE OF INSTRUMENTS.

The greatest source of danger to a delicate instrument is *careless handling*. It is often subjected to violent usages for which there is absolutely no need. The rude way of manipulating its delicate parts; the unnecessary display of digital strength in operating a clamp; the useless strain applied to the leveling screws; the careless manner of carrying it; the rough method of taking it out of its case, or replacing it; and the incautious closing of a lid or door of a box by force, before the instrument is somewhat adjusted to its position; all these are sources of danger that vitiate its adjustments and cause no end of trouble and expense. Although a well-made instrument is so designed as to stand many a shock without direct injury, any daily repeated abuse is sure to have its ill effect, from which your work must suffer. Our warning to be careful in the handling of your instrument, is therefore a well-intended piece of advice.

As the usefulness of a transit or level may be preserved for many years by a little attention to details, we shall enumer-

ate a few of the principal points which the engineer will do well to observe.

Always protect your instrument from rain by throwing over it a waterproof bag; and if it gets wet at all, clean it thoroughly after getting under shelter. It is not well to enter a hot room from the cold air, without giving it some protection. The condensing vapor settling on the metal and glasses is certain to give rise to injuries. It is always safe to place the instrument in its case before going into a warm room in winter. It is not wise to leave your transit or level exposed for hours to the hot sun. Shade must be given either by a hood thrown over the instrument, or by holding an umbrella. Attention to these points will preserve the accuracy of all the delicately adjusted parts, that by an unequal expansion or contraction would be certain to suffer.

But, accidents are liable to happen, and for that reason we have noted down a few remedies in case of an emergency.

The general tendency in the use of the screws is to overstrain them. This should never be done, especially with the cross-wire screws, which, when brought up too tight, are liable to constant change and loss of adjustment. The leveling and clamp screws, if overstrained, wear out sooner and may show fretting. If this takes place, they should be taken out and brushed with a little coal oil or benzine. The nuts are best cleaned by screwing a flat piece of soft wood through their apertures. In putting them together oil them slightly.

Fretting of the centers and of the telescope-slide will interfere more with a correct working of the instrument than any other part out of order. They should be watched, therefore, very closely, and as soon as any rough motion manifests itself, it should be remedied at once, if possible, by an instrument maker. If this cannot be had, and the fretting is in the slide, first scrape and then burnish down the place where it frets. It may also be ground slightly with oil and very fine pumice stone dust, which is best obtained by rubbing two pieces on each other. After grinding them a little, the tubes should be cleaned and placed together again with oil only; then move them in and out a number of times, wipe the oil off, and

finally put them together when dry. Should the fretting occur in the centers (if properly made and constructed, so that they do not come apart in detaching the instrument from the tripod, this will never happen), employ the same means; and if this be not effective, place a washer, made of paper or a thin card, between the shoulders. This will cause a shake, making accuracy impossible, and will introduce errors of parallax in reading off, which is better, however, than to destroy the centers wholly. The best unguent for them is very fine watch oil. Regarding *our centers*, we are fully prepared to *assure* our customers that *no fretting will ever happen*, as they are never exposed, and made with the utmost care.

The object-slide should not be oiled. Never, under any condition, use emery in trying to repair an instrument, as it cannot be removed again and will grind continually.

An efficient lubricant for leveling screws, clamps, pinions, etc., is well rendered marrow.

If an instrument is upset, thereby bending centers and plates, do not turn it unnecessarily, as this will disfigure the graduation, but send it to a competent instrument maker immediately. There should be no delay in repairing defects.

In the matter of the tripod, it is wise to look to the screws that hold the legs frequently, and to keep them well tightened up; and to inspect the shoes, to see that they do not come loose. An instrument cannot be steady if there is any shake in the tripod, which is its support and must be firm in every particular.

The graduation is a very delicate detail to handle, and should be approached only with the utmost care. It is safe to leave this part to the instrument maker, and not to attempt to remove the plates, as they cannot be properly re-centered without the aid of a testing apparatus. An exposed graduation may be cleaned with a little watch oil and a chamois skin.

To preserve the sensitiveness of the *needle*, the center pin must be prevented from becoming dull. The instrument should never be lifted without raising and arresting the needle, and if, upon letting it down again, the swing is too large, gently stop it when within a few degrees of its natural bearing. Every check and start must be made gently, never abruptly. Should

the point become dull, it is best to send it to an instrument maker; if this be not practicable, a watchmaker may perhaps attend to it. It should be remembered, however, that the point of poise must be centered—that is, occupy the center of the graduated circle. This cannot be done by a watchmaker, and is only to be relied upon if made in an instrument maker's shop.

If a needle is made of good steel, well hardened and properly charged, it will not often lose its magnetism; and if, when placed away, it is always brought to lie in the meridian, it will retain, or even increase its polarity. If a needle has lost its magnetism it may be charged again with an ordinary horse-shoe magnet; one of three inches in length will be suitable for this purpose. The operation is this: hold the magnet with the poles upward, then, with a gentle pressure, pass each pole of the needle from center to extremity over the opposite pole of the magnet, describing before each pass a circle with a diameter of about double the length of the needle, taking care not to return it in a path near the pole. If the magnet is strong enough, the needle need not be taken out at all, but by raising it against the glass and then passing the magnet over this, it will be charged sufficiently. After charging, the needle has lost its balance, which may be easily restored by shifting the brass wire on the south end.

The observer should always satisfy himself that there be nothing about his clothing, especially in the make of the buttons, that would have any influence upon the needle.

In the matter of the telescope, intelligent handling will do much towards preserving its accuracy and reliability for a long time. In cleaning any of the lenses, use a soft rag or chamois leather. If the glasses should become greasy, or very dirty, wash them with alcohol. The inner faces will seldom require cleaning, and it is not advisable to take the telescope apart too often, as it is likely to destroy its adjustment. If dust should settle on the cross-hairs, it is safest not to touch them. The only remedy that may be tried is to take out both the object-glass and the eye-piece, and to blow gently through the tube. This may remove the dust without injuring the threads, but it is quite a delicate operation.

Cross-hairs may be replaced in the field by the engineer. The spider web is cleansed from dirt by placing it in water for a few minutes. A little manipulation readily removes any particle that may adhere to the thread. After drying for a moment, adjust it to the diaphragm, previously cleaned from dust, and attach it by means of a little shellac. It requires considerable practice to do this nicely, for a spider's web, although quite strong, cannot be handled by clumsy fingers without parting; but in the case of an emergency the engineer must try to do the best under all circumstances.

Referring again to the lenses, it is well to remember that in taking them apart, the centering is disturbed, and the engineer is not able to replace them properly, especially if they fit loosely in the cell, which is very often the case. The staining of flint-glass lenses is caused by the corrosion of the oxide of lead contained in the glass. This will generally occur when the lens is kept in a damp place for some time. In cleaning an object-glass, care should be taken not to rub it any more than necessary. Brush off the dust first with a camel-hair brush, and then wipe it carefully with a clean piece of chamois leather. If very dirty, wash it with alcohol or water and soft chalk, being careful to have the latter free from grit.

Considering that, in cleaning, each rub will destroy more or less of the fine finish of the lens, upon which depends the brightness and brilliancy of the image, the surveyor will be well repaid for his care in this particular.

Similar attention must be bestowed upon the *eye-piece*. With our high power eye-pieces, a motion of only three-sixteenths of an inch is necessary to allow for difference in eyes. As the sliding motion is for this purpose alone, it is not at all necessary to disturb it after it has once been properly adjusted, as long as *the same* person is using the instrument; even in packing it away in the case the eye-piece may be left so, as this extra extension is allowed for in the box. The cap is provided with a slide to protect the eye-lens from dust while the instrument is not in use; the engineer should never neglect to close this, and to cover the object-glass with its cap as well, as soon as the instrument is set at rest.

REPAIRS.*

We are fully prepared to make careful repairs to all instruments, from the graduation of an arc or circle, and the straightening of a center or plate, to the setting of a simple screw. In this particular branch we have operated here for the last ten years, and have gained the fullest confidence of our people. Attention has already been called in the first part of this Manual to the first-class facilities that we have for making repairs in any line—mechanical, optical, nautical or otherwise—and for that reason we need only state here that we guarantee satisfaction to our customers in every way.

As we are located in California, separated by the breadth of the Continent from our Eastern colleagues, we are necessarily required to repair instruments of almost every known make, and this has compelled us to procure the various requisites in the workshop, for all emergencies. To-day we are in the position to renew any part of an instrument, no matter where it was originally manufactured. Time and money will be saved by sending directly to us, and we shall try to give our customers every satisfaction. Whatever is entrusted to us will be thoroughly overhauled, and put in the best possible condition, unless specified orders are received to confine the repairs to certain details. As a general thing it ought to be left to our judgment as to what the instrument requires; it may cost a little more if you follow our advice in this particular, but it will certainly be more satisfactory in the end. It will save time, trouble and additional expense. In the course of our examination of an instrument needing repairs, we discover defects that could not be apparent to anyone, before its parts were separated and individually tested. What may appear of no consequence, and is therefore neglected, is quite likely to lead to all sorts of subsequent inaccuracies in your work. Years of experience in this particular line have taught us the advisability of urging this point upon our patrons.

Considerable correspondence is had from inquiries about the cost of repairs. Although it is impossible to state the exact figures before an examination, there are certain rates for ordinary repairing that we may mention here.

* Experience has taught us that it is not wise to allow an ordinary mechanic to attempt instrumental repairs, as frequently resorted to in inland towns. It is always the case that this proves ruinous to the instrument, and subsequent repairs will be more extensive and expensive than if it had been shipped to the instrument-maker at once. Express charges are of far less importance, and may be made very reasonable. See notice preceding preface to this manual.

The most expensive instrument in this regard is the transit, being the most complicated in parts. If injured by a fall, new centers and a new telescope axis are generally required, the cost varying from \$10 to \$30, reaching sometimes as high as \$50. If slightly injured it will vary from \$5 to \$10.

Injuries sustained by leveling instruments are generally less serious. A new level vial costs from \$2 to \$7.50, according to size and sensitiveness. Instruments defective in construction or workmanship will not require a sensitive level, as that would be a source of constant annoyance to the engineer; the bubble should be chosen to harmonize with the general qualities. As a rule, we attach to the better class of instrument a level that shall give for each inch of motion of the bubble an angle of two minutes; to the inferior grade, one of three or four minutes.

Compasses sent to us are generally injured by the dulling of the center pin. Sometimes the plates and sights are bent and the glass broken. Often the center cap is worn out, and a new one is required. The cost of repairing ranges from \$2 to \$8, and even as high as \$10. A new needle, having the largest breadth in a vertical direction, which is far superior to the flat style, costs \$5. A new center pin, 75 cents. New center cap with jewel, \$1.50.

Careful re-adjustments made under the collimators are charged for at the rate of \$2.50 for each instrument.

Transits and levels should always be accompanied by the leveling plates; the tripod and head need not be sent. With compasses the ball spindle should be sent.

We advise our customers to pack their instruments carefully, when sending them to us for repairs, as they are liable to material injury if this precaution be neglected. The space in the box between the different parts—of the transit particularly—may be filled with soft paper wads to protect it from jars and blows. It is well to put the case in an additional box, a little larger in dimensions, in such a manner that the top of the case is plainly visible and its leather strap handy for carrying. The space between the case and the box may be padded

with shavings, or some soft material to take up the shocks. Mark upon the top of the box in large legible letters:

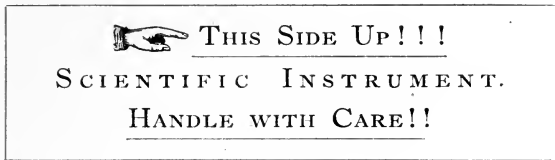

And ship through a responsible express company, plainly addressed to:

THE A. LIETZ CO.,
 422 SACRAMENTO STREET,
 San Francisco, Cal.

The name of the *sender* and *his address*, together with the *value of the instrument*, should also appear on the box.

This will insure comparative safety in transportation, which is a point that should be well observed by the engineer. And this precaution would also increase the responsibility of the carrier, in case the instrument had suffered during transportation.

When an instrument is sent to us for repairs, a letter or postal card should be mailed at the same time, to inform us of the fact, giving the necessary directions, and stating when the return is required. The receipt of the instrument will be acknowledged by us at once.

ADJUSTMENTS.

Adjusting an instrument consists in delicately moving to the right or left, and up or down, certain parts that must be either parallel or at right-angles to each other. This is done by slightly turning a number of capstan-headed screws or nuts by means of a small steel rod, called an adjusting pin. Adjusting the vernier and compass consists in placing certain points in a straight line; but as these corrections are always made by the instrument maker, they do not properly apply to the subject before us. Verniers, limb and needle, if properly placed at the outstart, will not need any correction in the ordinary use.

Of the Transit.

1. **ADJUSTMENT FOR PARALLAX.**—This is a very essential one, and must be looked to carefully in every surveying instrument, whether transit, level or theodolite. It consists in so focusing the eye-piece that the cross-hairs shall stand out distinctly and well-defined, when the telescope is directed upon an object in focus. If this is not properly done the hairs will be dim; they will appear to travel and to seem unsteady when set on a mark. We know that this has given considerable vexation to the observer, and instruments have been disparagingly condemned for their apparent parallax, when nothing more was necessary than a slight movement of the eye-tube to focus the hairs properly. This fact should be well borne in mind. Our eye-pieces are quite easily moved in or out by a revolving motion, which affords a very fine and precise adjustment to focus.

Operation.—Direct the telescope so as to have a clear view of the sky, and then turn the eye-tube by the cap as just described, until the cross-hairs stand out like two sharp and distinctly drawn black lines. After a few trials this is accomplished without difficulty. Then try the telescope upon some object brought into focus and test the clearness of the wires. A point now bisected must stay so while the eye is moved laterally in front of the eye-hole. If it remain stationary, there is no parallax and the adjustment is made. Once properly set, the eye-piece may remain for the same observer for all time, and need not be adjusted from day to day. Attention has already been called to this point in a previous chapter, where it was noted that the instrument box was made large enough to allow the eye-piece to extend beyond the tube. (The sun-shade should be put on the telescope first, and then focused to mean distance to balance it properly.)

2. **PLATE LEVELS.**—The object is to set the levels at right-angles to the vertical axis of the instrument, so that when the bubbles are centered the axis is truly vertical.

Operation.—Bring the bubbles to the middle of the tube by means of the leveling screws, then turn the instrument on its

center 180 degrees. If they remain central for any position, they are in adjustment; if not, they must be elevated or depressed at one end to correct them. One-half of the required correction is made with the capstan-headed screws on the vial case, the rest by the leveling screws of the instrument. Several repetitions of the operation may be required before attaining accuracy. It is well to have the plate in such a position, that the levels shall be parallel to a pair of opposing foot screws. If they are out considerably, it is better to adjust one first, approximately, and then the other.

3. THE STANDARD BEARINGS.—The telescope should revolve in a vertical plane when the instrument is level. One end of the telescope axis must be either raised or lowered until accuracy is reached. A capstan-headed screw is attached for that purpose.

Operation.—Set the instrument up within about fifty feet of the wall of a house. Take a well-defined point as high up as possible on the wall; clamp and bisect; then turn down the telescope and put a point in line as low on the wall as may be conveniently reached. Reverse the telescope and direct again to the upper mark, if you please; clamp and bisect; turn down to the lower mark, and if it is bisected, the telescope revolves in a vertical plane and requires no adjustment. If it does not strike the point absolutely, one-half of the difference is taken up by the capstan-headed screw, and the adjustment is done. Several repetitions of the operation may be required. It is not necessary to level the instrument, but it should be brought in such a position as to admit the bisecting of two well-defined points. Care should be taken, however, that the observation is made at the intersection of the cross-wires, and that the instrument is securely clamped.

This adjustment should always be made before that of the cross-wires, for this reason: that unless points of equal height are taken in the subsequent adjustment of the vertical hair, it will only then prove correct, if the telescope revolve in a truly vertical plane. It is, therefore, always better to look to this before the cross-hairs are adjusted.

This adjustment may also be made by means of an accurate striding level, such as manufactured by this Company for use in high-grade instruments. The transit must be precisely leveled up by the foot-screws and plate bubbles, after which the striding level is placed across the telescope, resting upon its axis. It is evident that the bubble will indicate any deficiency in the horizontal parallelism of this axis, and, therefore, any error in the true vertical motion of the telescope, which may be corrected until the bubble of the striding level remains centered.

4. THE CROSS-WIRES.—The line of collimation should be at right-angles to the axis upon which the telescope revolves.

Assuming that all the required conditions have been fulfilled by the instrument maker—having placed the telescope in the center of the instrument, and having the tubes perfectly straight and normal to the telescope axis, which are necessary instrumental requirements, there are two methods that may be employed. One is by means of back- and fore-sights, which is that generally used; the other consists of a test by means of three points in a range, where the middle one is occupied. Preceding either method the hair should be made truly vertical, so that either the upper or lower end will bisect a point when the telescope is moved up and down. This is easily done by loosening the diaphragm and turning it slightly in the required direction. To accomplish this the instrument must be leveled up.

Operation, First Method.—Occupying a point, direct the telescope to some well-defined mark, about four hundred or five hundred feet distant; clamp and bisect it; then revolve the telescope and place a point in the opposite direction at about the same distance. Now unclamp and turn the instrument half-way around; set the hair again on the first point, revolve the telescope and sight to the second point. If the intersection bisects the latter, the vertical hair is in adjustment. If not, the error can be corrected by the capstan-headed screws, which afford a lateral motion of the diaphragm. With them the vertical thread should be moved one-fourth of the space intercepted between the direction of the telescope and the direction of the



second point. Several repetitions may be necessary to obtain accuracy.

The reason why only one-fourth of the space should be corrected for, becomes evident from the fact, that in the first revolution of the telescope the error of the hair is doubled; and after reversing the instrument and revolving the second time, it is again doubled, but on the opposite side, so that the true direction lies exactly half way between the two, and to correct for it we must move the hair one-half the space between the true line and one of the points.

It is not necessary to level the instrument in order to make this adjustment; but in case it is not leveled up, the observations must be made exactly at the intersection of the cross-wires.

It must be remembered that the image at the cross-hairs is inverted, and that in consequence the screws must be moved in apparently wrong directions.

If there is any lost motion in the tangent screw, great care should be exercised in handling the telescope, so as not to influence its alignment.

Operation, Second Method.—Locate with the telescope three points in one direction, which are necessarily in a straight line, as long as the vertical movement of the telescope is in adjustment. Occupy the middle point with precision, and bisect one of the end points; revolve the telescope and sight at the other end point. If this is bisected, the instrument is in adjustment; if not, correct for it by taking up one-half the error. This method requires leveling of the instrument.

Thus far we have been speaking of the vertical hair only, as it is the more important in a transit telescope. In a plain transit—that is, one without a telescope level and without a vertical arc—the horizontal thread simply serves to define the middle of the vertical one, so that the observation may always be confined to a particular *point* in the latter. But if a level is attached to the telescope, then the horizontal hair should be brought into the optical axis, before the level is set parallel to the line of collimation; otherwise, though adjusted for long distances, it will fail to be correct for short sights.

Operation.—Set up the instrument near a house or fence and level up carefully. Clamp the telescope, and by means of its tangent screw bisect a point several hundred feet distant; then turn on center and mark a point on the house or fence, about ten feet distant. Now unclamp telescope, reverse it, revolve on center, and again bisect the nearest point. Turn instrument on center and see whether the hair intersects the further point. If it does not, the correction must be made, by lifting or lowering the diaphragm by means of the upper and lower capstan-headed screws, until the bisections, after repeated trials, will coincide.

5. THE TELESCOPE LEVEL.—The object of this adjustment is to make the level parallel with the line of collimation. The principle underlying the method is: that points taken with the same angle of elevation or depression, and equally distant from the instrument, are of equal height.

Operation.—Set up on a nearly flat surface and level carefully. On opposite sides, at *equal* distances, drive two stakes giving the *same* level-rod reading, with the telescope bubble centered in each instance. These points are necessarily on a level with each other. Now move the instrument to a point in line with both, and about ten feet distant from one. Level up again. Take a rod reading on the nearer and then on the further stake. If they agree, the level is in adjustment; if not, move the telescope with its tangent screw over nearly the whole error, and sight again at the nearer stake and then at the further, repeating this until the readings are the same on both, when the telescope is truly horizontal. Now bring the bubble in the center of the tube by the correcting screws of the level, and the adjustment is completed.

This adjustment may also be made in a room with the aid of a surveyor's level, with absolute accuracy.

Operation.—A few feet (one or more) from each other set up the transit and level, each directed to the other. The cross-hairs of the level must be illuminated by a light, so that they shall become plainly and clearly visible through the transit. For this purpose cover the eye-end of the level with a bit of

white paper and place a lamp behind it. Focusing both instruments properly will make the hairs appear very distinctly. Now, if both instruments are properly collimated, the level carefully leveled up, and the transit telescope of such height that we may view the interior of the level's tube, we are ready to adjust the transit telescope to a level plane, which is done by simply placing the intersection of its cross-hairs delicately over the intersection of the level's cross-hairs. All that is required after that, is to center the transit's level bubble by means of the proper adjusting screws.

This method recommends itself on account of its extreme simplicity.

6. ZERO OF VERTICAL ARC.—This adjustment, once made by the instrument maker, is seldom vitiated. The object is to have the zero line of the circle agree with the zero mark of its vernier, when the level of the telescope indicates a horizontal position, and when the centers of the instrument are truly vertical.

Operation.—The instrument must be carefully leveled by the small plate bubbles, and then the telescope by means of its level. This accurately accomplished, the vernier is shifted until the zero lines coincide. This must be carefully done, so that the instrument is not disturbed, and, when the vernier is fastened, care must be taken to allow a space that shall neither be too small nor too great between it and the vertical circle. In the first case it would bind under certain conditions of temperature, and in the latter the observer would not be able to obtain an accurate reading. The coincidence of the zero-lines must be made with a magnifying glass, and all parallax avoided.

7. CENTERING THE FIELD OF VIEW.—On some transit telescopes there will be found another set of four capstan-headed screws, exactly alike to that which regulates the cross-hair diaphragm, and placed in a position quite close to it. These screws are for the purpose of directing the tube of the eye-piece in such a manner that the field of view may be divided by the cross-wires into four uniform quadrants; that is, they enable the operator to so adjust his field that it may

be bisected horizontally and vertically by the threads. In the Lietz transits this adjustment has been omitted, for the reason that the tubes are made of such length and with such care—being absolutely straight—that there is no need of displacing the field, after the line of collimation has been made to agree with the optical center, and the hairs are properly adjusted. The lines can never appear noticeably out of the field in our transits, and any additional movement in the parts of the telescope would neither be useful nor desirable. A first-class transit instrument can dispense with this arrangement altogether, and for this reason it is not usually found there. With an extra long telescope, however, there would be a slight advantage in being able to direct the field of view, for a possible fall of the instrument may so injure the tube that it could not be made absolutely straight again afterwards, and in consideration of this, we have adopted this correction only in the case of the 18-inch Y-level, which is the most liable to be damaged in that way. It alone possesses two sets of capstan-headed screws near the eye-end of the telescope—one for the adjustment of the cross-hairs, and the other for shifting the field of view so that it shall appear equally divided by them.

Of the Y-Level.

There are three principal adjustments. The spirit level must be parallel to the axis of collimation; it must be at right-angles to the vertical axis of the instrument; the axis of collimation must agree with the optical axis.

There are other instrumental requirements which belong to the instrument maker, however, and it is with the above three adjustments only that the surveyor has to deal, as they are likely to become disturbed in time.

Before examining the adjustments, the sun-shade should be placed on the telescope, as it is only accurately in balance with this.

1ST ADJUSTMENT.—To set the spirit level parallel to the line of collimation, and, at the same time, place its axis in a plane with that of the telescope. It is best to attend to the latter first.

Operation.—Turn the telescope so as to stand over two op-

posing foot-screws, clamp the instrument and bring the bubble to the center of the tube; then rotate the telescope in its Ys, so as to put the level considerably out of a vertical—say about 15 or 20 degrees. If the bubble changes its position, it shows that the axis is not in a plane with that of the telescope. Correct it by moving the two side screws of the level case, until one-half of the deviation has been taken up. A few repetitions will insure accuracy, and destroy the side motion of the level.

The level must now be made parallel with the line of the bottom of the collars.

Operation.—Bring the bubble to the center of the tube; then reverse the telescope in the Ys end for end; do this carefully. The displacement of the bubble, if there be any, is the double error, which is corrected by taking up one-half of it by means of the adjusting nuts on the level case, and the other half with the leveling screws of the instrument. This operation is repeated until the bubble remains in the center.

To accomplish a proper adjustment of the level to the line of collimation, it becomes absolutely necessary that the collars be of equal diameter. We have already referred to the importance of even collar dimensions, and have laid great weight upon this requisite; and here again we shall point out the errors to which a neglect therein may lead. A Y-level in such an event is not any better than a dumpy, and will have to be adjusted as such.

Providing the Ys are filed out to the same absolute angle, the instrument may still be adjustable in all its parts:—the spirit level may be made parallel to the line of the bottom of the collars; the Ys may be so adjusted that the bubble will remain in the center of the tube; the line of collimation may be brought to the center of revolution of the telescope; and this reversed end for end in the Ys, leaving the bubble in the middle, even if there be some difference in the diameter of the collars. It is the general opinion that after level, Ys and cross-wires are adjusted, the instrument must be correct. This is by no means certain, as the least difference in the size of the collars will throw out the line of collimation considerably. This difference is sometimes found in new instruments, and is also

produced by unequal wear, denting, etc. It is therefore advisable that the equality of the collars should be tested from time to time, which is done by a method given further on.

2D ADJUSTMENT.—To place the level at right-angles to the vertical axis of the instrument.

Operation.—Turn the instrument so that the telescope shall stand over the line of two opposing leveling screws, and bring the bubble to the center of the tube; then turn the instrument 180 degrees on its center. If the bubble shows any displacement, correct one-half of it by means of the nuts under the bar at the Y supports, and one-half by the foot-screws. Several trials will make the correction perfect.

3D ADJUSTMENT.—To place the cross-web in the optical axis of the telescope, so that the intersection will remain on an object in revolving it.

Operation.—Set the intersection of the hairs on a point about two hundred or three hundred feet distant, then revolve the telescope in its Ys half-way, so as to have the level case on top. If the wires have moved from the point, bring them back one-half of the amount of the displacement. Try again, and repeat the operation if necessary.

The eye-piece may then be properly aligned and directed by the four black capstan-headed screws (nearest the eye-end of the telescope), so that the field of view shall appear evenly divided by the cross-hairs, as already explained.

In this, as well as in any other telescope, we assume that the tubes are straight, the object-glass well centered, and the slide well fitted. If such be not the case, the telescope can only be adjusted for certain distances. It is urged by some makers that it is almost impossible to produce straight tubes, and that, therefore, the object-slide must be adjustable. This, however, is entirely erroneous. Perfectly straight tubes *can* be made, if the necessary time and money be expended, which is the only requisite. In a great many instruments sold to-day, you will find that the object-glass is not centered, that the slide is poorly fitted, and that all these inaccuracies, which are not apparent at a glance, prove more injurious than ever if the tubes are not

quite straight. It must also seem clear to any one, that the constant working of the slide in an adjustable ring would loosen the screws and cause considerable annoyance.

PARALLAX is adjusted by moving the eye-piece in or out until a clear and distinct view of the cross-hairs is obtained, as in the case of the transit already described.

THE COLLAR TEST.—After the instrument is properly adjusted, the equality of the collars may be ascertained in the following manner:

Operation.—Make two bench-marks, place the instrument exactly midway between them, and find their true difference of level by reading leveling rods set upon them. Now place the instrument near one of the bench-marks and read the rods again. If the difference of the readings is equal to the true difference of level, the collars are of equal diameter, and the line of collimation is at right-angles to the vertical axis of the instrument. This test, once made, holds good ever after, as it shows that the collars are true, and consequently that a correct adjustment is assured of all its other parts, as already described. But it need hardly be mentioned that denting, the settling of sand particles and unequal wear will also affect the adjustment in the same manner.

If the test shows that the line of collimation is *not* perpendicular to the line of the vertical center, then the collars are of unequal diameter, and the instrument is really nothing more or less than a dumpy level, as this defect deprives it of all the advantages for an easy and convenient adjustment, which characterizes the Y-level in comparison with the dumpy.

This defect may, however, be temporarily remedied or adjusted in the same manner as the line of collimation in the dumpy level is adjusted, but it must ever thereafter remain permanently in its Ys, as it would, if reversed end for end, double the error which existed previous to this adjustment.

The correction may also be made by displacing the horizontal cross-hair to the extent that the line of collimation shall be truly horizontal and, at the same time, parallel with the axis of the spirit level; but, in that event, there will be no longer

any agreement with the optical axis, which again gives rise to a number of inaccuracies that cannot be obviated.

A Y-level, in order to deserve that name at all, must have equal diameters of its collars; and if that is not found after a crucial test, the instrument maker should be called upon to remedy this discrepancy.

No doubt can possibly exist in the mind of any engineer of the absolute necessity of the collar test. Considering the required parallelism of the axis of collimation and the axis of the spirit level, he must know that a contact can only be made between telescope and Ys by means of the collars, whose exteriors may either be parts of the surface of a cylinder, or that of a cone, and that the required parallelism is only possible in the former case. If one collar exceed the other in diameter, the centered level bubble, if reversed in the Ys, will indicate a displacement corresponding to four times the angle intercepted between the collar axis and that of the spirit level. No further demonstration of this fact is necessary.

Of the Dumpy Level.

In principle, the same laws govern the requirements of the dumpy that hold good in the Y-level. Although its construction differs, the condition of its line of collimation, optical center and level vial must be such as to bear that universal relation to each other, which we have fully explained in the other instruments. It is not difficult to make all the necessary adjustments properly, although it may not appear quite so handy to correct its errors as in the case of the Y-level. Once adjusted, however, the instrument will remain so for a long time, and it will give the operator considerable satisfaction, if used with the ordinary care.

The adjustments of the level, and the telescope for collimation, will now be briefly mentioned.

Put on the sun-shade, and focus the eye-piece until the hairs are distinctly visible and the parallax destroyed; then proceed as follows:

Operation.—Turn the instrument so that the telescope shall stand directly over the line of two opposing leveling screws,

and draw the bubble to the middle of the tube by means of the foot-screws. Then turn the instrument on its center 180 degrees, and if the bubble remain centered the adjustment is perfect. Any displacement, however, will have to be corrected by taking up one-half of it with the capstan-headed screws attached to the level case, and the other half by the foot-screws. This operation must be repeated several times, in directions normal to each other—that is, over one set of opposing foot-screws as well as over the other, until the telescope may be swung in any position and the bubble will remain in the middle. See that the adjusting screws of the level vial are firm, yet avoid all unnecessary force in tightening them; all cramming is injurious, and tends to destroy the proper degree of refinement required.

After having set the diaphragm so that the cross-hairs shall be absolutely horizontal and vertical, which is easily done by loosening the capstan-headed screws and turning the diaphragm slightly, being guided by some point bisected by the horizontal hair, we now proceed to adjust the cross-hair, which must be brought into the collimation line. Several methods are known; the one which is always available, however, is that by means of stakes and level-readings upon them, and it is to this that we shall confine ourselves here.

Operation.—Choose a piece of ground nearly level, set up the instrument and center the bubble. Drive a stake (point 1) firmly, say two hundred or three hundred feet from the instrument, in any convenient direction therefrom. Hold the level rod upon it and take a reading. Now point the telescope in the opposite direction, the bubble being centered, and plant another stake (point 2) at the same distance from the dumpy, driving it until the rod shall read the same as upon the first point. These two stakes are on the same level. Now set up the instrument about ten or fifteen feet from the first stake, and bring the bubble to the center; take a rod-reading on point 1, and then on point 2. If the two readings are alike with a truly centered bubble, the hair is collimated. If there is any difference, take up nearly all of it, by moving the diaphragm with the cross-hairs either up or down, as already explained. Repeat this

operation until the readings on points 1 and 2 are identical, when the instrument is in adjustment.

The vertical hair is of no particular importance.

With these precautions, a dumpy level may be made absolutely accurate, and there is no reason why, for any of the land surveyors, and for nearly all of the engineer's work, this compact and steady instrument should not meet every requirement. We frequently discuss its merits with our customers, and have never hesitated to recommend it.

Test of Telescopes in General.

If a telescope is to be tested for its qualities, make sure that all its lenses are perfectly clean.

To test for *definition*, use small, clear print, and view it from a distance of from thirty to fifty feet. If the print appears clear and well defined, and fully as legible at this distance as if viewed with the naked eye at the distance of distinct vision, the surfaces of the object-glass are perfect and well finished. If, on the contrary, the print appears dull and indistinct, and the finer details illegible, or even invisible, the surfaces are imperfect and faulty, for the rays proceeding from the various points of the object are not refracted to their corresponding points in the image.

Indistinctness may be caused by *spherical aberration*.

To test this, cover the object-glass with a ring of black paper, reducing the aperture to one-half; again focus small print to distinct vision; remove the ring of black paper and cover the center of the object-glass (previously left open), then mark how much the object-glass has to be moved in or out for distinct vision. If the spherical aberration has been reduced to a minimum, very little, if any, slide motion is necessary to obtain a distinct view under both tests. The amount of movement, however, constitutes a measure for the spherical aberration of the object-glass.

Another test, but not as good as the one just mentioned, is to focus an object to distinct vision; then slide the object-glass in or out, observing at the same time the quantity of motion

necessary to render the object indistinct. If the spherical aberration is completely corrected, the object should, theoretically, be rendered indistinct by the slightest motion of the lens; but, practically, this is not the case, as the eye will accommodate itself in a measure to the difference of divergence of the rays, caused by the motion, in or out, of the object-glass, in the same manner as it will accommodate itself to near and distinct objects when viewing without the aid of lenses. So, if the image formed by a perfect object-glass is viewed by another perfect lens of long focal length, say six inches, the object-glass might be moved in or out one-fourth of an inch from the point of distinct vision, and the object will still appear comparatively clear, as the one-fourth-inch motion, with an eye-lens of such long focal length, cannot cause enough difference in the divergence of the rays to prevent the accommodation of most eyes to it. The shorter the focal length of the eye-lens, the more rapid will be the change of divergence or convergence of the rays with a certain amount of motion; therefore, the second test is only applicable with eye-pieces of very high power, which, at the slightest motion in or out, will cause a sufficient amount of divergence of the rays to prevent the accommodation of the eye to the change.

To test the *chromatic aberration*, either a celestial body or a white disc should be selected for an object.

Focus the object to distinct vision, thereupon move the object-glass slowly in and out alternately. If, in the first instance, a light yellow ring is seen at the edge of the object, and in the second one a ring of purple light, the object-glass may be considered perfect, as it proves that the most intense colors of the prismatic spectrum (orange and blue) are corrected.

To test the *flatness of field*, take a square, flat object, the sides of which are about four inches long and perfectly straight—the best object is a heavily-lined square, drawn on white paper with india ink. Sight this object from such a distance that it will nearly fill the field of view of the telescope, and see if it still appears flat and its sides perfectly straight; if so, the telescope is a good one. If, on the contrary, the object appears distorted, *i. e.*, if the sides, instead of being straight, form curves and the surfaces appear concave, instead of flat, the tel-

escope is not good, for it shows that the proportions of foci, aperture and distances between the different lenses are not according to the laws of optics; owing, generally, to the attempt to force the magnifying power beyond its limits.

As all the refractions of light in the telescope are caused by flat and spherical surfaces, it is evident that the edge of a round flat object, when used for the above test, cannot be distorted, but that the surface only will appear concave to a keen observing eye. A telescope which distorts the image to a perceptible degree, will not, however, cause any errors in common use, if only one point in the lens is taken in all observations, but it is decidedly objectionable in stadia measurements, where two points in the field of view are used at the same time.

To Find the Magnifying Power of a Telescope.

A practical method for finding the magnifying power, available to anyone, which does not require any apparatus, taking up only a few moments time, is the following:

Set up the instrument, and about twenty or thirty feet therefrom hold up a graduated rod. Observe the rod with one eye by direct vision, and with the other through the telescope. Assume a certain space on the rod, say the height of a numeral, or two sharply-drawn lines, and count the number of divisions on the rod in that space; then observe the number of divisions that are seen by the naked eye in the same space enlarged. The ratio between the two is the power sought. It is the reading of a magnified space of known length on the graduated face of the rod. With a little practice both eyes will be able to distinguish the rod divisions at the same time. If what is known to be 0.1 of a foot, is enlarged by viewing it through a telescope so as to cover the space of 2.4 feet as seen by the unaided eye, the magnifying power is 24 for the distance in focus. The real power is somewhat less, for as the tube of the telescope is drawn out for near objects, the power necessarily increases. The magnifying power obtained by this method holds good for the distance that the rod can be read by the unaided eye, and it is always somewhat greater than the actual power.

It is well for the engineer to make a test of the power of a

telescope himself, for it is to the interest of the maker to rate this higher than it really is, for very obvious reasons. This method suggests itself as perfectly practicable, and is readily tried at the time of purchase.

For a very accurate determination of the magnifying power, it is necessary to ascertain the focal length of the objective and that of the eye-piece, in order to compare them and to find their proportion. While the former is easily obtained by a direct measurement from the objective lens to the cross-hairs, the latter, usually containing an entire system of lenses, presents numerous difficulties. For this purpose we possess an apparatus, which was especially designed and built for us by a prominent optician in Germany, and which is so perfectly adjusted to do its work, that we think it of interest to explain it in a general way.

Referring to the accompanying illustration:

Upon an iron base *F* stands the pillar *E*, carrying the cross bar *D*, upon which three standards are mounted. At one end of the bar the microscope *A* is held by a fixed stand. Its tube is adjustable to focus by the screw *a*. At the other end is the collimator *B*, which slides upon the bar and is held by the screw *d*. Between the two is the holder for the eye-piece *C* under consideration. The pillar slides upon the bar, and is clamped by the screw *c*. The screw *b* raises or lowers the small platform on which the eye-piece rests. The whole is recognized fully in the drawing.

To determine the focal length of any lens or combination, the eye-piece, etc., is placed on the platform as shown, the collimator being turned with its small opening *e* towards the light. (It may be used in the daytime, or by lamp-light at night.) The whole is properly adjusted by sliding the collimator and the platform on the bar as required. The eye-piece, which has been carefully aligned between collimator and microscope, is then viewed by the latter, which is focused by the screw *a*, until the collimator opening *e* is clearly and distinctly visible as a round disc of light with a sharply-defined outline. In the field of the microscope a small graduated scale is seen, and by this scale the diameter of the light disc may be measured, by

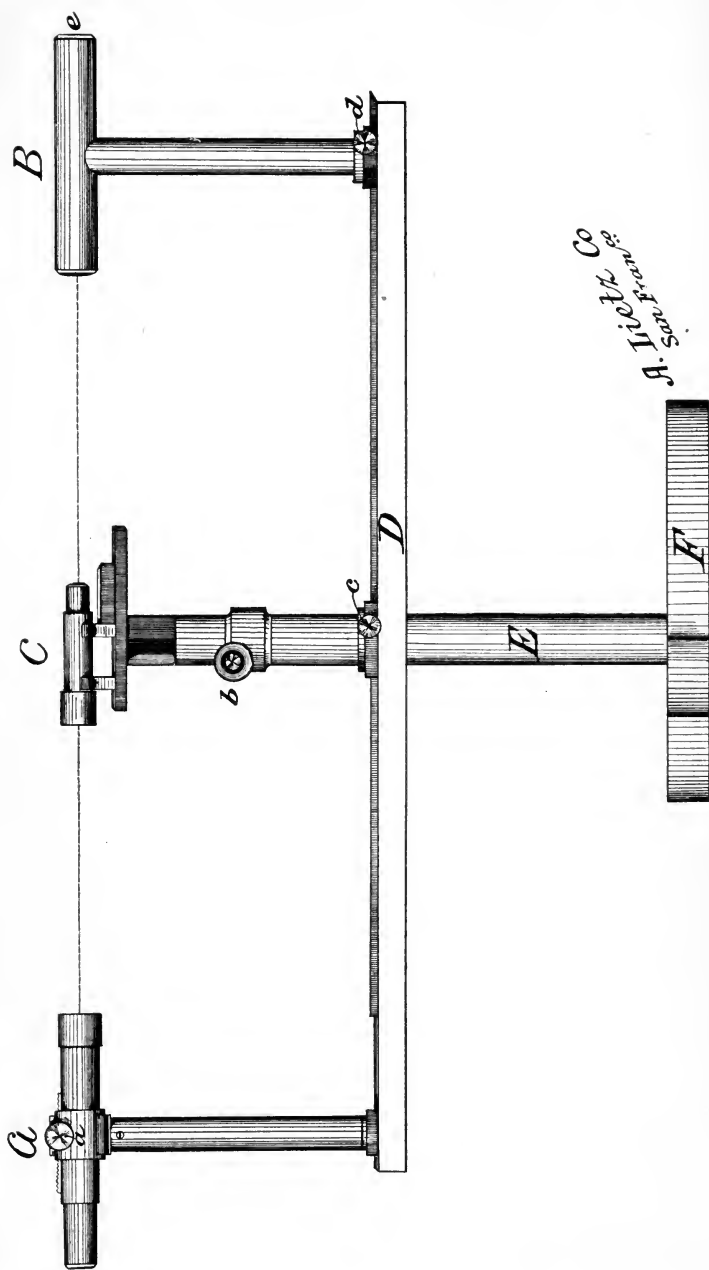

*A. T. Williams Co.
Salem, Mass.*

*Apparatus for measuring the focal length
of lenses and lens combinations.*

simply counting the number of lines that it covers. These give the focal length of the eye-piece directly in millimeters, and that with absolute accuracy.

Dividing the focal length of the objective (when the telescope is focused to mean distance) in millimeters, by the value just obtained, gives the magnifying power of the telescope under consideration.

This apparatus measures focal lengths up to 8 centimeters ($3\frac{1}{8}$ inches). It is applicable to simple lenses, as well as to any combination of them. Even concave lenses may be determined by it, but in that case the image lies behind the lens, and the device will measure until the lens touches the microscope, and no further.

This is the only apparatus of the kind ANYWHERE, as it was especially designed for us, and built for the exclusive use of the Company.

If any of our customers want the focal length of an eye-piece determined, we shall cheerfully do so, without charge, upon receipt of it, which should be sent carefully packed by express.

Adjustments of the Plane Table Alidade.

Without going again into all the details of instrumental adjustments, it behooves us to enumerate the points required of this instrument when in proper condition. These are:

- 1st—That the *fiducial edge* of the rule be absolutely straight;
- 2d —That all *parallax* be destroyed, by placing the cross-hairs in proper focus;
- 3d —That the line of collimation move in a vertical plane;
- 4th—That this plane be normal to the plane of the ruler;
- 5th—That the same plane also intersect the fiducial edge of the ruler, or at least be parallel thereto;
- 6th—That during parallelism of the optical axis and the fiducial edge, the zeros of the vertical arc and its vernier correspond.

This instrument is used in the topographical departments of the U. S. Coast and Geodetic Survey, and the U. S. Geological

Survey, and is exclusively applied in mapping the topographical features of the country in Europe, usually by officers of the army, who control these surveys, after the triangulation points have been established.

This method of surveying has been constantly improved in practice, particularly by the experts of the Geological Survey, and it may be safely said that, with the required accuracy, nothing surpasses it for small-scaled work in speed and application. All the bulky parts of the table have been reduced to a minimum, so that it may be handled with comparative ease in the roughest mountain country.

We refer our readers to appendix No. 22 of the Coast Survey Report of 1865, which may be had separately in bound book form, called *The Plane-Table and its Uses*, as an excellent theoretical and practical treatise of this interesting subject.

PART III.

PROFESSIONAL PAPERS

PUBLISHED BY

THE A. LIETZ COMPANY,

SAN FRANCISCO.

1896

NO. 1.

A SHORT AND PRACTICAL TREATISE
ON
STADIA SURVEYING
OR
TACHYMETRY,
WITH
TABLES

For the Determination of Horizontal Distance and Elevation.

WRITTEN FOR THIS MANUAL BY
OTTO VON GELDERN.

The value of this method of obtaining distances is now so generally appreciated, that every engineer will use it in his work, wherever the accuracy obtainable is sufficient for his purpose. While it cannot replace the usual means of precise linear measurements employed in cadastral surveys, it offers many other advantages that cannot be too highly estimated. Under difficult topographical conditions the results, if carefully obtained, may be even better than those of the ordinary chain. At all events, the rapidity with which distances may be measured at all times, and its adaptability to inaccessible places, have given it that prominence in topographical work which it justly deserves.

To make quick and reliable observations of this character, the instrument used should be a good one, and its telescope, above everything else, must possess power, definition and light in a high degree, in order to enable the observer to read the so-called telemeter rod with precision on long sights.

The Principle of the Stadia Method.

The fundamental basis underlying this method of measuring is well known, and is simply the geometrical proposition that parallel lines subtending the same angle from a given point, are proportional in length to their distances from that point. This explains generally the applied principle governing the stadia; all the modifications of it are due to the structure of the instrument used, and to certain optical and geometrical principles that involve corrections to be introduced under certain conditions of sight.

By placing two additional horizontal threads in the telescope, at equal distances from the middle hair, we obtain a gauge that may be applied to a graduated rod, the intercepted space upon the rod increasing, as the distance between it and the telescope increases. If the graduation to some adopted unit of measure be so marked, that it may be read clearly and distinctly without error on longer distances, it is evident that a mere inspection of the rod by means of the telescope, will be sufficient to indicate its distance from the instrument.

The threads may be inserted at random, and the rod marked to correspond to known distances; or they may be placed so as to intercept one unit of measure on the rod to a given number of units in distance. The latter is that generally employed, and the usual ratio is 1 in 100.

When the distance measured between two points is at an angle with the horizon, it becomes possible to determine the co-ordinates of horizontal distance and difference in elevation of the triangle, provided the angle of the slope is known. This may be read on the vertical arc of the instrument. If, in such cases, the telemeter rod be held at right-angles to the line of sight, the horizontal distance will equal the cosine of the observed vertical angle, multiplied by the distance indicated by the rod. This must be corrected by certain small values, to which reference will be made further on. And similarly does the sine of the angle indicate the difference in elevation.

The usual custom here is to hold the rod vertical under all conditions, which is more readily accomplished, and, in certain localities, perhaps the only possible way of holding it.

Optical Features and the Constants c and k .

Certain optical principles do not admit of a stadia measurement from the point occupied by the center of the instrument, but from a point outside of the objective lens, equal in distance to its focal length. This gives rise to a certain value by which the stadia distance must be increased, and which may be practically a constant for any length. It may be determined with sufficient accuracy by adding two measurements, taken with an ordinary scale or tape, from the object glass of the telescope, when the latter is focused to a distant object: one to the capstan-headed screws, holding the diaphragm with the cross-hairs, and the other to the center of the axis. The sum of these two ($f + h$, figure 1) is the constant c , which must be added to every horizontal distance, irrespective whether long or short.

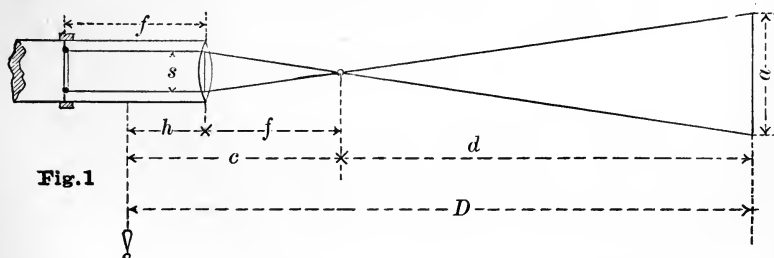

Fig. 1

In figure 1, let a = any rod reading, K = a constant expressed by the relation of the distance between the stadia threads and the focal distance of the object glass, then $K a = d =$ distance from the focal point to the rod, for

$$s : f :: a : d, \text{ or}$$

$$(1) \quad d = \frac{a f}{s}, \text{ wherein } \frac{f}{s} \text{ represents the constant } K.$$

It must be mentioned, however, that this is not *strictly* correct, because the focus is changed with the distance of the object, and the value f therefore variable. Nevertheless, the results, unless obtained on very short ranges, are as close as required for the purpose of the stadia, by assuming $\frac{f}{s}$ as a constant of any value that we may choose to assign it when we place the hairs, the ratio 1 : 100 being usually adopted.

To express the distance D of the rod from the point occupied by the instrument, on a level surface, we have, therefore,

$$(2) \quad D = K a + c,$$

remembering c as the constant expressing the distance from the center of the instrument to the outer focus of the objective, which must be added in every case.

If K , as customary, equal 100 and $c = 1.15'$ (as in the ordinary large transit), then $D = 100 a + 1.15'$, so that the following rod readings would correspond to the distances as shown:

$$\begin{aligned} 1 \text{ foot} &= 100 \text{ ft.} + 1.15 \text{ ft.} = 101.15 \text{ feet.} \\ 1.69 \text{ feet} &= 169 \text{ ft.} + 1.15 \text{ ft.} = 170.15 \text{ " } \\ 2.33 \text{ " } &= 233 \text{ ft.} + 1.15 \text{ ft.} = 234.15 \text{ " } \\ 1 \text{ meter} &= 100 \text{ m.} + 1.15 \text{ ft.} = 100.35 \text{ meters.} \end{aligned}$$

and so on.

Reduction of Elevated or Depressed Sights.

If, now, the observation be made on a slope with rod held vertically, the angle of elevation or depression may be expressed by n , and the angle intercepted between the stadia hairs by $2m$.

Any rod reading a may then be reduced to the reading a_1 , or normal rod reading, by the following formula, which is obtained from the elements given in the diagram, figure 2:

$$(3) \quad a_1 = \frac{a}{\cos n + \frac{1}{2} \sin n [\tan (n + m) + \tan (n - m)]}$$

Now, since the angle m in an instrument rated 1 : 100 only amounts to 17 minutes, it is evident that the expression

$$\frac{1}{2} \sin n [\tan (n + m) + \tan (n - m)]$$

is almost the same as $\sin n \tan n$, the difference being so small that it will not be noticeable at all in any of the stadia requirements, and writing $\sin n \tan n$ in terms of the cosine, we have $\frac{1 - \cos^2 n}{\cos n}$, and substituting in formula (3), it will reduce to the simple expression

$$(4) \quad a_1 = a \cos n.$$

This, then, is the normal rod reading, which, by applying the constant K , gives the distance $K a \cos n$, representing the hypotenuse h of a right-angled triangle, of which the horizontal distance d and the difference in elevation e are the co-ordinates. Their values in turn are proportional to the cosine and sine of the angle n , so that the distance

$$(5) \quad d = K a \cos^2 n,$$

and the elevation $e = K a \cos n \sin n$, which is

$$(6) \quad e = K a \frac{1}{2} \sin 2n.$$

(It is understood, in the case of the difference in elevation between the two points (e), that the middle hair touches the rod at a mark corresponding to the height of the instrument, as shown in figure 2.)

Introducing, now, our constant c , which causes corrections also dependent upon the angle n , we must add to the horizontal distance d the value $c \cos n$; and to the elevation e the value $c \sin n$, so that the corrected horizontal distance is

$$(7) \quad D = c \cos n + K a \cos^2 n, \text{ and the corrected elevation}$$

$$(8) \quad E = c \sin n + K a \frac{1}{2} \sin 2n;$$

or, if the constant $K = 100$,

and the constant $c = 1.15$,

$$\text{then } D = 1.15 \cos n + 100 a \cos^2 n,$$

$$\text{and } E = 1.15 \sin n + 100 a \frac{1}{2} \sin 2n.$$

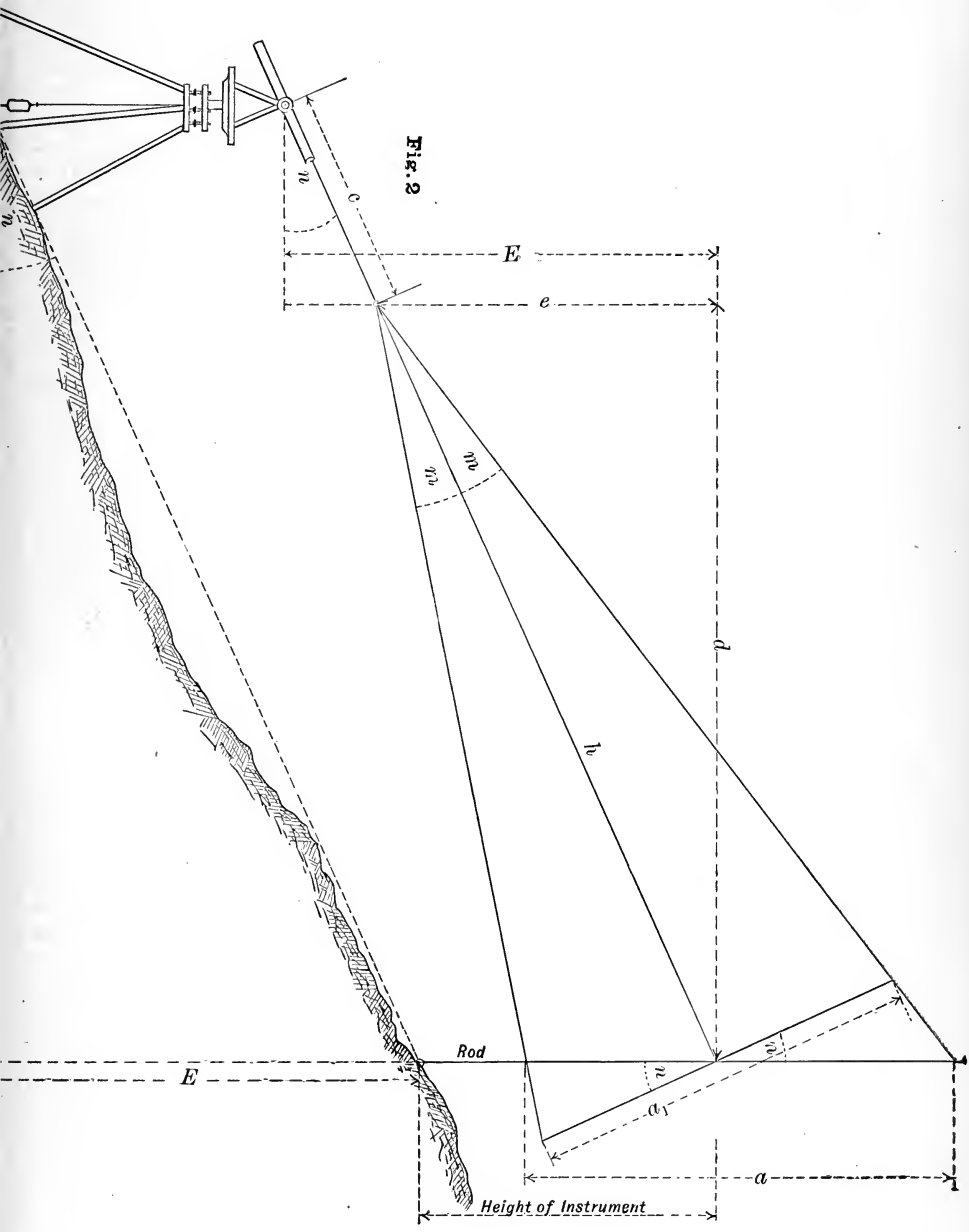

Fig. 2

If, for example, the rod reading a be 2.22 feet, and the vertical angle $n = 20^\circ$, then

$$D = (1.15 \times \cos 20^\circ = 1.08) + (222 \times \cos^2 20^\circ = 196.03) = 197.11 \text{ ft.}$$

$$E = (1.15 \times \sin 20^\circ = 0.40) + \left[222 \times \frac{\sin 40^\circ}{2} = 71.35 \right] = 71.75 \text{ ft.}$$

The second member of the equation is the important one, and that which characterizes the formula, the first being small and a constant for the same angle, independent of the distance. But as it cannot well be neglected altogether, it is customary — since it is not readily incorporated in tabular values — to supplement a table that shall furnish the values of d and e for different angles of inclination, by the terms $c \cos n$ and $c \sin n$ in a special place, usually at the bottom, where they may be readily found and applied. They vary so little from degree to degree that for the ordinary stadia measurements they may be entirely neglected.

The annexed tables were calculated by the formula

$$d = K a \cos^2 n$$

$$e = K a \frac{1}{2} \sin 2n,$$

and so arranged as to give the distance d and the elevation e for every 2 minutes of arc for a value of $K a = 100$, the rod held vertically. They admit of a simple application.

By what has preceded, let it be required to find the horizontal distance and the difference in elevation, when the rod indicated 285 feet and the vertical arc $10^\circ 12'$. Look for the column headed 10° ; run down this column with your finger to the figure on the same line with number 12 in the left-hand or minute column, where, for 100 feet, d is found as 96.86, and e 17.43. Multiply both of these by 2.85. This reduces the distance 285 feet to $d = 276.05'$, and $e = 49.67'$. At the bottom of the page will be found values of the corrections due to c for different focal lengths. Three values obtain: 1.90 (the large Y-level), 1.15 (the large transit), and 0.75 (the small transit). If a large transit has been used we look for the corrections corresponding to $c = 1.15$, and in the case before us we would obtain 1.13 and 0.21. These are added to the values already obtained, and we have:

$$\begin{aligned} \text{corrected horizontal distance } D &= 277.18 \text{ feet,} \\ \text{and corrected difference in level } E &= 49.88 \text{ feet.} \end{aligned}$$

The Stadia Board or Telemeter Rod.

For stadia work an ordinary leveling rod may be used, and, with the aid of a pocket level (a so-called rod level with a circular bubble, that may be fitted and held to the edge of the rod), its vertical position may be assured. By employing two targets and reading them with care, the results will be as precise as the telescopic power admits. It is usual, however, in order to save time, to prepare a self-reading rod, so marked that it shall facilitate rapid observation and reduce all chances of error from a wrong reading. Many patterns are employed by a combination of geometrical figures and by different colors (red, black, white), that are intended to indicate at a glance the space between the upper and lower hair in terms of the rod measure. These patterns are either painted directly on a board from 10 to 12 feet long, that may be folded for convenience in transportation by a hinge in the middle, or on stiff canvas, in which case it may be rolled up for carrying in the pocket, and tacked to a suitable board whenever required. These so-called flexible stadia boards answer very well, but the former are to be preferred in accurate work, as they cannot be materially distorted by conditions of weather.

In case the stadia hairs were set arbitrarily, it becomes a simple matter to ascertain the constant K . A distance of eight hundred feet or more is laid off on a level surface with a steel chain, and marked at each hundred feet. The instrument is placed the distance of its constant c away from one of the end points, and readings are taken on a leveling rod at every hundred-foot mark. From these the ratio between distance and rod reading is readily determined.

Or, a stadia board may be so divided that a unit of its measure shall agree with a hundred-foot space. If a blank board be held at every hundred-foot mark on the ground, we may draw upon it the intersection of the upper and lower hair for each station. If the rod units so obtained vary slightly from each other, the mean of them may be adopted without appreciable error, which is subsequently divided into smaller spaces, to read as close as desirable. In this wise we obtain a rod corresponding with the instrument of which it then becomes a part.

Some instruments possess adjustable stadia wires. In that event the hairs may be set to suit the rod.

In all these cases it is evident that the constant c must be previously determined and properly applied.

General Remarks.

In making a stadia observation, after having set up and adjusted the transit over a point, direct the telescope to the rod and clamp the instrument in position. Move the telescope in a vertical plane, until the middle hair of the three intersects a line on the rod as high above the ground as the telescope axis is over the point occupied, and read the space intercepted between the upper and lower hair. An even foot-mark, or unit-mark, can always be found, upon which either the upper or lower hair may be placed, that will satisfy the conditions nearly under which a should be taken, and from it the rod may be read quickly up or down. To obtain the vertical angle, the telescope should then be moved either up or down with its tangent screw, to the exact intersection on the rod corresponding to the height of the instrument — which is 4.5' ordinarily — and the vertical arc read.

There are occasions when the middle hair cannot be placed on the rod as explained — in the woods, for instance, when parts of the rod may be covered by leaves — and in that event we may read it wherever its exposed space permits, and make the necessary corrections afterwards. It is one of the particular advantages of the stadia that it may be used under very unfavorable conditions of the field, in forests, swamps, along declivities, etc., and yet obtain very reliable results. As long as the rodman is able to get to a place and to hold up his rod, and the observer can see a clear space on the face of it, the reading may be obtained that shall lead to the determination of the horizontal distance and to the difference in elevation.

In cases where both stadia wires are not visible on the rod, the space between the middle hair and the visible one may be read off and multiplied by 2, it being presumed that the upper and lower are equi-distant from the middle hair. But where very large vertical angles accompany the sight, however, it is not well to rely absolutely upon the result, for it is quite readily demonstrated that the horizontal distance will be either too large or too small by a quantity, that, in a rod-reading of 5, doubled to 10 feet, for instance, with a constant $K = 100$, an angle $n = 40^\circ$, will come within about $\frac{1}{5}\%$ of the correct value. With a vertical angle of 20° under the same conditions, the error in distance is about 2% . In the former case the correction would be plus or minus 2.43, and in the latter plus or minus 1.59 feet. But it shows that even under the most unfavorable conditions of sight we are able to approach the true distance within all the requirements of topographical surveying.

A survey may be made with the stadia altogether, or it may be preceded by a triangulation, in order to locate a number of fixed points—the relative elevations of which are established with a leveling instrument—between which the topography is filled in with the stadia. The latter method is necessarily more trustworthy, and should always be adopted where large areas are to be surveyed; but if the engineer is pushed for time, he may omit the triangulation and yet obtain very good results. In such an event great care should be exercised in locating the turning points. Occupying point 1 and observing upon point 2, read carefully the azimuth on the plate, and check it by recording the bearing of the needle also. Read your distance from the rod and record that. Having placed the middle horizontal hair on the rod as high above its foot as the telescope axis is over point 1, observe the vertical angle, which is either plus or minus, and note it down. Leaving point 1 and proceeding to point 2, set the instrument over the latter and level up. It may be clamped upon any desired known azimuth, but the reading of the plate should not be omitted in a direction toward point 1. Record this with the bearing of the needle, which will give the reverse course of the sight 1 to 2. Observe again the distance between the points as shown by the rod, and note it down, as well as the vertical angle from 2 to 1, as explained, which should give the same result as before with reversed sign. These precautions of observing twice between turning points form a very valuable check, and should never be omitted where every other datum is lacking and the stadia method alone is relied upon. After having taken his back-sights, the surveyor proceeds with the observation of all intermediate points required for his topographical details, before locating point 3 for a further advance.

Work may be done still more rapidly by occupying every other point only; but in that case the bearings of the lines are solely obtained by the needle, and there is no check.

By employing two or even three rodmen, distributed about the field as advantageously as possible, the engineer is able to observe rapidly without loss of time. It is always well to have a recorder accompany the party, whose sole duty it becomes to note down the observations of points, and the description as to what these points represent. If necessary and desirable, a small drawing-board may be taken into the field, and, instead of a recorder, a plotter may be employed, who lays down the reduced observations as the work progresses. This is considerably slower, but it offers the advantage of a completed field map when the survey is finished.

Instead of employing the tables here given, the reductions may be quite expeditiously and accurately made in the field by means of the *logarithmic slide scale*, which the author employs in his surveys altogether, a description of which is readily obtained.

With a little practice the engineer will work himself into the use of the stadia, and become an expert. Tachymetry, as it is called, is an indispensable method of measuring, and one that the surveyor of to-day must acquire.

Considerable might be said regarding useful hints and instructions for the field, but we prefer to let every engineer find his own method in the practical application, knowing well that after he has mastered the principle, he will adopt a system of work best suited to his requirements.

The essential requisites for a successful operation are a good clear telescope, affording a distinct view of the rod on long ranges (the author prefers the inverting eye-piece, as one affording better light and a more distinct image, there being no particular advantage in seeing objects erect, as the mind soon accustoms itself readily to an inverted vision), a steady instrument, and, for the method under discussion, a true *vertical* rod.

TABLE OF STADIA REDUCTIONS

For a Constant of 100.

ROD VERTICAL.

Min.	0°		1°		2°		3°		4°		5°		6°		7°	
	Hor. Dist.	Diff. Elev.	Hor. Dist.	Diff. Elev.	Hor. Dist.	Diff. Elev.	Hor. Dist.	Diff. Elev.	Hor. Dist.	Diff. Elev.	Hor. Dist.	Diff. Elev.	Hor. Dist.	Diff. Elev.	Hor. Dist.	Diff. Elev.
0	100.00	.00	99.97	1.74	99.98	3.49	99.73	5.23	99.51	6.96	99.24	8.68	98.91	10.40	98.51	12.10
2	100.00	.06	99.97	1.86	99.87	3.55	99.72	5.23	99.51	7.02	99.23	8.74	98.90	10.45	98.50	12.15
4	100.00	.12	99.97	1.92	99.87	3.60	99.71	5.34	99.49	7.13	99.22	8.80	98.88	10.51	98.48	12.21
6	100.00	.17	99.96	1.98	99.86	3.66	99.70	5.46	99.48	7.19	99.20	8.85	98.87	10.57	98.47	12.26
8	100.00	.23	99.96	2.04	99.86	3.72	99.70	5.46	99.48	7.19	99.20	8.91	98.86	10.62	98.46	12.32
10	100.00	.29	99.96	2.09	99.86	3.78	99.69	5.52	99.47	7.25	99.19	8.97	98.85	10.68	98.44	12.38
12	100.00	.35	99.96	2.09	99.85	3.84	99.69	5.57	99.46	7.30	99.18	9.03	98.83	10.74	98.43	12.43
14	100.00	.41	99.95	2.15	99.85	3.90	99.68	5.63	99.46	7.36	99.17	9.08	98.82	10.79	98.41	12.48
16	100.00	.47	99.95	2.21	99.84	3.95	99.68	5.69	99.45	7.40	99.16	9.14	98.81	10.85	98.40	12.54
18	100.00	.52	99.95	2.27	99.84	4.01	99.67	5.75	99.44	7.45	99.15	9.20	98.80	10.91	98.39	12.60
20	100.00	.58	99.95	2.33	99.83	4.07	99.66	5.90	99.43	7.53	99.14	9.25	98.78	10.96	98.37	12.66
22	100.00	.64	99.94	2.38	99.83	4.13	99.66	5.86	99.42	7.59	99.13	9.31	98.77	11.02	98.36	12.72
24	100.00	.70	99.94	2.44	99.82	4.18	99.65	5.92	99.41	7.65	99.11	9.37	98.76	11.08	98.34	12.77
26	100.00	.76	99.94	2.50	99.82	4.24	99.64	5.98	99.40	7.71	99.10	9.43	98.74	11.13	98.33	12.83
28	100.00	.81	99.93	2.55	99.81	4.30	99.63	6.04	99.39	7.76	99.09	9.48	98.73	11.19	98.31	12.88
30	100.00	.87	99.93	2.62	99.81	4.36	99.63	6.09	99.38	7.82	99.08	9.54	98.72	11.25	98.29	12.94
32	99.99	.93	99.93	2.67	99.80	4.42	99.62	6.15	99.38	7.88	99.07	9.60	98.71	11.30	98.28	13.00
34	99.99	.99	99.93	2.73	99.80	4.48	99.62	6.21	99.37	7.94	99.06	9.65	98.69	11.36	98.27	13.05
36	99.99	1.05	99.92	2.79	99.79	4.53	99.61	6.27	99.36	7.99	99.05	9.71	98.68	11.42	98.25	13.11
38	99.99	1.11	99.92	2.85	99.79	4.59	99.60	6.33	99.35	8.05	99.04	9.77	98.67	11.47	98.24	13.17
40	99.99	1.16	99.92	2.91	99.78	4.65	99.59	6.38	99.34	8.11	99.03	9.83	98.65	11.53	98.22	13.22
42	99.99	1.22	99.91	2.97	99.78	4.71	99.59	6.44	99.33	8.17	99.01	9.88	98.64	11.59	98.20	13.28
44	99.98	1.28	99.91	3.02	99.77	4.76	99.58	6.50	99.32	8.22	99.00	9.94	98.63	11.64	98.19	13.33
46	99.98	1.34	99.90	3.08	99.77	4.82	99.57	6.56	99.31	8.28	98.99	10.00	98.61	11.70	98.17	13.39
48	99.98	1.40	99.90	3.14	99.76	4.88	99.56	6.61	99.30	8.34	98.98	10.05	98.60	11.76	98.16	13.45
50	99.98	1.45	99.90	3.20	99.76	4.94	99.56	6.67	99.29	8.40	98.97	10.11	98.58	11.81	98.14	13.50
52	99.98	1.51	99.89	3.26	99.75	4.99	99.55	6.73	99.28	8.45	98.96	10.17	98.57	11.87	98.13	13.56
54	99.98	1.57	99.89	3.31	99.74	5.05	99.54	6.78	99.27	8.51	98.94	10.22	98.56	11.93	98.11	13.61
56	99.97	1.63	99.89	3.37	99.74	5.11	99.53	6.84	99.26	8.57	98.93	10.28	98.54	11.98	98.10	13.67
58	99.97	1.69	99.88	3.43	99.73	5.17	99.52	6.90	99.25	8.63	98.92	10.34	98.53	12.04	98.08	13.73
60	99.97	1.74	99.88	3.49	99.73	5.23	99.51	6.96	99.24	8.68	98.91	10.40	98.51	12.10	98.06	13.78
c=.75...	.75	.01	.75	.02	.75	.03	.75	.05	.75	.06	.75	.07	.75	.08	.74	.10
c=1.15...	1.15	.01	1.15	.03	1.15	.05	1.15	.07	1.15	.09	1.14	.11	1.14	.13	1.14	.15
c=1.90...	1.90	.02	1.90	.05	1.90	.08	1.90	.12	1.89	.15	1.89	.18	1.89	.21	1.88	.25

TABLE OF STADIA REDUCTIONS.—Continued.

Min	8°		9°		10°		11°		Mm.		12°		13°		14°		15°	
	Hor. Dist.	Diff. Elev.	Hor. Dist.	Diff. Elev.	Hor. Dist.	Diff. Elev.	Hor. Dist.	Diff. Elev.	Hor. Dist.	Diff. Elev.	Hor. Dist.	Diff. Elev.	Hor. Dist.	Diff. Elev.	Hor. Dist.	Diff. Elev.	Hor. Dist.	Diff. Elev.
0'	98.06	13.78	97.53	15.45	96.98	17.10	96.36	18.73	0'	95.68	20.34	94.94	21.92	94.15	23.47	93.30	25.00	
2	98.05	13.84	97.53	15.51	96.96	17.16	96.34	18.78	2	95.65	20.39	94.91	21.97	94.12	23.52	93.27	25.05	
4	98.03	13.89	97.52	15.56	96.94	17.21	96.32	18.84	4	95.63	20.44	94.89	22.02	94.07	23.58	93.24	25.10	
6	98.01	13.95	97.50	15.62	96.92	17.26	96.30	18.89	6	95.61	20.50	94.86	22.08	94.05	23.63	93.21	25.15	
8	98.00	14.01	97.48	15.67	96.90	17.32	96.27	18.95	8	95.58	20.55	94.84	22.13	94.04	23.68	93.18	25.20	
10	97.98	14.06	97.46	15.73	96.88	17.37	96.25	19.00	10	95.56	20.60	94.81	22.18	94.01	23.73	93.16	25.25	
12	97.97	14.12	97.44	15.78	96.86	17.43	96.23	19.05	12	95.53	20.66	94.79	22.23	93.98	23.78	93.13	25.30	
14	97.95	14.17	97.43	15.84	96.84	17.48	96.21	19.11	14	95.51	20.71	94.76	22.28	93.95	23.83	93.10	25.35	
16	97.93	14.23	97.41	15.89	96.82	17.54	96.18	19.16	16	95.49	20.76	94.73	22.34	93.93	23.88	93.07	25.40	
18	97.92	14.28	97.39	15.95	96.80	17.59	96.16	19.21	18	95.46	20.81	94.71	22.39	93.90	23.93	93.04	25.45	
20	97.90	14.34	97.37	16.00	96.78	17.65	96.14	19.27	20	95.44	20.87	94.68	22.44	93.87	23.99	93.01	25.50	
22	97.88	14.40	97.35	16.06	96.76	17.70	96.12	19.32	22	95.41	20.92	94.66	22.49	93.84	24.04	92.98	25.55	
24	97.87	14.45	97.33	16.11	96.74	17.76	96.09	19.38	24	95.39	20.97	94.63	22.54	93.81	24.09	92.95	25.60	
26	97.85	14.51	97.31	16.17	96.72	17.81	96.07	19.43	26	95.36	21.03	94.60	22.60	93.79	24.14	92.92	25.65	
28	97.83	14.56	97.29	16.22	96.70	17.86	96.05	19.48	28	95.34	21.08	94.58	22.65	93.76	24.19	92.89	25.70	
30	97.82	14.62	97.28	16.28	96.68	17.92	96.03	19.54	30	95.32	21.13	94.55	22.70	93.73	24.24	92.86	25.75	
32	97.80	14.67	97.26	16.33	96.66	17.97	96.00	19.59	32	95.29	21.18	94.52	22.75	93.70	24.29	92.83	25.80	
34	97.78	14.73	97.24	16.39	96.64	18.03	95.98	19.64	34	95.27	21.24	94.50	22.80	93.67	24.34	92.80	25.85	
36	97.76	14.79	97.23	16.44	96.62	18.08	95.96	19.70	36	95.24	21.29	94.47	22.85	93.65	24.39	92.77	25.90	
38	97.75	14.84	97.20	16.50	96.60	18.14	95.93	19.75	38	95.22	21.34	94.44	22.91	93.62	24.44	92.74	25.95	
40	97.73	14.90	97.18	16.56	96.57	18.19	95.91	19.80	40	95.19	21.39	94.42	22.96	93.59	24.49	92.71	26.00	
42	97.71	14.95	97.16	16.61	96.55	18.24	95.89	19.86	42	95.17	21.45	94.39	23.01	93.56	24.55	92.68	26.05	
44	97.69	15.01	97.14	16.66	96.53	18.30	95.86	19.91	44	95.14	21.50	94.36	23.06	93.53	24.60	92.65	26.10	
46	97.68	15.06	97.12	16.72	96.51	18.35	95.84	19.96	46	95.12	21.55	94.34	23.11	93.50	24.65	92.62	26.15	
48	97.66	15.12	97.10	16.77	96.49	18.41	95.82	20.02	48	95.09	21.60	94.31	23.16	93.47	24.70	92.59	26.20	
50	97.64	15.17	97.08	16.83	96.47	18.46	95.79	20.07	50	95.07	21.66	94.28	23.22	93.45	24.75	92.56	26.25	
52	97.62	15.23	97.06	16.88	96.45	18.51	95.77	20.12	52	95.04	21.71	94.26	23.27	93.42	24.80	92.53	26.30	
54	97.61	15.28	97.04	16.94	96.42	18.57	95.75	20.18	54	95.02	21.76	94.23	23.32	93.39	24.85	92.49	26.35	
56	97.59	15.34	97.02	17.00	96.40	18.62	95.72	20.23	56	94.99	21.81	94.20	23.37	93.36	24.90	92.46	26.40	
58	97.57	15.40	97.00	17.05	96.38	18.68	95.70	20.28	58	94.97	21.87	94.17	23.42	93.33	24.95	92.43	26.45	
60	97.55	15.45	96.98	17.10	96.36	18.73	95.68	20.34	60	94.94	21.92	94.15	23.47	93.30	25.00	92.40	26.50	
c= .75...	.74	.11	.74	.12	.74	.14	.73	.15	c= .75...	.73	.16	.73	.17	.73	.19	.72	.20	
c=1.15...	1.14	.17	1.13	.19	1.13	.21	1.13	.23	c=1.15...	1.12	.25	1.12	.27	1.11	.29	1.11	.31	
c=1.90...	1.88	.28	1.87	.31	1.87	.35	1.86	.38	c=1.90...	1.85	.41	1.85	.44	1.84	.48	1.83	.51	

TABLE OF STADIA REDUCTIONS.—Continued.

16°		17°		18°		19°		20°		21°		22°		23°	
Hor. Dist.	Diff. Elev.	Hor. Dist.	Diff. Elev.	Hor. Dist.	Diff. Elev.	Hor. Dist.	Diff. Elev.	Hor. Dist.	Diff. Elev.	Hor. Dist.	Diff. Elev.	Hor. Dist.	Diff. Elev.	Hor. Dist.	Diff. Elev.
0	26.50	91.45	26.96	90.45	29.39	89.40	30.78	88.30	32.18	87.16	33.56	85.97	34.73	84.73	35.97
2	26.55	91.42	27.01	90.42	29.44	89.36	30.83	88.26	32.24	87.12	33.60	85.93	34.77	84.60	36.01
4	26.59	91.39	27.06	90.38	29.48	89.33	30.87	88.23	32.27	87.08	33.64	85.89	34.80	84.55	36.05
6	26.64	91.35	27.10	90.35	29.53	89.29	30.92	88.19	32.30	87.04	33.69	85.85	34.86	84.61	36.09
8	26.69	91.32	27.15	90.31	29.58	89.26	30.97	88.15	32.33	87.00	33.74	85.80	34.90	84.57	36.13
10	26.74	91.29	27.20	90.28	29.62	89.22	31.01	88.11	32.36	86.96	33.77	85.76	34.94	84.52	36.17
12	26.79	91.26	27.25	90.24	29.67	89.18	31.06	88.08	32.41	86.92	33.79	85.72	34.98	84.48	36.21
14	26.84	91.22	27.30	90.21	29.72	89.15	31.10	88.04	32.45	86.88	33.80	85.68	35.02	84.44	36.25
16	26.89	91.19	27.34	90.18	29.76	89.11	31.15	88.00	32.49	86.84	33.80	85.64	35.07	84.40	36.29
18	26.94	91.16	27.38	90.14	29.81	89.08	31.19	87.96	32.54	86.80	33.81	85.60	35.11	84.35	36.33
20	26.99	91.12	27.42	90.11	29.86	89.04	31.24	87.93	32.58	86.77	33.82	85.56	35.15	84.31	36.37
22	27.04	91.09	27.46	90.07	29.90	89.00	31.28	87.89	32.63	86.73	33.83	85.52	35.19	84.27	36.41
24	27.09	91.06	27.50	90.04	29.95	88.96	31.33	87.85	32.67	86.69	33.87	85.48	35.23	84.23	36.45
26	27.13	91.02	27.54	90.00	30.00	88.93	31.38	87.81	32.72	86.65	34.01	85.44	35.27	84.18	36.49
28	27.18	90.99	27.58	89.97	30.04	88.89	31.42	87.77	32.76	86.61	34.06	85.40	35.31	84.14	36.53
30	27.23	90.96	27.62	89.93	30.09	88.86	31.47	87.74	32.80	86.57	34.10	85.36	35.36	84.10	36.57
32	27.28	90.92	27.66	89.90	30.14	88.82	31.51	87.70	32.85	86.53	34.14	85.31	35.40	84.06	36.61
34	27.33	90.89	27.70	89.86	30.19	88.78	31.56	87.66	32.89	86.49	34.18	85.27	35.44	84.02	36.65
36	27.38	90.85	27.74	89.83	30.23	88.75	31.60	87.62	32.93	86.45	34.22	85.23	35.48	83.98	36.69
38	27.43	90.82	27.78	89.79	30.28	88.71	31.65	87.58	32.98	86.41	34.27	85.19	35.52	83.94	36.73
40	27.48	90.79	27.82	89.76	30.32	88.67	31.69	87.54	33.02	86.37	34.31	85.15	35.56	83.89	36.77
42	27.53	90.75	27.86	89.72	30.37	88.64	31.74	87.51	33.07	86.33	34.35	85.11	35.60	83.84	36.80
44	27.57	90.72	27.90	89.69	30.41	88.60	31.78	87.47	33.11	86.29	34.40	85.07	35.64	83.80	36.84
46	27.62	90.69	27.94	89.65	30.46	88.56	31.83	87.43	33.15	86.25	34.44	85.02	35.68	83.76	36.88
48	27.67	90.66	27.98	89.61	30.51	88.53	31.87	87.39	33.20	86.21	34.48	84.98	35.72	83.72	36.92
50	27.72	90.62	28.02	89.58	30.55	88.49	31.92	87.35	33.24	86.17	34.52	84.94	35.76	83.67	36.96
52	27.77	90.59	28.06	89.54	30.60	88.45	31.96	87.31	33.28	86.13	34.57	84.90	35.80	83.63	37.00
54	27.81	90.55	28.10	89.51	30.65	88.41	32.01	87.27	33.33	86.09	34.61	84.86	35.85	83.59	37.04
56	27.86	90.52	28.14	89.47	30.70	88.38	32.05	87.24	33.37	86.05	34.65	84.82	35.89	83.54	37.08
58	27.91	90.48	28.18	89.44	30.74	88.34	32.09	87.20	33.41	86.01	34.69	84.77	35.93	83.50	37.12
60	27.96	90.45	28.23	89.40	30.78	88.30	32.14	87.16	33.46	85.97	34.73	84.73	35.97	83.45	37.16
c=.75	.72	.71	.70	.69	.68	.67	.66	.65	.64	.63	.62	.61	.60	.59	.58
c=1.15	1.10	1.09	1.08	1.07	1.06	1.05	1.04	1.03	1.02	1.01	1.00	0.99	0.98	0.97	0.96
c=1.90	1.82	1.81	1.79	1.78	1.77	1.76	1.75	1.74	1.73	1.72	1.71	1.70	1.69	1.68	1.67

TABLE OF STADIA REDUCTIONS.—Continued.

24°		25°		26°		27°		28°		29°		30°	
Hor. Dist.	Diff. Elev.	Hor. Dist.	Diff. Elev.	Hor. Dist.	Diff. Elev.	Hor. Dist.	Diff. Elev.	Hor. Dist.	Diff. Elev.	Hor. Dist.	Diff. Elev.	Hor. Dist.	Diff. Elev.
0	37.16	38.30	39.44	40.59	41.73	42.88	44.02	45.17	46.31	47.46	48.60	49.74	50.88
2	37.20	38.34	39.48	40.63	41.77	42.91	44.05	45.19	46.33	47.47	48.61	49.75	50.89
4	37.24	38.38	39.52	40.67	41.81	42.95	44.09	45.23	46.37	47.51	48.65	49.79	50.93
6	37.28	38.42	39.56	40.71	41.85	42.99	44.13	45.27	46.41	47.55	48.69	49.83	50.97
8	37.32	38.46	39.60	40.75	41.89	43.03	44.17	45.31	46.45	47.59	48.73	49.87	51.01
10	37.36	38.50	39.64	40.79	41.93	43.07	44.21	45.35	46.49	47.63	48.77	49.91	51.05
12	37.40	38.54	39.68	40.83	41.97	43.11	44.25	45.39	46.53	47.67	48.81	49.95	51.09
14	37.44	38.58	39.72	40.87	42.01	43.15	44.29	45.43	46.57	47.71	48.85	49.99	51.13
16	37.48	38.62	39.76	40.91	42.05	43.19	44.33	45.47	46.61	47.75	48.89	50.03	51.17
18	37.52	38.66	39.80	40.95	42.09	43.23	44.37	45.51	46.65	47.79	48.93	50.07	51.21
20	37.56	38.70	39.84	40.99	42.13	43.27	44.41	45.55	46.69	47.83	48.97	50.11	51.25
22	37.60	38.74	39.88	41.03	42.17	43.31	44.45	45.59	46.73	47.87	49.01	50.15	51.29
24	37.64	38.78	39.92	41.07	42.21	43.35	44.49	45.63	46.77	47.91	49.05	50.19	51.33
26	37.68	38.82	39.96	41.11	42.25	43.39	44.53	45.67	46.81	47.95	49.09	50.23	51.37
28	37.72	38.86	40.00	41.15	42.29	43.43	44.57	45.71	46.85	48.00	49.13	50.27	51.41
30	37.76	38.90	40.04	41.19	42.33	43.47	44.61	45.75	46.89	48.04	49.17	50.31	51.45
32	37.80	38.94	40.08	41.23	42.37	43.51	44.65	45.79	46.93	48.08	49.21	50.35	51.49
34	37.84	38.98	40.12	41.27	42.41	43.55	44.69	45.83	46.97	48.12	49.25	50.39	51.53
36	37.88	39.02	40.16	41.31	42.45	43.59	44.73	45.87	47.01	48.16	49.29	50.43	51.57
38	37.92	39.06	40.20	41.35	42.49	43.63	44.77	45.91	47.05	48.20	49.33	50.47	51.61
40	37.96	39.10	40.24	41.39	42.53	43.67	44.81	45.95	47.09	48.24	49.37	50.51	51.65
42	38.00	39.14	40.28	41.43	42.57	43.71	44.85	46.00	47.13	48.28	49.41	50.55	51.69
44	38.04	39.18	40.32	41.47	42.61	43.75	44.89	46.04	47.17	48.32	49.45	50.59	51.73
46	38.08	39.22	40.36	41.51	42.65	43.79	44.93	46.08	47.21	48.36	49.49	50.63	51.77
48	38.12	39.26	40.40	41.55	42.69	43.83	44.97	46.12	47.25	48.40	49.53	50.67	51.81
50	38.16	39.30	40.44	41.59	42.73	43.87	45.01	46.16	47.29	48.44	49.57	50.71	51.85
52	38.20	39.34	40.48	41.63	42.77	43.91	45.05	46.20	47.33	48.48	49.61	50.75	51.89
54	38.24	39.38	40.52	41.67	42.81	43.95	45.09	46.24	47.37	48.52	49.65	50.79	51.93
56	38.28	39.42	40.56	41.71	42.85	43.99	45.13	46.28	47.41	48.56	49.69	50.83	51.97
58	38.32	39.46	40.60	41.75	42.89	44.03	45.17	46.32	47.45	48.60	49.73	50.87	52.01
60	38.36	39.50	40.64	41.79	42.93	44.07	45.21	46.36	47.49	48.64	49.77	50.91	52.05
c= .75	.68	.31	.32	.67	.33	.66	.35	.65	.36	.64	.37	.63	.38
c=1.15	1.05	.48	.50	1.03	.51	1.02	.53	1.01	.55	1.00	.57	0.99	.58
c=1.90	1.73	.79	.82	1.70	.85	1.60	.88	1.67	.91	1.65	.94	1.64	.96

REMARKS

ON THE

Principle of the Logarithmic Slide Scale.

Written in 1885, but entirely revised for this Manual in 1893.

BY

HUBERT VISCHER, C. E.

The employment of mechanical devices for performing computations has attracted the attention of arithmeticians for a couple of centuries past, and to no class of persons is it of more direct interest than to those engaged in technical callings. These endeavors have been pursued upon several distinct lines, and we may notice by way of classification:

1st. The endeavor to perform desired arithmetical operations by devices distinctly mechanical in their nature, seeking by skilful combination of mechanical elements to carry out the ordinary sequence followed by the computer in making the calculation. We may here mention the celebrated machine of Babbage; and as a more recent illustration, the "Arithmometer" of Thomas, an instrument of only moderate cost, and one coming constantly into greater use.

2d.. The use of geometrical figures representing the mathematical relations existing between mutually dependent quantities. This method, first suggested by the development of the Des Cartian geometry, has, in very recent times, been developed into a new science, graphostatics — which does not merely seek to present the deductions of analytical reasoning graphically, but starting at the elements, builds up methods of its own in which the arithmetical conceptions of magnitudes fall more and more into the back ground and are replaced by operations which are mechanical in application, if not in their conception.

Besides these two methods, we have another, somewhat partaking in nature of both, yet embodying a distinct principle of its own, that of the Logarithmic Slide Scale.

It is here proposed to take a cursory survey of this field, which is of wide application and certainly of interest, being an important agent for the saving of time-robbing computations. It is worthy of more general attention than it has received in this country; though in Europe, the slide-rule is recognized as the engineer's daily pocket companion.

The slide-rule rests upon two most simple principles: first, that magnitudes in general may be represented by the length of lines; second, that these lines, when measured off upon one another may represent by the length of a resulting line, either a summation or a difference of the magnitude which the lines represent. The

first principle is made use of in the logarithmic graduation of the scales; the second principle finds application in the sliding motion which we impart to the scales. Slide-rules have been constructed of many kinds and for many special purposes, but they will all be found to reduce to these two elementary principles.

The use of the logarithmic graduation here, as in all other cases where logarithms are employed, is due to the desire to reduce arithmetical calculations by one step in the scale of operations; thus replacing multiplication and division by addition and subtraction, and reducing involution and evolution to multiplication and division.

The method in which the logarithmic graduation is carried out is explained most easily by taking a special case, and we refer to the scale $AB A'B'$ on Fig. 1. The length of this scale, measured between the two extreme outer limits, marked 1, 1, is assumed as a *unit of length*; and what the absolute length of this unit is, is perfectly immaterial. We may, for purposes of illustration, assume it to be just one foot long. As a preliminary step, let us first imagine this length divided off into say 1,000 equal parts. Before proceeding further, however, let us recall to mind the well known property of "periodical repetition" peculiar to the Briggs' system, whereby all numbers represented by the same numerals, grouped in the same order, are represented by the same logarithm, independent of the characteristic or mantissa.

It is clear that with the aid of a table of logarithms and using our scale of equal divisions, we may at once assign to any logarithm in the table a place on the scale, such that its distance from the zero (or left-hand end of the scale) may correctly represent the value of the logarithm, plotted in our unit or standard of length. Doing this for all logarithms, commencing at the number 1, and progressing by any suitable interval (say 1-100 of unity), let us mark each so determined point by a cross-line on the scale, and (in order to preserve it for future use) mark opposite the cross-line the *number* corresponding to the logarithm which the cross-line fixes.

Having done this, we reach the right-hand end of our scale, when in our table we reach the number 10. It is apparent that our scale represents graphically a table of logarithms for all whole numbers between 1 and 10, with suitable subdivisions, and corresponds in all particulars to the printed table from which it was constructed. But it is equally clear that if we agree to consider the scale as representing the fractional part of the logarithm only, and without reference to the "characteristic," we may at once extend its range so as to embrace the whole field of positive numbers without any reservation. The "characteristic" of the logarithm, however, only determines the position of the decimal point in its number. Therefore, this stipulation about dropping the characteristic implies, conversely, that our scale shall only give us the numerals which express a number, without reference to a decimal point; so that, if we read 2, 3, 5 on the scale, we may read this as 235, or as 235 with any number of zeros affixed or prefixed to it; as 0.00235 or as 2350, for example. In slide-rule calculations there must always be some foreign means employed for correctly assigning the position of the decimal point, a matter which will be referred to again later on.

It is now practically shown what constitutes the construction of the logarithmic scale—only one, however, of an infinite variety of possible logarithmic scales. Any series or group of numbers may be made the basis of a similar scale. Thus, by means of their logarithms, we may construct logarithmic scales for the natural sines or tangents of angles (see scales E and F, Fig. 2), or for any other function of angles; or, as the choice of the length of our unit was left perfectly open, we may plot scales to any enlarged or reduced scale, which latter observation is important, as it forms

the basis of all operations embodying involution and evolution in the slide-scale calculations (as will at once appear clear by remembering that these operations, logarithmically speaking, imply multiplication and division).

Returning, however, to our constructed scale, Fig. 1, let us conceive it severed longitudinally along its central line by a cut, $a b$, so as to fall into two identical scales, AA' and BB' . Furthermore, let us regard these scales as free to slide laterally to the right or the left, along their common line of contact, $a b$. With this motion we at once obtain the means of performing *any desired multiplication or division*. This is clear, if we consider that the divisions upon our scale are magnitudes logarithmically plotted, and that, therefore, an addition or subtraction, as far as these are concerned, executes a multiplication or division as regards their numbers (which are, by-the-by, the only records on the scale). With this capacity of motion, we have attained the simplest form of the slide-rule. A single setting of the slide performs a multiplication or division; if desired, a combination of both, *i. e.*, a proportion; and in many cases not simply for a single set of numbers, but for a whole series of sets of numbers at one and the same operation. The details of manipulation are not entered into here, having only the principles of the slide-rule in view. If desired, these can all be found described at length in the printed directions furnished with the scales. Be it remarked, however, that although the whole operation has been essentially a logarithmic one, we lose sight entirely of logarithms having been used at all. This is always the case in operations with the slide-rule. In fact, the peculiar merits of the slide-rule can hardly be better expressed than by pointing out this unconscious gaining of all the advantages of using logarithms, while saved the labor of taking them from tables. While the whole conception of the slide-rule is logarithmic in its nature, save as a means of understanding its construction and in studying out particular modes of application to meet special cases, this is lost sight of entirely in its use.

The slide-rule, as constructed by the firm of Dennert & Pape (in Altona, Germany), is shown in figures 1 and 2; the latter being an isometrical view of the scale in order to better show its working parts. These are as follows: A thin slab of boxwood, called the "slide," upon the edges of which two scales, B and C are engraved. The slide being fitted with tongue-and-grooved edges at its sides, is free to move between two other boxwood surfaces also bearing scales, A and D . The latter are parts of the same piece of wood, being connected with each other underneath the slide, and both of these (together with the connecting boxwood member) form the "rule," into which the slide is recessed laterally while left perfect freedom of motion lengthwise, in both directions. Scales A and B , as has been shown, are exact duplicates of one another, as are also scales C and D , thus forming two pair of scales. The latter pair, in principle of graduation correspond to the former pair entirely, but are graduated to one-half the scale (or length of unit) of A and B . This reduction in scale would make each of the upper scales one-half the length of the lower pair, were it not that we utilize the remaining half by engraving thereon another duplicate set of the smaller scales, placed alongside of the former; thus making the total length of the upper *double pair* exactly that of the single lower pair. Each half of either "double scale" is not to be regarded as separate from its neighbor, but as joined to it, so as to form one continuous scale; the idea being to allow the double scales to represent all numbers for an interval of two whole powers of 10, while the lower scales represent all numbers for half that interval; if the lower scale embraces, for instance, the period from 1 to 10, then the upper similarly represents the period from 1 to 10 on the first (or left hand) halves, while the second (right hand) halves

simultaneously represent the numbers from 10 to 100. The pair of scales on the slide (though movable as a pair) stand permanently with their extreme ends directly over and under one another; so also stand permanently fixed opposite one another the ends of scales *A* and *D*.

Now, while the double scales *C* and *D*, on account of their lateral motion along their common line of contact, answer the same purposes exactly that the lower pair do (that is, perform multiplication and division also), a little reflection and study of the figure will show how, regarding *A* and *D* or *B* and *C* as pairs, the following must always hold good, on account of the peculiarities of the mode of graduation: any number on the upper scale stands directly over its root on the *corresponding* lower scale; and conversely, any number on a lower scale may be raised to the second power by taking the corresponding number exactly above it in its companion scale. Thus a simple transfer made in a suitable manner, from either scale to the other, at right angles to the axis of the rule, effects an involution or a radication to the second degree; and either of these operations may be combined, at will, with multiplication and division, by a suitable movement of the slide.* Involution and evolution to higher powers may also be executed by the slide-rule, though we merely note the fact here.

The "slide," however, can be completely run out of the rule and re-inserted, when so desired, reverse side up. The reverse side of the slide bears two scales, *E* and *F*, these being respectively logarithmic scales of natural sines and natural tangents. The reverse side of the slide also carries a third scale, *G*, bearing equal divisions (1-1000ths of the scale length) and answering the purpose of a table of ordinary printed logarithms, in which the numerical value of any logarithm may be directly read off the scale.†

With the slide in the reversed position, the slide-rule presents the appearance shown in Fig. 2. When used in combination with each other, scales *A*, *D*, *E* and *F* enable us to perform any calculation into which enter the trigonometrical functions of angles, combined in any way, by multiplication, division, involution or evolution, with quantities expressed in simple numbers.

Our slide-rule, now fully equipped, is an instrument only a few inches long, ‡ suitable for being carried in one's breast pocket, and of but trifling cost. To enumerate its various uses, it at once serves as a table of numbers and their squares and cubes, their square and cube roots; it is at the same time a table of common logarithms of natural sines, cosines, tangents and cotangents. It is moreover capable of mechanically combining any of the above functions in any desired arithmetical combination, constantly showing up to better and better advantage the more complex the nature of the combination is. It serves also as a convenient pocket rule and straight edge, for it is both of these. It furthermore contains printed on its reverse side a valuable list of useful pocket data of many, frequently used, practical co-efficients. Yet while being all these things combined, alas, absolute perfection is unattainable! It must be admitted it has its shortcomings also. Owing to the mechanical difficulty of graduation, and the uncertainty of reading results closer than to the third (at times the fourth) numeral place, it remains, notwithstanding all its

* To accurately effect this transfer, a small brass part, called the "runner," is provided. See Fig. 2, *A*. This slides freely along the rule in grooves on its outer sides, and carries two indices, *a*, *a*, which accurately transfer points from one scale to another.

† Scale *G* is really the scale of imaginary equal divisions first referred to as a preliminary step towards graduating our original scale, *A*, *A'*.

‡ Generally 26 centimeters, or 10 inches.

theoretical perfection, practically an instrument only applicable where no greater accuracy than the third or fourth figure is required.

Its use must always be a judicious one. The banker, computing interest or exchange upon extended rows of figures, will find the slide-rule falls short of his requirements. Its accuracy is inadequate in many calculations of the engineer, and many have undoubtedly cast the slide-rule scornfully aside, only half examined, on account of the only approximate accuracy of its determinations.*

These shortcomings freely admitted, it still remains an invaluable assistant, and serves to good purpose wherever a limited degree of accuracy is required—and this, after all, holds good in the vast majority of cases in engineering practice. In construction; wherever we have to deal with practical co-efficients (generally themselves but approximations); where, moreover, wide factors of safety are generally introduced, and where, after all, practical considerations usually dictate a selection of the nearest marketable standard size—here, always, the slide-rule gives us results quite as reliable as the most elaborate calculation carried out to the fifth or sixth decimal place. In estimates of earthwork, where our surveys are at best but close approximations to the true condition of the ground; for proportionately distributing minor errors; for interpolating intermediate grades; for at once transforming quantities expressed in one standard unit to equivalents in another standard—for all these purposes, on account of its great rapidity and freedom from liability to “mistakes,” the slide-rule cannot be too highly estimated.

It may not be equal to figuring out traverses to the one hundredth, or the one thousandth parts of a foot (and how very seldom do our measurements really warrant such subsequent super-refinements in calculation); yet even here it may do good service as a check against “mistakes.” There are hundreds of cases where its use in the field may obviate the many half hours and quarter hours consumed—with a party standing idle all the time—while one man alone is busy figuring out some field problem of location. We have, besides these cases, another frequently recurring set; namely, where the relations expressed in an equation are so complex as to make solution only practical by continued approximation; or where we have to assume co-efficients, themselves functions of the element to be determined; where, *assuming* some probable value of the required quantity, we gradually, by successive trials, adjust all elements to conformity, as so frequently occurs in hydraulic work. Here we can always use the slide-rule advantageously for the first stages of the calculation, and when tolerably certain of being “near the mark,” we can then resort to ordinary modes of calculation in the last and final stage.

From what has been said of the general accuracy of the slide-rule, one important corollary should be drawn: to use it successfully, that is, *rapidly*, we should never waste time in straining at the last hair, either in setting the scale or in reading a result; this will reap no adequate return for the extra labor spent.†

One of the chief difficulties to beginners in using the slide-rule lies in assigning to a result its correct local value; that is, to fix the position of the decimal point. Many do this by rule of thumb entirely, placing the decimal point by guess-

* Notwithstanding the above remarks, those who really make a study of it, will be astonished at the accuracy it can be made to yield in the hands of an adept. The slide-rule, namely, often contains in itself the means of overcoming its own deficiencies. Thus used, the ordinary limit of the third or fourth numeral place falls away, and that of the sixth or seventh place appears as its limit in its stead. For instance, any rapidly converging series applied to the rule extends its range at once immensely. This study of the ultimate possibilities of the slide-rule and its special applications is a highly interesting one to any one with leisure to devote to it.

† In using the scale this is essential, as also that the slide should move with perfect freedom, though not so freely as to slip by an inadvertent touch. To effect this, keep the grooves clean, and, if necessary, lubricate with a drop of fine oil.

work, whereby mistakes are liable always to creep in. The most satisfactory method is to preserve in one's head the logarithmic characteristic separate, and to execute mentally the operation implied by the calculation, regarded as a logarithmic problem. The result of this simple calculation always fixes the local value of the result correctly. For example, say 230 is to be multiplied by 0.0003, and the result divided by 2.7. Then we have 230 [characteristic + 2], 0.0003 [characteristic - 4], 2.7 [characteristic 0]; then $+ 2 + (-4) - 0 = + 2 - 4 = - 2$. The slide-rule gives the figures of the answer to four places, 2555 (the last place a little uncertain), and from the foregoing we know the correct value of $230 \div 2.7 \times 0.0003$ to be 0.02555. An additional unit must, however, always be added or subtracted every time we have to resort to a substitution of one index for another in attaining a result, or when we read a result by passing through an index (which corresponds entirely to carrying a unit or borrowing one where ordinary logarithms are used). A little practice, however, teaches us how this is to be applied. To illustrate: $56 \times 7 = 392$. If not modified, our rule would give us $1 + 0 = 1$, or 39.2 as an answer. To obtain a reading at all, a substitution of the indices was required, for which a unit must be added, when we have $1 + 0 + 1 = 2$, giving the correct result 392. Or, say we inquire how often 7 goes into 56. For the position of the decimal point, we would have $1 - 0 = 1$, or the answer, 80 times. We had, however, to use the right-hand index to obtain a reading, where ordinarily the left-hand index would have given us the answer. This substitution implies our subtracting an additional unit, and we have $1 - 0 - 1 = 0$, or $56 \div 7 = 8$, the correct answer.

This calculation is never too difficult to be kept in one's head, save where the operation is a lengthy one, when it is well to keep the characteristic, as was done above in the process of illustration, on a separate scrap of paper, or to provide the slide-rule with some distinct recording device for keeping the characteristic. A simple device for this purpose is that of Mr. Deering, of the Southern Pacific R. R. A small annular disc, free to revolve around a center, upon which a radial scratch used as an index is marked, is provided with several radial divisions to either side of a central initial mark or zero. The disc is turned a suitable number of places to the right or left to record the characteristic, when the slide is set to the number and its position shifted appropriately at each stage of the operation; the index on the fixed center finally indicating the correct position of the decimal point. This little device is mounted on the runner of the slide-rule, and can be easily turned with the finger while one manipulates the runner.

We will now close our observations on the ordinary slide-rule, remarking that figures 1 and 2 are only illustrative representations of the rule, and only show the main subdivisions. An idea of the fineness of the graduation actually used may be derived from figures 3 and 4, which show the same rule with the runner removed, reduced to about four-fifths the usual size.

Besides that of Dennert and Pape the slide-rule of Le Noir has been widely introduced into this country, which, although apparently differing but slightly from the former, falls much short of it in practical efficiency. The most essential difference consists in its having three of the "double scales," and only one single scale, instead of two of each kind—and there is no runner. Slight variations in the arrangements of the slide make great differences in the degree of serviceability.

The slide-rules already described are applicable generally to all calculations, and there is no calculation which cannot be executed by carrying out with the rule, step by step, each successive intermediate operation necessary to attain the result. This, however, often necessitates several settings of the scale, in order to obtain a single

result. To avoid this extended manipulation, special slide-rules may be constructed, capable of solving almost any such case by one single, or at least by a greatly reduced number of settings of the rule.

Speaking generally, any function of two variables combined with constants, may be solved by one movement of a specially constructed rule, the peculiarity of the special construction being that the constants are embodied in a suitable manner with the variables directly. With each additional independent variable above *two*, one more movement is required, generally necessitating the introduction, however, of an additional scale.

Figure 5 gives an illustration of this kind, showing a scale very widely used in Germany in topographical work. With stadia measurements for direct readings of a vertical rod, we have the formulæ:

$$\begin{aligned}d &= K a \cos^2 n, \\e &= K a \frac{1}{2} \sin 2n,\end{aligned}$$

where n is the angle of elevation above the horizontal; K , a constant dependent upon the construction of the telescope, and generally so adjusted as to be exactly 100; a , the reading on the vertical rod between the stadia hairs; d , the corrected distance of the observed point from the instrument; and e , its elevation above the horizontal plane through the horizontal axis of the telescope.

In this form of slide scale, we have the slide bearing two scales; the upper scale graduated to $\frac{1}{2} \sin 2n$, the lower one for $\cos^2 n$. The rule carries two identically graduated scales of simple numbers representing the rod readings, a . Setting the index of the lower scale to coincidence with the rod reading, we read directly on the lower scale opposite the observed angle n , the corrected, *i. e.*, horizontal distance d , also on the upper scale, the difference in elevation, e .

This scale is very serviceable,* but as usually constructed is too long to be convenient for anything but office use. There is another scale for the same purpose, executed in metal, fitted for being used in the field, a vernier being employed. In this case, the finer metallic graduation is relied on to make up in accuracy what otherwise would be sacrificed by the reduced length of the scale.

Another direction presents itself for development of the slide-rule by artificially extending the length of unit (without correspondingly increasing the size of the instrument). In his catalogue of instruments, Stanley of London, describes an instrument by Professor Fuller. Here, by developing the scales on a spiral line upon a cylinder, a length of unit equivalent to 83 feet is attained, of course, hereby very materially increasing the accuracy of the slide-rule, although probably not nearly in the ratio of the increased length (which is about one hundred-fold that of the ordinary slide-rule).

* This scale is also very convenient in running grade lines, enabling the transit-man always to select his grade points on the ground, and keep track of his elevations without the aid of the level, and judiciously used will often save much "backing up" in field location.

Fig. 1.

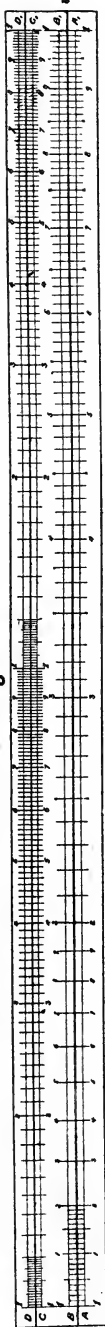

Fig. 2 A.

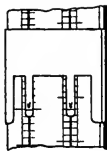

Fig. 2.

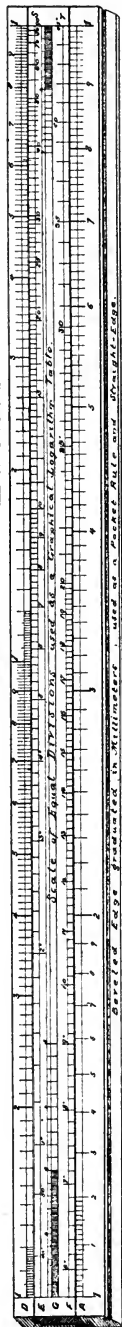

Fig 3

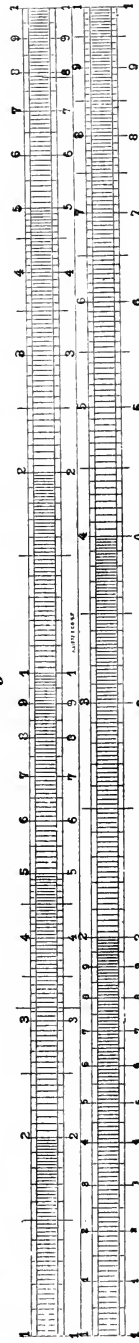

Fig. 4

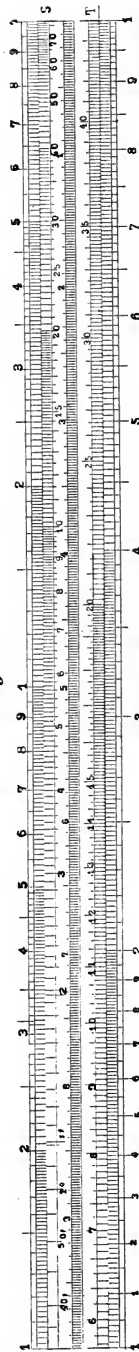
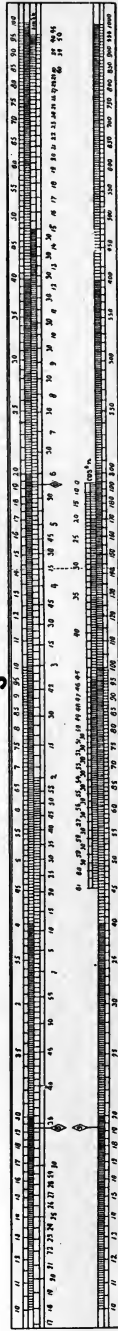

Fig. 5.



SOME PRACTICAL HINTS

ON

HOW TO TELL A GOOD SURVEYING INSTRUMENT*

By A. LIETZ, Member Tech Soc

Regarding their quality, engineers' instruments may be divided into two classes. In the first category we would place those which are disposed of by their makers directly to the engineer who uses them, while those of the second class are made for the trade, and sold principally by dealers. While in most of the latter class many so-called improvements are introduced that make them easily salable, they do not possess the thorough workmanship which makes up a first-class article. There are, indeed, many improvements, which may yet be added, but if they are not made in a thorough workmanlike manner they are of little, if any, importance, and will in no case make an instrument of fine quality.

Graduation.—In a transit, the graduation is the most important part. Solid silver is the best metal known, upon which a perfect graduation can be made, and it is therefore almost exclusively used by makers. It has the advantage of keeping its surface better than the silver wash, which is found on most of the older instruments.



A



B



C

To examine the graduation, the first thing should be to see whether each line is perfectly sharp and clearly cut; for this purpose it is well to use a compound microscope, as only a very keen observer will be able to detect unevenness in the lines with a common magnifier. The starting point of a line, if closely examined, will show whether a perfectly-shaped and well-set tool was used in cutting it.

The line shown in figure A, in which the upper or pointed end is the starting point, indicates by its true shape that it could only have been made with a perfect and properly set tool. It is a fact that this shape is found in all graduations of first-class instruments.

* Reprinted and revised, by permission, from the Transactions of the Technical Society of the Pacific Coast. Vol. VII, No. 5, December, 1890

In Fig. B the line has no taper, but begins with its full width. In such an event the cut was either made from the inner rim of the circle outward, or, what is more likely, the engraving tool was set end for end and drawn from the starting point backwards toward the center. In most cases is the blunt end of the line explained by the latter method. Although the tool used for such a purpose may have been sharp and of the proper form, the additional pressure required to draw it with its wrong end foremost vitiates the degree of accuracy of the graduation, for, if an unnecessary force is applied in producing a line, the tool will not always follow the motion in which it is guided by its drawing mechanism.

Figure C represents a line made with an imperfect drawing device and a dull tool not capable of doing good work.

It will be noticed in figures A, B and C, that the starting point of the line shows the shape of the tool with which it was made, and this is, therefore, the main point upon which to pass judgment on the value of a graduation.

After we have convinced ourselves that the shape of the line is perfect, we may feel somewhat assured that the graduation is a good one; but if the lines are not equally spaced, they are worthless. To determine this is the most difficult as well as the most tedious of tests to be made in the examination of an instrument with graduated circles. The manufacturers have apparatus with which such examinations can be made in a comparatively short time, and with a great degree of accuracy. No maker of first-class instruments will let one go out of his hands before having convinced himself that the divisions are as perfect as demanded by the character of the article.

The most accurate graduation, however, is of no value without a well-fitting center. To prove both, several methods are employed. The surest test is to clamp the vernier plate to any point of the circle, then, if by adding the reading of the two verniers together — frequently repeating this manipulation upon different parts of the circle — the sum will always be 180 degrees, they are correct. (This refers to plates graduated from 0 to 180 degrees, on both sides of zero; in case of a graduation to 360 degrees, a subtraction is required.)

The graduation of an instrument having but one vernier can only be tried with the telescope, which is a rather tedious operation.

It may also be remarked, that short lines on a graduated circle are of some advantage, as the spaces between them appear to be much larger, and there is consequently less fatigue to the eye while reading. It is another fact that during the process of graduating the tool is not required to do as much work, and is therefore apt to keep its fine edges better, thereby securing more perfect work.

The space between the circle and verniers must be very small if an accurate reading is to be obtained; it must appear through a reading glass like a very fine black and uniform line, and should remain so during the revolution of the circle.

In second-class instruments it is generally found that the verniers and circles are not set in the same plane; this is done to make any unevenness in the plate disappear, but it is a very objectionable feature, for it will cause parallax, and no accurate reading can be taken with such circles.

The Telescope.—The telescope forms a very important part of an instrument, and must, therefore, be closely examined. The reason why so many telescopes of second-class instruments are called good is because they have a very low magnifying power, and consequently will give a good definition; but if the magnifying power of such telescopes were to be increased to what it should be, with the same kind of glasses and workmanship, the definition would be entirely lost. Experience has

shown that a telescope of $11\frac{1}{2}$ inches length, such as is generally used in transits of the ordinary size, may have a magnifying power of twenty-four diameters, and give a good definition and sufficient light, if the new Jena glass is used; while most telescopes of the same size, which I have had occasion to examine, show, on an average, a magnifying power of fifteen diameters only. It is true that a low power may be of advantage under certain atmospherical conditions, but, as a rule, a higher power will give better satisfaction if the lenses are first-class.

Inverting telescopes, which are used almost exclusively in European countries, are comparatively little in vogue in the American engineering fraternity. They have a great advantage over the erect telescopes; the eye-piece having two lenses only and being shorter, the proportion between the focal lengths of the objective lens and the eye-piece may be increased considerably, and thusly the magnifying power, without loss of light.

Construction.—In regard to the construction, it is the aim of every maker to build an instrument of the least weight, it being limited only to the extent that it shall not be affected by the wind and become unsteady by reason of its lightness. While it is reasonable that a proper reduction can best be effected by decreasing the size of the whole instrument, instead of reducing the weight of individual parts of a large transit, for instance, great possibilities in this direction are open by a judicious use of aluminium in the manufacture of instruments. The author firmly believes that with this metal we shall be able to reduce the weight considerably without any sacrifice of steadiness, and it is his purpose to make some detailed investigations in the near future that shall lead to an intelligent understanding of this subject.

The steadiness of an instrument depends upon its construction; those that have the longest centers, with the shortest distance between the tripod-head and the plates, and in which the distance between the leveling screws is large enough to secure a proper base, or, in other words, a strong foundation, will prove to be firm and steady even in a strong wind.

The methods of placing the verniers of a transit in such a position that they may be read without stepping aside while observing, is a feature in construction which has been pronounced objectionable, because the size of the plate level, which is at right-angles to the line of collimation, and which is the more important of the two, has to be reduced. The manner in which this can be overcome without reducing its length, or without placing it over one of the verniers (which must affect the degree of accuracy of the reading considerably), and the way in which this level may be set without allowing it to extend beyond the circumference of the plate, will be explained on some other occasion.

The Compass.—The compass should be made as large as possible, but without reducing the value of more important parts. It can often be noticed that an instrument with very large compass has the telescope standards fastened too far from the center, which reduces steadiness; while others, of course still worse, have much spare room between standards and compass box. The point of the center-pin, as well as the upper ends of the needle, must lie in the same plane with the graduation, if the quivering motion which most sensitive needles possess, shall not be noticed on the reading points. As the accuracy depends principally on the pin and cap, these should consist of the best material, while the lift arrangement must be constructed in such a manner as to raise and lower the needle gently, in order to prevent the sudden jerking and falling, which is so often the cause for the rapid wearing out of the point and cap.

Other Details.—It is an important feature of most all of the later instruments that the clamp by which the horizontal circle is held in position works toward the center on a collar, instead of being clamped on the circumference of the plate, and that all tangent screws are provided with opposing springs.

It is also important that the telescope standards have bases large enough to secure proper connections with the plate. It is, furthermore, of great importance to insure steadiness that the lower parts containing the leveling screws be made out of one solid star-shaped casting, instead of the common round plates into which the nuts are simply stuck. There seems to be no other reason for making this latter style than to save a few dollars in labor.

If the star-shaped piece is slotted and provided with clamp screws, lost motion, which is liable to appear in time in the leveling screws, can be taken up.

It goes without saying that all transit instruments should be provided with shifting centers, that ought to be protected by a thin metal plate, to keep the dust out.

The Tripod.—The tripod legs must be light and strong, and of good hard wood, in order to secure steadiness, and should be fitted from the outside, so that any shrinkage of the wood may be drawn up by a nut at any time. In the older style, where the legs fit inside, this cannot be accomplished, and in that case it not only reduces the steadiness, but may also lead to serious accidents. The split or skeleton legs are best suited to come up to all the requirements of a good tripod.

The Case.—The manner in which an instrument is packed in its case is by no means unimportant. A transit must stand upright, so that it may be taken out by holding the lower base-plates and leveling screws, and not the upper plates or the telescope axis. A Y-level box should be provided with an extra space for the telescope to rest in upon its collars.

The Finish.—The outer finish of an instrument, although having little to do with its accuracy, will always be found of some elegance in a first-class article. Unfortunately, most of the second-class possess a brilliant finish that only too often leads purchasers to overlook the more important parts. If engineers, when selecting instruments, would thoroughly test the finer qualities, and take into consideration the construction, they would not only be certain to get a more perfect article, but would induce makers to construct and build instruments in accordance with scientific principles.

DISCUSSION

BY MR. LUTHER WAGONER.

The paper is a good practical résumé of the principal points concerning the working qualities of a field instrument, and I presume it refers solely to the selection of a new article.

My experience is that instruments do not often retain the good points shown in the shop after the ordinary usage and almost inevitable rough handling in the field and especially in transportation.

These injuries are usually springing or bending of the centers and eccentricity; that is, the two axes are not co-incident, and the latter condition is one common to nearly all instruments in a greater or less degree. I have seen it large enough to cause an error of three minutes in a right-angle.

As it may be necessary to try to do good work with such an instrument, I will explain my method of examining an instrument having two verniers.

Set one vernier at zero and read the other, calling less than 180 degrees minus and more than 180 degrees plus; take such readings, say, every 15 degrees on the circle and tabulate them properly. The mean of all the readings will be the angular

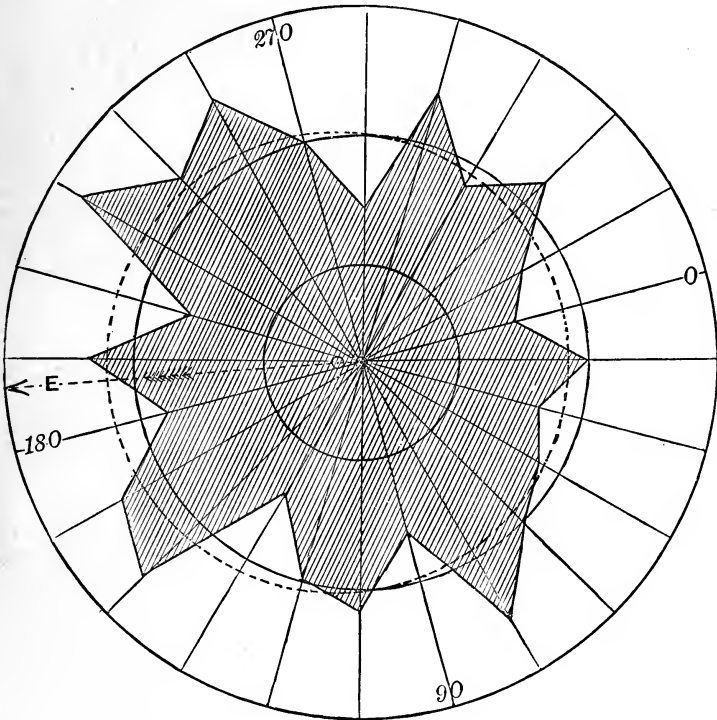

difference of the verniers from 180 degrees; subtract this mean quantity from each of the original readings (having due regard to the algebraic signs), and then use the resultant new column, as follows:

With any convenient radius draw a circle on a cardboard and divide the circle into as many parts as there are observations, numbering the card like the instrument; then using the circle as a base-line, plot the resultant new column, calling inside radical lines *minus* and outside radical lines *plus*, using any convenient scale; join the points thus plotted, and cut out with a sharp knife the resultant figure, as shown in the accompanying engraving by shaded lines; balance it over a knife-edge in two or more positions, and mark the center of gravity thus found. Replace the figure in the cardboard, and with the original radius and center of gravity as a new center draw a circle. (See figure.) The variations from this new circle are the residual errors due to graduation and observation.

Unless an instrument was either very poor originally, or has been very roughly handled, these residuals should not exceed a few seconds.

The center of gravity found by the above method is the vernier-plate axis; its distance from the original center is the amount of eccentricity measured by the scale used for plotting the figure, and a line drawn through the two axes gives its direction.

THE GOLDSCHMID ANEROID.*

It need hardly be stated that all aneroid barometers make use of the elasticity of a hermetically sealed box, or other closed compartment in which a partial vacuum has been established, to measure changes in atmospheric pressure. The movements of the box, always small, are magnified by means of a somewhat complex system of delicate levers in the ordinary aneroid forms, of which that of Naudet's make may be taken as a type. The extreme delicacy of the intermediate transmission has always proved the objectionable feature and the main source of inaccuracy, and it was with the object of totally suppressing this transmission that Goldschmid successively designed the series of instruments which bear his name.

The movements of the vacuum box were observed either by a micrometer screw or, as in the Goldschmid-Weilenmann's aneroid, several boxes are mounted, one upon another, the upper end of the series carrying an index, whose motion is observed by a minute telescope provided with cross-hairs, and mounted upon a micrometer screw.

The original instrument with a single box proved deficient in delicacy, and the compound-box aneroid disappointed the expectations of its designers in not possessing the requisite qualities of standing ordinary rough handling in shipment or field use. While giving admirable results when left stationary or carefully carried upon an observer's person, curiously enough this compound-box aneroid (No. 3) showed that sudden jars produced very considerable changes in the instrument — not abrupt changes only, but changes such that often weeks and months were required before the boxes again assumed a state of equilibrium. This deficiency was all the more surprising on account of the construction having been so simple, and all intermediate transmission having been eliminated, that special freedom from liability to disarrangement had been confidently anticipated.

Since Goldschmid's death his successor, Hottinger, of Zurich, has continued his investigations, and, after many modifications and changes, has produced the type of instruments shown in figures 1, 2 and 3, known as the Goldschmid Aneroid No. 1. The vacuum, $b b$ (Figs. 1 and 2), is kept in tension by the steel spring, ff ; this transfers the movement of the box-center to the lever, $h h$, turning on the fulcrum, a . To the top of this lever, $h h$, is attached a hair-spring, $e e$. The movements of the box are measured by means of a micrometer screw, M , whose contact with the hair-spring, $e e$, must be ascertained with greater accuracy than is possible by the mere sense of touch, and is accordingly indicated by the coincidence of two black lines on the heads of the lever, $h h$, and the hair-spring, $e e$, observed by means of a magnifying glass, L . The scale, SS (Fig. 3), gives the full revolution of the micrometer screw. The first instruments of this class were provided with a scale on which the readings increased with the altitude, the value of the scale-unit being arbitrary. The scale of the more recent instruments is divided to correspond with

* From Specht's description of the instrument and from Hottinger's illustrations.

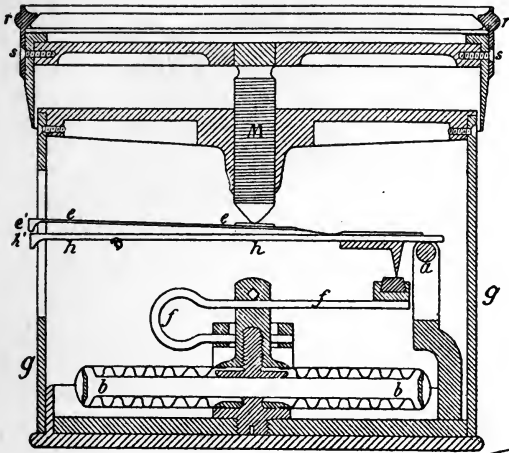

Fig. 1.

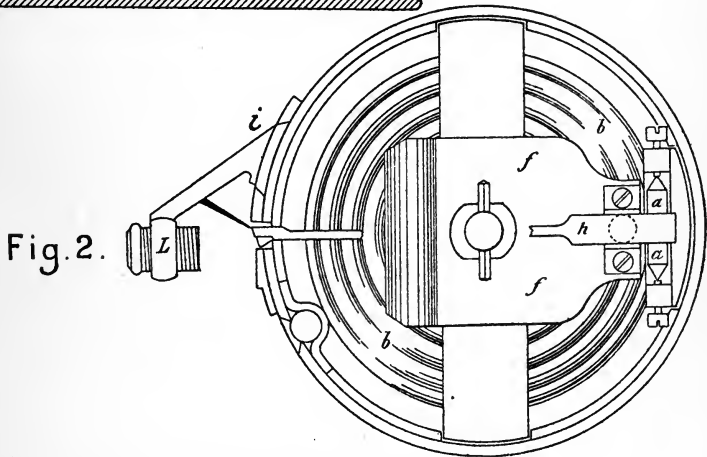

Fig. 2.

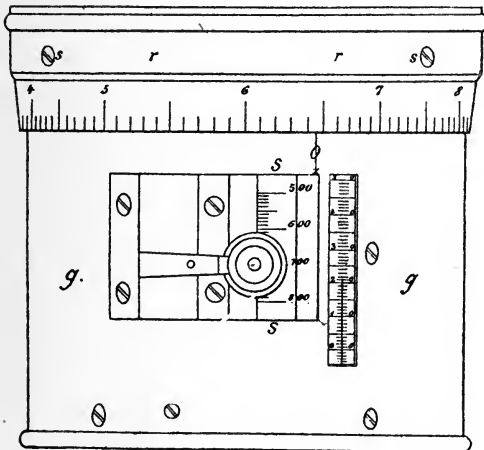

Fig. 3.

the mercurial barometer. Each revolution of the micrometer screw corresponds to 10 mm. of the mercury column, and the head of the micrometer screw is decimally graduated, admitting of accurate reading to the one-hundredth part of a millimeter.

The usual size of this instrument is $3\frac{1}{2}$ inches diameter and $2\frac{1}{2}$ inches high. Fig. 1 is a vertical section; Fig. 2, a top view, the cover being removed; Fig. 3, a side view; *gg* is the outer shell; *rr* the revolving and graduated head; *h'*, Fig. 1, the end of the main lever, and *e'* that of the hair-spring lever, each provided with an index-line; *SS*, Fig. 3, the scale by which the number of full revolutions of the micrometer screw, *M*, Fig. 1, are measured.

New aneroids give elevations at the ordinary atmospheric pressure (25 to 30 inches) correctly within one-half of one per cent., the difference of elevation not being more than 750 to 1,000 feet. For the determination of greater differences of elevation old aneroids should be used, in which the box has attained its equilibrium. Indeed, it may be said that the instruments improve with age.

The influence of temperature upon 44 of these aneroids, tested for a period of six months, at temperatures of 10° to 30° C. (50° to 86° Fahr.), was only 0.4 mm. per 1° C.

Each instrument is provided with a table of reduction, giving the value of its unit at different atmospheric pressures in millimeters, or inches of the mercurial barometer, and its value in inches or feet, and the corrections for temperature. Each is rated individually and tested daily for four months at the factory before being sent out. No. 2 differs slightly from No. 1 in construction; is considerably smaller, and less sensitive, and is better adapted for tourists than for engineers. Its probable error is nearly double that of No. 1.

In the aneroid No. 3 (Weilenmann's system), the small telescope already referred to is mounted upon a micrometer screw, which measures its movement. The cross-hairs of the telescope being brought into coincidence with the index on the upper of the combined series of boxes, the scale of the micrometer indicates directly the motion of the boxes in terms corresponding to the movements of the mercurial barometer.

The boxes are entirely independent of the micrometer screw, so that no changes in the instrument can occur by reason of wear on the point of the micrometer, or any other part. Its accuracy is so great that it can fully replace the mercury barometer at atmospheric pressure below 24 inches, and it is much more portable. Its size is 6 inches high by 3 inches diameter.

Self-Registering Aneroid or Barograph.

The purpose of this instrument is to register automatically the readings of the aneroid, which consists of a number of boxes like the one just described, the movements being transferred by a lever to a paper on a drum revolved by clock-work. Every hour a point is marked upon this paper, giving the reading of the aneroid. After 48 hours a paper 3 inches long is unwrapped, containing 48 equidistant points $1\frac{1}{2}$ mm. apart. The dimensions of this instrument are such that the maximum motion of the pointer is 2 inches, corresponding to the same movement of the mercurial barometer. Two-tenths of a millimeter can be read with certainty.

A SHORT AND PRACTICAL METHOD

To find the length of **one minute** of **Longitude** in any **Latitude**,
based upon certain Developments of the Terrestrial Spheroid.

By OTTO VON GELDERN.

For the determination of arcs of the Parallel and Meridional arcs, certain elements of the terrestrial spheroid have been used.

Up to within the last ten or fifteen years, Bessel's determinations of the earth's magnitude were employed, which were:

$$\begin{aligned} \text{Equatorial Radius, } a &= 6,377,397 \text{ meters,} \\ \text{Polar Radius, } b &= 6,356,079 \text{ meters.} \end{aligned}$$

$$\text{Compression} = \frac{1}{299.153}$$

Upon these elements the usual tables for the polyconic projection of maps were based, until those of Col. A. R. Clarke, R. E., were adopted, which furnish results more in harmony with recent geodetic measurements. Colonel Clarke's researches were published in his *Comparison of the Standards of Length of England, France, Belgium, Prussia, Russia, India and Australia, made at the Ordnance Survey Office, Southampton, 1866.*

The U. S. Coast and Geodetic Survey has adopted the Clarke form, and published a long and carefully computed series of polyconic projection tables for it in 1884, which are still in use. (See Appendix No. 6, Report 1884.)

Limiting the figure to that of an ellipsoid of revolution, Clarke's values are:

$$\begin{aligned} a &= 6,378,206 \text{ meters,} \\ &\quad \text{exceeding Bessel's } 809^m \\ b &= 6,356,584 \text{ meters,} \\ &\quad \text{exceeding Bessel's } 505^m. \end{aligned}$$

$$\text{Compression} = \frac{1}{294.98}$$

It shows that this spheroid is somewhat larger than Bessel's and that the eccentricity is also greater.

These elements have satisfied the conditions developed during scientific measurements of large areas, so that they may be safely adopted without fear of appreciable error.

It is not the present purpose to enter into the subject mathematically.

If the earth were a perfect sphere with a radius R , the expression for the value of one minute of longitude in any latitude would be

$$\cos \text{ lat. } \frac{2 R \pi}{360 \times 60}$$

Assuming R equal to the length of the equatorial radius, 6,378,206 meters, the constant 1855.3 is obtained for the second member. By this constant the cosine of the latitude would have to be multiplied, in order to determine the length of one minute of longitude in meters. Or logarithmically expressed it is:

$$\log. \cos \text{ lat. } + 3.2684256.$$

As we are dealing with a compression of nearly $\frac{1}{300}$ however, it becomes neces-

sary to take some recognition of this fact in the determination of distances on the parallel. For our present purpose it will answer if we find a method that shall furnish results approaching the truth within reasonably narrow limits, without considering exact mathematical formulæ for obtaining very great precision.

After a careful study of this subject, based upon comparisons with very exact tabular values, the following method is proposed by the author, who has had occasion to make frequent use of it.

APPROXIMATE METHOD.

If the length of one minute of arc on the parallel be required, that shall not vary greatly from the correct value, observe the following rule:

To the logarithmic constant 3.2684256 add the logarithmic cosine of any given latitude *less 5 minutes*, and the result will be the length in meters of one minute of longitude in the given latitude.

Example:—What is the length of one minute of longitude in latitude $37^{\circ} 47'$?

Log. constant, 3.2684256

Log. cosine of latitude $37^{\circ} 42'$ 9.8982992

$(37^{\circ} 47' - 05' = 37^{\circ} 42')$ 3.1667248

Answer, 1468.0 meters.

(Correct within 0. 2^m.)

By this method results are obtained correct within 0. 3^m. from the equator up latitude 60° ; from 60° to 70° within 0. 5^m.; beyond that limit the deviations from the true values grow more rapidly, yet even at 80° a minute of longitude thus obtained would have an excess of 1. 6^m. only. For all ordinary requirements, therefore, the above rule will apply.

A deduction of an even 5 minutes gives the best *average* results, and for that reason it has been adopted. If we want to be a little more precise about it, we may use 4 minutes from 0 to latitude 25° , and from 65° upwards; 5 minutes from 25° to 35° , and from 50° to 65° ; and 6 minutes from 35° to 50° . With this precaution the results will not vary more than 0. 2^m. for any case from the equator up to latitude 70° .

If the distance is desired in feet instead of meters, multiply the result by 3.28087, or use the logarithmic constant 3.7844146 instead of the one given above.

A MORE ACCURATE METHOD.

Where greater refinement is required, say that instead of one *minute* we should want the length of one *degree* of arc without appreciable error, the deductions from the latitude must be defined a little more closely still, if they shall furnish reliable results.

By using the deductions given in minutes and seconds in the table below, for every 5° of latitude, results may be obtained that will be without appreciable deviation from the truth, even in the case of the length of one degree on a parallel.

In latitude	0°	deduct	0' 0".	In latitude	45°	deduct	5' 50'.
" "	5°	"	1' 00'.	" "	50°	"	5' 40'.
" "	10°	"	1' 50'.	" "	55°	"	5' 30'.
" "	15°	"	2' 40'.	" "	60°	"	5' 00'.
" "	20°	"	3' 50'.	" "	65°	"	4' 30'.
" "	25°	"	4' 30'.	" "	70°	"	3' 50'.
" "	30°	"	5' 00'.	" "	75°	"	3' 00'.
" "	35°	"	5' 30'.	" "	80°	"	2' 00'.
" "	40°	"	5' 40'.				

Any intermediate value may be interpolated.

Referring again to the previous example, let us find the value of one minute of longitude in latitude $37^{\circ} 47'$ by this method.

By consulting our table we find that for $37^{\circ} 47'$ we must deduct $5' 35''$, leaving $37^{\circ} 41' 25''$. Then write:

Log. constant,	3.2684256
Log. cosine of latitude $37^{\circ} 41' 25''$,	9.8983724
	3.1667980

Answer, 1468.2 meters.

(Which is correct to the nearest tenth.)

If the length of a degree is wanted, multiply the result by 60, or use the constant 5.0465769 instead of the one above given.

Example:—What is the length of one degree of longitude in latitude 17° ?

Log. constant,	5.0465769
Log. cosine $16^{\circ} 56' 45''$,	9.9807216
($17^{\circ} - 3' 15''$)	5.0272985

Answer, 106,487 meters.

(Which is correct to the nearest meter.)

Again, for latitude 74° ?

Log. constant,	5.0465769
Log. cosine $73^{\circ} 56' 50''$,	9.4417308
	4.4883077

Answer, 30,782 meters.

(Correct within 1 meter.)

These results are readily reduced to either nautical or statute miles, by dividing by 1853.248 (log. 3.2679335) in the former, and by 1609.33 (log. 3.2066449) in the latter case. The logarithmic constant may be changed to suit these measures

THE NAUTICAL MILE.

The length of a nautical mile has been adopted at 1853.248 meters, or 6080.27 feet. It will be noticed that this is 2.1 meters less than the length of one minute of longitude at the equator, which is ordinarily assumed as that which defines the nautical mile. The fact is that this unit of measure has been arbitrarily based, and that it varies as the data from which the deductions are made. In order to establish uniformity for all time, the nautical mile is now defined as the length of one minute of a great circle of a sphere that shall have the same superficial area as the terrestrial spheroid. This basis was adopted by the U. S. Coast and Geodetic Survey, and computed from Clarke's elements.

Length of One Minute of Latitude in Different Latitudes.

At the Equator,	1842.8 meters	At 50° ,	1853.8 meters
“ 10° ,	1843.4	“ “ 60° ,	1856.9 “
“ 20° ,	1845.0	“ “ 70° ,	1859.4 “
“ 30° ,	1847.5	“ “ 80° ,	1861.1 “
“ 40° ,	1850.5	“ “ 90° ,	1861.7 “

No. 6.

THE
SAEGMÜLLER SOLAR ATTACHMENT*

AND

VERTICAL SIGHTING TELESCOPE.

(Patented May 3, 1881.)

HOW TO ADJUST AND USE IT, WITH REFRACTION TABLES.

THE A. LIETZ COMPANY,

Sole Agents on the Pacific Coast of the Saegmüller Solar.

SAN FRANCISCO, CAL., 1893

This attachment to the regular engineer's transit, by means of which the astronomical meridian may be obtained in a few minutes with an accuracy scarcely thought to be possible, has met with such success that it bids fair to supersede all other methods for the determination of the meridian by means of engineering instruments.

The transit has come to be the universal instrument for the engineer, and will be for the surveyor sooner or later, and the attachment of the solar apparatus to the transit has thus become a necessity.

Since its first introduction this attachment has been greatly improved, and, as now made, is nearly perfect.

Attached to any transit which possesses a telescope, level and a vertical circle, it will give the meridian within the nearest minute. By using instruments which have a finer graduated vertical circle and better levels than are usually found on transits, the meridian can be determined with greater accuracy still.

Advantages of the "Saegmüller Solar Attachment" over the Old Form.

First —It is more accurate.

Second.—It is simpler and easier of adjustment.

Third.—It can be used when the sun is partly obscured by clouds, when the ordinary "solar" fails altogether.

Fourth.—It can be used where the sun is quite close to the meridian.

Fifth.—The time can be obtained with it reliable to within a few seconds with perfect ease.

Sixth.—It can be used as a vertical sighting telescope.

It is as superior to all forms hitherto used as the transit is to the ordinary compass, or as a telescope is to common sights.

* Reprinted by permission, and revised for this Manual.

The sights of an ordinary solar compass consist merely of a small lens and a piece of silver with lines ruled on it placed in its focus. This is simply a *very primitive* telescope, since the exact coincidence of the sun's image with the lines has to be determined by the unaided eye, or at best with a simple magnifying glass.

That far greater precision can be attained by means of a suitable telescope is obvious; in fact, the *power* of the solar telescope is in keeping with the transit telescope, as it should be.

A glance at the illustration will show that the "Saegmüller Solar Attachment" is far simpler than the ordinary form. By raising or depressing, it can be set to north or south declination. To effect this with the ordinary solar compass *two sets of primitive telescopes* — one answering for north, the other for south declination — are required, which are difficult to adjust.

The addition of the level on the solar telescope dispenses with the declination arc altogether, the arc or circle on the transit also serving for that purpose in conjunction with it.

The "Saegmüller Solar Attachment" is, in fact, the only one which should be used in connection with a transit instrument. *It solves the solar problem*, as has been attested by leading astronomers and engineers who have used it.

Professor J. B. Johnson, of Washington University, St. Louis, Mo., has given it a thorough test, and writes as follows:

"In order to determine just what accuracy was possible with a Saegmüller Solar Attachment, I spent two days in making observations on a line whose azimuth had been determined by observations on two nights on Polaris at elongation, the instrument being reversed to eliminate errors of adjustment. Forty-five observations were made with the solar attachment on October 24, 1885, from 9 to 10 A. M., and from 1:30 to 4 P. M., and on November 7, forty-two observations between the same hours.

"On the first day's work the latitude used was that obtained by an observation on the sun at its meridian passage, being $38^{\circ} 39'$, and the mean azimuth was 20 seconds in error. On the second day, the instrument having been more carefully adjusted, the latitude used was $38^{\circ} 37'$, which was supposed to be about the true latitude of the point of observation, which was the corner of Park and Jefferson avenues in this city. It was afterwards found that this latitude was $38^{\circ} 37' 15''$, as referred to Washington University Observatory, so that when the mean azimuth of the line was corrected for this $15''$ error in latitude, it agreed exactly with the stellar azimuth of the line, which might have been $10'$ or $15'$ in error. On the first day all the readings were taken without a reading glass, there being four circle readings to each result. On the second day a glass was used.

"On the first day the maximum error was 4 minutes, the average error was 0.8 minute, and the 'probable error of a single observation' was also 0.8 minute. On the second day the maximum error was 2.7 minutes, the average error was 1 minute, and the 'probable error of a single observation' was 0.86 minute. The time required for a single observation is from three to five minutes.

"I believe this accuracy is attainable in actual practice, as no greater care was taken in the adjustment or handling of the instrument than should be exercised in the field.

"The transit has come to be the universal instrument for the engineer, and should be for the surveyor; so it is more desirable to have the solar apparatus attached to the transit than to have a separate instrument. The principal advantages of this attachment are:

"1. Its simplicity.

"2. Its accuracy of pointing, being furnished with a telescope which is accurately set on the sun's disk.

"3. In its providing that all angles be set off on the vertical and horizontal limbs of the transit, thus eliminating the eccentricity and other inaccuracies usually found in attachment circles or arcs.

"4. Its small cost.

"It is also readily removed and replaced without affecting its adjustments, and is out of the way in handling and reversing the telescope. It may be attached to any transit."

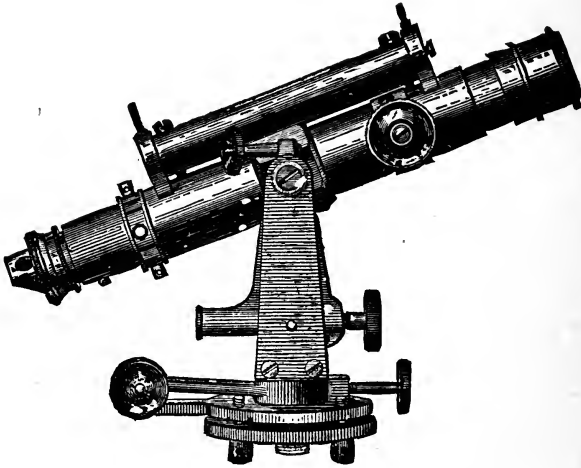

SAEGMÜLLER SOLAR ATTACHMENT.

This instrument may be had in ALUMINIUM, which gives that lightness particularly desirable in an attachment of this character.

The illustration represents the improved "Saegmüller Solar Attachment" as now made. It consists essentially of a small telescope and level, the telescope being mounted in standards, in which it can be elevated or depressed. The standard revolves around an axis, called the polar axis, which is fastened to the telescope axis of the transit instrument. The telescope, called the "Solar Telescope," can thus be moved in altitude and azimuth. Two pointers attached to the telescope to approximately set the instrument, are so adjusted that when the shadow of the one is thrown on the other the sun will appear in the field of view.

ADJUSTMENT OF THE APPARATUS.

1. The transit must be in perfect adjustment, especially the levels on the telescope and the plates; the cross-axis of the telescope should be exactly horizontal, and the index error of the vertical circle carefully determined.

2. The polar axis must be at right-angles to the line of collimation and horizontal axis of main telescope.

To effect this, level the instrument carefully and bring the bubble of each telescope level to the middle of its scale. Revolve the solar around its polar axis, and

if the bubble remain central, the adjustment is complete. If not, correct half the movement by the adjusting screws at the base of the polar axis, and the other half by moving the solar telescope on its horizontal axis.

3. The line of collimation of the solar telescope and the axis of its level must be parallel.

To effect this, bring both telescopes in the same vertical plane and both bubbles to the middle of their scales. Observe a mark through the transit telescope, and note whether the solar telescope points to a mark above this, equal to the distance between the horizontal axes of the two telescopes. If it does not bisect this mark, move the cross-wires by means of the screws until it does. Generally the small level has no adjustments, and the parallelism is effected only by moving the cross-hairs.

The adjustments of the transit and solar should be *frequently* examined, and kept as nearly perfect as possible.

DIRECTIONS FOR USING THE ATTACHMENT.

First.—Take the declination of the sun as given in the Nautical Almanac* for the given day, and correct it for refraction and hourly change. Incline the *transit telescope* until this amount is indicated by its vertical arc. If the declination of the sun is north, *depress* it; if south, *elevate* it. Without disturbing the position of the transit telescope, bring the solar telescope into the vertical plane of the large telescope, and to a horizontal position by means of its level. The two telescopes will then form an angle which equals the amount of the declination, and the inclination of the solar telescope to its polar axis will be equal to the polar distance of the sun.

Second.—Without disturbing the *relative* positions of the two telescopes, incline them and set the vernier to the co-latitude of the place.

By moving the transit and the “Solar Attachment” around their respective *vertical* axes, the image of the sun will be brought into the field of the solar telescope, and after accurately bisecting it, the *transit telescope must be in the meridian, and the compass-needle indicates its deviation at that place.*

The vertical axis of the “Solar Attachment” will then point to the pole, the apparatus being in fact a small equatorial.

Time and azimuth are calculated from an observed altitude of the sun by solving the spherical triangle formed by the sun, the pole, and the zenith of the place. The three sides, *SP*, *PZ*, *ZS*, complements respectively of the declination, latitude and altitude, are given, and we hence deduce *SPZ*, the hour angle, from apparent noon, and *PZS* the azimuth of the sun.

The “Solar Attachment” solves the same spherical triangle by construction, for the second process brings the vertical axis of the solar telescope to the required distance, *ZP*, from the zenith, while the first brings it to the required distance, *SP*, from the sun.

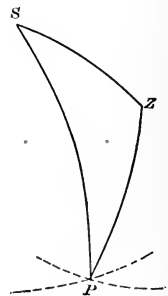

OBSERVATION FOR TIME.

If the two telescopes, both being in position — one in the meridian, and the other pointing to the sun — are now turned on their *horizontal* axes, the vertical

* A Nautical Almanac must be a part of the engineer's field outfit.

remaining undisturbed, until each is level, the angle between their directions (found by sighting on a distant object) is SPZ, the time from apparent noon.

This gives an easy observation for correction of time-piece, reliable to within a few seconds.

TO OBTAIN THE LATITUDE WITH THE "SAEGMÜLLER SOLAR ATTACHMENT."

Level the transit carefully and point the telescope toward the south, and elevate or depress the object end, according as the declination of the sun is south or north, an amount equal to the declination.

Bring the solar telescope into the vertical plane of the main telescope, level it carefully and clamp it. With the solar telescope observe the sun a few minutes before its culmination; bring its image between the two horizontal wires by moving the transit telescope in altitude and azimuth, and keep it so by the slow-motion screws until the sun ceases to rise. Then take the reading of the vertical arc, correct for refraction due to altitude by the table below. Subtract the result from 90° , and the remainder is the latitude sought.

Mean Refraction.

Barometer 30 inches, Fahrenheit thermometer 50 degrees.

Altitude.	Refraction.	Altitude.	Refraction
10°	5' 19'	20'	2' 39'
11	4 51	25	2 04
12	4 27	30	1 41
13	4 07	35	1 23
14	3 49	40	1 09
15	3 34	45	58
16	3 20	50	49
17	3 08	60	34
18	2 57	70	21
19	2 48	80	10

The following table, computed by Prof. Johnson, C. E., Washington University, St. Louis, will be found of considerable value in solar compass work:

"This table is valuable in indicating the errors to which the work is liable at different hours of the day and for different latitudes, as well as serving to correct the observed bearings of lines when it afterwards appears that a wrong latitude or declination has been used. Thus on the first day's observations I used a latitude in the forenoon of $38^\circ 37'$, but when I came to make the meridian observation for latitude I found the instrument gave $38^\circ 39'$. This was the latitude that should have been used, so I corrected the morning's observations for two minutes error in latitude by this table.

"It is evident that if the instrument is out of adjustment the latitude found by a meridian observation will be in error; but if *this observed latitude be used in setting off the co-latitude*, the instrumental error is eliminated. Therefore, always

use for the co-latitude that given by the instrument itself in a meridian observation."

Errors in Azimuth (by Solar Compass) for 1 Minute Error in Declination or Latitude.

HOUR.	FOR 1 MIN. ERROR IN DECLINATION.			FOR 1 MIN. ERROR IN LATITUDE.		
	Lat. 30°	Lat. 40°	Lat. 50°	Lat. 30°	Lat. 40°	Lat. 50°
	MIN.	MIN.	MIN.	MIN.	MIN.	MIN.
11:30 A. M. . . . } 12:30 P. M. . . . }	8.85	10.00	12.90	8.77	9.92	11.80
11 A. M. } 1 P. M. }	4.46	5.05	6.01	4.33	4.87	5.80
10 A. M. } 2 P. M. }	2.31	2.61	3.11	2.00	2.26	2.70
9 A. M. } 3 P. M. }	1.63	1.85	2.20	1.15	1.30	1.56
8 A. M. } 4 P. M. }	1.34	1.51	1.80	0.67	0.75	0.90
7 A. M. } 5 P. M. }	1.20	1.35	1.61	0.31	0.35	0.37
6 A. M. } 6 P. M. }	1.15	1.30	1.56	0.00	0.00	0.00

NOTE.—Azimuths observed with erroneous declination, or co-latitude may be corrected by means of this table by observing that for the line of collimation set *too high*, the azimuth of any line from the south point in the direction of S. W. N. E. is found *too small* in the forenoon and *too large* in the afternoon by the tabular amounts for each minute of error in the altitude of the line of sight. The reverse is true for the line set too low.

CORRECTION FOR REFRACTION.

This correction is applied to the declination of the sun, and is equal to the refraction-correction of the sun's observed altitude multiplied by the cosine of the angle which the sun makes between the declination-circle and the vertical.

In order to reduce the refraction correction to the simplest possible form, we have added a table showing the refraction for every day of the year, at different hours, for latitude 40°, in 5-day periods.

THE PREPARATION OF THE DECLINATION SETTINGS FOR A DAY'S WORK.

The Solar Ephemeris gives the declination of the sun for the given day, for Greenwich mean noon. Since all points in America are west of Greenwich, by 5, 6, 7 or 8 hours, the declination found in the ephemeris is the declination at the given place at 7, 6, 5 or 4 o'clock A. M., of the same date, according as the place lies in the "Eastern," "Central," "Mountain" or "Western Time" belts respectively.

The appended, termed "Refraction Correction," gives the correction to be made to the declination, for refraction, for any point whose latitude is 40°. If the latitude is more or less than 40°, these corrections are to be multiplied by the corresponding coefficients given in the table of "Latitude Coefficients."* Thus the

* This table just precedes the "Refraction Correction" table, see following pages.

refraction corrections in latitude 30° are 65 hundredths, and those of 50° , 142 hundredths of the corresponding ones in latitude 40° . There is a slight error in the use of these latitude coefficients, but the maximum error will not amount to over $15''$, except when the sun is very near the horizon, and then any refraction becomes very uncertain. All refraction tables are made out for the mean, or average, refraction, whereas the actual refraction at any particular time and place may be not more than one-half, or as much as twice the mean refraction, with small altitudes. The errors made in the use of these latitude coefficients are, therefore, very small as compared with the errors resulting from the use of the mean, rather than unknown actual refraction which affects any given observation.

Example I.

Let it be required to prepare a table of declinations for a point whose latitude is $38^\circ 30'$, and which lies in the "Central Time" belt, for April 5, 1890.

Since the time is 6 hours earlier than that at Greenwich, the declination given in the ephemeris of the Nautical Almanac is the declination here at 6 A. M. of same date. This is found to be $+6^\circ 9' 57''$. To this must be added the hourly change, which is also plus, and equal to $56''.83$. The latitude coefficient is 0.94, and the refraction corrections which must be multiplied by 0.94 are found in our table for April 5th, as follows:

1st hour	$0' 39'' \times 0.94 = 0' 37''$
2d "	$0' 44'' \times 0.94 = 0' 41''$
3d "	$0' 54'' \times 0.94 = 0' 51''$
4th "	$1' 14'' \times 0.94 = 1' 10''$
5th "	$2' 08'' \times 0.94 = 2' 00''$

The same corrections apply to the 4th, 5th, 6th, 7th and 8th of April, but they are strictly exact for the middle day of the 5-day period corresponding to that set of hourly corrections only. For the extreme days of any such period an interpolation can be made between the adjacent hourly corrections, if desired.

The following table may now be made out:

Declination Settings for April 5, 1890, Lat. $38^\circ 30'$, Central Time.

Hour.	Declination	Ref. Cor.	Setting.	Hour.	Declination.	Ref. Cor.	Setting.
7	$+6^\circ 10' 54''$	$+2' 00''$	$6^\circ 12' 54''$	1	$6^\circ 16' 35''$	$+ 37''$	$6^\circ 17' 12''$
8	6 11 51	$+1 10$	6 13 01	2	6 17 31	$+ 41$	6 18 12
9	6 12 47	$+ 51$	6 13 38	3	6 18 28	$+ 51$	6 19 19
10	6 13 44	$+ 41$	6 14 25	4	6 19 25	$+1' 10''$	6 20 35
11	6 14 41	$+ 37$	6 15 13	5	6 20 22	$+2 00$	6 22 22

Example II.

Let it be required to prepare a declination table for a point in Lat. 45° , in the "Eastern Time" belt, for October 10, 1890.

The time now is 5 hours earlier than that of Greenwich, hence the declination given in the ephemeris for Greenwich mean noon is the declination at our point at

7 A. M. The declination found is $-6^{\circ} 43' 56''$, and the hourly change is $-56''.87$. Our latitude coefficient is 1.20.

The table then becomes:

Declination Settings for October 10, 1890, Lat. 45° , Eastern Time.

Hour	Declination.	Ref. Cor.	Settings.	Hour	Declination.	Ref. Cor.	Settings.
7	$-6^{\circ} 43' 56''$	+ 5' 35"	$-6^{\circ} 38' 21''$	1	$-6^{\circ} 49' 37''$	+ 1' 16"	$-6^{\circ} 48' 21''$
8	$-6 44 53$	+ 2 31	$-6 42 22$	2	$-6 50 34$	+ 1 24	$-6 49 10$
9	$-6 45 50$	+ 1 44	$-6 44 06$	3	$-6 51 31$	+ 1 44	$-6 49 47$
10	$-6 46 47$	+ 1 24	$-6 45 23$	4	$-6 52 28$	+ 2 31	$-6 49 57$
11	$-6 47 44$	+ 1 16	$-6 46 28$	5	$-6 53 25$	+ 5 35	$-6 47 50$

If the date be between June 20, and September 20, the declination is positive, and the hourly change negative; while, if it be between December 20, and March 20, the declination is negative and the hourly change positive. The refraction correction is always positive — that is, always increases numerically the north declinations, and diminishes numerically the south declinations.

By using standard time instead of local time, a slight error is made, but the maximum value of this error is found at those points where the standard time differs from the local time by one-half hour, and in the spring and fall when the declination is changing rapidly. The greatest error, then, is less than $30''$, and this is smaller than can be set off on the vertical circle or declination arc. Even this error can be avoided by using the true difference of time from Greenwich in place of the standard meridian time.

THE SÆGMÜLLER SOLAR ATTACHMENT WHEN USED AS A VERTICAL SIGHTING TELESCOPE.

Although this attachment is familiar to every engineer, it is only quite recently that it has been recognized as the best Vertical Sighting Telescope which can easily be attached to the ordinary transit, and which will give accurate results.

It is readily seen that the construction of the attachment allows the small telescope to be placed in a vertical position, and when so placed, as represented in our illustrations of transits with solar attachments, it fulfils every requirement of an instrument designed for vertical as well as oblique sighting in mining work.

In order to use the solar for this purpose, proceed as follows:

See that the transit is in perfect adjustment. Point both telescopes horizontal and see that the Solar points as much above the transit telescope as equals the distance between their axes. When this is the case the lines of collimation of both telescopes are parallel. Now turn the transit telescope 90° , as shown by the vertical circle, taking care not to disturb the relative position of the solar telescope and that of the transit, and both will point vertically downwards.

As the standards of the Solar are high enough to allow the small telescope to clear the plates, it is evident that the solar telescope now points accurately to the Nadir.

The same *modus operandi* holds good when it is desired to obtain an oblique sight, as it is only necessary to set off the desired slope on the vertical circle, after having both telescopes parallel.

For very accurate work it is desirable to make the observations in two positions by reversal. By taking the mean of the two sets of observations, instrumental errors are eliminated.

In order to make the Saegmüller Solar Attachment as efficient as possible for the above purpose, the size of the telescope has been increased, giving it ample power to locate a point with great precision.

TABLE OF LATITUDE COEFFICIENTS,

To be Used in Connection with the Refraction Correction Tables for Latitude 40°. (See the following pages.)

LAT.	COEFF.	LAT.	COEFF.	LAT.	COEFF.
15°	.30	31°	.68	47°	1.29
16	.32	32	.71	48	1.33
17	.34	33	.75	49	1.38
18	.36	34	.78	50	1.42
19	.38	35	.82	51	1.47
20	.40	36	.85	52	1.53
21	.42	37	.89	53	1.58
22	.44	38	.92	54	1.64
23	.46	39	.96	55	1.70
24	.48	40	1.00	56	1.76
25	.50	41	1.04	57	1.82
26	.53	42	1.08	58	1.88
27	.56	43	1.12	59	1.94
28	.59	44	1.16	60	2.00
29	.62	45	1.20		
30	.65	46	1.24		

REFRACTION CORRECTION*.

LATITUDE 40°.

Jan.	Refraction Correction Lat. 40 deg.	Feb.	Refraction Correction Lat. 40 deg.	Mar.	Refraction Correction Lat. 40 deg.	Apr.	Refraction Correction Lat. 40 deg.	May.	Refraction Correction Lat. 40 deg.	June	Refraction Correction Lat. 40 deg.
	<i>h.</i> ' "		<i>h.</i> ' "		<i>h.</i> ' "		<i>h.</i> ' "		<i>h.</i> ' "		<i>h.</i> ' "
1	1 1.58	1		1	1 1.03	1	3 0.57	1	1 0.28	1	5 1.11
2	2 2.16	2		2	2 1.10	2	4 1.19		2 0.32	2	
3	3 3.04		<i>h.</i> ' "	3	3 1.27	3	5 2.18	2	3 0.39		
4	4 6.23	3	1 1.26	4	4 2.06				4 0.55	3	1 0.19
5		4	2 1.37	5	5 4.39	4	1 0.39	3	5 1.30	4	2 0.23
6	1 1.54	5	3 2.04	6	1 0.59	5	2 0.44			5	3 0.30
7	2 2.11	6		7	2 1.06	6	3 0.54	4	1 0.26	6	4 0.43
8	3 2.59	7	4 3.21	8	3 1.21	7	4 1.14	5	2 0.30	7	5 1.10
9	4 6.01	8	1 1.21	9	4 1.56	8	5 2.08	6	3 0.37	8	1 0.18
10		9	2 1.31	10	5 4.04	9	1 0.36	7	4 0.53	9	2 0.22
11	1 1.51	10	3 1.56	11	1 0.55	10	2 0.41	8	5 1.26	10	3 0.29
12	2 2.07	11	4 3.04	12	2 1.02	11	3 0.51	9	1 0.25	11	4 0.43
13	3 2.51	12		13	3 1.15	12	4 1.10	10	2 0.29	12	5 1.09
14	4 5.40	13	1 1.16	14	4 1.47	13	5 1.58	11	3 0.36	13	1 0.18
15		14	2 1.25	15	5 3.34	14	1 0.34	12	4 0.51	14	2 0.22
16	1 1.46	15	3 1.48	16	1 0.52	15	2 0.38	13	5 1.22	15	3 0.29
17	2 2.01	16	4 2.47	17	2 0.58	16	3 0.48	14	1 0.23	16	4 0.42
18	3 2.40	17	5 8.39	18	3 1.10	17	4 1.06	15	2 0.27	17	5 1.08
19	4 5.00	18	1 1.12	19	4 1.39	18	5 1.49	16	3 0.34	18	1 0.18
20		19	2 1.20	20	5 3.08	19	1 0.32	17	4 0.49	19	2 0.22
21	1 1.42	20	3 1.40	21	1 0.48	20	2 0.36	18	5 1.18	20	3 0.29
22	2 1.56	21	4 2.31	22	2 0.54	21	3 0.45	19	1 0.22	21	4 0.42
23	3 2.31	22	5 6.49	23	3 1.05	22	4 1.02	20	2 0.26	22	5 1.08
24	4 4.35	23	1 1.07	24	4 1.32	23	5 1.42	21	3 0.33	23	1 0.18
25		24	2 1.15	25	5 2.51	24	1 0.30	22	4 0.47	24	2 0.22
26	1 1.37	25	3 1.33	26	1 0.45	25	2 0.34	23	5 1.15	25	3 0.29
27	2 1.50	26	4 2.18	27	2 0.50	26	3 0.42	24	1 0.21	26	4 0.42
28	3 2.22	27	5 5.29	28	3 1.01	27	4 0.58	25	2 0.25	27	5 1.08
29	4 4.07	28		29	4 1.25	28	5 1.36	26	3 0.32	28	1 0.18
30		29		30	5 2.34	29	1 0.28	27	4 0.46	29	2 0.22
31	1 1.32			31	1 0.42	30	2 0.32	28	5 1.13	30	3 0.29
	2 1.44				2 0.47			29	1 0.20	31	4 0.43
	3 2.13							30	2 0.24		
	4 3.41							31	3 0.31		
									4 0.44		
									5 1.11		

*These corrections are strictly correct for the middle day only of the five-day period, for the hours as shown. In the case of extreme days of the period, an interpolation may be made.

THE CYCLOTOMIC TRANSIT

—BY—

OTTO VON GELDERN

THE PRINCIPLE OF THE INSTRUMENT.

The evolution of this instrument is due to a constant tendency to create a transit with *one spindle, i. e.*, having but one central cone turning within the leveling head, that shall, at the same time, sacrifice none of the advantages that the so-called compound center possesses.

It goes without saying that the principal advantage of the double spindle lies in the fact that, no matter in what direction the telescope may be pointed, the operator is enabled to make any azimuth of his graduated plate agree therewith. How this may be done without giving the lower plate an independent motion around the vertical axis of the instrument, is the problem to be solved.

The lower plate is the important member that carries the graduated azimuth circle, and if it be made a part of the rigid sub-structure—of the leveling-head and base-plate—the control of it in reference to known azimuths is apparently lost. If we were enabled, however, to shift the figure-series—the nomenclature of the circle—at will, so as to make any one of the graduation lines the zero, the advantage lost by having a rigid lower plate would be regained.

The novelty of the new transit lies in a floating exterior ring, placed around the periphery of the lower plate, upon which the figures from 0 to 360 are engraved. These figures are then no longer a fixed part of the circle, but possess that independent rotation which the lower plate had in the case of the double spindle. Instead of turning the whole plate around its vertical axis, we turn a narrow metal band around the stationary plate, which is the same thing.

As this band appears to be sliced from the plate, the name *Cyclotome* has been applied to it, from *κυκλος*, ring or circle, and *τεμνειν*, to cut, that is, a ring cut or severed as from a disk.

Since the object of the ring is merely to designate the graduated lines upon the plate by corresponding figures, absolute concentricity of the cyclotome is not a matter of importance.

THE CONSTRUCTION.

Attention is drawn to the illustrations herewith, figure 1 showing a vertical section through the plates, and figures 2 and 3 a top and bottom view respectively of the upper plate. In the vertical section the arrangement of the principal parts may be readily understood.

The lower plate and the leveling-head become one member, which is mounted upon the base-plate in the ordinary manner. The cyclotome *C* is fitted exteriorly around the plate, its top resting upon the graduation, of which it is a part.

The upper plate revolves upon the lower by means of its long and stout spindle, within the socket of the leveling-head. It carries the vernier *V*, visible through an opening in the plate, which also exposes a part of the graduated lower plate and a part of the cyclotome.

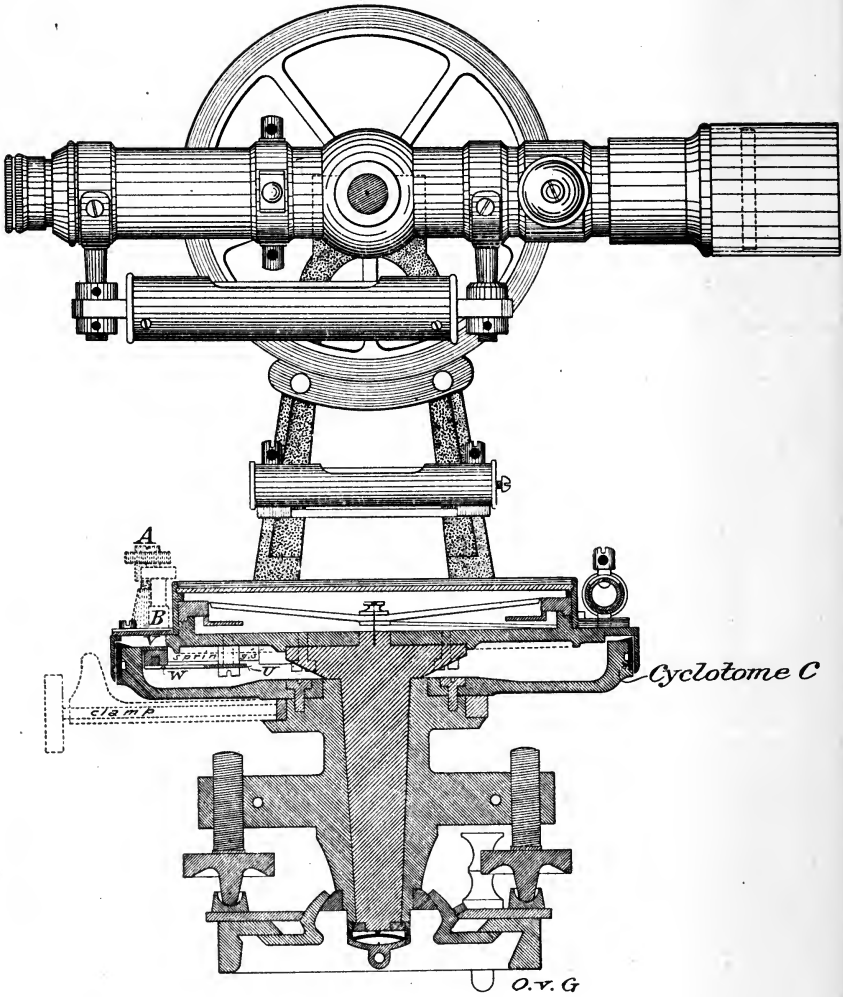

| 2 |

*Section through Plates
on Line X - Center - Y,
with side view of Telescope*

A. LIETZ CO

*San Francisco, Cal
April 1895*

All rights reserved.

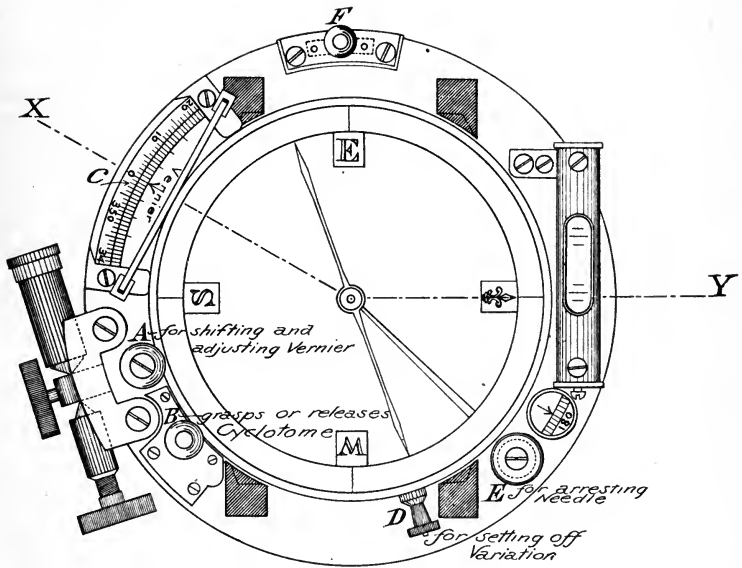

Fig. 2.

Top View of Upper Plate

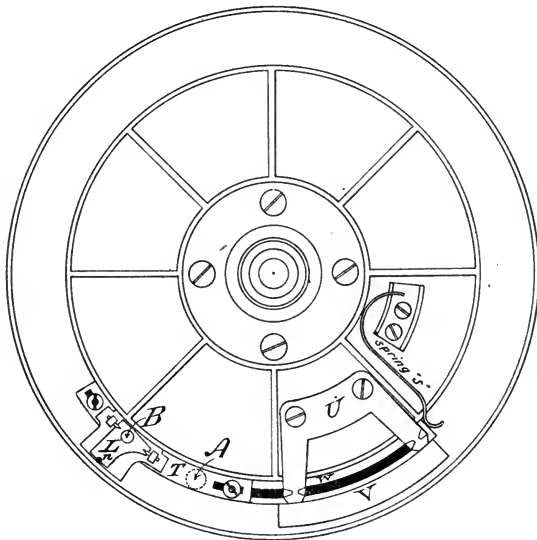

Fig. 3.

Bottom View of Upper Plate

A. LIETZ CO.

*San Francisco, Cal
April 1895.*

All rights reserved.

The horizontal motion of the instrument is arrested by the clamp and collar, and the position adjusted by a tangent screw, as common to all transits.

Compass box and telescope are mounted on the top of the plate, as usual.

The flange forming the top of the lower plate is graduated into 720 even spaces of half-degree divisions. The vernier moves along the inner rim of this graduation, and is held whenever the line of collimation (the telescope) has the desired direction. In order to effect a coincidence between the vernier's zero and the nearest half-degree division, the entire vernier may be shifted independently to the right or left by means of the screw *A*, shown in the illustrations, and in the manner presently to be explained.

And having thusly determined upon and indicated one of the 720 lines to be the initial or starter, it would be necessary only to bring the zero of the cyclotome—or any other reading for that matter—to match this line.

In the simpler form of the new transit, the exterior ring or cyclotome is revoluble by hand around the periphery of the plate, and the required azimuth is thus readily set off. In the improved form, as shown by the illustrations, the ring is encased, and so arranged that the upper plate in its rotation may or may not carry the cyclotome with it. It is picked up and revolved together with the telescope, or left at rest upon the lower plate in any desired position. It is within the power of the operator to manipulate this at will, and there are two means of doing so, as will be noted further on.

As it is generally required to place the zero upon the azimuth from which observations are started, an automatic catch *L* (see figure 3), having a small projecting pin *n*, is so arranged that whenever it is desired to make the cyclotome travel together with the upper plate, the pin *n* must be made to drop into a hole provided for it in the cyclotome; the moment this takes place, the two (plate and cyclotome) are connected, and—this is a peculiar feature of the device—in such a position that the zero of the vernier *V*, and the zero of the cyclotome *C* are brought together, separated, of course, by the intervening graduated flange of the lower plate. If the vernier be now revolved with the upper plate, the figure-system will travel with it, their respective zeros coinciding.

The bottom of the upper plate, figure 3, illustrates the mechanism with which all this is accomplished. *U* is a guide, fastened to the plate, for the arc *W*, carrying the vernier *V*. A strong spring *S* presses the arc against the slide *T*, the position of the whole being regulated by the exterior screw *A*, which allows the adjustment of the vernier already referred to. The catch *L* is poised in *T*. The screw *B* raises or lowers the catch, so that with it we may throw the cyclotome either in or out. A small spring under the catch *L* admits of this. The mechanism is so simple that it needs no further description.

With this device there is no difficulty in placing the zero of the horizontal circle so as to correspond with any pointing of the telescope.

USE IN THE FIELD.

The field manipulation is reduced to a minimum.

Having set the instrument over a point (1) in the usual manner, it is desired to direct the telescope to another point (2), and to make the zero of the horizontal graduation correspond with this azimuth. The main clamp being loose, the first operation is to turn the screw *B* so that the catch *L* is depressed; the upper plate is then turned, until a click indicates that the little pin *n* has caught the cyclotome and is carrying it along, with the zero in position, as explained. The operation is automatic to this extent, that the manipulator need not watch his plate to set the zeros. He will now direct the telescope to point (2), clamp the plate, and bisect the object with the tangent screw. His attention is thereupon directed to the vernier, for it is essential that its zero should correspond exactly with a line of the fixed graduation. He turns the screw *A* to the right, or left, shifting the vernier

sufficiently to accomplish this. The cyclotome travels with the vernier, so that he does not need to watch it. The instrument is now oriented, the vernier indicating the starting azimuth, and measurements to other points may begin. Before commencing, however, the screw *B* is turned so as to release the catch and allow the cyclotome to remain in position. The instrument is now unclamped and ready for operation. Any subsequent reading will indicate directly in degrees and minutes the deflection from the starting point. The whole operation is simple and rapid, and will require less time than the setting of the compound-center instrument.

If it be desired to set any other azimuth to a telescope pointing, recourse is had to the clamp *F* (see top view of plate, figure 2), by which the cyclotome may be connected to the upper plate at any point.

The operation is as follows :

Set up instrument ; drop catch *L* by a turn of screw *B* ; revolve plate on center, click indicates that *L* has caught cyclotome *C* ; point telescope, clamp plate and bisect object ; shift zeros to the nearest graduation line by screw *A* ; release cyclotome by screw *B* ; unclamp instrument and lay off the reading of the required azimuth to the nearest thirty minutes by means of the clamp and tangent screws, and then to the minute with precision by means of the screw *A* ; now turn down the screw *F*, which catches the cyclotome ; unclamp instrument, revolve on center, direct telescope to original object, clamp and bisect. The reading of the vernier will now indicate the azimuth wanted. Release the screw *F* and the cyclotome will remain in the position into which it has been brought.

The reason why the reading is laid off to the nearest thirty-minute mark only, and then adjusted to precise reading by shifting the vernier, becomes obvious, if we remember that it is always necessary to match the graduation lines of the plate with those of the cyclotome, and that any setting disturbing their coincidence (readings from 1° to 29° and 31° to 59°) will have to be corrected by a vernier displacement.

This operation is rapid, although perhaps a trifle slower than the manipulation with the hand cyclotome, mentioned above, in which case the telescope is directed, plate clamped, object bisected, vernier zero brought to a line, cyclotome turned by hand to read within the nearest half degree of the line, after which the vernier is adjusted to the exact reading.

The principle remains the same in either method, the only difference being that in the case of the hand cyclotome one is able to set it irrespective of the motions of the upper plate.

After these explanations it becomes very obvious that there are no advantages that the double spindle system can claim over the cyclotomic system in the ready manipulation of the horizontal arc.

ANGULAR REPETITION.

While the reiteration of an angle, resorted to in geodetic measurements, to obtain the value of an arc with its probable error to the fraction of a second, is not possible with the cyclotomic transit, because the main graduation is fixed and cannot be turned in reference to the direction of the objects observed upon, it is perfectly feasible to take the same angle on different parts of the plate. Since there are two verniers, located 180 degrees apart, two readings may also be had of each measurement and the mean taken.

Unless a double spindle transit be of the very best workmanship, that is, a first-class and therefore a high-priced article, all the reiteration and repetition will fail to reach a better result than that attainable with a well built cyclotomic instrument, which is made to read to half minutes directly, or to twenty seconds in the larger sizes ; and anything within the limits of this accuracy is guaranteed by the maker. As the reiteration of an angle is uncalled for in any but the most refined measurements, the cyclotomic transit does not lack completeness for the want of this particular feature.

ADVANTAGES OF THE CYCLOTOMIC TRANSIT.

The main feature is its single spindle. Its adoption obviates the necessity of the lower clamp and tangent screws, and simplifies this part of the transit very much. It affords an opportunity to bring the plates closer to the leveling-head, thereby lowering the center of gravity of the instrument. It sits directly upon the rigid substructure, fitted into it by a thick metal axis and must therefore be very steady. The main graduation, the most vital part of the transit, is fixed for all time. Once properly centered, the chances for eccentricity are reduced to a minimum. The instrument possesses a comparing vernier, opposite the reading vernier, (see figure 2) which shows through a circular opening in the plate. By means of the two, used in conjunction, the plate eccentricity may be accurately determined.

What is justly claimed for this instrument as more advantageous than the compound-center transit is included in the following :

Greater simplicity ; reduction of parts and reduction of weight, with greater steadiness for instruments of the same size ; greater solidity of the axis, and therefore greater rigidity, and the least liability to serious injury through accident ; simple mechanism enabling a more rapid setting of the plates to the zero azimuth ; avoiding the manufacture of an extra cone and socket, that is, reduction of prominent and costly parts to be made by the artisan, and a reduction, therefore, of the *price* of the article.

In its optical appointments and constructive details, the instrument is up to the standard of a first-class modern transit and surveying instrument ; it is a tachymeter, and fitted for any possible expediency of modern engineering.

It has not been the object to replace the compound-center instrument with a cheap and inferior substitute, but rather to simplify the required parts and to improve, if possible, the stability and concentricity, without losing those features that have thus far made the double-center instrument the preferred one for meeting the manifold demands made by the profession upon a universal measuring tool.

THE MANUFACTURE.

The instrument in its present shape was designed in detail by Mr. Adolph Lietz, the original suggestion having been made to him by Mr. Luther Wagoner, civil engineer, of San Francisco, who had conceived the application of the floating ring or cyclotome.

All rights have been legally secured by the designer, who is also the manufacturer.

The instrument is made in San Francisco, in different styles and sizes. In their main and essential parts all styles are alike, but they may vary a little in the arrangement of minor detail. In appearance the instrument does not differ from any standard type, except that the bulky apparatus of clamp, collar, tongue, spring-case and tangent screw below the plates is missing, and that the plates sit a little closer to the base.

The cyclotomic transit is particularly adapted to aluminium construction, by placing a light superstructure upon a firm and solid base. This will insure very great steadiness even in a strong wind.

REMARKS.

It is very probable that the instrument will work itself into the favor of the profession, for while it has been much simplified, nothing has been sacrificed, and the item of cost has been reduced.

The principle here made use of may be extended with advantage to many forms of arc-measuring apparatus, and will undoubtedly find a much wider application in time. Although extremely simple and readily understood by anyone, it will require a little field practice to make the engineer an expert in the use of the cyclotome, which, like the slide-rule, will be appreciated all the more the longer it is used and its advantages become apparent.

REVISED EDITION OF
PART IV.

ILLUSTRATED CATALOGUE AND PRICE LIST

OF

MODERN

ENGINEER'S AND SURVEYOR'S INSTRUMENTS,

GUARANTEED IN EVERY DETAIL.

MADE BY

THE A. LIETZ COMPANY,

Manufacturers of Scientific Instruments

No. 422 SACRAMENTO STREET,

SAN FRANCISCO,

CALIFORNIA.

INTRODUCTION TO PART IV.

THE following illustrations show the principal articles manufactured by this Company, being in the case of this catalogue almost exclusively confined to instruments required by the civil, mining, irrigation, hydraulic and military engineer, for making accurate measurements and surveys for any purpose whatever.

Of the surveying instruments each illustration, or plate, is complete within itself. Every part is carefully noted upon the back, together with the price, and a general description in a condensed form. The additional accessories that may be had in each instance, are also enumerated and their prices given. It is well, however, that the engineer who is looking for an article, should consult the preceding Part II of this Manual, wherein every detail is carefully described and extensively discussed. If pains are taken to look this over, the reader will obtain all the information that could possibly be given him in the shop.

Every article has been numbered, and by these numbers our customers may order, without going into a minute description of the articles wanted. For example:

“Send me transit No. 4, (1896) with the following extras” is all that is required to designate to us exactly what is desired by our patron.

In ordering please mention the issue of the catalogue, as the numbers of preceding issues necessarily conflict.

With the detailed information on its reverse side, every plate becomes a complete price list of the particular instrument illustrated. Every effort has been made to make this part of the book as intelligible as possible, without the necessity of searching over numerous pages to gather information.

Although we shall make any instrument of precision called for, we desire to state clearly that we have made a particular specialty of engineer's and surveyor's instruments, because there is for them alone a demand at the present time, and for this reason our shop facilities have been especially designed and improved for the manufacture of these articles.

If instruments for a more scientific purpose are wanted, for astronomical or geodetic work, for instance, we can either *make* them on a special order, or we can *import* them for our customer, having made arrangements in Europe, which enables us to sell such instruments as cheaply as any one in the United States. For institutions of learning we import without payment of duty.

We have added a number of illustrations of imported astronomical and geodetic instruments, which are marked with a †, to distinguish them from our own make. We shall be glad to furnish an estimate of the probable cost of these articles.

In all our manufacture the prices have been marked commensurate with the quality of the work, and no deductions can be made from our price list, which agrees in all its quotations with those of our best Eastern firms.

We furnish a first-class article at a fair price, and all goods stand upon their individual merit. It is our object to introduce the Lietz instrument to the profession generally, and to prove all the claims that we are making for it, and with our earnest effort and encouragement we feel confident of future success.

Our Cyclotomic Transit which we brought into the market several years ago, has been successfully introduced. The especial and careful attention of our practitioners is hereby called to this simple and valuable instrument.

THE A. LIETZ COMPANY.

Engineer's and Surveyor's Transits,

Nos. 1 to 4.

These are elegant instruments, absolutely accurate in all working parts, designed for land surveying and engineering work of a high character.

The general dimensions are given on the back of each illustration, as well as the price, and the extras that may be had upon application. By carefully inspecting the plates, the price list and the enumerated extras, the purchaser is enabled to choose the article and any desired accessory, and make an estimate of its cost.

We make each style in hard aluminium, which increases the price 15%.

The horizontal circle is graduated to read to either 60, 30 or 20 seconds, two double verniers being provided, placed so as to afford a reading without stepping aside. The vertical arc or circle is graduated to read to 60 or 30 seconds. Every instrument has long compound centers, shifting plates on tripod head, with new improved coupling. The telescope possesses definition, light and power in a high degree. It has Jena glass lenses, achromatic objective and eye-piece. Erect vision. The telescope is reversible and evenly balanced, provided with slide protector, and screw motion for focusing cross-hairs. The standards are cloth-finished. The case has leathern straps, rubber cushions, and contains all the usual accessories. For a minute description of every detail, see Part II of the Manual.

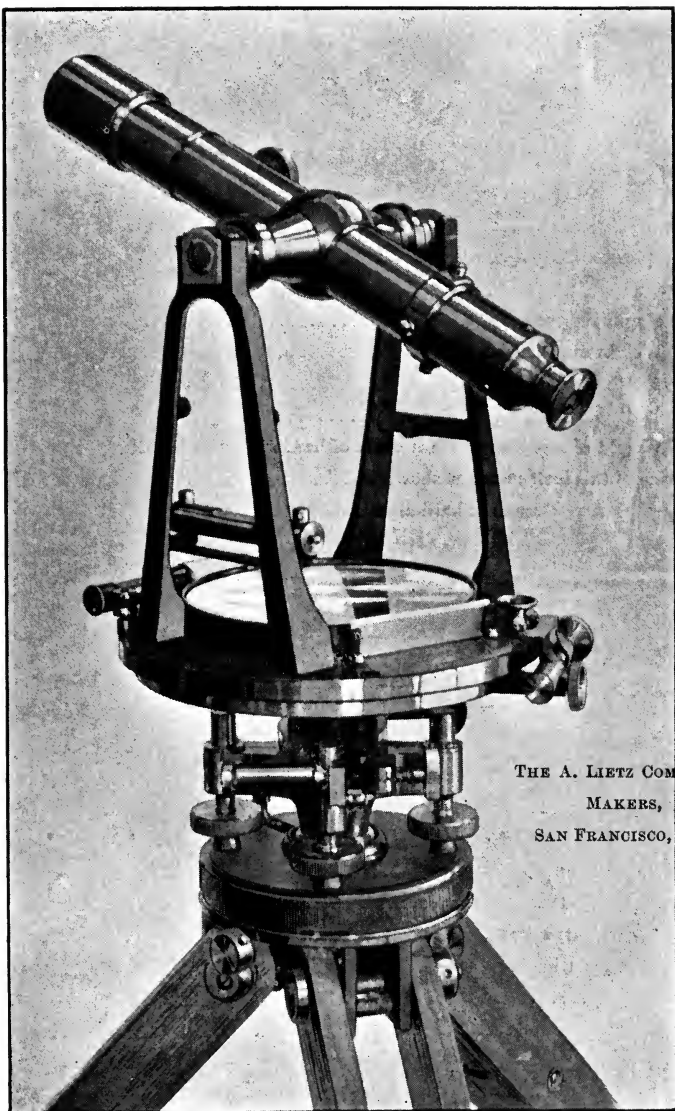

THE A. LIETZ COMPANY,
MAKERS,
SAN FRANCISCO, CAL.

No. 1.
PLAIN TRANSIT.

Price, \$185.00.

 For details and extras see the following page.

No. 1.

Dimensions and Weight.

Horizontal Circle (measured to the edge of graduation)	6¼ inches diam.
Compass Needle.....	4½ “ long
Object Glass	1⅛ “ diam.
Telescope	11 “ long
Magnifying power	24
Weight of instrument	15 lbs.
“ tripod	8½ “
“ box.....	8 “
Weight of this instrument if made of hard aluminium.....	7½ “
The price of this instrument as shown is.....	\$185 00
And if made of hard aluminium, 15 per cent are added.	

The Extras, for which additional charge is made, are as follows:

Solid Silver Graduations :	
On horizontal circle	\$10 00
Verniers, reading to 30"	10 00
“ “ 20"	20 00
Stadia hairs, fixed	3 00
“ “ adjustable	10 00
Variation plate.....	10 00
Arrangement for offsetting right angles.....	5 00
Striding level to axis of telescope	20 00
Constructed with three leveling screws on base plate, instead of four	10 00
Three leveling-screw shifting center.....	5 00
Extra extension tripod.....	15 00
Protection bag	1 00
Bottle of fine watch oil.....	25

NOTE.—On all Lietz Transits the variation of the needle may be laid off to the minute, see page 24.



THE A. LIETZ COMPANY,
MAKERS,
SAN FRANCISCO, CAL.

No. 2.
TRANSIT, WITH LEVEL TO TELESCOPE.

Price, \$215.00.

 For details and extras see the following page.

No. 2.

Dimensions and Weight.

Horizontal Circle (measured to the edge of graduation)	6¼ inches diam.
Compass Needle	4½ " long
Object Glass	1⅛ " diam.
Telescope	11 " long
Magnifying power	24
Weight of instrument	15 lbs.
" tripod	8½ "
" box	8 "
Weight of this instrument if made of hard aluminium	7½ "
The price of this instrument as shown is	\$215 00
And if made of hard aluminium, 15 per cent added.	

The Extras, for which additional charge is made, are as follows:

Solid Silver Graduations:

On horizontal circle	\$10 00
Verniers, reading to 30"	10 00
" " 20"	20 00
Gradiometer Attachment	5 00
Stadia hairs, fixed	3 00
" " adjustable	10 00
Variation plate	10 00
Arrangement for offsetting right angles	5 00
Striding level to axis of telescope	20 00
Reversion level for telescope (see slip 134A)	10 00
Constructed with three leveling screws on base plate, instead of four	10 00
Three leveling-screw shifting center	5 00
Extra extension tripod	15 00
Protection bag	1 00
Bottle of fine watch oil	25

The Reversion Level.

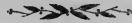

The REVERSION LEVEL is ground on both sides, and the case open on top and bottom, so that the bubble is always visible when the telescope is revolved in transit. Absolute levels may be obtained, and errors in adjustment may be corrected in reversion, by a method of vertical double centering.

THE UNIVERSITY OF CHICAGO

1900

The University of Chicago is a leading center of research and learning in the liberal arts and sciences. It is a place where the best minds from all over the world come to study and work together. The university is committed to the highest standards of academic excellence and to the advancement of knowledge in all fields of inquiry. It is a place where the past meets the future, and where the pursuit of truth is the highest goal.

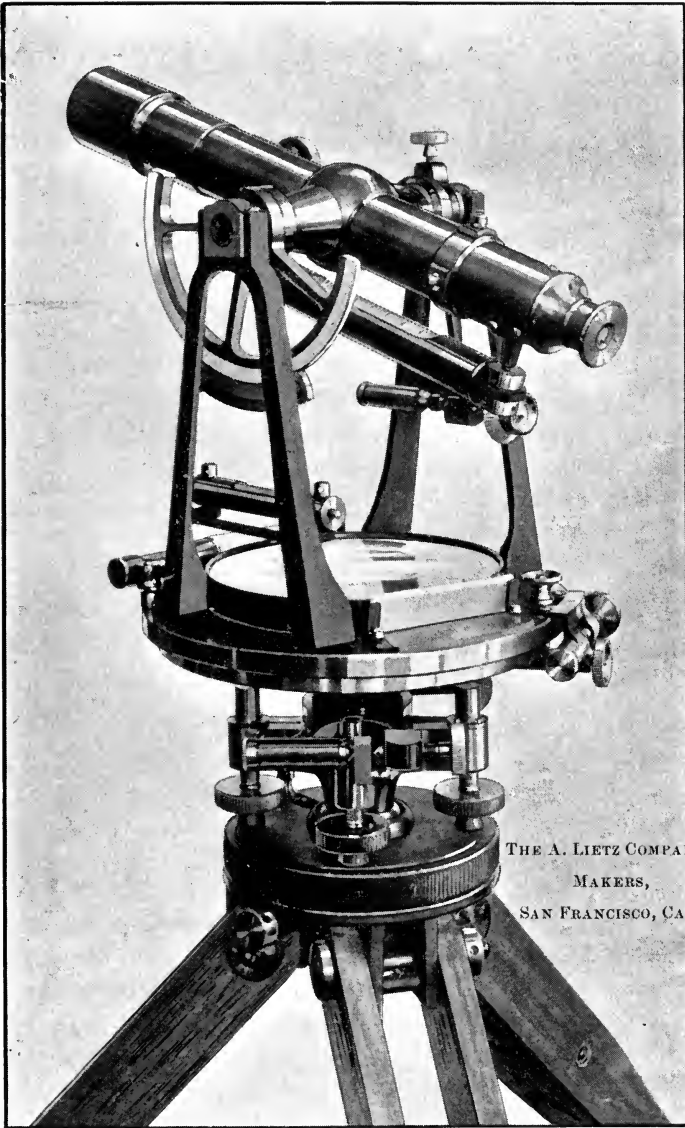

THE A. LIETZ COMPANY,
MAKERS,
SAN FRANCISCO, CAL.

No. 3.
COMPLETE ENGINEERS' TRANSIT,

WITH VERTICAL ARC.

Price, \$230.00.

For details and extras see the following page.

The 5-inch vertical arc is provided with a double vernier, reading to minutes.

No. 3.

Dimensions and Weight.

Horizontal Circle (measured to edge of graduation).....	6¼ inches diam.
Vertical Arc (measured to edge of graduation).....	5 " "
Compass Needle	4½ " long.
Object Glass.....	1⅞ " diam.
Telescope.....	11 " long.
Magnifying power	24
Weight of instrument.....	15 lbs.
" tripod	8½ "
" box	8 "
Weight of this instrument if made of hard aluminium ...	7½ "
The price of this instrument as shown is.....	\$230 00
And if made of hard aluminium, 15 per cent added.	

The Extras, for which additional charge is made, are as follows :

Solid Silver Graduations :

On horizontal circle	\$10 00
On vertical arc.....	5 00
Verniers, reading to 30" on horizontal circle.....	10 00
" " 20" " "	20 00
Gradienter Attachment	5 00
Stadia hairs, fixed	3 00
" " adjustable	10 00
Variation plate.....	10 00
Arrangement for offsetting right angles.....	5 00
Striding level to axis of telescope.....	20 00
Reversion level to telescope (see slip 134A).....	10 00
Constructed with three leveling screws on base plate, instead of four	10 00
Three leveling-screw shifting center.....	5 00
Prism, attachable to eye piece.....	8 00
Extra extension tripod.....	15 00
Protection bag.....	1 00
Bottle of fine watch oil.....	25
Saegmüller Solar Attachment of aluminium.....	50 00

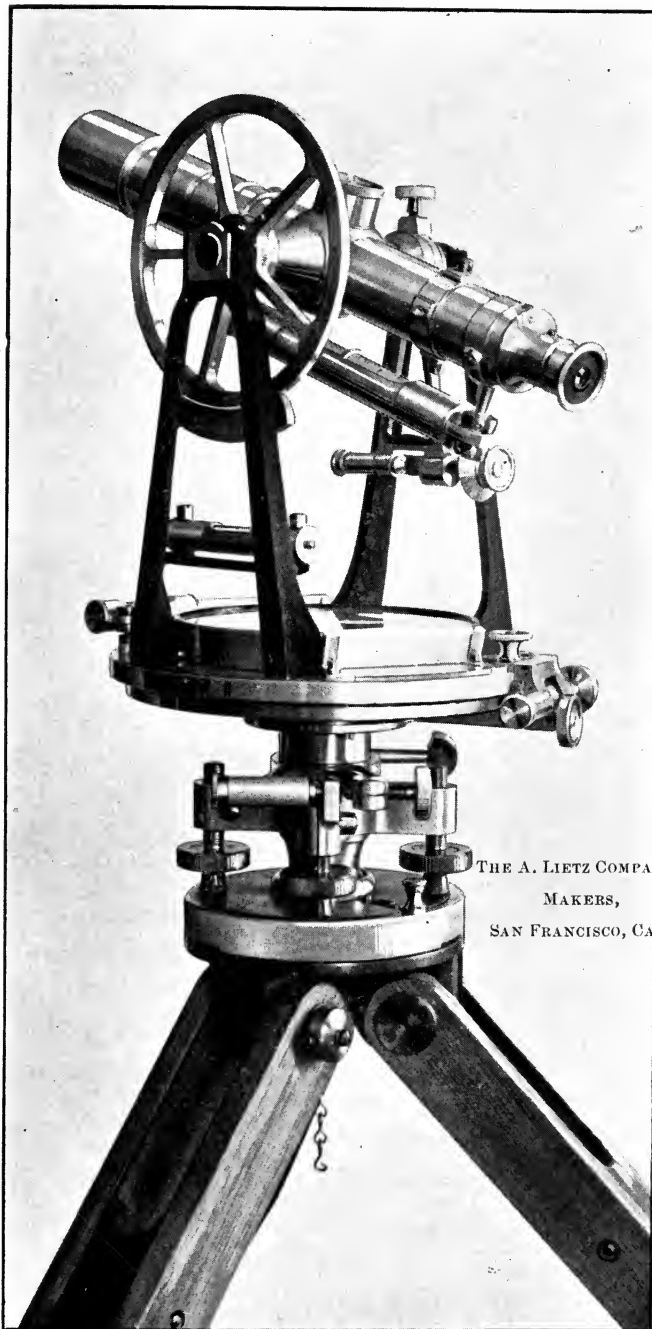

THE A. LIETZ COMPANY,
MAKERS,
SAN FRANCISCO, CAL.

No. 4.
COMPLETE ENGINEERS' TRANSIT,
WITH FULL VERTICAL CIRCLE.

Price, \$235.00.

 For details and extras see the following page.
The 5-inch vertical circle is provided with a double vernier, reading to minutes.

No. 4.

Dimensions and Weight.

Horizontal Circle (measured to edge of graduation).....	6¼ inches diam.
Vertical Circle (measured to edge of graduation).....	5 “ “
Compass Needle.....	4½ “ long.
Object Glass	1⅛ “ diam.
Telescope.....	11 “ long.
Magnifying power.....	24
Weight of instrument	15 lbs.
“ tripod.....	8½ “
“ box.....	8 “
Weight of this instrument if made of hard aluminium..	7½ “
The price of this instrument as shown is.....	\$235 00
And if made of hard aluminium, 15 per cent added.	

The Extras, for which additional charge is made, are as follows :

Solid Silver Graduations :

On horizontal circle	\$10 00
On vertical circle.....	5 00
Verniers, reading to 30" on horizontal circle	10 00
“ “ 20" “ “	20 00
Gradienter Attachment.....	5 00
Stadia hairs, fixed	3 00
“ “ adjustable.....	10 00
Variation plate.....	10 00
Arrangement for offsetting right angles.....	5 00
Striding level to axis of telescope.....	20 00
Reversion level to telescope (see slip 134A).....	10 00
Constructed with three leveling screws on base plate, instead of four.....	10 00
Three leveling-screw shifting center.....	5 00
Prism, attachable to eye-piece.....	8 00
Extra extension tripod	15 00
Protection bag	1 00
Bottle of fine watch oil.....	25
Saegmüller Solar Attachment of aluminium.....	50 00

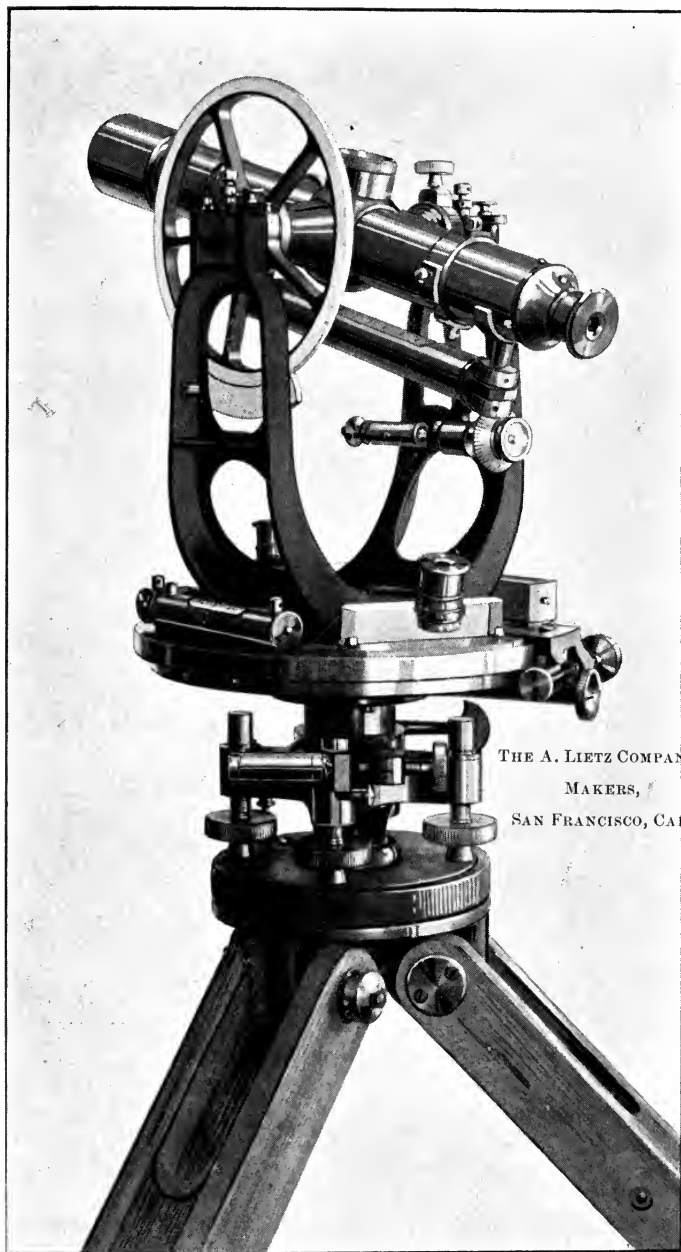

No. 5.
COMPLETE TRANSIT-THEODOLITE.

FOR HIGHEST GRADE ENGINEERING WORK.

 For particulars and price, see the following page.

TRANSIT-THEODOLITE.

This is an instrument of very superior construction.

The standards upon which the telescope rests are cast in one U-shaped piece, thus affording more strength than the ordinary form.

The telescope is reversible in position, as well as exchangeable in its bearings, which are provided with dust-caps and screws, to give them the proper friction. The telescope is either erect or inverting. For reasons already set forth, the inverting form should be given the preference. The telescope possesses the finest lenses and optical accessories. It has a slide protector and is provided with a sunshade. The cross hairs are focused by a screw motion of the eye-piece.

All the graduations are on solid silver. The horizontal circle reads to either 30, 20 or 10 seconds, by two opposite verniers, near the line of collimation, which are supplied with two attached reading glasses, if desired. The vertical arc or circle is graduated to read to 30 seconds.

The instrument is furnished with either three or four leveling screws, that operate through a slotted star, as already described in the case of the other instruments.

A shifting center is provided, with extra cover plate to protect it from dust.

The U-shaped casting, constituting the support for the telescope, may be either in cloth-finish, or in bright lacquer, like the rest of the instrument. The metal finish may be had of any desired color.

The new Lietz Tripod Coupling is furnished without extra charge.

The case contains all the usual accessories, such as plumb bob, screw driver, adjusting pins, etc.

Dimensions and Weight.

Horizontal Circle (measured to edge of graduation).....	6¼ inches diam.
Vertical Arc or Circle (measured to edge of graduation).....	5 " "
Compass Needle (in box on plate).....	3½ " long.
Telescope	11 " "
Object Glass.....	1½ " diam.
Magnifying power.....	24
Weight of instrument.....	16 lbs.
" tripod	8½ "
" box.....	8 "

If made of aluminium, the weight of the instrument is reduced 50%.

The price of the plain transit-theodolite (without a level, clamp and arc to telescope) is \$240.00, and if made of hard aluminium 15% are added.

The Extras, which make the instrument more or less complete,
are as follows:

Verniers reading to 20" on a 6¼ inch horizontal circle.....	\$10 00
" " " 10" " 7 " " " "	35 00
A 5-inch vertical arc, reading to minutes.....	20 00
A 5-inch full vertical circle, reading to minutes.....	25 00
" " " " with opposite double verniers, reading to minutes.....	50 00
Two vernier microscopes.....	15 00
Long ground level to telescope, with compound clamp and tangent screw, telescope reversible, and supplied with gradienter attachment.....	40 00
Reversion level to telescope (see slip 134A).....	10 00
Striding Level.....	20 00
Stadia Hairs, fixed.....	3 00
" " adjustable.....	10 00
Box Needle, on plate.....	20 00
Constructed with three leveling screws on base plate, instead of four.....	10 00
Three leveling screw shifting center.....	5 00
Prism attachable to eye-piece.....	8 00
Protection bag.....	1 00
Bottle of fine watch oil.....	25
Saegmüller solar attachment of aluminium.....	50 00

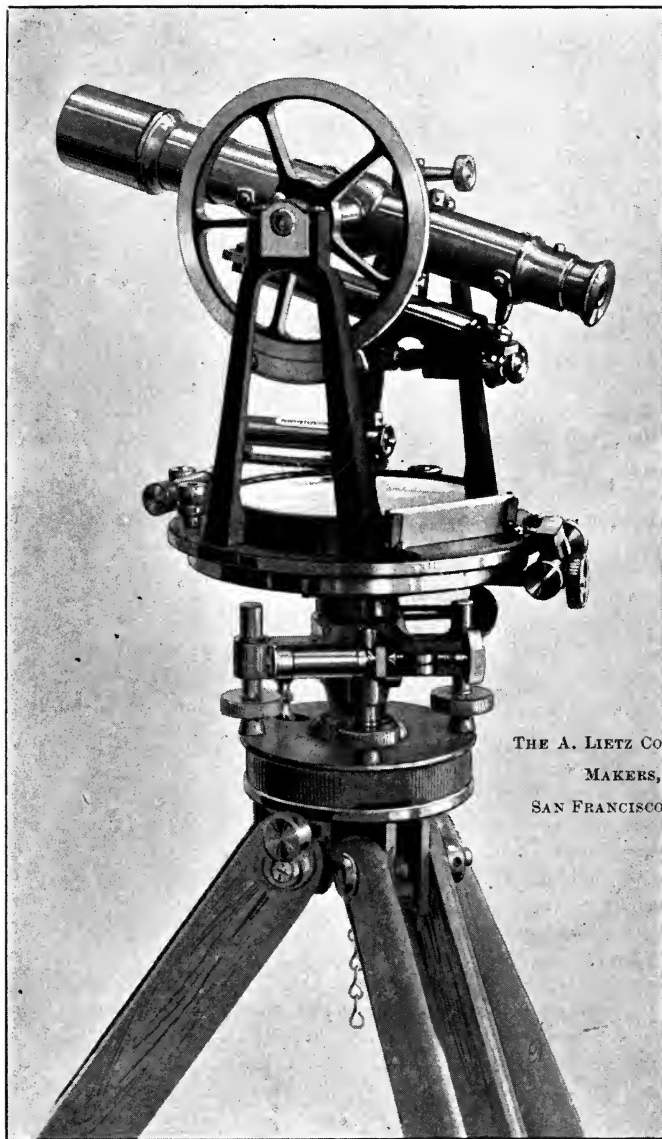

THE A. LIETZ COMPANY,
MAKERS,
SAN FRANCISCO, CAL.

No. 9.
COMPLETE MOUNTAIN AND MINING TRANSIT.

Nos. 6 to 9.

No. 6 is the Plain Mountain and Mining Transit.

No. 7 the same as No. 6, with telescope level.

No. 8 the same as No. 7, with a vertical arc.

 For details, prices and extras, see the following page.

SMALL, MOUNTAIN AND MINING TRANSIT.

No. 6.

THE PLAIN TRANSIT.

This is a beautiful instrument, made to correspond in every way with No. 1, except in size and weight. It is a superior and reliable article for general land surveying, and particularly for mining purposes.

Dimensions, Nos. 6 to 9.

Horizontal Circle (measured to edge of graduation).....	5 inches diam
Vertical Arc or Circle (measured to edge of graduation).....	4 " "
Compass Needle.....	4½ " long.
Object Glass.....	1 " diam.
Telescope.....	8 " long.
Magnifying power.....	18
Weight of instrument.....	8½ lbs.
" tripod.....	6 "
" box	6 "
Weight of this instrument, if made of hard aluminium.....	4¼ "
The price of the plain transit, No. 6 is.....	\$180 00
With level to telescope and tangential movement, No. 7.....	210 00
With Vertical arc in addition, No. 8.....	225 00
With full vertical circle, No. 9.....	230 00
And if made of hard aluminium, 15% are added.	

The Extras, for which additional charge is made, are as follows:

Solid Silver Graduations :

On horizontal circle.....	\$10 00
On vertical arc or circle.....	5 00
Gradienter Attachment.....	5 00
Stadia hairs, fixed.....	3 00
" " adjustable.....	10 00
Variation Plate.....	10 00
Arrangement for offsetting right angles.....	5 00
Striding level to axis of telescope.....	20 00
Reversion level for telescope (see slip 134 A).....	10 00
Constructed with three leveling screws on base-plate, instead of four.....	10 00
Three leveling-screw shifting center.....	5 00
Prism attachable to eye-piece.....	8 00
Half-length tripod.....	13 00
Extra extension tripod.....	15 00
Extension tripod in lieu of the ordinary.....	5 00
Detachable side telescope.....	35 00
Lamp for mining engineering, of brass, with ground lens.....	7 00
Reflector, for illuminating cross hairs.....	4 00
Plummet lamp.....	10 00
Large plumb-bob, weight 4 lbs., for use in shafts.....	5 00
Protection bag.....	1 00
Bottle of fine watch oil.....	25
Saegmuller solar attachment of aluminium.....	50 00

No. 10. Mining Transit.

The same dimensions as in Nos. 1 to 4. Graduations on solid silver; verniers, reading to minutes, provided with glass shades; 5-inch full vertical circle; spirit level, clamp and tangent screw to telescope; extension tripod, etc. Price, \$258.00. If made of hard aluminium, 15% added.

No. 11. Mining Transit.

The same dimensions as in Nos. 6 to 9. Graduations on solid silver; verniers, reading to minutes, provided with glass shades; 4-inch full vertical circle; spirit level, clamp and tangent screw to telescope; extension tripod, etc. Price, \$253.00. If made of hard aluminum, 15% added.

It must be apparent that there cannot be any great difference in price between a large and a small-sized instrument. The workmanship in each is alike, and, if anything, more complicated and costly in the smaller. The only difference is in the quantity of metal used, but as this can not possible amount to much in price, it is more than compensated by the additional care required in handling the smaller parts. This explanation would hardly seem necessary, were it not for the prevailing impression that all merchantable articles of the same kind should be rated by their respective sizes. That this cannot obtain in the case of instruments must stand to reason. The price of a transit can only be reduced by omitting certain features, or by changing it to a simpler construction. For this reason we have invented and are now building an instrument, called by us the Cyclo-tomic Transit, to which your attention is particularly called. See pages 121 and 153, this Manual.

Simplified Transit Compasses

These instruments, Nos. 12, 13 and 14, are high grade compasses possessing transit accessories; but as there is no graduated horizontal plate, they are only fitted for needle surveys.

The telescope, mounted upon cloth-finished standards, has the best lenses, accurately centered and of ample power.

The needle is of the best make, and may be read with the same accuracy as that of any other transit.

The leveling is done by two pairs of opposing leveling screws, mounted horizontally (see the appended illustrations), that operate against a ball in a socket, admitting of a very accurate adjustment to the proper plane indicated by two sensitive plate bubbles. While one leveling screw is loosened or drawn out, the opposing one is operated against the ball until the inclination of the vertical axis is nil. This is done with both sets until the plate bubbles remain centered for any position in azimuth. The ball must be so held that it becomes rigid and the axis steady.

These compasses are made of standard size (refer to illustrations), and in three varieties. No. 12 is the plain transit compass. No. 13 has in addition a telescope level with clamp and tangential movement therefor. No. 14 has a vertical arc and is completely fitted for stadia work. Surmounted with a Saegmüller Solar attachment, this compass becomes the Compound Mining and Solar Instrument shown in No. 15, by means of which meridional work may be done with much greater accuracy than with the old-fashioned surveyor's compass having metal sights, or the cumbersome solar compass, with its rough motions and its crude means of obtaining approximately the direction of a line. These antiquated relics, although costing fully as much as our transit compasses, cannot by any possibility be so reliable.

The solar attachment possesses the additional advantage of a side telescope for certain mining work.

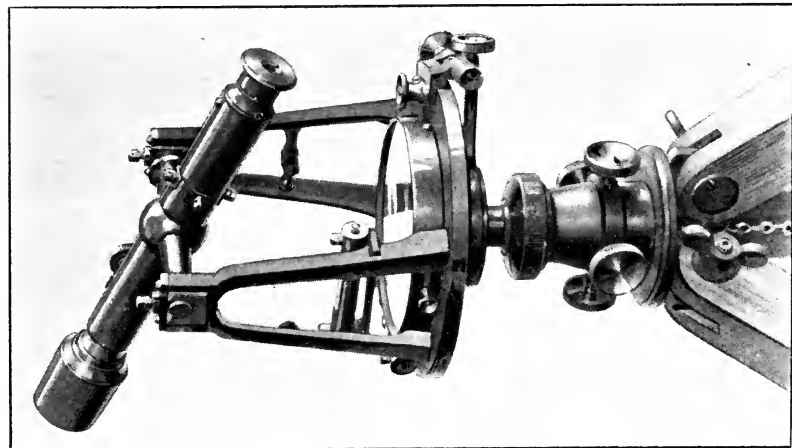

No. 12.
Price, \$80.00.

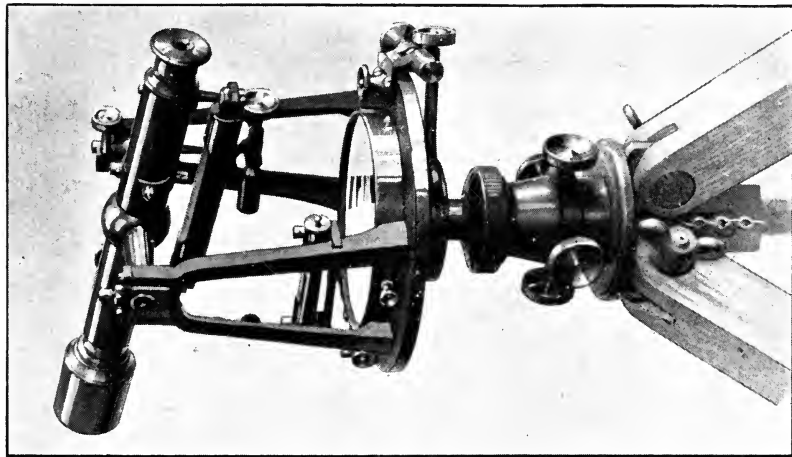

No. 13.
Price, \$105.00.

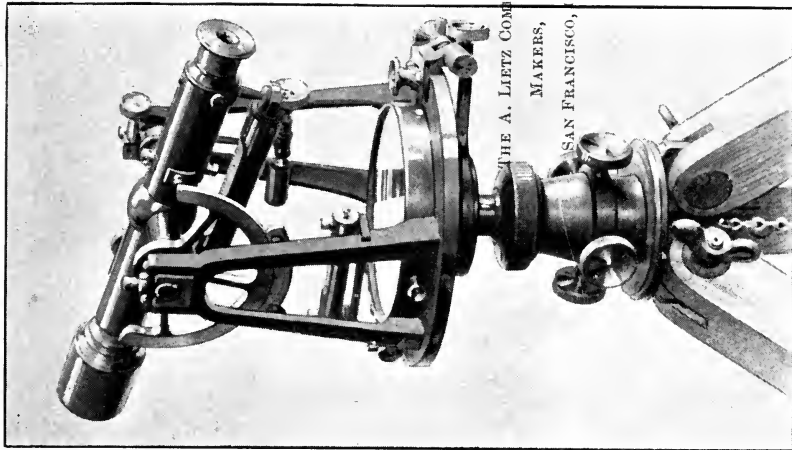

No. 14.
Price, \$118.50.

SIMPLIFIED TRANSIT COMPASSES.

For details see the following page.

SIMPLIFIED TRANSIT COMPASSES.

No. 12.

Possessing a long center ; horizontal leveling screws, and ball joint movable in socket. No horizontal plate. Compass needle and graduated compass ring, with variation plate. Sensitive plate levels. Cloth finished standards, carrying a fine achromatic telescope. The telescope is reversible and accurately balanced. It affords ample definition, power and light. May be had with or without stadia hairs.

The instrument is packed in a handsome case containing a plumb bob, adjusting pins and all the usual accessories.

A light but strong tripod is furnished.

Dimensions and Weight.

Compass Needle.....	3½ inches long.	
Telescope	8 “	long.
Vertical Arc.....	4 “	diam.
Object Glass	1 “	“
Magnifying power.....		18
Weight of instrument.....	7½ lbs.	
“ tripod.....	6 “	
“ box.....	4½ “	
The price of this instrument is.....		\$80.00
Stadia hairs, \$3.00 extra.		

No. 13.

The same as No. 12, with a level to the telescope, and clamp and tangential movement to telescope axis.

Price.....\$105.00
Stadia hairs, \$3.00 extra.

No. 14.

The same as No. 13, with a vertical arc graduated to read to minutes.

Price.....\$118.50
Stadia hairs, \$3.00 extra.

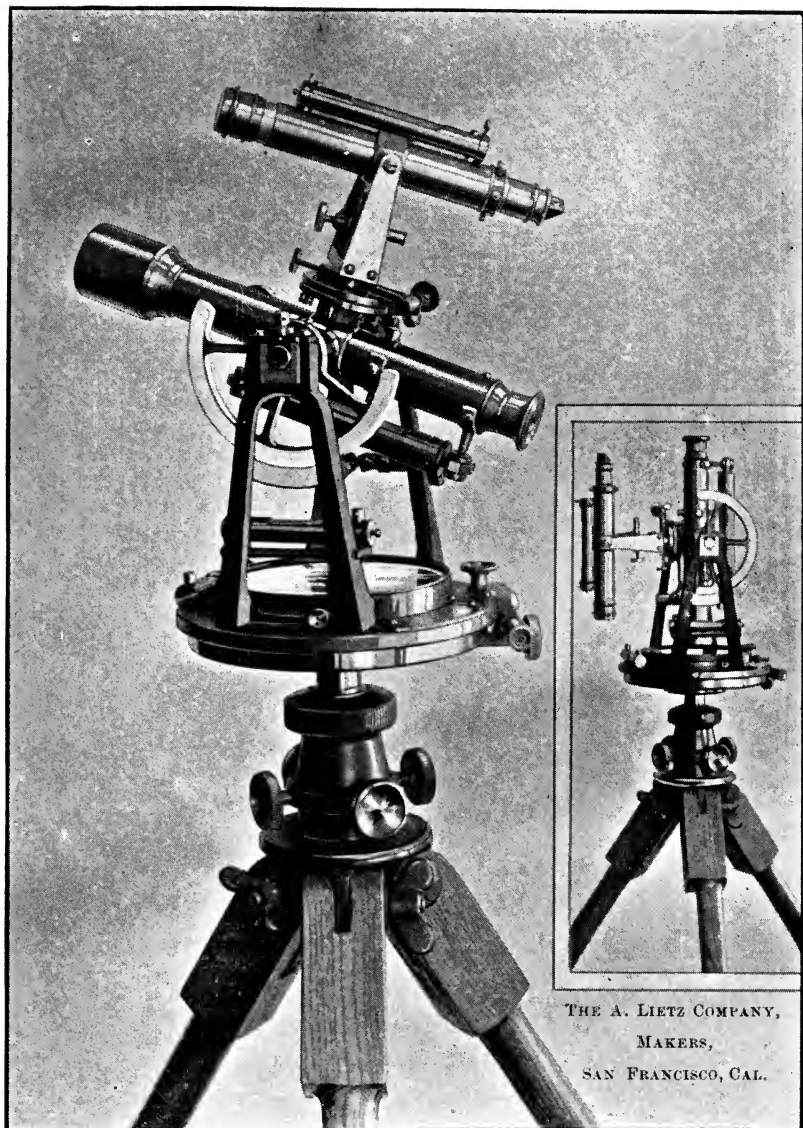

No. 15.
COMPOUND MINING AND SOLAR INSTRUMENT.

Price, \$168.50.

 For details, see the following page.

No. 15.

COMPOUND MINING AND SOLAR INSTRUMENT.

This instrument is like No. 14, with a Saegmüller solar attachment. It possesses a long center, horizontal leveling screws, operating against a ball in a socket. No horizontal plate. Compass needle and graduating compass ring, with variation plate. Sensitive plate levels. Cloth finished standards, carrying a fine achromatic telescope. The telescope is reversible and accurately balanced. It affords ample definition, power and light. May be had with or without stadia hairs.

The solar attachment is screwed into the top of the telescope axis and becomes a part of the instrument. It answers all the purposes of a side telescope, as shown in the marginal sketch.

The whole instrument is packed in a handsome case, with a special place for the solar attachment, containing a plumb bob, adjusting pins, and all the usual accessories.

A light but strong tripod is furnished.

Dimensions and Weight.

Compass Needle	3½ inches long.
Telescope.....	8 " "
Object Glass	1 " diam.
Vertical Arc.....	4 " "
Magnifying power	18
Weight of instrument with solar attachment	8½ lbs.
" tripod	6 " "
" box	4½ "
The price of this instrument is.....	\$168 50
Stadia hairs, \$3.00 extra.	

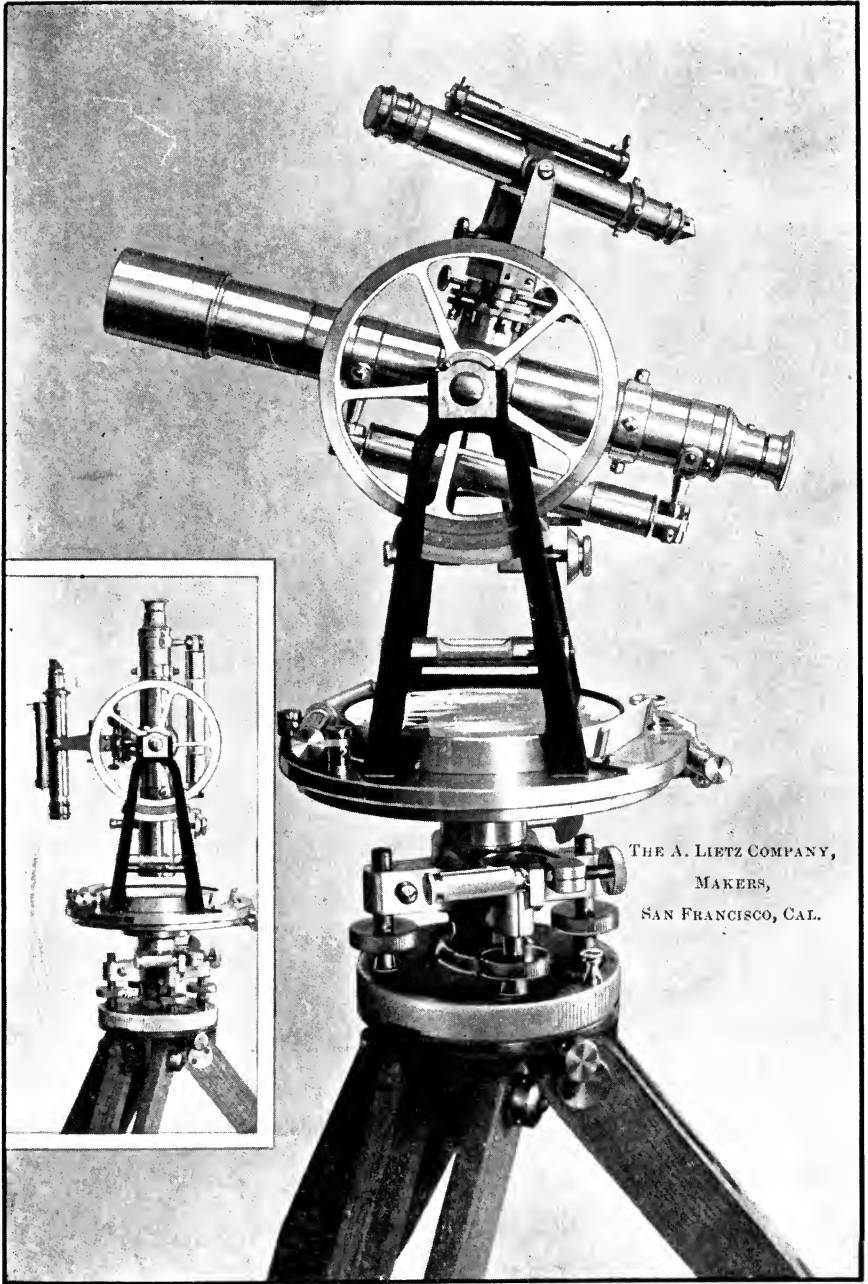

THE A. LIETZ COMPANY,
MAKERS,
SAN FRANCISCO, CAL.

No 16.
COMPOUND MINING AND SOLAR TRANSIT,
Price, Complete, \$318.00.

 For details, see the following page.

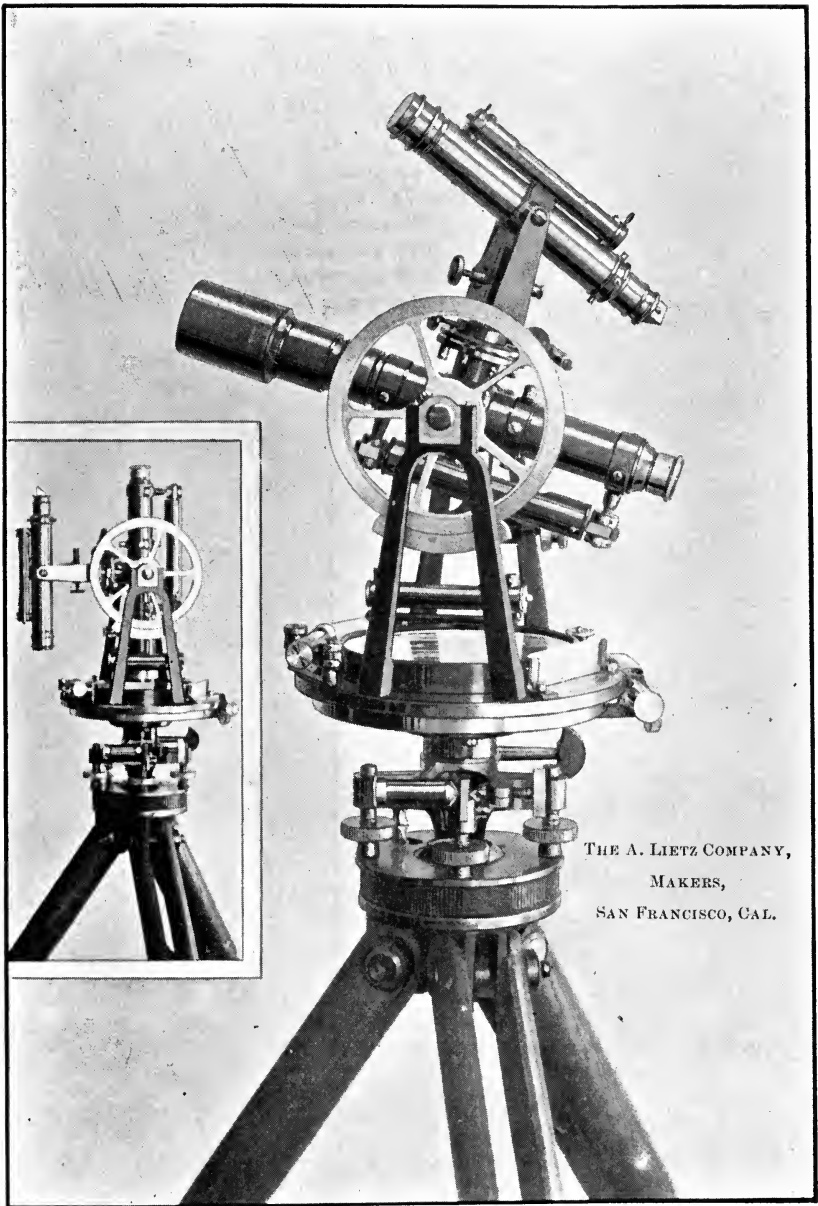

THE A. LIETZ COMPANY,
MAKERS,
SAN FRANCISCO, CAL.

No. 17.
COMPOUND MINING AND SOLAR TRANSIT.

Price, Complete, 313.00.

 For details, see the following page.

COMPOUND MINING AND SOLAR TRANSIT.

This instrument is like No. 9, with the Saegmüller solar attachment.

It possesses a double center, lower clamp and tangential movement ; plate movement with clamp and tangent screw, and sensitive plate levels ; double verniers reading to minutes, placed conveniently for reading without stepping from the eye end. Compass needle and graduated compass ring, with variation plate. Cloth finished standards, carrying an improved telescope. The telescope is reversible and evenly balanced ; it affords ample definition, power and light ; fixed stadia hairs are supplied ; it has a long level and possesses a clamp and tangential movement ; also gradienter attachment ; a full or half vertical circle reading to minutes. All graduations are on solid silver. The instrument has the Lietz tripod coupling, and a shifting center.

The solar attachment is detachable, screws into the top of the telescope axis, and becomes a part of the instrument. It answers all the purposes of a side telescope, as shown in the marginal sketch.

The whole instrument is packed in a handsome case, with a special place for the solar attachment, containing a plumb-bob, adjusting pins and all the usual accessories.

Dimensions and Weight.

Horizontal Circle (measured to edge of graduation).....	5 inches diam.
Vertical Circle (measured to edge of graduation).....	4 " "
Compass Needle.....	3½ " long.
Telescope.....	8 " "
Object Glass.....	1 " diam
Magnifying power	18
Weight of instrument	9 lbs.
" tripod.....	6 "
" box.....	6 "
Weight of this instrument, if made of hard aluminium....	5 "
The price of this instrument, complete, is.....	\$313 0
And if made of hard aluminium, 15% are added	

The Extras, for which additional charge is made, is as follows:

Adjustable Stadia Hairs	\$10 00
Arrangement for offsetting right angles.....	5 00
Striding level to axis of telescope.....	20 00
Reversion level on telescope (see slip 134A)	10 00
Constructed with three leveling screws on base-plate, instead of four.....	10 00
Three leveling-screw shifting center	5 00
Prism attachable to eye-piece	8 00
Extra extension tripod.....	15 00
Half-length tripod.....	13 00
Extension tripod in lieu of the ordinary.....	5 00
Detachable side telescope.....	35 00
Lamp for mining engineering, of brass, with ground lens.....	7 00
Reflector, for illuminating cross hairs.....	4 00
Plummet lamp.....	10 00
Large plumb-bob, weight 4 lbs., for use in shafts.....	5 00
Protection bag.....	1 00
Bottle of fine watch oil.....	25

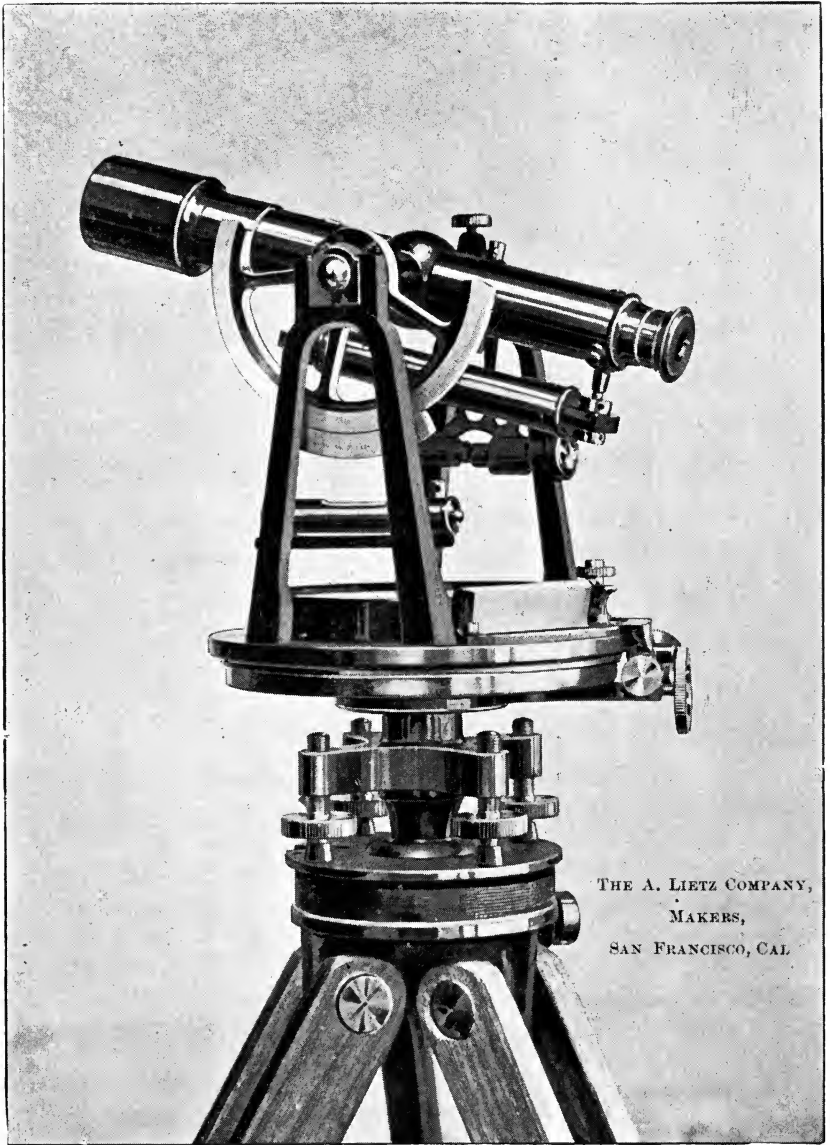

No. 18.
CYCLOTOMIC TRANSIT.

Patent applied for.

A single center instrument, admitting of every evolution that the double center transit is able to carry out. (See Professional Paper No. 7, Part III.)

☛ For details and prices, see the following pages.

THE CYCLOTOMIC TRANSIT.

(Patent Applied for.)

This instrument has been described and its advantages fully set forth, together with its use in the field, in Part III, pages 121-126, Professional Paper No. 7, to which we would now refer.

The instrument is first-class in every particular, and made to correspond in all details to our high-grade transits shown in previous numbers; it is intended for any of the most accurate work the engineer is called upon to do.

It has but one spindle, but the simple arrangement of the cyclotome admits of every evolution that the double center is capable of carrying out.

Its invention is the result of a constant aim on our part to create a simple long center instrument, against which it may not be said that the value of a horizontal angle cannot be determined at once, without taking two readings and obtaining a calculated difference.

The design is **novel**, but several instruments have been out in the field for months and **are giving absolute and perfect satisfaction.**

The instrument contains the best optical accessories, the most accurate plate divisions, and is guaranteed to give results to the limits of its vernier graduations, which may be had to twenty seconds of arc, if desired.

The high-grade **Cyclotomic Transit** is made in two sizes, of dimensions similar to our other transits, and these sizes are manufactured either in red metal or aluminium. They are numbered 18 for the larger and 18a for the smaller size.

A complete Cyclotomic Reconnaissance Transit, No. 18b, is also manufactured, in which the advantages of the system are combined to make a reliable instrument, complete in every detail, for **any work** in the line of modern engineering, at the **most reasonable cost.** See page 156 for details.

We recommend the **Cyclotomic Instrument** to the profession. Its use and manipulation are extremely simple, and the results of its work absolutely reliable.

Any special information, if called for, will be furnished.

See testimonials in front on fly leaves.

No. 18.

COMPLETE CYCLOTOMIC TRANSIT.

(Patent applied for.)

Dimensions and Weight.

Horizontal circle (measured to edge of graduation)	6 $\frac{1}{4}$ inches diam.
Vertical circle	5 " "
Compass needle	4 $\frac{1}{2}$ " long.
Object glass	1 $\frac{1}{8}$ " diam.
Telescope	11 " long.
Magnifying power	24
Weight of instrument	15 lbs.
" tripod	8 $\frac{1}{2}$ "
" box	8 "
Weight of this instrument if made of hard aluminium. . .	7 $\frac{1}{2}$ "
The price of this instrument complete, as shown is	\$200 00
And if made of hard aluminium, 15 per cent added.	

No. 18a.

COMPLETE CYCLOTOMIC TRANSIT.

(The same as No. 18, but smaller.)

Dimensions and Weight.

Horizontal circle (measured to edge of graduation)	5 inches diam.
Vertical arc or circle (measured to edge of graduation)	4 " "
Compass needle	3 $\frac{1}{2}$ " long.
Object glass	1 " diam.
Telescope	8 " long.
Magnifying power	18
Weight of instrument	8 $\frac{1}{2}$ lbs.
" tripod	6 "
" box	6 "
Weight of this instrument if made of hard aluminium. . .	4 $\frac{1}{2}$ "
The price of this instrument complete is	\$195 00
And if made of hard aluminium, 15 per cent added.	

The Extras, for which additional charge is made for either size, except where noted, are as follows :

Solid silver graduations :	
On horizontal circle	\$10 00
On vertical arc or circle	5 00
Verniers (horizontal) reading to 30'' (No. 18)	10 00
" " " " 20'' (No. 18)	20 00
Gradienter attachment	5 00
Stadia hairs, fixed	3 00
" " adjustable	10 00
Variation plate	10 00
Arrangements for offsetting right angles	5 00
Striding level to axis of telescope	20 00
Reversion level (see slip 134A)	10 00
Constructed with three leveling screws on base plate, instead of four	10 00
Three leveling-screw shifting center	5 00
Prism, attachable to eye-piece	8 00
Extra extension tripod	15 00
Extra tripod, in lieu of the ordinary	5 00
Protection bag	1 00
Bottle of fine watch oil	25
Saegmüller solar attachment of aluminium	50 00

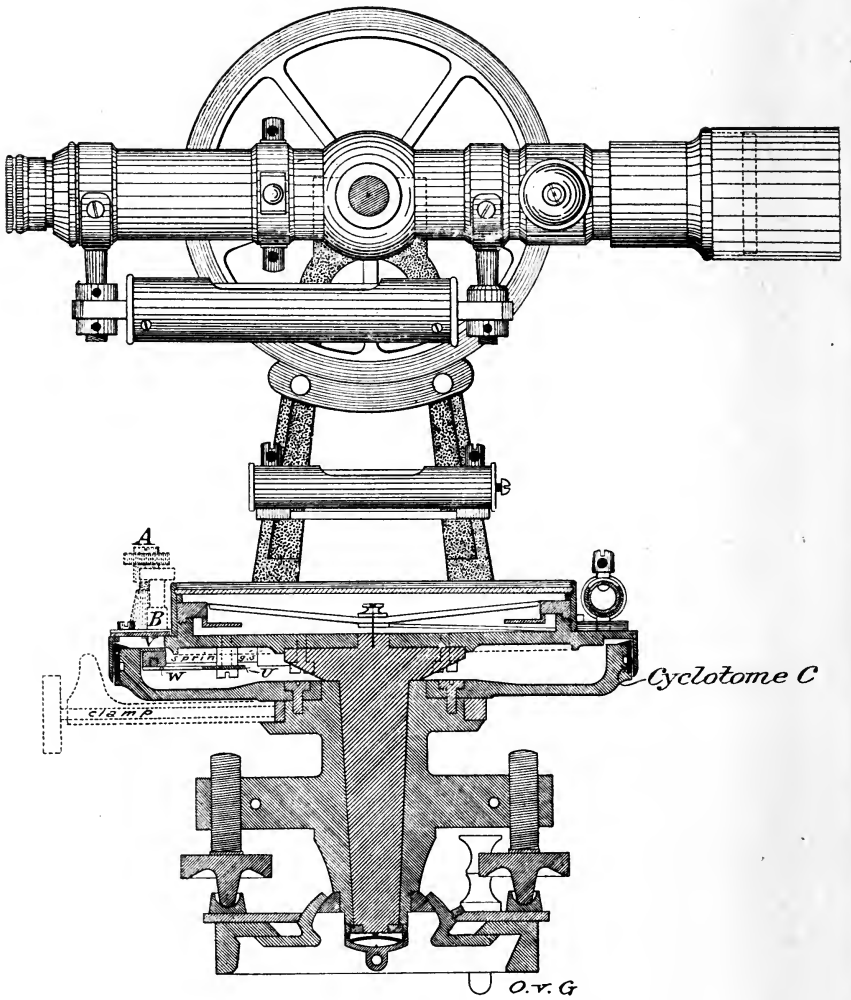
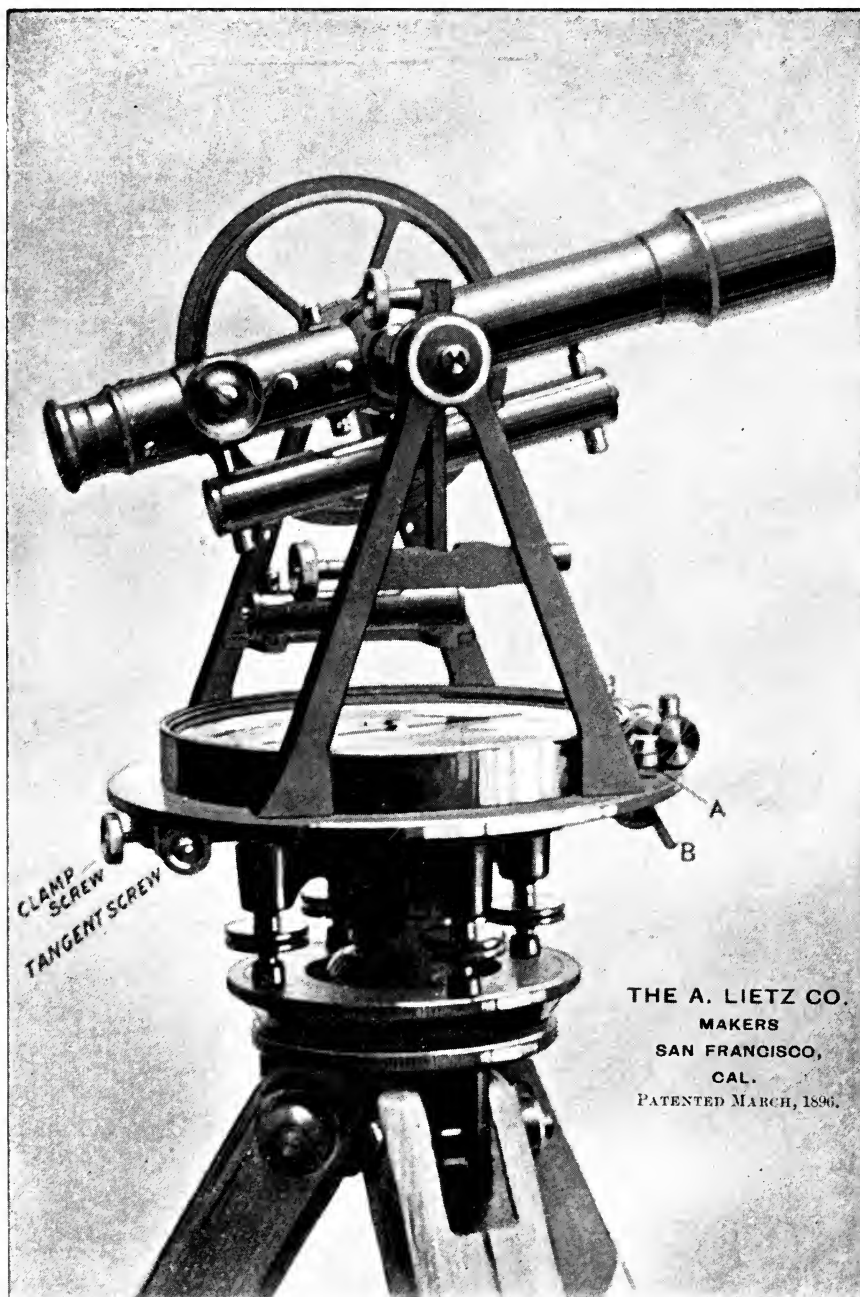

Fig 1.

*Section through Plates
on Line X - Center - Y,
with side view of Telescope*

PATENTED MARCH, 1896.

All rights reserved.



No. 18b.
COMPLETE CYCLOTOMIC RECONNOISSANCE TRANSIT.
Price, as shown complete, \$125 00.
For Extras and Details see the following page.

No. 18b.

COMPLETE CYCLOTOMIC RECONNOISSANCE TRANSIT.

(Patented March 1896.)

A field instrument of medium size, possessing a **VERY LARGE NEEDLE**, one horizontal vernier, vertical arc or circle, and every accessory to make the instrument a complete tachymeter for stadia work. For topography it has no equal in simplicity of operating parts, and full equipment for work of such character.

It admits of laying off horizontal and vertical angles correctly to one minute of arc; the starting azimuth may be made zero or any other reading, with as much facility as any other known transit, although the instrument has only one spindle. This spindle or center is of extra large dimensions in length and diameter, which affords great stiffness and rigidity to the whole structure.

Dimensions and Weight.

Horizontal circle (measured to edge of graduation)	4 inches diam.
Vertical arc (or circle)	4 " "
Compass needle	4½ " long.
Object glass	⅞ " diam.
Telescope	8 " long.
Weight of instrument	7½ lbs.
" " tripod	6 " "
" " box	5 " "
Weight of this instrument if made of hard aluminium	4½ " "
The price of this instrument, complete, is	\$125 00
And if made of hard aluminium, 15 per cent added.	.

The Extras, for which additional charge is made, are as follows :

Stadia hairs, fixed	\$ 3 00
Variation plate	10 00
Extension tripod in lieu of the ordinary	5 00
Protection bag	1 00
Bottle of fine watch oil	25

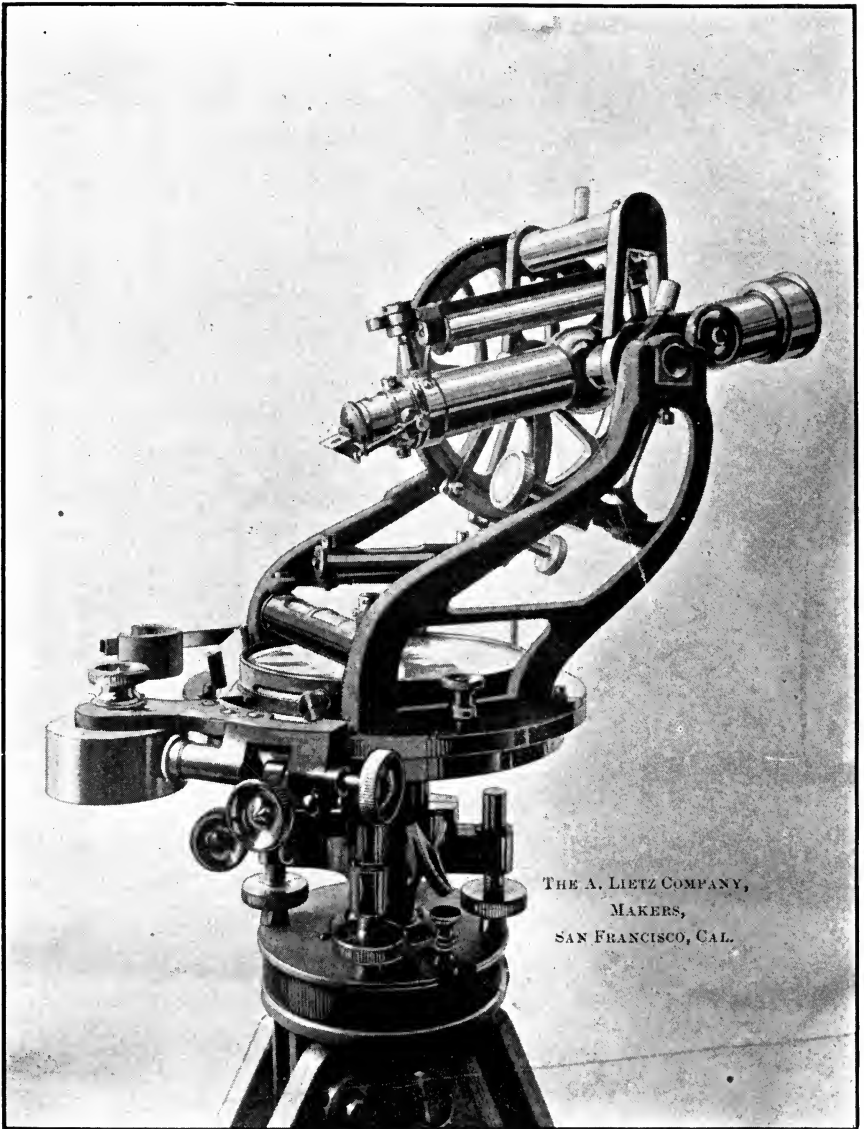

No. 18c.

MINING TRANSIT, WITH INCLINED STANDARDS.

Built to order from a special design.

See the following page.

No. 18c.

This mining transit with inclined standards was designed by C. S. Batterman, Esq., Mining Engineer, of Aspen, Colorado, and built for him by this Company.

The design is a novel one, and for Mr. Batterman's purpose, the instrument has given full satisfaction.

We are prepared to carry out any order of a similar character. If our customers have special designs for special purposes, we shall build to their own specifications, if so ordered.

Prices will depend upon the time consumed, and we are always ready to furnish estimates of the probable cost.

Any communication will receive our prompt attention and consideration.

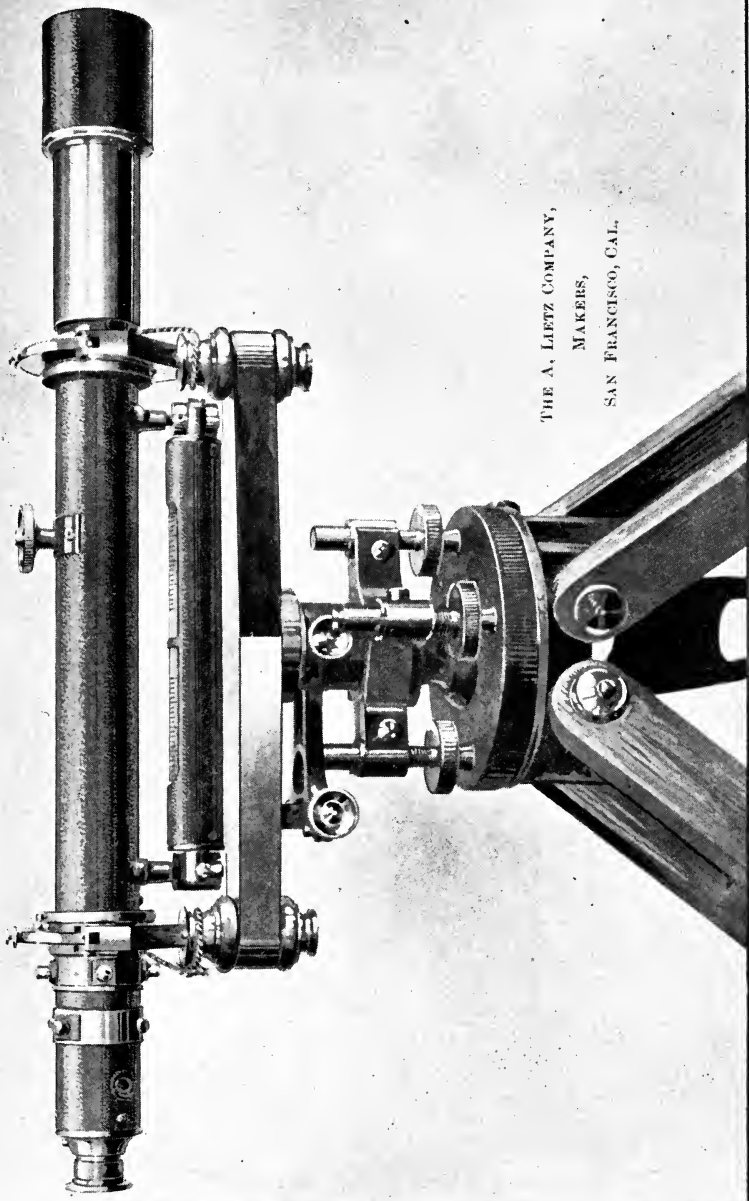

THE A. LIETZ COMPANY,
MAKERS,
SAN FRANCISCO, CAL.

No. 19.
ENGINEER'S Y-LEVEL.

Price, \$140.00

For details, see the following page.

No. 19.

ENGINEERS' Y-LEVEL.

Possesses all recent improvements. Long steel center; star-shaped construction of the guide for the foot-screws; clamp and tangential movement; sensitive spirit level. The telescope has definition, light and power in a high degree; best achromatic Jena glass lenses (erect vision) and stadia hairs if desired; is provided with a slide-protector, and either cloth, bright or bronzed finished. Fastened to the tripod by means of the Lietz coupling.

The whole is packed in a neat case, containing all the usual accessories.

Dimensions and Weight.

Length of telescope	18	inches
Diameter of objective.....	1 $\frac{3}{8}$	"
Magnifying power	33	
Weight of instrument.....	10 $\frac{1}{2}$	lbs.
" tripod	8	"
" box	7 $\frac{1}{2}$	"
Weight of this instrument, if made of hard aluminium.....	6 $\frac{1}{4}$	"
The price of this instrument is.....	\$140	00

And if made of hard aluminium, 15% are added.

The Extras, for which additional charge is made, are as follows:

Mirror, to control the bubble at eye end.....	\$10	00
Stadia hairs, fixed.....	3	00
" " adjustable	10	00
Agate-fitted Y's.....	10	00
Reversion level to telescope (see slip 134A).....	15	00
Three leveling screws on base-plate, instead of four	10	00
Protection bag	1	00
Bottle of fine watch oil	25	

 If this instrument is provided with a micrometer screw for the vertical control of one of the Y's, and an additional spirit level, set normal to the line of collimation, it becomes a HYDROGRAPHIC Y-LEVEL. The charges for these additions are \$40.00.

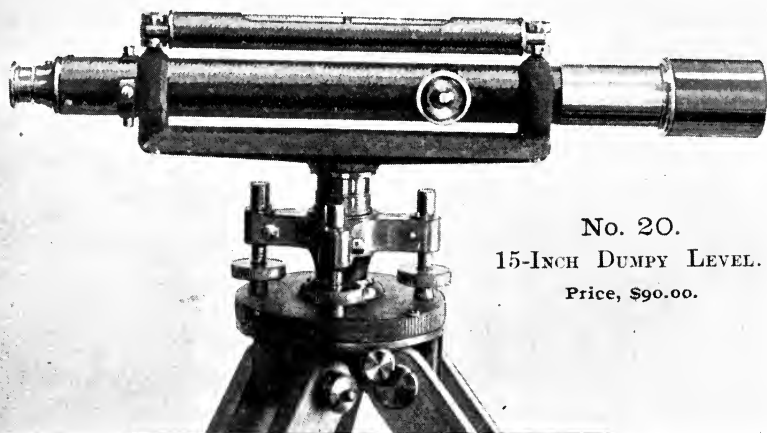

No. 20.
15-INCH DUMPY LEVEL.
Price, \$90.00.

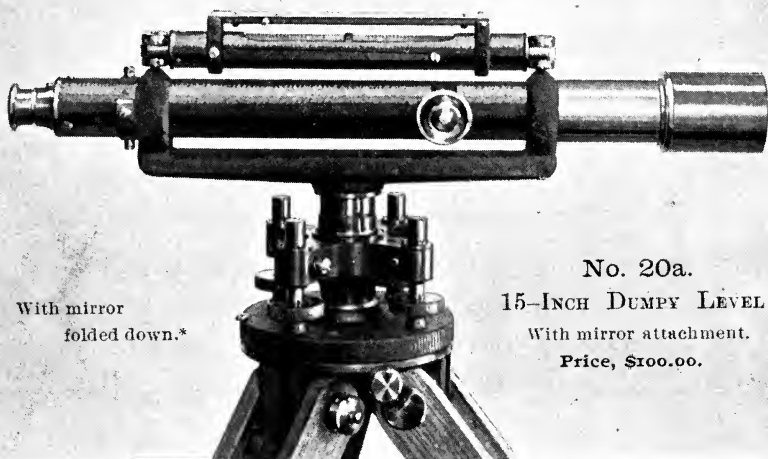

With mirror
folded down.*

No. 20a.
15-INCH DUMPY LEVEL
With mirror attachment.
Price, \$100.00.

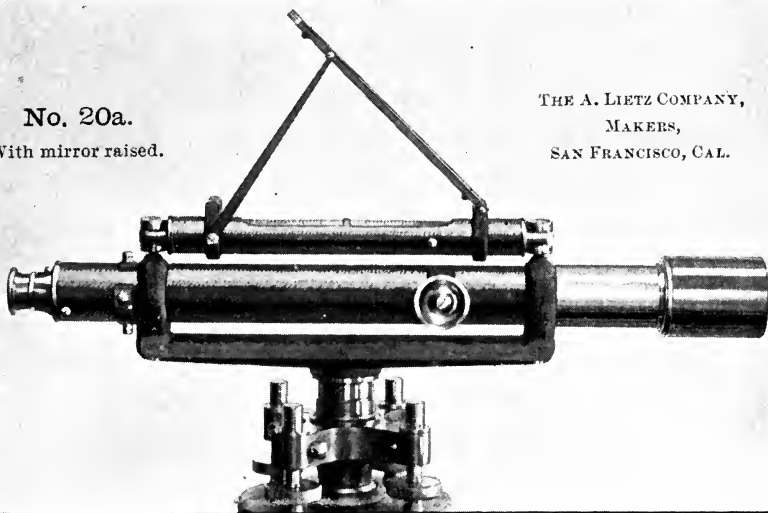

No. 20a.
With mirror raised.

THE A. LIETZ COMPANY,
MAKERS,
SAN FRANCISCO, CAL.

*The mirror, when folded down, serves as a protection to the spirit level; when raised, it indicates the position of the bubble at the eye end of the telescope, so that the observer may control it without changing his position.

For details of the Dumpy Level, see the following page.

No. 20.

ENGINEERS' DUMPY LEVEL.

Long center and most approved construction of the lower parts, with slotted star. Sensitive spirit level, placed over the telescope, to lower the center of gravity. The telescope has definition, light and power in a high degree; best achromatic Jena glass lenses, erect vision and stadia hairs if desired. Is provided with a slide protector and cloth-finished. Fastened to the tripod by means of the Lietz coupling.

Packed in a neat case, containing all the usual accessories.

This is an elegant instrument, fit for the best class of surveyors' work, and is guaranteed in every detail.

Dimensions and Weight.

Length of Telescope.....	15	inches.
Diameter of Objective	1 $\frac{3}{8}$	"
Magnifying power.....	28	
Weight of instrument.....	9	lbs
" tripod	8	"
" box.....	5 $\frac{1}{2}$	"
Weight of this instrument, if made of hard aluminium.....	4 $\frac{1}{2}$	"
The price of this instrument is		\$90.00
And if made of hard aluminium, 15% are added.		

No. 20a.

Is the same as No. 23, but provided with a mirror to indicate the position of the bubble to an observer at the eye end.

Price\$100.00

If made of hard aluminium, 15% are added.

The Extras to Nos. 23 and 24, for which additional charge is made, are as follows:

Stadia Hairs, fixed.....	3	00
Horizontal Circle, reading to minutes....	25	00
Protection bag.....	1	00
Bottle of fine watch oil.....	25	

THE GERMAN LEVEL AND POCKET SURVEYING INSTRUMENT.

For many purposes where great accuracy is not required, it is often far more convenient to use some small instrument that will admit of measurements within practical limits. The irrigator, farmer, ditcher, grader, building contractor, gardener, forester, road builder, etc., often require means of obtaining heights and relative positions, for which a higher grade instrument would be unnecessarily refined.

It is for the use of such men that we have imported a leveling apparatus, patented in Germany, that combines portability with accuracy and reliability, within reasonable limits, at a minimum expenditure. Such an instrument we now offer for sale. Specimens of it are shown on **page 165**. It offers an advantage in this, that bubble, cross-hairs and image may be viewed at the same time, for the bubble is not controlled from the outside, as usual in nearly all instruments, but, as in the case of a hand level, is regulated by looking through the tube, and adjusting it to the center by raising or depressing the telescope. (This holds good for all, except No. 24 which is a small dumpy level.) The magnifying eye-lens increases the size of the bubble several times, so that it may be accurately brought to the middle of the field. The instrument is made very compact, while its manipulation is so simple that anyone will be able to use it after a short practice.

The level, when packed in a leathern case, may be easily put in the coat pocket.

The instrument consists of a terrestrial telescope, having a magnifying power of from 10 to 15; an achromatic objective; and an appropriate eye-piece, allowing an extension of the eye-tube, with room sufficient to attach the level case underneath it.

The instrument may be screwed into any support, like a heavy walking stick or a Jacob's staff, but we make for it a light tripod for convenient use. The ball and socket movement, just below the standard, admits of clamping in an upright position, so that the telescope axis may be placed approximately in a horizontal plane before finer adjustment is made

The focus is regulated by a motion of the eye-piece, and extension tube respectively. The former is pulled out far enough to make the cross-wires plainly visible; the tube is extended until the image becomes clear and distinct, and remains stationary with the cross-hairs, when the eye is moved from side to side in front of the eye-piece, insuring a freedom from all parallax.

In the tube is placed a mirror at an angle of 45 degrees, having a circular opening in the middle, behind which the cross-hairs are located. Under the mirror lies the level vial, which is adjustable by two small screws. By means of an opening in the bottom of the case, light is admitted through the vial to the glass, and when the telescope is brought into a horizontal position, the bubble is seen standing vertically in the mirror by looking through the eye-end; and through the opening in the mirror appear the cross-hairs and the image. To obtain the horizontal position of the telescope, the large screw head at the objective end and below it is turned either up or down, until

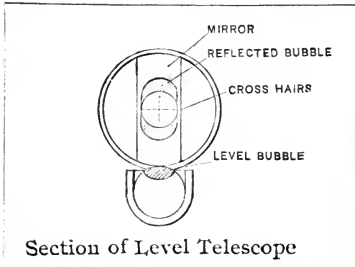

Section of Level Telescope

the reflected bubble is brought to appear *evenly above and below* the field of the cross-hairs, which is readily done by the eye (see marginal figure). At every turn of the instrument in a horizontal plane the bubble must be re-adjusted as described.

Attention is called to the fact that it is of advantage to bring the eye as closely as possible to the tube, so that the surface of the mirror may be in full view through the eye-lens. In case the instrument is used in a closed room, where the floor is dark, the bubble must be illuminated by holding under it a piece of white paper or some light object.

Combinations are made and kept in stock, wherein this level is supplied with an azimuth compass, so that directions may be obtained as well. The higher-class combinations have a graduated plate, and admit of reading the horizontal angle to one minute of arc. They are also supplied with a vertical arc and with stadia hairs set 1 : 100 so that the instrument becomes a little theodolite for manifold purposes.

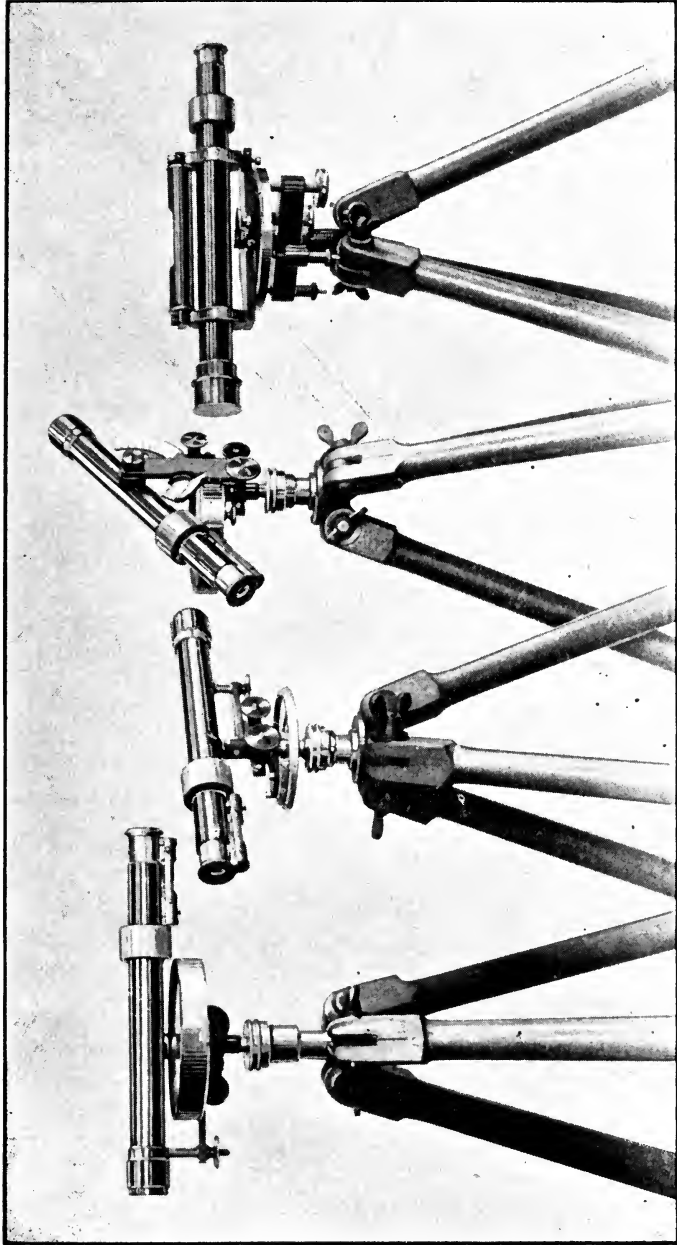

No. 21.

Price, \$25.00.

No. 22.

Price, \$30.00.

No. 23.

Price, \$35.00.

No. 24.

Price, \$40.00.

GERMAN LEVEL AND POCKET SURVEYING INSTRUMENT.†

GERMAN LEVEL, AND POCKET SURVEYING INSTRUMENT.

No. 21.

Instrument mounted on strong tripod ; ball and socket movement with clamp ; horizontal movement with clamp and tangent screw ; needle and compass, the ring graduated to degrees ; telescope adjustable to focus ; achromatic objective ; adjustable eye-piece ; the level bubble is viewed in the field like a Locke's hand level. the whole is packed in a neat wooden case.

Dimensions and Weight.

Length of telescope.....	8 inches
Diameter of objective.....	$\frac{5}{8}$ "
Length of compass needle.....	$2\frac{3}{8}$ "
Magnifying power	10
Weight of instrument.....	2 lbs.
Price of this instrument, with tripod,....	\$25 00
Stadia hairs	\$3 00 extra
Small plumb bob.....	1 00 "

No. 22.

Is like No. 21, but instead of the compass it has a 3-inch horizontal circle, with a vernier reading to minutes. The whole is packed in a fine morocco pocket case.

Price, with tripod.....	\$30 00
Stadia hairs.....	\$3 00 extra
Small plumb bob.....	1 00 "

No. 23.

Is like No. 21, and in addition possesses a 3 inch vertical arc. Packed in neat wooden case.

Price, with tripod.....	\$35 00
Stadia hairs.....	\$3 00 extra
Small plumb bob.....	1 00 "

No. 24.

This is a small dumpy level of firm and substantial construction. It has leveling screws with opposing springs, operating through a star, suspended over the center. Provided with a horizontal circle, with vernier reading to minutes. The telescope is adjustable to focus ; achromatic objective, with protection cap ; adjustable eye-piece ; the 4-inch spirit level is mounted on top of the telescope. Packed in a neat wooden case, with the usual accessories.

Dimensions and Weight.

Length of telescope	10 inches
Diameter of objective.....	$\frac{7}{8}$ "
Diameter of horizontal circle	4 "
Magnifying power.....	15 "
Weight of this instrument	3 lbs.
Price, with tripod	\$40 00
Stadia hairs	\$3 00 extra

Its cost is within the reach of all, and we know of no present better adapted to the young student, than one of these complete little field instruments, with which so much can be accomplished, and so much can be learned. Every manipulation of the theodolite is represented here, and it admits of obtaining results approaching those of the ordinary land surveyor's compass and level.

Crude instruments are placed on the market to supply the demand for a fairly reliable measuring tool at small cost; these are usually worthless, as they are made without any regard for the underlying principles that should govern the make of such an article. But with our German pocket instrument, which is protected by letters patent in the Empire, the object has been attained. It is perfectly reliable within the scope for which it was intended. Every part is carefully made and nicely finished, and its cost is less, in comparison, than the inferior article that is usually offered for sale in the market.

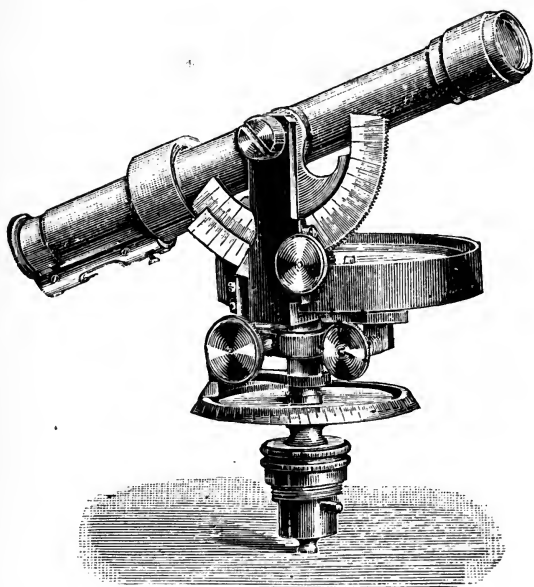

No. 25.

COMPLETE POCKET INSTRUMENT.

Telescope is now mounted on the outside of the Standard.
Price, with stadia hairs and tripod, complete, \$58.00.

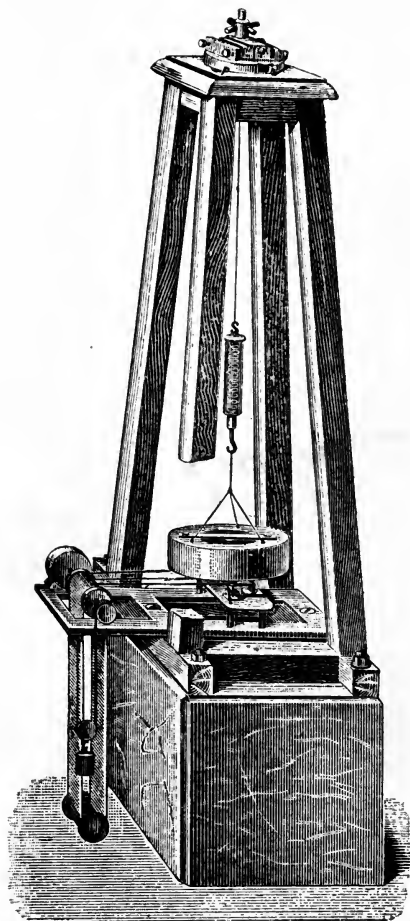

No. 26.

SEISMOGRAPH.

Registers both components of the shock motion, horizontal and vertical.

An improved and simplified instrument, suggested by E. Brassart, of the Geodynamic Institute of Rome.

Information furnished upon application. Instruments of this character are built to order.

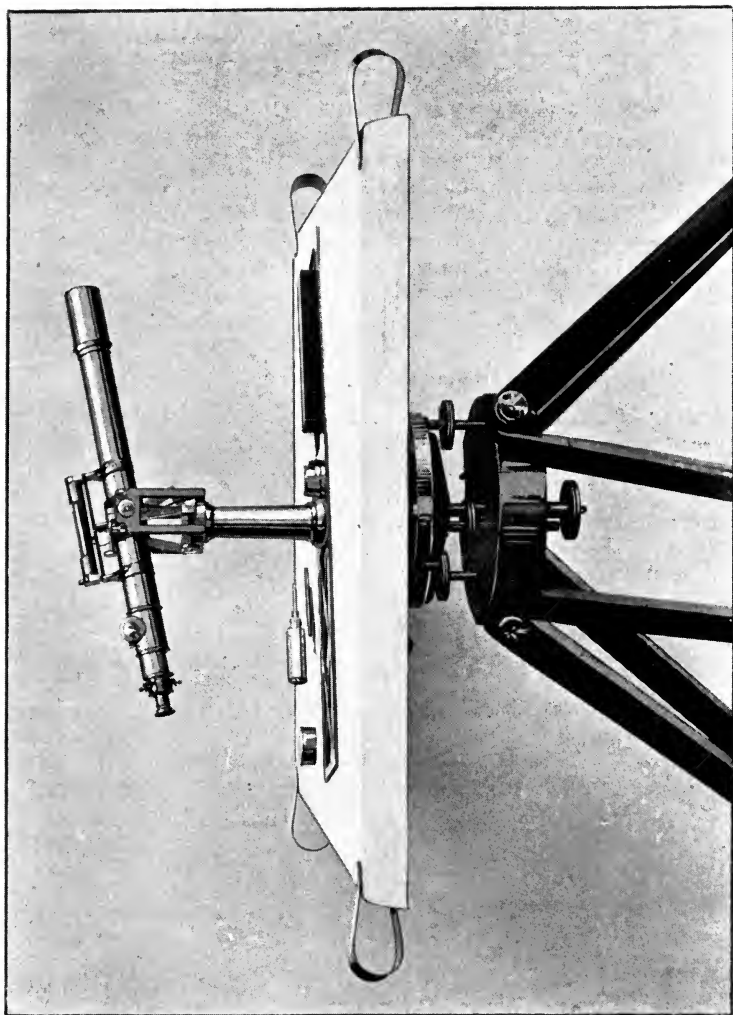

No. 27.

PLANE-TABLE.

Price, complete as shown, \$300.00.

See details, on the following page.

PLANE TABLES.

No. 27.

This is the style used in the topographical work of the U. S. Coast and Geodetic Survey, containing all the parts necessary for a proper equipment of the table, and an alidade of the most approved pattern. The table is so made that a change from temperature or humidity is impossible. Its dimensions are about 24 inches square. The telescope is achromatic, and of sufficient power for accurate stadia measurement; the stadia hairs are always supplied. It may be either erect or inverting. It is furnished with a vertical arc and an accurate striding level. The table has a plumbing bar, and the alidade a box compass and a circular level. Furnished with an elegant case.

Dimensions.

Size of table.....	24 inches square
Length of ruler.....	21 "
Length of needle in box.....	4 "
Length of telescope.....	15 "
Radius of vertical arc.....	3½ "
Magnifying power.....	32 "
The price of this instrument complete as described and shown on plate, is	\$300 00

No. 27a.

An improved table and alidade, the latter either of brass or aluminium, as used in the topographical work of the Geological Survey; the alidade having been especially designed for mountain surveys by the able officers of that department. Everything is made with a view to insure compactness. Supplied with all the necessary accessories.

Price, complete, with brass alidade	\$300 00
With aluminium alidade	330 00

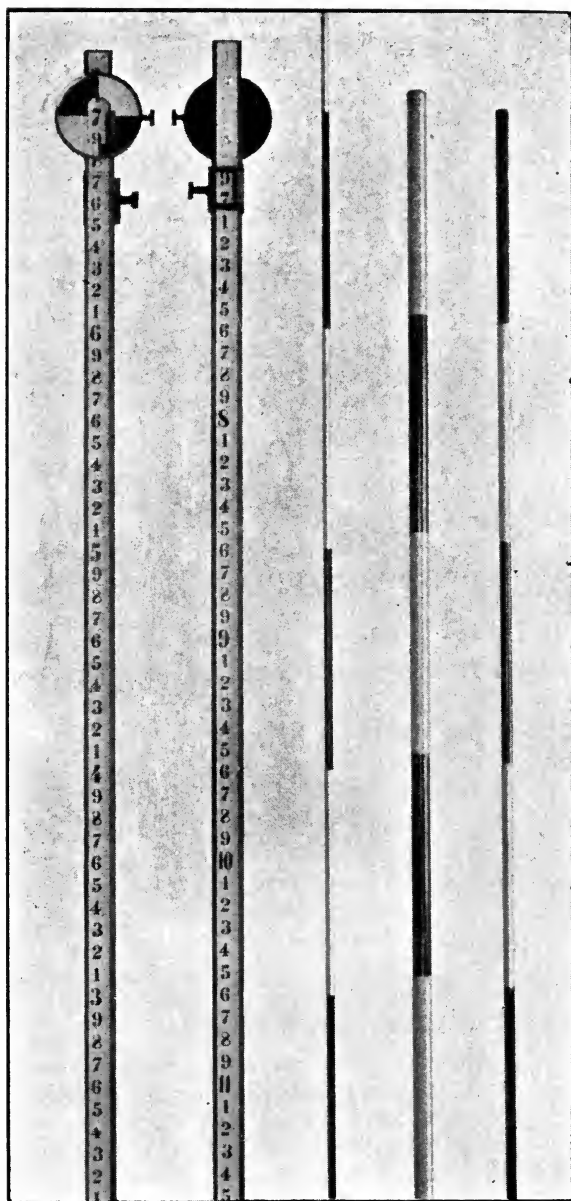

No. 28.

Nos. 29 to 31.

LEVELING ROD

RANGING POLES.

Price, \$7.00.

Price, \$2.75 to \$3.00.

See details on the following page, and marginal note on this page.

Note.—The leveling rods are our own make, graduated with a precise dividing machine, especially designed for that purpose. The lines are cut in hundredths, by uniform, clear and deep incisions, so that when the paint of the rod wears off, and the figures become dim and obliterated, the marks remain, and may be easily retraced. The black numerals corresponding to the tenths, have an exact height of 0.06 foot, and the rod, or foot numerals are 0.08 foot high. This affords a rod reading at distances where graduation lines disappear. The wood is the best cherry thoroughly seasoned. The target and all connecting metal parts are cast in one piece; the vernier made to thousandths, the scale is brass, and the face of the target is japanned. We recommend this rod as the best in the market; it is by far the cheapest, if the amount of work involved is duly considered. It is a self-reading rod, similar to the Philadelphia pattern.

THE A. LIETZ COMPANY,
MAKERS,
SAN FRANCISCO, CAL.

LEVELING RODS.

No. 28.

Philadelphia self-reading rods, with vernier, clamps and target, reading to 1000ths; from 6 to 8 feet long. Slides out to 13 feet.

Price\$16 00

No. 28a.

Mining rod, 3 feet long, sliding out to 5 feet, with vernier clamps and target, reading to 1000ths.

Price\$13.50

RANGING POLES.

No. 29.

Wooden pole, 6 and 8 feet long, with steel pointed shoe, divided in feet, red and white alternately.

Each\$2.25

No. 30.

Octagonal steel spear, 6 to 8 feet long, divided in feet, red and white alternately.

Each\$2.75

No. 31.

Of half-inch iron pipe, with pointed steel shoe, divided in feet, red and white alternately.

Each.....\$2.75

FLEXIBLE RODS.

No. 32.

FOR LEVELING AND STADIA WORK.

Painted on either heavy or light canvas, with a legible design to read to hundredths of a foot. The numerals of the tenths are black and one-tenth of a foot high; the foot numerals are red and two-tenths of a foot high. Length, 10 or 12 feet. May be rolled up in a package $2\frac{1}{2}$ to 3 inches long (the width of the canvas), and less than $1\frac{1}{2}$ inches in diameter, weighing less than 3 ounces. A very handy requisite on a long trip.

Price, 10 feet long.....\$3 00

“ 12 “ “ 3 25

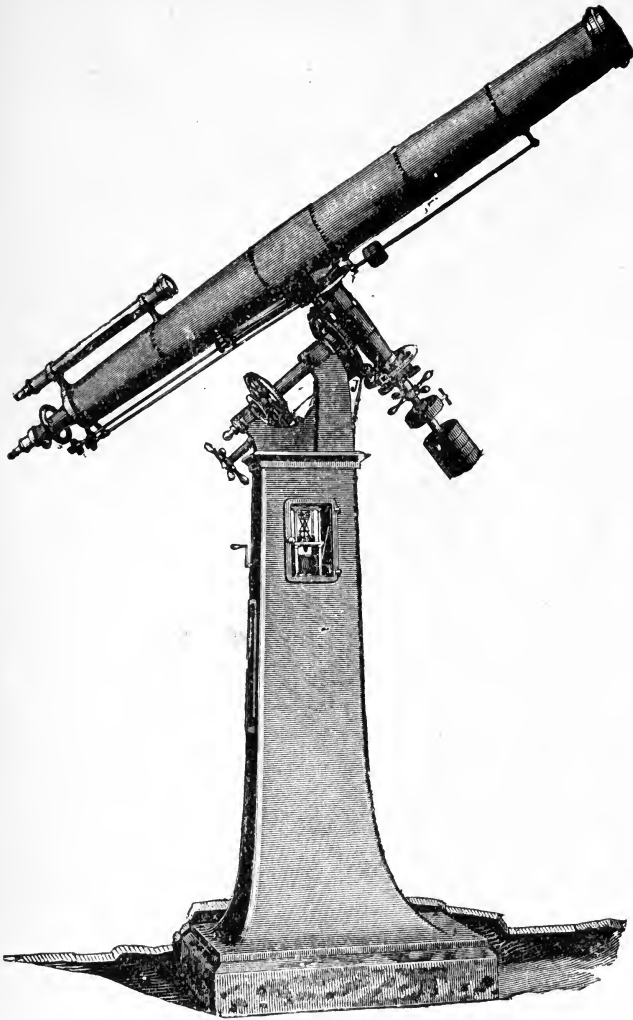

No. 33 †.

EQUATORIAL.

9-inch aperture; focal length, 11' 10".

(See the following page.)

(† See introduction to Part IV.)

EQUATORIAL REFRACTORS.

Improved mounting upon a rectangular pillar, containing the strong driving clock.

All necessary adjustments and manipulations possible from the eye-piece.

The telescope possesses a number of astronomical and micrometer eye-pieces, varying in power with the size of the instrument, from 40 to 1200.

The diameter of the aperture varies from $3\frac{1}{2}$ inches to 12 inches, and the focal length from 4 feet 5 inches to 15 feet 9 inches.

Has one or two ring micrometers, the declination circle reading to 5 seconds of arc, the hour circle to 2 seconds of time.

The finder has an aperture of from 2 to 3 inches.

The smaller sizes may be had with or without driving clock.

All the necessary accessories are supplied.

We invite correspondence on this subject, and will furnish prices upon application.

PORTABLE

MERIDIAN INSTRUMENTS.

(With rectangular prismatic telescope.)

The lower frame of these instruments is of cast iron, containing a mechanical device for rapidly reversing the axis, without removing the spirit level. Graduated circle at the eye-end of the axis. Micrometer eye-piece; adjustable central illumination of the field through the axis, the latter balanced on friction rollers. Adjustable in azimuth. Furnished with a number of eye-pieces, varying with the size of the instrument; the power ranging from 48 to 160.

The diameter of the circle may reach 10 inches, and the distance between bearings, 25 inches.

These instruments are made in different sizes, the diameter of the aperture varying from $2\frac{1}{4}$ to 3 inches, and the focal length from 25 to 38 inches.

All necessary accessories supplied.

Correspondence invited and detailed prices furnished upon application.

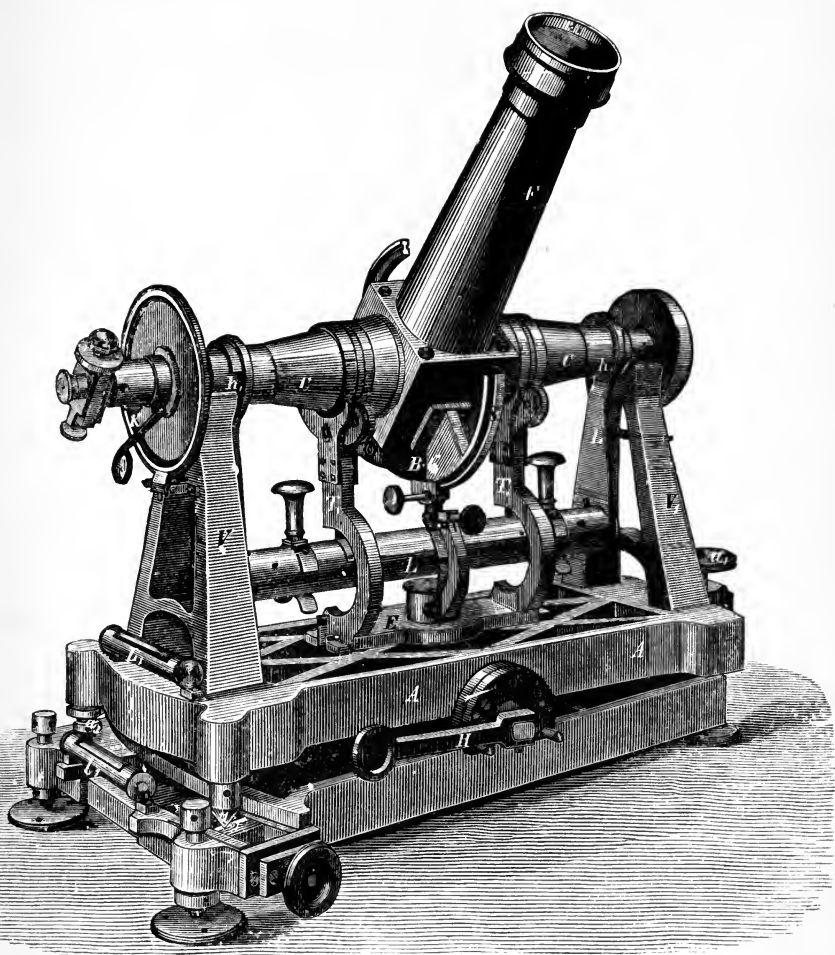

No. 34 †.

MERIDIAN INSTRUMENT.

With rectangular prismatic telescope, eye-piece at axis. $2\frac{1}{4}$ -inch aperture,
focal length, 33 inches.

(See the opposite page.)

No. 35.

ALT-AZIMUTH INSTRUMENT.

Circles 11 inches in diameter. Micrometer microscopes, reading to seconds direct; with additional reading-glasses to verniers. Telescope has an aperture of $1\frac{1}{4}$ inches, and a focal length of $20\frac{1}{2}$ inches. Power, 40 and 60.

Auxiliary telescope with eye-piece micrometer as shown. May be clamped to the iron ring of the base, upon which it slides. The eye-pieces of the telescopes are interchangeable.

All accessories furnished.

Complete in two fine packing cases.

Different sizes are made of the same style at different prices.

Correspondence is invited, and detailed information will be furnished upon application.

Note.—These alt-azimuths are elegant instruments, which are a specialty of the manufacturing firm. The general construction and the shape is that of Pistor & Martin, but a number of recent improvements have been added by the present makers, so that the instrument is an absolute standard in every particular. The graduations are made with great precision on a dividing engine one meter in diameter.

We recommend these instruments; they have a European reputation, and are not excelled by any other make.

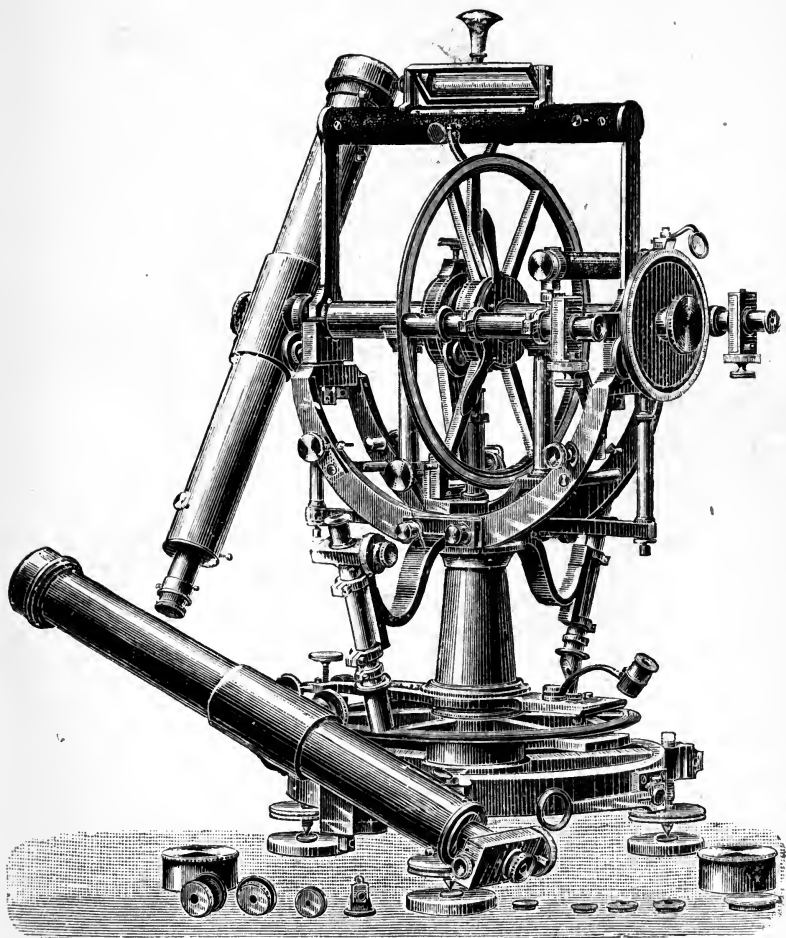

No. 35 †.

ALT-AZIMUTH INSTRUMENT,

With auxiliary telescope.

11-inch circles.

Prices furnished upon application.

(See opposite page.)

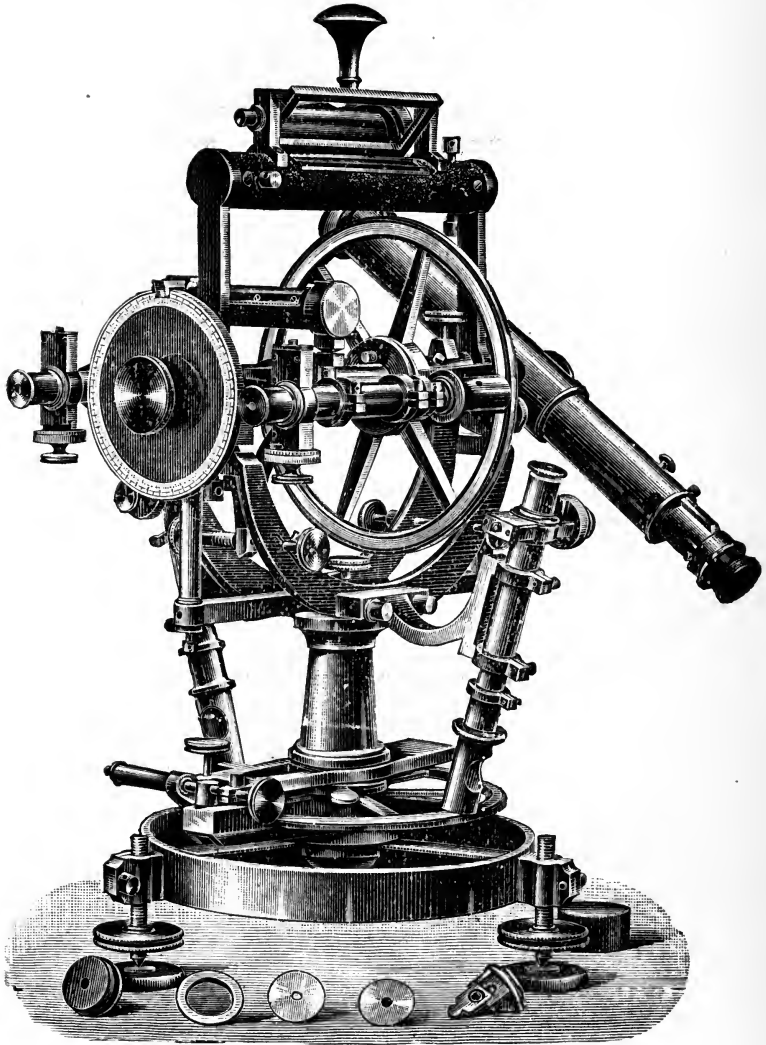

No. 36†.

ALT-AZIMUTH INSTRUMENT.

Circles 7 inches in diameter. Microscopes read directly to 5 seconds.
Telescope, 13-inch focal length and 1½-inch aperture. Power, 25 and 36.

Prices furnished upon application.

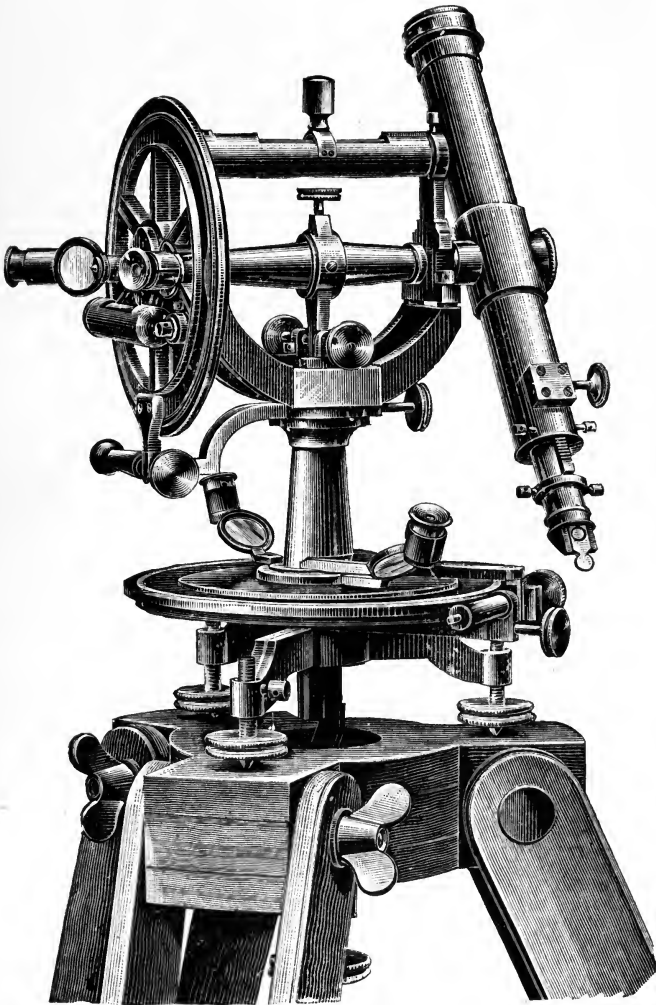

No. 37†.

ALT-AZIMUTH INSTRUMENT.

Circles, $5\frac{1}{2}$ inches diameter, verniers read to 10 seconds with reading-glasses. Telescope has a focal length of $9\frac{1}{2}$ inches and a $1\frac{1}{4}$ -inch aperture. Power, 20 and 30. Adjustable eye-piece. Striding level and level to vertical limb. Reversible axis.

Prices furnished upon application.

THEODOLITES WITH MICROMETER - MICROSCOPES.

The horizontal circle is read by two opposite microscopes directly from 1 to 5 seconds; its diameter varies from 7 to 14 inches. The vertical circle has a diameter of from $5\frac{1}{2}$ to $9\frac{3}{4}$ inches; it is read by two opposing verniers that indicate 5 or 10 seconds. This circle may be omitted. The telescope may be either in the middle or at the side; axis reversible.

The dimensions and optical powers of the telescope vary within the same limits as in the case of the preceding alt-azimuth instruments. Striding level for telescope and fixed level for horizon.

Packed in two cases.

Price varies with the size and the accessories desired.

We invite correspondence and will furnish figures upon application.

The instruments are of the highest grade.

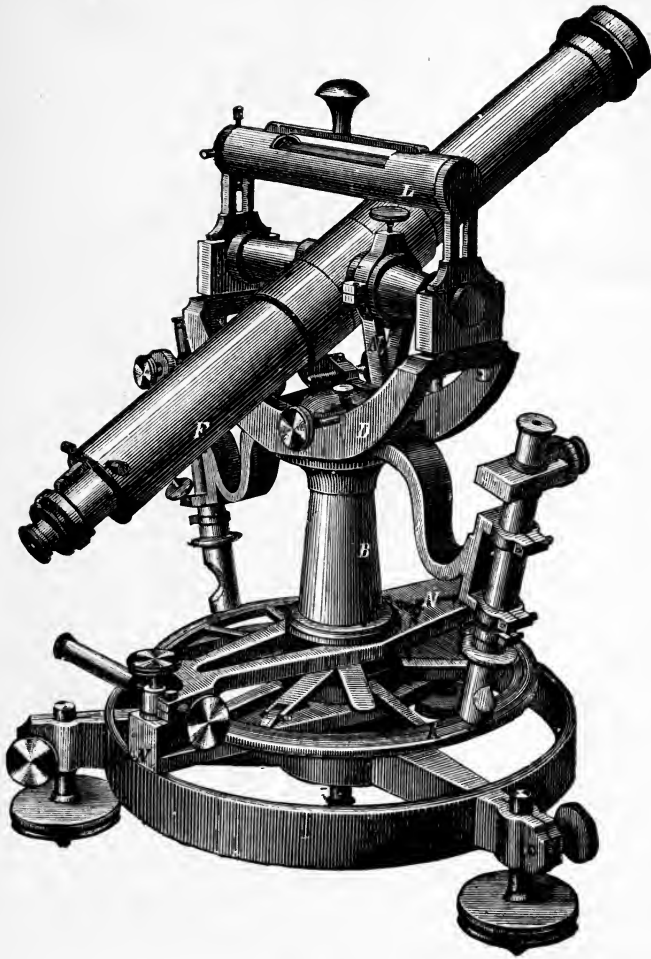

No. 38 $\frac{1}{2}$.

THEODOLITE WITH MICROMETER - MICROSCOPES.

Horizontal circle, 8 $\frac{3}{4}$ inches diameter. Both microscopes read 5 seconds direct.
Striding level to telescope,

May be had

With vertical circle, 6 $\frac{1}{2}$ inches diameter, reading to 10 seconds, by double verniers,

Prices furnished upon application.

(See the opposite page.)

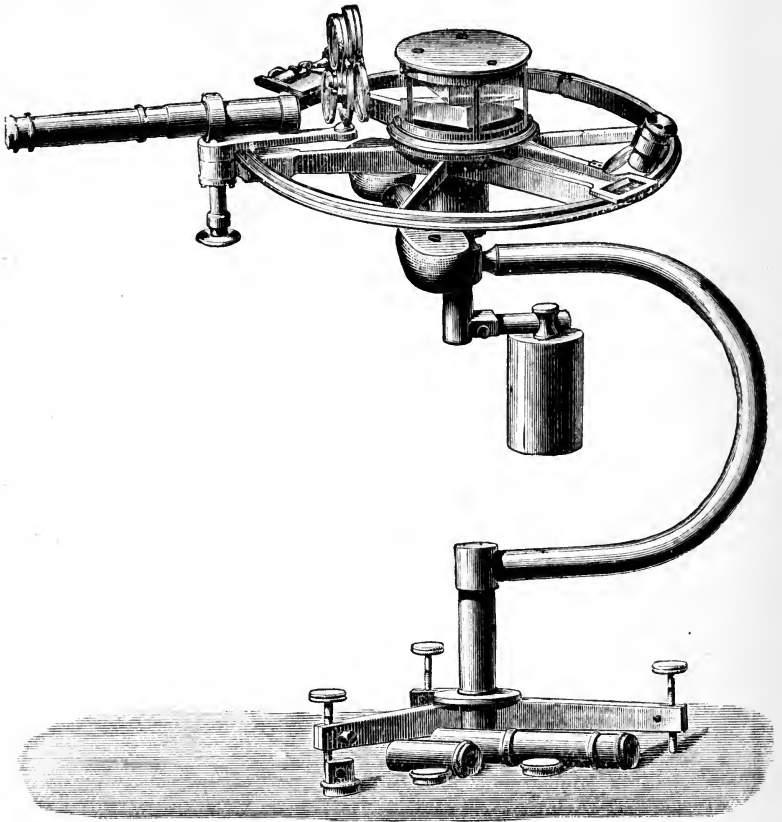

No. 39†.

REFLECTING CIRCLE,

MOUNTED ON A BRASS STAND.

Has two prisms. Circle, $10\frac{1}{4}$ inches diameter, with two verniers reading 10 seconds. Measures angles from 0 to 360° , which is made possible by the peculiar shape of the prisms. Provided with three pairs of colored shades. Telescope has an aperture of $\frac{3}{4}$ inch, with two astronomical eye-pieces; power, 6 and 10; and one terrestrial eye-piece of 3. Prismatic eye-piece, etc.

Prices furnished upon application

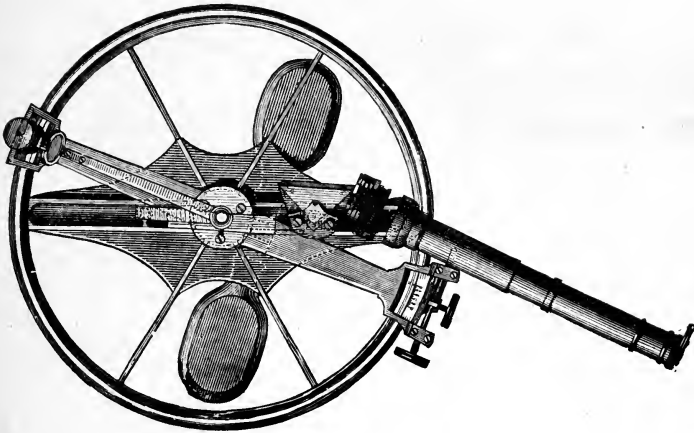

No. 40†.

REFLECTING CIRCLE,

FOR NAUTICAL PURPOSES.

Diameter, 10 inches. Complete with telescope, having two astronomical eye-pieces. Verniers reading to 10 seconds. Measures angles from 0 to 288°. Prismatic eye-piece. Three pairs of colored shades.

Complete with brass stand and lamp for night observation.

These **REFLECTING CIRCLES** and **SEXTANTS** are made in great variety as to size and style.

Correspondence is solicited and prices will be furnished upon application.

AMSLER'S PLANIMETER,

(IN GERMAN SILVER)

Arranged for Measuring Areas in either Metric or English Units.

Price, \$30.00.

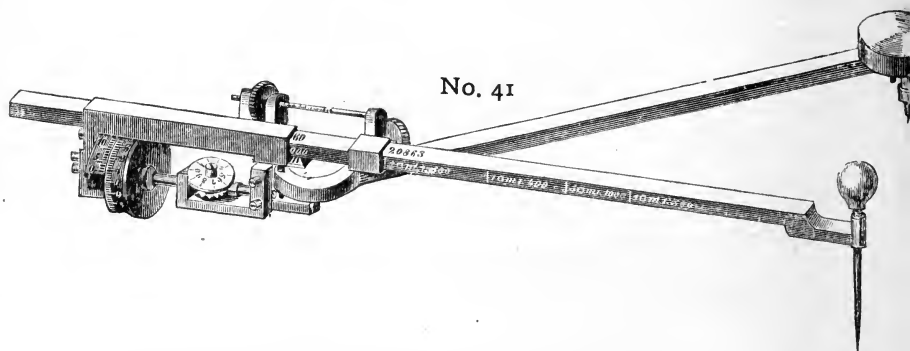

We also keep in stock another form, in which the indicator is entirely open from above, and not concealed by the bar of the tracer, as in the design shown in No. 41, at the same price.

This very useful instrument for obtaining areas is so well known to the engineer that it need not be described in particular. A theoretical discussion of the principles underlying its operation will be found in almost any handbook on higher surveying.

Instructions how to use it are published by Amsler, which are given below:

“Adjust the sliding-tube on the bar so that the index mark on the tube coincides with one of the marks on the bar. The unit of area is engraved to the right of the corresponding mark. Then proceed as follows:

“*Needle point outside the diagram.*—Put the instrument on the drawing surface with the tracing point at a mark on the curve, the area of which is to be measured, press the needle-point slightly into the paper outside the curve and read off the rolling wheel and the counting disk, taking the whole circumference of the recording roller as the unit of reading. (The roller need not be set to zero.) Then move the pointer (or tracer) around the area in the direction of the movement of the hands of a watch, and when you reach the starting point take a reading. Subtract the first from the second reading, and multiply the remainder by the coefficient of the scale.

“Example: Area required in square feet. Slide the tube on the bar so that the index of the former coincides with the mark denoted by 0.1 square ft. Suppose the dimensions of the diagram allow the needle-point to be placed *outside*. Then

Second reading (say) 8.311
First reading (say) 2.322

$$5.989 \times 0.1 = 0.5989 \text{ square feet.}$$

“*Needle point inside the diagram.*—Circumscribe the diagram with the pointer in the direction of the movement of the hands of a watch, observing at the same time the counting disc, in order to see whether the total rotation is a forward or a backward motion.

“This preliminary rough operation completed, proceed as before explained, now following the curve *carefully* with the pointer. If the total rotation of the roller has been a *forward* motion, subtract the first reading from the second, and add the difference to the figure engraved on the top of the bar just over the mark.

Thus, in a similar example:

Second reading..... 5.423

First reading..... 3.004

2.419

Figure on top of bar 20.741

$$23.160 \times 0.1 = 2.316 \text{ square feet.}$$

The figures on the top of the bar are slightly different for different instruments.

“If the total rotation of the roller is a *back* motion, subtract the second reading from the first reading, and *subtract* the difference from the figure on the bar.

“Note: When the mark 0 on the roller is at the mark 0 of the vernier, a mark of the counting disc should be opposite the fixed index mark. Any slight non-coincidence due to play between roller and disc may readily be allowed for in taking readings.”

The engineer finds this instrument most useful in determining the areas of profiles drawn upon cross-section paper, and it is there nearly always the case that the needle-point is placed outside of the diagram.

These profiles are generally drawn on an exaggerated scale, the vertical scale being considerably larger than the horizontal one.

The best means of obtaining the area of such a profile is to draw a rectangular figure on the same scale, or scales, of a known area; to circumscribe that area with the planimeter set arbitrarily, but well fastened so that the bar cannot slip, and to read the disc, roller and vernier. The starting point may have been 0 or not; in the latter case we note the difference.

The figure may be circumscribed several times and the mean taken, should we desire greater accuracy. Knowing the area of this rectangular figure, it is an easy matter to compare it with the reading of the planimeter, and to find a coefficient by which every planimeter determination of the area of any profile drawn on the same scale, or scales, of the test figure must be multiplied to give the true result in square units represented by the scale. This is so apparent that it need not be demonstrated. It is by far the safest method, as it will recognize not only scale-exaggeration, but any inaccuracies in the divisions of the cross-section paper. If we want to be very precise, we may determine a coefficient for every sheet of the cross-section paper used.

The instrument we keep in stock is Amsler's Planimeter, No. 4 (German Silver), price \$30; but we will, upon order, procure for our customers any one of the highest grade planimeters, or Integrators for measuring areas, moments and moments of inertia. We invite correspondence on this subject.

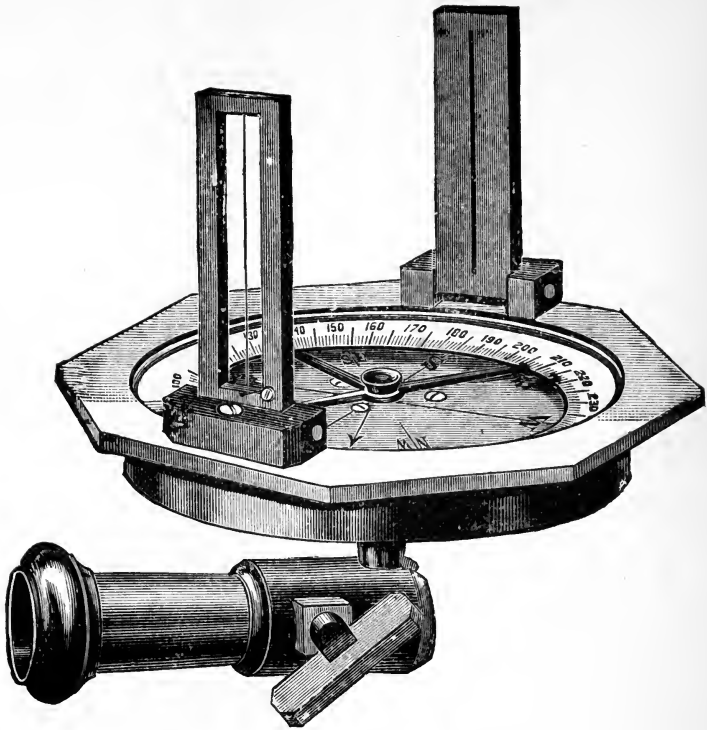

SURVEYOR'S COMPASS.

- No. 42. The instrument has a 5½-inch needle, 14-inch plate, open sights, in box with strap \$45 00
 No. 43. The same with variation plate..... 50 00

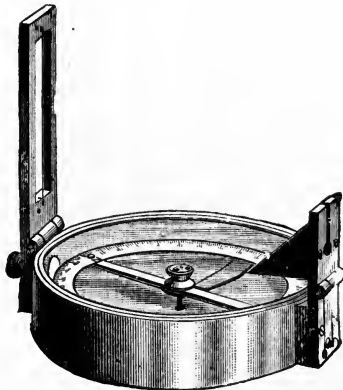

No. 44.

- No. 44. Prismatic Compass, 3 inches diameter, with divided ring on needle and folding sights; packed in neat case, very convenient for reconnaissance \$15 00
 These Compasses range between \$15 00 and \$48 00.

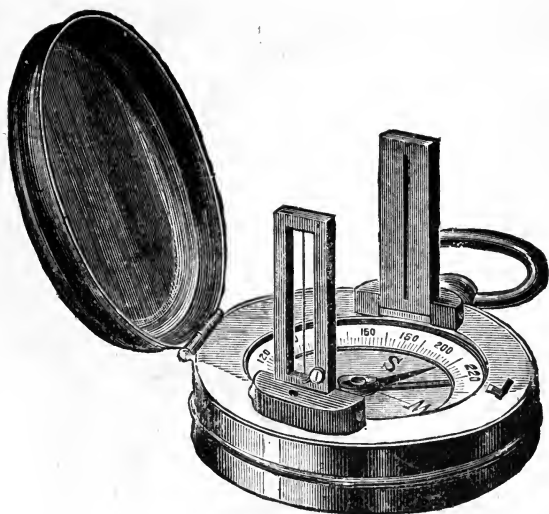

- No. 44a. Pocket Compasses, with folding sights, varying in price from.. \$6 00 to \$25 00
- No. 44b. Small Pocket Compasses, with or without sights, ranging in price from..... 1 00 to 8 00
- No. 45. Miner's Compass, or Dipping Needle. An instrument for determining the location of iron by means of a magnetic needle. Price....\$14 00
- No. 46. Prospector's Pocket Balance, for making a field analysis of minerals. Price\$12 00

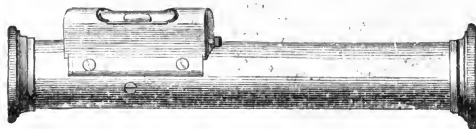

No. 47.

- No. 47 Locke's Hand Level, with prism \$8 00
- No. 48 Locke's Hand Level, with plated mirror..... 5 00
- No. 49 Abney's Reflecting Level or Pocket Altimeter, improved, with divided arc to show gradients, in morocco case, each..... 15 00
- No. 50 Abney's Reflecting Level or Pocket Altimeter, with bar needle, compass and socket for jacob staff..... 18 00
- Nos. 51 to 52 German Telescopic Hand Levels and Altimeters, from \$10 00 to 20 00

ROD LEVEL.

- No. 53 Level, for plumbing a rod or a sight-pole, made to fit the edge of a rod or pole.....\$3 50

A. Lietz

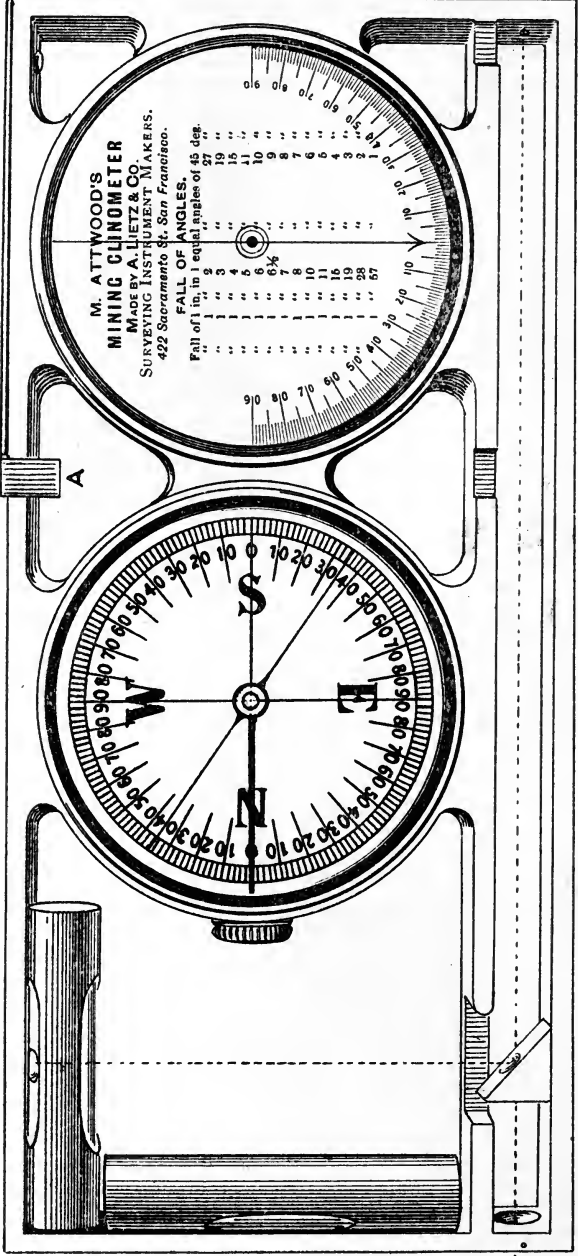

A. LIETZ CO

This is a new Universal Pocket Instrument with M. Attwood's Mining Clinometer. It is not only the most useful Clinometer and Compass for Mining Work, but the combination admits to make an entire Reconnaissance Survey within the degree of accuracy to be expected from a Pocket Instrument. It is made of our special Aluminum Alloy and weighs, inclusive of leather case, 8 ounces. Price complete with case, \$15.00

ILLUMINATING LAMPS.

No. 56.	Lamp for illuminating graduations, cross-wires, etc., for use in underground work, common	\$ 4 00
No. 57.	Lamp of brass, with ground lens.	7 00
No. 58.	Small Plummet Lamp of brass, steel point.....	8 00
No. 59.	Large " " " "	10 00
59a.	Plumb Bobs of the most improved shape and of any desired size and weight, from.....	\$1 00 to \$5 00

SURVEYOR'S CHAINS.

No. 60.	Iron Chain, brass handles, No. 8 wire, 33 feet.....	\$ 2 60
" 61.	" " " " 50 "	3 25
" 62.	" " " " 66 "	4 00
" 63.	" " " " 100 "	5 25
" 64.	Steel Chains, " No. 10 " 33 "	3 50
" 65.	" " " " 50 "	4 25
" 66.	" " " " 66 "	6 50
" 67.	" " " " 100 "	8 00
" 68.	Steel Chains, brazed links and ring, No. 12 wire, 33 feet.....	5 50
" 69.	" " " " " 50 "	6 00
" 70.	" " " " " 66 "	10 00
" 71.	" " " " " 100 "	11 50

CHAIN PINS AND MARKERS.

No. 72.	Steel Arrows, 11 in a set.....	\$1 50
No. 73.	Marking Tool, timber scribe for surveyor's use.....	1 25

Eddy's Improved Standard Steel Tapes.

IN LEATHER COVERED CASES, FLUSH HANDLE.

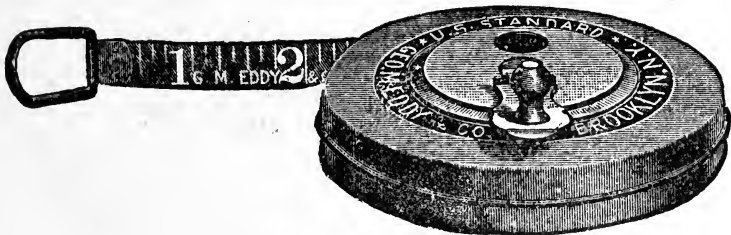

Metal-lined with flush handles, graduated in 10ths or 12ths of a foot or metric measure.

Manufacturer's Number.....	210	211	212	213	214
Feet.....	33	50	66	75	100
Price, each.....	\$4.15	6.00	7.50	9.00	11.25

$\frac{3}{8}$ INCH WIDE IN RED LEATHER COVERED CASES.

Manufacturer's Number.....	300	301	302	303	304	305	306
Feet.....	25	33	40	50	66	75	100
Price, each.....	\$3.75	4.15	5.25	6.00	7.50	9.00	11.25

$\frac{1}{2}$ INCH WIDE IN RED LEATHER COVERED CASES.

Manufacturer's Number.....	400	401	402	403	404	405	406
Feet.....	25	33	40	50	66	75	100
Price, each.....	\$4.15	4.50	5.65	6.75	8.25	9.75	12.00

Metallic Warp Tapes.

These tapes are made of the best linen tape, with wire threads to prevent stretching, and by our process of making are always soft and pliable. The ends are reinforced with leather to prevent wearing, and all the cases have our new improved flush handle. Graduated in 10ths, with links on opposite side.



METALLIC TAPE, $\frac{5}{8}$ INCH WIDE.

Manufacturer's Number.....	137	138	139	140	141	142	143
Feet.....	25	33	40	50	66	75	100
Price, each.....	\$1.40	1.60	1.80	2.00	2.40	2.80	3.20

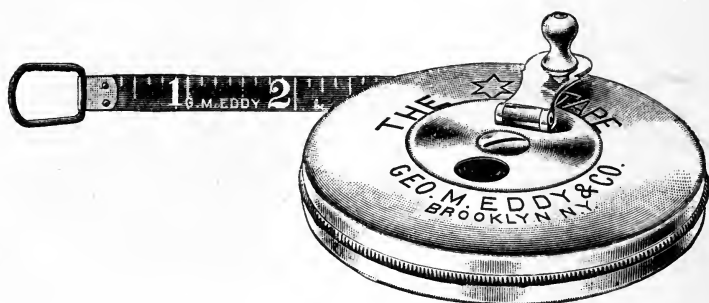

We herewith present to the profession a new **steel tape** which is intended to fill a long-felt want. A cheap but accurate and reliable **steel tape**. The line is made of the best steel, marked and finished in the best style and mounted in a brass case, handsomely nickel-plated. It is light and durable, and easily carried in the pocket, and having an improved new handle, winds freely.

Send for a 4-inch sample piece of the tape.

When ordering, state if divisions in 10th or 12th are desired.

Star Steel Tapes— $\frac{3}{8}$ in. wide.

Our Number, 107.—	Manufacturer's Number, 500.	50 feet.....	each \$3 40
“ “ 108.—	“ “ 501.	66 feet.....	each 4 15
“ “ 109.—	“ “ 502.	75 feet.....	each 4 50
“ “ 110.—	“ “ 503.	100 feet.....	each 6 00

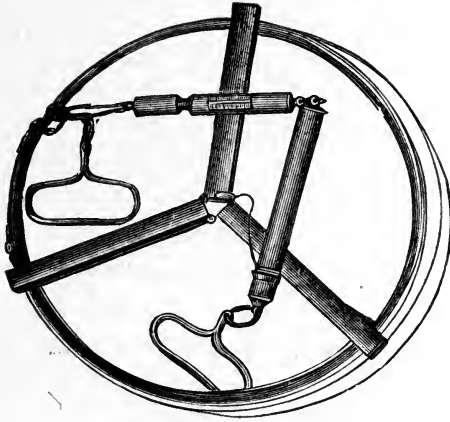

No. 111.

STEEL STANDARD TAPES.

Made of heavy steel, 3-16 inch wide, with brass graduations ; only used for rough work.

For each 100 feet of tape.....	\$1 00
For each graduation.....	15
Pair of clamping handles.....	3 00
Wooden reel.....	3 00

SEXTANTS.

No. 112. **Sextant of gun metal**, light, but very strong, 7-inch radius, 120 degrees, graduated on silver to 10 minutes, vernier reading to 10 seconds, 2 astronomical telescopes magnifying 6 and 10 times, 1 terrestrial telescope, object glass, 1½ in., seven neutral glasses and two reflecting mirrors. Instrument complete in polished mahogany box, each \$120 00
 Cheaper grades of Sextants and Octants, in metal or wood, kept in stock.
 We keep supplies for sextants always on hand.

No. 113. **Pocket or Box Sextant.** A small instrument, encased in a brass box; has a telescope sight and colored glasses attached, so that it may be used for both field and nautical observations \$42 50

113 a. **Angle Mirrors or Prisms.** Small pocket instruments for laying off right angles. Useful in field work. Price varies from \$5 00 to \$10 00

ARTIFICIAL HORIZONS.

No. 114. **Mercurial Horizon**, iron trough, iron bottle with screw stopper and funnel cap, glazed metal roof. All in polished mahogany box \$27 50
 No. 115. **Reflecting Horizon**, black glass plane mounted in brass, with three leveling screws and spirit level, in polished mahogany case, each. 16 00

HELIOTROPES.

No. 116. **Gauss' Heliotrope** \$150 00
 No. 117. The telescope body is an iron tube, in the middle is a wood screw with joint for attaching the instrument to a tree or post. Price in box, 30 00
 No. 118. Heliotrope as made by us for the United States Coast and Geodetic Survey, with wooden base, mirrors 4x4 35 00
 No. 119. Same as before, but with mirror 6x6 41 50
 No. 120. Same, with mirror 8x8 48 50
 Prices for larger sizes on application.
 No. 121. **Pocket Heliotrope**, Steinheil's, a beautiful instrument that requires no adjustment. In case 25 00

Extras to Heliotrope, Nos. 118 to 120 inclusive.

121 a. Tangent screws for vertical and horizontal movement 7 50
 121 b. Outlifting arrangement for tangent screws 5 00

No. 121 c.

ANEROID AND ALTITUDE BAROMETERS.

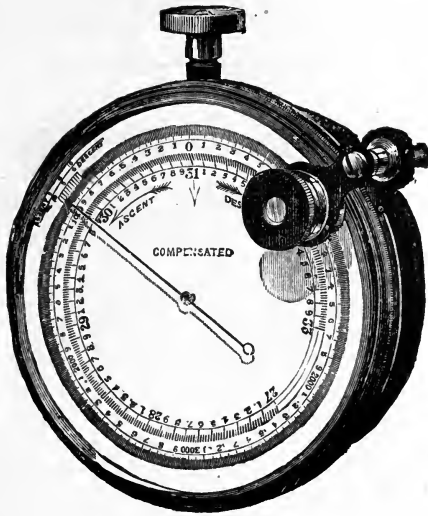

Prices from \$12 to \$60, according to size and altitude scale.

Aneroid barometers are made expressly for us by the best makers, in German silver or nickel plated cases, truly compensated for temperature, with or without thermometers, ranging from 5,000 feet to 20,000 feet, size, 1½, 2½ and 5 inches. Guaranteed correct, every one being subjected to a severe test before being sold.

121 d. MERCURIAL STANDARD MOUNTAIN AND SEA BAROMETERS.

Prices from \$20.00 to \$100.00.

Supplies for these barometers, as tubes, mercury packings, etc., we have constantly on hand.

No. 121 e.

Goldschmid Aneroid, as made by Hottinger of Zurich, complete in leathern case, with thermometer and tables showing rating, graduated to read to millimeters (see description of this instrument in Part III of this **Manual**). Prices range from\$50 00 up

No. 121 f.

ACHROMATIC FIELD AND MARINE GLASSES AND TELESCOPES.

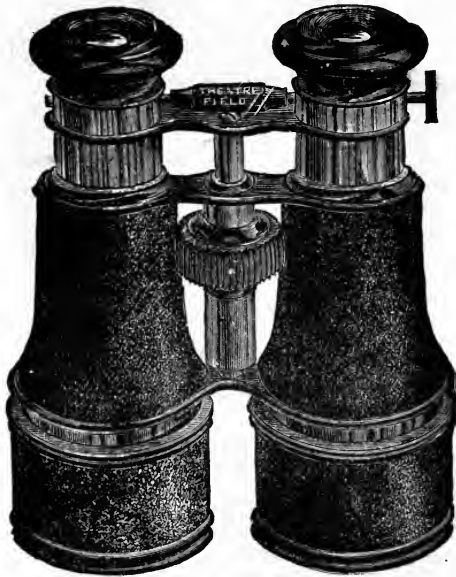

Prices vary according to size and quality, and range from \$8.50 to \$25.00

No. 121 g. BINOCULAR TELESCOPES.

These telescopes are similar in construction to the ordinary field glasses, but possess a much higher magnifying power; for this reason they are very extensively used, especially where a large field in connection with a high power is desirable.

Prices from \$25.00 to \$52.00.

ODOMETERS.

No. 122. Odometer for measuring distances by wagon. It is enclosed in a brass box, $4\frac{1}{2}$ inches diameter, furnished with leathern case and double straps to fasten to the center of the wheel. It is the most correct instrument for practical use. Price.....\$17 00

PEDOMETERS.

Nos. 123 to 125.

Pedometers are pocket instruments for measuring the distance traversed in walking, the number of miles being registered by a mechanism inclosed in a nickel-plated watchcase, and operated by the motion of the body.

- No. 123. Pedometer, watch pattern, nickel case, 1 $\frac{3}{4}$ -inch, registering 12 miles by $\frac{1}{4}$ mile. Price \$4 50
No. 124. The same; registering 50 miles by 80 yards 5 25
No. 125. The same; registering single steps up to 100,000 \$6 50
Nos. 126 and 127.

Level constructed for the use of Millwrights, Machinists and Carpenters. The iron frame is 28 inches long; has two adjustable levels 6 and 3 inches long.

- No. 126. With common levels \$15 00
No. 127. Same, with ground levels 20 00

127a. **Anemometers** or Wind Gauges, improved pattern. Prices from \$17 00 to \$35 00.

No. 128. SACCHARIMETER.

An instrument for estimating the percentage of sugar in fluids.

With tube for liquids, 8 inches long, made to slide in a brass tube, that carries a polarizer and double quartz plate at one end, and at the other an analyzer with divided circle. The circle is graduated to thirty minutes and may be estimated to six minutes with accuracy.

Observation is made by adjusting the so-called transition color on both halves of the quartz plate, the tube being directed by hand towards a white surface. Suitable for fluids containing a small percentage of sugar. Complete with directions.

Price \$40 00

No. 129. **POCKET SPECTROSCOPE** (Browning's pattern), for observing the effect of absorption in larger objects, with adjustable slit and Amici prism of high dispersion.

- 129a. Without comparison prism \$20 00
129b. With " " 30 00

129 c. MICROSCOPES.

We keep in stock microscopes for professional purposes.
Special designs made to order.

129 d. EQUATORIAL MOUNTINGS.

Portable equatorial mountings are made to order for the amateur, for schools and colleges, from \$35 00 to \$150 00.

129 e. POCKET MAGNIFIERS.

Reading glasses especially adapted for observing the vernier and needle of transits, single or double glasses, in hard rubber or celluloid cases, from 50 cents to \$2 00.

DRAWING INSTRUMENTS AND SUPPLIES.

Different grades and styles are constantly kept in stock, in sets as well as in single pieces. We furnish our patrons with any desired make and will send prices upon application.

Single instruments always on hand, consisting of dividers, plain and with the accessories of pin point, extension leg, pencil point, pen, etc.; proportional dividers; bow pens and pencils; steppers; beam compasses; drawing pens; dotting pens; road and railway pens; curve pens; folding and rolling parallel rulers, etc., etc.

Drawing paper of any desired quality is supplied, as well as cross-section paper, profile paper, tracing cloth, tracing paper, drawing pencils, rubber, colors and color dishes, brushes, thumb tacks, note books for field and office. We can always furnish our customers with office supplies of any kind at the shortest notice.

Drawing boards or trestles, or any combination made to order.

PROTRACTORS.

No. 129 g.

Three-armed protractor or station pointer, as used in plotting hydrography by the U. S. Coast and Geodetic Survey, graduated to read to minutes, with verniers and reading glass, extension arms and center plugs, complete in fine case, securely packed \$80 00

Cheaper grades upon application.

These articles will be made to order to suit any particular line of work.

No. 129 h.

Circular and semi-circular German silver protractors, graduated as required, with or without verniers, from 60c. to \$20 00

No. 129 i.

Paper, horn, ivory and boxwood protractors, from 15c. to \$15 00

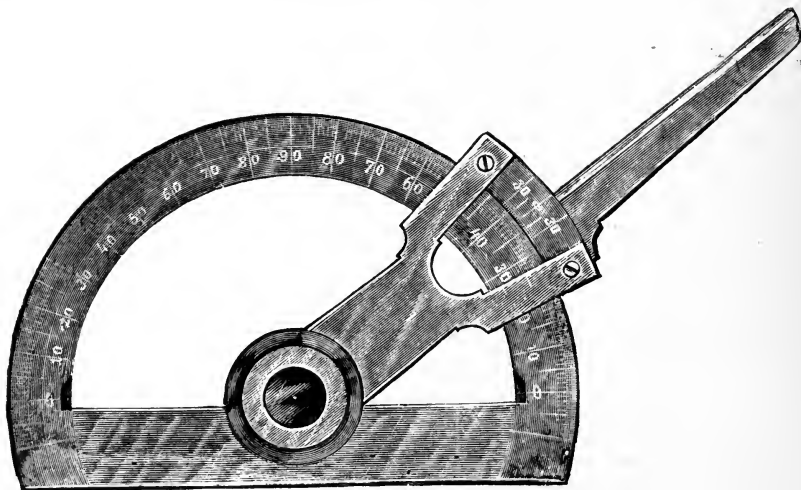

No. 129 j.

GERMAN SILVER PROTRACTOR.

5½-inch diameter, arm 11 inches long from center, divided to 30 minutes, figures as desired \$10 00

SCALES.

No. 130.	Flat Boxwood Scale, 6-inch, div. 10×50 parts to the inch, each	\$0 50
“ 131.	“ “ “ 6 “ “ 20×40 “ “ “ “	50
“ 132.	“ “ “ 6 “ “ 30×60 “ “ “ “	50
“ 133.	“ “ “ 6 “ “ 80×100 “ “ “ “	75
“ 134.	“ “ “ 12 “ “ 10×50 “ “ “ “	75
“ 135.	“ “ “ 12 “ “ 20×40 “ “ “ “	75
“ 136.	“ “ “ 12 “ “ 30×60 “ “ “ “	75
“ 137.	“ “ “ 12 “ “ 80×100 “ “ “ “	1 20
“ 138.	Flat Celluloid-edged Scale, 6-inch, div. 10×50 parts to the inch, each		75
“ 139.	“ “ “ 6 “ “ 20×40 “ “ “ “		75
“ 140.	“ “ “ 6 “ “ 30×60 “ “ “ “		75
“ 141.	“ “ “ 6 “ “ 80×100 “ “ “ “		1 00
“ 142.	“ “ “ 12 “ “ 10×50 “ “ “ “		1 25
“ 143.	“ “ “ 12 “ “ 20×40 “ “ “ “		1 25
“ 144.	“ “ “ 12 “ “ 30×60 “ “ “ “		1 25
“ 145.	“ “ “ 12 “ “ 80×100 “ “ “ “		1 75

Foot divided decimally.

No. 146.	Flat Celluloid-edged Scale, 12-inch, div. 100×500 parts to the foot, ea.,	\$1 25
“ 147.	“ “ “ 12 “ “ 200×400 “ “ “ “	1 25
“ 148.	“ “ “ 12 “ “ 300×600 “ “ “ “	1 25
“ 149.	“ “ “ 12 “ “ 800×1000 “ “ “ “	1 75

Triangular Boxwood Scales, Engineer's, div. 10, 20, 30, 40, 50, 60 parts to the inch.

No. 150.	6-inch, each	1 00
“ 151.	12 “ “	1 75

Triangular Celluloid-edged Scales, Engineer's.

No. 152.	6 inches long, divided like Nos. 150 and 151, each	\$1 50
“ 153.	12 “ “ “ 150 and 151, “	2 50

Divided for Architects at same prices.

 Any particular scale, for any purpose whatever, upon any material, engraved to order.

TRANSPARENT AMBER TRIANGLES.

30×60°—Inches.	4	5	6	7	8	9	10	11	12	14	16
No. 154. Each, \$0.25	.35	.40	.45	.55	.65	.75	.85	1.00	1.65	2 50	
45°.—Inches,	4	5	6	7	8	9	10	12	14	16	
No. 155. Each, \$0.35	.45	.55	.65	.75	.95	1.10		1.65	2 20	3.15	
Amber Lettering Angles, per set (3)											\$1.50

MAHOGANY STRAIGHT-EDGES.

TRANSPARENT AMBER EDGES.

Inches,	18	24	30	36	42	48
No. 156. Each, \$0.75	1 00	1.25	1.50	1.80	2 20	

Triangles and Curves of rubber and wood kept in stock and supplied.

SLIDE RULES.

No. 157.	Dennert & Pape's logarithmic slide scale, (Mannheim Rule) 10 inches long, celluloid covered, graduated as described in the discussion of the use of this scale in Part III of this <i>Manual</i> .	\$4.50
----------	--	--------

McCULLOUGH TAPE LEVEL.

No. 158.

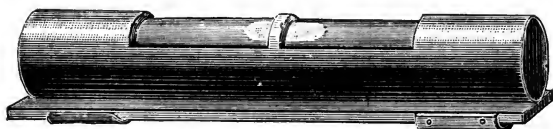

(Pat. July 26, 1892.)

Insures accuracy in measurements with steel tapes. Above cut full size. Weight one ounce. It is used by clamping to the tape, about one foot from the handle, by means of the two springs shown, and can be attached and detached instantly.

Price, \$1.00

No. 159. THERMOMETERS.

A full supply of thermometers, plain, maximum and minimum, and hygrometers kept in stock.

NAUTICAL INSTRUMENTS.

This catalogue does not contain our supply of nautical instruments, of which we keep in stock a number of the usual articles required by the navigator, particularly in the line of ship's compasses and logs. In the near future a price list of these goods will be published by the Company, but for the present a mere reference to this branch of our work shall only be made here.

See our Special Catalogue for Nautical Goods.

200



INDEX.

	No. or Page.
Address an instrument to the Company, how to	59
Adjusting Room, the.....	4
Adjustments, charges for	58
" collimators for.....	4
" of the dumpy level	70
" of the plane-table alidade	77
" of the transit	60
" of the Y-level.....	66
Agate fittings for Y-level.....	44, 160
Agate setting for needle	23
Air pump for testing aneroids	6
Airy eye-piece, the.....	33
Alidade, adjustment of the.....	77
" the plane-table.....	47
" of aluminium.....	49
Alt-Azimuth instrument	178, 179
Altimeter, Abneys	187
Aluminium alloys.....	48
" adaptability of.....	4, 47, 52, 101
" alidade	49
" instruments, stability of	48
" levels	49
" solar attachments.....	49
" transits.....	49
Anemometers	197
Aneroid, the Goldschmid	104, 195
Angle mirrors.....	194
Artificial horizons	194
Axes of transit telescopes	25
Balsam used in lenses.....	37
Barograph (self-registering aneroid).....	106
Barometers, Aneroid.....	195
" Goldschmid Aneroid	104
Bell metal, use of.....	42, 49
Bending of plates and centers.....	54
Bessel's spheroid, elements of	107
Careless handling of instruments	52
Care of instruments	52
Case, the instrument.....	38, 44, 102
Centering apparatus, the.....	4
" the field of view.....	65
Center pin for needle, adjusting.....	23, 55
Centers, bending of.....	54
" length of.....	19
" of dumpy level.....	45
" of Y-level	40
" or vertical axis, the.....	18
" single, cyclotomic	121-126, 153-156

Chain Pins.....	139
Chains, Surveyors'.....	189
Chromatic aberration, test for.....	73
Circle, horizontal.....	20
" vertical.....	25
" " adjustment of.....	65
Clamp screws.....	22, 102
Clarke's Spheroid, elements of.....	107
Clinometers.....	188
Cloth-finish, dumpy level.....	45
" Y-level.....	43
" telescope standards.....	25
Clothing, influence on needle.....	55
Collars of the Y-level.....	42
" the inequality of.....	42, 69
Collar test, the.....	69
Collimation, line of.....	62
Collimators, the mural.....	4
Compass, graduation of the.....	23
" needle.....	22, 101
" pocket.....	187
" prismatic.....	186
" repairs to.....	58
" Surveyors'.....	186
Conical bearings of telescope axis.....	25
Construction of instruments.....	101
Correspondence regarding repairs.....	57
Cost of repairs.....	58
Cross-hairs, adjustment of.....	62, 68, 71
" frame for.....	34
" glass diaphragm for.....	35
" how to replace.....	56
Crown glass in lenses.....	31
Cyclotomic transit.....	121-126, 153-156
Definition of telescopes.....	42, 72
Dividing engine, large circular.....	4
" " linear.....	6
Directors of the A. Lietz Company.....	VI
Drawing instruments.....	198
Dumpy level, the.....	44
" " adjustment of.....	70
" " centers of.....	45
" " cloth-finished.....	45
" " of aluminium.....	49
" " price of.....	161, 162
Dust caps.....	18
Eccentricity.....	19
" graphical determination of.....	103
Electric currents, influence of, on needle.....	VIII

Emery, danger of using	54
Equatorial	173
Equatorial mountings	197
Establishment, description of the A. Lietz	2
Eye-piece, the	32
" care of	56
" the Airy	33
" the erect	33
" the Huyghens	33
" the inverting	33
" the Kellner	32
" the negative	33
" the positive	33
" the Ramsden	32
" the Steinheil	32
" the terrestrial	33
Field glasses	196
Finish of instruments, the	38, 43, 102
Flatness of field, test for	73
Flint glass in lenses	31
Focal length, apparatus for determining the	75
Focal length of objectives	32
Foundry the	2
Fretting of working parts	53
Glass diaphragms for cross-lines	35
Goldschmid Aneroid, the	104
Gradiometer, observing horizontal distances by the	26
Gradiometer, the	25
Graduation, accuracy of lines	99
" of compass	23
" on solid silver	20
" plate, the	19
" room, the	4
" tester, the	4
Heliotropes	194
How to tell a good surveying instrument	99
Huyghens eye-piece, the	33
Illumination of cross-hairs	34
Imports	6
Incorporation of the A. Lietz Company	VII
"Irrigation Age," extract from	8
Jena Glass Works	27
Kellner eye-piece, the	32
Lamps, illuminating	189
Latitude coefficients, table of	118
" length of one minute of	109
Lenses, balsaming of	37
" centering of	32, 37, 56, 68

Lenses cleaning of.....	56
“ imported	6
“ staining of.....	56
“ transit telescope.....	27
Level, Dumpy (see D)	44
“ German Pocket	45, 163-167
“ Hand	187
“ instrument.....	40
“ McCullough tape.....	200
“ Millwright's, Carpenter's and Machinist's.....	197
“ Reflecting (Abneys).....	187
“ Reversion	slip 134 A
“ Rod	187
“ screws	17
“ sensitiveness of bubble.....	26, 40, 58
“ tester.....	6, 27
Y-Level, the.....	40
“ adjustments.....	66
“ agate fittings.....	44
“ aluminium	49
“ center of ..	40
“ cloth-finish of.....	43
“ collars of.....	42
“ curvature of tube.....	40
“ magnifying power of.....	41
“ packing in case	44
“ precision	44
“ price of.....	159, 160
“ repairs to.....	58
Lifting arrangement of needle.....	23
Longitude, how to find the length of one minute of.....	107
Lubrication of certain parts.....	54
Magnetic attraction in clothing.....	55
Magnetic needle.....	22, 101
Magnetic variation, to set off the.....	24, Slip VIII A
Magnifiers, Pocket.....	197
Magnifying power of telescopes.....	36, 41
“ “ to find the.....	74
Marking tools.....	189
Mechanical devices made.....	6
Meridian instruments.....	175
Metal tester, the.....	6
Microscopes	197
Mining transit, with inclined standards.....	157
Models made, mechanical.....	6
Nautical Department, the.....	6
“ Mile, length of.....	109
Needle, the magnetic.....	22, 101
“ center-cap of.....	23

Needle center-pin of.....	23
“ lifting arrangement of.....	23
“ to restore magnetism of.....	55
“ to preserve sensitiveness of.....	54
Nonius, the.....	20
Object glass, the.....	31
Objectives, focal length of.....	32
Odometers.....	196
Optical axis, coincidence of.....	32, 37, 56, 68
Orthoscopic eye-piece.....	32
Packing transit in case.....	38
“ level in case.....	44
Parallax, adjustment of.....	60, 69
Parallelism of collars in Y-level.....	67
“ “ telescope in Y-level.....	66
Pedometers.....	197
Plane-table, the.....	47
“ adjustment of alidade.....	77
“ price of.....	169, 170
Planimeters.....	184, 185
Plates, bending of.....	54
“ horizontal.....	19
“ levels for.....	60
Plumb-bobs.....	189
Plumbing arrangement.....	18
Poles, Sight.....	171, 172
Prices of Dumpty level.....	161, 162
“ German level.....	165, 166, 167
“ Y-level.....	159, 160
“ Plane-table.....	169, 170
“ Theodolite.....	139, 140
“ Transit, complete.....	135-138
“ “ compound mining and solar.....	147-152
“ “ cyclotomic.....	153-156
“ “ mining.....	143
“ “ mountain and mining.....	141, 142
“ “ plain.....	131, 132
“ “ with telescope level.....	133, 134
“ “ compasses.....	145, 146
Protection from rain.....	53
“ “ sun.....	53
Protractors.....	198
Ramsden eye-piece, the.....	32
Reconnaissance transit, cyclotomic.....	154, 156
Reflecting circles.....	182, 183
Refraction correction table.....	119, 120
Refraction table, mean.....	114
Remarks on instruments.....	46, 99
Repairs.....	57
“ cost of.....	58
“ what to send.....	58

Reversion level.....	slip 134 A
Right-angles, arrangement for laying off.....	38
Rods, level.....	171, 172
" sight.....	171, 172
" Stadia (flexible).....	172
Rules, Slide.....	199
Saccharimeter	197
Saegmüller Solar Attachment.....	38, 49, 110
Scales.....	199
Screws, overstraining.....	53
Seismograph.....	168
Sextants.....	194
Shake in the slide.....	34
" " tripod.....	54
Shifting center.....	18, 102
Shipping an instrument.....	11, 59
Shoes, tripod ..	39
Silver, graduation on solid.....	20
Simplified transit compasses	145, 146
Size of transits.....	38
" levels.....	158-167
Slide, the	34, 53
" protector, the.....	34, 43
" rules	199
" scale, the logarithmic.....	91
Solar attachment.....	38
Solar attachment of aluminium.....	49
Solar attachment, Saegmüller.....	38, 49, 110
Spectroscopes.....	197
Spherical aberration, test for.....	72
Spheroid, elements of the terrestrial.....	107
Spider web, the	34
Spirit levels (vials).....	6, 26
" " importance of sensitive.....	26
Stability of instruments.....	17, 101
" " aluminium instruments.....	48, 101
Stadia hairs, fixed.....	35, 44, 45
" " adjustable.....	35
Stadia reduction tables.....	86
" surveying, treatise on	80
Standards, the.....	24, 102
" unequal expansion in.....	25
Star-shaped casting for leveling screws.....	17, 102
Station pointer.....	198
Steel center in Y-level.....	40, 49
Steinheil eye-piece, the.....	32
Straight edges.....	199
Sunshade, the	34, 43
Surveying instrument, how to tell a good.....	99

Tables, mean refraction	114
“ of latitude coefficients	118
“ refraction correction	119, 120
“ stadia reduction	87
Tangent screws	22, 102
Tape lines (steel and metallic)	190-192
“ ribbons	193
Telescope, accurate balance of	36
“ bearings, adjustment of	61
“ cleaning of	55
“ definition of	72
“ finding the magnifying power of a	74
“ general remarks on	36, 99
“ level	41
“ “ adjustment of	64, 68
“ magnifying power of	36
“ reversibility of transit	36
“ test of	72
“ transit	27
“ “ adjustment of	61
Testimonials (on first leaves of Manual).	
Theodolite, description of	14
“ highest grade	47
“ “ with micrometers	181
“ price of	139, 140
“ size of	140
Three-leveling-screw arrangement	18
Thermometers	200
Transit, adjustments of the	60-66
“ aluminium	49
“ centers of	18
“ cyclotomic	121-126, 153-156
“ description of	14
“ mining, with inclined standards	157
“ packing in case	38
“ price of	134-158
“ reconnaissance (cyclotomic)	154, 156
“ repairs to	58
“ simplified (compasses)	145-148
“ single center, cyclotomic	121-126, 153-156
“ sizes of	134-158
Triangles	199
Tripod connection	15, 102
“ coupling, the new Lietz	15, 16
“ shake in	54
“ split leg	39
Variation, setting off the magnetic	24
“ plate	23
Vernier, the	20
“ position of	21, 101

Vernier, protected by glass.....	21
" shades	21
" theory of the.....	21
Vertical arc.....	25
" " adjustment of the.....	65
Werner, Peter.....	21
Workshop, description of the.....	2
Y-level (see level).....	40
Zero of vertical arc.....	65

LIST OF ILLUSTRATIONS.

PART I.

	Page
Plate 1. Interior View of Workshop.....	IX
“ 2. Interior of Graduating and Adjusting Room.....	3
“ 3. Circular Dividing Engine.....	5
“ 4. Centering Apparatus for Testing Graduations.....	7
“ 4. Linear Dividing Engine.....	7
“ 5. Level Tester.....	9
“ 5. Apparatus for Testing Magnetic Influence.....	9
“ 6. Mural Collimator Apparatus.....	11

PART II.

The Lietz Tripod Coupling.....	16
Apparatus for Measuring the Focal Length.....	76

PART III.

Figure 1. Diagram of Optical Features in Telescope.....	81
“ 2. Diagram showing Stadia Reductions.....	83
Figures 1-5. Logarithmic Scales.....	98
“ A, B and C. Magnified Graduation Lines.....	99
Graphical Determination of Eccentricity.....	103
“ 1, 2 and 3. Goldschmid Aneroid Barometer.....	105
Saegmüller Solar Attachment.....	112
Spherical Triangle.....	113
Figure 1. Section of Cyclotomic Transit.....	122
Figures 2 and 3. Views of Plate of Cyclotomic Transit.....	123

PART IV.

Plain Transit.....	131
Transit, with Telescope Level.....	133
Complete Engineer's Transit.....	135
Complete Engineer's Transit.....	137
Complete Transit-Theodolite.....	139
Complete Mountain and Mining Transit.....	141
Simplified Transits (Compasses).....	145
Compound Mining and Solar Instrument.....	147
Compound Mining and Solar Transit.....	149
Compound Mining and Solar Transit.....	151
Cyclotomic Transit.....	153
Mining Transit, with Inclined Standards.....	157
Y-Level.....	159

	Page
Dumpy Levels.....	161
Section of German Level Telescope.....	164
German Levels.....	165
Complete Pocket Surveying Instrument.....	167
Seismograph.....	168
Plane-table.....	169
Leveling Rods and Range Poles.....	171
Equatorial.....	173
Meridian Instrument.....	175
Alt-Azimuth Instruments.....	177-176
Theodolite with Micronometers.....	181
Reflecting Circles.....	182, 183
Amsler's Planimeter.....	184
Surveyor's Compasses.....	186, 187
Lock's Hand Level.....	187
Atwood's Clinometer.....	188
Steel Tape Lines.....	190-193
Altitude Barometer.....	195
Field Glasses.....	196
Protractor.....	198
McCullough Tape Level.....	200

Lietz. Manual of modern surveying instruments.

1676

YC 14756

RETURN CIRCULATION DEPARTMENT
TO → 202 Main Library

LOAN PERIOD 1	2	3
HOME USE		
4	5	6

ALL BOOKS MAY BE RECALLED AFTER 7 DAYS

1-month loans may be renewed by calling 642-3405
6-month loans may be recharged by bringing books to Circulation Desk
Renewals and recharges may be made 4 days prior to due date

DUE AS STAMPED BELOW

FEB 8 1980	
REC. FEB 4 1980	
SENT ON ILL	
MAR 09 2004	
U. C. BERKELEY	



