



This is a digital copy of a book that was preserved for generations on library shelves before it was carefully scanned by Google as part of a project to make the world's books discoverable online.

It has survived long enough for the copyright to expire and the book to enter the public domain. A public domain book is one that was never subject to copyright or whose legal copyright term has expired. Whether a book is in the public domain may vary country to country. Public domain books are our gateways to the past, representing a wealth of history, culture and knowledge that's often difficult to discover.

Marks, notations and other marginalia present in the original volume will appear in this file - a reminder of this book's long journey from the publisher to a library and finally to you.

Usage guidelines

Google is proud to partner with libraries to digitize public domain materials and make them widely accessible. Public domain books belong to the public and we are merely their custodians. Nevertheless, this work is expensive, so in order to keep providing this resource, we have taken steps to prevent abuse by commercial parties, including placing technical restrictions on automated querying.

We also ask that you:

- + *Make non-commercial use of the files* We designed Google Book Search for use by individuals, and we request that you use these files for personal, non-commercial purposes.
- + *Refrain from automated querying* Do not send automated queries of any sort to Google's system: If you are conducting research on machine translation, optical character recognition or other areas where access to a large amount of text is helpful, please contact us. We encourage the use of public domain materials for these purposes and may be able to help.
- + *Maintain attribution* The Google "watermark" you see on each file is essential for informing people about this project and helping them find additional materials through Google Book Search. Please do not remove it.
- + *Keep it legal* Whatever your use, remember that you are responsible for ensuring that what you are doing is legal. Do not assume that just because we believe a book is in the public domain for users in the United States, that the work is also in the public domain for users in other countries. Whether a book is still in copyright varies from country to country, and we can't offer guidance on whether any specific use of any specific book is allowed. Please do not assume that a book's appearance in Google Book Search means it can be used in any manner anywhere in the world. Copyright infringement liability can be quite severe.

About Google Book Search

Google's mission is to organize the world's information and to make it universally accessible and useful. Google Book Search helps readers discover the world's books while helping authors and publishers reach new audiences. You can search through the full text of this book on the web at <http://books.google.com/>

A TREATISE OF ELECTRO-CHEMISTRY
EDITED BY HENRY RAMSAY HUNT, F.R.C.

The Manufacture of Chemicals by Electrolysis

BY
ARTHUR J. HALE, B.Sc., F.I.C.

UC-NRLF



QB 32 013



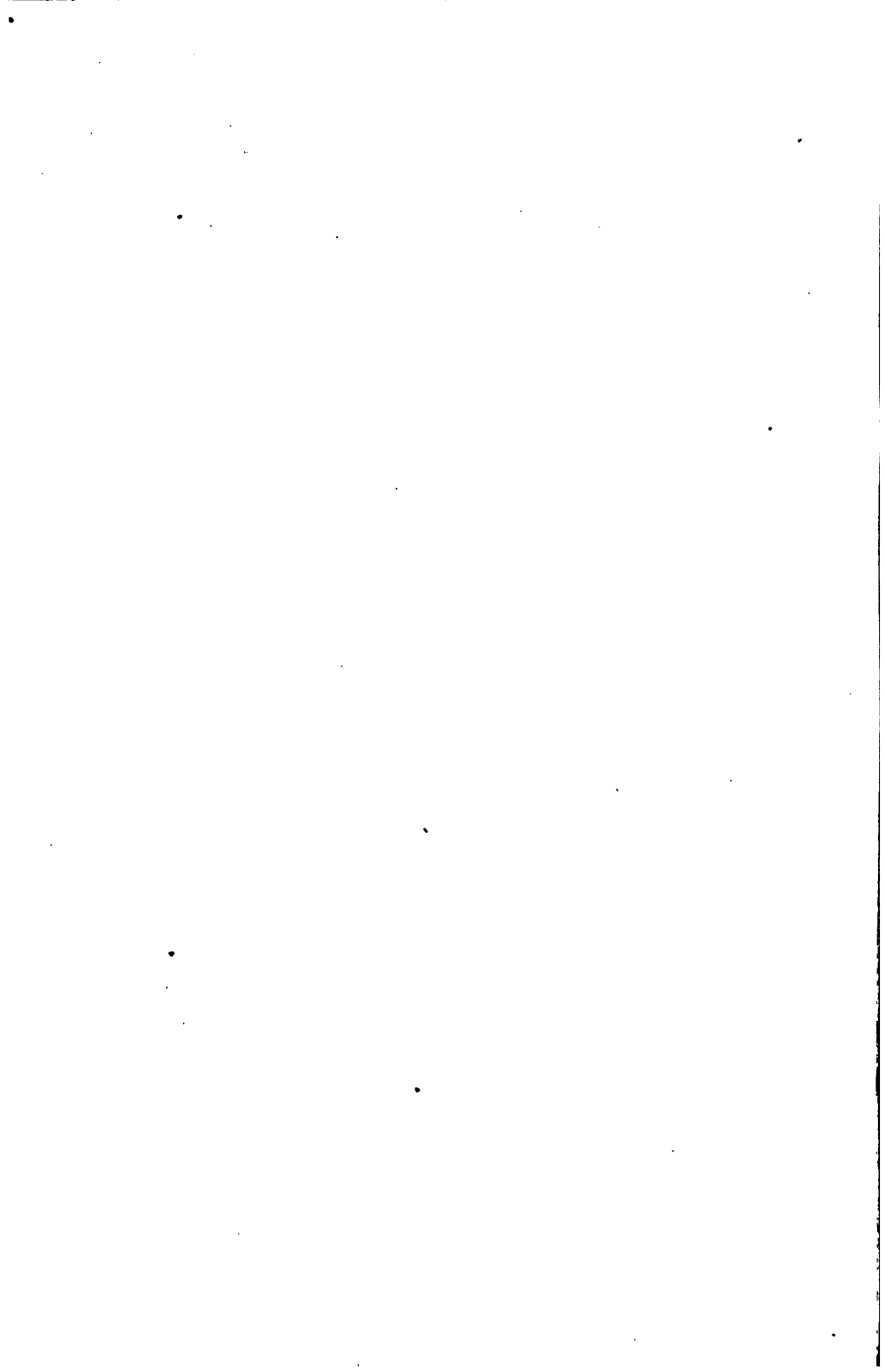

A TREATISE OF ELECTRO-CHEMISTRY.

EDITED by BERTRAM BLOUNT, F.I.C., ETC.

THE MANUFACTURE OF CHEMICALS
BY ELECTROLYSIS

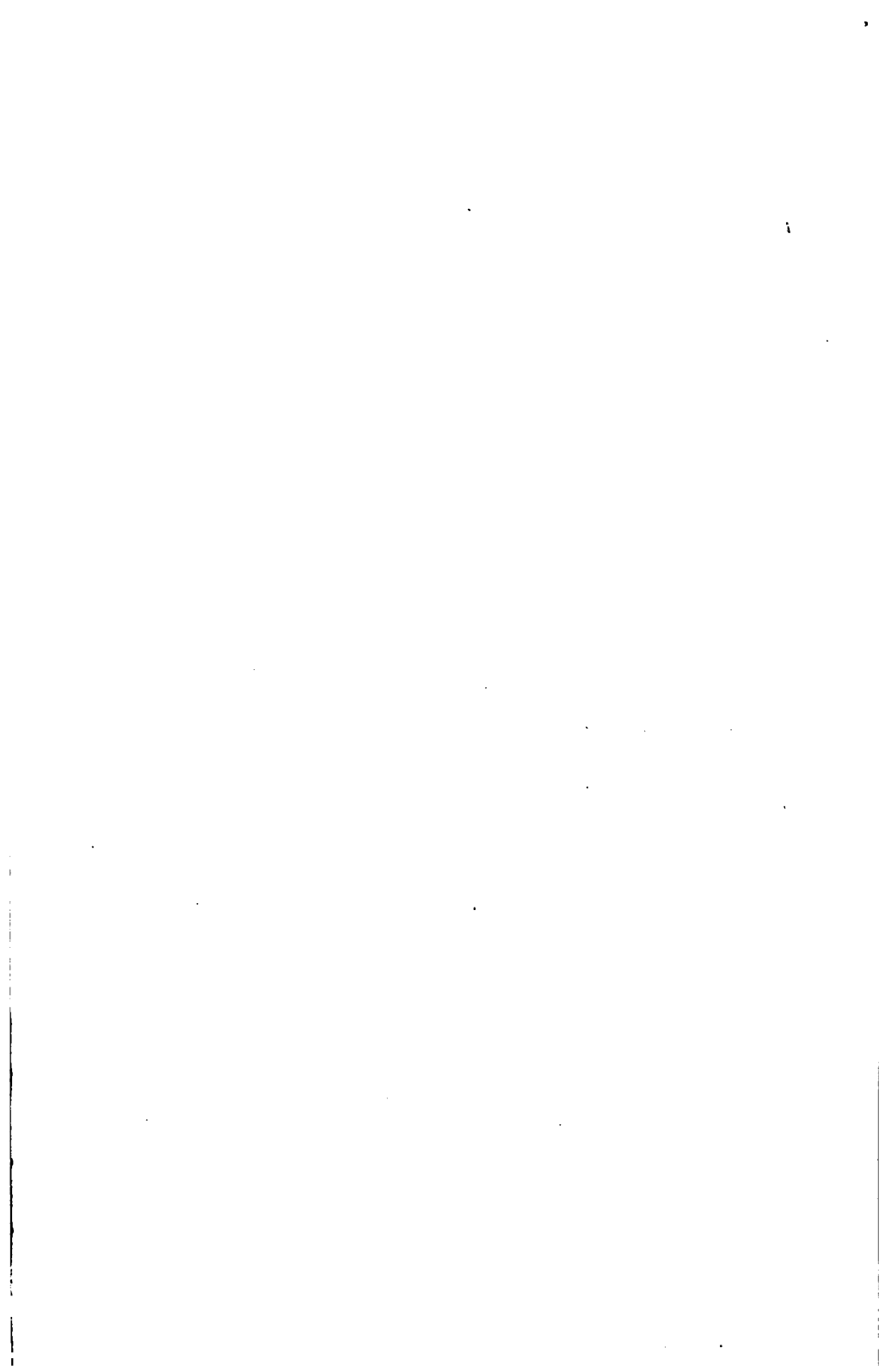

A TREATISE OF ELECTRO-CHEMISTRY.

EDITED by BERTRAM BLOUNT, F.I.C., ETC.

THE
MANUFACTURE OF CHEMICALS
BY ELECTROLYSIS

BY

ARTHUR J. HALE, B.Sc., F.I.C.

CHIEF ASSISTANT IN THE CHEMICAL DEPARTMENT, CITY AND GUILDS TECHNICAL
COLLEGE, FINSBURY

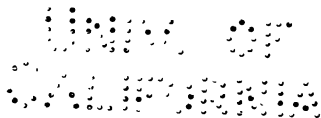

NEW YORK
D. VAN NOSTRAND CO.
TWENTY-FIVE PARK PLACE

1919

1 1 1

TP255
H3

TO VINI
ASSOCIADO

EDITOR'S PREFACE.

THE idea of a series of books on Electro-Chemistry emanated not from me, but from Messrs. Constable. Some years back I wrote for them a book called "Practical Electro-Chemistry," intended to cover a great part of the ground of knowledge then extant. Fortunately, knowledge has a habit of growing and of propagating its kind, and my book, in consequence of this, became a "back number".

The subject of Electro-Chemistry is so ramified and specialized that it was impossible for one man to make a survey of the whole field. This fact is the genesis of the present series in which those who have accurate and intimate knowledge of the various branches of electro-chemistry have undertaken the work for which they are particularly qualified. It will be readily understood that, as the series of books was started at an early period of the war, many contributors were engaged in work of national and primary importance, and were unable, however willing, to apply themselves at the moment to exacting literary work. But this difficulty was gradually overcome, as some prospect of a period to the struggle came within view,

with the result which the reader will judge with consideration for the onerous conditions under which my contributors have wrought.

The monographs resulting from their labours speak for themselves, and if the educational advantages which I have obtained from reading them during their passage through the press is shared by the public, I believe that the thorough and modern work of my friends and collaborators will be appreciated, and such faults as there be will be attributed to the person ultimately responsible—the Editor.

PREFACE.

THE manufacture of chemicals by electrolysis is now sufficiently important to justify the appearance of a monograph dealing with the subject. The author has given a complete and up-to-date account of processes now in use, and it is hoped that the matter has been so presented as to indicate, to some extent, future developments.

There are many signs that industrial chemists realise the importance of electrolysis in the manufacture of organic chemicals, and the author has endeavoured to portray clearly the present position of this branch of the subject.

A. J. H.

LONDON,

January, 1919.



CONTENTS.

CHAPTER I.

ELECTROLYTIC HYDROGEN AND OXYGEN. OZONE.

	PAGE
General principles. PLANT AND APPARATUS FOR THE ELECTROLYSIS OF WATER: Apparatus of D'Arsonval—Apparatus of Latchinoff—Apparatus of Renard. MODERN PLANT: Schmidt process—Schoop's plant—Process of Garuti—Schuckert process—Hasard-Flamand process—Cell of International Oxygen Company. Modern filter-press cells. Electrolytic production of ozone	1

CHAPTER II.

PRODUCTION OF PER-SALTS AND HYDROGEN PEROXIDE.

Persulphates and persulphuric acid. Hydrogen peroxide. Percarbonates. Perborates. Potassium permanganate. Potassium ferricyanide. Electrolytic sulphuric acid. Sodium selenate	17
--	----

CHAPTER III.

NITRIC ACID. HYDROXYLAMINE. HYDROSULPHITES. FLUORINE.

Nodon's process for nitric acid. REDUCTION OF NITRIC ACID: Hydroxylamine—Nitrites. Sodium hydrosulphite. Electrolytic production of fluorine	30
--	----

CHAPTER IV.

ELECTROLYTIC PREPARATION OF PIGMENTS AND INSOLUBLE SUBSTANCES.

PRECIPITATION OF METALLIC OXIDES: Work of Lorenz—Luokow's improvement—Lead chromate—Lead sulphate—Lead peroxide—White lead—Zinc white. Separation of rare earth oxides. Pyrophoric alloys. Tungsten bronzes	40
---	----

CHAPTER V.

ELECTRO-OSMOTIC AND ELECTRO-COLLOIDAL
PROCESSES.

	PAGE
General. Dehydration. Separation of constituents of glue. Tanning of skins. Purification of silicic acid. Alumina. Electrolytic lixivation. Principles of electro-osmosis	49

CHAPTER VI.

ELECTROLYTIC REDUCTION OF ORGANIC COMPOUNDS.

Introductory. REDUCTION OF NITRO-COMPOUNDS: Aminophenols—Chloranilines—Amines—Benzidine—Azoxybenzene—Azobenzene—Hydrazobenzene—Importance of electrode potential—Catalytic action of cathode—Overvoltage—Reduction in aqueous-alkaline emulsions—Production of aminophenols. Hydrazines. REDUCTION OF THE CARBONYL GROUP: Secondary alcohols—Pinacones—Deoxycaffeine. Hydrogenation of quinolines. Indigo white. <i>p</i> -Rosaniline	53
---	----

CHAPTER VII.

OXIDATION AND SUBSTITUTION OF ORGANIC
COMPOUNDS.

OXIDATION PRODUCTS: Oxidation of aromatic side chains—Quinone—Basic dyes—Purpurogallin—Anthraquinone—Vanillin—Saccharin. Oxidation of alcohols. ELECTROLYTIC SUBSTITUTION: Iodoform — Bromoform — Chloroform — Chloral — Diazo-compounds — Azo-dyes — Substituted phenols. CONDENSATION BY ELECTROLYSIS: Esters of dicarboxylic acids. Effect of superimposing alternating current on direct current	65
APPENDIX	75
NAME INDEX	77
SUBJECT INDEX	79

ABBREVIATIONS EMPLOYED IN THE REFERENCES.

Amer. Chem. J.	American Chemical Journal.
Annalen	Justus Liebig's Annalen der Chemie.
Ber.	Berichte der Deutschen chemischen Gesellschaft.
Bull. de l'Assoc. Ing. Elect.	Bulletins de l'Association des Ingenieurs Electriques.
Chem. Zeit.	Chemiker Zeitung.
Compt. rend.	Comptes rendus hebdomadaires des Séances de l'Académie des Sciences.
D.R.P.	Deutsches Reichspatent.
Electrochem. Ind.	Electrochemical Industry.
Electrochem. Review	Electrochemical Review.
Electrochem. Zeitsch.	Elektrochemische Zeitschrift.
Eng. Pat.	English Patent.
Fr. Pat.	French Patent.
Int. Cong. App. Chem.	International Congress of Applied Chemistry.
J. Amer. Chem. Soc.	Journal of the American Chemical Society.
J. Physical Chem.	Journal of Physical Chemistry.
J. pr. Chem.	Journal für praktische Chemie.
J. Soc. Chem. Ind.	Journal of the Society of Chemical Industry.
Met. Chem. Eng.	Metallurgical and Chemical Engineering.
Monatsh.	Monatshefte für Chemie und verwandte Theile anderer Wissenschaften.
Rec. trav. chim.	Recueil des travaux chimiques des Pays-Bas et de la Belgique.
Trans. Amer. Electrochem.	Transactions of the American Electro-Chemical Society.
Trans. Chem. Soc.	Transactions of the Chemical Society.
Trans. Farad. Soc.	Transactions of the Faraday Society.
U.S. Pat.	United States Patent.
Zeitsch. angew. Chem.	Zeitschrift für angewandte Chemie.
Zeitsch. anorg. Chem.	Zeitschrift für anorganische Chemie.
Zeitsch. Electrochem.	Zeitschrift für Elektrochemie.
Zeitsch. physikal. Chem.	Zeitschrift für physikalische Chemie.



CHAPTER I.

ELECTROLYTIC HYDROGEN AND OXYGEN. OZONE.

THE electrolytic decomposition of water provides a suitable introduction to the manufacture of chemicals by electrolysis. Many of the processes described herein depend upon the employment of electrolytic hydrogen and oxygen, and the electrolysis of water furnishes a convenient subject with which to introduce certain fundamental principles and electrical quantities.

Since 1895 several forms of apparatus and plant have been on the market for providing hydrogen and oxygen by electrolysing water. They are largely employed in accumulator works where the oxy-hydrogen flame is needed for lead-welding, and also in metallurgical processes where a high temperature flame is necessary for melting refractory metals such as platinum.

The production of these two gases by electrolysis for storage and transport can only be commercially successful when the cheapest power is utilised, because there are established economical processes for making both oxygen and hydrogen.

Pure water is practically a non-electrolyte, and in order that it may become a conductor, a small quantity of acid, alkali, or soluble salt must be dissolved in it. On passing

2 THE MANUFACTURE OF CHEMICALS BY ELECTROLYSIS

a continuous current of electricity at a pressure of about 2 volts between metal electrodes immersed in the solution, a definite volume of hydrogen is liberated at one electrode, and half the volume of oxygen at the opposite electrode. That electrode at which the hydrogen is discharged is known as the cathode, and is connected with the negative pole of the battery or machine supplying the current. The electrode at which oxygen is discharged is the anode, and is connected with the positive pole of the current source.

The decomposition voltage necessary for decomposing water by electrolysis can be calculated from the heat of formation which is 68,400 calories. Since 1 joule or 1 volt-coulomb¹ is equivalent to 0.239 calorie, the electrical energy necessary for decomposing 1 gram-molecule of water will be $\frac{68400}{0.239} = 285,714$ volt-coulombs. Two equivalents of hydrogen will be discharged, and this amount will require, according to Faraday's Law, 2×96500 coulombs of electricity; the voltage necessary for decomposition will therefore be $\frac{285714}{2 \times 96500} = 1.48$ volts. Owing to various conductivity losses the voltage needed between the electrodes in the various forms of plant varies from 1.9 to as much as 4 volts.

The solutions generally employed are dilute sulphuric acid (10-20 per cent.) or dilute alkali solution containing potassium or sodium hydroxide, and sometimes potassium carbonate is utilised (10-25 per cent.).

¹ See Appendix.

Experimentally determined minimum voltages necessary for decomposing, continuously, such aqueous solutions between platinum electrodes approximate closely to 1.67 volts.

Since 1 gram of hydrogen is liberated by the passage of 96,500 coulombs of electricity, therefore 1 amp.-hour (3600 coulombs) will liberate 0.037 gram or 0.0147 cubic foot at normal temperature and normal atmospheric pressure (N.T.P.).¹

The amount of current generally passed through an industrial unit is about 400 amps., and this will discharge approximately $400 \times 0.0147 = 5.88$ cubic feet of hydrogen per hour and simultaneously 2.94 cubic feet of oxygen. This amount of gas will be discharged by $400 \times 1.67 = 668$ watt-hours or 0.668 K.W.H., hence one K.W.H. will discharge 8.8 cubic feet of hydrogen. In practice the volume of hydrogen obtained is 4.5 - 8.25 cubic feet per K.W.H.

The following statement will convey some indication of the energy utilised annually in a typical installation designed to give about 15,000 cubic feet of hydrogen per day: If the working day be 24 hours for 300 days per annum, the yearly output will be $15,000 \times 300 = 4,500,000$ cubic feet. Each cell takes about 400 amps. at 2 volts, that is, 0.8 K.W.H. per hour, and if there be 100 units in the plant, the energy utilised each year will be $100 \times 0.8 \times 24 \times 300$, or 576,000 K.W.H. To this must be added approximately 25 per cent. to allow for loss

¹That is a temperature of 0° C., and the pressure of a column of mercury 760 mm. high at latitude 45° and at sea level; the temperature of the mercury being 0° C.

4 THE MANUFACTURE OF CHEMICALS BY ELECTROLYSIS

through the motor generator employed, making a total of 720,000 K.W.H. per year. If the gases are to be compressed, 300 lb. per sq. inch for hydrogen will necessitate about 1.5 K.W.H. per hour, that is, $1.5 \times 24 \times 300 = 10,800$ K.W.H. per year. The oxygen is usually compressed to 1800 lb. per sq. inch, and this will require 4.5 K.W.H. per hour, that is, $4.5 \times 24 \times 300 = 32,400$ K.W.H. per year. The total energy required will be $720,000 + 10,800 + 32,400 = 763,200$ K.W.H. per year in the production of 4,500,000 cubic feet of hydrogen and 2,250,000 cubic feet of oxygen. At the rate of 0.5d. per B.O.T. unit the cost of energy per annum will be about £1600.

The first plant devised for supplying oxygen was that of D'Arsonval, of the Royal College of France (1885), who employed a 30 per cent. solution of potash as electrolyte.

A perforated iron cylinder enclosed in a sack of wool or cotton served as anode, whilst a similar iron cylinder was made the cathode. The apparatus gave about 150 litres of oxygen per day.

Latchinoff,¹ of Petrograd (1888), devised the first apparatus for collecting both gases under pressure, and he was also the first to utilise bipolar electrodes. In his earlier forms of apparatus, he employed an alkaline electrolyte and iron electrodes, or 15 per cent. sulphuric acid with carbon cathodes and lead anodes, but in improved large-scale plant he used only alkaline solutions in an iron tank which contained a number of bi-polar

¹ *Elektrochem. Zeitsch.*, 1894, 1, 108; D.R.P. 51998 (1888).

iron electrodes separated from each other by parchment sheets.

Colonel Renard of Paris¹ (1890) prepared hydrogen, for balloon work, in a cylindrical iron cathode vessel in which was suspended a cylindrical iron anode surrounded by an asbestos diaphragm. The electrolyte was caustic soda, and 250 litres of hydrogen were obtained per hour.

The first modern plant was introduced by Dr. O. Schmidt² in 1899. It is constructed on the filter-press principle, and

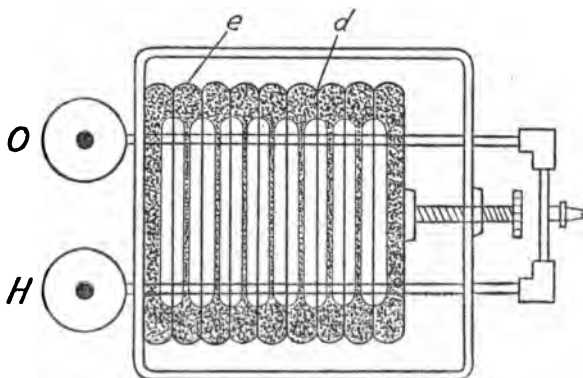

FIG. 1.

is manufactured by the Maschinenfabrik, Oerlikon, Zurich. Bi-polar iron electrodes *e* are fixed in a strong iron frame (Fig. 1) and are separated from each other by diaphragms of asbestos *d*, which are bound with rubber borders. The electrodes are bordered by thick rims, so that when close together there is a cavity between two adjacent plates which is divided into two equal portions by the diaphragm, the rubber edge of which serves to insulate the adjacent

¹ *La Lumière Electrique*, 39, 89.

² D.R.P. 111131 (1899); *Zeitsch. Elektrochem.*, 1900, 7, 296.

6 THE MANUFACTURE OF CHEMICALS BY ELECTROLYSIS

plates from each other. Two holes *ho* (Fig. 2) in the rim of each electrode communicate so as to form two channels when the unit is made up, and these serve to convey the hydrogen and oxygen from the cells, whilst the lower channels *WW'*, formed in a similar manner, serve to supply the chambers with electrolyte.

The channels *h* and *W* communicate with the cathode spaces only, whilst *o* and *W'* connect anode spaces. The

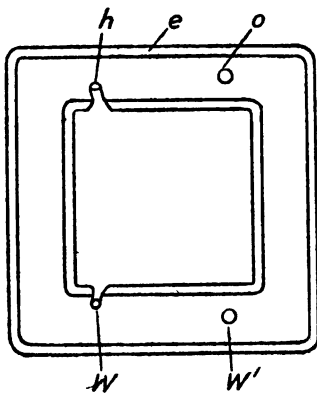

FIG. 2.

channels *WW'* for supplying water are connected with a main pipe A, and at the other end of the unit the gas channels *ho* communicate with the washing chambers H and O. The stopcock *a*, shown in the diagram of a complete Schmidt apparatus (Fig. 3), is for emptying the apparatus. The electrolyte recommended is a 10 per cent. potassium carbonate solution, and is probably preferred to the corresponding sodium salt on account of its freedom from chloride, which exerts a corrosive action upon the iron-work of the apparatus.

A voltage of 2.5 volts is maintained between adjacent electrodes, and the energy efficiency is stated to be approximately 54 per cent. The hydrogen generated has a purity of 99 per cent. and the oxygen purity is 97 per cent., but this can be raised to over 99 per cent. by passing the gas over platinum at 100° C.

Standard types of plant are manufactured for working

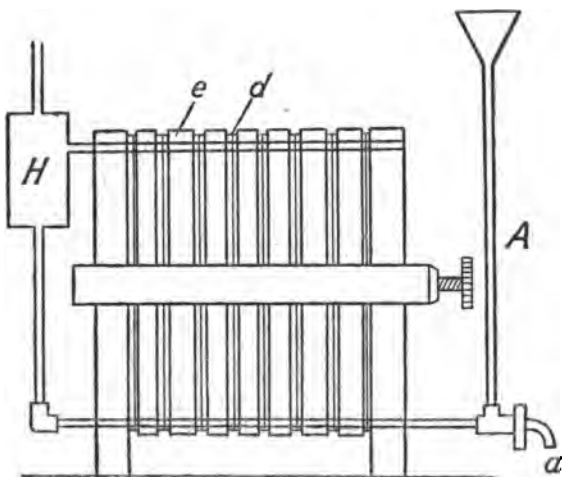

FIG. 3.

at a pressure of 65 or 110 volts. The quantity of water decomposed per K.W.H. is about 130 c.c., and this loss must be made good continuously to prevent the electrolytic gases from collecting in the cells. A Schmidt plant for generating 33 cubic metres of oxygen per twenty-four hours costs about £6000, and for immediate use without compression the cost of the electrolytic gas per cubic metre (35 cubic feet) is approximately 5d. to 6d.

The conductivity of an alkaline electrolyte is lower than

that of 20-30 per cent. sulphuric acid, but it has the great advantage that it is without corrosive action on iron, and therefore plant can be constructed of iron or steel with electrodes of the same material when an alkaline liquid is employed.

Moreover, when lead is used for the electrodes, as it must be with a sulphuric acid electrolyte, considerable over-voltage occurs at the electrodes; hence, in spite of increased conductivity the economy in energy is negligibly small.

Great difficulty has been experienced by all inventors in constructing a cell which will effectually prevent any mixing of the gases evolved and the formation of a dangerously explosive mixture. This point, it will be observed, receives special attention in all the cells described.

SCHOOP'S PLANT.¹

In this cell dilute sulphuric acid is employed, and the electrodes, as well as the containing vessel, are constructed of lead. Each electrode is encased in an earthenware tube which is perforated round its lower portion, and sealed at the top with insulating material. Each electrode is thus completely separated from the rest, and intermixture of the gases is rendered impossible. Dilute sulphuric acid (density 1.235) is the electrolyte employed, and the voltage required for each unit is about 3.9 volts. The diagram (Fig. 4), which shows a section through two cells, will explain the construction.

Each unit consists of a lead-lined vat which contains

¹ *J. Soc. Chem. Ind.*, 1901, 20, 258; D.R.P. 141049 (1901); *Electrochem. Ind.*, 1902, 1, 297.

two cylindrical lead anodes and two corresponding cathodes. Each electrode contains a bundle of lead wires which give increased electrode surface, and the lower part of the electrode is perforated to give free access to the current and to the electrolyte. For the same reason each surrounding earthenware tube is perforated round its lower portion.

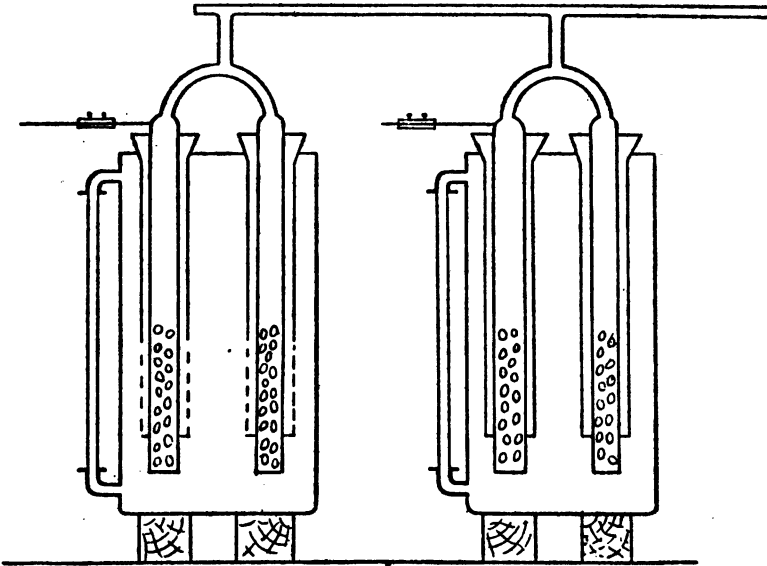

FIG. 4.

The apparatus can be constructed with iron electrodes for use with an alkaline electrolyte, and the working voltage is then about 2.25 volts as compared with 3.8 volts for sulphuric acid and electrodes of lead.

The following costs are quoted by the makers for plant with acid electrolyte: One H.P. hour gives 97.5 litres of hydrogen and half this amount of oxygen; or, stated in another way, 1 cubic metre of the mixed gases requires

10 THE MANUFACTURE OF CHEMICALS BY ELECTROLYSIS
6.2 to 6.8 H.P. hours of energy costing 3.3.5d. With an alkaline electrolyte and iron electrodes the cost is even lower. The generated oxygen has a purity of 99 per cent. and the hydrogen 97.5-98 per cent.

PROCESS OF GARUTI.

The plant invented by Garuti and Pompili in 1893 is a well-known type in which iron electrodes are employed with alkaline electrolyte.

Anodes and cathodes are connected in parallel, and the diaphragms separating the electrodes from each other are iron sheets perforated near the lower edge. The successful working of this arrangement depends on the fact, first ascertained by Del Proposto,¹ that if the voltage between the electrodes is not above 3 volts, the iron diaphragm between them does not become bipolar, and hence no gas is evolved on its surface.

In the cells constructed by Garuti² and Pompili prior to 1899 lead electrodes were employed, and the electrolyte was sulphuric acid solution which was contained in a lead-lined wooden tank, but this was abandoned ultimately for iron construction and an alkaline electrolyte.

The outer case and electrode system are made of iron. In Fig. 5 a longitudinal vertical section is shown, in which B represents the iron casing holding the electrodes and diaphragms. The spaces H and O are bells in which the hydrogen and oxygen respectively collect before rising

¹ *Bull. de l'Assoc. des Ingen. Electr.*, 1900, 11, 305.

² *L'Industrie Electrochimique*, 1899, 11, 113; Eng. Pats. 16588 (1892), 23663 (1896), 12950 (1900), 2820 (1902), 27249 (1903).

through the exit tubes TT'. The electrodes and diaphragms traverse the entire length of B and are shown sectionally in Fig. 6, which is a transverse section. Electrodes *e* are

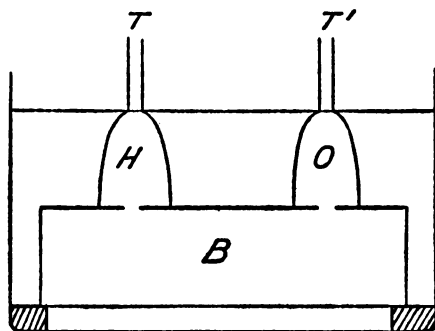

FIG. 5.

12 mm. apart, and the lower edge of each is 12 cms. from the bottom of the tank. Each diaphragm *d* has a zone of perforations 4 cms. wide running parallel with and about

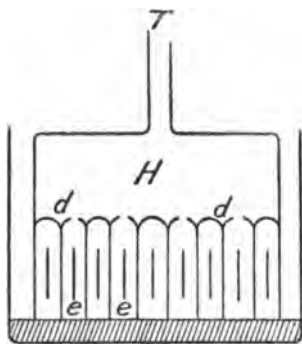

FIG. 6.

7.5 cms. above the lower edge. Anode spaces open at the top, on one side, into the bell O which receives oxygen, and in a similar manner the cathode spaces open on the other side to the bell H which collects hydrogen (see Fig. 5).

Electrodes and diaphragms are kept in position by a wooden frame-work.

The purity of the generated hydrogen is 98·9 per cent. and that of the oxygen 97 per cent. On an average the consumption of energy is 4·17 K.W.H. per cubic metre of mixed gases, and a current output of 96 per cent. is attained with an energy efficiency of 57 per cent.

The energy expended in generating 3 cubic metres of the mixed gases in any ordinary plant is, on an average, 13·5 K.W.H.

The cost of a 100 H.P. Garuti plant comprising 50 cells, each using about 400 amps., together with two gasometers, is about £3000, and this price is increased to £4000 if plant is required for compressing the gases.

Following are particulars of a Garuti plant operated by the Société l'Oxyhydrique at Brussels, according to Winsinger:¹ Each amp.-hour gives 0·4 litre of hydrogen and 0·2 litre of oxygen. A plant taking 350 amps. at a pressure of 2·5 volts gave 3·36 cubic metres of hydrogen and 1·68 cubic metres of oxygen per 24 hours, requiring a daily expenditure of 21,000 watt-hours or an average of 4166 watt-hours per cubic metre of mixed gases. This agrees with a current efficiency of 96 per cent. and an energy efficiency of 57 per cent.

An account of a Garuti plant used at Rome, by the air-ship branch of the Italian army, for generating hydrogen is given in the *Jahrbuch der Elektrochemie*, 1901, 7, 336.

In 1902 Garuti introduced an improvement in the dia-

¹ *Chem. Zeit.*, 1898, 22, 609.

phragm of the cell by enlarging the zone of perforations. This facilitated the conduction of the current, and the passage of the liberated gases through the enlarged zone was prevented by covering each side with fine-mesh metallic netting.

In 1903 an important addition was made in the form of a special arrangement for purifying the evolved gases by passing them over heated platinum; this also included testing lamps for continuous observation of the purity of the gases.

THE SCHUCKERT PROCESS.¹

The process was introduced in 1896. Iron tanks contain the electrolyte, which is 15 per cent. caustic soda solution, and the working temperature is 70° C. Sheet iron bells are employed to isolate the electrodes and collect the gas evolved.

Each tank takes about 600 amps. and has the dimensions 26" × 18" × 14", so that it holds about 50 litres. Each pair of unlike iron electrodes is separated by strips of good insulating material extending from the top downwards about three-quarters of the total depth. Between these separating plates and enclosing the electrodes are the iron bells which collect the evolved gas and lead it away.

The plant is manufactured by the Elektrizitäts A. G. vorm. Schuckert & Co., Nurnberg, and standard types are supplied to take from 100 to 1000 amps.

¹ D.R.P. 80504; *Electrochem. Ind.*, 1908, 1, 579; *Electrochem. Zeitsch.*, 1908, 290, 248.

14 THE MANUFACTURE OF CHEMICALS BY ELECTROLYSIS

The following prices are quoted for a plant giving 10 cubic metres of hydrogen per hour :—

Electrolyser	£470	<i>Accessories—</i>	
Soda	80	2 gas holders	£400
Insulating materials	20	Wooden stages for cells	40
Scrubbers, Dryers, etc.	50	Compressors	570
2 gas purifying stoves and packing	150	Water still	40
	<u>£770</u>		<u>£1050</u>

HAZARD-FLAMAND PROCESS.¹

This process has been worked successfully for some years by the Société Anonyme l'Electrolyse Française. Glass or porcelain diaphragms are employed to ensure complete separation of oxygen and hydrogen, and the purity of the generated oxygen is said to be 99 per cent.

INTERNATIONAL OXYGEN Co.,² NEW YORK.

This cell consists of an iron tank acting as cathode, and from the cover is suspended a perforated anode box made of low-carbon steel to prevent the formation of spongy rust. The anode and cathode are separated by an asbestos sack suspended from the cover.

Each cell takes about 390 amps. at a pressure of 2.61 volts, and the working temperature is 30° C. The purity of the oxygen is said to be 98.3 per cent., and each cell gives over 3 cubic feet per hour.

A cell somewhat similar to this in design is the Halter³ cell. An iron tank forms the cathode, and in this an inverted funnel or box-shaped anode of iron is suspended,

¹ *Electrochemist and Metallurgist*, 1903, 3, 837.

² *Met. and Chem. Eng.*, 1911, 9, 471; 1916, 14, 108.

³ U.S. Pats. 1172885, 1172887 (1916).

from the edge of which an asbestos sack diaphragm hangs to prevent mixing of the gases. Cells of the filter-press type have been developed during recent years. The International Oxy-Hydric Company¹ of Chicago makes a cell of this pattern in which the electrodes, corrugated to increase their surface, are constructed of special alloy heavily nickel-plated. The electrolyte employed is 20 per cent. caustic potash, and asbestos diaphragms are used. Oxygen is generated, of 99.5 per cent. purity, at the rate of 4 cubic feet per K.W.H. Other plant of this type is made by L'Oxyhydrique Française² and by Messrs. Eycken, Leroy & Moritz.³

The following cells of various patterns for producing hydrogen and oxygen have been patented during the last few years, but many of them still await industrial development:—

Cell of Siemens Bros. & Obach, Eng. Pat. 11973 (1893).

A cell devised by K. J. Varelle⁴ in which the gases are effectively separated by a system of V-shaped troughs which completely divide cathodes from anodes.

The cell of Fischer, Leuning & Collins described in U.S. Pat. 1004249 (1911).

The Tommasini System, U.S. Pat. 1035060 (1912).

The Burdett System, U.S. Pat. 1086804 (1914).

ELECTROLYTIC PRODUCTION OF OZONE.

During the electrolysis of dilute sulphuric acid a considerable amount of ozone is mixed with the oxygen evolved

¹ *Met. and Chem. Eng.*, 1916, 14, 288.

² Fr. Pat. 459967 (1912).

³ *Ibid.* 897319 (1908), U.S. Pat., 603058.

⁴ *Ibid.* 855652 (1905).

at a platinum anode if a high current density be maintained.

The amount of ozone may be increased by employing a water-cooled anode so that the temperature in its neighbourhood is at 0° C. or lower.

With a current density of 80 amps. per cm.² and a voltage of 7.5 volts the oxygen evolved from 15 per cent. sulphuric acid contains 28 grams of ozone per cubic metre, equivalent to a yield of 7.1 grams per K.W.H.¹

Alkaline solutions yield considerably less ozone, and are not suitable for the preparation of this gas.²

A method suitable for producing large quantities of ozone has been devised by Archibald and Wartenburg³ in which alternating current is superimposed upon the direct current used for electrolysis. The amount of ozone obtained by this means is very much greater than that produced by direct current alone, and the improvement is no doubt due to the depolarising effect of the A.C. at the anode. This same beneficial effect is made use of in Wohlwill's improved process for gold refining, and this advantageous combination of D.C. and A.C. is referred to later⁴ in connection with other electro-chemical processes.

In an experimental run, a maximum yield was obtained with an A.C. of 6 amps. and a D.C. of .25-1 amp. The sulphuric acid employed had a density of 1.48, and the most suitable current density was found to be 33 amps. per dm.²

¹ *Zeitsch. anorg. Chem.*, 1907, 52, 202.

² *Ibid.*, 1908, 36, 408.

³ *Zeitsch. Elektrochem.*, 1911, 17, 812.

⁴ Page 78.

CHAPTER II.

THE ELECTROLYTIC PRODUCTION OF PER-SALTS AND HYDROGEN PEROXIDE.

PERSULPHATES AND PERSULPHURIC ACID.

THE existence of highly oxidised salts of sulphuric acid was first demonstrated by H. Marshall¹ when investigating the result of electrolysis of solutions of potassium sulphate in well-cooled sulphuric acid. He succeeded in preparing potassium and ammonium persulphates, and he ascribed the formula $M_2S_2O_8$ to these compounds.

The preparation of the persulphates was further studied by K. Elbs² in 1893, when he prepared a good yield of the ammonium salt by electrolysing a saturated solution of the sulphate in 1 part of sulphuric acid and 8 parts of water, contained in a porous cell which was immersed in a vessel containing 50 per cent. sulphuric acid. A lead cylinder cathode is employed, and a spiral of platinum dips into the anode ammonium sulphate solution. If the entire cell be cooled by immersion in ice-water and an anode current density of 50 amps. be employed, the persulphate gradually separates in a crystalline form in the anode compartment. The cathodic sulphuric acid must be renewed

¹ *Trans. Chem. Soc.*, 1891, 59, 771.

² *Journ. prakt. Chem.*, 1893, 43, 185.

occasionally because its acidity becomes steadily neutralised by the alkali formed at the cathode during electrolysis. It is also necessary to keep the ammonia content of the anode liquor constant by continual addition of ammonium hydroxide.

Later, in 1895, Elbs and Schönherr¹ studied the formation of persulphuric acid itself. They found that when the density of the acid employed is less than 1.20 very little persulphuric acid is obtained by electrolysis. Increasing the acid content above this value leads to an increased yield of persulphuric acid, and the maximum quantity is obtained when acid of density 1.35-1.50 is used.

The harmful influence of acid above this strength is probably due to the following causes: Concentrated acid is a bad electrical conductor, and the heat developed by the current in passing through such an electrolyte causes partial destruction of the persulphuric acid; the persulphuric acid formed at the anode is not free to move rapidly from the anode and is partially decomposed there. Elbs emphasised the importance of maintaining a low temperature to avoid decomposition. Marshall² showed in 1897 the necessity for employing a high current density at the anode and keeping the solution cold. Presumably, the high current density increases the chances of two (HSO_4) or (KSO_4) ions uniting.

Müller and Friedberger³ then prepared persulphates in

¹ *Zeitsch. Elektrochem.*, 1895, 1, 417, 468.

² *J. Soc. Chem. Ind.*, 1897, 16, 896.

³ *Zeitsch. Elektrochem.*, 1902, 8, 230.

an undivided cell, using chromate in the electrolyte in order to retard the cathodic reduction of the persulphate. A current density of 50 amps. per dm.² was employed. Only 30 per cent. of potassium salt was obtained, but as much as 80 per cent. of ammonium persulphate was formed, provided the ammonia liberated in the cathode compartment during the process was neutralised from time to time.

It was then shown by M. G. Levi¹ that the yield is not diminished by allowing the temperature to rise as high as 30° C., and is almost independent of the cathode material used, but he found that a new smooth platinum anode gives a better yield than an old one which has a somewhat rough surface. A patent process of 1904 claimed the use of an undivided cell with the addition of hydrofluoric acid, under which circumstances E. Müller² had shown that the yield of potassium persulphate was equal to that of the ammonium salt. This rendered possible the direct production of the potassium salt without relying on the intermediate formation of ammonium persulphate and subsequent decomposition with potassium chloride.

Platinum electrodes are used, and the increased yield is related in some way to the increased anode potential caused by the presence of fluoride.

Further work by E. Müller³ on the production of persulphuric acid indicated that permonosulphuric acid or

¹ *Zeitsch. Elektrochem.*, 1903, 9, 427.

² *Ibid.* 1904, 10, 776; D.R.P. 155805.

³ *Ibid.* 1907, 13, 257; 1912, 18, 752.

Caro's acid (H_2SO_5) is formed by the action of water on the persulphuric acid first formed thus :—

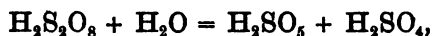

and Caro's acid is then destroyed by interaction with hydroxyl at the anode, and oxygen is evolved :—



Current efficiency may be increased by adding a substance such as hydrofluoric acid which raises the anode potential, and also by adding sulphurous acid or hydrogen sulphide which destroys Caro's acid but does not affect persulphuric acid. The addition of sulphurous acid to the point of saturation in sulphuric acid of density 1.38 raises the current efficiency to 92 per cent. The addition of hydrochloric acid to the bath has a beneficial effect because it raises the anode potential and also destroys Caro's acid, and so removes the harmful depolarising effect of this substance. It has been shown that the concentration of persulphuric acid increases with rise in current density, but the final concentration of Caro's acid is independent of the current density.

According to a patent claim of the Consortium für Elektrochemie an undivided cell may be used, and even without the addition of chromate or fluoride a high yield of ammonium persulphate may be obtained, provided the solution is cooled and a high current density employed (50 amps. per dm.²). Under favourable conditions a 40 per cent. solution of persulphuric acid can be obtained by direct electrolysis of sulphuric acid.

HYDROGEN PEROXIDE is produced either by decomposing

electrolytic persulphuric acid by distillation under reduced pressure,¹ or an alkaline persulphate solution is treated with sulphuric acid, and the solution distilled under reduced pressure.² A solution containing 10-30 per cent. of hydrogen peroxide can be produced by this means.

A recent patent³ specifies the following conditions: Ammonium hydrogen sulphate solution is electrolysed at a temperature of 7° C. with a platinum anode and a lead cathode. If the temperature is allowed to rise above 15°, evolution of oxygen takes place and the yield of persulphate is diminished; on the other hand, a temperature below 7° C. causes increased resistance in the electrolyte without any compensating advantage as regards yield. The persulphate solution is then heated in an autoclave at 130-140° C. under a pressure of 100 lb. per sq. inch, and decomposition ensues according to the equation:—



The temperature is then lowered to 65° C., and by sufficiently lowering the pressure a solution of hydrogen peroxide distils. It is necessary to conduct the distillation in an atmosphere of nitrogen.

Another process for preparing hydrogen peroxide directly from dilute sulphuric acid is the subject of two patents.⁴ Electrolysis is conducted under high pressure inside steel cylinders, each of which is lined with a suitable cathode material, e.g. silver amalgam or copper amalgam.

¹ D.R.P. 199958, 217538, 217589 (1908).

² Eng. Pats. 23158, 23660 (1910).

³ U.S. Pat. 1195560 (1916).

⁴ Eng. Pats. 10476 (1918); 22714 (1914).

The anode is fixed axially in the cylinder, and is surrounded by a diaphragm of asbestos.

A certain amount of oxygen is discharged during electrolysis, and separated from the solution of hydrogen peroxide.

According to another recent patent¹ a good yield of ammonium persulphate can be obtained in a special cell with a platinum anode and a cathode of zinc-aluminium alloy.

PERCARBONATE of potassium was first prepared by E. J. Constam and A. V. Hansen² in 1896 by employing a divided cell, similar to that used for preparing ammonium persulphate, fitted with platinum electrodes.

The electrolyte was a concentrated solution of potassium carbonate which occupied anode and cathode compartments. At first oxygen was evolved plentifully at the anode, but as the temperature was lowered this evolution diminished and at -10°C . ceased, whilst a pale blue amorphous solid separated out. This solid proved to be percarbonate of potassium $\text{K}_2\text{C}_2\text{O}_6$, and was apparently formed in a similar manner to the persulphates by combination of the anions KCO_3' , discharged under the influence of high anodic current density at a low temperature, $2\text{KCO}_3 = \text{K}_2\text{C}_2\text{O}_6$.

It was further shown by Hansen³ that the temperature may rise to 0°C . without diminishing the yield, provided the density of the carbonate solution, in the neighbourhood of the anode, does not fall below 1.52. If the current

¹ D.R.P. 276985 (1914).

² *Zeitsch. Elektrochem.*, 1896, 3, 187.

³ *Ibid.*, 1897, 3, 445.

density is 1-2 amps. per dm.² the product contains only 30-50 per cent of percarbonate, but with 30-60 amps. per dm.² the amount rises to 85-95 per cent. $K_2C_2O_6$. The best result is obtained by running slowly a saturated solution of carbonate into the bottom of the anode compartment, and allowing the less dense solution in which the percarbonate is suspended to flow out at the top of the cell. A yield of 2.2-2.4 grams per amp.-hour is obtained of 87-93 per cent. percarbonate. As the solubility of ammonium and sodium carbonates is very small at low temperatures it is not possible to work successfully with these salts, but rubidium carbonate gives satisfactory results.

Potassium percarbonate should be dried by draining on porous earthenware, and then exposing to warm dry air. The crude salt can be purified from carbonate by digestion with potassium hydroxide solution at about $-5^\circ C.$, and if it be washed subsequently with alcohol to remove adherent potash, the purity reaches 95-99 per cent.

SODIUM PERBORATE has been for some time in use mixed with soap, borax, alkali, etc., and is sold for laundry work under such names as *Persil*, *Clarax*, and *Ozonite*. It possesses detergent and bleaching properties. Since 1914 the salt $NaBO_3 \cdot 4H_2O$ has been produced by electrolysis, and many recent patents deal with this process. Formerly, the only means available for preparation was that of mixing borax with hydrogen peroxide.

A suitable solution for preparing the salt is made up of 45 grams of borax and 120 grams of sodium carbonate per

litre. With a platinum gauze anode and a water-cooled cathode at 18° C. a good yield of crystalline perborate can be obtained, and the loss due to cathodic reduction is small.¹

If an alkali chromate and turkey red oil be added to the electrolyte, the cathode reduction amounts only to that due to 3 per cent. of the hydrogen discharged. A patent was granted in 1913 for producing alkali perborate by electrolysis, and others have followed.

The deleterious effects of iron salts can be removed, it is stated, by addition of stannic acid or sodium bicarbonate to the electrolyte.²

It is claimed that increased yields are obtained by the addition of alkali chromate, calcium chloride, and colloids such as gelatin and gum arabic; further, a high current density at the anode is desirable.³

According to another patent⁴ a solution of borax containing 13-15 per cent. of carbonate is electrolysed. Presumably, percarbonate is first formed, and this oxidises the borate to perborate. It is necessary to saturate the solution with borax, and solid perborate must also be present. Metallic catalysts which act negatively must be excluded, but stannic acid, bicarbonate of soda and magnesium silicate act as accelerators.

Another patent of the same year⁵ follows similar lines, but stipulates that the bicarbonate produced during electrolysis must not be allowed to exceed 70-75 grams

¹ *Zeitsch. Elektrochem.*, 1915, 39, 806.

² Eng. Pat. 14292 (1915).

³ *Ibid.* 100778 (1916).

⁴ *Ibid.* 100158 (1916).

⁵ *Ibid.* 102859 (1916).

per litre, or the stability of the perborate will be affected. Free alkali is added, therefore, to the lye used, before or during electrolysis, or the free alkali may be replaced by carbonate of soda and borax, or by metaborate.

POTASSIUM PERMANGANATE is now manufactured by oxidising the manganate solution in the anode compartment of a divided cell. The first patents were taken out in 1884. One by Theodor Kemp¹ describes the use of a negative electrode in water at which alkali is formed, the manganate solution in the anode compartment being converted into permanganate. The anode and cathode are separated by a porous diaphragm.

The other patent by E. Schering² describes the use of a cement diaphragm to separate anode from cathode. Several advantages are evident over the older process in which chlorine or carbon dioxide is used to decompose the manganate which results from the fusion of manganese dioxide with chlorate. These can be shown by comparing the equations representing the reactions:—

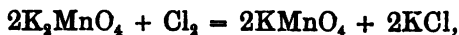

In the electrolytic oxidation the change is as follows:—

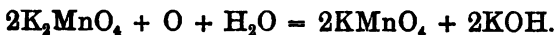

It will be observed that the last oxidation is effected by electrolytic oxygen liberated at the anode, no manganese dioxide is formed, and the potash which is produced may be used again in the fusion process for preparing more manganate.

¹ Eng. Pat. 8218 (1884).

² D.R.P. 28782 (1884).

A cell used by the Salzbergwerke,¹ Stassfurt, is shown in section in Fig. 7. It is of iron, and contains the solution of manganate, which is replenished by gradual solution of the fused product contained in the metal baskets B. The cathodes are immersed in cement boxes C which serve as diaphragms, and sheet iron anodes A dip into the liquor between the metal baskets and the cement cathode

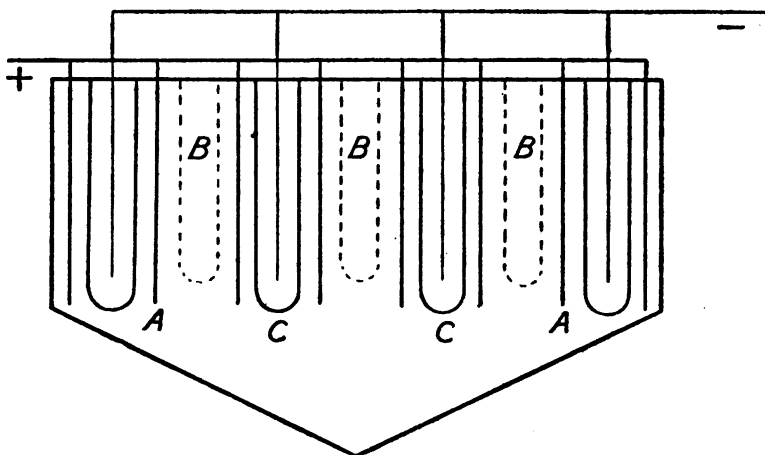

FIG. 7.

compartments; 1 kilogram of permanganate requires about 0.7 K.W.H. and the voltage is about 2.8 volts.

The Griesheim Elektron Company² use a closed diaphragm cell for preparing metallic permanganates, which is fitted with tubes for the escape of electrolytic gas. Their method for preparing the calcium salt is as follows: The cathode compartment contains caustic potash solution, and the anode compartment is filled with saturated manganate

¹D.R.P. 101710 (1898).²*Ibid.* 145368 (1904).

solution. During electrolysis, lime is added in the form of a cream to the anode compartment, and the permanganic acid produced combines to form the calcium salt. Hydrogen and oxygen are evolved from the cathode and anode respectively. After some time the calcium and potassium permanganates may be separated by fractional crystallisation. It is possible to use calcium chloride instead of lime, but in that case potassium chloride is used in the cathode compartment in place of caustic potash.

P. Askenasy and S. Klonowski¹ have shown that the diaphragm may be dispensed with. In their experiments a solution of potassium manganate containing 80-90 grams per litre was electrolysed at 60° between iron electrodes; the current density at the cathode was 0.8 amp. per cm.² and at the anode about 0.1 amp. Under these conditions the cathodic reducing action was small, and permanganate crystallised from the solution. When the calculated amount of current had passed, 60 per cent. of the manganate had been oxidised, but it was found possible to continue electrolysis until 75 per cent. had been changed.

R. Lorenz² has shown that it is possible to produce permanganate by electrolysing a solution of caustic potash, if a manganese or ferro-manganese anode be used and a cathode of copper oxide (the positive plate of a cupron cell for example).

The same method can be used for preparing potassium bichromate if the anode be of ferro-chromium. In both

¹ *Zeitsch. Elektrochem.*, 1910, 16, 170.

² *Zeitsch. anorg. Chem.*, 1896, 12, 898, 896.

cases the iron in the anode is converted to ferric hydroxide which collects at the bottom of the cell.

POTASSIUM FERRICYANIDE¹ can be produced by the electrolytic oxidation of ferrocyanide.

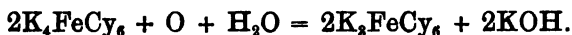

A saturated solution of ferrocyanide is used at a temperature of 20° C. The Deutsche Gold und Silber Scheideanstalt modify the process by addition of calcium ferrocyanide which prevents the contamination of the end-product with alkali. H. von Hayek² has examined the process, and shown that a 100 per cent. yield may be obtained if a high current density be used and the anode rotated, whilst the electrolyte is kept alkaline to prevent the formation of free ferrocyanic acid.

The surface of the anode should be greater than that of the cathode, and high concentration of salt is necessary to prevent the high current density from producing secondary reactions and thus reducing the yield.

ELECTROLYTIC SULPHURIC ACID³ is produced and a concentration as high as 95 per cent. obtained by oxidising sulphurous acid in a diaphragm cell with a cylindrical nickel cathode and an anode of platinum gauze. A porous cup or cell which acts as cathode is filled with sulphuric acid or sodium sulphite, and the outer anode compartment contains a solution of sulphur dioxide which is kept saturated during the process by passing in the gas con-

¹ Eng. Pat. 7426 (1886); *Electrical Review*, 1893, 32, 216.

² *Zeitsch. anorg. Chem.*, 1904, 39, 240.

³ M. de K. Thompson, *Mot. and Chem. Eng.*, 1916, 15, 677.

tinuously. The current density used is about 1 amp. per dm.²

SODIUM SELENATE can be produced by electrolytic oxidation of neutral selenite solution.¹ On evaporation of the solution, crystals of selenate can be obtained together with a small amount of selenium. The addition of a small quantity of chromate to the bath prevents the cathodic deposition of selenium. F. Foerster² had previously shown that neutral sulphites give, by electrolytic oxidation, both sulphate and dithionate. No dithionate analogue was found by Müller when oxidising the selenites, and in attempting to oxidise sodium tellurite a considerable amount of free tellurium was obtained.

It may be remarked that descriptions in patent specifications do not necessarily represent the process as carried out in practice, and in some cases are drawn with that intention. They should therefore be accepted with caution.

¹ E. Müller, *Ber.*, 1903, 36, 4262.

² *Ber.*, 1902, 35, 2815.

CHAPTER III.

NITRIC ACID. HYDROXYLAMINE. HYDROSULPHITE FLUORINE.

NITRIC ACID can be separated from the alkali nitrate present in peat by a process devised by M. A. Nodon,¹ a French engineer. The peat deposits are treated *in situ* by electrolysis, and the nitric acid which is discharged at the anodes is drained away to a collecting tank. Earthenware pots, having a depth of approximately 8 feet and a diameter of 16 inches, are sunk in the peat deposit and serve as anode compartments. Each pot is packed with coke in the centre of which is embedded a central graphite anode, and it also contains two earthenware tubes, one for drawing off the nitric acid solution as formed *d* (Fig. 8), and the other *e* to supply water in order to make good that which is carried off to the nitric acid tank.

Corresponding to each anode cell are four cast iron cathodes KK, about 8 feet long, which are connected as shown in Fig. 9. A continuous production of acid takes place during electrolysis, and no harmful effect is exerted upon the nitrifying bacteria, which continue their work of converting nitrogenous matter into calcium nitrate without interruption. Stakes of tarred wood *g*

¹ G. Dary, *London Electrical Review*, 1913, 73, 1020; *Met. and Chem. Eng.*, 1914, 12, 107.

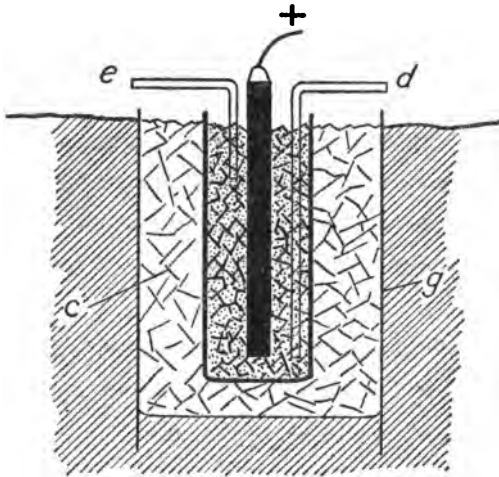

FIG. 8.

encase a packing of limestone *c* which surrounds each earthenware anode cell.

The resistance of the peat electrolyte is approximately

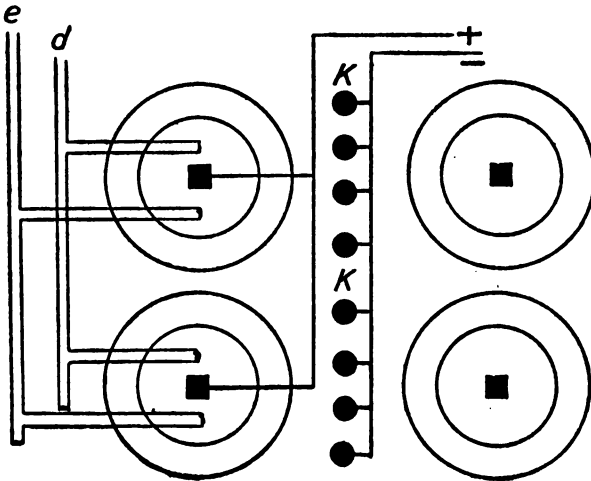

FIG. 9.

3 ohms per cubic metre, and the pressure required per cell is 10 volts. The optimum temperature at which the bacteria convert the maximum amount of nitrogenous matter into nitrate is 25° C., and at this temperature 2 per cent. of the available nitrogen is converted into nitric acid. The limestone filling which encircles each earthenware pot serves to prevent the peat itself from becoming acid.

On one deposit, which had an average depth of 6 feet, a yearly output of 800 tons of nitrate was obtained at an approximate cost of one penny per lb.

HYDROXYLAMINE.

In 1902 it was shown by J. Tafel that nitric acid can be reduced in a divided cell, in the presence of sulphuric acid, in such a manner as to give a good yield of hydroxylamine sulphate, and the process was covered by patents issued about that time.

Tafel¹ showed that a mercury cathode or one of amalgamated lead gives the best results. At a platinum cathode very little reduction takes place, and the products are ammonia and hydroxylamine. According to Tafel, a lead cathode gives a 40 per cent. conversion of nitric acid to hydroxylamine, but with a copper electrode only 15 per cent. reduction to this substance takes place, whilst much ammonia is formed.

Since hydroxylamine is not reduced to ammonia by a copper cathode, it follows that the reduction of nitric acid

¹ *Zeitsch. anorg. Chem.*, 1902, 31, 289.

to this gas is direct, and depends upon the specific action of the metal. For the preparation of hydroxylamine, dilute nitric acid may be used, but the strength of the sulphuric acid into which the nitric acid is dropped or slowly run, should not be less than 40 per cent.

Tafel showed that the sulphate is comparatively stable in the presence of sulphuric acid even at a temperature of 40° C. He obtained the hydrochloride by using hydrochloric acid in place of sulphuric acid, and a cathode of spongy tin gave satisfactory results. The reduction may be represented by the equation :—

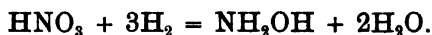

According to the patents of Boehringer and Söhne,¹ a two-compartment cell is employed containing 50 per cent. sulphuric acid in each compartment. The cathode is of amalgamated lead, whilst the anode is lead. A 50 per cent. nitric acid solution is dropped into the cathode compartment during the passage of the current, and the temperature kept below 20° by cooling coils. The current density employed is 60-120 amps. per dm.²

According to a French patent,² an anode of platinum is used with a tin cathode. Sodium nitrate solution is dropped into the cathode compartment, and the anolyte is sodium chloride solution. The yield of hydroxylamine is said to be 60-80 per cent. and chlorine is a by-product.

A suitable arrangement for producing hydrochloride on a large scale is described by R. H. Pritchett.³ The

¹ D.R.P. 133457, 137697 (1902).

² Fr. Pat. 318978, 322943 (1903).

³ *J. Amer. Chem. Soc.*, 1916, 38, 2042.

cathode compartment is filled with three volumes of water and one volume of hydrochloric acid (density = 1.20). The anode liquid is cooled by causing it to circulate through a lead pipe immersed in a freezing mixture, which latter is used to cool the cathode liquor.

The current density used is 50 amps. per dm.² at 25 volts, and the nitric acid (density 1.4) mixed with one volume of water is run into the cathode compartment at the rate of 30 c.c. per hour. The reduced liquor on being evaporated *in vacuo* gives 80 per cent. of the calculated amount of hydroxylamine hydrochloride.

THE PRODUCTION OF NITRITE FROM NITRATE.

The reduction of nitrate to nitrite can be accomplished satisfactorily, and the process is the subject of a recent patent.¹ It has been shown (Müller and Weber)² that in a divided cell, smooth platinum or copper cathodes reduce nitrate to nitrite and ammonia, but platinised platinum gives much ammonia and little nitrite. A spongy copper or silver cathode was found to give the best results. With a current density of 0.25 amps. per dm.² and a concentration of 2.3 grams of sodium nitrate per litre, a current efficiency of 90 per cent. was obtained. The current efficiency with an amalgamated copper cathode was found to diminish when 50 per cent. of the nitrate had been changed. Considerable care is evidently needed to prevent the formation of ammonia, since it has been shown by W. H. Easton³

¹ Eng. Pat. 16648 (1915); 25415 (1918).

² *Zeitsch. Elektrochem.*, 1903, 9, 955, 978; 1905, 11, 509.

³ *J. Amer. Chem. Soc.*, 1903, 25, 1042.

that nitrates may be quantitatively reduced to ammonia by electrolysis.

In the patent referred to above, the cell described is suitable for the electrolysis of alkali chloride and is of the bell type, but it is particularly suitable for electrolysing alkali nitrate. Pure nitric acid is formed at the anode inside the bell and is removed by distillation, which is effected by working under reduced pressure and by heating the bells with superheated steam. The nitrite which is formed at the cathode is drawn off continuously and separated outside the cell. The cell itself acts as cathode, and the anode is of such size as to almost fill the bell and thus reduce the working space of the electrolyte. High current density (16 amps. per dm.²), reduced pressure and high temperature, are favourable to the distillation of a large amount of concentrated nitric acid.

SODIUM HYDROSULPHITE (HYPOSULPHITE).

Many patents have been granted for processes to prepare sodium hydrosulphite by the electrolytic reduction of sodium sulphite.

The first process was that of P. Spence and Sons¹ in 1903, in which the sulphite was reduced by mixing it with titanium trichloride. The mixture was subsequently poured into caustic soda solution and stable sodium hydrosulphite formed, whilst the titanium was precipitated as titanate hydroxide $Ti(OH)_4$. This hydroxide was afterwards dissolved in hydrochloric acid and reduced by electrolysis

¹ D.R.P. 141452 (1903).

to the trichloride (TiCl_3), which was employed to reduce a fresh quantity of sulphite.

Subsequent investigation by Elbs¹ and his co-workers showed that it is possible to prepare hydrosulphite by the direct electrolytic reduction of sulphite, but it was not until Jellinek, in 1910, had demonstrated the importance of current concentration,² that good yields were obtained. Jellinek showed that the decomposition of hydrosulphite is not due to cathodic reduction but to spontaneous decomposition, which takes place according to the following equation: $2\text{Na}_2\text{S}_2\text{O}_4 + \text{H}_2\text{O} = \text{Na}_2\text{S}_2\text{O}_3 + 2\text{NaHSO}_3$, and results in the formation of sodium thiosulphate and bisulphite. He succeeded in retarding this decomposition by increasing the current concentration; that is, the ratio of current employed to volume of electrolyte.

Jellinek also devised methods for purifying the salt and preparing it in a stable anhydrous condition.³ By saturating the solution with common salt, hydrated hydrosulphite having the composition $\text{Na}_2\text{S}_2\text{O}_4 \cdot 2\text{H}_2\text{O}$ is salted out, and can be dehydrated by heating to 60°C . under reduced pressure.

With a 5N solution of sodium bisulphite, Jellinek obtained a 10 per cent. solution of hydrosulphite, with a current efficiency of 80 per cent. The current concentration he employed was 5 amps. per 100 c.c. of cathode

¹ Elbs and Becker, *Zeitsch. Elektrochem.*, 1904, 10, 361; A. R. Frank, *Zeitsch. Elektrochem.*, 1904, 10, 450.

² *Ibid.*, 1911, 17, 157, 245.

³ *Zeitsch. anorg. Chem.*, 1911, 70, 98; 71, 96.

solution, and he proved that current density was of small moment compared with the importance of current concentration.

For large-scale production two-compartment cells are employed, and it is advisable to use freshly-prepared bisulphite in the process.

According to one patent,¹ dilute sodium bisulphite is electrolysed in the cathode compartment, and the addition of neutral chloride or sulphate is recommended in order to increase the yield. During electrolysis the temperature should be kept at 0-5° C. and sulphurous acid added to the electrolyte continuously.

According to another patent,² the process may be made continuous by circulating the bisulphite solution through the cells from a reservoir, and when the liquor becomes sufficiently concentrated the hydrosulphite separates in a solid form.

A French patent³ claims the utilisation of zinc sponge prepared electrolytically for reducing sulphite to hydrosulphite.

FLUORINE.

This gas was isolated by H. Moissan in 1887, by the electrolysis of anhydrous hydrofluoric acid containing potassium fluoride. This salt rendered the anhydrous acid a conductor, and the electrolysis was effected in apparatus

¹ D.R.P. 276058, 276059 (1912); 241991 (1910).

² *Ibid.* 278588 (1912); Eng. Pat. 18901 (1913).

³ Fr. Pat. 467448 (1914).

constructed throughout of platinum. Moissan subsequently showed that copper may be employed instead of platinum, since it becomes coated with copper fluoride,

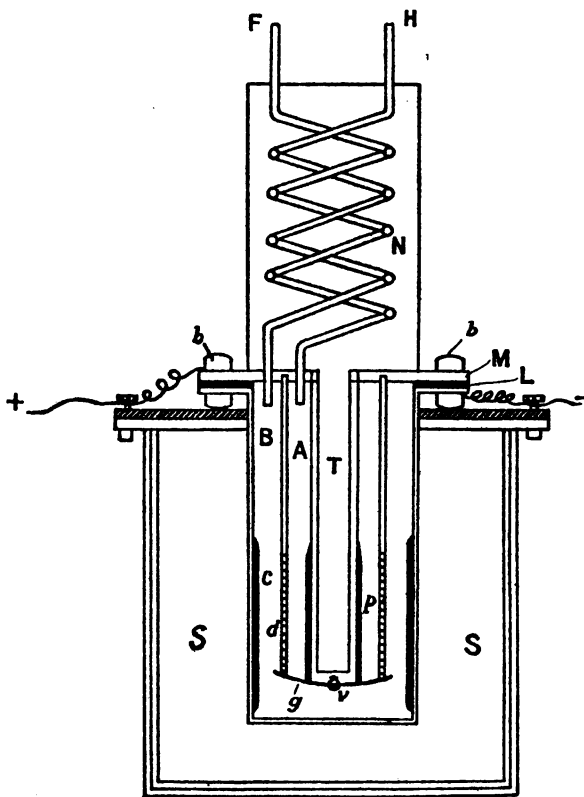

Fig. 10.

which protects the metal from further corrosion. Apparatus was designed by Moissan for producing fluorine on a large scale, and a diagram of the plant, as constructed by MM. Poulenc Frères¹ of Paris, is shown in Fig. 10.

¹ *Zeitsch. Elektrochem.*, 1900, 7, 150.

The hydrofluoric acid is contained in a copper vessel B, the inner surface of which C acts as cathode and the top of which is closed by a copper lid M, from which it is insulated by a rubber ring L and also by rubber insulation round the bolts, *b*. The large outer vessel S contains a freezing mixture.

A copper tube A, perforated round the lower part by a number of small holes *d*, serves as a diaphragm to separate the cathode from the anode *p*, which is of platinum attached to the inner copper tube T.

The tube T communicates with the upper vessel N, which also contains a cooling mixture, and the lower end of this anode vessel T is closed by a copper plate *g*, which is fastened on by screws *v*.

The diaphragm is in electrical connection with the anode *p* and at first, when electrolysis has commenced, it becomes coated with a deposit of copper fluoride, but then, being insulated by this deposit, it acts as a true diaphragm, and fluorine is discharged only from the anode.

Copper tubes H and F serve to carry away the evolved hydrogen and fluorine.

CHAPTER IV.

THE ELECTROLYTIC PREPARATION OF PIGMENTS AND INSOLUBLE SUBSTANCES.

THE production of such substances as white lead, lead sulphate, oxides, hydroxides, and sulphides of the heavy metals, can be effected by the electrolysis of a suitable solution, such as sodium (or potassium) nitrate, chloride, or sulphate, with an attackable anode and a cathode of platinum or some metal not attacked by the electrolyte.

For example, a solution of sodium sulphate, when electrolysed between a copper anode and a platinum cathode, furnishes SO_4 ions at the anode which attack the copper and produce copper sulphate; simultaneously, sodium hydroxide is formed at the cathode by the interaction of the water with the discharged sodium. The two substances react, and copper hydroxide is precipitated.

The general utility of this process was outlined by R. Lorenz¹ in 1896. He employed a bath of alkali chloride, nitrate or sulphate, with a platinum cathode and an anode of that metal, the hydroxide of which was to be precipitated. This investigation established the following facts: In potassium chloride solution, a copper anode gives yellowish cuprous hydroxide, whilst in a potassium nitrate solution

¹ *Zeitsch. anorg. Chem.*, 1896, 12, 436.

blue cupric hydroxide is precipitated. The following metallic anodes furnish corresponding hydroxides: Silver, magnesium, zinc, cadmium, aluminium, lead, manganese, and iron. A mercury anode gives no hydroxide in potassium chloride solution, but calomel (Hg_2Cl_2) is formed; however, in a potassium nitrate solution a black mercury compound is precipitated. Thallium becomes coated with suboxide, and a brown precipitate of thallium hydroxide is gradually formed. A tin anode in a chloride, sulphate or nitrate solution, gives a precipitate of ortho-stannic acid. Nickel in sodium chloride solution gives green nickel hydroxide, whilst antimony and bismuth anodes are merely coated with a grey skin.

One advantage of this method of preparation of hydroxides is that formation in a neutral solution renders unnecessary careful washing to free from excess of alkali, which is generally needed in ordinary precipitation processes. Further, there is no risk that excess of alkali will redissolve the hydroxide or oxide of metals such as zinc or aluminium, and the electrolyte is re-formed continuously so that it lasts indefinitely, and hence the cost of alkali is avoided. The reaction in the case of copper is represented by the equation: $\text{CuCl}_2 + 2\text{NaOH} = \text{Cu}(\text{OH})_2 + 2\text{NaCl}$.

Lorenz¹ has shown that sulphides can be formed in a similar manner by employing a cathode of copper sulphide and an anode of metal, the sulphide of which is required, in an aqueous solution of alkali chloride, nitrate, or sulphate.

¹ *Zeitsch. anorg. Chem.*, 1896, 12, 442.

For example, a cadmium anode in sodium chloride solution yields cadmium chloride by the reaction of the discharged chlorine with the metal, whilst the hydrogen liberated at the cathode reacts with the copper sulphide to form hydrogen sulphide, $H_2 + Cu_2S = 2Cu + H_2S$, and the gas precipitates cadmium sulphide.

In this manner the sulphides of copper, silver, cadmium, tin, lead, iron, and nickel can be formed without employing either hydrogen sulphide or alkali sulphide, and there is no necessity to wash the product till free from alkali or hydrogen sulphide, because it is formed in a neutral solution.

In those cases where the anodic compound formed by the action of the discharged anions upon the anode metal is insoluble, i.e. lead sulphate formed by the action of sulphate ions upon a lead anode, the anode is speedily covered with the insoluble product, and further action is prevented. Luckow¹ showed that this difficulty can be obviated by using a considerable quantity of a secondary salt (sodium chlorate), the anions of which attack the anode and "crowd out" the anions of the primary salt, so that precipitation takes place a short distance from the anode, and the product falls continuously to the bottom of the vat instead of clinging to the anode surface.

The use of a secondary salt has been applied in the manufacture of white lead.² Luckow recommends as electrolyte a 1.5 per cent. solution of a mixture consist-

¹ *Zeitsch. Elektrochem.*, 1903, 9, 797; D.R.P. 91707 (1897); 105143 (1899).

² *Trans. Amer. Electrochem.*, 1904, 5, 230; U.S. Pat. 644779 (1900).

ing of 9 parts of sodium chlorate and 1 part of sodium carbonate. Carbon dioxide is passed in near the cathode during electrolysis, and the anode of lead remains clean. Luckow employed a current density of 0.25 amp. per dm.², and obtained 3.5-4 kgs. of white lead per K.W.H.

Lead chromate¹ and lead sulphate can be produced in a similar manner, but instead of carbon dioxide it is necessary to add chromic acid in the first case, and sulphuric acid in the second case, to maintain the concentration of sodium chromate or sodium sulphate.

Cuprous oxide² may be formed by electrolysing a common salt solution which contains a small quantity of alkali, if a copper anode be employed. It has been found that the formation of large particles of dark colour is favoured by low current density and high temperature, whilst the addition of a small quantity of gelatin diminishes the size of the particles and lightens their colour. The colour and regularity of the product are improved by the addition of a small quantity of sodium nitrate to the electrolyte.³ The nitrate must be replenished at intervals since it is converted into nitrite during the process.

LEAD PEROXIDE⁴ is formed if between lead electrodes a 1.5 per cent. solution of sodium sulphate (99.5 parts) and sodium chlorate (0.5 part) be electrolysed with a current density of .5 amp. per dm.² Air should be blown through this solution, and it should be acidified with sulphuric acid.

¹ Le Blanc and Bindsohedler, *Zeitsch. Elektrochem.*, 1902, 8, 255.

² *J. Phys. Chem.*, 1909, 13, 256, 332.

³ Eng. Pat. 14310 (1915).

⁴ U.S. Pat. 626330 (1899).

WHITE LEAD processes which have been employed on an industrial scale are as follows: In the Gardner¹ process, worked at Millwall, lead sheet anodes are packed between graphite cathodes. The lead and graphite are connected by strips of tin so that when the acetic acid vapours reach the metal, electrical action takes place and the conversion into white lead is greatly accelerated. The process is similar to the ordinary chemical one, but the time required for the formation of a batch of white lead is reduced from fourteen weeks to about five weeks.

In the process of A. P. Browne² a 10 per cent. solution of sodium nitrate is electrolysed in a wooden cell which is divided into two compartments. At the lead anode NO_3 ions attack the metal forming lead nitrate, and at the copper cathode caustic soda is produced. These electrolytically prepared solutions are drawn off when a suitable concentration is reached, and by mixing them, hydrated lead oxide is precipitated, which by subsequent treatment with sodium bicarbonate is converted into white lead.

The process of C. Woltereck depends upon the electrolysis of an alkaline solution of an ammonium salt of any acid which will form a soluble lead salt. For example, ammonium nitrate solution containing bicarbonate may be employed with a lead anode and cathode of carbon or lead. Nitrate of lead is formed at the anode, and converted into white lead by the bicarbonate present in the electrolyte:—

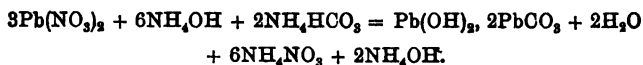

¹ *Electrochemist and Metallurgist*, 1901, 1, 145.

² *J. Amer. Chem. Soc.*, 1895, 17, 835; U.S. Pat. 496109, 563555.

C. F. Burgess¹ and C. Hambuechen, in 1903, investigated the various conditions requisite for the electrolytic production of a good white lead. They found that a two-compartment cell is necessary to obtain a pure product. When lead anodes and sodium nitrate solution are employed a certain quantity of basic lead salt is produced, and there is not therefore a 100 per cent. formation of pure lead nitrate. The reduction of sodium nitrate at copper cathodes cannot be prevented so that a certain amount of ammonia is formed, and the solution being alkaline after a time, plumbates are formed and a layer of spongy lead is deposited on the cathode. If, therefore, the cathode compartment be not separated from the anode, the loosely-deposited cathodic lead will fall into the white lead which is collecting at the bottom of the cell.

It is advisable to make the electrolyte acid in the neighbourhood of the anode. Burgess and Hambuechen tried N/10 nitric acid, and found, after a trial run, that the cathode liquor contained caustic soda 25 grams, ammonia 3.5 grams, sodium nitrite 0.16 gram, and sodium nitrate 54.3 grams per litre. The anode solution contained lead nitrate 113.5 grams, and sodium nitrate 57.6 grams per litre. According to these authors, sodium acetate gives better results than nitrate, but of course is more expensive.

Isenberg has pointed out that in precipitating substances like white lead, by anodic action and subsequent precipitation in the same vat, it is necessary to employ dilute

¹ *Trans. Amer. Electrochem.*, 1903, 3, 299.

² *Zeitsch. Elektrochem.*, 1908, 9, 275.

solutions of the precipitating salt and a low current density, if regular precipitates are to be obtained and the formation of crusts avoided.

But, on the other hand, a more finely divided product is obtained by high concentration of the precipitating salt and a high current density, so that there are two opposing sets of conditions which must be suitably adjusted to obtain a good product.

ZINC WHITE has been produced with some success, and a brief account of the processes employed has been given by E. Leriche.¹

It is certainly difficult to prepare by electrolysis a white lead as good as that formed in the older Dutch process. This aspect of the problem was discussed after a paper read by F. M. Perkin² before the Paint and Varnish Society in 1911.

THE SEPARATION OF THE RARE EARTH OXIDES.

Recent work by L. M. Dennis³ and his co-workers has shown that electrolysis may be of considerable value in effecting a complete or partial separation of the oxides of the rare earth metals. From a neutral solution of the nitrates of neodymium, praseodymium, lanthanum, and samarium, nearly all the lanthanum is deposited as hydroxide in the last fractions discharged on the cathode. The hydroxides are deposited fractionally in order of their basicity, and the deposition is not dependent upon the

¹ *Int. Cong. App. Chem.*, 1909, **X**, 45.

² *Oil and Colour Trades Journal*, 1911, **39**, 457, 578.

³ *J. Amer. Chem. Soc.*, 1915, **37**, 181, 1968.

ammonia which is formed by cathodic reduction of the nitric acid, because the separation can be effected in a similar manner from a solution of the chlorides of the rare earths.

A mercury cathode and a platinum or carbon anode were employed, and a voltage of 8-10 volts. It was further shown that when a diaphragm is employed so that no ammonia is produced by reduction of nitric acid the earths are still separated as before. Nitrate solutions are preferable because the deposition of the hydroxides takes place with considerably greater velocity than when chloride solutions are employed.

PYROPHORIC ALLOYS.

During an investigation of the alloys deposited by electrolysis from mixtures of metallic salts, R. Kremann¹ and his co-workers have found that solutions of ferrous sulphate and magnesium chloride in glycerol-water mixtures containing about 75 per cent. of glycerol, deposit, when electrolysed, a pyrophoric mixture. This consists of iron and magnesium oxides together with carbon and hydrogen. One such cathode deposit had the following composition: iron 34.20, magnesium 8.45, carbon 5.26, hydrogen 1.98, and oxygen 50 per cent.

When the ratio of ferrous sulphate (FeSO_4) to magnesium chloride (MgCl_2) is 0.76, the deposit shows pyrophoric properties, and these become more pronounced as the ratio increases to 1.25, after which they diminish and entirely

¹ *Monats.*, 1914, **35**, 1887; 1917, **38**, 91.

disappear when the ratio reaches the value 1.70. The magnesium in the deposit apparently does not affect its pyrophoric nature, but the presence of carbon is essential. Current density employed is usually 0.6-3.3 amps. per dm.²

These deposits may prove useful for the same purposes as those to which the cerium-iron alloys (Misch Metall) have been adapted.

By substituting cerous chloride for magnesium chloride in the solution the pyrophoric nature of the deposit is not increased. Temperature has considerable influence, because in certain cases the deposit formed in the cold is not pyrophoric, whilst that produced at 60° C. exhibits pronounced pyrophoric properties. Analysis of these alloys always shows the presence of a small quantity of magnesium, generally between 0.4 and 0.5 per cent.

TUNGSTEN BRONZES.

Complex tungstates (polytungstates) are formed at the anode during the electrolysis of normal alkali tungstates. E. Engels¹ has shown that tungsten bronzes can be prepared by electrolysis of a fused mixture of tungstic acid and alkali carbonate.

Mixtures of barium and sodium tungstates in the molten state give, with a current density of about 4.5 amps. per dm.² at a pressure of 1.6 volts, bronzes which correspond to the following formulæ:—



This may prove to be a convenient method for preparing various tungsten bronzes.

¹ *Zeitsch. anorg. Chem.*, 1908, **37**, 125.

CHAPTER V.

ELECTRO-OSMOTIC AND ELECTRO-COLLOIDAL PROCESSES.

MANY substances can now be produced in a pure condition by electro-osmotic methods, that is, by causing electrolytic separation to take place by employing diaphragms between which the substance to be treated is placed while under the influence of the current passing between electrodes situated outside the diaphragmed compartment.

Crystalloid substances can be separated from colloids, and colloids may be separated from each other by utilising suitable diaphragms.

The Gesellschaft für Electro-Osmose have devised several processes since 1912, and it is evident that practice is in advance of theory in this sphere of work, for it was not until 1914 that papers appeared which devoted attention to the theoretical side of the subject.

The method has been adapted to the removal of liquids from all classes of substances¹ and is related to the electro-colloidal processes which have been devised for desiccating peat and other materials.² In one process peat is packed between sheet anodes and perforated sheet cathodes so that

¹D.R.P. 233281 (1910); Eng. Pats. 11626 (1911), 6995 (1914); Fr. Pat. 439271 (1912).

²Eng. Pats. 12431 (1900), 22301 (1901).
(49)

during electrolysis the water driven towards the cathodes will pass through these and away from the peat. The negative plates, therefore, function as filter-plates.

A process similar to this is one in which electrodes are fitted in the cells of a filter-press, and during filtration the colloidal particles in the liquor are coagulated at the surface of the electrodes, and so prevented from blocking the pores of the filter-cloths.¹

The separation of the constituents of glue can be effected by placing the solution between diaphragms so that, during electrolysis, inorganic constituents migrate through the diaphragm leaving the albuminoid material behind.²

Separation of colloids from each other is effected by employing diaphragms which are charged electrically to various potentials, so that certain colloidal particles pass through whilst others are unable to penetrate the diaphragm. For example, with a viscose diaphragm near the anode and one of parchment at the cathode, a mixture of sulphuric and lactic acids can be separated, because only the sulphuric acid can permeate the viscose membrane. Similarly sugars can be separated from non-sugars in crude sugar-liquors, and a solution of glue can be separated into several fractions.

A process for tanning skins by electro-osmosis has been devised.³ The skin is placed between two suitable diaphragms selected, so that active tanning materials cannot pass through them, whilst those substances which are harm-

¹ *Zeit. angew. Chem.*, 1915, 28, 808.

² *Eng. Pats.* 21448 (1914), 11823 (1914).

³ *Ibid.* 19849 (1914).

ful, penetrate the diaphragms under the influence of the current and pass out of the tanning liquid.

Silicic acid,¹ in a form which is soluble and chemically pure, can be obtained by employing a divided cell with alkali silicate in the anode compartment. Perforated electrodes are fitted against the diaphragm wall, and during electrolysis alkali diffuses into the cathode compartment whilst silicic acid remains in the anode compartment. Hydrated silica is thus separated in a pure form specially suitable for stabilising colloids.

Purified alumina² is prepared in a similar way by neutralising crude alkali aluminate with sulphuric acid, and then placing the gelatinous mass in a space which is separated from anode and cathode by diaphragms. During electrolysis the alkali is expelled from the alumina and passes to the cathode.

In another process for the electrolytic lixiviation of animal, vegetable, and mineral substances,³ electrically active material is extracted by causing the liquor, in which the substance is suspended, to travel backwards and forwards through perforated electrodes. The negative and positive constituents collect at their respective electrodes.

A short account of the technical applications of electro-capillary processes has been given recently by W. C. McC. Lewis,⁴ in which mention is made of many of the above processes.

The phenomenon of electro-osmosis has been investigated

¹ Fr. Pat. 471678 (1914).

² Eng. Pat. 6727 (1915).

³ D.R.P. 294687 (1915).

⁴ *J. Soc. Chem. Ind.*, 1916, 575.

by Byers and Walter,¹ and other valuable contributions to our knowledge of this subject have been recently made, which render important aid in the study of a process of which little is known at the present time, although its industrial importance is considerable.

The term electro-osmosis refers to the passage of a liquid through a membrane during electrolysis. The flow of liquid through this membrane which separates anode from cathode depends upon current strength, the resistance of the liquid, and the thickness and porosity of the membrane.

Cohen² has shown that during electro-osmosis both liquid and diaphragm become electrically charged with charges of opposite sign.

According to Bancroft,³ the charge on the diaphragm, which controls the direction of the osmotic flow, depends upon the relative adsorption of anions and cations, being positive if cations are adsorbed to a greater extent than anions. The same view is held by T. R. Briggs,⁴ who has recently contributed an important paper on this subject.

¹ *J. Amer. Chem. Soc.*, 1914, **36**, 2284.

² *Wiedemann's Annalen*, 1898, **64**, 217.

³ *Trans. Amer. Electrochem.*, 1912, **21**, 233.

⁴ *J. Physical Chem.*, 1917, **21**, 196.

CHAPTER VI.

ELECTROLYTIC REDUCTION OF ORGANIC COMPOUNDS.

A LARGE number of patents published during the last thirty years indicate that considerable activity has been displayed in the application of electrolytic methods to the production of organic substances. Most of the patents¹ are of German origin, but during the past five years much attention has been devoted to this branch of chemistry in other countries.

Most of the processes relate to the reduction of organic compounds, particularly the reduction of nitro-compounds, but oxidation methods have been utilised successfully, and in many cases substitution products and dye-stuffs have been prepared by electrolytic means.

The literature of electro-chemistry indicates that a large amount of research has been conducted in connection with the preparation of organic substances, and an excellent summary of this work will be found in the text-book by Löb.²

Much of the work has been conducted with platinum electrodes and with relatively expensive organic solvents of high electrical resistance. These conditions militate

¹ *Met. and Chem. Eng.*, 1915, 13, 211.

² *Electrochemistry of Organic Compounds*, Walther Löb, 1903.

against the utilisation of the methods in industrial chemistry, but fortunately it is possible to dispense with platinum in most cases, and an aqueous emulsion of an organic compound can be reduced efficiently, provided the electrolyte be thoroughly stirred during the process. Such aqueous electrolytes are good conductors, and by excluding organic solvents the electrical energy costs can be reduced to the dimensions of commercial requirements.

THE REDUCTION OF NITRO-COMPOUNDS.

When reduced by electrolysis, nitrobenzene and its homologues yield the same products as may be obtained by the various chemical methods of reduction. Aniline, azobenzene, azoxybenzene, hydrazobenzene, and *p*-aminophenol, as well as phenylhydroxylamine, can thus be obtained from nitrobenzene, and most, if not all, of these products could be prepared satisfactorily on an industrial scale by electrolysis, by adjusting the manner of working so that economy of energy is combined with maximum yields. Many of these products demand a comparatively high price, so that low power cost is not so important in this class of manufacture as high percentage yields.

In concentrated sulphuric acid solution, Gattermann¹ and his co-workers have shown that with platinum cathodes aminohydroxy-bodies result. With diaphragm cells in which the cathode compartment is separated from the anode, they found that all nitro-compounds in which the

¹ *Ber.*, 1893, 26, 1844, 2810; 1894, 27, 1927.

para position is unoccupied give *p*-aminophenols, the yield amounting to about 40 per cent.

It is necessary to dilute the sulphuric acid slightly or to keep the temperature low, otherwise sulphonation occurs and a *p*-aminophenol sulphonic acid results.¹ Elbs² was the first to prove that a considerable quantity of aniline is formed at the same time, and that a lead cathode increases the amount of this substance.

Gattermann subsequently proved that phenylhydroxylamine is the primary reduction product, and this was demonstrated by causing it to combine with benzaldehyde (which was present during reduction) as fast as formed, giving benzylidene-phenylhydroxylamine:—

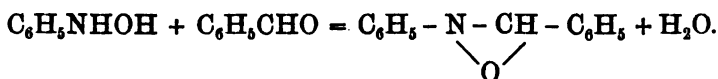

With a platinum cathode in hydrochloric acid suspension nitrobenzene gives *o*- and *p*-chloraniline, but Löb³ has shown that with a lead cathode aniline is the only product. Probably *o*- and *p*-chloraniline result from the molecular re-arrangement of the chloramine, $\text{C}_6\text{H}_5 - \text{NHCl}$, which is produced from the phenylhydroxylamine first formed. Elbs and Silberman⁴ also found that, in acid solution, lead cathodes give more aniline than platinum when reducing nitrobenzene.

This was confirmed by the reduction of the nitrotoluenes,

¹ Noyes and Clement, *Ber.*, 1893, 26, 990.

² *Zeitsch. Elektrochem.*, 1896, 2, 472.

³ *Ber.*, 1896, 29, 1894; *Zeitsch. Elektrochem.*, 1898, 4, 480.

⁴ *Ibid.*, 1896, 3, 472.

which gave a 90 per cent. yield of the corresponding amines (toluidines), by employing lead cathodes in sulphuric acid.¹ Cathodes of zinc and tin were found suitable also for producing amines from nitro-compounds, and two patents of Boehringer and Söhne² describe the use of a tin cathode, or an unattackable cathode (platinum) with the addition of a tin salt to the acid electrolyte.

Later, the same firm patented the use of powdered copper, lead, iron, chromium, and mercury, or the salts of these metals, in place of tin, and also the use of a tin cathode for reducing azo-compounds to amines.³ A considerable number of investigations were conducted about that time upon the effect of various cathodes on the reduction of nitro-compounds. Löb⁴ published results in 1901 which showed that platinum and nickel gave benzidine under similar conditions, but zinc and amalgamated zinc favoured the formation of aniline, whilst graphite gave very little benzidine. In alcohol-sulphuric acid solution mercury gave a good yield of benzidine from azobenzene, and in alkaline-alcoholic solution mercury and nickel gave good yields of azobenzene by reducing nitrobenzene, whilst in aqueous alkaline suspensions of nitrobenzene good yields of azoxybenzene were obtained with mercury and nickel cathodes.

Alkaline electrolytes give azo-, azoxy-, and hydrazo-compounds, but if a copper cathode be used and copper

¹ *Zeitsch. Elektrochem.*, 1901, 7, 589.

² D.R.P., 116942 (1899); 117007 (1900). ³ *Ibid.* 121835 (1900).

⁴ *Zeitsch. Elektrochem.*, 1901, 7, 387, 597.

powder added, amines result.¹ An alkaline suspension of the nitro-compound may be used provided the liquid is well stirred during electrolysis, and, usually, the cathode compartment is separated from the anode by a diaphragm of porous earthenware or asbestos. However, in many cases it is possible to dispense with the diaphragm, and thus diminish the resistance of the vat.

Nickel or mercury cathodes increase the amount of azoxy- or azo-body formed, but lead, zinc, copper, and tin favour the formation of azo- and hydrazo-compounds.² Addition of copper powder to the electrolyte increases amine formation.

A German patent³ covers these results by describing the use of an alkaline suspension of nitro-compound which is stirred vigorously, and oxide of zinc, tin, or lead is added to the electrolyte.

The electrode potential exerts an important influence upon the course of the reduction, but there is undoubtedly a catalytic effect as well; the latter is particularly evident with cathodes of copper or platinum. Löb⁴ and Haber⁵ consider that electrode potential is the determining factor, but Tafel⁶ emphasises the importance of the catalytic effect of the electrode material. Undoubtedly the product

¹ D.R.P. 130742 (1901).

² Löb, *Zeitsch. Elektrochem.*, 1902, 8, 778.

³ D.R.P. 121899, 121900 (1899).

⁴ *Zeitsch. physical. Chem.*, 1904, 47, 418.

⁵ *Zeitsch. Elektrochem.*, 1898, 4, 506.

⁶ *Zeitsch. anorg. Chem.*, 1902, 21, 289; *Zeitsch. Elektrochem.*, 1906, 12,

obtained during reduction depends in many cases entirely upon the electrode potential (potential difference between the cathode and the solution in which it is immersed), and the experimental work of Löb and Haber confirms this.

The catalytic effect of copper is shown in the reduction of nitrobenzene, which at a copper cathode is reduced to aniline, but while copper sponge under ordinary chemical conditions will reduce phenyl-hydroxylamine to aniline it has no effect upon nitrobenzene, and the inference is that in electrolytic reduction phenylhydroxylamine may be first formed by electrolysis, and this substance is then converted to aniline largely by the catalytic effect of the copper cathode.

Nitric acid is reduced electrolytically to hydroxylamine at a lead cathode, but at a copper cathode ammonia is the product; and since copper will not reduce nitric acid chemically to hydroxylamine but will reduce this substance itself to ammonia, it would appear that the first stage is electrolytic, and in the presence of a copper cathode the hydroxylamine is further reduced to ammonia. There is room for further investigation regarding the matter.

Some recent work by E. Newbery¹ has provided a considerable number of trustworthy overvoltage determinations which should prove valuable in choosing the proper electrode for any given reduction. By overvoltage is understood the excess back electromotive force above that of a hydrogen electrode in the same electrolyte, and this has been measured by direct comparison with a hydrogen

¹ *Trans. Chem. Soc.*, 1916, 109, 1061.

electrode. Overvoltage must be distinguished from electrode potential since the latter term refers only to the potential difference between an electrode and the solution with which it is in contact.

The reduction of nitrobenzene follows a well-defined course as shown by Haber.¹ Nitrosobenzene is first formed, then phenylhydroxylamine, and finally aniline; other products are formed by subsequent condensation. Nitrosobenzene and phenylhydroxylamine condense to azoxybenzene, which becomes reduced to hydrazobenzene:—

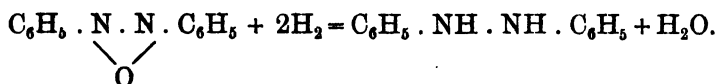
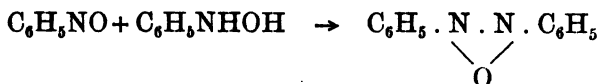

Hydrazobenzene and nitrosobenzene condense to form azobenzene:—

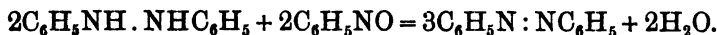

These results were confirmed by Haber and Schmidt,² who succeeded in separating phenylhydroxylamine by reducing nitrobenzene in an alcoholic solution of ammonia containing ammonium chloride.

By reduction in alcoholic-alkaline solution, Elbs and Kopp³ obtained azo- and hydrazobenzene. They employed a porous pot in which a platinum anode was immersed in a saturated solution of sodium carbonate. This

¹ *Zeitsch. Elektrochem.*, 1898, 4, 506; *Zeitsch. angew. Chem.*, 1900, 493.

² *Zeitsch. physikal. Chem.*, 1900, 32, 271, 288.

³ *Zeitsch. Elektrochem.*, 1898, 5, 108.

was surrounded by a larger vessel containing sodium acetate dissolved in 70 per cent. alcohol, and the nitro-compound. A nickel gauze cathode surrounded the porous pot, and with a current density of 10-16 amps. per dm.², a 90 per cent. yield of azobenzene was obtained. Further reduction gave hydrazobenzene, but it was found advisable to lower the current density for this stage to 2-3 amps. per dm.²

This work was extended by Elbs and his pupils,¹ and the processes were protected by patents.² Subsequently alcohol was dispensed with and aqueous caustic soda employed.³ For example, an emulsion of nitrobenzene in 10 per cent. aqueous sodium hydroxide may be reduced with a cathode of lead or nickel in a porous earthenware cell, with a current density of 10-12 amps. per dm.² An anode of graphite or lead may be employed in an outer containing vessel filled with sodium hydroxide solution or sodium sulphate. Azo- or hydrazobenzene is obtained according to the quantity of electricity passed through, and the azobenzene emulsion can be transformed into benzidine by acidifying the cathode liquor and completing the reduction.⁴

According to another patent⁵ the diaphragm is not essential, and the alkaline emulsion of nitro-compound can

¹ *Zeitsch. Elektrochem.*, 1898, 5, 118; 1900, 7, 133, 141, 335; 1902, 8, 789.

² D.R.P. 100233, 100234 (1898).

³ *Ibid.* 116467, 116942 (1899); 121900 (1900); 130742 (1901).

⁴ *Zeitsch. Elektrochem.*, 1900, 7, 320, 333, 597.

⁵ D.R.P. 141535 (1903); Eng. Pat. 15750 (1915).

be reduced in an iron vessel which serves as cathode. The liquor is vigorously stirred by a small iron anode, and since the working temperature is 105-115° C. the containing vessel is closed with a lid into which a reflux condenser is fitted. Small amounts of azoxy- and hydrazobenzene are found in the resulting azobenzene.

Aminophenols which were formerly obtained only by the reduction of nitro-compounds in concentrated sulphuric acid can now be prepared by reducing dilute acid suspensions of nitro-compounds, provided the mixture be well stirred and the cathode surfaces made up of two or more metals. This improved process, which it is claimed gives good yields of amino-hydroxy bodies, is due to the Society of Chemical Industry, Basle.¹ When an indifferent cathode is employed, the addition of certain metals in the form of salts or finely powdered metal to the electrolyte increases the yield of amine at the expense of amino-hydroxy compound; such are copper, iron, or lead if added separately. If, however, two at least of these and other metals be added, reduction to aminophenol is favoured.

For example, a lead cathode reduces nitrobenzene mainly to aniline in dilute sulphuric acid, so that the proportion of aniline to aminophenol is 3 : 2, but if some powdered bismuth be added to the cathode chamber, the ratio of aminophenol to aniline becomes 5 : 1. The following combinations or alloys have been found suitable: copper-mercury, lead-arsenic, copper-tin-arsenic.

In one particular case a lead cylindrical vessel was

¹ Eng. Pat. 18081 (1915).

employed as anode, and in this was a porous pot which contained a perforated cylindrical copper cathode and a suitable stirrer. Into the cathode chamber one or more rods of lead extended. The anode liquid was 30 per cent. sulphuric acid and the cathode mixture was composed of 25 litres sulphuric acid (15° B.) and 6 kgs. of nitro-benzene. The working temperature was 80-95° C. and a current density of 3 amps. per dm.² was employed at a pressure of 3.5 volts.

The aniline formed simultaneously can be removed by adding lime, and steam-distilling the mixture. After filtering calcium sulphate from the residue, crystals of aminophenol can be obtained by evaporation. The average yield is reported to be 50 per cent. of the nitrobenzene used.

In conclusion, the following reductions should be noticed: Primary and secondary hydrazines can be formed satisfactorily by reduction of nitroamines.¹

Boehringer and Söhne employ cathodes of tin, or copper coated with tin, for reducing nitro-guanidine to amino-guanidine.²

The reduction of nitro-derivatives of naphthalene, anthracene, and phenanthrene has been investigated by J. Möller.³

Oximes can be reduced to amines⁴ in 50 per cent.

¹ N. J. Becker, *Rec. Trav. Chim.*, 1912, **31**, 1, 142; 1918, **32**, 89.

² D.R.P. 167687 (1912).

³ *Zeitsch. Elektrochem.*, 1901, **7**, 741, 797; *Elektrochem. Zeitsch.*, 1904, **10**, 199, 222.

⁴ D.R.P. 141846 (1908).

sulphuric acid solution, at temperatures below 20° C., with a cathode current density of 16 amps. per dm.²

Aliphatic amines are obtained by reducing aldehyde-ammonia compounds in neutral or ammoniacal solution, or the aldehyde mixed with ammonia or ammonium salts can be electrolysed directly.¹

REDUCTION OF COMPOUNDS CONTAINING THE CARBONYL GROUP.

Ketones are converted by electrolytic reduction into secondary alcohols or pinacones.² A mercury cathode gives a good yield of the former class, but other cathodes give a mixture³ of the two compounds.

Tafel⁴ has shown the value of a mercury cathode for obtaining a good yield of secondary alcohol in a dilute sulphuric acid electrolyte (40 per cent.).

Camphor which contains the carbonyl group gives the secondary alcohol borneol, on reduction.

Reduction of compounds of the uric acid group which contain a carbonyl group results in the conversion of >CO into >CH_2 . Caffeine,⁵ for example, is reduced to deoxycaffeine in 50 per cent. sulphuric acid, and succinimide⁶ is reduced under similar conditions to pyrrolidine. Whilst lead cathodes are satisfactory for reducing succinimide, mercury cathodes reduce caffeine more efficiently.

¹ D.R.P. 148054 (1904).

² Merck, D.R.P. 118719 (1899).

³ *Zeitsch. Elektrochem.*, 1902, 8, 788.

⁴ *Ibid.* 288.

⁵ *Ber.*, 1899, 32, 686.

⁶ *Zeitsch. Physikal. Chem.*, 1905, 50, 718; 1906, 54, 483.

Acetanilide and its homologues undergo intra-molecular rearrangement when reduced, and the corresponding amines are formed :—¹

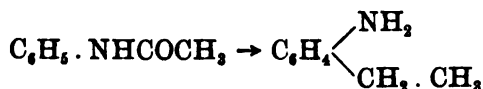

In the reduction of pyridine and quinoline compounds, hydrogenation generally occurs.²

An interesting application of electrolytic reduction to vat-dyeing is the process of the Farbwerke vorm. Meister Lucius and Brüning, in which alkali sulphite is electrolytically reduced in the presence of indigo. In an acid solution, indigo white is precipitated.³

p-Rosaniline⁴ can be obtained by the electrolytic reduction of *p*-nitrodiaminotriphenylmethane.

When nitro-group and keto-group are both present in the compound to be reduced, the former is preferably attacked so that azo-, azoxy-, or amino-keto compounds⁵ result.

¹ *Ber.*, 1899, 32, 68.

² D.R.P. 104664 (1898); *Zeitsch. Elektrochem.*, 1898, 2, 580.

³ D.R.P., 189567 (1902).

⁴ *Ibid.* 84607 (1894).

⁵ Elbs and Wogrinz, *Zeitsch. Elektrochem.*, 1908, 9, 428.

CHAPTER VII.

OXIDATION AND SUBSTITUTION OF ORGANIC COMPOUNDS.

ALTHOUGH many substances have been produced by oxidation methods: anthraquinone, vanillin, saccharin; oxidation is not so easily graduated as the reduction processes. The overvoltage of oxygen is relatively high at most anodes, and frequently the compound to be oxidised is decomposed during treatment and carbon dioxide formed.

Generally, conditions can be devised for oxidising alcohols to aldehydes and to acids, and the substituent side chains of aromatic compounds can be converted into aldehyde (CHO) or carboxyl (COOH) groups.

For example *o*-cresol yields salicylic acid:—¹

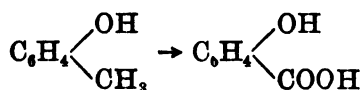

A good yield of *p*-nitrobenzoic acid ² is obtained from *p*-nitrotoluene if a lead peroxide anode be employed in a mixture of sulphuric and acetic acids. Investigations upon the oxidation of aromatic side-chains have been conducted by Smith ³ and also by Law and Perkin.⁴

¹ Eng. Pat. 103709 (1917).

² D.R.P. 117129 (1900).

³ *J. Amer. Chem. Soc.*, 1900, 22, 723.

⁴ *Trans. Farad. Soc.*, 1904, 1, 1; 1905, 1, 251.

Further examples of successful oxidation by electrolysis may be indicated by reference to the following patents:—

Aniline and hydroquinone can be oxidised to quinone,¹ and the addition of a manganese salt to the electrolyte accelerates the oxidation.

Basic dyes are formed by the oxidation of homologues of triamino-triphenylmethane.²

The oxidation of pyrogallol in a sodium sulphate electrolyte yields purpurogallin.³

Addition of cerium salts accelerates the electrolytic oxidation of anthracene, naphthalene, and phenanthrene, which yield the corresponding quinones.⁴ The hydrocarbons may be in solution or in the form of a finely divided suspension. Anthracene, for example, is oxidised to ANTHRAQUINONE in 20 per cent. sulphuric acid; anode current density is about 5 amps. per dm.², and by the addition of 2 per cent. of cerium sulphate the current efficiency⁵ is stated to reach nearly 100 per cent.

The revival of "spent" chromic acid is closely connected with these oxidations, since it has been the practice, for some time, to regenerate the chromic acid after use by electrolysis⁶:—

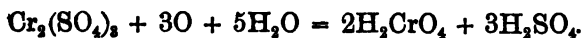

For this oxidation the "spent liquors," consisting of sulphates of potassium and chromium and also free sulphuric

¹ D.R.P. 117129 (1900).

² *Ibid.* 100556 (1897).

³ *Trans. Chem. Soc.*, 1904, 85, 243.

⁴ D.R.P. 152063 (1904).

⁵ *Electrochem. Ind.*, 1904, 2, 249.

⁶ D.R.P. 103860 (1899); *Zeitsch. Elektrochem.*, 1900, 6, 290, 308.

acid, are run into the cathode compartment of the electrolytic cell. Here they serve as cathode electrolyte, whilst the previous liquors are oxidised in the anode compartment with a lead anode. At the lead cathode which is separated from the anode by a porous diaphragm, hydrogen gas is discharged, and the acidity of the liquor is diminished whilst that of the anode liquor becomes increased. The amount of Cr_2O_3 present is generally about 100 grams per litre and the sulphuric acid content about 300 grams per litre. A current density of 3 amps. per dm^2 is employed and the temperature is maintained at $45\text{--}60^\circ\text{C}$.

Müller and Soller¹ have shown that the anode surface, which is actually lead peroxide, acts as a catalyst in accelerating the oxidation.

Naphthalene by similar treatment gives at first naphthoquinone, but further oxidation yields phthalic acid. Phenanthraquinone similarly passes to diphenic acid and benzoic acid.

Vanadium² compounds may be employed as catalysts in oxidation and reduction processes. For example, anthracene is oxidised to anthraquinone with a lead anode in 20 per cent. sulphuric acid which contains 3 per cent. of vanadic acid. Aniline under similar conditions may be oxidised to benzoquinone, and the latter substance can be efficiently reduced to hydroquinone. Azobenzene and azoxybenzene are stated to give a good yield of benzidine

¹ *Zeitsch. Elektrochem.*, 1905, 11, 868; 1913, 19, 344.

² D.R.P. 172654 (1906).

in 20 per cent. sulphuric acid in the presence of vanadic acid.

VANILLIN¹ can be formed by electrolytic oxidation of the sodium salt of *iso*-eugenol. According to the process of F. von Heyden Nchfg. a 15 per cent. alkaline solution of the sodium salt forms the anolyte, and the cathode compartment is filled with caustic soda solution (10-20 per cent.). The temperature is maintained at 60° C., and the lead peroxide anode evidently acts as a catalyst, since with platinum the discharged oxygen is evolved without effecting the oxidation :—

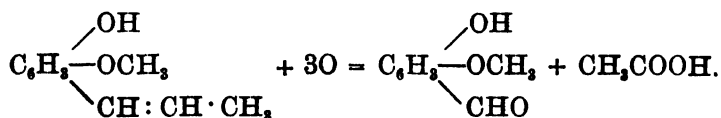

SACCHARIN² can be produced by the electrolytic oxidation of *o*-toluenesulphonamide.

ELECTROLYTIC OXIDATION OF ALCOHOLS.

Methyl alcohol can be oxidised under certain conditions to formaldehyde with a yield of 80 per cent. Elbs and Brunner³ employed 160 grams of methyl alcohol and 75 grams of sulphuric acid per litre. A smooth platinum anode with a current density of 3.75 amps. per dm.² gave good results at 30° C., whilst anodes of platinised platinum or lead peroxide gave a low yield of formaldehyde and much carbon dioxide.

Ethyl alcohol in dilute sulphuric acid gives small amounts

¹ D.R.P. 92007 (1895); *Electrochem. Review*, 1900, 1, 31.

² D.R.P. 85491 (1895).

³ *Zeitsch. Elektrochem.*, 1900, 6, 604.

of acetaldehyde and acetic acid, whilst in alkaline solution aldehyde resin is formed. If platinised platinum anodes are used, a high yield of acetaldehyde is obtained, whilst at bright platinum, only acetic acid results.

Propyl alcohol¹ shows a somewhat greater resistance to oxidation. Propionic acid is the chief product, and a good yield is obtained at platinum or lead peroxide anodes in sulphuric acid. *Iso*-propyl alcohol which is more easily oxidised gives a 70 per cent. yield of acetone.

Iso-amyl alcohol is oxidised to *iso*-valeric acid, and glycol² gives glycollic acid, trioxymethylene, and a sugar-like substance.

Glycerol³ gives both glyceric aldehyde and trioxymethylene in sulphuric acid with carbon and platinum anodes, but in alkaline solution acrolein and acrylic acid are formed.

Mannitol on oxidation gives oxalic acid, trioxymethylene, and a sugar-like substance.

A process was devised some years ago by M. Moest⁴ for producing alcohol from fatty acids, and by subsequent oxidation the corresponding aldehydes or ketones. For example, an organic acid in the presence of an inorganic acid gives, as chief product, an alcohol containing one carbon atom less than the organic acid. In the presence of sodium chlorate, Moest obtained a yield of 34 per cent. methyl alcohol from sodium acetate, with a current density of 5-20 amps. per dm.², whilst with a current density of

¹ *Zeitsch. Elektrochem.*, 1900, 6, 608.

² *Compt. rend.*, 1876, 82, 562.

³ *Amer. Chem. J.*, 1898, 15, 656.

⁴ D.R.P. 138442 (1908).

20-30 amps. he obtained 40 per cent. of methyl alcohol. Other fatty acids were found to give similar results.

ELECTROLYTIC SUBSTITUTION OF ORGANIC COMPOUNDS.

Substitution by chlorine, bromine, and iodine has received much attention. The most successful industrial application is presented by IODOFORM.

In the older chemical process in which alcohol reacts with iodine in the presence of sodium carbonate, only about 30 per cent. of the iodine is converted into iodoform :—

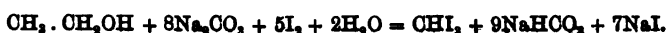

By electrolysing a solution containing 50 parts of sodium carbonate, 170 parts of potassium iodide, and 100 parts of 96 per cent. alcohol, with a smooth platinum anode, practically all the iodine is generally used in producing iodoform :—¹

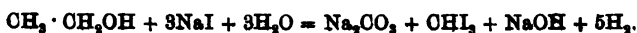

The cathode should be of lead, and encased in parchment to prevent cathode hydrogen from destroying the product.² The temperature should be 60-70° C. and anode current density 1-2 amps. per dm.² with a voltage of 2-2.5 volts. The iodoform is produced at the rate of 500 grams per kilowatt-hour (1.8 grams per amp.-hour) and the current efficiency is about 90 per cent.

The conditions necessary when employing acetone instead of alcohol have been given by H. Abbot.³

¹ D.R.P. 29771 (1884); Eng. Pat. 8748 (1884).

² *Zeitsch. Elektrochem.*, 1899, 3, 268.

³ *J. Physical Chem.*, 1908, 84.

Bromoform¹ is obtained in a similar manner if alkali bromide be employed in the presence of alcohol or acetone. Chloroform is produced by employing alkali chloride with acetone. Schering's² patent in this connection has been worked through and confirmed by Teeple.³ Chloral is produced if alcohol is used in the presence of alkali chloride.⁴

The production of AZO-DYES by electrolysing an anode liquor containing amine, nitrite, and phenol or naphthol was worked out by Löb.⁵

The nitrous acid liberated at the anode reacts with the amine to form a diazonium compound, and this immediately condenses with the phenolic substance which is present to produce the azo-dye. Cooling is desirable though not so important as in the ordinary chemical method, since the diazonium compound couples with the phenol immediately it is formed; but a diaphragm must be used to separate anode from cathode. Orange II., Congo red, dianisidine blue, and many other colours have been formed in this way.

Aromatic compounds in the presence of alkali halides or solutions of halogen acids are usually substituted when subjected to electrolysis. Phenols are readily substituted, and several antiseptics have been obtained in this manner. From thymol in alkali solution, and in the presence of

¹ *Amer. Chem. Journ.*, 1902, 27, 68; *Trans. Amer. Elektrochem.*, 1905, 8, 281.

² D.R.P. 29771 (1884).

³ *J. Amer. Chem. Soc.*, 1904, 26, 536.

⁴ *Elektrochem. Zeitsch.*, 1894, 1, 70.

⁵ *Zeitsch. Elektrochem.*, 1904, 10, 287.

potassium iodide, the substitution compound dithymol-diiodide (aristol) ¹ is formed. This method has also been employed for obtaining eosin and other halogen derivatives of the fluorescein group. ² Good yields of excellent quality, it is claimed, can be obtained.

CONDENSATION BY ELECTROLYSIS.

Many years ago, Brown and Walker ³ found that by electrolysis of mono-esters of dibasic acids, carbon dioxide was removed, and the residues condensed to form a dibasic ester of higher molecular weight.

For example, ethyl potassium malonate reacts in the following manner, giving diethylsuccinic ester:—

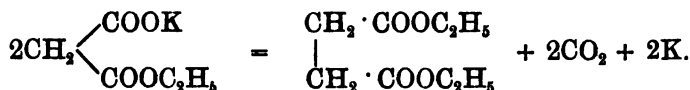

The method has been expanded by Mulliken and Weems, ⁴ and also by von Miller and Hofer. ⁵

The principle has been applied to the preparation of aromatic compounds from the carboxylic acid copper salts. ⁶ The disappearance of the blue colour of the copper salt indicates the completion of the reaction. Ethylene diamine is produced from the copper salt of glycine:—



¹ D.R.P. 64405 (1891).

² *Ibid.* 108838 (1899).

³ *Annalen*, 1891, 261, 107; 1893, 274, 41.

⁴ *Amer. Chem. Journ.*, 1893, 15, 323; 1894, 16, 569.

⁵ *Ber.*, 1895, 28, 2427, 3438.

⁶ D.R.P. 147943 (1904).

In a similar manner the copper salt of *p*-amino-benzoic acid gives benzidine:—

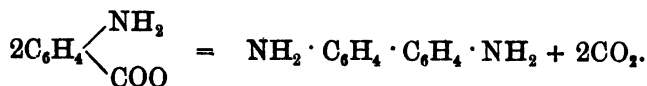

ELECTROLYSIS WITH ALTERNATING CURRENT.

Electrolytic oxidation may be moderated by superimposing alternating current upon direct current. O. Reitlinger¹ has shown that alternating current diminishes the overvoltage at the anode during electrolysis, and it is thus possible to prepare oxidation products which are not easily obtained by direct current only. Ethyl and propyl alcohols give aldehydes, whereas when oxidised with continuous current only, the principal product is the corresponding acid.

From toluene suspended in dilute sulphuric acid (density 1.22) it is possible to obtain benzaldehyde and benzoic acid if A.C. be superimposed upon D.C., whereas with D.C. only, the toluene is completely oxidised to carbon dioxide and water. Similarly *p*-benzaldehyde sulphonic acid is obtained from toluene sulphonic acid.

By the same method sulphuric acid may be made to yield a considerable quantity of ozone, whilst ammonia may be oxidised to nitrous acid (40 per cent. yield) without the formation of nitric acid.

These investigations indicate that we have here a valuable means of controlling oxidation processes.

¹ *Zeitsch. Elektrochem.*, 1914, 20, 261.

APPENDIX.

ELECTRICAL UNITS.

Ampere = A current carrying 1 coulomb per second.

Coulomb = A quantity of electricity which will deposit 0.001118 gram of silver from a specified solution of silver nitrate.

$$\begin{aligned}\text{Quantity} &= \text{current} \times \text{time} \\ &= I \times T.\end{aligned}$$

Faraday = 96,500 coulombs.

Gram-calorie = A unit of energy = 4.189 joules.

Horse-power = A unit of power = 746 watts.

Joule = A unit of energy = 1 watt-second
= 0.239 gram-calorie.

$$\text{Joules} = \text{volts} \times \text{coulombs}.$$

Kilowatt-hour (K.W.H.) = A unit of energy = 1000 watt-hours.

= Work done in 1 hour when the power in the circuit is 1 kilowatt.

Ohm = The unit of resistance. The resistance of a column of mercury 106.3 cms. long, cross-section 1 mm² and weight 14.452 grams at 0° C.

Ohm's Law is stated thus: $I = E/R$ where I = current strength

E = pressure in volts, R = resistance in ohms.

Volt = A unit of pressure or potential.

= The pressure necessary to send a current of 1 ampere through a resistance of 1 ohm.

Watt = A unit of power = The rate at which energy is expended when an unvarying current of 1 ampere flows under a pressure of 1 volt.

Watts = amperes \times volts.

1000 Watts = 1 kilowatt.

INDEX OF AUTHORS AND NAMES OF FIRMS.

ARCHIBALD & Wartenburg, 16.
Askenasy, 27.

BACKER, 62.
Bancroft, 52.
Boehringer & Söhne, 33, 56, 62.
Briggs, 52.
Browne, 44.
Brown & Walker, 72.
Brunner, 68.
Burgess & Hambuechen, 44.
Byers & Walter, 52.

COHEN, 52.
Consortium für Elektrochemie, 20.
Constam, 22.

D'ARSONVAL, 4.
Dary, G., 30.
Del Proposto, 10.
Dennis, 46.

EASTON, 34.
Elbs, 17, 18, 36, 55.
Engels, 48.

FARADAY, 2.
Farbwerke vorm. Meister, Lucius
und Brüning, 64.
Friedberger, 18.

GARDNER, 43.
Garuti, 10.
Gattermann, 54.
Gesellschaft für Elektro-Osmose, 49.
Griesheim Elektron Co., 26.

HABER, 57, 59.
Hansen, 22.
Hayek von, 28.
Hazard-Flamand, 14.

INTERNATIONAL Oxygen Co., 14.
Isenberg, 45.

JELLINEK, 36.

KREMMANN, 47.

LATCHINOFF, 4.
Law, 65.
Le Blanc, 43.
Leriche, 46.
Levi, 19.
Lewis, 51.
Löb, 53, 55, 57, 71.
Lorenz, 27, 40.
Luckow, 42.

MARSHALL, 17, 18.
Moest, 69.
Moissan, 37.
Möller, 62.
Müller, 18, 19, 29, 34, 67.

NATIONAL Oxy-hydric Co., 15.
Newbery, 58.
Nodon, 30.
Noyes & Clement, 55.

PERKIN, F. M., 46, 65.
Pompili, 10.
Pouleno Frères, 38.
Pritchett, 38.

REITLINGER, 73.
Renard, 5.

SALEBERGWERKE, 26.
Schering, 25.
Schmidt, 5.
Schönherr, 18.
Schoop, 8.
Schuckert, 18.
Smith, 65.

78 THE MANUFACTURE OF CHEMICALS BY ELECTROLYSIS

Société l'Oxyhydrique, 12.
Society of Chemical Industry,
Basle, 61.

TAFEL, 82, 83, 57, 63.
Thompson, 23.

VAREILLE, 15.

WINSINGER, 12.
Wolterock, 44.

SUBJECT INDEX.

- ACETANILIDE**, reduction of, 64.
 Alcohols, oxidation of, 68.
 Aldehydes, formation of, 68, 69.
 Alloys, pyrophoric, 47.
 Alternating current, use of, 16, 73.
 Alumina, purification of, 51.
 Aminophenols, formation of, 54, 61.
 Ammonium persulphate, 19, 21.
 Aniline, formation of, 55, 61.
 Anthracene, oxidation of, 66.
 Anthraquinone, 67.
 Aromatic side chain, oxidation of, 65.
 Azo-compounds, formation of, 56, 59, 60.
 Azo-dyes, production of, 71.
 Azoxy-compounds, production of, 59.

BENZIDINE, formation of, 56, 60.
 Bromoform, formation of, 71.
 Browne process for white lead, 44.

CADMIUM sulphide, formation of, 42.
 Carbonyl group, reduction of, 68.
 Catalytic electrodes, 57, 67.
 Chloral, formation of, 71.
 Chloranilines, formation of, 55.
 Chloroform, formation of, 71.
 Chrome yellow, precipitation of, 49.
 Chromic acid, regeneration of, 66.
 Condensation by electrolysis, 72.
 Current concentration, 86.

DECOMPOSITION voltage, 2.
 Dehydration by electro-osmosis, 50.
 Deoxycaffeine, formation of, 68.
 Dibasic esters, formation of, 72.
 Diazotisation by electrolysis, 71.

ELECTRO-CAPILLARY processes, 51.
 Electrodes of alloy, 27, 61.
 Electrode potential, 57, 59.
 Electro-osmosis, 49, 52.

FILTER-press cells for electrolysis of water, 5, 15.
 Fluorine, production of, 37.
 Formaldehyde, production of, 68.

GARDNER process for white lead, 43.
 Garuti cell for electrolysis of water, 10.
 Glue, separation of constituents of, 50.
 Glycerol, oxidation of, 69.
 Glycol, oxidation of, 69.

HYDRAZINES, formation of, 62.
 Hydrazo-compounds, formation of, 59, 60.
 Hydrogen, electrolytic production of, 2.
 Hydrogen peroxide, 21.
 Hydrosulphite, formation of, 35.
 Hydroxylamine, formation of, 32.

INDIGO, reduction of, 64.
 Iodoform, production of, 70.

LANTHANUM, separation of, 46.
 Lead chromate, 43.
 — peroxide, 43.
 — sulphate, 43.

MANGANESE salts, use of, in oxidation, 66.
 Mannitol, oxidation of, 69.
 Methyl alcohol, oxidation of, 68.
 Misch metall, preparation of, 47.

NAPHTHALENE, oxidation of, 67.
 Nitric acid from peat, production of, 30.
 Nitrites, formation of, 34.
 Nitrobenzene, reduction of, 54.
 Nitro-compounds, reduction of, 54.
 Nodon's process for making nitric acid, 30.

- OVERVOLTAGE**, 58, 65.
Oxygen, electrolytic production of, 2.
Ozone, production of, 15.
- PEAT**, dehydration of, 50.
 — nitric acid from, 30.
Perborates, formation of, 23.
Percarbonates, formation of, 22.
Permanganates, formation of, 25.
Persulphuric acid, formation of, 17.
Phenanthrene, oxidation of, 66.
Potassium ferriocyanide, 28.
 — percarbonate, preparation of, 22.
 — permanganate, preparation of, 25.
 — persulphate, preparation of, 19.
Power utilised in electrolysis of water, 8.
Pyridine, reduction of, 64.
Pyrophoric alloys, deposition of, 47.
- QUINOLINE**, reduction of, 64.
Quinone, formation of, 66, 67.
- RARE earth oxides**, separation of, 46.
p-Rosaniline, formation of, 64.
- SACCHARIN**, formation of, 68.
Schmidt cell for electrolysis of water, 5.
Schoop cell for electrolysis of water, 8.
Schuckert cell for electrolysis of water, 18.
Silicic acid, purification of, 51.
Sodium hydrosulphite, production of, 35.
 — perborate, production of, 23.
 — selenate, formation of, 29.
Sugar liquors, purification of, 50.
Sulphides, preparation of, 42.
Sulphuric acid, preparation of, 28.
TANNING of skins by electro-osmosis, 50.
Toluidines, formation of, 56.
Triphenylmethane dyes, 66.
Tungsten bronze, formation of, 48.
- VANADIUM**, catalytic use of, 67.
Vanillin, preparation of, 68.
- WATER**, electrolysis of, 2.
White lead, production of, 43.
- ZINC white**, production of, 46.

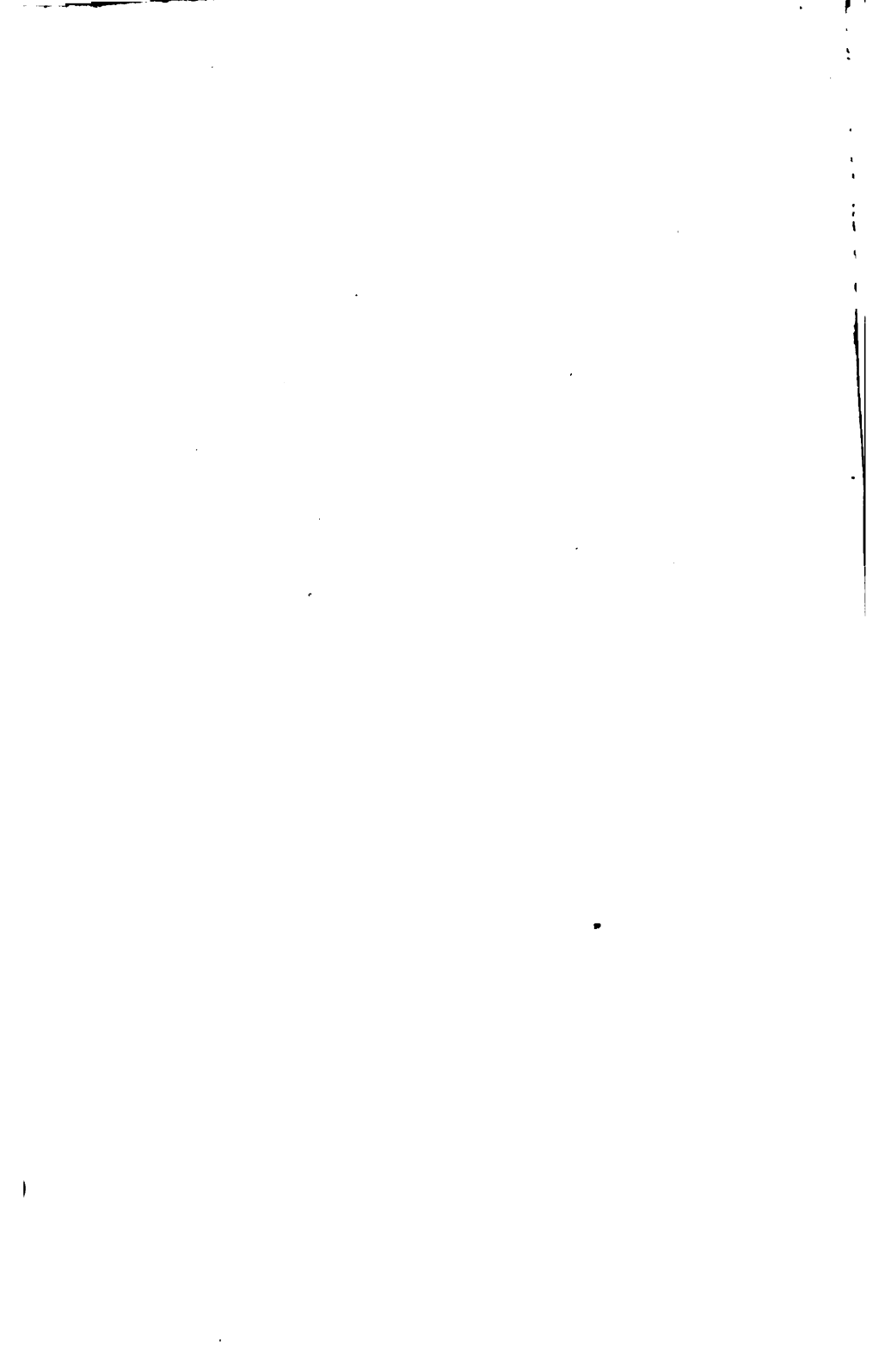

THIS BOOK IS DUE ON THE LAST DATE
STAMPED BELOW

AN INITIAL FINE OF 25 CENTS
WILL BE ASSESSED FOR FAILURE TO RETURN
THIS BOOK ON THE DATE DUE. THE PENALTY
WILL INCREASE TO 50 CENTS ON THE FOURTH
DAY AND TO \$1.00 ON THE SEVENTH DAY
OVERDUE.

330

NOV 8 1934

MAR 9 1937

AUG 13 1944

SEP 24 1947

3 Jun '51 PM
20 May '51 LU

5 '55 WM
M 9 1955 LU

13 Mar '57 BR

FEB 24 1957

LD 21-100m-7,'83

YC 18397

434857

TP205

H3

UNIVERSITY OF CALIFORNIA LIBRARY

